

MAPPIN BROTHERS, CUTLERS AND ELECTRO-SILVER PLATERS.

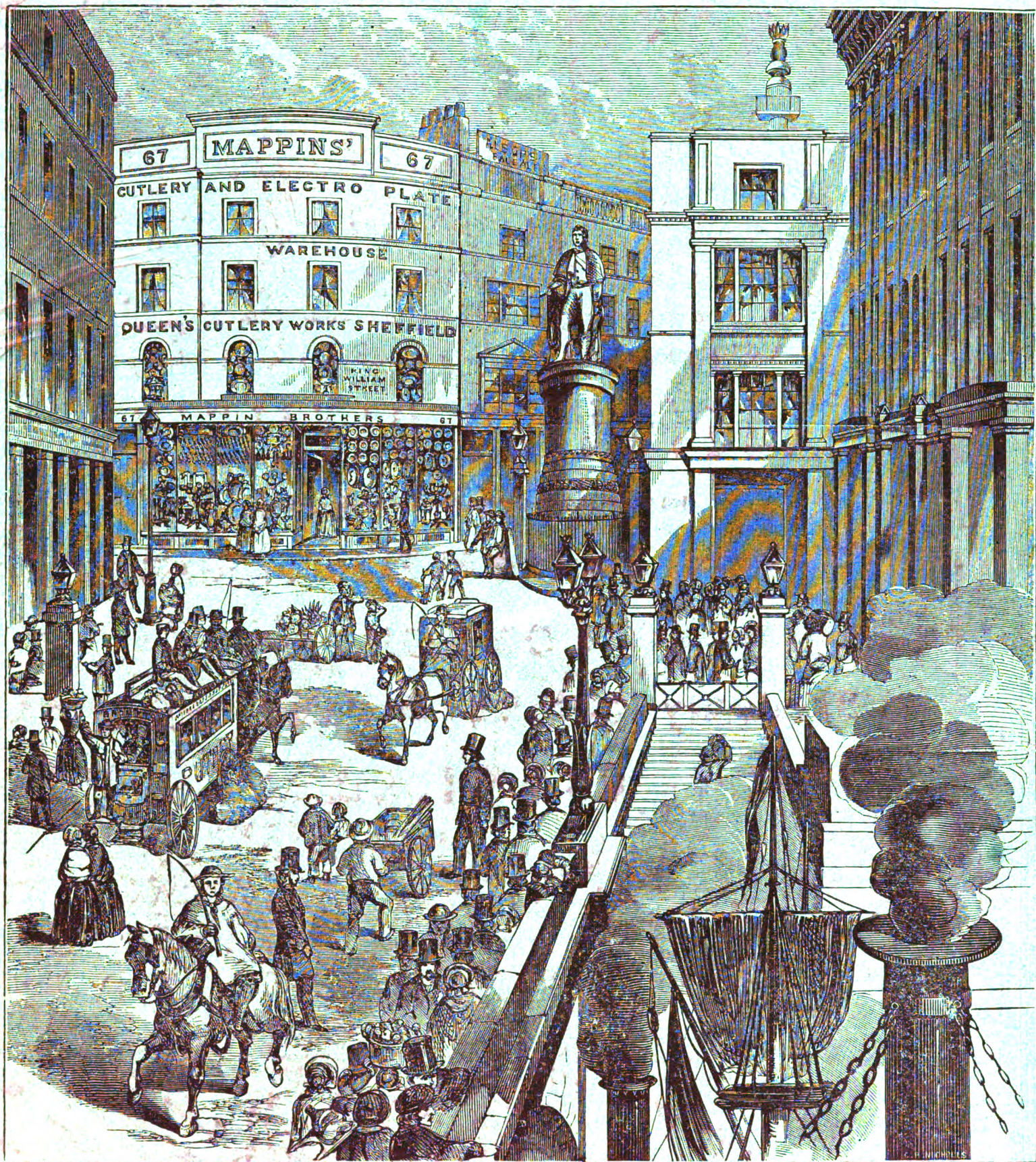

LONDON ESTABLISHMENT—

67 & 68, KING WILLIAM STREET, CITY,

Where the Largest Stock in the World is kept.

MAPPIN BROTHERS, CUTLERS AND ELECTRO-SILVER PLATERS.

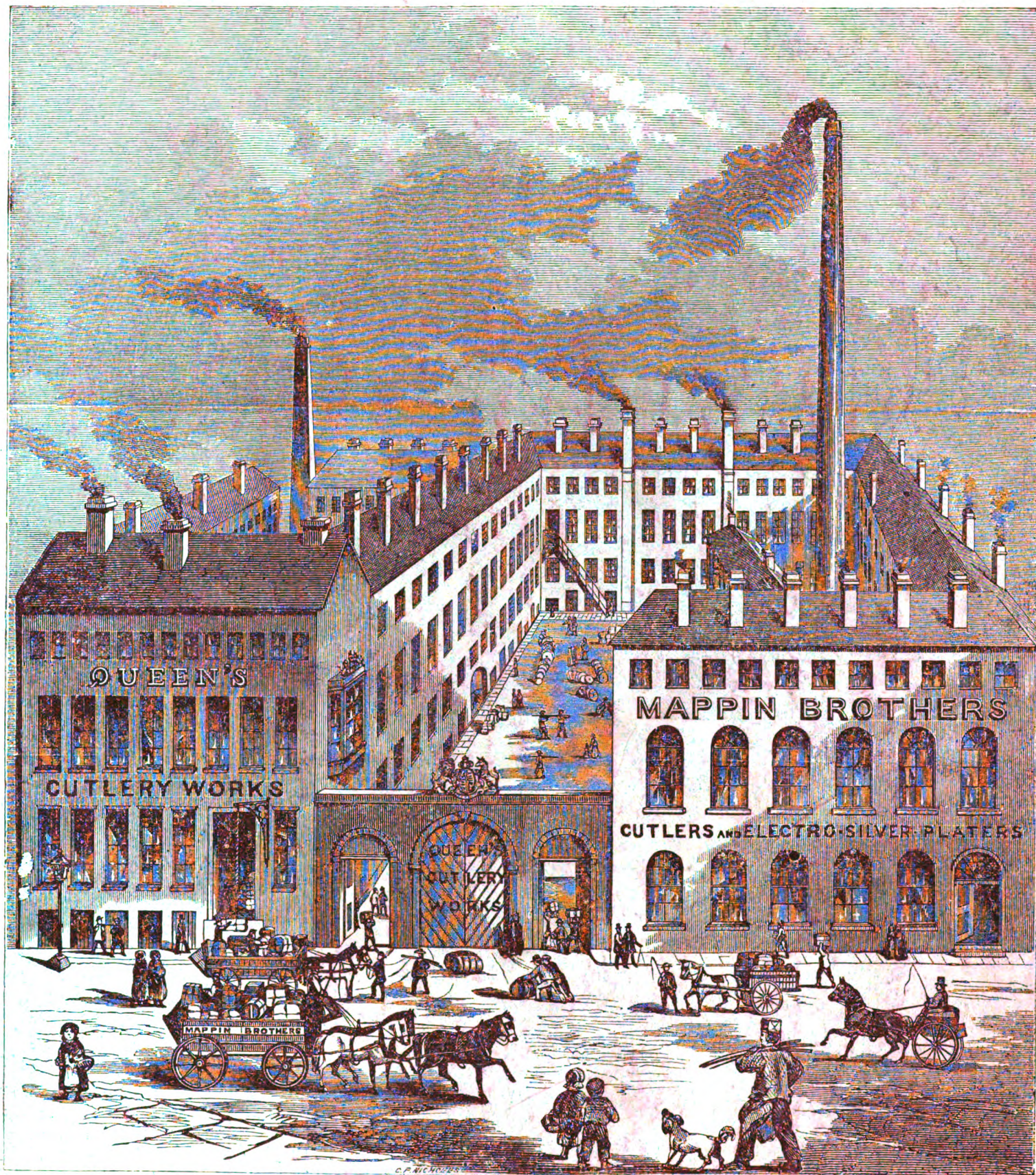

MANUFACTORY—

QUEEN'S CUTLERY WORKS, SHEFFIELD.

MAPPIN BROTHERS,

MANUFACTURERS OF CUTLERY,

AND

ELECTRO-SILVER PLATE.

ESTABLISHED IN SHEFFIELD, A.D. 1825.

MESSRS. MAPPIN BROTHERS, having transmitted the Largest Stock of Cutlery and Electro-Silver Plate in the World from their Manufactory, QUEEN'S CUTLERY WORKS, SHEFFIELD, to their Warehouse, 67 and 68, KING WILLIAM STREET, LONDON BRIDGE, (which premises have been rebuilt for this unprecedented display) respectfully invite buyers to inspect their extensive assortment, which is received direct from their Manufactory in Sheffield.

The limits of a Catalogue being necessarily very small, MESSRS. MAPPIN have only illustrated a moiety of the Goods they manufacture, new designs are continually being added; any advance or reduction in price taking place hereafter, MESSRS. MAPPIN will charge the Goods accordingly.

CONTENTS.

Cutlery :—	PAGE	Electro-Silver Plate:—	PAGE
COOKS AND BUTCHERS' KNIVES	23	FISH CARVERS, in Cases	27, 28
DESSERT KNIVES AND FORKS	29, 30	„ EATING KNIVES	31
DIRK AND HUNTING KNIVES	13	FLOWER STANDS AND VASES	35, 37, 46
FISH CARVERS, in Cases	27, 28	FORKS AND SPOONS	32
„ EATING KNIVES	31	GRAPE SCISSORS	42
POCKET KNIVES	1 to 9	HASH DISH	49
PRUNING AND BUDDING KNIVES	10	INKSTAND	47
RAZORS	21*, 22	KNIFE RESTS	42
SCISSORS	14 to 20, 42	LIQUEUR STANDS	34, 35, 36
„ in Cases	21	„ FRAMES	39, 40, 50
SPORTSMEN'S KNIVES, ETC.	11, 12	MUSTARD POTS	43, 45
TABLE KNIVES, ETC.	24, 25, 26	NUTCRACKERS	42
Dressing and Toilette Cases :—		PEPPER CASTOR	43
GENTLEMEN'S	54, 55, 57 to 73	PICKLE STANDS	37
LADIES'	53, 57, 59, 61, 64 to 67, 69 to 71	SALT CELLARS	45, 49
SOLID WOOD	73	SIDE AND CURRY DISHES	43, 45, 49
“TIEN TOUT” Tourists' Dressing Case	73	SOUP TUREENS	43
Dressing and Travelling Bags:—		SOY FRAMES	36
GENTLEMEN'S	72	SPOONS AND FORKS	32
LADIES'	72	SUGAR BASKETS	33, 35, 46
“SAC DE NUIT”	73	TEA AND COFFEE SETS	39, 40, 41, 48, 52
Electro-Silver Plate:—		„ POTS	47
ASPARAGUS TONGS	42	„ KETTLES	41, 48
BOTTLE OR DECANTER STANDS	43, 45	„ TRAY	44
BUTTER COOLERS	33, 35, 44, 47	TOAST RACKS	34
CAKE BASKETS	44, 46	VEGETABLE DISH	49
CANDELABRA	37	WAITERS AND SALVERS	35, 38, 46, 47
CANDLESTICKS: Table	35, 36	WINE STRAINER	45
„ „ with Glass Shades	38	Miscellaneous Articles:—	
„ Piano	36	DESPATCH BOXES	73
„ Taper	37	WRITING CASES AND PORTFOLIOS	73
„ Chamber	38	„ DESKS	73
„ „ with Glass Shades	38	„ AND DRESSING CASE “COM- BINATION”	73
CIGAR LAMP	47	LADIES' INSTRUMENT CASES	53, 73
CLARET JUGS	49	„ JEWEL CASES	73
COMMUNION SERVICE	47	„ WORK BOXES	73
CRUET FRAMES	33, 36, 42, 51	SCISSORS CASES AND NEEDLE CASES	21
CUPS OR TANKARDS	38	SCENT AND PERFUME CASES	73
DESSERT KNIVES AND FORKS	29, 30	LUNCHEON, “CRIMEA” OR PICNIC, REFRESHMENT, AND SPIRIT CASES	56, 73
DISH COVERS	43, 49		
EGG FRAMES	33, 44		



MAPPIN BROTHERS,
MANUFACTORY, QUEEN'S CUTLERY WORKS, SHEFFIELD,
WAREHOUSE, 67 & 68, KING WILLIAM STREET, LONDON.

PRICES OF MAPPINS' VERY SUPERIOR POCKET KNIVES.

For Drawings, see corresponding numbers on Plate.

		per doz.	
		s.	d.
5829	Stag Handle, 1 Blade Penknife, Polished	8	0
5882	Buffalo do. do. German Silver Shoulder, Polished	12	0
5881	Stag do. do. do. same pattern as 5882	12	6
8940	Buffalo do. same pattern as 5882, but with 2 Blades	22	0
7700	Stag do. 1 Blade Penknife, and Shield	12	0
8897½	Do. do. same pattern as 7700, but with 2 Blades	20	0
8897	Do. do. do. do. do. no Shield	18	6
8896	Ivory do. do. do. do. do. do.	17	0
05453	Stag do. 1 Blade Penknife, Polished	7	0
7932½	Buffalo do. same pattern as 05453	7	0
7932	Ivory do. do. do.	7	0
8129	Stag Handle Penknife, 1 Blade, Polished	10	6
8130	Do. do. 2 Blades, pattern as 8129	18	0
6334	Do. do. 1 Blade	12	0
5603½	Do. do. do.	10	0
6192	Do. do. do. with Shield	18	0
5082	Do. do. do.	12	0
6425	Do. do. 2 Blades, pattern as 5082	18	0
7861	Do. do. 1 Blade, flush	18	6
5607½	Do. do. do. with name plate	12	6
7330	Do. do. 2 Blades, pattern as 5607½	22	0
6800	Do. do. 1 Blade	15	0
7998	Buffalo Handle do. do. pattern as 6800	14	0
6181	Stag Handle do. do. with name plate	18	6
6532	Do. do. do. do.	16	0
7154	Do. do. do. do.	19	0
5794	Do. do. do. do.	17	0
5698	Do. do. do.	17	6
6464½	Do. do. do. with name plate	26	0
7862	Do. do. do.	16	6
8048	Buffalo Handle do. do. same pattern as 7862	15	6
7159	Stag Handle do. do. with name plate	18	6
6468½	Do. do. 2 Blades	22	0
7708	Do. do. do.	22	0
5627	Buffalo Handle do. do.	15	0
7616	Stag Handle do. do. with name plate	23	0
7336	Do. do. do. flush, with name plate	33	0
8245½	Ivory Handle do. do. same pattern as 7336	36	0
7336B	Buffalo do. do. do. do.	34	0
6738	Stag do. do. do. with name plate	24	0
06337	Do. do. do. do. flush, with name plate	27	0
6123	Pearl do. do. do. same pattern as 06337	44	0
6084	Ivory do. do. do. same pattern as 06337, without name plate	26	0
5926	Buffalo do. do. do. Glazed	11	0
5928	Stag do. do. do. Polished, same pattern as 5926	14	0
5927	Ivory do. do. do. do. do. do.	14	6
6817	Stag do. do. do. do.	12	6
7937½	Buffalo do. do. do. same pattern as 6817	12	6
7418½	Stag do. do. do.	20	0
5650	Do. do. do. do.	21	0
7940½	Buffalo do. do. do. same pattern as 5650	20	0
5690	Stag do. do. do. with name plate, same pattern as 5650	23	0
7871	Buffalo do. do. do. do. do.	25	0
7179	Stag do. do. do. do. do.	26	0
7612	Cocoa do. do. do. do. do.	22	6
7862½	Stag do. do. do. do.	27	0
7699	Do. do. do. do. with name plate	20	0
7308	Do. do. do. do. do.	30	0
7308B	Buffalo do. do. do. do. same pattern as 7308	30	0
7419	Stag do. do. do. do. with name plate	24	0
6532½	Do. do. do. do. do. do.	25	0
7165	Do. do. do. do. do. do.	28	0
6742	Do. do. do. do. do. do.	32	0
7307	Do. do. do. do. flush, with name plate	34	0
7307B	Buffalo do. do. do. do. flush, same pattern as 7307	34	0
8008B	Do. do. do. 4 blades, flush, with name plate	52	0
8008S	Stag do. do. do. do. flush, same pattern as 8008B	50	0
6507½	Do. do. do. do. flush, with name plate	46	0
6819½	Do. do. do. do. with name plate	30	0
8145	Do. do. do. do. do. do.	44	0
7604	Do. do. do. do. do. do.	38	0

The London Warehouse contains the Largest Stock of Cutlery in the World.

**JOSEPH MAPPIN & BROTHERS,
QUEEN'S CUTLERY WORKS, SHEFFIELD.**

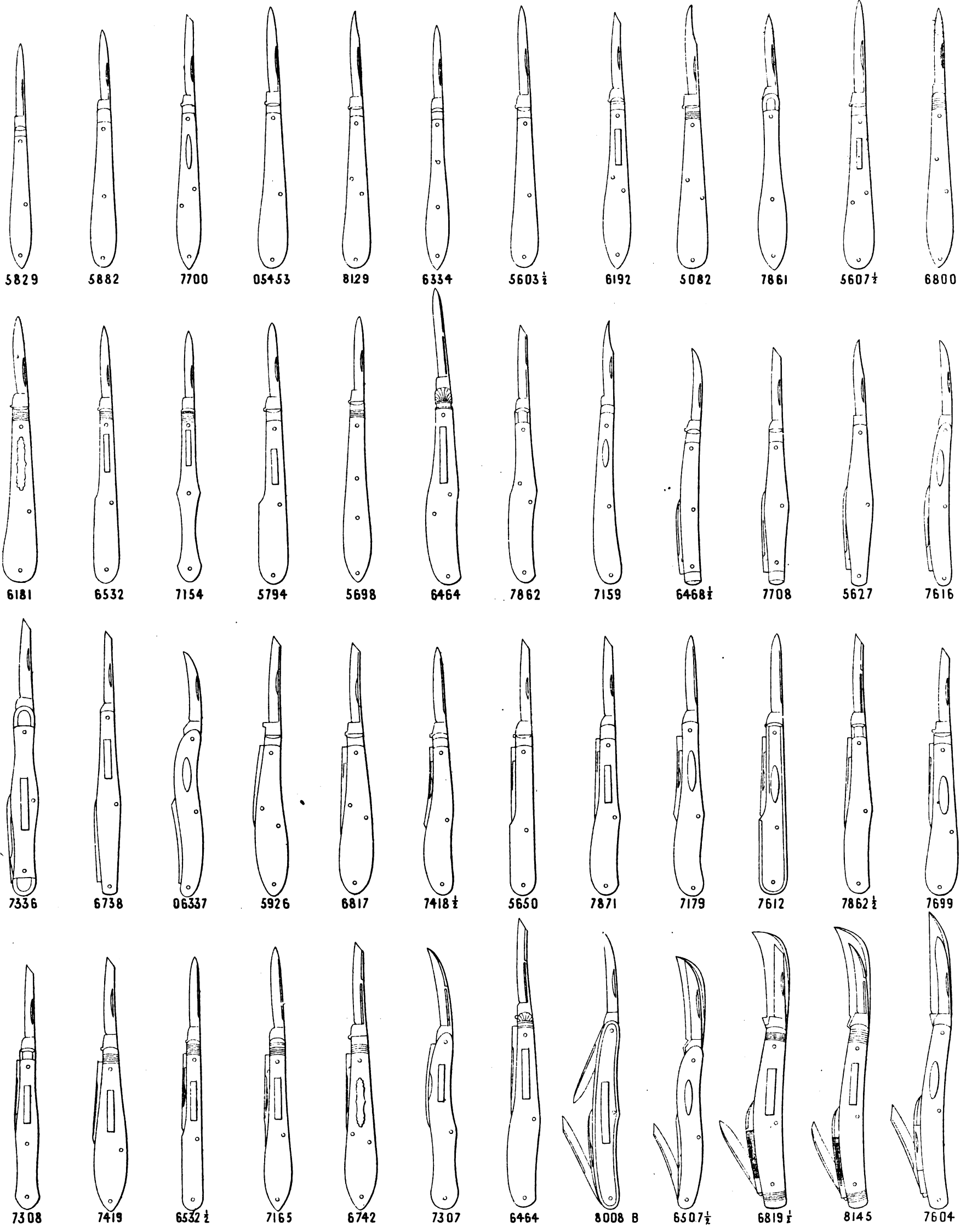

Drawn half real size.

Stock ready at the Warehouse

67 & 68, KING WILLIAM STREET, CITY, LONDON.

MAPPIN BROTHERS,
MANUFACTORY,
QUEEN'S CUTLERY WORKS, SHEFFIELD,
WAREHOUSE,
67 & 68, KING WILLIAM STREET, LONDON.

PRICES OF MAPPINS' VERY SUPERIOR POCKET KNIVES.

For Drawings, see corresponding numbers on Plate

								per doz.	
								s.	d.
6018	Ivory	Handle,	Penknife,	1	blade,	with	name	plate	14 0
6196	Do.	do.	do.	do.	do.	do.	do.	do.	15 0
6197	Pearl	do.	do.	do.	same	shape	as	6196,	no
									Shoulder
									or
									Plate
5830	Ivory	do.	do.	do.	do.	do.	do.	do.	8 0
8090½	Do.	do.	do.	do.	shape	as	5830,	with	Shoulder
5856	Do.	do.	do.	do.	do.	do.	do.	do.	9 6
5857	Tortoiseshell	do.	do.	do.	shape	as	5856	do.	do.
8138	Ivory	do.	do.	do.	flush,	with	name	plate	20 0
8137	Pearl	do.	do.	do.	flush,	shape	as	8138,	with
									rounded
									edge
6388	Ivory	do.	do.	do.	do.	do.	do.	do.	11 0
06388	Do.	do.	do.	do.	shape	as	6388,	with	plain
									round
									Shoulder
7539	Do.	do.	do.	do.	flush,	with	name	plate	21 0
6335	Do.	do.	do.	do.	do.	do.	do.	do.	18 0
7600	Do.	do.	do.	do.	with	name	plate	do.	14 0
7692	Do.	do.	do.	do.	polished	do.	do.	do.	7 0
8902	Stag	do.	do.	do.	same	shape	as	7692	do.
8943	Do.	do.	do.	2	blades,	do.	do.	do.	15 6
8941	Ivory	do.	do.	do.	do.	do.	do.	do.	14 6
8049	Do.	do.	do.	1	blade,	polished	do.	do.	7 0
7897	Stag	do.	do.	do.	same	pattern	as	8049	do.
06119	Ivory	do.	do.	do.	do.	do.	do.	do.	9 0
6119	Buffalo	do.	do.	do.	same	shape	as	06119	do.
6119½	Stag	do.	do.	do.	do.	do.	do.	do.	8 6
7830	Ivory	do.	do.	do.	flush,	German	Silver	Shoulder	18 0
6193	Do.	do.	do.	do.	German	Silver	Shoulder	do.	11 0
6737	Do.	do.	do.	do.	do.	do.	with	Shield	18 0
6947	Do.	do.	do.	do.	with	Shield	do.	do.	16 0
7191	Do.	do.	do.	do.	with	Shield,	Octagon	Handle	21 0
6795	Do.	do.	do.	do.	do.	do.	do.	do.	15 0
8034	Do.	do.	do.	do.	do.	flush,	Octagon	Handle,	"badly
									drawn"
7866	Do.	do.	do.	do.	do.	German	Silver	Shoulder	28 0
7145	Do.	do.	do.	2	blades,	do.	do.	do.	19 0
5858	Do.	do.	do.	do.	do.	do.	do.	do.	18 0
7261	Do.	do.	do.	do.	do.	German	Silver	Shoulders,	Octagon
								Handle	do.
6446	Do.	do.	do.	do.	do.	do.	do.	do.	19 0
7716	Do.	do.	do.	do.	do.	"omitted	in	sketch"	30 0
8066	Do.	do.	do.	do.	do.	do.	do.	do.	28 0
6398	Do.	do.	do.	do.	do.	flush,	Octagon	Handle	36 0
8299	Do.	do.	do.	do.	do.	Octagon	Handle	do.	32 0
7717½	Do.	do.	do.	do.	do.	do.	do.	do.	32 0
7813	Do.	do.	do.	do.	do.	do.	do.	do.	18 0
6078	Do.	do.	do.	do.	with	Shield	do.	do.	28 0
5862	Do.	do.	do.	do.	do.	do.	do.	do.	22 0
7155	Do.	do.	do.	do.	do.	do.	do.	do.	26 0
6591	Do.	do.	do.	do.	do.	German	Silver	Shoulder	24 0
5853½	Do.	do.	do.	do.	do.	do.	do.	do.	20 0
7509	Do.	do.	do.	do.	with	Shield	do.	do.	24 0
8055	Do.	do.	do.	do.	do.	do.	do.	do.	25 0
6540	Do.	do.	do.	do.	do.	Octagon	Handle	do.	28 0
7866½	Do.	do.	do.	do.	do.	do.	German	Silver	Shoulder
									36 0
5887	Tortoiseshell	do.	do.	1	blade,	Shield,	German	Silver	Shoulder
									22 6
6502	Do.	do.	do.	2	blades,	do.	do.	do.	42 0
8069	Do.	do.	Pocket	Knife	3	blades,	do.	German	Silver
									Shoulder
									50 0
7517	Do.	do.	do.	do.	do.	do.	do.	do.	56 0
7536½	Ivory	Handle	Lady's	Fruit	Knife,	Steel	blade,	German	Silver
									Shoulder
									10 0
8204	Do.	do.	do.	do.	do.	do.	do.	do.	18 6
8202	Do.	do.	do.	do.	do.	Octagon	Handle	do.	21 0
8206	Do.	do.	do.	do.	with	Pen	blade	do.	25 0
8128	Do.	do.	2	blade	Pocket	Knife,	German	Silver	Shoulder
									26 0

The London Warehouse contains the Largest Stock of Cutlery in the World.

JOSEPH MAPPIN & BROTHERS,
 QUEEN'S CUTLERY WORKS, SHEFFIELD.

IVORY HANDLES.

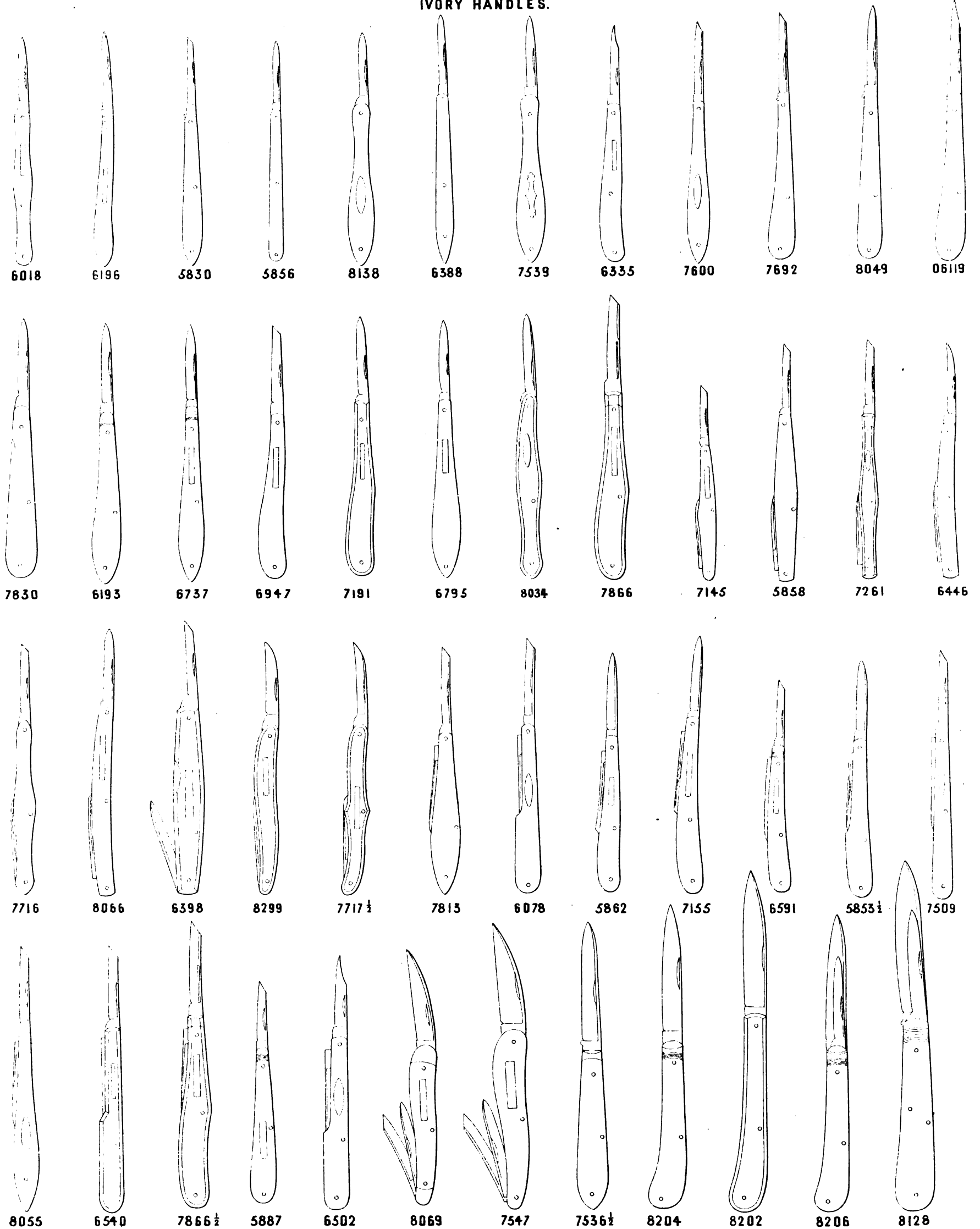

Stock ready
 AT 37, MOORGATE ST, CITY, LONDON.

Drawn half real size

MAPPIN BROTHERS,
MANUFACTORY,
QUEEN'S CUTLERY WORKS, SHEFFIELD,
WAREHOUSE,
67 & 68, KING WILLIAM STREET, LONDON.

PRICES OF MAPPINS' VERY SUPERIOR POCKET KNIVES.

For Drawings, see corresponding numbers on Plate.

								per doz.
								s. d.
7169	Mother-of-Pearl Handle, 1 Blade Penknife, Carved Handle							22 0
6884	Pearl Handle, 1 Blade Penknife, Shield, German Silver Shoulders							20 0
7867	Do. do. do.							13 0
6886	Do. do. do. Shield							22 0
6701	Do. do. do.							16 0
7508	Do. do. do. German Silver Shoulders							15 0
7161	Do. do. do.							20 0
6796	Do. do. do. Shield, German Silver Shoulders							24 0
7842	Do. do. do. do. do. do.							24 0
8056	Do. do. do. do. Octagon Handle							28 0
7810½	Do. do. do. do. randed edge of Handle							30 0
7868	Do. do. do. do.							30 0
6303½	Do. do. do. do. German Silver Shoulders							28 0
7162	Do. do. do. Silver Backs, and Carved Handle							54 0
7742	Do. do. do. Flush, Silver Mounted							52 0
6622	Do. do. do. Shield, German Silver Shoulders							24 0
7743	Do. do. do. Flush, Silver Mounted, Shield							54 0
8057	Do. do. do. Shield, Octagon Handle and Head							34 0
6357	Do. do. do. Silver Mounted, Carved Handle							54 0
7714	Do. 2 Blades do. Shield, Flush							36 0
8070	Do. do. do. Flush, German Silver Shoulders, Shield							38 0
7260	Do. do. do. Shield, Octagon Handle							38 0
6879	Do. do. do. do.							34 0
7262	Do. do. do. do. German Silver Shoulders							36 0
7717	Do. do. do. Silver Mounted, Shield							50 0
6731½	Do. do. Wharnccliffe Knife, Shield							42 0
8214	Do. do. do. do. German Silver Shoulders							42 0
8212	Do. do. do. do.							35 0
6592	Do. do. Penknife, German Silver Shoulders							30 0
7534	Do. do. do. Shield, Octagon Handle							38 0
6603	Do. do. do. do.							33 0
7309	Do. do. do. do. German Silver Shoulders							38 0
7869	Do. do. do. do. Randed Edge							40 0
7870	Do. do. do. Randed Edge							44 0
7520	Do. do. do. Shield							36 0
7535	Do. do. do. Flush, Shield							54 0
8060	Do. do. do. Shield, German Silver Shoulders							56 0
7703	Do. 3 blade Wharnccliffe, Shield							54 0
6432	Do. 4 blade Pocket Knife, Shield							70 0
7857	Do. 3 blade do. do.							66 0
6034	Do. do. Wharnccliffe Knife							60 0
7511	Do. do. do. do. Shield							63 0
7877½	Do. do. Pocket Knife, Shield							78 0
6723	Do. do. Wharnccliffe Knife, Silver Mounted							108 0
8141	Do. 1 blade Congress Knife, Flush							60 0
6544	Do. 3 blade Wharnccliffe Knife, very round Handle							100 0
8136	Do. 4 blade do. do. do. do.							114 0

The London Warehouse contains the Largest Stock of Cutlery in the World.

JOSEPH MAPPIN & BROTHERS,
 QUEEN'S CUTLERY WORKS, SHEFFIELD.

PEARL HANDLES.

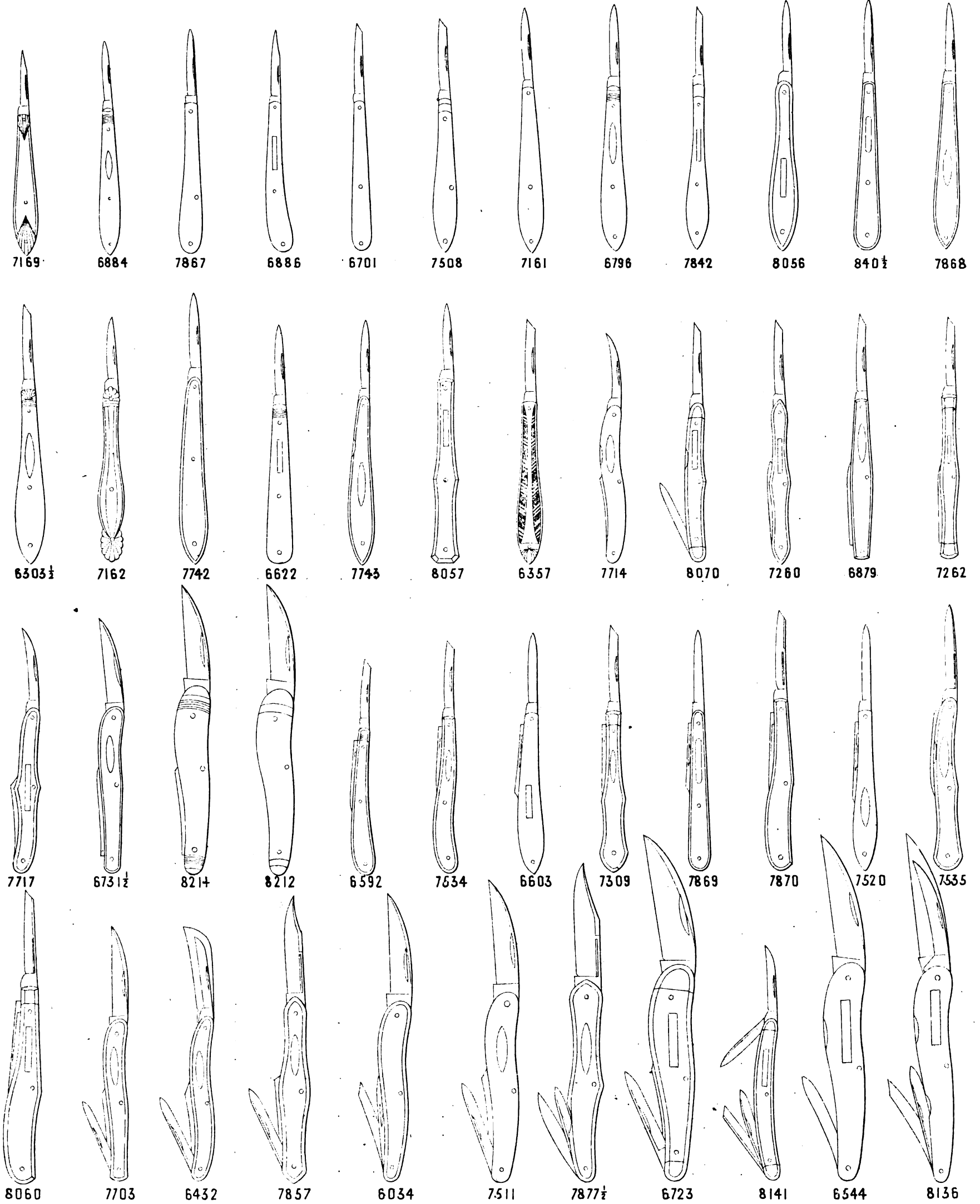

Drawn half real size.

Stock ready at the Warehouse.

67 & 68 KING WILLIAM STREET, CITY, LONDON.

MAPPIN BROTHERS,
MANUFACTORY,
QUEEN'S CUTLERY WORKS, SHEFFIELD,
WAREHOUSE,
67 & 68, KING WILLIAM STREET, LONDON.

PRICES OF MAPPINS' VERY SUPERIOR POCKET KNIVES.

For Drawings, see corresponding numbers on Plate.

									per doz.
									s. d.
7659	Stag Handle, 2 Blade Wharncliffe Knife	24 0
7880	Do. do. do. do. German Silver Shoulders	28 0	
6527	Do. do. do. do.	22 0	
5875	Cocoa Handle do. do. do. Flush, Octagon Handle	24 0	
7879	Do. do. do. do. German Silver Shoulders	22 0	
8003½	Do. do. do. do. Octagon Handle	21 0	
8080	Do. do. do. do. do. do. Shield	25 0	
6690	Stag Handle do. Norfolk Knife, Flush, Shield	38 0	
6780	Cocoa do. do. Wharncliffe Knife, Shield	23 0	
6054	Stag do. do. do. do. Flush, Shield	38 0	
6558	Cocoa do. do. do. do. do. do. Plump Handle	38 0	
7883	Do. do. do. do. do. German Silver Shoulders	26 0	
7882	Stag do. 3 blade do. do. Flush, very light and thin, German Silver Shoulder	48 0	
5907	Buffalo do. do. do. do. Shield, Octagon	40 0	
7546	Stag do. do. do. do. do.	40 0	
06487	Do. do. do. do. do.	32 0	
5788½	Cocoa do. do. do. do. Shield, and Octagon Handle	38 0	
8082	Stag do. do. do. do. Shield, Flush, German Silver Shoulder	54 0	
7825	Do. do. do. do. do. Flush, Shield, very light and thin	48 0	
6051½	Cocoa do. do. do. do. Flush, Shield, Octagon Handle	46 0	
6054½	Stag Handle do. do. do. Flush, Shield	50 0	
7877	Do. do. Norfolk Knife, Flush, Shield	54 0	
7217	Do. do. Wharncliffe Knife	24 0	
6430	Do. do. do. do. Shield, German Silver Shoulder	40 0	
6700	Do. do. do. do.	35 0	
5908	Do. do. do. do. Shield, Steel filed Shoulders	42 0	
8267	Do. do. do. do. German Silver Shoulders	28 0	
8268½	Cocoa Handle do. do. do. do. do. do. do.	25 0	
8266	Do. do. 2 Blade do. do. do. do. do.	16 0	
07416	Stag do. 3 Blade do. do. do. do. do. Shield	50 0	
7905½	Do. do. do. Norfolk Knife, flush, Shield	54 0	
5579	Do. do. do. Wharncliffe Knife, flush, Shield	60 0	
06074	Cocoa do. do. Strong Pocket Knife, Shield, Octagon Handle	48 0	
7297	Do. do. do. do. do. flush, German Silver Shoulders	54 0	
8311	Stag Handle Wharncliffe Knife, 2 Blades and Corkscrew, Shield	46 0	
8333	Black Buffalo Handle, 2 Blade Pocket Knife, long German Silver Shoulders, ornamented Blade, Shield	30 0	
8144	Cocoa Handle, 4 Blade Congress Knife, German Silver Shoulder, Octagon Handle	38 0	
8657	Buffalo do. do. do.	22 6	
8145	Stag do. do. do. Shield, German Silver Worked Shoulders	44 0	
8125½	Do. do. do. do. very large, French Blades, Shield	40 0	
8132	Do. do. 6 Blade do. Shield, French Blades	48 0	
8121	Buffalo do. 3 Blade Strong Pocket Knife, German Silver Shoulders	58 0	
8308	Stag do. do. Wharncliffe Knife	24 0	
7850	Do. do. do. do.	22 0	
7701	Do. do. 2 Blade Pocket Knife, German Silver Shoulders	24 0	
7850½	Do. do. 3 Blade Wharncliffe Knife, Shield	24 0	

The London Warehouse contains the Largest Stock of Cutlery in the World.

JOSEPH MAPPIN AND BROTHERS,
 QUEEN'S CUTLERY WORKS, SHEFFIELD.

Stag Buff Wood Handles

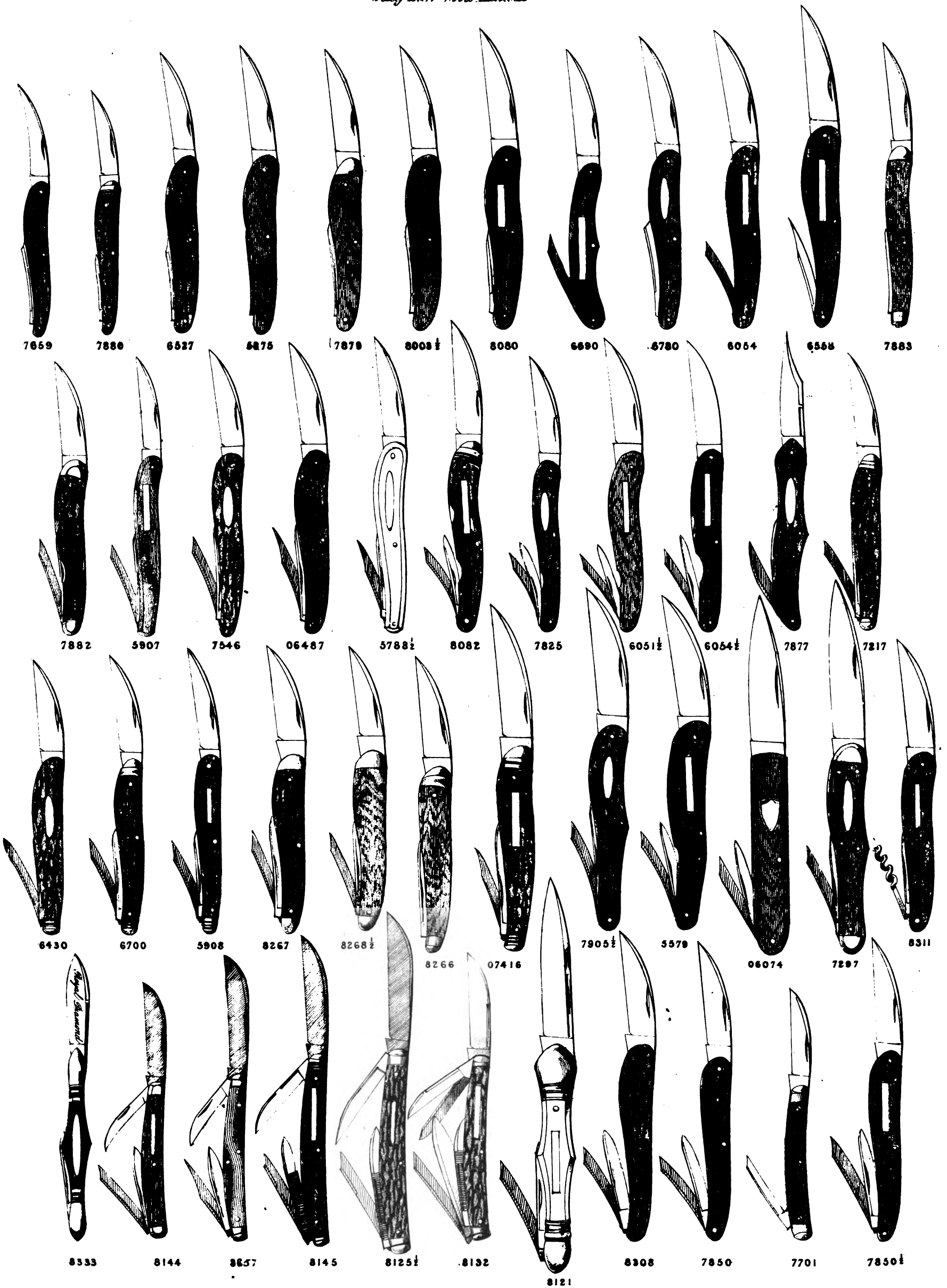

Drawn half real size.

Stock ready at the Warehouse

67 & 68 KING WILLIAM STREET. CITY. LONDON.

Digitized by Google

MAPPIN BROTHERS,
MANUFACTORY,
QUEEN'S CUTLERY WORKS, SHEFFIELD,
WAREHOUSE,
67 & 68, KING WILLIAM STREET, LONDON.

PRICES OF MAPPINS' VERY SUPERIOR POCKET KNIVES.

For Drawings, see corresponding numbers on Plate.

		per doz.	
		s.	d.
6427	Ivory Handle, 2 Blade Wharnccliffe Knife, Shield	23	0
7513	Do. do. do. Norfolk Knife	26	0
6733	Do. do. do. Wharnccliffe Knife, Shield	26	0
6129	Do. do. do. do. do. do. German Silver Shoulders	34	0
8077	Do. do. do. do. do. do. Octagon Handle	26	0
06125	Do. do. do. do. do.	20	0
7603½	Do. do. do. do. do. very thick round Handle	36	0
6486	Do. do. do. do. do. Shield	34	0
7884	Do. do. 3 blade do. do. flush, Octagon Handle	42	0
5975½	Do. do. do. do. do.	36	0
7209½	Do. do. do. do. do. German Silver Shoulders	40	0
6693	Do. do. do. do. do.	32	0
6651½	Do. do. do. do. do. flush, Shield, Octagon Handle	48	0
8073	Do. do. do. Victoria Knife do. do.	48	0
5905	Do. do. do. Wharnccliffe Knife	38	0
8074	Do. do. do. Norfolk Knife, flush, Shield, Octagon Handle	50	0
7698	Do. do. do. do. do. do. do.	52	0
7856	Do. do. do. Crescent Knife do. do. do.	52	0
7603	Do. do. do. Wharnccliffe Knife, thick Round Handle	48	0
6052½	Do. do. do. do. do. flush, Shield, Octagon Handle	54	0
7321	Do. do. do. Norfolk Knife, flush, Shield, thick Round Handle	58	0
6807	Do. do. do. Wharnccliffe Knife, flush, Octagon Handle	44	0
7878	Do. do. 2 blade Serpentine Knife, flush, Shield, Octagon Handle	46	0
8033	Do. do. 3 blade do. do. do. do. thick Round Handle	75	0
8063	Do. do. 4 blade Pocket Knife, flush, Shield, Octagon Handle	48	0
6184	Do. do. do. Congress Knife, Shield	36	0
8008	Do. do. do. Norfolk Knife, flush, Shield, Octagon Handle	58	0
7852	Do. do. do. do. do. do. do. German Silver Shoulders	56	0
6404	Do. do. do. Congress Knife, Shield	30	0
6740	Do. do. do. do. do. do.	38	0
7352	Do. do. 3 blade Nail Knife, flush, Octagon Handle	54	0
6047	Do. do. 4 blade Wharnccliffe Knife, with Ivory Paper Knife	78	0
6557	Do. do. 2 blade do. do. thick Round Handle, flush	66	0
5903	Do. do. 4 blade do. do. flush	54	0
8076	Do. do. 3 blade Pocket Knife, Shield, German Silver Shoulders	56	0
7958	Do. do. do. and Ivory Paper Folding Blade, flush, Shield	72	0
6891	Do. do. do. Norfolk Knife, flush, Shield, Octagon Handle	60	0
7415	Do. do. do. Pocket Knife, with German Silver Comb	90	0
5793	Do. do. 2 blade Knife, and Nail-file, Octagon Handle	36	0
6872	Do. do. 6 inch Folding Rule, with Penknife Blade	35	0
7831	Do. do. 2 blade Knife, Shield, Octagon Handle	32	0
8463	Do. do. 3 blade Wharnccliffe Knife, Shield	44	0
7408	Do. do. 2 blade Pocket Knife, with Nail-scissors to shut flush	90	0
8219	Do. do. do. do. do. with Button-hook	28	0
7687	Do. do. do. do. do. with Silver Pencil	63	0
07687	Do. do. do. do. do. with "Mordan's" Silver Pencil	84	0
7739½	Do. do. do. Wharnccliffe Knife, with Ivory Paper Folding Blade, and "Mordan's" Silver Pencil	108	0

The London Warehouse contains the Largest Stock of Cutlery in the World.

**JOSEPH MAPPIN & BROTHERS,
QUEEN'S CUTLERY WORKS, SHEFFIELD.**

IVORY HANDLES.

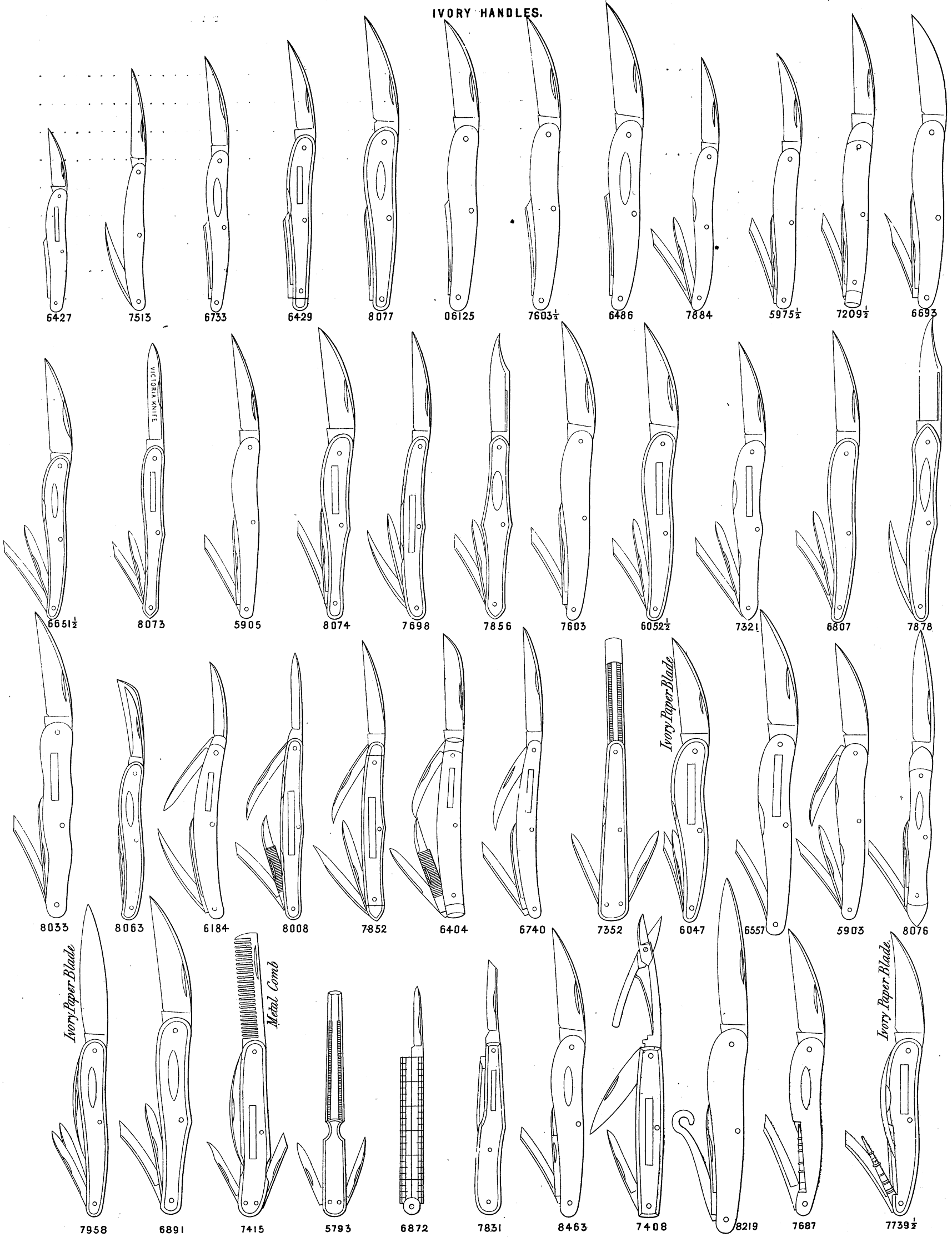

Drawn half real size.

Stock ready at the Warehouse

67 & 68 KING WILLIAM STREET, CITY, LONDON.

MAPPIN BROTHERS, MANUFACTORY, QUEEN'S CUTLERY WORKS, SHEFFIELD. WAREHOUSE, 67 & 68, KING WILLIAM STREET, LONDON.

PRICES OF MAPPINS' VERY SUPERIOR POCKET KNIVES.

For Drawings, see corresponding numbers on Plates.

Table with columns for item number, description, and price per dozen. Includes items like 'Ivory Handle, 4 Blades, long G. S. Shoulders, Shield, Octagon Handle' and 'Tortoise Shell Handle, same pattern as 8597'.

JOSEPH MAPPIN AND BROTHERS.
 QUEEN'S CUTLERY WORKS, SHEFFIELD.

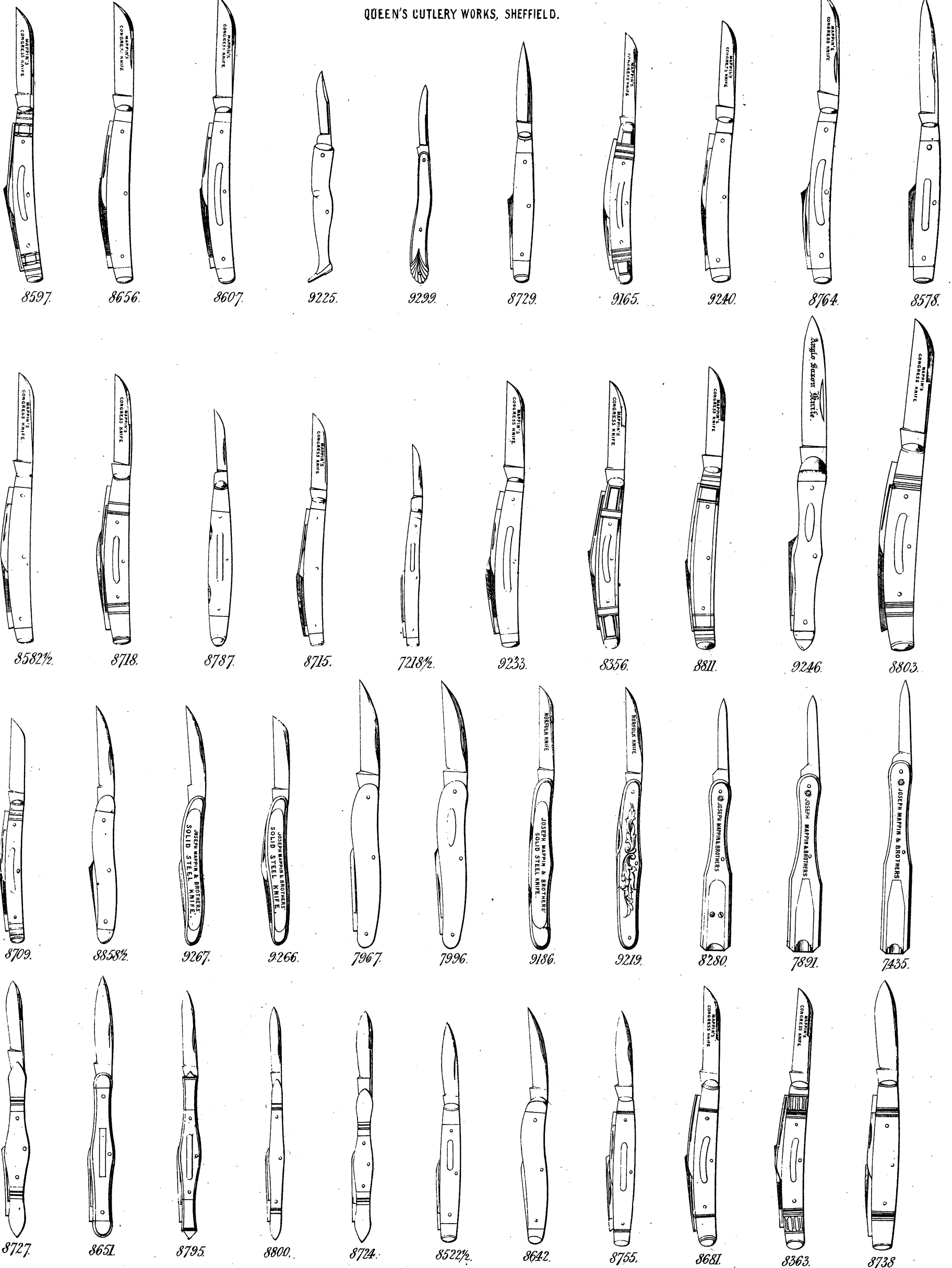

Stocks ready at the Warehouse.
 67 & 68, KING WILLIAM STREET, CITY, LONDON.

MAPPIN BROTHERS,
MANUFACTORY,
QUEEN'S CUTLERY WORKS, SHEFFIELD,
WAREHOUSE,
67 & 68, KING WILLIAM STREET, LONDON.

PRICES OF MAPPINS' VERY SUPERIOR POCKET KNIVES.

For Drawings, see corresponding numbers on Plate

						per doz.
						s. d.
7536	Buff	Handle, 1	Blade	Lady's Fruit Knife	.	7 4
6173	Do.	do.	do.	Pocket Knife	.	6 0
6173½	Stag	do.	do.	do.	.	6 9
6002	Do.	do.	2 blade	do.	.	10 6
7837	Do.	do.	do.	do.	.	12 6
7876½	Do.	do.	do.	do.	.	17 0
5589	Do.	do.	do.	do.	.	19 0
5965	Ivory	do.	do.	do.	.	24 0
6342½	Stag	do.	do.	do.	.	25 0
6595½	Buff	do.	do.	do.	with Gun-picker and Screw-driver	24 0
6704	Stag	do.	do.	do.	.	13 0
6571	Do.	do.	do.	do.	with Shield	30 0
8699	Do.	do.	do.	do.	.	15 0
7477½	Do.	do.	do.	do.	with Corkscrew	42 0
7964	Do.	do.	do.	do.	.	20 0
7965	Do.	do.	do.	do.	.	18 0
6599	Do.	do.	do.	do.	.	20 0
6611	Do.	do.	do.	do.	with Gun-picker, Tweezers, and Fleam	38 0
7960	Cocoa	do.	1 blade	do.	.	7 6
7553	Stag	do.	3½ inch, 1	Blade Pocket Knife	.	8 4
7552	Cocoa	do.	do.	do.	.	7 9
7753	Buff	do.	do.	do.	.	9 0
5831	Stag	do.	do.	do.	.	10 0
7326	Ivory	do.	4 inch	do.	with Corkscrew	50 0
7560	Stag	do.	do.	do.	with Gun-picker, Tweezers, and Fleam	34 0
7472	Do.	do.	4½ inch	do.	with Lock-spring to Blade	26 0
7787	Do.	do.	5 inch	do.	Sailor's Knife, with Hole in Handle	15 0
6658	Do.	do.	do.	do.	Deer Knife, with Corkscrew and Lock-spring	63 0
7754	Buffalo	do.	4½ inch	do.	Sailor's Knife, with Hole in Handle	12 0
7736	Stag	do.	do.	do.	do.	12 6
8370	Do.	do.	do.	do.	with Copper Shackle	13 6

The London Warehouse contains the Largest Stock of Cutlery in the World.

JOSEPH MAPPIN AND BROTHERS,
 QUEEN'S CUTLERY WORKS, SHEFFIELD.

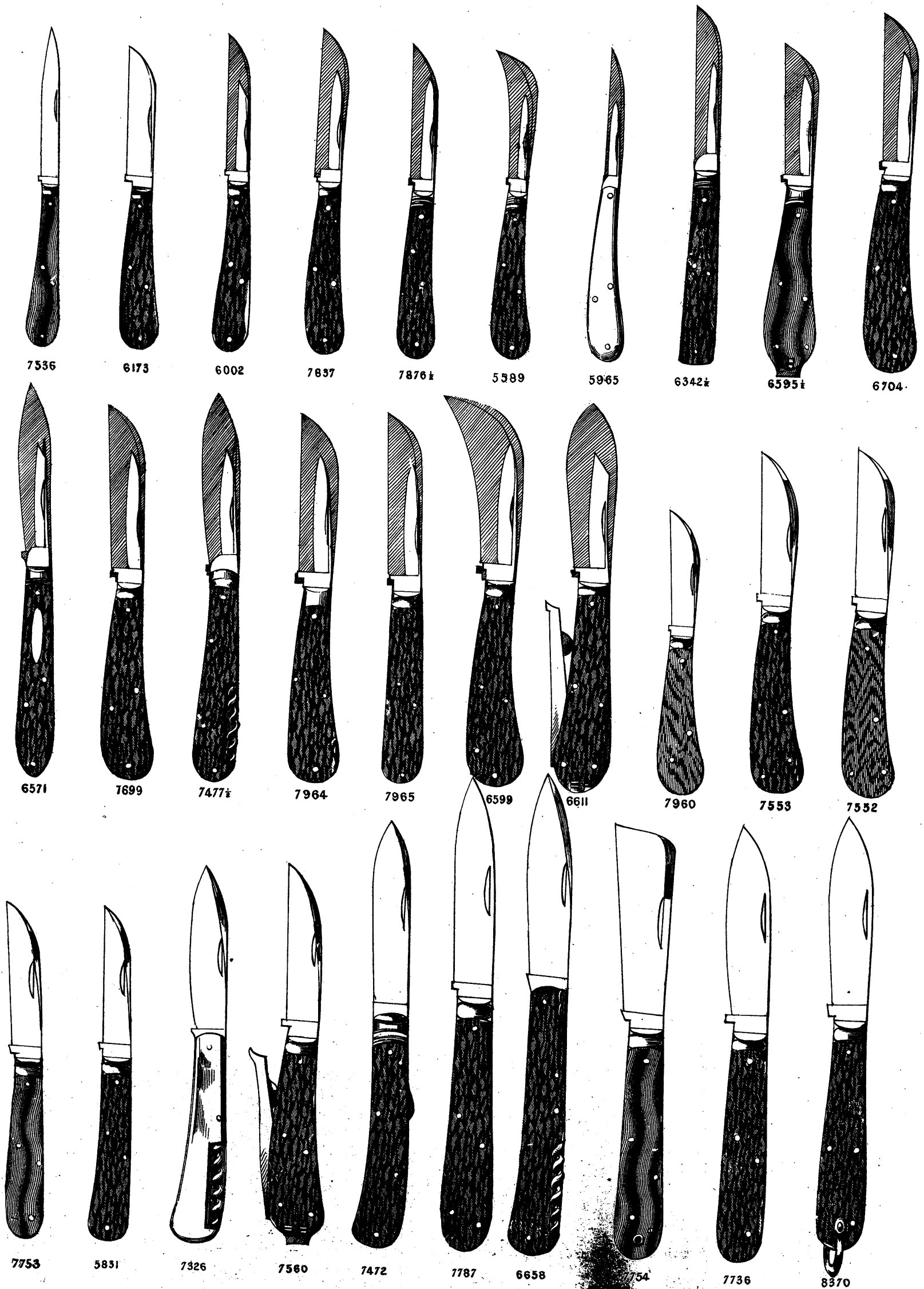

Drawn half real size.

AND AT 37, MOORGATE ST CITY, LONDON.

MAPPIN BROTHERS,

WAREHOUSE, 67 & 68, KING WILLIAM STREET, LONDON.

PRICES OF MAPPINS' VERY SUPERIOR POCKET KNIVES.

For Drawings, see corresponding numbers on Plates.

per doz.	s.	d.	Handle	Blade	Material
12	0	0	4 1/2 in. 1 Blade Sailor's Knife, with hole in Handle	do.	Cocoa
12	6	0	do.	do.	Buffalo
12	6	0	do.	do.	White Bone
10	8	0	same pattern as 7736, but only 4 in. long	do.	Stag
13	6	0	4 1/2 in. 1 Blade Sailor's Knife, with Copper Shackles	do.	White Bone
15	6	0	5 in. same pattern as 8370, but 5 in. long	do.	Buffalo
16	0	0	3 1/2 in. 1 Blade Castrating Knife	do.	Stag
13	0	0	3 in. strong, 1 Blade	do.	Cocoa
14	6	0	do.	do.	Buffalo
15	0	0	do.	do.	Stag
17	6	0	do.	do.	Buffalo
20	0	0	do.	do.	Stag
14	0	0	do.	do.	Buffalo
18	6	0	do.	do.	Stag
40	0	0	do.	do.	Buffalo
20	0	0	do.	do.	Stag
16	0	0	do.	do.	Buffalo
18	0	0	do.	do.	Stag
19	0	0	do.	do.	Buffalo
21	0	0	do.	do.	Stag
33	0	0	do.	do.	Buffalo
22	0	0	do.	do.	Stag
22	0	0	do.	do.	Buffalo
26	0	0	do.	do.	Stag
26	0	0	do.	do.	Buffalo
18	0	0	do.	do.	Stag
15	6	0	do.	do.	Buffalo
15	0	0	do.	do.	Stag
25	0	0	do.	do.	Buffalo
20	0	0	do.	do.	Stag
17	0	0	do.	do.	Buffalo
17	6	0	do.	do.	Stag
21	0	0	do.	do.	Buffalo
21	0	0	do.	do.	Stag
22	0	0	do.	do.	Buffalo
32	0	0	do.	do.	Stag
30	0	0	do.	do.	Buffalo
28	0	0	do.	do.	Stag
20	0	0	do.	do.	Buffalo
21	0	0	do.	do.	Stag
20	0	0	do.	do.	Buffalo
21	0	0	do.	do.	Stag
38	0	0	do.	do.	Buffalo
42	0	0	do.	do.	Stag
33	0	0	do.	do.	Buffalo
34	0	0	do.	do.	Stag
18	0	0	do.	do.	Buffalo
16	0	0	do.	do.	Stag
54	0	0	do.	do.	Buffalo
45	0	0	do.	do.	Stag
32	0	0	do.	do.	Buffalo
54	0	0	do.	do.	Stag
26	0	0	do.	do.	Buffalo
38	0	0	do.	do.	Stag
15	0	0	do.	do.	Buffalo
63	0	0	do.	do.	Stag

MAPPIN BROTHERS.
 QUEEN'S CUTLERY WORKS. SHEFFIELD.

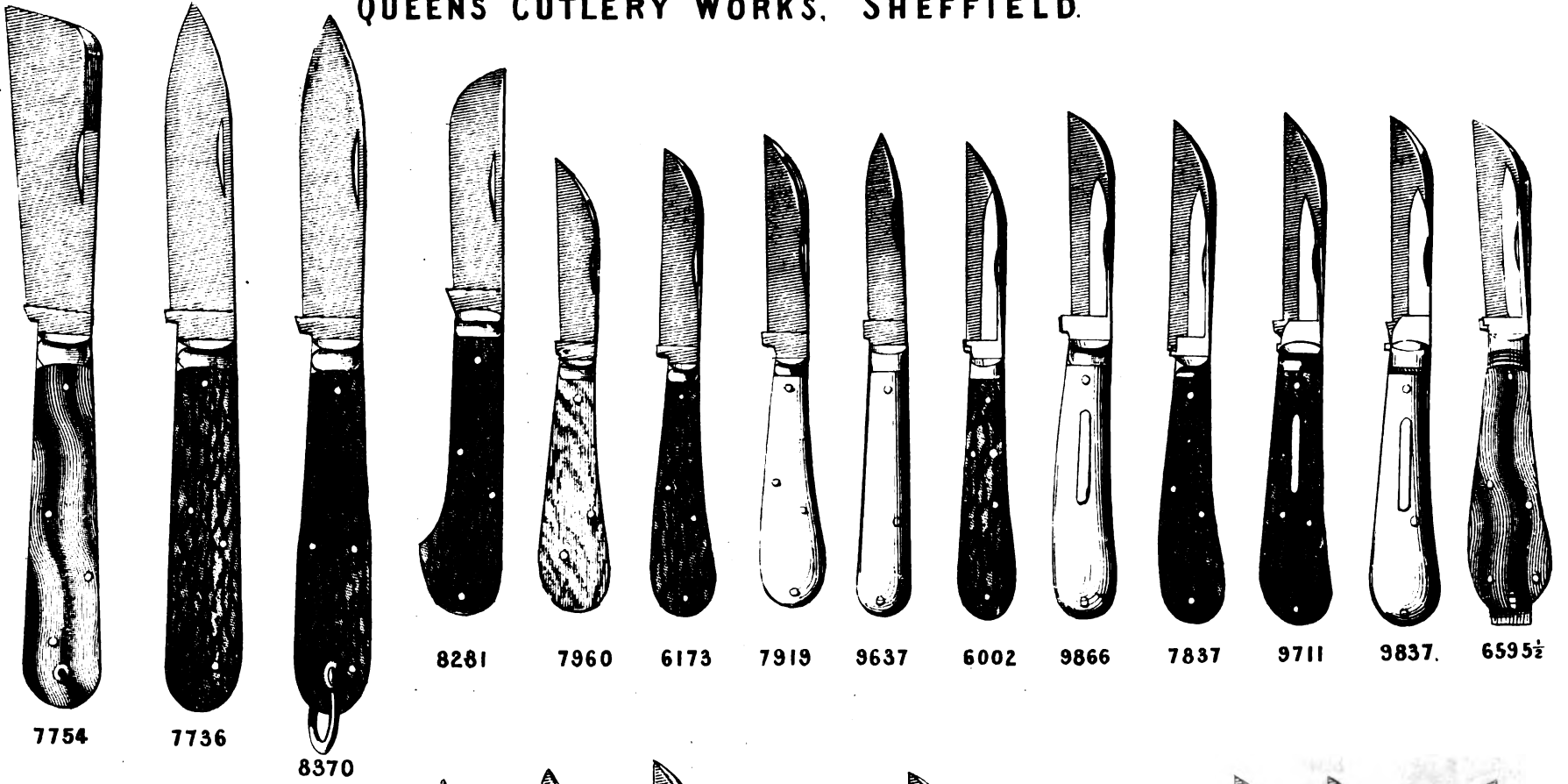

7754

7736

8370

8281

7960

6173

7919

9637

6002

9866

7837

9711

9837

6595½

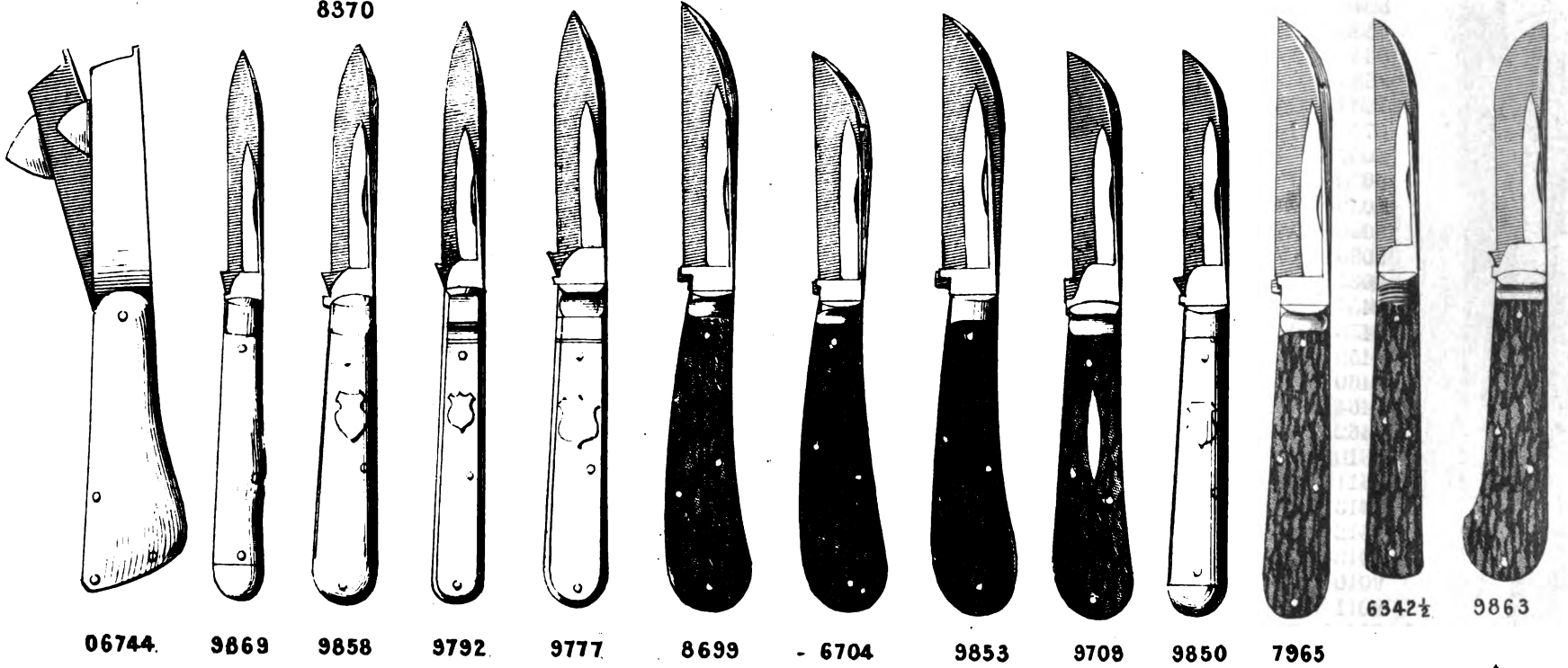

06744.

9869

9858

9792

9777

8699

- 6704

9853

9709

9850

7965

6342½

9863

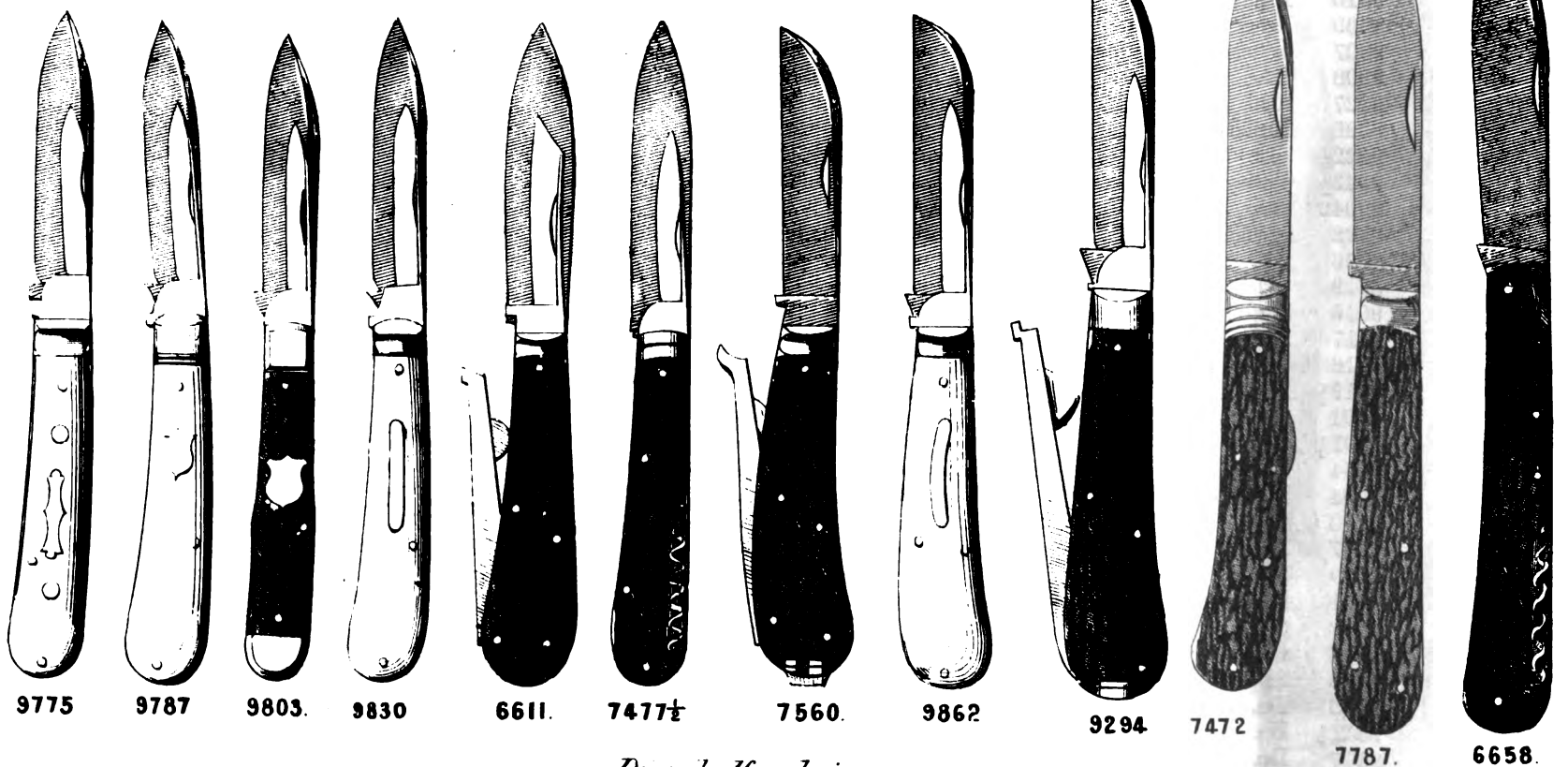

9775

9787

9803.

9830

6611.

7477½

7560.

9862

9294

7472

7787.

6658.

Draw half real size.
 AND AT 67, KING WILLIAM ST., CITY, LONDON.

MAPPIN BROTHERS,
 MANUFACTORY, QUEEN'S CUTLERY WORKS, SHEFFIELD,
 WAREHOUSE, 67 & 68, KING WILLIAM STREET, LONDON.

PRICES OF MAPPINS' VERY SUPERIOR POCKET KNIVES.

For Drawings, see corresponding numbers on Plate.

						per doz.	
						s.	d.
9078	Pressed Stag Handle, 3½ in. strong 1 Blade	6	0
9079	Cocoa do. do. same pattern as 9078	6	0
9081	Stag do. do. same pattern as 9078	7	6
9083	White Bone do. do. same pattern as 9078	7	0
7753	Buffalo do. do. 1 Blade	9	0
8987	Stag do. do. do.	9	0
8986	Cocoa do. do. same pattern as 8987	8	0
8289½	Do. do. 3½ in. 1 Blade	9	0
9682	Stag do. do. same pattern as 8289½	10	6
9670	Do. do. 3½ in. 1 Blade	9	6
9051½	Buffalo do. do. do. polished blade	10	0
9052	Stag do. do. same pattern as 9051½	11	0
9053	Cocoa do. do. same pattern as 9051½	10	0
9054	White Bone do. do. same pattern as 9051½	10	0
9854	Stag do. 3½ in. 1 Blade	11	0
7552	Cocoa do. 3½ in. do.	7	9
8368	Buffalo do. do. same pattern as 7552	8	4
7553	Stag do. do. 1 Blade	8	4
9885	Cocoa do. do. do.	7	9
8989	Pressed Stag do. do. do.	6	8
8988	Cocoa do. do. same pattern as 8989	6	8
8946	Buffalo do. do. same pattern as 8989	7	6
8338	Do. do. 3½ in. 1 Blade, German Silver Shoulder, polished Swage.	11	0
8344	White Bone do. do. same pattern as 8338	12	0
8688	Cocoa do. do. same pattern as 8338	10	6
7536	Buffalo do. 1 Blade Lady's Fruit Knife	7	4
07536	Ivory do. same pattern as 7536	8	0
9057	Cocoa do. 3½ in. 1 Blade, polished Blade	9	0
9058	Buffalo do. do. same pattern as 9057	9	6
9059	Stag do. do. same pattern as 9057	10	6
9060	White Bone do. do. same pattern as 9057	10	0
9036	Stag do. do. 1 Blade, polished Blade	11	6
9035	Buffalo do. do. same pattern as 9036	10	6
9457	Stag do. do. 1 Blade, polished Blade	12	0
9456	Buffalo do. do. same pattern as 9457	11	0
9459	Cocoa do. do. same pattern as 9457	10	6
9460	White Bone do. do. same pattern as 9457	12	0
9464	Stag do. do. same pattern as 9457, with Pen Blade in addition	18	0
9462	Buffalo do. do. same pattern as 9457, do. do. do. do.	16	0
9810	Cocoa do. 3½ in. strong 1 Blade	9	0
9811	Buffalo do. do. same pattern as 9810	9	6
9813	Stag do. do. same pattern as 9810, polished Blade	11	6
9812	Buffalo do. do. 1 Blade, polished Blade	11	0
9013	Stag do. 4 in. do. do.	12	6
9010	Cocoa do. do. same pattern as 9013	11	0
9011	Buffalo do. do. same pattern as 9013	10	0
09012	White Bone do. do. same pattern as 9013, blade etched	12	6
9608	Stag do. do. 1 Blade, polished Blade	14	0
9606	Cocoa do. do. same pattern as 9608	12	6
9607	Buffalo do. do. same pattern as 9608, with Shield	13	6
9611	Stag do. do. same pattern as 9608, with Pen Blade	22	0
9610	Buffalo do. do. same pattern as 9608, with Penknife Blade	20	0
9009	Do. do. do. 1 Blade, polished Blade, with 2 Shields in Handle	12	6
9007	White Bone do. do. same pattern as 9009, no Shields	12	6
9008	Stag do. do. same pattern as 9009, no Shields	13	0
9027	Do. do. 4½ in. 1 Blade, polished Blade	15	0
9026	Buffalo do. do. same pattern as 9027	14	0
9022½	Do. do. do. 1 Blade, polished Blade	14	6
9043½	Cocoa do. do. same pattern as 9022½	13	6
09042	Stag do. do. same pattern as 9022½	15	0
8322	Buffalo do. do. Spanish Lock Knife, with Shield, polished Blade	30	0
8776	Stag do. do. same pattern as 8322, no Shield	30	0
8319	Do. do. do. same pattern as 8322, addition of Pen Blade, & no Shield	45	0
9016	Buffalo do. 4 in. 1 Blade, polished Blade	11	0
9017	Stag do. do. same pattern as 9016	12	0
9018	White Bone do. do. same pattern as 9016	11	6
9019½	Buffalo do. do. same pattern as 9016, Shield in Handle, Blade ornamtd.	12	6
8291	Stag do. do. 1 Blade	11	0
8291½	Do. do. do. same pattern as 8291, polished Blade	12	0
7554	Do. do. do. 1 Blade	10	8
7904	Buffalo do. do. same pattern as 7554	10	0
8290	Cocoa do. do. same pattern as 7554	9	6
8287	Buck do. do. same pattern as 7554	9	6
9439	Stag do. do. same pattern as 7554, with Pen Blade in addition	18	0
9061	Buffalo do. 4½ in. 1 Blade, polished Blade	12	0
9032	Stag do. do. same pattern as 9061	13	0
8843	Cocoa do. 4½ in. 1 Blade, very thick Handle, with hole in Head	13	6
9883	Stag do. 4 in. 1 Blade Budding Knife, Ivory Grafter to fold in Handle	28	0
9333	Do. do. do. Gardener's Pruning Knife	17	0
9332½	Do. do. do. do. 1 Blade Pruning Knife	17	0
9337	Do. do. 4½ in. do. do. do.	21	0
9335	Do. do. 4½ in. do. do. do.	18	6

MAPPIN BROTHERS,
 QUEEN'S CUTLERY WORKS—SHEFFIELD.

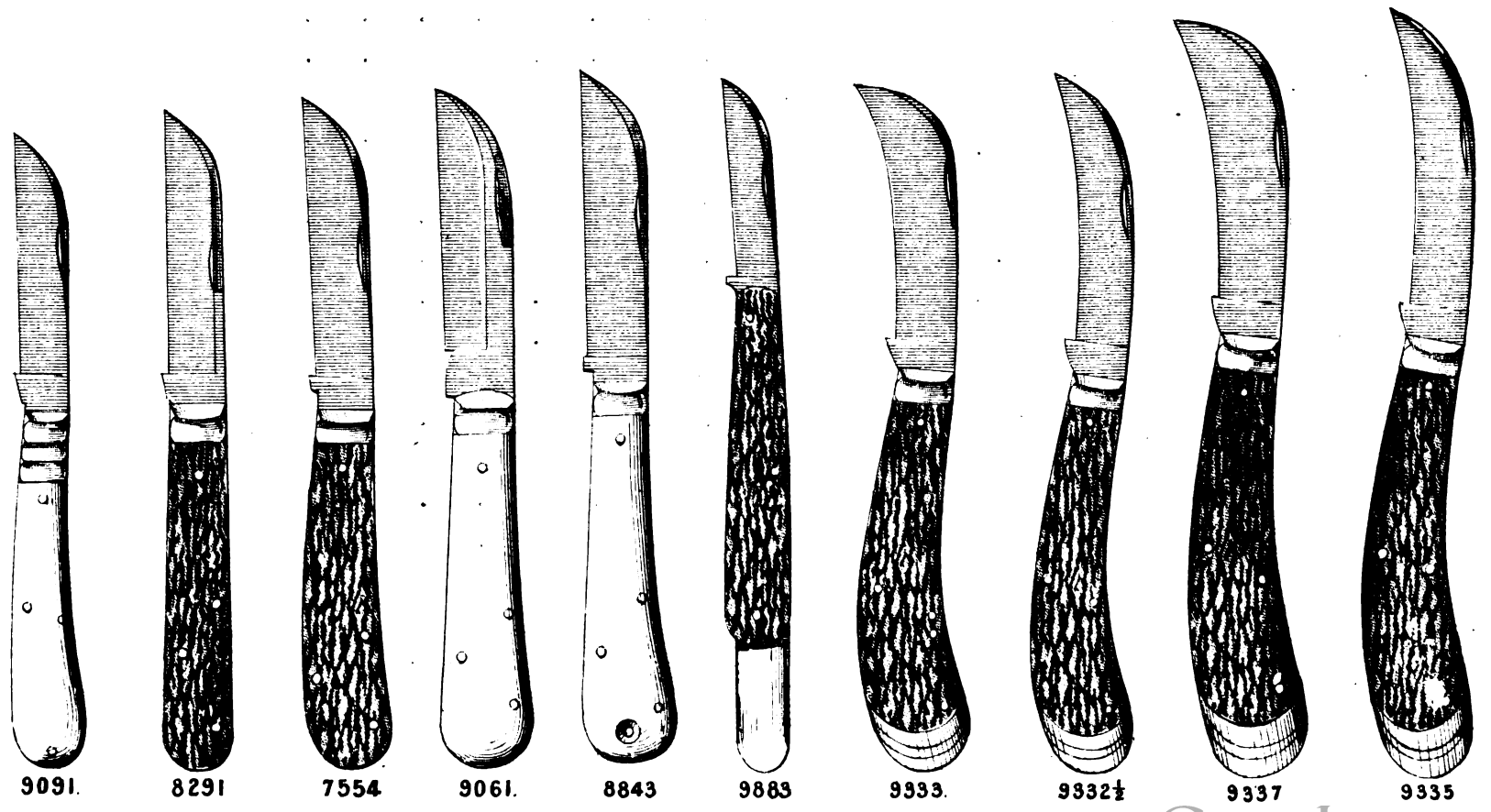
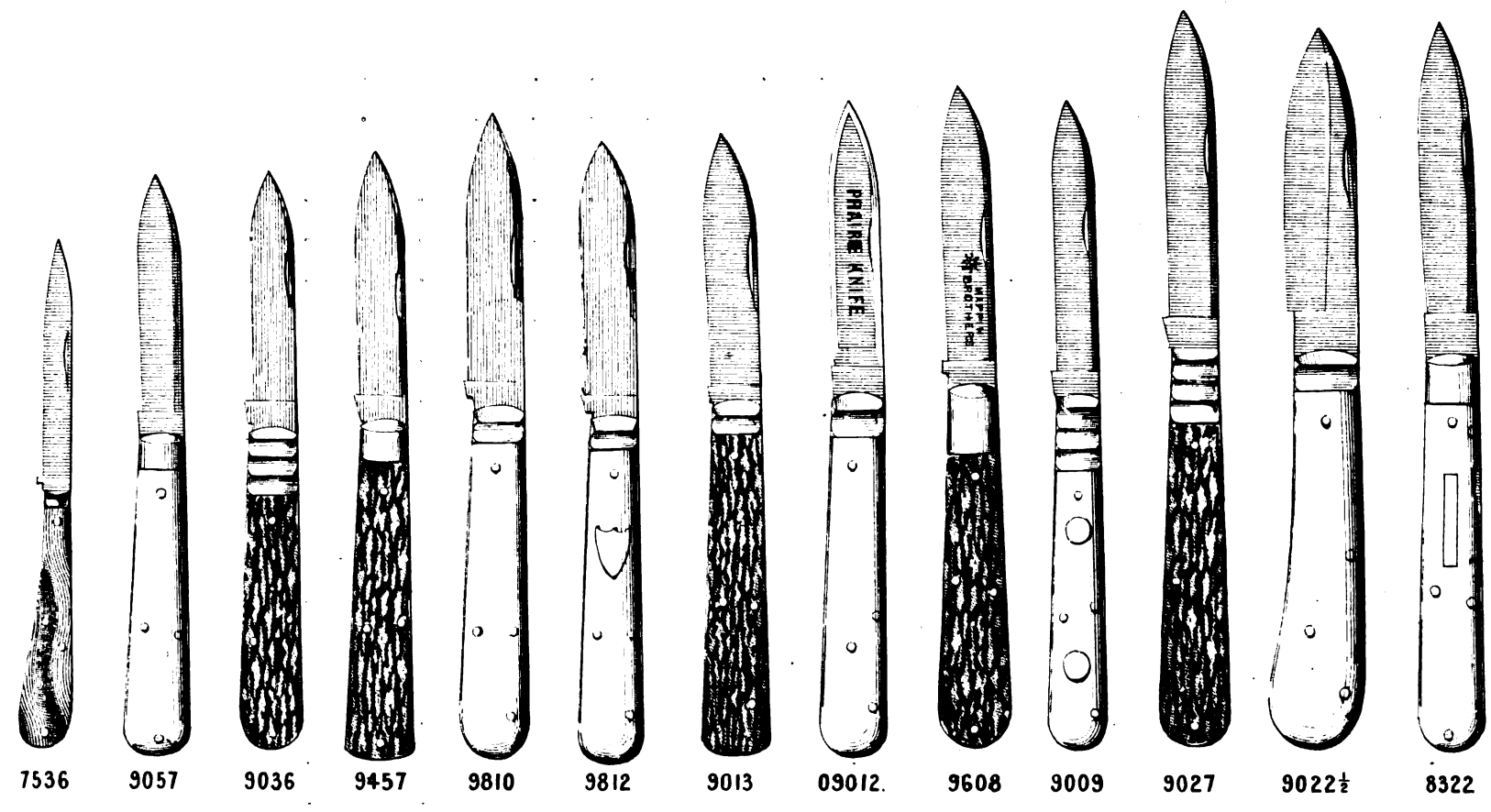
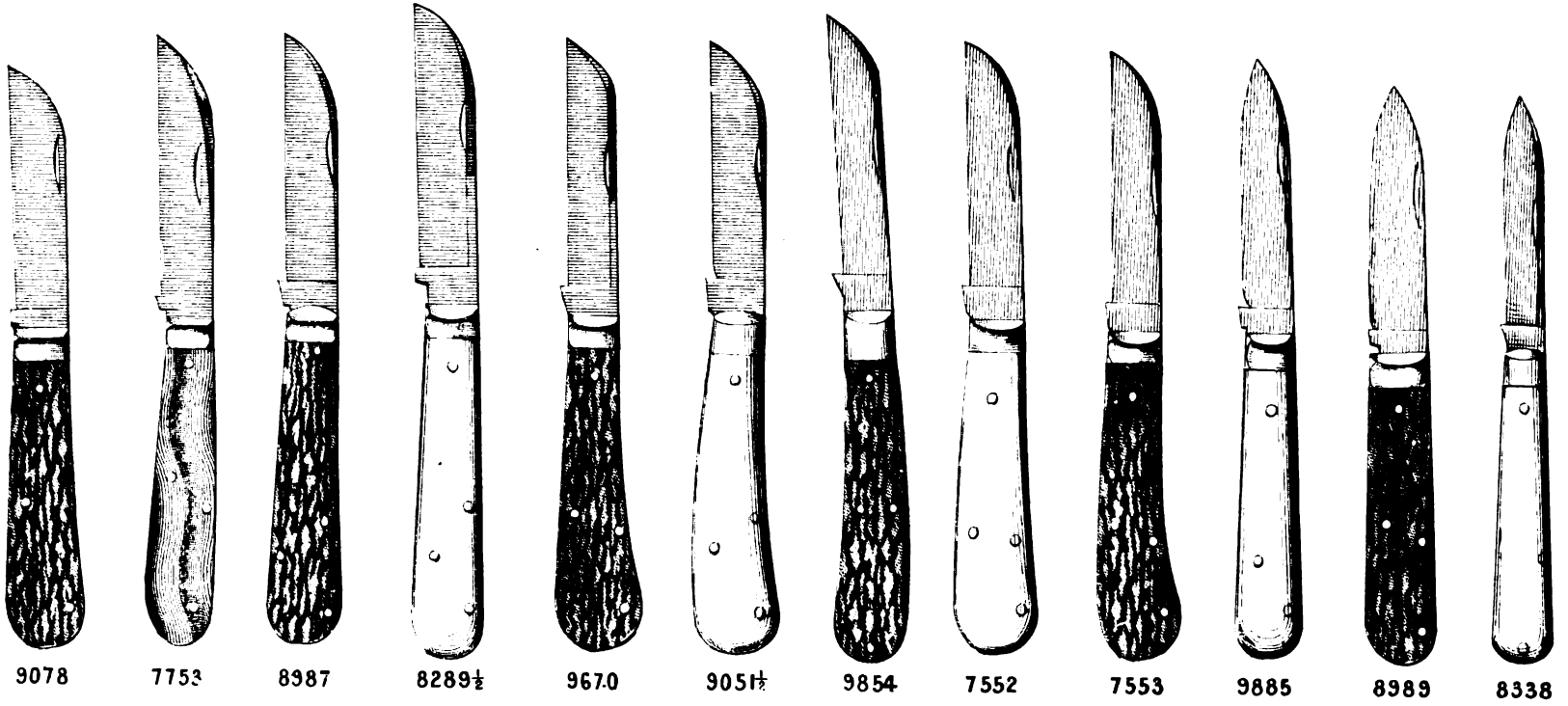

*Drawn half real size.
 Stock ready at the Warehouse*
 67 & 68 KING WILLIAM STREET CITY LONDON.

MAPPIN BROTHERS,
MANUFACTORY,
QUEEN'S CUTLERY WORKS, SHEFFIELD,
WAREHOUSE,
67 & 68, KING WILLIAM STREET, LONDON.

PRICES OF MAPPINS' CELEBRATED PRUNING AND BUDDING KNIVES.

For Drawings, see corresponding numbers on Plate.

EVERY BLADE OF THE VERY FIRST QUALITY.

									per doz.
									s. d.
7920	Stag Horn	3½ inch	Clasp Pruner	13 0
8067	Do.	3½ inch	do.	15 0
6355½	Do.	3½ inch	do.	with cap and polished blade	26 0
6348½	Do.	3½ inch	do.	do.	22 0
6349	Do.	4 inch	do.	do.	28 0
8188	Do.	do.	Clasp Budder	do.	26 8
8186	Do.	do.	Clasp Pruner	do.	28 0
8189	Do.	do.	do.	do.	26 8
8018½	Do.	do.	do.	do.	28 0
8018	Do.	do.	do.	do.	25 0
8190	Do.	do.	do.	do.	26 8
7561	Wood Handle	4½ inch	do.	with brass cap	21 0
7559	Stag Horn	4½ inch	do.	with steel cap	26 8
8192	Do.	4½ inch	do.	do.	32 0
7999½	Do.	4 inch	do.	do.	20 0
6635	Do.	4½ inch	Clasp Budder	17 0
7494	Do.	do.	Clasp Pruner	16 0
6172½	Do.	do.	Pruner, fast handle in sheath, with pin	13 0
6637	Do.	do.	Clasp Pruner, with Saw	33 0
8179	Do.	4½ inch	do.	steel cap	30 0
8191	Do.	4½ inch	Clasp Budder, steel cap	32 0
8181	Do.	do.	do.	17 0
8178	Do.	4½ inch	Clasp Pruner, steel cap	30 0
06580	Do.	4½ inch	do.	do.	File shoulder	.	.	.	35 0
7554	Do.	4 inch	Clasp Budder	do.	10 8
7785	Do.	do.	Spear Point Clasp Knife	10 8
7554½	Do.	4½ inch	Clasp Budder	13 0
07555	Buffalo Horn,	4½ inch	Spear Point Clasp Knife	11 0
8068	Ivory Handle,	4 inch	"Curtis's" Budding Knife, Polished Blade, Brass Lined	32 0
5685	Do.	5 inch	Clasp Budding Knife	28 0
05685	Do.	do.	do.	do.	Brass Lined and Polished Blades	.	.	.	32 0
8020	Do.	3½ inch	Clasp Rose Budding Knife	19 0
8021	White Bone,	5 inch	Budding Knife, with Sheath	13 0

The London Warehouse contains the Largest Stock of Cutlery in the World.

**JOSEPH MAPPIN AND BROTHERS,
QUEEN'S CUTLERY WORKS, SHEFFIELD.**

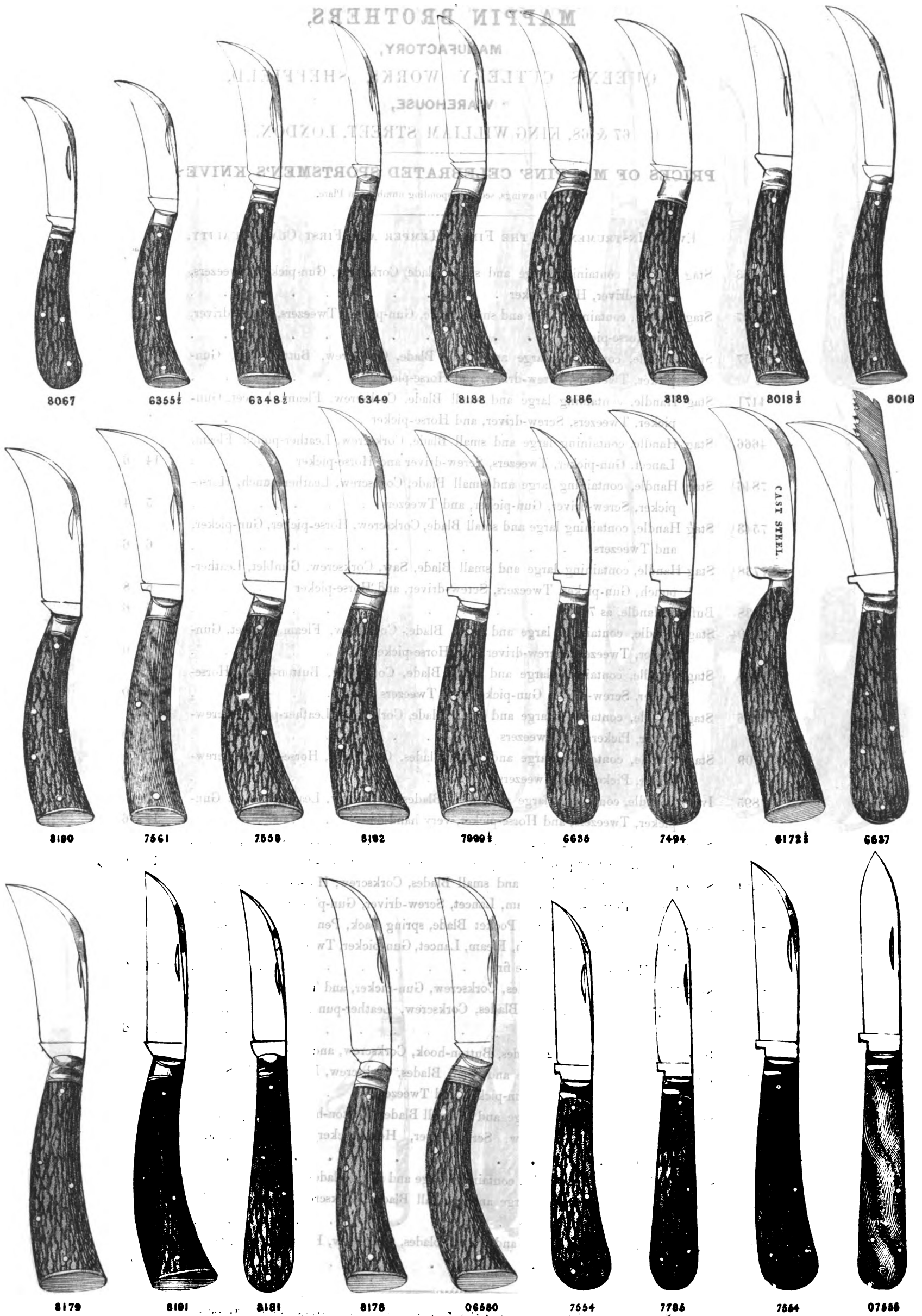

8067 6355 6348 6349 8188 8186 8189 8018 8018

8190 7561 7559 8192 7999 6636 7494 6172 6637

8179 8191 8181 8178 06580 7554 7786 7564 07556

Stock ready at the Warehouse.

67 & 68, KING WILLIAM ST. CITY, LONDON.

Digitized by Google

Drawn by J. G. ...

MAPPIN BROTHERS,**MANUFACTORY,****QUEEN'S CUTLERY WORKS, SHEFFIELD,****WAREHOUSE,****67 & 68, KING WILLIAM STREET, LONDON.****PRICES OF MAPPINS' CELEBRATED SPORTSMEN'S KNIVES.**

For Drawings, see corresponding numbers on Plate.

EVERY INSTRUMENT OF THE FINEST TEMPER AND FIRST CLASS QUALITY.		each.
		s. d.
4253	Stag Handle, containing large and small Blade, Corkscrew, Gun-picker, Tweezers, Screw-driver, Horse-picker	5 6
5427	Stag Handle, containing large and small Blade, Gun-picker, Tweezers, Screw-driver, and Horse-picker	4 0
5757	Stag Handle, containing large and small Blade, Corkscrew, Button-hook, Gun-picker, Tweezers, Screw-driver, and Horse-picker	11 6
4471	Stag Handle, containing large and small Blade, Corkscrew, Fleam, Lancet, Gun-picker, Tweezers, Screw-driver, and Horse-picker	9 6
4666	Stag Handle, containing large and small Blade, Corkscrew, Leather-punch, Fleam, Lancet, Gun-picker, Tweezers, Screw-driver and Horse-picker	14 6
7846½	Stag Handle, containing large and small Blade, Corkscrew, Leather-punch, Horse-picker, Screw-driver, Gun-picker, and Tweezers	5 4
7543½	Stag Handle, containing large and small Blade, Corkscrew, Horse-picker, Gun-picker, and Tweezers	6 6
7738½	Stag Handle, containing large and small Blade, Saw, Corkscrew, Gimblet, Leather-punch, Gun-picker, Tweezers, Screw-driver, and Horse-picker	6 8
7738	Buffalo Handle, as 7738½	6 6
7710½	Stag Handle, containing large and small Blade, Corkscrew, Fleam, Lancet, Gun-picker, Tweezers, Screw-driver, and Horse-picker	11 0
7888	Stag Handle, containing large and small Blade, Corkscrew, Button-hook, Horse-picker, Screw-driver, Gun-picker, and Tweezers	14 0
8086	Stag Handle, containing large and small Blade, Corkscrew, Leather-punch, Screw-driver, Picker, and Tweezers	4 0
7709	Stag Handle, containing large and small Blades, Corkscrew, Horse-picker, Screw-driver, Picker, and Tweezers	6 6
7895	Ivory Handle, containing large and small Blades, Corkscrew, Leather-punch, Gun-picker, Tweezers, and Horse-picker, very handsome	17 6
6645	Stag Handle, containing large and small Blades, Corkscrew, Horse-picker, Fleam, Lancet, Leather-punch, Gun-picker, Tweezers, and Screw-driver	18 6
6674	Stag Handle, containing large and small Blades, Corkscrew, Horse-picker, Leather-punch, Button-hook, Fleam, Lancet, Screw-driver, Gun-picker, and Tweezers	22 0
7686	Stag Handle, containing large Pocket Blade, spring back, Pen-blade, Button-hook, Corkscrew, Leather-punch, Fleam, Lancet, Gun-picker, Tweezers, Screw-driver, and Horse-picker to strike fire	24 0
7315	Stag Handle, containing 3 Blades, Corkscrew, Gun-picker, and Tweezers	10 6
7316	Buffalo Handle, containing 3 Blades, Corkscrew, Leather-punch, Gun-picker, and Tweezers	12 6
6555	Ivory Handle, containing 2 Blades, Button-hook, Corkscrew, and Gun-picker	10 0
6073½	Ivory Handle, containing large and small Blades, Corkscrew, Button-hook, Screw-driver, Leather-punch, Gun-picker, and Tweezers	15 0
6587	Stag Handle, containing 1 large and 2 small Blades, Button-hook, Fleam, Lancet, Leather-punch, Corkscrew, Screw-driver, Horse-picker, Gun-picker, and Tweezers	22 0
6094	Stag Handle Wharncliffe Knife, containing large and small Blades, and Cork-screw	6 8
7563	Ivory Handle, containing 1 large and 2 small Blades, Corkscrew, Leather-punch, Gun-picker, and Tweezers	16 6
6374	Stag Handle, containing 1 large and 2 small blades, Corkscrew, Fleam, Lancet, Gun-Picker, and Tweezers	15 0

The London Warehouse contains the Largest Stock of Cutlery in the World.

JOSEPH MAPPIN AND BROTHERS,
 QUEEN'S CUTLERY WORKS, SHEFFIELD



4253



5427



5757



4471

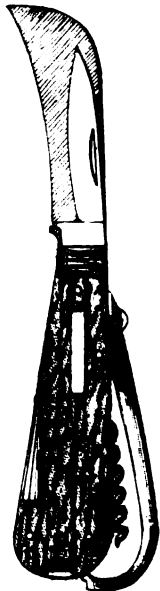

4666



7846 1/2



7543 1/2

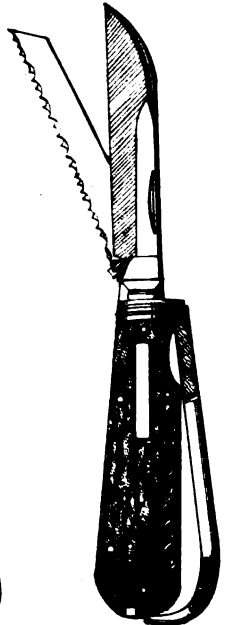

7738 1/2

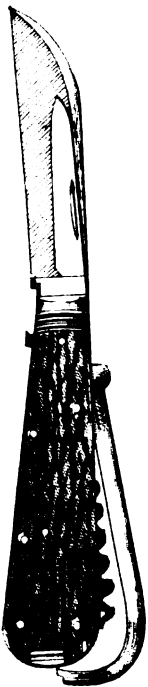

7710 1/2



7888



8086

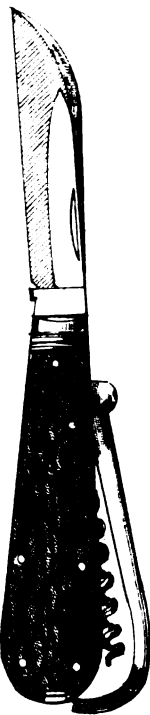

7709

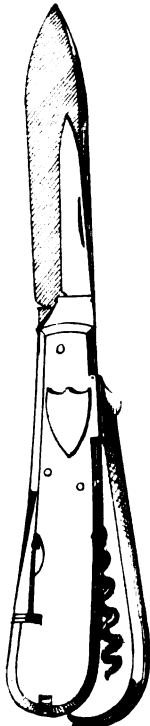

7895



6645



6674

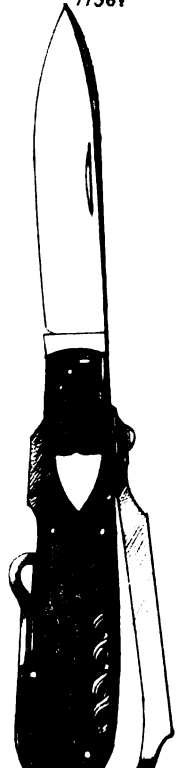

7686

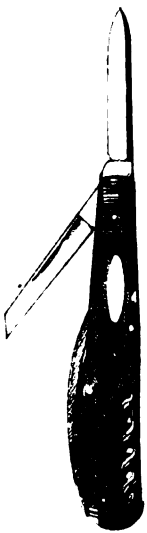

7915



7316

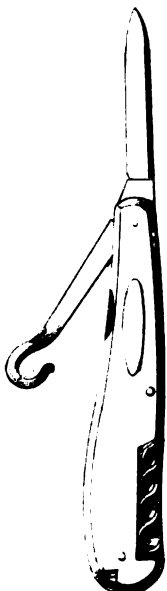

6555

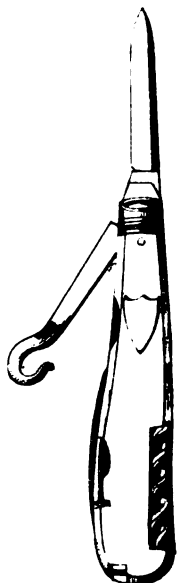

6073 1/2

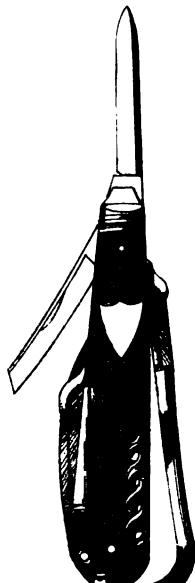

6587



6094

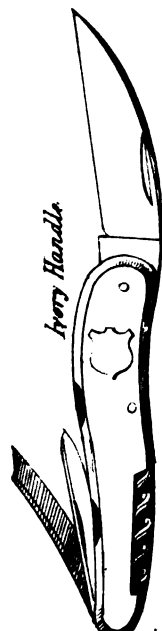

7563

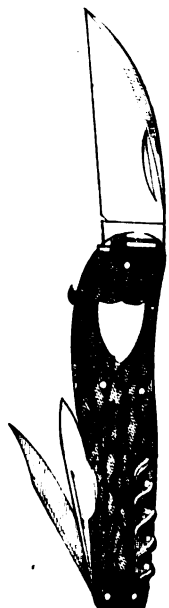

6374

Drawn half real size

AND AT 37, MOORGATE ST. CITY, LONDON.

MAPPIN BROTHERS,
MANUFACTORY,
QUEEN'S CUTLERY WORKS, SHEFFIELD,
WAREHOUSE,
67 & 68, KING WILLIAM STREET, LONDON.

PRICES OF MAPPINS' CELEBRATED SPORTSMEN'S KNIVES.

For Drawings, see corresponding numbers on Plate.

	each knife. s. d.
7414 Stag Handle, containing large and small Blade, Fleam, Saw, Button-hook, Horse-picker, Lancet, Picker, Tweezers, Screw-driver, Leather-punch, and Corkscrew	26 0
8023 Ivory Handle, containing large and small Blade and Corkscrew	5 0
6789 Stag Handle, containing large Blade and Corkscrew	5 0
7303 Ivory Handle, containing large and small Blade, Corkscrew, Picker, Screw-driver	8 6
6122 Stag Handle, containing large and small Blade, Button-hook, Leather-punch, Corkscrew, Lancet, Gun-picker, and Tweezers	15 0
6585 Stag Handle, with Lock Blade, Pen Blade, Leather-punch, Corkscrew, Lancet, Picker, and Tweezers	16 0
6586 Stag Handle, large and small Blade, Leather-punch, Gimblet, Corkscrew, Lancet, Picker, Tweezers, and Screw-driver	20 0
6875 Ivory Handle, Pocket and Pen Blade, Corkscrew, Leather-punch, Picker, and Tweezers	13 0
6609 Stag Handle, Spanish Lock, Pocket Blade, Pen Blade, Corkscrew, Lancet, Gun-picker, Tweezers, and Screw-driver	14 0
7421 Ivory Handle, Spanish Lock Knife, with Corkscrew	8 0
7756 Stag Handle, 5-inch do. no Corkscrew	3 8
6467 Stag Handle, Spanish Lock Blade, Pen Blade, Button-hook, Corkscrew, Leather-punch, Lancet, Gun-picker, Tweezers, and Screwdriver	24 0
8035 Stag Handle, Lock Blade, Pen Blade, Corkscrew, Button-hook, Leather-punch, Lancet, Picker, Tweezers, and Screw-driver	22 0
7481 Stag Handle, Pocket and Pen Blade, Screw-driver, Leather-punch, Button-hook, Corkscrew, Gimblet, Horse-picker, Lancet, Gun-picker, and Tweezers	30 0
7572 Stag Handle, Pocket and Pen Blade, Fleam, Nail Blade, Button-hook, Leather-punch, Screw-driver, Horse-picker, Gimblet, Corkscrew, Lancet, Gun-picker, and Tweezers	30 0
6434 Ivory Handle, large Blade, Pen and Nail Blades, Button-hook, Screw-driver, Leather-punch, Gimblet, Corkscrew, Gun-picker, and Tweezers	24 0
7349 Stag Handle, Pocket and Pen Blade, Button-hook, Leather-punch, Nipple-wrench, Corkscrew, Horse-picker, Nut-cracker, Lancet, Picker, Tweezers, and Screw-driver	28 0
6673 Stag Handle, Lock Spear Blade, Pen Blade, Button-hook, Leather-punch, Corkscrew, Gimblet, Lancet, Picker, Tweezers, Screw-driver, and Nail blade	24 0

The London Warehouse contains the Largest Stock of Cutlery in the World.

MAPPIN BROTHERS.
 QUEEN'S CUTLERY WORKS SHEFFIELD.

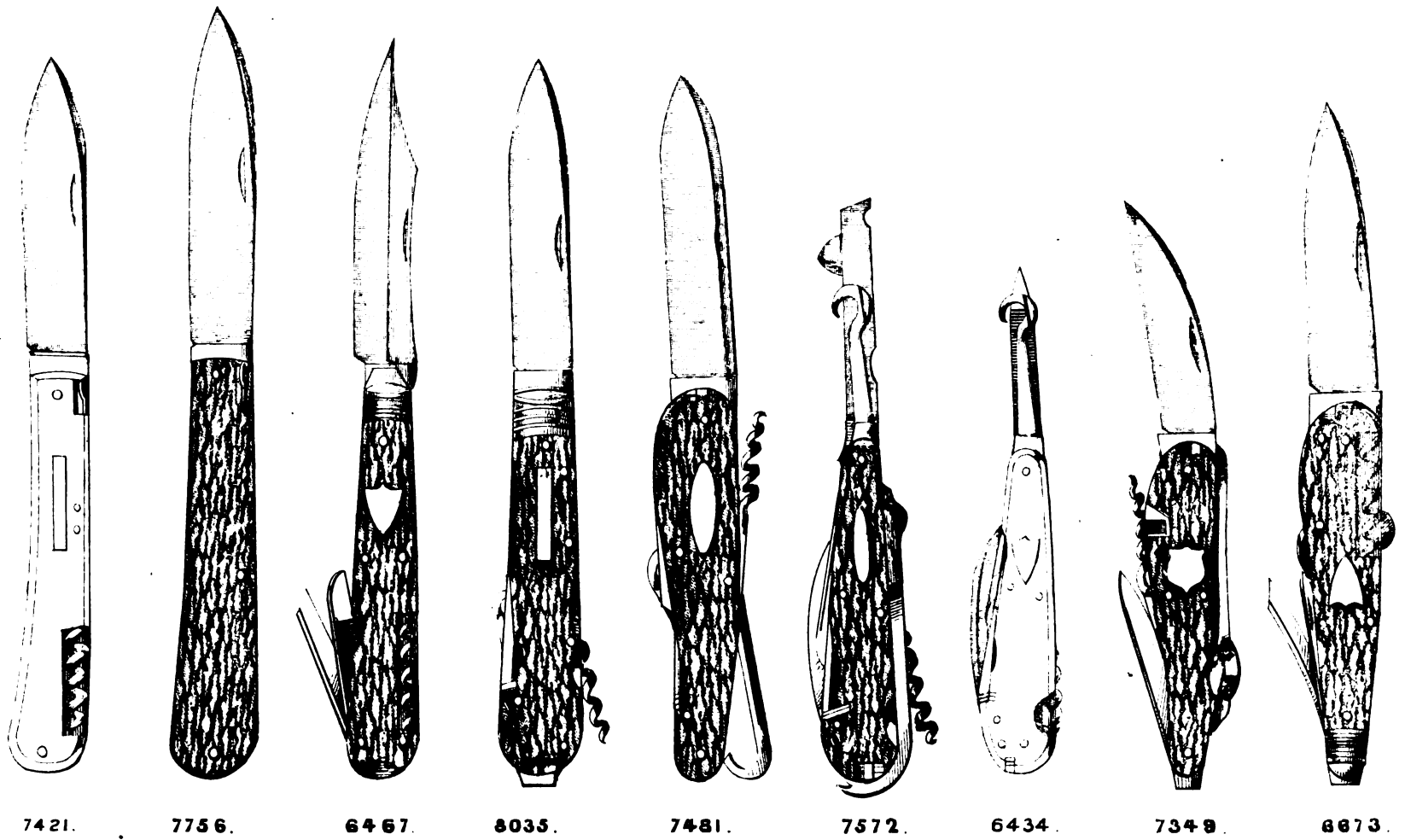
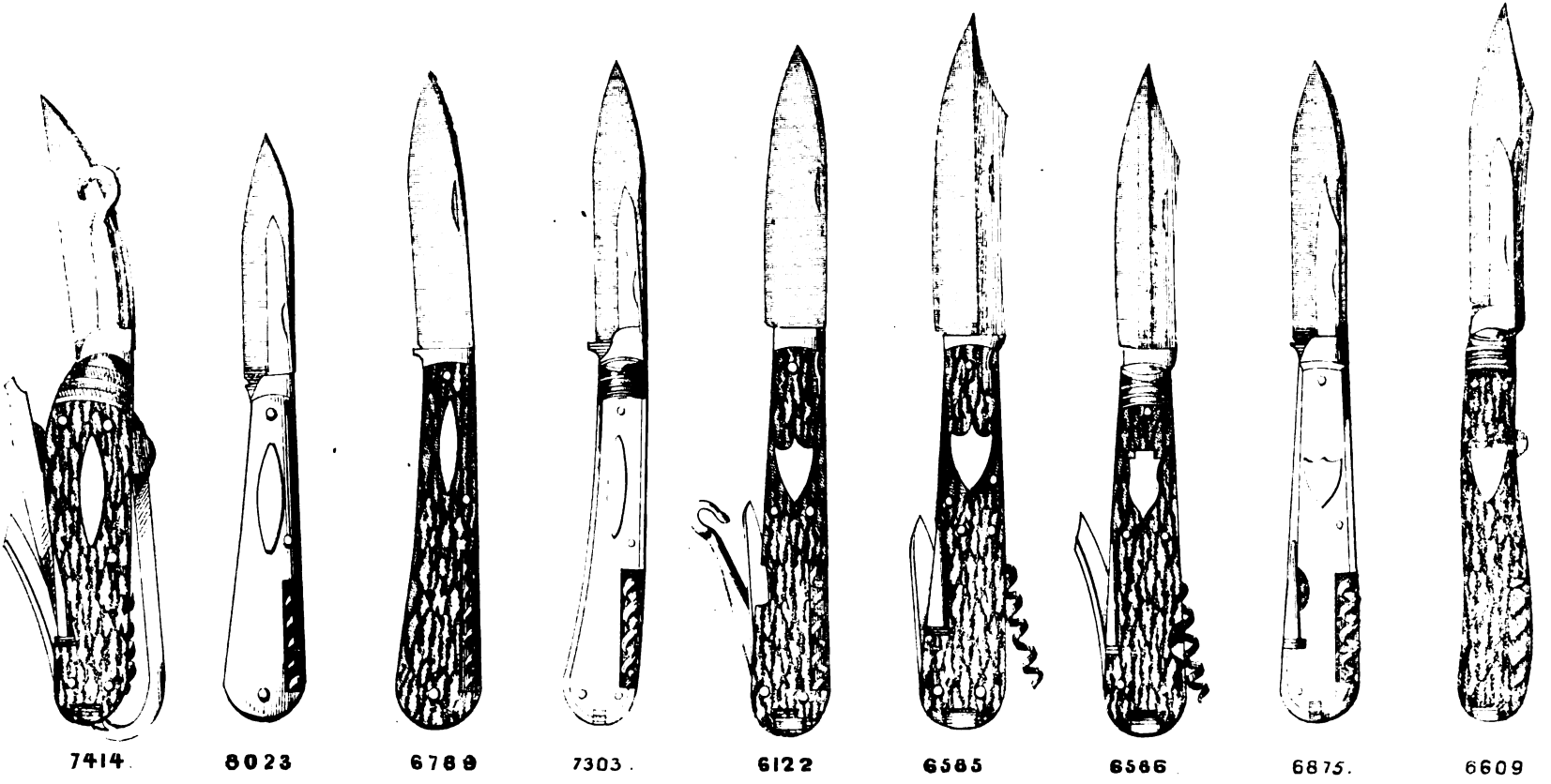

Stock ready at the Warehouse.

67 & 68 KING WILLIAM ST CITY LONDON.

Drawn half real size.

MAPPIN BROTHERS,
MANUFACTORY,
QUEEN'S CUTLERY WORKS, SHEFFIELD,
WAREHOUSE,
67 & 68, KING WILLIAM STREET, LONDON.

PRICES OF MAPPINS' CELEBRATED DIRK AND HUNTING KNIVES.

For Drawings, see corresponding numbers on Plate.

		each knife. s. d.
6105	Stag Handle, 5 inch, Fly-open Dagger Knife, Lock-spring	12 6
8875	Do. do. do. do. do. do. do. with Guard	14 6
7200	Do. do. 5½ inch, Hunting Knife, containing large Blade, Lock-spring, Lancet, Scissors, Corkscrew, Button-hook, Leather-punch, Gun-picker, and Tweezers .	32 0
8091	Stag Handle, 6 inch, Rollo Hunting Knife, Lock-spring	7 0
7994	Ivory do. do. Fly-open Self-defence Knife, very handsome	22 0
8396	Do. do. Hunting Knife, with Sheath, very strong, containing large Corkscrew, Button-hook, Lancet, Gun-picker, and Tweezers	24 0
8395½	Stag Handle, as 8396	21 0
7195	Do. do. 6 inch Fly-open Dagger and Self-defence Knife	16 6
7207	Ivory do. 5 inch do. do. do. do. do.	16 0
7185½	Do. do. 4¾ inch slides in two pieces, one piece containing the Knife, the other piece containing the Plated Fork and Corkscrew	10 0
7814	Ivory Handle, 4¾ inch, slides in two pieces, one piece containing the Knife and Corkscrew, the other piece containing the Fork and German Silver Spoon .	12 0
8300	Stag Handle, 4 inch, Angling Knife, containing large Blade, Pen Blade, Scissors and Disgorger	16 0
8397	Ivory Handle, 4¾ inch, containing large Blade, Pen-blade, Button-hook, Corkscrew, Sacking-needle, Leather-punch, Nail-file, Gimblet, Screw-driver, Lancet, Gun- picker, and Tweezers	33 0
8468	Stag Handle, 6 inch, Hunting Knife, very strong Pocket Blade, Corkscrew, Button- hook, Leather-punch, Horse-picker, Screw-driver, Gun-picker, and Tweezers .	15 0
7725	Stag Handle, 4½ inch, Sportsman's Knife, containing large Blade, small Blade, Saw, Button-hook, Nail-file, Needle, Disgorger, Corkscrew, Leather-punch, Gimblet, Screw-driver, Horse-picker, Scissors, Lancet, Gun-picker, and Tweezers . . .	42 0
6905	Stag Handle, 4½ inch, Norfolk Knife, containing large Blade, small Blade, Nail-file, Needle, Button-hook, Corkscrew, Leather-punch, Gimblet, Screw-driver, Lancet, Horse-picker, Tweezers, and Gun-picker	25 0
8306	Ivory Handle, 3½ inch, containing large Blade, Spanish Lock-spring, two small Blades, Corkscrew, Button-hook, Gun-picker, and Tweezers	14 0

The London Warehouse contains the Largest Stock of Cutlery in the World.

JOSEPH MAPPIN AND BROTHERS,
 QUEEN'S CUTLERY WORKS, SHEFFIELD.

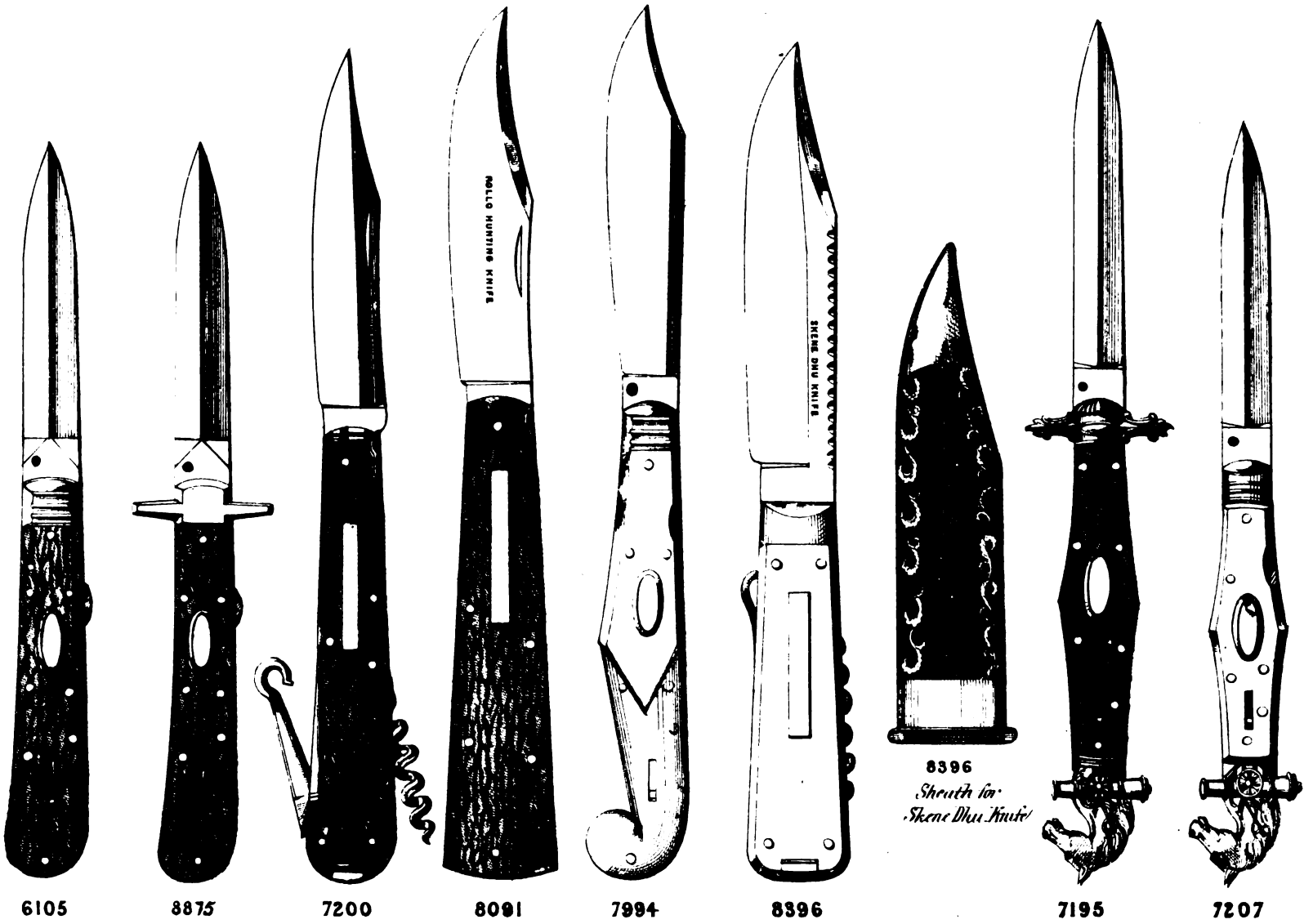

8396
*Sheath for
 'Stene Blu Knife'*

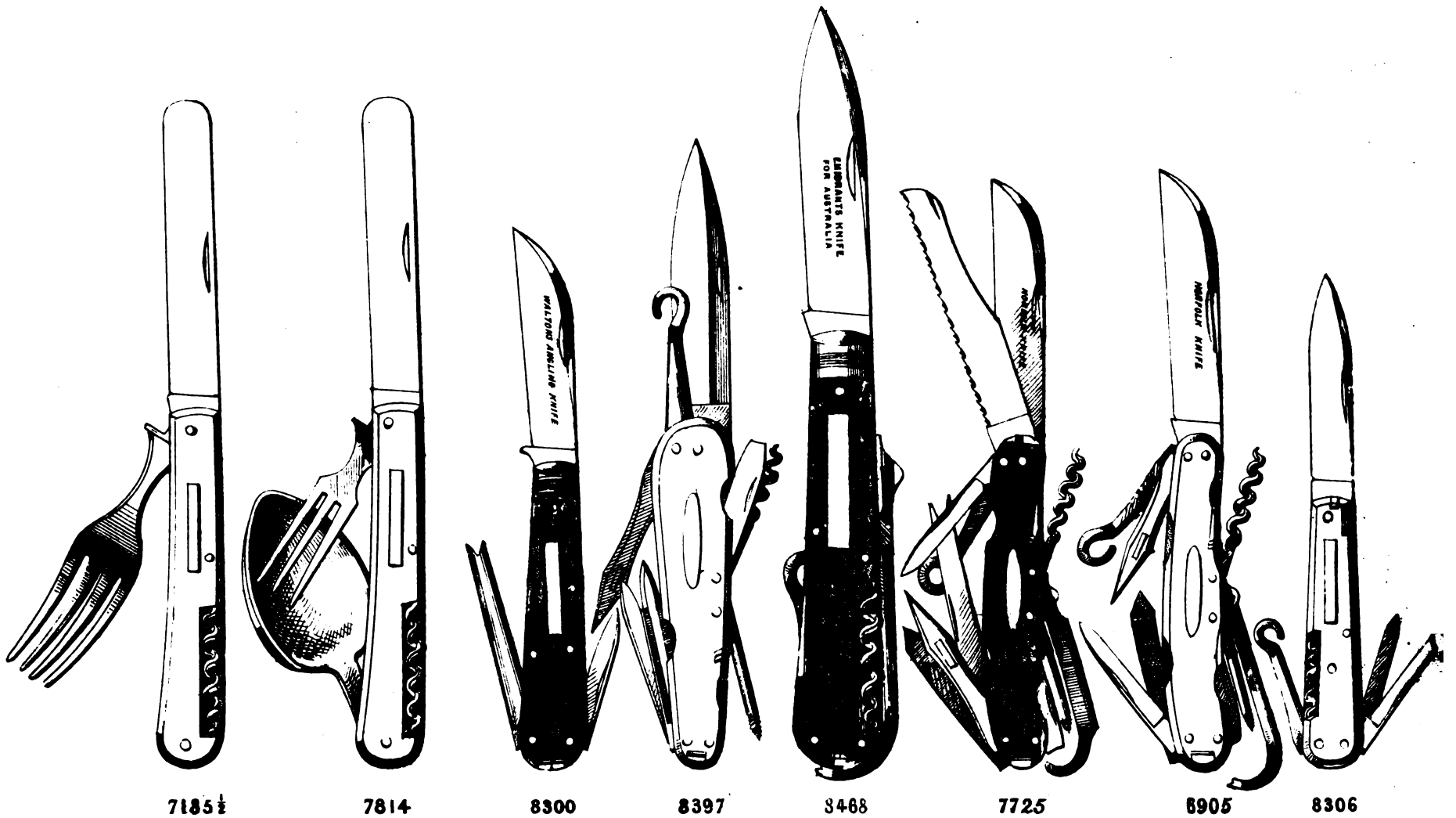

*Drawn half real size.
 Stock ready at the Warehouse*

67 & 68 KING WILLIAM STREET, CITY, LONDON.

MAPPIN BROTHERS,
MANUFACTORY,
QUEEN'S CUTLERY WORKS, SHEFFIELD,
WAREHOUSE,
67 & 68, KING WILLIAM STREET, LONDON.

PRICES OF MAPPINS' CELEBRATED STEEL SCISSORS.

For Drawings, see corresponding numbers on Plate.

		per doz.	
		s.	d.
S203	4 $\frac{1}{4}$ inch Cutting-out Scissors, polished	10	0
S 74	4 $\frac{1}{2}$ inch Work do. glazed	9	0
S265	4 $\frac{3}{4}$ inch do. do. do.	8	6
S516 $\frac{1}{2}$	4 $\frac{1}{2}$ inch Draper's do. do.	13	0
S138	Do. do. do. polished	17	0
S135	5 inch do. do. glazed	15	0
S574	3 $\frac{1}{2}$ inch Work do. do.	11	0
S575	3 $\frac{3}{4}$ inch Embroidering do. do.	11	0
S576	Do. Nail do. do.	12	0
<hr/>			
S577	3 $\frac{1}{2}$ inch Button-hole Scissors, glazed	13	0
S577 $\frac{1}{2}$	4 $\frac{1}{2}$ inch Work do. do.	11	0
S578	5 $\frac{1}{2}$ inch Cutting-out do. do.	16	0
S579	6 $\frac{1}{2}$ inch do. do. do.	21	0
S586	3 $\frac{1}{2}$ inch Work do. do.	9	0
S587	4 $\frac{1}{2}$ inch do. do. do.	9	6
S588	5 inch Cutting-out do. do.	11	0
S589	5 $\frac{1}{2}$ inch do. do. do.	14	0
S590	6 inch do. do. do.	16	0
<hr/>			
S591	6 $\frac{1}{2}$ inch Cutting-out Scissors, glazed	19	0
S659	3 $\frac{1}{2}$ inch Embroidering do. polished	30	0
S660	3 $\frac{1}{2}$ inch Button-hole do. do.	32	0
S661	3 $\frac{3}{4}$ inch Nail do. do.	30	0
S662	4 $\frac{1}{2}$ inch Work do. do.	30	0
S663	5 $\frac{1}{2}$ inch Cutting-out do. do.	42	0
S664	6 $\frac{1}{2}$ inch do. do. do.	56	0
S671	3 $\frac{3}{4}$ inch Embroidering do. do.	28	0
S672	4 $\frac{1}{2}$ inch Work do. do.	28	0
<hr/>			
S673	5 inch Cutting-out Scissors, polished	32	0
S674	5 $\frac{1}{2}$ inch do. do. do.	40	0
S675	6 inch do. do. do.	44	0
S676	7 inch do. do. do.	60	0
S442	4 $\frac{1}{2}$ inch Work do. do.	28	0
S441	5 $\frac{1}{2}$ inch Cutting-out do. do.	36	0
S440	6 $\frac{1}{2}$ inch do. do. do.	48	0
S151	5 $\frac{1}{2}$ inch do. do. do.	22	0

The London Warehouse contains the Largest Stock of Cutlery in the World.

JOSEPH MAPPIN AND BROTHERS,
 QUEEN'S CUTLERY WORKS, SHEFFIELD.

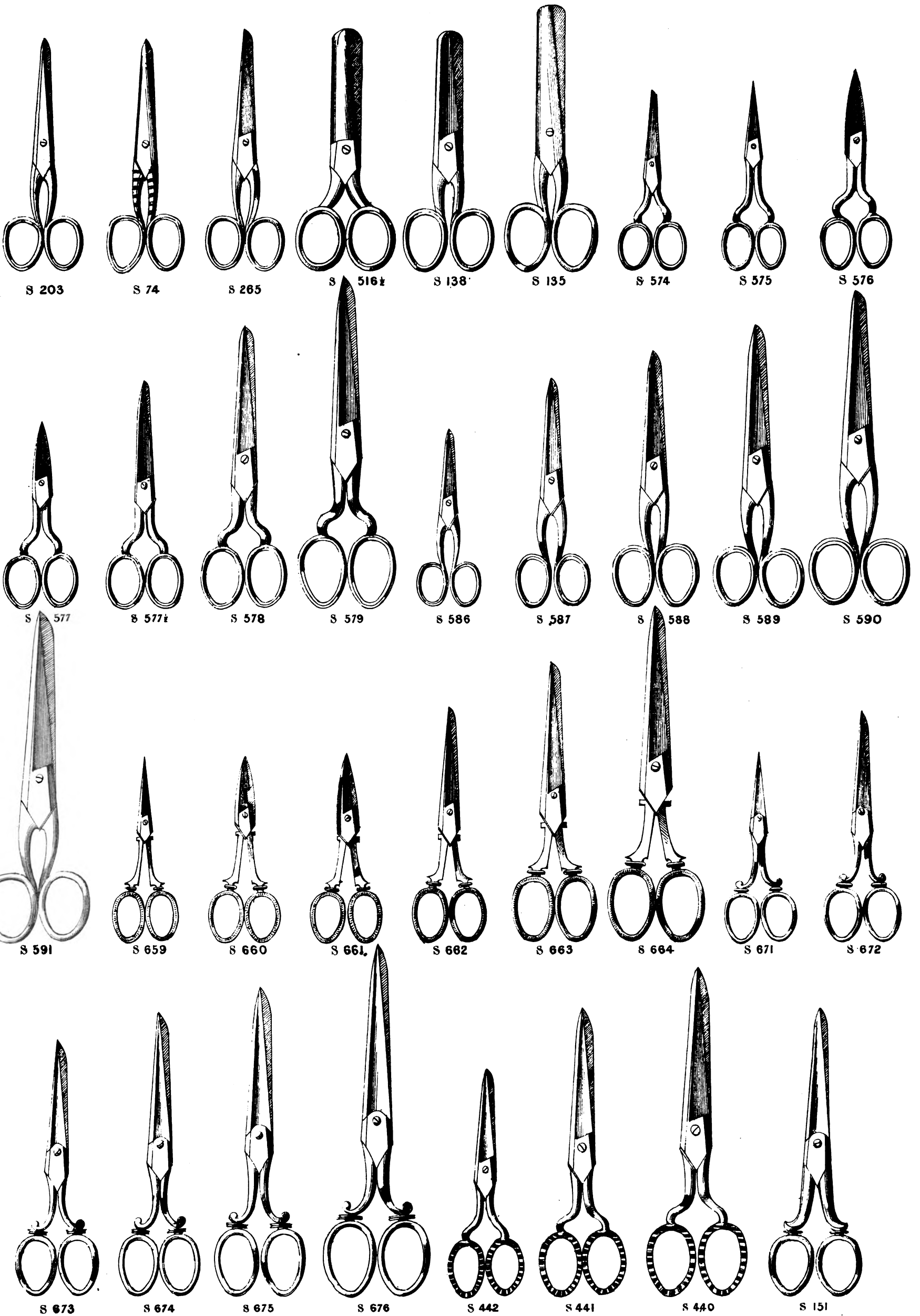

Drawn half real size.

AND AT 37 MOORCATE STREET LONDON

MAPPIN BROTHERS,
MANUFACTORY,
QUEEN'S CUTLERY WORKS, SHEFFIELD,
WAREHOUSE,
67 & 68, KING WILLIAM STREET, LONDON.

PRICES OF MAPPINS' CELEBRATED STEEL SCISSORS.

For Drawings, see corresponding numbers on Plate.

										per doz.
										s. d.
S646	4½ inch	Lady's Work	Scissors,	polished	18 6
S647	Do.	do.	do.	do.	18 0
S 91	Do.	do.	do.	do.	15 0
S649	Do.	do.	do.	do.	16 0
S497	3½ inch	Button-hole	do.	do.	16 0
S498	3¾ inch	Nail	do.	do.	15 0
S500	4½ inch	Lady's Work	do.	do.	14 0
S501	5 inch	Cutting-out	do.	do.	16 0
S502	5½ inch	do.	do.	do.	19 0
S503	6½ inch	do.	do.	do.	28 0
<hr/>										
S562	3½ inch	Button-hole	Scissors,	glazed	14 0
S563	3¾ inch	Nail	do.	do.	13 0
S564	4½ inch	Lady's Work	do.	do.	12 0
S565	5 inch	Cutting-out	do.	do.	14 0
S566	5½ inch	do.	do.	do.	17 0
S567	6½ inch	do.	do.	do.	24 0
S624	5 inch	do.	do.	polished	16 0
S630	6 inch	do.	do.	do.	26 0
<hr/>										
S439	3¾ inch	Embroidering	Scissors,	polished	22 0
S438½	Do.	Button-hole	do.	do.	24 0
S439½	Do.	Nail	do.	do.	23 0
S438	4½ inch	Lady's Work	do.	do.	22 0
S437	5½ inch	Cutting-out	do.	do.	32 0
S436	6½ inch	do.	do.	do.	40 0
S635	Do.	do.	do.	do.	35 0
S637	7 inch	do.	do.	do.	36 0

The London Warehouse contains the Largest Stock of Cutlery in the World.

JOSEPH MAPPIN AND BROTHERS,
 QUEEN'S CUTLERY WORKS, SHEFFIELD.

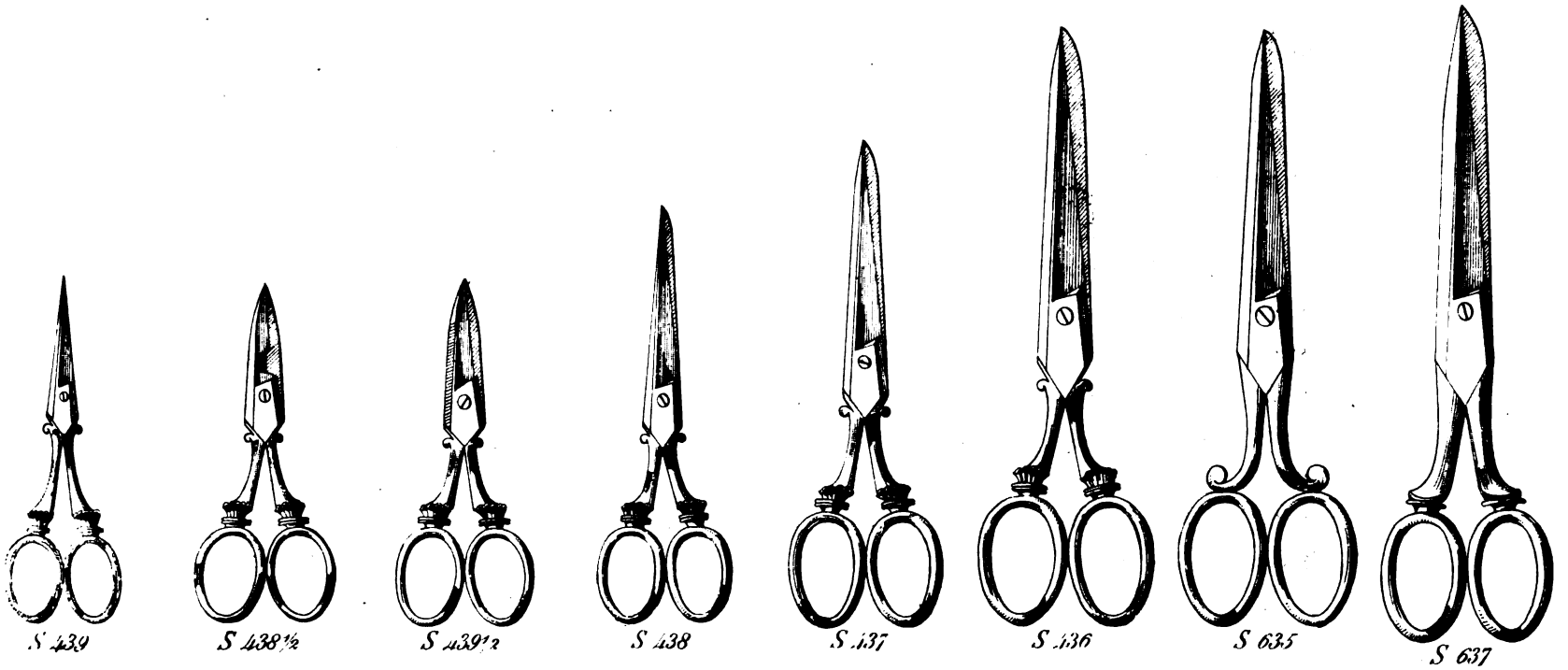
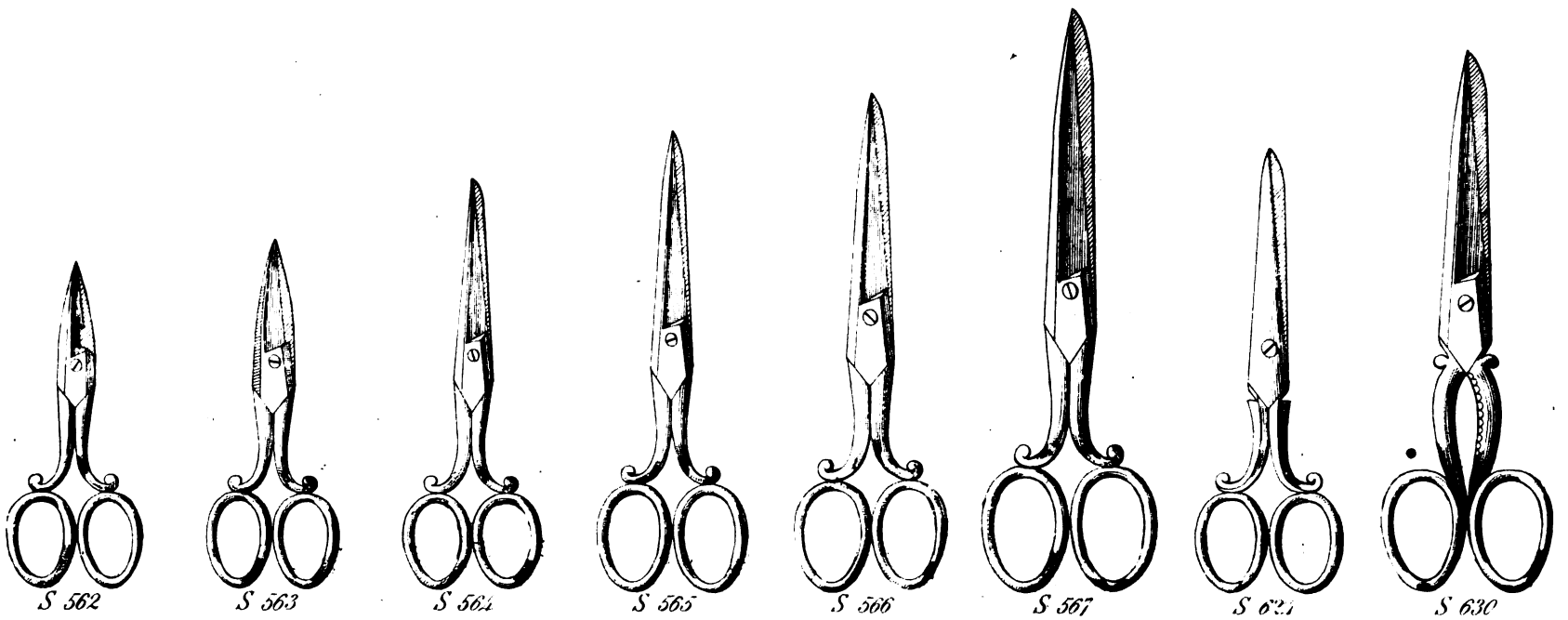
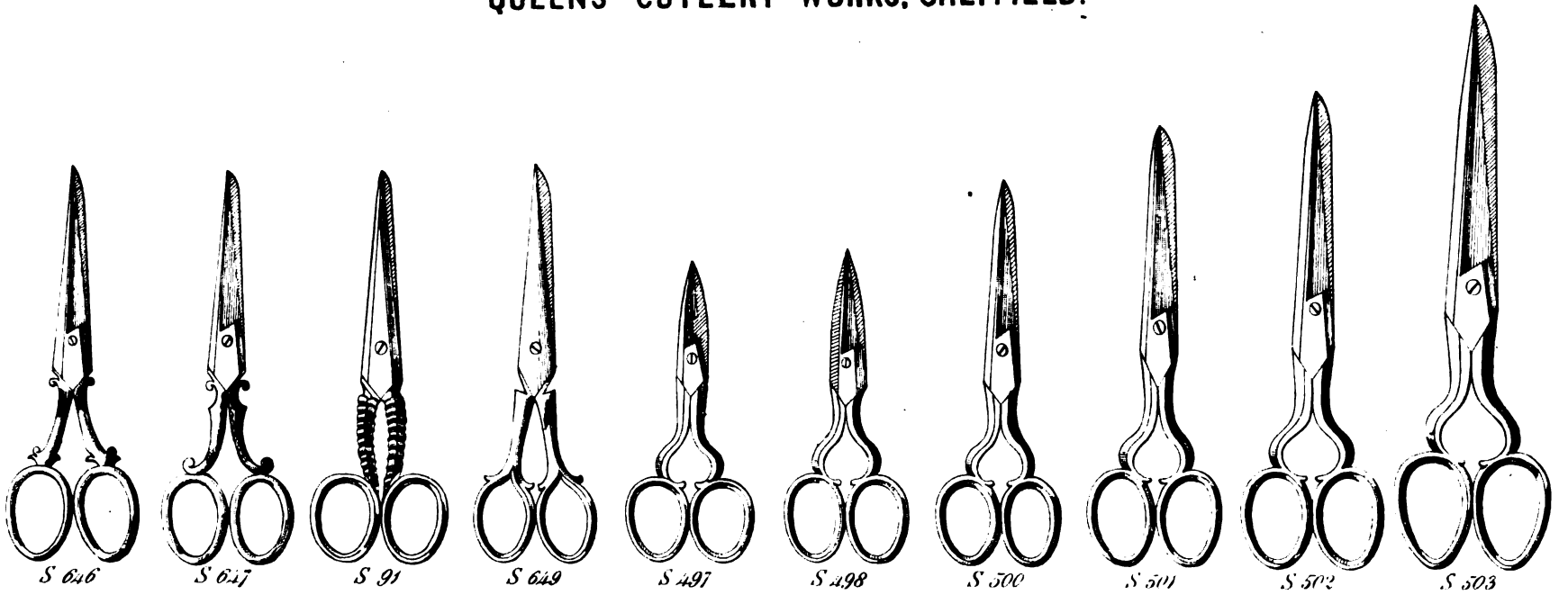

*Drawn half real size.
 Stock ready at the Warehouse.*

67 & 68 KING WILLIAM STREET CITY LONDON.

MAPPIN BROTHERS,
MANUFACTORY,
QUEEN'S CUTLERY WORKS, SHEFFIELD,
WAREHOUSE,
67 & 68, KING WILLIAM STREET, LONDON.

PRICES OF MAPPINS' CELEBRATED STEEL SCISSORS.

For Drawings, see corresponding numbers on Plate.

		per doz.
		s. d.
S616	Fine-pointed Scissors, polished	30 0
S622	Button-hole do. do.	34 0
S623	Nail do. do.	30 0
S618	Lady's Work-table Scissors, polished	30 0
S620	Do. 5½ inch Cutting-out Scissors, polished	40 0
S621	Do. 6½ inch do. do. do.	54 0
<i>The above form a set of six Scissors of one pattern.</i>		
S613	Lady's Work Scissors, polished	36 0
S614	Do. 5½ inch Cutting-out Scissors, polished	46 0
S615	Do. Cutting-out Scissors, polished	68 0
S026	6½ inch Cutting-out Scissors, glazed	18 6
S 35	Do. Barber's Hair-cutting Scissors	16 0
S568	3¼ inch Nail Scissors, glazed	10 0
S569	4½ inch Lady's do. do.	9 6
S570	5 inch do. Work Scissors, glazed	11 0
S571	5½ inch Cutting-out do. do.	14 0
S572	6 inch do do. do.	16 0
S573	6½ inch do. do. do.	20 0
S 74½	4½ inch Lady's Work Scissors, glazed	8 6
S 22	5 inch do. do. do.	9 0
S 24	Do. do. do. do.	10 6
S153	5½ inch Cutting-out Scissors, polished	22 0
S258	6 inch do. do. do.	20 0
S216½	Do. do. do. do.	10 6
S 28	Do. do. do. do.	12 6
S309	Do. Horse do. do.	10 6

The London Warehouse contains the Largest Stock of Cutlery in the World.

JOSEPH MAPPIN AND BROTHERS,
 QUEEN'S CUTLERY WORKS, SHEFFIELD.

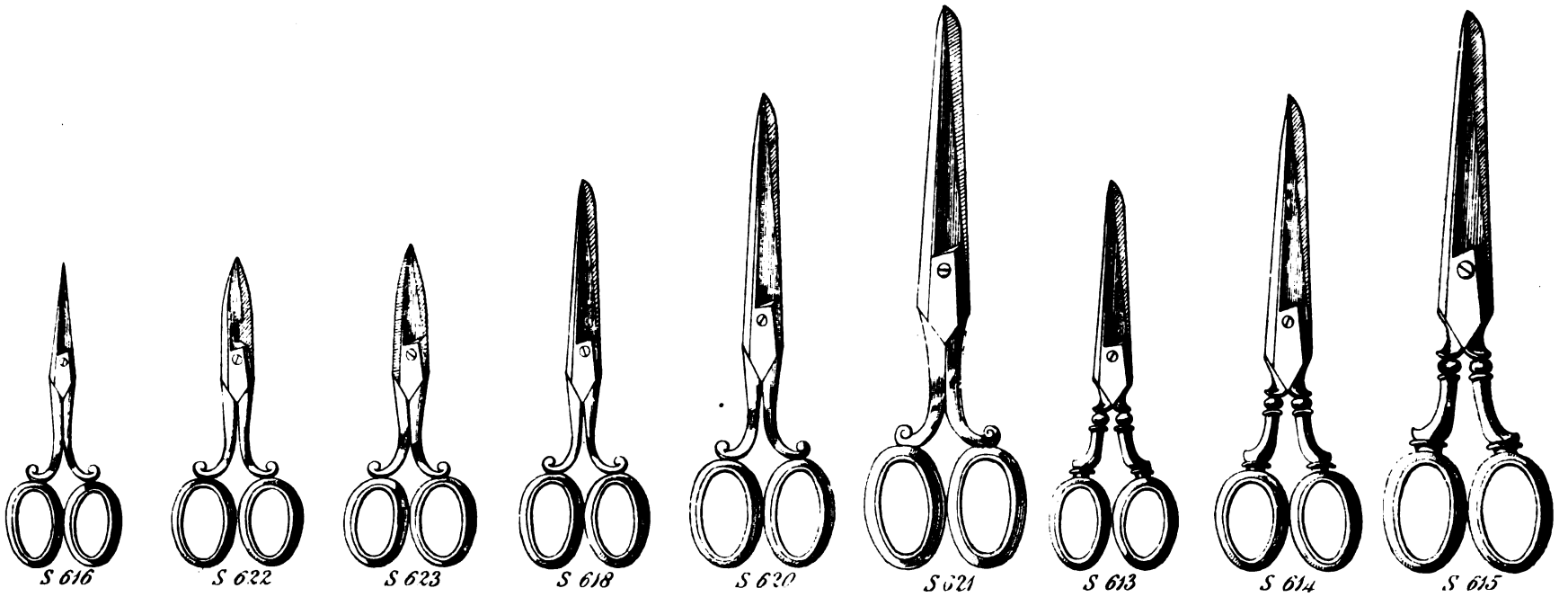

Drawn half real size.

AND AT 37, MOORGATE ST. CITY, LONDON.

MAPPIN BROTHERS,
MANUFACTORY, QUEEN'S CUTLERY WORKS, SHEFFIELD,
WAREHOUSE, 67 & 68, KING WILLIAM STREET, LONDON.

PRICES OF MAPPINS' CELEBRATED STEEL SCISSORS.

For Drawings, see corresponding numbers on Plate.

									per doz.
									s. d.
S325	2½ inch	Embroidering	Scissors, polished	28 0
S419	2¾ inch	do.	do. do.	24 0
S546	3⅜ inch	do.	do. do.	28 0
S175	3½ inch	Lady's Work	do. do.	28 0
273L	Do.	Lace Point	do. do.	32 0
S176	Do.	Embroidering	do. do.	26 0
S404	Do.	do.	do. do.	26 0
S406	Do.	do.	do. do.	38 0
S156	3¾ inch	do.	do. do.	26 0
S429½	Do.	do.	do. do.	42 0
<hr/>									
S423	3¾ inch	Embroidering	Scissors, polished	30 0
S549	Do.	do.	do. do.	34 0
S183	3 inch	Lace Pointed	do. do.	28 0
S108	Gentlemen's	Pocket Nail	do.	40 0
S168	3¾ inch	Embroidering	do. do.	28 0
S409	3½ inch	do.	do. do.	32 0
S410	Do.	do.	do. do.	44 0
S650	Do.	do.	do. do.	56 0
S159	4 inch	do.	do. do.	54 0
S559	3¾ inch	do.	do. do.	24 0
<hr/>									
S186	3½ inch	Lace Pointed	Scissors, polished	18 0
S529	Do.	do.	do. do.	14 0
S554	3¾ inch	Embroidering	do. do.	16 0
S555	3½ inch	Lady's Work	do. do.	18 0
S556	3¾ inch	Embroidering	do. do.	20 0
S558	3¼ inch	do.	do. do.	18 0
S 07	3½ inch	Lady's Work	do. glazed	7 0
S189	Do.	do.	do. do.	6 8
S187	Do.	do.	do. polished	11 6
S173	Do.	Embroidering	do. do.	10 0
<hr/>									
S581	3½ inch	Embroidering	Scissors, polished	12 6
S561	3¾ inch	do.	do. glazed	11 0
S654	3 inch	do.	do. polished	14 0
S 77½	Do.	do.	do. do.	14 0
S163	3¾ inch	do.	do. do.	13 6
S148	Do.	Draper's Pocket	do. do.	11 0
S143	4½ inch	do.	do. do.	9 6
S134	4¾ inch	Strong Draper's	do. glazed	13 0
S709	4½ inch	do.	do. do.	11 0
<hr/>									
S141	5 inch	Round Point Shop	Scissors, polished	18 0
S142½	Do.	Flower Gatherer's	do. do.	22 0
S142	6 inch	do.	do. do.	28 0
S0142	7 inch	do.	do. do.	34 0
S0142½	6 inch	do.	do. do.	44 0
S 73	4½ inch	Work	do. glazed	6 0
S205	5 inch	Cutting-out	do. do.	9 0
S253	Do.	do.	do. do.	10 0
S 6	Do.	do.	do. polished	16 0
S 23	Do.	do.	do. do.	12 8
S195	4½ inch	Women's Work	do. glazed	7 6
S198	Do.	do.	do. do.	7 0
S 5	Do.	do.	do. do.	10 0

The London Warehouse contains the Largest Stock of Cutlery in the World.

JOSEPH MAPPIN AND BROTHERS,
 QUEEN'S CUTLERY WORKS, SHEFFIELD.

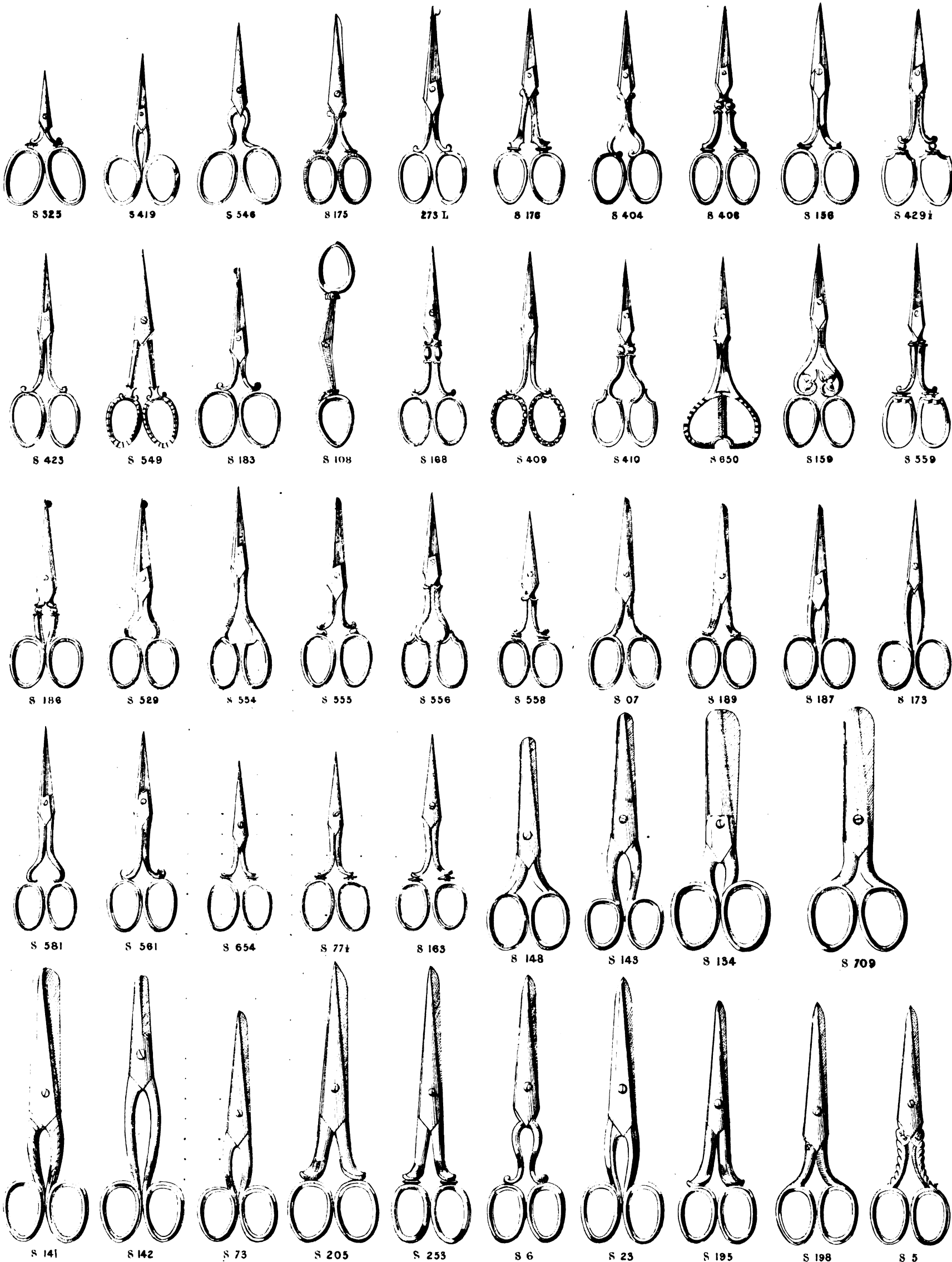

*Drawn full real Size
 Stock ready at the Warehouse*

67 & 68 KING WILLIAM STREET, CITY, LONDON.

MAPPIN BROTHERS,
MANUFACTORY,
QUEEN'S CUTLERY WORKS, SHEFFIELD,
WAREHOUSE,
67 & 68, KING WILLIAM STREET, LONDON.

PRICES OF MAPPINS' CELEBRATED STEEL SCISSORS.

For Drawings, see corresponding numbers on Plate.

										per doz.
S110	3½ inch	Nail Scissors,	bent blade	40 0
S114	Do.	do.	do.	50 0
S245½	Do.	Lady's Work	Scissors,	polished.	32 0
S415	4 inch	Embroidering	do.	do.	40 0
S390½	4½ inch	Lady's Work	do.	do.	28 0
S240¾	4 inch	do.	do.	do.	28 0
S418	Do.	do.	do.	do.	40 0
S493	4¼ inch	do.	do.	do.	38 0
S471	4½ inch	do.	do.	do.	28 0
S248	Do.	do.	do.	do.	26 0
<hr/>										
S245	4½ inch	Lady's Work	Scissors,	polished.	32 0
S 11	Do.	do.	do.	do.	25 0
S342½	4¼ inch	do.	do.	do.	58 0
S226	4½ inch	do.	do.	do.	28 0
S392	Do.	do.	do.	do.	54 0
S428	4¼ inch	do.	do.	do.	44 0
S394	4½ inch	do.	do.	do.	26 0
S389	Do.	do.	do.	do.	30 0
S391	Do.	do.	do.	do.	32 0
S 1	Do.	do.	do.	do.	26 0
<hr/>										
S244	4½ inch	Lady's Work	Scissors,	polished.	18 0
S 8	Do.	do.	do.	do.	11 6
S 16	Do.	do.	do.	do.	11 6
S229	Do.	do.	do.	do.	9 6
S639	4 inch	do.	do.	do.	17 0
S640	4½ inch	do.	do.	do.	16 0
S641	Do.	do.	do.	do.	16 0
S642	Do.	do.	do.	do.	16 0
S101	Do.	do.	do.	do.	16 0
S645	4 inch	do.	do.	do.	20 0
<hr/>										
S427	4½ inch	Lady's Work	Scissors,	polished.	30 0
S399	5 inch	Cutting-out	do.	do.	30 0
S234½	Do.	do.	do.	do.	28 0
S251	Do.	do.	do.	do.	32 0
S656	Do.	do.	do.	do.	46 0
S 36½	5½ inch	do.	do.	do.	38 0
S257	Do.	do.	do.	do.	38 0
S475	5 inch	do.	do.	do.	42 0
S474	Do.	do.	do.	do.	42 0
S 57	Do.	do.	do.	do.	26 0

The London Warehouse contains the Largest Stock of Cutlery in the World.

JOSEPH MAPPIN AND BROTHERS,
 QUEEN'S CUTLERY WORKS, SHEFFIELD.

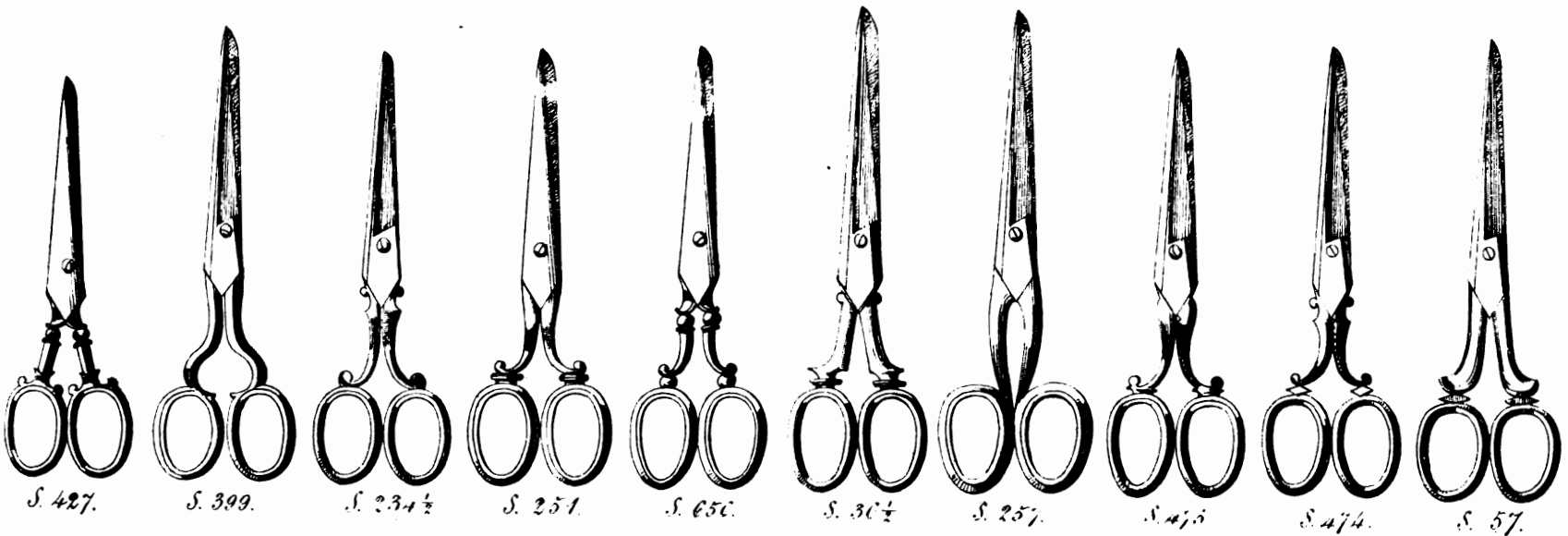
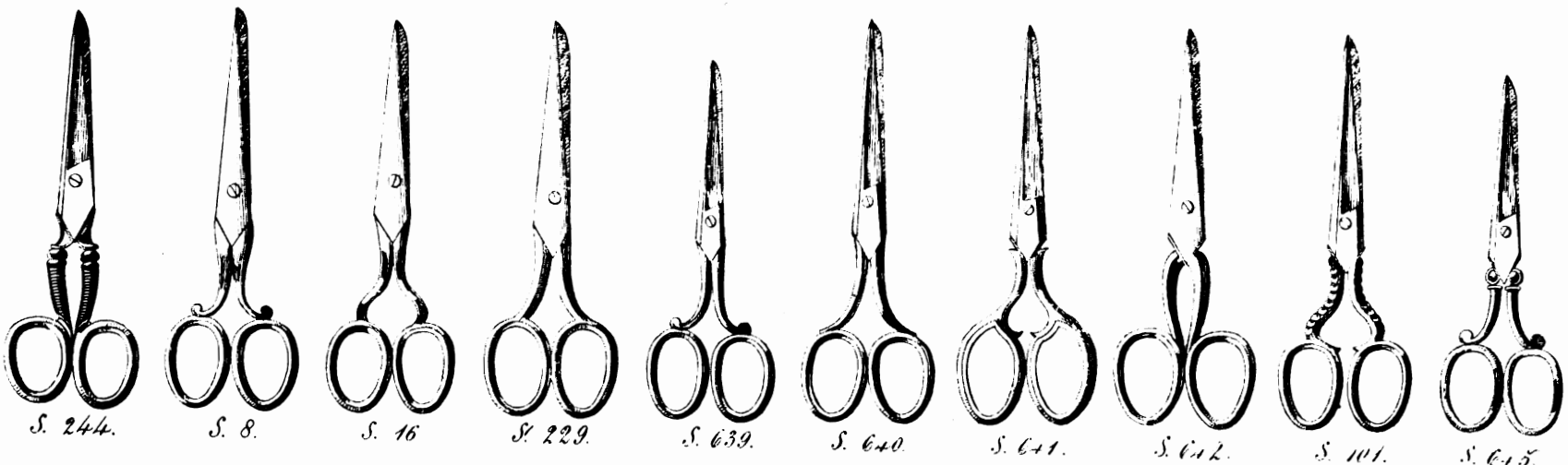
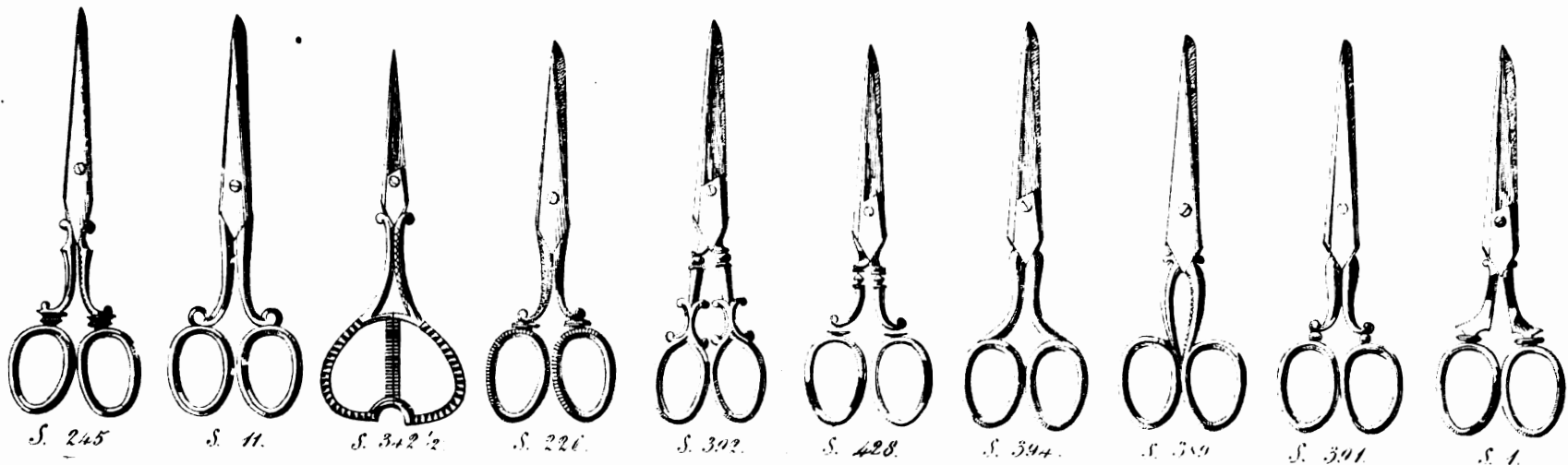
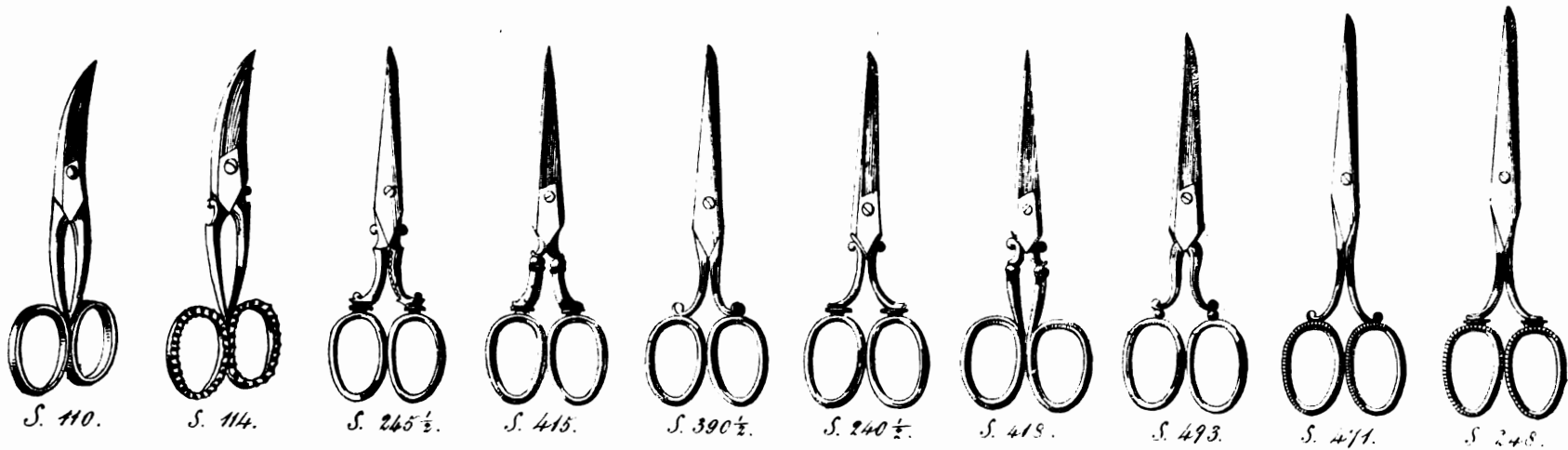

Drawn half real size.

Stock ready at the Warehouse.

67 & 68 KING WILLIAM STREET, CITY, LONDON.

MAPPIN BROTHERS,
MANUFACTORY,
QUEEN'S CUTLERY WORKS, SHEFFIELD,
WAREHOUSE,
67 & 68, KING WILLIAM STREET, LONDON.

PRICES OF MAPPINS' CELEBRATED STEEL SCISSORS.

For Drawings, see corresponding numbers on Plate.

								per doz.
								s. d.
S633	7 inch Cutting-out Scissors, polished	33 0
S634	Do. do. do. do.	44 0
S302	{ 8 inch Paper do. do.	40 0
	{ 7 inch do. do. do.	28 0
	{ 9 inch do. do. do.	56 0
S304	{ 8 inch do. do. glazed	20 0
	{ 9 inch do. do. do.	28 0
	{ 10 inch do. do. do.	36 0
	{ 11 inch do. do. do.	48 0
	{ 12 inch do. do. do.	66 0
S305	8 inch Hatter's do. do.	32 0
S 40	6½ inch Cutting-out do. polished	44 0
S223	7 inch do. do. do.	48 0
S299	{ 6½ inch Horse-clipping do. glazed	14 0
	{ 7 inch do. do. do.	16 0
S354	{ 6½ inch Pruning do. do.	24 0
	{ 7 inch do. do. do.	30 0
	{ 8 inch do. do. do.	38 0
S307½	5½ inch Lamp do. do.	16 0
S278	Do. do. do. with Guard	20 0
S312	6 inch do. do. do.	22 0
S321	{ 7 inch Bent Shank and Bent Blade Horse-clipping Scissors	40 0
	{ 6½ inch do. do. do. do.	36 0
S300	{ 6½ inch Bent Blade Horse-clipping Scissors	28 0
	{ 7 inch do. do. do.	32 0
S306	{ 6½ inch Bent Shank Horse-clipping Scissors	18 0
	{ 7 inch do. do. do.	20 0
S678	{ 8½ inch Bent Blade Horse-clipping Scissors, Bows covered with Leather	56 0
	{ 7½ inch do. do. do. do. do.	48 0
S682	{ 8 inch Bent Shank and Bent Blade Horse-clipping Scissors, Bows covered with Leather	60 0
	{ 7 inch do. do. do. do. do. do.	52 0
S308	{ 7 inch Tailor's Scissors	14 0
	{ 7½ inch do. do.	18 0
	{ 8 inch do. do.	20 0
	{ 8½ inch do. do.	24 0
	{ 9 inch do. do.	30 0
	{ 9½ inch do. do.	36 0
	{ 10 inch do. do.	44 0
	{ 10½ inch do. do.	50 0
{ 11 inch do. do.	60 0	

. Scissors are measured from the smallest Bow to the Point.

The London Warehouse contains the Largest Stock of Cutlery in the World.

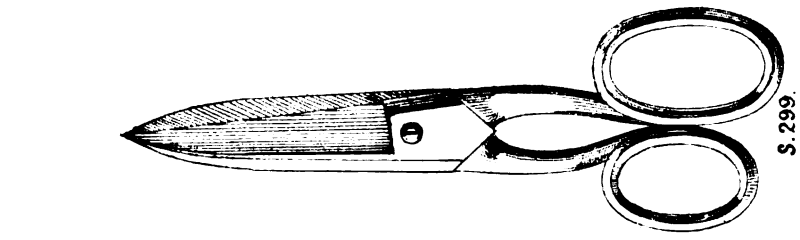

S. 299.

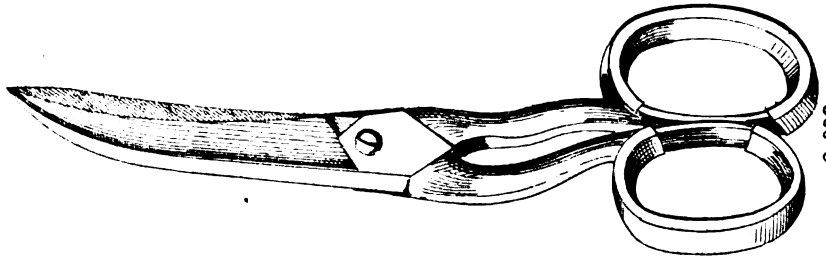

S. 682.

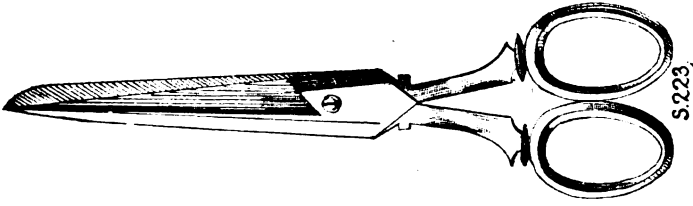

S. 223.

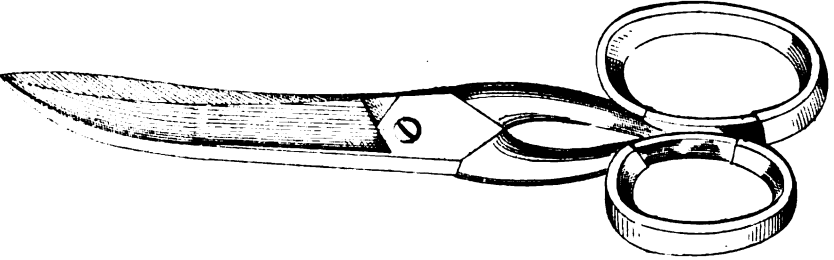

S. 678.

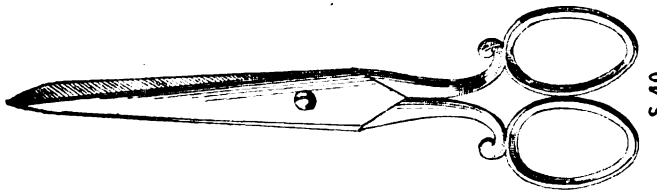

S. 40.

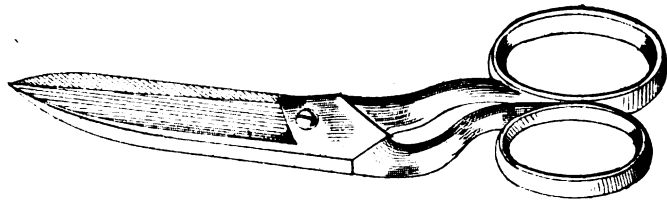

S. 306.

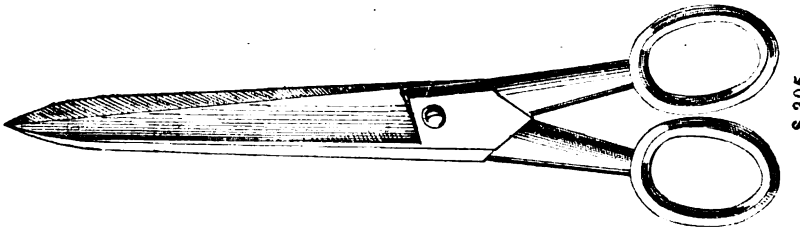

S. 305.

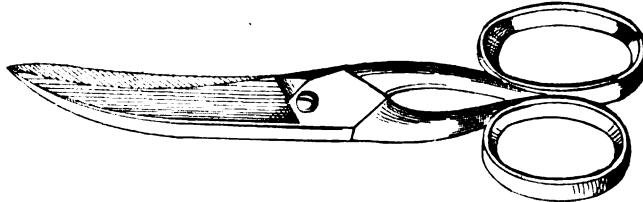

S. 300.

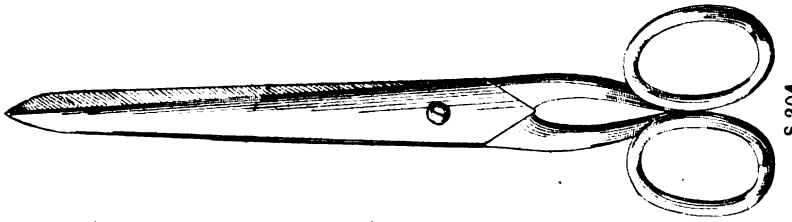

S. 304.

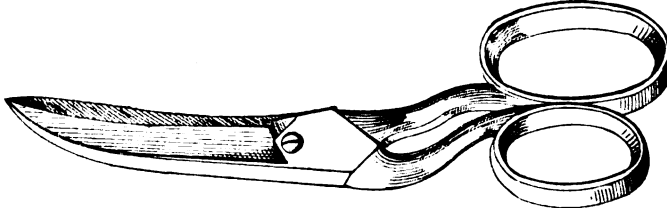

S. 921.

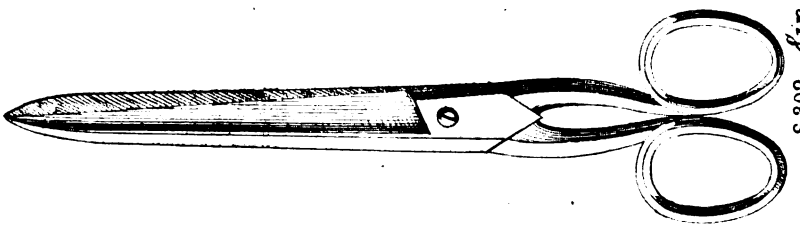

S. 302.

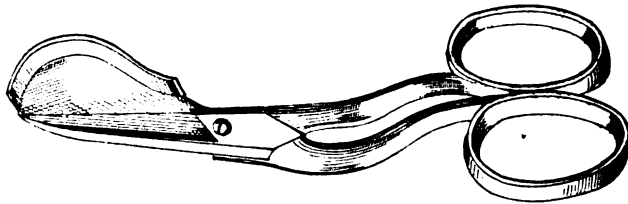

S. 312.

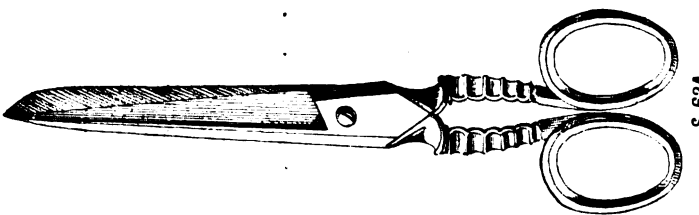

S. 634.

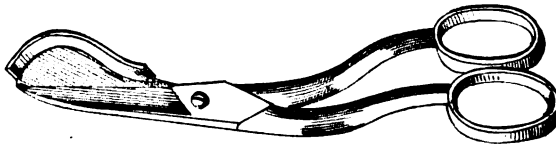

S. 278.

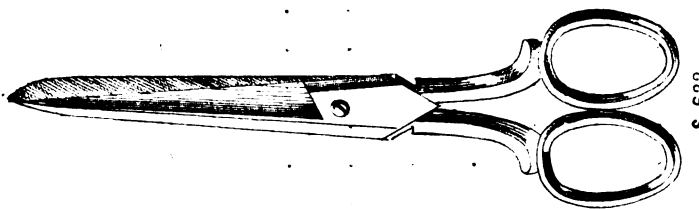

S. 633.



S. 307 1/2.

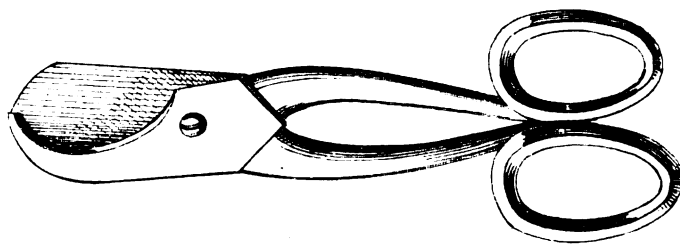

S. 354.

*Drawn half real size
Stock ready at the Warehouse*

67 & 68. KING WILLIAM STREET. CITY. LONDON.

MAPPIN BROTHERS,
MANUFACTORY,
QUEEN'S CUTLERY WORKS, SHEFFIELD,
WAREHOUSE,
67 & 68, KING WILLIAM STREET, LONDON.

PRICES OF MAPPINS' CELEBRATED STEEL SCISSORS.

For Drawings, see corresponding numbers on Plate.

		per doz
		s. d.
S657	3¼ inch Nail Scissors, polished	18 6
S176½	2½ inch do. do.	28 0
S542	3 inch do. do.	32 0
S543	Do. do. do.	40 0
S396	3½ inch Button-hole Scissors, polished	34 0
S102	3¾ inch Nail Scissors, polished	26 0
S123	3 inch do. do.	20 0
S113	3½ inch do. do.	36 0
S104	4 inch do. do.	44 0
S129	3½ inch do. do.	28 0
S276	3 inch do. do.	12 0
S115	3½ inch Button-hole Scissors, glazed	10 8
S324	3¾ inch Nail Scissors, polished	13 0
S146	Do. do. do.	12 0
S119	4 inch do. do.	12 0
S398	4½ inch very strong Nail Scissors, polished	36 0
S107	4 inch Nail Scissors, polished	26 0
S124	3½ inch do. do.	15 0
S126	Do. do. do.	15 0
S122	3 inch do. do.	14 0
S549	3½ inch Embroidering Scissors, polished	34 0
S548	4½ inch Lady's Work do. do.	36 0
S547	5½ inch Cutting-out do. do.	44 0
S553	3¾ inch Embroidering do. do.	48 0
S552	Do. Nail do. do.	48 0
S551	4½ inch Lady's Work do. do.	48 0
S550	5 inch do. do. do.	54 0
S403	5½ inch Cutting-out do. do.	48 0
S536	Do. do. do. do.	60 0
S650	3½ inch Embroidering do. do.	56 0
S651	4½ inch Lady's Work do. do.	56 0
S342	5 inch do. do. do.	64 0
S652	5½ inch do. do. do.	72 0
S367½	Do. Cutting-out do. do.	38 0
S425	Do. Hair do. do.	48 0
S207	6 inch Cutting-out do. do.	38 3
S363	Do. do. do. do.	52 0
S 55	5½ inch Hair do. do.	38 0

The London Warehouse contains the Largest Stock of Cutlery in the World.

**JOSEPH MAPPIN AND BROTHERS,
QUEEN'S CUTLERY WORKS, SHEFFIELD.**

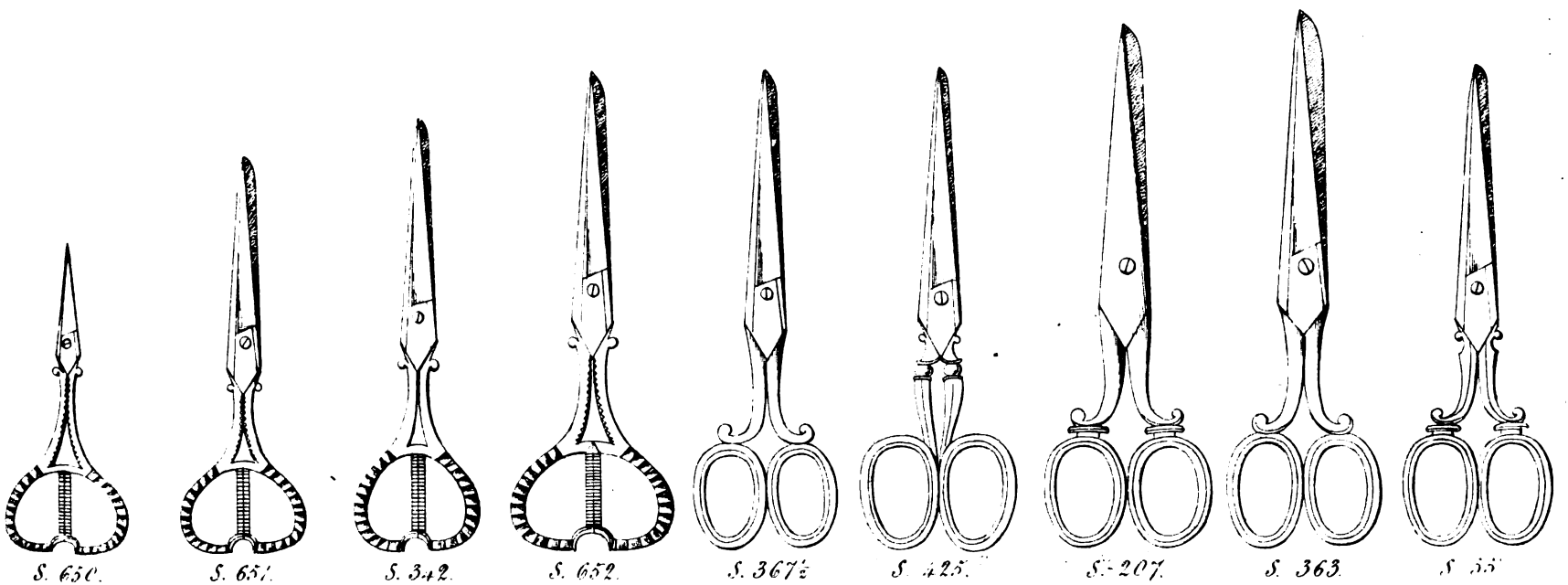
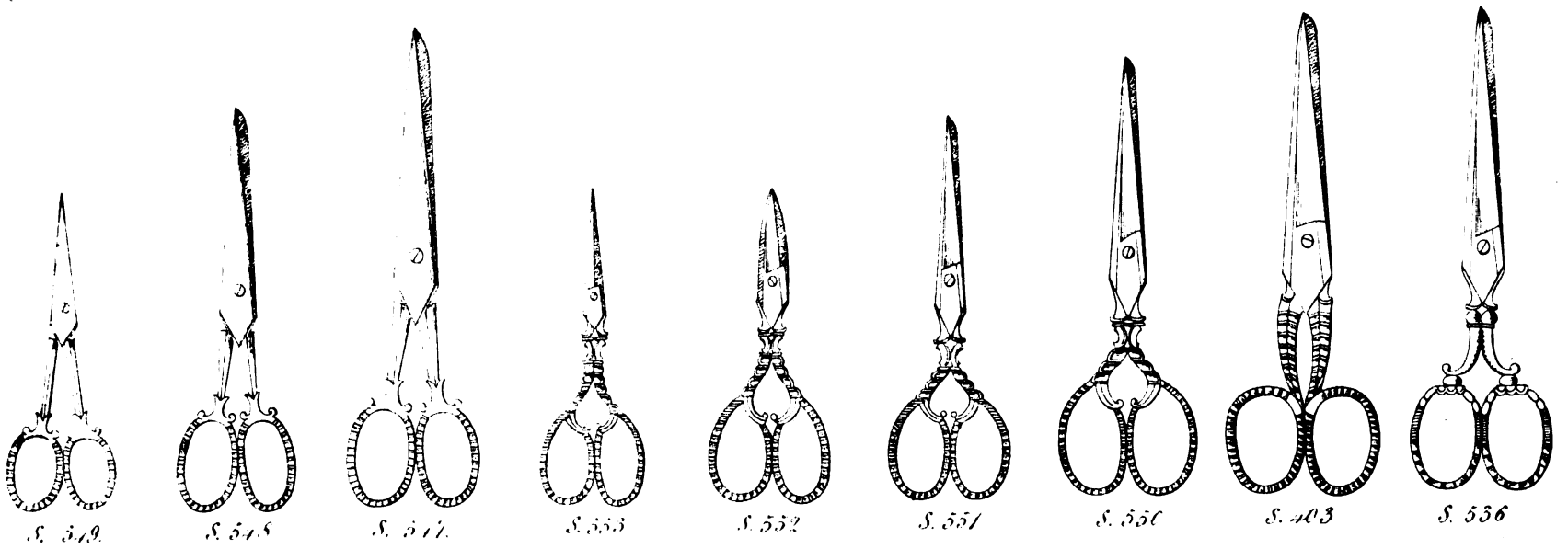
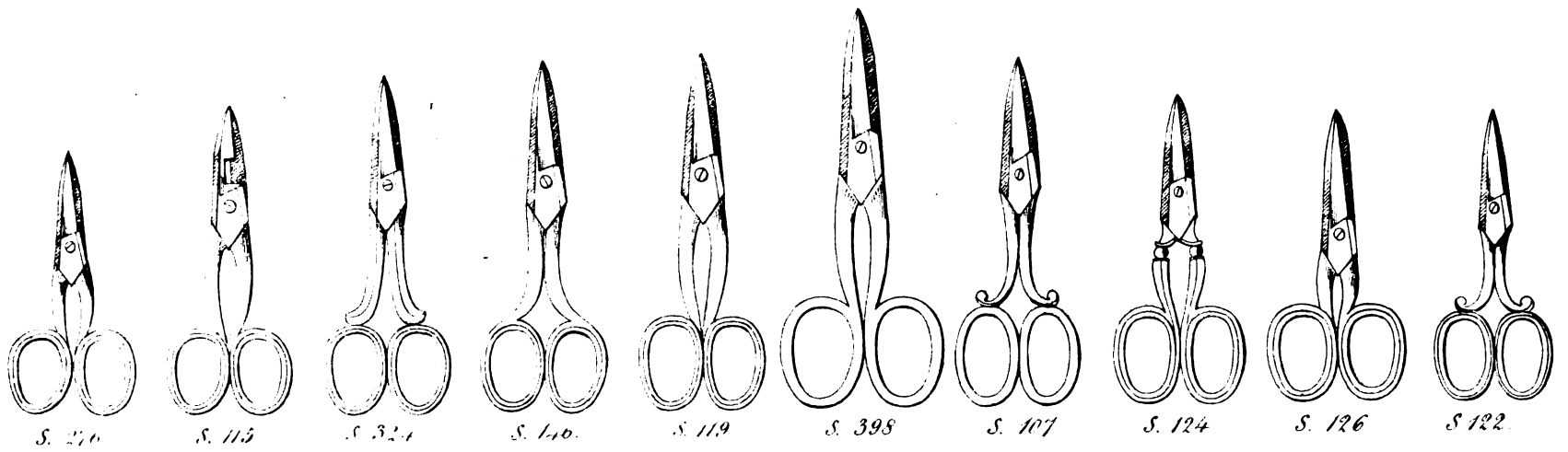
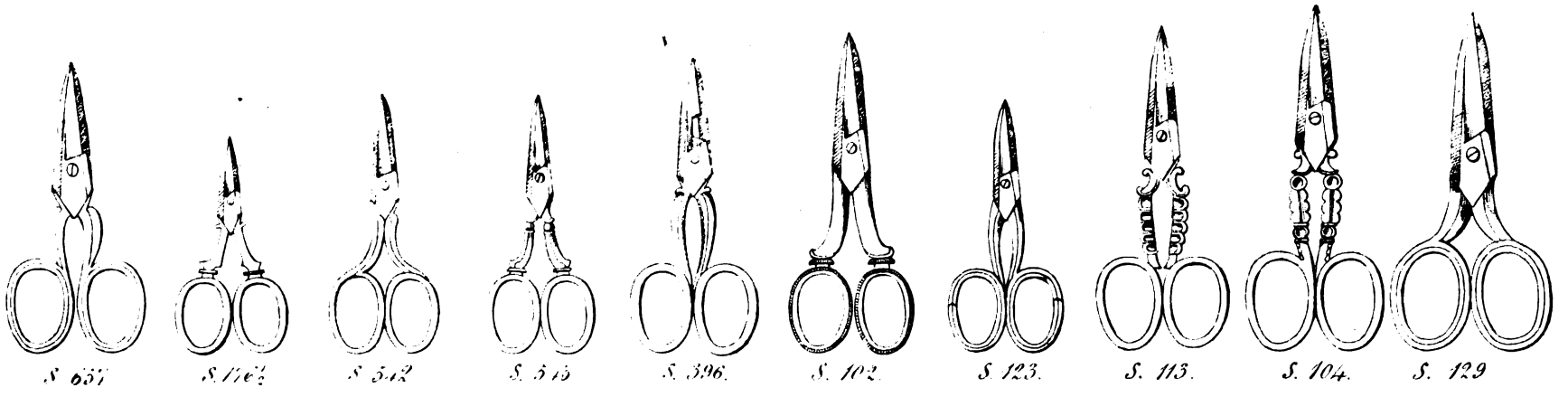

*Drawn half real size
Stock ready at the Warehouse*
67 & 68, KING WILLIAM STREET CITY LONDON.

MAPPIN BROTHERS,
MANUFACTORY,
QUEEN'S CUTLERY WORKS, SHEFFIELD,
WAREHOUSE,
67 & 68, KING WILLIAM STREET, LONDON.

PRICES OF MAPPINS' SCISSORS AND NEEDLE CASES.

For Drawings, see corresponding numbers on Plate.

		each.
		£ s. d.
E4913	Leather Case, lined Cloth, with three pair very excellent Scissors <i>Complete</i>	0 3 8
E4910	Roan Case, containing four pair of very good Scissors, assorted sizes	0 7 0
E4906½	As E4910, but three pair ditto	0 4 6
E1408	Maroon Case, containing three pair of very excellent Polished Scissors	0 6 0
E3190	As E1408, but four pair Scissors	0 7 6
E3191	As E1408, but five pair Scissors	0 11 0
E3192	As E1408, but six pair Scissors	0 14 0
E4912	Best Roan Case, containing four pair very good Scissors	0 7 0
E4911	As E4912, but three pair only	0 5 6
E3062¾	Gilt Illumined Calf Case, Silk Velvet lined, containing three pair very best Polished Flat Bow Scissors	0 12 0
E3062½	Plain Calf Case, containing three pair Scissors as E3062¾	0 11 0
E3062	Morocco Case, three pair Scissors as E3062¾	0 10 0
E3306	Four pair Scissors, in Case as E3062¾	0 16 0
E3827	Russia Leather Case, and four pair Scissors as E3062¾	0 16 0
E3966	Russia Case, but containing six pair of various sorted sizes, viz., Large Cutting-out, smaller size ditto, regular Work Scissors, Lace point, Embroidery, and Button-hole Scissors, as E3062¾	1 6 0
E2416	Polished Mahogany Sliding Case, containing three pair best Polished Bow Scissors	0 14 0
E3360	Plain Calf Case, containing three pair of very handsome Fluted Bow Scissors	0 12 0
E4510	Do. do. do. do. <i>Gilt Bows</i>	0 14 0
E4641	Morocco Leather Case, containing three pair various size Scissors; the Bows are of a very elegant design, termed the "Crown Pattern," very beautifully fluted	0 18 0
E4291	Plain Calf Case, containing three pair various size Scissors, flat Bows; the Shanks and Bows are strongly Plated with Silver. For Hot Climates	0 16 0
E3405	Scotch Tartan Case, lined Silk Velvet, Chased and Gilt Lock, containing three pair of very fine Flat Bow Scissors, very handsome	0 15 0
E3465	Scotch Tartan Case as E3405, with four pair very superbly Fluted Scissors <i>Complete</i>	1 4 0
E4124	Scotch Tartan Case but six pair very useful and elegantly Fluted Scissors, the same pattern as E3465	1 16 0
E4917	Scotch Tartan Wood Case, lined Silk Velvet, containing five pair of best Polished Flat Bow Scissors	1 4 0
E3076	Morocco Leather Case, containing four pair very finely Fluted Scissors, as sketch, Polished Bows and Shanks	0 18 0
E4903	Green Russia Case, lined Silk Velvet, containing one pair Scissors each, large Cutting-out, second size ditto, Work size, Embroidery, Lace point, fine point, Nail and Button-hole Scissors <i>Complete</i>	1 16 0
E4841	Illuminated Calf Case, containing six pair of best Polished Bow Scissors, the Handles of which are Electro-Plated. For Hot Climates	1 12 0
C347	Tortoiseshell Case, inlaid with Pearl, containing six pair best Polished Flat Bow Scissors, with Chased and Gilt Snap, lined Blue Silk Velvet	2 16 0
C199	Inlaid Tortoiseshell Case, with Snap, Ivory Mounted Tops, lined Silk Velvet, containing five hundred best assorted Drilled Eyed Needles; each packet of 25 has a separate partition for itself	1 4 0

The London Warehouse contains the Largest Stock of Cutlery in the World.

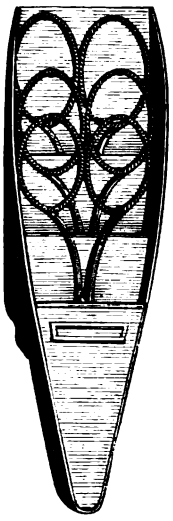

E4913



E4910

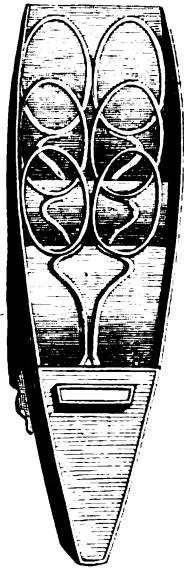

E1408

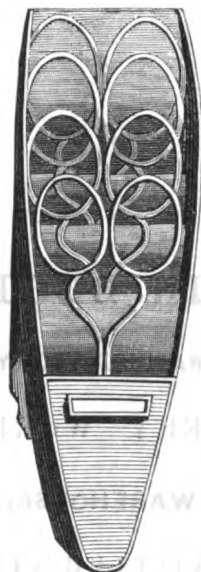

E4912

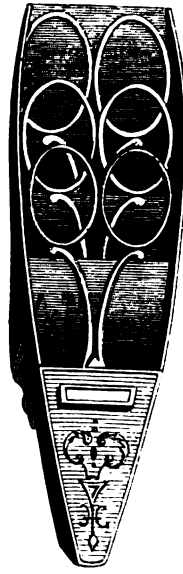

E30624

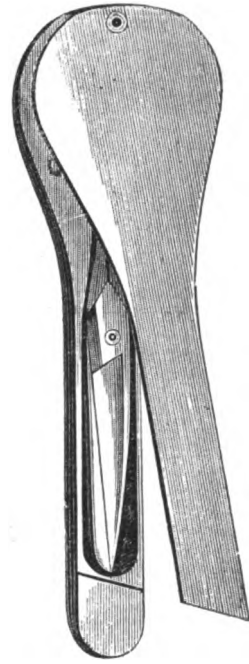

E2416

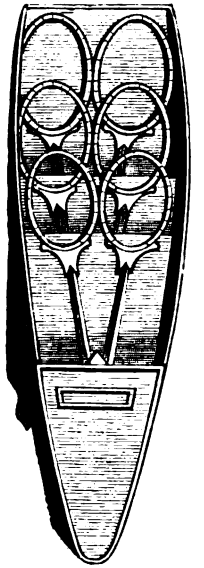

E3360

MAPPIN BROTHERS'
QUEENS' CUTLERY WORKS, SHEFFIELD,

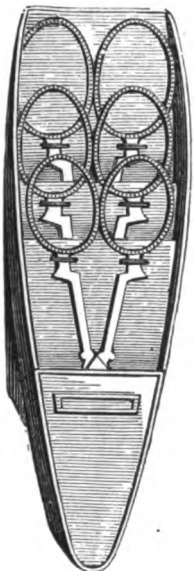

E4510

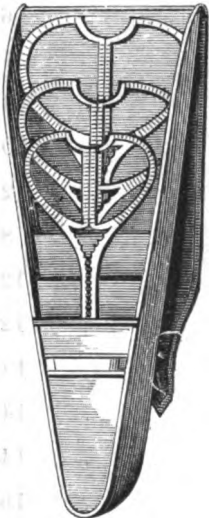

E4641

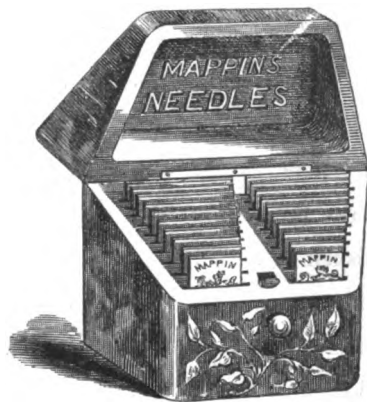

C199

STOCK READY AT THE WAREHOUSE,

67 & 68, KING WILLIAM STREET, CITY,
LONDON.

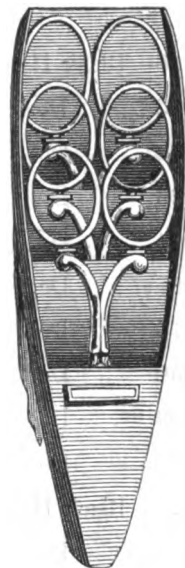

E4291



E3405

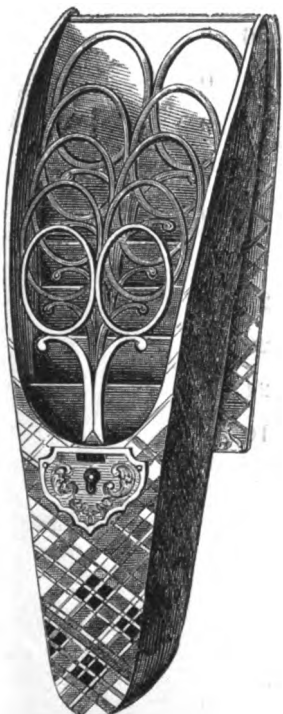

E4917

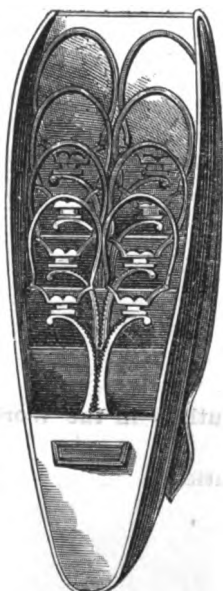

E3076

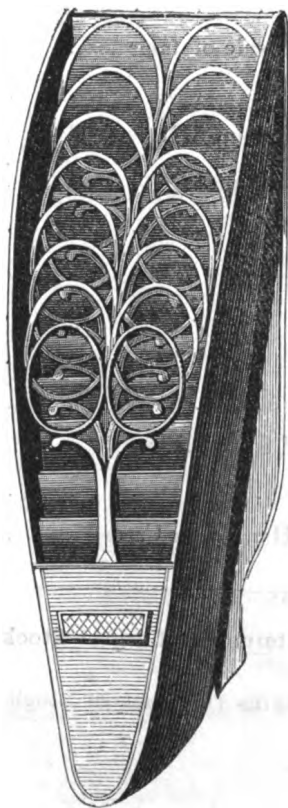

E4903

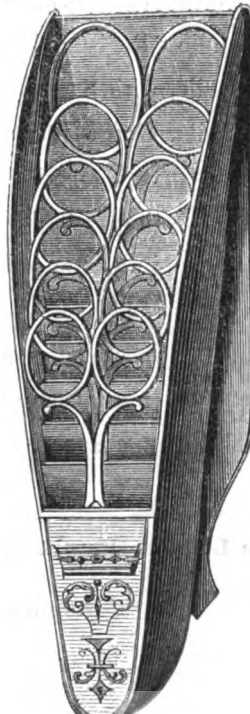

E184

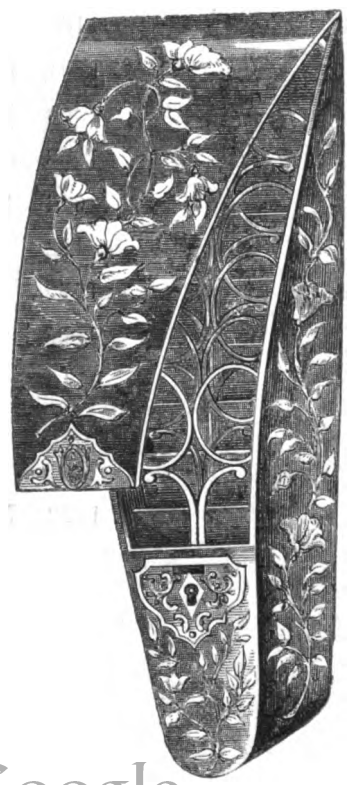

C347

MAPPIN BROTHERS,
MANUFACTORY,
QUEEN'S CUTLERY WORKS, SHEFFIELD,
WAREHOUSE,
67 & 68, KING WILLIAM STREET, LONDON.

PRICES OF MAPPINS' CELEBRATED RAZORS.

For Drawings, see corresponding numbers on Plate.

		per doz
		s. d.
788	Black Handle, polished Blade	6 0
933	Do. do.	7 6
933½	Do. do. etched	8 0
926	Do. do.	10 6
1074	Do. file tang, gilt letters	12 0
1087	Do. Army and Navy Razor	8 8
1075	Do. file tang, polished	12 6
359	Do. do. do.	12 6
709	Do. do. do.	14 0
1117	Do. do. do.	14 0
925	Black Handle, Old English Razor	14 0
925½	Do. do. do.	16 0
964	Do. hollow ground, etched	14 0
1103	Cocoa Handle, with Shield, polished	18 0
1031	Clear Handle, Chinese Razor	14 0
1104	Cocoa Handle, file tang	20 0
1107	Stag Horn Handle, file tang	36 0
950	Black Handle, with Pearl Shield, file tang and side deadened	17 0
725	Buffalo Horn Handle, file tang	36 0
1109	Stag Horn Handle, file tang, fluted side of tang	40 0
1104½	Buffalo Horn Handle, with Shield	40 0
1069	Black Handle "Registered" Lancet edge Razor, in Cases	26 8
1106	Cocoa Handle, with Shield sunk in Handle	28 0
634	Black Handle, narrow Razor, jimped	20 0
442	Do. very superior	20 0
1122	Do. jimped back	20 0
1090	Do. jimped on side	22 0
1116	Do. round point	22 0
1118	Do. very handsome, and fancy Blade	26 0
805	Do. crescent tang	24 0
1322	Mappins' Shilling Razor, Black Handle, in Cases	10 8

The London Warehouse contains the Largest Stock of Cutlery in the World.

JOSEPH MAPPIN & BROTHERS,
 QUEEN'S CUTLERY WORKS, SHEFFIELD.

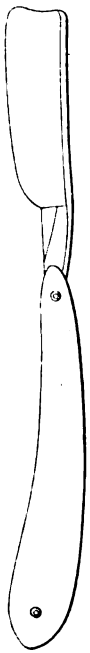

788



933



933 1/2

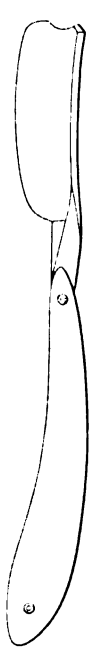

926

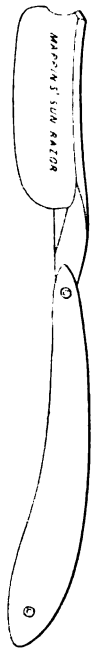

1074



1087



1075



359



709



1117

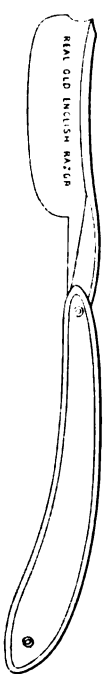

925

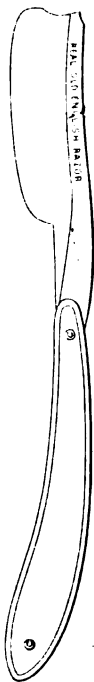

925 1/2



964



1103

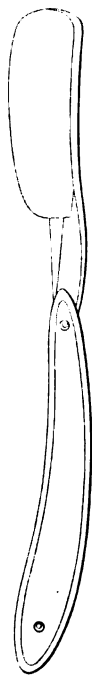

1031



1104

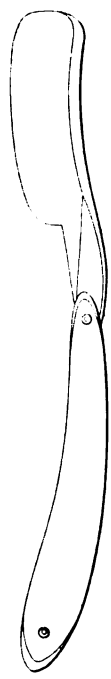

1107



950

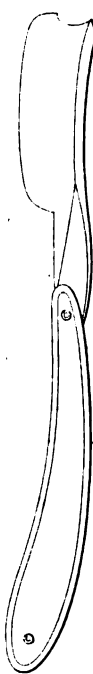

725



1109



1104 1/2

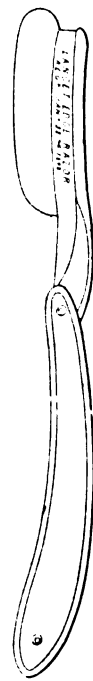

1069

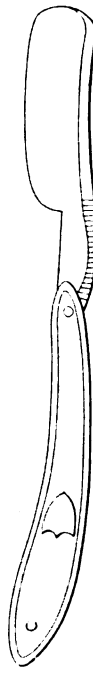

1106



634

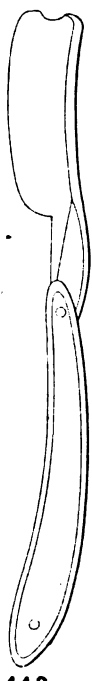

442



1122



1090



1116



1118



805

Drawn Third real size.

67 & 68 KING WILLIAM ST CITY LONDON.

MAPPIN BROTHERS,
MANUFACTORY,
QUEEN'S CUTLERY WORKS, SHEFFIELD,
WAREHOUSE,
67 & 68, KING WILLIAM STREET, LONDON.

PRICES OF MAPPINS' CELEBRATED RAZORS.

For Drawings, see corresponding numbers on Plate.

		per doz.
		s. d.
1114	Bone Handle, polished Blade	10 0
872½	Do. do. and File cut	12 0
1064	Do. do. do.	13 0
1117½	Do. File cut	15 0
915	Do. Chased Blade	20 0
923	Common Ivory, polished Blade	16 0
606	Better do. do. and File Cut	20 0
924	Do. do. do. do.	26 0
1089	Do. do. ornamented Blade	30 0
814	Do. do. with Shield, polished and File cut	30 0
1155	Good Ivory, Yorkshire Razor	30 0
1015	Do. light and narrow	25 0
783	Fine Ivory, hollow ground, very superior	52 0
673	Good Ivory, with Shield sunk in the Handle	28 0
924½	Do. Old English Razor	26 0
810	Do. Fluted Tang	42 0
282	Do. plain and good	40 0
1112	Do. do.	40 0
939	Do. Ornamented Blade	30 0
1018	Fine Ivory, King's Razor	44 0
1135	Fine Ivory, Ornamented Blade	44 0
1090½	Do. do. do.	42 0
1020	Do. Military Razor	44 0
817	Transparent Ivory, hollow ground, very superior	54 0
818	Do. do. do.	58 0
787F	Do. very handsome Blade, and No. 1 and 2	70 0
1132½	Do. with Shield sunk in Handle, Ivory Tang to the Blade	80 0
1008F	Carved Transparent Ivory Handle, very handsome blade	60 0
702F	Do. do. with Shield, round point	60 0
719F	Do. do. studded with Silver	60 0
1070	Mappins' Registered Lancet-edge Razor, Ivory Handle	40 0

The London Warehouse contains the Largest Stock of Cutlery in the World.

**JOSEPH MAPPIN & BROTHERS,
QUEEN'S CUTLERY WORKS, SHEFFIELD.**

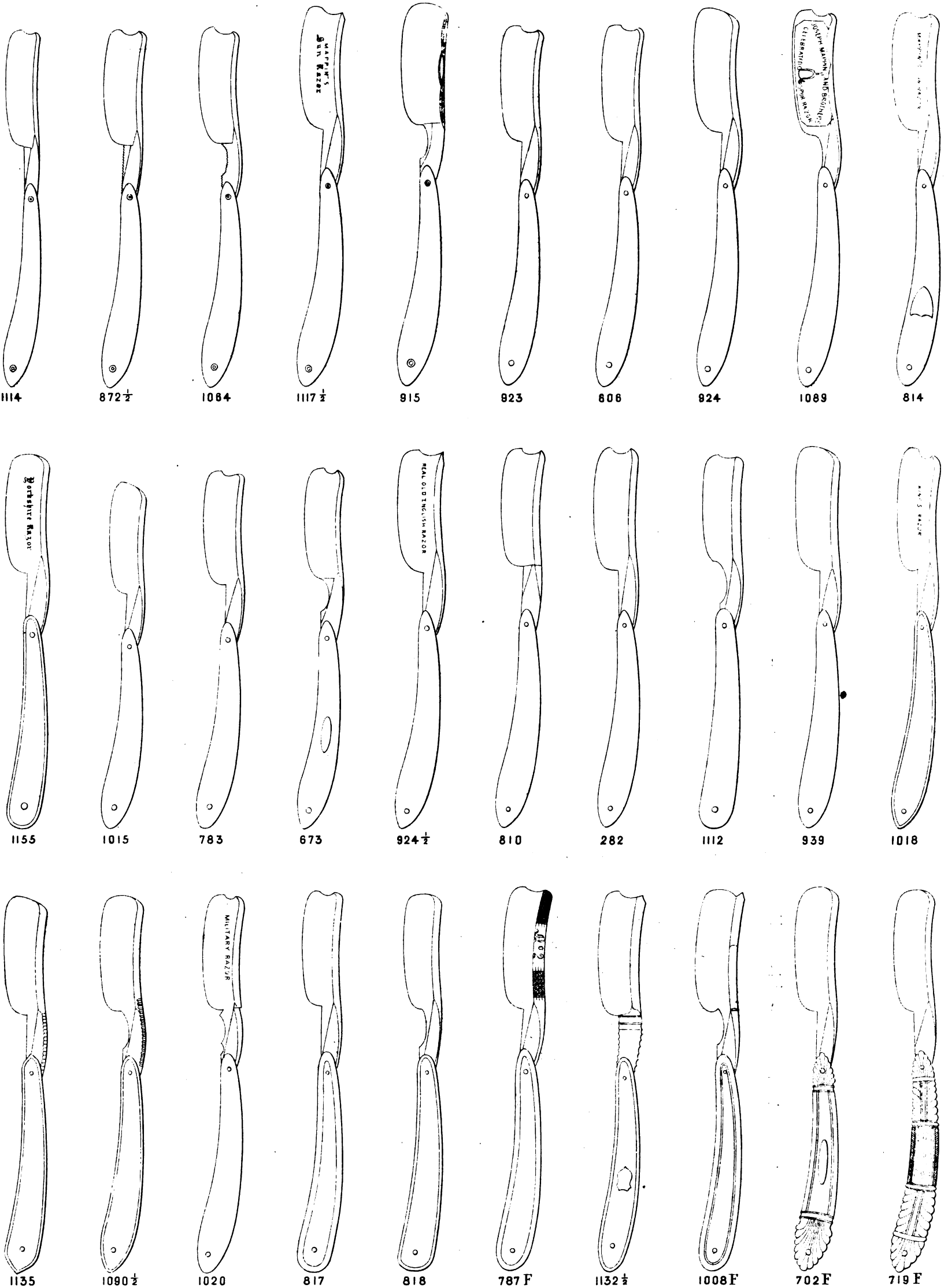

*Drawn one third real size.
Stock ready at the Warehouse.*

67 & 68 KING WILLIAM STREET. CITY. LONDON.

MAPPIN BROTHERS,
MANUFACTORY,
QUEEN'S CUTLERY WORKS, SHEFFIELD,
WAREHOUSE,
67 & 68, KING WILLIAM STREET, LONDON.

PRICES OF MAPPINS' COOKS' AND BUTCHERS' KNIVES.

For Drawings, see corresponding numbers on Plate

										per doz.
										s. d.
320	Black Handle, Table Steel, four sides									14 0
299P	Cocoa Handle Palette Knives, pinned,									
	4 in. 5 in. 6 in. 7 in. 8 in. 9 in. 10 in. 11 in. 12 in.									
	5/3 6/8 8/0 10/6 12/9 16/8 21/0 27/0 34/0									per doz.
298P	Cocoa Handle Palette Knives, "balanced," pinned,									
	4 in. 5 in. 6 in. 7 in. 8 in. 9 in. 10 in. 11 in. 12 in.									
	6/9 8/0 9/6 12/0 15/0 19/0 24/0 30/0 38/0									per doz.
342	Ebony Handle, "King's" Cook Knives, Copper Ferrule,									
	4 in. 5 in. 6 in. 7 in. 8 in. 9 in. 10 in. 11 in. 12 in.									
	2/0 2/0 2/6 3/0 3/6 4/6 5/6 6/6 8/0									each.
799	Ebony Handle, "French" Cook Knives,									
	4 in. 5 in. 6 in. 7 in. 8 in. 9 in. 10 in. 11 in. 12 in.									
	3/0 3/0 3/6 4/6 5/0 6/0 7/6 8/6 10/6									each.
300	Wood Handle, Butcher's Knives,									
	4 in. 5 in. 6 in. 7 in. 8 in. 9 in. 10 in. 11 in. 12 in.									
	5/9 5/9 7/0 9/0 11/0 14/6 18/6 22/0 26/0									per doz.
300½	Wood Handle, Butcher's Knives,									
	4 in. 5 in. 6 in. 7 in. 8 in. 9 in. 10 in. 11 in. 12 in.									
	6/0 6/0 7/6 9/6 11/6 15/0 19/0 23/0 27/0									per doz.
314	Black Handle Oyster Knife									per doz. 6 8
755	Real Natural Coloured Horn Handle, Billingsgate Oyster Knife									,, 14 0
314	Black Handle Oyster Knife, with Guard									,, 9 0
Guard.										
758	Cocoa Handle Painter's Stopping Knife, elastic									,, 11 0
382	Leather Handle Glazier's Chipping Knife									,, 11 0
329	Black Handle Knife Sharpener, 4 Wheels, Brass Frame									,, 36 0
823	Do. do. 2 Wheels									each 4 0
823	Ivory Handle do. 3 Wheels									,, 7 0
Ivory 3 Wheels,										
299P	Cocoa Handle Pill Knives, { 4 in. 5 in. 6 in.									
Pill Knives.										5/6 6/0 8/0 per doz.

The London Warehouse contains the Largest Stock of Cutlery in the World.



320.



299P.



298P.



342.

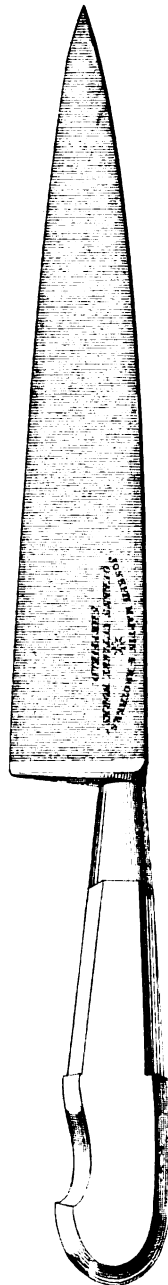

799.

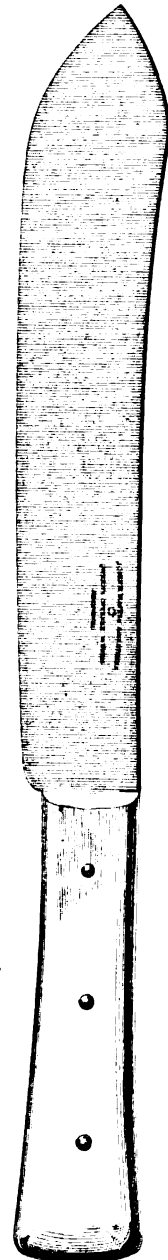

300.

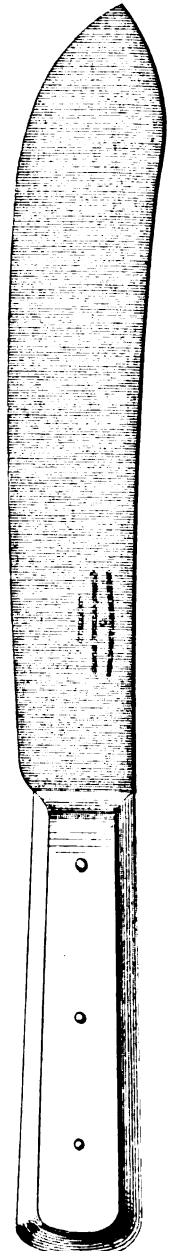

300 1/2.

**JOSEPH MAPPIN AND BROTHERS,
QUEEN'S CUTLERY WORKS, SHEFFIELD.**

Stock ready at the Warehouse,

67 & 68, KING WILLIAM STREET, CITY, LONDON.

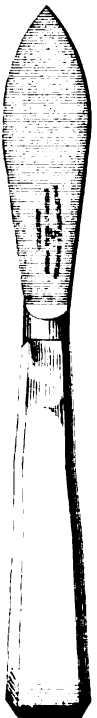

314.



755.

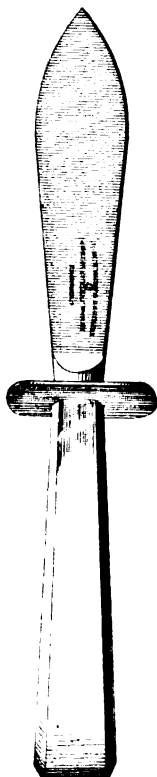

314 Guard.

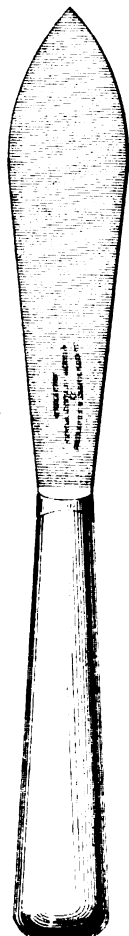

758

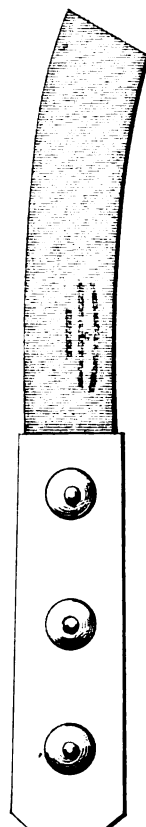

382.



329.

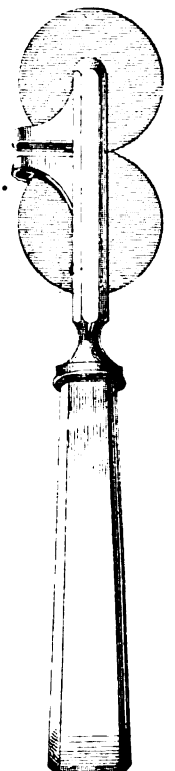

825.

Drawn half real size.

MAPPIN BROTHERS,
MANUFACTORY,
QUEEN'S CUTLERY WORKS, SHEFFIELD,
WAREHOUSE,
67 & 68, KING WILLIAM STREET, LONDON.

PRICES OF MAPPINS' CELEBRATED TABLE CUTLERY.

For Drawings, see corresponding numbers on Plate.

With Ivory Handles, warranted **NOT TO COME LOOSE** in hot water, for which they received
the Prize Medal of the Great Exhibition of all Nations in 1851.

	Tables, per doz. Knives and Forks.		Desserts, per doz. Knives and Forks.		Carvers, per pair.		Table Knives, per doz.		Dessert Knives, per doz.	
	s.	d.	s.	d.	s.	d.	s.	d.	s.	d.
817p Common Ivory, 3½ in. Handle, Octagon, Edge-pin, Balance	27	0	21	0	4	6	17	0	13	0
331p Better do. do. do. do. do.	32	0	24	0	6	0	20	0	16	0
996p Common Ivory do. Oval, Balance . . .	26	6	20	0	4	6	17	0	12	0
1007p Better Ivory do. Oval, Waterloo Balance .	34	0	25	0	6	0	21	0	16	6
135 Stag Handle, 3½ in. Steel Cap, 3 prong Forks . . .	9	6	9	0	2	6				
136 do. 4 in. do. do.	12	6	11	0	3	0				
143F do. 4 in. do. Strong do.	16	0	13	6	3	6				
1020p Better Ivory, 3½ in. Handle, Octagon, Waterloo Balance	34	0	25	0	6	0	21	0	16	6
998p Thick Ivory do. Round, Balance	34	0	28	0	6	0	21	0	17	0
1001p Middle Ivory do. do. with Ferrule, G.S. . . .	40	0	33	0	6	6	24	0	20	0
904½ do. 4 in. Handle, Table Steel . . . do.	36	0								
940 do. do. Sexagon Fluted, Steel do.	48	0								
721 Plated on G.S. Handle, Thread Pattern, Balance . . .	38	0	34	0	6	6	21	6	18	6
721B do. do. King's Pattern do.	38	0	34	0	6	6	21	6	18	6
721J do. do. Scroll Pattern do.	38	0	34	0	6	6	21	6	18	6
818 Middle Ivory, 4¼ in. Handle, Bread Knife . . . each	5	0								
725 Fine Ivory, 4¼ in. Handle, Fluted, Silver Ferrule, Bread } Knife each }	15	0								
984 Box Wood, 5 in. Handle, Carved, Bread Knife do.	4	6								

The London Warehouse contains the Largest Stock of Cutlery in the World.

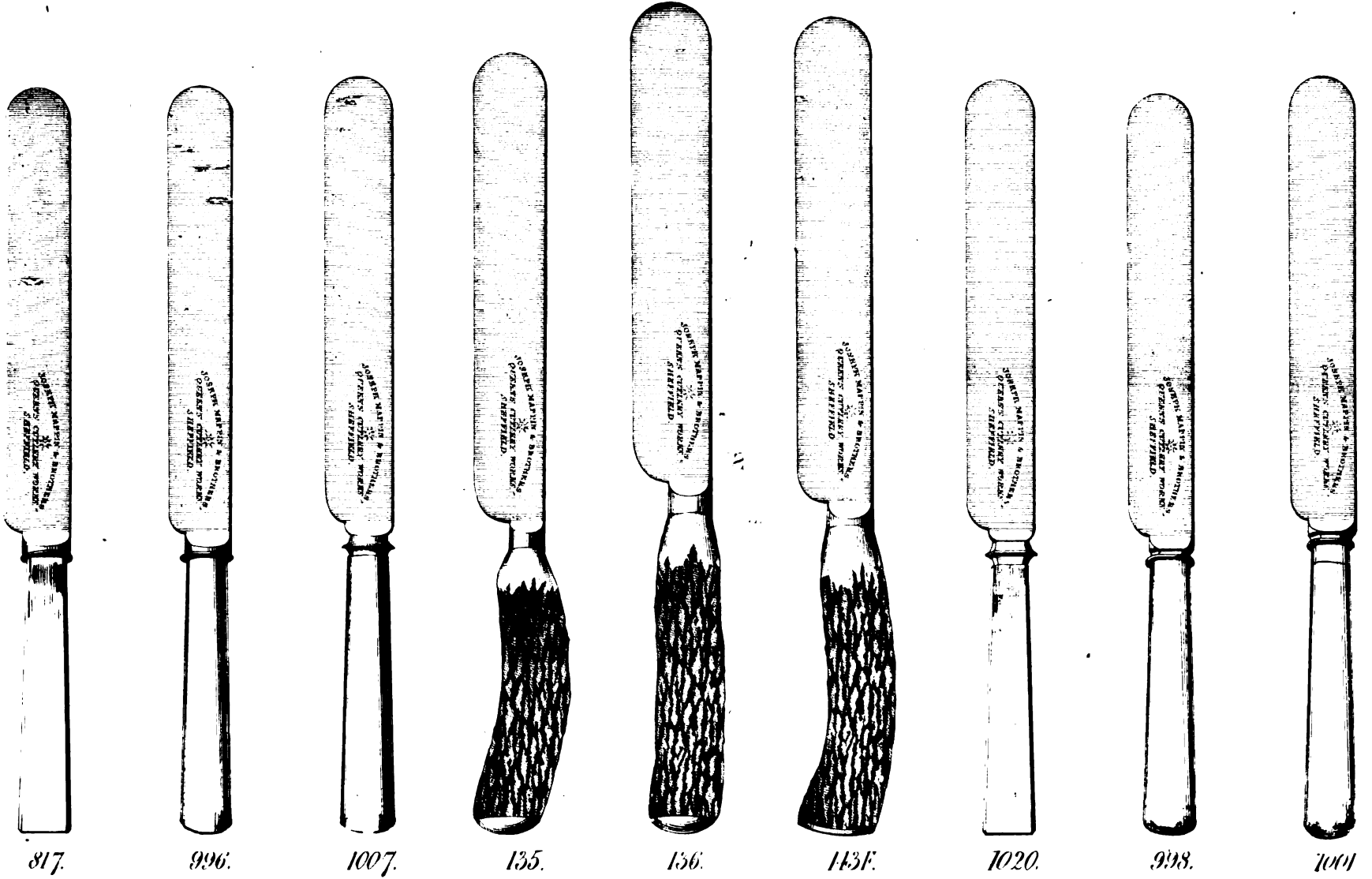

817. 996. 1007. 135. 136. 143F. 1020. 998. 1001

JOSEPH MAPPIN AND BROTHERS.
QUEEN'S CUTLERY WORKS, SHEFFIELD.

Stock ready at the Warehouse!

67 & 68, KING WILLIAM STREET, CITY, LONDON.

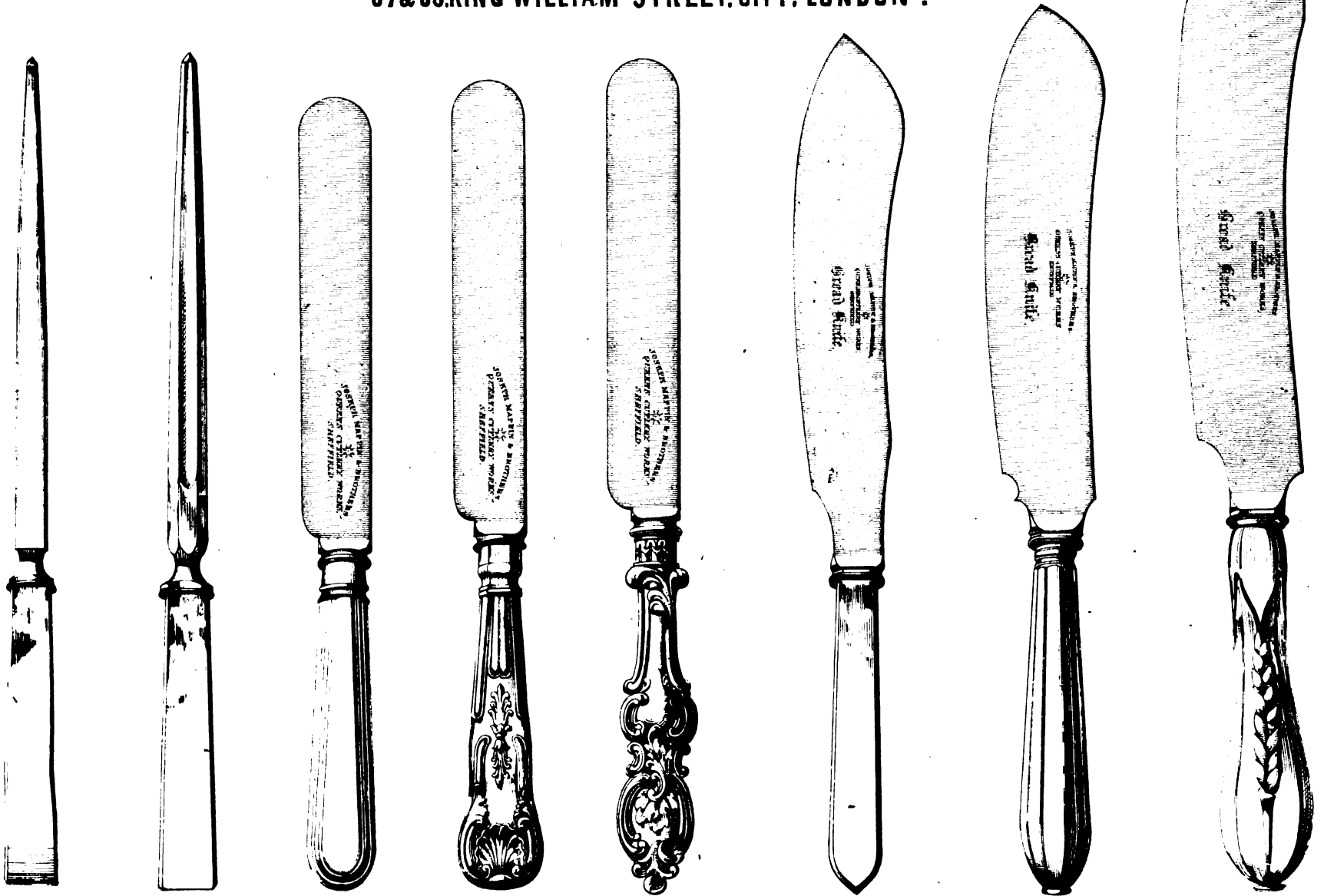

904 940 721. 721B. 721.I. 818. 725. 984

Drawn half real size.

MAPPIN BROTHERS,
MANUFACTORY,
QUEEN'S CUTLERY WORKS, SHEFFIELD,
WAREHOUSE,
67 & 68, KING WILLIAM STREET, LONDON.

PRICES OF MAPPINS' CELEBRATED TABLE CUTLERY.

For Drawings, see corresponding numbers on Plate.

	Tables. per doz. Knives and Forks.		Desserts. per doz. Knives and Forks.		Carvers. per pair.		Table Knives. per doz.		Dessert Knives. per doz.	
	s.	d.	s.	d.	s.	d.	s.	d.	s.	d.
341½p Common Ivory, Octagon, Edge-pin, 4in. Handle, Balance	34	0	26	0	7	6	22	0	16	0
150p Better do. do. do. do. do.	42	0	30	0	9	0	25	0	18	0
195p Middle do. do. do. do. do.	50	0	34	0	10	6	30	0	21	0
151p Do. do. Strong, do. do. do. do.	56	0	38	0	11	0	33	0	23	0
1064p Do. do. do. Oval, do. do. do.	56	0	38	0	11	6	34	0	24	0
0703p Do. do. do. Round, do. do. do.	56	0	38	0	11	6	34	0	24	0
971p Do. do. do. for Hotel or Ships' use . ' . . .	56	0	38	0	10	6	34	0	24	0
837p Fine Ivory, Strong, 4in. Handle, Edge-pin, Balance	77	0	55	0	15	6	46	0	34	0
349p Middle do. do. do. do. do.	58	0	40	0	12	0	35	0	25	0
152p do. do. do. do. do. Waterloo, } Balance }	58	0	42	0	12	0	35	0	25	0
325p Common do. do. do. do. do.	46	0	34	0	9	6	28	0	20	0
152½p Middle do. do. do. do. do.	58	0	42	0	12	0	35	0	25	0
155½p Fine do. do. do. do. do. } with French Forks }	84	0	60	0	16	0	48	0	36	0
891p Fine Ivory, 3½in. Fluted Handle, Silver Ferrule, Edge-pin	78	0	63	0	12	0	43	0	36	0
890p Do. do. do. do. do. do.	78	0	63	0	12	0	43	0	36	0
713p Middle Ivory 4in. do. do. do. do.	62	0	44	0	12	6	36	0	26	0
710½p Do. do. Round do. do. do.	70	0	50	0	13	6	40	0	30	0
716p Fine Ivory, 4in. Fluted Handle, do. do.	100	0	74	0	20	0	57	0	44	0
730p Middle do. do. do. do. do. do.	74	0	55	0	15	0	43	0	32	0
160p Fine do. do. do. do. do. do.	96	0	74	0	20	0	56	0	43	0
827p Fine do. 4½in. Round do. do. do.	90	0	70	0	18	0	54	0	42	0
743p Fine do. do. Fluted do. do. do.	95	0	72	0	20	0	56	0	43	0

The London Warehouse contains the Largest Stock of Cutlery in the World.



341 1/2



341 1/2



1064

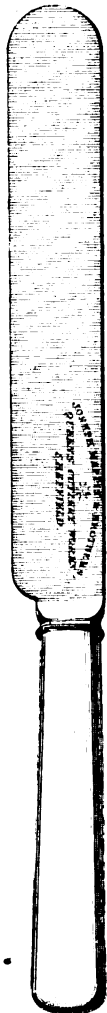

0703



971



857



349



152

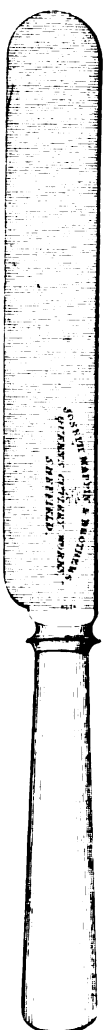

152 1/2

JOSEPH MAPPIN AND BROTHERS.

QUEEN'S CUTLERY WORKS, SHEFFIELD.

Stock ready at the Warehouse.

67 & 68, KING WILLIAM STREET, CITY, LONDON.



891



890



715



710 1/2



716

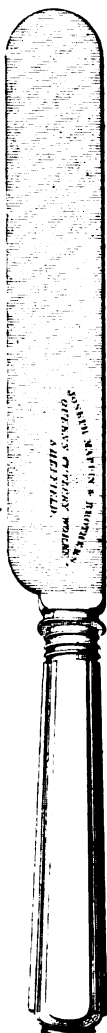

750

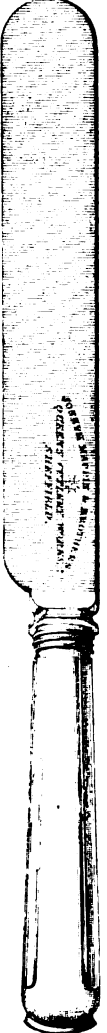

160



827



743

Drawn full real size

MAPPIN BROTHERS,
MANUFACTORY,
QUEEN'S CUTLERY WORKS, SHEFFIELD,
WAREHOUSE,
67 & 68, KING WILLIAM STREET, LONDON.

PRICES OF MAPPINS' CELEBRATED TABLE CUTLERY.

For Drawings, see corresponding numbers on Plate.

	Tables. per doz. Knives and Forks.		Desserts. per doz. Knives and Forks.		Carvers. per pair.	
	s.	d.	s.	d.	s.	d.
543 Best Black Horn, 3-pin, Scale-tang, small size, 3 prong Steel Fork	7	6	7	2	2	3
1039 Do. do. do. large size, do. do.	9	6	8	8	2	6
121 Do. do. do. full size, do. do.	10	6	9	6	2	6
124 Black Horn Octagon Handle, Round-tang, small size, do. do.	9	0	8	6	2	3
125 Do. do. do. full size, do. do.	10	6	9	4	2	6
125p Do. do. do. Edge-pin, do. do. do.	11	6	10	4	2	9
653 Do. do. Oval rim, 6½ in. Blade, do. do.	12	6	11	4	3	0
206 Do. do. do. 6½ in. Blade, do. do.	13	6	11	8	3	4
206p Do. do. Pinned, do. do. do. do.	14	6	12	8	3	7
207B Do. do. Balance, do. do. do. do.	16	6	14	0	4	0
885 Do. do. Round Head, Oval rim, 6½ in. Blade, 3 prong } Steel Fork }	15	0	13	0	3	8
189 Best White Bone, 3-pin, Round Handle, Scale-tang, 6½ in. Blade, } 3 prong Steel Fork }	12	6	9	6	3	0
134 Best White Bone, Octagon Handle, 3-pin, Scale-tang, 6½ in. Blade, } 3 prong Steel Fork }	12	6	10	0	3	2
185 White Bone, Octagon Handle, Round-tang, 6½ in. Blade, 3 prong Steel } Fork }	10	6	9	0	2	6
510 White Bone, Octagon Handle, Oval rim, 6 in. Blade, 3 prong Steel Fork	11	6	11	0	3	0
297 Best White Bone Handle, (shape of Octagon Ivory), Balance, 3 prong } Steel Fork }	19	0	14	6	4	3
652 Best White Bone Handle, Oval rim, 6½ in. Blade, 3 prong Steel Fork	14	6	12	6	3	6
123 Do. do. do. 6½ in. Blade, do. do.	19	0	14	6	4	0
144 Natural coloured Horn, 4 in. Octagon Handle a m. 3 prong } Steel Fork }	22	0	18	0	4	6
144B Natural coloured Horn, 4 in. Octagon Handle, Balance, Oval rim, } 3 prong Steel Fork }	23	0	19	0	4	9
695 Natural coloured Horn 4 in. Octagon Handle, Balance, 3 prong } Steel Fork }	23	0	19	0	4	9

The London Warehouse contains the Largest Stock of Cutlery in the World.

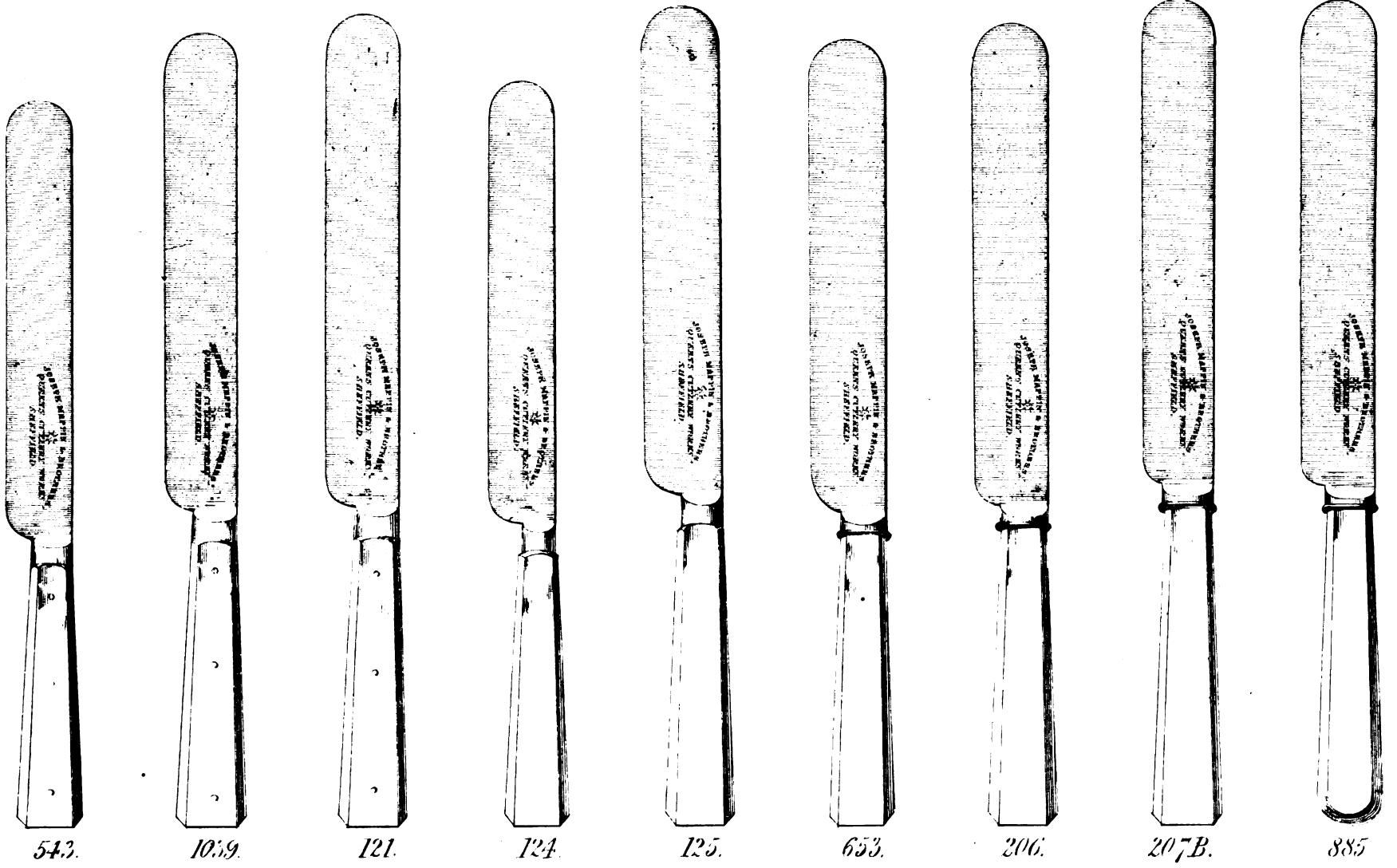

543.

1059.

121.

124.

125.

653.

206.

207B.

885

JOSEPH MAPPIN AND BROTHERS.
QUEEN'S CUTLERY WORKS, SHEFFIELD.

Stock ready at the Warehouse.

67 & 68, KING WILLIAM STREET, CITY, LONDON.

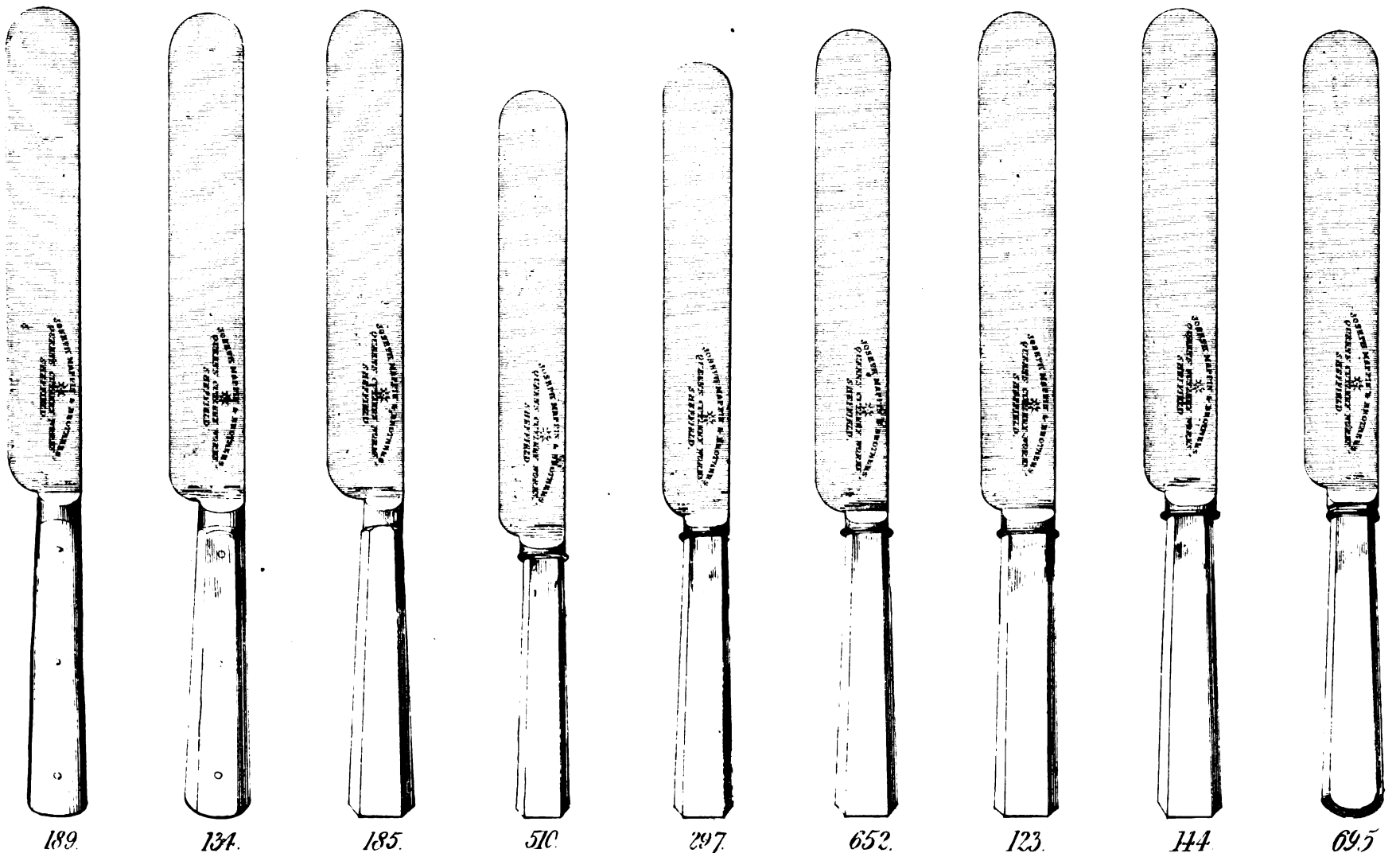

189.

134.

185.

510.

297.

652.

123.

144.

695

Drawn half real size.

MAPPIN BROTHERS,
MANUFACTORY,
QUEEN'S CUTLERY WORKS, SHEFFIELD,
WAREHOUSE,
67 & 68, KING WILLIAM STREET, LONDON.

PRICES OF MAPPINS' ELECTRO SILVER PLATED FISH CARVERS.

For Drawings, see corresponding numbers on Plate.

								per pair.
								£ s. d.
A229p & c	Plated Handles, Plated Blades, Pierced and Chased, in Case	1 2 0
A241p & c	Ivory Handles	do.	do.	do.	.	.	.	1 6 0
A242p & c	Do.	do.	do.	do.	.	.	.	1 10 0
A303p & c	Plated Handles,	do.	do.	do.	.	.	.	1 14 0
A232	Do.	do.	do.	do.	.	.	.	1 4 0
A230c	Do.	do.	Chased,	do.	.	.	.	1 4 0
A325p & c	Do.	do.	Pierced and Chased,	do.	.	.	.	2 0 0
A379p & c	Do.	do.	do.	do.	.	.	.	1 16 0
A354p & c	Silver Handles, Silver Blades,	do.	do.	do.	.	.	.	6 6 0

The London Warehouse contains the Largest Stock of Cutlery in the World.

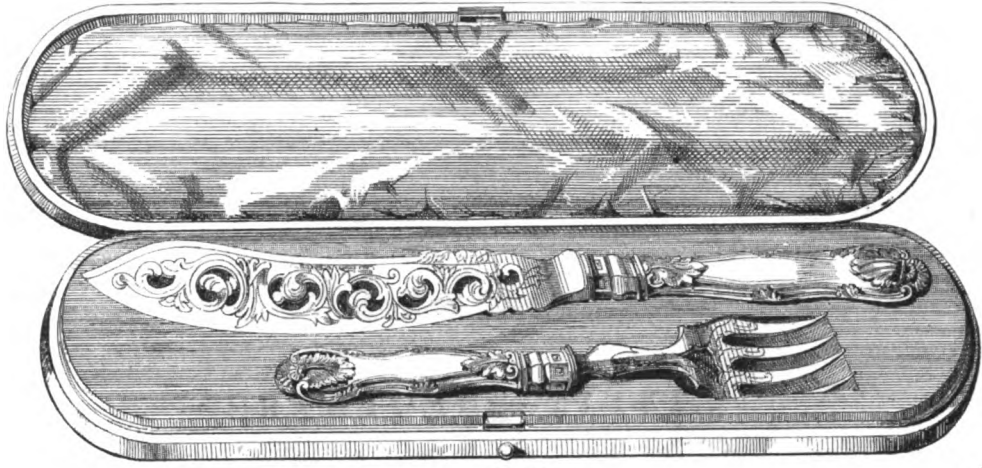

A. 354.



A. 229. P&C.

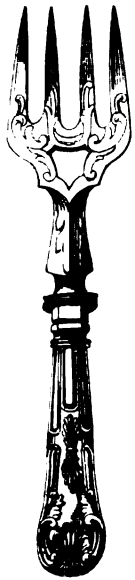

A. 229. P&C.



A. 241. P&C.



A. 241. P&C.



A. 242. P&C.



A. 242. P&C.

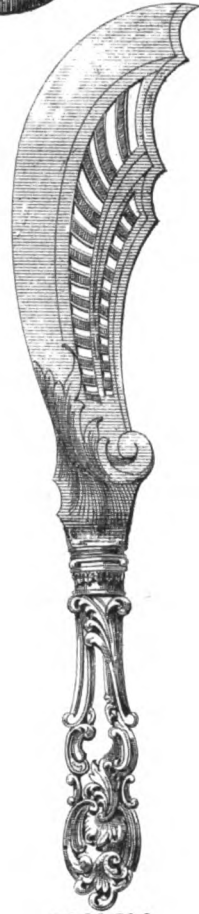

A. 303. P&C.

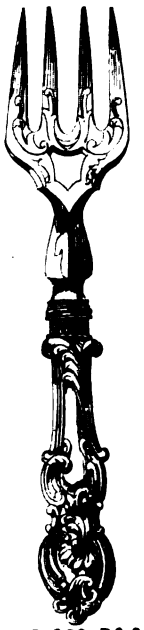

A. 303. P&C.

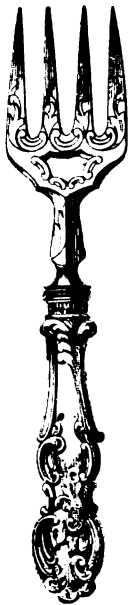

A. 232



A. 232

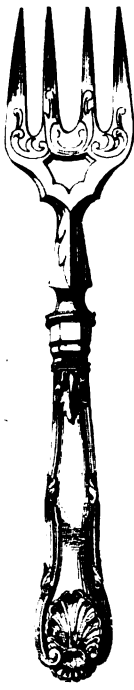

A. 230. C.

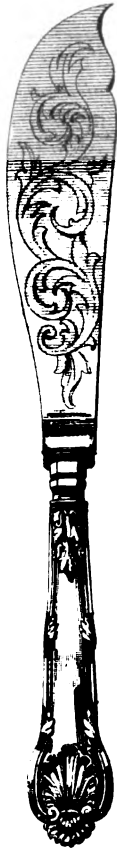

A. 230. C.



A. 325. P&C.



A. 325. P&C.



A. 379. P&C.



A. 379. P&C.

Drawn and cut by hand.
JOSEPH MAPPIN AND BROTHERS.
 QUEEN'S CUTLERY WORKS SHEFFIELD.
Stock ready at the Warehouse.
67 & 68, KING WILLIAM ST. CITY, LONDON.

MAPPIN BROTHERS,
MANUFACTORY,
QUEEN'S CUTLERY WORKS, SHEFFIELD,
WAREHOUSE,
67 & 68, KING WILLIAM STREET, LONDON.

PRICES OF MAPPINS' ELECTRO SILVER PLATED FISH CARVERS.

For Drawings, see corresponding numbers on Plate.

		per pair.		
		£	s.	d.
A 375 <i>p & c</i>	Ivory Handles, Plated Blades, Pierced and Chased, in Case	.	.	1 16 0
A0287 <i>c</i>	Do. do. Chased, do.	.	.	2 0 0
A 374 <i>p & c</i>	Do. do. Pierced and Chased, do.	.	.	2 10 0
A 381 <i>p & c</i>	Do. do. do. do.	.	.	2 12 0
A 238 <i>c</i>	Do. do. Chased, do.	.	.	3 0 0
A 371½ <i>p & c</i>	Do. Silver Blades and Forks, Pierced and Chased, in Case	.	.	6 10 0
A 350½	Do. do. do. Plain Blades, do.	.	.	4 0 0
A 291 <i>p & c</i>	Silver Handles, do. do. Pierced and Chased, do.	.	.	5 6 0

The London Warehouse contains the Largest Stock of Cutlery in the World.

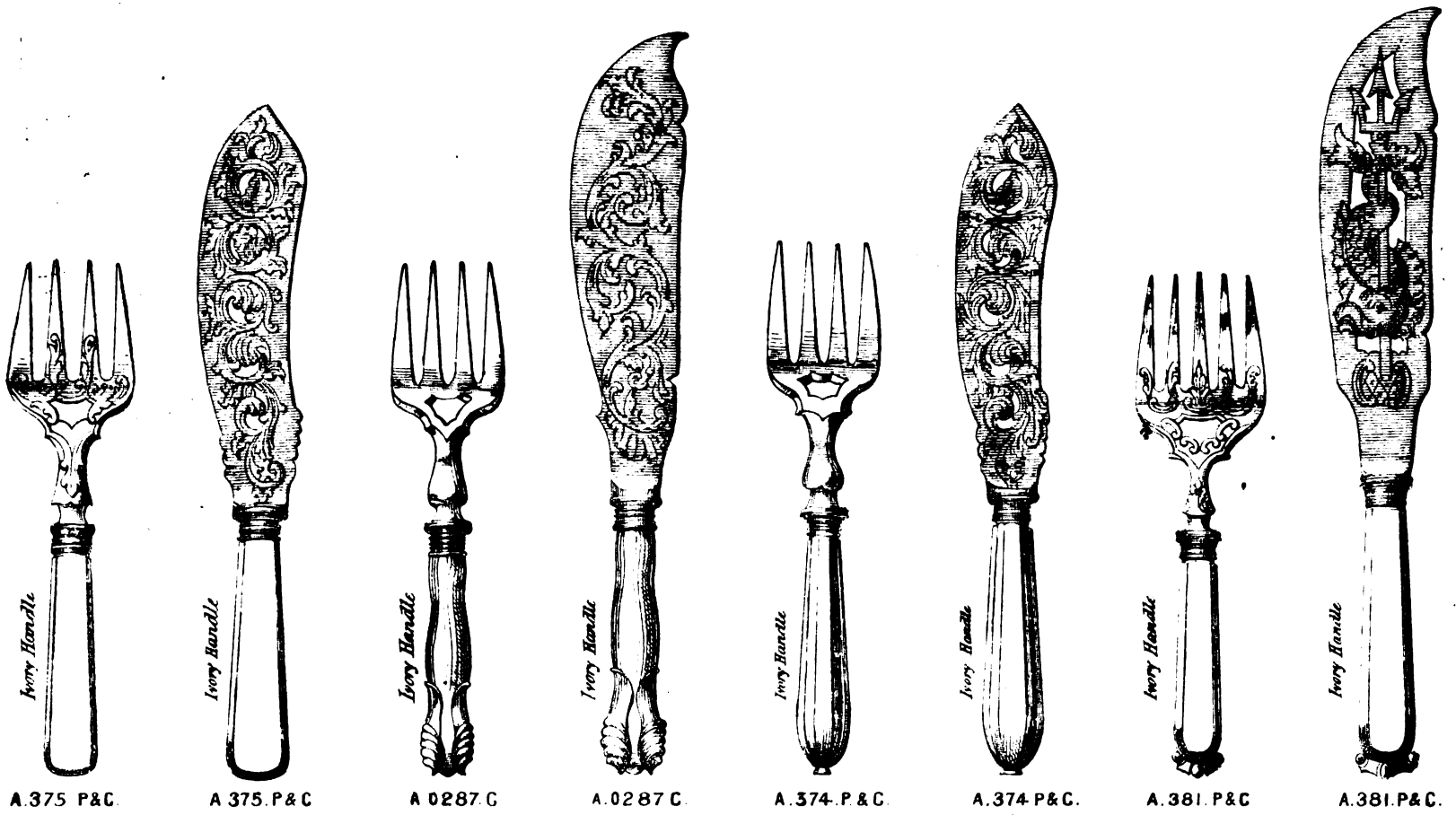

Shown one third real size.

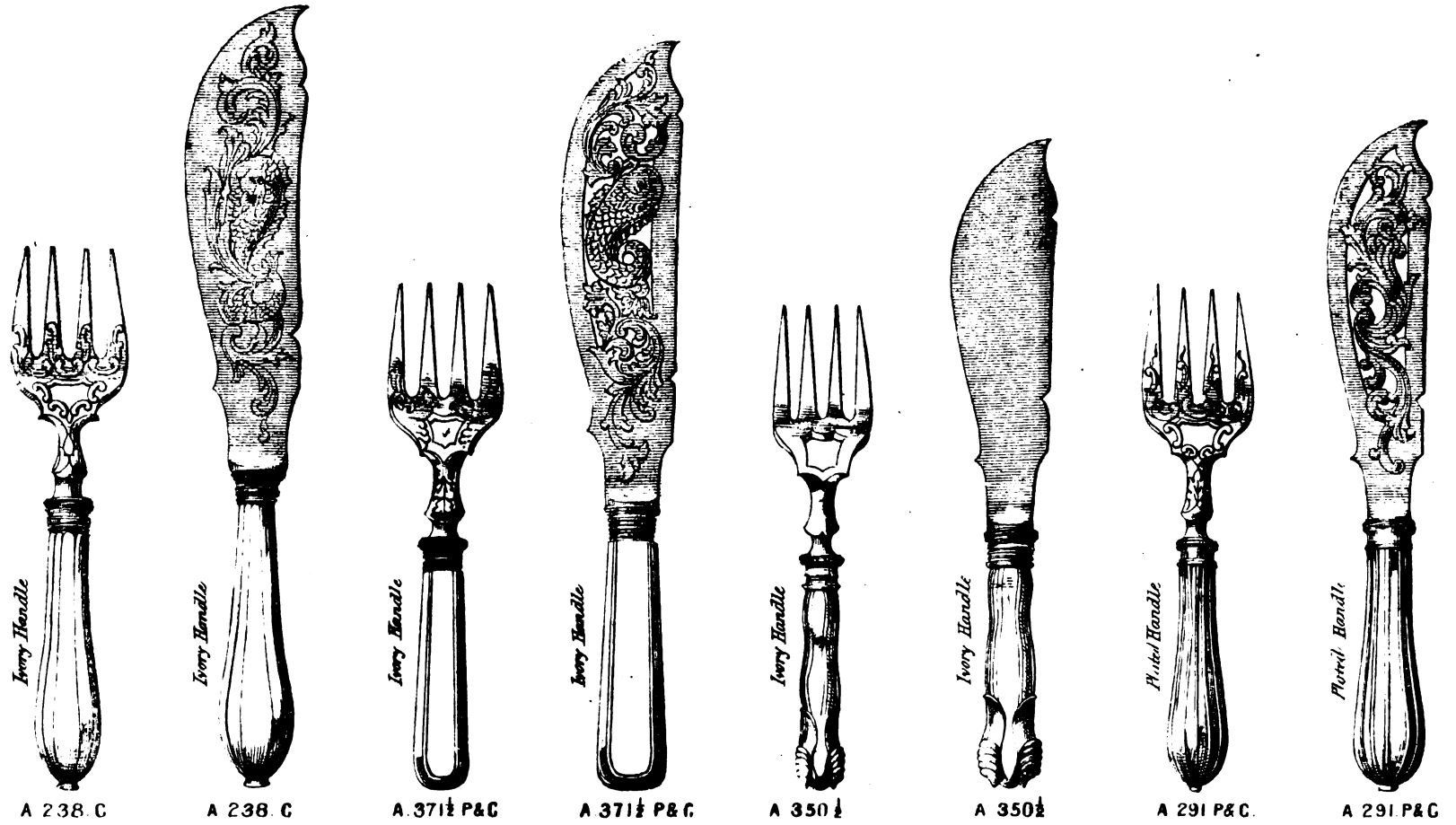

JOSEPH MAPPIN AND BROTHERS.

QUEEN'S CUTLERY WORKS SHEFFIELD.

Stock ready at the Warehouse

67 & 68, KING WILLIAM ST. CITY, LONDON.

MAPPIN BROTHERS,
MANUFACTORY,
QUEEN'S CUTLERY WORKS, SHEFFIELD,
WAREHOUSE,
67 & 68, KING WILLIAM STREET, LONDON.

PRICES OF MAPPINS' SILVER PLATED DESSERT KNIVES AND FORKS.

For Drawings, see corresponding numbers on Plate.

							per doz. pair.		
							s.	d.	0
A254	Middle quality, Ivory, Fluted, Silver Ferrules, 4 prong French Forks	4	4	0
A448c	Better quality do. do. do. Chased Blades and Forks	5	2	0
A 14	Transparent do. do. do. 4 prong French Forks	5	0	0
A246	Middle quality do. do. do. do. do.	4	0	0
A255	Do. do. do. do. do.	4	0	0
A253	Do. do. do. do. do.	4	4	0
A 4	Better quality do. Octagon do. do. do.	4	0	0
A251	Middle quality do. Fluted do. do. do.	4	4	0
A244	Do. do. do. do. do.	4	0	0
A252	Do. do. do. do. do.	4	0	0
A263	Common quality do. Octagon do. do. do.	3	10	
A211½	Middle quality do. do. do. do. do.	4	15	0
A 94½	Transparent do. Fluted do. do. do.	6	6	0
A405	Middle quality do. do. do. do. do.	5	0	0
A 96c	Transparent do. do. do. Chased Blades and Forks	6	16	0
A101c	Long Pearl Handle do. do. do. do. do.	10	0	0
A100	Transparent Ivory do. do. 4 prong French Forks	7	14	0
A 10c	do. do. do. do. do. Chased Blades and Forks	6	10	0
A 12c	do. do. do. do. do. do. do.	6	8	0
A367c	do. do. do. do. do. do. do.	7	15	0
A400c	do. do. do. do. do. do. do.	6	16	0
A398c	do. do. do. do. do. do. do.	6	10	0

PRICE OF DESSERT CASES.

12 pair plain	each	10s.		12 pair dome top	each	15s.
18 pair do.	„	14s.		18 pair do.	„	20s.

The London Warehouse contains the Largest Stock of Cutlery in the World.

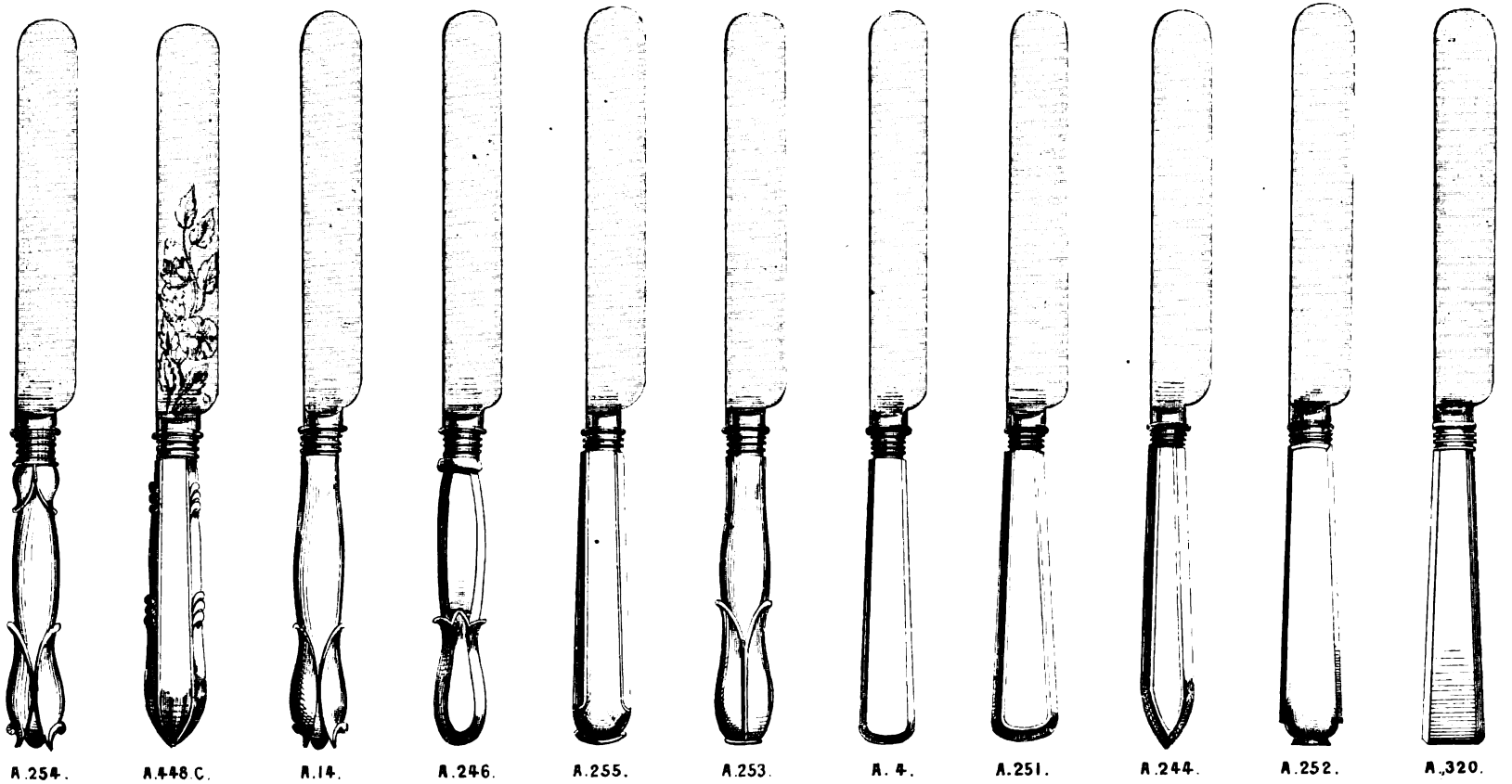

A. 254. A. 448 C. A. 14. A. 246. A. 255. A. 253. A. 4. A. 251. A. 244. A. 252. A. 320.

JOSEPH MAPPIN AND BROTHERS,
QUEEN'S CUTLERY WORKS, SHEFFIELD.

Stock ready at the Warehouse

67 & 68 KING WILLIAM ST., CITY, LONDON.

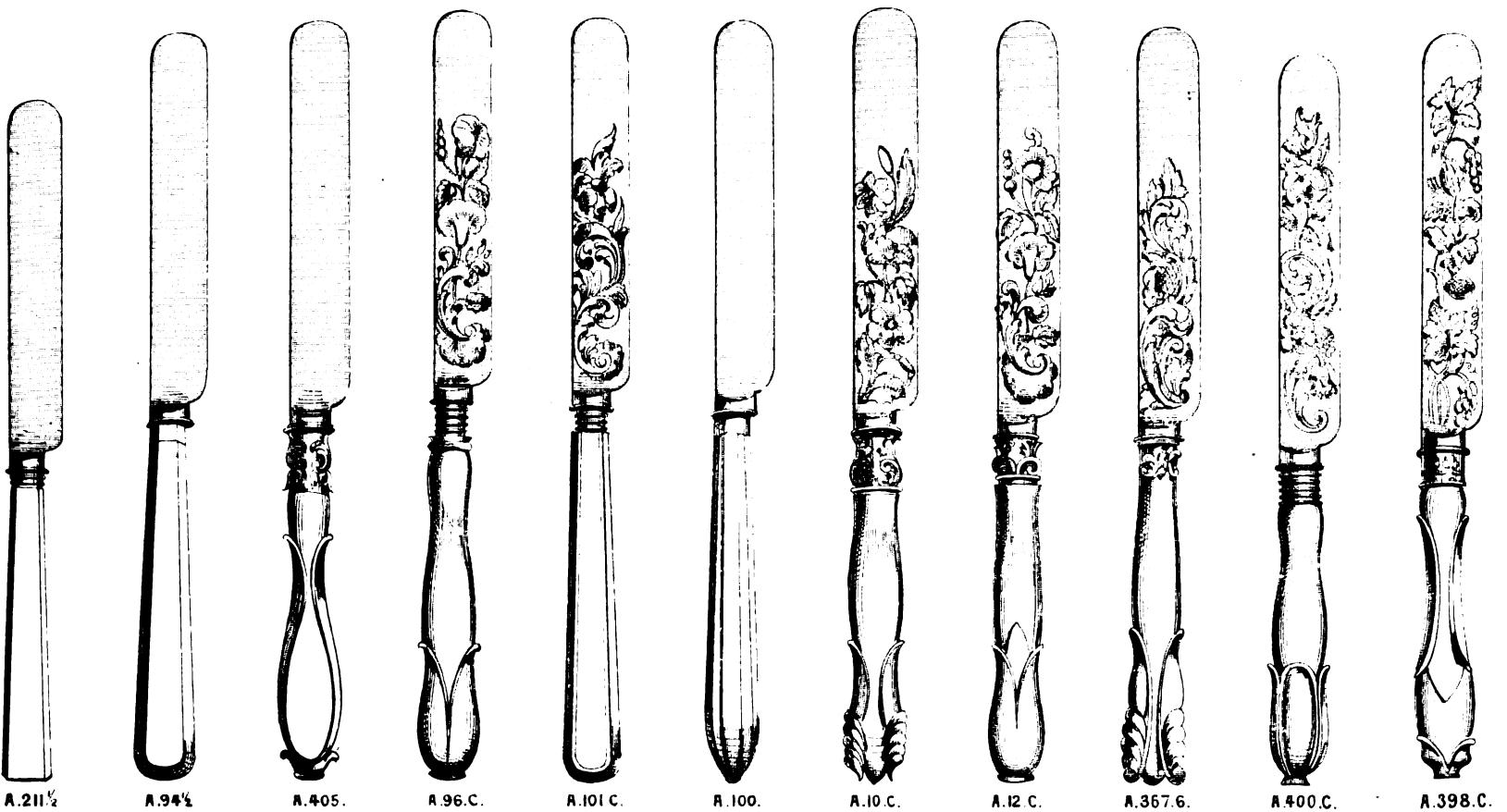

A. 211 1/2 A. 94 1/2 A. 405. A. 96 C. A. 101 C. A. 100. A. 10 C. A. 12 C. A. 367.6. A. 400 C. A. 398 C.

Drawn one half real size

MAPPIN BROTHERS,
MANUFACTORY,
QUEEN'S CUTLERY WORKS, SHEFFIELD,
WAREHOUSE,
67 & 68, KING WILLIAM STREET, LONDON.

PRICES OF MAPPINS' SILVER PLATED DESSERT KNIVES AND FORKS.

For Drawings, see corresponding numbers on Plate.

							per doz. pair.		
							£	s.	d.
A 75c	Common Pearl, Octagon, Silver Ferrules, Chased Blades and Forks						4	16	0
A 80	Do. do. do. 4 prong French Forks						5	5	0
A 32	Best Pearl, Oval, do. do. do.						6	0	0
A258	Do. Carved, do. do. do.						7	0	0
A 35	Do. do. do. do. do. do.						6	0	0
A208c	Best Pearl, Octagon, Silver Ferrules, Chased Blades and Forks						8	0	0
A341	Common do. do. 4 prong French Forks						5	0	0
A433	Best Pearl, Carved, do. do. do.						7	10	0
A 55c	Do. do. do. Chased Blades and Forks						8	16	0
A406c	Do. do. do. do. do. do.						9	0	0
A376	Do. do. do. do. do. do.						8	4	0
A396	Best Pearl, Carved, Silver Ferrules, 4 prong French Forks						9	10	0
A 97c	Do. do. do. Chased Blades and Forks						10	0	0
A 86c	Do. do. do. do. do. do.						9	10	0
A 87	Do. do. do. 4 prong French Forks						9	0	0
A103c	Do. do. do. Chased Blades and Forks						11	0	0
A 98	Do. do. do. 4 prong French Forks						9	0	0
A 46	Silver Handle, King's Pattern, Plated Blades and Forks, or any other pattern Handle						6	10	0
A107	Plated Handle, Grecian do. do. do. do. do.						3	10	0
A 38	Silver Handle, Thread do. do. do. do. do.						7	0	0
A 44	Do. Melon do. do. do. do. do.						7	0	0
A106	Plated Handle, Quill do. do. do. do. do.						3	10	0

The London Warehouse contains the Largest Stock of Cutlery in the World.

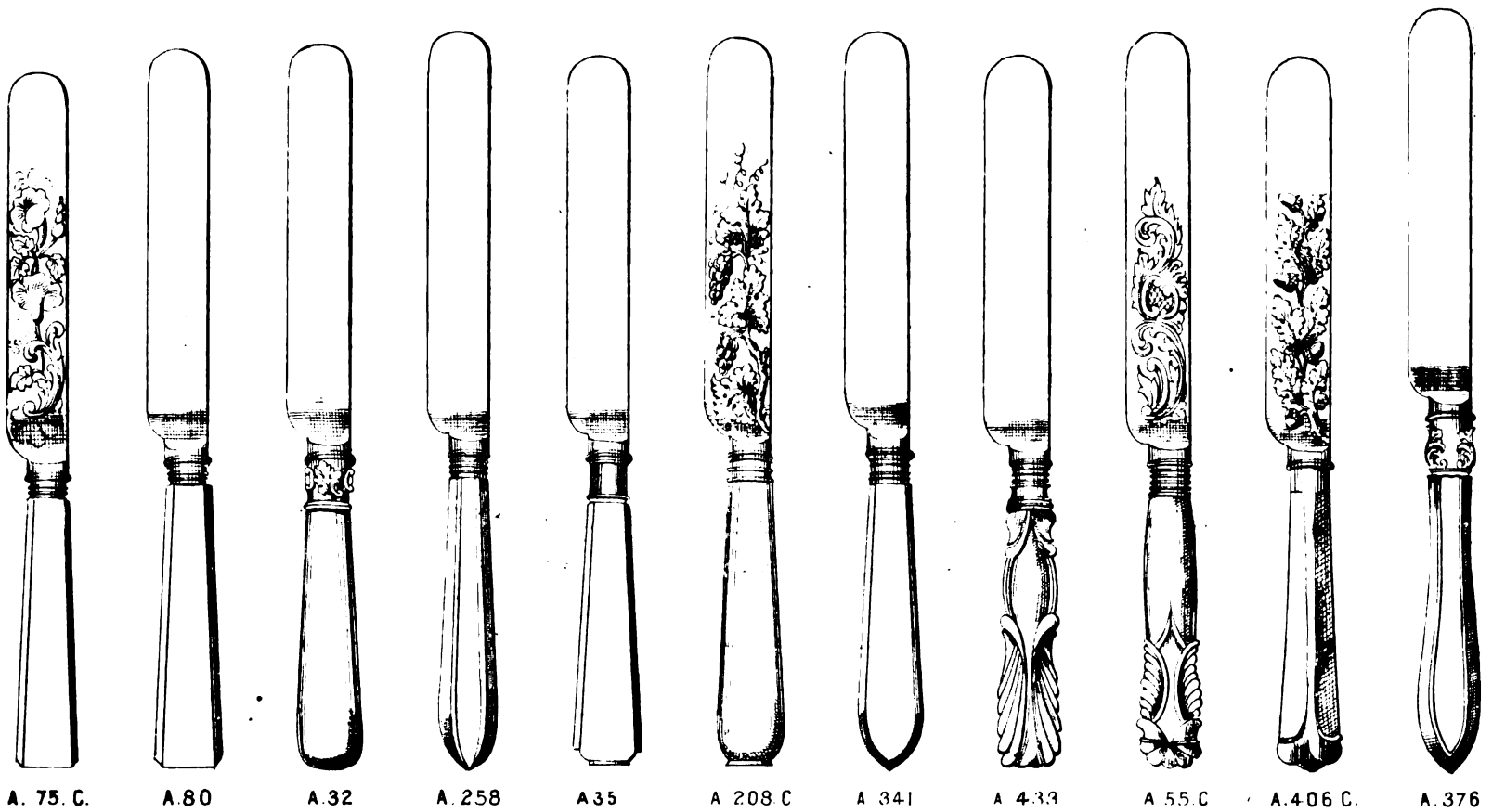

A. 75. C. A. 80 A. 32 A. 258 A. 35 A. 208 C A. 341 A. 433 A. 55. C A. 406 C. A. 376

JOSEPH MAPPIN AND BROTHERS.

QUEEN'S CUTLERY WORKS SHEFFIELD.

Stock ready at the Warehouse.

67 & 68, KING WILLIAM ST. CITY, LONDON.

Drawn one half real size

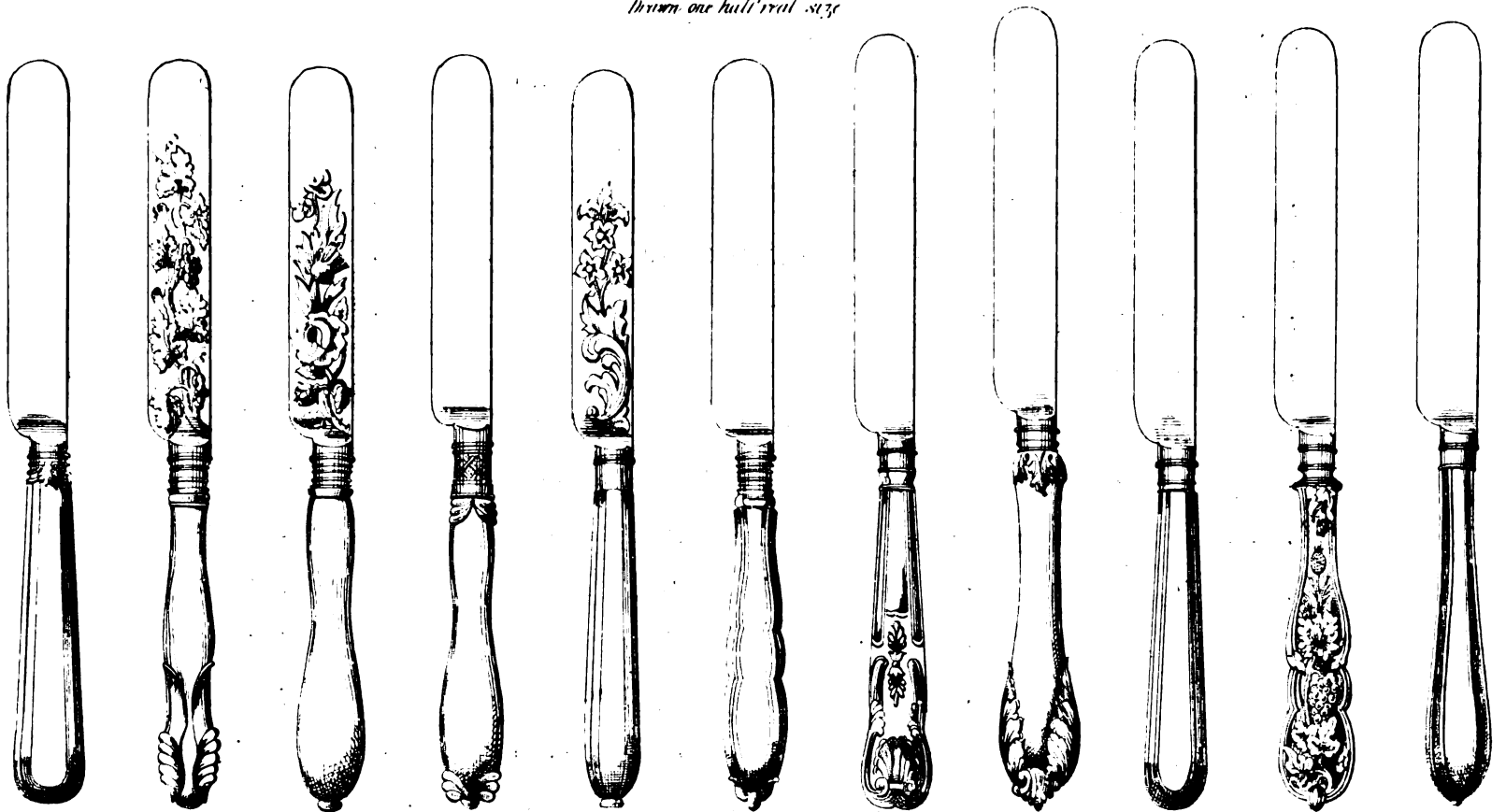

A. 396. A. 97. C. A. 86 C A. 87 A. 103 C. A. 98. A. 46. A. 107. A. 38 A. 44 A. 106.

MAPPIN BROTHERS,
MANUFACTORY,
QUEEN'S CUTLERY WORKS, SHEFFIELD,
WAREHOUSE,
67 & 68, KING WILLIAM STREET, LONDON.

PRICES OF MAPPINS' SILVER PLATED FISH EATING KNIVES.

For Drawings, see corresponding numbers on Plate.

		per doz.		
		£	s.	d.
A 440	Ivory Handles, Silver Ferrules, Plated Blade	2	10	0
A 447	Do. do. do.	3	0	0
A 442	Do. do. do. Chased	3	18	0
A 344	Do. do. do. do.	3	5	0
A 326	Do. do. do. do.	3	12	0
A 343	Do. do. do. do.	4	10	0
A 459	Do. do. do. Pierced and Chased	5	12	0
A 460	Do. do. Silver Blade do.	15	10	0
A 443	Plated Handle, Plated Blade, Chased	3	4	0
A 458	Do. King's Pattern, Plated Blade, Chased	3	0	0
A 446	Silver Handle, Silver Blade, Chased	15	10	0
A0342	Plated Handle, Plated Blade, do.	3	6	0
A 342	Silver Handle, do. do. (same Pattern as A0342)	5	5	0
A 445	Do. Silver Blade, do. (King's Pattern Handle)	15	10	0
A 457	Do. Plated Blade, do. (Thread Pattern Handle)	5	8	0
A 457½	Plated Handle, do. do. do.	3	12	0
A 441	Do. do. do.	3	12	0
A 345	Do. do. do.	3	0	0

Plain Mahogany Cases, Lock and Key, for 12 Knives 10s. for 18 Knives 12s.

Dome Top do. do. do. 15s. do. 20s.

The London Warehouse contains the Largest Stock of Cutlery in the World.

The New Fashion.

FISH EATING KNIVES.
SILVER AND SILVER PLATED BLADES.

MANUFACTURED BY

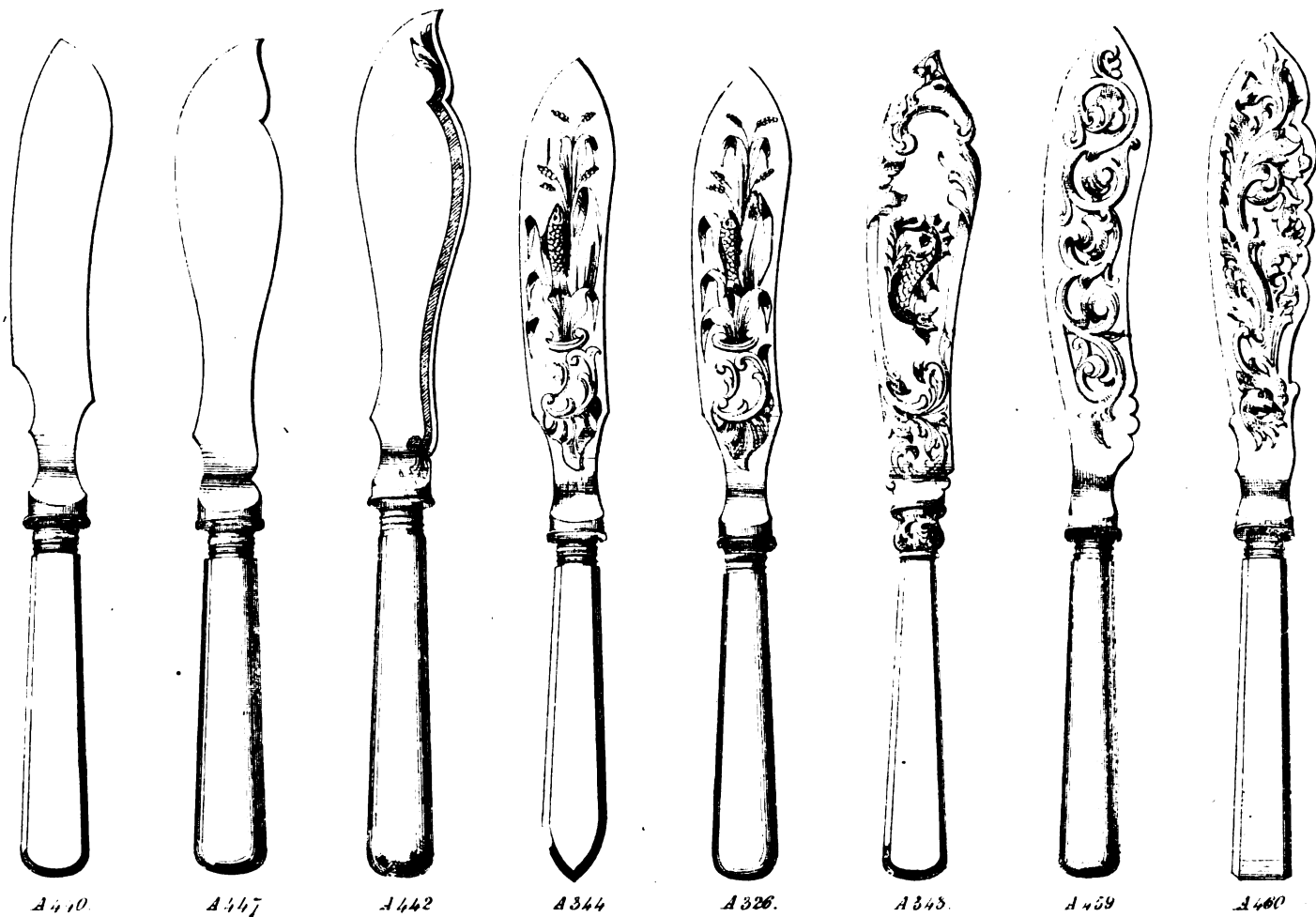

A 440.

A 447.

A 442.

A 344.

A 326.

A 343.

A 439.

A 460.

JOSEPH MAPPIN AND BROTHERS.

QUEEN'S CUTLERY WORKS SHEFFIELD.

Stock ready at the Warehouse.

67 & 68, KING WILLIAM ST. CITY, LONDON.

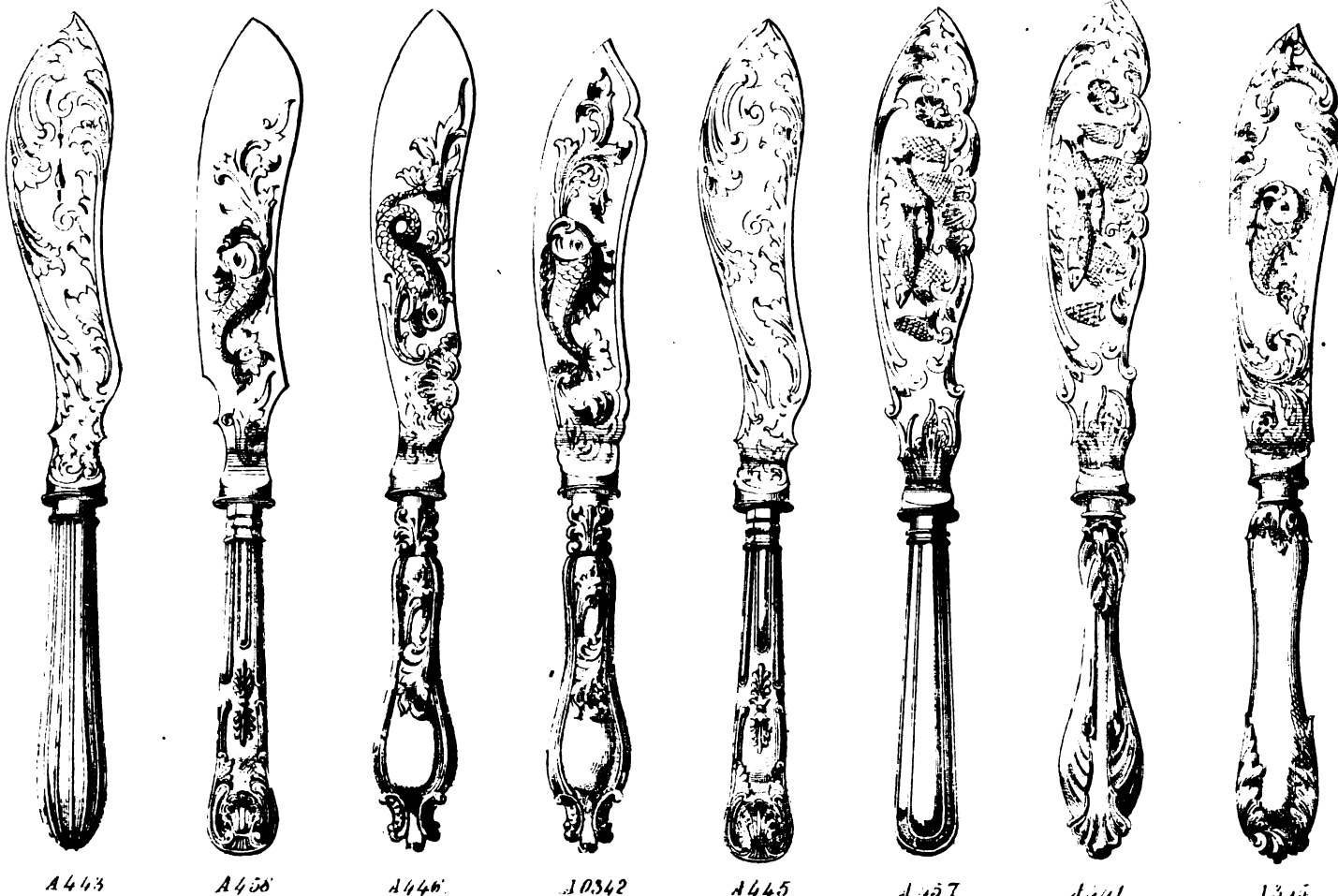

A 443.

A 456.

A 446.

A 342.

A 445.

A 457.

A 471.

A 375.

Drawn half real size.

MAPPIN BROTHERS,
MANUFACTORY,
QUEEN'S CUTLERY WORKS, SHEFFIELD,
WAREHOUSE,
67 & 68, KING WILLIAM STREET, LONDON.

**PRICES OF MAPPINS' NICKEL SILVER AND ELECTRO SILVER
 PLATED SPOONS AND FORKS.**

For Drawings, see corresponding numbers on Plate.

NICKEL SILVER.
PLAIN FIDDLE PATTERN.

No.		COM. QUALITY.			BEST QUALITY.		
		v.s.	s.	d.	v.s.	s.	d.
E1821	Table Spoons, per doz.	9 4	8 4	7 8	16 8	14 8	13 0
E1822	Do. Forks	9 0			16 8		
E1823	Dessert Spoons	6 4			12 8		
E1824	Do. Forks	6 4			12 8		
E1825	Tea Spoons	4 0	3 4	3 0	6 8	6 0	5 0
E1826	Salt Spoons } Gilt						
E1827	Mustard do. } Bowls	3 8			6 0		
E1828	Egg do. } 4s. per						
E1831	Sugar Tongs, per doz.	10 0			18 8		
E1834	Toddy Ladles				16 0		12 0
E1835	Sauce do.	13 6			18 8		
E1836	Soup do. each	5 0			6 9		
E1837	Gravy Spoons	2 8			4 8		

**ELECTRO SILVER PLATED SPOONS,
 FORKS, &c.**
PLAIN FIDDLE PATTERN.—COMMON QUALITY.

No.		s.	d.
B213	Table Spoons, full size per doz.	23	0
B214	Do. Forks	23	0
B215	Dessert Spoons	17	0
B216	Do. Forks	17	0
B217	Tea Spoons	9	0
B218	Sugar Tongs	22	0
B219	Sauce Ladles	27	0
B220	Salt Spoons	9	6
B221	Mustard Spoons	9	6
B222	Egg Spoons	9	6

BETTER QUALITY.

No.		s.	d.
E2434	Table Spoons per doz.	27	0
E2435	Do. Forks	27	0
E2436	Dessert Spoons	21	0
E2437	Do. Forks	21	0
E2438	Sugar Tongs	30	0
E2439	Tea Spoons	10	6
E2441	Salt do.	12	0
E2442	Mustard do.	12	0
E2443	Egg do.	12	0
B 234	Gravy do. each	5	6

**ELECTRO SILVER PLATED ON
 NICKEL SILVER.**
PLAIN FIDDLE PATTERN.—BEST QUALITY.

No.		s.	d.	Plated extra Strong.
E1842	Table Spoons, full size per doz.	36	0	48 0
E1843	Do. Forks do.	36	0	48 0
E1844	Do. Spoons, middle size	32	0	
E1845	Do. Forks do.	32	0	
E1846	Do. Spoons, small size	27	0	
E1847	Dessert Spoons, full size	27	0	38 0
E1848	Do. Forks do.	27	0	38 0
E1849	Do. Spoons, small size	23	0	
E1850	Do. Forks do.	23	0	
E1851	Tea Spoons, full size	16	0	20 0
E1852	Do. middle size	13	0	18 0
E1853	Do. small size	12	0	
E1854	Salt Spoons } Gilt Bowls			
E1855	Mustard do. } 6s. per doz.	14	0	24 0
E1856	Egg do. } extra.			
E1857	Caddy do. } Chased 3s.	14	0	
E1858	Sugar do. } per doz. extra			
E1859	Sugar Tongs, full size per pair	3	6	4 0
E1860	Pickle or Oyster Forks per doz.	18	0	
E1861	Toddy Ladles, full size	42	0	48 0
E1862	Sauce Ladles do.	48	0	60 0
E1864	Soup do. do. each	12	0	16 0
E1865	Gravy Spoons	7	0	10 0
E1866	Skewers per inch	0	4	
E1867	Knife Rests per pair	4	6	
				6 0
E1868	Do. ornamental			12 0

THREADED PATTERN.

No.		s.	d.	Plated extra Strong.
E1906	Table Spoons per doz.	54	0	70 0
E1907	Do. Forks	54	0	70 0
E1908	Dessert Spoons	40	0	50 0
E1909	Do. Forks	40	0	50 0
E1910	Tea Spoons	24	0	32 0
E1920	Sauce Ladles each	5	0	6 0
E1915	Toddy	4	0	5 0
E1912	Egg Spoons			
E1914	Salt } gilt	2	6	3 0
E1913	Mustard } bowls			
E1917	Sugar Tongs	5	6	6 0
E1919	Soup Ladles	16	0	18 0
E1918	Gravy Spoons	10	6	12 0

ELECTRO SILVER PLATED ON NICKEL SILVER.

KING'S PATTERN.				LILY PATTERN.			
No.		s.	d.	No.		s.	d.
E1976	Table Spoons per doz.	60	0	E4392	Table Spoons per doz.	72	0
E1977	Do. Forks	60	0	E4393	Do. Forks	72	0
E1978	Dessert Spoons	44	0	E4395	Dessert Spoons	54	0
E1979	Do. Forks	44	0	E4394	Do. Forks	54	0
E1980	Tea Spoons	27	0	E4396	Tea Spoons	36	0
E1990	Sauce Ladles each	5	6	E4400	Sauce Ladles each	6	6
E1985	Toddy	5	0	E4406	Toddy Ladles	6	0
E1982	Egg Spoons			E4398	Egg Spoons		
E1984	Salt } gilt	3	0	E4397	Salt } bowls	3	6
E1983	Mustard } bowls			E4399	Mustard		
E1987	Sugar Tongs	6	0	E4406	Sugar Tongs	7	0
E1989	Soup Ladles	17	6	E4402	Soup Ladles	20	0
E1988	Gravy Spoons	11	0	E4401	Gravy Spoons	13	0

The London Warehouse contains the Largest Stock of Electro Silver Plate in the World.

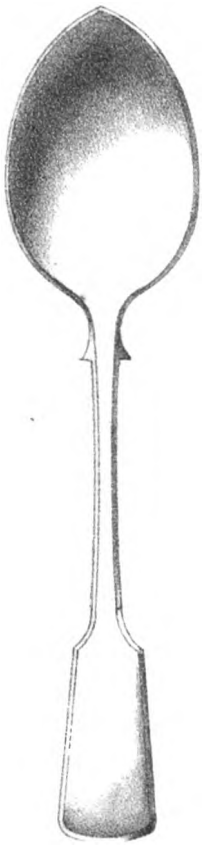

E 1842.

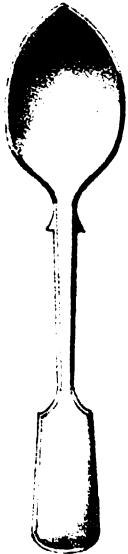

E 1851.



E 1843.

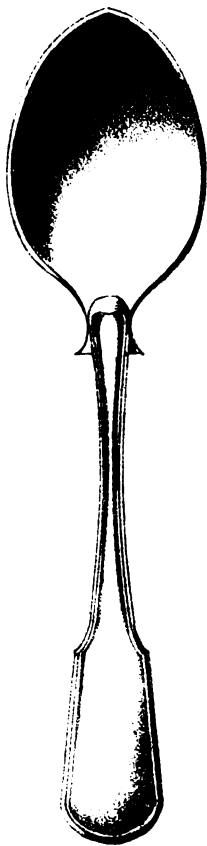

E 1906.

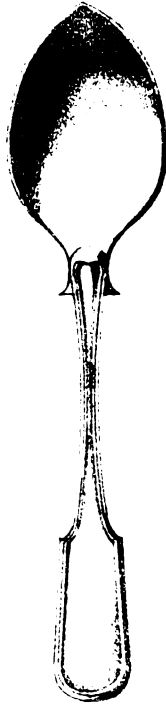

E 1908.



E 1910.



E 1907.

MAPPIN, BROTHERS.
 QUEEN'S CUTLERY WORKS, SHEFFIELD,
Stock ready at the Warehouse
 67 & 68 KING WILLIAM ST CITY, LONDON.
Drawn half real size.

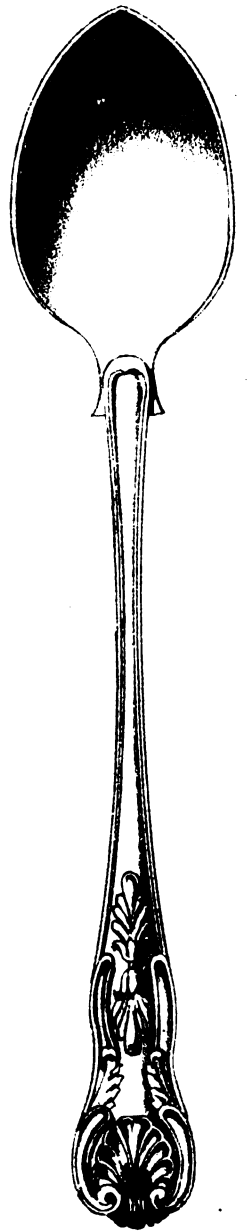

E 1988.



E 1909.

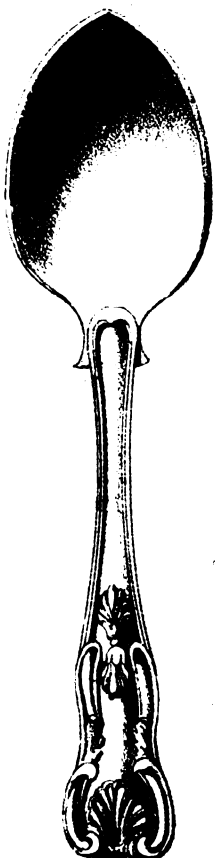

E 1976.



E 1978.

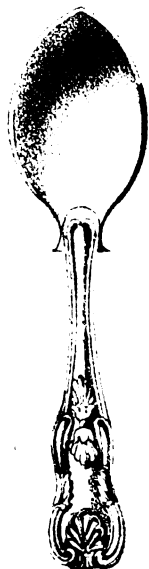

E 1980.

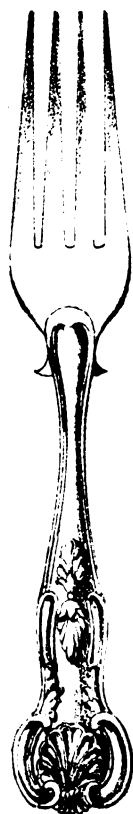

E 1977.

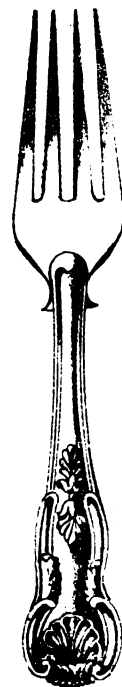

E 1979.

MAPPIN BROTHERS,
MANUFACTORY,
QUEEN'S CUTLERY WORKS, SHEFFIELD,
WAREHOUSE,
67 & 68, KING WILLIAM STREET, LONDON.

**PRICES OF MAPPINS' ELECTRO SILVER PLATE ON PURE
 NICKEL SILVER.**

For Drawings, see corresponding numbers on Plate.

CRUET FRAMES.

		4 Glass.	5 Glass.	6 Glass.	7 Glass.		
		s. d.	s. d.	s. d.	s. d.	s. d.	
E2324	Plain round Body, Scroll Handle, Pierced Side .	14	0	18	0	26	0
E3297	Bead Mounted, Pierced Sides, Crystal Cut Bottles } Eglinton Pattern }			76	0		
E1758	Maltese Cross, Piercing Ornamental Scroll Border, } Bottles as in E3297, very good }	36	0	40	0	46	0
E2742	Strong Pierced Cruet, recommended for Hotel use, } Gadroon Pattern }	28	0	34	0	40	0
E1757	Pierced Scroll Pattern, Buhl Border, Scroll Handles, } and Feet to correspond, good }	32	0	38	0	44	0
E3161	Raised, Chased, Massive and Good, Handles, Feet } and Mounts all to correspond, Richly Cut } Bottles, "New Orleans Pattern" }			90	0	100	0
E2132	Diamond Pierced, Vine Leaf and Flowers for Handle, } Mounts and Feet, a very superb and elegant } Design }			68	0	76	0
E3159	Corinthian Scroll Piercing Revolving, the Orna- } mental work being raised above the Body, } called the "Warwick Pattern" }			84	0	90	0

BUTTER COOLER.

E3407	Porcelain Tub, neat E. P. Plate and Cover with Cow on Top	20	0
-------	---	----	---

SUGAR BASKETS.

		Blue Glass.	Ruby Glass.
		s. d.	s. d.
E2907	Electro Plated on White Metal, Scroll Pattern,	18	0
E2539	Do. do. Nickel Silver, Pavilion Pattern, good.	42	0

EGG FRAME.

E2605½	Electro Plated on Nickel Silver, "New Scroll" Pattern, Pierced Sides, } Revolving, with Spoons complete }	4 Cups.	6 Cups.
		70	0
		80	0

The London Warehouse contains the Largest Stock of Electro Silver Plate in the World.

MAPPIN AND BROTHERS,
QUEEN'S CUTLERY WORKS, SHEFFIELD.
Stock ready at the Warehouse
67 & 68 KING WILLIAM ST. CITY. LONDON.

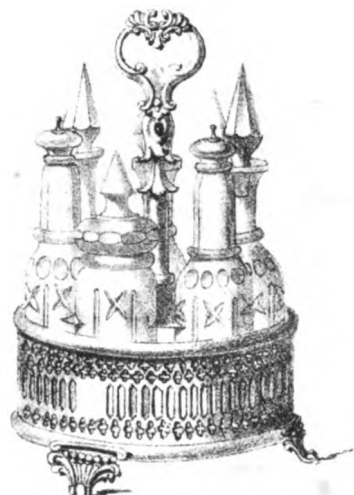

E2324.



E3297.



E1758.



E2907.



E3407.



E2539.



E2742.

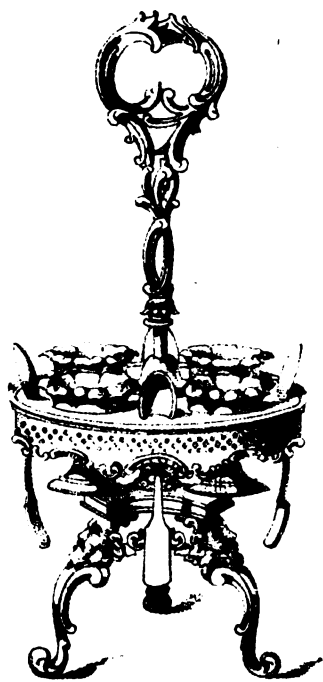

E2605½



E1757.



E3161.



E2132.



MAPPIN BROTHERS,
MANUFACTORY,
QUEEN'S CUTLERY WORKS, SHEFFIELD,
WAREHOUSE,
67 & 68, KING WILLIAM STREET, LONDON.

**PRICES OF MAPPINS' ELECTRO SILVER PLATE ON PURE
NICKEL SILVER.**

For Drawings, see corresponding numbers on Plate.

TOAST RACKS.

	each.
	s. d.
E3379 Plain shaped	7 0
E2906 Grecian, Plated on White Metal	11 6
E2748 Hollow Ridge, Plated on Nickel	10 0
E2325 Gothic	18 0
E3170 Beaded	14 0
E3387 Serpent and Dolphins	24 0
E3125 4 Bars with 2 Egg Cups and Spoons	36 0

LIQUEUR STANDS.

E3464 3 Glass Liqueur Frames	66 0
S4286 3 do. do. Pierced	112 0

The London Warehouse contains the Largest Stock of Electro Silver Plate in the World.

Drawn at real size

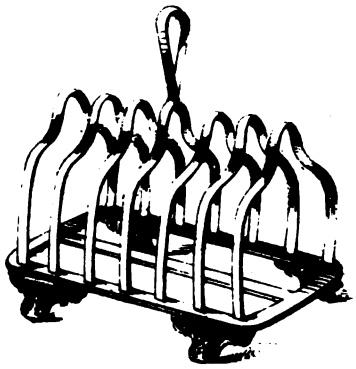

E 2748.

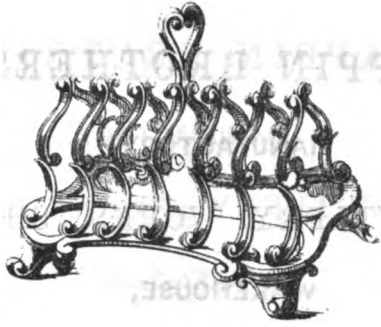

F 2906.

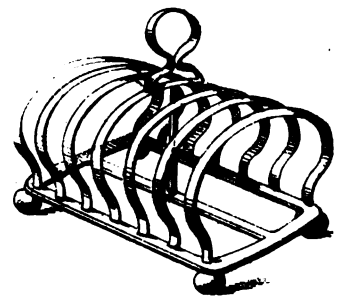

E 3379.

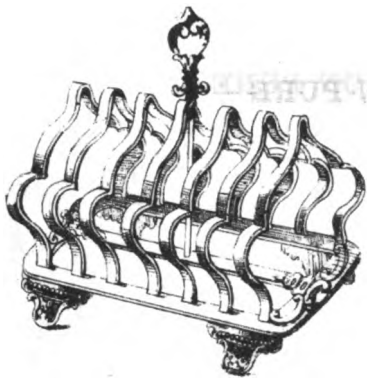

E 2325



F 3170

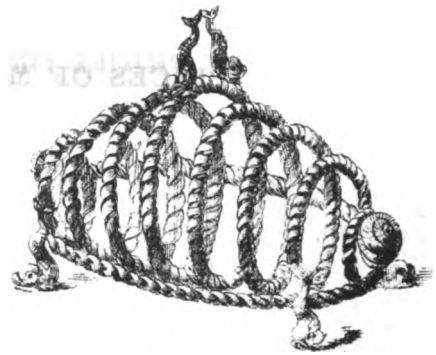

H 3387



E 3464.

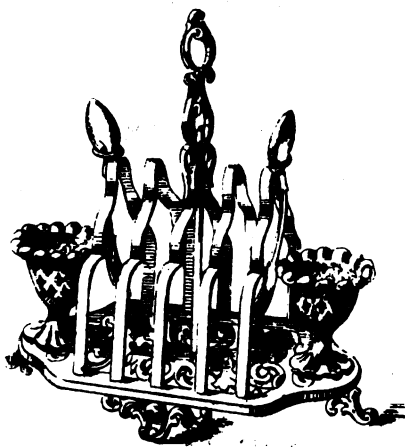

F 3125



S 4286.

JOSEPH MAPPIN AND BROTHERS.
QUEEN'S CUTLERY WORKS SHEFFIELD.
Stock ready at the Warehouse.
67 & 68, KING WILLIAM ST CITY, LONDON.

MAPPIN BROTHERS,
MANUFACTORY,
QUEEN'S CUTLERY WORKS, SHEFFIELD,
WAREHOUSE,
67 & 68, KING WILLIAM STREET, LONDON.

**PRICES OF MAPPINS' ELECTRO SILVER PLATE ON PURE
 NICKEL SILVER.**

For Drawings, see corresponding numbers on Plate.

CANDLESTICKS.

		per pair.
		s. d.
B42	10 Inch Plain Pattern	17 0
E3071	11 Inch Fluted do.	70 0
E2879a	10 Inch Nelson do.	56 0
E4535	10½ Inch Gadroon do.	50 0

SUGAR BASKETS.

		each.
		s. d.
E2536	Flower Pattern	56 0

BUTTER COOLER.

E3291½	Glass Tub, Plated Cover and Plate	42 0
--------	---	------

FLOWER STANDS.

E3035	Leaf Pattern	60 0
B173	Vine Pattern	60 0

WAITERS.

		6 in.	8 in.	10 in.	12 in.	14 in.	16 in.	18 in.	20 in.
		s. d.	s. d.	s. d.	s. d.	s. d.	s. d.	s. d.	s. d.
E2796	Chased	22 6	30 0	38 0	48 0	84 0	120 0	144 0	180 0

LIQUEUR STANDS.

E3369	3 Glass Liqueur Frame	£2 16 0
E3466	3 do. do. do. very good	£6 14 0
E3363	3 Richly Cut Glass Bottles, in very superior Frame	£7 15 0

The London Warehouse contains the Largest Stock of Electro Silver Plate in the World.



E 329 1/2

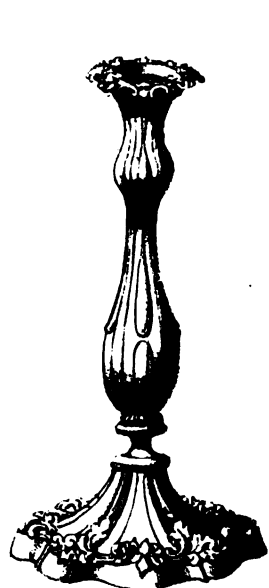

E 2879.

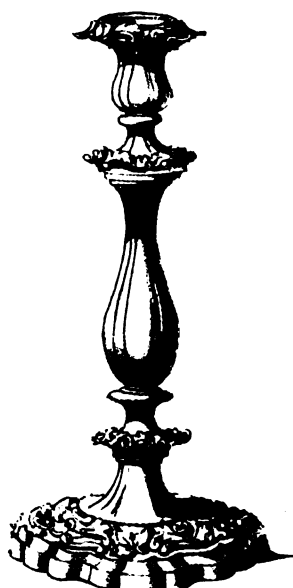

E 3071.

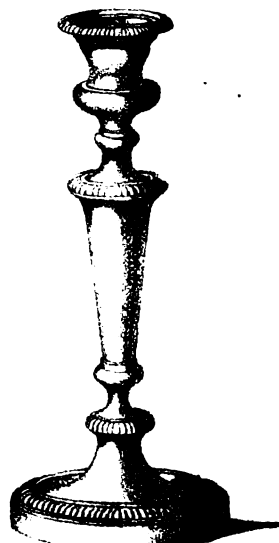

E 4535.



E 2536.



E 3055

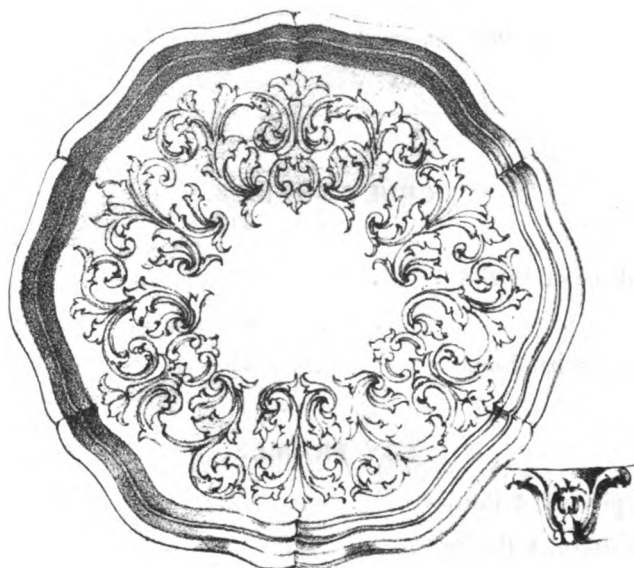

E 2796



B 173.

MAPPIN, BROTHERS.

QUEEN'S CUTLERY WORKS SHEFFIELD.

Stock ready at the Warehouse.

67 & 68 KING WILLIAM STREET, LONDON.

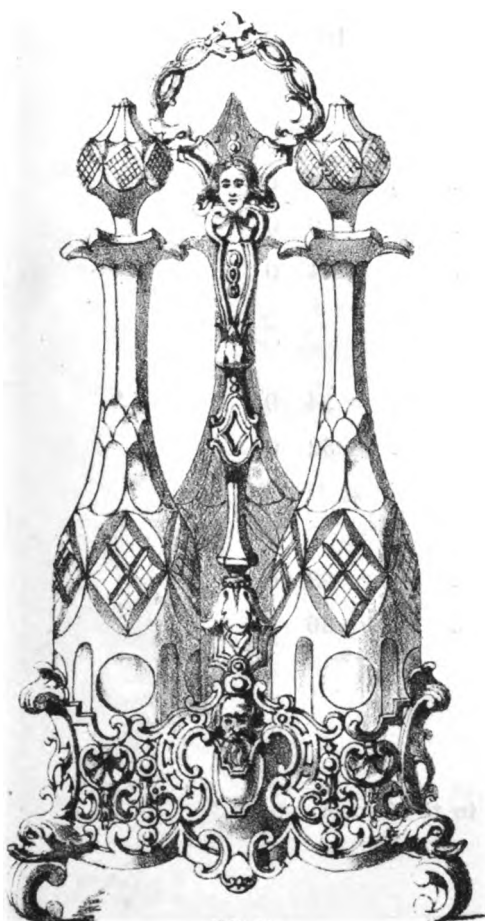

E 3363

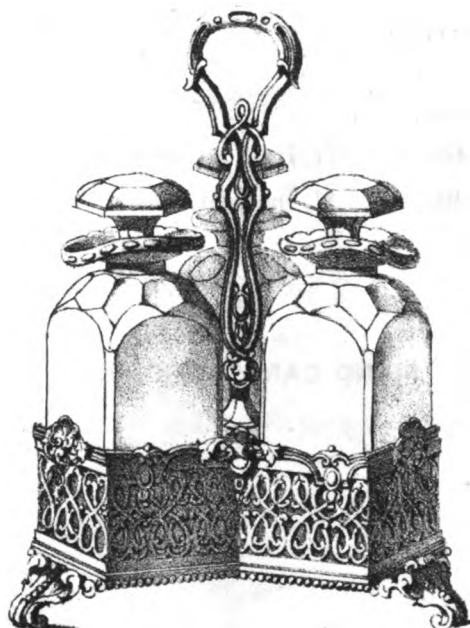

E 3466

Drawn one fourth real size.

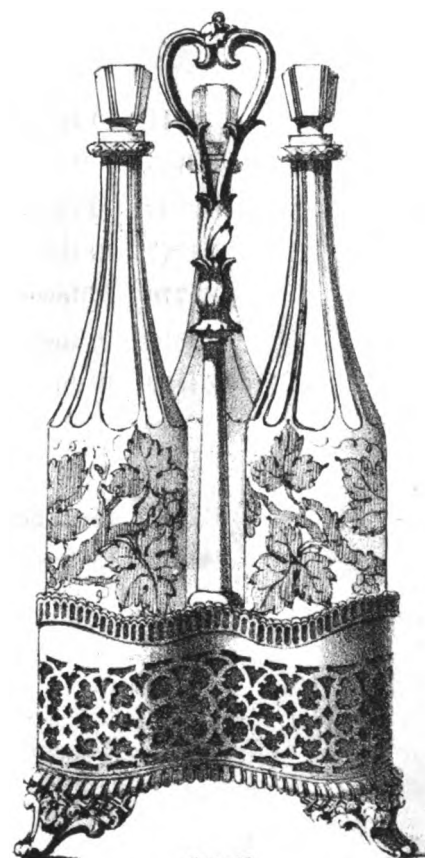

E 3369

MAPPIN BROTHERS,**MANUFACTORY,****QUEEN'S CUTLERY WORKS, SHEFFIELD,****WAREHOUSE,****67 & 68, KING WILLIAM STREET, LONDON.****PRICES OF MAPPINS' ELECTRO SILVER PLATE ON PURE
NICKEL SILVER.**

For Drawings, see corresponding numbers on Plate.

CRUET FRAMES.

		4 Glass. s. d.	5 Glass. s. d.	6 Glass. s. d.	7 Glass. s. d.
E2329	Stand pierced, shape of bottles	44 0	50 0	55 0	
E1761	Raised Border	46 0	54 0	62 0	70 0
E2344	Octagon Stand, very handsome	52 0	60 0	66 0	75 0

SOY FRAMES.

E3482	Gadroon Edge, pierced, 4 Bottles				20 0
E2760	Pierced Scroll Pattern, 4 Bottles				50 0

LIQUEUR STANDS.

E3185	3 White Cut Glass Bottles				100 0
-------	-------------------------------------	--	--	--	-------

TABLE CANDLESTICKS.

B44	10 Inch, Embossed (on Copper)				per pair 24 0
B45	10 Inch, Embossed				30 0
E2332	10 Inch, Richmond Pattern				44 0
E1777	10 Inch, Scroll Pattern, 46s.		11 Inch, do., 60s.		
E1776	10 Inch, Silver Pattern, 40s.		11 Inch, do., 54s.		
E3610	10 Inch, Orleans Pattern				24 0
E4479	10 Inch Thread Pattern				32 0

PIANO CANDLESTICKS.

E2962	Piano Scroll				28 0
E3373	Embossed				36 0

The London Warehouse contains the Largest Stock of Electro Silver Plate in the World.

MAPPIN BROTHERS.

QUEEN'S CUTLERY WORKS. SHEFFIELD.

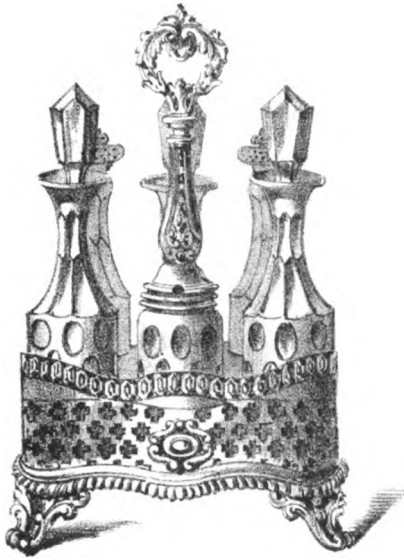

E2329.

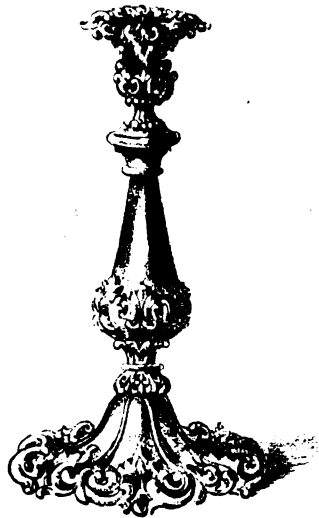

B45.

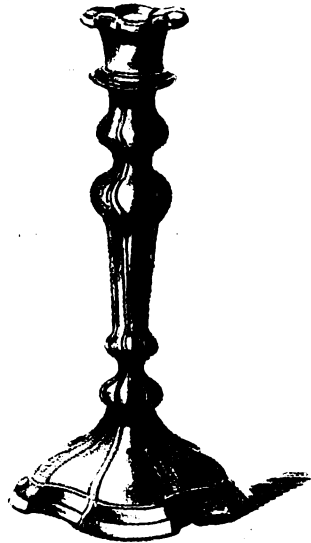

E4479.



E1761.

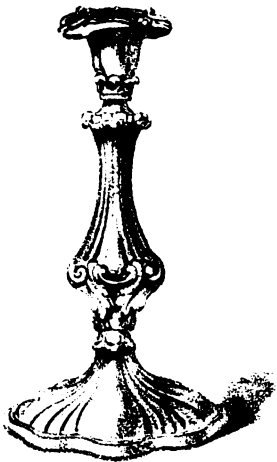

E3610.

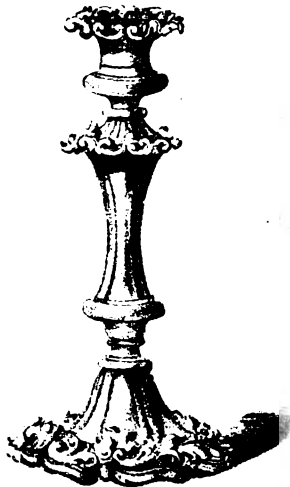

E1776.



E3185.



E1777.



E2332.

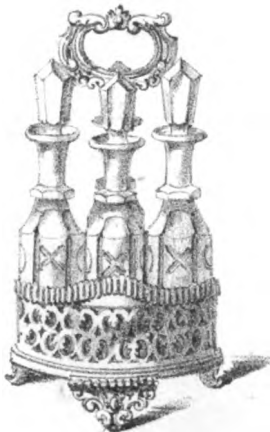

E3482.



E2760.

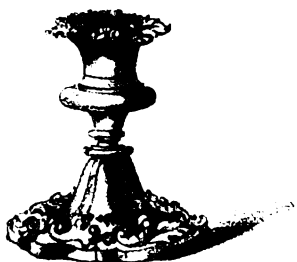

E2962.



E2344.

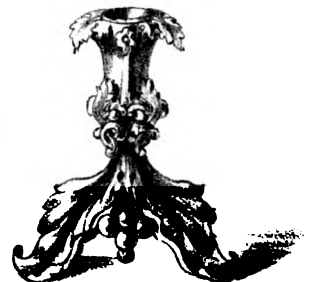

E3373.

Stock ready at the Warehouse.

67 & 68. KING WILLIAM ST. CITY LONDON.

Drawn one fourth real size.

MAPPIN BROTHERS,
MANUFACTORY,
QUEEN'S CUTLERY WORKS, SHEFFIELD,
WAREHOUSE,
67 & 68, KING WILLIAM STREET, LONDON.

**PRICES OF MAPPINS' ELECTRO SILVER PLATE ON PURE
NICKEL SILVER.**

For Drawings, see corresponding numbers on Plate.

PICKLE STANDS.

		each.
		s. d.
E 3391	2 Glass Bottles, White or Coloured	30 0
E 1775	2 Glass Coloured Bottles, good pattern, 36s. White Glass	48 0
E 4262	Handsome Cut Bottles ditto	70 0
B 66	2 Glass Bottles (White), Electro Plated on Copper (<i>common quality</i>)	24 0

FLOWER VASES AND STANDS.

E 3551	Blue Glass	32 0
E 3550	Blue Glass	32 0
E 3552	Ruby Glass	44 0

CANDELABRA.

E 3377	4 Lights	£8 0 0
E 3377½	3 Lights	5 10 0

TAPER CANDLESTICKS.

		per pair.
B 177	Leaf Pattern	32 0
B 65	Leaf Pattern	36 0

The London Warehouse contains the Largest Stock of Electro Silver Plate in the World.

JOSEPH MAPPIN AND BROTHERS.
QUEEN'S CUTLERY WORKS — SHEFFIELD.

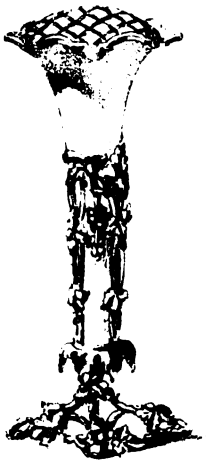

E.3550.



E.3391.

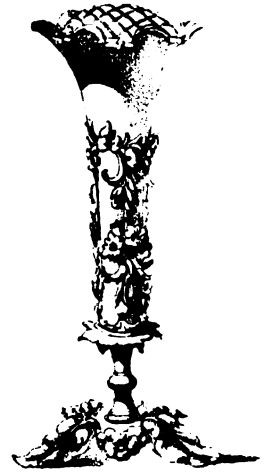

E.3551.

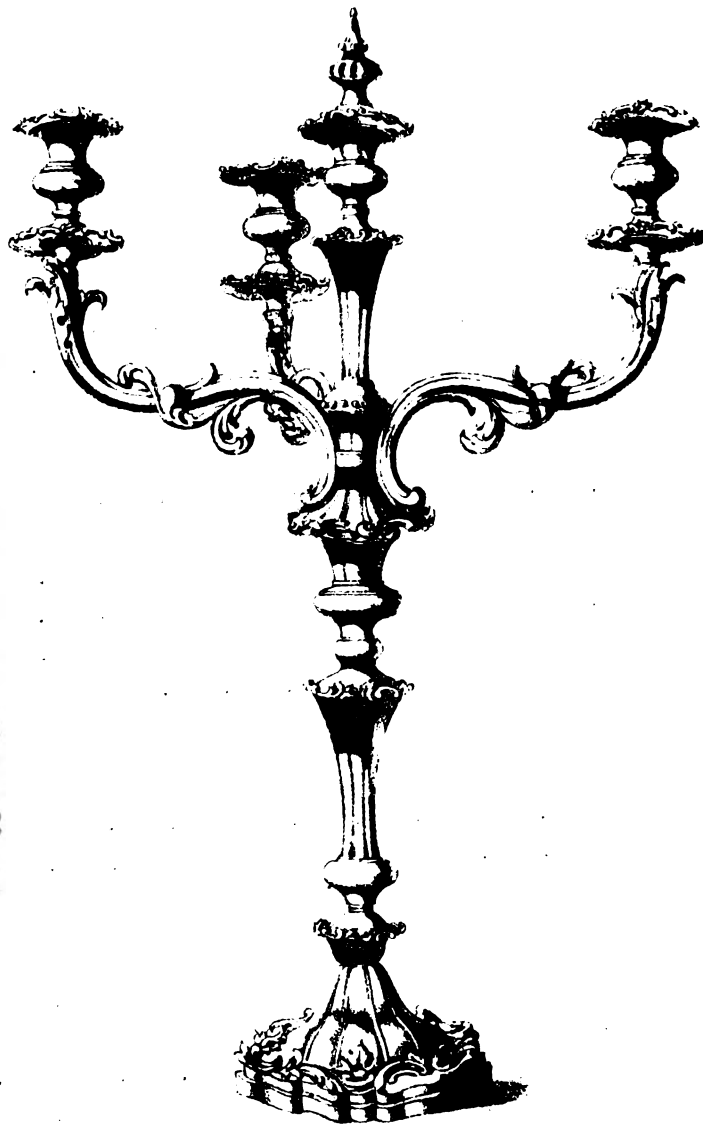

E.3377.

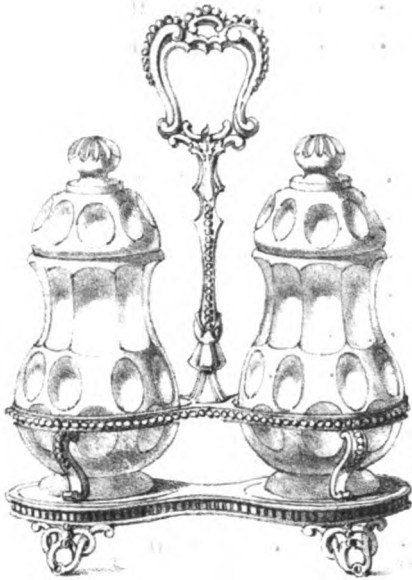

B.66.



E.1775.



B.177



E.3552



B.65

MAPPIN BROTHERS,
MANUFACTORY,
QUEEN'S CUTLERY WORKS, SHEFFIELD,
WAREHOUSE,
67 & 68, KING WILLIAM STREET, LONDON.

**PRICES OF MAPPINS' ELECTRO SILVER PLATE ON PURE
 NICKEL SILVER.**

For Drawings, see corresponding numbers on Plate.

TABLE CANDLESTICKS WITH GLASS SHADES.

		per pair
E 3459	10 Inch with Glass Shades	66 0
E 3460	10 Inch do. do. Engraved	70 0

CHAMBER CANDLESTICKS.

E 2354	Gadroon Edge	20 0
E 4532	Do. do.	46 0
E 3607	Fluted	20 0
B 578	Gothic Pattern	24 0
E 1779	Gadroon "Good Pattern"	38 0
E 3352	Silver Pattern	40 0

CHAMBER CANDLESTICKS WITH GLASS SHADES.

E 3072	Gadroon Edge	36 0
E 3047	Silver Pattern	48 0

CUPS OR TANKARDS.

		each.
S 4666	HALF-PINT Tankard, Imperial Measure, extra strongly plated	24 0
S 4666	Do. do. do. do. do. do. do. gilt inside	30 0
S 4666	PINT Tankard, Imperial Measure, extra strong plated	32 0
E 3058½	PINT Drinking Cup	28 0
E 3058½	Do. do. do. gilt inside	34 0
E 3058½	QUART Drinking Cup	44 0
E 3058¾	PINT Drinking Cup, with Glass Bottom, same Pattern as E 3058½	30 0

WAITERS.

	6 in.	7 in.	8 in.	10 in.	12 in.	14 in.	16 in.	18 in.	
	<i>s. d.</i>	<i>s. d.</i>	<i>s. d.</i>	<i>s. d.</i>	<i>s. d.</i>	<i>s. d.</i>	<i>s. d.</i>	<i>s. d.</i>	
E 4019	26 0	32 0	36 0	45 0	54 0	66 0	80 0	132 0	each.
E 4718	Raglan Pattern		54 0	72 0	110 0	each.			

The London Warehouse contains the Largest Stock of Electro Silver Plate in the World.

JOSEPH MAPPIN & BROTHERS.
 QUEENS CUTLERY WORKS. SHEFFIELD.

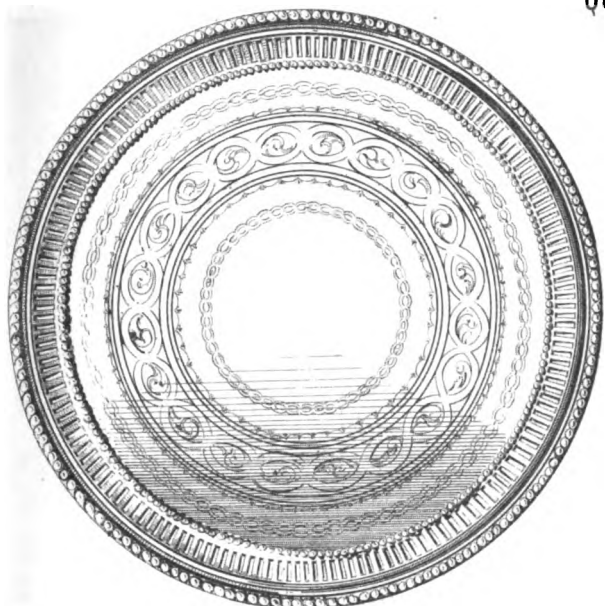

E4019.

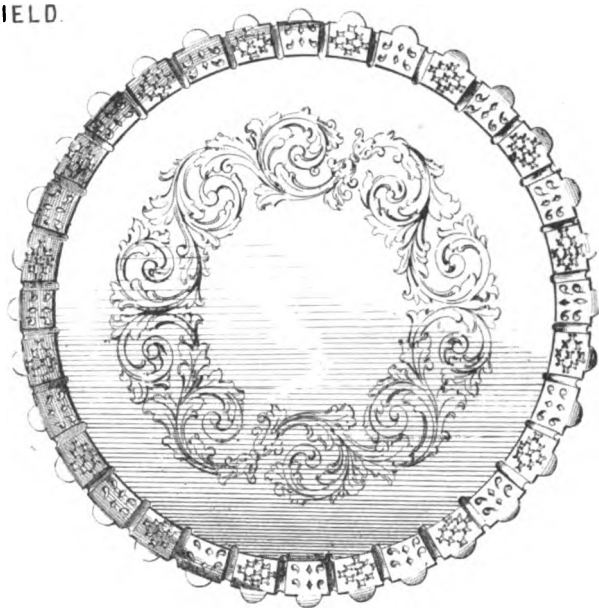

E4716.

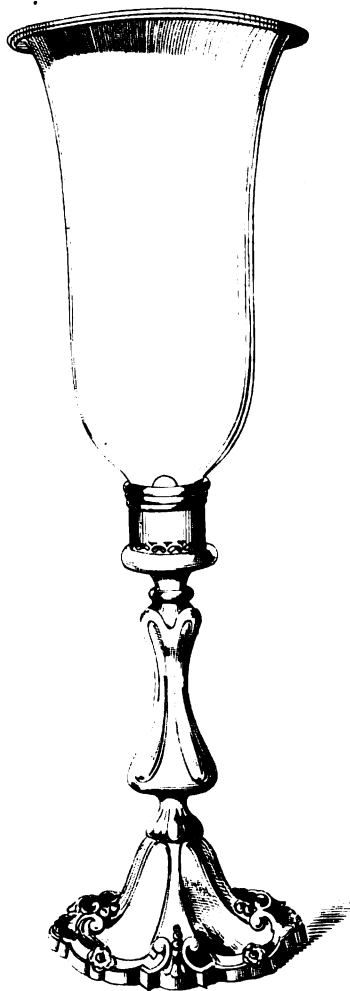

E3459.

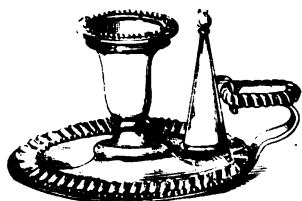

E2354.

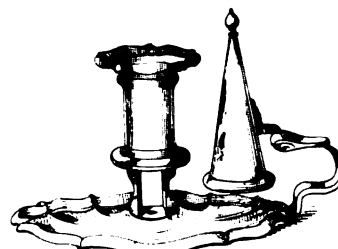

B578.

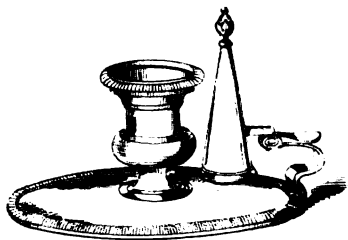

E4532.

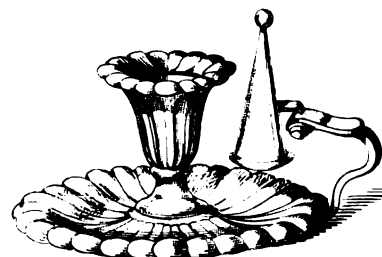

E3607.

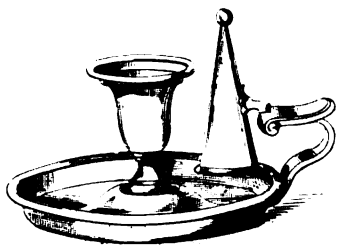

E3352.

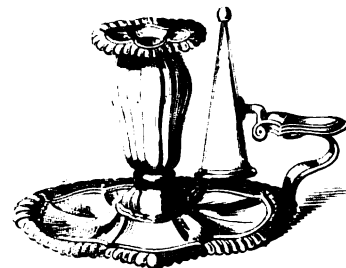

E1779.

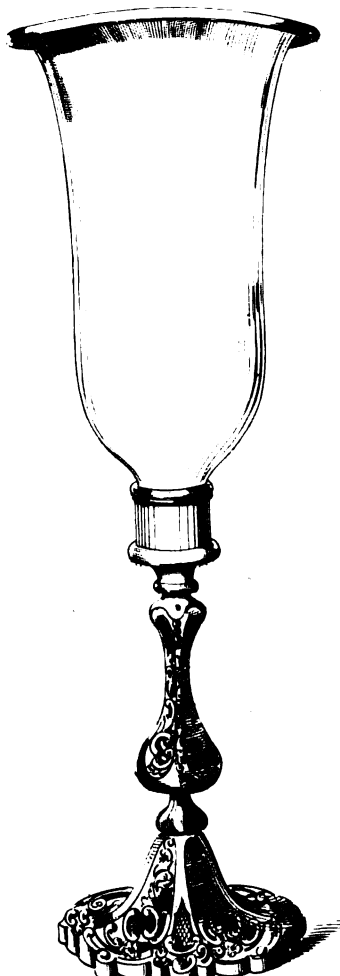

E3460.

Stock ready at the Warehouse.



S4666.

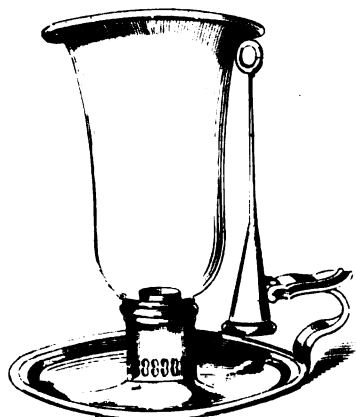

E3047.

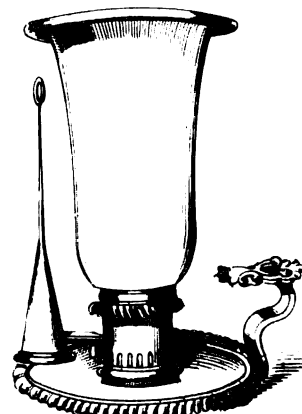

E3072



E3058¹²

67 & 68. KING WILLIAM ST. CITY. LONDON.

Drawn one fourth real size

MAPPIN BROTHERS,
MANUFACTORY,
QUEEN'S CUTLERY WORKS, SHEFFIELD,
WAREHOUSE,
67 & 68, KING WILLIAM STREET, LONDON.

**PRICES OF MAPPINS' ELECTRO SILVER PLATE ON PURE
NICKEL SILVER.**

For Drawings, see corresponding numbers on Plate.

LIQUEUR FRAMES.

		each.	
		s.	d.
E3464	3 Glass Frame, Coloured Bottles, Gadroon Edges	60	0
E3365	Do. Handsomely Chased, White Cut Glass Bottles	95	0

TEA AND COFFEE SETS.

E3004	Electro Silver Plated on White Metal, and Chased—		
	Tea Pot 4 Half-pints	28	0
	Do. 5 do.	32	0
	Coffee Pot 5 Half-pints	36	0
	Do. 6 do.	40	0
	Sugar Basin, Gilt Inside	26	0
	Cream Ewer, do.	22	0
B40	Electro Silver Plated on hard German Silver, "very Serviceable"—		
	Coffee Pot 5 Half-pints	90	0
	Tea Pot 4 do.	72	0
	Sugar Basin, Gilt Inside	66	0
	Cream Ewer, do.	50	0

The London Warehouse contains the Largest Stock of Electro Silver Plate in the World.



E3001.



E3002.



E3004.



E3001.

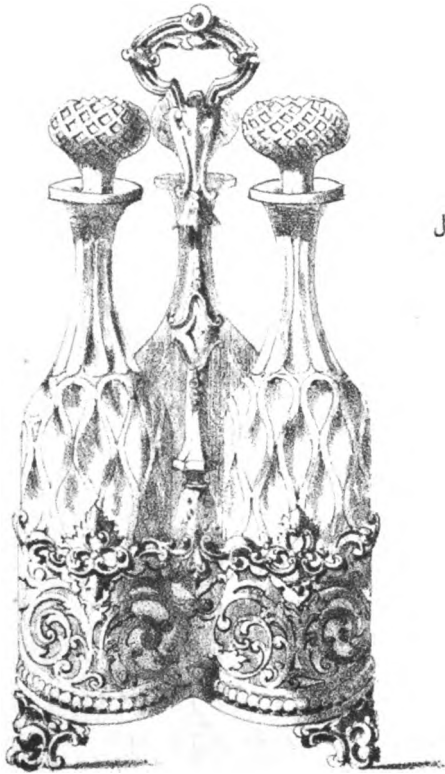

E3365.

JOSEPH MAPPIN AND BROTHERS.
QUEEN'S CUTLERY WORKS SHEFFIELD.
Stock ready at the Warehouse
67.68, KING WILLIAM ST. CITY, LONDON.



B40.



E3161.



B40.



B40.



B40.

Drawn one fourth real size.

MAPPIN BROTHERS,**MANUFACTORY,**

QUEEN'S CUTLERY WORKS, SHEFFIELD,

WAREHOUSE,

67 & 68, KING WILLIAM STREET, LONDON.

**PRICES OF MAPPINS' ELECTRO SILVER PLATE ON PURE
NICKEL SILVER.**

For Drawings, see corresponding numbers on Plate.

LIQUEUR FRAMES.

		each.		
		£	s.	d.
E2945	3 Glass Frame, Beaded Pattern, Cut Glass Bottles	3	0	0
E3393	4 do. very handsome, fine Cut Flint Bottles	4	16	0

TEA AND COFFEE SETS.

E2586	Electro Silver Plated on hard Nickel Silver, and neatly Engraved—			
	Coffee Pot 5 Half-pints	4	0	0
	Do. 6 do.	4	6	0
	Tea Pot 4 do.	3	8	0
	Do. 5 do.	3	14	0
	Sugar Basin, Gilt Inside	2	14	0
	Cream Ewer, do.	2	8	0
	Tea and Coffee Service	£12	10	0
E2982	Electro Silver Plated on hard Nickel Silver, Engraved and Chased—			
	Coffee Pot 6 Half-pints	4	0	0
	Tea Pot 5 do.	3	8	0
	Coffee Pot 5 do.	3	16	0
	Tea Pot 4 do.	3	0	0
	Sugar Basin, Gilt Inside	2	16	0
	Cream Ewer, do.	2	6	0
	Tea and Coffee Service	£11	10	0
	Tea Kettle to match this Set	9	10	0

The London Warehouse contains the Largest Stock of Electro Silver Plate in the World.



E2982.



E2982.



E2982.



E3393.



E2982.

JOSEPH MAPPIN AND BROTHERS.
QUEEN'S CUTLERY WORKS SHEFFIELD.
Stock ready at the Warehouse!
67 & 68 KING WILLIAM ST., CITY, LONDON



E2586.

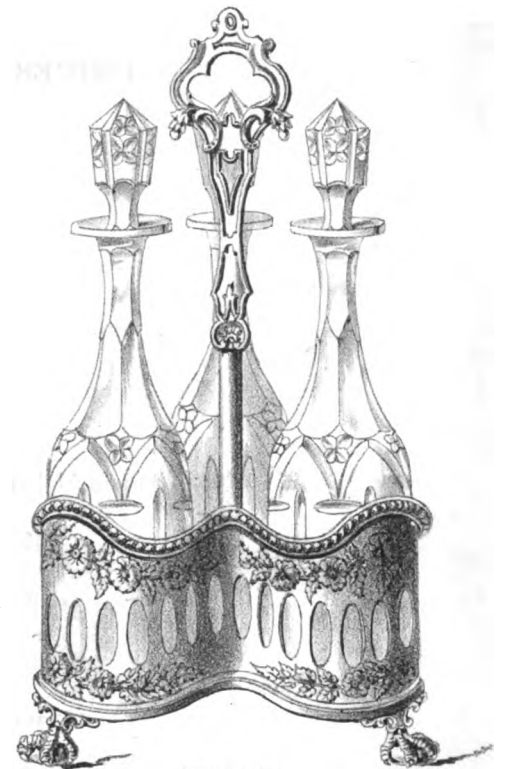

E2945.



E2586.



E2586.



E2586.

Drawn one fourth real size.

MAPPIN BROTHERS,
MANUFACTORY,
QUEEN'S CUTLERY WORKS, SHEFFIELD,
WAREHOUSE,
67 & 68, KING WILLIAM STREET, LONDON.

**PRICES OF MAPPINS' ELECTRO SILVER PLATE ON PURE
NICKEL SILVER.**

For Drawings, see corresponding numbers on Plate.

TEA AND COFFEE SETS

										each
										£ s. d.
E3075	Plain Melon Pattern with solid Silver Mounts, <i>very best quality</i> —									
	Coffee Pot 6 Half-pints	6 5 0
	Tea Pot 5 do.	5 5 0
	Sugar Basin, Gilt Inside	4 0 0
	Cream Ewer, do.	3 0 0
	The Set complete £18 10 0									
S3193	Elegantly Chased "Arabesque" Pattern, <i>very best quality</i> —									
	Coffee Pot 6 Half-pints	7 0 0
	Tea Pot 5 do.	6 0 0
	Sugar Basin, Gilt Inside	4 15 0
	Cream Ewer, do.	3 15 0
	The Set complete £21 10 0									
3131	Kettle with Spirit Lamps and Ivory Handle	9 9 0

The London Warehouse contains the Largest Stock of Electro Silver Plate in the World.



E3075

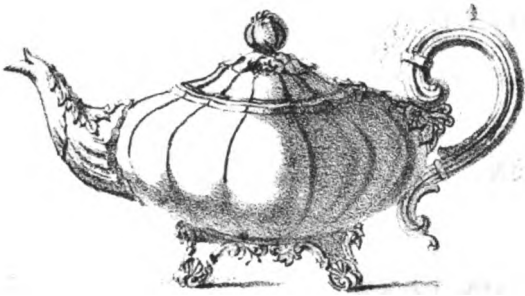

E3075



E3193

JOSEPH MAPPIN AND BROTHERS

QUEEN'S CUTLERY WORKS SHEFFIELD

Stock ready at the Warehouse

67 & 68 KING WILLIAM'S CITY LONDON.

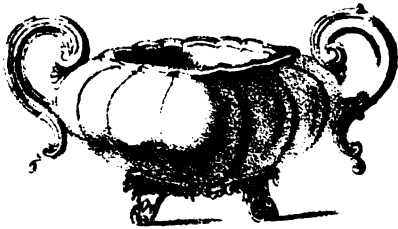

E3075



E3131



E3193



E3075



E3193



E3193

Drawn "real sig."

MAPPIN BROTHERS,
MANUFACTORY,
QUEEN'S CUTLERY WORKS, SHEFFIELD,
WAREHOUSE,
67 & 68, KING WILLIAM STREET, LONDON.

**PRICES OF MAPPINS' ELECTRO SILVER PLATE ON PURE
 NICKEL SILVER.**

For Drawings, see corresponding numbers on Plate.

GRAPE SCISSORS, PLATED ON STEEL.

		each.
		s. d.
B894 or 5045	Plain Pattern	10 0
B895 or 4462	King's do.	15 0
B271 or 5234	Vine do. elegant design	18 0

NUTCRACKERS, PLATED ON STEEL.

B155	Plain Spire Pattern	3 0
B115	Plain Fluted do.	4 0
B17	Plain Shell do.	6 0
B98	Plain, <i>Improved Patent</i>	6 0
B139	Beaded <i>do. do.</i>	6 6
B170	Elegantly Fluted, <i>Improved Patent</i>	8 0

* * * *By using this Improved Nutcracker, the nut is cracked easily and the kernel left quite whole.*

KNIFE RESTS.

		per pair.
E 1867	Plain Pattern	4 6
B15	Fancy do.	6 0
B14	Leaf do.	5 0
B16	Elegant do.	8 6
B13	5 6

ASPARAGUS TONGS.

		each.
B11	Plain, with Patent Guide	25 0
B12	Pierced do. do.	30 0

CRUET FRAMES.

E3547	Pierced Frame, <i>very good</i> , 6 Glass	60 0
B69	Shield Pattern, Cut Bottles, 7 Glass	80 0
E3463	Electro Plate on White Metal <i>Pickle Frame</i> , 3 Colored Glass Bottles	46 0

The London Warehouse contains the Largest Stock of Electro Silver Plate in the World.

JOSEPH MAPPIN AND BROTHERS.
 QUEEN'S CUTLERY WORKS, SHEFFIELD

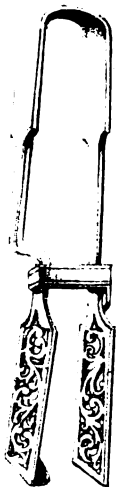

B 12



5045



4462



5234



B 11



E 3547

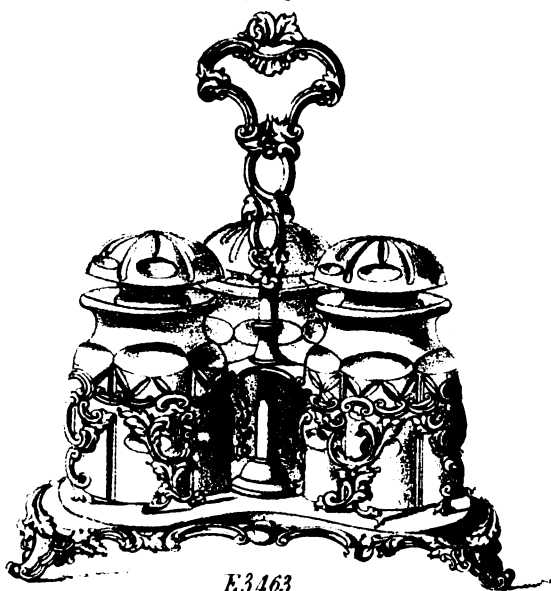

E 3463



B 69

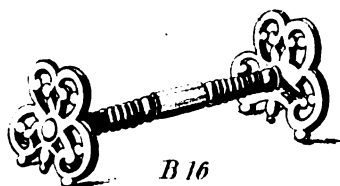

B 16

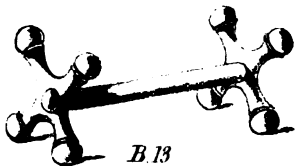

B 13

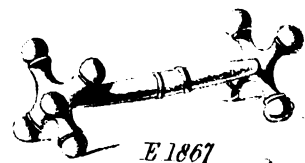

E 1867



B 14

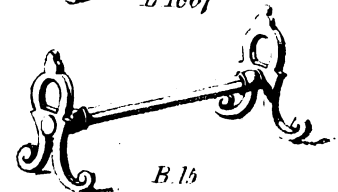

B 15

Scale The Pickle & Cruet Frames & Asparagus Tongs & the other articles & size.

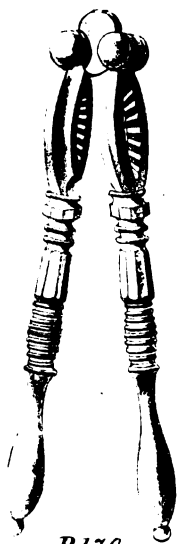

B 170

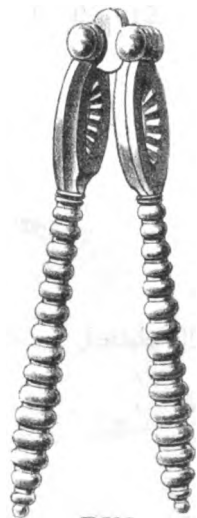

B 139

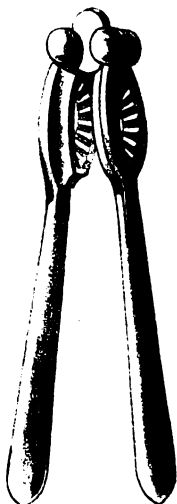

B 98

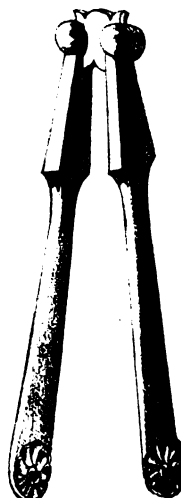

B 17

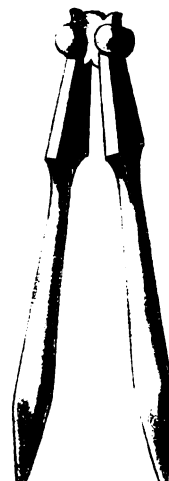

B 155



B 115

Stock ready at the Warehouse...

67 & 68 KING WILLIAM ST CITY LONDON

MAPPIN BROTHERS,
MANUFACTORY,
QUEEN'S CUTLERY WORKS, SHEFFIELD,
WAREHOUSE,
67 & 68, KING WILLIAM STREET, LONDON.

**PRICES OF MAPPINS' ELECTRO SILVER PLATE ON PURE
 NICKEL SILVER.**

For Drawings, see corresponding numbers on Plate.

SIDE AND CURRY DISHES AND COVERS.

		per set.		
		£	s.	d.
E3678	Gadroon Pattern	8	8	0
E1801	Rose and Leaf Pattern, best quality	15	0	0
E1799	Round Dishes, Gadroon Edge	15	0	0
E1799	Four Warmers with Top Plate	15	0	0
E1794	Round Dishes, Norfolk Pattern, very handsome	16	0	0
E1794	Four Warmers with Top Plate	15	0	0
E1790	Quite Plain, best quality	14	0	0
E1790	Warmers to match, with Top Plate, per Set of Four	14	0	0

DISH COVERS,

E2750	Plain Pattern	10	10	0
E2751	Fluted do.'	13	0	0
E1804	Fluted and Chased, Norfolk Pattern, very elegant, best quality	22	0	0

SOUP TUREENS.

E2927	Elegant Shaped, Gadroon Pattern	2 Quarts. £7 10 0	4 Quarts. £10 10 0	5 Quarts. £11 10 0
-------	---	----------------------	-----------------------	-----------------------

E2550	Silver Pattern Engraved Mustard Pot, Blue Glass	each	1	4	0
-------	---	------	---	---	---

E3388	Pierced Plated Bottle Stand	per pair	0	14	0
-------	---------------------------------------	----------	---	----	---

B9	PEPPER CASTOR, Electro Plate on Best Nickel Silver beautifully chased	each	0	18	0
----	---	------	---	----	---

The London Warehouse contains the Largest Stock of Electro Silver Plate in the World.

MAPPIN AND BROTHERS.
QUEEN'S CUTLERY WORKS, SHEFFIELD.
Stock ready at the Warehouse.
67 & 68, KING WILLIAM STREET, CITY, LONDON.

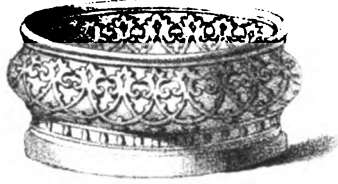

E3388.



E1790



E2550.

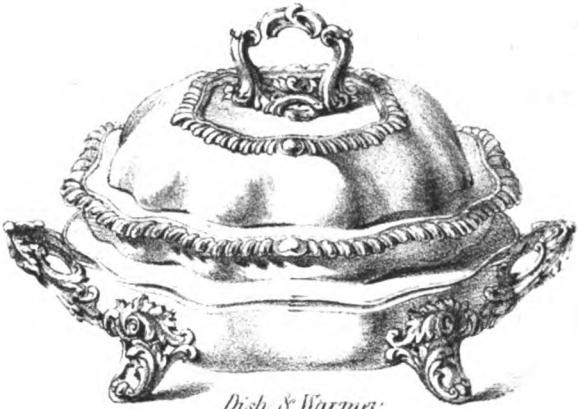

Dish & Warmer.
E1799.

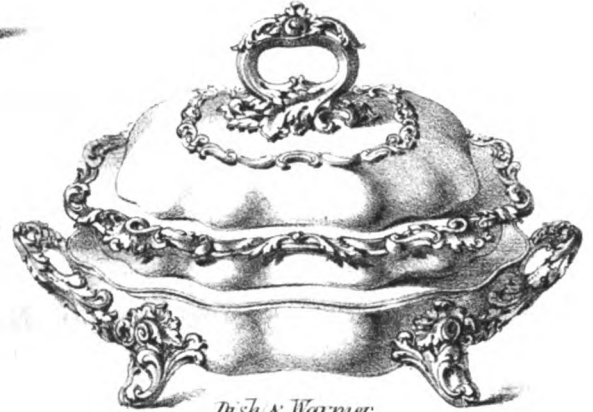

Dish & Warmer
E1794.

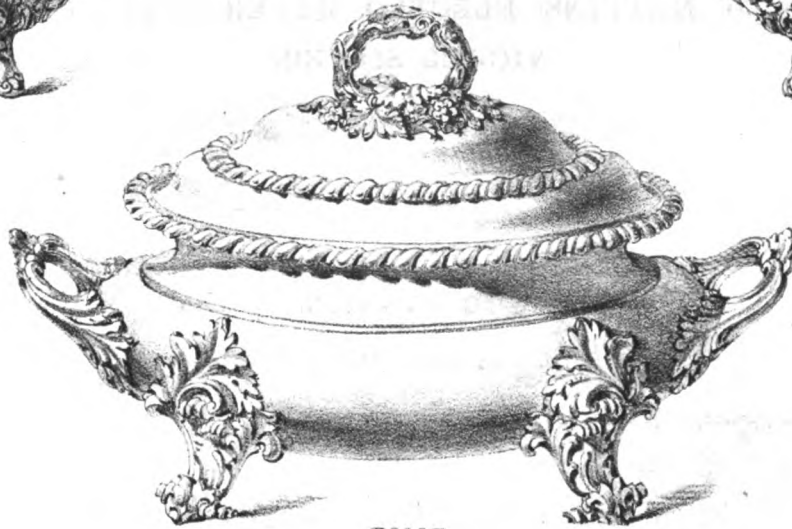

E2927.

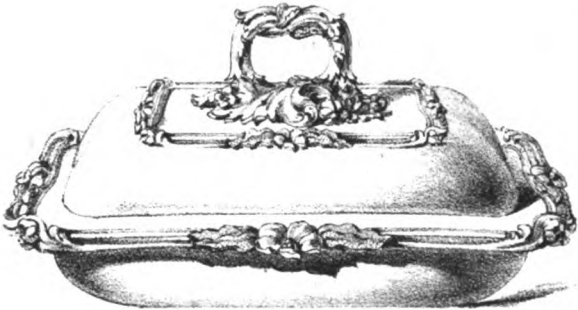

E1801.

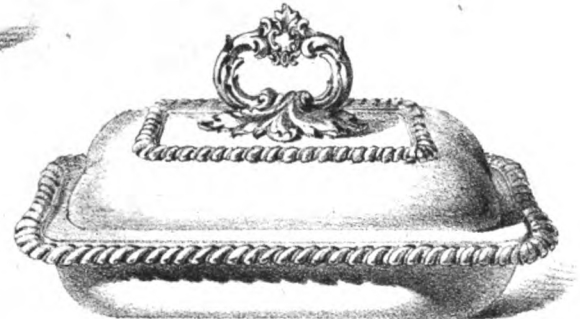

E3678.



B9.

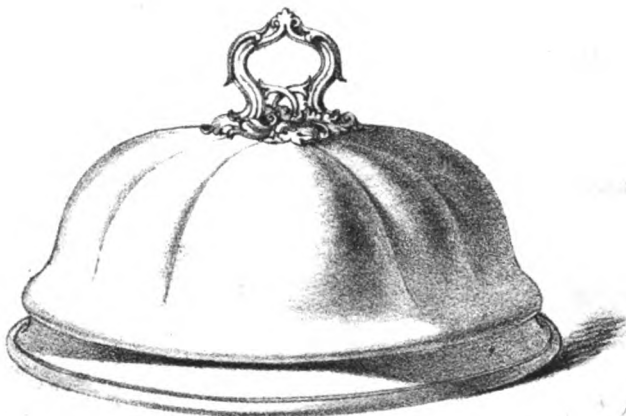

E2751.

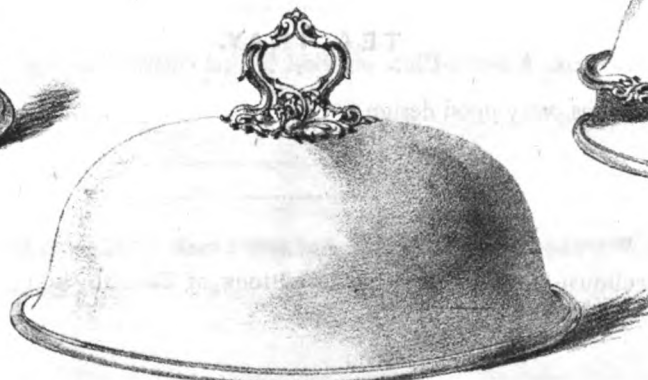

E2750.

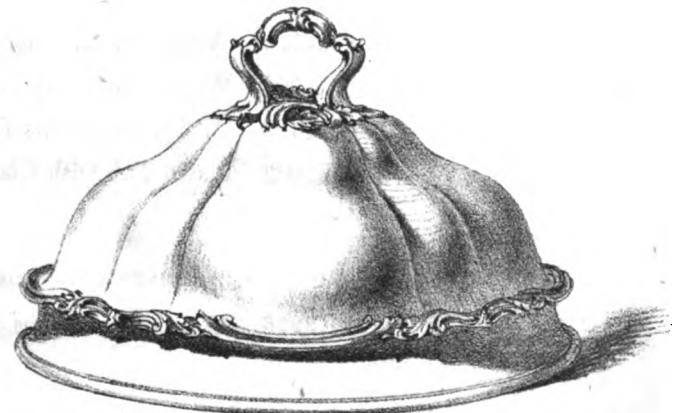

E1804.

MAPPIN BROTHERS,
MANUFACTORY,
QUEEN'S CUTLERY WORKS, SHEFFIELD,
WAREHOUSE,
 67 & 68, KING WILLIAM STREET, LONDON.

**PRICES OF MAPPINS' ELECTRO SILVER PLATE ON PURE
 NICKEL SILVER.**

For Drawings, see corresponding numbers on Plate.

EGG FRAMES.

WITH PLATED EGG SPOONS COMPLETE.

	£	s.	d.
E2956 4 Cup Frame, with Four Spoons	3	0	0
E2956½ 6 Cup do. do. Six do.	4	4	0
E3340 4 Cup do. elegant "Tulip" Pattern, very best quality, with Four Spoons	4	0	0
L80 B7 4 Cup do. neat pattern, with Four Spoons	3	5	0
E2594 6 Cup do. very good design, very best quality, with Six Spoons	7	0	0

CAKE BASKETS.

E3357 Elegant "Shell" Pattern, very good	4	4	0
E2530 Do. "Scroll" do. do. large size, <i>for Bread</i>	4	0	0
E2530 Do. small size, <i>for Cake</i>	3	10	0

BUTTER COOLERS.

E2798½ White Crystal Glass Tub, plain Massive Plate and Lid, "Cow" Knob	2	14	0
B708 White Glass Tub, Plated Lid	1	16	0
E3492 Coloured Porcelain Cooler or Tub, Plated Plate and Lid	1	16	0
E3032 Plated Tub with Glass Lining, very handsome, Moulded or Chased	3	0	0

TEA TRAY.

E3276 25 in. with Handles, very good design	12	12	0
---	----	----	---

The London Warehouse contains the Largest Stock of Electro Silver Plate in the World.

MAPPIN, BROTHERS,
QUEEN'S CUTLERY WORKS SHEFFIELD.
Stock ready at the Warehouse.
67 & 68 KING WILLIAM ST, CITY, LONDON.

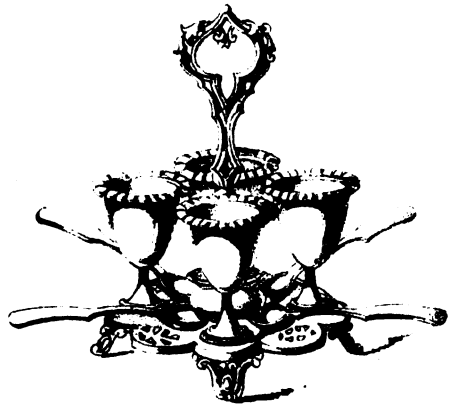

E2956



E3357

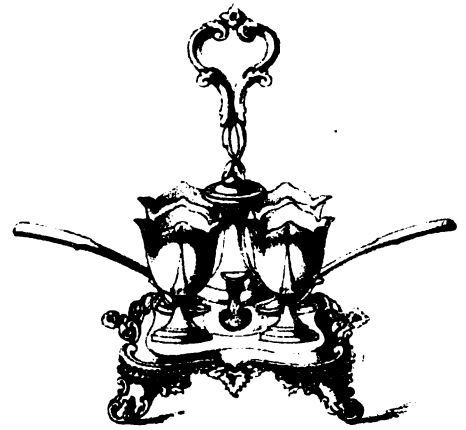

E3340

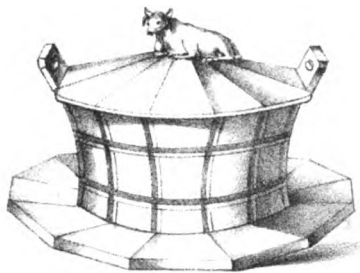

E2798 1/2



B 708

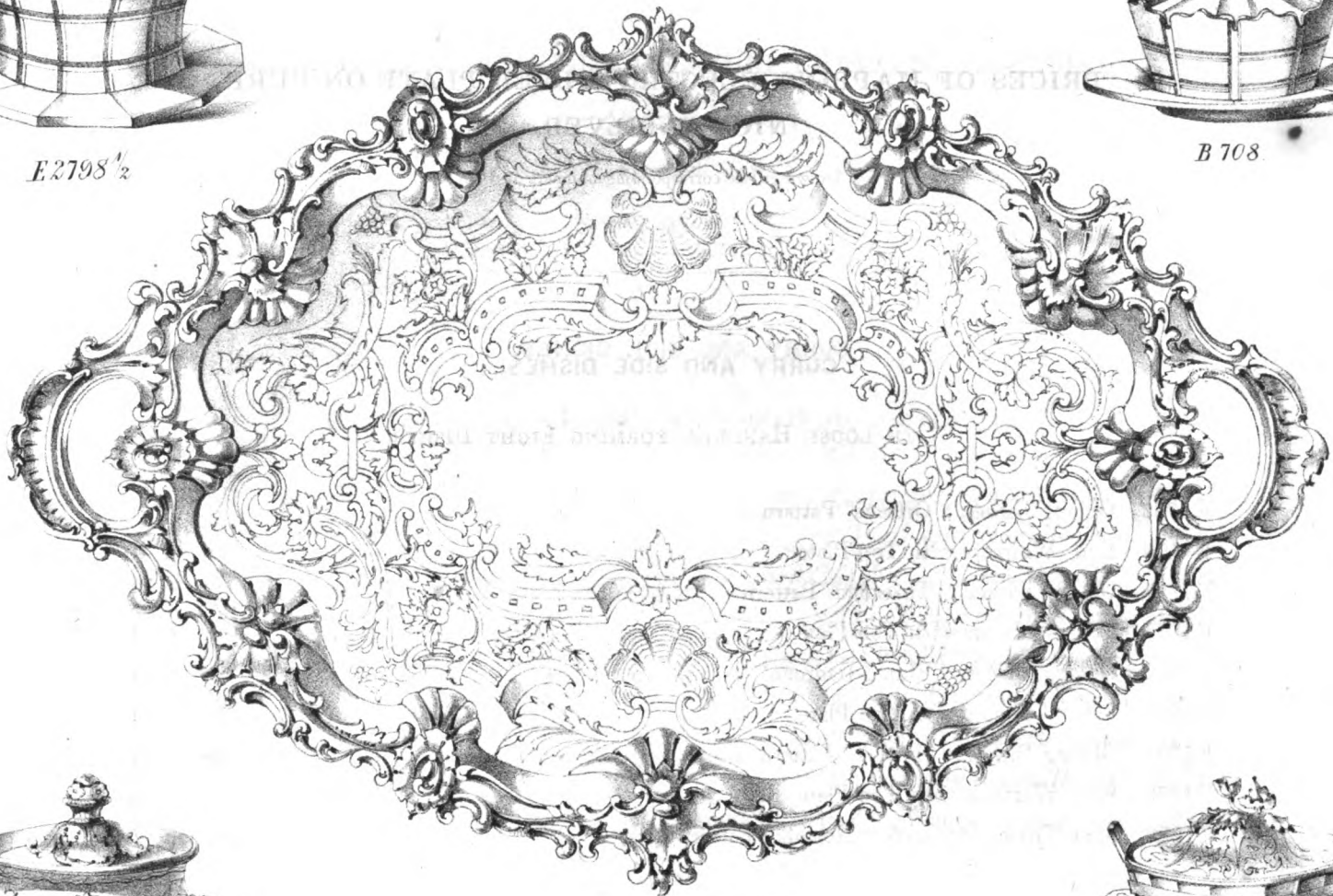

E3276



E3192



E3032



E2594

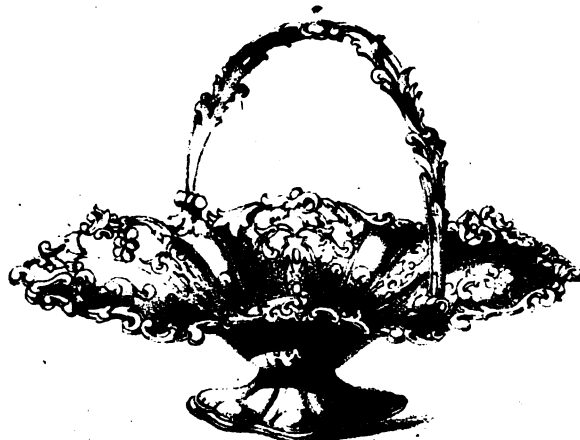

E2530



I. 80.

Drawn one fourth real size.

MAPPIN BROTHERS,
MANUFACTORY,
QUEEN'S CUTLERY WORKS, SHEFFIELD,
WAREHOUSE,
67 & 68, KING WILLIAM STREET, LONDON.

**PRICES OF MAPPINS' ELECTRO SILVER PLATE ON PURE
 NICKEL SILVER.**

For Drawings, see corresponding numbers on Plate.

CURRY AND SIDE DISHES.

WITH LOOSE HANDLES, FORMING EIGHT DISHES.

		per set.
		£ s. d.
E1796	Oblong Dishes, "Orleans" Pattern	16 0 0
E1796	Four Warmers with Top Plate	15 0 0
E1797	Oblong Dishes, "Threaded" Pattern	16 0 0
E1797	Four Warmers with Top Plate	15 0 0
E1800	Oblong Dishes, "Fluted Gadroon"	15 0 0
E1800	Four Warmers with Top Plate	15 0 0
E1792	Oblong Dishes, "Norfolk" Pattern	18 0 0
E1792	Four Warmers with Top Plate	15 0 0
E1802	Soup Tureen, 5 quarts, "Norfolk" Pattern	18 10 0

MUSTARD POTS.

		each.
E1803	Electro Plated on Pure Nickel Silver	1 2 6
B172	Do. on White Metal	0 9 0

B5	WINE STRAINER, Gilt Inside.	0 18 0
		per pair.
B171	SALT CELLARS, Electro Gilt, Sea Shell Pattern	2 5 0
E2353	DECANTER STANDS, "Vine" Border	1 8 0
E2353	Do. do. with Shield for Engraving	1 10 0

The London Warehouse contains the Largest Stock of Electro Silver Plate in the World.

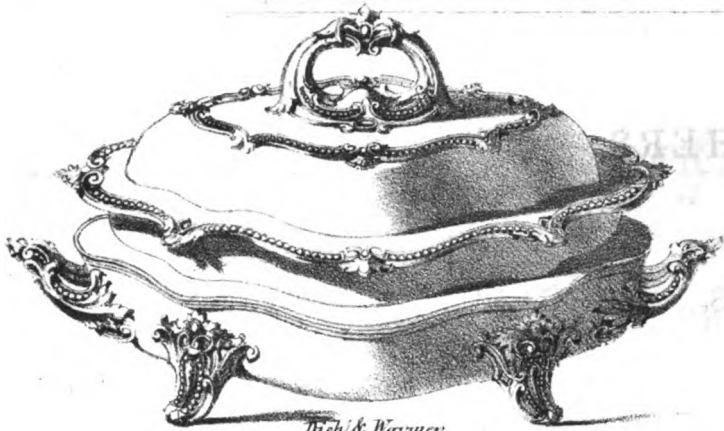

Dish & Warmer
E1796.

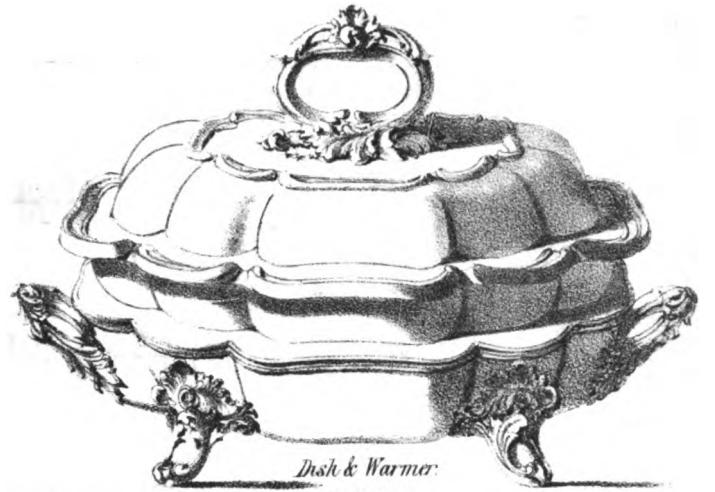

Dish & Warmer
E1797.

JOSEPH MAPPIN AND BROTHERS.

QUEEN'S CUTLERY WORKS SHEFFIELD.

Stock ready at the Warehouse

67 & 68, KING WILLIAM ST CITY, LONDON.

Drawn one fourth real size



E2553.



B171.



B172.

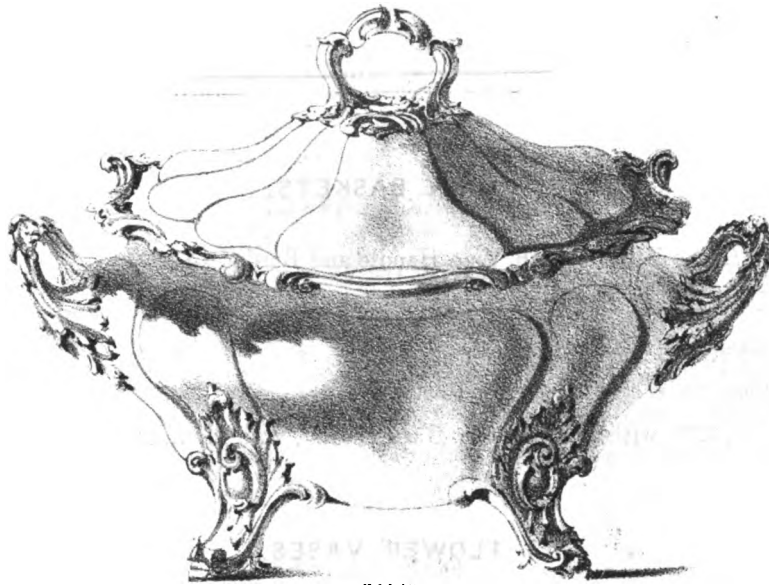

E1802.



E1803.

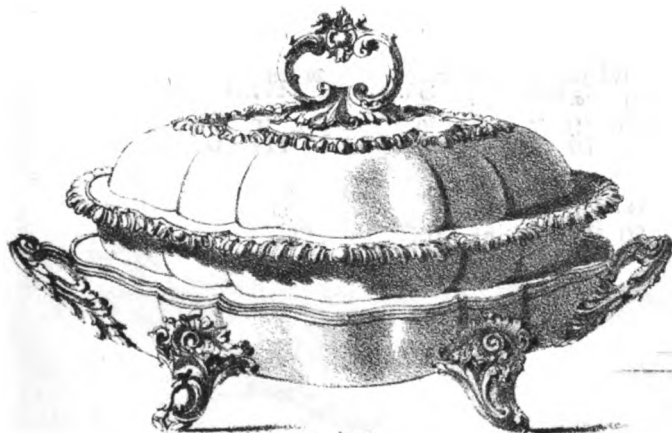

Dish & Warmer
E1800.



B5

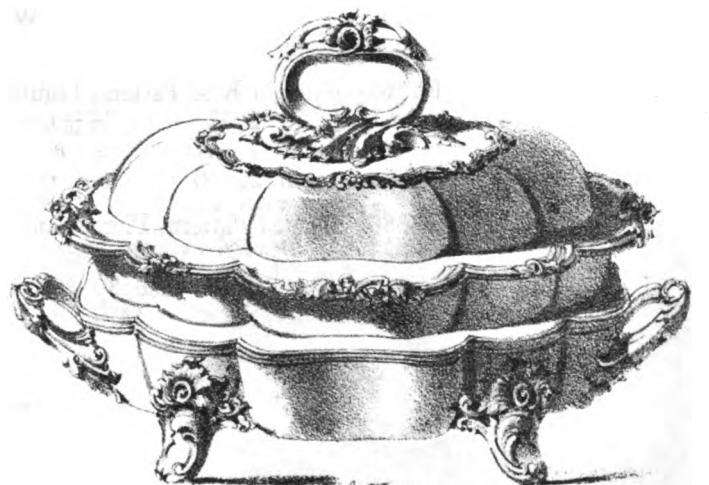

Dish & Warmer
E1792.

MAPPIN BROTHERS,
MANUFACTORY,
QUEEN'S CUTLERY WORKS, SHEFFIELD,
WAREHOUSE,
67 & 68, KING WILLIAM STREET, LONDON.

**PRICES OF MAPPINS' ELECTRO SILVER PLATE ON PURE
NICKEL SILVER.**

For Drawings, see corresponding numbers on Plate.

CAKE BASKETS.

								each.
								<i>s. d.</i>
B109	Very good Grape Pattern, with Vine Handle and Border	4 10 0
E3064	Cake or Card Basket, Scroll Piercing and Chased	3 0 0
E2477	Elegant Design, Vine Handle	2 14 0
E2909	Electro Plate on White Metal, good pattern	1 16 0
E3302	SUGAR BASKET, with Cover, Ruby Glass Lining, with Handles	2 10 0

FLOWER VASES.

E3496	Tripod Stand, Blue Glass Lining, with Wire Net for Flowers	2 2 0
E3497	As above, but larger, and White Opal Gilt Glass Lining	2 10 0

WAITERS AND SALVERS.

E1765½ Elegant Rose Pattern, beautifully Chased:—

	8 Inch.	10 Inch.	12 Inch.	14 Inch.	16 Inch.	18 Inch.	20 Inch.
	<i>s. d.</i>	<i>s. d.</i>	<i>s. d.</i>	<i>s. d.</i>	<i>s. d.</i>	<i>s. d.</i>	<i>s. d.</i>
each	24 0	30 0	36 0	50 0	70 0	84 0	114 0

E3368 Beaded Pattern, Pierced and Chased:—

	8 Inch.	10 Inch.	12 Inch.	14 Inch.	18 Inch.
each	30 0	38 0	46 0	50 0	86 0

The London Warehouse contains the Largest Stock of Electro Silver Plate in the World.



B109



E3064

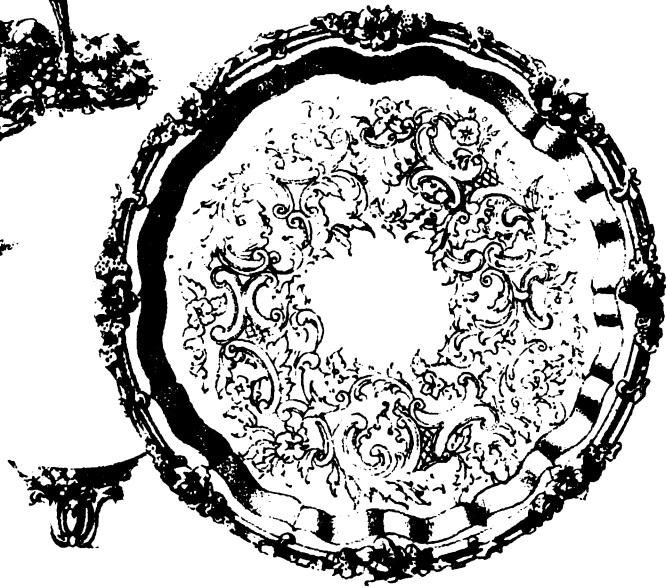

H.1765 1/2

JOSEPH MAPPIN AND BROTHERS.
QUEEN'S CUTLERY WORKS SHEFFIELD.
Stock ready at the Warehouse
67 & 68 KING WILLIAM ST. CITY LONDON.

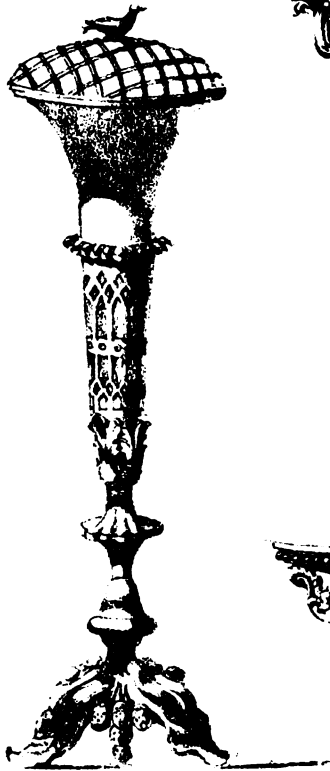

E3496

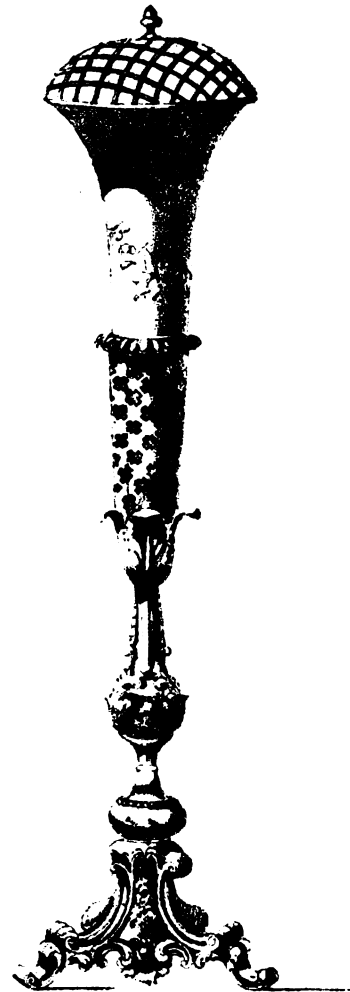

E3497



E5568



E2477



E3302



E2909

Drawn one-fourth real size

MAPPIN BROTHERS,
MANUFACTORY,
QUEEN'S CUTLERY WORKS, SHEFFIELD,
WAREHOUSE,
67 & 68, KING WILLIAM STREET, LONDON.

**PRICES OF MAPPINS' ELECTRO SILVER PLATE ON PURE
 NICKEL SILVER.**

For Drawings, see corresponding numbers on Plate.

TEA POTS, ON WHITE METAL.

	each	
	s.	d.
E3211 Plain Upright Pattern, 4 Half-pints	24	0
	2 Half-pints.	3 Half-pints.
	s. d.	s. d.
E3211c Chased do.	22	0
	2 Half-pints.	3 Half-pints.
E3209 Plain Squat Pattern, Melon Knob	16	0
	2 Half-pints.	3 Half-pints.
E3209 Coffee to Match	29	0
	5 Half-pints.	6 Half-pints.
each.		
B1 WAITER, Handsome 16 in., Vine Border, a most elegant Design, best quality	80	0
E3300 INKSTAND, with 2 Ruby Ink Glasses, and Taper Stand	66	0
B174 CIGAR LAMP, with 2 Spirit Lighters	36	0
E3020 BUTTER COOLERS, very Chaste, Ground Glass Tub, "Cow" Knob, very good	32	0

COMMUNION SERVICE.

ENGRAVED I.H.S. IN GLORIA, VERY BEST QUALITY.

B64 Flagon	105	0
B64 Patten, or Stand	63	0
B64 Chalice Cups, Gilt Inside	60	0
B64 Plates	44	0

Service complete £18 16 0

ELECTRO PLATED ON WHITE METAL.

E4790 Chalice Cup 1 Pint	32	0
Flagon 6 Gill	86	0
10½ in. Patten	42	0
10 in. Plate	20	0

Set complete £9 0 0

Engraved 6d. each extra.

The London Warehouse contains the Largest Stock of Electro Silver Plate in the World.

JOSEPH MAPPIN AND BROTHERS.
 QUEEN'S CUTLERY WORKS SHEFFIELD.
Stock ready at the Warehouse
 67 & 68, KING WILLIAM ST. CITY, LONDON.



E324.C.

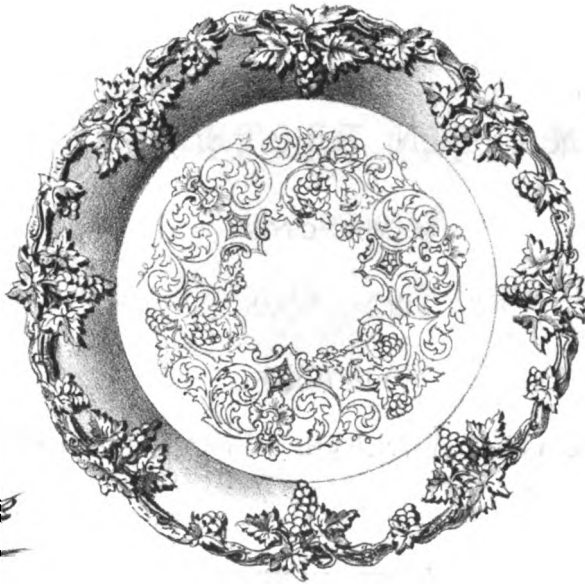

B1.

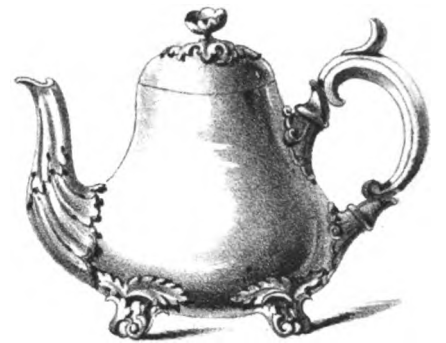

E324.



B64.

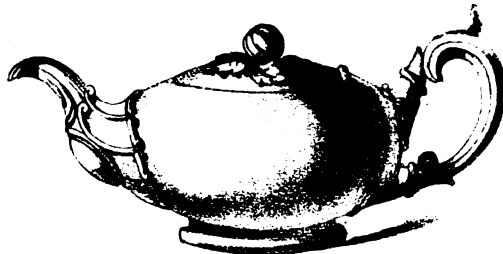

E3269.

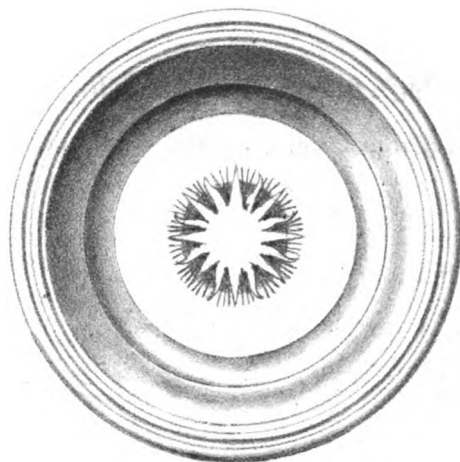

B64.



B64.



E3300.



B174.



B64.

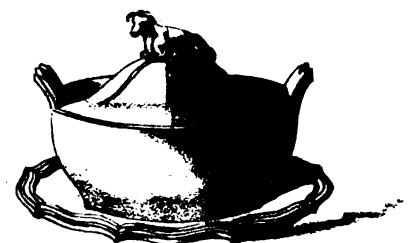

E3020.

Drawn one-fourth real size.

MAPPIN BROTHERS,
MANUFACTORY,
QUEEN'S CUTLERY WORKS, SHEFFIELD,
WAREHOUSE,
67 & 68, KING WILLIAM STREET, LONDON.

**PRICES OF MAPPINS' ELECTRO SILVER PLATE ON PURE
NICKEL SILVER.**

For Drawings, see corresponding numbers on Plate.

TEA AND COFFEE SETS.

		each.		
		£	s.	d.
E4220	Electro-Plated on hard Nickel Silver, finest quality, "Eugenie" Pattern—			
	Kettle 2½ Quarts	12	0	0
	Coffee Pot, 6 Half-pints	6	0	0
	Tea Pot, 5 do.	5	0	0
	Cream Ewer, Gilt Inside	4	0	0
	Sugar Basin do.	4	10	0
Tea and Coffee Service £19 10 0				
B57	Electro-Plated on hard Nickel Silver, finest quality, "Albert" Pattern—			
	Kettle 3 Quarts	15	0	0
	Coffee Pot, 6 Half-pints	6	10	0
	Tea Pot, 5 do.	5	10	0
	Cream Ewer, Gilt Inside	3	0	0
	Sugar Basin, do.	4	0	0
Tea and Coffee Service £19 0 0				

The London Warehouse contains the Largest Stock of Electro Silver Plate in the World.



E4220



E4220



B57



E4220



E4220

MAPPIN BROTHERS'
QUEEN'S CUTLERY WORKS, SHEFFIELD.

STOCK READY AT THE WAREHOUSE,
67 & 68, KING WILLIAM STREET, CITY,
LONDON.



B57



B57



E4220



B57



B57

MAPPIN BROTHERS,
MANUFACTORY,
QUEEN'S CUTLERY WORKS, SHEFFIELD,
WAREHOUSE,
67 & 68, KING WILLIAM STREET, LONDON.

**PRICES OF MAPPINS' ELECTRO SILVER PLATE ON PURE
 NICKEL SILVER.**

For Drawings, see corresponding numbers on Plate.

		each.
B532	CLARET JUG, with Silver Plated Handle, Glass beautifully engraved "Vine"	£ s. d.
	Pattern	4 0 0
B659	CLARET JUG, with Silver Plated Handle and Lip, splendidly Cut Flint Glass .	4 10 0
S4268	HASH DISH, best quality, with Stand and Spirit Lamp, "Beaded" Pattern .	5 10 0
B489	VEGETABLE DISH, with Divisions inside, and Warmer for Hot Water, large loose Ivory Handle, Gadroon Pattern, best quality	7 10 0
		per pair
E4002	SALT CELLARS, Chased, Gilt Inside	0 18 0
B608	,, Blue Glass Lining	1 2 0
		per set of 4
E4013	SIDE DISHES, with Loose Handles (forming 8 Dishes at pleasure), "Beaded"	
	Pattern	9 0 0
E4013½	as E4013 Pattern, but with Feet to Dishes, and better Plating	12 0 0
E4375	SIDE DISHES, very handsomely Chased, "Vine" Handle, very best quality .	16 0 0
E4085	DISH COVERS, to match E4375 Side Dish, each set containing 2-14 in., 1-18 in., 1-20 in.	24 0 0
E3812	DISH COVERS, "Beaded" Pattern, each set containing 2-14 in., 1-18 in., 1-20 in.	15 0 0

The London Warehouse contains the Largest Stock of Electro Silver Plate in the World.



B659



S4268



B582

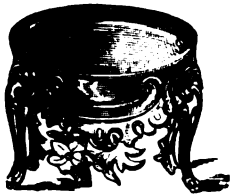

B608



B489



E4002

MAPPIN BROTHERS'
QUEEN'S CUTLERY WORKS, SHEFFIELD,
 STOCK READY AT THE WAREHOUSE,
67 & 68, KING WILLIAM STREET, CITY,
LONDON.



E4018½



E4375



E3812



E4085

MAPPIN BROTHERS,

MANUFACTORY,

QUEEN'S CUTLERY WORKS, SHEFFIELD,

WAREHOUSE,

67 & 68, KING WILLIAM STREET, LONDON.

**PRICES OF MAPPINS' ELECTRO SILVER PLATE ON PURE
NICKEL SILVER.**

For Drawings, see corresponding numbers on Plate.

LIQUEUR FRAMES

			each.		
			£	s.	d.
B120	Stand with 3 White Cut Bottles		2	10	0
E4590	Neat pattern, 3 White Engraved Bottles		5	12	0
E4468	Wicker pattern Cut Bottles		4	0	0
S4286	Short Size for Sideboard, with 3 elegant Cut Bottles, White Glass		5	12	0
S4329	Pierced Frame, with 3 handsome White Cut Glass Bottles		6	6	0
B704	Very fine handsome Stand, with 3 finest Cut Flint Glass Bottles		9	0	0
E4090	Oil and Vinegar Cruet for Salad, with 2 handsome Cut Glass Bottles		3	12	0
E4166	Pickle Frame, with 2 Flint Cut Glass Bottles		4	6	0

The London Warehouse contains the Largest Stock of Electro Silver Plate in the World.

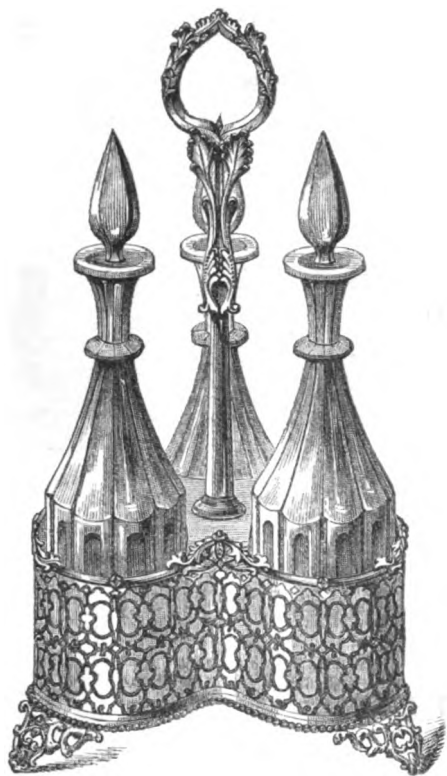

S4286

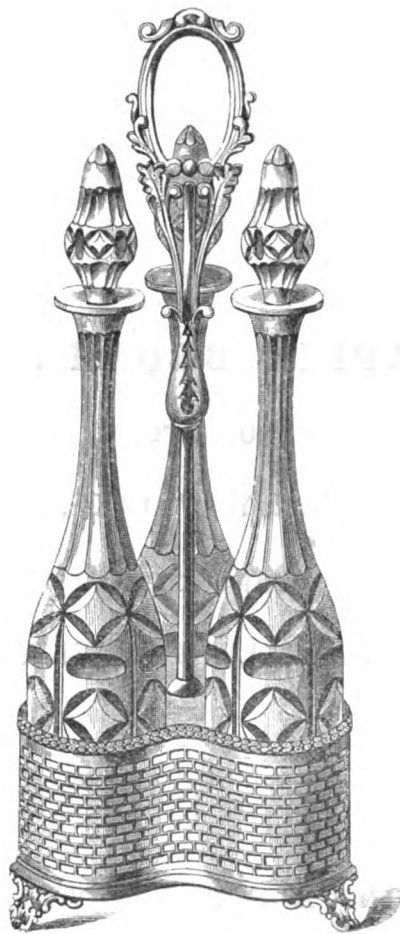

E4468



B120



F1090

MAPPIN BROTHERS,
QUEEN'S CUTLERY WORKS, SHEFFIELD,
STOCK READY AT THE WAREHOUSE,
67 & 68, KING WILLIAM STREET, CITY,
LONDON.



E4166



S4329

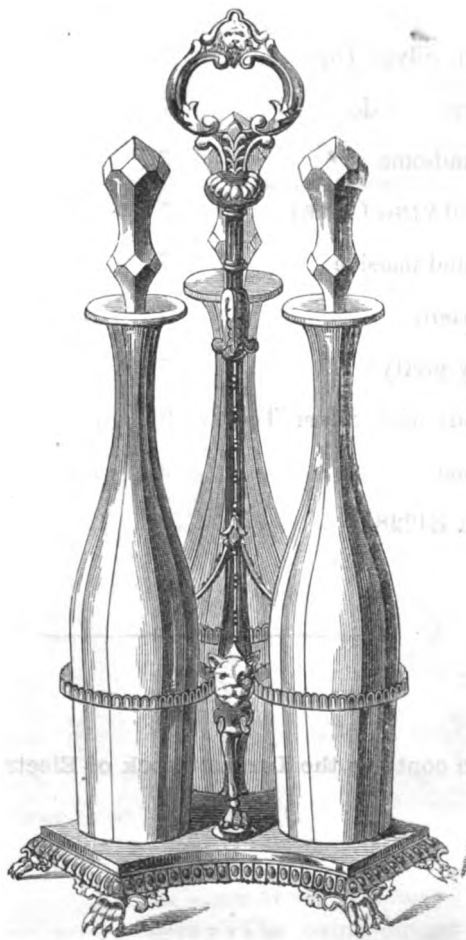

B704



E4590

DRAWN ONE FOURTH REAL SIZE.

MAPPIN BROTHERS,
MANUFACTORY,
QUEEN'S CUTLERY WORKS, SHEFFIELD,
WAREHOUSE,
67 & 68, KING WILLIAM STREET, LONDON.

**PRICES OF MAPPINS' ELECTRO SILVER PLATE ON PURE
 NICKEL SILVER.**

For Drawings, see corresponding numbers on Plate.

CRUET FRAMES.

		each.	
		£	s. d.
E4041	Handsome Scroll Pattern, . . . 6 Glasses	5	5 0
E1773	Chaste Silver ,, . . . 6 ,,	2	8 0
E4073	Oval Gothic ,, . . . 6 ,,	2	10 0
E4577	Boat Pattern . . . 6 ,,	3	6 0
B421	Very neat, Ring Frame, . . . 6 ,,	3	16 0
S4331	Chain Cable, <i>very good</i> , . . . 6 ,,	4	0 0
S4503	Gothic Pattern Pierced . . . 6 ,, strong plating	3	16 0
E4638	Ring Pattern, Beaded, Silver Tops . . . 7 ,,	6	6 0
E4636	Elegant Scroll Pattern do. . . 7 ,,	8	8 0
E4615	New Design, very handsome . . . 7 ,,	8	8 0
E3940	Basket Pattern, REVOLVING CRUET, . . 7 ,,	4	14 0
E3364	New Design, strong and massive . . 7 ,,	7	16 0
B707	Very neat, Silver Pattern . . . 7 ,,	5	0 0
E4524	Cottage Pattern, very pretty . . . 7 ,,	4	0 0
S4637	Very strong and good, with Silver Tops, . 8 ,,	9	0 0
E4228	Beaded Breakfast Cruet . . . 3 ,,	2	4 0
E4140	Soy Frame, to match E4228 . . . 3 ,,	1	10 0

The London Warehouse contains the Largest Stock of Electro-Silver Plate in the World.

**MAPPIN BROTHERS,
QUEEN'S CUTLERY WORKS, SHEFFIELD,**



E4011



E1773



E4577



E4073



E4638



B121



E4503



S4331



E4615



E4228



E4636



E4140



E3940



E3364

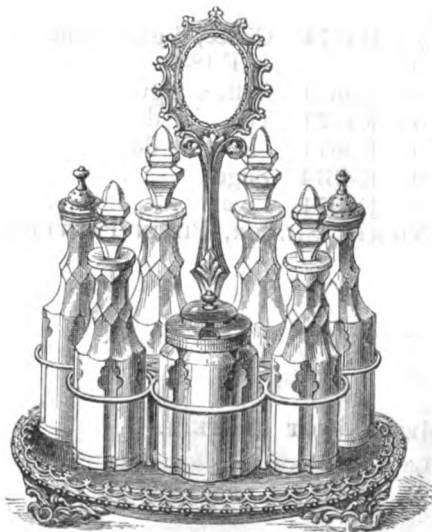

B707



E4524



S4637

STOCK READY AT THE WAREHOUSE,
67 & 68, KING WILLIAM STREET, CITY, LONDON.

DRAWN ONE FOURTH REAL SIZE.

Digitized by Google

MAPPIN BROTHERS,
MANUFACTORY, QUEEN'S CUTLERY WORKS, SHEFFIELD,
WAREHOUSE, 67 & 68, KING WILLIAM STREET, LONDON.

**PRICES OF MAPPINS' ELECTRO SILVER PLATE ON PURE
NICKEL SILVER.**

For Drawings, see corresponding numbers on Plate.

TEA AND COFFEE SERVICES.

		ELECTRO-PLATED ON HARD NICKEL SILVER, ENGRAVED.		each.	
		s.	d.	s.	d.
E4021	Coffee, 6 gills			108	0
E4021	Tea, 5 do.			90	0
E4021	Sugar, gilt inside			70	0
E4021	Cream, do.			60	0
The Set, £16 8s.					
		ELECTRO-PLATED ON BEST WHITE METAL, CHASED.			
E4108	Coffee, 6 gills			46	0
E4108	Do. 5 do.			42	0
E4108	Tea, 5 do.			36	0
E4108	Do. 4 do.			33	0
E4108	Sugar, gilt inside			33	0
E4108	Cream, do.			25	0
ELECTRO-PLATED ON BEST WHITE METAL, PLAIN.		each.		BEST WHITE METAL (NOT PLATED).	
		s.	d.		
E4381	Coffee, 6 gills	36	0	E4382	Coffee, 6 gills, same pattern as E4381
E4381	Do. 5 do.	34	0	E4382	Coffee, 5 gills
E4381	Tea, 5 do.	28	0	E4382	Tea, 5 do.
E4381	Do. 4 do.	24	0	E4382	Do. 4 do.
E4381	Sugar, gilt inside	22	0	E4382	Sugar
E4381	Cream, do.	16	0	E4382	Cream
ELECTRO-PLATED ON BEST WHITE METAL, MELON PATTERN.		each.		BEST WHITE METAL (NOT PLATED).	
		s.	d.		
E4380	Coffee, 6 gills	46	0	E4383	Coffee, 6 gills, same Pattern as E4380
E4380	Do. 5 do.	40	0	E4383	Coffee, 5 gills
E4380	Tea, 5 do.	32	0	E4383	Tea, 5 do.
E4380	Do. 4 do.	28	0	E4383	Do. 4 do.
E4380	Sugar, gilt inside	27	0	E4383	Sugar
E4380	Cream, do.	20	0	E4383	Cream
ELECTRO-PLATED ON WHITE METAL, QUITE PLAIN PATTERN.					
E3209	Coffee, 6 gills			31	0
E3209	Do. 5 do.			29	0
E3209	Tea, 5 do.			23	0
E3209	Do. 4 do.			21	0
E3209	Sugar, gilt inside			22	0
E3209	Cream, do.			18	0
ELECTRO-PLATED ON BEST WHITE METAL, CHASED PATTERN.					
E3807	Coffee, 6 gills			40	0
E3807	Do. 5 do.			38	0
E3807	Tea, 5 do.			30	0
E3807	Do. 4 do.			28	0
E3807	Sugar, gilt inside			30	0
E3807	Cream, do.			24	0
ELECTRO-PLATED ON BEST WHITE METAL, ENGRAVED PATTERN.		each.		BEST WHITE METAL (NOT PLATED).	
		s.	d.		
E4838	Coffee, 6 gills	42	0	E4674	Coffee, 6 gills, same Pattern as E4838
E4838	Do. 5 do.	38	0	E4674	Coffee, 5 gills
E4838	Tea, 5 do.	32	0	E4674	Tea, 5 do.
E4838	Do. 4 do.	30	0	E4674	Do. 4 do.
E4838	Sugar, gilt inside	30	0	E4674	Sugar
E4838	Cream, do.	24	0	E4674	Cream
ELECTRO-PLATED ON HARD NICKEL SILVER, PLAIN PATTERN.					
E4123	Coffee, 6 gills			65	0
E4123	Do. 5 do.			58	0
E4123	Tea, 5 do.			46	0
E4123	Do. 4 do.			40	0
E4123	Sugar, gilt inside			42	0
E4123	Cream, do.			34	0
BEST WHITE METAL (NOT PLATED).					
E4064	Coffee, 4 gills			11	0
E4064	Do. 5 do.			12	0
E4064	Do. 6 do.			13	0
E4064	Tea, 3 do.			7	0
E4064	Do. 4 do.			8	0
E4064	Do. 5 do.			9	0
E4064	Do. 6 do.			10	6



No. 1.

E4021



No. 2.

E4108



No. 3.

E4381



No. 4

E4381



No. 5.

E3004



No. 7.

E4380



No. 9.

E3209



No. 6.

E3004



No. 8.

E4380

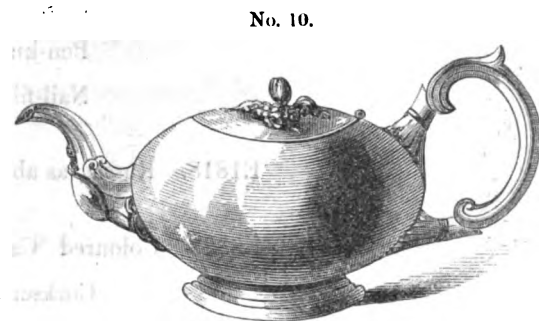

No. 10.

E3209



No. 11.

E3807

MAPPIN BROTHERS'
QUEEN'S CUTLERY WORKS, SHEFFIELD,

STOCK READY AT THE WAREHOUSE.

67 & 68, KING WILLIAM STREET, CITY,
LONDON.



No. 13.

E4838



No. 12.

E3807



No. 15.

E4064



No. 16.

E4064

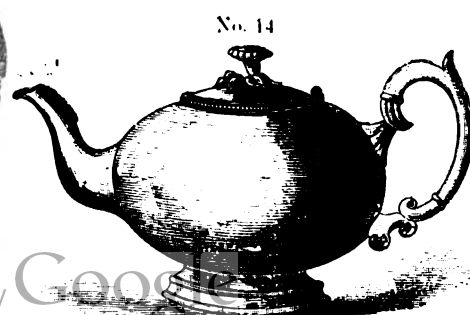

No. 14

E4123

MAPPIN BROTHERS,
MANUFACTORY,
QUEEN'S CUTLERY WORKS, SHEFFIELD,
WAREHOUSE,
67 & 68, KING WILLIAM STREET, LONDON.

**PRICES OF MAPPINS' LADIES' INSTRUMENT, WORK, AND
 TOILETTE CASES.**

For Drawings, see corresponding numbers on Plate.

		each.
		£ s. d.
E1818	Maroon French Morocco, lined, Silk Velvet, containing Work and Embroidery Scissors, Silver Thimble, Silver ever-pointed Pencil, Steel Bodkin, Pearl Pen-knife, Pearl-handle Stiletto, Cork-screw, Tweezers, Button-hook, Nail-file, and Crochet Needle <i>Case Complete</i>	0 16 0
E1818r	Russia, as above <i>Case Complete</i>	1 0 0
E2323	Coloured Calf Leather, lined Silk Velvet; containing two pairs Scissors, Corkscrew and Bodkin, Steel Tweezers, Pearl Pen-knife, Pearl Crochet Needle, Button-hook, and Stiletto <i>Case Complete</i>	0 14 0
E2390	Coromandel Wood Case, lined Silk Velvet; containing one pair each of Work, Embroidery and Nail Scissors; Silver Thimble, Silver Pencil-case, and Silver Yard-measure, Steel Bodkin, Pearl Pen-knife; six Instruments with Pearl handles and Silver ferrules, in top of Case <i>Case Complete</i>	1 12 0
E3188½	Maroon Leather Case, containing Work Scissors, Silver Thimble, Silver Pencil-case, Steel Bodkin, and Pearl Pen-knife <i>Case Complete</i>	0 11 0
1079 or B452	Russia or Morocco Pocket Instrument Case, containing Pen-knife, Nail Scissors, Tweezers, Button-hook, Cork-screw, and Nail-file <i>Complete</i>	0 12 6
E3395	Calf Leather, beautifully Illuminated and Gilt Ladies' Companion; containing Silver Cap Bottle, Silver Thimble, Silver Yard-measure, Silver Pencil-case, Steel Bodkin, Pearl Stiletto, Pearl Penknife, Embroidery Scissors, and "Mappins' Needles" <i>Complete</i>	1 1 0

**The London Warehouse contains the Largest Stock of Dressing Cases, and
 Dressing and Travelling Bags in the World.**

JOSEPH MAPPIN AND BROTHERS,
QUEEN'S CUTLERY WORKS SHEFFIELD,

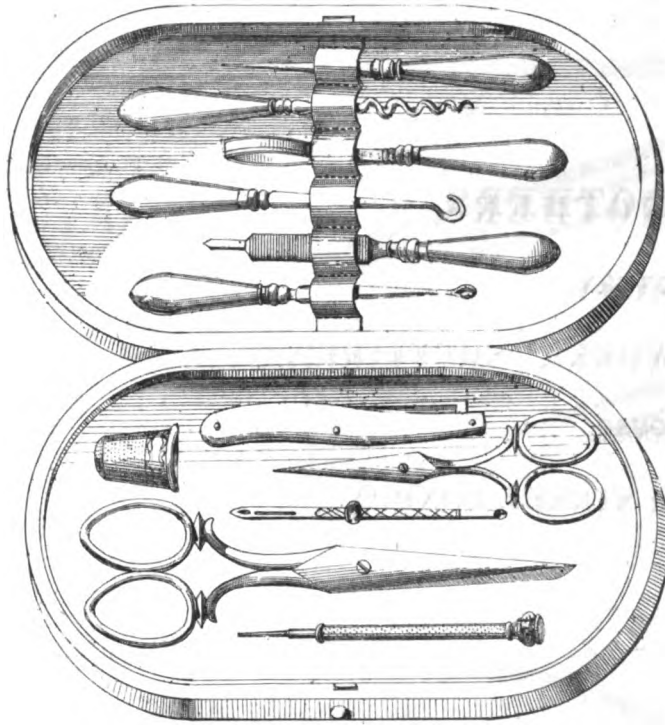

E1818

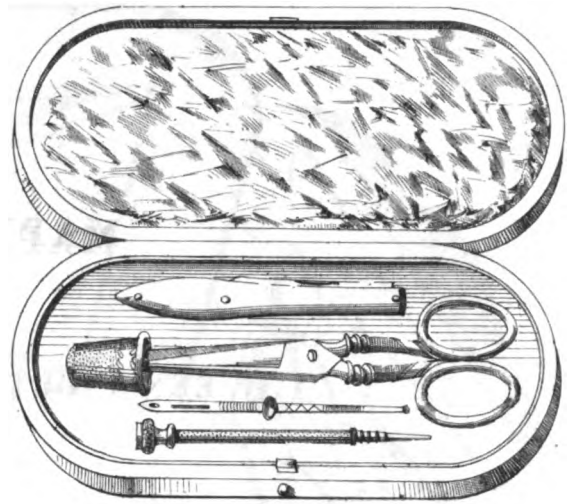

E3188½

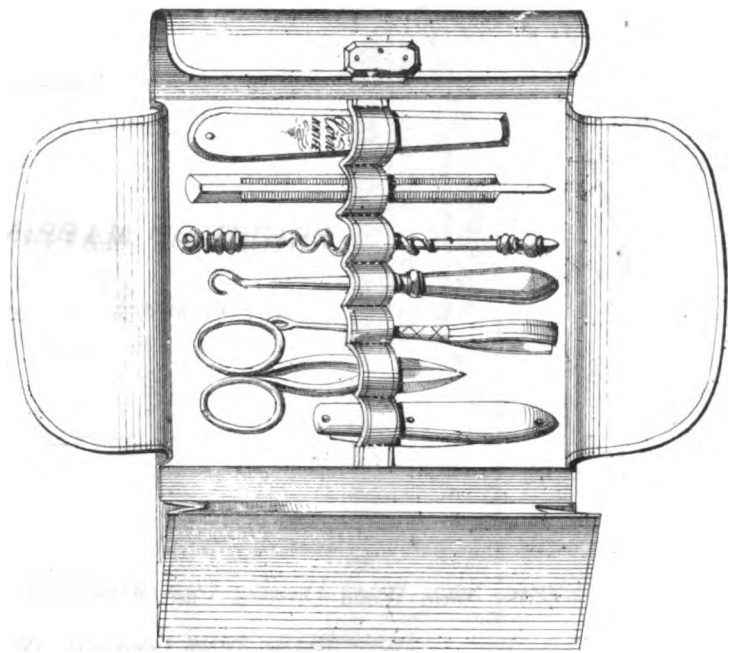

1079

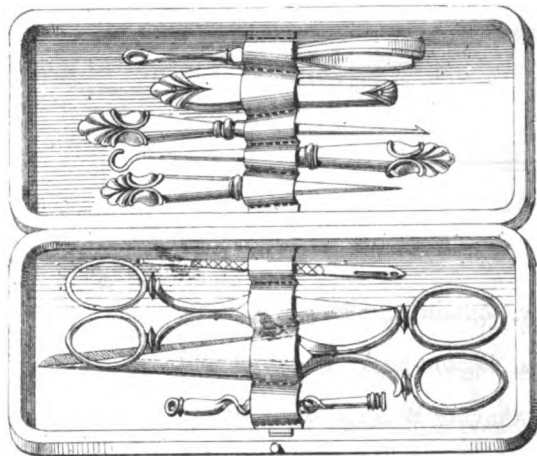

E2323

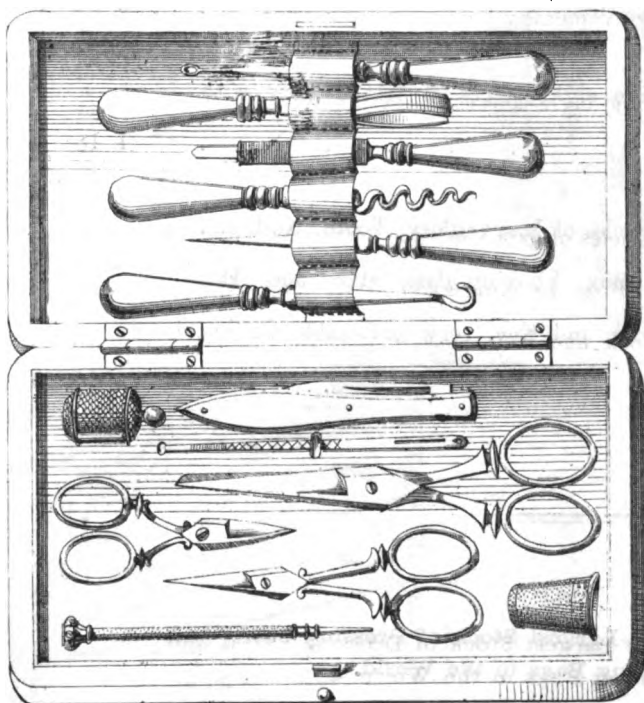

E2390

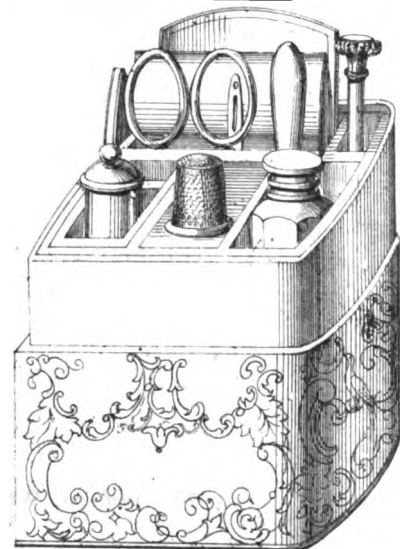
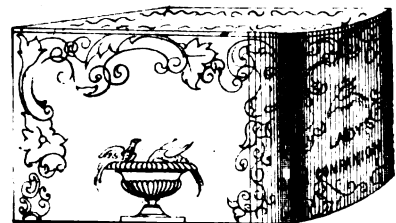

E3395

Stock ready at the Warehouse.
67, & 68, KING WILLIAM ST CITY, LONDON.

Drawn half real size.

MAPPIN BROTHERS,
MANUFACTORY,
QUEEN'S CUTLERY WORKS, SHEFFIELD,
WAREHOUSE,
67 & 68, KING WILLIAM STREET, LONDON.

PRICES OF MAPPINS' DRESSING CASES.

For Drawings, see corresponding numbers on Plate.

		each		
		£	s.	d.
E3408	Satin Wood Dressing Case, with Lock and Key, containing one pair of best Ivory Razors, Ivory Pen-knife, Nail-scissors, Button-hook, Tweezers, and Nail-file, Silver-cap Bottle, Tooth, Nail and Shaving Brushes, Razor Strop, and Comb <i>Complete</i>	1	13	0
E2310	Pocket Leather Case, with six Dressing Instruments	0	15	0
E2166	Solid Mahogany Dressing Case, containing eight pieces of best Cutlery, with moveable Looking-glass to hang up	1	18	0
E3530	Solid Mahogany Case, containing eight articles of best Cutlery, Tooth, Nail, and Shaving-soap Box, Tooth-powder Box, Looking-glass, Hair and Hat Brushes, Strop and Comb, with Lock and Key, very serviceable for hot Climates	3	10	0

The London Warehouse contains the Largest Stock of Dressing Cases, and Dressing and Travelling Bags in the World.

JOSEPH MAPPIN AND BROTHERS.
 QUEEN'S CUTLERY WORKS SHEFFIELD.
Stock ready at the Warehouse
67 & 68, KING WILLIAM ST. CITY, LONDON.

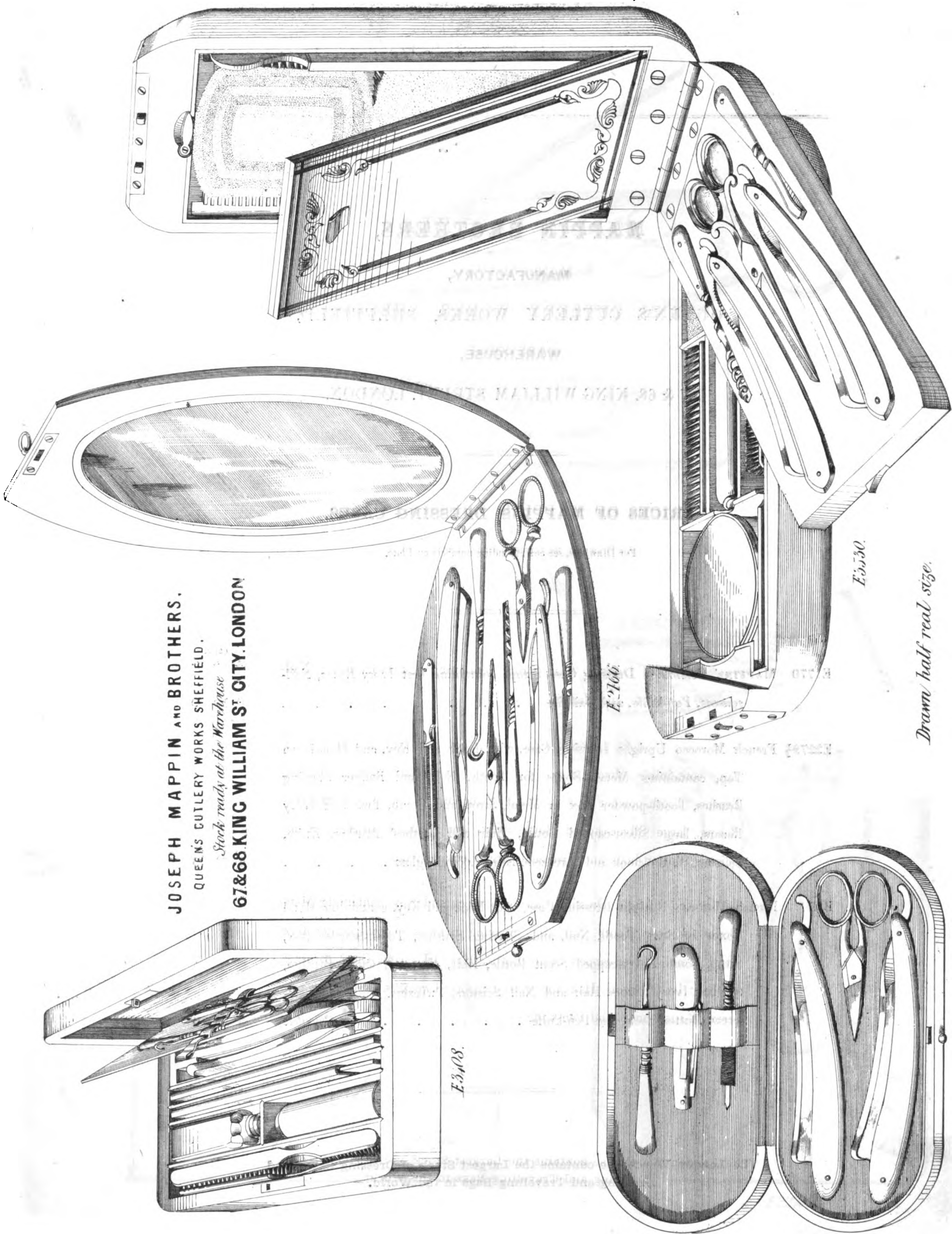

Drawn half real size.

MAPPIN BROTHERS,
MANUFACTORY,
QUEEN'S CUTLERY WORKS, SHEFFIELD,
WAREHOUSE,
67 & 68, KING WILLIAM STREET, LONDON.

PRICES OF MAPPINS' DRESSING CASES.

For Drawings, see corresponding numbers on Plate.

	each.
	£ s. d.
E1770 MAPPINS' Celebrated Dressing Case Strop; containing best Ivory Razor, Nail-scissors, Pen-knife, and Nail-file	0 10 0
E2278½ French Morocco Upright Dressing Case, with Lock and Key, and Handle on Top, containing Metal Boxes for Tooth, Nail, and Badger Shaving Brushes, Tooth-powder Box in Metal, Strop and Comb, Two best Ivory Razors, large Silver-capped Bottle, Hair and Clothes' Brushes, Knife, Scissors, Button-hook and Tweezers, large Looking-glass	2 16 0
B53 French Morocco Upright Dressing Case, with Lock and Key, containing Metal Boxes for Soap, Tooth, Nail, and Shaving Brushes, Tooth-powder Box, Strop, Comb, Silver-capped Scent Bottle, Hair, Hat, and Cloth Brushes, two best Ivory Razors, Hair and Nail Scissors, Tweezers, Nail-file, Cork-screw, Button-hook, and Pen-knife Complete	3 10 0

The London Warehouse contains the Largest Stock of Dressing Cases, and Dressing and Travelling Bags in the World.

JOSEPH MAPPIN AND BROTHERS,
QUEEN'S CUTLERY WORKS, SHEFFIELD.

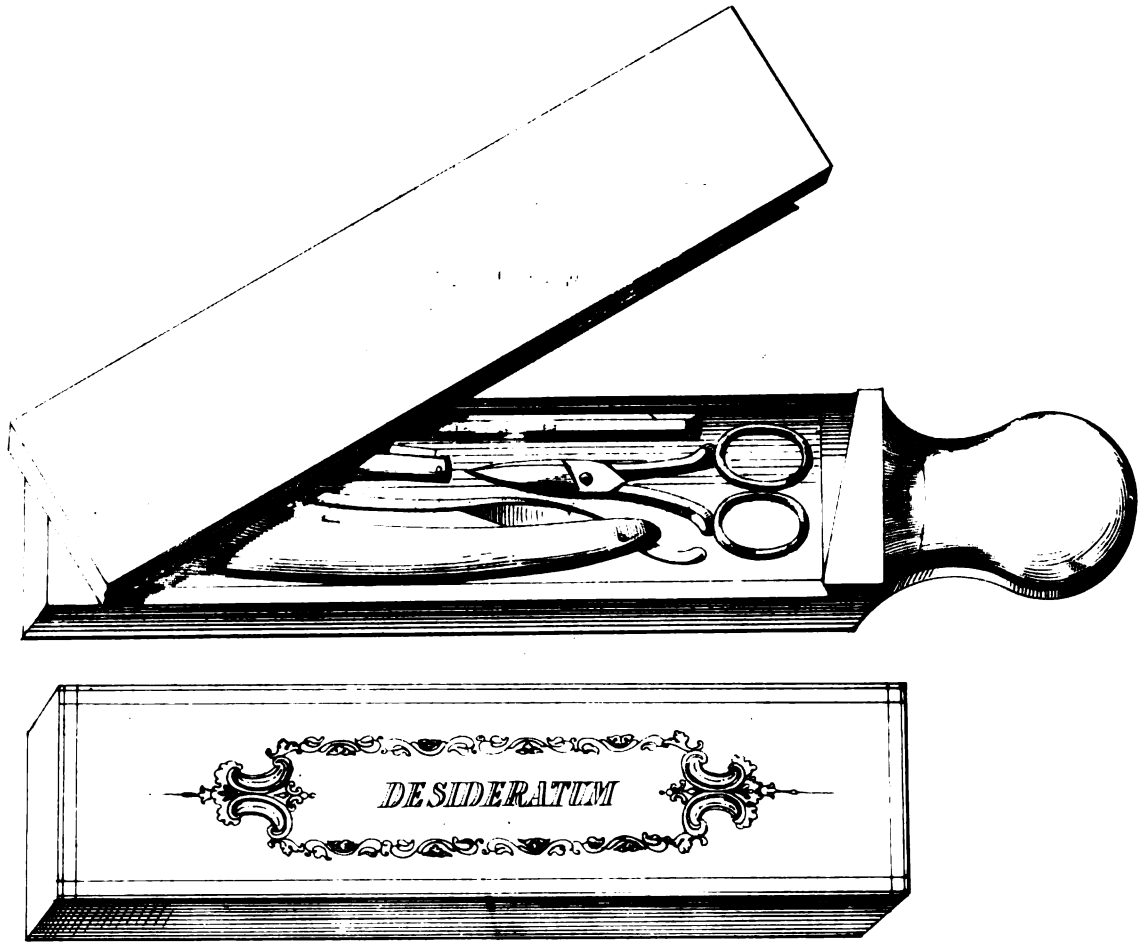

E1770

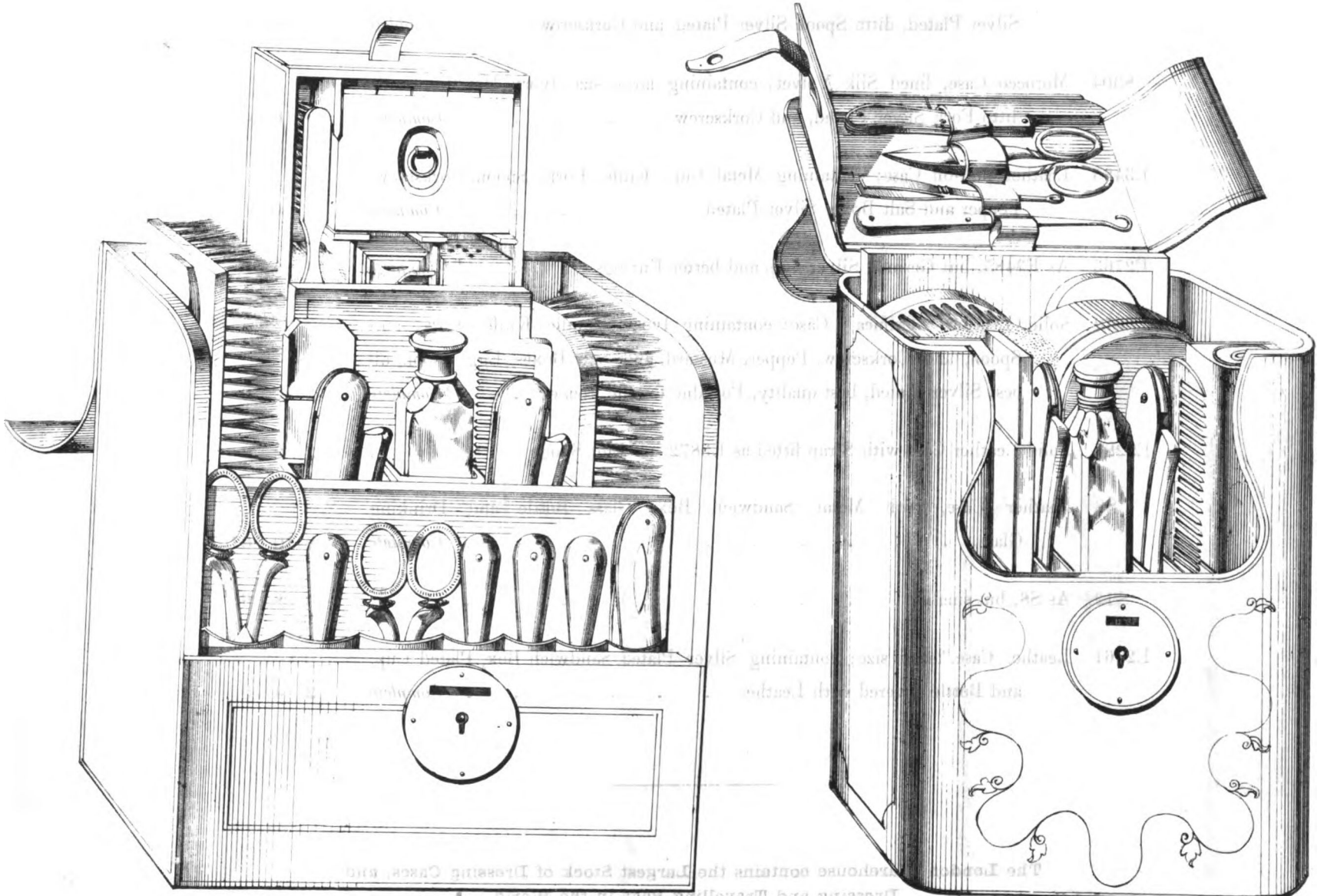

B53

E2278

Stock ready at the Warehouse!
67 & 68 KING WILLIAM STREET, CITY, LONDON.

Drawn half real size.

MAPPIN BROTHERS,**MANUFACTORY,****QUEEN'S CUTLERY WORKS, SHEFFIELD,****WAREHOUSE,****67 & 68, KING WILLIAM STREET, LONDON.****PRICES OF MAPPINS' "CRIMEA," AND PICNIC CASES AND
RAILWAY OR TRAVELLING COMPANIONS.**

For Drawings, see corresponding numbers on Plate.

	each.
	£ s. d.
6615 Morocco Case, lined Silk Velvet; containing Ivory Handle Knife, ditto Fork Silver Plated, ditto Spoon Silver Plated, and Corkscrew . . . <i>Complete</i>	1 4 0
8304 Morocco Case, lined Silk Velvet; containing large size Ivory Handle Knife, ditto Fork Silver Plated, and Corkscrew <i>Complete</i>	0 16 0
E3485 Leather pull-off Case; containing Metal Cup, Knife, Fork, Spoon, Corkscrew, Pepper and Salt Boxes Silver Plated <i>Complete</i>	1 0 0
E2763 As E3485, but German Silver Cup and better Fittings <i>Complete</i>	1 15 0
E3872 Solid Leather "Crimea" Case; containing Ivory Handle Knife, Fork, and Spoon, and Corkscrew, Pepper, Mustard, and Salt Boxes, Egg Spoon, all best Silver Plated, best quality, Portable for the Pocket <i>Complete</i>	2 2 0
E2281 Solid Leather Case with Strap fitted as E3872, no Egg Spoon	2 2 0
S8 Leather Case, with Metal Sandwich Box, Glass Bottle and Drinking Glass <i>Complete</i>	0 10 0
S12 $\frac{1}{4}$ As S8, but smaller	0 8 6
E2761 Leather Case, large size; containing Silver Plated Sandwich Box, Plated Cup, and Bottle covered with Leather <i>Complete</i>	2 4 0

The London Warehouse contains the Largest Stock of Dressing Cases, and
Dressing and Travelling Bags in the World.

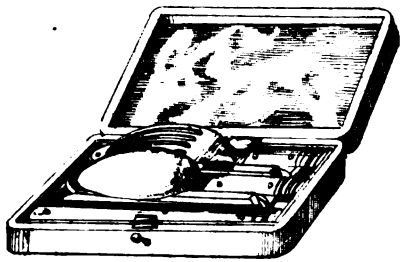

6675.



F.2281.

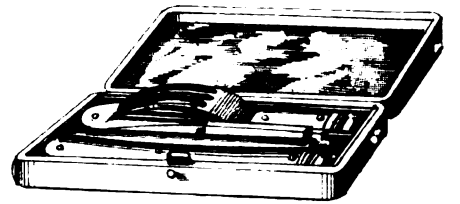

8304

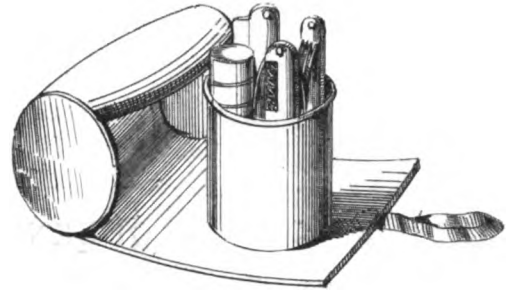

E 3872
MAPPIN'S CRIMEA CASE.



E3185.

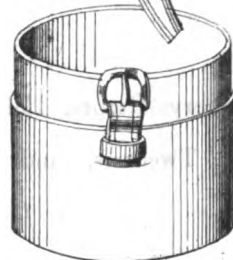

Case for E.2281.

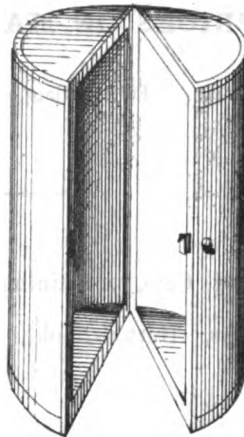

Case for F.2763.



E2763

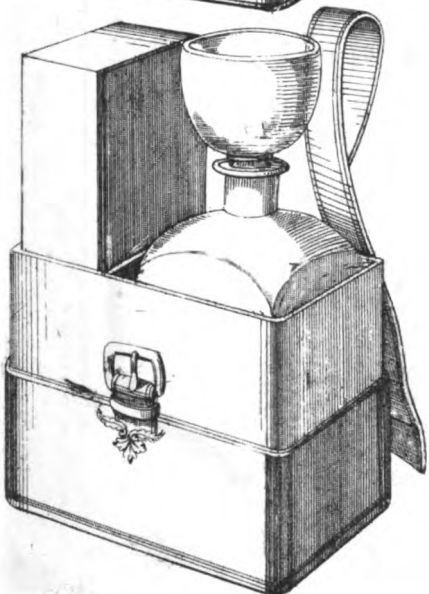
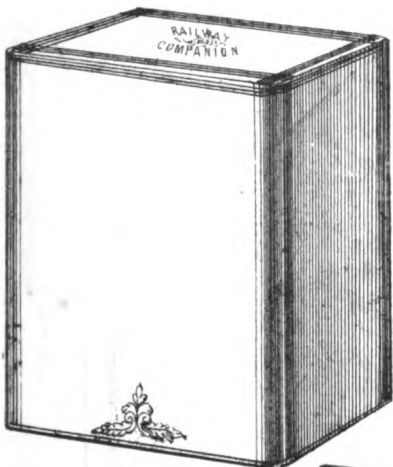

58

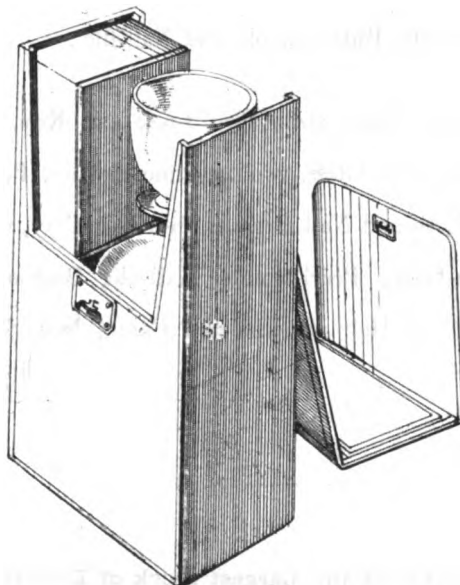

512 1/2

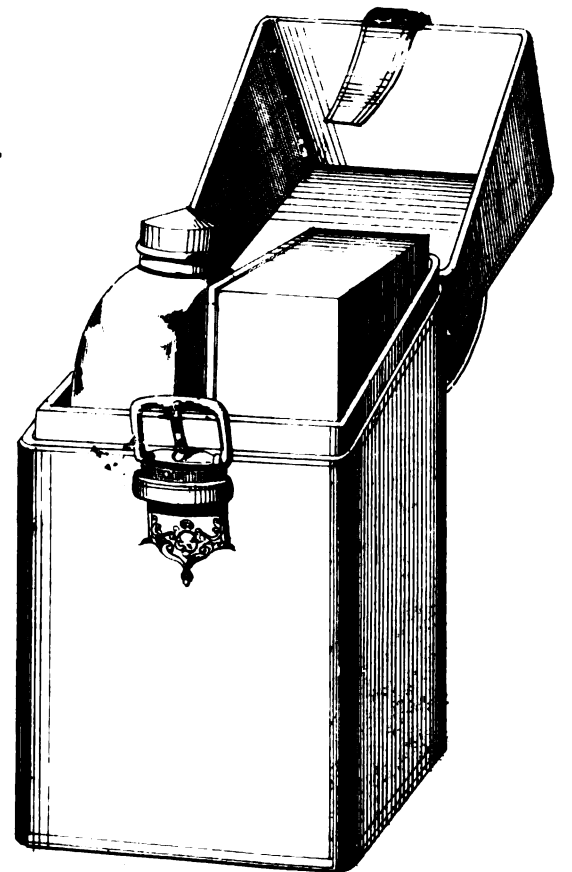

52761.

JOSEPH MAPPIN AND BROTHERS.
QUEEN'S CUTLERY WORKS SHEFFIELD.
Stock ready at the Warehouse.
67 & 68 KING WILLIAM STREET, CITY, LONDON.

Drawn half real size.

MAPPIN BROTHERS,
MANUFACTORY,
QUEEN'S CUTLERY WORKS, SHEFFIELD,
WAREHOUSE,
67 & 68, KING WILLIAM STREET, LONDON.

PRICES OF MAPPINS' DRESSING CASES.

For Drawings, see corresponding numbers on Plate

	each.
	£ s. d.
E2309 Solid Satinwood Case, containing one pair best Ivory Razors, Hair and Nail-scissors, Button-hook, Nail-file, Pen-knife, Tweezers, and Cork-screw <i>Complete</i>	1 8 0
E2309g Ditto ditto ditto, with Looking-glass, extra	1 12 0
E2276g Solid Satinwood Toilette Case, containing one Ivory Razor, Tooth and Shaving Brushes, Nail-file, Pen-knife, Nail-scissors, Corkscrew, Tweezers, and Looking-glass <i>Complete</i>	1 8 0
B51 Leather Upright Case, with Lock and Key, containing Hair, Cloth, and Hat Brushes, Tooth, Nail, and Shaving Brushes, Soap-box, Strop, Comb, Looking-glass, two best Ivory Razors, Silver-cap Bottle, Knife with two blades, Hair and Nail-scissors, Button-hook, and Nail-file <i>Complete</i>	2 6 0
B190 Lady's Rosewood Dressing Case, large size, with Lock and Key, containing Jewel Drawer, large Looking Glass, two perfume Bottles, Pomade Jar, Tooth-powder Boxes, Tooth and Nail Brushes in Glass Tray, Glass Soap-box, Nail-scissors, Pen-knife, Pearl-handle Nail-file, Button-hook, and Tweezers, Pin-box, two best Hair Brushes and Comb, best Silver-plated fittings <i>Complete</i>	4 10 0

The London Warehouse contains the Largest Stock of Dressing Cases, and Dressing and Travelling Bags in the World.

Glass on Top.

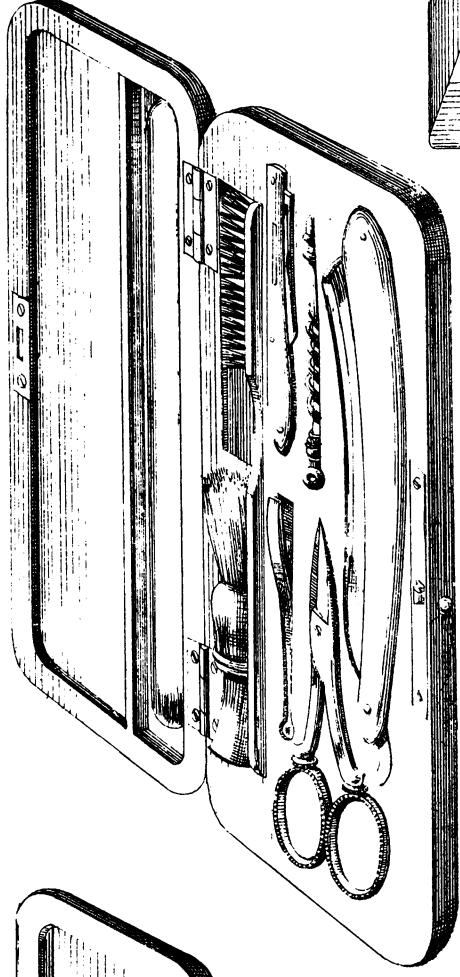

E 22276 G.

JOSEPH MAPPIN AND BROTHERS,
QUEEN'S CUTLERY WORKS SHEFFIELD,
Stock ready at the Warehouse,
67 & 68 KING WILLIAM STREET, CITY, LONDON.

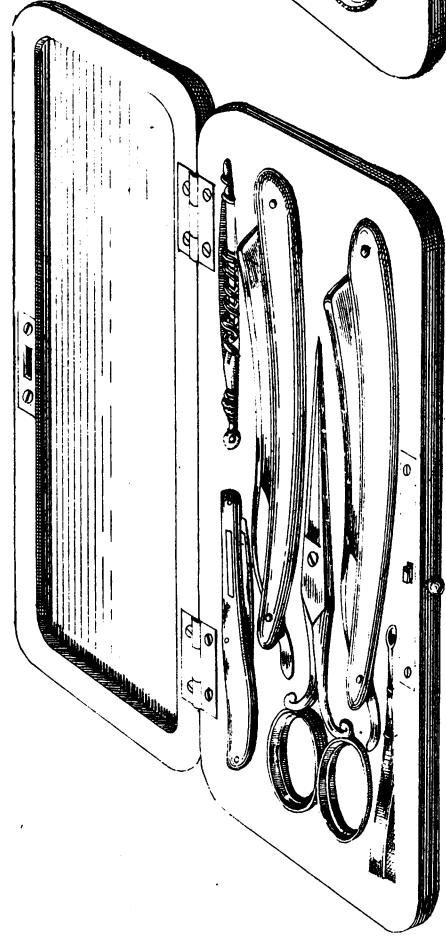

E 22279

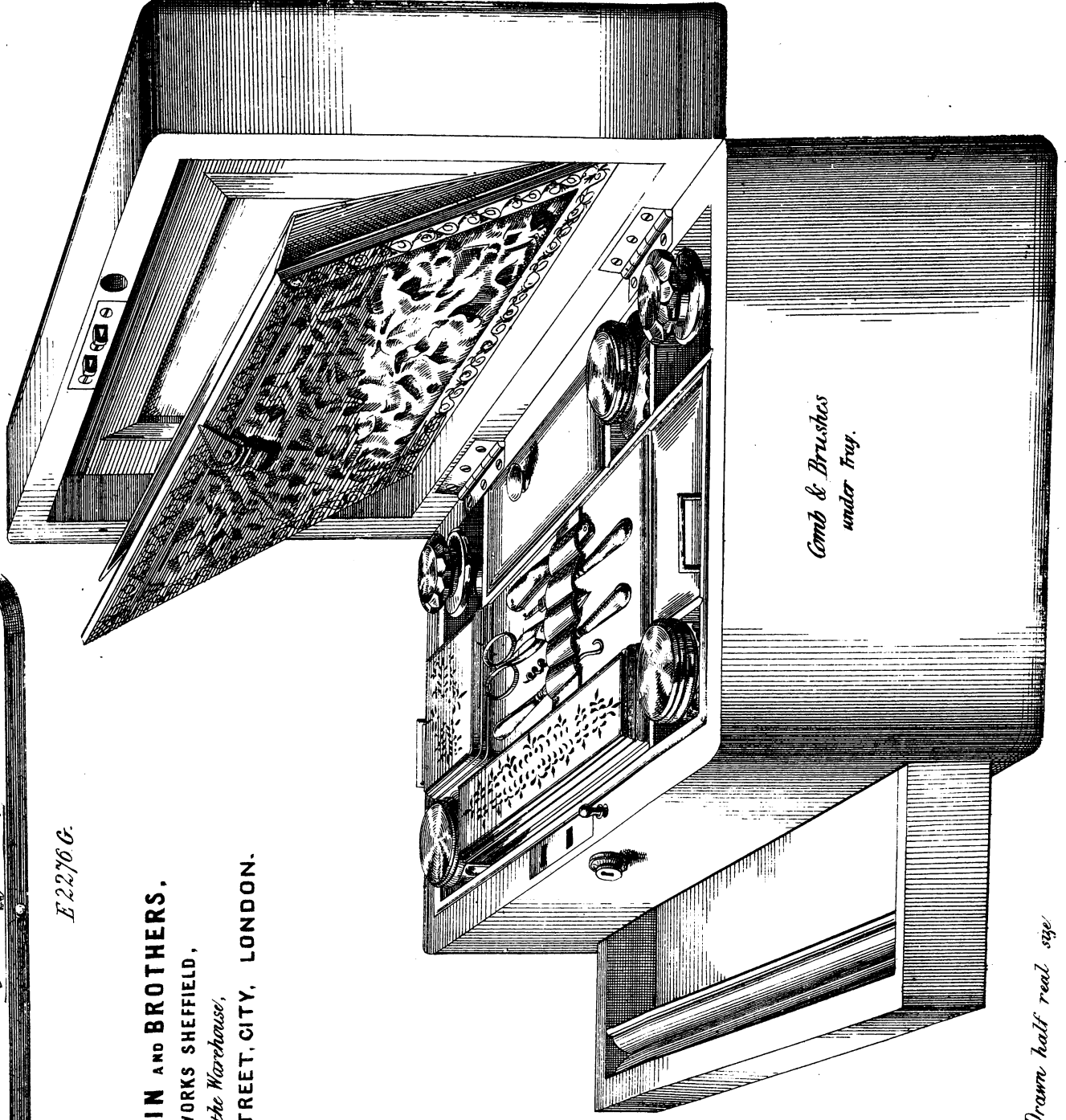

*Comb & Brushes
under Tray.*

Drawn half real size

B 190

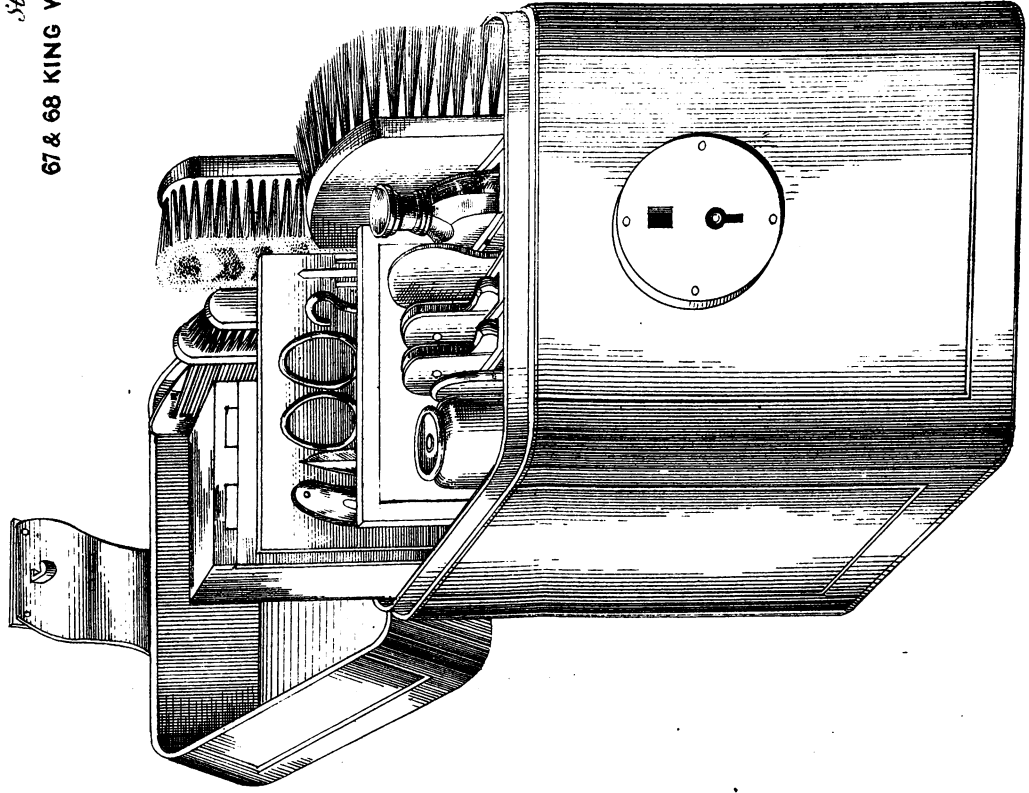

B 51.

MAPPIN BROTHERS,
MANUFACTORY,
QUEEN'S CUTLERY WORKS, SHEFFIELD,
WAREHOUSE,
67 & 68, KING WILLIAM STREET, LONDON.

PRICES OF MAPPINS' DRESSING CASES.

For Drawings, see corresponding numbers on Plate.

	each,
	£ s. d.
E2165 French Morocco Case, with Lock and Key, containing Tooth, Nail, and Shaving Brushes, Silver-cap Bottle, Strop and Comb, and fitted with finest Cutlery, as drawing, Looking Glass in Lid <i>Complete</i>	2 0 0
E3525 Maroon Leather Case, containing Tooth and Shaving Brushes, Strop, Comb, one pair of best Razors	0 9 6
B181 Rosewood Brass-edged Case, best Plated Fittings, containing Tooth, Nail, and Shaving Brushes, Strop, Comb, Box for Studs, Soap-box, Tooth-powder and Pomade Jar, two Perfume Bottles, Hair, Clothes, and Hat Brushes, Seven Articles of Mappins' finest Cutlery <i>Complete</i>	5 10 0
B182 Rosewood Brass-bound large size Case, containing Nine Articles of the finest Cutlery, Tray for Studs, Soap-tray, Tooth-powder Box, Shaving-soap Can, Plated Shaving Brush, Silver-cap Bottle, two Pomade Jars, Tooth, and Nail Brushes, Strop and Comb, large size Cloth, Hair and Hat Brushes, large Looking Glass in Top, fitted with "Bramah" Lock, and best Silver Plated Fittings	8 10 0

The London Warehouse contains the Largest Stock of Dressing Cases, and Dressing and Travelling Bags in the World.

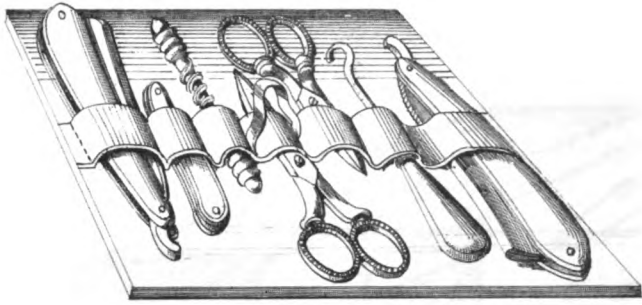

for B181 under Tray.

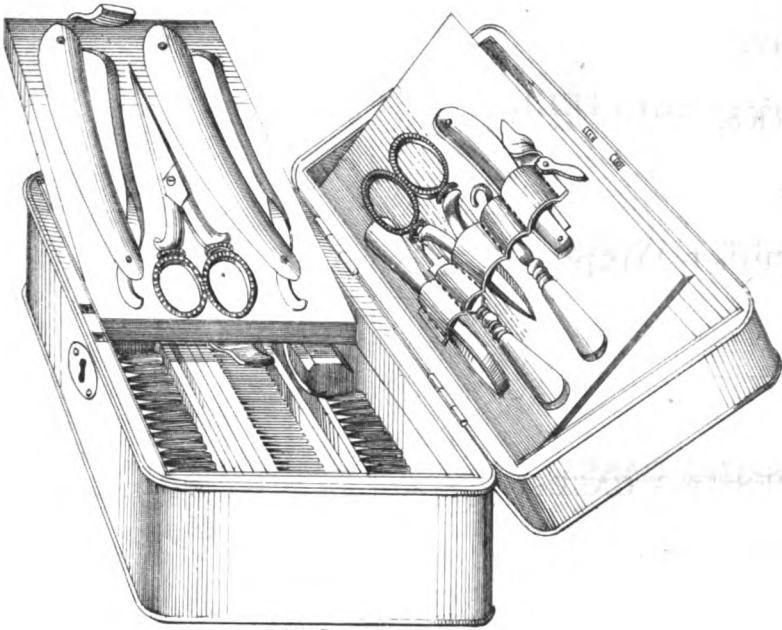

E 2105.
Locking Glass in Lid.

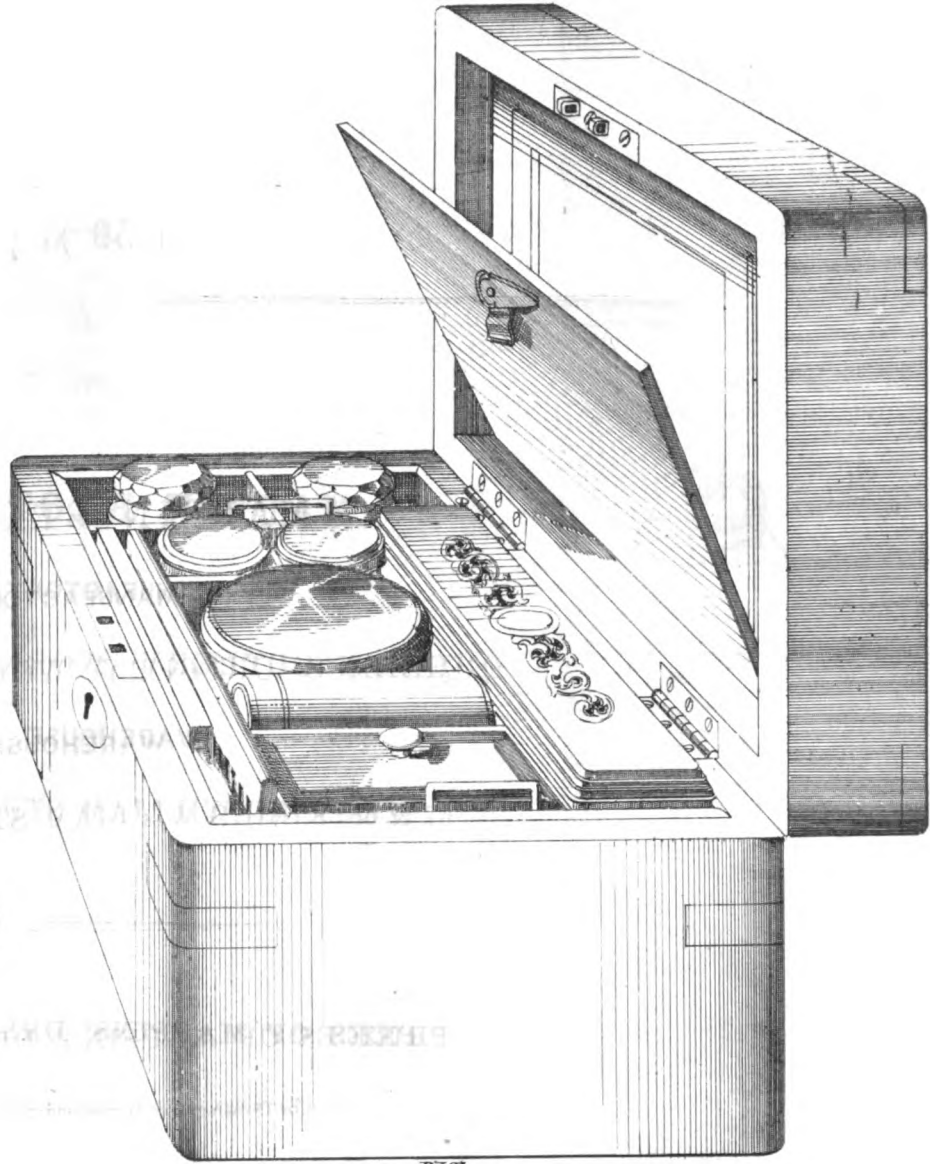

B181.
Brushes under Tray.

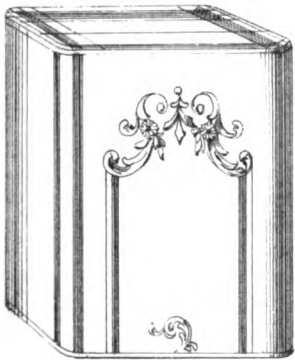

JOSEPH MAPPIN AND BROTHERS,
 QUEEN'S CUTLERY WORKS SHEFFIELD,
Stock ready at the Warehouse
 67 & 68 KING WILLIAM STREET, CITY, LONDON.

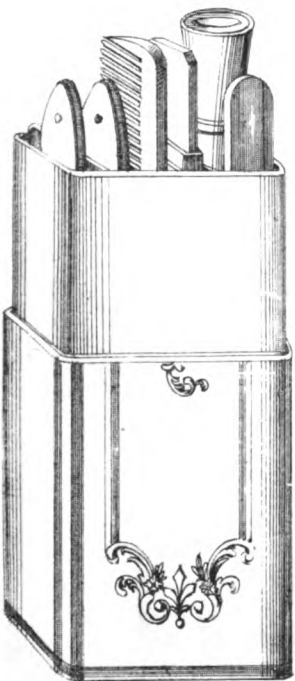

E3525.

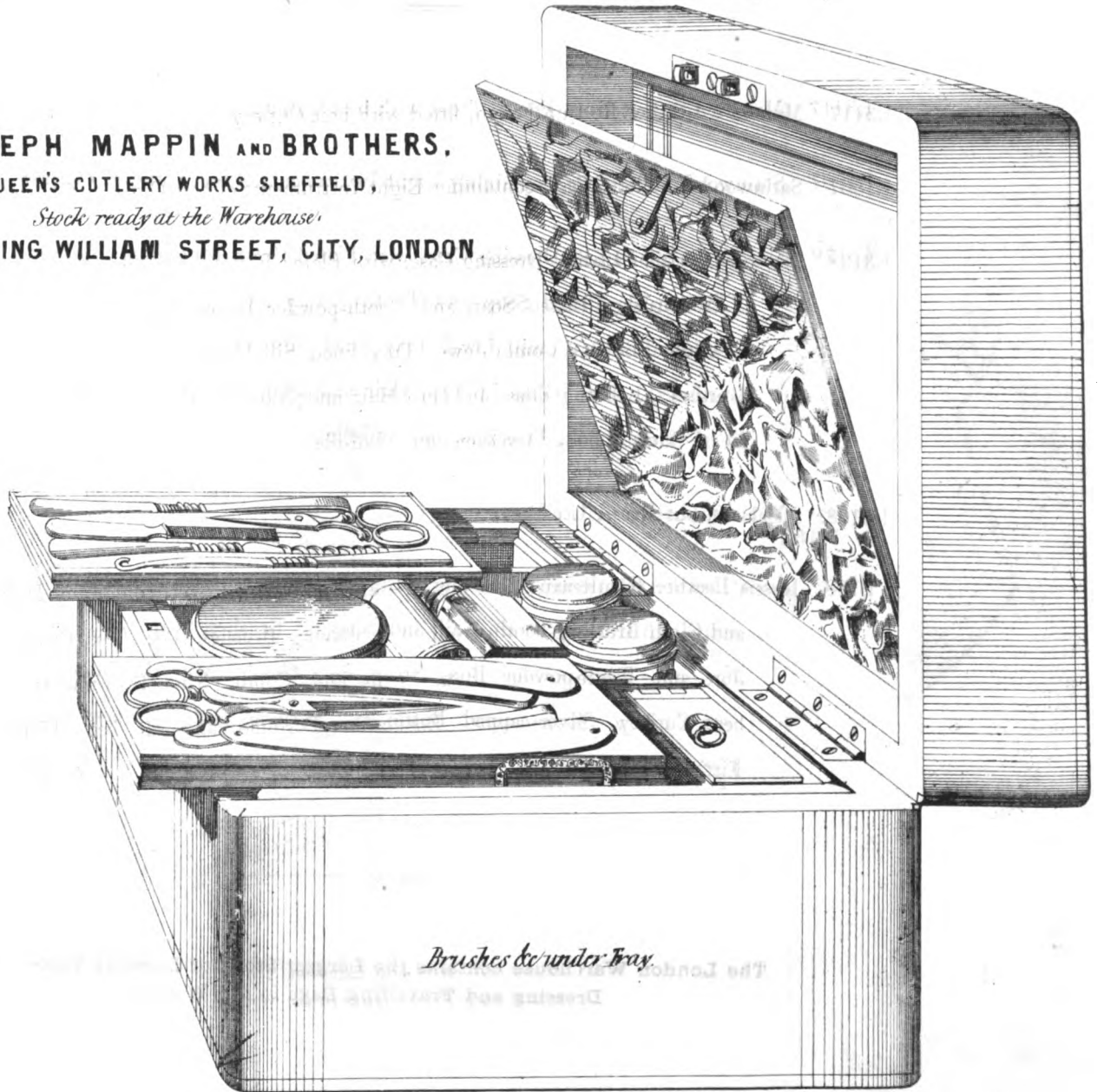

Brushes &c under Tray

B182 Edged with Brass
 Wood

Drawn 1/2 real size.

MAPPIN BROTHERS,
MANUFACTORY,
QUEEN'S CUTLERY WORKS, SHEFFIELD,
WAREHOUSE,
67 & 68, KING WILLIAM STREET, LONDON.

PRICES OF MAPPINS' DRESSING CASES.

For Drawings, see corresponding numbers on Plate.

	each.
	£ s. d.
E3117 Maroon Leather Roll-up Pouch, fitted with best Cutlery <i>Complete</i>	1 4 0
E1807 Satinwood Toilette Case, containing Eight Instruments of best Cutlery. <i>Complete</i>	0 17 6
E3138 Maroon Leather Ladies' Dressing Case, with Plated Boxes containing Tooth and Nail Brushes, Plated Soap and Tooth-powder Boxes, Two Silver-capped Perfume Bottles, Comb, Jewel Tray lined Silk Velvet, Hair and Velvet Brushes, Looking Glass in Top, Hair and Nail Scissors, Pearl Penknife, Pearl Button-hook, Tweezers, and Nail-file <i>Complete</i>	4 0 0
E3138r As above, but Russia Leather	4 10 0
B188 Russia Leather Gentleman's Dressing Case, with outside Cover, containing Hair and Cloth Brushes, Tooth, Nail, and Shaving Brushes, Soap Box, Pomade Jar, and Tooth-powder Box, Strop and Comb, Nine Instruments of best Cutlery, Silver-capped Bottle for Perfume, and all best Plated Fittings <i>Complete</i>	5 12 0

The London Warehouse contains the Largest Stock of Dressing Cases, and Dressing and Travelling Bags in the World.

JOSEPH MAPPIN AND BROTHERS,
QUEEN'S CUTLERY WORKS SHEFFIELD.

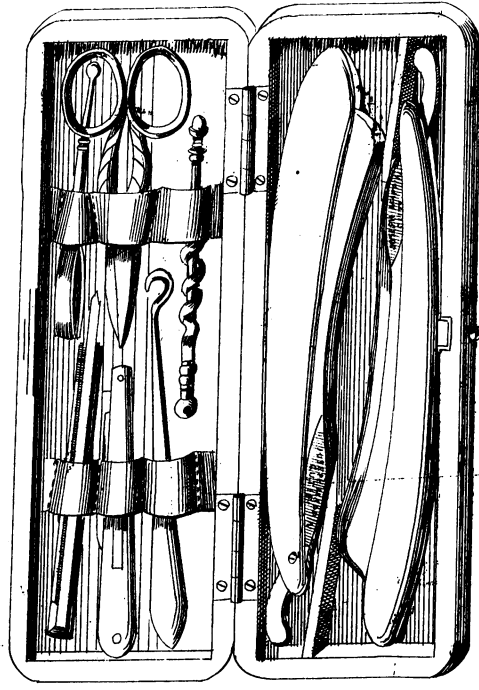

E.1607.

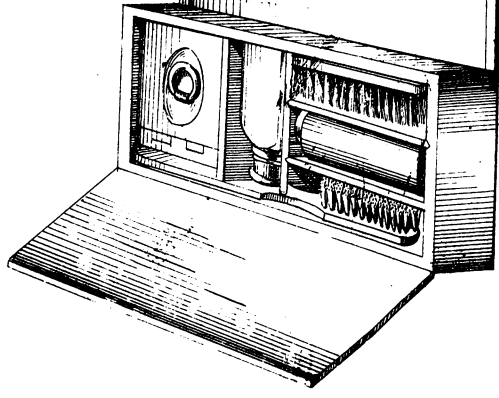

E.3117.
Drawn one third size.

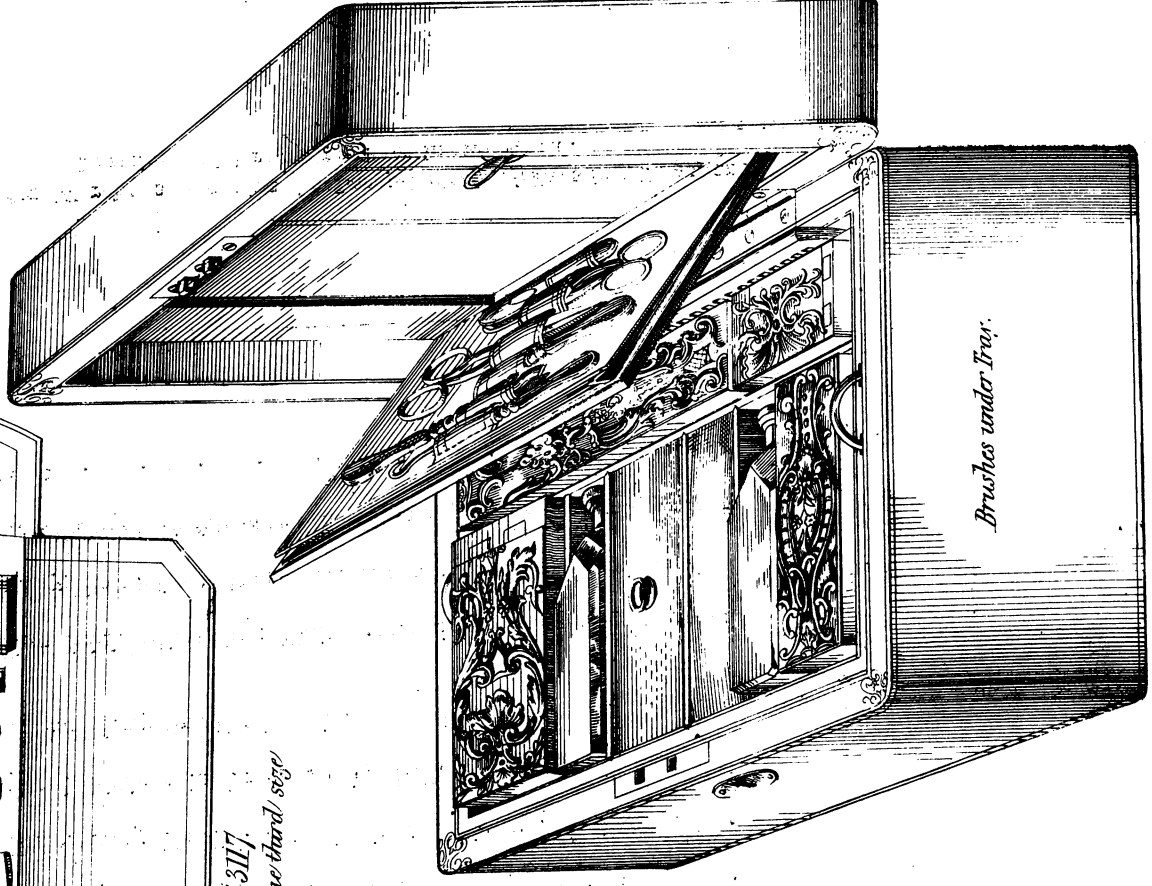
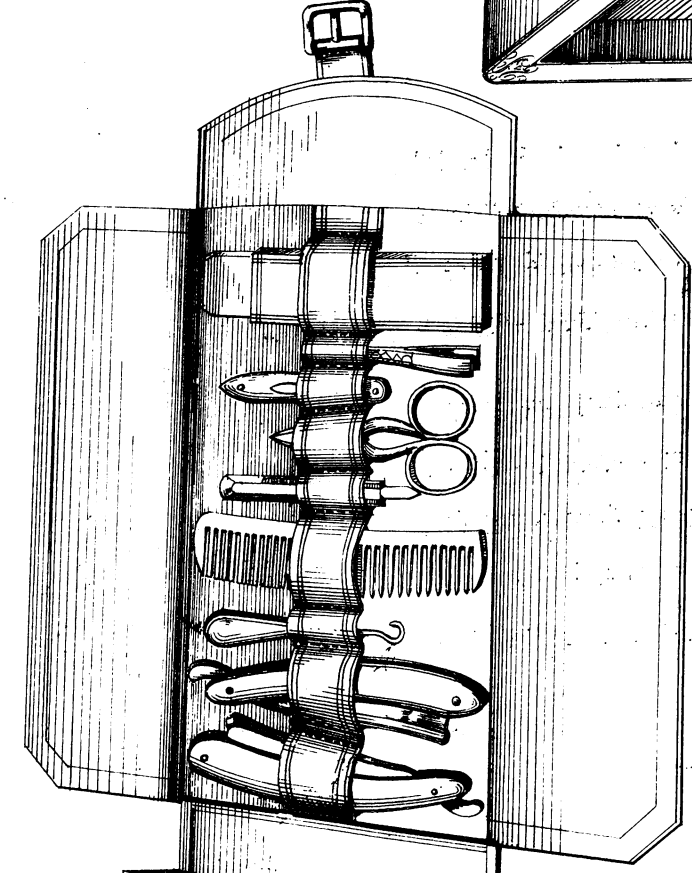

B.188 Wood Case

Stock ready at the Warehouse,
67 & 68, KING WILLIAM STREET, CITY, LONDON.
Drawn half size.

E.3136.

Brushes under Tray.

MAPPIN BROTHERS,
MANUFACTORY,
QUEEN'S CUTLERY WORKS, SHEFFIELD,
WAREHOUSE,
67 & 68, KING WILLIAM STREET, LONDON.

PRICES OF MAPPINS' DRESSING CASES.

For Drawings, see corresponding numbers on Plate

	each.
	£ s. d.
B74 Best Coromandel Wood Brass-bound Case, lined Silk Velvet, and best Lock; containing one pair finest Ivory Razors, Hair and Nail Scissors, three blade Ivory Knife, Ivory Handle Button-hook, Nail-file and Corkscrew, best Silver-plated Fittings in Tray, Tooth, Nail, Shaving, Hair, Hat and Cloth Brushes, Strop, and Comb, and best Looking-glass <i>Complete</i>	7 10 0
E3471 Maroon Leather Folding Case, best Fittings; containing Six Instruments of best Cutlery, Strop, Comb, Hair and Hat Brush, Tooth, Nail and Shaving Brushes, Looking-glass, Silver-capped Bottle, and Ring Box, with drawer underneath <i>Complete</i>	2 16 0

The London Warehouse contains the Largest Stock of Dressing Cases, and Dressing and Travelling Bags in the World.

JOSEPH MAPPIN AND BROTHERS.
 QUEEN'S CUTLERY WORKS SHEFFIELD,
Stock ready at the Warehouse!
 67 & 68 KING WILLIAM ST. CITY, LONDON.

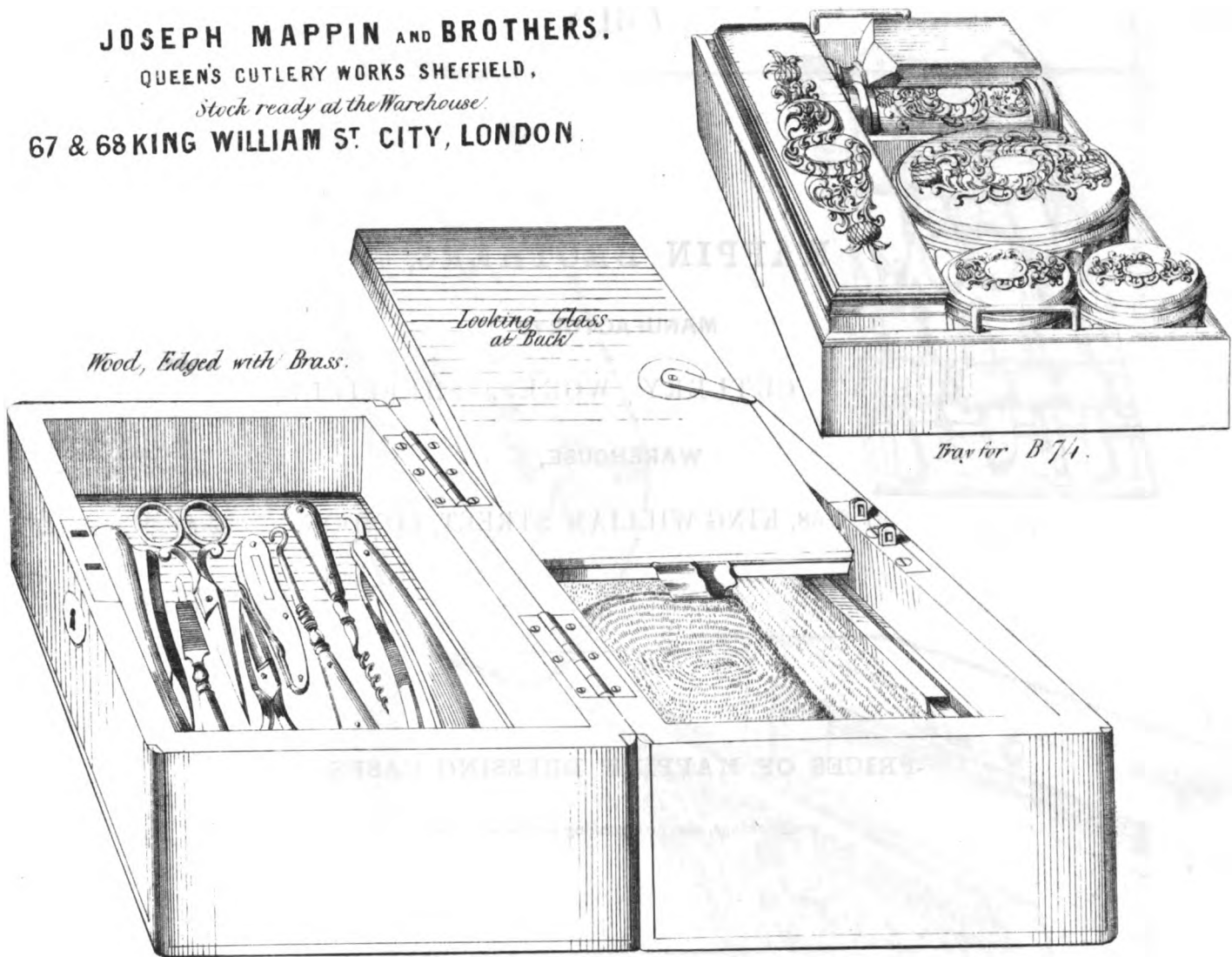

B74.

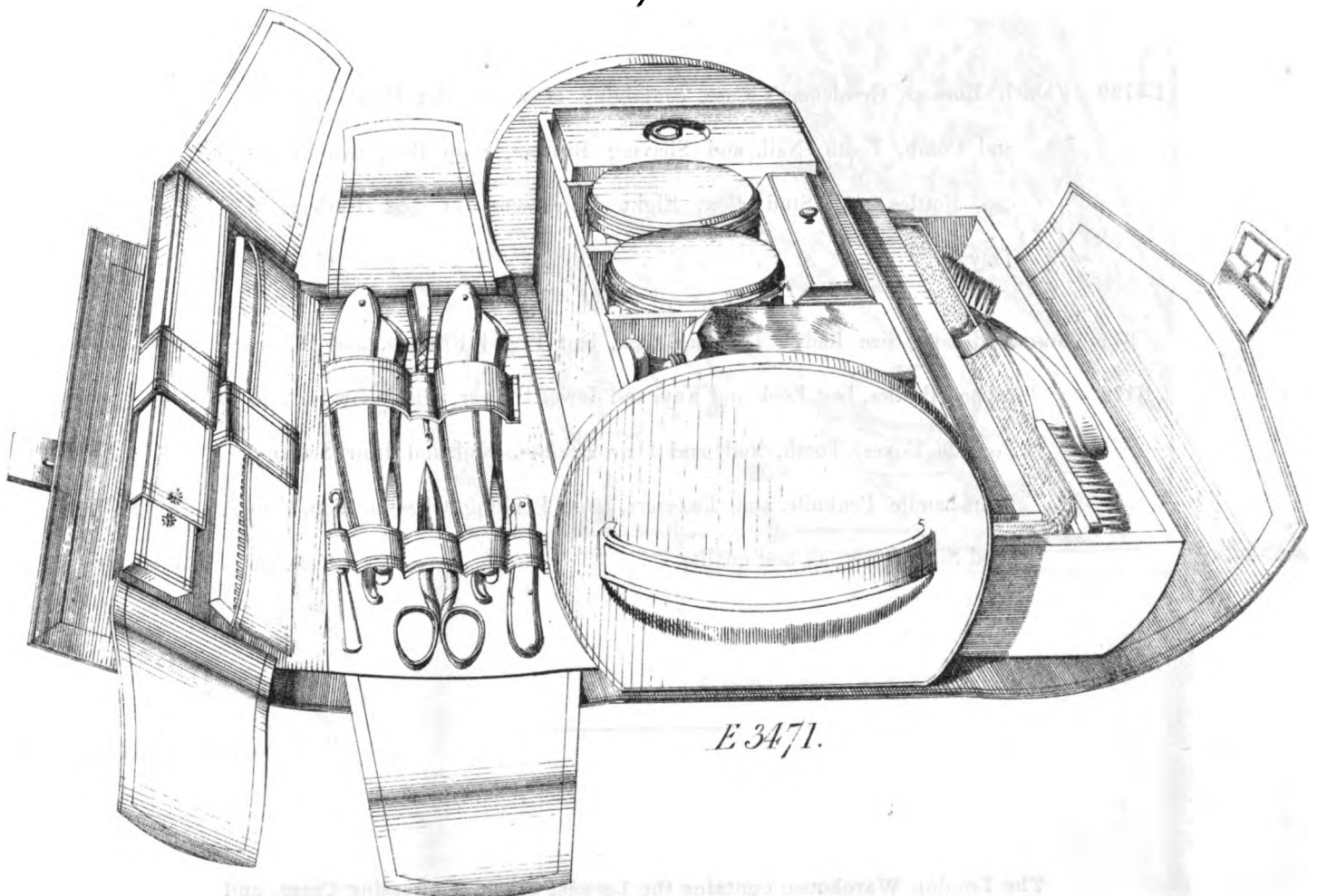

E 3471.

Drawn half real size

MAPPIN BROTHERS,
MANUFACTORY,
QUEEN'S CUTLERY WORKS, SHEFFIELD,
WAREHOUSE,
67 & 68, KING WILLIAM STREET, LONDON.

PRICES OF MAPPINS' DRESSING CASES.

For Drawings, see corresponding numbers on Plate.

		each.
		£ s. d.
E3129	French Morocco Gentleman's Case, containing Hair and Hat Brushes, Strop, and Comb, Tooth, Nail, and Shaving Brushes, Soap Box, two Silver-cap Bottles and Stud Box, Eight Instruments of best Cutlery in Tray Complete	3 0 0
911 or B176	Rosewood large size Lady's Dressing Case, best Plated Fittings, and Silver-capped Bottles, best Lock and Key, and Jewel Drawer, Tooth-powder, and Pomade Boxes, Tooth, Nail, and Hair Brushes, Nail and Hair Scissors, Pearl-handle Penknife, and Tweezers, large Looking Glass in Top, Case lined Silk Velvet, all best quality Complete	5 10 0

The London Warehouse contains the Largest Stock of Dressing Cases, and Dressing and Travelling Bags in the World.

JOSEPH MAPPIN AND BROTHERS.
QUEEN'S CUTLERY WORKS SHEFFIELD.



E3129

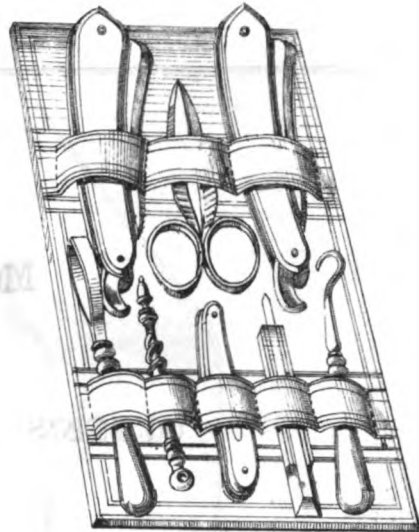

E3129

Drawn half real size.

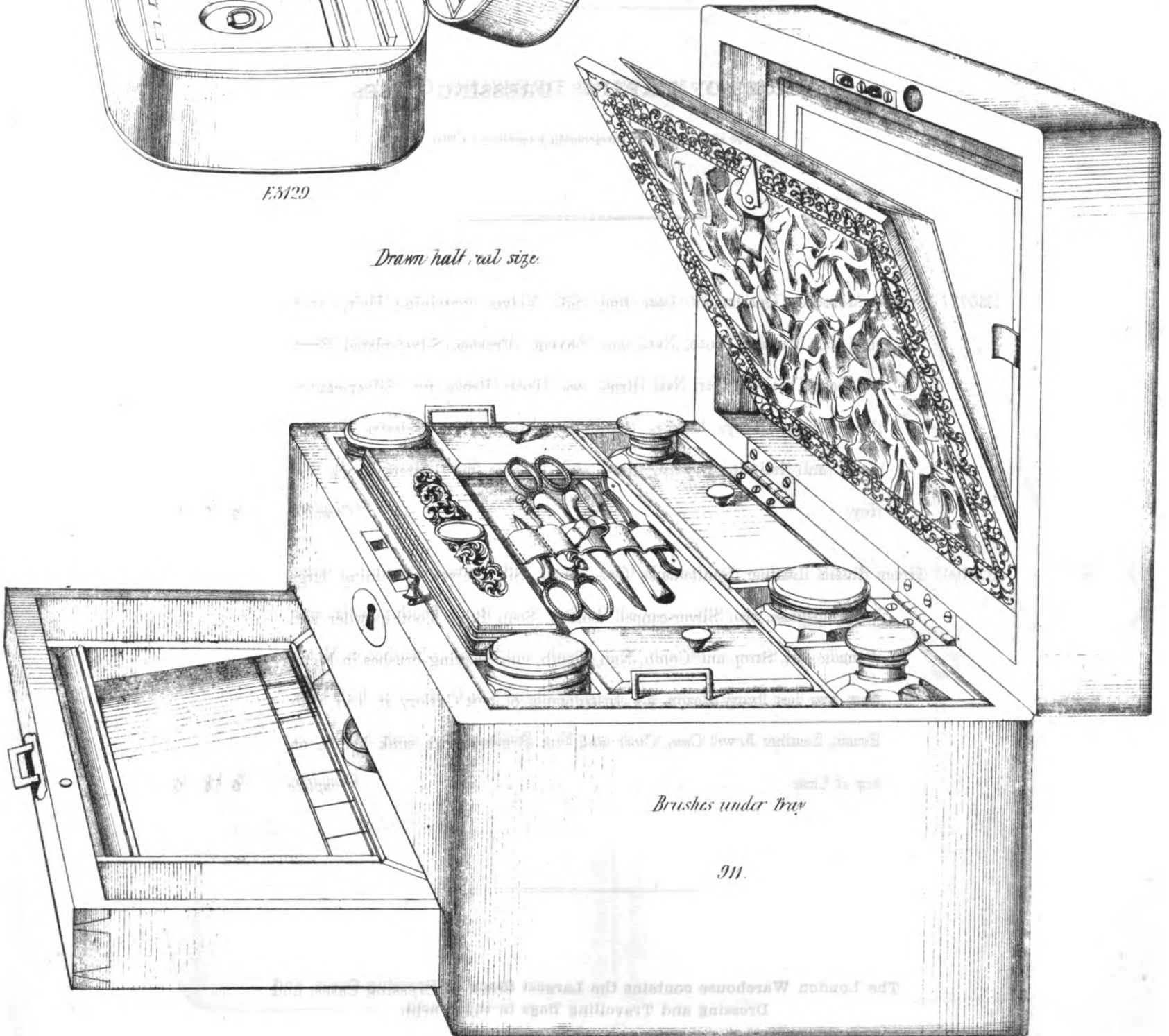

Brushes under tray

911

Stock ready at the Warehouse!
67 & 68 KING WILLIAM STREET, CITY, LONDON.

MAPPIN BROTHERS,
MANUFACTORY,
QUEEN'S CUTLERY WORKS, SHEFFIELD,
WAREHOUSE,
67 & 68, KING WILLIAM STREET, LONDON.

PRICES OF MAPPINS' DRESSING CASES.

For Drawings, see corresponding numbers on Plate.

	each.
	£ s. d.
E3077 French Morocco Gentleman's Case, lined Silk Velvet, containing Hair, Cloth, and Hat Brushes, Tooth, Nail, and Shaving Brushes, Silver-plated Boxes for Soap, Tooth-powder, Nail Brush and Tooth Brush, two Silver-capped Bottles, two Ivory Razors, two-bladed Knife, Nail Scissors, Button-hook, and Nail-file, Looking-glass, and Pocket for Letters, Lock and Key Complete	4 0 0
E3404 Green Russia Leather Gentleman's Case, lined, Silk Velvet, containing large Looking-glass, two Silver-capped Bottles, Soap Box, Tooth-powder and Pomade Jar, Strop and Comb, Nail, Tooth, and Shaving-brushes in Metal Box, two best Ivory Razors, six Instruments of best Cutlery in Lid, Hair Brush, Leather Jewel Case, Cloth and Hat Brushes, with sunk handle on top of Case Complete	5 14 0

The London Warehouse contains the Largest Stock of Dressing Cases, and Dressing and Travelling Bags in the World.

JOSEPH MAPPIN AND BROTHERS,
QUEEN'S CUTLERY WORKS SHEFFIELD,

E.3077.
Brushes under Tray.

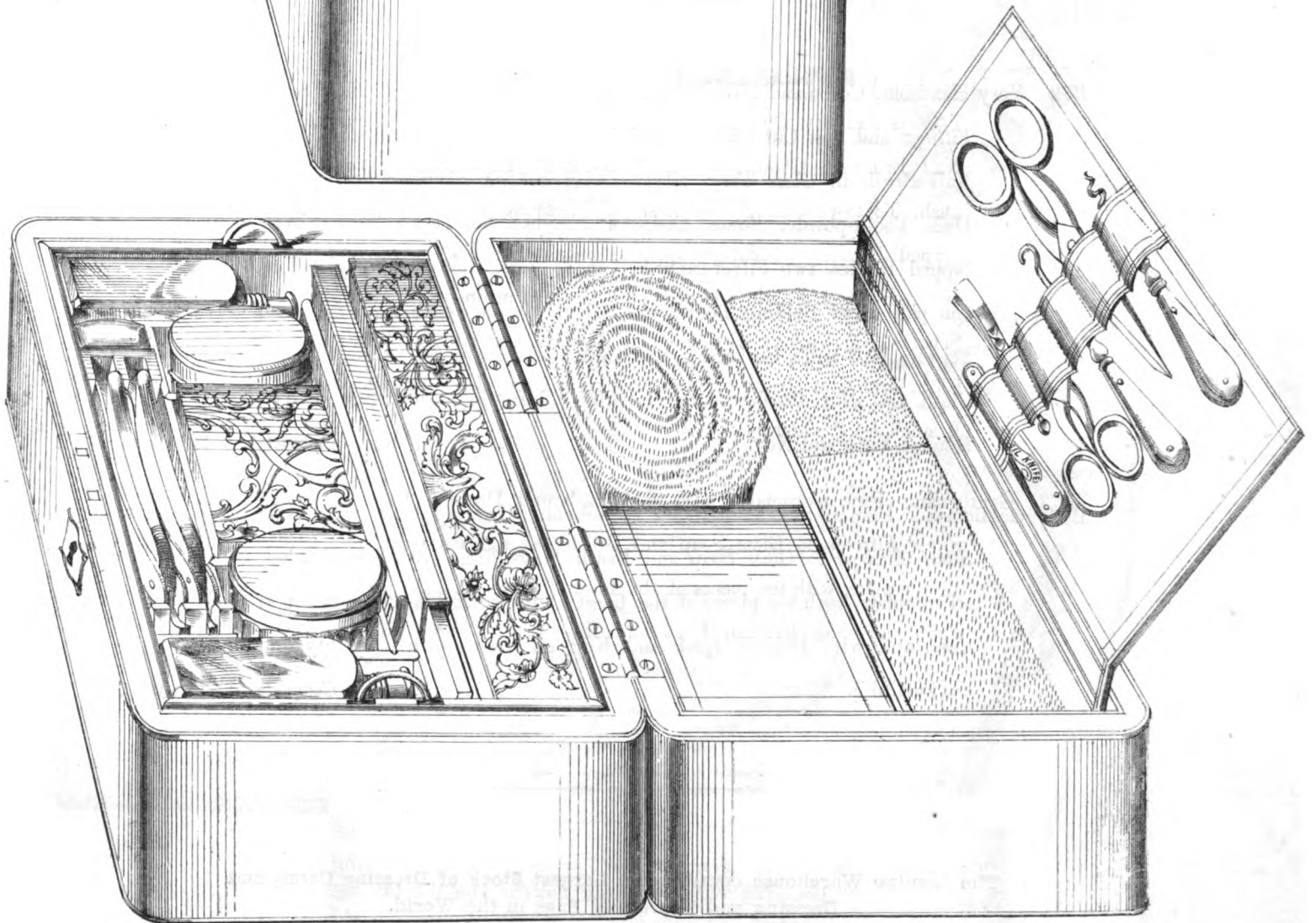
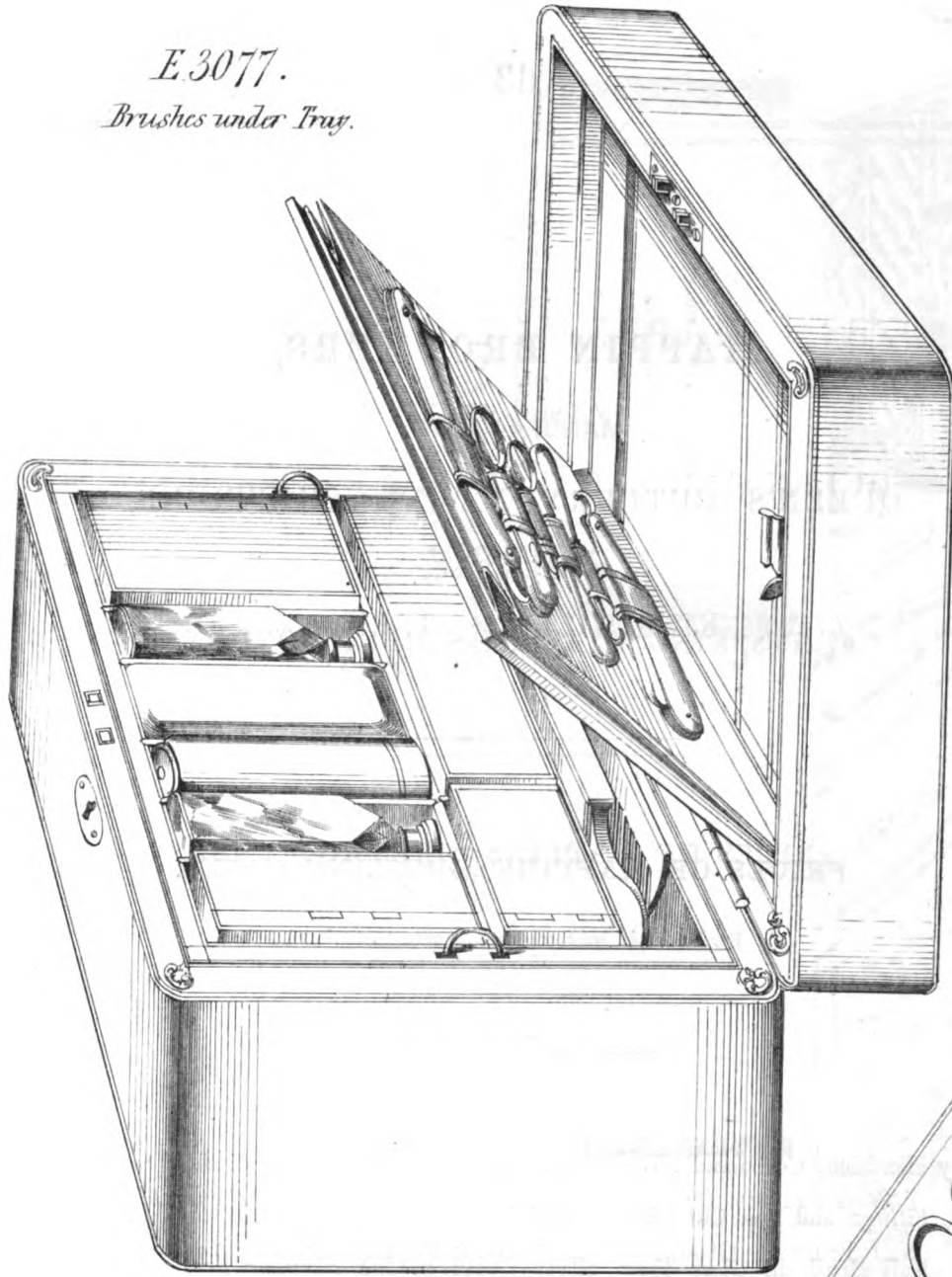

F.3404.

Looking Glass under Tray.
Drawn half real size.

Stock ready at the Warehouse!

67 & 68 KING WILLIAM STREET, CITY, LONDON.

MAPPIN BROTHERS,
MANUFACTORY,
QUEEN'S CUTLERY WORKS, SHEFFIELD,
WAREHOUSE,
67 & 68, KING WILLIAM STREET, LONDON.

PRICES OF MAPPINS' DRESSING CASES.

For Drawings, see corresponding numbers on Plate

	each.		
	£	s.	d.
B72 Very Handsome Coromandel Wood Gentleman's Dressing Case, with <i>Solid Silver Fittings</i> and best Cut Glass; containing two Tooth Brushes in Glass Tray, Nail Brush in Glass Tray, Silver Badger's Hair Shaving Brush, Soap Dish, Tooth-powder Boxes, Dish for Shaving Soap, two large Silver-capped Bottles, two Silver-capped Pomade Jars, two best Ivory Razors, one pair Steel Folding Boot-hooks, Glove Button-hook, Hair and Nail Scissors, Nail-knife, Corkscrew, and Button-hook, two best Hair Brushes, Cloth and Hat Brushes, large Looking Glass, Case lined Silk Velvet, Bramah Lock and Key Complete	22	0	0
B73 Gentleman's Fine Coromandel Wood Brass-bound Dressing Case, with <i>Solid Silver Fittings</i> to Glass Soap and Brush Trays, fitted with best Brushes, all complete, with ten pieces of the finest Cutlery, Looking Glass in top of Case, and with Bramah Lock and Key, all the very best quality and workmanship Complete	23	0	0

The London Warehouse contains the Largest Stock of Dressing Cases, and Dressing and Travelling Bags in the World.

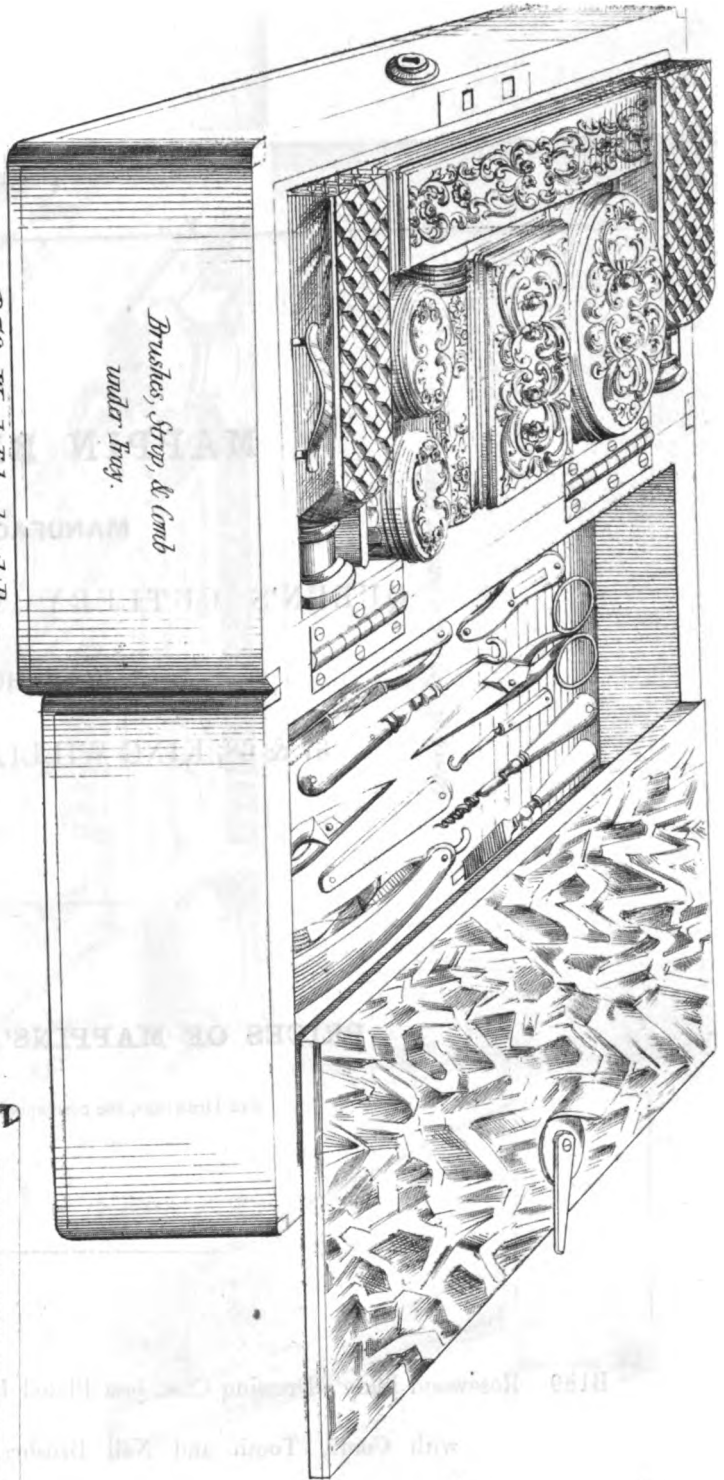

*Brushes, Strap, & Comb
under Tray.*

B 73. Wood, Edged with Brass.

JOSEPH MAPPIN AND BROTHERS.

QUEEN'S CUTLERY WORKS SHEFFIELD.

Stock ready at the Warehouse.

67 & 68 KING WILLIAM STREET, CITY, LONDON.

Drawn half real size.

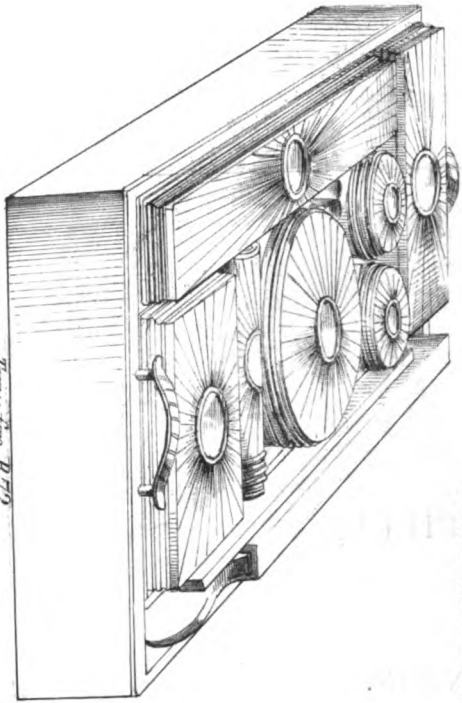

Tray for B 72.

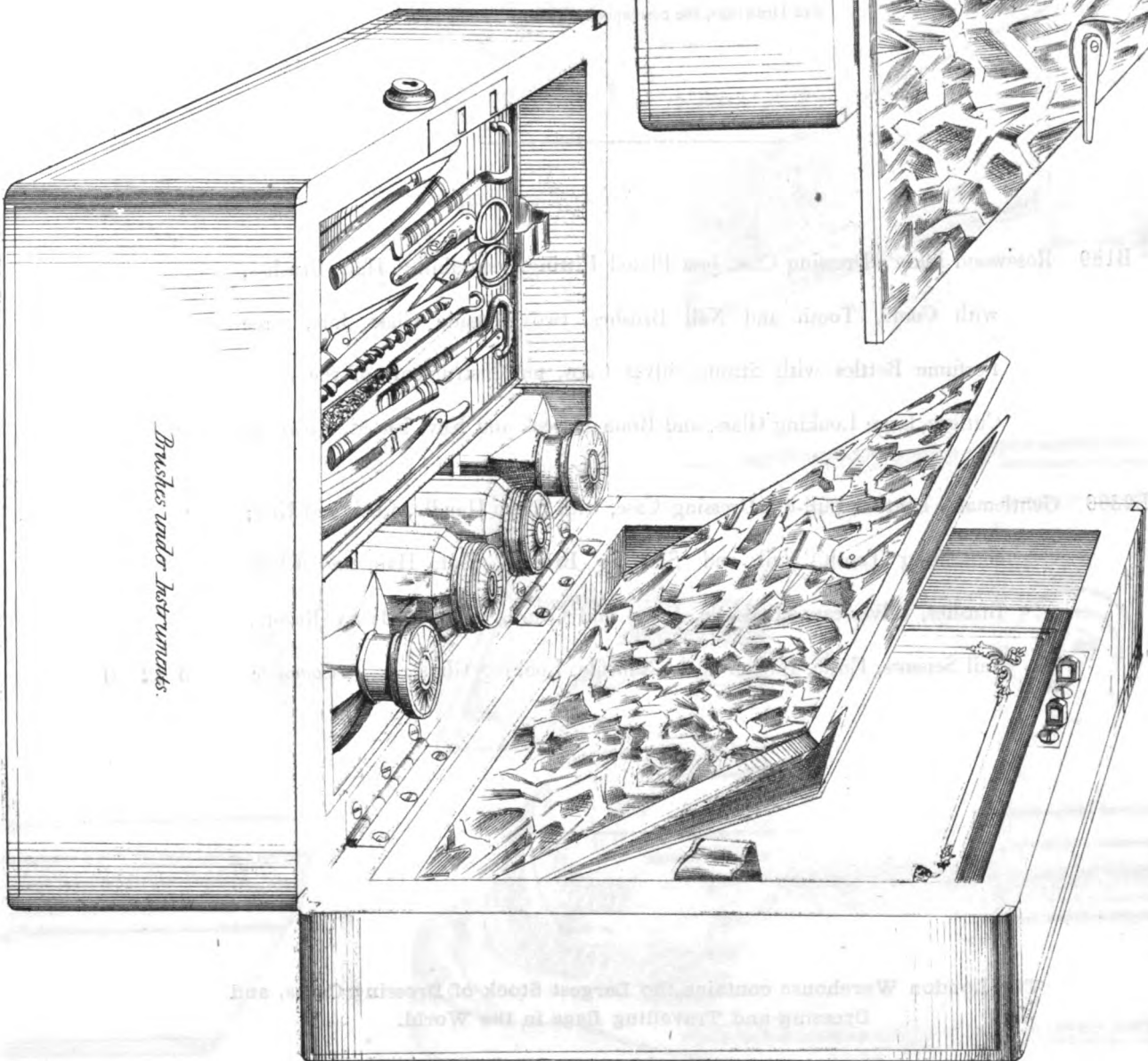

Brushes under Instruments.

B 72. Wood, Edged with Brass.

MAPPIN BROTHERS,
MANUFACTORY,
QUEEN'S CUTLERY WORKS, SHEFFIELD,
WAREHOUSE,
67 & 68, KING WILLIAM STREET, LONDON.

PRICES OF MAPPINS' DRESSING CASES.

For Drawings, see corresponding numbers on Plate.

	each.
	£ s. d.
B189 Rosewood Lady's Dressing Case, best Plated Fittings, containing Hair Brushes, with Comb, Tooth and Nail Brushes, two Pomade Glass Jars, three Perfume Bottles with Strong Silver Caps, ten Instruments of the finest Cutlery, large Looking Glass, and Bramah Lock and Key, Fitted. <i>Complete</i>	8 16 0
E2396 Gentleman's Leather pull-off Dressing Case, with Strap Handle, Lock and Key; containing Tooth, Nail and Shaving Brushes, Hat, Hair and Cloth Brushes, Silver-capped Bottle, Strop and Comb, two best Ivory Razors, Nail Scissors, Knife, Button-hook, Nail-file, Looking Glass . <i>Complete</i>	3 12 0

The London Warehouse contains the Largest Stock of Dressing Cases, and Dressing and Travelling Bags in the World.

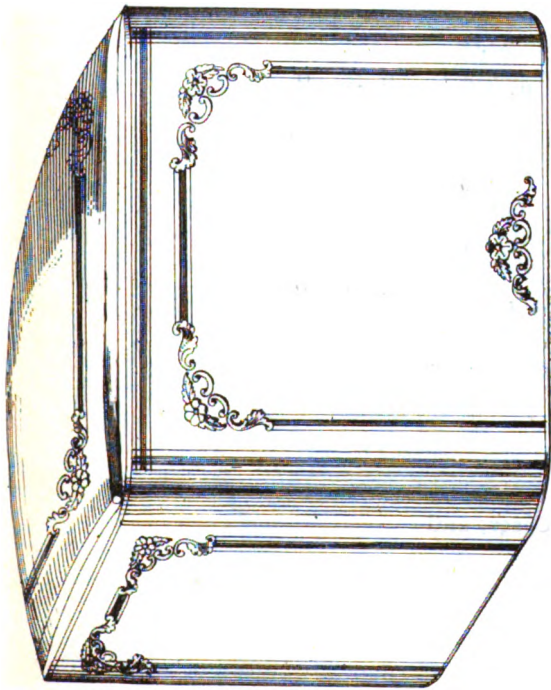

F 2396 Ltd.

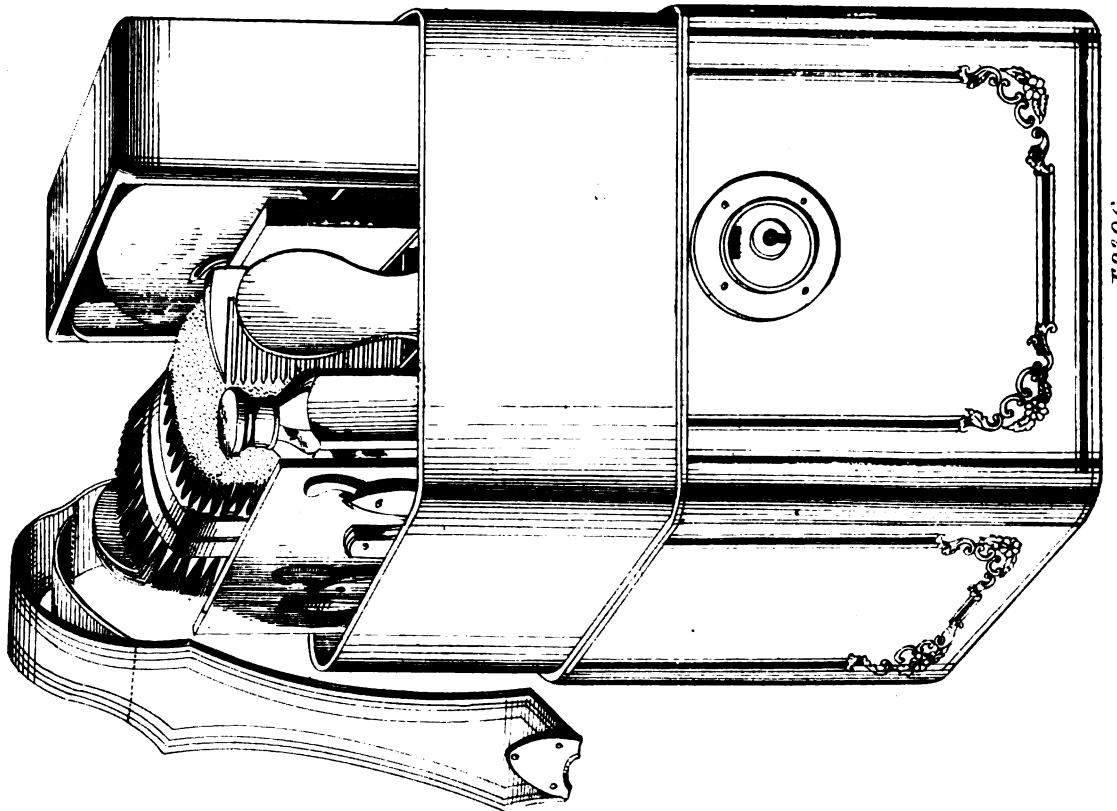

F 2396.

JOSEPH MAPPIN AND BROTHERS.
 QUEEN'S CUTLERY WORKS SHEFFIELD,
Stock ready at the Warehouse,
 67. & 68, KING WILLIAM STREET, LONDON.

Drawn half real size.

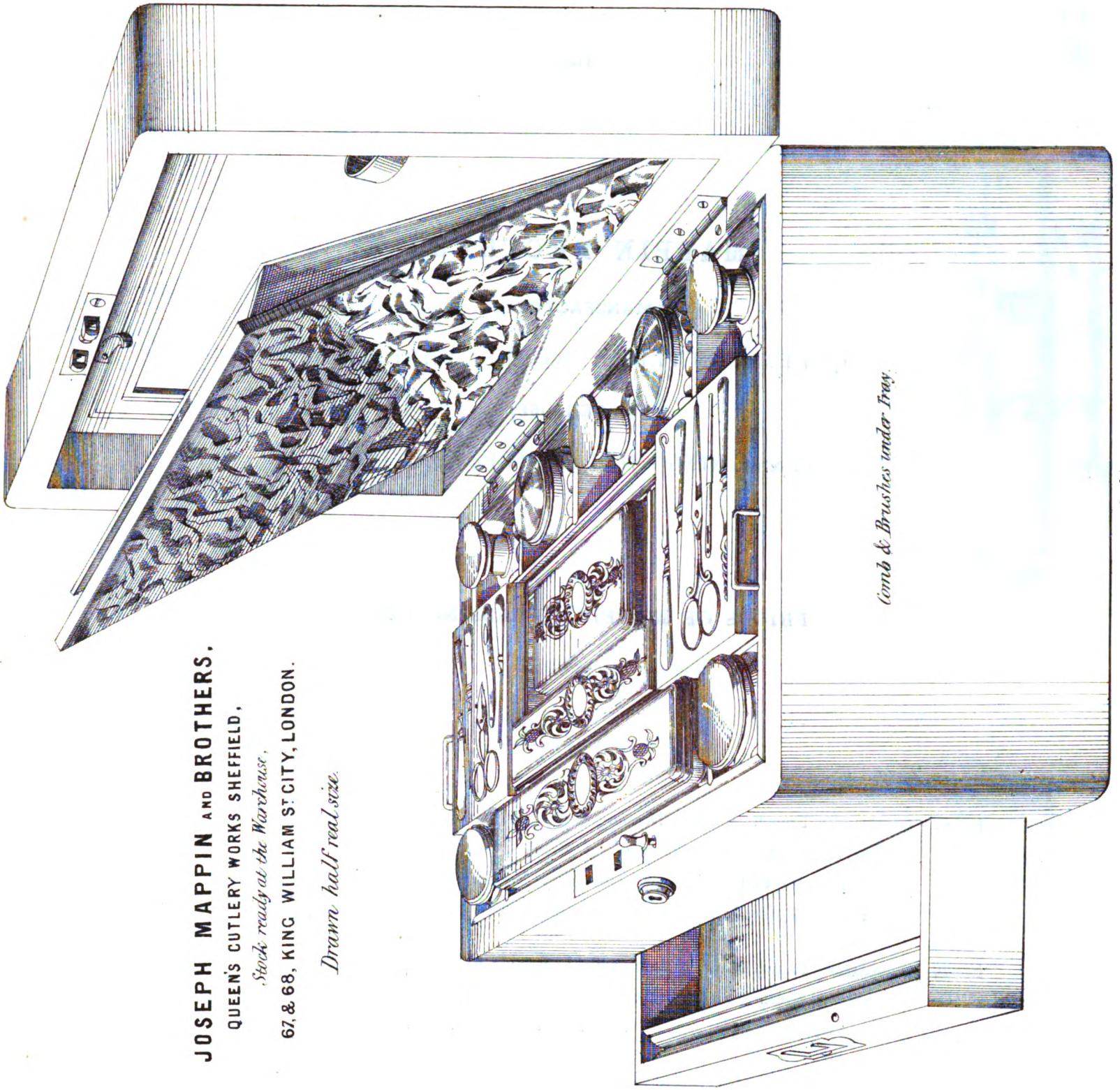

Comb & Brushes under Tray.

*B 189.
 Wood.*

MAPPIN BROTHERS,
MANUFACTORY,
QUEEN'S CUTLERY WORKS, SHEFFIELD,
WAREHOUSE,
67 & 68, KING WILLIAM STREET, LONDON.

PRICES OF MAPPINS' DRESSING CASES.

For Drawings, see corresponding numbers on Plate.

	each.
	£ s. d.
E2589 Gentleman's French Morocco Dressing Case, with Lock and Key, lined Silk-velvet; containing complete set of Brushes, Silver-capped Bottle, Glass Boxes with Plated Tops, two best Ivory Razors, Nail and Hair Scissors, Knife and other Instruments, with Looking-glass <i>Complete</i>	3 15 0
E3520 Gentleman's French Morocco Case, with Lock and Key; containing complete sets of Brushes, Strop and Comb, Silver-capped Bottles, two best Razors and other Cutlery <i>Complete</i>	2 12 0
B183 Lady's Morocco or Russia Dressing Case, Lock and Key, lined Silk-velvet; fitted with best Cut Glass Fittings, with best Plated Tops, Screw Tooth-powder Box, two Silver-capped Perfume Bottles, Set of Brushes, complete with Comb, Looking Glass in top, fitted with finest Pearl Handle Cutlery, with outside cover for Travelling <i>Complete</i>	6 15 0
B184 Lady's French Morocco Dressing Case, with Lock and Key, best Plated Fittings, and Silver-capped Bottle, Sets of Brushes, complete with Comb, Jewel Tray, lined Silk Velvet, large Looking Glass, and fitted with best Pearl Handle Cutlery <i>Complete</i>	4 6 0

The London Warehouse contains the Largest Stock of Dressing Cases, and Dressing and Travelling Bags in the World.

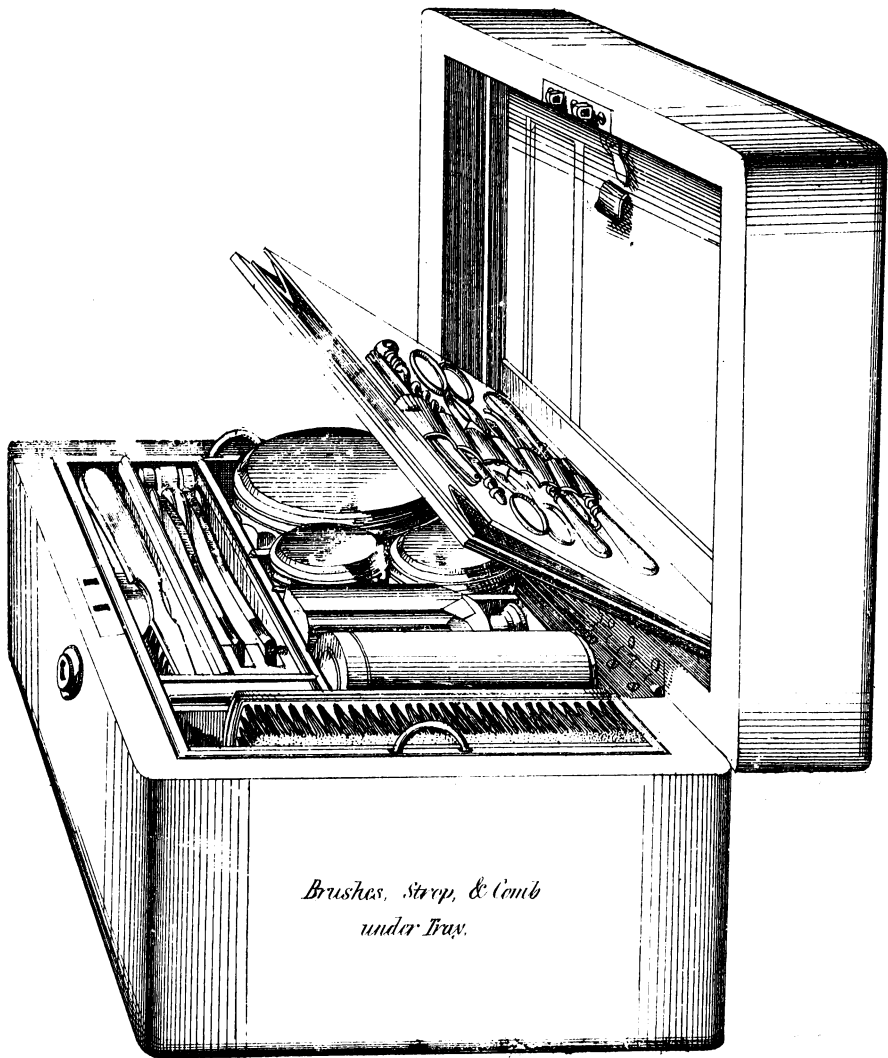

E2589.

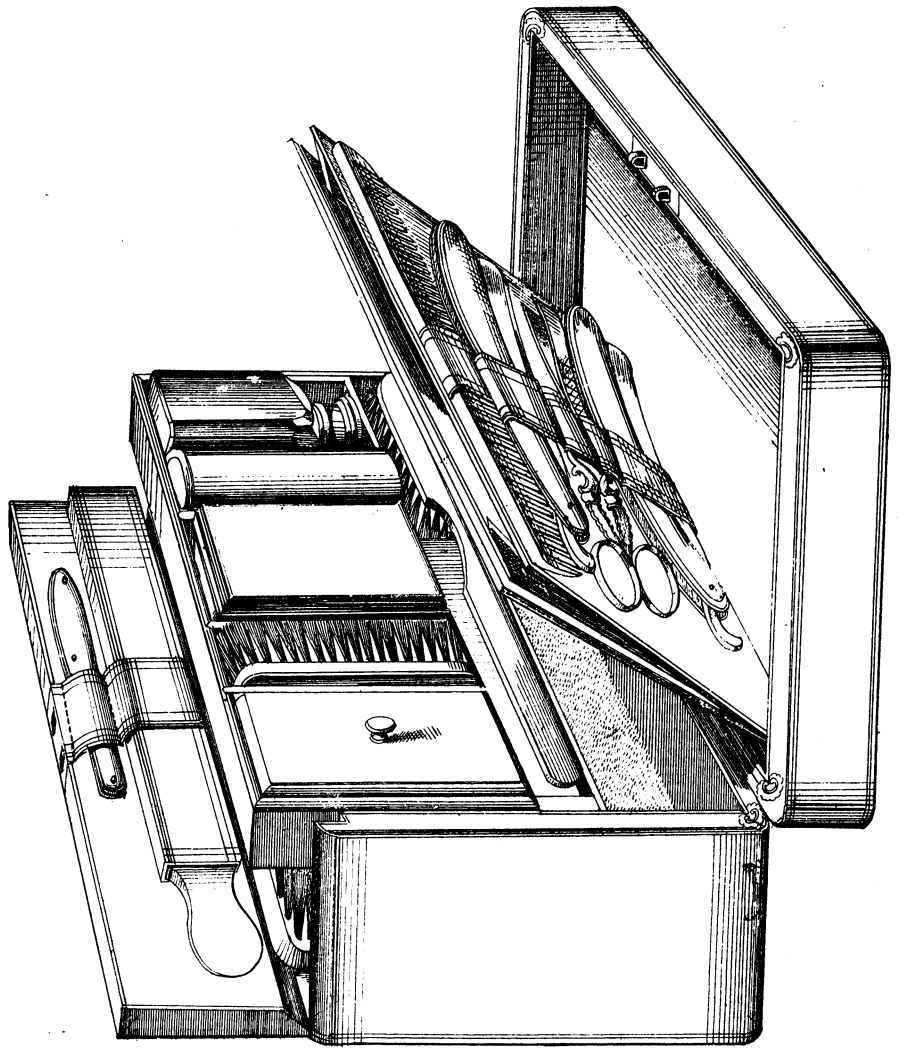

E3520.

JOSEPH MAPPIN AND BROTHERS.
 QUEEN'S CUTLERY WORKS SHEFFIELD,
Stocks ready at the Warehouse.
 61 & 63 KING WILLIAM STREET CITY, LONDON.

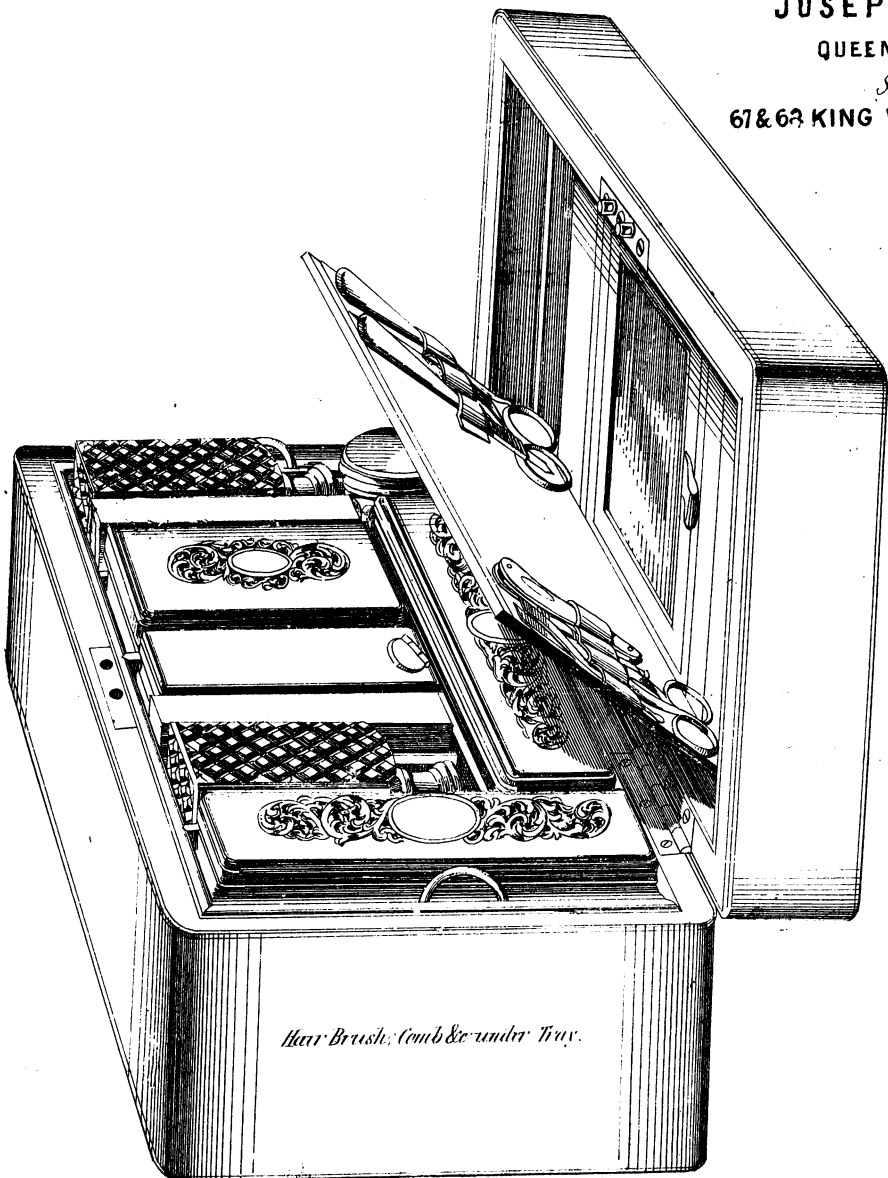

B183.

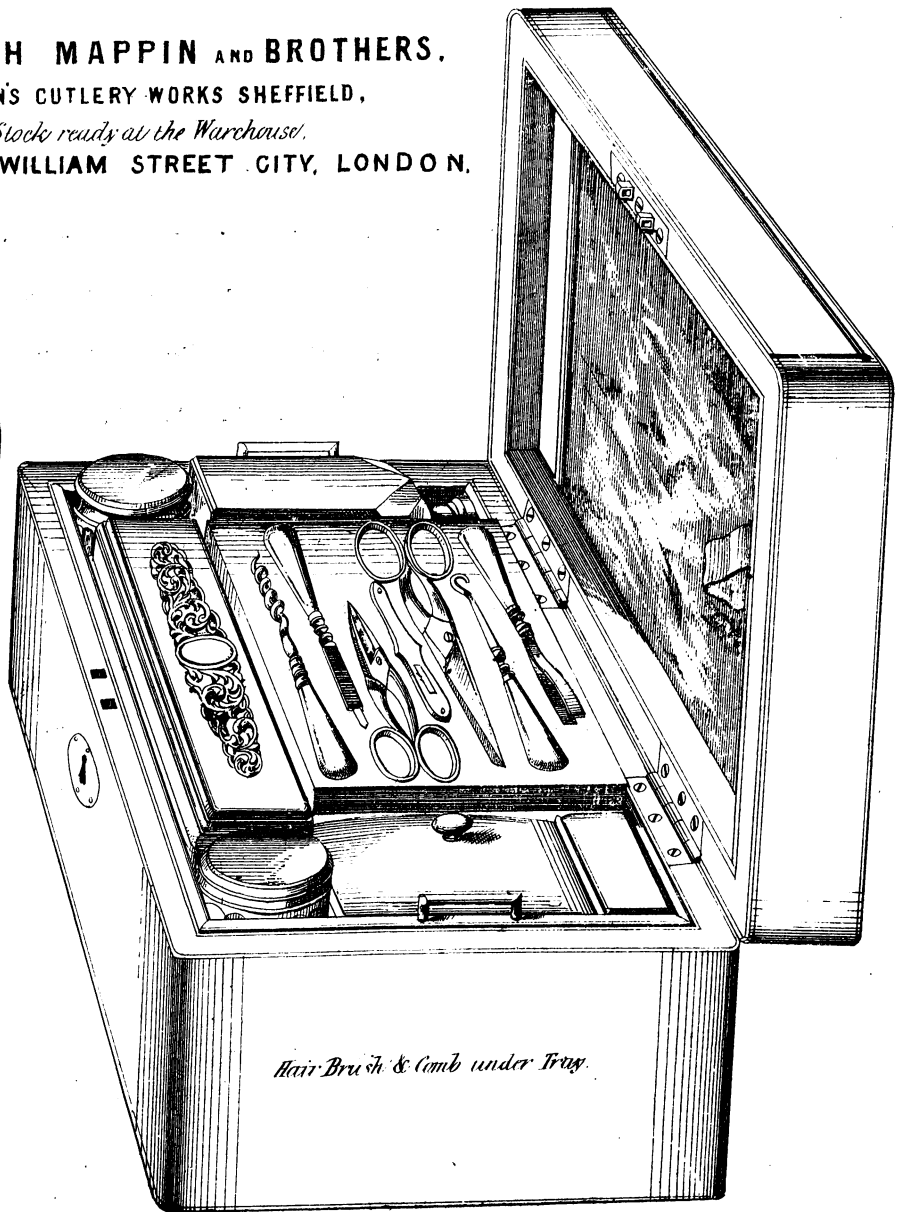

B.184.

Drawn half real size.

MAPPIN BROTHERS,
MANUFACTORY,
QUEEN'S CUTLERY WORKS, SHEFFIELD,
WAREHOUSE,
67 & 68, KING WILLIAM STREET, LONDON.

PRICES OF MAPPINS' DRESSING CASES.

For Drawings, see corresponding numbers on Plate.

	each.
	£ s. d.
E2408 Gentleman's Roan Leather Dressing Case, with Lock and Key; containing Hat Brush, Tooth, Nail and Shaving Brushes, Metal Soap Box, Strop and Comb, two best Ivory Razors and other Cutlery, with Looking Glass <i>Complete</i>	1 14 0
B187 Gentleman's Russia or Morocco Dressing Roll, fitted with Silver-capped Bottle and the finest Cutlery, Tooth, Nail and Shaving Brushes . . . <i>Complete</i>	2 10 0
B93 Lady's Coromandel Wood Dressing Case, with <i>Solid Silver</i> mounted Fittings to Glass Jars and Boxes; fitted with complete sets of Brushes and Comb, Jewel Tray and eight Instruments of the finest Cutlery, large Looking Glass <i>Complete</i>	12 0 0

The London Warehouse contains the Largest Stock of Dressing Cases, and Dressing and Travelling Bags in the World.

JOSEPH MAPPIN AND BROTHERS,
QUEEN'S CUTLERY WORKS SHEFFIELD,

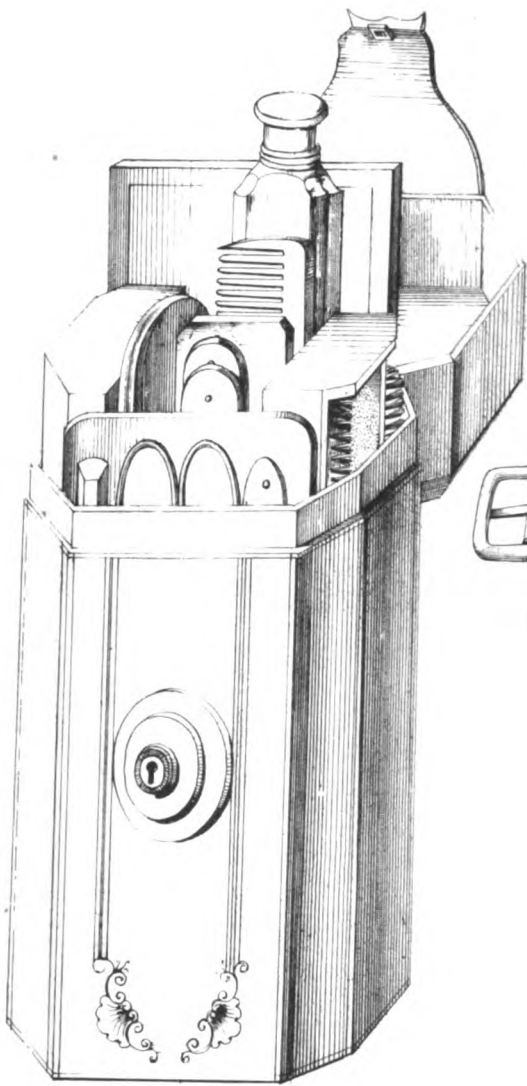

E2408.

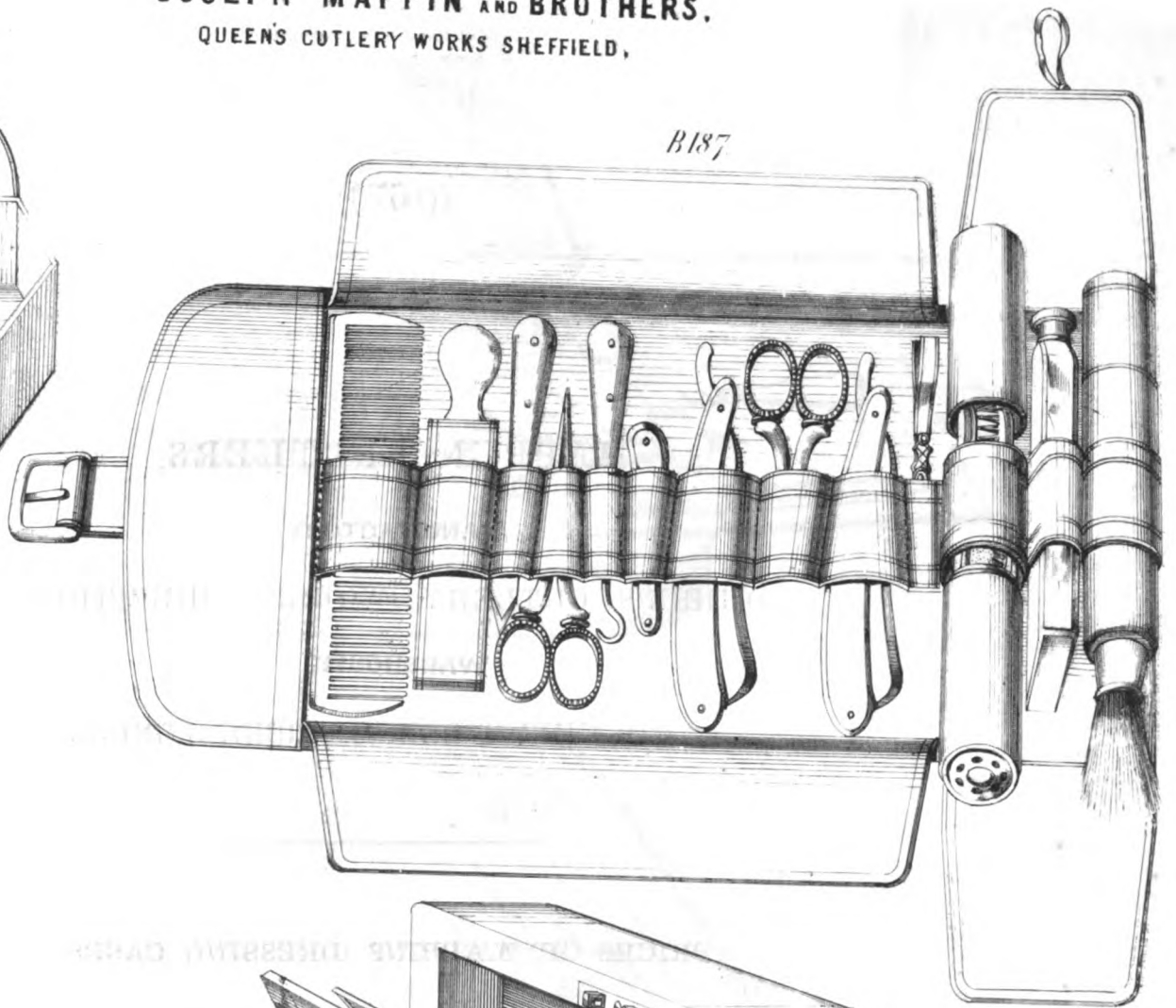

B187

B93.
Wood.

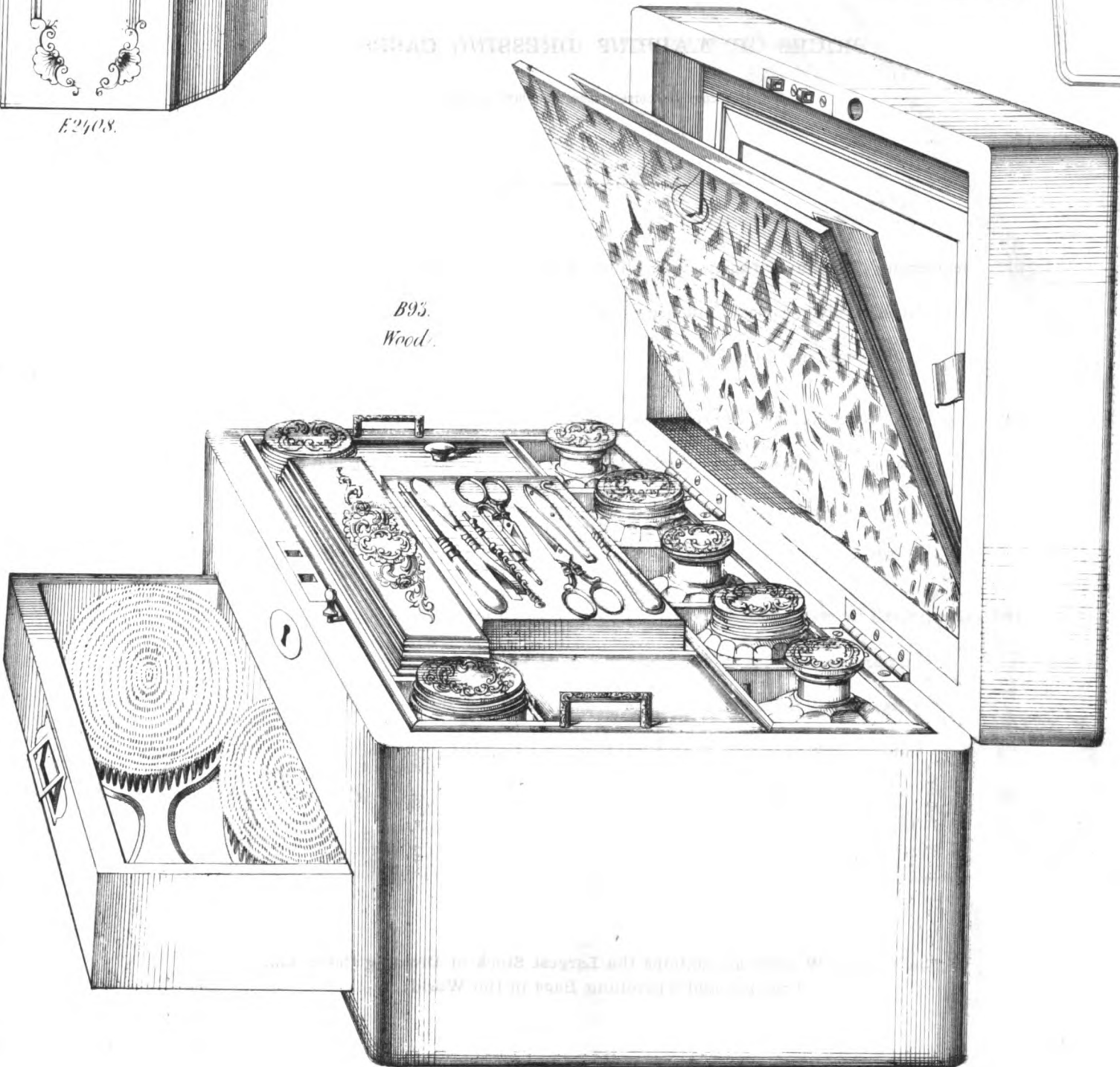

Stock ready at the Warehouse
97 & 98, KING WILLIAM ST CITY, LONDON.
Drawn half real size.

MAPPIN BROTHERS,
MANUFACTORY,
QUEEN'S CUTLERY WORKS, SHEFFIELD,
WAREHOUSE,
67 & 68, KING WILLIAM STREET, LONDON.

PRICES OF MAPPINS' DRESSING CASES.

For Drawings, see corresponding numbers on Plate.

	each.
	£ s. d.
E2432 Gentleman's Maroon Dressing Case, fitted with Tooth, Nail and Shaving Brushes, Silver-capped Bottle and Comb, Looking Glass in top, Nail-file, Nail-scissors, and Button-hook <i>Complete</i>	1 3 0
B185 Lady's Morocco Silk-lined Dressing Case, with Lock and Key, best Silver Plated Fittings to Glass Trays, containing set of Brushes and Comb, Jewel Drawer, Silver-capped Bottle, Hair and Nail-scissors, Pearl Pen-knife and Button-hook, Looking Glass <i>Complete</i>	4 0 0
B186 Gentleman's Russia Leather Dressing Case, lined Silk Velvet, and with best Plated Fittings to fine Cut Glass Trays, complete sets of best Brushes, large Silver-capped Bottle, Strop and Comb, fitted with nine Instruments of best Cutlery, large Looking Glass and Bramah Lock, with outside Leather Cover for Travelling <i>Complete</i>	9 0 0

The London Warehouse contains the Largest Stock of Dressing Cases, and Dressing and Travelling Bags in the World.

JOSEPH MAPPIN AND BROTHERS.
QUEEN'S CUTLERY WORKS SHEFFIELD.

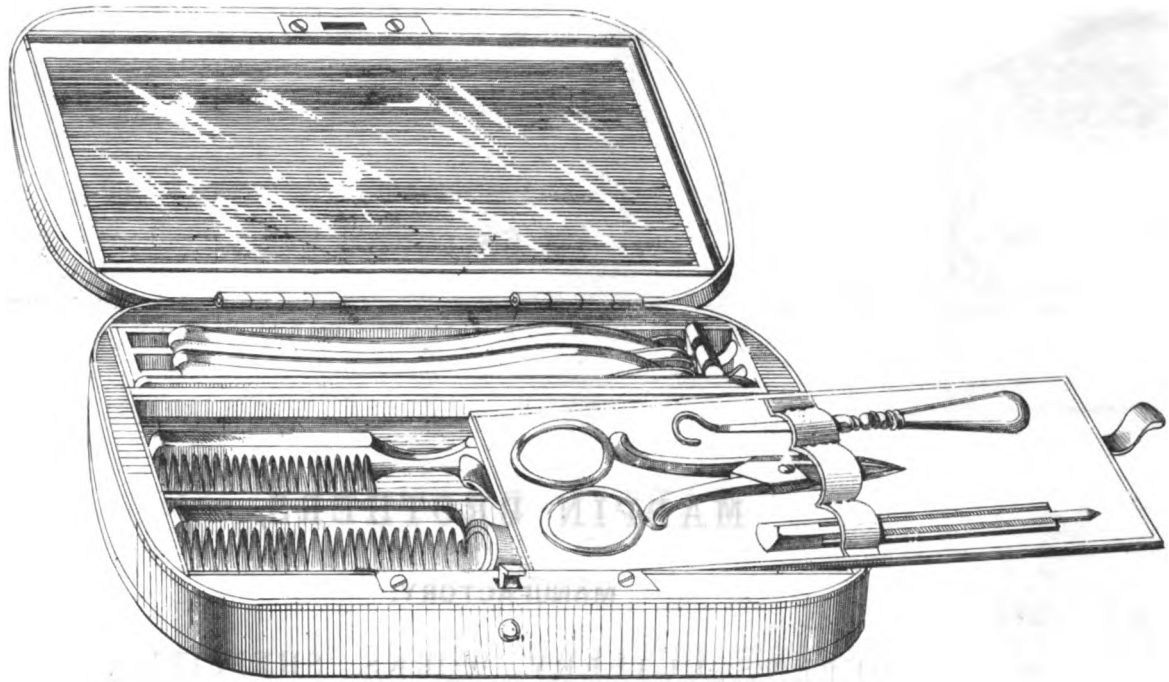

E2132.

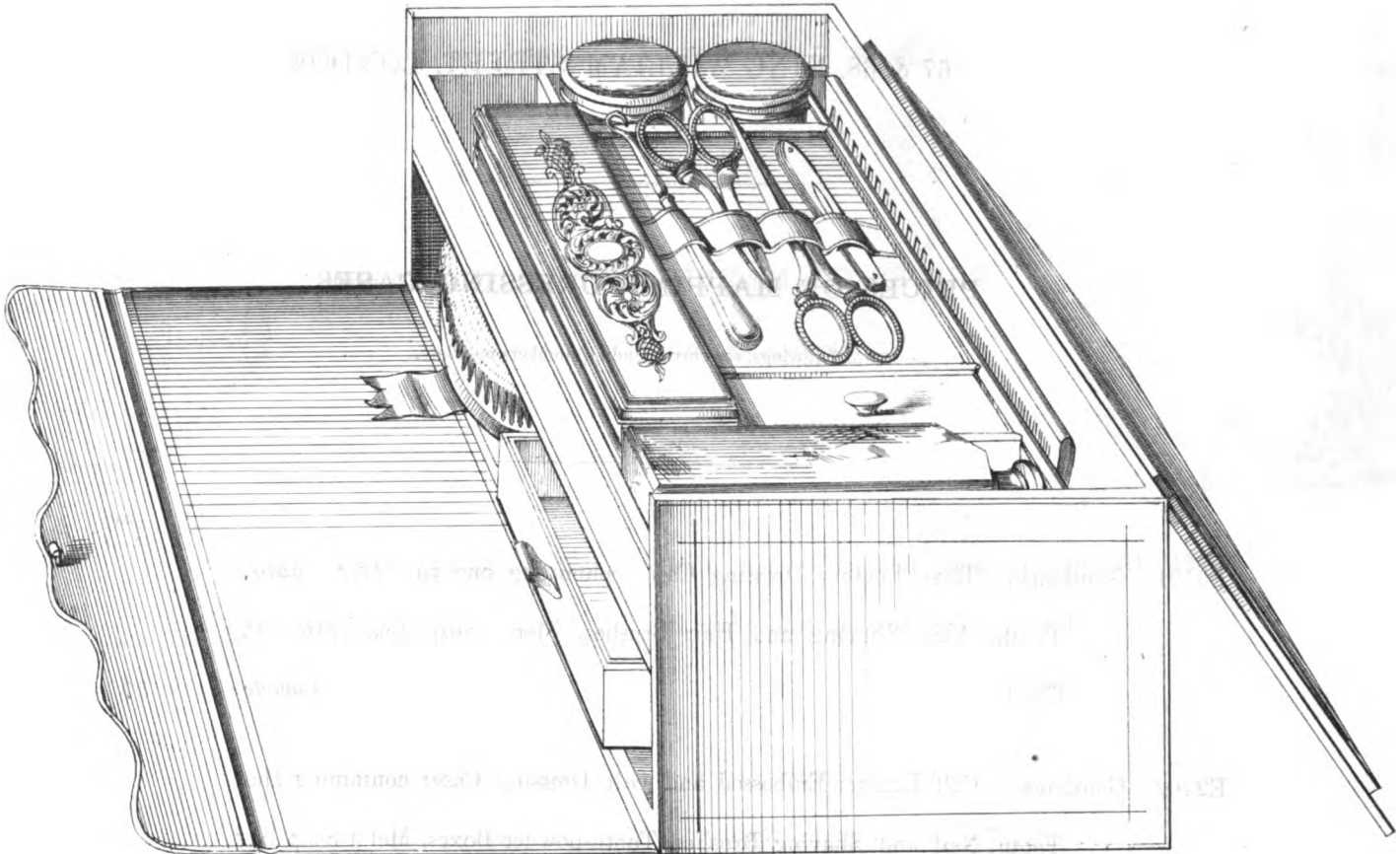

B 185.

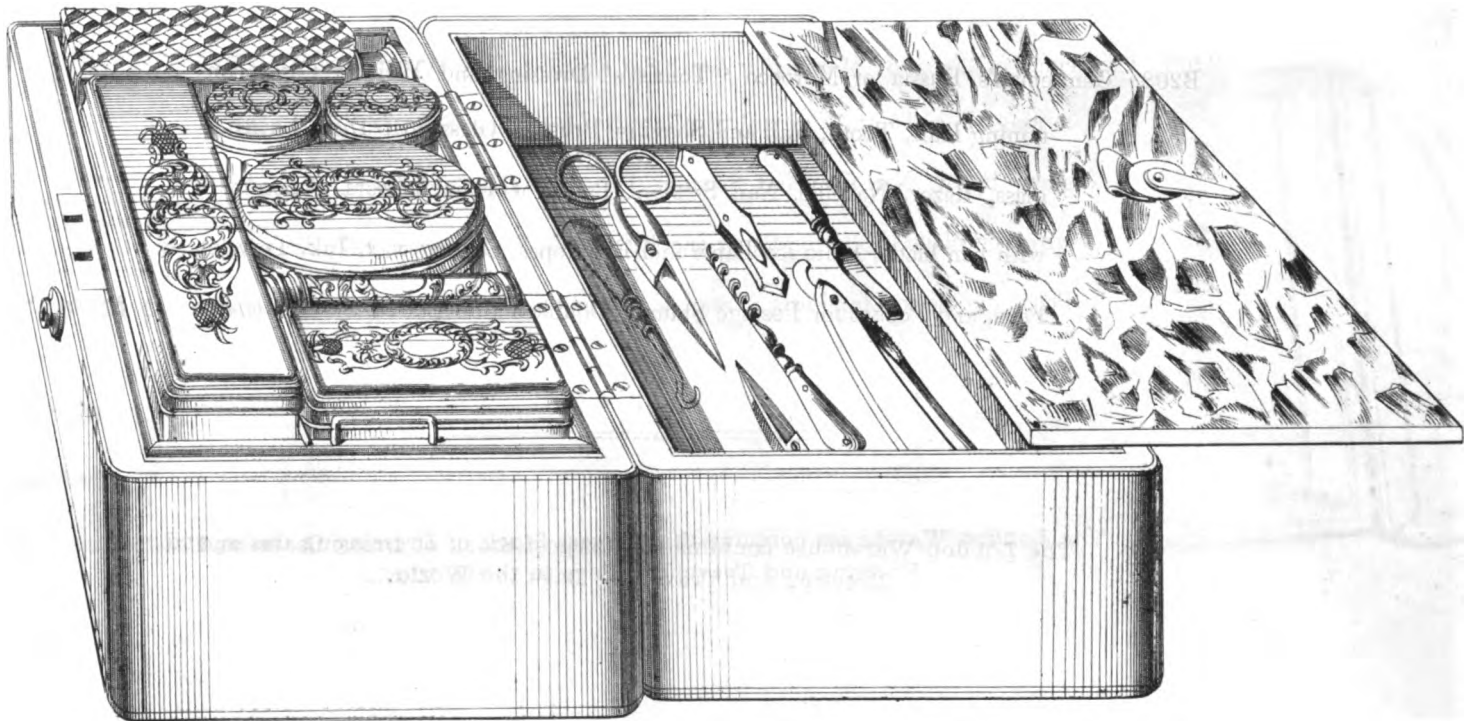

B 186.

Brushes, Strap & Comb under Tray.

Stock ready at the Warehouse.
67 & 68, KING WILLIAM ST CITY, LONDON.

MAPPIN BROTHERS,
MANUFACTORY,
QUEEN'S CUTLERY WORKS, SHEFFIELD,
WAREHOUSE,
67 & 68, KING WILLIAM STREET, LONDON.

PRICES OF MAPPINS' DRESSING CASES.

For Drawings, see corresponding numbers on Plate.

		each.
		£ s. d.
E3521	Gentleman's Roan Leather Dressing Case; containing one pair Ivory Razors, Tooth, Nail, Shaving and Hair Brushes, Metal Soap Box, Strop and Comb <i>Complete</i>	0 17 0
E2267	Gentleman's Calf Leather Embossed and Gilt Dressing Case; containing Hair, Tooth, Nail and Shaving Brushes, Tooth-powder Boxes, Metal Soap Box, two best Ivory Razors, Strop and Comb <i>Complete</i>	1 2 0
B208	Gentleman's Russia or Morocco "Tourist's" Dressing and Writing Case; containing Hair, Tooth, Nail and Shaving Brushes, Glass Soap Dish, Looking-glass, Razor, Nail-file, Nail Scissors, Paper or Hair Scissors, Paper-knife with pen blade, Folio for Paper and Envelopes, Scaling-wax, Ink, Tray for Pens, and Pocket for Postage Stamps, Double-action Lock <i>Complete</i>	3 12 0

The London Warehouse contains the Largest Stock of Dressing Cases, and Dressing and Travelling Bags in the World.

JOSEPH MAPPIN AND BROTHERS.
 QUEEN'S CUTLERY WORKS SHEFFIELD.

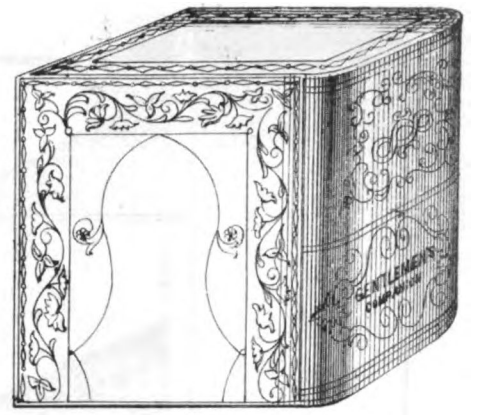
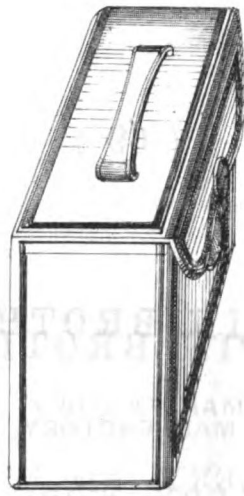
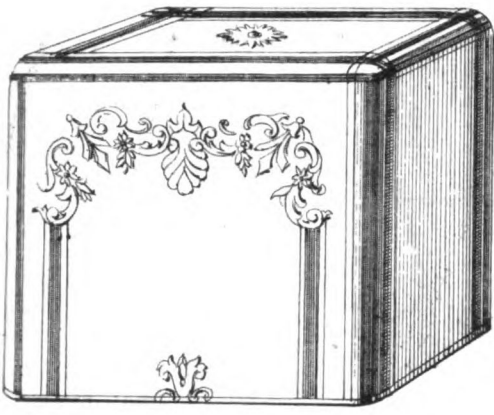

B208 when shut.
1/4 Size

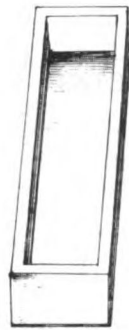
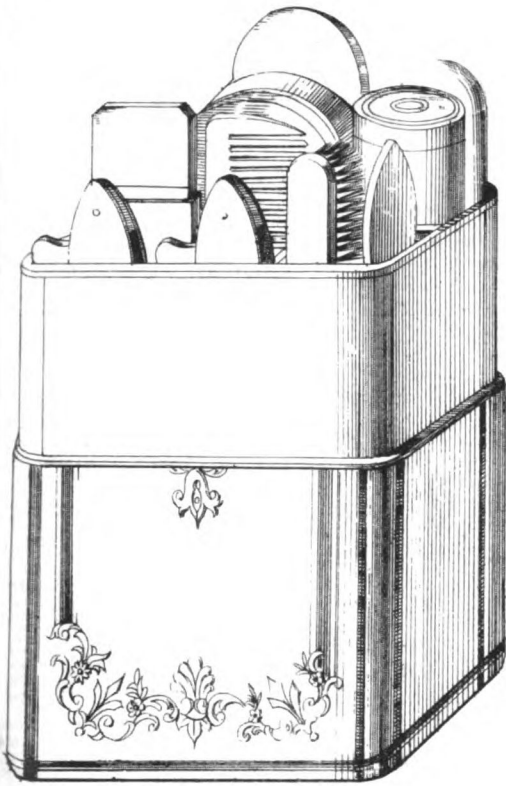

Tray for B208.

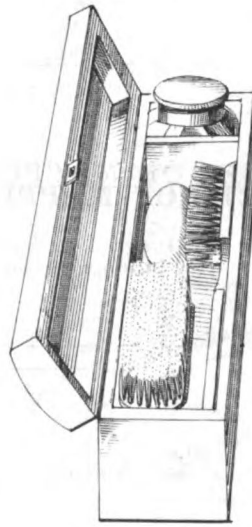

Tray for B208.

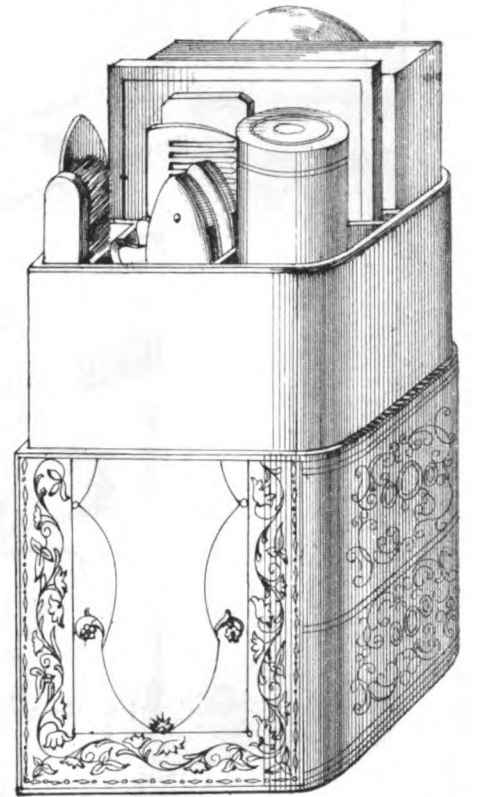

E 2267

E 3571

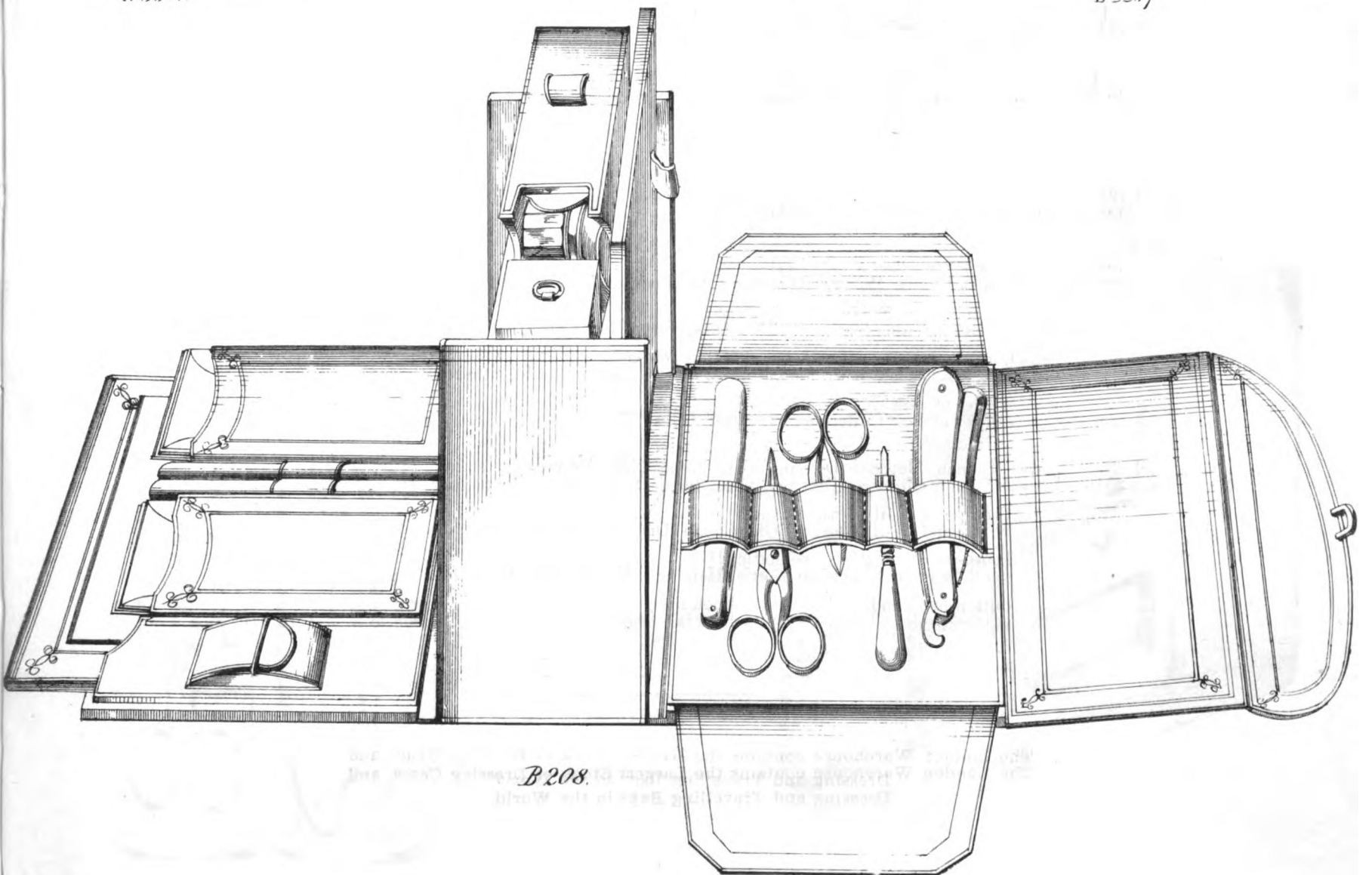

B 208.

MAPPIN BROTHERS,
MANUFACTORY,
QUEEN'S CUTLERY WORKS, SHEFFIELD,
WAREHOUSE,
67 & 68, KING WILLIAM STREET, LONDON.

PRICES OF MAPPINS' DRESSING CASES.

For Drawings, see corresponding numbers on Plate.

	each.
	£ s. d.
E3310 Gentleman's Roan Leather Toilette Instrument Case, with six articles best Cutlery <i>Complete</i>	0 9 6
E1411 Ditto ditto with five Instruments best Cutlery <i>Complete</i>	0 11 0
E1806 Ditto ditto, with nine Instruments best finished Cutlery, with Hinges at back	1 2 0
E1806r Ditto as above, but Russia Leather	1 8 0
E3025 Gentleman's French Morocco Dressing Case, Lock and Key, lined Silk Velvet, containing complete sets of Brushes, Strop and Comb, Glass Soap and Pomade Dishes, with Plated Tops, Silver-capped Bottle, fitted with six articles of best Cutlery and Looking Glass <i>Complete</i>	4 0 0
E2316 Lady's French Morocco Dressing Case, lined Silk Velvet, containing Hair, Tooth and Nail Brushes, Glass Soap Dish with Plated Top, ditto for Tooth-powder, Silver-cap Bottle, Hair and Nail-scissors, Pearl Pen-knife, Button-hook and Nail-file, with Looking Glass <i>Complete</i>	2 16 0

The London Warehouse contains the Largest Stock of Dressing Cases, and
Dressing and Travelling Bags in the World.

QUEENS CUTLERY WORKS SHEFFIELD.

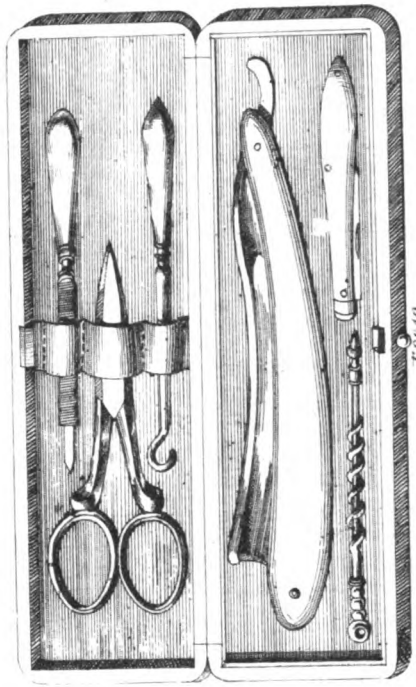

E.5510

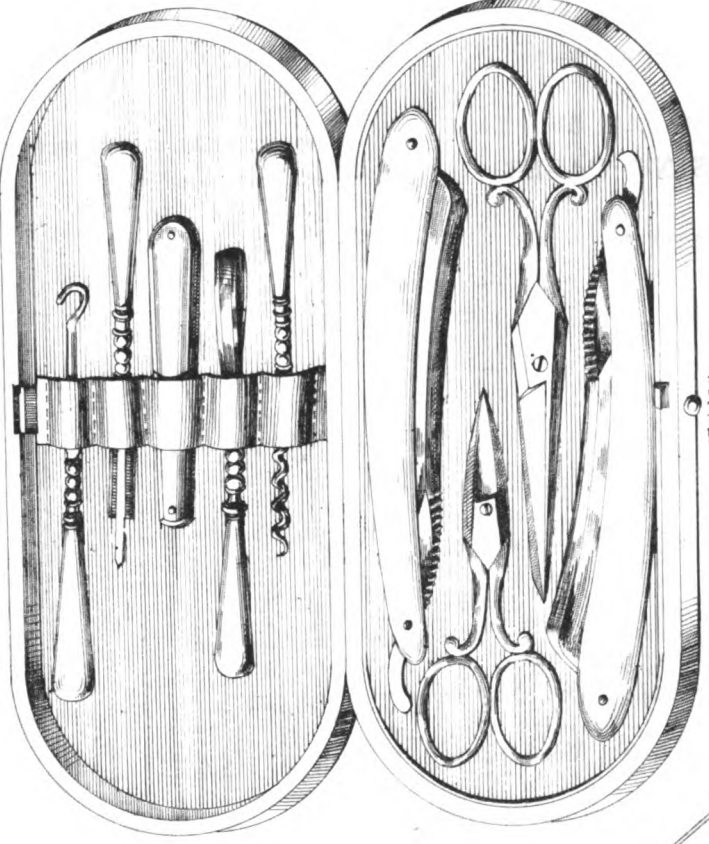

E.1806

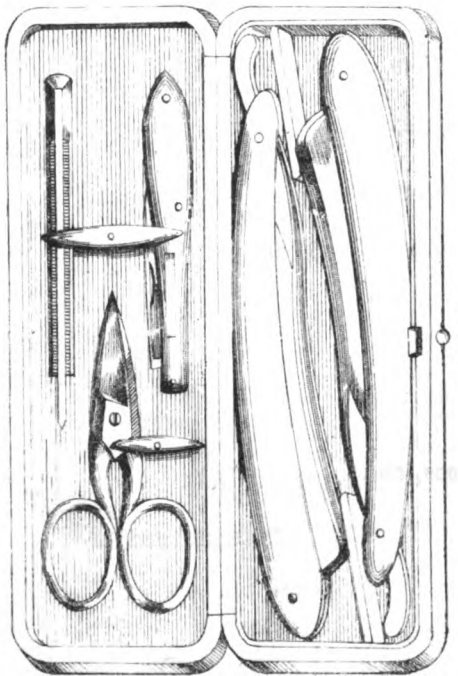

E.111.

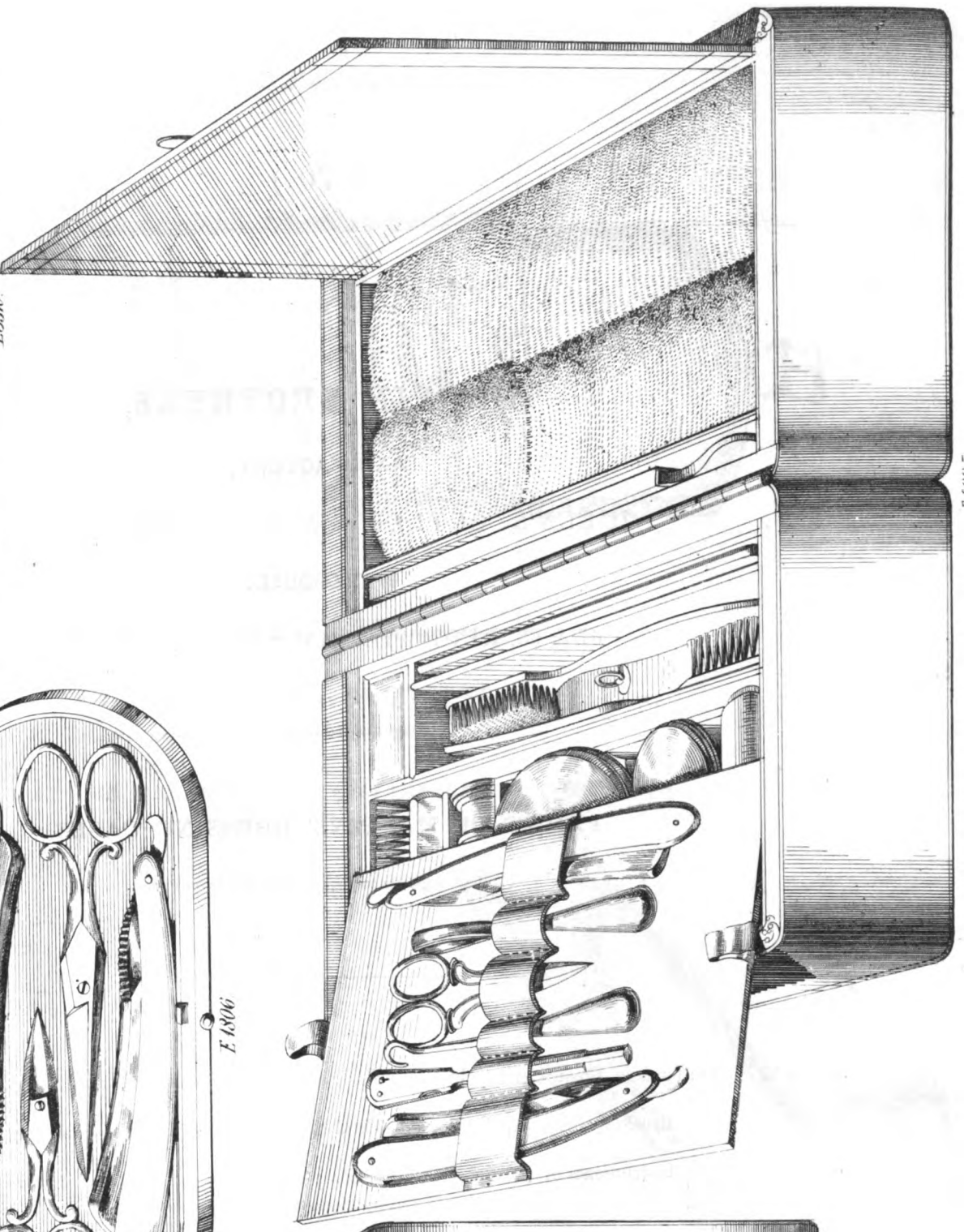

E.2025

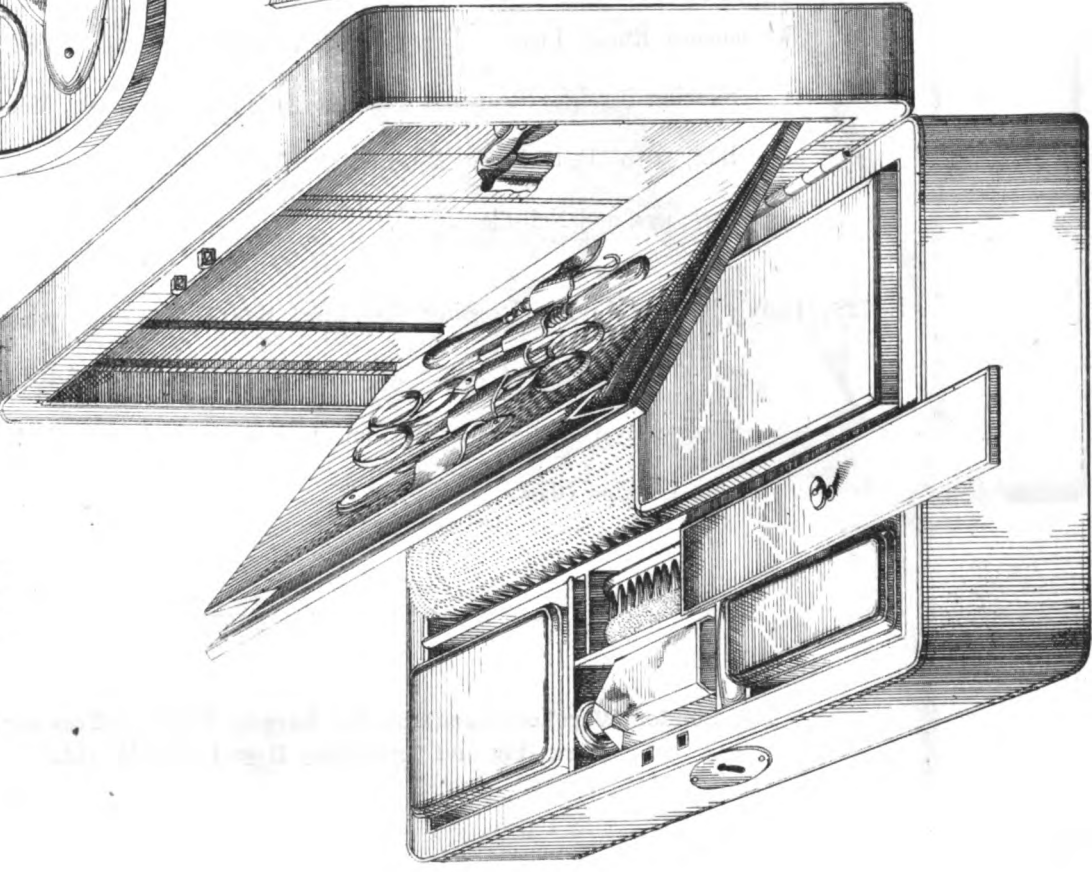

E.2516

Stock ready at the Warehouse.
67 & 68 KING WILLIAM STREET, CITY, LONDON
Drawn half real size.

MAPPIN BROTHERS,
MANUFACTORY,
QUEEN'S CUTLERY WORKS, SHEFFIELD,
WAREHOUSE,
67 & 68, KING WILLIAM STREET, LONDON.

PRICES OF MAPPINS' DRESSING CASES.

For Drawings, see corresponding numbers on Plate

		each.
		£ s. d.
E3526	Gentleman's Roan Leather Dressing Roll, containing Tooth, Nail and Shaving Brushes, Silver-cap Bottle, and Metal Soap Box, with Looking Glass, eight Instruments of the finest Cutlery, Strop and Comb <i>Complete</i>	2 0 0
E3119	Gentleman's Russia Leather Dressing Case, containing Hair, Tooth, Nail and Shaving Brushes, Strop and Comb, large Silver-cap Bottle, Metal Shaving Box, two best Ivory Razors, Pen-knife, Nail-scissors, Button-hook, Tweezers, and Nail-file <i>Complete</i>	1 18 0
E3528	Lady's French Morocco Dressing Case, lined Silk Velvet, fitted with complete set of Brushes and Comb, Cut Glass Trays, with best Plated Tops, two Silver-capped Bottles, five Instruments of finest Cutlery, with Jewel Tray, large Looking Glass <i>Complete</i>	5 0 0

The London Warehouse contains the Largest Stock of Dressing Cases, and Dressing and Travelling Bags in the World.

Drawn one third size.

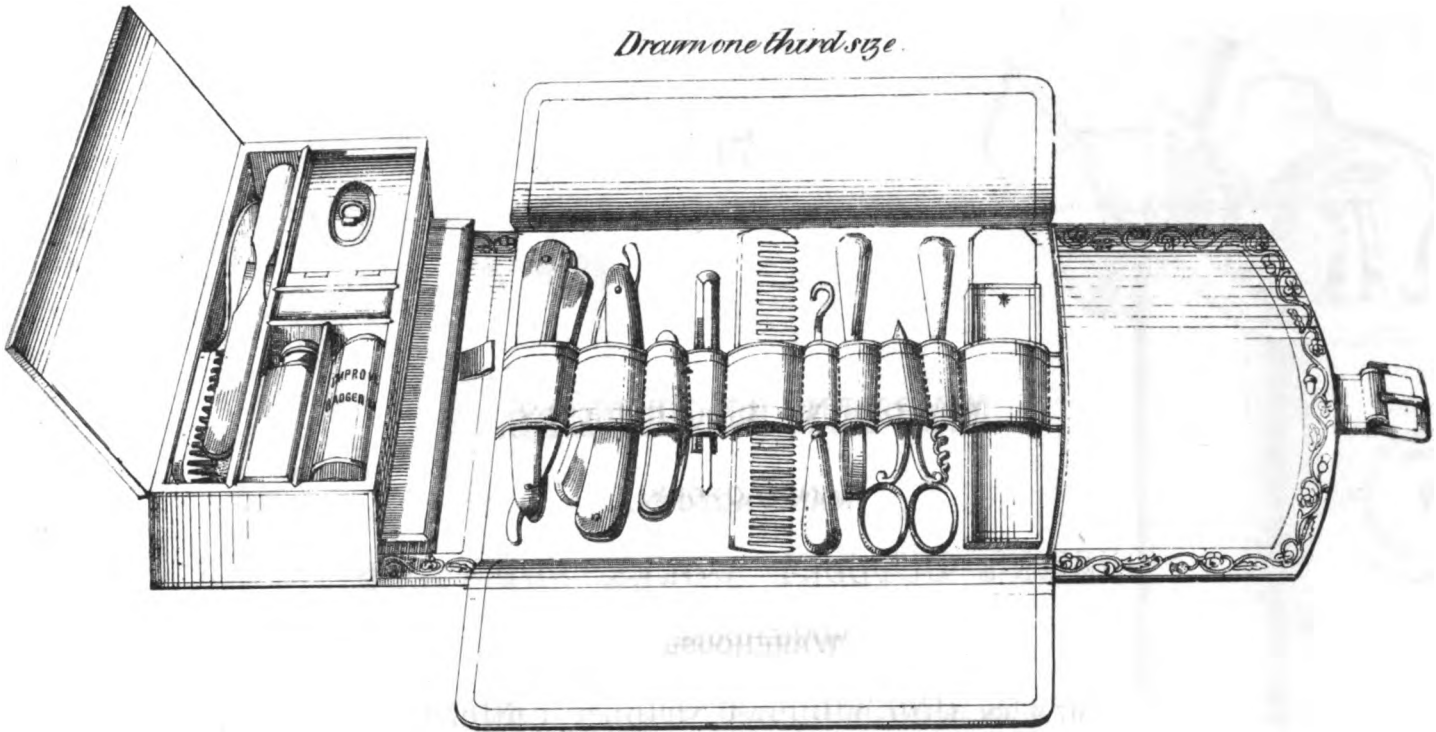

E 3526

JOSEPH MAPPIN AND BROTHERS.
QUEEN'S CUTLERY WORKS SHEFFIELD.

Stock ready at the Warehouse
67 & 68, KING WILLIAM ST. CITY, LONDON.

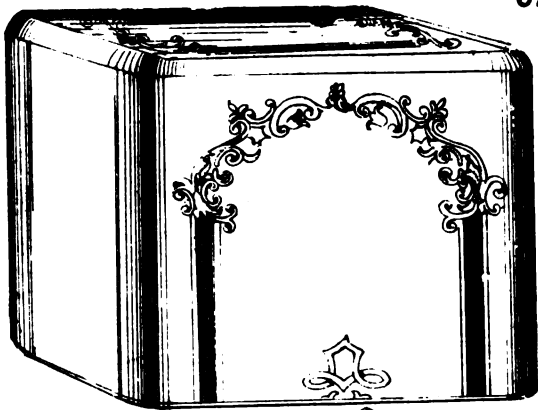

E 3119

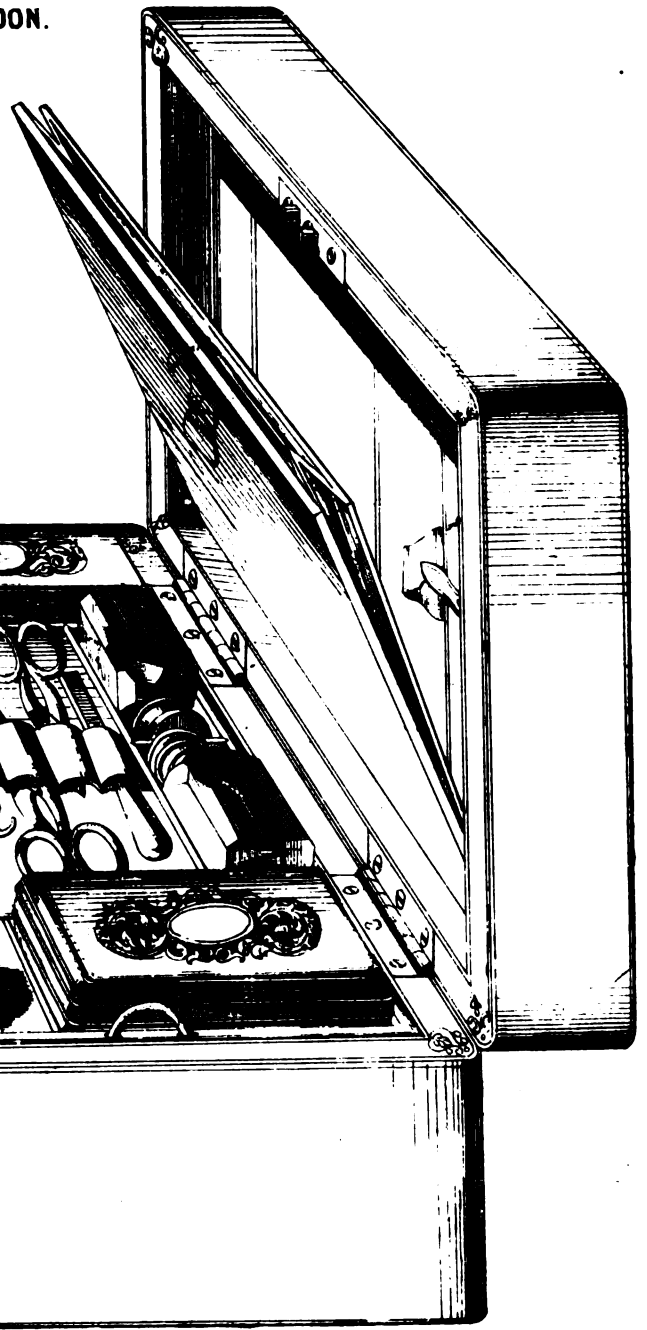
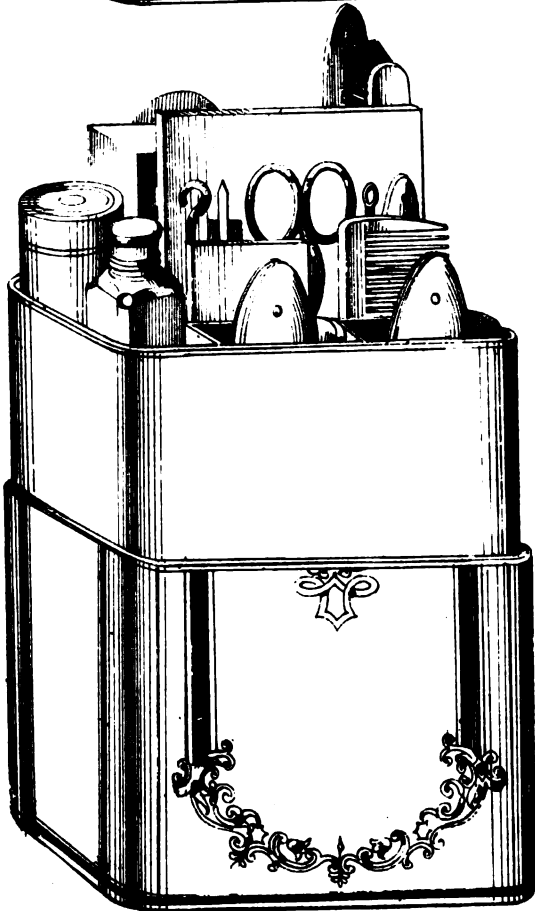

E 3528.

2 Hair Brushes & Comb round Box.

Drawn half real size.

MAPPIN BROTHERS,
MANUFACTORY,
QUEEN'S CUTLERY WORKS, SHEFFIELD,
WAREHOUSE,
67 & 68, KING WILLIAM STREET, LONDON.

PRICES OF MAPPINS' DRESSING CASES.

For Drawings, see corresponding numbers on Plate.

	each.
	£ s. d.
E2610 Gentleman's Roan Leather Dressing Case, lined, Silk Velvet, containing Tooth, Nail and Shaving Brushes, Strop and Comb, Silver-capped Bottle, Pomade Jar, Box for Studs, with Looking Glass	1 12 0
B49 Gentleman's Roan Leather Dressing Case, with Lock and Key, containing Metal Soap Box, Hair, Tooth, Nail and Shaving Brushes, Strop and Comb, two best Ivory Razors, and Looking Glass <i>Complete</i>	0 15 6
B71 Lady's Handsome Coromandel Wood Dressing Case, lined Silk Velvet, with <i>Solid Sterling Silver</i> Fittings to Glass Trays, Bottles, and Boxes, with Secret Spring to Jewel Drawer, Spring Drawer for two Hair Brushes and Comb, eight Instruments of the finest Cutlery with Pearl handles, Bramah Lock, and large Looking Glass <i>Complete</i>	17 0 0

The London Warehouse contains the Largest Stock of Dressing Cases, and Dressing and Travelling Bags in the World.

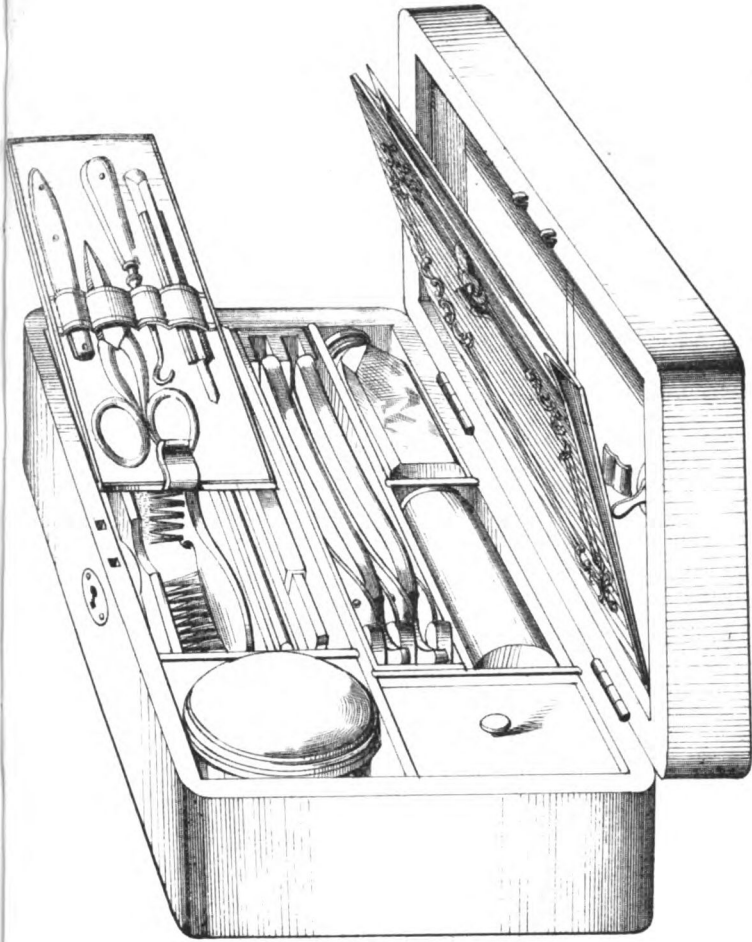

E. 267 C.

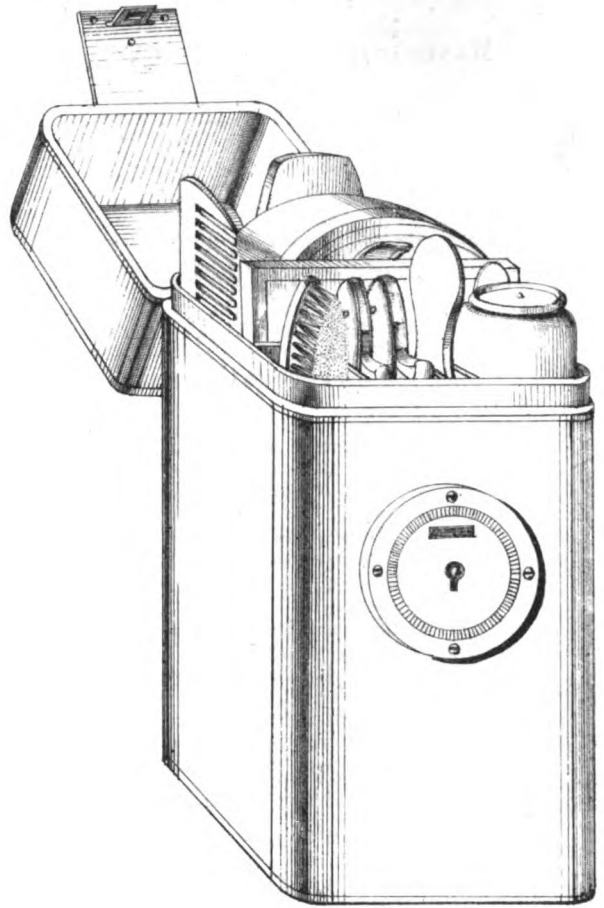

B. 49.

JOSEPH MAPPIN AND BROTHERS.
 QUEEN'S CUTLERY WORKS SHEFFIELD.
Stock ready at the Warehouse.
67 & 68 KING WILLIAM STREET, CITY, LONDON

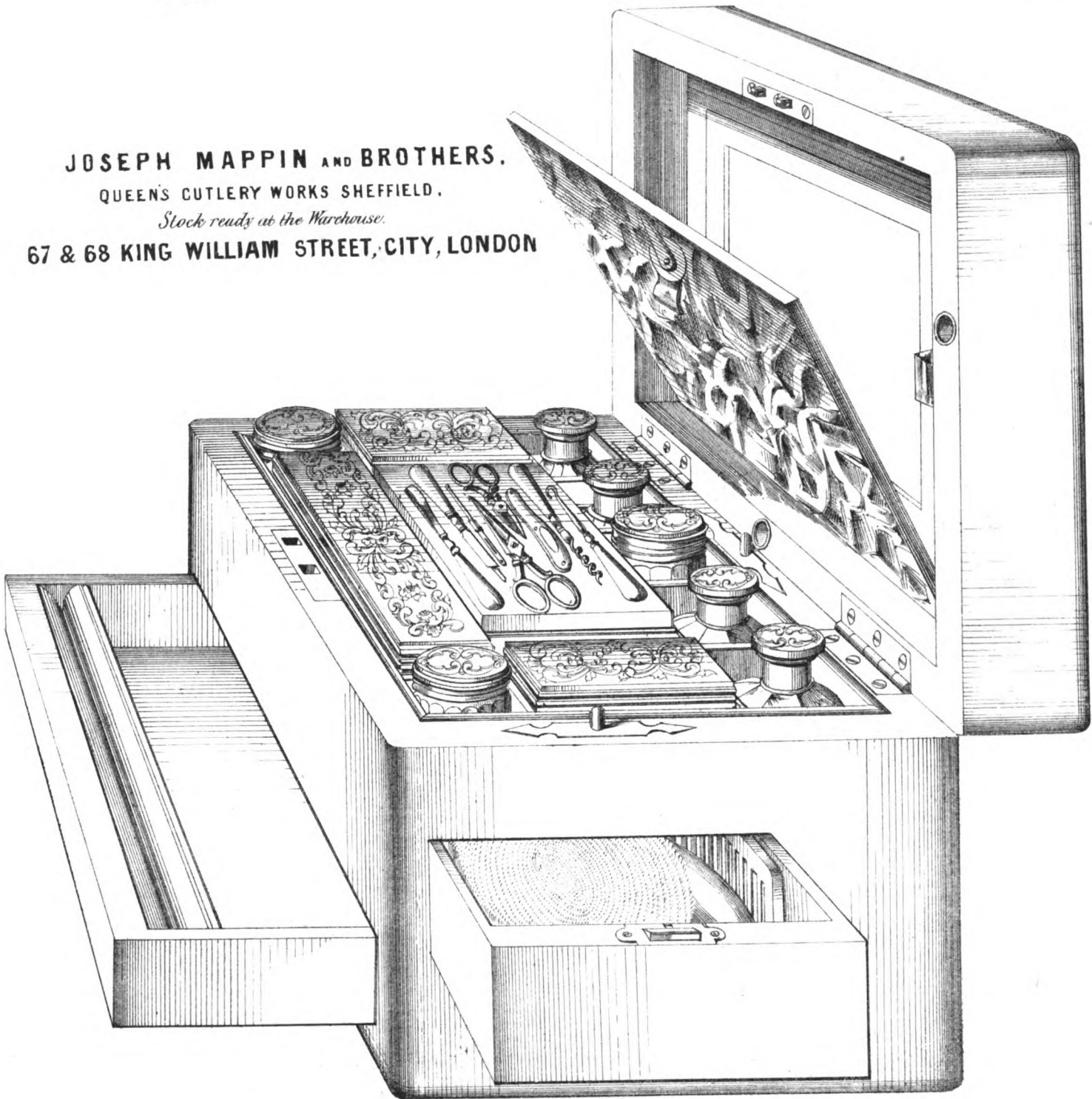

B7A. Wood / Lady's.

Drawn half real size.

MAPPIN BROTHERS,

MANUFACTORY, QUEEN'S CUTLERY WORKS, SHEFFIELD. WAREHOUSE, 67 & 68, KING WILLIAM ST., LONDON.

PRICES OF MAPPINS' TRAVELLING AND DRESSING BAGS.

For Drawings, see corresponding numbers on Plate.

	Each		Each.
	£	s.	£
	d.	d.	d.
C412 Patent Leather 15 in. Gentleman's Dressing Bag, lined with Calico, exterior Pocket, Patent Lock, with three divisions inside, containing Looking-glass, Soap Case, Strop, Comb, Hair, Hat and Cloth Brush, Shaving Brush and Box, Nail and Tooth Brushes in Roller, one pair Razors, Scissors, Penknife, Button-hook and Nail-file <i>Complete</i>	3	12	0
C169 Best Enamel Leather 14 in. Gentleman's Travelling and Dressing Bag, Patent Wide Opening, exterior Pocket, double-action Lock, fitted with Looking-glass, Hair, Hat and Clothes Brush, Shaving Brush, Tooth Brush and Box for Tooth-powder, Razor Strop, Comb, Tablet Soap Box, five Articles of best Cutlery <i>Complete</i>	4	0	0
C52 Gentleman's Morocco Leather 14 in. Travelling Bag, with double-action Gilt Lock, Outside Pocket, with Elastic Fasteners, lined with Leather; containing Hair, Hat and Cloth Brushes, shaving Brush and Roller, exact as C169, with addition of Silver-capped Scent Bottle, Tablet Soap Case, Sandwich Case and Drinking Flask, with Cup attached <i>Complete</i>	5	10	0
B376 As C52, with addition of Writing Case, fitted with Paper and Envelopes, Wax, etc., Patent Spring Inkstand, Light Case, and Pen-holder <i>Complete</i>	6	15	0
B588 Gentleman's 16 in. Wide Opening Bag, with double-action Lock, Outside Pocket, and very strongly made; fitted with two Hair Brushes, one Hat and Cloth Brush, Tablet Soap Box, Tooth-powder Box, Silver-capped Oil Bottle, Glass, Writing Case fitted complete, Ink and Light Cases, Sandwich Case, Drinking Flask with Cup, Silver-capped Scent Bottle, Tooth and Nail Brushes in Roller, Shaving Brush in Roller, large Comb and Strop, Cutlery, etc. <i>Complete</i>	10	0	0
C58 Morocco Leather Gentleman's Travelling Bag, 16 in. long, lined Leather, Patent Wide Opening Frame, Spring Lock, Exterior Pocket, with Gilt Fasteners, fitted with Hair and Clothes Brushes, Tooth and Nail Brushes in Roller, Shaving Brush in Roller, Strop, and Comb in Sheath, Silver-capped Scent Bottle, Soap Box, Looking-glass, Thread Case, containing 100 Needles, Sandwich Case and Spirit Flask, Pomade Jar, two Razors, Knife, Nail Scissors, Button Hook, Tweezers <i>Complete</i>	8	10	0
C111 Patent Enamel Leather Bag, 18 in., fitted exactly as C58, with the addition of one pair of Boot Hooks, a Patent Knife, Fork, Spoon and Corkscrew for Travelling, and Housewife fitted with Needles, larger Strop, and with Square Soap Box; the Outside Pocket has Patent Spring Fasteners <i>Complete</i>	13	0	0
C119 Best Maroon Morocco Leather 17 in. Gentleman's Travelling, Dressing and Refreshment Bag, fitted as C58, with addition of Ivory Sportman's Knife containing twelve useful articles, Knife, Fork, Spoon and Corkscrew fitting into one knife, Engraved Paper-knife, Morocco Thread Case and Card Case; a very elegant and useful Bag, much recommended <i>Complete</i>	17	0	0
C180 Lady's Morocco Leather 14 in. Travelling or Dressing Bag, with Gilt double-action Lock, Outside Pocket, Gilt Spring Fasteners, lined with best Watered Silk, fitted with Hair Brush, Comb and Cases for ditto, Leather Card Case, Looking-glass, Instrument Board, two pair best Scissors, Knife, Tweezers, Crochet Needle and Bodkin, Metal Soap Box, Tooth and Nail Brush in Roller, and Silver-capped Cut Glass Scent Bottle <i>Complete</i>	4	4	0
C456 Same as 180, with addition of Glass Roller for Tooth Brush, small Drinking Flask and Sandwich Case <i>Complete</i>	5	6	0
C68 Lady's best 14 in. Morocco Travelling, Writing and Dressing Bag, lined with best Watered Silk, Engraved Lock and Fasteners to Outside Pocket, fitted with Hair Brush in Case, Comb in Case, 2 Tooth Brushes in Glass Jar with Plated Top, Nail Brush in Glass Jar with Plated Top, Scent Bottle, Cutlery, Looking-glass, Leather Card Case, Tablet Soap Case, large Writing Case fitted complete, Patent Spring Inkstand, Patent Match-box, Dram Bottle and Cup, and large Metal Sandwich Case, Penholder, &c. <i>Complete</i>	7	15	0
C116 Lady's best Levant Leather 14 in. Travelling, Writing, and Dressing Bag, as C68, but with Patent Wide Opening Frame, and Patent double-action Lock; a very useful Bag <i>Complete</i>	9	0	0
B695 Very best Levant Leather 15 in. Lady's Bag, with double-action Lock, Patent Wide Opening Frame, lined with Silk, 2 Outside Pockets, Gilt Fasteners and Engraved, Gilt double-action Locks to ditto, fitted with Ivory Hair Brush in Morocco Case, two Tooth Brushes, one Nail Brush, two beautiful Cut Glass Jars with <i>Solid Silver Tops</i> Engraved, Two Silver Thimbles, Shell Comb in Case, Silver-capped Pomade Jar, Silver-capped Scent Bottle, Silver Plated Soap Box, Writing Case, Ink and Light, Card Case, Housewife, Purse, Plated Sandwich Case and Dram Flask, a Tray of ten articles of very superior Cutlery <i>Complete</i>	22	0	0
A very elegant Bag for a Lady.			
B694 Finest 15 in. Morocco Leather Lady's Bag, with two Outside Pockets, Engraved and Gilt double-action Locks to ditto, lined with best Watered Silk, fitted with Ivory Hair Brush in Case, Ivory Velvet Brush, Tortoise Shell Comb in Case, Tooth Brushes, Nail Brushes, Ivory Paper-knife, seven superbly Cut Glass Jars and Bottles for Scents, Oil, Soap, etc., etc., mounted with beautifully Engraved Silver Tops, Silver Plated Sandwich Case, and Silver Plated Wine Flask, Measuring Tape, two Silver Thimbles, Looking-glass, Housewife, Portmonnaie, Morocco Card Case, Tray of Cutlery, comprising Cutting-out, Work and Embroidery Scissors, Pearl Penknife, eight Pearl-handle Instruments for the Work Table.—This Bag being fitted in the most beautiful manner, is highly recommended for Ladies travelling abroad. With Waterproof Cover Over-all <i>Complete</i>	30	0	0
B784 As B694, but lined with best Silk Velvet, two more Scent Bottles, Silver Mounted; all the Silver Mountings Engraved in beautiful designs, and Gilt to represent solid Gold. With cover, etc. <i>Complete</i>	36	0	0
B786 Lady's 16 in. Writing, Toilet and Refreshment Travelling Bag, five Exterior Pockets, with Gilt and Engraved Lock and Fasteners, on the improved principle, made of strong Levant Leather, lined inside with rich Genoa Velvet; containing eight cut crystal Glass Jars and Bottles, for various Scents, Perfumes, etc., with massive Silver Tops Engraved, Ivory Hair and Velvet Brush, Shell Dressing and Tail Comb, Russia Leather Card Case, Needle Case, Jewel Box, Looking Glass, Portmonnaie, Measuring Tape, Vinaigrette Engraved, Gilt Soap Box, Gilt inside, Instrument Board, containing 13 articles of Cutlery, Pin-cushion, Writing Case, completely fitted with Box for Lights and Ink, Penholder, Paper-knife, etc., Thimble and Shield. With Waterproof Cover <i>Complete</i>	40	0	0
C51 Best 14 in. Morocco Leather Lady's Travelling Bag, with Exterior Pocket, Double-action Lock, lined best Silk, fitted with Looking Glass, Hair-brush, Comb, Soap Box, Scent Bottle, Oil Bottle, Nail and Tooth Brush fitted in Glass Jar, Writing Case fitted with every requisite, Patent Light and Ink Boxes, Ivory Paper-knife, Sandwich Case, Wine Flask with Cup attached, Card Case, Housewife fitted with Needles, Silk, etc., and six articles of best Cutlery <i>Complete</i>	8	5	0
C297 Best Morocco Leather 15 in. Lady's Travelling Bag, as C51, with Patent Wide Opening, and the following extra articles, viz., Glass Pomade Jar with Plated Cover, Russia Leather Card Case, Housewife and Instrument Board: this Bag is very much recommended <i>Complete</i>	13	0	0
C113 Best Enamel Leather 16 in. Gentleman's Travelling Bag, fitted as follows, viz., Hair, Hat and Clothes Brushes, Comb, Strop, Shaving Brush, Looking Glass, Comb Case, Purse, Pomade Jar, Nail Brush in Jar, Tooth Brush in Jar, Long Scent Bottle, Sandwich Case, Spirit Flask and Drinking Cup, Writing Case completely fitted, Light and Ink Cases, Boot-hooks, Razors, and Six articles of best Cutlery <i>Complete</i>	10	0	0
B788 Best Morocco Leather 17 in. Gentleman's Bag, fitted as C113 <i>Complete</i>	14	0	0

The London Warehouse contains the Largest Stock of Dressing Cases, and Dressing and Travelling Bags in the World.



C119

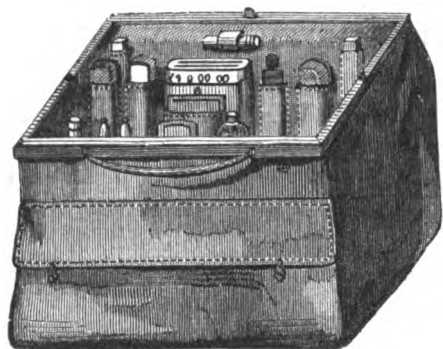

B588

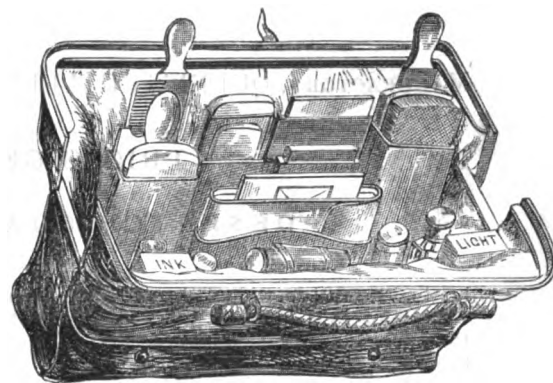

B788

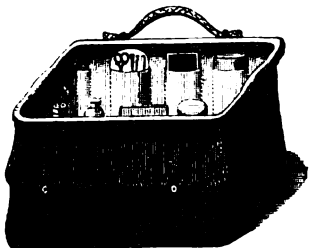

C180

MAPPIN BROTHERS'
QUEENS' CUTLERY WORKS, SHEFFIELD,

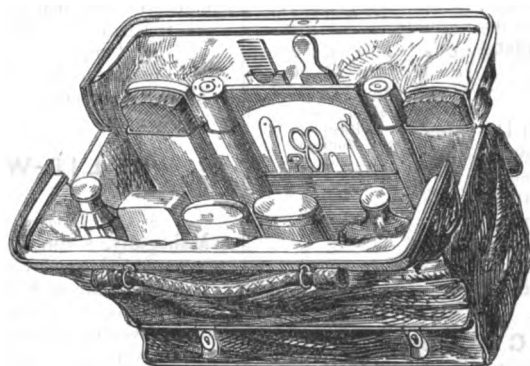

C179

STOCK READY AT THE WAREHOUSE,
**67 & 68, KING WILLIAM STREET, CITY,
LONDON.**

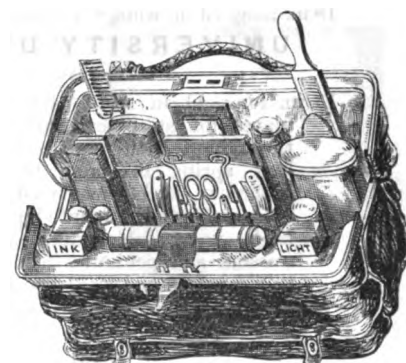

C113

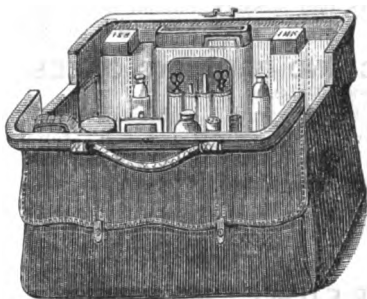

C116

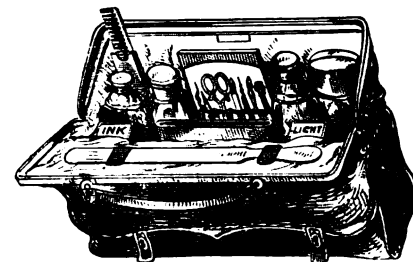

C51

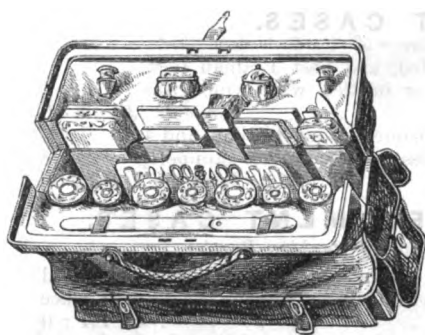

B786

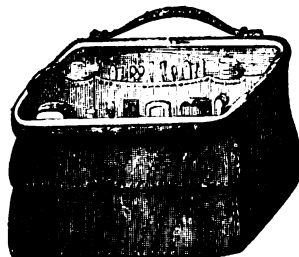

C52

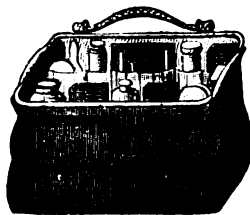

C68

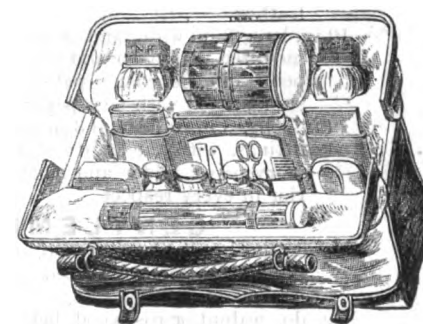

C297

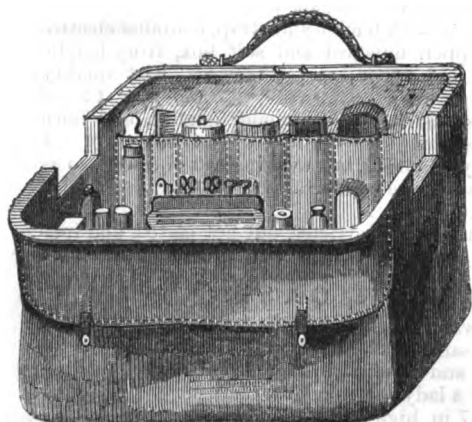

C111

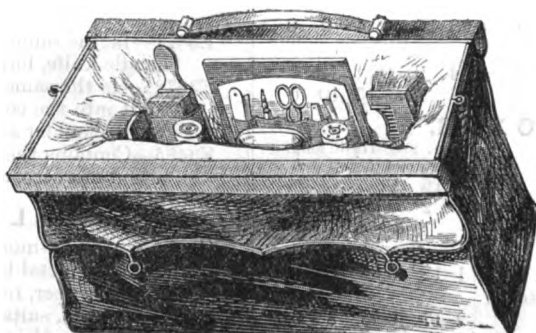

C169

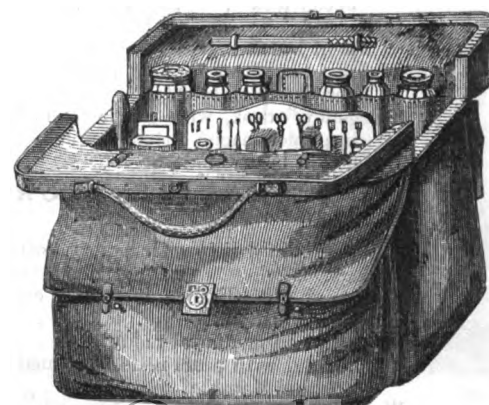

MAPPIN BROTHERS,

MANUFACTORY, QUEEN'S CUTLERY WORKS, SHEFFIELD. WAREHOUSE, 67 & 68, KING WILLIAM ST., LONDON.

PRICES OF MAPPINS' WRITING CASES, DESKS, &c., &c.

For Drawings, see corresponding numbers on Plate.

DESPATCH BOXES.

	Russia or Morocco Leather.	Second quality, not Russia.
C353		
14½ in. long, 10½ in. wide, 4½ in. deep, with Bramah's patent lock, lined leather, and registered head	£ 2 16 0	£ 2 0 0
16 in. long, 11 in. wide, 6 in. deep	£ 3 10 0	£ 2 12 0
18 in. " 13 in. " 8 in. "	£ 3 17 0	£ 3 0 0
C403		
14 in. long, 10 in. wide, 5½ in. deep, with tray for papers, best Bramah's patent lock, lined leather, with extra tray for pens, wax, patent spring inkstand, and box for lights	£ 3 16 0	£ 3 0 0
Ditto, ditto, with blotting book extra	£ 4 0 0	£ 3 4 0
15 in. long, 10 in. wide, and 6½ in. deep, with blotting book extra	£ 4 10 0	£ 3 10 0
18 in. long, 13 in. wide, 8 in. deep	£ 5 8 0	£ 4 12 0

UNIVERSITY DESPATCH BOXES.

	Best Russia Leather.	Second quality, not Russia.
C438		
15 in. long, 11 in. wide, 5½ in. deep, with double places for stationery, long gilt hinge, lined throughout with morocco leather, fitted with best spring inkstand, blotting book, three different sized packets of envelopes, 9-inch ivory rule, silver-mounted pen and pencil, pen knife, ivory folder and paper knife, cheque scissors and penknife, cash book and journal, tray for pens and wax, stamps, and various divisions for useful articles, with cover, complete, much recommended	£ 8 0 0	£ 6 15 0
C445		
16 in. long, 11 in. wide, 7 in. deep, Desk and Despatch Box combined, with strong continuous hinge and best tumbler lock, porcelain slate, spring ink and light, cash book and journal, four packets best envelopes, foolscap, cream-laid and note paper, spring head, cheque scissors, ivory pen machine, pen knife with two blades, long ivory folder, pen and pencil, eraser and 6-inch rule knife	£ 9 5 0	£ 7 15 0

TRAVELLING WRITING CASES.

	Octavo, or note paper size.	Quarto, or letter paper size.	Foolscap size.
Mock russia leather, with secure inkstand, good lock, and tray for pens and wax, &c.	£ 11 0	£ 12 0	£ 13 0
Maroon leather, with secret drawer, inkstand, fitted with paper, &c.	£ 15 0	£ 16 0	£ 17 0
Do., do., with Bramah lock, do. do.	£ 17 0	£ 18 0	£ 20 0
Ditto double desk, with flaps, and plated top inkstand, pen knife and scissors, penholder, wax, &c., &c.	£ 23 0	£ 28 0	£ 34 0
Morocco, do., do., better quality	£ 36 0	£ 44 0	£ 50 0
Best russia leather, and best cutlery	£ 64 0	£ 76 0	£ 88 0

PORTABLE WRITING PORTFOLIO,

FOR TOURISTS.

	Good French Morocco Leather.	Best Russia Leather.
9 in. long, 5½ in. wide, fitted with papers and envelopes, india rubber, wax, glass inkstand, penholder and pencil, desk knife, pen knife, and folder, match box, double-action lock, lined leather	£ 0 17 0	£ 1 2 6
10 in. long, 8 in. wide, and 3 in. deep, with silver-mounted penholder and pencil, cheque scissors, pen knife, Mordan's patent lock, spring inkstand, fitted with best paper and envelopes	£ 1 12 0	£ 2 8 0
12 in. long, 8 in. wide, and 3 in. deep, with all above fittings, with the addition of 6-inch ivory rule, ivory paper folder and ivory eraser, very superior in every respect	£ 3 16 0	£ 4 8 0

GENTLEMEN'S DESKS.

	12 in. long.	14 in. long.	16 in. long.
Mahogany, brass plate on top, good lock, ink and light box, fitted with good paper and envelopes	£ 1 0 0	£ 1 4 0	£ 1 8 0
Do., do., walnut or rosewood, better quality	£ 1 10 0	£ 1 17 0	£ 2 8 0
Do., lined with leather, and town-made lock	£ 2 5 0	£ 3 0 0	£ 3 15 0
Mahogany or Coromandel, and secret drawers	£ 3 12 0	£ 4 0 0	£ 4 8 0
Extra good quality, with drawer at side and tumbler lock	£ 4 0 0	£ 5 0 0	£ 6 0 0

LADIES' WRITING DESKS.

	14 in. long.	16 in. long.	17 in. long.
Rosewood, lined with velvet, tray for wax, pens, &c., fitted with paper and envelopes, inkstand, wax, &c.	£ 1 4 0	£ 1 8 0
Do., do., with pearl mounts outside, and better lock	£ 1 10 0	£ 1 16 0
Coromandel do., do., with patent ink and light box, secret drawer, &c.	£ 2 8 0	£ 2 16 0	£ 3 7 0
Walnut do., better quality, lined silk velvet, completely fitted	£ 3 0 0	£ 3 10 0	£ 4 0 0
"Regency" desk, with mediæval mounts, in papier maché, fitted complete	£ 3 6 0	£ 4 0 0
Do., do., in best walnut wood	£ 6 0 0	£ 7 10 0

LADIES' WORK BOXES.

	10 in. long.	11½ in. long.
Rosewood, lined silk, with cutlery, cottons, &c.	£ 0 16 0
Walnut, do. do. do. silver thimble	£ 1 2 0	£ 1 6 0
Rosewood, with French buhl top, cutlery and cottons, lined silk	£ 1 8 0
Walnut, with mediæval mounts	£ 1 12 0	£ 2 0 0
Coromandel, with pearl reels, and lined best watered silk, and thimble	£ 2 17 0	£ 3 8 0
Walnut, with best mediæval mounts, with superior cutlery, pearl reels, lined best watered silk, and thimble	£ 4 15 0	£ 5 16 0

LADIES' JEWEL CASKETS.

11 in. long, 7½ in. wide, 4½ in. high, outside measure, fitted with two trays, lined velvet, and covered with imitation morocco leather, good lock with two keys	£ 2 5 0
Do., do., in morocco leather	£ 2 15 0
Ebony wood, 9 in. long, 6 in. wide, 5 in. deep, with gilt and engraved mediæval mounts, with three trays and best lock	£ 2 10 0
Do., do., size larger	£ 3 0 0
A smaller size, in good leather, good quality	£ 1 4 0

"SAC DE NUIT."

	12 in.	14 in.	16 in.	18 in.	20 in.
Best strong cow's-hide, water-proof, lined fancy twill, with double-action lock, 2 handles (as drawing)	£ 16 0	£ 18 6	£ 22 0	£ 26 0	£ 28 0
Do. do. with 2 extra straps	£ 17 6	£ 20 0	£ 23 6	£ 28 0	£ 30 0
Do. do. with exterior pocket and fasteners	£ 23 0	£ 26 0	£ 33 0	£ 37 0	£ 42 0
As above, but with the celebrated wide-opening frame, outside pocket, &c.	£ 26 0	£ 30 0	£ 38 0	£ 43 0	£ 50 0

"TIEN TOUT" TOURISTS' DRESSING CASE.

	Basil or Mock Solid Leather.	Best Town-made Solid Leather.	Best Russia Leather.
C490—Outside Measure—8½ in. long, 4 in. wide, 1½ in. high. Contains hair brush, comb, soap box, shaving brush, tooth and nail brushes in metal tray, strop, razor, knife, scissors, button hook, with strap over all	20s.	25s.
Addition of corkscrew, and catch instead of strap over all	40s.

SOLID-WOOD DRESSING CASES,

FOR HOT CLIMATES.

C432—Outside Measure—9 in. long, 6½ in. wide, 3 in. high. Mahogany, strongly bound with brass, oval shield on top, morticed partitions, lever lock, warranted to stand any climate; contains best hair and cloth brushes, 1 nail and 2 tooth brushes, strop and comb, best silver-plated soap box, pomade and lip-salve boxes, silver-mounted scent bottles, plated handle badger shaving brush, looking-glass, 2 best ivory razors, nail scissors, button hook, and tweezers	£ 3 : 6 : 0
---	-------------

"COMBINATION" WRITING AND DRESSING CASES.

9 in. long, 7½ in. wide, 3 in. deep. Finest quality russia leather, with gilt and engraved double action lock, containing note paper and envelopes, blotting book, inkstand, paper knife, silver-mounted penholder, sealing wax and lights, pen knife, scissors, looking glass, 2 best ivory razors, strop, comb, soap box, shaving, nail and tooth brushes, scent bottle, nail scissors, button hook, and nail brush	Complete £ 4 : 5 : 0
Second quality	£ 3 : 4 : 0

SCENT AND PERFUME CASES.

French morocco case, with lock and key, containing 2 silver-capped scent bottles, good quality	£ 1 0 0
Do. do. containing 3 bottles	£ 1 5 0
Real morocco, lined velvet, containing 3 neatly cut bottles	£ 2 0 0
Coromandel wood, do. do.	£ 2 15 0
Do. richly-cut bottles	£ 4 0 0

SPIRIT CASES.

C399—Outside Measure—8 in. square, 8 in. deep. Best mahogany case, brass banded, and best Bramah lock, with 4 cut glass pint liquor bottles, with wine glass stoppers, best quality	Complete £ 4 8 0
Best walnut wood case, brass banded, lined leather, and 4 beautifully cut liquor bottles, with cut-glass stoppers, Bramah lock	Complete £ 4 12 0

WICKER REFRESHMENT CASES,

For Pic-Nic, Fishing, or Racking Parties.

C472—Contains 1 quart bottle covered with wicker, 2 wicker-covered tumblers, and sandwich case, in strongly made basket case, place for shoulder strap	£ 1 : 4 : 0
C470—Contains all the above articles, with addition of wine bottle, and larger case, place being left for knives and forks, napkins, &c.	£ 1 : 14 : 0
C473—Contains all the above, with addition of 2 enamelled iron plates.	Complete £ 2 : 2 : 0
C475—Contains all the above, but lined with green baize, and the sandwich box is electro-silver plated, also containing plated pepper box	Complete £ 3 : 6 : 0

"CRIMEA" OR "PIC-NIC" POCKET CASE.

Outside Measure, 4½ in. long, 3 in. wide. E3872—Best solid leather case, with buckle and strap, contains electro-plated half-pint cup, pepper, mustard and salt box, ivory-handle knife and plated fork and spoon, and corkscrew, best quality	Complete £ 2 : 2
E3871—Is the same size as E3872, but commoner quality, and horn handle knife, fork, and spoon	Complete £ 1 : 4
E3872½—Is the same quality as E3872, but oval instead of round, so as to fit into the coat pocket more comfortably	Complete £ 2 : 2
With shoulder strap	£ 2 : 5
E3485—Contains the same number of articles, but not plated, and imitation morocco, at	£ 1

LUNCHEON CASE.

Contains a silver-mounted wicker flask, bottle for wine, wine glass and tumbler, metal box for sandwiches, knife and fork, spoon and corkscrew, pepper, mustard and salt box, in morocco case, with double-action lock, suitable for a lady's use or for a carriage.	Complete £ 4
7½ in. long, 3½ in. wide, 7 in. high	£ 4 : 10
With addition of two dinner plates, best metal	£ 4 : 10
Do. do. electro-plated, best quality	£ 6

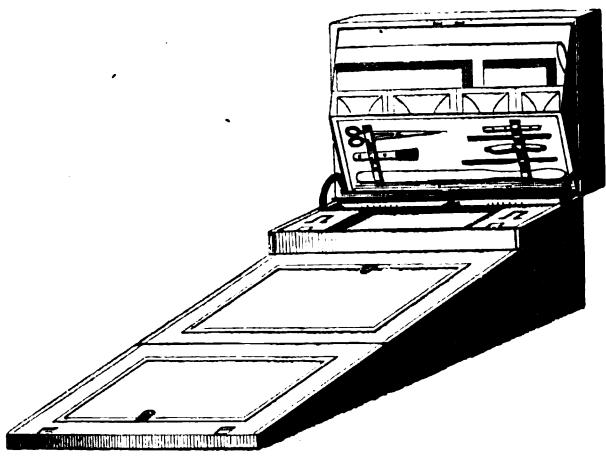

C445

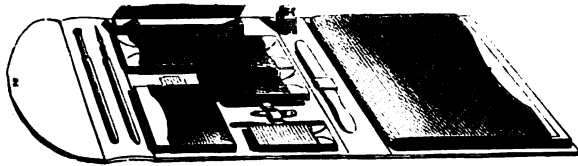

PORTABLE WRITING PORTFOLIO.

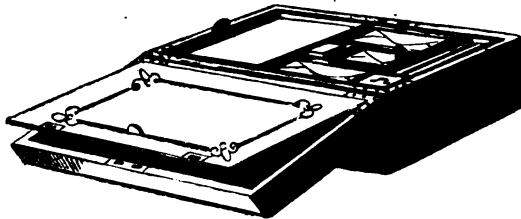

C438

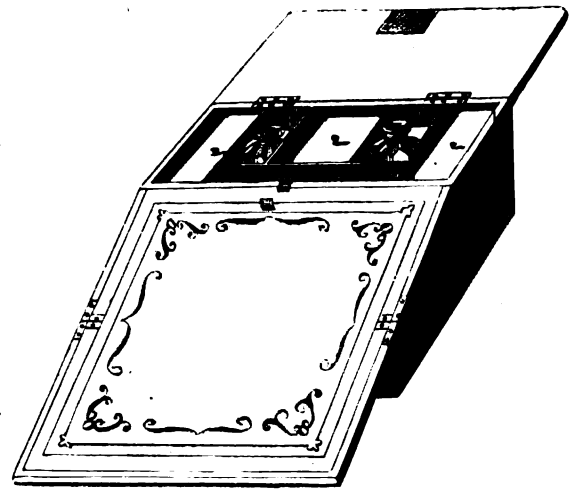

LADIES' WRITING DESKS.

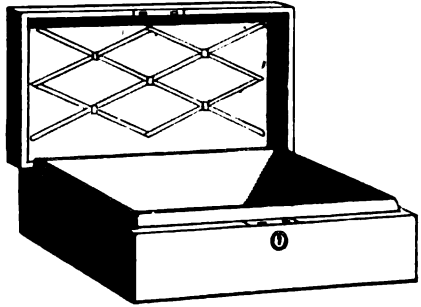

C353

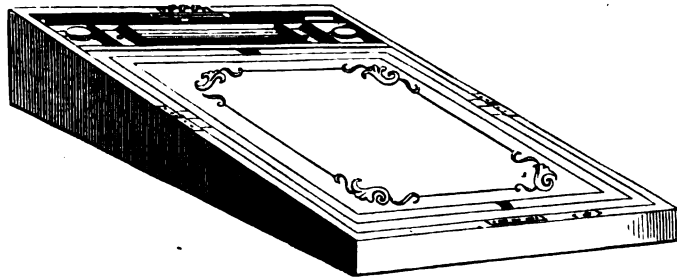

GENTLEMEN'S DESKS.

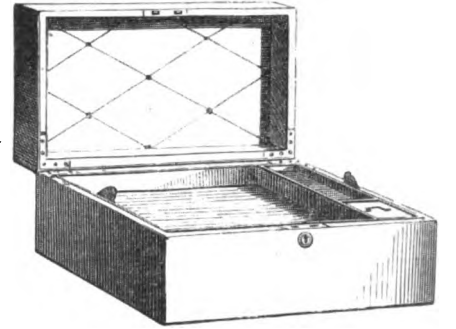

C408

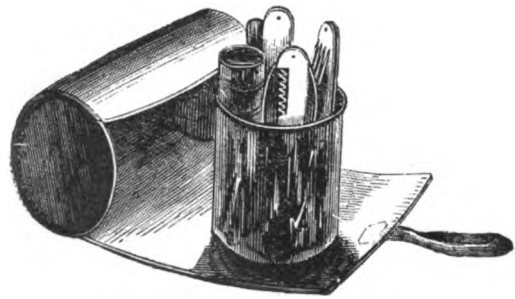

B3871

MAPPIN BROTHERS'
QUEEN'S CUTLERY WORKS, SHEFFIELD,
STOCK READY AT THE WAREHOUSE,
67 & 68, KING WILLIAM STREET, CITY,
LONDON.



C512

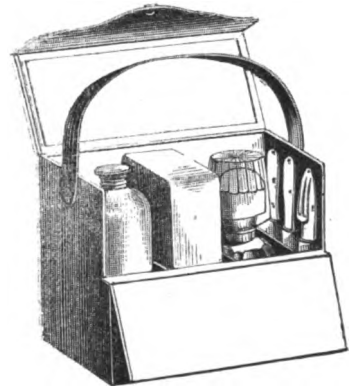

LUNCHEON CASE.

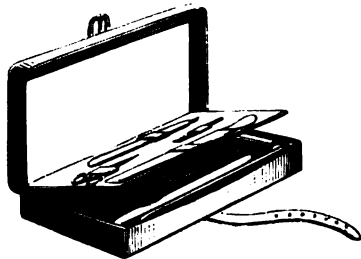

C490

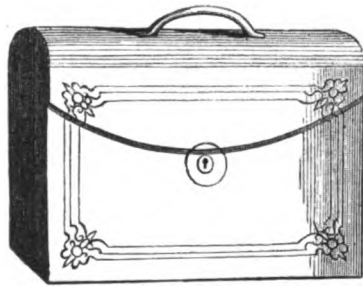

TRAVELLING WRITING CASES.

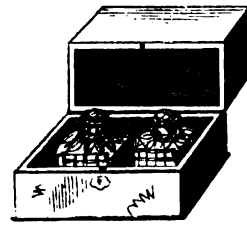

SCENT AND PERFUME CASES.



C399

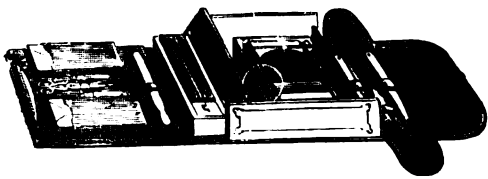

"COMBINATION" WRITING AND DRESSING CASES.

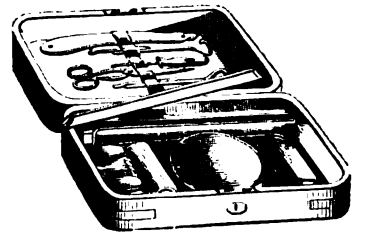

C482

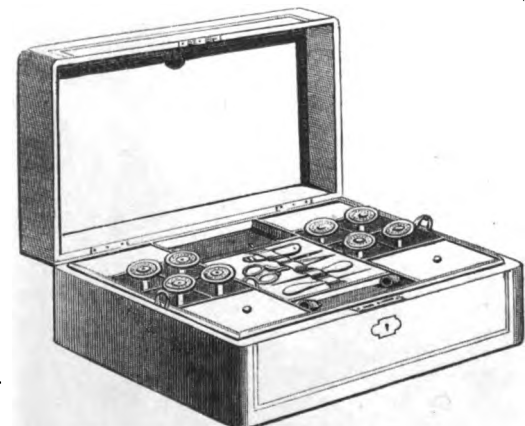

LADIES' WORK BOXES.

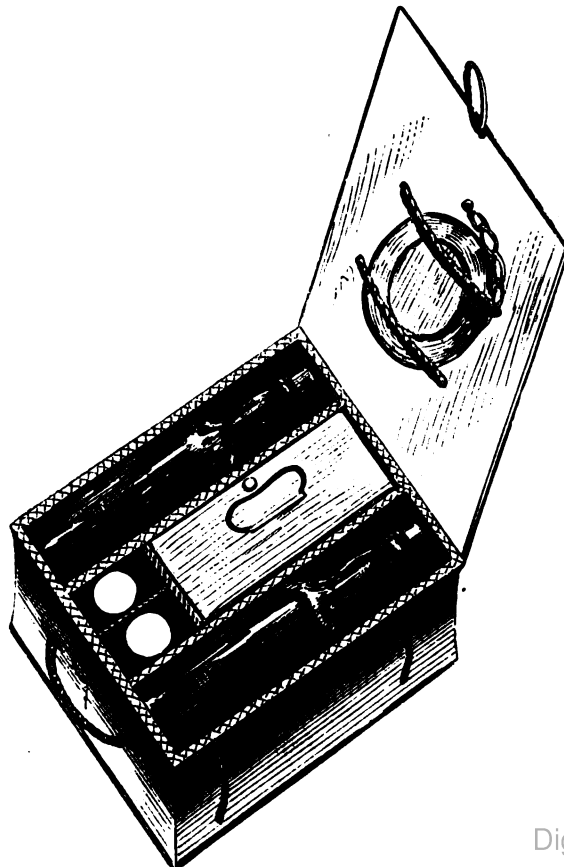

WICKER REFRESHMENT CASES.

11 MA60



LADIES' JEWEL CASSETS.

