

LIBRARY
OF THE
UNIVERSITY OF CALIFORNIA.

Class

GENERAL

Digitized by the Internet Archive
in 2006 with funding from
Microsoft Corporation

WORKS OF PROF. H. N. OGDEN

PUBLISHED BY

JOHN WILEY & SONS

Sewer Construction.

8vo, xii + 335 pages, 192 figures. Cloth, \$3.00.

Sewer Design.

12mo, xi + 234 pages, 54 figures, 5 plates. Cloth,
\$2.00.

SEWER CONSTRUCTION

BY

HENRY N. OGDEN, C.E.

ASSOC. MEM. AM. SOC. C.E.

PROFESSOR OF SANITARY ENGINEERING, CORNELL UNIVERSITY

SPECIAL ASST. ENGINEER, N. Y. STATE DEPT.
OF HEALTH

FIRST EDITION

FIRST THOUSAND



NEW YORK

JOHN WILEY & SONS

LONDON: CHAPMAN & HALL, LIMITED

1908

T II 675
04

GENERAL

COPYRIGHT, 1908,
BY
HENRY N. OGDEN

Stanbope Press
F. H. GILSON COMPANY
BOSTON, U.S.A.

PREFACE

THE following pages comprise, in a somewhat amplified form, a course of lectures given in the College of Civil Engineering, Cornell University.

The course is an elective one, intended for students whose purpose to enter the field of Sanitary Engineering calls for more special and detailed work than is required of all civil engineering students.

The illustrations of the classroom, made possible by a series of lantern slides, a portion of which only have been reproduced, are accompanied by abundant explanation brought out by questions and answers — a feature not possible to repeat in this present volume. It is hoped, however, that sufficient detail has been given to make clear the examples of current practice which are offered.

The course represents the second part of a year's work, of which the book on "Sewer Design," already published, is the first part, and it is assumed that the reader is familiar with that volume. Wherever serious omissions from the present text have been made on that account, references have been given so that duplication may be avoided.

It is believed that due acknowledgment has been made to the various books and periodicals and to the reports of the prominent engineers and city officials from which this monograph has been prepared, and it is hoped that the collection and unification of this scattered material may not only aid the students entering upon the investigation of sewer construction, but may also be of some service to practicing engineers who may have occasion to take up the matter of sewer work for the first time.

A small number of the illustrations have no references cited, due to the fact that they were filed among the author's notes at

various times without mention of the source, and an extended search has not been able to locate them. They have nevertheless been included because they have proved useful in classroom work.

Special acknowledgment is made to the volumes of *Engineering News*, *Engineering Record*, and *Municipal Engineering*, from which examples of construction have been freely taken, the figures however, having all been redrawn. Examples of costs have been taken from current volumes of *Engineering-Contracting*, where most valuable data on the cost of engineering work is to be found. Thanks are due to the Eureka Machine Company of Jackson, Mich., to the C. W. Raymond Company of Dayton, Ohio, to the Turner, Vaughn, and Taylor Company of Cuyahoga Falls, Ohio, and to the Carson Trench Machine Company of Boston, Mass., for the loan of cuts from which figures 1, 2, 3, 190, and 192 have been made. The cut of the Moore Machine was made from a photograph kindly furnished by Mr. Thos. F. Moore, president of the Moore Machine Company.

The comments on the clauses of the specifications and contract in the chapter of that title are based on the exposition of parallel phrases as set forth in Wait's "Engineering Jurisprudence," and due acknowledgment is hereby made to the author of that valuable treatise. This chapter has been submitted to Professor E. H. Woodruff of the College of Law, Cornell University, and to Alec H. Seymour, Esq., legal adviser to the New York State Department of Health, to whom the thanks of the author are most cordially extended.

CONTENTS

CHAPTER I. TERRA-COTTA PIPE.

	PAGES
The manufacture and composition of sewer pipe. Commercial sizes. Cross-sections. Standard lengths. Thickness of pipe. Double-strength pipe. Standard and deep-and-wide sockets. Corrugations.....	1-12

CHAPTER II. TERRA-COTTA PIPE (*continued*).

Strength of pipe. Early tests. Howe's experiments. Barbour's tests and formula. Average breaking loads. Records of failures in trenches. Cement joints. Substitutes for cements. Other forms of joints.....	13-28
---	-------

CHAPTER III. BRICK SEWERS.

Kinds of brick. Invert blocks and their value. Quantity of brick-work for different sizes. Proper thickness of sewer walls. Earth pressures of sewer arch. Sections adopted in Washington, Ottawa, New Orleans, Denver, Brooklyn and Rochester. Bond in sewer work. General considerations.....	29-51
---	-------

CHAPTER IV. CONCRETE SEWERS.

Chenoweth and Ransome processes. Cement pipes. Arch blocks of concrete. Examples of concrete sewers at Chicago, New York, Victoria, Truro and Swampscott. Sections from Blaw Centering Co.....	52-66
--	-------

CHAPTER V. CONCRETE AND BRICK SEWERS.

The propriety of their use. Examples of construction at Medford, Altoona, Melbourne and Boston.....	67-74
---	-------

CHAPTER VI. REINFORCED CONCRETE SEWERS.

Examples with steel mesh at Mexico City, Providence, Wilmington and Harrisburg. The Jackson reinforced pipe. Examples with steel rods at Jersey City, New York, Des Moines, St. Louis, Philadelphia, South Bend and Cleveland.....	75-88
--	-------

CHAPTER VII. MANHOLES.

PAGES

The location, cross-section and size of manholes. The construction of foundation and bottom. The proper thickness of manhole walls. High level laterals and their connection. Frames and covers. Locks and dirt pans. Lamp holes.....	89-112
---	--------

CHAPTER VIII. CATCH-BASINS.

Location and use of catch-basins. Gratings and traps. Examples of basins at Columbus, Providence, Margate, Michigan City, Boston, Wilmington, Peoria, Burlington, Philadelphia, Washington, Louisville, Warsaw, Tarrytown. Maintenance of catch-basins.....	113-132
---	---------

CHAPTER IX. SIPHONS.

Examples of direct siphons at Norfolk and Breslau. Bridge crossings. Inverted siphons. Examples of their use at Roanoke, Newton, New Orleans, Woonsocket, Springfield, New York, Ithaca, Buenos Ayres, Los Angeles and Providence. Auxiliary devices.	133-152
---	---------

CHAPTER X. SCREENS.

The function and location of screens. Proper area of screens. Examples of screen chambers at Boston, Ithaca, Manchester, and Providence. Mesh screens, rod screens, and plate screens. Examples of screens at White Plains, Marlborough, Cranston, Wayne, Newark, Providence, Pullman, Richmond and Birmingham.....	153-169
---	---------

CHAPTER XI. STORM-WATER OVERFLOWS AND REGULATORS.

Proper location of storm overflows. Example at Rochester. Leaping weir. Its theory with example of its use at Milwaukee. Overflow weirs. Examples at Cleveland, Providence and Rochester. Regulators. Examples at Boston, Worcester, Harrisburg, Brookline and Woburn	170-184
---	---------

CHAPTER XII. BELL MOUTHS.

The description of bell mouths and a discussion of their use. Examples at Philadelphia, Boston and Providence. Alternate construction.	185-194
---	---------

CONTENTS

vii

CHAPTER XIII. FOUNDATIONS.

PAGES

Plank and gravel footings. Wooden platforms and cradles. Concrete foundations. Piling. Examples of pile foundations at Cambridge, Lynn, Troy, Boston, New York, St. Paul. Allowance for settlement at Boston 195-210

CHAPTER XIV. OUTFALL SEWERS.

Outlet through high bank. Example at Niagara Falls. Outlet into shallow water. Examples at Harrisburg and Binghamton. Outlet into tidal waters. Examples at Philadelphia, Boston, New York, and New London. Protection from erosion. Examples at Burlington and Los Angeles. 211-226

CHAPTER XV. HOUSE CONNECTIONS.

Y and T branches. Records of location. Size of house drain. Connections with deep sewers. Two-story lines. In rock trenches. 227-234

CHAPTER XVI. SURVEYING.

Location of sewer line. Location of manholes. Offset line. Grade boards. Field notes. Estimates. Records of branches. 235-244

CHAPTER XVII. TRENCHING.

Width of trenches. Sheeting. Conveying machines. Carson, Lidgerwood and Moore machines. Rock trenching. Drilling and explosives. 245-256

CHAPTER XVIII. ESTIMATES AND COSTS.

Earth excavation, back-filling, ramming. Rock-work. Sheeting. Tunnel-work. Vitrified pipe. Brickwork. Concrete. Manholes. Iron castings. Flush-tanks. Engineering. 257-278

CHAPTER XIX. SPECIFICATIONS AND CONTRACTS.

Typical form of contract and specifications, with comments thereon, 279-323

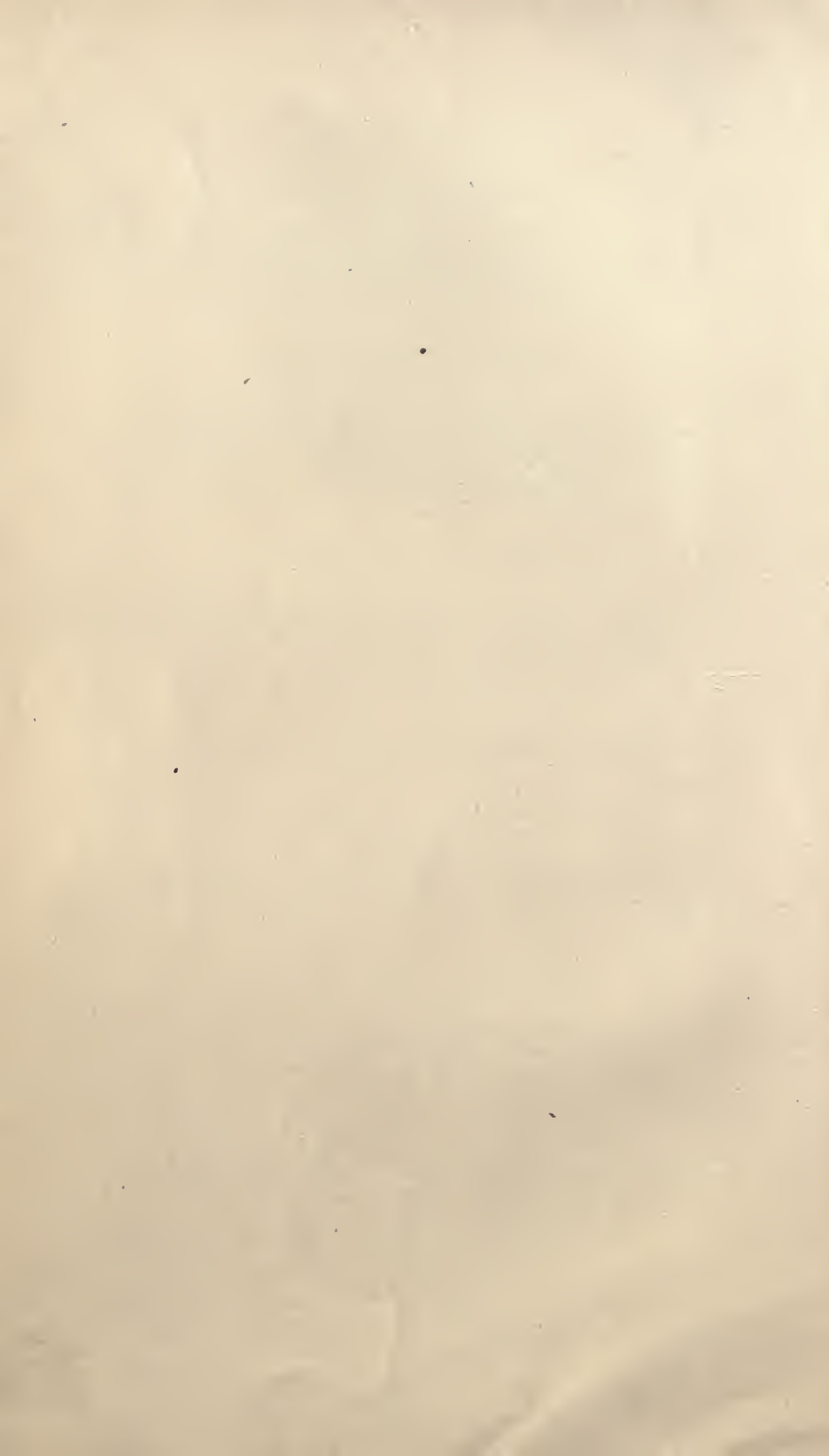

LIST OF FIGURES

FIGURE	PAGE
1. Pug mill	3
2. Roll mill.....	4
3. Pipe press.....	5
4. Pipe die.....	6
5. Bell and spigot pipe.....	9
6. Forms of sockets.....	12
7. Support for jointing pipe.....	21
8. Device for holding jointed pipe.....	22
9. Molds for Stanford joint.....	23
10. Conical Stanford joint section.....	27
11. Spherical Stanford joint section.....	27
12. Archer joint.....	27
13. Hassal joint.....	27
14. Sykes joint.....	28
15. Brick section in New York.....	30
16. Joints in brick sewer.....	31
17. Invert blocks of American Sewer Pipe Co.....	32
18. Talbot's invert block.....	32
19. Latham's invert block.....	33
20. Babcock's invert block.....	33
21. Equilibrium polygon in Philadelphia section.....	38
22. Equilibrium polygon in Philadelphia section.....	39
23. Equilibrium polygon for different loadings.....	40
24. Egg-shaped section at Washington, D.C.....	41
25. Egg-shaped section at Washington, D.C.....	42
26. 5-foot 9-inch sewer on piles.....	43
27. 7-foot sewer at Ottawa, Canada.....	43
28. 6-foot sewer at New Orleans, La.....	44
29. 94-inch sewer at Denver, Colo.....	46
30. Egg-shaped sewer at Rochester, N.Y.....	46
31. Basket-handle section at Rochester, N.Y.....	47
32. Row-lock bond for brickwork.....	48
33. Headers for bonding.....	49
34. Strap iron reinforcement.....	49
35. Concrete reinforcement at Washington, D.C.....	58
36. Concrete sewer at Chicago.....	59
37. Sewer along New York subway.....	60
38. Concrete sewer at Victoria, B.C.....	60
39. Brick and concrete sewer at Truro, N.S.....	61
40. Forms used at Truro, N.S.....	62
41. Concrete sewer at Swampscott, Mass.....	62
42. Sections from catalogue of Blaw Collapsible Steel Centering Co.....	64
43. Sections from catalogue of Blaw Collapsible Steel Centering Co.....	65
44. Brick and concrete sewer at Medford, Mass.....	67

FIGURE	PAGE
45. Forms used at Medford, Mass.	68
46. Brick and concrete sewer on platform.	69
47. Sixty-four-inch brick and concrete sewer on firm ground.	70
48. Brick and concrete sewer at Altoona, Pa.	71
49. Circular section of Melbourne, Aus., outfall.	71
50. Egg-shaped section of Melbourne, Aus., outfall.	72
51. Section of sewer with basket-handle section.	73
52. Section showing continuous wood lagging for wet soil.	73
53. Section of Boston Aqueduct.	74
54. Section of reinforced concrete aqueduct at Mexico.	76
55. Reinforced concrete sewer at Providence, R.I.	77
56. Reinforced concrete sewer at Wilmington, Del.	78
57. Reinforced concrete sewer at Harrisburg, Pa.	78
58. Section of reinforced concrete aqueduct at Jersey City, N.J.	81
59. Reinforced concrete sewer, Borough of Queens.	81
60. Section of Ingersoll Run sewer, Des Moines, Ia.	83
61. Section of Harlem Creek sewer, St. Louis, Mo.	83
62. Section of McKean St. sewer, Philadelphia.	84
63. Section of sewer at South Bend, Ind.	86
64. Section of intercepting sewer at Cleveland, O.	87
65. Cross-section of manhole.	91
65. Cross-section of shallow manhole.	92
67. Split pipe in manhole bottom.	92
68. Construction of manhole floor.	93
69. Drawings of junction manhole.	95
70. Manhole from side of brick sewer.	97
71. Detail drawing of connection.	98
72. Manhole over axis of brick sewer.	99
73. High level connection at Santos, Brazil.	100
74. High level connection on outside of manhole.	101
75. Inclined connection from high level sewer.	102
76. Deep manhole at Melbourne, Australia.	103
77. Deep manhole at Cleveland, Ohio.	103
78. Slips in sewer at St. Louis, Mo.	103
79. Manhole cover designed for Santos, Brazil.	105
80. Manhole cover built by Sessions Foundry Co.	105
81. Manhole cover from Auburn contract drawings.	106
82. Lock used at Ithaca, N.Y.	107
83. Lock used at Salt Lake City, Utah.	108
84. Dirt pail designed for deep sewers.	109
85. Dirt pail designed for shallow sewers.	109
86. Dirt pan as built at Ithaca, N.Y.	110
87. Dirt pail from Baumeister.	110
88. Lampholes with concrete supports.	111
89. Lamphole cover.	112
90. Location of inlets at street corner.	114
91. Location of inlets at street corner.	115
92. Location of inlets at street corner.	115
93. Flat top grating made in Dayton, Ohio.	116
94. Circular flat top grating.	117
95. Circular dome-shaped grating.	117
96. Horizontal grating with vertical opening.	118

LIST OF FIGURES

xi

FIGURE	PAGE
97. Castings for horizontal grating with vertical opening	118
98. Grating for curb corner	119
99. Grating for straight curb	119
100. Catch-basin at Columbus, Ohio.	120
101. Catch-basin at Providence, R.I.	121
102. Catch-basin at Margate, Eng.	122
103. Catch-basin at Michigan City, Ind.	123
104. Cast-iron hood for catch-basin trap	124
105. Catch-basin at Wilmington, Del.	125
106. Catch-basin at Peoria, Ill.	126
107. Catch-basin at Burlington, Iowa.	126
108. Catch-basin at Philadelphia, Pa.	127
109. Catch-basin at Washington, D.C.	128
110. Catch-basin at Louisville, Ky.	129
111. Inlet at Warsaw, N.Y.	130
112. Inlet at Tarrytown, N.Y.	131
113. Direct siphon at Norfolk, Va.	134
114. Bridge designed for sewer crossing	136
115. Inverted siphon at Roanoke, Va.	138
116. Inverted siphon at Newton, Mass.	139
117. Inverted siphon at New Orleans, La.	141
118. Inverted siphon at Woonsocket, R.I.	143
119. Inverted siphon at Springfield, Mass.	144
120. Inverted siphon under New York subway	145
121. Inverted siphon designed for Ithaca, N.Y.	146
122. Inverted siphon at Buenos Ayres	147
123. Inverted siphon at Providence, R.I.	149
124. Detail of inverted siphon at Ithaca, N.Y.	150
125. Screen chamber for Boston sewer	155
126. Screen chamber for Ithaca sewer	155
127. Screen chamber at Manchester, Eng.	158
128. Screen chamber at Providence, R.I.	160
129. Rectangular mesh screen at White Plains, N.Y.	160
130. Rectangular mesh screen at Marlborough, Mass.	161
131. Basket mesh screen at Cranston, R.I.	162
132. Horizontal mesh screen at Wayne, Pa.	163
133. Vertical iron-rod screen at Ithaca, N.Y.	165
134. Wooden slat screen at Providence, R.I.	166
135. Tank screen at Pullman, Ill.	167
136. Mechanical cleaning rake at Richmond, Va.	168
137. Movable screen at Birmingham, Eng.	169
138. Location of overflows, Rochester trunk sewer	171
139. Leaping weir at Milwaukee.	173
140. Parabolic path over leaping weir.	174
141. Overflow weir at Cleveland, Ohio.	175
142. Overflow weir at Providence, R.I.	177
143. Overflow weir at Rochester, N.Y.	178
144. Automatic regulator at Boston, Mass.	179
145. Automatic regulator at Worcester, Mass.	180
146. Automatic regulator at Harrisburg, Pa.	181
147. Automatic regulator at Brookline, Mass.	182
148. Regulating device of Coffin Valve Co.	183

FIGURE	PAGE
149. Automatic regulator at Woburn, Mass.....	184
150. Sections of bell-mouth intersection.....	186
151. Bell-mouth sections at Philadelphia, Pa.....	188
152. Bell-mouth sections at Boston, Mass.....	189
153. Bell-mouth sections at Boston, Mass.....	190
154. Photograph of Providence bell-mouth.....	191
155. Bell-mouth cover of I-beams with vertical walls.....	192
156. Perspective sketch of sewer junction at Minneapolis, Minn.....	193
157. Wooden cradle for brick or concrete sewer.....	197
158. Ten-inch pipe supported on piles.....	199
159. Eighteen-inch pipe supported on piles.....	200
160. Egg-shaped sewer on piles at Cambridge, Mass.....	201
161. Egg-shaped sewer on piles at Lynn, Mass.....	202
162. Egg-shaped sewers on piles at Troy, N.Y.....	203
163. Wooden barrel supported on piles.....	204
164. Basket-handle sections on piles at Boston, Mass.....	205
165. Rectangular section on piles at New York, N.Y.....	206
166. Rectangular section on piles at St. Paul, Minn.....	207
167. Cross-section of Moon Island embankment, Boston, Mass.....	208
168. Curves of settlement, Moon Island embankment, Boston, Mass.....	209
169. Protection wall and flap valve for outlet.....	212
170. Submerged outlet at Binghamton, N.Y.....	213
171. Outlet pipe in high bank.....	214
172. Outlet pipe down bluff at Niagara Falls, N.Y.....	215
173. Section of outlet, Aramingo Canal sewer, Philadelphia.....	215
174. Outlet sewer, South Metropolitan District, Boston.....	217
175. Section of outlet, Broadway outfall sewer, New York.....	218
176. Outlet sewer at Spring Lake, N.J.....	219
177. Section of wooden outlet, New London, Conn.....	220
178. Photographs of construction of Ithaca wooden outlet.....	221
179. Bank protection at Burlington, Iowa.....	223
180. Steel outfall pipe at Toronto, Canada.....	225
181. V branch with $\frac{1}{8}$ bend for house connection.....	228
182. Sketch to record location of V branches.....	229
183. T branch for connections with deep sewers.....	231
184. V branch for connections with deep sewers.....	232
185. Double V branch for connections with deep sewers.....	233
186. Sketch showing location of offset stakes.....	237
187. Sketch showing method of supporting grade boards.....	239
188. Sketch showing method of supporting grade boards.....	239
189. Sketch showing method of driving sheeting.....	247
190. Perspective sketch of Carson trench machine.....	249
191. Perspective sketch of Lidgerwood cableway.....	251
192. Photograph of Moore conveying machine.....	253



SEWER CONSTRUCTION

CHAPTER I.

SEWER PIPE.

DURING the slow development which has taken place, not only in the design of sewers, but also in the details of their construction, many kinds of material and many forms of cross-section have been used, and a great difference in the care displayed in the work itself has resulted. Stone, brick, wood, concrete, cement pipe, terra cotta pipe, and even iron pipe have all been used. Sewers have been made rectangular, horse-shoe shaped, triangular, oval, egg-shaped, and circular. They have been built of rough field stone, without mortar, and of paving brick with cement mortar. They have been rough on the inside and smoothly plastered on the outside, and vice versa. In the course of years, however, engineering practice has become crystallized, and engineers have generally adopted circular glazed terra cotta or vitrified sewer pipe as the standard conduit for all sewers under 24 inches in diameter. A large quantity of 30 and 36-inch pipe is also used, but with that size the practice is not so well established. For still larger sizes, brick or concrete is used, either separately or together, according to the judgment of the engineer.

The chief reason for the general adoption of vitrified terra cotta sewer pipe is probably cheapness, although it has the great additional advantage of having an impervious surface not affected by acids or steam, and not abraded by silt in suspension. The disadvantages are two: first, that it is impossible to prevent leakage through the joints; and second, that such pipe has only a limited strength, and must, therefore, be handled carefully, and

be thoroughly bedded in place. Compared with stone or brick, such pipe has the further advantage which comes from a smooth interior, viz., a greater discharging capacity for the same grade, an advantage which will be discussed later. It is not entirely satisfactory for the two reasons above named, and specifications are worded to minimize, as far as possible, the inherent defects of the material. The manufacturer, however, is only able to reach his standard, and the specifications must be a compromise between the wishes of the engineer and the present possibilities of the manufacturer. To make these limitations clear, the following description of the method of manufacture is given, followed by a discussion of the strength of the manufactured article.¹

Roughly speaking, vitrified terra cotta pipe is made like brick, of burned clay, but the process is more intricate. The clay must be better, that is, a purer silicate of alumina, yet with more fluxing agents, and there must be a proper admixture of sand and loam, or of old burned pipe, in order to give toughness and prevent excessive and irregular shrinkage in burning. The temperature of the kiln must be higher, and the various processes of drying, heating, burning, and cooling must be more carefully regulated than in the manufacture of brick. In some plants a careful proportioning by weight of the various ingredients is made, while in others the manager or foreman mixes two or more piles by barrowfuls in such a way as his experience dictates. The plant at St. Louis is reported to use material as follows: Fire clay, 40 per cent; surface soil, 40 per cent; yellow clay, 15 per cent; burnt pipes, 5 per cent. The analyses on the following page are taken from Ries' "Clays," 1906, and show the composition of the clays from which pipe is made in various parts of the United States.

A plant at Portland, Me., uses a clay mined in New Jersey, brought by boat to the factory and there mixed with the native clay and a small proportion of burnt pipe, finely ground.

Probably any clay which is known to make good vitrified brick

¹ Eng. News, Vol. 10, p. 329; Mun. Eng. Vol. 9, p. 280. Eng. News, Vol. 27, p. 624; U. S. Geological Survey, 18th Ann. Rep. Pt. 5, p. 1105. Eng. News, Vol. 28, p. 473; *Brick*, May 1, and June 1, 1899.

would make pipe as well, and in fact many factories make both pipe and brick with the same raw material.

ANALYSES OF SEWER PIPE CLAYS.

Silica	57.10	55.60	63.00	59.96	57.62
Alumina	21.29	24.34	23.57	15.76	21.76
Ferric oxide	7.31	6.11	1.87	7.72	3.41
Ferrous oxide46		3.70
Lime29	.43	.44	.60	.60
Magnesia	1.53	.77	.89	.93	.83
Potash	3.44	3.00	2.40	3.66	3.57
Soda61	.09	.29		.03
Titanium oxide			1.10		.83
Water	6.00	6.75	6.45	7.70	7.27
Moisture	1.30	2.65			.86
Sulphur trioxide73	
Phosphoric pentoxide14
Total	98.87	99.74	100.47	97.06	100.67

In all cases the clay has to be worked up, that is, so spaded and cut up as to make a mass of uniform moisture and density alone, and then with the burned pipe or grog.

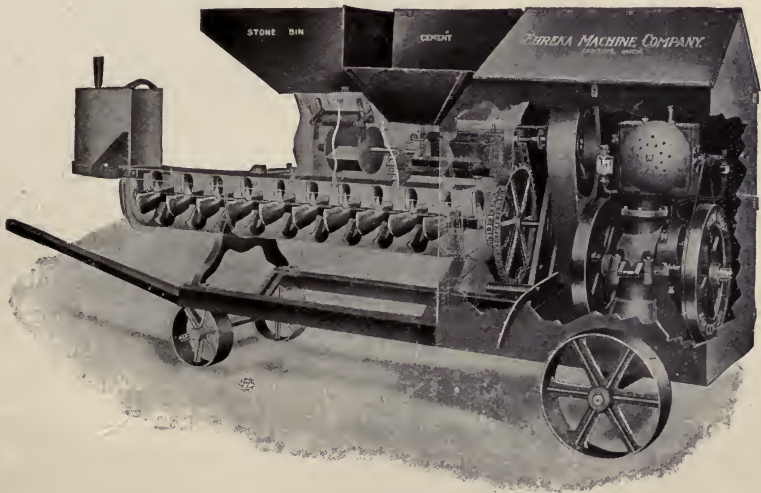

Fig. 1

The most recent plants use the common pug mill (see Fig. 1)¹ for this purpose, wheeling or conveying the clay into the mill at

¹ From Catalogue of Eureka Machine Company, Jackson, Mich.

one end and catching it at the other for another mixing in the same or another mill. The large roll mills (see Fig. 2)¹ formerly

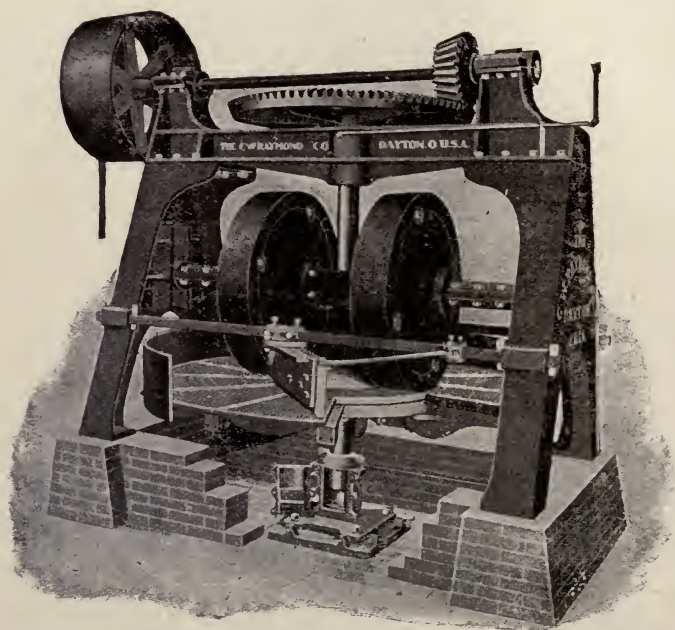

Fig. 2

used, are mills in which the clay is deposited in a large dish or pan about ten feet in diameter; a vertical spindle in the center carries a horizontal bar which extends across the pan and is revolved about the spindle by suitable bevel gearing. On the horizontal bar are two symmetrically placed cylindrical rolls of cast iron about four feet in diameter, weighing three tons each. The outer edge of the pan is perforated so that the powdered clay can pass through, while the coarser portions are being continually thrown back by guides under the rolls. Such a mill answers admirably for breaking down old pipe, but clay which has been in the open air is too wet and tenacious to be thoroughly broken up. For this reason the pug mill is preferred. The well-ground clay with its admix-

¹ From Catalogue of C. W. Raymond Company, Dayton, Ohio.

No.4 Sewer Pipe Press,
Steam Cylinder 44" x 50"
Clay Cylinder 20" x 56"

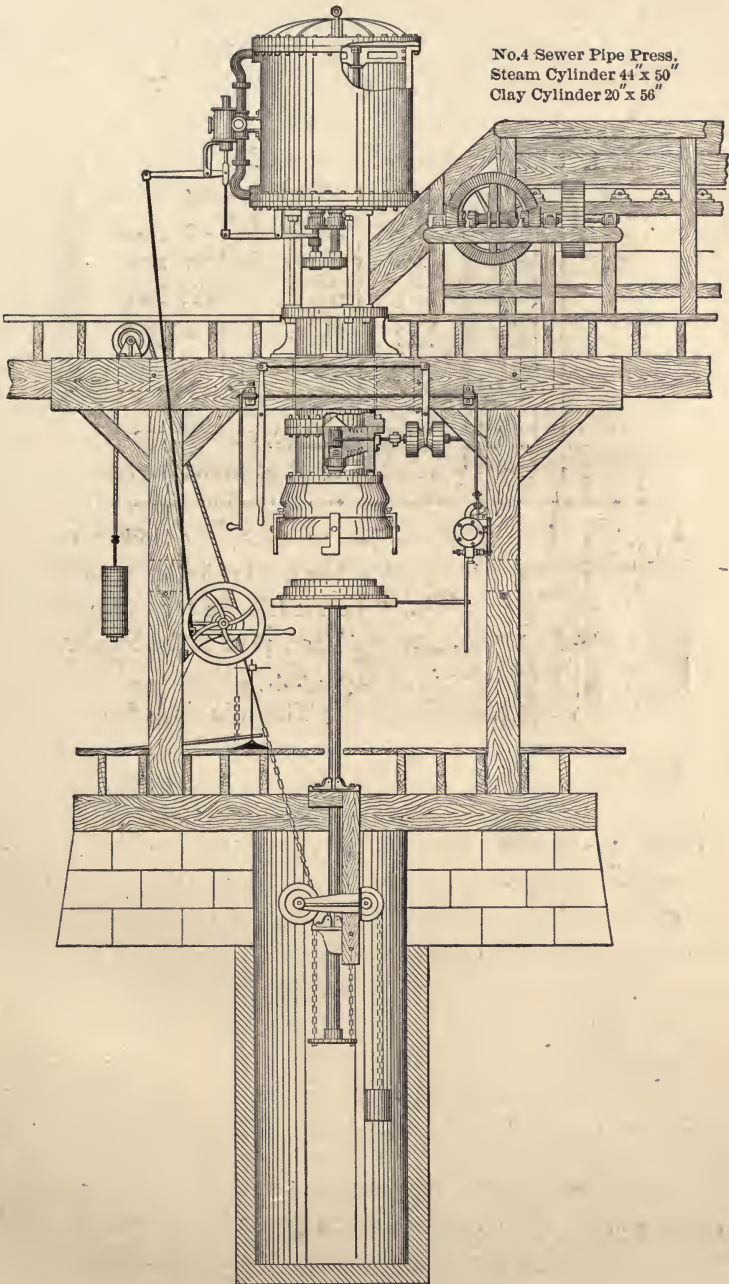

Fig. 3

ture of grog when in a proper state of moisture is brought finally by an elevator to the top of the press which forms the pipe. (See Fig. 3.)¹

The press consists essentially of two parts: the steam cylinder, three to four feet in diameter, and the mud cylinder underneath, about twenty inches in diameter. The pistons of the two cylinders are direct-connected usually by three piston rods. The clay or mud is delivered into the mud cylinder automatically at each up stroke, one charge being sufficient to make several pipes of the smaller sizes. To form the pipe, the lower end of the mud cylinder has attached to it the die for the particular sized pipe to be made. (See Fig. 4.)²

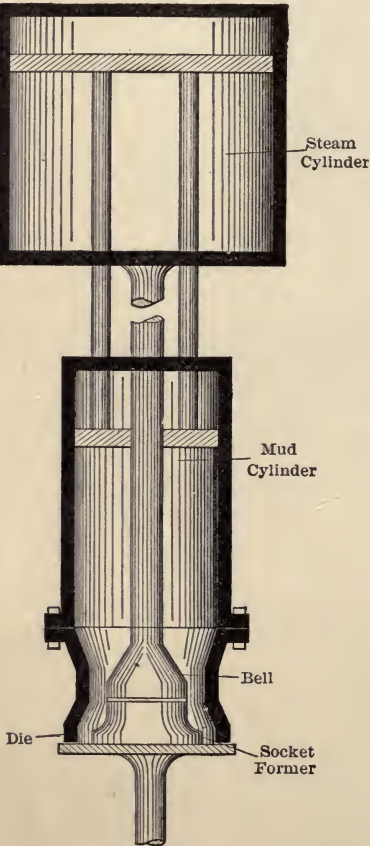

Fig. 4

The die is of cast iron, bolted by flange joints on to the mud cylinder, and so shaped that the mud forced against it takes the form of the socket of the pipe. Above the socket-former, or lower end of the die, a straight cylindrical portion serves to shape the body or straight part of the pipe. Inside the die is a cast iron bell,

the outside of which forms the inside of the pipe bell and the

¹ From Catalogue of the Turner, Vaughn & Taylor Company, Cuyahoga Falls, Ohio.

² From Eng. News, Vol. 27, p. 624.

pipe. In operation, the mud cylinder being filled, steam is admitted above, which forces the mud down between the bell and the socket-former, the escape of the mud being prevented by the table on which the bell stands. This table is then lowered slowly, the pressure being continued, and the mud, squeezed out between the bell and the die, forms the hollow cylindrical pipe. When of proper length the pipe is cut off and is then carefully set away to dry. It can be readily seen that the mud must be stiff, in order to stand up under its own weight, and it is found that practically, even with the stiffest mud, a three-foot pipe is the longest possible. Any irregularity in mixing or in the moisture tends to settle the pipe on one side, giving a curve to the pipe and detracting from its value as straight pipe. All sizes of pipe are made in the same way, the different diameters being obtained by using different dies.

The pipes are dried in large rooms, heated by steam, the process requiring from 3 to 15 days, depending on the weather. During this time the pipes are cut off to exact lengths, the edges are rounded, the corrugations are scratched on, and the Y's, T's, etc., are formed or molded on by hand. When the pipes are well dried they are wheeled into the kilns, stacked on end, small pipes inside larger ones, all resting on rings set on the floor to prevent excessive warping at that point.

The kilns are of brick, beehive shaped, 30 to 40 feet in diameter. The bottom is formed of firebrick about three feet deep, so placed as to allow the passage of smoke and gases downward to the flue, which latter runs horizontally under the bottom of the kiln to the chimney outside. The fires are built around the outside between the outside wall and the fire wall, which is about 18 inches inside and rises to the springing line of the dome, about six feet up. The hot gases in this way do not strike the pipe directly, but are reflected from the roof downwards, giving an even heat through the kiln. The time of burning depends on the size of the kiln, the kind of clay, etc., but it usually takes about five days, the increase in temperature being made very gradually, especially at first. When the pipes have reached the point of vitrification,

about 2400° F., salt in shovelfuls is thrown on the fires, and the process repeated three or four times an hour. The salt is volatilized in the presence of moisture, and hydrochloric acid is disengaged, which in the presence of the vitreous silicates of the clay unites to form a double alkaline silicate or vitreous glaze on the surface of the pipe. This glaze is a chemical union penetrating the pipe, and is not a surface skin which can scale off. It is very hard, an emery wheel scarcely cutting it, and while it is admirable in its resisting power to abrasion, it is so hard and smooth that material used for joints adheres but imperfectly. A barrellful or less of salt is used for a kiln 20 feet in diameter and 15 feet high. Common coarse salt answers the purpose, the sweepings from packing houses having been found to be satisfactory. The salting being finished, the fires are banked, the kiln gradually cooled off, and in four or five days the pipes are taken out ready for market. In drying and burning, the pipes shrink about 10 per cent in diameter and in length, so that each pipe is molded about five forty-eighths inch larger for each inch of diameter, and 10 per cent longer than is required in the final product. The exact temperature at which the salt is applied is a matter of importance, and while pyrometers of various sorts have been tried, dependence is, as a rule, placed on the experience of workmen, who are guided by the appearance of small test pieces placed in the kiln within reach. If the pipe are overburned, they are brittle, and are likely to have blisters formed in the glaze, especially with lime in the clay; if the pipe are underburned, the glaze is not well formed, and the pipe lack strength.

The usual form of sewer pipe is the so-called bell and spigot, the spigot end being merely the end of the straight pipe, with no rim as in cast iron pipe, and the bell formed on to the straight length as shown in Fig. 5.¹ Egg-shaped pipe have been made in small quantities in this country; and in 1897 a pipe, circular on the outside but with a small channel formed inside of the thick pipe to accommodate small flows, was patented in Eng-

¹ Paving, Vol. 13, p. 377. From Catalogue Monmouth Mining and Manufacturing Company.

land.¹ It is probable that attempts to change the form of the cross-section will not be successful, since any pipe except circular would be so warped in burning that the proportion of unsalable pipe would be large, making the cost of the perfect ones very high.

Many forms of bells have been made, all with the attempt to improve the water-tightness of the joint. Pipes have been made

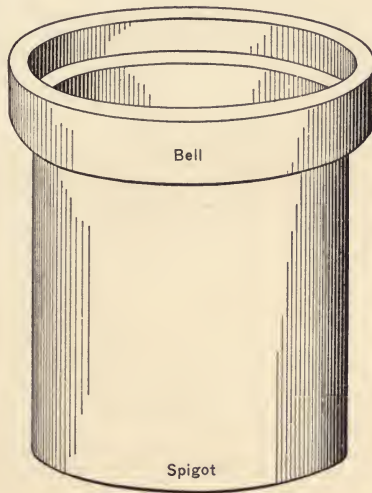

Fig. 5

without bells, the joint being made with rings or sleeves. It has been claimed that better joints can be made in this way, but their superiority has never been proved by actual experience. In England much use has been made of a joint cast onto the spigot and inside of the bell in such a way that a ball and socket motion is obtained, allowing small changes in alignment to take place without breaking the joint or the pipe. Bells much larger than the ordinary bell are required for this. Their value will be discussed under the head of joints.

Pipes are made throughout the country of the following com-

¹ Paving, Vol. 13, p. 314.

mercial sizes, 4, 5, 6, 8, 9, 10, 12, 15, 18, 20, and 24-inch diameters, and engineers, in designing, increase the size demanded by theory so as to use one of the above sizes. It is possible, if a large quantity of an odd size is wanted, to have special dies made, and the pipe burned to order. Such a requirement, even if the size of the order is such that the manufacturer is willing to meet the cost of the die, requires at least a month for the actual manufacture, and more, if the factory is full with orders for regular sizes. Certain firms make and keep on hand other sizes, such as 7, 14, 16, 21, and 22-inch diameters, but in general it is not wise to select one of these odd sizes, since it either forces a contractor to buy from one firm, shutting out other bidders, or else adds to the price he must pay for the pipe, and increases the time required for putting material on the ground. Of late, larger sizes than 24 inches have been made, and their use substituted for brick, especially for diameters of 30 and 36 inches. Their adoption is to be decided on only after a careful study of their cost and of their probable strength.

The standard length of a sewer pipe has been two feet until within the past few years, but now two and a half and three-foot lengths are generally available. Y's and T's, however, are still made in two-foot lengths only. The advantage in the greater length lies in the reduction of the number of joints, thus giving a tighter line in wet ground, and no evidence is forthcoming that the longer pipes are more likely to break when once placed in the trench. On bad bottom, where there is danger of settlement, the longer lengths should be more stable and a better alignment thus preserved. The engineer is, therefore, justified, since manufacturers have proved their ability to make three-foot lengths, in always specifying that dimension.

The proper thickness of sewer pipe has been much discussed, the relation of the strength of the pipe to the thickness being manifest. Since sewer pipe do not carry internal pressure, the method of determining the thickness must be by the other function of a pipe, namely, to withstand external pressure — a function to which theory does not readily lend its aid. The thickness,

therefore, is practically that which the experience of manufacturers has found to be necessary, and in all factories, that thickness is nearly, though not entirely, uniform for the different sizes of pipe. In the early days of the use of sewer pipe when little was known either of the strength or durability of the material, many failures resulted from the injudicious haste with which pipes were used in large quantities without any tests being made as to their ability to withstand the strains to which they were to be subjected. As a rule, all the early pipes were made too thin to stand the weight of the superincumbent earth in deep cuttings, even had they been of the good quality of the modern pipe. In Croyden,¹ England, for example, where sewer pipes were first used, 15-inch pipes were laid in a trench 20 feet deep, and as the pipes were what we should call bad, and were only five-eighths inch thick, it is not surprising that the pipe line collapsed, and that a brick arch had to be built over the top. The thickness has been increased since that time, however, and at present the average thickness of standard pipe is as given in the following table.² Manufacturers also make a thicker pipe in the larger sizes, intended to be used under railroads, near street surfaces, and in very deep cuttings. The thickness of this "double-strength pipe" is also given, its value being discussed later under the head of strength of pipe.

Size of pipe.....	6	8	9	10	12	15	18	20	24	30	36
Standard.....	$\frac{5}{8}$	$\frac{3}{4}$	$\frac{13}{16}$	$\frac{7}{8}$	1	$1\frac{1}{8}$	$1\frac{1}{4}$	$1\frac{3}{8}$	$1\frac{5}{8}$	$2\frac{1}{8}$	$2\frac{1}{2}$
Double strength.....	$1\frac{1}{8}$	$1\frac{1}{4}$	$1\frac{1}{2}$	$1\frac{7}{8}$	2	$2\frac{1}{2}$	$2\frac{3}{4}$

The joint is the weakest part of a sewer pipe line, because of its lack of rigidity, and from its failure to be water-tight. In 1891, there were inaugurated by the Portland Stoneware Company (in 1895 adopted by the Eastern Association of Pipe Manufacturers) changes in the dimensions of the sockets, in which two classes were recognized, Standard and Deep-and-wide sockets. The following

¹ Latham's Sanitary Engineering, p. 187.

² Catalogue of American Sewer Pipe Company.

table gives the depth of socket and the thickness of joint for the two classes, the relative appearance being shown in Fig. 6.

Size of pipe.....	6	8	9	10	12	15	18	20	24
Depth Standard joints.....	$1\frac{7}{8}$	2	2	$2\frac{1}{8}$	$2\frac{1}{2}$	$2\frac{1}{2}$	$2\frac{3}{4}$	3	$3\frac{1}{2}$
Thickness " ".....	$\frac{3}{8}$	$\frac{3}{8}$	$\frac{3}{8}$	$\frac{3}{8}$	$\frac{1}{2}$	$\frac{1}{2}$	$\frac{3}{4}$	$\frac{1}{2}$	$\frac{1}{2}$
Depth Deep-and-wide joints.....	2	$2\frac{1}{2}$	$2\frac{3}{4}$	$2\frac{3}{4}$	3	3	$3\frac{1}{2}$	$3\frac{1}{2}$	4
Thickness " ".....	$\frac{5}{8}$	$\frac{5}{8}$	$\frac{5}{8}$	$\frac{5}{8}$	$\frac{5}{8}$	$\frac{5}{8}$	$\frac{5}{8}$	$\frac{5}{8}$	$\frac{5}{8}$

Experiments have been made on the relative value of the two kinds of sockets, and while it has been found in laboratory experiments that on account of the porosity of the cement filler, a well-made joint in a wide socket allows a greater leakage than in a

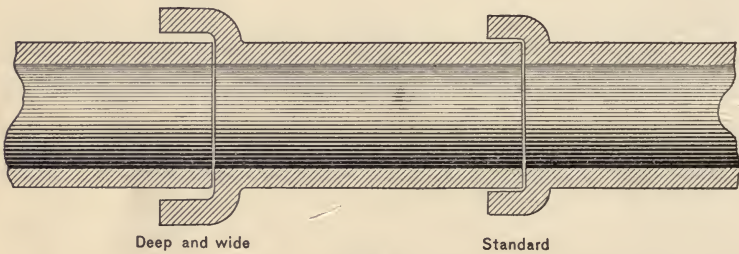

Fig. 6

standard socket, yet practically the increased space for the joint filler makes imperfect joints less likely, and really makes a tighter line. The deep-and-wide sockets should, therefore, always be used wherever the sewer is laid below ground water, and where consequently there is danger of leakage into the pipe.

Another recent improvement in the socket is the introduction of corrugations on the inside of the bell and on the outside of the spigot, by which the cement is held firmly and cannot be driven out by settlement or pressure. These corrugations are not added by all firms, but they are easily scratched on the pipe and should always be called for in specifications.

CHAPTER II.

SEWER PIPE, Continued.

UP to the year 1890, no comprehensive experiments on the strength of pipe had been carried out, and no systematic attempts to discover under what conditions sewer pipe could be safely trusted to carry its given load had been made. The few tests recorded before that time are isolated experiments by engineers made in the course of their regular work. In 1859, Mr. Adams, City Engineer of Brooklyn, made some crushing tests of the material used in pipes.¹ He prepared some two-inch cubes, and obtained a pressure of 50,000 pounds, the capacity of the machine, or 12,500 pounds per square inch, without crushing the material. He also applied pressure along the top of some domestic and imported pipes, and found that they broke as follows:

	Length.	Diameter.	Pounds.	Pounds per Linear Foot.
	Feet.	Inches.		
Scotch pipe	3	18	5542	1847
Scotch pipe	3	12	4000	1333
English pipe	3	12	4600	1533
English pipe	2	12	1672	836

In 1878, Mr. J. Herbert Shedd,² City Engineer of Providence, made some tests on the strength of standard sewer pipes, half-bedded in sand, with the following results in pounds per linear foot of pipe.

	No. of Kinds.	Minimum.	Maximum.	Average.
12-inch pipes	4	1456	1765	1601
15-inch pipes	4	1261	1765	1452
18-inch pipes	3	1464	1942	1670

¹ Sewers and Drains for Populous Districts, p. 92.

² Sewers and Drains for Populous Districts, p. 93.

In 1890, Mr. Malverd A. Howe,¹ of the Rose Polytechnic Institute, undertook to make systematic tests that would be comprehensive, so far as American pipes were concerned, and for this purpose he obtained in the open market specimens of pipe from the different factories between Wilmington, Del., and St. Louis, Mo., fifteen different firms being represented. The pipes were subjected to five different kinds of tests, viz., hydrostatic, drop, concentrated load, uniform load, and joints.

The hydrostatic tests were made to find out the strength of the pipe against internal pressure, the ends of single lengths of pipe being closed and water pumped in until the pipe broke. The average tensile strength of the material for the different sizes was as follows:

4 inches.....	517 lbs.	12 inches.....	592 lbs.
6 inches.....	678 lbs.	18 inches.....	529 lbs.
8 inches.....	552 lbs.	21 inches.....	617 lbs.
10 inches.....	702 lbs.	24 inches.....	856 lbs.

The number of specimens tested for all sizes up to 18 inches was 25, and but two above 18 inches. From these results the experimenter concluded that the average tensile strength of the material composing American vitrified sewer pipe was at least 600 pounds per square inch.

Most of the pipes broke at an internal pressure of about 100 pounds per square inch, and the following table shows the computed thickness of the various sizes, assuming an internal pressure of 100 pounds per square inch, with a tensile strength of the material of 600 pounds, as compared with the thicknesses now made commercially.

Size.....	6	8	10	12	18	21	24
Theoretical thickness.....	.50	.66	.83	1.00	1.50	1.75	2.00
Manufactured ".....	.76	.82	.90	1.05	1.39	1.89	2.02

The table shows that the thickness of sewer pipe is such that pipes will stand an internal pressure of 100 pounds and even more

¹ Jo. Assn. Eng. Soc., Vol. 10, p. 284.

with the smaller sizes before bursting, or a safe pressure of 33 pounds with a factor of safety of three.

The drop test was made to determine the resistance of the pipe to percussive action, such as a blow from a wagon wheel. It was made by supporting the pipe on two pieces of wood 2 inches wide, 16 inches apart, so arranged that a falling weight would strike the pipe near its center, midway between the supports. The weight was a box full of iron, weighing 18 pounds. A rounded strip of wood on the bottom was the striking part. The length of the drop was adjustable, but was 12 inches for the first five blows. If the pipe was not then broken, the length of drop was made 18 inches, then 24 inches, with 30 inches as a maximum. Twenty lengths were broken at the first blow, and most of the pipes were broken in four to ten blows. Mr. Howe's conclusion was that sewer pipe as made is strong enough to sustain ordinary blows, but it is evident that where successive blows may be expected, ample covering of earth or similar material should be provided to distribute the shock.

The concentrated load test was made by supporting the pipe, as just described, and then slowly applying the load through the medium of an hydraulic piston, acting against a small block of wood at the middle of the top of the pipe. Forty-two pipes of various sizes were broken, and while the smaller sizes withstood much more than 2000 pounds, it seemed a safe conclusion that the average pipe would stand at least that amount concentrated at the center with the supports 16 inches apart.

The uniform load test was made by bedding the pipe in sand in a strong box and applying pressure through a sand cover. Most of the pipe failed by splitting longitudinally at the top, bottom, and sides, and after splitting and taking their new bearings, were able to carry much heavier loads. The breaking loads, however, were taken when the pipe cracked. The small sizes sustained a load of about 8000 pounds per linear foot of pipe, and the larger sizes a little over 2000 pounds, the conclusion being that all sizes of pipe will stand a load of 2000 pounds per linear foot before breaking.

In 1897, Mr. Barbour, then City Engineer of Brockton, Mass., made some experiments¹ on the strength of pipe by covering it with about a foot of earth and applying the pressures by means of an hydraulic piston pressing down upon the earth cover. He found that the breaking load per linear foot averaged about 2800 pounds for standard pipe, and about 4200 pounds for double strength pipe. He also studied the relation between the strength and thickness and concluded that the strength varied inversely as the diameter and directly as a function of the thickness, the relation being approximately expressed by the equation $P = C \frac{t^{1.65}}{d}$, where P is the pressure in pounds per linear foot, t is the thickness in inches, and C a constant equal to 33,000. The table shows the relation obtained experimentally and by the formula, and their close agreement.

Single Strength, or Standard.				Double Strength.		
Size.	Thickness.	Strength by Experiment.	Strength by Formula.	Thickness.	Strength by Experiment.	Strength by Formula.
Inches.				Inches.		
6	.695	2613	3015
8	.822	2902	2985
10	.832	2834	2440
12	1.024	3226	2862	1.26	3916	4028
15	1.18	3207	2890	1.405	4562	3855
18	1.29	2681	2790	1.54	4146	3738
20	1.305	2584	2560	1.74	4119	4113
24	1.47	2549	2598	2.02	4334	4382

Mr. Barbour concludes from his experiments that manufacturers should be able to produce, and that engineers should demand, pipe which would have a breaking load of 3000 pounds per linear foot for standard pipe, and of 4500 pounds for double strength pipe, the thickness being so varied according to his formula or otherwise, that this strength should be obtained in all sizes. The thickness thus required is given below and may be compared with the thicknesses given in the table on page 11:

¹ Jo. Assn. Eng. Soc., Vol. 19, p. 193.

BARBOUR'S TABLES.

Size.	Thickness for 3000 Pounds.	Thickness for 4500 Pounds.	Size.	Thickness or 3000 Pounds.	Thickness for 4500 Pounds.
6.....	0.7	0.89	15.....	1.21	1.54
8.....	0.82	1.06	18.....	1.35	1.72
10.....	0.94	1.21	20.....	1.44	1.84
12.....	1.06	1.36	24.....	1.60	2.08

The *average* breaking load for sewer pipe is unfortunately not a fair criterion for the strength of the individual pipe. It is customary to test pipes roughly by striking them with a hammer in order to detect by the sound cracked and underburned pipes; whereupon such defective pieces are thrown out. But even with such pipes eliminated, those which are apparently perfectly sound show great differences in strength. For example, in the case of the 180 pipes tested by Mr. Barbour, in each size the best pipe withstood a load nearly double that withstood by the poorest, the 24-inch pipe varying from 1482 pounds to 3280 pounds per linear foot.

In Providence, in 1894, the City Engineer¹ tested some pipe as follows:

- 8-inch, minimum load per foot 757, maximum 2498 pounds.
- 12-inch, minimum load per foot 924, maximum 2816 pounds.
- 15-inch, minimum load per foot 1063, maximum 2666 pounds.
- 18-inch, minimum load per foot 1305, maximum 2401 pounds.

This shows a great difference in the possible loading, and it also shows the danger of pipes breaking, if loaded, even approximately, to what an average pipe would bear.

Mr. Barbour thinks that the average pipe will stand about 2800 pounds, although from his own experiments this amount is twice that which the poorest pipe actually withstood and 35 per cent more than the average of the poorest pipes of the 15 different groups tested.

The tests, moreover, are made on pipes carefully bedded or supported. In a trench, there is continual danger of the pipes not

¹ See Report of City Engineer, p. 41.

being supported carefully, of the dirt not being well tamped back under the pipes, of the sheeting being withdrawn on one side, and not on the other, etc. This makes the danger from broken pipes still greater, and it is a matter of experience that such imperfections do frequently develop under actual conditions.

For example, Mr. Rust, City Engineer of Toronto, said in 1888,¹

We had occasion to take up a short time ago a piece of 18-inch drain laid with Scotch pipe in a newly annexed territory, when it was found that about 75 per cent of the pipe were cracked, a large majority being broken on bottom, top, and sides.

Mr. Keating,² in the city of Halifax, says that it is an unusual thing to find a pipe sewer over 12 inches in diameter in a perfect state. He cites a case in Halifax, about 1884, where a long line of 15-inch pipe collapsed entirely a few months after being laid, due to the back-filling being frozen and, therefore, imperfectly tamped in under the pipe.

Mr. J. H. Parker,³ discussing failures of pipe in trench, comments on the frequency of such occurrences, and shows that much of the trouble is due to the method of draining the trench during construction, the pumps and drains withdrawing sand and earth from around the pipe for a distance, in some cases, of as much as ten feet. The subsequent settlement of the pipe results in fracture.

Mr. Hastings,⁴ City Engineer of Cambridge, Mass., has had the same experience of frequent instances of broken pipe; and concludes that in soils or under construction methods where standard pipe would fail, double strength would also fail. He recommends, therefore, that where the soil is uneven and uncertain, the sewer pipe be surrounded or reinforced with brick or concrete. He cites instances where 10-inch and 12-inch pipe in a 7-foot trench have been crushed by the passage of a steam roller on the surface of the street above.

¹ Trans. Can. Soc. C. E., Vol. 2, p. 306.

² Trans. Can. Soc. C. E., Vol. 1, p. 517.

³ W. Soc. Engineers, Vol. 1, p. 517.

⁴ Assn. Eng. Soc., Vol. 22, p. 87.



At Oberlin, Ohio,¹ where the sewer after completion was tested by passing a wooden ball through the pipes, 1300 linear feet were found broken out of a total length of 8650 feet of 18-inch sewer, continuous breaks occurring from 25 to 500 feet each. The pipe was good pipe, carefully laid, with bell-holes, but with untamped trenches. In relaying, shale pipe was used with careful tamping. In a month, 150 feet of this was broken.

In the construction of the joint trunk sewer in New Jersey, Mr. Alexander Potter was able to investigate this question with the following results:²

On 26,303 feet of 24-inch pipe, breaks occurred aggregating 1500 feet, each break running from 15 to 150 feet, nearly all of them being either in gravel or rock cuttings. No breaks were found in quicksand. The depths of cuts where breaks occurred varied from 6 to 20 feet, but more broken pipes were found at the lesser depths.

On 8197 feet of 22-inch standard pipe, at depths varying from 6 to 20 feet, much of which was laid on timber foundation, and none on gravel or broken stone, not a single cracked pipe was found.

Fourteen breaks occurred on 4382 feet of 20-inch pipe, aggregating 500 feet in all. All of these breaks occurred in rock cuttings where the pipe was temporarily supported on blocks until selected material was rammed solidly around and under the pipe. A close inspection of the uncovering of the pipe revealed the fact that at certain places sufficient spaces had not been left at the springing line of the pipe to allow room for the proper ramming of the back-filling around the lower half of the pipe.

On the short stretch of 18-inch pipe, laid on a heavy grade, the sewer collapsed shortly after construction, due to the flood of water washing out the newly filled-in material over the sewer under the macadam pavement which dropped on the pipe and ruptured it.

Mr. Potter's conclusion is that

the larger sizes of vitrified pipe should not be used in sanitary sewer construction, say on 20-inch and over, except on a concrete base, and the relative cost of other material should be compared upon this assumption. On sizes smaller than 20-inch, concrete should be used under the vitrified pipe far more generally than it is at present.

The author, however, in 1894, laid about 3000 feet of 24-inch double strength pipe in a trench 8 to 16 feet deep, and so far as

¹ Eng. News, Vol. 31, p. 205.

² Spec. Rept. on Joint Trunk Sewer System in Valleys of Rahway and Elizabeth Rivers.

he can ascertain by the records of house connections, none of the pipe has been broken.

The weight of superincumbent earth on a 24-inch pipe, assuming (which is doubtful) that the full weight of the earth presses on the pipe, would be, for a 20-foot trench, $2 \times 20 \times 100$, or 4000 pounds, the weight of a cubic foot of earth being taken at 100 pounds. From references given on page 17 the strength of 24-inch standard pipe may be as low as 1482 pounds, so that breakage under such conditions is not surprising. Mr. Barbour thinks from his experiments that in trenches over 10 feet deep, the pressure of the earth on the pipes is a definite ratio of the weight of the superincumbent earth, the ratio being the difference between the coefficient of friction for that earth and unity. This implies a ratio running from 35 per cent for sand to 65 per cent for clay. But even with this assumption, the pressure of the earth on the pipe for clay filling would be more than the strength of the pipe could stand, and a failure might be reasonably expected.

The usual method of making cement joints in sewer pipe is to fill the space between the bell and spigot with cement, sometimes introducing first a strand of oakum into the bottom of the joint. That this may give a tight joint is proved by the fact that cement joints are frequently used for gas pipes without appreciable leakage. Laboratory tests where the joint between the two sewer pipes is made in full view, well compacted, and given two weeks or more to harden, show that such a joint allows but a negligible amount of leakage. But the fact that the number of joints in a sewer line is large, that sewers are laid in deep trenches, frequently bedded in mud or quicksand, between sheeting boards where room is limited, causes cement joints in sewer pipes to be generally unsatisfactory. Mr. Howe,¹ in his series of tests made a number of cement joints, under the most favorable conditions, with all parts of the joint equally visible and accessible, and yet with all possible care used, with the joints hardened from one to six weeks, and with practically no leakage with the pipe barely full of water, some

¹ Loc. cit.

of the joints would allow no pressure at all, and the best of them failed utterly under a pressure of 15 pounds per square inch. The fact that when the pipes concerned in the joint were held together by iron rods to prevent axial motion, they withstood much higher pressures, shows that the failure is due probably to the water under pressure getting behind the end of the spigot. The laboratory tests that have been made indicate that even with every precaution taken, and solely on account of the porosity of the cement, a leakage of about 5000 gallons per mile per day for 6-inch pipe must be expected as a minimum, this amount increasing approximately as the square of the diameter for other sizes. Under actual conditions, however, this amount may very easily increase four or five times. A proper care in making cement joints in sewer lines would undoubtedly diminish the leakage through them, such care being expended on having the cement mixed to just the right consistency, so that it may be rammed, on having the cement thoroughly rammed into the joint completely around the pipe, on having the trench kept free from water until the cement has set, and on having the joints undisturbed by careless workmen until the cement has thoroughly hardened. It is an advantage to have two or three pipes jointed on the bank, especially in the case of 6-inch or 8-inch pipe to be laid below ground water level, the joints made out of the trench

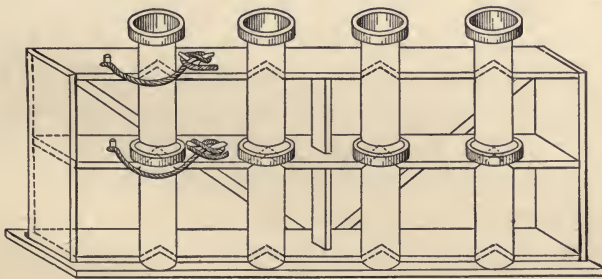

Fig. 7

being better than those made in. Fig. 7¹ shows a form of support suggested by Mr. Coffin, as suitable for this purpose, and

¹ Assn. Eng. Soc., Vol. 13, p. 712.

Fig. 8¹ shows an auxiliary device for holding the lengths of pipe, so joined, rigid while they are lowered into the trench.

Improvements in joints as they have been suggested or actually put to test, divide themselves naturally into two classes, viz., first, those where the ordinary bell and spigot pipe is used, but where,

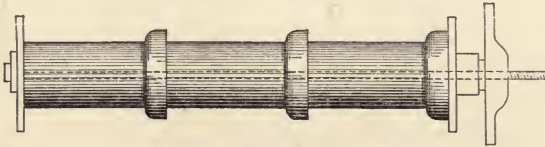

Fig. 8

instead of cement, some other jointing material is substituted; and second, where, instead of the ordinary form of pipe, a modified form of bell or spigot, or both, is used.

In the first class several substitutes for cement have been tried, among which sulphur and sand, with or without tar in addition, is the most common. With tar, the proportion being about one part of tar, four parts of sulphur, and six parts of sand, the mixture is that used in the so-called Stanford joint, popular for many years in England. The late Colonel Waring used it in Stamford, Conn., and in Norfolk, Va.,² though with doubtful success. Mr. Mohun, Chief Engineer of the Sewerage Works of Victoria, B.C., however, was well satisfied with its use in that city.³ To prepare the mixture, which is molded on to the pipe so that a water-tight slip joint is obtained, the sulphur and sand are heated separately in kettles, then mixed and the tar added, and while still hot the mixture is poured into the molds which form the castings. The castings are made with the pipe vertical, exposing it on all sides for inspection. The composition cools in a few moments, and the molds, shown in Fig. 9, are ready to be used with another pipe. The pipes, thus molded, are laid by coating the joint with some heavy oil or grease and simply shoving the pipes together. The defect of this joint as first made was that the surfaces in contact were conical, so that no movement of the pipe was possible

¹ Eng. News, Vol. 33, p. 122.

² Waring's Sewerage, pp. 104, 153.

³ Trans. Can. Soc. C. E., Vol. 10, p. 84.

without destroying the joint or breaking the pipe. An English firm, Doulton & Co.,¹ casts the material so as to make a ball

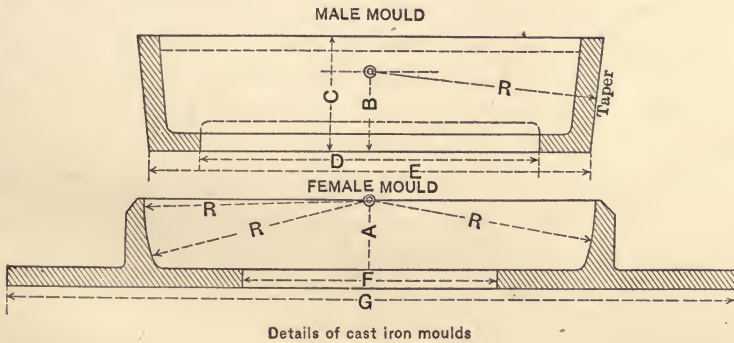
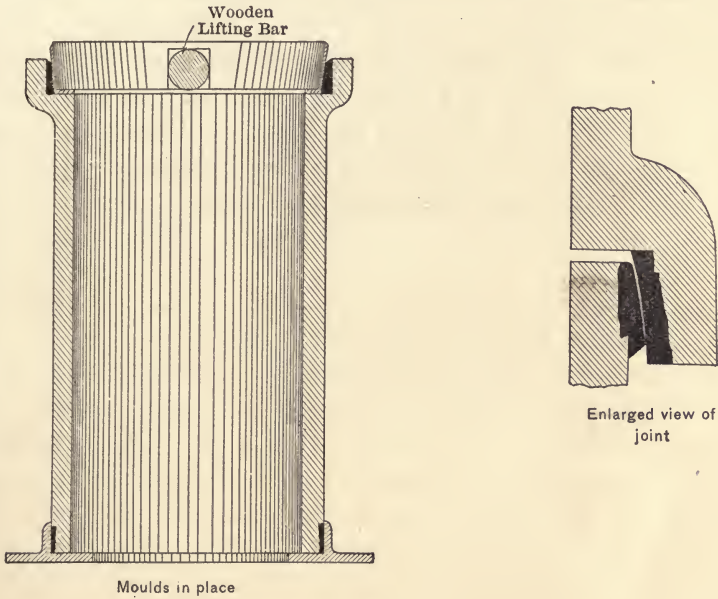

Fig. 9

and socket joint, allowing a small deflection, an improvement much appreciated by English engineers. The author has made and tested the ordinary form of these joints, and believes that if

¹ Doulton's Catalogue.

the space between the bell and spigot could be increased, the joints would be very serviceable, but with the present dimensions of American pipe there is not space enough to give a proper thickness to the casting.

Mr. Potter,¹ for pipes in wet ground in connection with the joint trunk sewer of New Jersey, omitted the tar, and used only the sulphur and sand mixture, pouring it as a lead joint in iron pipe would be poured. He claims in this way to be able to get a practically water-tight joint at a cost but little above that of the ordinary cement joint. He used from 35 to 45 per cent of sand. The larger portion of this sand was used when the temperature of the air was above 35° F. His experience indicates that even in winter, when the rapid cooling makes fine hair cracks appear, the composition is practically water-tight, provided the mixture fills the joint space completely. The finer the sand, the better the results obtained, and it is possible to buy the sulphur and sand, of the proper fineness, all mixed, from the sulphur manufacturers. The cost of the mixture was \$40 per ton, and the cost of the joint for the 8-inch pipe was 2.5 cents. The experience of the author indicates that it requires some little practice to regulate the temperature of the mixture, too low a temperature reducing the fluidity, and too high a temperature causing the mixture to become thick and pasty, so that it will not pour. The material and corresponding cost for different sizes of pipe are given by Mr. Potter as follows:

Size.	Pounds of Mixture per Joint.	Cost of Joints.				Cost per Foot.	
		Mixture.	Gasket.	Labor.	Total.	3-Foot Length.	2-Foot Length.
24	10	.125	.02	.13	.295	.10	.15
22	9	.112	.02	.13	.282	.095	.14
20	8	.10	.02	.12	.260	.090	.13
18	7	.087	.02	.11	.247	.08	.12
15	5.5	.069	.01	.10	.187	.065	.095
12	4.2	.052	.01	.09	.162	.055	.08
10	3.3	.041	.01	.08	.141	.045	.07
8	2.5	.031	.01	.07	.121	.04	.06

¹ Special Report on Joint Trunk Sewer.

Another mixture also used by Mr. Potter in this work was a combination of North Carolina pine tar and cement, mixed and kneaded until about the consistency of putty.¹ This can be forced into the joint even under water so as to completely fill the joint space. In laboratory experiments of the author, the material has the disadvantage of hardening so slowly that, in a horizontal position and especially on warm days, the material settles slowly by its own weight, leaving an open space at the top of the pipe. Mr. Potter had the same experience, the tendency to sag offsetting, in his opinion, the advantages which the plasticity of the material offered.

Asphalt has been used as a substitute for cement, the first tests and use probably being at Frankfort-am-Main about 1896. Mr. H. W. Lindley² there used ordinary sewer pipe, and a mixture of Trinidad liquid asphalt with solid bitumen. This was poured hot into the joint as in jointing iron pipe. In this country, equal quantities of Trinidad bitumen and rock asphalt have been used in the same way. At Steelton, Pa.,³ strips of burlap, 4 inches wide, were soaked in hot asphalt, twisted, and calked into the joint like oakum. It was claimed that joints thus made, when hard, stood an internal pressure of 50 pounds per square inch, without giving way, the time to harden being about 30 minutes. At Oakland, Cal.,⁴ pipes without bells were used, and the joints made by wrapping a wide strip of burlap around the joint. The burlap was soaked in hot asphalt and tied on to both pipes tightly. The engineer, Mr. Miller, reported at the time that he was able to get a joint in this way that would stand an internal pressure of 200 pounds per square inch — a seeming impossibility.

Considerable improvement in the ordinary cement joint may be obtained, especially in wet ground, by wrapping the joints tightly with cloth. At Medford, Mass., Mr. Barnes used cheese-cloth;⁵ in Ithaca, N. Y., the sewer superintendent uses table oil-

¹ Loc. cit.

² Paving, Vol. 30, p. 35.

³ Eng. News, Vol. 41, p. 405.

⁴ Paving, Vol. 19, p. 45, and Eng. Rec., Vol. 41, p. 571.

⁵ Paving, Vol. 13, p. 306.

cloth. This latter material holds the cement up to the joint even in water and allows it to harden without falling away from the pipe.

Since defective joints add so largely to the expense of a sewerage system (if ground water is to be kept out), requiring the use of cast iron pipe or a large expense in maintenance for handling the extra water, it would seem desirable that if a better material than cement is to be had that it should be used to hold the leakage down to a minimum. Instances are by no means rare in this country of sewerage systems being practical failures through the large amount of ground water leaking into the system, and the importance of this subject of joint-making can hardly be over-estimated.

In order to prevent leakage, many special forms of joints have been made in England,¹ and pipe manufacturers regularly supply these forms to the trade. The most common of the special forms is the Stanford joint already referred to. The pipes may be had with the composition already cast on, and either in the conical or spherical section, the latter being preferred. Figs. 10 and 11 show the two forms of section.

The Archer joint shown in Fig. 12 demands a special form of pipe, requiring the bell end to be changed into a double groove, into which the tongue of the spigot end may fit. In making the joint a band of clay or other material is placed in the groove so that the tongue, on being driven home, is sealed at its base. Then Portland cement grout, 3 cement to 2 water, is poured through the hole on top so as to fill the joint. The joint is claimed to be entirely water-tight.

The Hassal joint calls for no different form of pipe, except perhaps a wider socket, but it requires two composition rings to be cast on to the bell and spigot ends, exactly as if for a double Stanford joint. (See Fig. 13.) Between these rings cement grout is poured to fill the intervening space. These pipes were used extensively in Southampton, England, where new works have recently been constructed.

¹ See Moore's Sanitary Engineering.

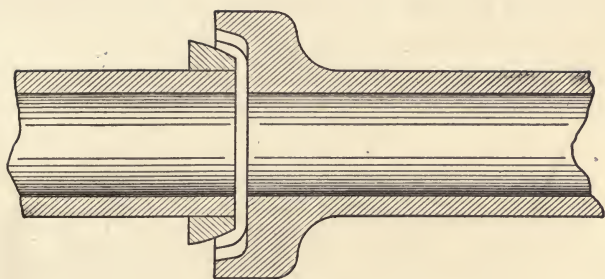

Fig. 10

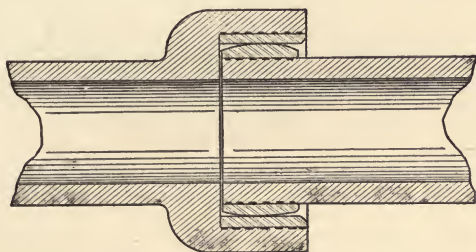

Fig. 11

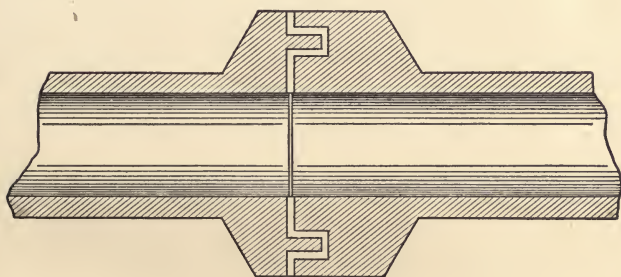

Fig. 12

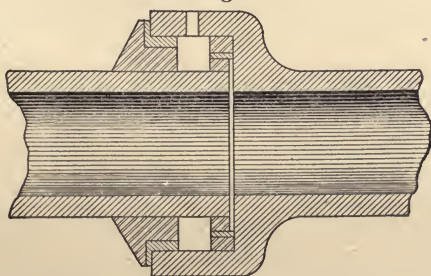

Fig. 13

Other forms, which are but variations of the above, are on the market, but the principle is that of one of these two.

The Sykes patent joint, shown in Fig. 14, however, is a new type, the joint being due to a screw thread formed in the pipe,

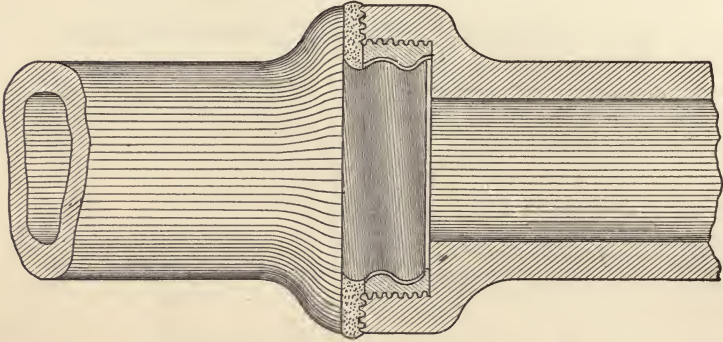

Fig. 14

a mixture like putty being first put in at the shoulder of the thread so that an effectual seal is obtained. It is stated that this joint has withstood an hydraulic pressure of 140 pounds per square inch.

CHAPTER III.

BRICK SEWERS.

WHEN a sewer has a diameter greater than 36 inches, a brick or concrete conduit must be used instead of tile pipe, and it is not unusual for these materials to be used in sizes as small as 24 inches. Where the soil is wet and there is danger of infiltration, pipe should be used up to the largest size made. If the ground is dry, the cheapest construction should be followed. A further advantage, however, belongs to the pipe, viz., its greater smoothness, giving the pipe line, as compared with brick, a smaller coefficient of roughness or a larger coefficient of flow. Compare, for example, a mile of 36-inch pipe with a coefficient of roughness (n , in Kutter's formula) of .011, with the same length of brick sewer, whose coefficient is .013. The grade for the pipe to secure a velocity of 2.5 feet per second is 1 in 2130, or .046 per cent. For the brick sewer the required grade for the same velocity is 1 in 1444, or .07 per cent. The brick sewer would therefore be 1.27 feet deeper in the ground than the pipe sewer at the lower end, an increase of excavation of about 600 cubic yards.

In some localities, as in Nova Scotia, where English pipe is generally used, and in the western states of this country, transportation charges may be so high as to make the use of brick or concrete, even with the larger amount of excavation, the cheaper; but in general, it may be said that economy will be best served by not using brick until the size required has exceeded that of the largest pipe made.

Brick for sewers should be smooth and especially hard burned — smooth, in order to reduce the friction and to prevent the arrest of floating particles, and hard, in order to reduce the wearing away of the brick by the attrition of the silt in suspension. Well-burned arch building brick are often used, but paving brick

of the smaller sizes offer an admirable combination of all the needed qualities except perhaps economy. In some localities, second-class pavers may be had at a price but little in excess of the cost of the best building brick.

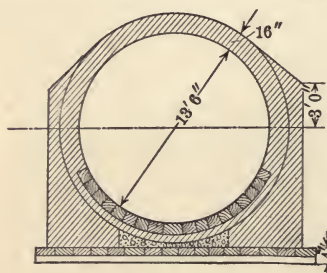

Fig. 15

Paving brick have the advantage of being impervious and non-absorptive. Since smoothness and toughness are essential only in the bottom of the sewer, it is common to economize by building only that part of paving brick or of the best building brick, using for the backing, the outer rings, and for the arch, ordinary building brick. (See Fig. 15.)¹

The plastering is then depended on to prevent infiltration.

Where egg-shaped brick sewers are built, the small radius of the invert requires the joints on the outside to be excessively thick, as shown in Fig. 16, which has been carefully drawn to scale; and to avoid this element of constructional weakness, invert blocks are often used, as shown in the same figure. These blocks are made of terra cotta and replace about four rows of brick. Fig. 17 shows the form and dimensions of the standard blocks made by the American Sewer Pipe Company. These are about a foot long, have a vertical rib in the center, a plane bottom, and the top surface conforms in curvature to the radius of the sewer in which they are to be built. Talbot's block, shown in Fig. 18, however,² has the top surface with a radius of three inches, in order to increase the hydraulic radius for small flows. The sides of the block are inclined at such an angle that they make the abutments for the brick side walls. The use of these blocks in dry soils has a distinct advantage, the alignment being accurately preserved, the surface of the blocks being smoother than that of the bricks, and the large blocks securing more rapid work. In wet soil, or in unstable soil, their use is questionable. It is claimed that if the

¹ Eng. News, Vol. 46, p. 272.

² Paving, Vol. 16, p. 154.

blocks are set on planks that there is no settlement and that the hollows in the blocks act as a drain to carry off the ground water, to the great advantage of the sewer. But the joints between successive blocks are weak, and in a large flow ground water must surely find its way through the joints into the sewer. Latham, the eminent English Sanitary Engineer, says that while these blocks act as drains during construction to remove the subsoil

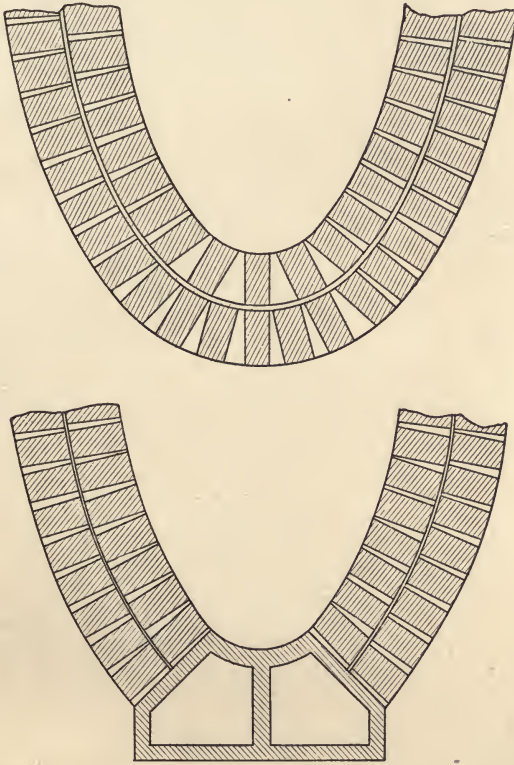

Fig. 16

water, they should be stopped up as soon as possible, and may well be filled with concrete their entire length, the reason being that particles of earth are washed from around each joint into the drain, and a settlement fatal to the integrity of the sewer follows.

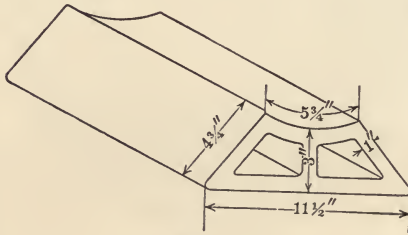
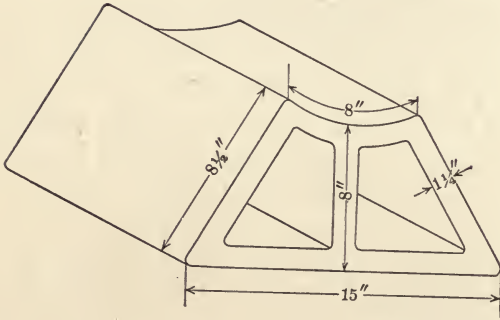

Fig. 17

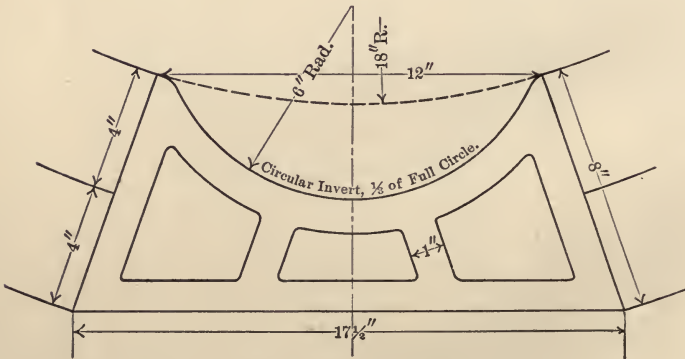

Fig. 18

He gives as his preference a form of invert block, shown in Fig. 19,¹ the block being solid, with grooves on sides and ends.

The block is so laid as to break joints, the jointing cement entering the groove on all sides, thus effectually tying the whole together. In view of Latham's experience and statement, it would



Fig. 19

seem that the hollow blocks should not be used for drainage; instead, if subsoil drainage is necessary, it should be obtained through a special pipe laid below the sewer grade.

An attempt is made in the invention of the Babcock Hollow Invert Block to remove the difficulties inherent to the use of hollow blocks for drainage, by providing a special means for the

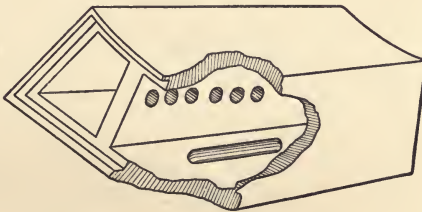

Fig. 20

admission of ground water. Fig. 20 shows the construction of the blocks.² It is claimed for these blocks that on account of the circuitous way by which the ground water gets into the blocks that no soil washings will occur, and further that the joints between

¹ Latham's Sanitary Engineering, p. 221.

² Redrawn from catalogue.

the separate blocks are so designed that there will be no leakage from the blocks up into the sewer itself. This seems to the author doubtful, and he would prefer in all cases to use separate drain pipes.

Brick sewers possess the advantage over pipe sewers that their cross-section can be varied to suit special and local conditions, as well as to secure more uniform flow with varying depths of flow. For the latter purpose egg-shaped sewers are used, their advantage having been pointed out in Chapter XVI of "Sewer Design."¹ The number of bricks used in egg-shaped sewers is slightly in excess of circular sewers of the same capacity, and the following tables give data as to the comparative dimensions of sewers of the same capacity, and the number of brick necessary for different sizes.

QUANTITY OF BRICKWORK FOR CIRCULAR SEWERS.

From Wollheim's "Sewerage Engineer's Notebook."

Diameter.		Cubic Yards of Brickwork per Lineal Foot.			
Ft.	In.	4½ In. Thick.	9 In. Thick.	13½ In. Thick.	18 In. Thick.
2	0	.103	.240
	3	.113	.260
	6	.123	.283
	9	.137	.307
3	0	.147	.327
	3	.157	.347
	6	.170	.373
	9	.180	.393
4	0	.190	.413	.670
	3	.200	.433	.703
	6	.213	.460	.737
	9	.223	.480	.770
5	0	.233	.500	.800
	3	.243	.520	.830
	6	.256	.543	.867
	9	.266	.567	.900
6	0	.277	.590	.930	1.31
	3	.287	.613	.970	1.36
	6	.300	.633	1.00	1.40
	9	.310	.653	1.03	1.44
7	0	.320	.673	1.06	1.48
	3	.330	.700	1.10	1.53
	6	.343	.720	1.13	1.57
	9	.353	.740	1.16	1.61
8	0	.363	.760	1.19	1.65
	3	.376	.786	1.23	1.70
	6	.387	.807	1.26	1.75
	9	.397	.827	1.29	1.79
9	0	.407	.850	1.32	1.83
	3	.420	.873	1.36	1.88
	6	.430	.893	1.39	1.92
	9	.440	.913	1.42	1.96
10	0	.453	.937	1.46	2.01

¹ Ogden's Sewer Design, p. 192.

QUANTITY OF BRICKWORK FOR EGG-SHAPED SEWERS.

From Wollheim's "Sewerage Engineer's Notebook."

Dimensions Ft. In. Ft. In.		Area in Square Feet.	Cubic Yards of Brickwork per Lineal Foot.		
			4½ In. Thick.	9 In. Thick.	13½ In. Thick.
2 0	3 0	4.600	.127	.287	.480
2 4	3 6	6.261	.143	.323	.533
2 8	4 0	8.178	.163	.360	.590
3 0	4 6	10.350	.180	.396	.643
3 4	5 0	12.778	.200	.433	.700
3 8	5 6	15.461	.217	.470	.753
4 0	6 0	18.400	.237	.506	.807
4 4	6 6	21.594	.257	.543	.867
4 8	7 0	25.044	.273	.580	.916
5 0	7 6	28.750	.293	.617	.973
5 4	8 0	32.711	.310	.653	1.027
5 8	8 6	36.928	.330	.690	1.083
6 0	9 0	41.400	.347	.726	1.136

NOTE. — The quantity of brickwork for a new egg-shaped sewer is from one to two per cent less than that for a standard egg-shaped sewer of equal internal dimensions, and for all practical purposes may therefore be taken as equal to the same.

To compare the amount of brickwork in circular sewers and in egg-shaped sewers, Folwell says that the diameter of a circular sewer having an equal area with an egg-shaped sewer is $1.209 D$ where D is the horizontal diameter of the egg-shaped sewer. Wollheim says that the transverse diameter of an egg-shaped sewer, of equal discharging capacity with a circular sewer whose diameter is unity, is 0.8388 . The latter also gives this rule to determine the relative proportions of an egg-shaped and a circular sewer to deliver equal volumes, provided they both flow full and have the same fall, viz.,

Diam. of circle : radius of egg-shape :: 0.300 : 0.116 or radius of egg-shape equals diam. of circle $\times 0.39$.

For further discussion of the mathematical elements involved, articles may be found in Eng. News, Vol. 43, pp. 259 and 357; also Eng. News, Vol. 44, pp. 28 and 94.

The proper thickness of a brick sewer must be determined chiefly by experience. Up to 36 inches diameter or 2 feet 8 inches by 4 feet 0 inches egg-shape, in firm and unyielding soils, a half-brick of four and one-half inches thickness is considered sufficient. In soft, yielding soils, however, this is not safe, and either con-

crete backing must be used under the haunches or the sewer made 9 inches thick. An example of a failure occurred during the construction of a 2 × 3-foot brick sewer at Newton, Mass., where in passing through quicksand the arch settled so much that the thickness had to be increased to 9 inches, though elsewhere 4½ inches was sufficient. On the other hand, in firm, dry clay, 4½-inch walls may be used for even larger sewers, as the following examples show:

At South Bend, Ind., the city engineer, by an experience of many years, has become convinced that a 4-inch wall is ample, and in 1894 he wrote:¹ "We continue to construct brick sewers up to 48 × 68 inches of a single ring, that prove perfectly stable in our soil." He built a single ring four-foot sewer in a 12-foot trench, which in 1893 had lasted for 30 years. The 48 × 68-inch sewer is in a 22-foot trench, and seems perfectly stable.

In Springfield, Ill.,² the construction of a 7-foot circular brick 4-inch thick sewer was begun in 1894, and is probably the largest single-ring brick sewer ever built. The brick used are side-cut, shale pavers, and they are laid in 1 : 2 cement mortar. The adoption of such a doubtful construction was due entirely to a small appropriation and to the stability of the clay soil. Mr. Richard, the engineer, says he would not advocate the construction of all sewers of this dimension with a single ring, but that in many localities they can be used with a great saving to the taxpayers.

Baldwin Latham gives the following formula,³ which he says is convenient for determining the proper thickness: $t = \frac{d.r}{100}$, where t is the thickness of the brickwork in feet, d the depth of excavation in feet, and r the external radius of the sewer in feet. That this formula can be only approximate is apparent from its form, no account being taken of the character of the soil or of the fact

¹ Paving, Vol. 6, p. 10.

² Paving, Vol. 7, p. 17; Proc. Ill. Soc. C. E., 1895.

³ Latham's Sanitary Engineering, p. 226.

that the thickness may increase indefinitely with the depth of the cutting.

Scheffle, a noted French railroad engineer, says, in speaking of arch linings for tunnels, "I believe that in earth of average character, the load on the arch lining of a two-track tunnel never exceeds that due to the weight of the superincumbent earth of 30 to 40 feet depth, and that for a single-track tunnel the depth would be considerably reduced." In the narrow sewer trench, the depth of earth furnishing load would be still more decreased, so that Latham's formula would be limited in its use to depths within that limit. Mr. Barbour has made experiments on this point, and finds that with the width of trench experimented on, from 3 to 8 feet, the percentage of the load transmitted to a buried structure is constant for a fill of more than ten feet, and in no case below that depth is the full weight of the superincumbent earth carried to the arch. His experiments are the only ones, so far as the author knows, on this subject, and his conclusions are worth repeating here, since they bear directly on the loading to be imposed on the sewer arch. The thickness of the arch ring should be determined by the loading on the same, and therefore the inquiry into the loading is pertinent.

The experiments¹ were made in a trench dug for the purpose, from 3 to 8 feet wide, 5 feet long, and 11 feet deep. A calibrated hydraulic press was placed in the bottom so arranged that the pressure could be read on the surface of the ground. On the press a platform was built on which the filling was placed. The filling was of loam, or sand and gravel, and the sides of the trench were sheeted, left in earth with vertical side and with sides battered at different angles. In one experiment, the sheeting was purposely roughened by nailing on cleats. Mr. Barbour's conclusions were as follows: First, that the friction of the earth against the sides of the trench has little effect, but that the cohesion of the filling material is the factor determining the net pressure. Second, the cohesion increases rapidly to a depth of about five feet, and from there it changes slightly up to ten feet,

¹ Assn. Eng. Soc., Vol. 19, p. 193.

where it becomes almost constant. Third, in the case of two kinds of material the per cent of the weight of the superincumbent earth is nearly constant above ten feet of filling, and is practically the difference between unity and the coefficient of friction for the material in question, viz., 31 per cent for loam and 36 per cent for gravel. Fourth, if this may be considered a law, and extended to wet clay with a coefficient of 35, the greatest per-

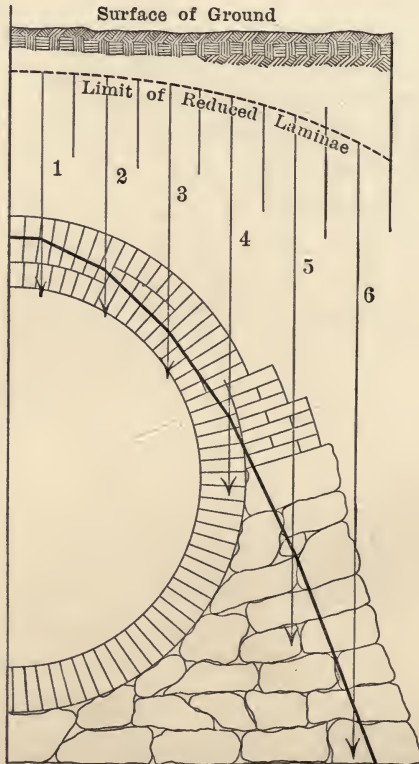

Fig. 21

centage of the weight of superincumbent earth would be 65 per cent. Fifth, the addition of concentrated loads on the filling adds a percentage of pressure to the pipe, but the increase is in a less ratio than that found for the filling, so that the filling ratio is safe for any concentrated loading.

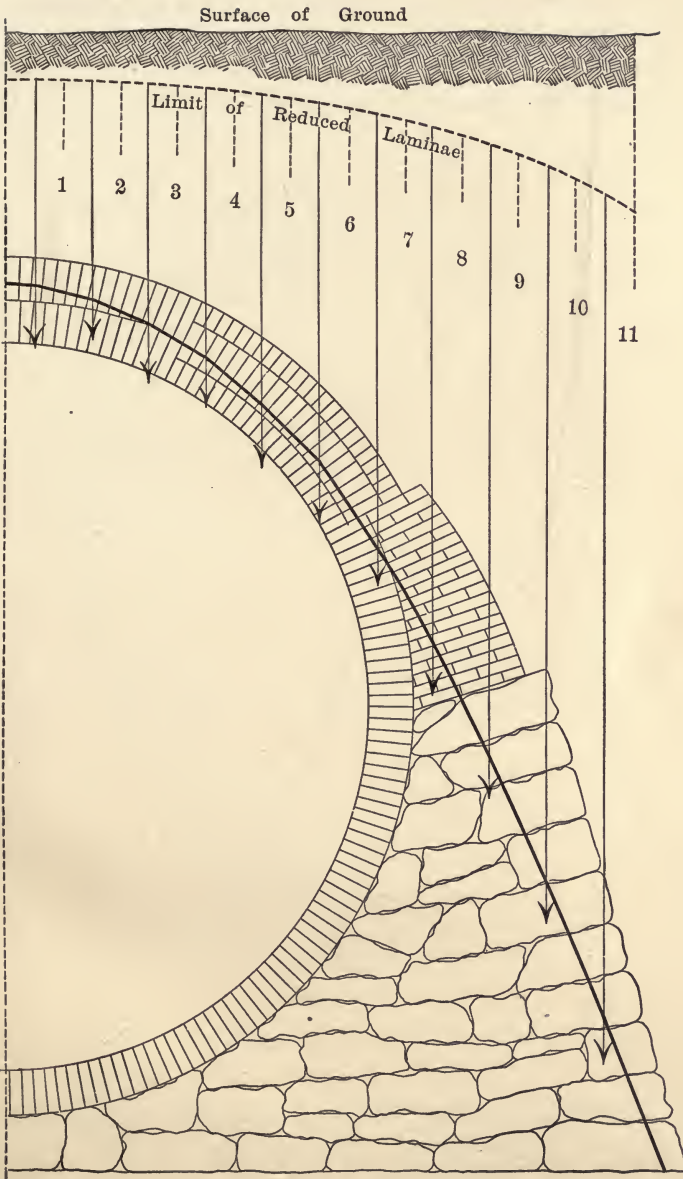

Fig. 22

For the sake of illustration, the above data may be applied to the selection of a 24-inch pipe for an assumed trench in gravel, 15 feet of cover on the pipe, the gravel weighing 115 pounds per cubic foot. The weight on the pipe then is $115 \times 2 \times 15$, or

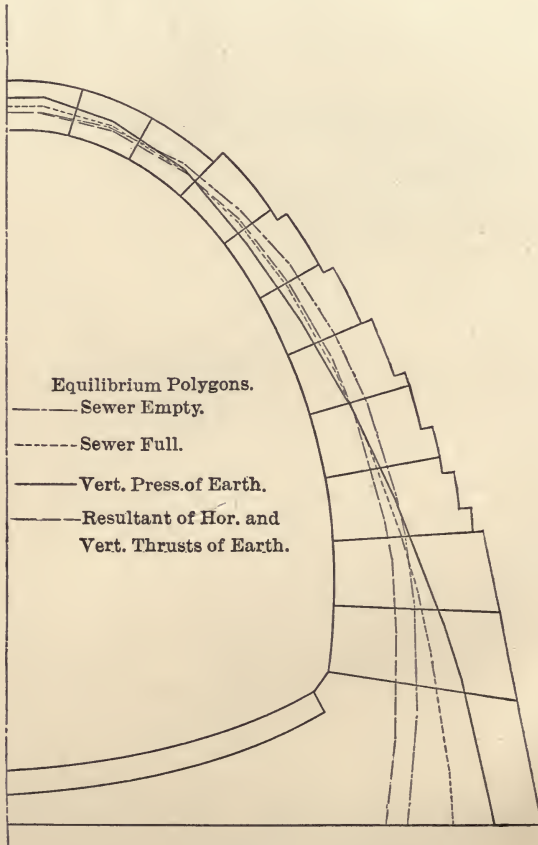

Fig. 23

3450 pounds per running foot, and the pressure transmitted to the pipe is 3450 pounds \times 36 per cent, or 1242 pounds. Standard pipe should sustain a load of 3000 pounds per lineal foot without breaking, but the pipe as made in 24-inch sizes

only average about 2000 pounds. Mr. Barbour thinks that in order to allow for weak, cracked, or underburned pipe, a factor of safety of 3 should be used, making the safe load on the pipe about 700 pounds per lineal foot. The inference then is that

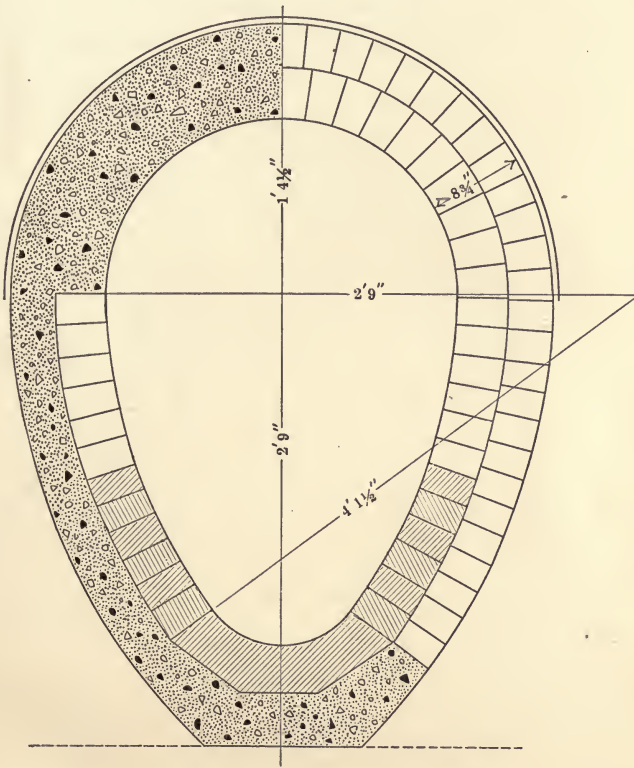

Fig. 24

double-strength pipe should be used, or else some concrete reinforcement.

For sewers larger than 6 feet diameter an analysis of the strains in the brick arch should be made, together with the abutment reactions. If the soil on the side of the trench is not considered firm enough to withstand the thrust of the arch,

additional brickwork or other masonry backing must be added, the maximum amount being that necessary to act as an abutment if the arch were built entirely above ground. A thorough study of the strains in the arches of large sewers and the necessary amount of masonry backing to take up those strains was given to the intercepting sewers of the city of Philadelphia by Mr. Rudolph Hering, and described by him in an interesting

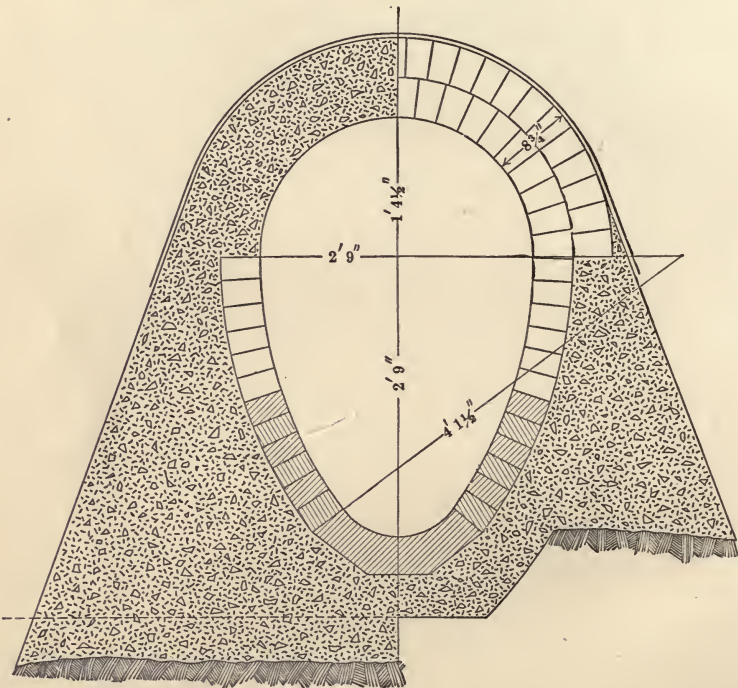

Fig. 25

paper before the American Society of Civil Engineers.¹ Figs. 21 and 22 show the lines of pressures as determined for the two given arches with the assumed loading and the variation in the thickness of the arch in order to keep this line within the middle third. Fig. 23 shows an investigation of the same

¹ Trans. Am. Soc. C. E., Vol. 7, p. 252.

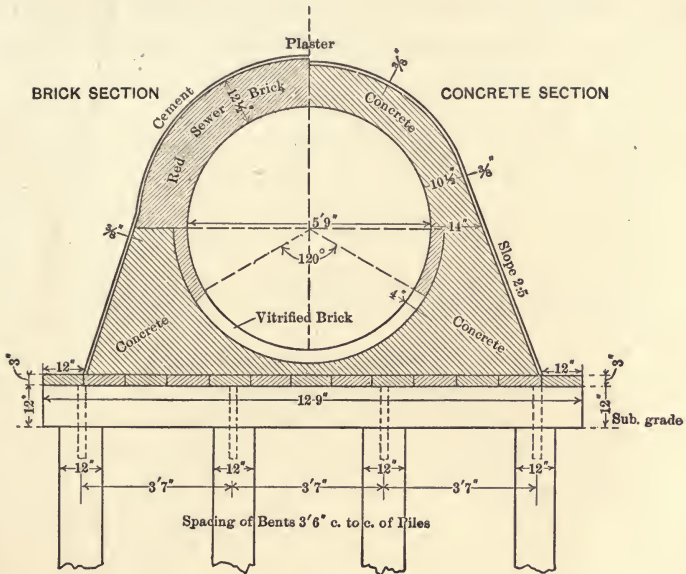

Fig. 26

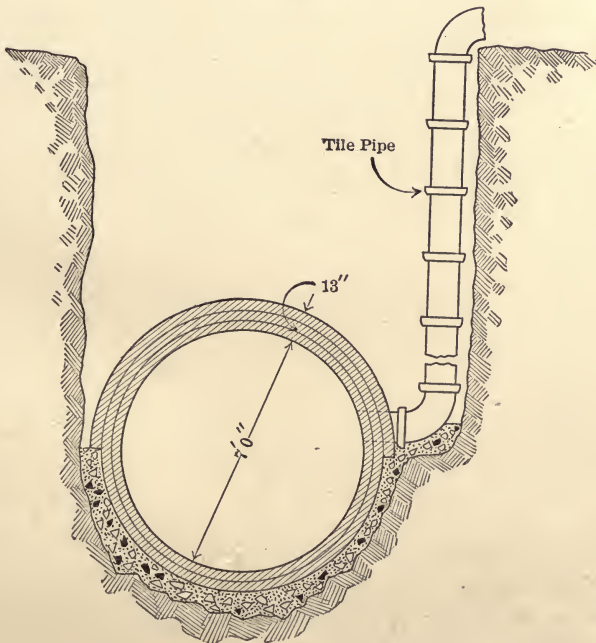

Fig. 27

sort but made more complete, 4 different lines of pressures being drawn for 4 different sorts of loading, and the thickness

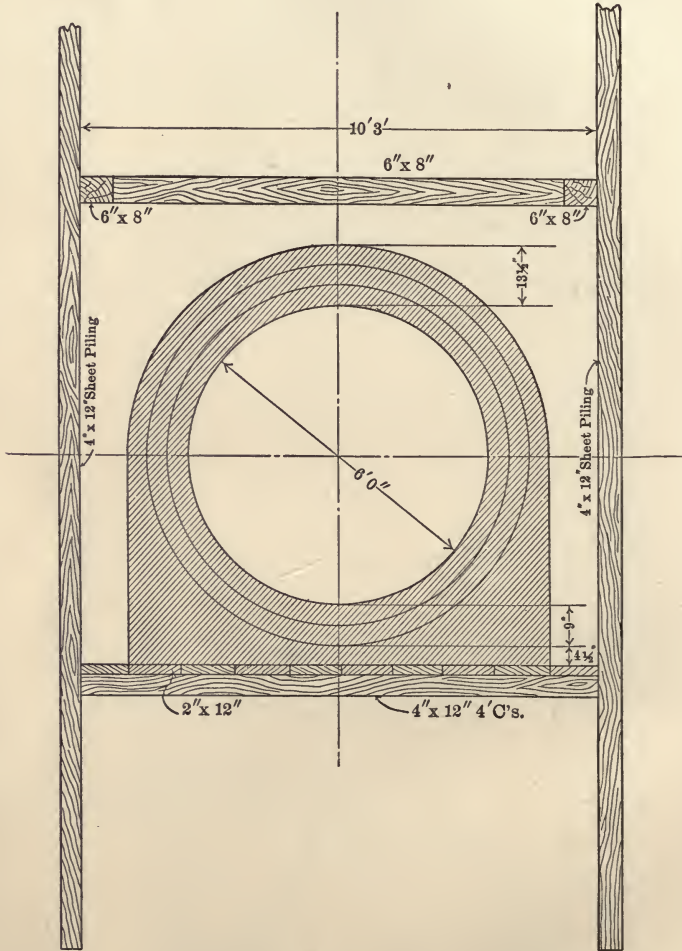

Fig. 28

being determined so that the line will fall within the middle third for all cases. The method of analysis by which the lines of pressure are drawn may be found in Church's "Mechanics,"

Chapter X, in Howe's "Symmetrical Masonry Arches," and in many other treatises and text-books on arches.

If the earth filling were perfectly compacted and noncompressible, no thickening of the arch would be necessary, and there would be no need of any abutment, the thickness of the arch being carried around uniformly. Between this condition and that where the filling cannot be depended on for any resistance, there are intermediate conditions where a partial backing must be substituted, the amount of backing being determined altogether by the judgment of the engineer. The following examples are given to show the actual variation in practice, the thickness being partly a matter of the filling, and partly a matter of the caution or boldness of the engineer.

The section shown in Fig. 24 of the Washington, D.C., sewer¹ is used for all sizes between 2 feet 6 inches \times 3 feet 9 inches and 3 feet 3 inches \times 4 feet 10½ inches, no single-ring sewers being laid. If the soil is yielding, however, the invert is made heavier, as shown in Fig. 25, one row of brick being cut out. In these two drawings a terra cotta block is shown in the invert, flanked on each side by six vitrified or paving brick. The other brick shown are ordinary red building brick, the whole surrounded with concrete.

Fig. 26 (on piles)¹, in its left half shows a brick section for a sewer 5 feet 9 inches diameter, 12½ inches, or three brick thick, the placing of the concrete backing being more economical.

Fig. 27 shows a section of a seven-foot brick sewer at Ottawa, Can., in rock, and illustrates how the uneven surface of the rock may be smoothed up with concrete in readiness for the rings of brickwork.²

Fig. 28 shows a section of the 6-foot main sewer in New Orleans, the uncertain and water-bearing soil requiring the timber foundation with tongue and grooved sheeting.³

¹ Report of Eng. Dep. of the Dist. of Col. for year ending June 30, 1895.

² Engineering Record, Vol. 40, p. 600.

³ Assn. Eng. Soc., Vol. 27, p. 199.

Fig. 29 shows a section of the 94-inch Delgany Street sewer in Denver, Col. A large part of the sewer is on made ground,

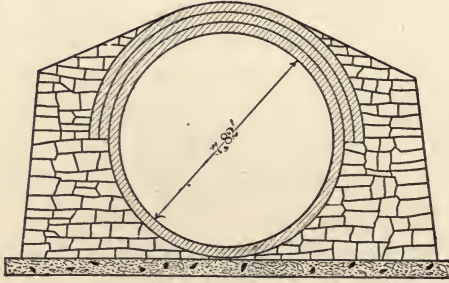

Fig. 29

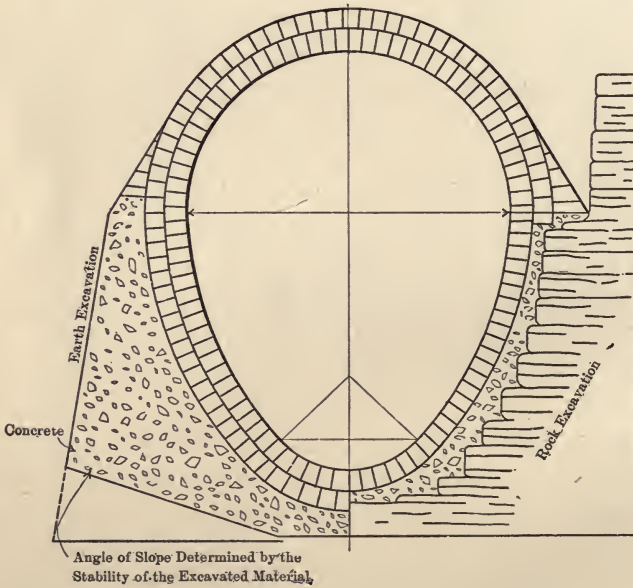

Fig. 30

and a part of it is above ground so that the heavy section shown was required.¹

¹ Eng. News, Vol. 34, p. 430; Am. Soc. C. E., Vol. 35, p. 102.

Fig. 15, already referred to, shows a section of the sewer masonry in open cut 40 × 60 inches in Sixtieth Street sewer tunnel, Brooklyn. The material is firm sand, carrying considerable water; it will not stand up during excavation, but is hardly unstable enough to class as quicksand.¹

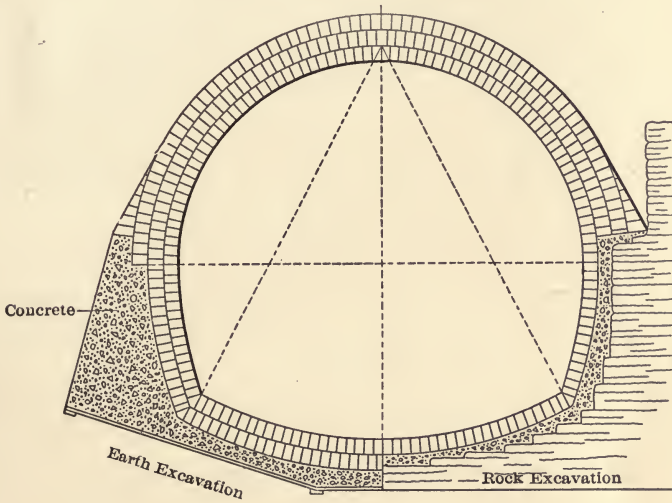

Fig. 31

Fig. 30 shows a typical cross-section of an egg-shaped sewer whose vertical diameter is from 4 to 6 feet. In a rock trench, as shown on the right half of the drawing, concrete backing is used in sufficient quantity only to fill up the irregularities of the rock which is excavated to fit the outside of the sewer. In earth excavation, enough concrete is placed to act as an abutment, the amount being made to vary with the stability of the earth. The design shown is that of the West Side Trunk sewer in Rochester, N. Y. Fig. 31 shows a section of the same sewer at a point where the vertical diameter is 8 feet 7 inches and the maximum horizontal diameter is 9 feet 3 inches, the two conditions of backing being shown as before.

¹ Eng., Vol. 46, p. 272.

The brickwork of sewers is generally laid in rowlock bond, so called (see Fig. 32); that is, the brick are laid as stretchers and separately in the different rings, the bond being made up only by

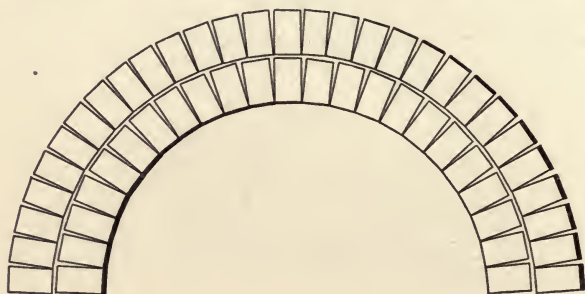

Fig. 32

the strength of the cement between. For small sizes, the space on the outside of the joint, even in single rings, is large, and it is often required that pieces of slate or brick be used to chink in these openings. English engineers have required the use of specially molded brick shaped to the proper radius of the sewer, but in this country this refinement has not been considered necessary. In order to distribute the pressure in the arch ring evenly, through the different rings of brick, some better bond than that due to the adhesion of the cement ought to be provided. This can be done by laying a course of brick as headers through the arch at such intervals as the radius allows, one more brick in the outer ring than in the inner one. In a 3-foot sewer this is possible every three courses, as shown by Fig. 33, originally drawn to full scale. In large sewers, the change in length of the inner and outer circumference takes place more gradually, and the opportunity for inserting headers comes less frequently. A block voussoir may be built through the arch at regular intervals, and the brick of the different courses cut to fit between the several voussoirs. These voussoirs may be of cut stone or of brick built up in the form of voussoirs or headers, the former practice being the better. The question of bond should be thoroughly worked out on paper, the drawing being of large scale, so that the bond may be specifically

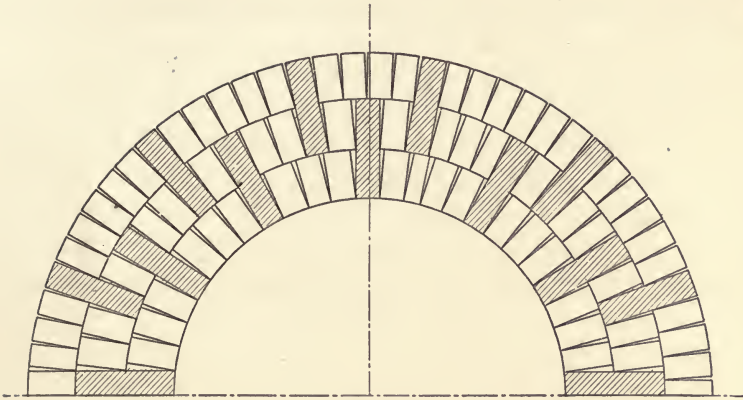

Fig. 33

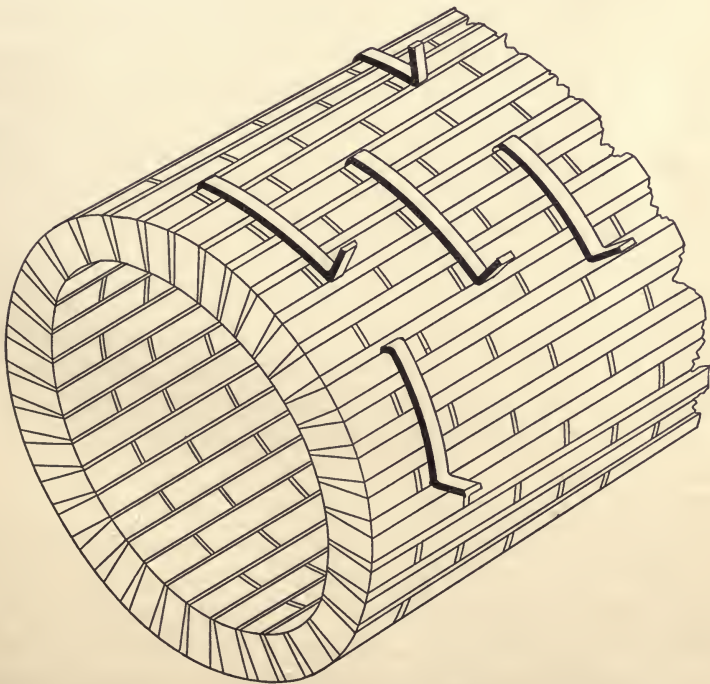

Fig. 34

detailed and instructions given to the masons before the work is begun.

A cheap and useful reinforcement is afforded by the use of strap iron laid about two feet apart around the sewer between the rings, with one end turned up between the brick of the outer course, and the other end turned down between the brick of the next inner one. (See Fig. 34.)

The mortar for brick sewers is commonly made of Portland cement mixed 1 : 3, the plaster coats being 1 : 1. Cement mortar, especially when wet, works with difficulty under the trowel. The brick absorb the moisture, and the mortar seems to have no adhesion to the brick. If the mortar is made very wet, the brick slide out of place, and it is difficult to keep the walls to line and grade. A small amount of slaked lime not only increases the density of the mortar, but causes the mortar to work more easily. Probably 10 per cent of lime, based on the weight of the cement, would have no bad effects on the strength of the mortar, but would improve it, both in strength and density. Experienced bricklayers become very expert at laying sewer brick, and instead of 1000 or 1500 brick, which is a fair day's work on a house wall, a good man will lay from 2500 to 4000 brick a day in a large sewer. The mortar is mixed thin, and the brick dropped into place much as the brick in a street pavement are placed. The author has seen a laborer detailed to place the mortar by the shovelful, while the mason handled the brick only, making the joint by the dexterous shove he gave the brick as it was put into place. Work is well done by this method, and joints are well filled, and the surface is left smooth, the only requirement being a form, or cradle, in which to place the brick.

The actual construction of a brick sewer involves little that is unusual. The first step is the placing of the row of brick which is to form the invert. In good soil this is laid on a bed of mortar placed directly on the ground. Then next to this row, on each side consecutively, the adjoining rows are placed, tamping dirt underneath to bring the top edge to line. If it is a two-ring sewer, the second ring follows three or four courses behind the

first, both stopping at the horizontal diameter, where the two courses are brought to a plane and leveled up. This lower part is allowed to set two or three days, when the arch centering is placed and the brickwork of the arch is built up. If the ground is soft, a concrete base must be placed first, on which the brick may be supported. Or a timber cradle can be built, the ribs of 2-inch lumber spaced about 4 feet, and 2-inch lagging nailed to the inside, so that it has the form of the outside of the brickwork. These cradles are best made in place, and carefully held to grade while gravel is tamped under and around them. The brick is then laid against these forms. The arch forms are made in lengths of from 8 to 16 feet, so designed that they can be readily lowered from their position against the arch, taken out, and used again. Some examples of arch forms are shown under concrete.

CHAPTER IV.

CONCRETE SEWERS.

THE use of concrete in sewer construction is growing constantly, both in connection with brickwork, either for backing or as an integral part of the sewer ring, and also separately in cases where brick or pipe is not easily available. For building small sewers the Chenoweth process is convenient, allowing, as it does, a continuous mixing and placing of the concrete without stopping to make or move the necessary forms. This process was used in 1894 for building 900 feet of 24-inch pipe and a mile of 10-inch pipe at Scarborough-on-the-Hudson.¹ The concrete was composed of 5 parts broken stone, 2 parts sand, and 1 part cement, and was reported to have cost for the larger size, 95 cents, and for the smaller, 30 cents, per foot, for the conduit alone in place, as compared with 97 cents and 23 cents for the corresponding sizes of vitrified tile. The process, invented by Mr. Alexander Chenoweth, of New York City, is described as follows: A collapsible mandrel, held apart by wedges, is placed on grade, and a thin galvanized ribbon is wound spirally around the mandrel. The concrete is tamped around the mandrel to the proper thickness. The mandrels are then loosened and drawn forward, while the ribbon is left in place supporting the green concrete. A new piece of ribbon is attached to that in place, and wound around the mandrels. The trench is filled with the ribbon of steel in place, and the ribbon is not moved for about 10 days, when it is withdrawn from the rear through a manhole. The inventor claims that a length of several hundred feet of pipe can be freed

¹ Eng. News, Vol. 26, p. 369; Vol. 31, p. 81; Vol. 33, p. 223; Vol. 51, p. 164.

from the ribbon in this way. An experimental piece of sewer built after this patent in 1891 at High Bridge¹, is still in good condition.

Another invention for making concrete pipe continuously is that of Mr. W. L. Ransome, of Chicago, which has the advantage that all the concrete, even that of the invert, can be tamped in place. The essential part of the invention is the mold, which is cylindrical but cut off obliquely at the front.² When placed in position in the trench, which is trimmed properly to grade, the prow of the mold is located at the beginning of the sewer. A cover box or outside mold is laid on the trench bottom at such a depth below the core mold as will give the proper thickness to the pipe. The cover box, drawn ahead, slowly smooths, and by its weight compresses the earth bottom. The core mold following, with its long, oblique prow, gives the thickness to the concrete, which is tamped from the front end. A cover mold, also cut off obliquely, gives the thickness to the top of the pipe. The three molds are drawn ahead at a rate corresponding to the rate of placing the concrete, and the green concrete is found to be self-sustaining in the smaller sizes of pipe. When the pipe is larger than 24-inch diameter a modification has to be made. The top part of the core mold is made with a projecting horn, on which are strung half-rings of iron. These rings, supported by small iron struts, are left behind at intervals as the mold moves ahead. The struts are placed vertically and horizontally by a boy who stays inside for this purpose.

This form of mold has been used at Oakland, Cal., where 400 feet of cable conduit were laid per day, and at Denver, Col., where it was employed for making 7000 feet of 38-inch water pipe. In this latter city, with a gang of 30 men, performing all their various duties systematically, the machine was capable of making about 600 feet of pipe daily, although on account of stoppages and delays the average daily rate did not exceed 300 feet. The proportions used were three and three

¹ Eng. News, Vol. 26, p. 369.

² Eng. Rec., Vol. 53, p. 349.

and one-half parts of river gravel to one part of cement. The cost of the pipe was \$1.35 to \$1.50 per foot, with cement at \$3.75 per barrel, gravel \$1.25 per yard, and wages \$1.75 to \$2.00 per day. The cost of the same size vitrified pipe, if it could be bought, would be about \$3.00 per foot in place.

There has been some attempt in the past to make and use cement pipe in the same way that sewer pipe are made, viz., singly in molds, afterwards to be jointed together in the trench. Brooklyn for many years had the distinction of being the one city which demanded cement pipe for all its sewer extensions. Washington, D.C., uses cement in the form of concrete largely, making the pipe in place, and generally of larger sizes than vitrified pipe are made.

There has been a prevalent opinion that a cement pipe was likely to be more porous and more brittle than vitrified pipe, and therefore to be shunned. Of late years, however, several cement sewer pipe machines have been devised and put on the market, which will probably result in the increasing use of cement pipe. Formerly, the high price of cement prevented competition with clay pipe, but in the past few years this does not hold. There seems to be no reason why well-constructed cement sewer pipe should not last as long as vitrified pipe, unless, indeed, subjected to acids which attack the concrete matrix. There are good and bad grades of cement pipe, and the pipe must be properly made and used, or the results will prove unsatisfactory. The possibility of weak and porous spots in cement or concrete pipe is probably the greatest fault. One shovelful of gravel deficient in or poorly mixed with cement makes a defect in the pipe line which cannot be remedied. Where the cement layer is as thin as it must be in a cement pipe to compare with a vitrified clay pipe, the danger is, of course, greater than with concrete in thicker layers. Not for a moment even must the vigilance of the inspector or the faithfulness of the workmen be relaxed if good pipe are to be obtained. Even under these conditions, some imperfections are likely to be found in the pipe.

During 1904, the United States Geological Survey¹ conducted a series of experiments on concrete pipe, reinforced with steel rods. Seven pipes were made, each 5 feet in diameter, 20 feet long, the concrete being 6 inches thick in all pipes. The tests were made with the hope that the pipes would show themselves capable of withstanding an interior pressure of at least 100 feet without excessive leakage. The materials were carefully mixed and placed, and every precaution taken to secure good pipes. The results of testing the first two pipes were such that the engineer in charge concluded that it was practically impossible to make a concrete pipe non-porous without some water-proof plaster on the inside. Without the plaster, the pipes, though six inches thick, leaked so much that it was not possible to get any pressure in them. The water leaked away faster than the pumps could supply it. He found the greatest leakage where tamping seams occurred, places where different batches of concrete met, and where the tamping was not sufficient for thorough incorporation. He found it difficult to get water-tight joints with short lengths, and insists that concrete pipe must have imperfections, many of which cannot be easily avoided. Altogether the experiments were not favorable to concrete or cement pipe, proving without question the supreme importance of eternal vigilance, and, even with it, the impossibility of obtaining pipe good enough to withstand any internal pressure without good plaster coating on the inside.

Cement pipes are made by tamping a dry mixture of sand and cement, either 1 : 3 or 1 : 4, into a vertical mold. The molds can be removed at once and are ready for a second pipe. Three men can mold and set aside about 4 twenty-four inch pipes and 9 twelve-inch pipes per hour.

The following table shows the thickness of cement pipe as made by the Miracle Company, with their estimate of quantities and cost.²

These figures were computed for a 1 : 3 mixture, the pipe made

¹ Water Supply Papers, No. 143.

² Catalogue Cement Machinery Manufacturing Company, Columbus, Ohio.

in two-foot lengths, the sand costing 75 cents per cubic yard, and the cement \$2.00 per barrel. Twenty-four-inch pipe in three-foot lengths, made by the author for testing purposes, a few at a time, cost at the rate of about 50 cents per foot.

Size.	Thickness.	Cubic Feet of Sand per Pipe.	Cost of Labor.	Total Cost per Foot.
Inches.	Inches.	Feet.	Dollars.	Dollars.
6.....	1	0.324	0.08	0.050
8.....	1	0.452	0.08	0.065
10.....	1	0.830	0.10	0.115
12.....	1	1.100	0.10	0.155
15.....	1	1.400	0.11	0.192
18.....	1	1.840	0.13	0.237
20.....	1	1.950	0.13	0.255
24.....	2	2.750	0.15	0.343
30.....	2 $\frac{1}{2}$	3.700	0.17	0.443
36.....	3	4.900	0.20	0.575

At Coldwater, Mich.,¹ in the summer of 1901, use was made of molded blocks for the construction of the arch of a $3\frac{1}{2}$ -foot circular sewer. The invert up to the horizontal diameter was of gravel concrete, the roughly shaped trench bottom serving as the outside form. The blocks were molded in advance of field construction, each block being solid, 24 inches long along the line of the sewer, $5\frac{3}{4}$ inches on the intrados, 8 inches on the extrados, and 8 inches through, or thick. The gravel cost but little, the molds were of wood lined with tin, and the cement cost \$1.35 per barrel. The blocks cost about 12 cents each under those conditions, or at the rate of about \$4.20 per cubic yard for the concrete in the form of blocks. This is, of course, a low price for concrete in such small forms, and it is possible that under other conditions the use of brick might be cheaper. The only advantage of the blocks over the concrete placed in mass in the arch is that the forms can be made somewhat cheaper, and can be moved ahead as soon as the key block is placed. Otherwise, this method has no advantage over other methods.

The greatest use of concrete in sewer construction, however, is not in the form of molded pipe, nor yet of blocks, both made

¹ Eng. Rec., Vol. 48, p. 101.

in a factory and brought on to the work, but is in its use at the site of the work. For convenience in description its use there may be divided into three classes:

- (1) Used alone in monolithic construction.
- (2) Used in connection with brickwork.
- (3) Used in connection with steel.

The following examples may be cited of sewers built of concrete alone.

Fig. 35 shows concrete sections used at Washington, D.C., for 12 and 24-inch pipes. The inside lining is a $1\frac{3}{4}$ -inch plaster coat, depended on to make the sewer impervious.

A monolithic concrete storm sewer was built in 1900 by the Chicago Transfer and Clearing Company¹ to carry off storm water from their extensive railroad yards. (See Fig. 36.) The mixture was in the ratio of 92 cubic yards stone, 51.5 cubic yards sand, and 18 cubic yards cement. The bottom of the trench was trimmed to the outside of the sewer ring. The invert concrete was then put in and tamped and carried up on the sides without outside forms until the invert had an angle of about 140 degrees. Then arch forms were put in, the lagging being 3 × 2-inch stuff, edges chamfered. The lagging was loose and merely laid in place. Where necessary, planks were used to set out the side of the trench and keep the side concrete of the specified thickness. No outside forms were used on the arch. The centers were easily removed by swinging about their vertical diameter. A plaster coat of 1 : 3 was used to smooth up the inside and to insure imperviousness. The 90-inch and 84-inch mains had a uniform thickness of wall of 12 inches; the 48-inch main, a ring 10 inches thick; and the 42 and 36-inch mains, rings 8 inches thick. The excavation was mostly in blue clay.

A solid concrete sewer 3 feet 6 inches × 2 feet 4 inches was built in New York City along the subway between Fifty-fourth and Fifty-eighth Streets.² (See Fig. 37.) For this sewer, the

¹ Assn. Engrs. Cornell University, Vol. 10, p. 47.

² Eng. News, Vol. 47, p. 201.

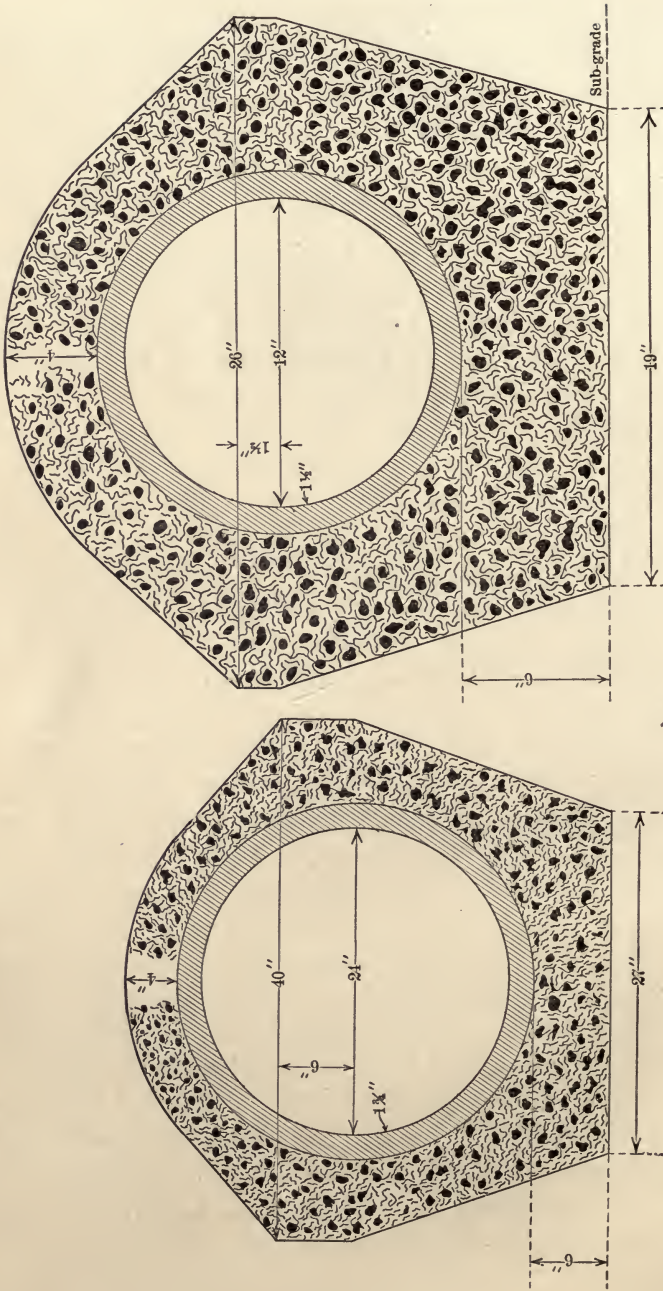

Fig. 35

concrete was placed in the bottom of the trench until its top surface was within one-fourth inch of flow line grade. An inside form was then set and planks used to form the outside of the

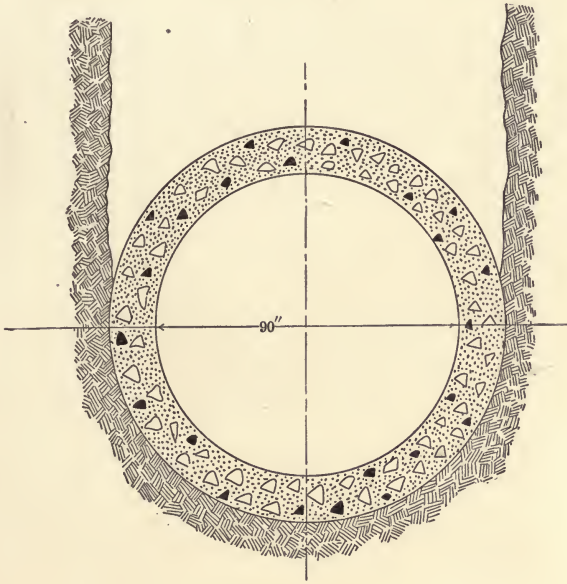

Fig. 36

spandrel. The invert concrete was 1 : 2 : 4, the stone being broken to pass through a 1-inch ring. After the invert was set and the form withdrawn, a thin wash of cement was given the inside to perfect the smooth interior. The arch forms were then placed, and filling was held in place by battered side boards braced against the sides of the trench. It was reported that these sewers cost one-third less than brick sewers of the same dimensions, and that no variation from the true grade was found to be as much as .01 foot.

Fig. 38 shows the cross-sections of the concrete sewers used as mains in Victoria, B.C., as designed by Mr. Edward Mohun.¹

The concrete was made in the proportion of $2\frac{1}{2}$ shingle,

¹ Can. Soc., Vol. 10, p. 80.



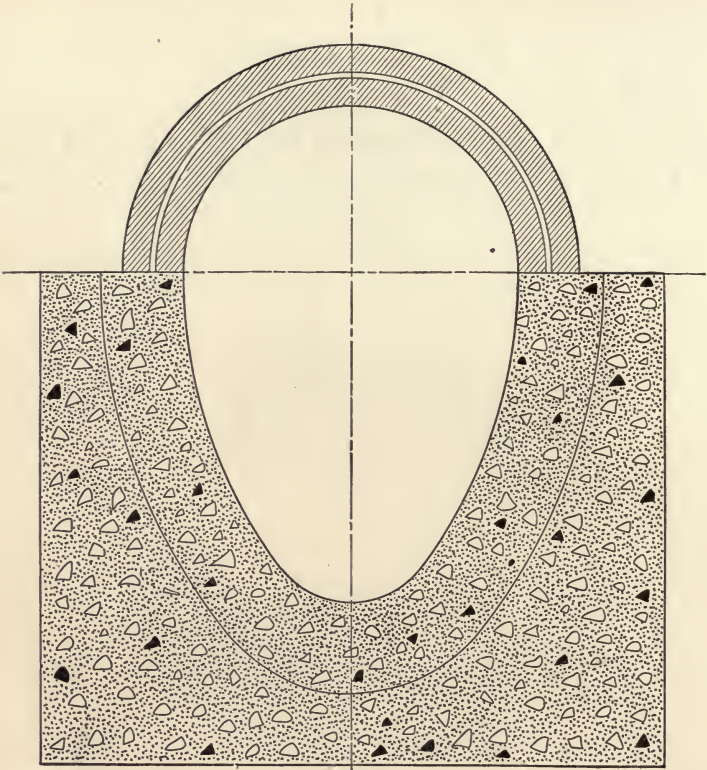

Fig. 37

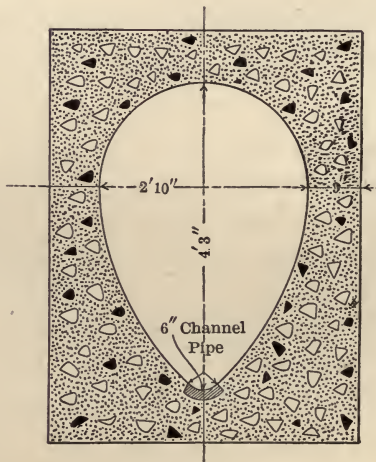

Fig. 38

$2\frac{1}{2}$ sand, and 1 cement, the shingle and sand being both taken directly from the sea beach. The trenching was largely in sand, and planks were placed inside the trenches to form the outside of the concrete walls. The channel pipe was laid to grade and the concrete tamped in tight. Forms for the inner surface were then set, the invert part first, and when the concrete was set and that part moved ahead, the arch form was placed and the concrete filled in. It was stated that the additional cost of the concrete in this method was more than saved by the use of unskilled labor in moving and preparing the outside forms, the lumber being removed and used over and over.

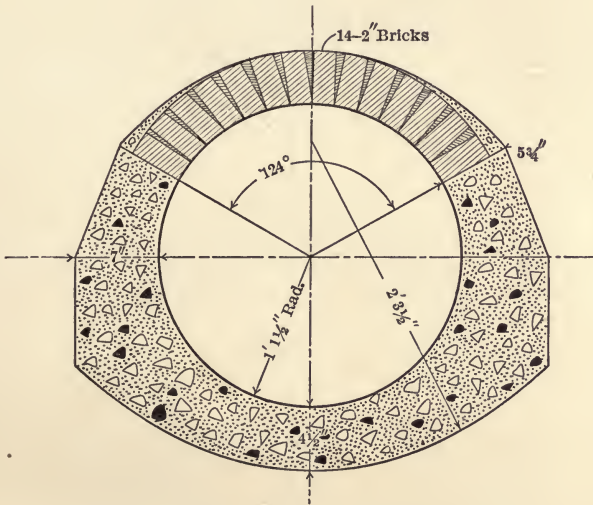

Fig. 39

A storm-water sewer was constructed in Truro in 1902,¹ which possesses some noteworthy features, the engineers being Lea & Coffin, of Montreal and Boston. (See Fig. 39.)

The concrete used consisted of 1 part cement, $2\frac{1}{2}$ parts sand, and $4\frac{1}{2}$ parts gravel, passing a 2-inch screen and caught on a sand screen. The determination of the proportions was such

¹ Eng. Rec., Vol. 46, p. 196.

SEWER CONSTRUCTION

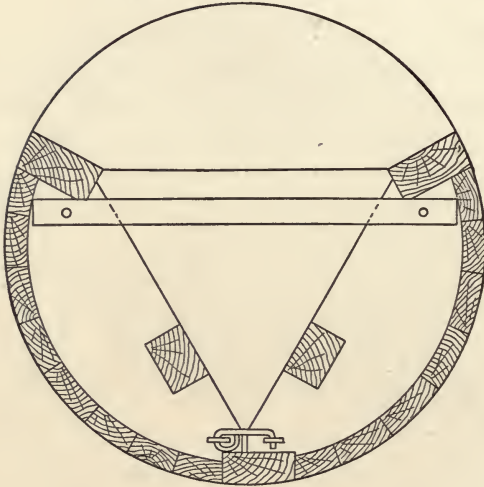

Fig. 40

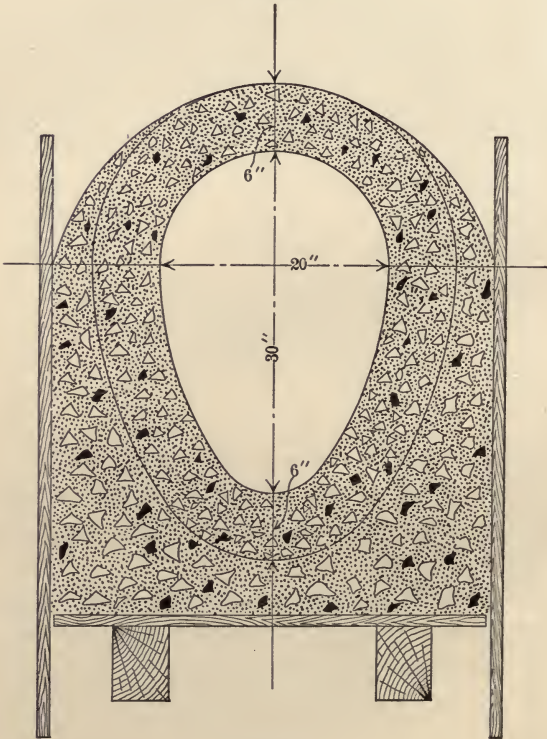

Fig. 41

as to give a slight excess of sand and cement in the voids of the gravel. The centering was of 1-inch planed and matched pine, nailed to ribs of 2-inch planking spaced 2 feet apart. Along the top on each side of the centering were placed two 2×4 -inch hardwood stringers, between which at every second rib was a 2×3 -inch removable hardwood brace. The centering was made in 10 and 12-foot lengths, and in halves hooked together at the bottom and held in place at the top, while in use, by the hardwood braces (shown in Fig. 40). The concrete was laid to grade in the bottom. The forms were then set, and planks laid on edge along each side of the trench as a mold for the outside of the concrete, held in place by iron pins driven into the ground. The arch, of about 124 degrees, was of brick laid on light forms.

A 20×30 -inch concrete sewer, shown in Fig. 41, was built in Swampscott, Mass., in 1903, partly in tunnel and partly in soft ground.¹ The concrete was 1:2:4 gravel. The foundation concrete was first laid, then the invert was built, its outside being braced against the sides and bottom of the tunnel or sheeting. The concrete backing was then put in place and the arch of the sewer put in. The lagging of 1-inch boards was covered with zinc for smoothness, the sections being 10 feet long. After the concrete had fully set in the tunnel work, the space was filled with gravel.

The following additional typical cross-sections are given (see Fig. 42 and Fig. 43), taken from the catalogue of the Blaw Collapsible Steel Centering Company, of Pittsburg, the thickness in each case being that recommended by William B. Fuller, City Engineer of Newport City, for average practice in both hard and soft material. The same engineer gives the following directions for determining the proper proportions of concrete, a method which is so definite and direct, and at the same time so convincing, that it deserves the widest circulation.

On important work, where the greatest strength and water-tightness are desired from the given cement, sand and stone, the right proportions should be obtained

¹ Eng. Rec., Vol. 47, p. 550.

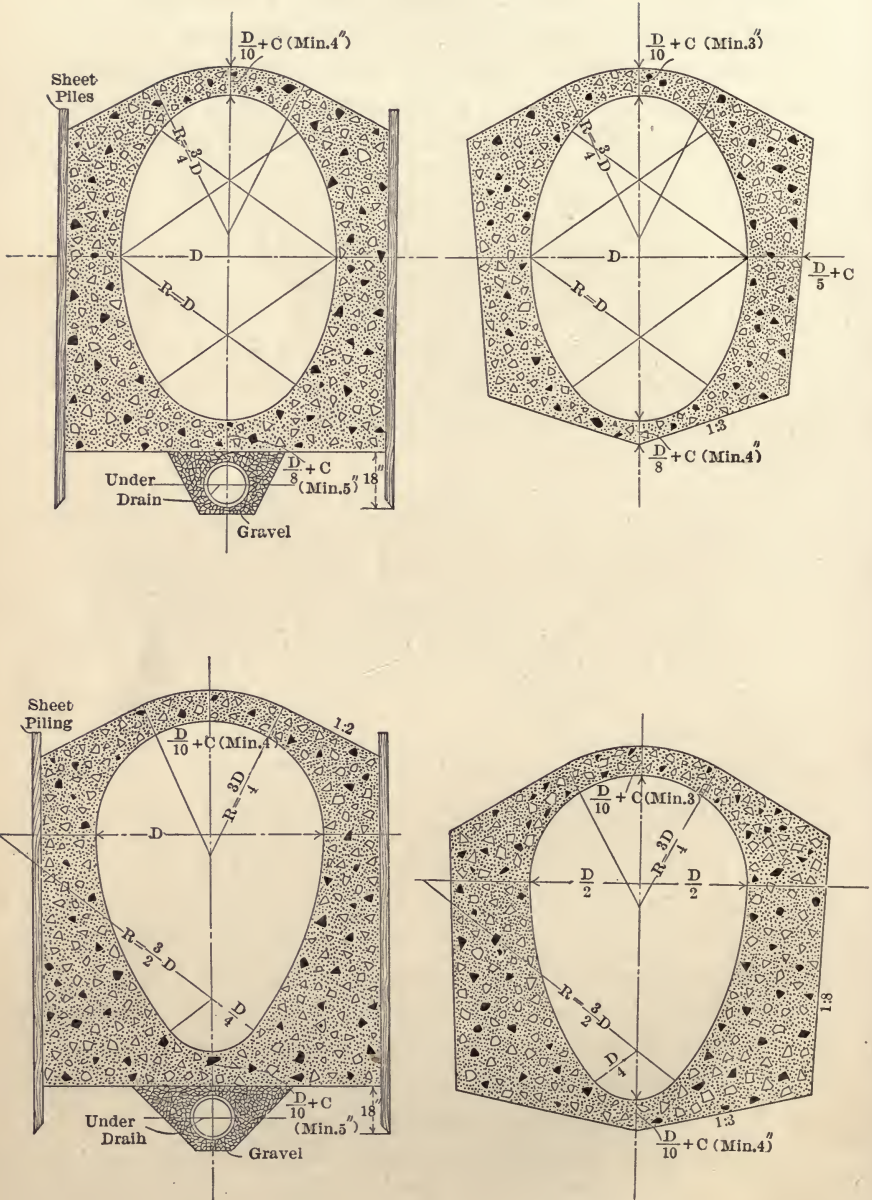

Fig. 42

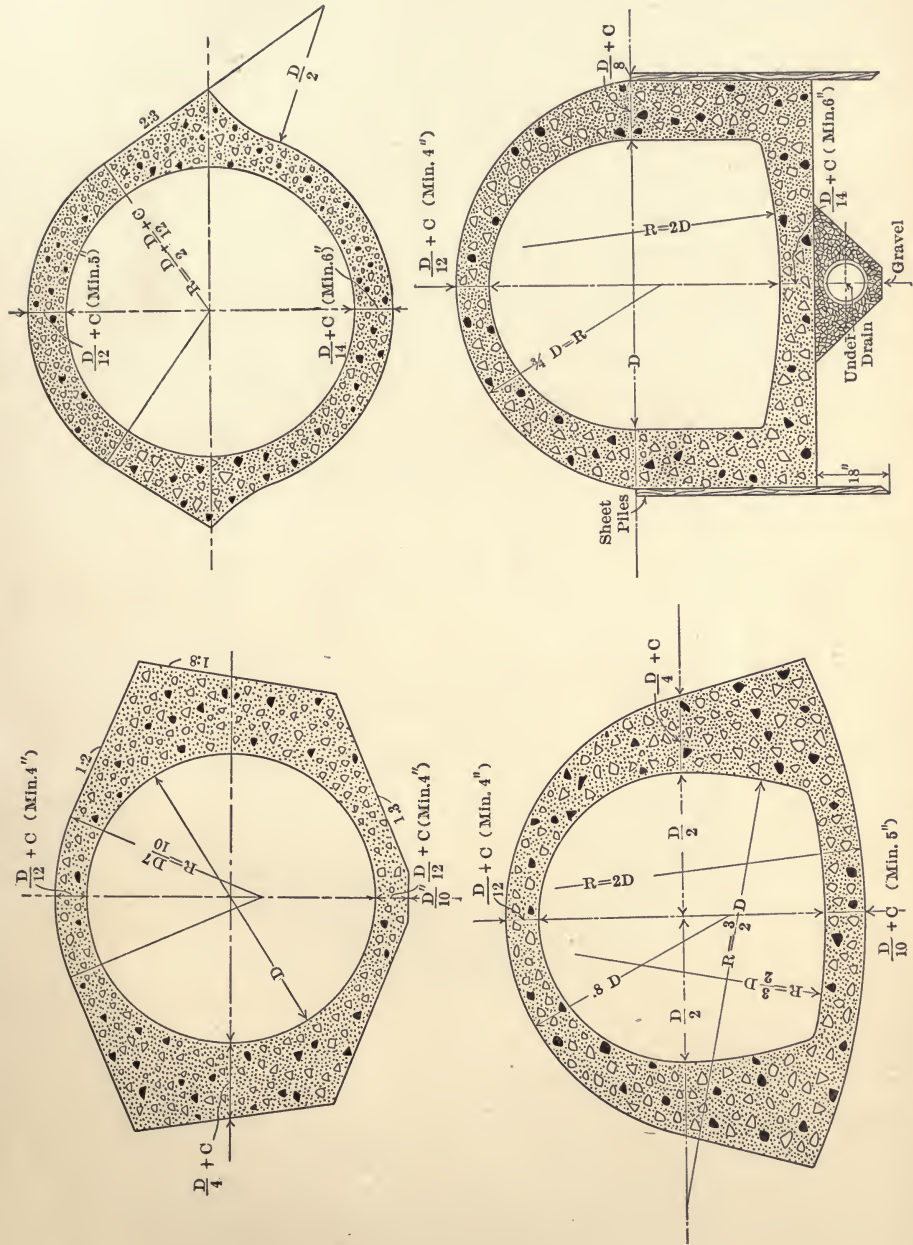

Fig. 43

by trial as follows: Procure a hollow cylinder, such as a piece of 12-inch pipe, and an accurate set of weighing scales. Weigh out the proportions you think right of cement, sand and stone, and mix thoroughly with water on an impervious platform, such as a sheet of iron; then put all the concrete in the pipe, stood on end, tamping it thoroughly, and measure the depth of the concrete in the pipe. Now throw this concrete away and clean the pipe and make up another batch, with the total weight of cement, sand and stone the same as before, but with the proportions of the sand to the stone slightly different. Measure the depth as before, and if the depth is less, and the concrete still looks nice and works well, this is a better mixture than the first. Continue trying in this way until you get the least depth in the pipe.

This simply shows to you that you are getting the same amount of material into a smaller space, and that consequently the material is more dense, and, as has been proved by many experiments, is both the strongest and most water-tight material possible to obtain from the kind of sand and stone, and the proportion of cement used in the experiments.

A little trouble taken in this way will often be productive of very important results. I have known concrete to be increased in strength fully 200 per cent by simply changing the proportions of the sand to the stone, and not changing the amount of cement used in the least.

CHAPTER V.

CONCRETE AND BRICK SEWERS.

THE use of concrete in connection with brick marks a transition stage between the use of brick alone and the use of concrete alone. It allows the use of the cheaper material, concrete, in the bottom where the inequalities of the trench require adjusting, and assigns the brickwork to the arch, where such work may be done more

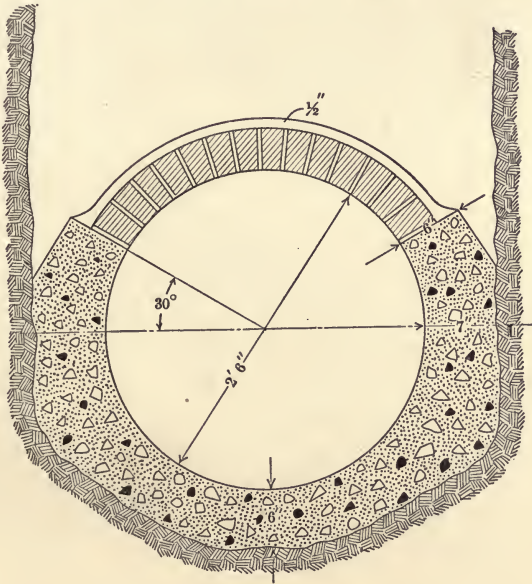

Fig. 44

easily and expeditiously. The fact that the invert is sometimes lined with brick goes to show that the designing engineer is still afraid of the new material, as to its ability both to withstand erosion and to present a smooth surface, a fear entirely unfounded. Since concrete is intrinsically cheaper than brick, and has

besides the other economic advantages named, it seems almost puerile to hesitate about its use throughout, and probably the use of brick and concrete together will rapidly decrease.

The following examples of the use of concrete and brick may be cited:

Fig. 44 shows a combination brick and concrete sewer as

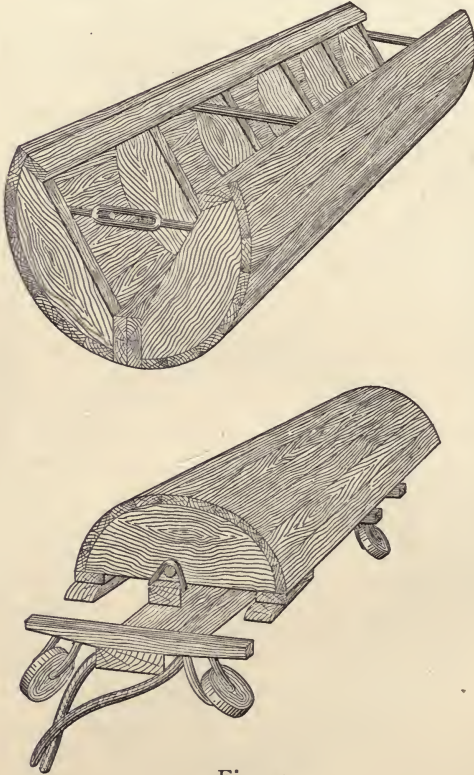

Fig. 45

built in Medford, Mass., in 1903, and Fig. 45 shows the forms used in construction. The material for the invert was concrete 1:3:6 bank gravel, and the arch was built of one ring of hard-burned brick. The forms used involved some peculiar features. They were so designed that the invert template, instead of stopping at the springing line of the arch, extended up to planes at 30

degrees with the horizontal. This was done to save brickwork of which the arch was built, but it resulted in the use of unusually simplified forms. These were in two parts, invert form and arch form, both 10 feet long. The invert forms were made in halves, but were firmly held together by means of malleable iron clamps, which fitted over the stringers on the inside. The tops were held firmly and at the proper distance apart by iron rods, with turn-buckles which allowed the forms to be most carefully separated from the concrete. The arch forms were made of 2-inch ribs, spaced 2 feet apart and covered with $\frac{7}{8}$ -inch lagging. This form was held in place at the rear by heavy wedges on the bottom of the form behind, and the front end was held up by a screw jack from the invert. These centers proved entirely satisfactory, were readily set up and removed, and were handled without the least injury to the comparatively fresh concrete.

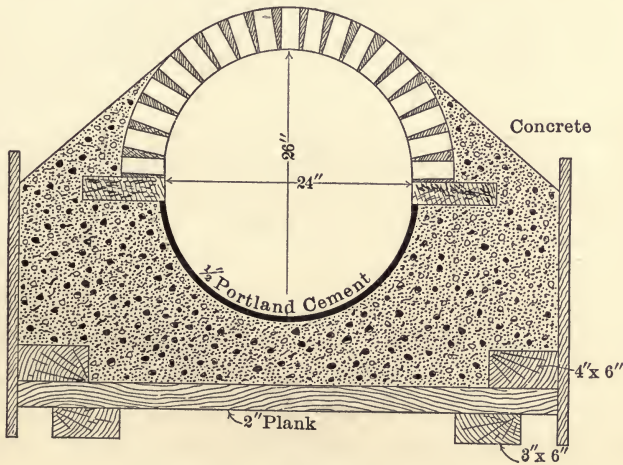

Fig. 46

Fig. 46 and Fig. 47 show additional sections of sewers where combinations of concrete and brick have been used. Fig. 46 shows a 24-inch sewer in soft ground, the concrete resting on a timber platform and filling the entire space between sheeting boards. The arch of one row of brick starts on a row of

headers which mark its springing line. The concrete is 12 inches thick on the sides and 6 inches thick on the bottom of the sewers.

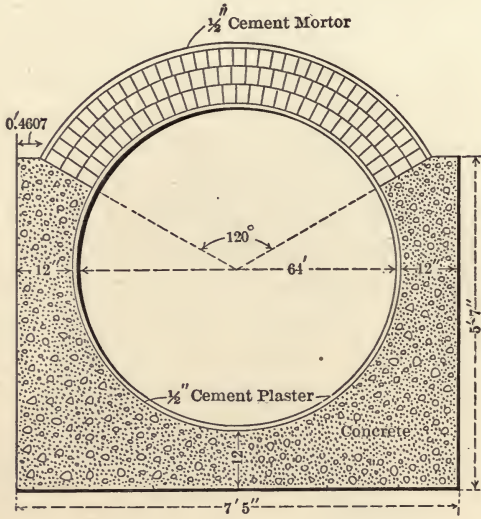

Fig. 47

Fig. 47 shows a 64-inch sewer in firm ground. The concrete is brought up higher than in Fig. 39, the concrete is 12 inches thick on both bottom and sides, and fills the trench which has been carefully trimmed out to grade.

At Altoona, Pa.,¹ a combination brick and concrete sewer $33\frac{1}{2} \times 44$ -inch oval was built, one ring of vitrified shale paving brick being surrounded by from 4 to 8 inches of concrete. Many engineers believe that paving brick resist wear and erosion better than concrete, and hence prefer the section shown to one all concrete, the combination being cheaper than two-ring brick. (See Fig. 48.)

The rich plaster coat on the outside of the brick is of advantage as tending to make the walls of the sewer less pervious.

Fig. 49 shows the outfall sewer, $15\frac{3}{4}$ miles long, at Melbourne, Australia. This is a circular sewer built of concrete

¹ Proc. Engineers' Club of Philadelphia, Vol. 14, p. 92.

and brick as shown. A wooden platform is built in the bottom of the trench, and the concrete invert laid, with a

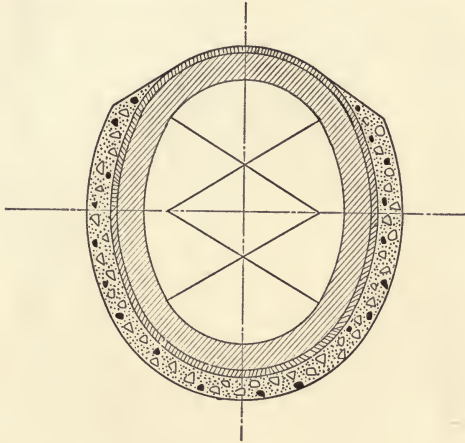

Fig. 48

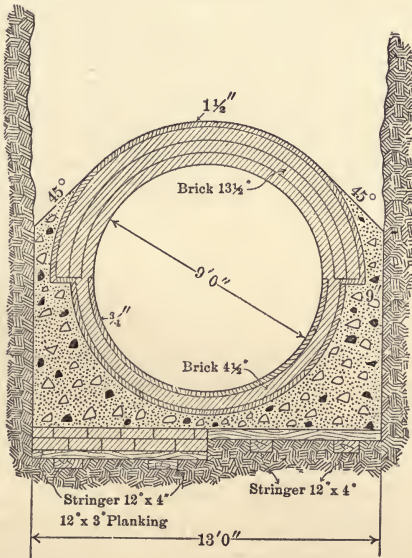

Fig. 49

plaster coat under the brick lining. The arch is a three-ring brick arch, backed with concrete at the haunches. The egg-

Fig. 53 shows a section of the basket-handled arch adopted for the aqueduct from the Wachusett Dam on the Nashua River, to the Sudbury River. The aqueduct, about 9 miles long, is 11 feet 6 inches wide by 10 feet 5 inches high, and has a slope of 1

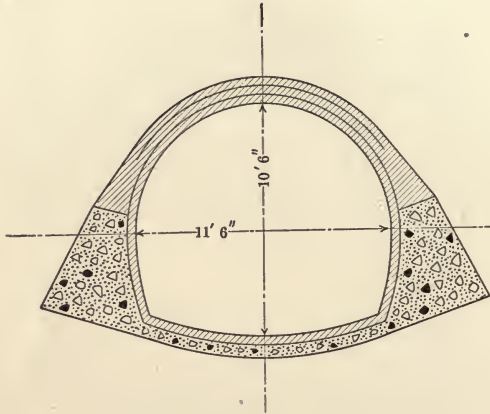

Fig. 53

in 2500, and an estimated capacity of 300,000,000 gallons per day. The arch has three rows of brick, cut down to one where the concrete backing is added. The entire masonry is 3 feet thick at the springing line and about 6 feet thick at the base. This backing was, however, reduced in tunnel and in rock cuts.

CHAPTER VI.

REINFORCED CONCRETE SEWERS.

THE tendency of construction is towards the use of reinforced concrete for all large sewers. It has many advantages; and the great disadvantage, the porosity, has not been emphasized sufficiently to act as a drawback. The saving of expense is very great, since the additional cost of steel does not equal the cost of the concrete saved, except for small sewers, i.e. up to 3 feet diameter. For these smaller sizes it is cheaper to increase the amount of concrete slightly and omit the reinforcement. The steel is supplied in two forms, either as a wire mesh wrapped around the pipe and buried in concrete, the size of mesh being from 3 to 6 inches, or as rods placed around the pipe at intervals of about 12 inches with longitudinal rods spaced twice that distance. The amount of metal needed, empirical entirely, is about the same in the two cases, and the more intimate association of the steel and concrete afforded by the mesh gives that form of reinforcement a decided advantage. As a guide to the amount of steel used, the table on the following page, taken from the catalogue of the Jackson Reinforced Pipe Company, is given, there being two circular bands in each two feet, and five longitudinal rods in the circumference.

The following examples of actual construction are given, where expanded metal has been used.

Fig. 54 shows a cross-section of the reinforced concrete aqueduct which was built in 1906 to supply the City of Mexico with water. This aqueduct is about 17 miles long, and is laid on a grade of 3 feet in 10,000, its capacity being estimated at about 60 cubic feet per second. The rock used was a hard basalt, mixed in the proportion of 1:3:3, fine screenings being

used in place of sand. The maximum width is 6 feet 8 inches, and the maximum height is 8 feet 5 inches. The thickness of the crown is 7 inches and of the base 12 inches, the haunches being thickened as shown. One layer of expanded metal was used by way of reinforcement, and was located in the section as shown in the drawing.

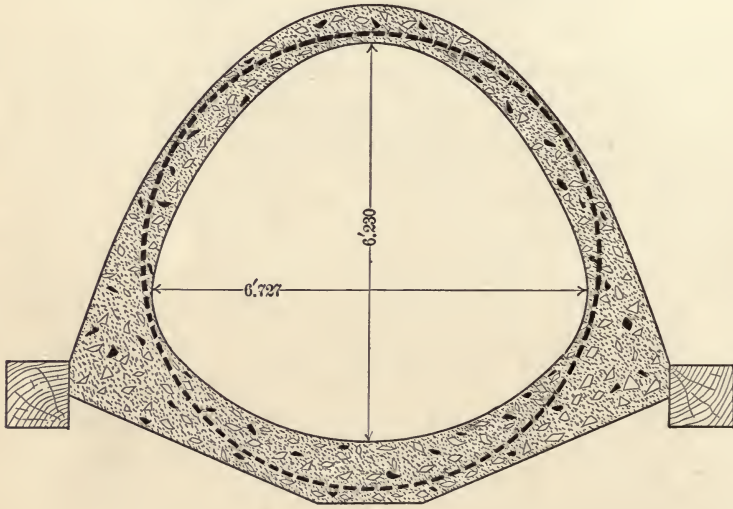

Fig. 54

A concrete sewer in Providence shown in Fig. 55 is reinforced with expanded metal. The sewer is 36, 48, and 56-inch diameter, and for the smaller size is but 4 inches thick at the crown. The expanded metal is No. 14 gauge, 4-inch mesh. A piece of the metal 18 inches wide is embedded in the invert, and then the arch form placed. The arch reinforcement is then placed so as to lap the invert metal about 6 inches. The concrete was made of 1 cement to 9 bank gravel. A portion of the invert, where the scour is greatest, is finished with a rich mixture and troweled down like a sidewalk.

During the year 1903 a reinforced concrete sewer was built in the city of Wilmington, the entire length being 7436 feet.

Of this, 1726 feet was 9 feet 3 inches in diameter, 2426 feet, 6 feet 6 inches in diameter, 1374 feet, 6 feet in diameter, 804 feet, 5 feet in diameter, and 64 feet, 4 feet 9 inches in diameter.

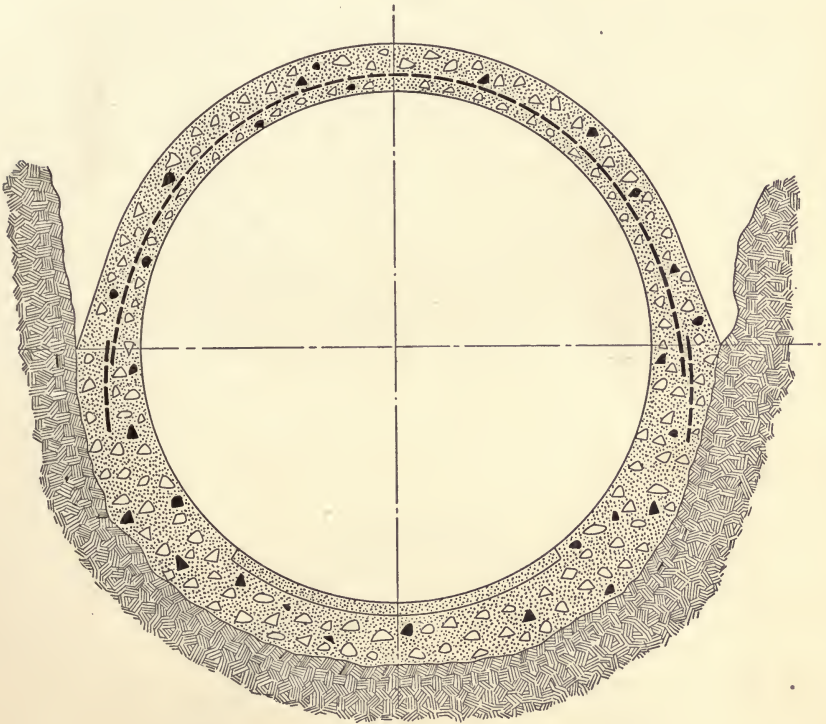

Fig. 55

The accompanying drawings, Fig. 56, show the cross-sections of the different sizes. The engineer, Mr. Hatton, calls attention to the thin crown, only 8 inches for 9 feet 3 inches diameter, and to the fact that it proved strong enough to withstand the shock resulting from dumping a cubic yard of dirt and rock from the cable buckets from heights of from 3 to 10 feet, and the weight of 25 feet of loose filling, without any apparent fracture. In construction, both inner and outer forms, and

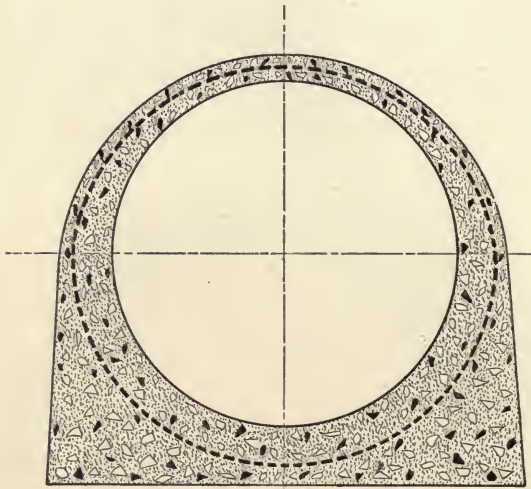

Fig. 56

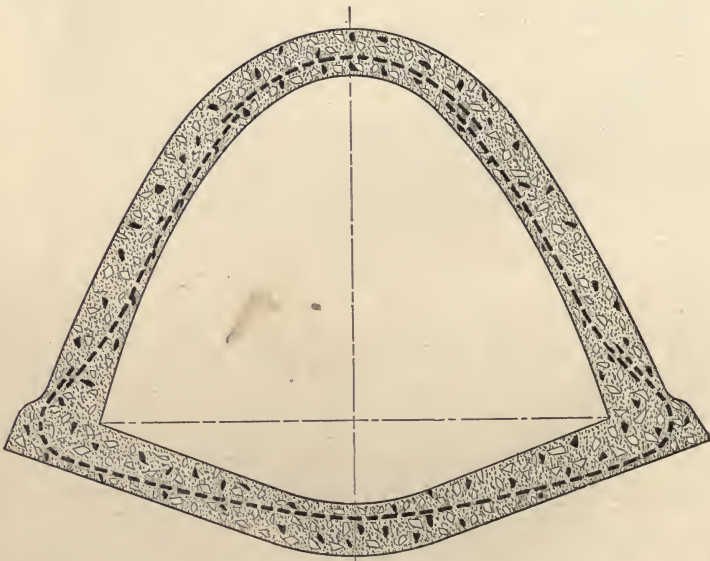

Fig. 57

lagging, were used, the latter being movable and placed consecutively from the invert up, as the concrete was deposited. The concrete consisted of $1\frac{1}{2}$ -inch stones mixed with stone dust and cement in proportion of 1 cement, 2 dust, and 6 stone. The reinforcements for the largest size consisted of expanded steel 6 inches No. 6 gauge, lapped 1 inch. The other sizes were reinforced with a woven-wire fabric, mesh 6 inches \times 4 inches, the wire being No. 8 gauge.

The Paxton Creek intercepting sewer at Harrisburg, Pa.,¹ was built in 1903 to take the sewage out of Paxton Creek and at the same time carry creek water enough to give a self-cleaning velocity on the necessarily small grade. The invert of this sewer is a short arc of a circle with tangents on each side which have an inclination of 3 to 1 as shown in Fig. 57. The larger section, shown in the figure, is 5 feet high by 6 feet wide, the arch being a parabola to the invert. The reinforcement is 3-inch No. 10 gauge expanded metal. The concrete was 1 : $2\frac{1}{2}$: $4\frac{1}{2}$, and the invert was finished to the lines of templates set 12 feet apart. The arch centers were $2\frac{1}{2} \times 2\frac{1}{2} \times \frac{1}{4}$ -inch steel angle bent to proper shape, spaced 3 feet 4 inches apart, the lagging being 2-inch pine plank 10 feet long. The thin arch was subjected to a severe test when a coal train was derailed on to the ground directly over the trench with only about 5 feet of filling, but no damage resulted.

The following examples are given to show the construction where longitudinal and transverse rods have been used.

Fig. 58 shows a section of reinforced concrete conduit used by the Jersey City Water Supply Company.² The construction was of Portland cement concrete, reinforced with Ransome steel rods. The thickness of the sections, the size of the rods and their spacing, were modified according to the character of the soil and the depth of the cutting. Ninety per cent of the conduit, however, had the arch 5 inches thick, the haunches 11 inches thick, and the base 6 inches thick. The reinforcement consisted of cold twisted $\frac{3}{8}$ -inch square steel rods bent to the

¹ Eng. Rec., Vol. 50, p. 444.

² Eng. Rec., Vol. 49, p. 73.

form shown in the drawings, spaced 1 foot apart, and of $\frac{1}{4}$ -inch longitudinal rods spaced 2 feet apart and wired to the transverse rods. The transverse rods were made of such lengths as to extend 1 foot below the bottom of the outside forms, below which the concrete was built against the hard earth or rock sides of the trench.

TABLE OF SIZES AND REINFORCEMENT.

Size of Pipe.	Thickness of Wall.	Size of Rods.	Size of Bands.
Inches.	Inches.	Inches.	Inches.
24	$2\frac{1}{2}$	$\frac{1}{8} \times \frac{1}{2}$	$\frac{1}{16} \times 1\frac{1}{2}$
27	3	$\frac{1}{8} \times \frac{1}{2}$	$\frac{1}{16} \times 1\frac{1}{2}$
30	$3\frac{1}{2}$	$\frac{1}{8} \times \frac{1}{2}$	$\frac{1}{8} \times 1\frac{1}{2}$
36	4	$\frac{1}{4} \times \frac{1}{2}$	$\frac{1}{8} \times 1\frac{1}{2}$
42	$4\frac{1}{2}$	$\frac{1}{4} \times \frac{1}{2}$	$\frac{1}{8} \times 1\frac{1}{2}$
48	5	$\frac{1}{4} \times \frac{1}{2}$	$\frac{1}{8} \times 1\frac{3}{4}$
54	$5\frac{1}{2}$	$\frac{1}{4} \times \frac{3}{4}$	$\frac{1}{8} \times 1\frac{3}{4}$
60	6	$\frac{1}{4} \times \frac{3}{4}$	$\frac{1}{8} \times 2$
66	$6\frac{1}{2}$	$\frac{1}{4} \times \frac{3}{4}$	$\frac{1}{8} \times 2$
72	7	$\frac{1}{4} \times \frac{3}{4}$	No. 10 $\times 2\frac{1}{4}$
78	7	$\frac{1}{4} \times \frac{3}{4}$	No. 10 $\times 2\frac{1}{4}$
84	$7\frac{1}{2}$	$\frac{1}{4} \times \frac{3}{4}$	No. 10 $\times 2\frac{3}{4}$
90	8	$\frac{1}{4} \times \frac{3}{4}$	No. 10 $\times 2\frac{3}{4}$
96	$8\frac{1}{2}$	$\frac{1}{4} \times 1$	No. 10 $\times 3$

Fig. 59 shows the cross-section of a large reinforced concrete sewer built (1907) in the borough of Queens, New York City. This sewer, nearly two miles long, varies in size from $2\frac{1}{2}$ to 15 feet in diameter. The drawing shows the 10-foot section, larger sizes having a double reinforcement, one row at the extrados and one row at the intrados. In the section shown the transverse rods are $\frac{1}{4}$ -inch Johnson corrugated bars spaced 12 inches center to center. The longitudinal bars are $\frac{3}{4}$ -inch and are spaced 18 inches center to center. The thickness of the crown in the section shown is 12 inches, of the springing line 24 inches, and of the base 15 inches, the minimum thickness of crown for the smallest size being 6 inches.

Fig. 60 shows a storm-water sewer, 7 feet in diameter, built in Des Moines, Iowa, in 1906, and known as the Ingersoll Run Sewer. In construction the trench was dug to the form of the outside of the invert, and transverse $\frac{1}{2}$ -inch steel bars were then placed 1 foot

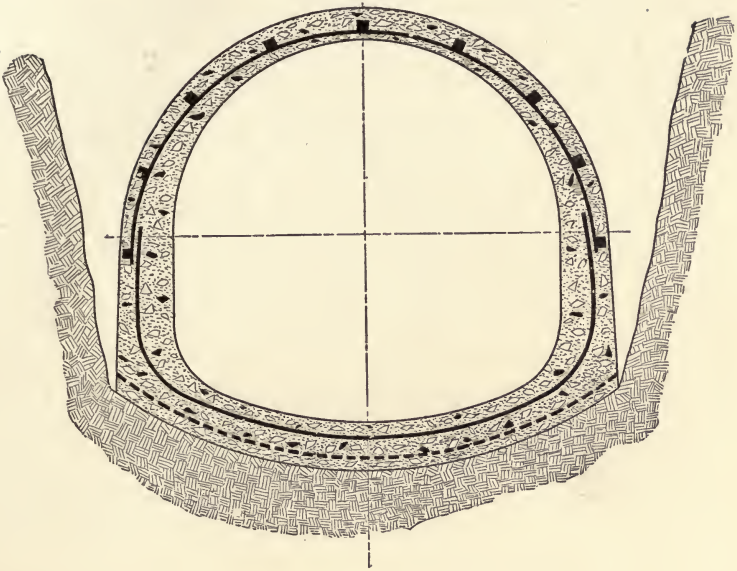

Fig. 58

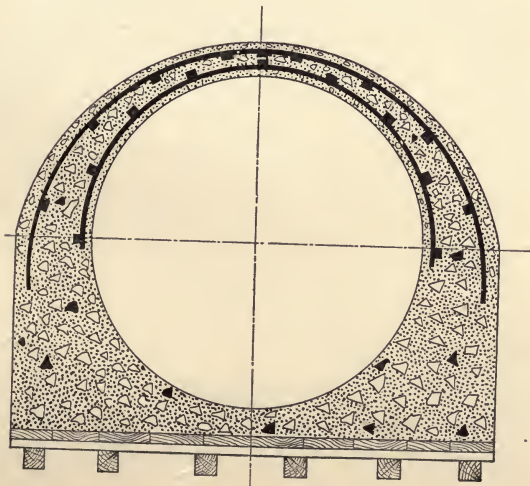

Fig. 59

apart. The template was then placed in position, and the concrete, a 1 : 2 : 4 mixture, was placed between the trench and the template. The invert being completed, the top template was placed upon the lower one, and the steel bars were bent over this and wired together. Longitudinal bars, $\frac{1}{4}$ inch square, were laid in the concrete as it was built up.

Fig. 61 shows the cross-section of the Harlem Creek sewer in St. Louis, now (1908) under construction. The width at the point where it empties into the Mississippi River is 29 feet and its center height is 19 feet, making it probably the largest concrete sewer in this country. The thickness of the arch is 14 inches at the center and 26 inches at the springing line. The invert in earth is 16 inches thick at the center with a lining of one row of vitrified brick. The transverse rods are in double rows, spaced 10 inches apart and $\frac{3}{4}$ -inch Johnson corrugated bars used. The longitudinal rods are also in double rows, about 3 feet apart, and are $\frac{1}{2}$ -inch bars.

A reinforced concrete sewer of unusual section and strength was built in McKean Street, Philadelphia,¹ in 1901. As shown in Fig. 62, the bottom concrete, supported on piles, was very thick, and was heavily reinforced with steel bars in both directions, while the roof was a combination beam and slab construction. The concrete in the bottom and sides was 1 : 3 : 6, the stone screened to exclude pieces of more than $1\frac{1}{2}$ inch, and less than $\frac{1}{4}$ inch. The roof was mixed 1 : 2 : 5, and the granolithic coating was 1 : 1. The reinforcement in the bottom consisted of four longitudinal $\frac{3}{4}$ -inch rods, one directly over each pile, with transverse $\frac{3}{4}$ -inch rods, spaced 12 inches apart. The side reinforcement consisted of vertical $\frac{3}{4}$ -inch rods, spaced 12 inches apart. The roof of the sewer was made up of concrete beams 2 feet apart, spanned with slabs of concrete 5 inches thick. The beams have one $1\frac{1}{2}$ -inch rod in the bottom, and are 13 inches deep by $2\frac{1}{2}$ inches wide. This is unusually heavy construction, justified by the poor foundation, and by the heavy loading on the surface just above the sewer.

¹ Eng. Rec., Vol. 45, p. 342.

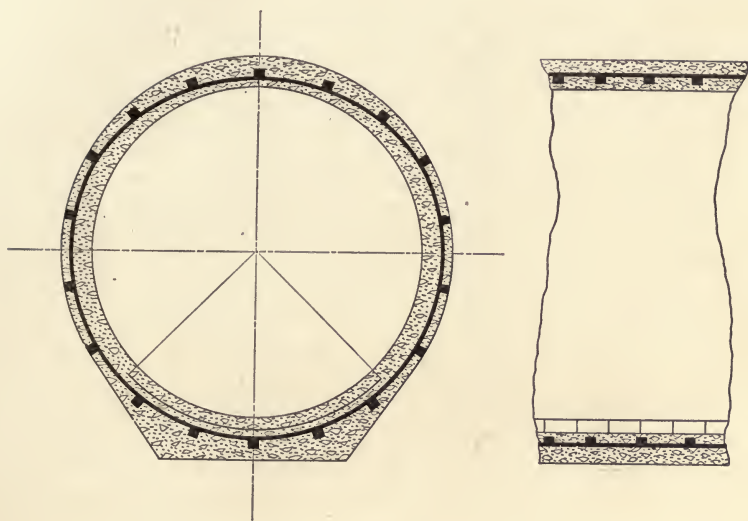

Fig. 60

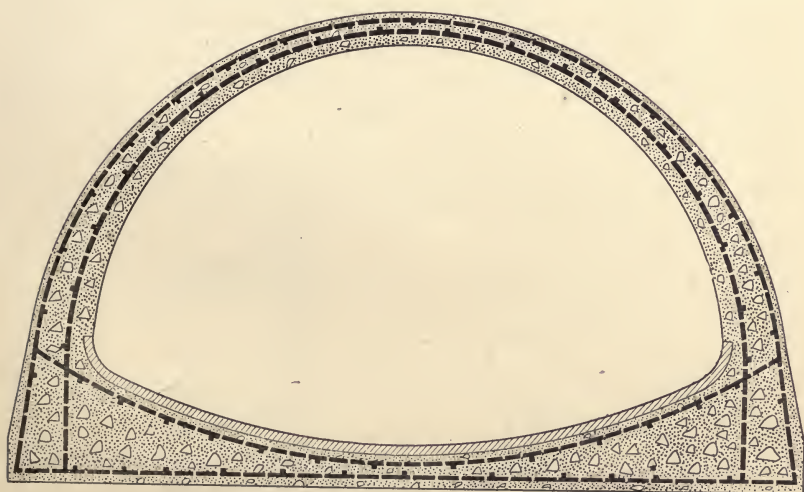

Fig. 61

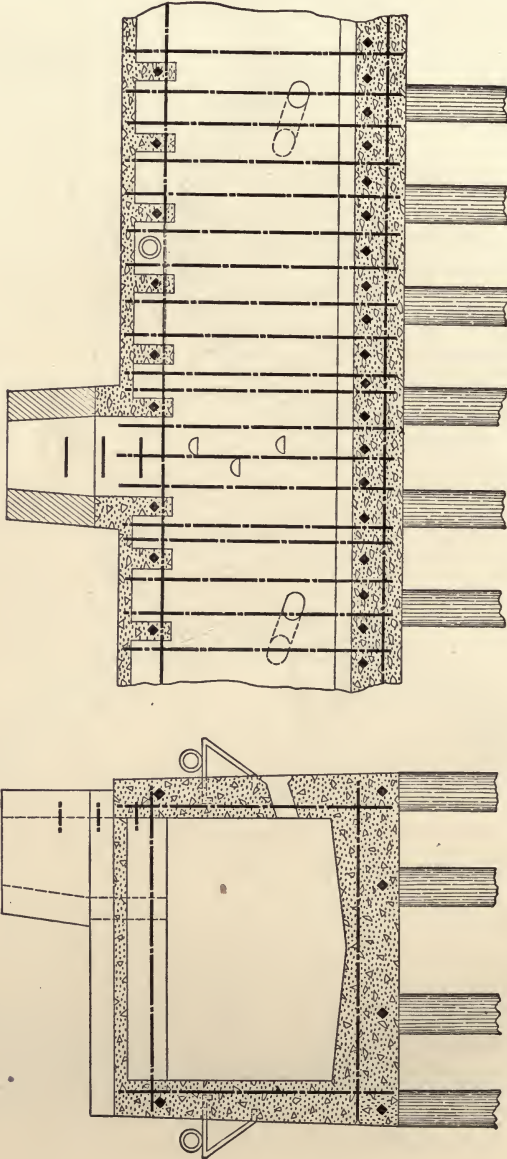

Fig. 62

Fig. 63 shows the forms and section used in a storm-water sewer at South Bend, Ind.,¹ built during the year 1906. This sewer was from 66 to 81 inches in diameter, the average depth of trench being about 18 feet. The arch of the sewer barrel is reinforced with $\frac{3}{16} \times 1$ -inch steel bands placed transversely 12 inches apart on centers. These bands extend by means of a pin connection and short anchor pieces into the concrete of the abutment. The bottom of the trench was shaped as nearly as possible to the grade and form of the outside of the sewer. Braces, 3 feet apart, were cut and nailed on to the rangers across the trench. A vertical form shown in Fig. (a) was then set up in 12-foot lengths, and fastened to stakes which were driven, one on each side at each brace to further hold the forms in exact position. A template for the invert of the barrel was suspended from the cross-braces and fastened as shown by the diagonals. Concrete was then tamped in between the bottom of the trench and the invert form, and between the two vertical side forms, the concrete being left horizontal as shown in Fig. (b). The side pieces of the reinforcement bands were then set in place, and firmly held at points A, Fig. (b). Then two additional sections were placed, one on each side, and extending from the inside template up to the springing line of the arch. These pieces were held in place by a cross-brace nailed to the ribs on each side, and by a notched brace which fitted into the lower ends of the ribs. The concrete was then filled in between this template and the vertical form until it reached the springing line, all as shown in Fig. (c). The two sections of the arch form were then put in place, the other pieces of reinforcement fastened on, and the forms on each side to hold the extrados were set. The concrete for the arch was then deposited. Two features of these forms are noteworthy; namely, the number of sections into which the forms are divided, conducive to easy handling and rapid work, and also the light sections of the forms. The lagging is all $\frac{7}{8}$ -inch; the ribs are 4 inches deep, cut from 2-inch lumber, and are spaced 3 feet apart. Concrete in the invert and in the bench walls of the arch is mixed in the propor-

¹ Eng. Rec., Vol. 53, p. 736.

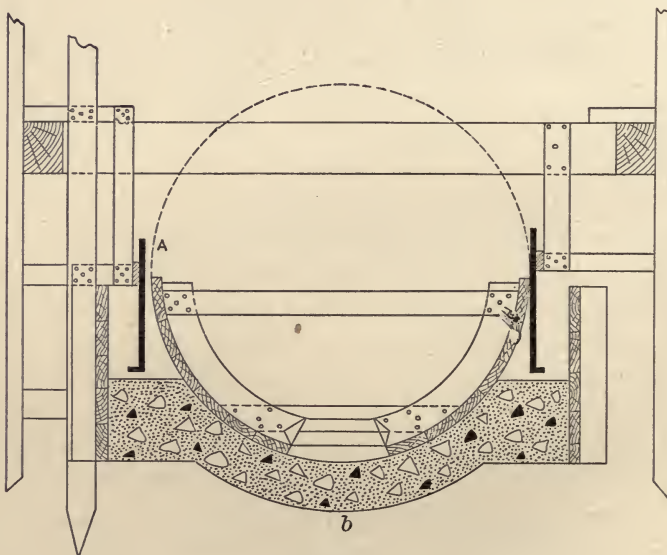
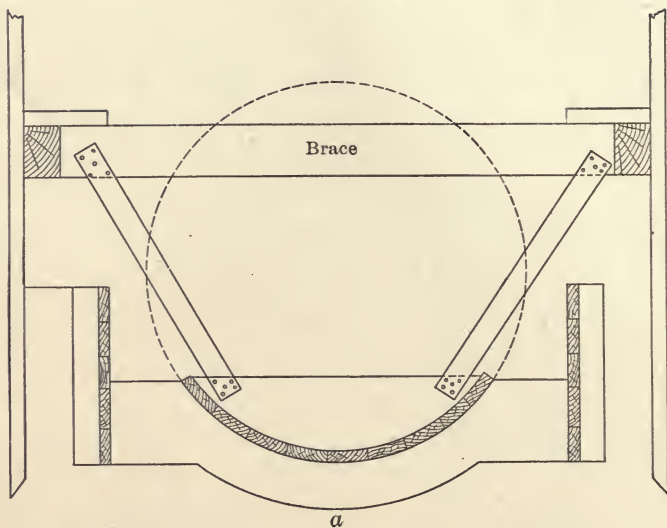

Fig. 63

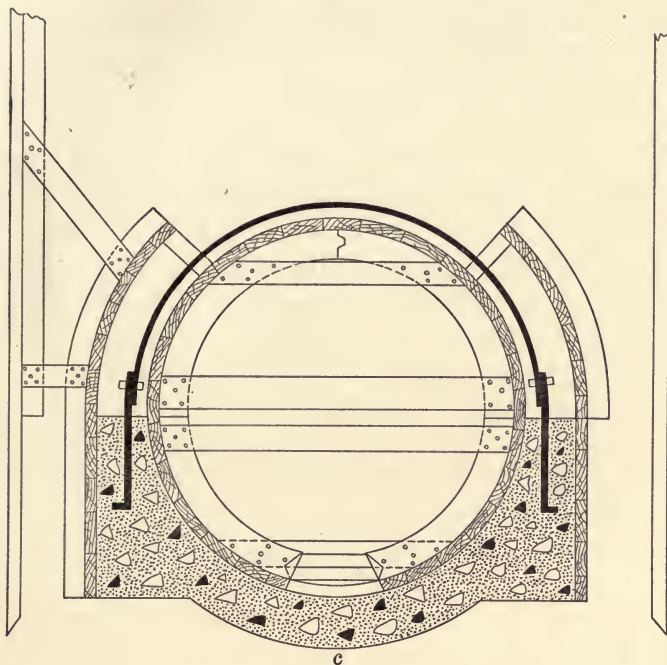

Fig. 63c

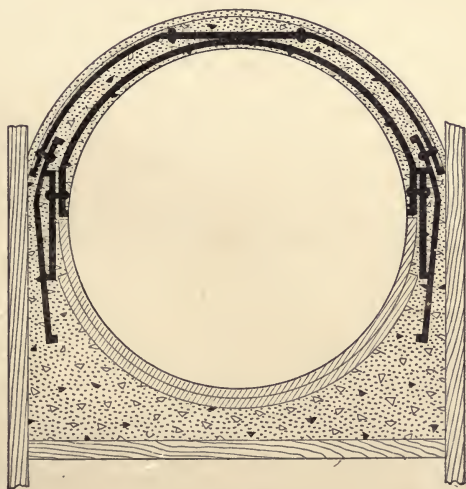

Fig. 64

tion of 1 part of cement, 3 parts sand, and 6 parts gravel, the invert coated with $\frac{1}{2}$ inch of 1 to 1 cement mortar. The arch concrete is made of 1 part cement, 2 parts sand, and 4 parts gravel.

The main intercepting sewer of Cleveland, extending along the lake front for a distance of $3\frac{1}{2}$ miles, is built of reinforced concrete, under the Parmlee patent.¹ Figure 64 shows the section used, having $2 \times \frac{1}{2}$ -inch steel bars as reinforcement 15 inches apart, with $1\frac{1}{2} \times \frac{1}{4}$ -inch longitudinal bars. The feature of the design and of the patent is the method of inserting anchor bars in the invert which are bolted to the tension bars of the arch so that the form for the arch can be put in place without difficulty.

The concrete for the arch was 1:3:7 $\frac{1}{2}$ with $1\frac{1}{2}$ -inch screened broken stone, but where the voids in the stone exceeded 40 per cent it was made 1:3:6.

¹ Eng. Rec., Vol. 48, p. 247.

CHAPTER VII.

MANHOLES.

MANHOLES, as the name would imply, are built to allow access to the sewer for the purposes of inspection or cleaning. For this reason they must be built large enough to admit cleaning tools into the sewer; they must be near enough together to admit of an examination of the intermediate pipe; and they must not introduce any element of weakness in the sewer line, either in the matter of settlement or the admission of ground water. Their construction, for purposes of description and estimation of cost, may be divided into three parts,—the bottom, the side walls, and the cover. The cover of cast iron is often, in contracts, separated from the rest of the manhole work and bought at a fixed price per pound. The equity of this is evident when it is noted that the cost of the cover is constant for all manholes, while the cost of the side walls varies with the depth. Manholes are usually located over the axis of the sewer line, but with large sewers they may be eccentric, and occasionally they may be built entirely separate and connected into the side of the sewer by a horizontal tunnel or by a descending stairway. On pipe sewers their location is governed by the requirements of alignment and of grade. It is generally agreed that the pipe should run in a straight line from manhole to manhole (both vertically and horizontally), and that all connecting curves should be entirely in manholes. The sewer line is, therefore, plotted, on the street plan (in chords where the streets are curved), and the manholes located at the angles. The changes of grade are fixed, if possible, to take place at these points; otherwise additional manholes must be located. Manholes are always placed at the intersections of sewers, and

generally at street intersections. Finally, they should not be more than 400 feet apart, although, to save expense on trunk lines with good grade, this distance is often increased to 600 feet. On brick sewers, large enough for a man to enter, manholes are less frequent. The depth of the sewer affecting the cost of the manholes should be a factor in determining their frequency. One thousand feet may be fixed as the maximum distance under the best conditions.

The cross-section of a manhole is generally bottle-shaped (see Fig. 65), carried up vertically from the bottom for about five feet, and then in the remaining distance contracted in a reversed curve so that at the top it will be about 2 feet in diameter. Generally the ends of the brick are kept horizontal, although some engineers prefer to keep the ends normal to the side lines, a method which the author believes to give the better construction.

In very cold climates it is advisable to avoid vertical walls at the top, and to bring the side walls up as the frustum of a cone. At Brockville, Ont.,¹ during a severe winter, the frost in its expansion by holding the earth tightly against the cover cracked the brickwork just below the cover in a manhole shaped like Fig. 65*b*, and the manholes were taken down and rebuilt as in Fig. 65*a*, in order to avoid future trouble of that sort.

In shallow trenches it is difficult to form any reversed curve, and in such places the beds are kept perpendicular to the side lines of the manholes, and the covers cast with the bottoms inclined so that the covers will form a keystone of a vault.² (See Fig. 66.)

The bottom may be formed of either brick or concrete, and consists of a channel for the flow of the sewage, with a platform or floor on each side of this channel on which to stand. If the manhole is located by the requirements of distance alone, allowing access to a straight line of pipe, and there are no lateral sewers entering, the most convenient channel is formed of a

¹ Eng. Rec., Vol. 27, p. 97.

² Report on Sewerage of Santos, Brazil.

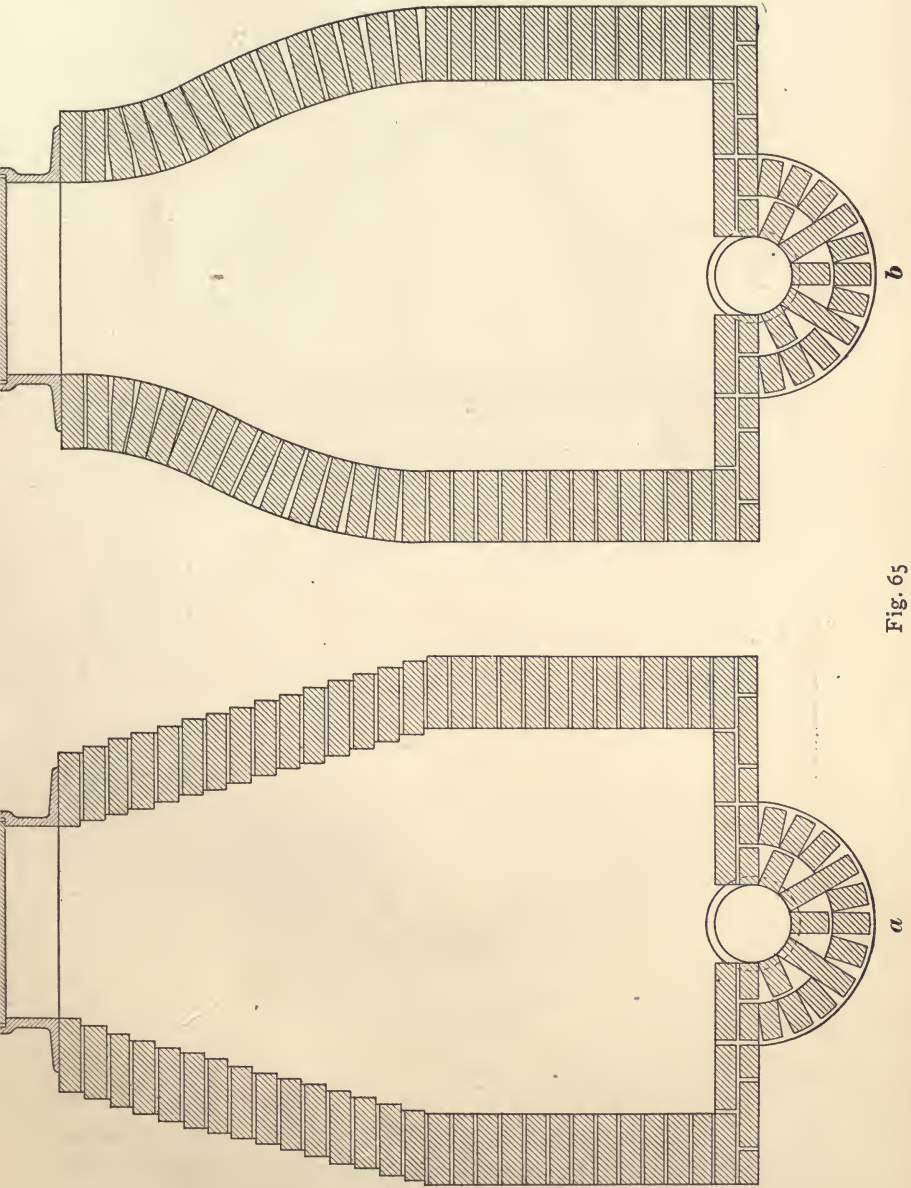

Fig. 65

split pipe bedded in concrete, the smooth interior of the pipe making a most desirable surface. (See Fig. 67.) In other cases the channel must be formed of brick or shaped in concrete.

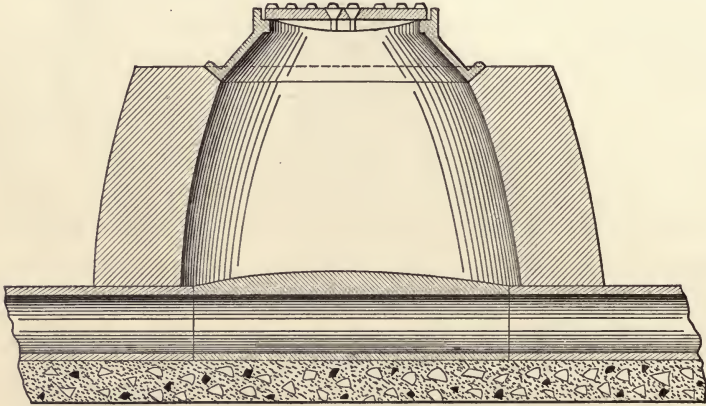

Fig. 66

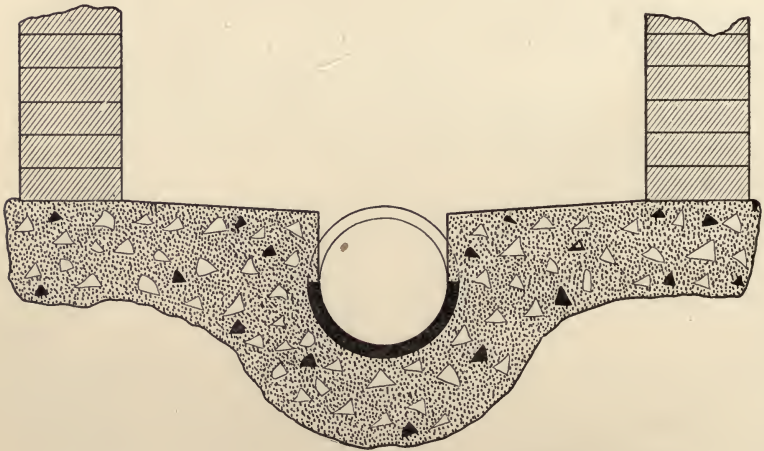

Fig. 67

When of brick, the bottom is formed by laying the lowest course through first on edge, the top of this course being lined in between the ends of the pipe already in place. Other rows

conforming to the curvature of the pipe are added on each side up to the horizontal diameter. (See Fig. 68.) The bricks are then laid up vertically as far as the top of the pipe. At this level the floor is paved out horizontally far enough to make a foundation for the side walls. When concrete is used, it is

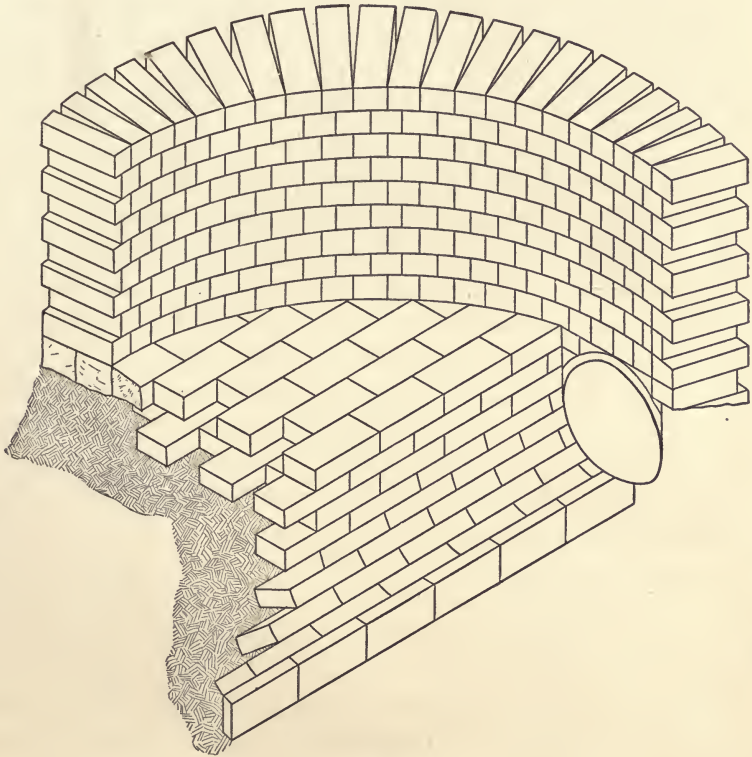

Fig. 68

thrown in to a depth of about six inches under the invert grade and then shaped to form the channel and the floor. Exact forms may be used for this, but if the concrete is dry it may readily be formed by hand into the shape required.

The size of the floor area varies, according to the size of the pipes entering the manholes, the smallest size being that on a

straight line of 6-inch pipe. The limit is placed by the room required for entering and working in the manhole, and this may be fixed at an oval shape, 3 feet by 4 feet inside, the longer dimension being along the axis of the pipe. Manholes, where laterals enter, require more room, and a circular plan, 4 feet in diameter, may be fixed as the minimum. Rectangular sections, while more symmetrical and capacious in appearance, have really additional room only in the corners, where it is not useful, and since they require more brick and are not as strong as the other forms, they are little used. The choice between the circular and oval shape must be made according to the special requirements of each manhole. As the sizes of sewers increase from a 6-inch sewer, the size of the manholes must also be increased, a plan drawn to scale of the pipes entering the manholes being a satisfactory way of determining the proper size. For example, to determine the proper size of a manhole to be built where a 24-inch sewer turned at right angles, and at the same time was entered by a 16-inch pipe, a sketch was made and the plans as shown adopted. (See Fig. 69.) To secure good results in the flow, the connecting curves in the laterals and main should be of such radius as to carry the flow line well into the main, allowing the streams to mingle smoothly. Care should be taken that the brickwork in the projecting tongue be not too sharp to be strongly built. As small pieces of brick are easily dislodged, cut stone may be used to advantage to give stability to the end of the tongue.

The walls of a manhole are generally 9 inches thick, though occasionally, where there is no frost and where the soil is firm, 4½-inch walls have been used. Where the manhole is deep, however, or where the soil is wet and unstable, 13 or 17-inch walls should be used. The author had an experience of a 9-inch manhole wall broken entirely across just above the sewer and the manhole itself moved laterally a few inches by unequal filling around the manhole. Another experience was with a manhole built on the edge of a stream, the manhole being 13 inches thick to within 5 feet of the top and 9 inches thick for that distance. A

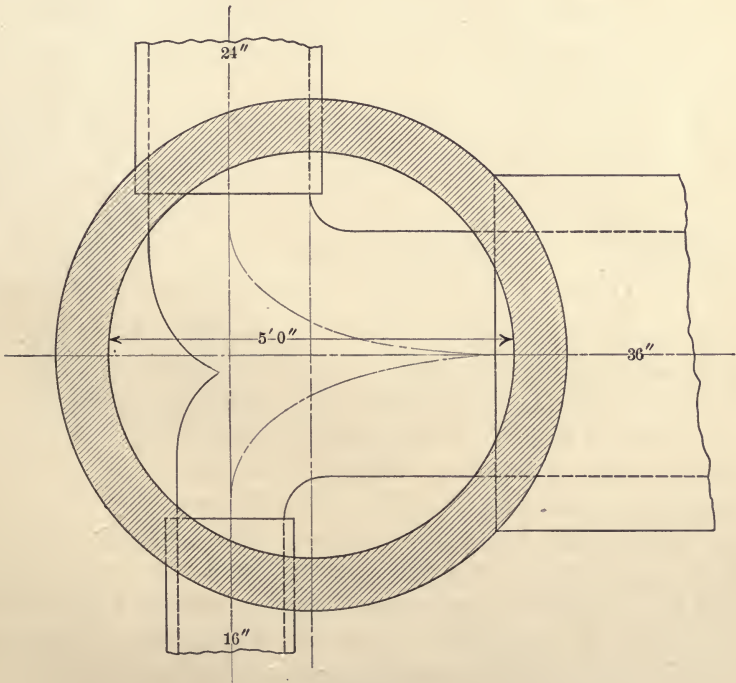
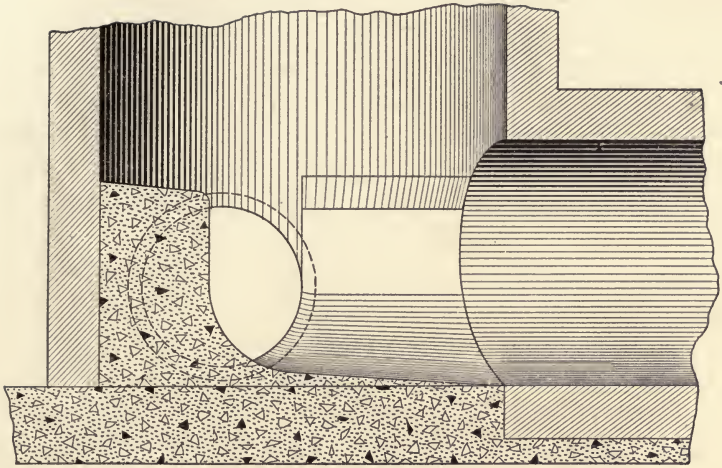

Fig. 69

period of high water in the fall brought ice pressure to bear against the manhole at the top, and the wall was broken just above the point where the 9-inch wall began.

In soft ground it may be necessary to provide artificial foundation for the manhole, and care must be taken to have the manhole bring the same unit loads on the ground as the pipe. For example, a 24-inch pipe half full weighs about 700 pounds per running foot, or has a pressure of 350 pounds per square foot on the soil. A manhole 20 feet deep, 6 feet in diameter, weighs about 22,000 pounds, and if uniformly distributed over the bottom gives a pressure of about 800 pounds per square foot, or more than double the pipe load. In soft ground this would cause the manhole to settle away from the pipe, breaking it off where it enters the manhole. This can be avoided only by increasing the area of the manhole floor, either by a concrete steel foundation, or by a timber platform. With a smaller pipe the difference is still greater, and when the ground is soft special precautions must be taken to equalize the pressure.

When a manhole is built into a sewer 3 feet or more in diameter, no special foundation for the manhole is needed, but the side walls start from the side walls of the sewer. The bonding of the lower courses of the manhole into the brickwork of the sewer must be carefully done, the mere setting of a manhole on top of the sewer and a hole broken in the top of the sewer not being admissible construction. Where the sewer is larger than 6 feet, the manhole has one side wall tangent to the sewer barrel, and the other side ends on top of the sewer.¹ (See Fig. 70.) For this construction two rings of brick should be built in the sewer arch to such a template that they will form the bottom of the manhole. See Fig. 71 for drawing of such a construction as is here described. A wooden cylinder may be set vertically at the right position projecting up through the arch, and the regular courses of brick brought up against the rows of brick set around the cylinder. A pattern could be made for the line of intersection of the two cylinders, which would answer the same purpose.

¹ Eng. News, Vol. 49, p. 8.

Occasionally, engineers prefer to place the axis of the manhole directly over the center line of the sewer, as shown in Fig. 72.¹ The intersection in this case probably contributes less to the weakness of the sewer arch, but the function of the manhole in giving ready access to the sewer is much decreased in value. A portable ladder is necessary to get to the invert, while with the side support the steps are built in to the bottom.

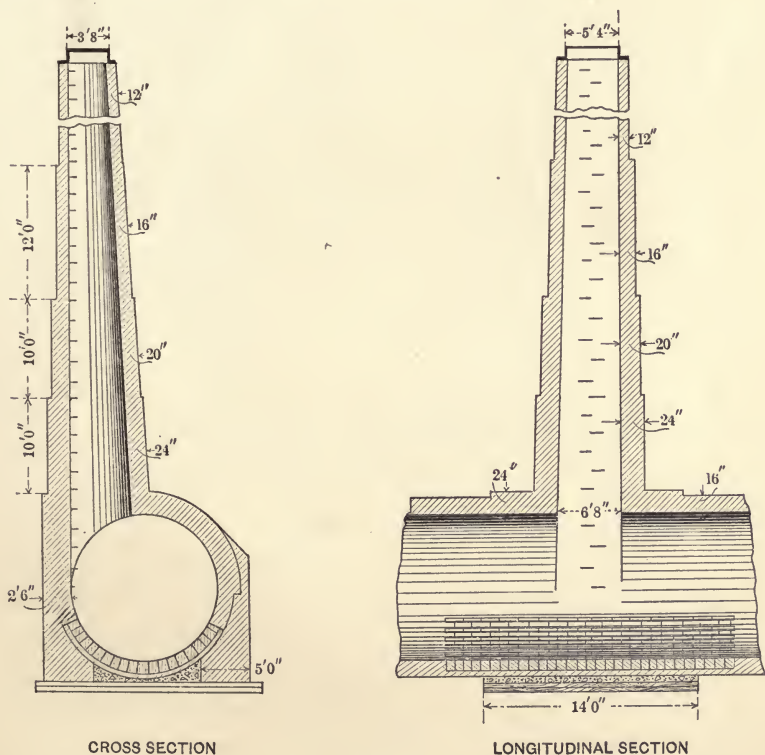

Fig. 70

Special forms of manholes are needed when the entering pipes are on different levels, that is, when some special device is needed to bring the sewage from the laterals into the main. The most common method is to bring the sewage down through a vertical

¹ Eng. News, Vol. 49, p. 8.

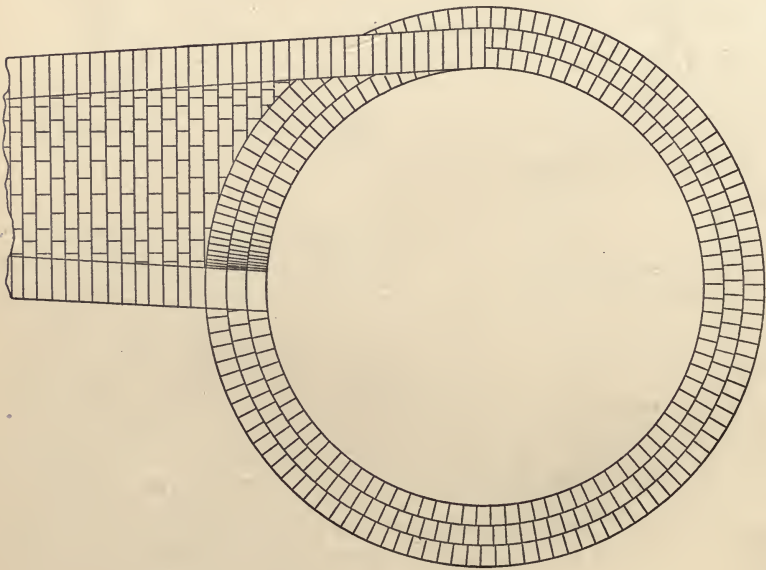
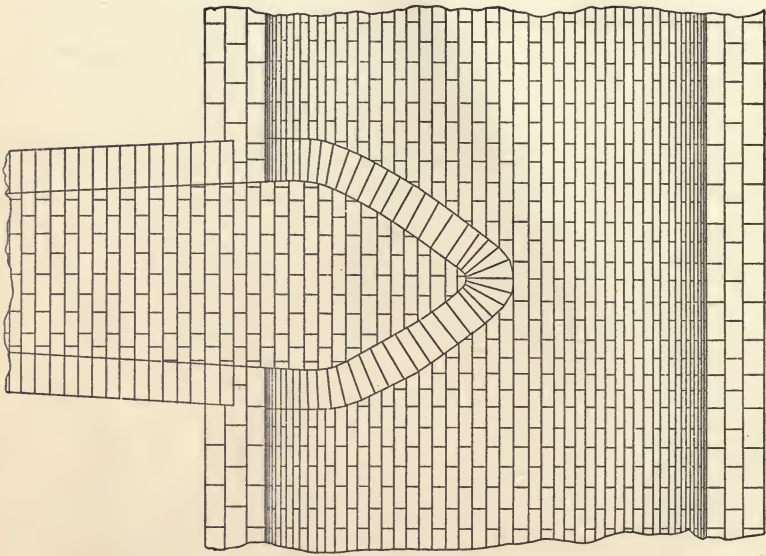

Fig. 71

pipe, and then through a 90-degree bend into and in the direction of the flow of the mainstream.¹ (See Fig. 73.) This vertical pipe may be brought down either on the inside or on the outside of the

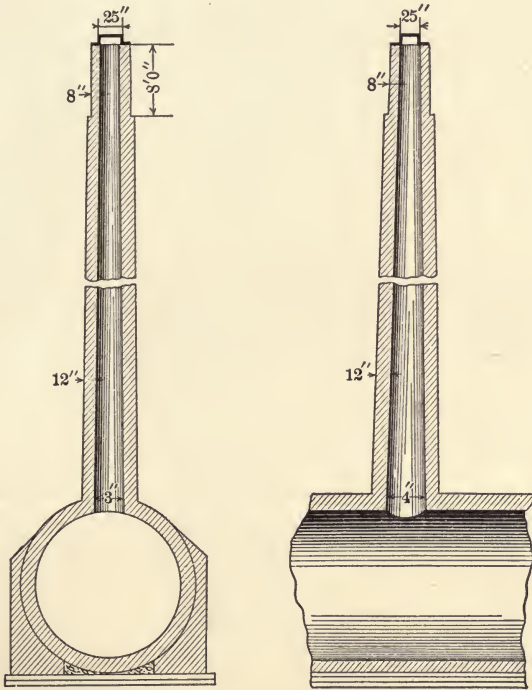

Fig. 72

manhole, in both cases the horizontal pipe being prolonged by a T through the manhole wall for inspection purposes. The advantage of the first method, Fig. 73, is that the vertical pipe is secured to the manhole and is supported by it so that the connection is more stable. On the other hand, it occupies a large amount of room in the manhole, requiring the latter to be built larger than where no such construction exists. The advantage of the second method, Fig. 74, is that no room in the manhole is usurped,²

¹ Report on Sewerage of Santos, Brazil.

² Eng. News, Vol. 35, p. 338.

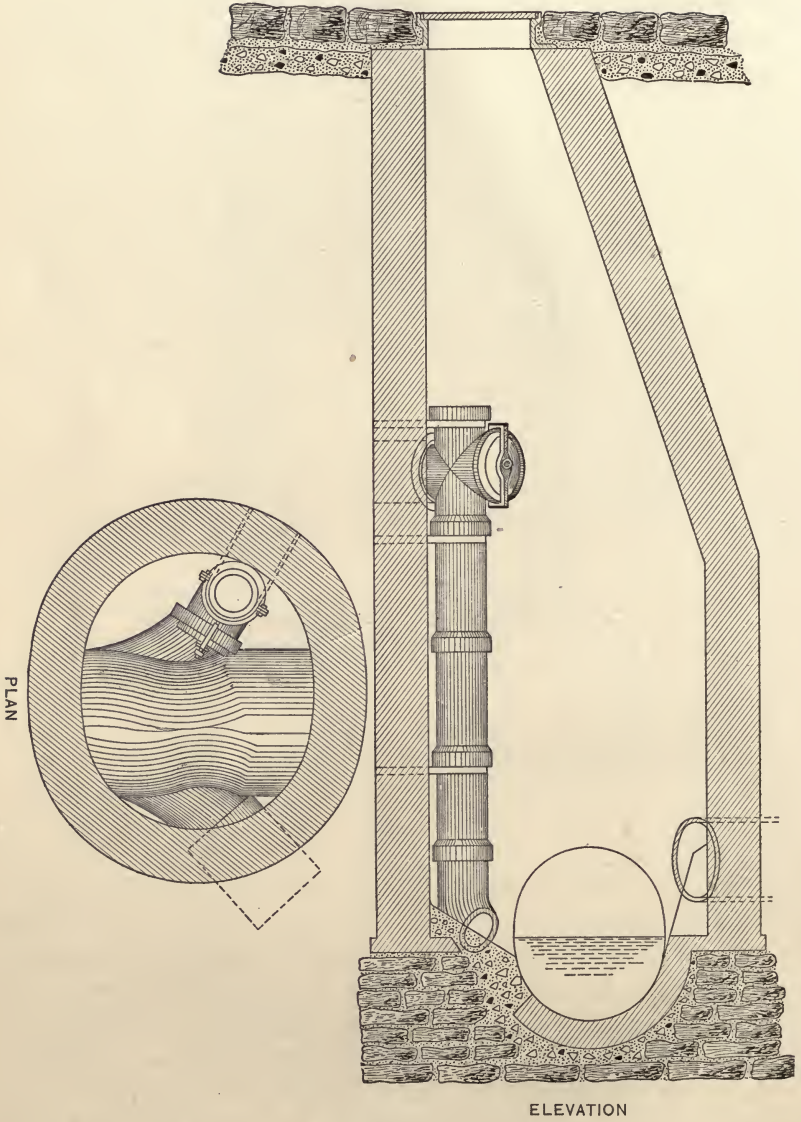

Fig. 73

but unless the bottom of the vertical pipe is well supported the settlement of the pipe is different from that of the manhole, and they break apart. In both cases the invert of the bend should be placed at the height of the average surface in the main in order to prevent deposits in the bend. Instead of a vertical pipe, an inclined pipe coming out of the lateral by a Y may be used. Thus greater velocity on entering the main is secured, but this advantage is discounted by the great difficulty of supporting the inclined pipe (Fig. 75). To avoid the erosion which takes place when a free fall of water occurs, a pool of sewage may be provided at the bottom of the manhole into which the fall is made, as shown in Fig. 76. This is the design adopted at Melbourne, Victoria, and provides a pocket, in which an accumulation of water is retained.¹

In some cases, as in Fig. 77, a series of steps are provided to reduce the fall, the illustration showing it in one of the main sewers at St. Louis. For laterals the same principle may be used, dropping the grade in steps instead of by a vertical pipe. The St. Louis steps shown were in an 8-foot sewer, 11½ feet high, with the bottom steps on which the scour would occur, of oak. The steps themselves were stone.²

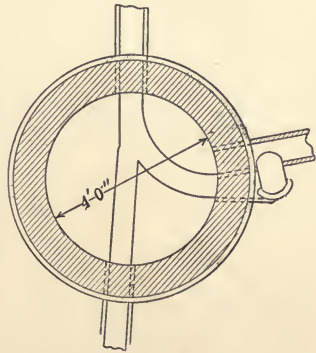
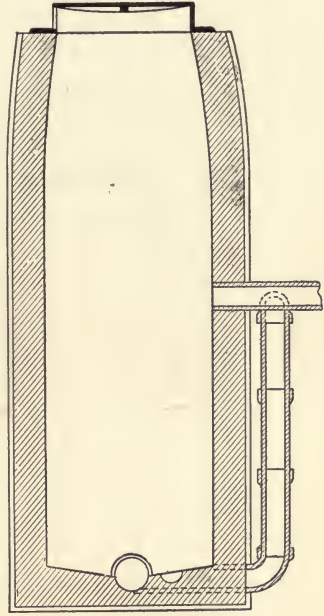

Fig. 74

¹ Eng. Record, Vol. 44, p. 586.

² Eng. Rec., Vol. 26, p. 345.

Fig. 78 shows a manhole 65.8 feet deep, as built at Cleveland, Ohio. To prevent the erosion that would be caused by a stream of sewage falling freely through that distance, slabs of stone flagging were built into the manhole in such a way that the sewage would be checked constantly in velocity as it fell from one to another of the stone slabs. The stone was 2 brick thick, and the slabs were spaced 5 feet apart vertically.

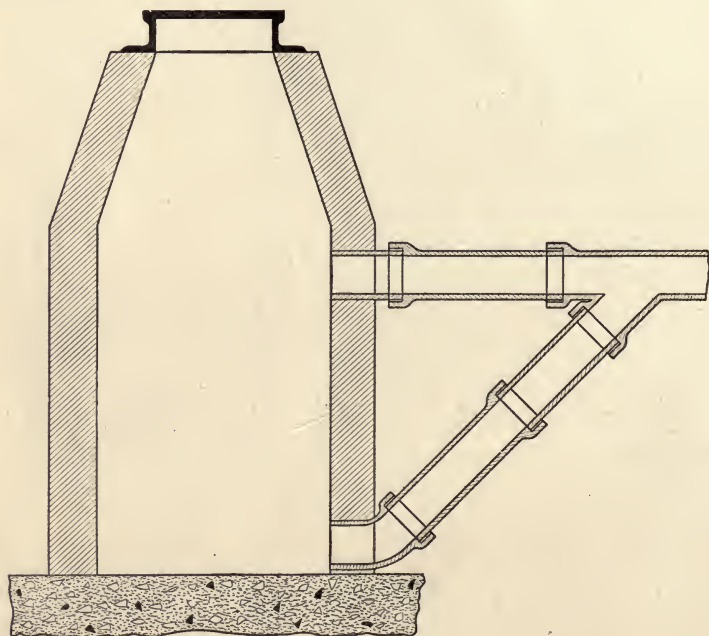

Fig. 75

Manholes in which gates or valves are to be placed have usually to be built with one side wall vertical, as in Fig. 73, and such special manholes should always be carefully drawn out before construction commences.

The frames and covers of manholes are made of cast iron, and together weigh from 300 to 400 pounds. They have various shapes according to the fancy of the designer, and their weight

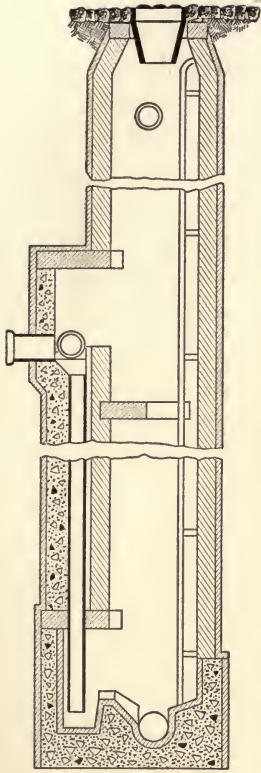

Fig. 76

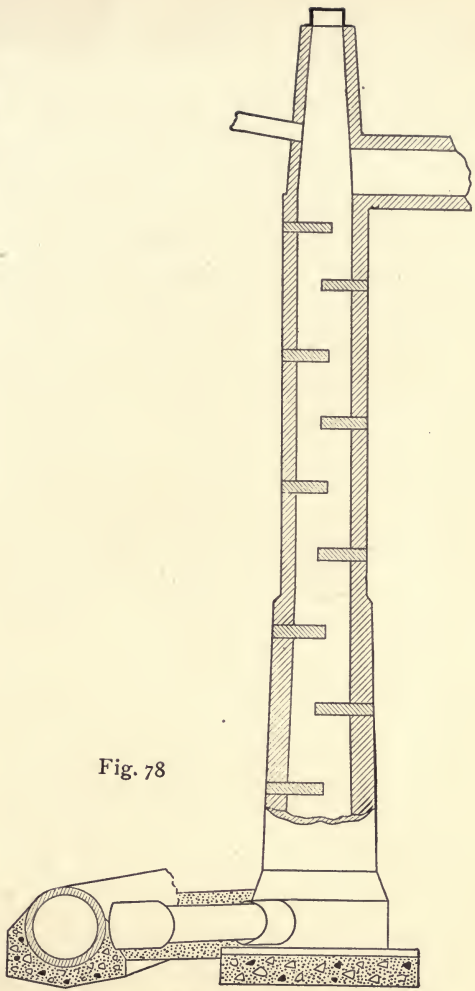

Fig. 78

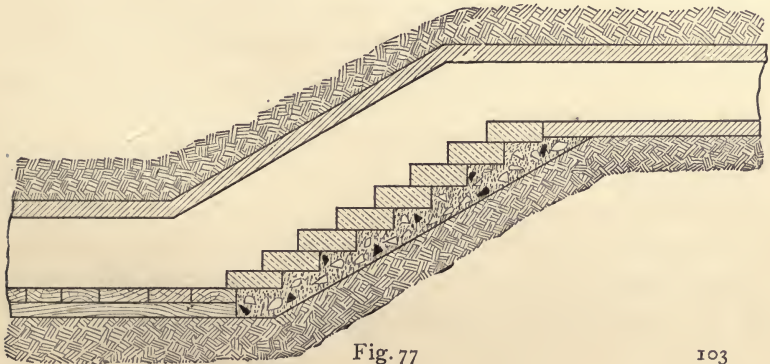

Fig. 77

varies with the thickness and amount of ribbing in the cover, and also with the height of the frame. The cover is usually made one inch thick, is stiffened with ribs underneath, roughened with knobs on top. It may be pierced with 1-inch holes, as the engineer believes in sewer ventilation or not. The frame for paved streets is made deep enough to take a paving block between its top and base, or about 8 inches for stone. For a brick or asphalt pavement this depth might well be reduced to 4 or 5 inches, some depth being necessary to secure enough weight to keep the frame from being displaced and to spread its base on to the top of the brick walls. Figs. 79, 80, and 81 show three different patterns of frame and cover.

Fig. 79, from the Report on the Sewerage of Santos, Brazil, by E. A. Fuertes, shows the top and bottom of the cover designed for that city. It has an elaborate system of ribbing, and a lock to be described later.

Fig. 80 shows a Standard form of manhole made by the Sessions Foundry Company of Bristol, Conn., known as the New York Standard Manhole. As made, the total weight is 650 pounds, exceptionally heavy, and massive.

Fig. 81 shows the manhole cover recently shown in contract drawings for the construction of a part of the sewer system of Auburn, N.Y.

Provided the freight is not excessive, it is entirely feasible to buy frames and covers direct from large foundries, where it is cheaper than buying from local foundries. By specifying the required weight of cover and frame they may be made as strong as desired. If they are designed by the engineer to be cast in local foundries, care must be taken to so arrange the sections and surfaces that they may be readily molded and cast; and it is wise foresight on the part of the engineer, unless he has had special experience in designing castings, to submit his plans to a practical foundryman before their formal adoption. To facilitate molding, the stiffening ribs should not be so deep or so close together that the sand clings and breaks off from the rest of the mold, as will be the case unless the ribs have a good batter and are separated

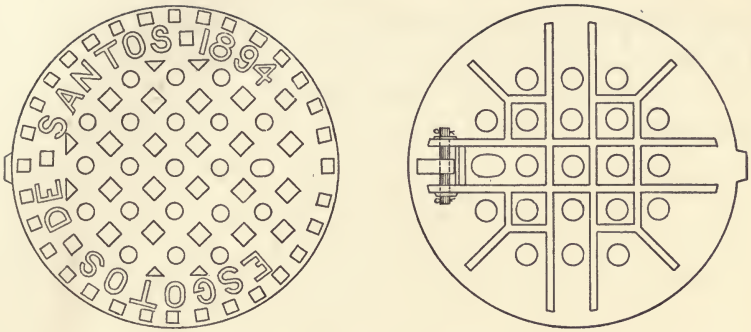

Fig. 79

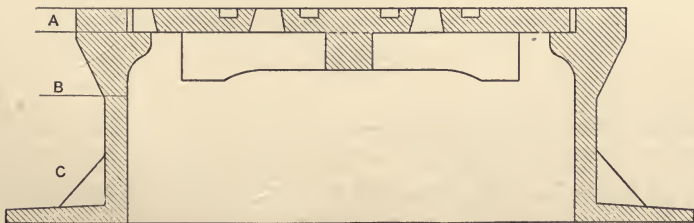
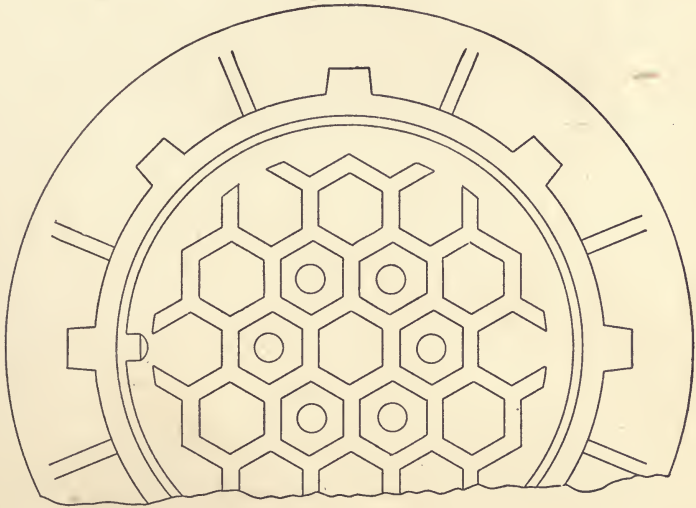

Fig. 80

enough to give adhesion at the bases of the projecting sand. It may also be noted that if patterns have to be made for the covers of special manholes of which only one or two are wanted, a large proportion of the cost of the cover is the cost of the pattern, and by

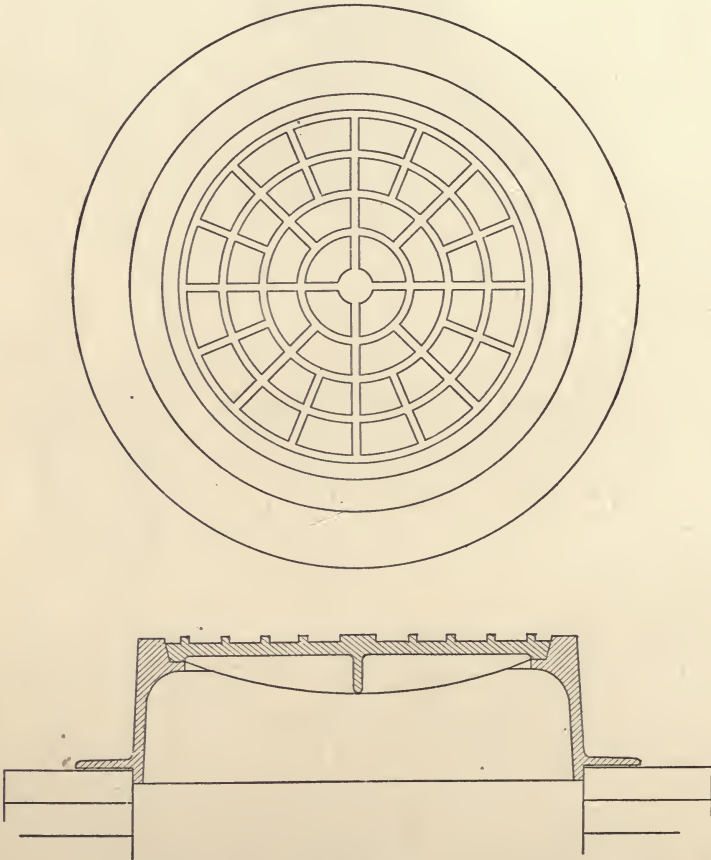

Fig. 8r

simplifying the latter, a noticeable saving may be effected. For example, over screening chambers or tanks, where a large opening may be wanted, a square cover would cost from \$5.00 to \$10.00 less than a round one, on account of the relative cheapness of

the square pattern. In places, also, where heavy traffic is not anticipated, as in fields or over filter beds, the weight of the regular cover may be much reduced. There are occasional instances of broken covers, but the breakage is due generally to frost, and only occasionally to a sharp blow from a heavily loaded wagon.

There is a story of a horse breaking the cover of a large man-hole in Washington with his hind feet, and thereby precipitating himself backwards into the sewer; but such accidents are rare.

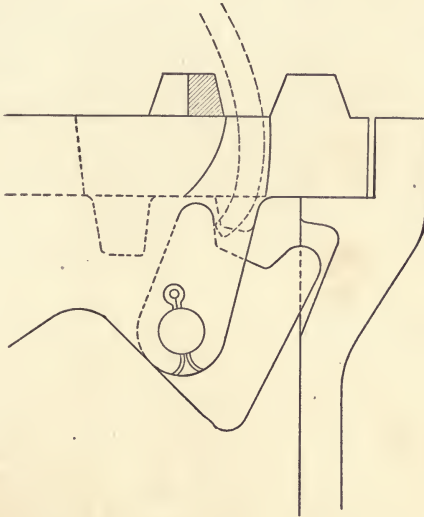

Fig. 82

Covers should be loose, not wedged fast in the frame, and should be supported at three points, so that they will rest firmly in place.

Some engineers have designed covers with simple locks, so that mischievous men and boys may not lift them from place. The author believes from his experience that a lock is unnecessary, the 150-pound weight being ample insurance against careless interference. Locks will rust or otherwise stick. A cover must sometimes be removed when a key is not at hand, and the mechanism adds to the cost. Figs. 82 and 83 show two of the simplest forms of such locks.

Fig. 82 is the lock designed by Rudolph Hering for the manholes at Ithaca, N. Y., the eccentric lug shown falling by its own weight so as to engage in a hole left in the casting of the manhole frame.

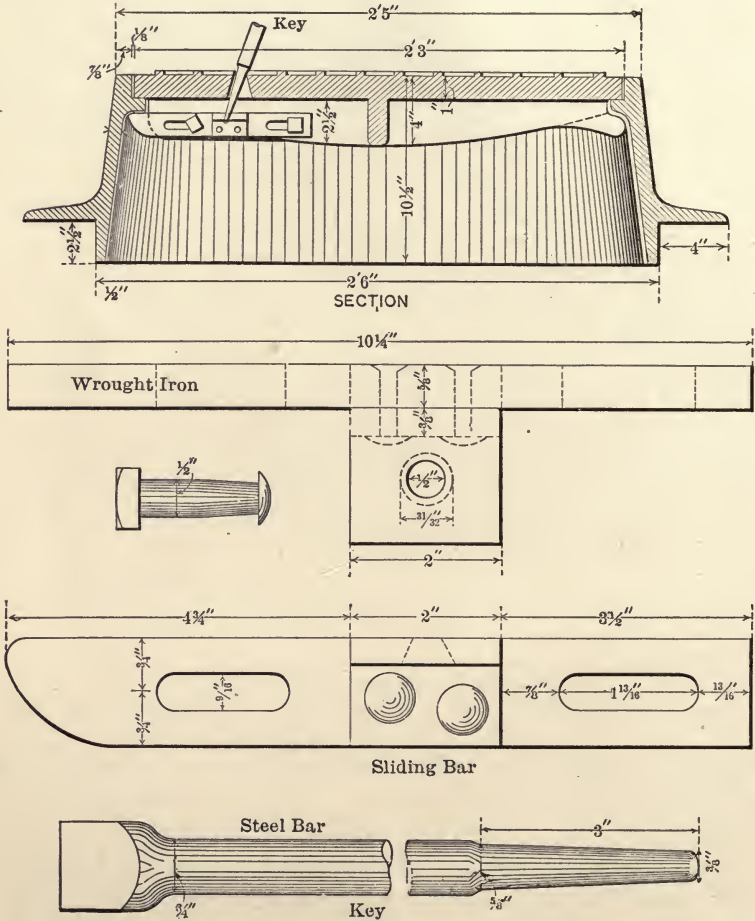

Fig. 83

To unlock, a curved lever is inserted through an opening left for the purpose and the lug pushed back until the cover is lifted.

Fig. 83 shows the lock used at Salt Lake City¹ similar in

¹ Eng. News, Vol. 31, p. 10.

principle, but the lock in this case is a sliding bar, working through slots on bolts attached to the manhole cover.

Where the covers are perforated, it is customary to suspend pans just below the cover in order to arrest the street dirt from

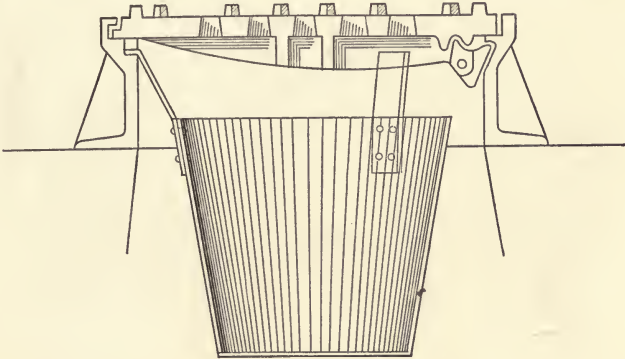

Fig. 84

falling into the sewer. The author doubts the necessity for this practice, since the amount thus reaching the sewer is ordinarily very small, and should be carried on by the sewage without causing any difficulty. If water finds its way through

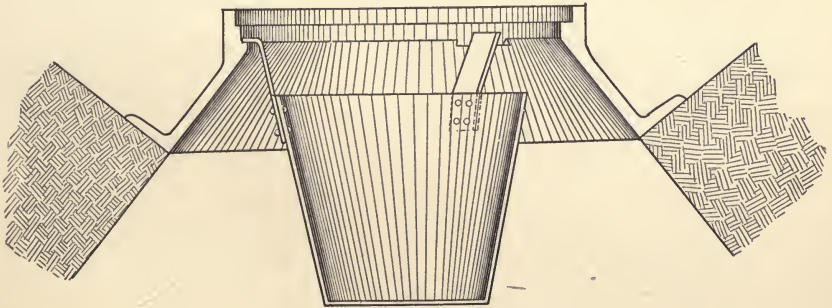

Fig. 85

the covers, it fills the pans, and in overflowing carries the street dirt with it into the sewer. Small openings in the pan about 3 inches above the bottom are of advantage in getting rid of the water and leaving the dirt. Figs. 84 and 85 show the pans

designed for Ithaca, N.Y., for deep and shallow manholes respectively, and Fig. 86 shows the pan as built. It is made of galvanized iron, No. 20 gauge, and is suspended by three straps

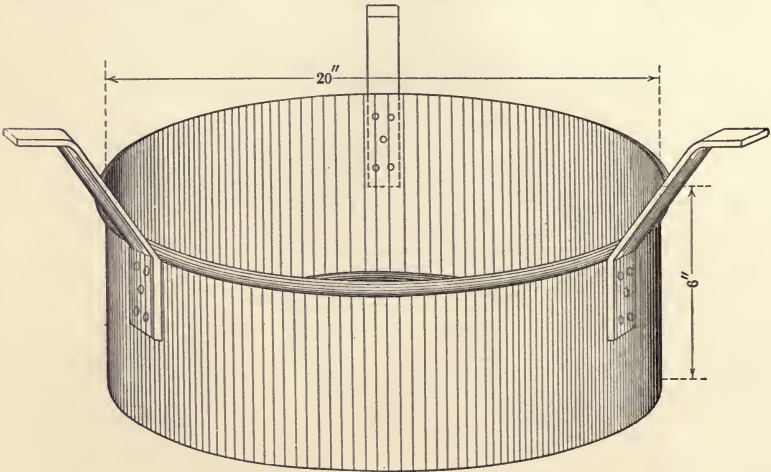

Fig. 86

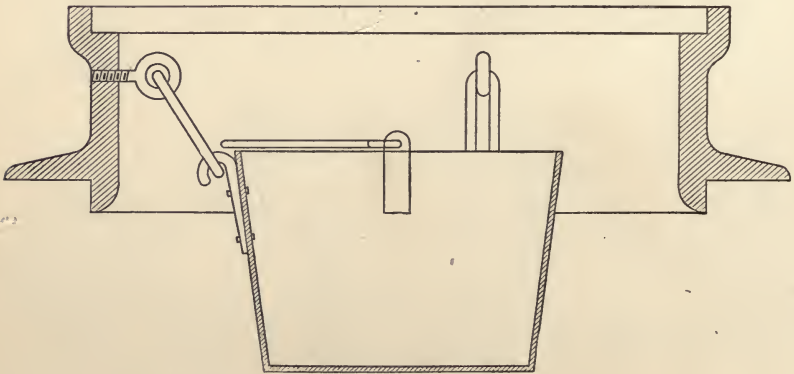

Fig. 87

resting on the top of the frame in depressions cast there for that purpose. These pans cost about 50 cents each and have proved satisfactory. Fig. 87 shows a more elaborate and heavier type.¹

¹ Baumeister, p. 244.

Lampholes are occasionally used to reduce the expense, but in the opinion of the author their use is seldom justified. They consist of a 6-inch or 8-inch pipe brought up vertically (by

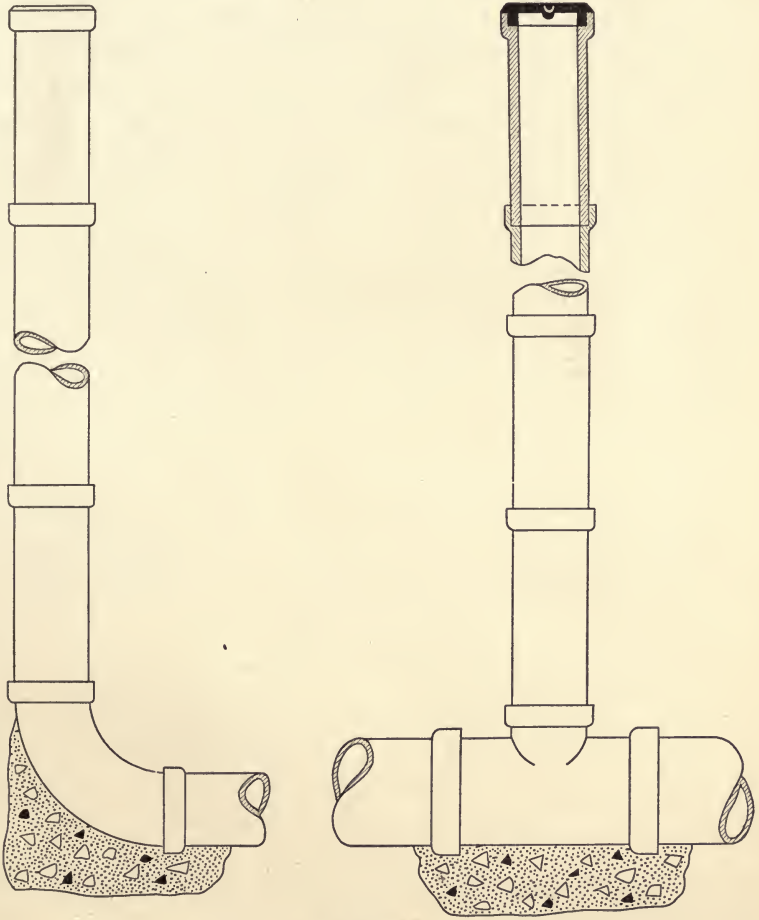

Fig. 88

means of a T branch) to the surface and protected there by a cast-iron cover. The lamphole is supposed to have two functions, viz., to allow a lantern to be lowered into the sewer, the light of which, seen from a manhole each side, assures the

freedom of the pipe from obstructions; and to enable fire hose to discharge water for flushing into the sewer. For such purposes lampholes are placed at points intermediate between manholes where the grade or line changes and where the distance between the manholes is so short that an intermediate manhole seems an unnecessary expense. In the experience of the author, lampholes are little used, and the economy is not proved. He would always use manholes as being altogether more satisfactory, as will readily be acknowledged should any obstruction occur in the line in question. The additional expense of manholes over that of lampholes is only a very small percentage of the total cost of the system. As temporary endings for laterals which will later be prolonged, he believes lampholes are useful, but elsewhere he prefers manholes. Fig. 88¹ shows the construction of a lamphole, and how the weight of the vertical pipe, which might otherwise crush down the sewer pipe, is supported by concrete. To still further save expense, the upper end of the

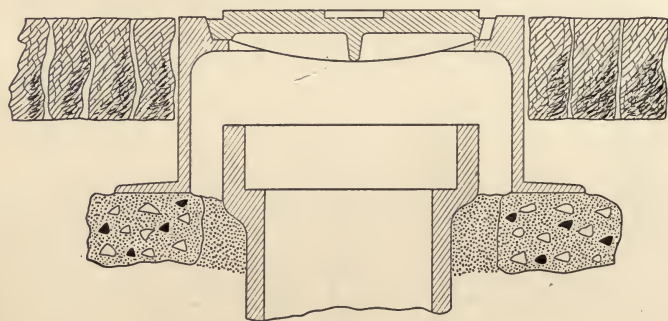

Fig. 89

pipe is sometimes covered with a stone and left buried a foot or so below the street surface, the place being referenced so as to be found readily. Otherwise a cast-iron cover must be provided, not touching the pipe, but free to settle independently, as shown in Fig. 89.¹

¹ From Auburn contract drawings. J. W. Ackerman, City Engineer.

CHAPTER VIII.

CATCH-BASINS.

WHERE the system of sewers is "combined," i.e. designed to receive both domestic sewage and storm water, or where the system is for storm water alone, adequate means must be provided for the admission of such storm water into the sewer. This is commonly done by making openings in the gutter so that the water flowing there will be intercepted and led off in a pipe to the sewer. There are a number of variations, however, in the method by which this is done, as the following discussion and illustrations will show:

The location of the inlet is usually at or near the street corner in order that the rush of storm water across a street may be avoided. For example, in Fig. 90, the grades of the street being represented by the arrows, water coming down the gutters on A Street would flow across B Street unless intercepted at the points *C* and *D*. If so intercepted no inconvenience is experienced by pedestrians on the crossing below, and no channel is required across B Street, a great advantage to drivers. Similarly, to avoid a rush of water across A Street from left to right inlets should be provided at *E* and *F*. One inlet at *G* might take the place of *E* and *C*, but the water would then have to be led across or under both cross-walks.

This arrangement will be modified by the topographical conditions. On the summit of a hill no inlets would be needed. In the center of a depression 8 inlets would be needed, and intermediate numbers would correspond to intermediate conditions. The method of construction of these inlets depends upon the use or non-use of catch-basins. Since gutter water presumably carries large quantities of sand, gravel, leaves,

sticks, manure, and other street debris, engineers in the past have constructed, in connection with the street inlets, pits or basins through which the gutter water should pass, and by the reduced velocity deposit such debris. But in view of the expense of such basins, it is desirable to eliminate their construction if possible. In many cities such a basin is built in

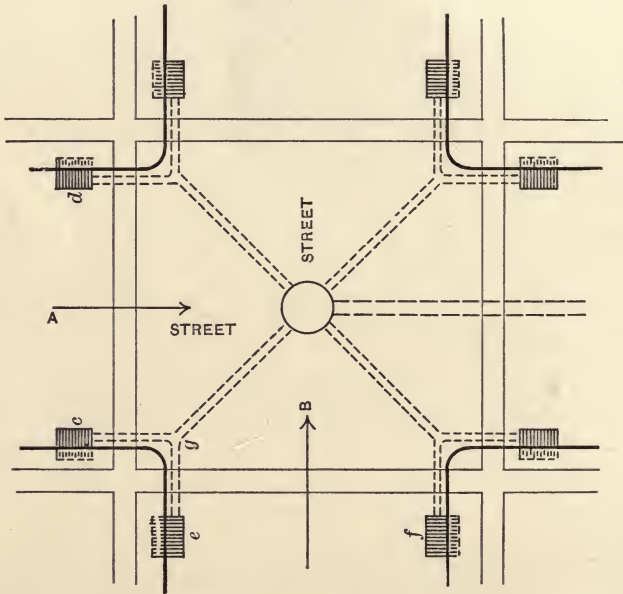

Fig. 90

connection with each inlet, but it is manifestly possible to bring the two inlets at each corner into one basin, as in Fig. 91, and this economical plan would reach its logical limit by having one basin into which all the inlets should discharge, as in Fig. 90 or Fig. 92. Many engineers to-day believe that with sewers of good grades, discharging freely into deep water, the basins are unnecessary, and that any material passing through the inlet grating will readily be carried to the outlet. Where the velocity of the sewage is less than 2 feet per second, or where a light-grade sewer succeeds a steep-grade gutter, so that the velocity is

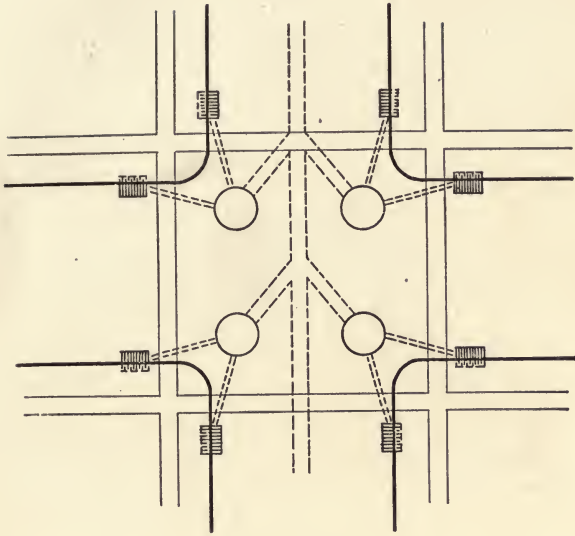

Fig. 91

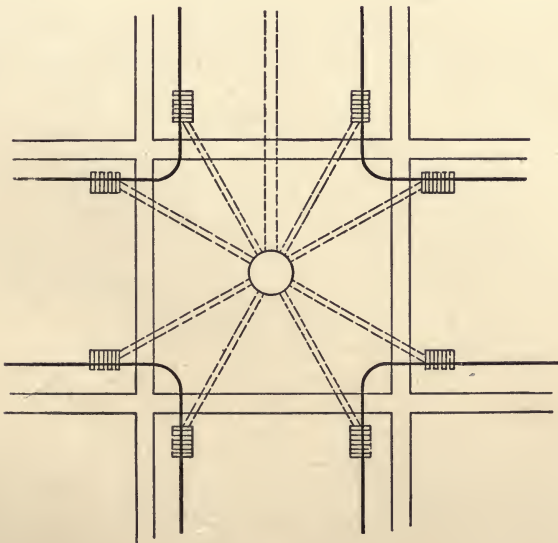

Fig. 92

much diminished, or if in the same sewer itself a steep grade precedes a light one, a catch-basin is desirable to prevent deposits of silt in the sewer. When the inlets are from dirt or macadam streets, catch-basins should be provided.

The size of the basin or pit is determined by the condition of the surface drained and by the frequency of cleaning both streets and basins. If the pavement on the street drained is brick or asphalt, the pit need not contain more than two or three cubic feet. If the street surface is macadam, it should be of twice that size. It is better to have basins cleaned frequently to avoid the accumulation of decaying organic matter, and, therefore, too large a basin is objectionable. When the basin is too small, on the other hand, it may fill up in the first rain, and, if not at once cleaned out, become perfectly useless.

The author believes that basins should be avoided when possible, but that the conditions of grades and street surface may sometimes require them, and that old sewers, or sewers badly designed or laid, may make the construction of basins imperative to prevent filling up the sewer.

Gratings to hold back floating matter can generally be bought of any local foundry, although the forms of casting will differ materially.

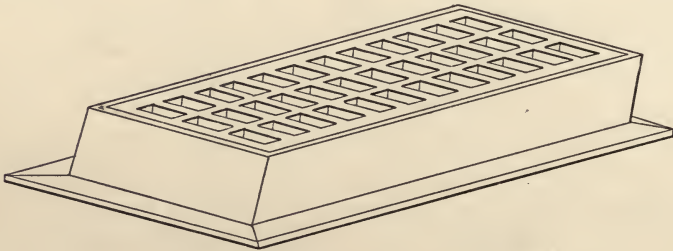

Fig. 93

Fig. 93 shows a rectangular flat-top grating manufactured by a foundry in Dayton, Ohio; 94 shows a circular flat-top grating made by a foundry in South Bend, Ind.; and Fig. 95 a circular elevated top; in fact, these gratings are formed of every conceivable design

or pattern. It may be safely said, however, that in spite of the large number of these gratings on the market, such horizontal openings will inevitably become clogged, since leaves, paper, sticks, etc., which are arrested on the grating, soon form an impenetrable coating, and the gutter water then flows over the grating. There should, therefore, unless the inlet is in the

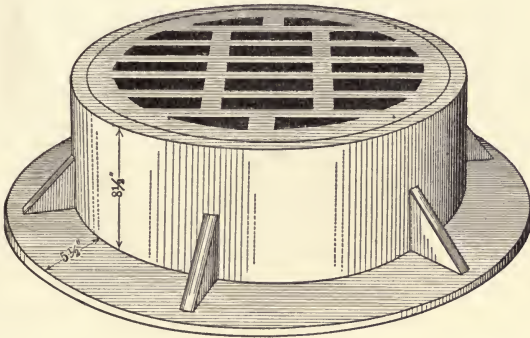

Fig. 94

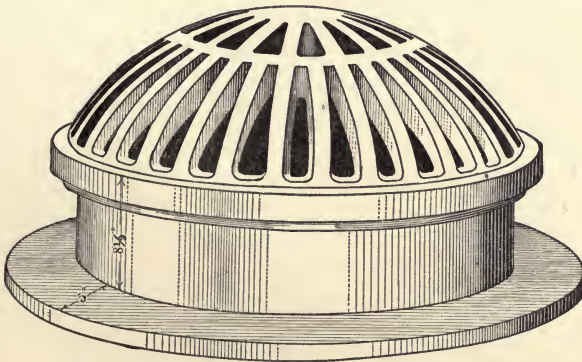

Fig. 95

center of the street, be a vertical opening into the curb. The horizontal grating may be retained or not. Fig. 96 shows a horizontal grating and vertical opening, furnished by a foundry in Cleveland. Fig. 97 shows the casting by itself. Fig. 98 shows the opening arranged for a corner inlet instead of at the

middle of the block. Fig. 99 shows another design, for straight curb. Frequently $\frac{3}{4}$ -inch rods fastened into the stone curb are used satisfactorily. About a 2-inch opening seems to

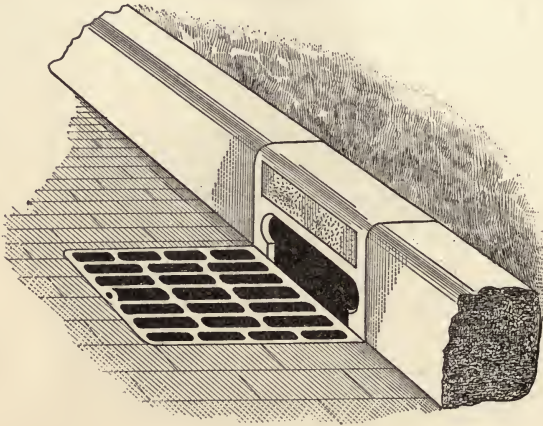

Fig. 96

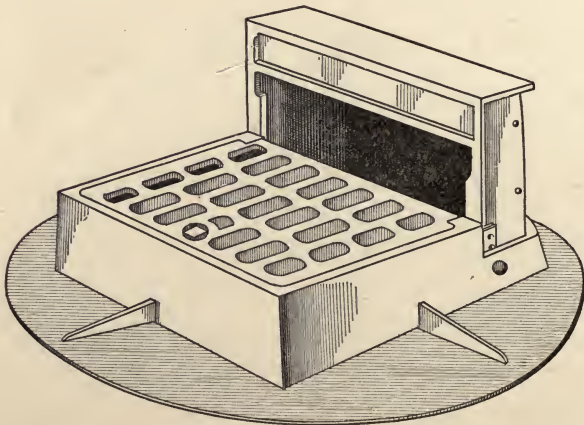

Fig. 97

be the approved spacing of the grating bars. The size of the grating varies from about 20 inches in diameter to 20 × 30 inches rectangular. The vertical opening is commonly

about 6 inches high, by from 12 to 24 inches wide. On steep grades the grating may be carried into a recess in the curb, or the opening may be depressed below the gutter to induce the flow to enter, otherwise the velocity of the water may cause it to shoot by.

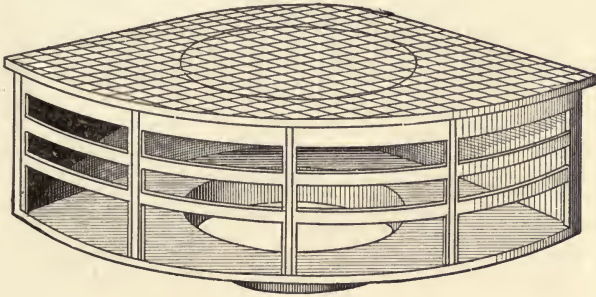

Fig. 98

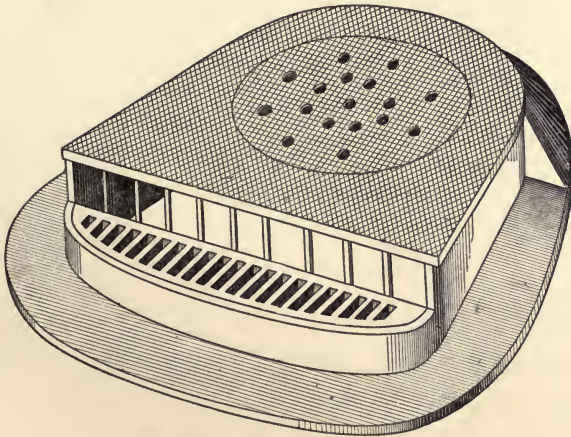

Fig. 99

Traps have been built into catch-basins with a view to avoid the escape of gases from the sewer, but opinion is much divided as to their necessity. Folwell, for example, holds that the inlet to a storm sewer should be without traps, so as to assist in venti-

lating the sewer, but the test of present-day practice is that they are generally used.

The avowed purpose of the trap is to prevent the escape of noisome gases generated in the sewer. But such formation of gas does not or should not occur, and the trap really remains as an evidence of the time when sewers were elongated cess-pools, and had to be cleaned out with shovels. The smell sometimes detected from a catch-basin is due generally to the organic

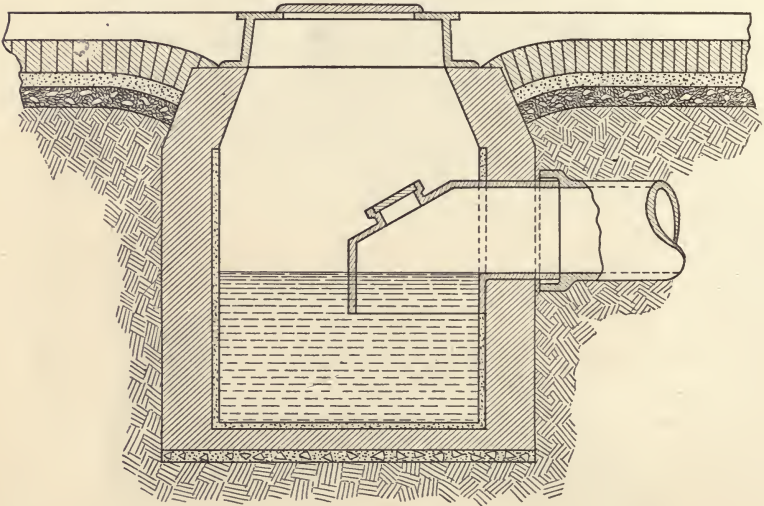

Fig. 100

decay in the basin itself, and not to any gases rising from the sewer. Where a proper velocity is maintained in a sewer there is no opportunity for deposits to form nor for decomposition to take place, and therefore, no gases being generated, the purpose of the trap is defeated. It would be equally necessary to trap the openings in manhole covers if traps were necessary at storm inlets. There is, however, a function of the trap which has value, namely, its power of holding back floating material, such as paper, sticks, banana skins, etc. The advantage is lost, however, in the mind of the author, by the obstruction which is

introduced into the flow of the water, the fundamental axiom to keep everything moving in an unobstructed waterway to the outfall, being violated. Traps are used, however, in a number of cities. Folwell found, out of 43 cities, 26 with traps on all connections, 14 with traps on important connections, and only 3 with no traps at all. In view of such general practice, the elimination of the traps ought to be carefully studied in the light of a complete examination of the sewers themselves.

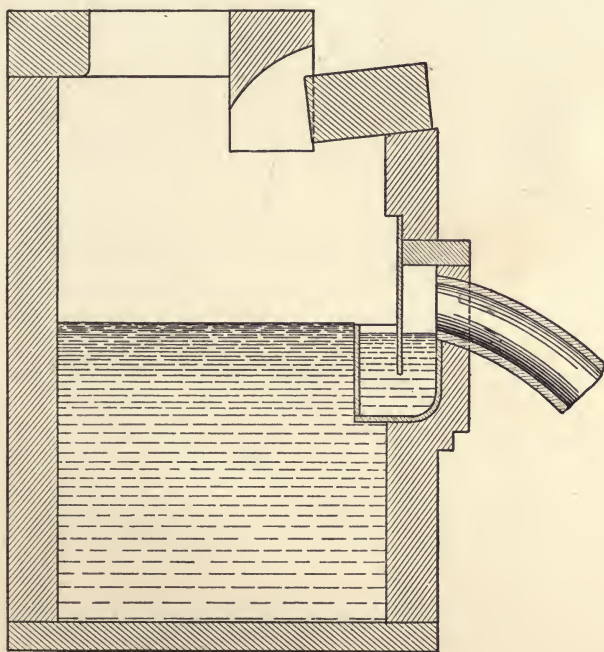

Fig. 101

There are three general types of traps, viz.:

(1) A pipe trap formed by an elbow or special, in continuation of the basin outlet pipe, as shown in Fig. 100, forms the simplest trap. Here there is an elbow of the 12-inch pipe used, which is built into the brick wall and cemented into the main pipe.

To remove any possible obstruction under the elbow, a workman must reach down under the water, or must pump out the basin from the top, or else there must be provided an elbow, with a clean-out, as is shown here. This represents the type in use at Columbus, Ohio, and gives satisfaction.

Fig. 101 (Baumeister) shows a special tile trap, which is used in Providence, R.I. There is an improvement over Fig. 100, in that the space in the basin is not so encroached upon, but there is no way of cleaning out the trap nor of removing the trap from the brickwork. The section also shows in detail the method of placing the stonework, and of forming the inlet.

Fig. 102 shows this type of construction carried to the extreme, where the trap has been reduced in size until it is compressed into

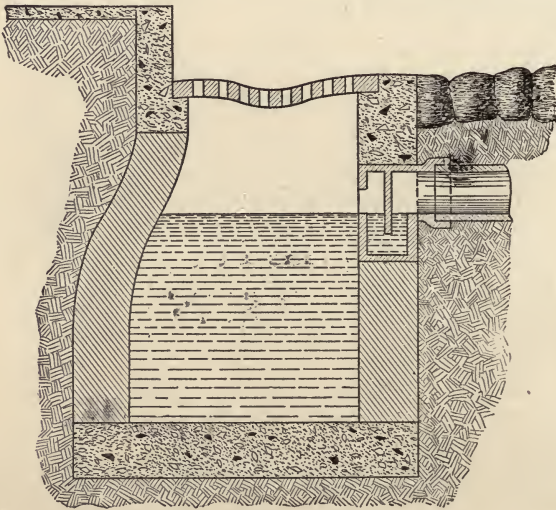

Fig. 102

the thickness of the wall, forming an integral part of it. No provision is made, whatever, for cleaning the trap, but the basin is free from any obstruction. This is used at Margate, England.

Fig. 103 shows a basin used at Michigan City, Ind.,¹ where the trap has been removed from the basin entirely. The con-

¹ Paving, Vol. 20, p. 10.

struction is ingenious — a 24-inch tile sewer on end, the 8-inch Y forming the outlet. A concave bottom is formed in concrete and a cast-iron cover is supported on brickwork. The chief advantage, however, of this type, is its economy.

(2) A cast-iron hood, protecting the end of the basin outlet pipe, so arranged that it can be removed for cleaning, is the next type. This is the simplest and best trap if one must be built,

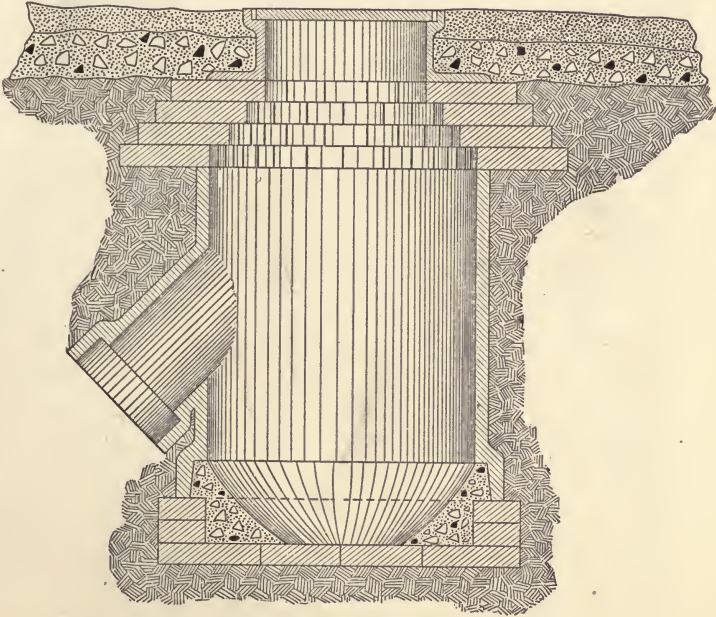

Fig. 103

since it leaves the entire catch-basin available for deposit, and does not restrict the area at times of cleaning.

Fig. 104 shows the trap used in Boston as made by one of the Boston foundries. When the hood is down, the sides form a joint sufficiently tight to enable the trap to hold back, or at least restrain, the escaping gases, so that they are not objectionable. When cleaning is necessary the hood is lifted, hung on the hook provided, and rods may be forced directly down the sewer.

Fig. 105 shows the catch-basin in use at Wilmington, Del. This is made of brick, circular in plan, 2 feet 8 inches in diameter, and 8 feet 8 inches deep. A cast-iron hood which is hooked on over projections left for the purpose, serves for the trap. Inside

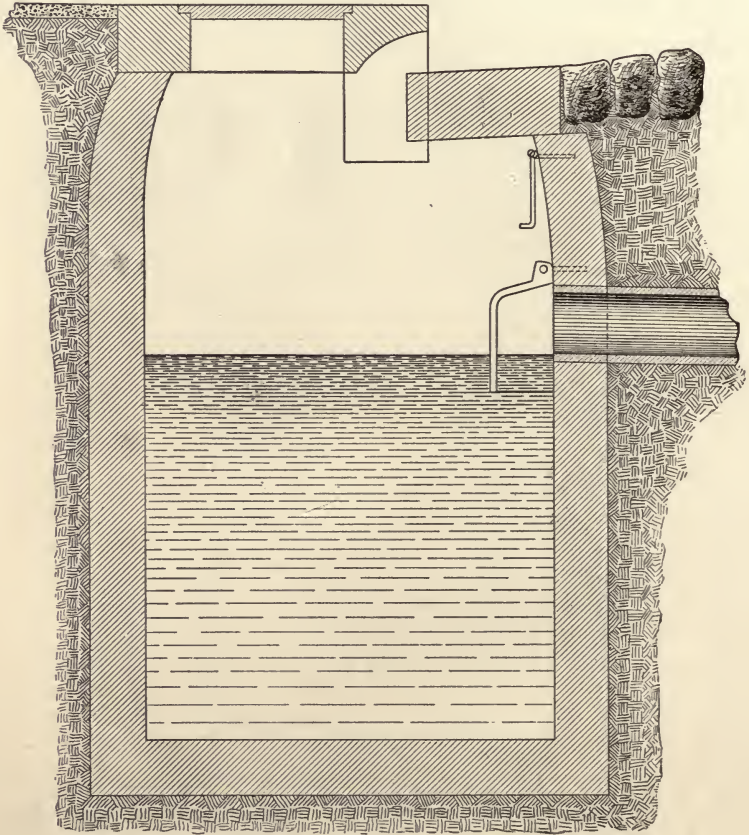

Fig. 104

the basin is a bucket, 2 feet 5 inches in diameter, which can be lifted out with its contents and the basin thus cleaned at one operation. The bucket is made of heavy oak staves, very substantially, and a windlass is used to raise it to the sidewalk.

(3) A division wall in the basin built from the top down to about 6 inches below the water level, making the trap an integral part of the basin, constitutes the third type. This is a clumsy arrangement, making the basin unduly large, making cleaning

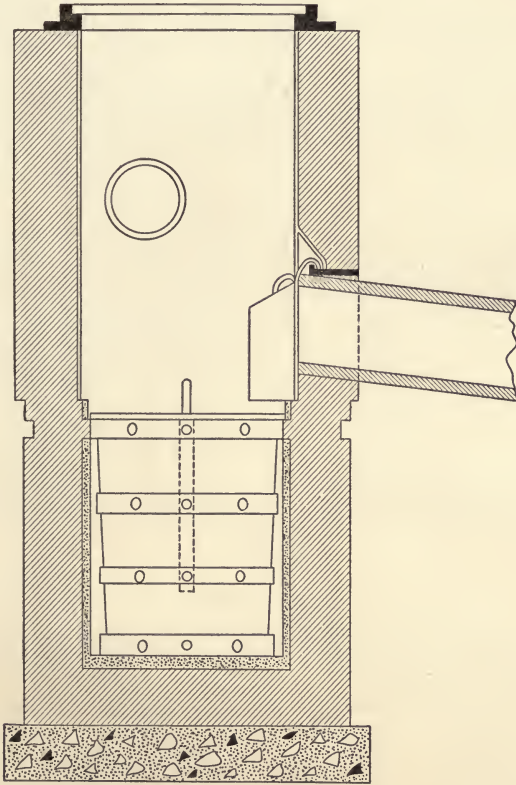

Fig. 105

difficult, and increasing the cost, both of construction and maintenance.

The following example may, however, be given of this form of construction. Fig. 106 shows the elaborate basin at Peoria,¹ as designed by Mr. Parmley. This basin is 6 feet long, 2 feet wide,

¹ Eng. News, Vol. 34, p. 432.

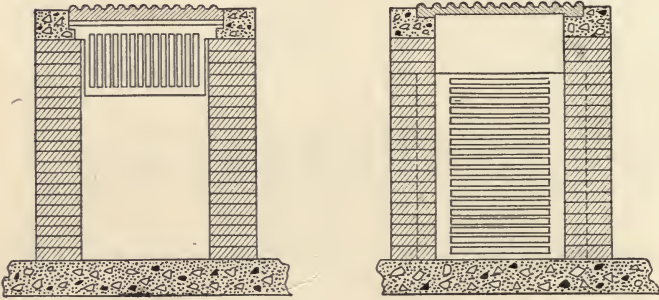
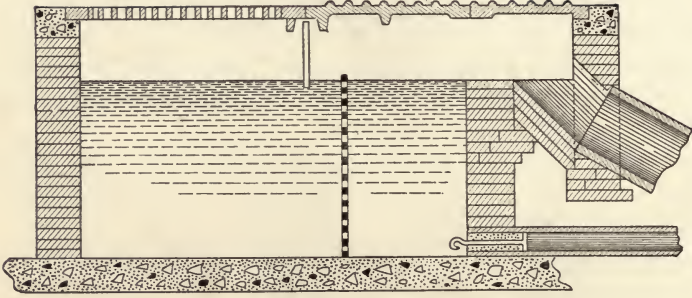

Fig. 106

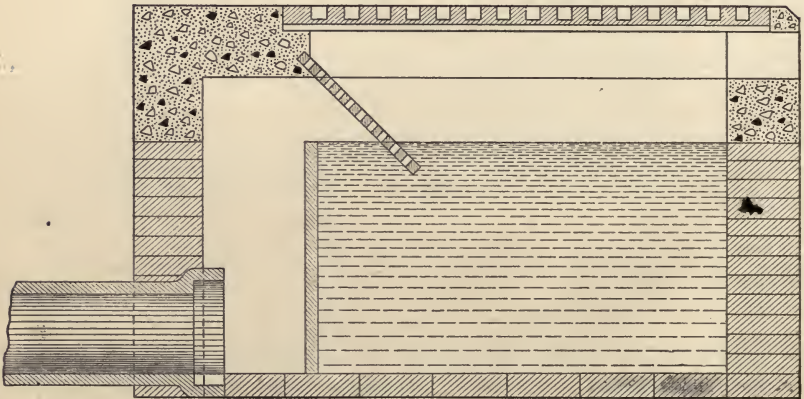

Fig. 107

and 3 feet deep. It has two interior gratings as shown, so that no floating or suspended matter larger than the screen space can pass to the sewer. A clean-out is provided for the apparent purpose of admitting the retained silt to the sewer, but a gravel

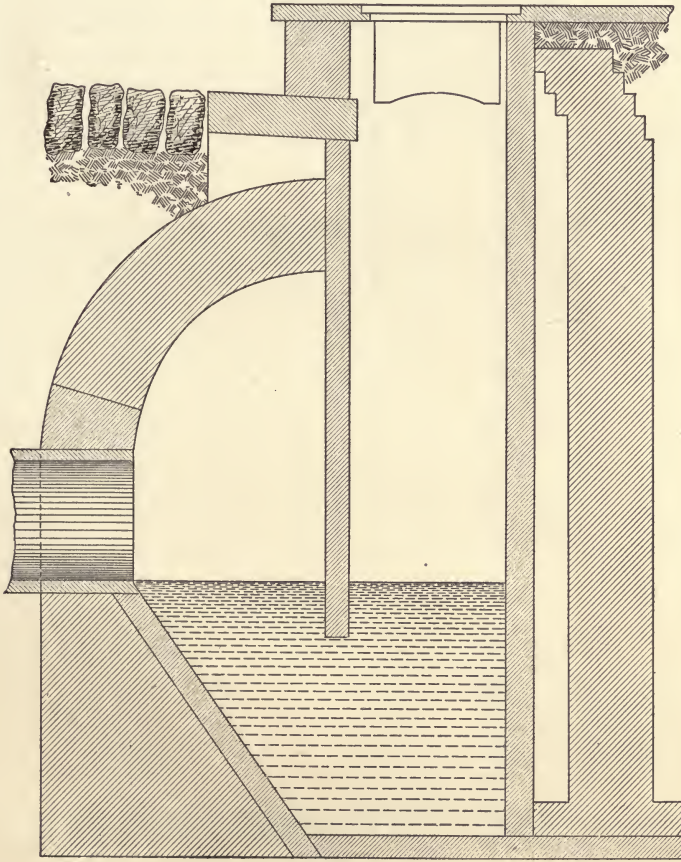

Fig. 108

filter allows the water to escape, after which the silt, etc., is shoveled out.

Fig. 107 shows a similar construction used at Burlington, Iowa. As in the preceding figure, no trap is shown because the lip of

the trap is made a grating, but the principle in each case is that of a trap. In both of these cases, the facility with which the

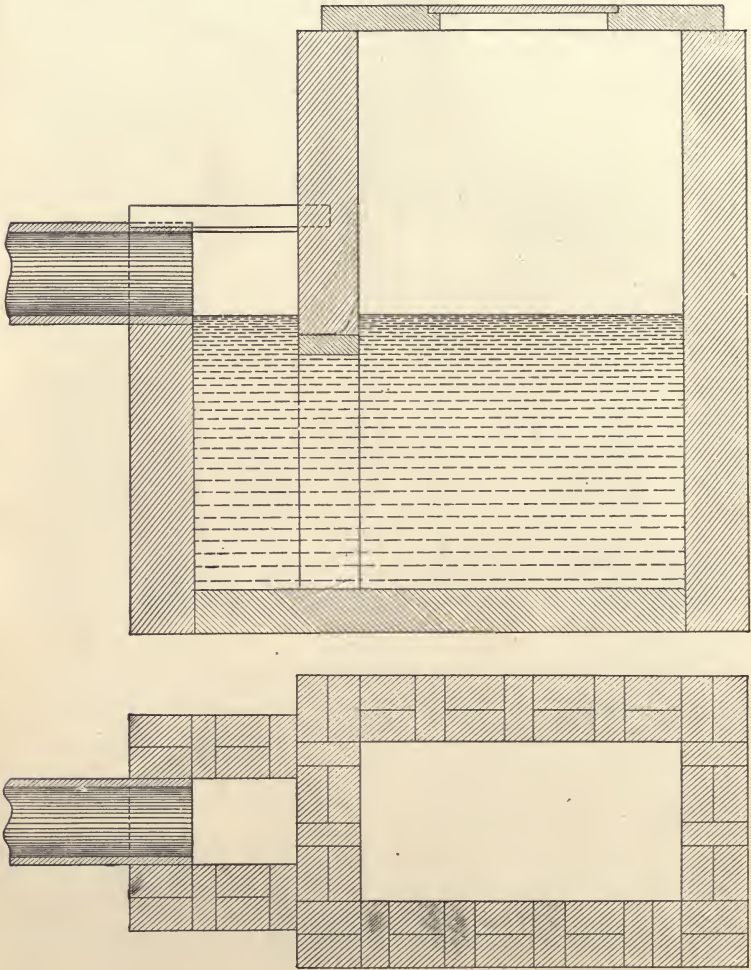

Fig. 109

basins, on account of their size, can be cleaned out, is probably not the least of their advantages.

Fig. 108 shows the old standard type used in Philadelphia.

The plan of the basin shows two intersecting cylinders, one that part of the basin carrying the cover, and the other the trap part.

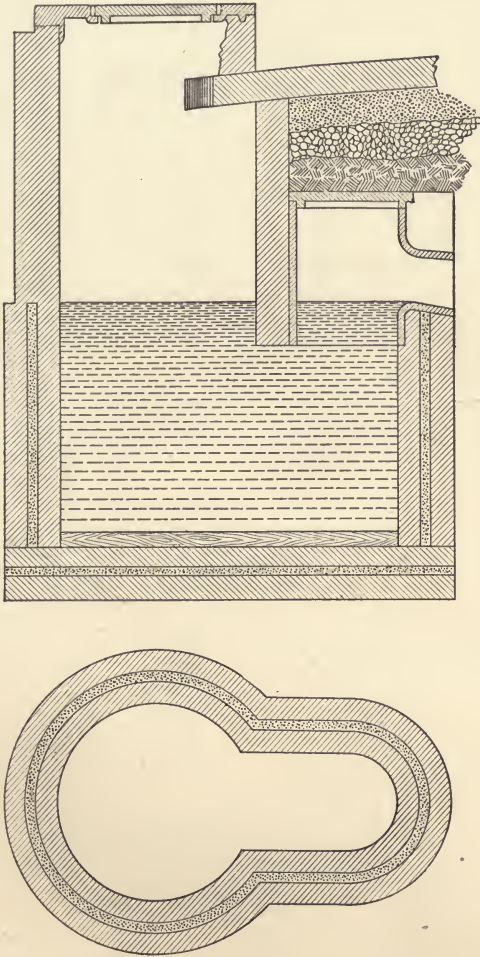

Fig. 110

To avoid carrying up both cylinders to the surface, the cylinder containing the trap is arched over against the other, involving some elaborate forms and masonry. The trap wall is a slab of

bluestone set on edge in the brick walls, and projecting about 3 inches below the water level.

Fig. 109 shows the plain and substantial catch-basin built in Washington. It is about 4 feet long, 4 feet deep, and 2 feet wide, containing a little more than a cubic yard. The trap is formed by supporting one wall on a stone sill about 5 inches below the water level. It is necessary in both these last to pump out the basin to remove any obstruction beyond the trap.

Fig. 110 shows a catch-basin used at Louisville, which is a combination of types (1) and (3). A T pipe is used, the vertical pipe forming the trap. In addition there is a stone slab set vertical, its lower edge flush with the bottom of the pipe. To prevent any disturbance to the brick floor a false bottom of 2-inch oak plank is laid down.

If no pits or traps are deemed necessary, then an inlet, so called, is alone needed. The simplest way of accomplishing this is

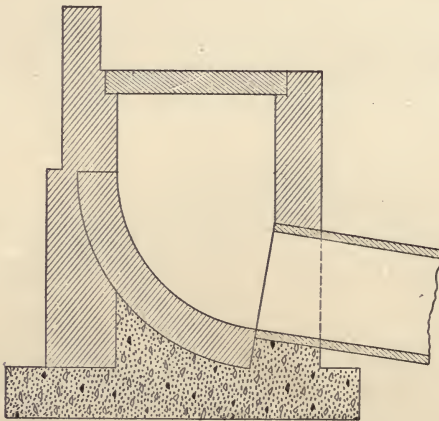

Fig. 111

shown in Fig. 111, as used in Warsaw, N.Y. The curb is of stone, but the rest of the masonry shown is brick and concrete, all surrounding the end of the sewer pipe and directing the flow of the gutter into the sewer.

Fig. 112 shows a similar construction for Tarrytown, where a T pipe is used at some depth below the surface of the ground. The author believes that with a 90-degree bend, substituted for the T pipe, and then enlarged to the size necessary to fit the

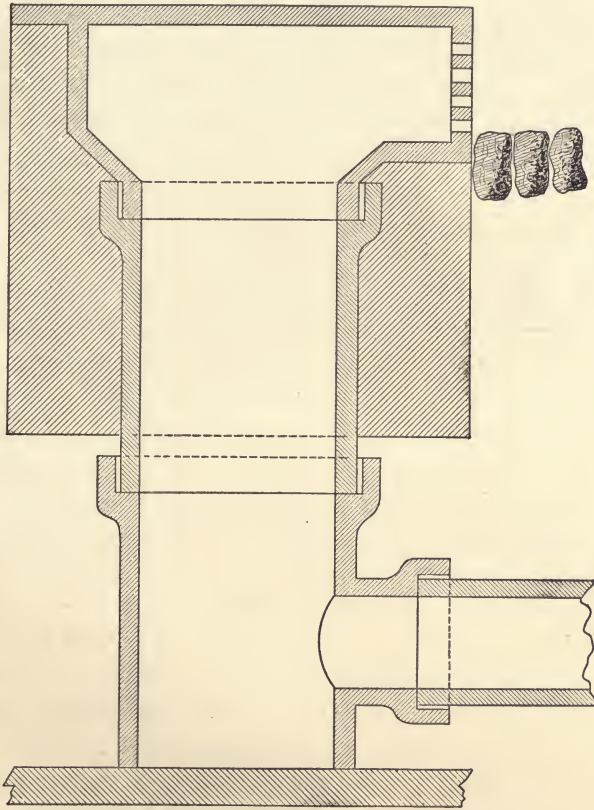

Fig. 112

bottom of the inlet casting, an ideal inlet connection would be made.

In the construction of catch-basins, brick, stone, and concrete have been used. Brick was used in curved forms like those at Philadelphia on account of the ease of working, but because of the porosity of ordinary brick and their behavior

under frost, they are not now generally considered good material. Their porosity also permits leakage through the walls of the basin, which is not desirable. The trap, to be effective, requires that the water level be constantly maintained, and if the basin leaks, this cannot be done.

In Fig. 110, the drawing indicates the special requirements at Louisville in the matter of interior layers of cement plaster. It is generally specified that the basins shall be plastered, one-half inch thick, inside and out, to prevent leakage, and sometimes tar or asphalt is used.

Concrete is the cheapest material of which to construct catch-basins, and, except for the matter of perviousness, is entirely satisfactory.

In the matter of cleaning catch-basins, each city is a law unto itself. Folwell thinks that every catch-basin should be cleaned after every rainfall. This may be ideal, but seems entirely impracticable. For example, one of the New England cities has 600 catch-basins, so that if one gang of three men and a one-horse cart cleaned six basins a day, it would take 100 days to cover the city, or, the gang would reach each basin 3 times a year. As a matter of fact, in this city the basins were cleaned on an average of 1.84 times per year, and that in a New England city, where municipal housekeeping is acknowledged to be carefully looked after. It follows that in this city, and in others under similar conditions, the basins must soon become filled to their capacity, and then further amounts of sediment are carried over into the sewer, and the inference is that the retention of a small portion only of the sediment in the basin is not worth while. It is cheaper to dig out the sediment when brought together to one large sedimentation basin at the outlet if it has to be dug out, than to collect it from hundreds of small receptacles. In severe winters trouble is had from the formation of ice on the water in the basin. A movable boiler is used to furnish steam by which the basins are restored to usefulness. If well below ground and untrapped, no trouble need be feared except in extreme weather.

CHAPTER IX.

SIPHONS.

IN laying out the lines of pipe through a town, it is often convenient, in order to avoid excessive cuttings, to arrange a portion of the pipe line to act as a siphon. For this purpose, the line must be air-tight, and therefore either of wrought iron or of cast iron. Precautions must be taken to prevent the siphon emptying itself, and so having to be primed and started frequently. Some automatic device for freeing the siphon of air is of great help in maintaining a constant flow, since the entrained air collecting at the highest point will gradually reduce the flow until it stops altogether. An excellent example of the use of a true siphon is found at Norfolk, Va., the siphon having been designed by the late Colonel Waring, and installed and operated by the city engineer, Mr. W. T. Brooke. The illustration, Fig. 113, shows the arrangement. The main on Brewer Street, 18 inches in diameter, was so designed that for a distance of about half a mile the pipe was from 16 to 19 feet deep. The soil was a quicksand, very troublesome and expensive for such work. A large brick building on the narrow street was additional cause for avoiding, if possible, the deep trenching in quicksand. Colonel Waring recommended the use of a siphon of 14-inch cast-iron pipe, its intake at the bottom of a manhole at the upper end, and its outlet into a manhole at the lower end. To prevent unsealing of the siphon the lower end was provided with a return bend which overflowed at a point 5 inches higher than the intake end, insuring a 5-inch seal on the siphon. The summit of the siphon is connected by a 2-inch pipe with an air-pump so that accumulations of air may be readily removed. It is said that this pump has to be worked a

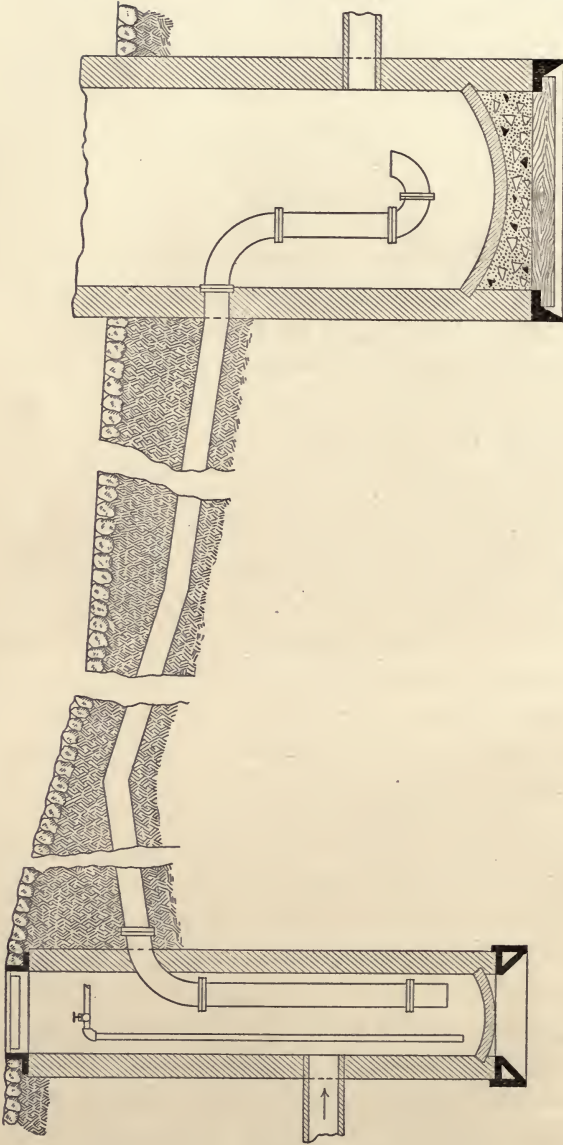

Fig. 113

few minutes every day to remove bubbles of air, but otherwise the success of the design is unquestionable.

About the same time that the Norfolk siphon was installed, an engineer of Breslau, Germany, designed and built a similar pipe line to carry the sewage from an island forming part of the city of Breslau. The population was about 2000, and inasmuch as the channels on both sides of the island were wide and deep, it was decided to use a direct siphon instead of the usual submerged pipe. Use was made of a bridge, the 6-inch sewer pipe of cast iron with flanged joints and rubber packing being brought up to the lower chord of the bridge and so across the river. The rise in the siphon is 10.7 feet, and the distance between the manholes at each end of the bridge is 375 feet. The fall or head available for working the siphon is 10 inches. To remove the entrained air an automatic air-valve was installed at the summit which acts as an aspirator through the agency of a small stream of water from the city supply. It is entirely automatic, the water being turned on by a float in the air chamber. The usual conditions required the city water to flow (under city pressure through an inch pipe) about two minutes at a time and five or six times in 24 hours. It is said that the arrangement is satisfactory and works without interruption.¹

On the other hand, unless perfectly air-tight pipes are used, continual difficulty must be expected. The Journal of the Association of Engineering Societies, November, 1900, describes difficulties due to air leaking through a small 1-inch iron pipe siphon used for a private water supply system, and it was not till a continuous lead pipe was substituted that the troubles ceased. The inference, therefore, is that while direct siphons can be made to work, the construction must be exceptionally good, maintenance charges will be continuous, and their combined cost should be compared with the cost of other methods of construction.

For crossing gulleys and gorges a bridge may be the cheapest and the most convenient arrangement. Fig. 114 shows a design

¹ Inst. of C. E., Vol. 85, p. 464.

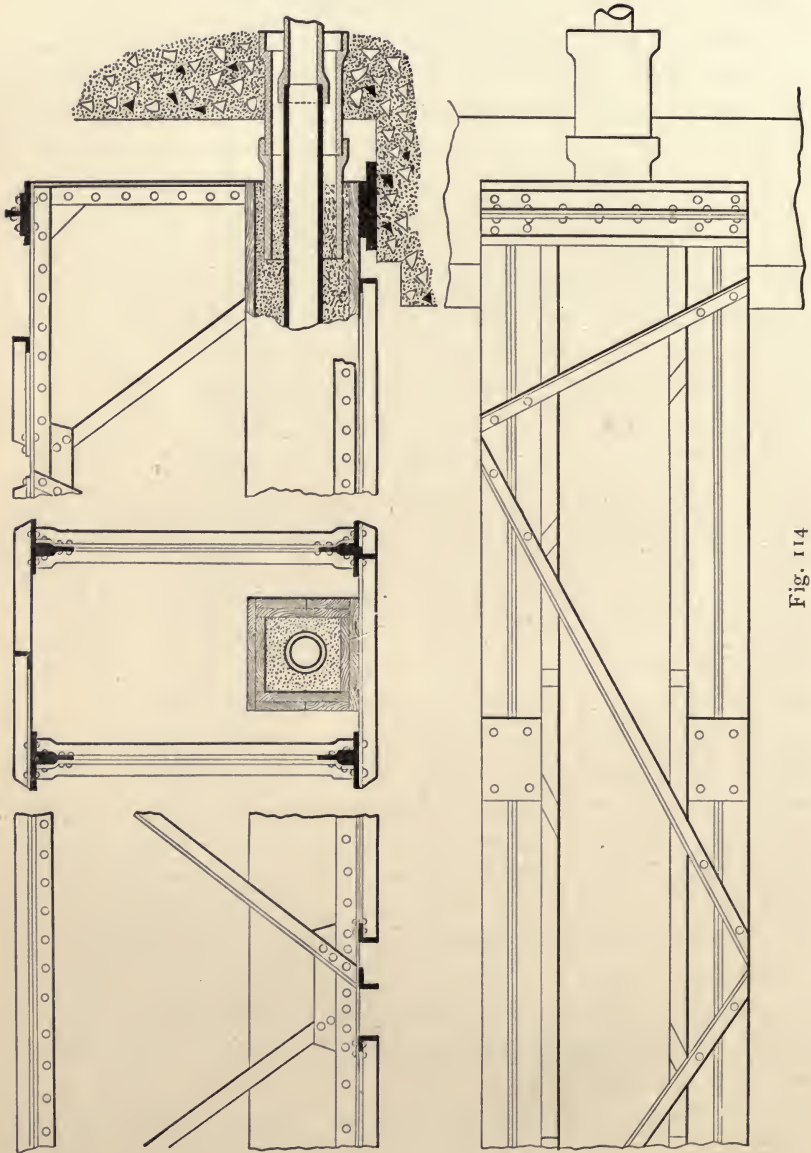

Fig. 114

of Rudolph Hering for such a structure to cross Cascadilla Gorge in Ithaca, N.Y. This bridge was to be 120 feet long, 4 feet wide, and 6 feet deep, of a simple Warren girder type as shown. This was never built, the estimated cost being \$1500. Instead the sewer pipe was carried in a wooden box attached to the upper chord of a highway bridge, which crossed the gorge at that place. To avoid the vibration, which is the great objection to such construction, the pipe line on the bridge was made of heavy wrought-iron pipe with screw joints. Expansion was provided for by fastening the upper end firmly in masonry, and arranging a slip joint in the masonry of the lower end. This has been working satisfactorily for ten years without any repairs or special attention.

Other devices for crossing a ravine will readily suggest themselves. For example, a light wooden pony truss may be built, on which the pipe may rest. The sewer pipe itself, if of iron, may serve as the compression member of a truss to which struts and diagonals may be attached. Since, however, it is customary to box in the sewer pipe on account of frost, this last method would answer only in the south. Finally, the sides of the box, which would naturally be of 2-inch plank, may be made the upper chord of a truss, the floor of the box being laid on a platform hung between the two chords. This method is undoubtedly the cheapest for short spans. For protection against frost, the sewer should be surrounded with about six inches of some non-conducting material like sawdust, tan bark, or straw. Mineral wool is a highly desirable non-conductor, and has the additional advantages of neither decaying nor rotting like sawdust, nor settling to the bottom of the box as other material is likely to do. The sides of the box ought to be carefully protected from the weather, a $\frac{7}{8}$ -inch tongue and grooved sheathing on the outside of the box being a common arrangement. A tin roof is desirable as a further protection.

If the pipe line is carried down one side of the valley, across, and up the other side, there is formed what is known as an "inverted siphon," though there is nothing present involving the principle of the siphon. The pipe in the bottom of the valley is

merely working under pressure, and the flow will always take place, provided the outlet end is lower than the inlet end. On account of the pressure it is usual to construct the siphon of either cast or wrought iron, although wood and concrete have been used. Several accessories are common, viz., an overflow at the inlet end to discharge the sewage into the stream if the siphon becomes clogged; an inlet pipe to admit water from the stream

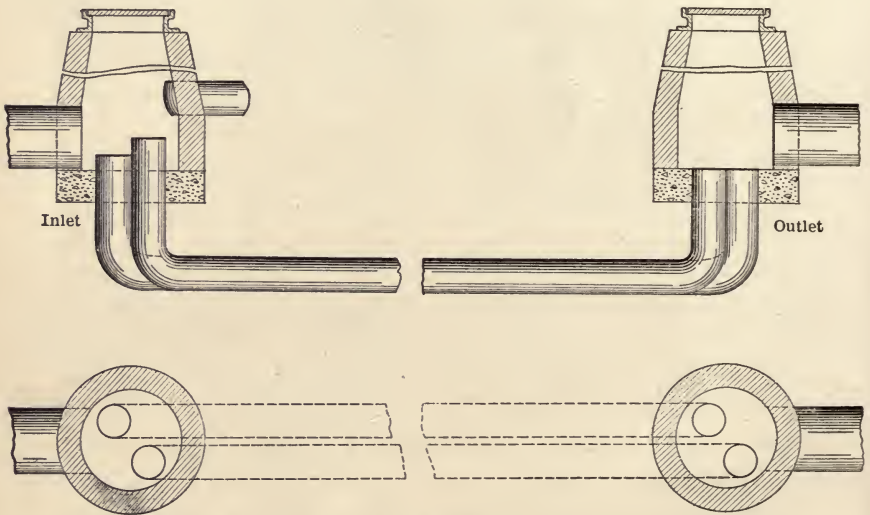

Fig. 115

for flushing purposes; and a double or triple system of pipes, so that the variations of flow may be taken care of without a serious reduction of the velocity in the siphon. It should be noted that since the sewer in open channel is designed to flow half full, and since the siphon flows full, the area of the latter should be at most only half that of the former. Also, since, at times of minimum flow, the velocity becomes much reduced, it is necessary to have the siphon pipe of even smaller capacity, or else deposits in the siphon may be expected. It is advantageous, therefore, to provide either an automatic overflow, or else a second pipe, coming into use when the capacity of the siphon is exceeded, in order to care for the

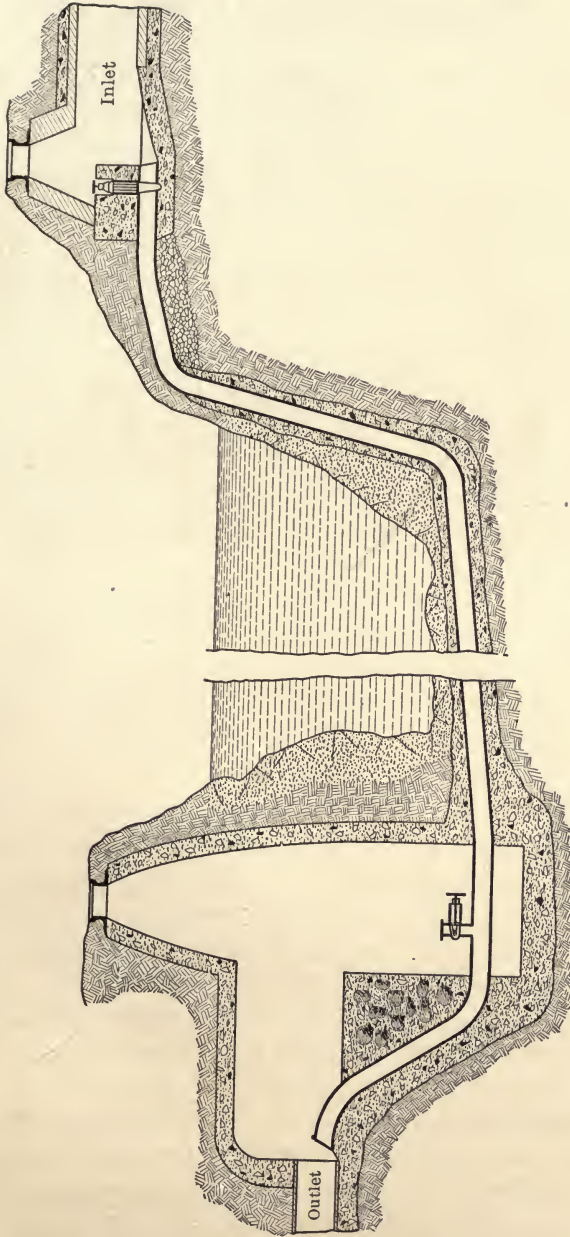

Fig. 116

maximum flow, and usually both are provided. The following examples are cited.

Fig. 115 shows the arrangement adopted at Roanoke, Va. Two 12-inch pipes are provided, rising vertically through the bottom of the manhole, one to a height of 6 inches and one to a height of 14 inches above the bottom. In this way the small flows are all taken through one pipe, and it is not until that pipe becomes overtaxed that the sewage in the manhole rises to the level of the higher pipe, and the second pipe begins to flow. The overflow pipe is also shown.¹

Mr. Farnham, City Engineer of Newton, Mass., referring to the maintenance of siphons, says that in the course of operation, lasting six years, no emergency has ever arisen which required the opening of the siphons in that city. They have been scraped out once in each year, but the amount removed, grease and sand, is hardly sufficient to justify the trouble. He describes one siphon as follows:

The sewer is brick, 24 × 30 inches, egg-shaped, up to the point where it became necessary to carry the flow across the Charles River. Between the manholes on the banks, 245 feet apart (see Fig. 116), two iron pipes were laid, one 6 inches and one 8 inches, each pipe being provided with a gate, so that either pipe, or both, can be used at will. An overflow pipe is also provided. The horizontal portion of the siphon is given a good grade, and the manhole on the lower end extends to the low point, so that by means of a special flange casting (not shown) supplied for the purpose, access may be had to the siphon pipe for cleaning. A T pipe is also provided, closed with a valve, but so arranged that a vertical pipe can be screwed on above the valve. By observing the height of water in this pipe, and comparing with the water level of the upper manhole, an idea of the freedom from obstruction in the siphon can be obtained. A flushing pipe not shown in the drawing was also provided.²

Fig. 117 shows a siphon used at New Orleans, by which the sewage is carried under one of the drainage canals. Three

¹ Paving, Vol. 6, p. 154.

² Paving, Vol. 25, p. 410.

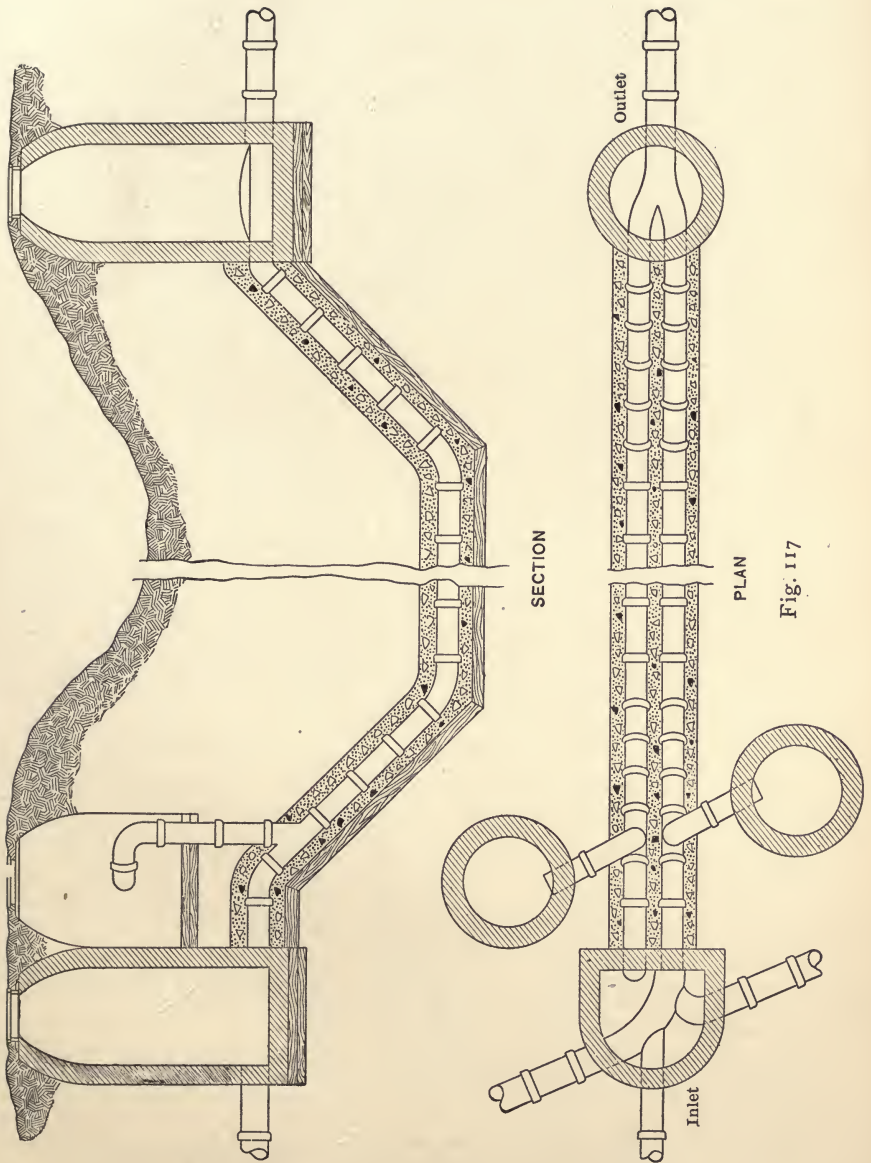

sewers, one 10-inch, one 12-inch, and one 15-inch, meet at the upper manhole, while a 15-inch sewer leads out from the lower manhole. Two 10-inch pipes are provided under the canal, one being 3 inches higher than the other in the upper manhole. Only .05 foot fall is given the lower pipe in the length of the siphon (92.45 feet), an unusually low gradient. Besides the difference in the levels, valves are provided in the upper manhole to direct the flow from one pipe to the other at will.¹

At Woonsocket, R.I., the main sewer, just before reaching the disposal works, passes under the Blackstone River by means of an inverted siphon. The main sewer entering the upper manhole is 36 inches diameter; and for the siphon pipes, use is made of three lines of vitrified pipe buried in concrete, one 8 inches, one 12 inches, and one 18 inches diameter. Fig. 118 shows the plan, elevation, and the relative position of the three pipes. The grade of all three pipes is 6 inches in 100 feet. The sewage at the upper manhole on the right falls into a sump, and there enters one or more of the siphon pipes depending on the opening of valves. In the lower manhole the sewage rises and overflows into the 36-inch brick sewer which is continued. A 24-inch by-pass is also provided, controlled by a valve on the 36-inch pipe just beyond the by-pass.²

Fig. 119 shows a combined storm-water and house-sewage siphon built at Springfield, Mass., in 1900. The sewer entering the upper manhole is five feet in diameter, the dry-weather flow occupying but a small part of the total area. To care for this small flow two 10-inch cast-iron pipes were laid, opening out of a sewage basin in the upper manhole. To divert the domestic flow into this basin a depression in the large sewer was arranged, a large flow discharging equally into that basin and into the storm-water basin by its side. The storm-water siphon, a low oval cross-section 5 feet wide by 2 feet 1 inch high opens out of the storm-water basin. An overflow is provided.³

¹ Assn. Eng. Soc., Vol. 27, p. 211, Figs. 9 and 11.

² Eng. Rec., Vol. 39, p. 251, Fig. 1.

³ Eng. Rec., Vol. 43, p. 551.

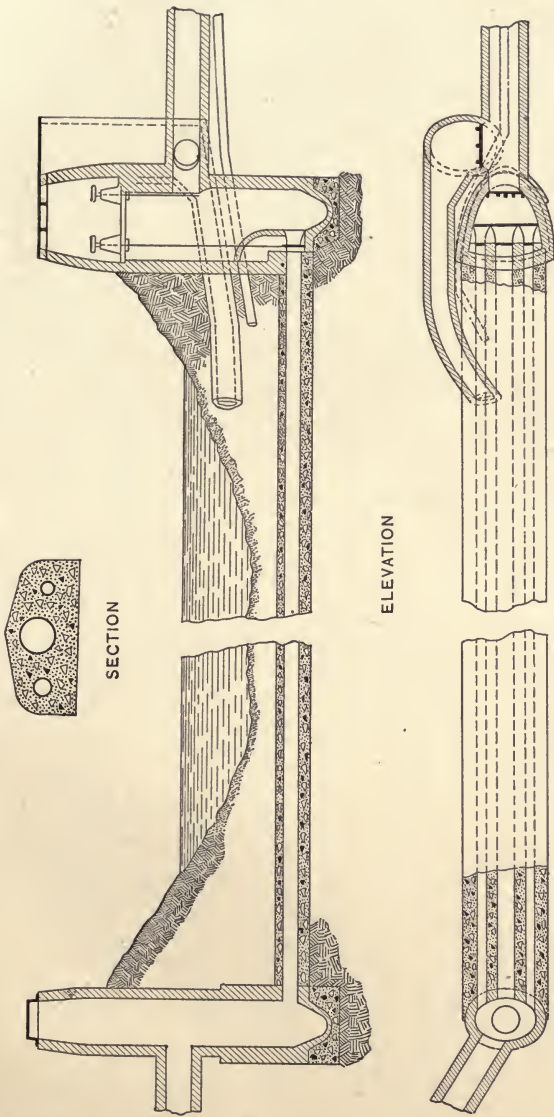

PLAN
Fig. 118

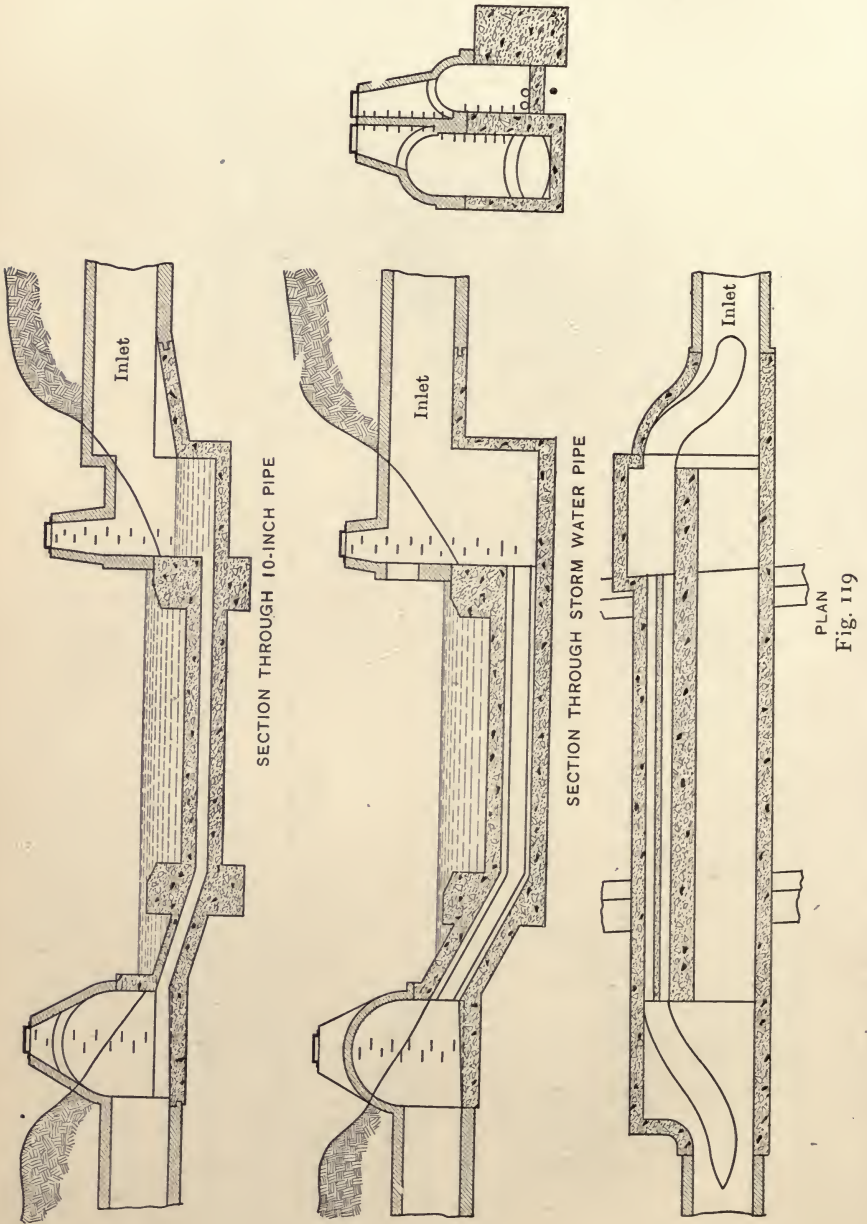

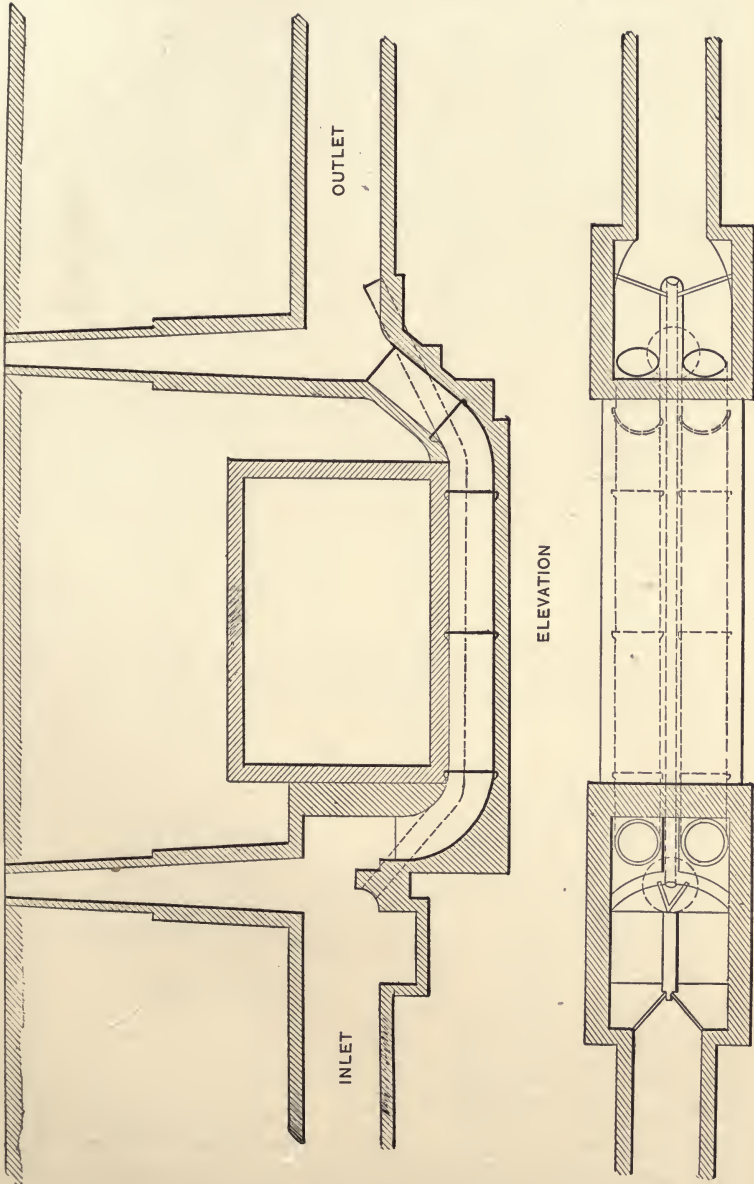

PLAN
Fig. 120

Fig. 120 shows the method of separating the dry-weather flow from the storm water, in one of the siphons of the New York City sewers.¹ It was necessary to carry the sewage from a 5-foot 5-inch sewer under the subway, the domestic flow being very small. A small curved dam was built in the upper manhole,

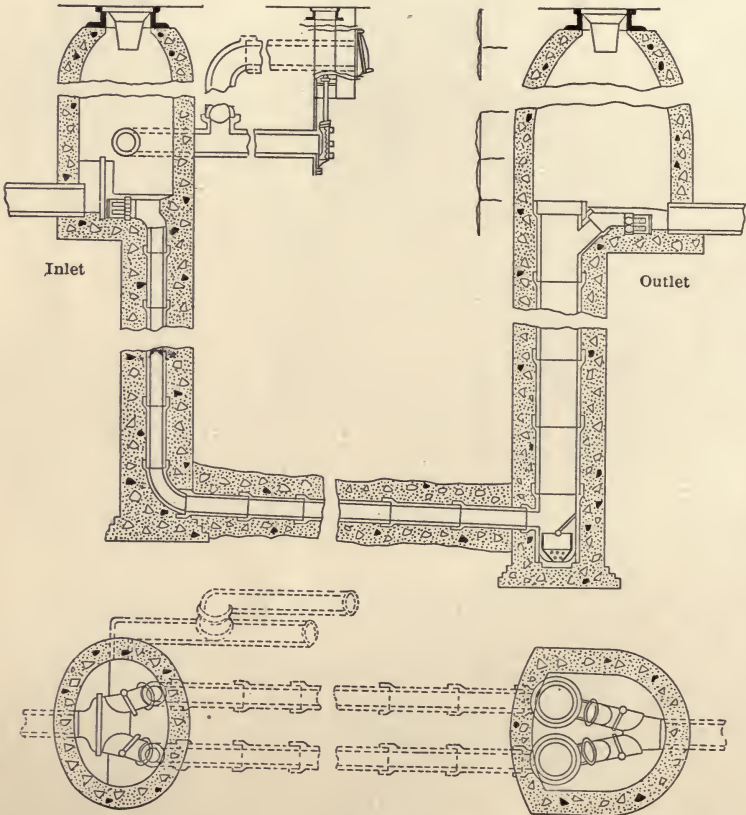

Fig. 121

through which the 14-inch cast-iron pipe for dry-weather flow was laid. The storm-water siphon consisted of two 42-inch cast-iron pipes, but to reach these the flood had to overtop the curved dam. The 14-inch pipe was laid between the two

¹ Eng. News, Vol. 47, p. 239.

larger ones and all three bedded in concrete. No valves are provided, and there is, of course, no opportunity for an overflow.

Fig. 121 shows the device designed for sewers in Ithaca, N.Y., where two 6-inch wrought-iron pipes incased in concrete were used to carry a 10-inch sewer under Cayuga Inlet. An open cast-iron Y was used at the upper manhole, a piece of brass plate being cut to fit across the branch to divert the flow from one line to the other. A feature of this design is the clean-out bucket at the bottom of the ascending leg which was supposed to collect sediment. An overflow and flushing inlet were provided, as is shown in the figure. This design was never carried out.

In the construction of the sewerage system of Buenos Ayres, it was necessary to carry the main intercepting sewer, 6 feet 9 inches diameter, under the Riachuelo River. The details are shown in Fig. 122. That portion under the river consists of three elliptical tubes of cast iron, surrounded with concrete 18 inches

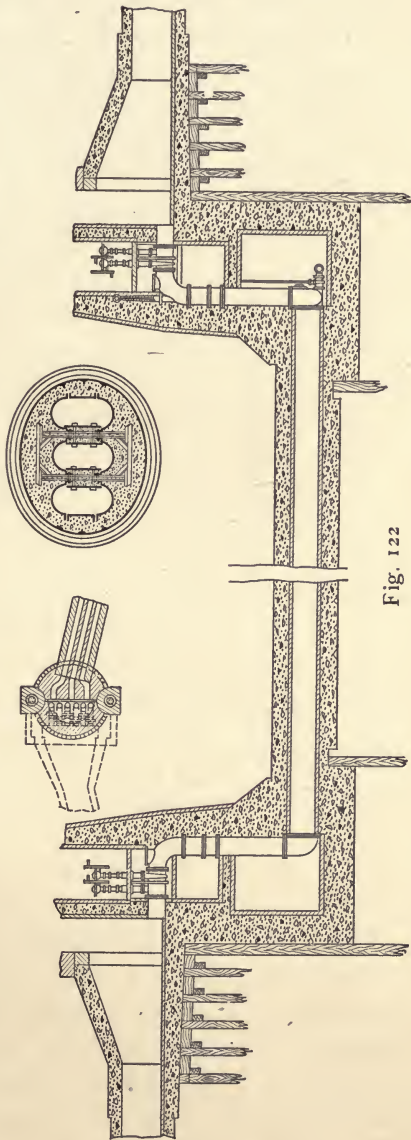

Fig. 122

thick. These pipes end in massive abutments, which also form the end of the main sewer. Between the pipes and the sewer are placed 6 30-inch cast-iron pipes each controlled by a valve, the arrangement being the same at each end. The tubes are 5 feet high by 2 feet 3 inches wide, so that they can readily be cleaned out by hand. An interesting detail of construction is that in the concrete between the tubes were embedded lattice girders computed to carry the entire weight of tubes and concrete from one abutment to the other, a distance of 52 feet.

On account of delay in the construction of the permanent inverted siphon at Buenos Ayres, it was found necessary to adopt a temporary method of crossing the river. For this purpose a direct siphon was used. Four wrought-iron pipes, 18 inches diameter, were carried across the river on a light wooden bridge constructed for the purpose. A circular well, 12 feet diameter, was sunk on the northern bank of the river, and one 7 feet diameter on the southern bank, the two ends of the siphon dipping into these two wells. The siphon was started by filling it with water from the city mains (by means of temporary valves). The siphon being started, the air which accumulated was expelled once a day through a chamber acted on by running water from the city mains. This siphon was 368 feet in length, the head available to work the siphon being 18 inches. It is said to have worked well and without a single interruption for two years.¹

In the construction of the 13-mile outfall sewer, of Los Angeles, two inverted siphons became necessary on account of the intermediate topography. They are both built of wooden staves, one 38 inches, one 36 inches diameter, and are each about 3 miles long. There is little that requires comment in the construction. The sewers outside of the siphon are brick, 40 inches diameter, and a sand pit is built in the manhole at the upper end of each siphon to arrest the sand which might otherwise be carried into the siphon and cause trouble. These were not satisfactory in that they caught too much sand, and the engineer

¹ Inst. C. E., Vol. 124, p. 37.

has recommended that they be cut out, trusting that the sand will be carried through the siphon and not deposited. The most interesting feature of these siphons is the opportunity furnished for anaërobic bacterial action, and the effect of the gases produced thereby on the brickwork of the sewer is a matter deserving serious consideration.

Fig. 123 shows a very simple type of siphon, as built at Providence, R.I.¹ A 68-inch brick sewer passes under the Woonasqua-

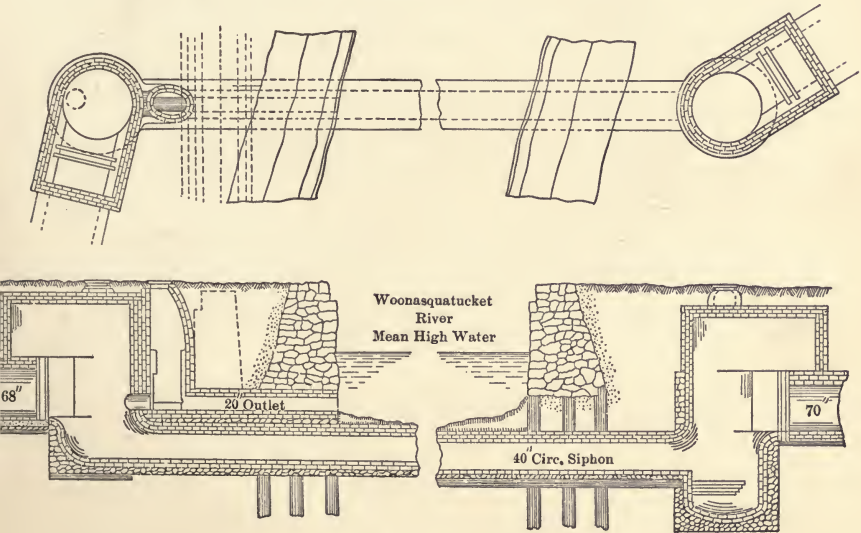

Fig. 123

tucket River, changing to a 40-inch circular pipe, and then rising into a 70-inch sewer. No accessories of any sort are provided, except that there is a 20-inch overflow.

Summary. It may be well to repeat the variations in design exemplified by the figures given. There are five different methods of managing the variations in flow.

First. As at Roanoke, Fig. 115, by having the vertical legs of descending pipes of different lengths, so that one only will work with a low flow.

¹ City Report, 1893.

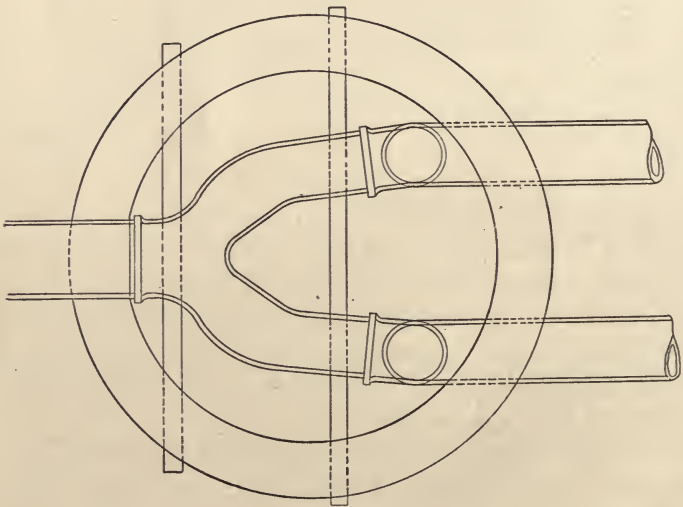
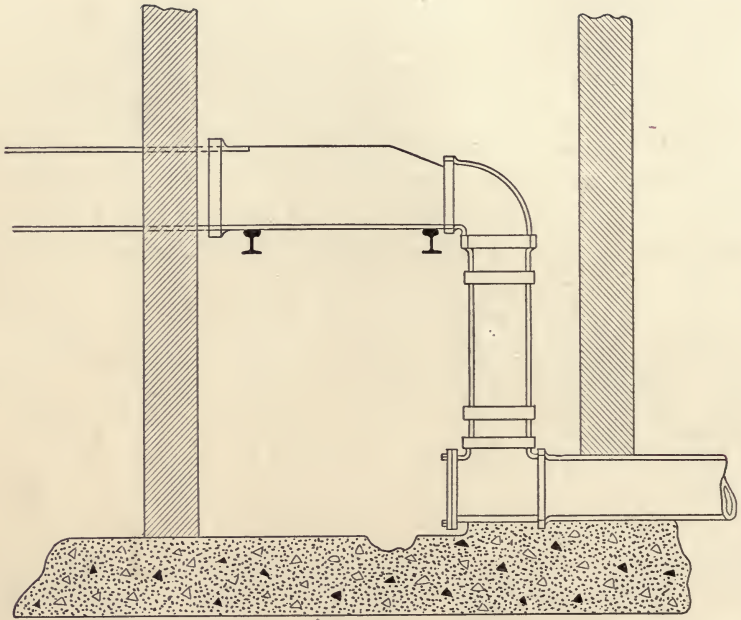

Fig. 124

Second. As in Ithaca, Fig. 121, by having an open Y-pipe at the inlet so that by a low dam the sewage may be deflected into one or the other for low flows, and may overflow the dam in times of high flow.

Third. As in Woonsocket, Fig. 118, by providing valves at the entrance of a number of horizontal lines so that one or more may be brought into use as desired.

Fourth. As in Springfield, Fig. 119, by forming a depressed channel in the main sewer, through which the minimum flow can be led away into a small pipe, any excess continuing through a larger siphon pipe.

Fifth. As in New York, Fig. 120, by building a dam in the main sewer, through which a small pipe is led to care for the low flow. The excess overflows this low dam and enters the larger pipe or pipes.

Another point to be noted is that in some of the designs, as at Springfield and Woonsocket, sump-holes are built, apparently inviting sedimentation, whereas in Roanoke and in Newton, the inlet pipes are so arranged that no sedimentation can occur. The only advantage of the sump is that by pumping it out, access may be had to the horizontal line of the siphon, an impossibility in the Roanoke design.

In building the Ithaca siphon, Fig. 121, the inlet end was modified so that the manhole was brought down to the horizontal line of the siphon, and a clean-out provided, as shown in Fig. 124. A similar manhole at the outlet end made it possible to run clean-out rods directly from one side of the stream to the other, and thoroughly brush out the pipe.

Nearly all of the designs provide for an overflow pipe, through which the sewage can be discharged if the siphon becomes stopped up, or if repairs are necessary, and this would seem to be a wise precaution wherever possible.

A flushing gate is also a wise addition if the level of the water in the stream makes it possible. It will then be easy occasionally to run clean water through the siphon pipes, and thus wash out any sediment which may have accumulated. The author has

seen a design, never built, where automatically such a flush of clean water was provided whenever any one of the several pipes making up the siphon stopped running on account of a decrease of flow in the sewer. The idea was evidently to wash out the matter in suspension before the stagnant sewage had an opportunity to deposit it in the horizontal part of the siphon.

CHAPTER X.

SCREENS.

SCREENS play an important part in the process of sewage purification. Indeed, they may be said to constitute the first or primary step in the process. Their function is to arrest and hold back the coarse material which is naturally brought down in the sewage flow, such as undigested paper, rags, corks, sticks, leaves, and similar material, which is not offensive in itself, and which may therefore be removed before the disposal plant proper is reached. For example, on filter beds or contact beds, the formation of a surface coating is to be avoided on account of its action as an air-tight blanket, and a preliminary screening is of great service in this regard. Screens are also to be used wherever the sewage has to pass through any moving machinery, such as pumps, valves, and siphons, where coarse material would interfere with the proper working of such mechanism. For example, if the sewage is to be lifted by a piston pump, screens are essential just in front of the pump, or the valves will be caught by bits of wood, corks, bones, etc., and the capacity of the pumps much reduced. Screens are also to be used in places where the admission of water to the sewer is to be provided for, as at flushing inlets or at storm-water inlets, and where discharge is made, as at the mouth of the outlets. In fact, the proper use of screens in sewer construction may make the difference between a system working satisfactorily and a system constantly needing repairs or overhauling.

In using screens it must be remembered that the solid portion obstructs the channel to the extent of its area, and that, besides, a considerable loss of head is introduced by the frictional resistance of the passages of the screen. For example, a rectangular

screen made up of $\frac{3}{4}$ -inch bars, with $\frac{3}{4}$ -inch clear spaces, reduces the area of free flow in the channel by one-half; and the cross-section of the channel, where the screen is to be placed, ought, therefore, to be doubled, merely to compensate for the solid screen area. The resistance to the flow on account of the loss of head in passing through the screen is not known. Mr. Kuichling, in a lecture at Cornell University in 1898, noted the lack of information on this point, and mentioned his uncertainty in providing screening area for the intake pipe for the Rochester Water Supply. In sewage screens the resistance is greatly increased by the accumulation on the screen of foreign matter, so that the excess of area provided is largely a matter of maintenance; the larger the screen area, the less labor to be expended on cleaning, and vice versa. Probably a free area, at least 50 per cent in excess of the area of the sewer channel, or a screen area three times the channel area, should be provided.

The forms of screen chamber in general use are two in number. The first and most common is to enlarge the cross-section of the sewer into a screen chamber, in which screens are placed at right angles to the flow. Fig. 125,¹ shows the arrangement of one of the Boston main sewers, the area of the sewer flowing full being 28 square feet, and the total screen area being 56 square feet. The screens are made of $\frac{3}{4}$ -inch vertical rods with 1-inch clear space between. These screens are really eight screens, $7\frac{1}{2} \times 7\frac{1}{2}$ feet, two pairs of double screens being provided; one set of each pair is left in place, while the other is being hoisted up for cleaning.

Fig. 126 shows the Ithaca screen chamber, plan and elevation, similar in design.

The screen chamber, in the latter case, is built within the pumping station building, the walls of which appear in the drawing. The entering sewer is $3\frac{1}{2}$ -feet diameter, and the screen chamber is 9 feet wide and 30 feet long. The screens, 9 feet wide \times 8 feet high, are in duplicate as shown. They are designed with hoisting apparatus, and a horizontal apron at the

¹ Boston Main Drainage, p. 54.

bottom to hold and bring up material which might otherwise be washed off. The small pipes on the right of the figure lead directly to the pumps. Experience with these screens has

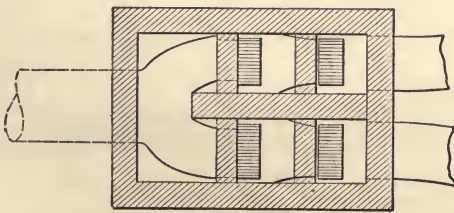
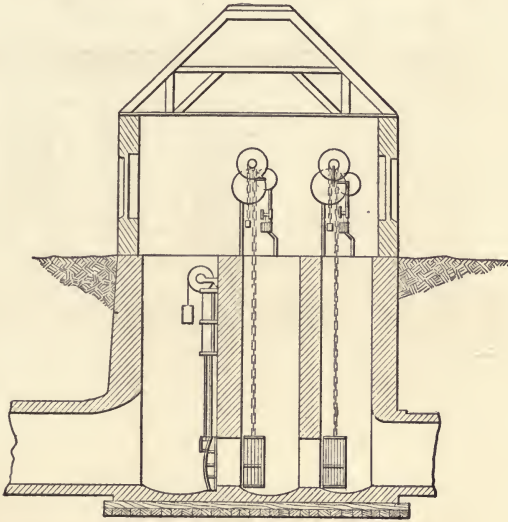

Fig. 125

shown that the design was faulty in that the sudden enlargement of section from the sewer into the chamber caused deposits in the corners. It was necessary to build a wooden flume in the chamber, changing the section gradually from the sewer section to the screen section. The screens were made of

an oak frame, 10 feet wide \times 8 feet high, the framework being made of 2×6 pieces bolted together at the corners. The screen itself was made of round iron $\frac{3}{4}$ inch in diameter fastened to the frame at top and bottom and to a center

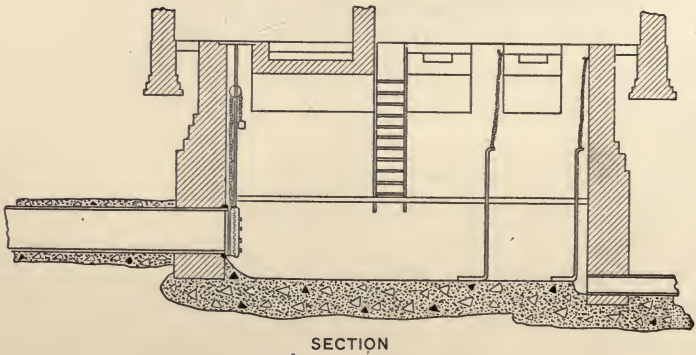
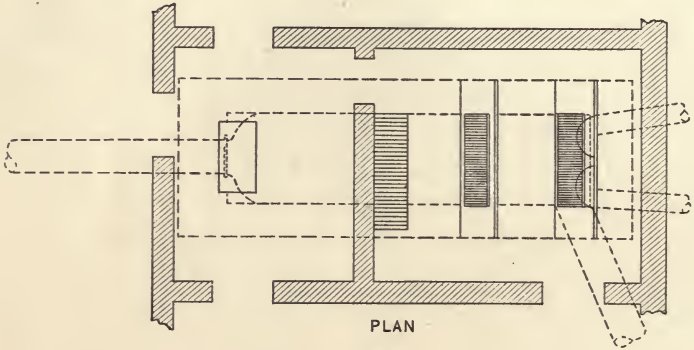

Fig. 126

piece by staple bolts. The screen was arranged to drop into place between two wooded strips 2×4 inches bolted to the concrete walls of the screen chamber. The second screen had a horizontal extension, reaching from its top to the end wall of the chamber, so that if the pumps shut down and the chamber

filled to a depth greater than 8 feet the horizontal screen would prevent any solid getting in behind the vertical screen. No trouble has been found with the screens, nor has it been necessary to raise them from place in the twelve years they have been installed. The strength of the oak frame, however, has been found to be insufficient, since, with an accumulation of debris on the screen, the difference of level of the sewage has been at times as much as 3 feet. This head of water acted against the screen as against a dam, and the timbers 2 inches thick were bent and threatened to break. Braces have therefore been inserted from the screen to the back wall of the chamber to counteract this unexpected water pressure.

Fig. 127 shows the elaborate screening chamber in use at Manchester, England. The following description is taken from a report of Dr. Fowler, and Mr. Wilkinson, superintendent and engineer to the Manchester Corporation, in 1902.

“The plant consists of a system of screens, catchpits, and elevators, which is in duplicate, one set on each side of a central storm-relief channel. One set only is used when the flow is at its lowest, or when repairs are necessary. Both sets of machinery are used during the hours of heavier flow or during storms.

“At the entrance to the screening chamber is a fixed screen formed of bars $4\frac{1}{2} \times 1$ inch, with 6-inch space. This screen serves to arrest all large pieces of timber, etc., which may be carried down the sewer from where constructional work is in progress, or any other large floating matters which might tend to injure the finer screens. This screen is cleared by hand.

“Between this screen and the next is a cutwater of concrete cased in iron plates for the better distribution of the sewage over the screens and catchpits.

“The second screen extends the whole width of the screening chamber, viz. 37 feet, but is formed in three sections, each of which can be worked independently. It is constructed of $\frac{3}{8}$ -inch iron bars with $1\frac{1}{4}$ -inch openings. This screen is mechanically cleaned by tines attached to channel-iron bars, which are fixed

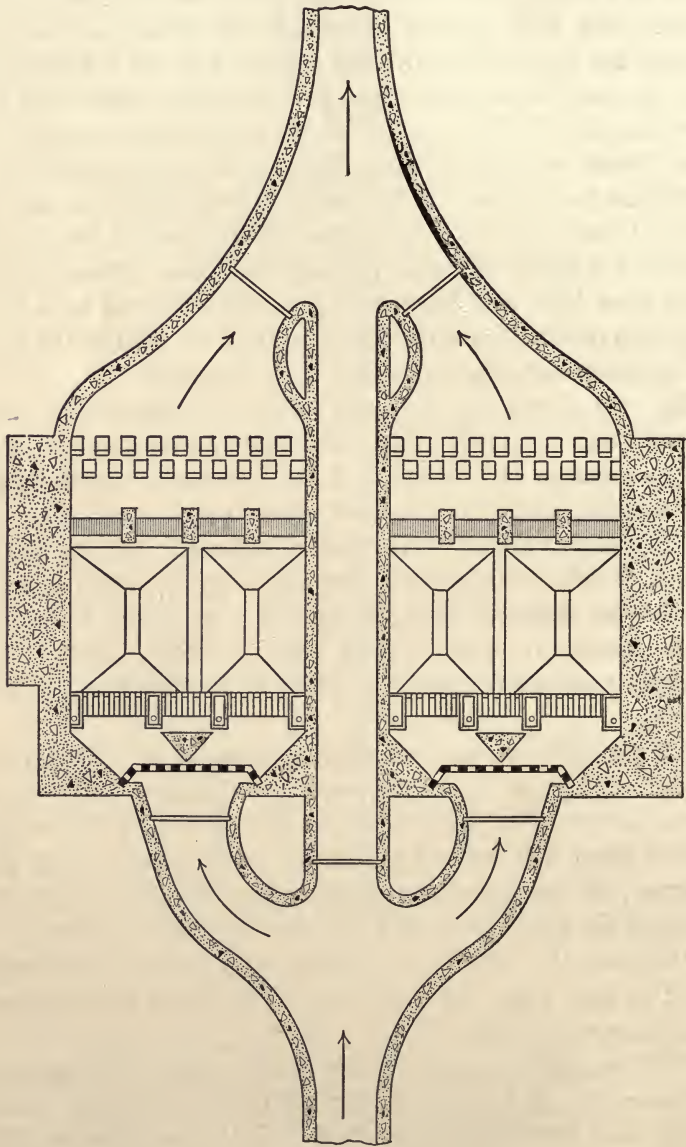

Fig. 127

to endless chains working on sprocket wheels at each end of the section of the screen. As the chains revolve, the tines pass between the openings in the screen. The distance between the tined bars is such that two of them traverse the screen at the same time. The rate of speed of the cleaning bars with tines is $1\frac{1}{2}$ feet per second. The floating matter arrested by the screen is carried by the tined bars to a point above the screening-chamber floor immediately over a wrought-iron channel.

“On passing over the sprocket wheels the tines recline to a vertical position, and any matters which tend to adhere to the tines are swept off by means of a brush into the wrought-iron channel. The brush extends the whole length of the section of screen, and is fixed on a shaft actuated by a lever and counterweight for reversing the motion.

“The wrought-iron channel is cleaned with a squeegee, and its contents loaded into wagons which pass through the center of the chamber immediately over the storm-relief channel.

“The third screen is very similar to No. 2 (described above), with the exception that the mesh of the screen is $\frac{1}{2}$ -inch, the bars being of $\frac{3}{8}$ -inch metal. The screen is divided into four independent sections.”

The other method of providing screen area is to build the screen into the side of the sewer, the length of the screen being six or eight times the width of the sewer, and then to build an adjoining section or sewer to intercept the flood after passing the screen.

Fig. 128 shows the general arrangement as used at Providence: Here the sewage is subjected to a double screening. The sewage first passes through the filth hoist cages, of which there are four, each about 3 feet wide and 8.5 feet high. They are semicircular in plan, and are made of $\frac{7}{8}$ -inch steel rods set vertically with 2 inches space between the same, the bottom being of boiler plate. These cages slide vertically in channel irons, a gate in front being shut to deflect the flow through the other cage when one is raised for cleaning. These cages are intended to retain all coarse and bulky material over two inches in diameter.

The screen chamber proper is 16 feet wide by 69 feet long, the sewer entering being 8.5 feet in diameter. The screen, standing at an angle of about 17 degrees from the vertical, runs lengthwise about in the middle of the chamber. The screen is

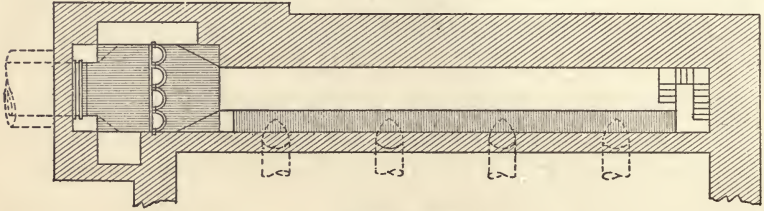

Fig. 128

made of oak slats 10 inches wide, 11 feet 3 inches long, and 1 inch in thickness, the bronze spacing pieces which separate the slats being $\frac{3}{4}$ inch wide. The screen is kept clean by men with hand rakes. Behind the screens are the four inlets to the pump wells, each 48 inches diameter.

The screens themselves may be made in one of four ways, viz.: (1) of a rectangular mesh; (2) of perforated plates; (3) of vertical rods; (4) of a chain or link combination which by a suitable mechanism is kept in motion and automatically cleaned.

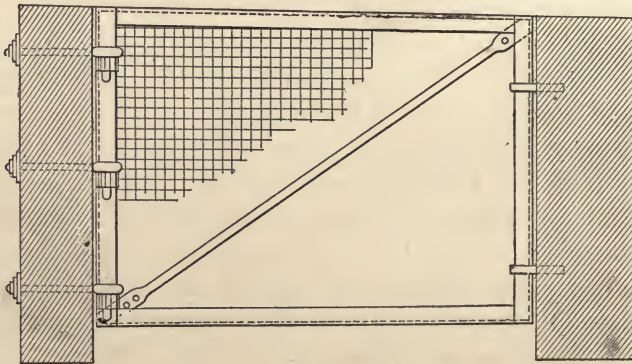

Fig. 129

An example of the rectangular mesh screen used at White Plains is shown in Fig. 129.¹

¹ Rafter and Baker, p. 377.

Fig. 130 shows a similar screen used at Marlborough.¹ Both were of galvanized iron with selvedge edge, 1-inch mesh, and made of $\frac{3}{8}$ -inch (or No. 8) wire. Such a screen has to be specially made, since the standard screening is of lighter wire. The former screen is 7 feet 6 inches \times 4 feet 9 inches, strengthened by the diagonal tie, as shown, to allow swinging on hinges for cleaning.

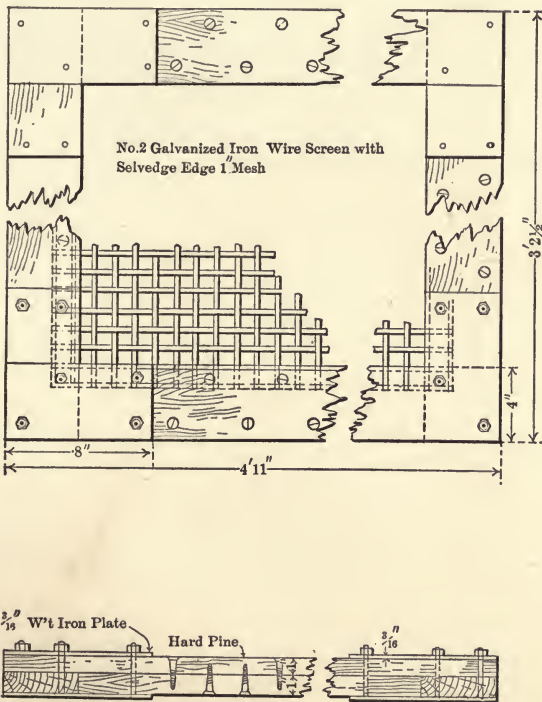

Fig. 130

The latter is 4 feet 3 inches \times 2 feet 4 inches, but proved to be of little practical value, since the screen is placed below the precipitation tank beyond which few solids passed.

A unique form of mesh screen was used at the Cranston, R.I., outlet (see Fig. 131),² where the wire mesh was made up in the form of a basket with a capacity of about a bushel, the basket

¹ Rafter and Baker, p. 505.

² Rafter and Baker, p. 477.

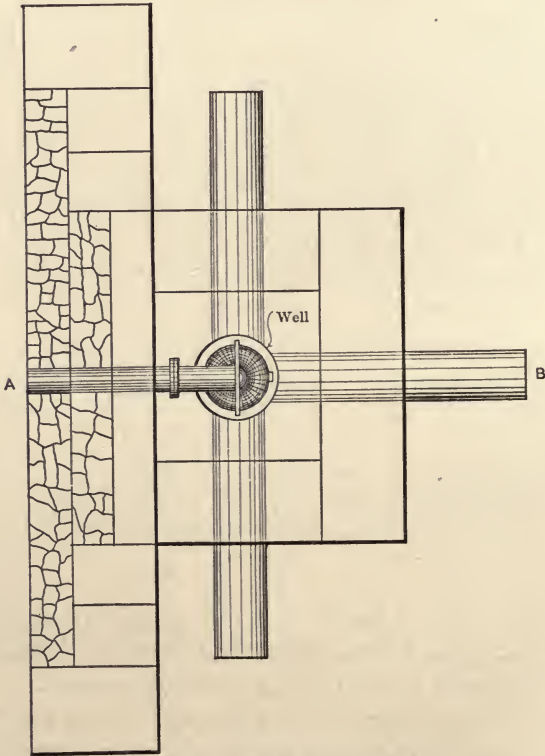
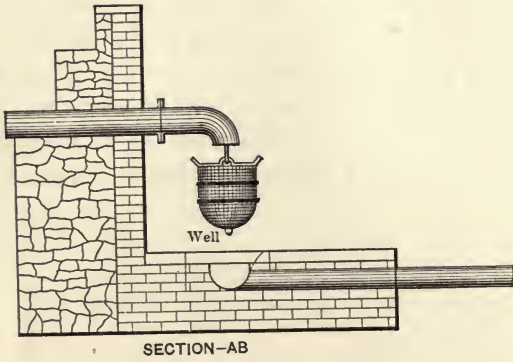

PLAN

Fig. 131

being suspended under the end of the outlet pipe which had a free fall. To clean the screen it was only necessary to take off the basket and turn it upside down.

At Wayne, Pa.,¹ a horizontal wire-mesh screen was used, a loss of head being permissible. (See Fig. 132.) The screens first used had a mesh 2 inches square, but this was found to be

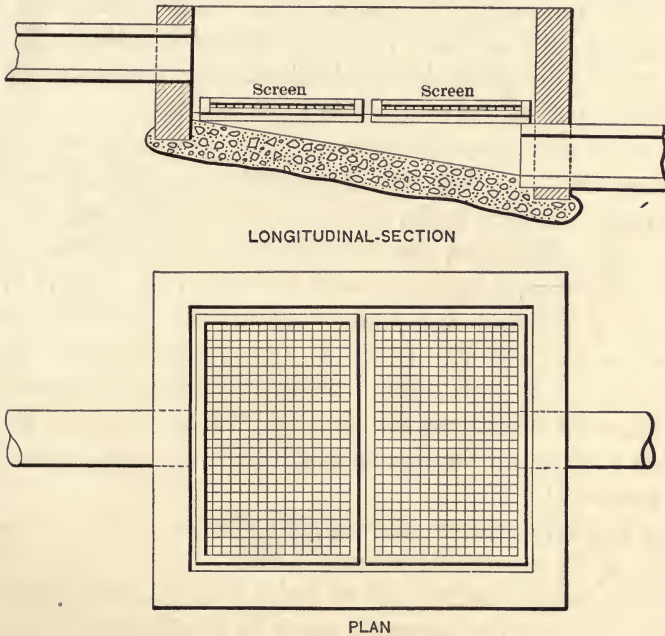

Fig. 132

too coarse to properly protect the irrigation area, and a $\frac{1}{8}$ -inch mesh was substituted with satisfactory results. From a sewage flow of one-fourth million gallons about two barrels of screenings per day were obtained.

The effects of a mesh screen are admirable, but its disadvantage is that fibrous material clings so persistently to the meshes that it is difficult to keep such a screen clean. A rake cannot be used, and a brush working only on the surface fails to clean the wires properly. For this reason slat screens are preferred.

¹ Rafter and Baker, p. 534.

The second class of screens, perforated plates, is open to the same objection — difficulty of cleaning — and although many examples of their use may be found in Europe, there are very few in this country.

At the Worcester State Hospital such a screen is used at the entrance to the receiving tank. Four brass plates, about 10 feet \times 18 inches, are set into the brick side walls, each plate perforated with 60 holes $\frac{1}{4}$ inch in diameter. Above the walls and over these plates is a galvanized wire screen with $\frac{1}{2}$ -inch mesh to intercept the overflow in times of flood.

At the outlet chamber of the Pequannock River reservoir at Newark, N.J., a plate screen is used in connection with the waterworks. Four wells, each 8 \times 6 \times 50 feet deep, are built in the outlet chamber, two of which contain the screens. These are built on steel frames formed of T iron, $2\frac{1}{2} \times 2\frac{1}{2} \times \frac{3}{8}$, bent to form a square 4 feet 7 inches on a side. On this frame is riveted a sheet of No. 18 hard copper, punched with $\frac{5}{16}$ -inch holes, spaced $\frac{7}{16}$ inch apart. The screens slide in grooves, and are raised to the surface for cleaning by a 4-horsepower gasoline engine running an endless sprocket chain to which the screens are attached.¹

An English device employing plate screens may be mentioned, which is the cylindrical screen, consisting of a hollow cylinder of sheet metal punched full of holes and immersed across the channel, which the screen is made to fit tightly. The screen revolves and continually presents a clean surface to the flow which passes across the cylinder. A brush on the top automatically keeps the surface clean.

Slat screens are the most common, and, on the whole, the most satisfactory. They may be made of round iron or of flat iron, and are usually set vertically or inclined at a small angle. Fig. 133 shows the screen in use at Ithaca, which has proved satisfactory, except that the rods lack stiffness. The frame of oak is so arranged that the entire screen may be removed from the chamber if desired. Ordinarily, however, a rake, so made that the teeth

¹ Eng. Rec., Vol. 51, p. 625.

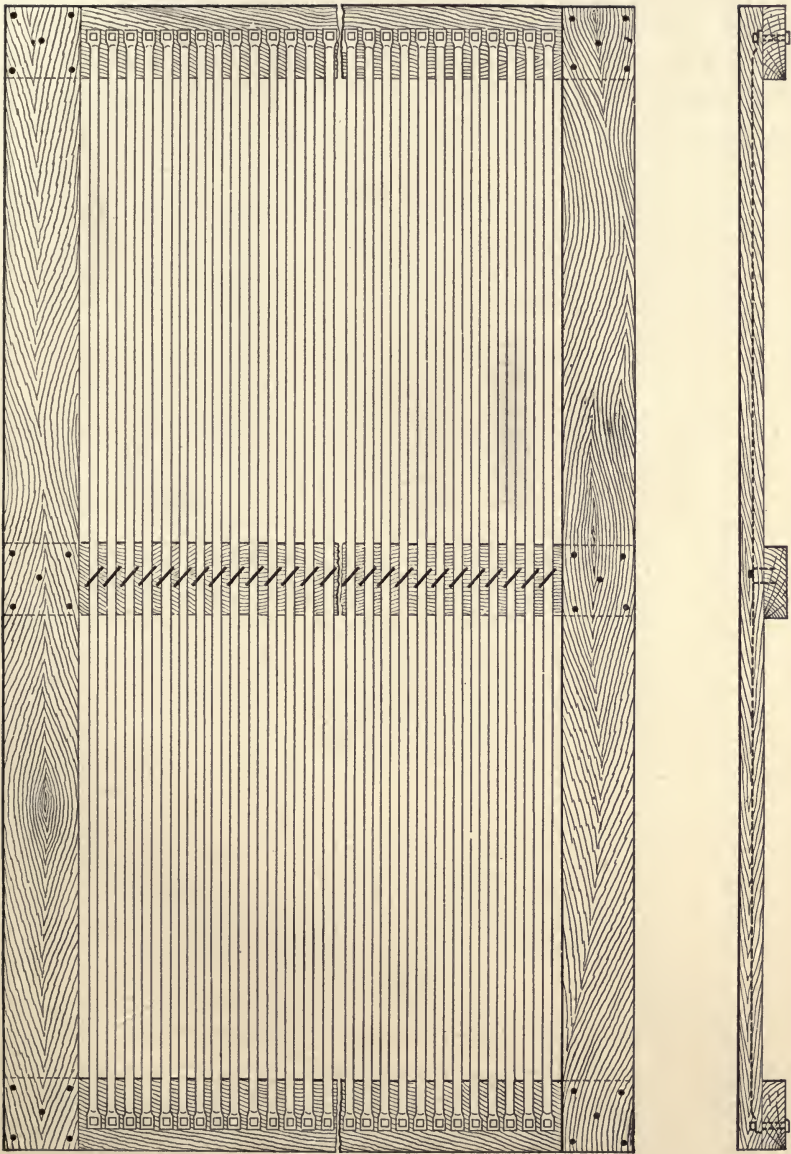

Fig. 133

fit between the rods, is ample provision for keeping the screen clear. The unsupported length of the $\frac{3}{4}$ -inch rods is 4 feet, and it has been found that in this distance the rods are so flexible that two proximate rods may touch, and the adjacent openings increase to nearly double the intended space.

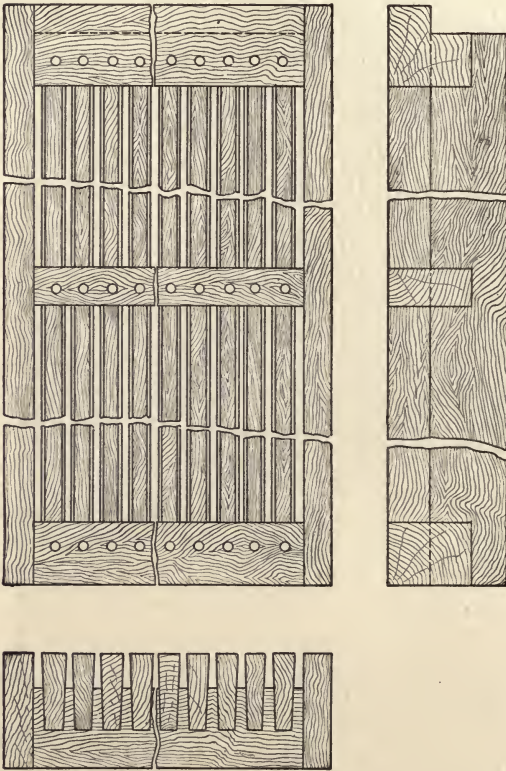

Fig. 134

In the plans for the Ontario Insane Hospital, Colonel Waring designed a screen across an opening into one of the tanks 8.3×4.5 feet, the screen to be made of wrought iron, galvanized. The bars of the screen were to be vertical, of $\frac{1}{2}$ -inch round iron spaced one inch in the clear; the height of the screen, and apparently the unsupported length of the rods, being 4.5 feet. The author,

in view of his experience with $\frac{3}{4}$ -inch rods, with an unsupported length of 4 feet, believes that the Ontario construction was too light.

Sometimes instead of iron rods, wooden slats are employed, making a screen similar to those used in racks for waterpower. At Providence, for example,¹ a wooden screen is described which is placed in manholes to intercept mill refuse. This same form of screen is used on the large screen chamber shown in Fig. 119.

Fig. 134 shows the design.

At Pullman, Ill., an elaborate screening tank was built, a section of which is shown in Fig. 135.² The tank is boiler iron 6 feet in diameter and 24 feet high, the bottom being set up from the ground high enough to allow a wagon to drive underneath and receive the screenings, which are allowed to fall through a door in the bottom of the tank. The screen is of rectangular mesh with $\frac{1}{2}$ -inch openings.

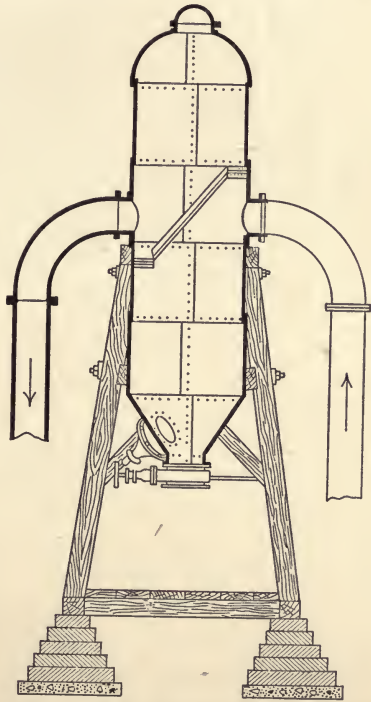

Fig. 135

In front of the wheel pits of a power plant at Richmond, Va., is a fixed screen, with a mechanical cleaning device which merits attention. The screen is vertical, made up of $3\frac{1}{2} \times \frac{3}{8}$ -inch steel bars spaced $1\frac{1}{8}$ -inch centers, 18 feet wide and 21 feet high. In front of this screen is a movable rake,

supported on shafts at the top and bottom of the screen. The cleaning device consists of a number of pieces of angle iron, fastened to endless chains, which are revolved by sprocket wheels

¹ City Report, 1894.

² Rafter and Baker, p. 460.

on the shafting, through three vertical legs. Riveted to the horizontal leg are projecting teeth, so spaced that they fit between the bars, just passing the cross-bars through which the screen bars are fastened. These teeth are of $\frac{1}{2} \times 1$ -inch iron. Fig. 136 shows the general arrangement.¹

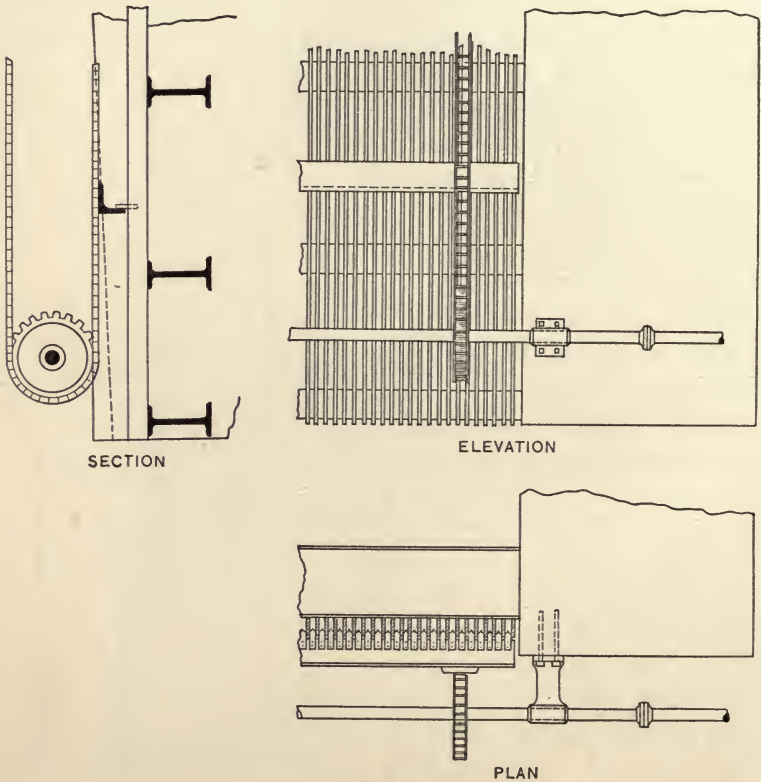

Fig. 136

The third type of screens, characterized as mechanical, are commonly used in England, but have found little favor in this country. Mr. John D. Watson, engineer in Birmingham, has recently installed a mechanical screen described as follows:

The screens are perforated, flexible, endless metal belts inclined at an angle of 30 degrees and running over a horizontal revolving drum at each end, the lower

¹ Eng. Rec., Vol. 49, p. 12.

end immersed in the sewage. The drums are placed transversely across the channel through which the sewage is passed, and are operated by a Poncelet water wheel, driven by the flow of the sewage, the speed at which they revolve and the capacity of the screens varying with the changes in the amount of sewage flowing. The intercepted material is lifted out of the sewage and carried around the drum, where a rotary brush cleans it off and transfers it to a worm conveyor placed transversely in the rear of the screens and discharging in a barrow or truck at one end.

Fig. 137 shows diagrammatically the general arrangement.

In conclusion it may be said that the importance of screening as the first step towards the purification of sewage is becoming

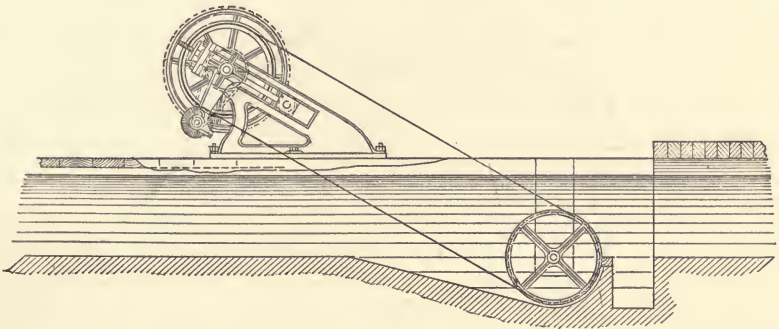

Fig. 137

more and more recognized. Before any biological process can be successfully carried on, all coarse and unresponsive material must be eliminated; and while grit chambers or roughing filters may be used, engineers are appreciating more and more the efficiency and economy of the use of screens. At Columbus, Ohio, for example, the engineer in charge of the experimental plant, after experimenting with various types of screens and size of mesh, adopted two screens of diamond mesh wire cloth woven with No. 12 wire. The first screen had a clear opening of $\frac{1}{2}$ inch, and the second of $\frac{3}{8}$ inch, and the action of the screens was considered to be of great importance as a part of the entire method of treatment.

CHAPTER XI.

STORM-WATER OVERFLOWS AND REGULATORS.

IN the construction of combined sewers, that is, sewers which carry both storm water and house drainage, there are two methods or opportunities for reducing the expense involved in the construction of large storm sewers: First, by diverting the storm water, in excess of a certain amount, from the trunk sewer into a convenient stream, thereby avoiding the first cost of a long and large trunk sewer; and second, by diverting the excess storm water before it passes through a pumping station or on to a purification bed, thereby avoiding the continual expense of handling a large amount of storm water.

To illustrate a suitable use of these storm-water overflows, the following example is given:

The city of Rochester has a long intercepting sewer, surrounding the city on three sides, as shown in Fig. 138. This sewer collects a large part of the city sewage, both domestic and storm water, and prevents the contamination of the small streams shown. When this sewer has reached the point *A*, the diameter is 8 feet, and the capacity is 340 cubic feet per second, although the house-sewage flow is only 10 cubic feet per second. In order to avoid the cost of building this large sewer further, it is reduced to 4 feet in diameter, and capacity of 40 cubic feet per second, and provision made by which the difference between 40 cubic feet and 340 cubic feet can escape through a special channel into the waters of Thomas Brook, as shown. This has worked well for ten years, but there are indications that the overflow comes into more frequent use than was intended, that the result is likely to be a nuisance in Thomas Brook, and that some remedy must soon be provided. A second overflow is also provided, at the

point *B*, under similar circumstances, also at three other convenient points.

The propriety, from the sanitary standpoint, of the use of this arrangement depends on the local conditions. If the



Fig. 138

stream is small, tortuous and sluggish, with shallow ponds, the storm overflow should not be used. But if the discharge is to be into a large river, already organically polluted, and thereby unfitted for drinking water, such a device is proper and economical.

This separation of sewage from storm water is accomplished

in one of three ways, viz., by a so-called leaping weir, by an overflow weir, or by a mechanical regulator.

The leaping weir has been little used in this country, although there are many references to it in English works. It was first used in waterworks at Bradford to allow highly discolored waters of storms to pass by the purer water of other stages. Baldwin Latham also used the device many years ago.

Fig. 139 shows the principle on which it works, as well as its practical application. The construction illustrated was built in Milwaukee, where it was necessary to divert the dry-weather sewage flow of some twelve old outlet sewers from the Menominee River into the new intercepting sewer, the storm water being allowed to continue through the old sewer to the river. It is said that the device works admirably and with little need for repairs.¹ In general, with small dry-weather flow, the concentrated sewage falls through the opening into the intercepting sewer, which goes to the pump or to the disposal works. In time of storm, however, the width of opening being properly adjusted, the heavy flow leaps the opening and is discharged directly into the river or tide water. Moore² assumes that the mean velocity of the water flowing over this weir is expressed by the equation $V = .66 \sqrt{2gH}$. He then computes the horizontal width of the weir by assuming that a particle will pass horizontally from *A* to *B* in *t* seconds, or, if the velocity is *V*, the width *AB* must be *Vt*, or $.66 \sqrt{2gH} \times t$. But the vertical velocity is that due to a free fall, so that the distance *AD* will be by mechanics $= \frac{1}{2}gt^2$. From these two equations *t* may be eliminated and the depth expressed in terms of the width, as

$$D = \frac{9}{16} \frac{W^2}{H}$$
 This is for a definite head, *H*, in the sewer, fixed as that depth when the weir shall come into action, and will enable the parabolic path of the overflow to be plotted, just under which the weir may be built wherever desired. (See Fig. 140.) However, it is safer to provide for a final adjustment by having

¹ Eng. News, Vol. 30, p. 401.

² Moore's Sanitary Engineering, p. 72, Fig. 49.

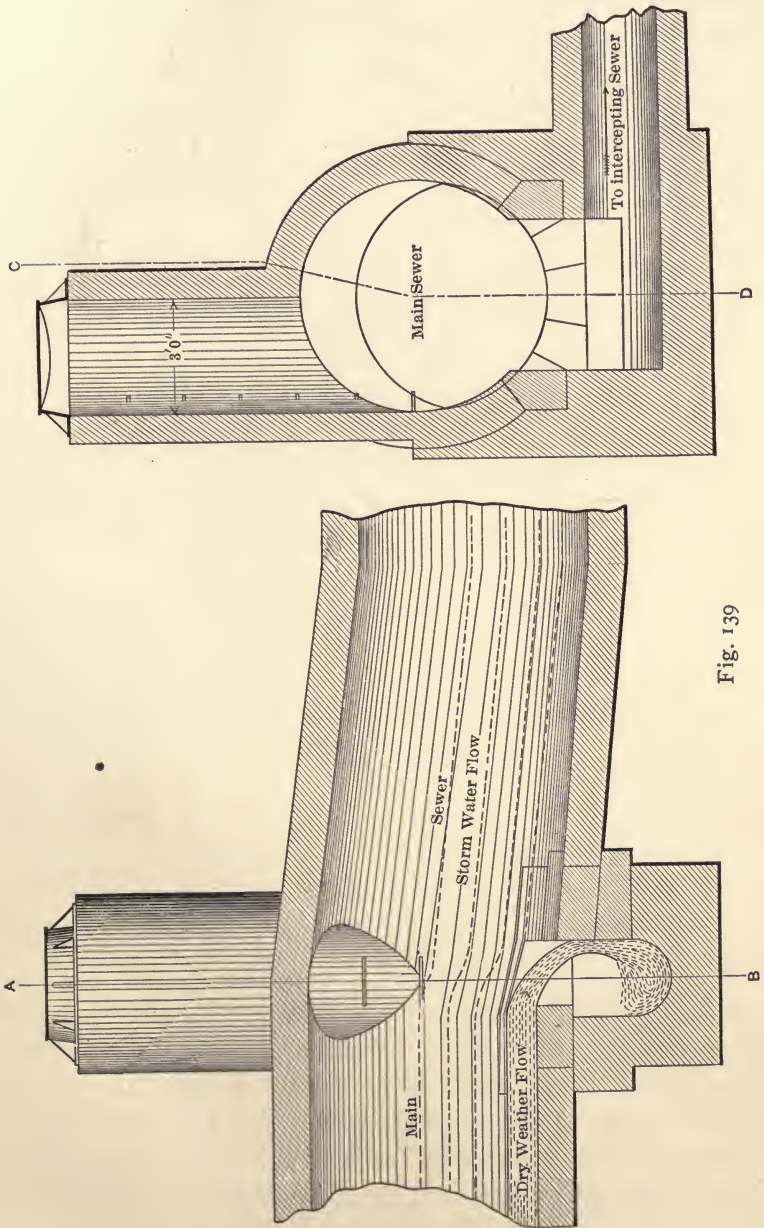

Fig. 139

the stone or iron weir at the opening movable, and only fastened permanently after the capacity has been tested.

An overflow weir, as the name indicates, provides that when the flow of storm water has reached a certain volume, the excess shall pass over a weir whose height has been carefully deter-

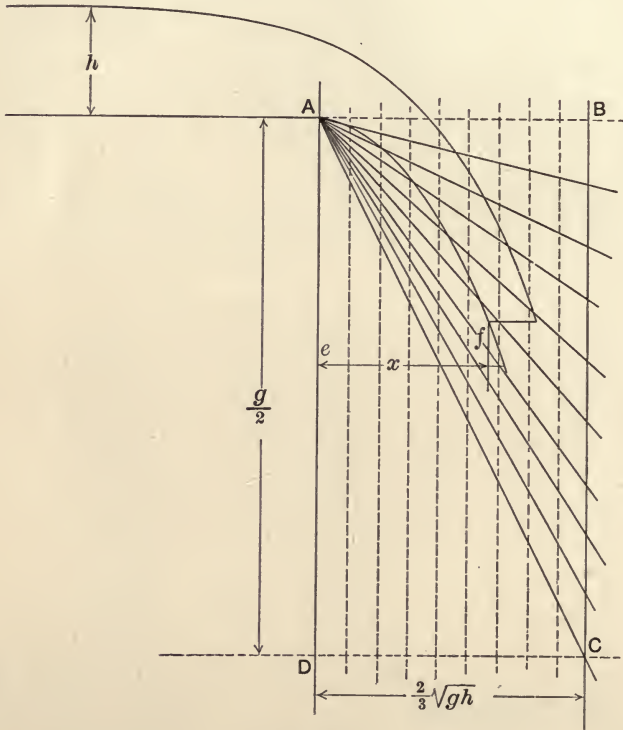

Fig. 140

mined. By such a device the quantity passing to the disposal plant can be restricted to a certain volume, although there must always be a certain flow, varying, however, in concentration. Fig. 141 shows the overflow weir at Cleveland, Ohio.¹

A large sewer 14 feet 9 inches in diameter, known as the Walworth Run Sewer, drains about 3000 acres, and carries both

¹ Eng. Rec., Vol. 40, p. 60.

house sewage and storm water. To avoid the discharge of the concentrated house sewage into the Cuyahoga River, an

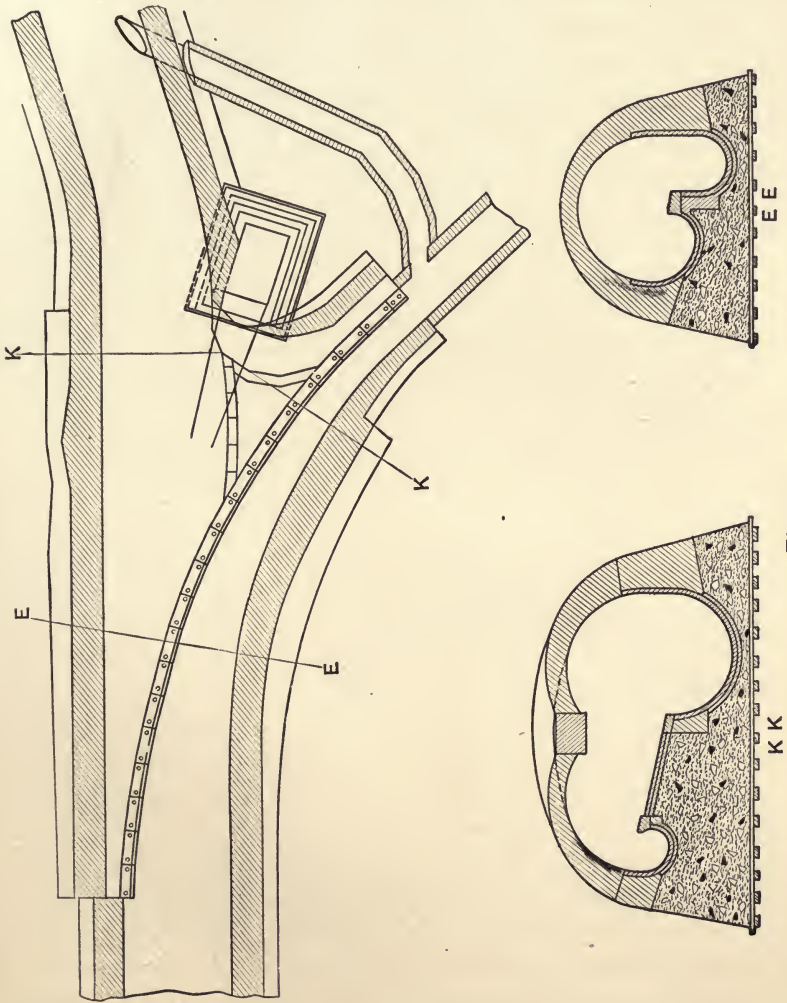

Fig. 141

overflow chamber was built; the small sewer at the bottom of the figure, 5 feet in diameter, leads to the main intercepting sewer, and any excess escapes over the long curved weir

into the outlet sewer, which is 13 feet 6 inches in diameter. The short connecting sewer shown is a by-pass to be used until the intercepting sewer is completed. The estimated maximum flow in the 14 $\frac{3}{4}$ -foot sewer was 2500 cubic feet per second. The domestic sewage flow was estimated at 60 cubic feet per second, the 5-foot sewer having that capacity when nine-tenths full. The weir then is designed to discharge 2440 cubic feet per second without allowing the 5-foot sewer to flow under a head. The weir sill is 4 $\frac{1}{2}$ feet above the invert of the sewer. The overflow sill is built of hard sandstone, and is secured in place by anchor bolts reaching into the concrete below. The inverts of the sewers are lined with hard shale brick, and the rest of the arch built of softer material.

The points specially considered in arranging the different details were:

(1) The weir must act positively to prevent internal pressure in the 5-foot sewer, or to prevent any flow greater than it is intended to carry.

(2) The effect of the full flow in the 5-foot sewer must not reduce the hydraulic grade or the predetermined minimum velocity in the combined sewer.

(3) The weir must not become submerged, and the flow be thus checked.

(4) The fall over the weir must not be too abrupt, or forces will be set in action which tend to destroy the masonry.

The article from which the figures are taken gives further interesting details of construction.

Fig. 142¹ shows a similar construction used at Providence, R.I., the diversion in this case being to relieve the overtaking of two 48-inch cast-iron pipes which carry the normal effluent out into the deep-water channel. The main twin sewers shown in the drawing are 86 \times 94 inches. The lower of the two goes directly to the storm outlet. The upper sewer, carrying the domestic flow, ordinarily extends to the intercepting sewer (not shown) through a pipe 70 \times 76 inches, but when this becomes

¹ Prov. Rept., 1891.

overtaxed, the excess flows over the curved weir and to the storm-water outlet. The arch construction for the three sewers

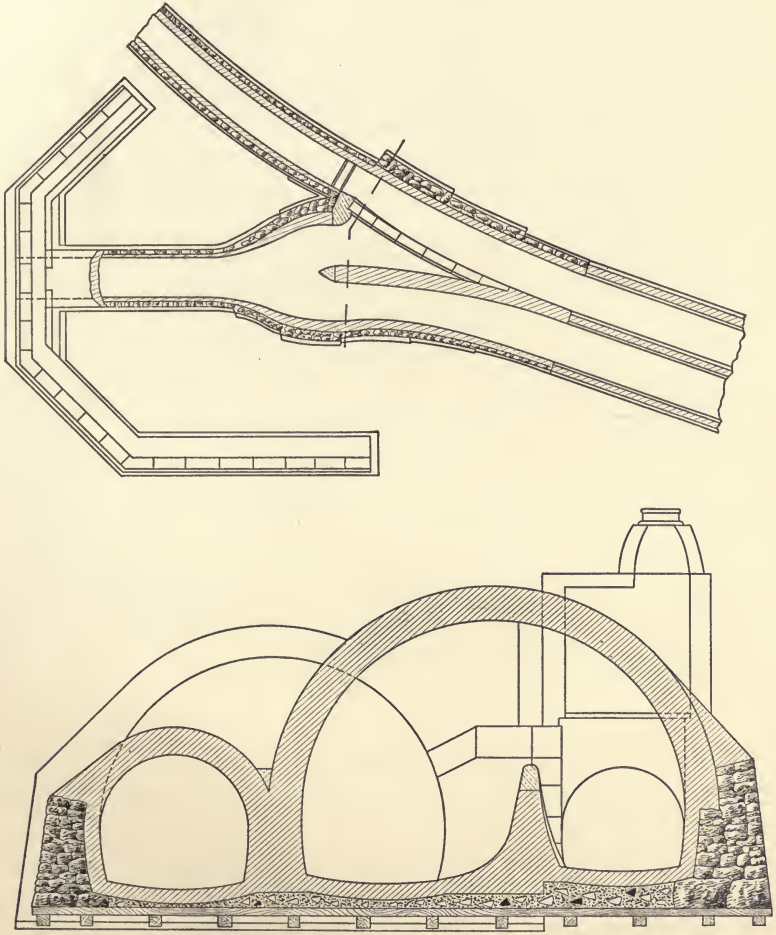

Fig. 142

at the junction chamber is particularly interesting, the large arch having a span of 20 feet.

Fig. 143 shows the plan and section of the overflow weir provided at point *A* in the Rochester East Side Trunk Sewer, above referred to. The section on the right, 8 feet diameter, is

the main sewer before the reduction in size, while the section on the left, 3 feet diameter, is the overflow pipe.

The third class of regulators are mechanical in action, valves which work automatically opening or shutting with the rise and fall of the sewage.

Fig. 144¹ shows one in use in the Boston Metropolitan System, by means of which the discharge into the interceptor can be kept constant. It was desired in this case to take from the main brick sewers, 3 feet 6 inches in diameter, a certain uniform quantity,

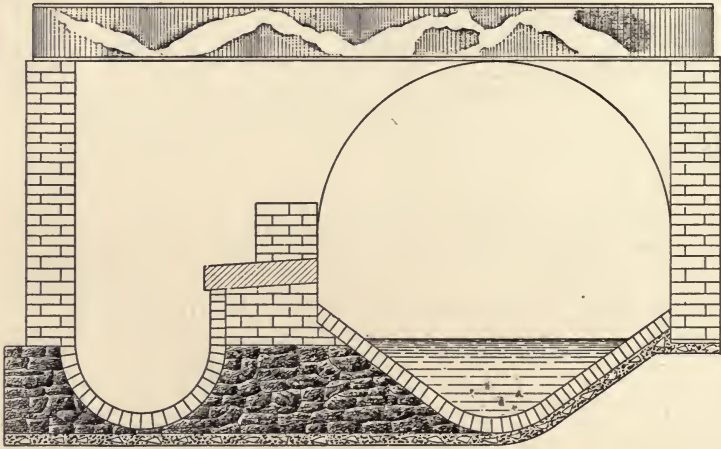
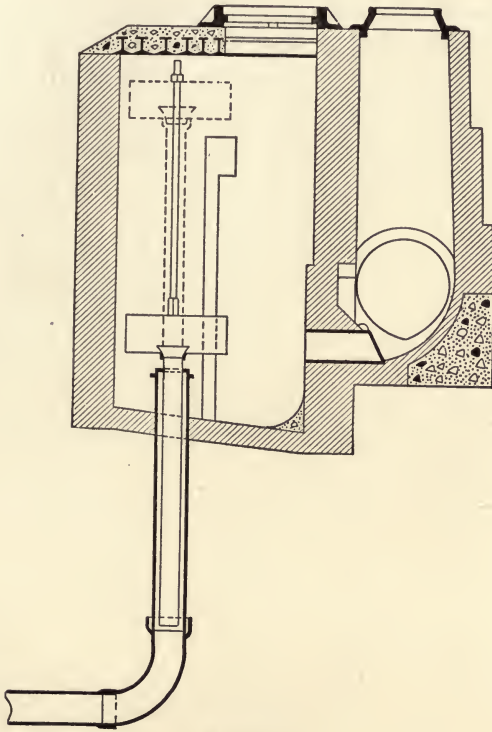

Fig. 143

the surplus continuing in the sewer. On account of the limited capacity of the interceptor, a rectangular chamber 3 feet 6 inches by 6 feet 6 inches is entered by the 12-inch connecting pipe, to which is attached the regulating device. This consists of two copper floats, connected by a cast-iron beam. Between these floats, and attached to the beam connecting them, is a vertical brass pipe with open mouth, which slides up and down in the 12-inch pipe. As the floats rise and fall, the brass pipe also rises and falls, the open mouth maintaining always the same submergence. By changing the relative position of the brass pipe and the floats, a different quantity can be discharged.

¹ Eng. Rec., Vol. 40, p. 74.



ELEVATION

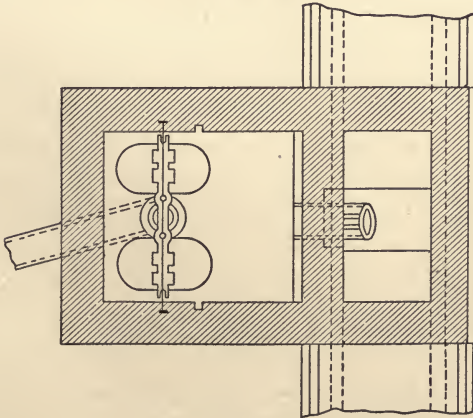

PLAN

Fig. 144

A different type used in Worcester, Mass., is shown in Fig. 145.¹ The sewage enters the manhole from which an overflow leads into the brook. A special regulator manhole is built near by, connected with the former by an 8-inch pipe. A catch-basin or sand pit 2½ feet deep is provided to eliminate the sand, etc., which the combined sewer brings down. The regulator is operated by a float resting in the water at the same level as in the main intercepting sewer. As that water rises, the float rises, exerting a pull on the strap attached to the end of the valve, which, of course, tends to close the valve.

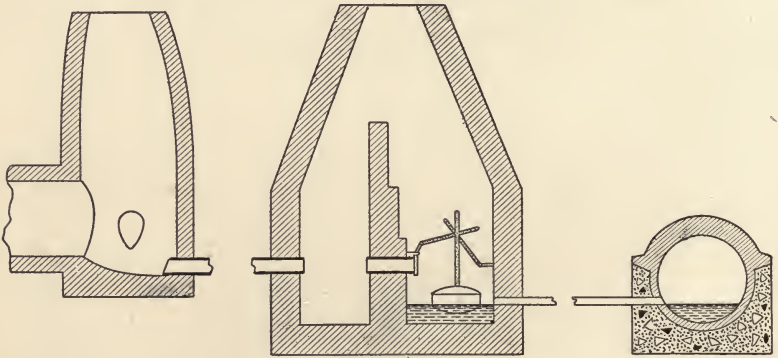

Fig. 145

Fig. 146² shows a regulating device used at Harrisburg, Pa. The problem here was to admit to the intercepting sewer in dry weather a certain amount of creek water, in order to increase the velocity of flow. In case of rain, however, it was necessary to shut this off. There are two sets of three 12-inch vitrified pipes laid through the concrete head wall to serve as inlets for the creek water, one set four feet higher than the other. A silt basin 20 × 8 × 12 feet deep, with a bar grate, is introduced for the purpose of settling and screening out silt, leaves, etc. The water then passes through a rectangular cast-iron orifice into the regulating chamber. A galvanized iron float is so arranged

¹ Eng. Rec., Vol. 44, p. 395.

² Eng. Rec., Vol. 46, p. 342.

as to rise and fall with the level of the water in the interceptor at a point about 10 feet down stream; connection between the well and this point is made by means of a 4-inch pipe. As

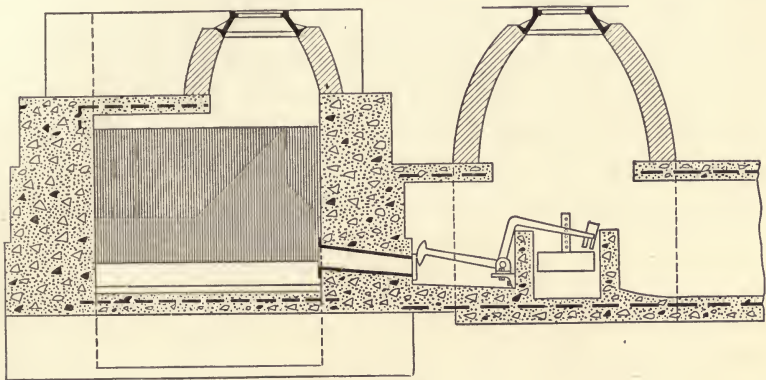

SECTION

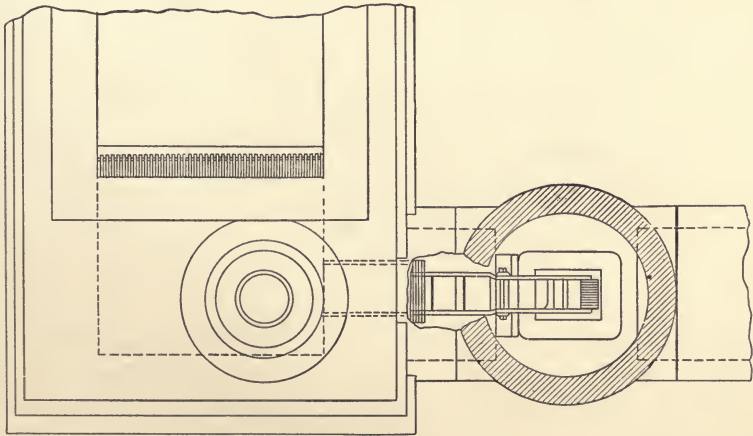

PLAN

Fig. 146

the float rises, the bell-crank connection with the sliding valve causes the valve to close, and vice versa. This connection arm is fastened into the concrete wall of the chamber by means of a short piece of angle iron, the holes for the anchor bolts being slotted to allow of a vertical adjustment. The attachment to

the arm is made by slotted holes on the horizontal leg of the angle, so that the adjustment for position may be exactly made. The face of the valve and all wearing parts are made of bronze, the rest being of cast-iron.

Fig. 147 shows the simple regulator used on the Brookline sewers. A bent arm acts as a lever, one end forming a sliding gate, which opens or closes the exit from the main village sewer. The other end is attached to a float which moves up and down in a float chamber. When the level of the sewage in the intercepting sewer rises to a point where it overflows into the chamber, the

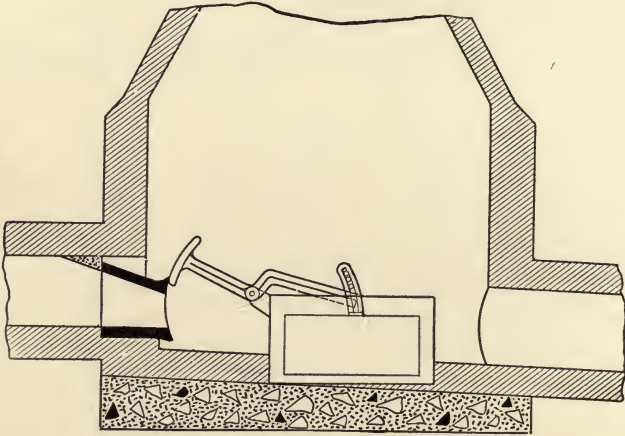

Fig. 147

float is lifted and the valve closes, forcing the sewage into an overflow pipe leading out from a manhole on the left (not shown). A small drain pipe leads out from the chamber so that as the level in the intercepting sewer falls, the float descends, opening the gate. This device has worked admirably for twelve years.

Fig. 148 shows a regulating device furnished by the Coffin Valve Company. A copper float moves up and down in its chamber, the motion being communicated through a rocker arm to a valve which slides across the entrance to the intercepting sewer as the float rises. The cut apparently shows the outlet to the outfall, which then comes into play, the inlet not being

visible. The side motion of this valve differs markedly from the other valves, which are all of the flap-valve type.

Fig. 149¹ shows a regulator installed at Woburn, Mass., about twenty years ago. A large copper float rises and falls in a well, built by the side of the manhole. The float is attached to a lever which, working through an opening in the manhole wall, causes

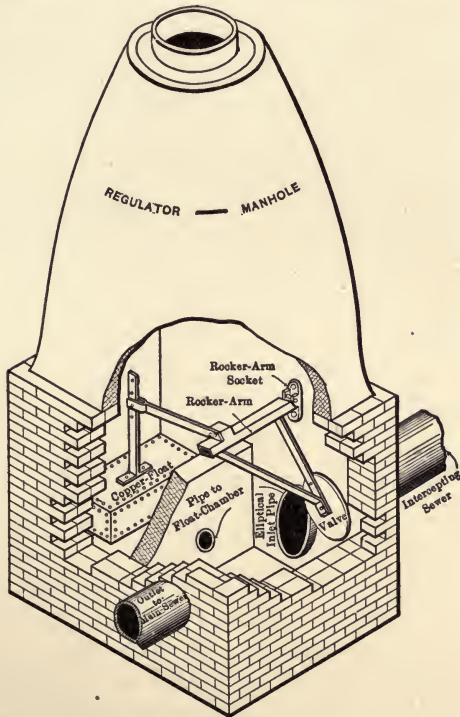

Fig. 148

the flap valve to open and shut as the sewage in the well falls and rises.

The use of overflows or regulators is a relic of the time when storm-water sewers formed the general type of sewers, and is really a makeshift, to adjust the undesirable conditions thus formed to the modern necessities for purification. Except for

¹ Eng. Rec., Vol. 22, p. 41.

the need of purification, or for the construction of long, intercepting sewers to relieve excessive local pollution, no such devices would be needed. Nor would they be needed if house sewage had been kept out of the storm sewers. It is not likely that in

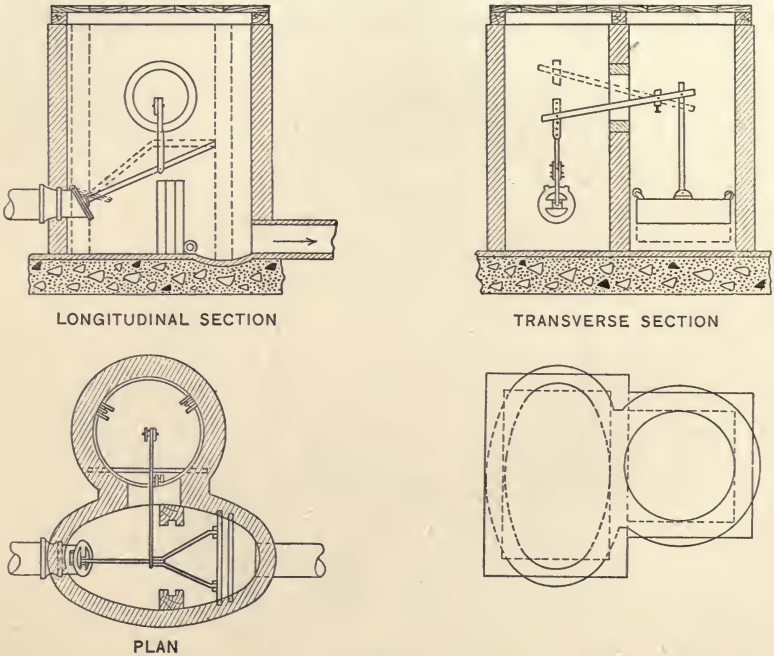

Fig. 149

the future the construction of combined sewers will be permitted by the state sanitary authorities, so that the devices here described will be limited in their application to old sewers built on the combined plan, the proportional number of which must steadily decrease.

CHAPTER XII.

BELL MOUTHS.

WHEN sewers are over three feet in diameter it is not necessary to make bends entirely within the manhole walls, since workmen can readily enter such sewers and remove obstructions by hand. Also the junction of two large sewers need not be made within the manhole, but the sewer walls can be brought to an intersection. When the angle between the axes of the intersecting sewers is greater than about 30 degrees, the walls are brought into each other, the weight of the arches, with their loadings, being safely carried down through the walls of one of the two sewers to the foundation. For this construction a template of the line of intersection of the inside walls should be made, and the brickwork carefully laid up to this on the main sewer, the other being afterward tied on along this line. When the angle is less than about 30 degrees, the arch thrust cannot be taken up, and a construction known as a bell mouth must be resorted to. In this (and the same construction applies when one sewer is brought into the other in a curve), the side walls nearest each other are stopped where the springing lines intersect, and a vertical wall is built across in the triangular spaces above. Then from the outside walls at the springing lines a large cover arch is thrown from outside to outside, the former small arches being omitted. This large arch is then gradually reduced in span in the form of a trumpet until it coincides with the arch of the main sewer below the junction. The object of this construction is to avoid a reëntrant intersection of the two arches which would be entirely unsupported and unstable. The section on *KK* in Fig. 141 shows the conditions, the intersection of the arches evidently introducing unbalanced and unsupported vertical

forces. The dotted lines in that figure show the relative position of the enveloping arch which would be used in a bell-mouth construction.

The plan of the intersecting sewers should show a connect-

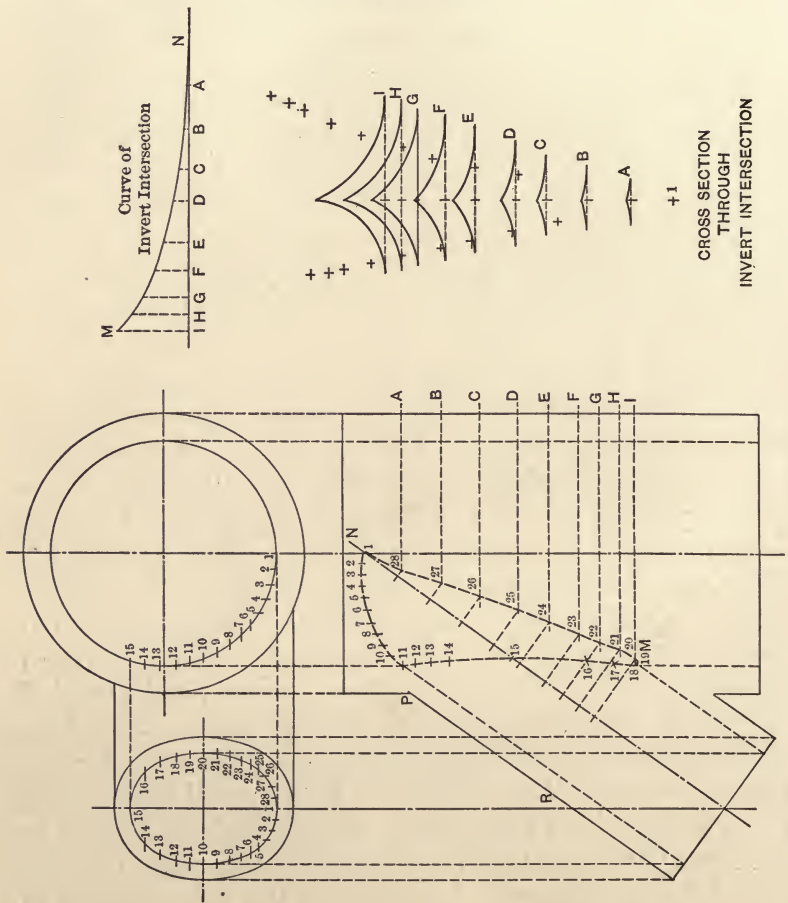

Fig. 150

ing curve even if the angle between the two lines is as small as 25 or 30 degrees. An ideal intersection will bring the central threads of the surface flow in the two sewers together tangentially, so that the connecting curve is always desirable. Such an intersection, however, makes the quoin, or wedge-shaped

masonry, forming the edge of the intersecting surfaces, too acute to be substantially built of brickwork. It has therefore been customary to replace the brickwork with a cut stone quoin, ending with a flat top at the spring-line level. Theoretically this quoin-stone extends, wedge-shaped, from the point where the spring lines intersect along a curve to the point where the invert of the upper sewer intersects the inner surface of the other sewer. The following drawing (see Fig. 150), prepared by one of the author's students, will make this clear. The plan and elevation of the two intersecting sewers were drawn, and horizontal elements of the two surfaces at the same level (bearing the same numbers in the figure) were produced to an intersection. The elements of the lower part of the sewers show the line of the quoin referred to, that is, from *M* to *N*. An elevation of this line is shown in detail, and cross-sections at a number of points show the wedge angle. If the arch of the smaller sewer enters the larger sewer above the springing line, a reëntrant angle referred to above is formed, and the trumpet-shaped arch should be thrown across both sewers, i.e., from *A-1* to *P-R*.

Fig. 151 shows¹ the horizontal considerations just discussed illustrated by a concrete example. The main sewer shown is known as the Wingohocking sewer in Philadelphia, and the intersection is with a lateral at the corner of Eighteenth Street and Bellfield Avenue. Three cross-sections are shown, illustrating both the shape of the floor intersection and also the arch spanning both sewers. In the longitudinal section the heavy line shows the curve of invert intersection.

Fig. 152 shows a similar construction in the case of the basket-handle sections used on the Metropolitan Sewerage System of Massachusetts. The plan and two cross-sections are given to show the gradual change in the line of division between the two channels, and to show the unusual form of the pointed arch used as a cover arch. The section showing the manhole, at the top of the quoin, shows also the curvature of the quoin in a vertical

¹ Eng. News, Vol. 35, p. 163.



SECTION G-H

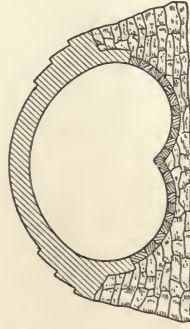

SECTION C-D

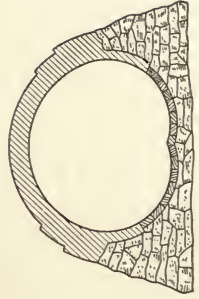

SECTION E-F



SECTION A-B

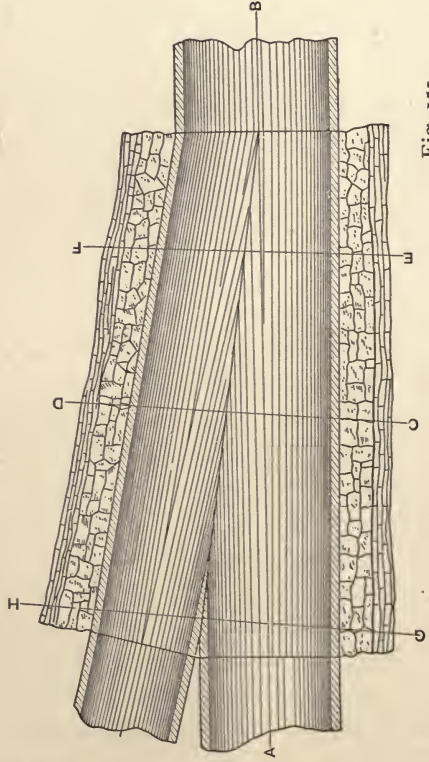

Fig. 151

plane.¹ The figure also shows more clearly than the preceding one that the plan of this line is not straight. Only when the

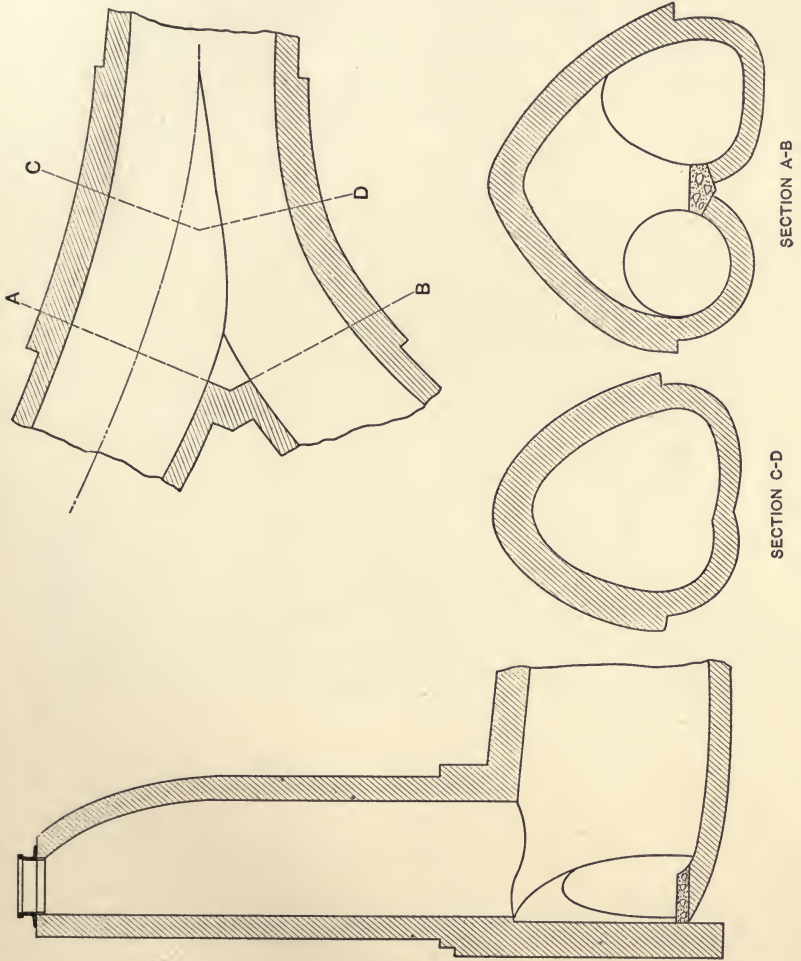

Fig. 152

two sewers joining are of the same size and elevation would the plan be truly straight, although in many other cases the approximation is very great.

Fig. 153 shows another intersection, also on the Metropolitan

¹ Eng. News, Vol. 31, p. 386.

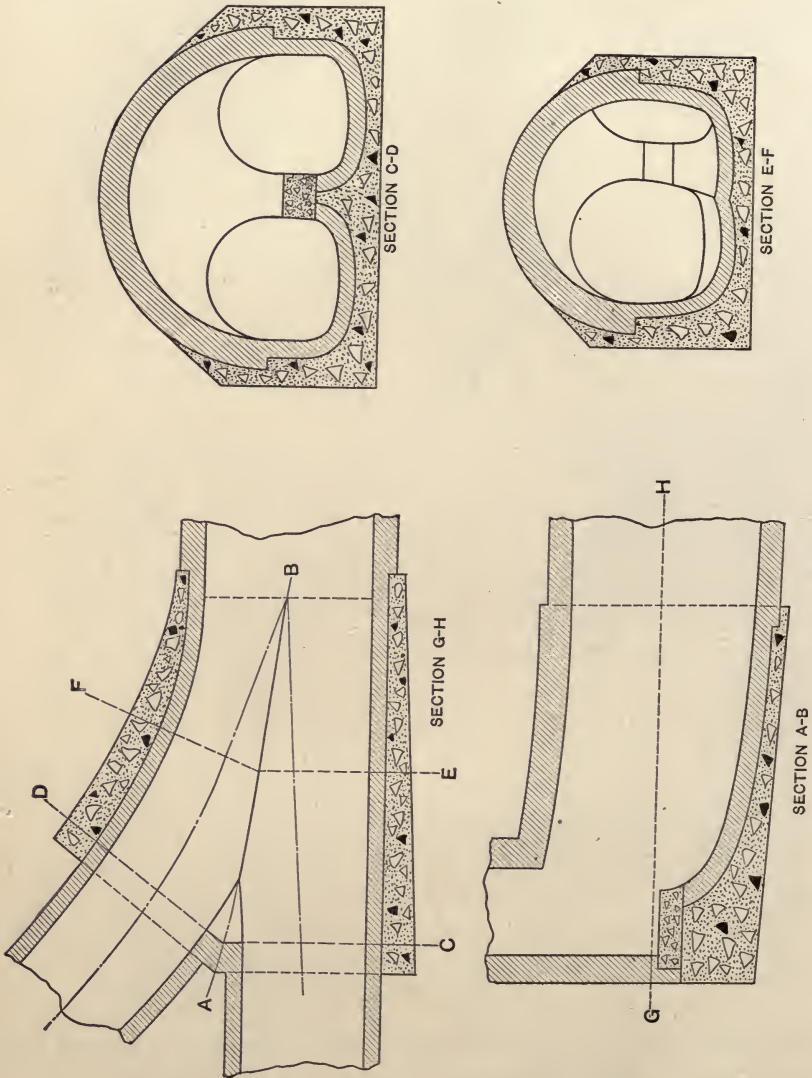

Fig. 153

system at Boston, with the same basket-handle sewers, but with a semicircular arch instead of a pointed arch. The effect of the flat invert and the vertical side walls on the shape of the quoin curve may be clearly seen by comparison with Figs. 150 and 151.

Fig. 142, showing the overflow at Providence, shows also the cross-section of the bell-mouth chamber and the large cover arch, 20 feet in diameter. Fig. 154 shows a photograph of the

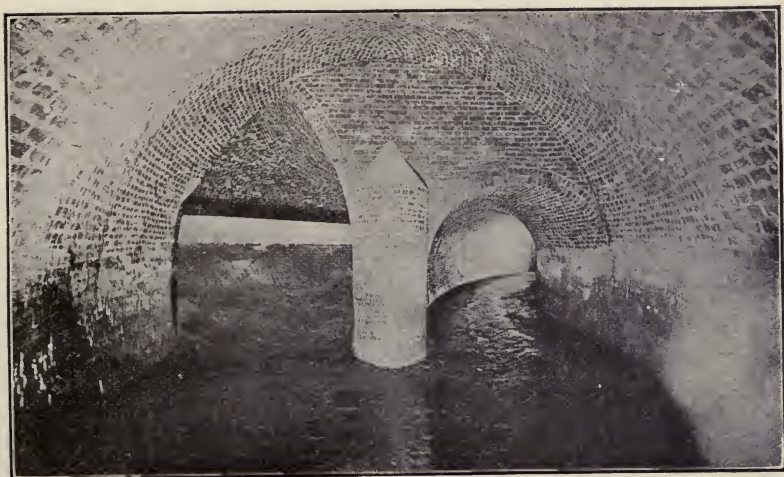

Fig. 154

same bell mouth looking up stream at the quoin, which on account of the weir is here made vertical. One difficulty which may arise in this construction is the lack of head room, since the large cover arch, if made semicircular, rises above the arches of the connecting sewers. If the arch is flattened as in Fig. 141, heavy abutment pressures are introduced, and additional masonry at extra cost is required. In many cases, however, any form of cover arch would be out of the question, and a substitute must be found.

Fig. 155 shows the alternate construction as recommended by

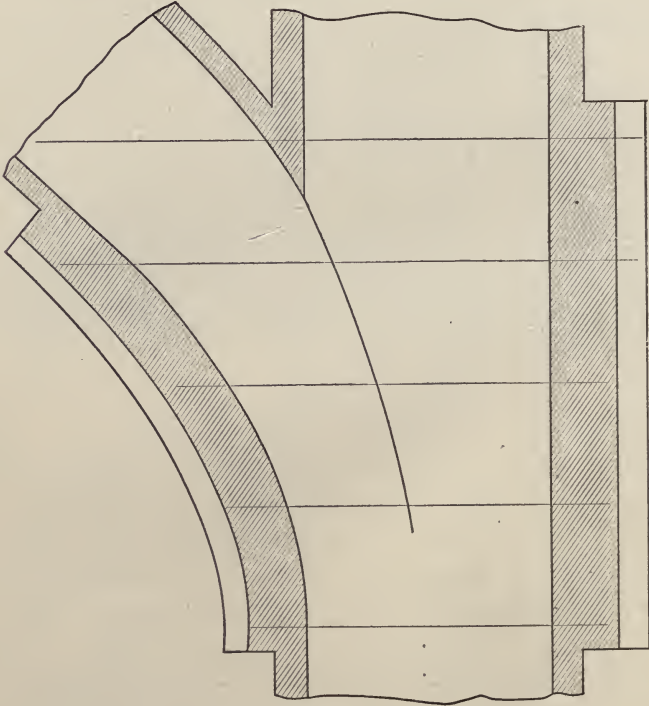
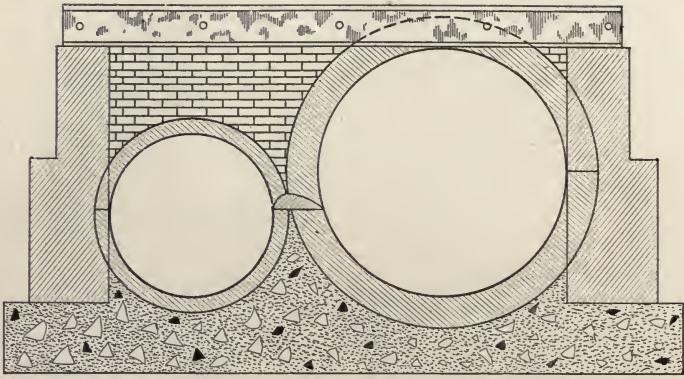

Fig. 155

Mr. E. H. Bowser, of Louisville, Ky.¹ Below the spring line the connection is made as before described. Above the spring line, the walls, instead of being arched across the opening, are built straight up to the height of the intrados of the larger sewer. On top of these walls across the bell mouth I beams are laid about 3 feet apart, and the spaces between the beams filled with brick arches backed with concrete, or with reinforced concrete slabs. Mr. Bowser says that the crowns of these small

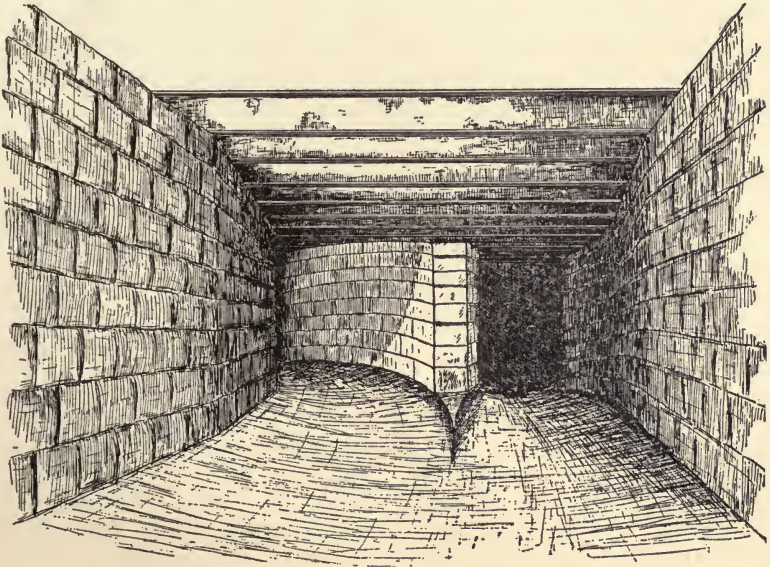

Fig. 156

arches should not be made higher than the crown of the larger sewer, although the reason for such a limitation is not plain to the author. Fig. 156 shows a sketch drawing to illustrate a junction chamber in Minneapolis, redrawn from *Engineering News*.²

Care must be taken to secure good construction, even with the bell mouth carefully designed. There is danger, otherwise, of the arch structure failing, as at Nashville, Tenn., where the

¹ Eng. News, Vol. 35, p. 163.

² Vol. 31, p. 268.

centers were pulled after twenty-four hours, and the whole bell mouth caved in.

A large proportion of the cost of the bell mouth is the value of the labor employed, and as this is ever increasing it is likely that the construction shown in Fig. 145 will be hereafter the most common. With reinforced concrete, a flat roof of girders and slabs can be substituted for the I beams and small brick arches, and unless the sewers flow full, no advantage belonging to the bell mouth is lost. If the sewer flows full, the bell mouth is the most satisfactory method of construction, because thereby the two flows are brought together into one stream in a manner most free from disturbances.

CHAPTER XIII.

FOUNDATIONS.

IF the ground through which a sewer is to pass is loam, dry clay, sand or gravel, no special foundation is needed for the pipe, even in the case of the largest sewers. The trench is excavated to subgrade, and trimmed, when possible, to conform to the outer circumference of the pipe, special excavations being made for the bells. But if the bottom is mud, or running sand or silt, or a clay, which, when wet and disturbed, softens and slides, some special preparation for the pipe is needed.

The simplest means of adding to the stability of the pipe line is to excavate enough below the pipe to place a wide plank underneath, butting the plank at the end joints, and nailing on a splice piece. It is best to have this plank low enough so that at least three inches of gravel or ashes can be placed between the plank and the pipe to give the latter a good bed, and avoid a bearing on the hubs alone. This is a suitable construction when the soft material occurs in pockets, the plank aiding to bridge the pocket without abrupt settlement. The plank should be well below the level of the ground water, so that there may be no decay of the plank, a condition which usually exists, however, when any artificial foundation is needed. Often the plank can be omitted and the foundation improved by extra excavation and refilling with gravel. The pressure per unit area on the mud is thus reduced, and at the same time a good drainage is provided. Whether this is an advisable method depends on the weight of the pipe and on the bearing power of the soil. If the width of the pressure area is increased along 45-degree lines, the bearing area is increased by twice the thickness of the gravel bed, or a bed one foot deep reduces the unit pressure on the natural soil to

about one-third. A 15-inch pipe weighs, when half full of water, $65 + 40 = 105$ pounds per running foot, and a 24-inch pipe weighs $170 + 205 = 375$ pounds per running foot. If the natural soil will not hold up the loads in either case, without undue or unequal settlement, the gravel bed will reduce these loads to 35 and 125 pounds respectively. The level of the ground water need not be considered, and the cost is that of the extra excavation and the value of the gravel for refilling.

If the sewer is brick or concrete, and the earth is soft, or the bottom a running sand, a wooden bottom should be put in either as a platform or as a cradle. Care must be taken to have gravel, sand, or ashes well tamped under and behind such wooden supports, and the wood must be below the permanent level of the ground water.

There is not any basis for computation of sizes of timbers in the design of such a timber platform, base, or cradle, since the supporting power of the natural soil is quite uncertain. It is necessary to provide ample stiffness, and it is better to err by burying too much timber rather than not enough. For an average platform, cross-timbers in a trench about 3 feet wide should be about 4×4 , and in a trench 8 or 10 feet wide they should be about 6×8 .

The wooden platform used under 30-inch sewers in Manila consisted of cross-timbers 4×8 inches, laid across the bottom of the 5-foot trench, and the floor was made of 2-inch plank, laid longitudinally on these stringers. The planking running longitudinally in a trench should be spiked to the cross-timbers, the latter spaced about 5 feet apart. Great care should be taken to pack gravel around the timbers and under the floor plank, in order to secure good bearing.

Fig. 157 shows a wooden cradle suitable for the outside of either brick or concrete work. Such a cradle will usually be from 8 feet to 10 feet long, depending on the size of the sewer, large sizes requiring shorter lengths in order to keep the weight of the cradle within reasonable limits.

The frames are sawed from 2×10 -inch plank, and are spaced

about 4 feet apart if 2-inch lagging is used, and about 18 inches apart if 1-inch lagging is used. These cradles, in continuous line, are carefully set to grade, the space between their outside and the trench sides is thoroughly filled with sand or gravel, and

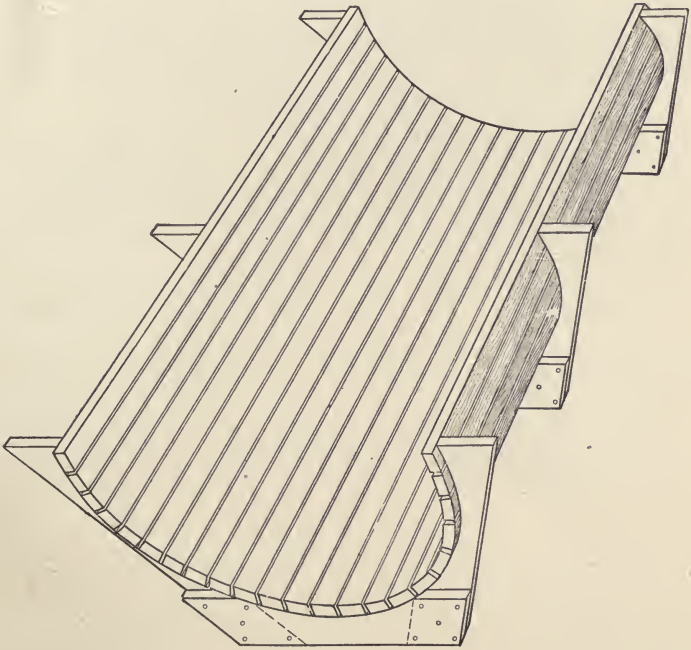

Fig. 157

often the top of the frames is nailed to the bracing of the trench. They are, of course, left in place permanently, and, therefore, ought to be used only under the level of ground water.

Instead of the plank in the bottom, or sometimes on the plank, if the bottom is so soft that concrete thrown directly on to the mud would be injured, concrete is used as a foundation. This

may be either as a part of the sewer itself, the invert being increased in thickness, or as a separate construction. The use of an added mass of concrete for a foundation course is generally not to be advised, since the weight of the concrete itself adds to the insecurity of the foundation. The lighter weight of the timber has a decided advantage. If concrete is to be used, as it should be in all cases above ground-water level, the thickness should be reduced as much as possible, and the resistance to flexure, both longitudinal and transverse, obtained by metal reinforcement. By this means a tough, stiff, and permanent light platform may be placed, which does not need to be below water level, and the cost of which is but little, if any, more than a timber one. The thickness need not be more than 6 inches, and the various forms of wire cloth or similar metal reinforcement are suitable.

A last resort, when the earth seems to have little or no sustaining power, or is so variable as to indicate that the vertical alignment of the sewer would be quite destroyed, is to drive piles and thus support the sewers. Colonel Waring¹ invented and made use of so-called saddle piles, which were pieces of 2-inch plank 10 to 12 inches wide sharpened at the lower end and so driven in the bottom of the trench that the pipe would rest in notches cut in the upper end, a pile coming just behind the bell of each pipe. Mr. Hastings, at Cambridge, has driven 10-inch piles 4 feet apart in the bottom of the trench, capping them with a 4 × 12-inch spruce timber, and resting the 10-inch pipe on triangular blocks spiked to the longitudinal timbers. See Fig. 158 for drawings showing the construction when the pipe is reinforced with a brick arch, as well as when it is not.

Fig. 159 shows a more elaborate design intended for an 18-inch pipe, the piles being double in the bent, and the bents spaced 5 feet apart.

Fig. 160 shows the design by the same engineer, Mr. Hastings,² for an egg-shaped sewer 24 × 30 inches. The timbering in all

¹ Sewerage, pp. 58 and 108.

² Assn. Eng. Soc., Vol. 22, p. 92.

these cases is about the same, — a 4-inch floor, 8-inch longitudinal timbers, and pile bents spaced 5 feet apart.

Fig. 161¹ shows the construction adopted in the case of an egg-shaped 26 × 39-inch sewer in Lynn, Mass. A single row of piles were driven longitudinally, 6 feet apart, capped with 6 × 6-inch timbers as shown, braced by 3 × 4-inch diagonals. The

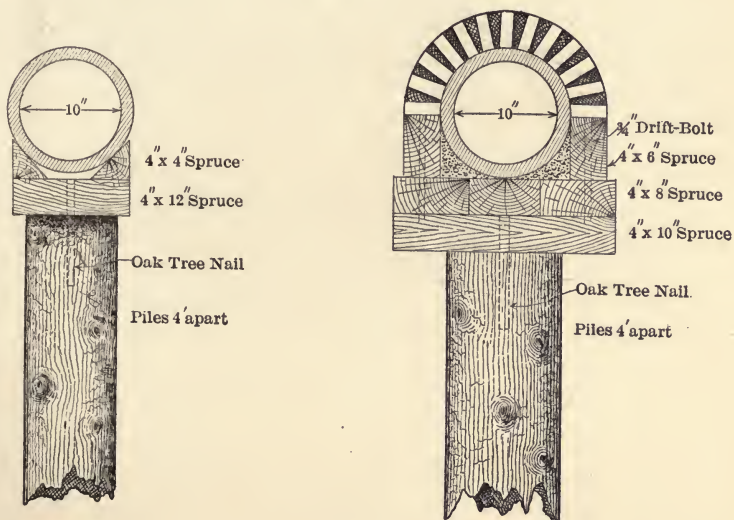

Fig. 158

stringers are 4 × 6 inches on the ends and 6 × 6 inches in the middle, covered with a 2-inch spruce floor. The concrete foundation was placed on this floor, confined between the 2-inch sheeting shown. The piles were from 35 to 38 feet long, and in spite of this support, filling to one side of the sewer has crowded the sewer sideways about 4 feet for a distance of 125 feet.

Fig. 162 shows the design adopted in Troy, N.Y., some years ago.² The egg-shaped brick sewer, 24 × 30 inches, was to be carried across a marsh; and a timber cradle, supported directly on piles, was built. The frames are the same as shown in Fig.

¹ Eng. News, Vol. 35, p. 103.

² Paving, Vol. 8, p. 314.

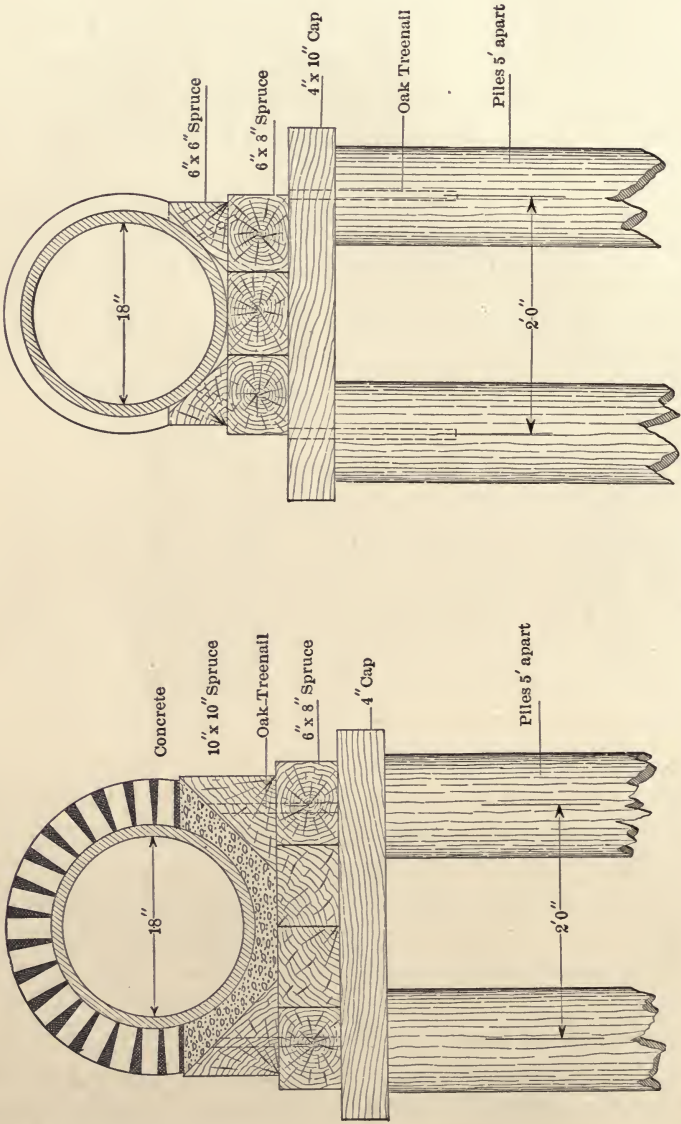

Fig. 159

157; but instead of the parts being fastened together into one continuous frame, the two side pieces are bolted to the piles

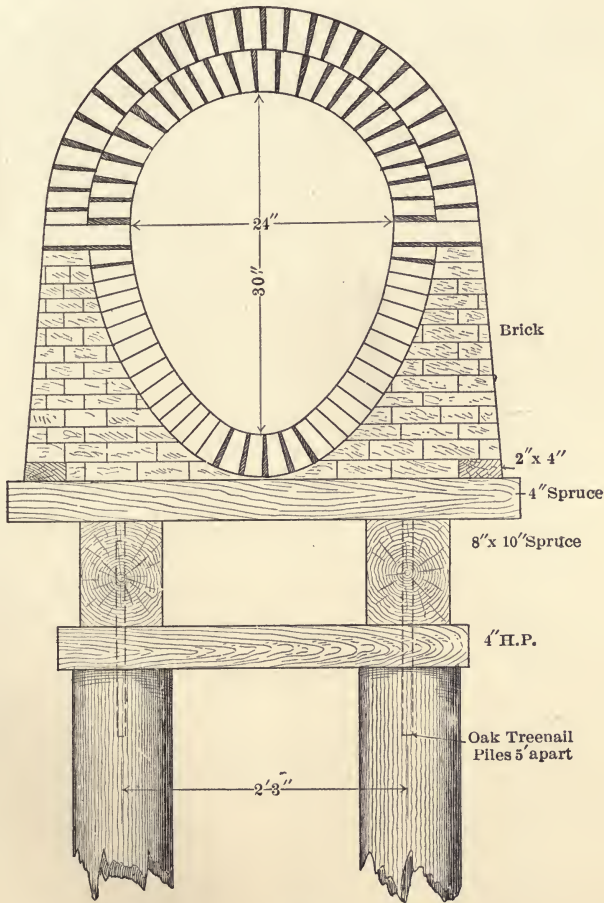

Fig. 160

and to the cross-timber, and then the lagging is nailed on as before. This is all, of course, below ground-water level.

Fig. 163 shows the supports for a sewer, the barrel of which is wood staves, 3 x 8 inches. In this case no longitudinal stringers are necessary, and the pile bents are spaced 8 feet

apart instead of 5. This construction, also a design of Mr. Hastings, is adapted for an outfall in shallow water, where

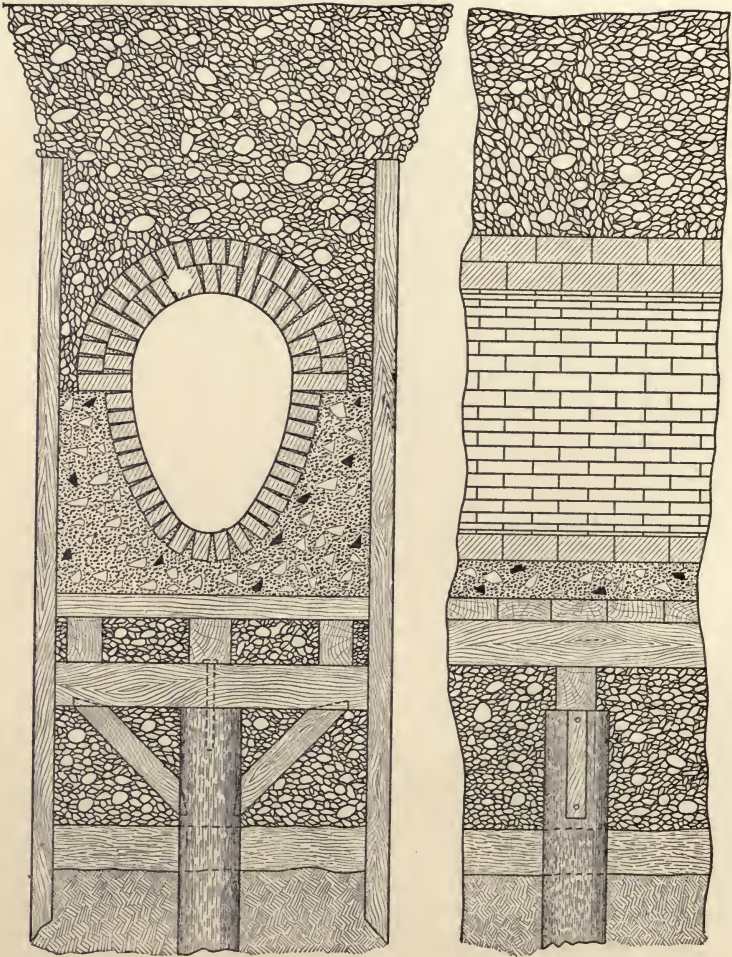

Fig. 161

the bolts required may be placed, by a diver if necessary, where the wooden barrel is under water continually, and where the upper cross-piece keeps the sewer from being floated away.

Fig. 164 shows the construction used to support an $8 \times 8\frac{1}{2}$ -foot and a 9×13 -foot sewer at Boston.¹ There are 5 and 7 piles respectively in the bents, driven closer together in the bent under the abutments. Both sections are admirable examples of type

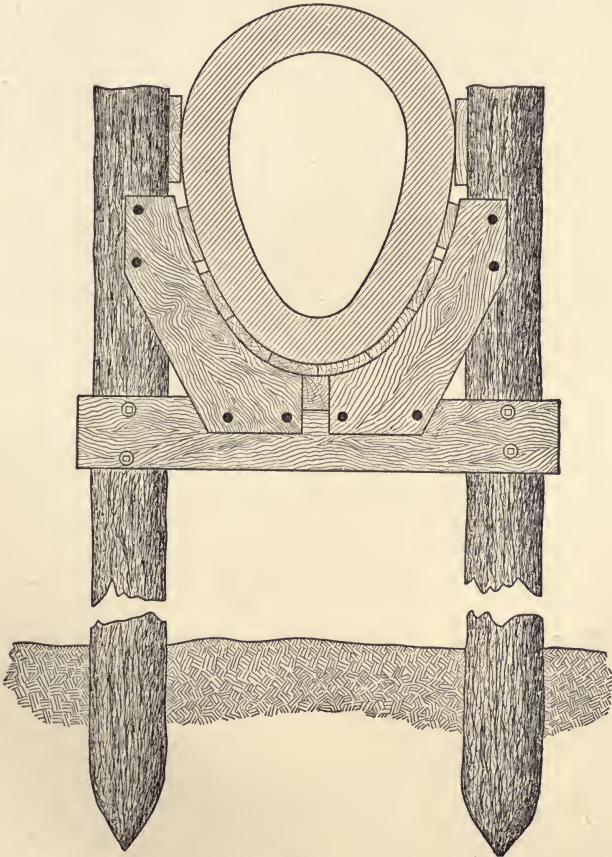

Fig. 162

forms of self-contained sewers, i.e., sewers built above ground, or in such soft material that no dependence can be placed on the soil for backing or support.

¹ Eng. News, Vol. 27, p. 512.

Fig. 165 shows the cross-section of a sewer at the foot of Canal Street, New York City.¹ It is 7 feet high by 16 feet wide, and supported on pile bents, containing 8 piles, the bents being

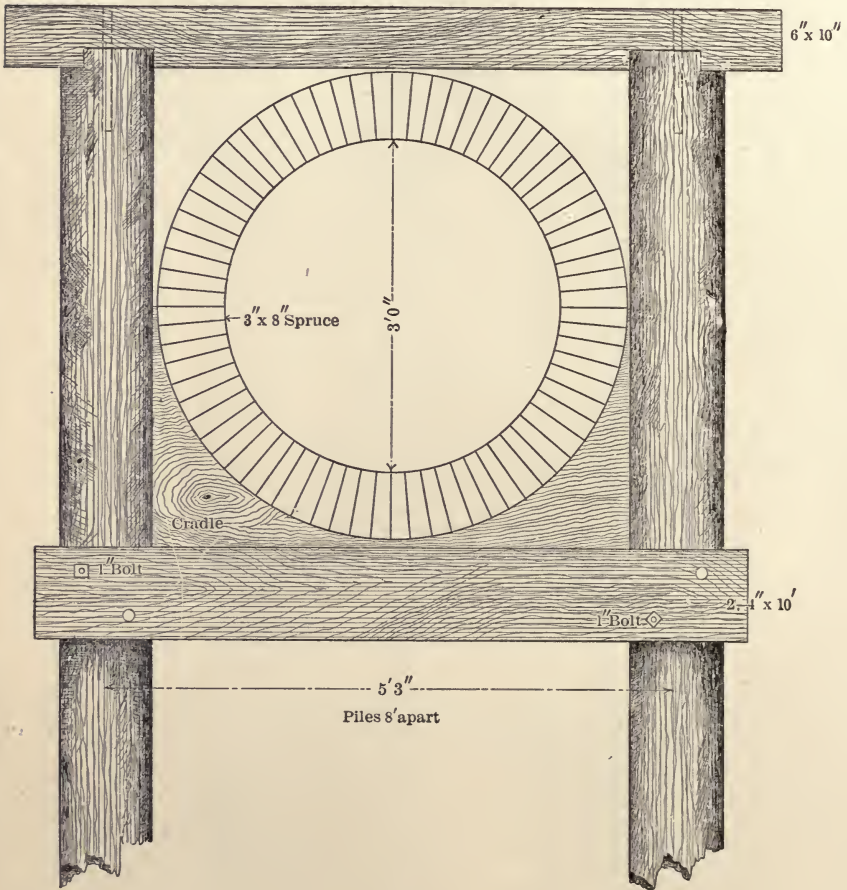

Fig. 163

3 feet apart. The timbering on the piles was 12×12 caps, floored over with 4-inch plank, and protected with a flagstone cover of 3-inch bluestone. The side walls were large concrete

¹ Trans. Am. Soc. C. E., Vol. 31, p. 569.

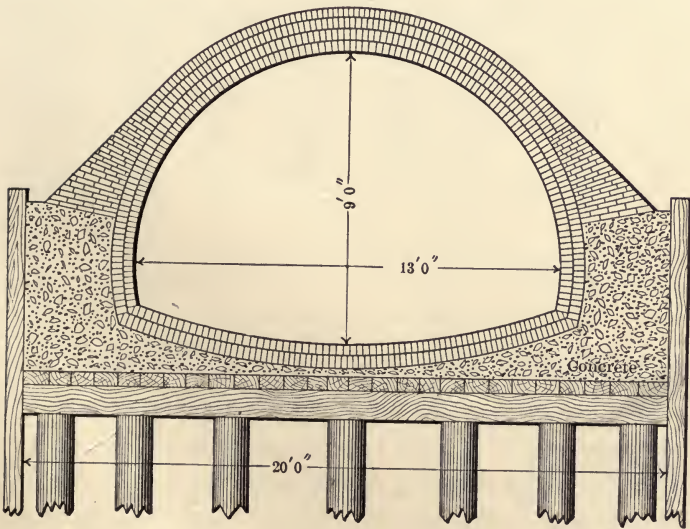
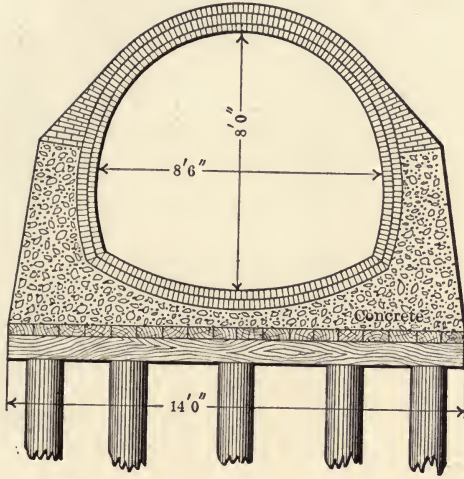

Fig. 164

blocks molded in forms and weighing from 4 to 10 tons each. The roof was made of 10-inch I beams spaced 3 feet apart with concrete arches between.

Fig. 166 shows a similar construction at St. Paul, Minn.,¹ the sewer being 16 feet wide by 12 feet high. Here there are 9 piles to the bent, and the bents are 6 feet apart. The caps are 12 × 12 and the stringers 12 × 10 on the sides and 10 × 10 in the center. The side walls are built up of coursed rubble, and

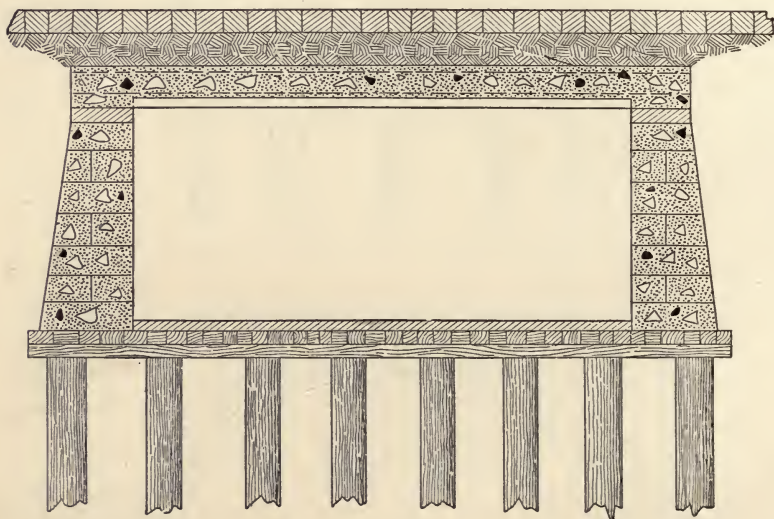

Fig. 165

the invert of the sewer is formed of vitrified paving brick set in cement. The roof is formed of 20-inch I beams, spaced 5 feet apart with 2-ring brick arches thrown between. These latter have a radius of $43\frac{1}{2}$ inches.

In all these designs special attention should be paid to distributing the pressure among the different piles, since with the sewer flowing only part full the pressure under the abutments is much greater than at the center. This is taken care of partly by the spacing of the piles in the bent, and partly by the use of heavy transverse timbers. It is easy to see that careless-

¹ Eng. News, Vol. 31, p. 268.

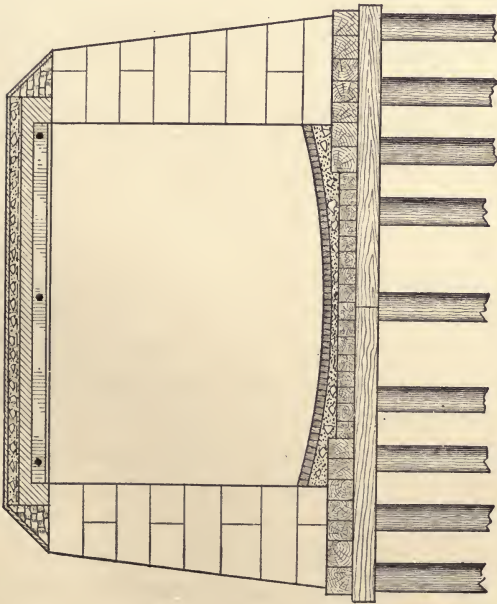
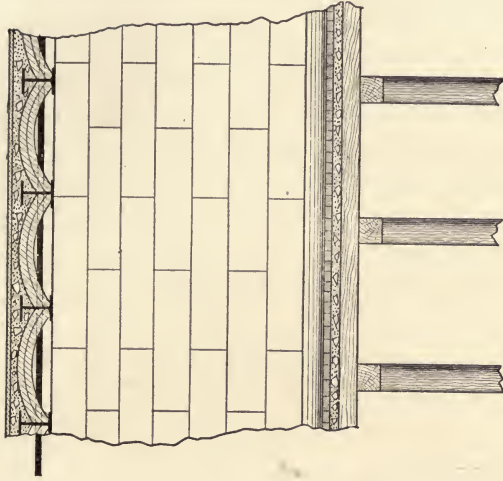

Fig. 166

ness in this regard might result in a longitudinal break at the invert and at the crown.

Sometimes it becomes necessary to deliberately allow the sewer to settle, making due provision for the same, as was done in Boston about 1880.¹ The outfall sewer from Squantum to Moon Island was planned to be built in an embankment 20 feet wide on top, and about 30 feet high (see Fig. 167), the embankment being formed by newly made fill on the mud flats, whose elevation was about that of low tide. It was at first supposed that the mud was underlaid by gravel, and that no difficulty would be encountered in making

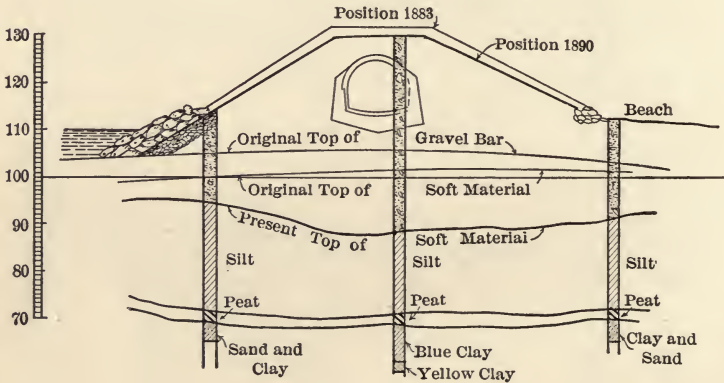

Fig. 167

the embankment stable from the first. But it developed that the gravel was only a thin stratum, and that it in its turn was underlaid by mud. A temporary box sewer was built on piles alongside, and the embankment was built and allowed to settle, careful observations being made as to the rate of settlement. For this purpose six rods were placed vertically in position in the longitudinal axis of the filling, with iron plates 2 feet square at their lower ends, which were set at the top of the embankment as soon as it was brought up to grade. Additional rods were screwed on where necessary, and levels read regularly from above on each of the six rods. For nine years the fill was allowed

¹ Assn. Eng. Soc., Vol. 11, p. 355.

to settle, and Fig. 168 shows the settlement from 1885 to 1890, the total settlement in the four years prior to 1885 being as follows:

Plate at Station 369 + 0	17.09
Plate at Station 374	3.89
Plate at Station 382 + 50	30.55
Plate at Station 389 + 22	1.26
Plate at Station 396 + 54	1.53
Plate at Station 401 + 79	1.42

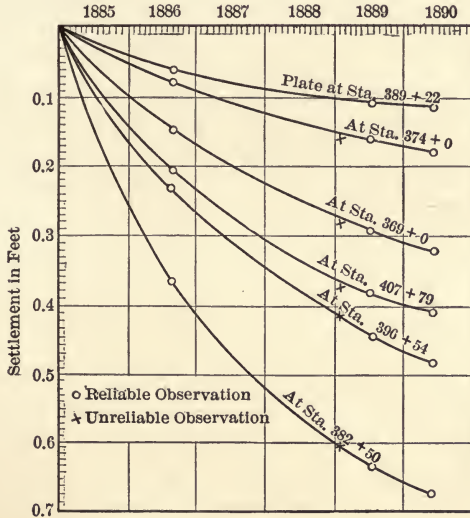

Fig. 168

The diagram shows that the curves are all gradually approaching a direction parallel to the axis of the curves, and that in time the settlement would cease. In this case the construction of the masonry sewer was begun before the end of the settlement, since the wooden temporary sewer was rotting away, and the grade of the sewer was raised to provide for an estimated future settlement.

The proper design of a foundation, and a reasonable adjustment of the character of the foundation to the necessities of the particular case in hand, call for the best judgment of the engineer, and should be based on experience and observation. Elaborate

foundations in soils which may not require them may indicate the anxious conservatism of the constructing engineer, but they are extravagantly expensive, and may expose the ignorance of the engineer quite as much as a failure of a sewer due to insufficient foundation. A municipality before entering into any extensive foundation work for sewer construction can well afford to secure advice from engineers experienced in such work, rather than follow the designs of a local engineer whose training has not given him the special knowledge obtained in wider practice.

CHAPTER XIV.

OUTFALL SEWERS.

FREQUENTLY the term "outfall sewer" is applied to that part of the sewer system between the point of discharge and the last lateral, or between the point of discharge and a pumping station or a disposal plant, in which cases no special construction is required. On the other hand, there are definite and peculiar forms of construction used in the building of the discharge end of a sewer system.

In the simplest form of discharge the sewer is led in its trench to the bank of the stream and there ended, and the only special construction is the masonry wall, which should always be built around the end of the pipe to protect it against blows from above, and from erosion of the water from beneath. Fig. 169 shows the design of Mr. Hering for such a construction.¹ Frequently this form of construction does not have the end of the pipe submerged, and, the pipe being high out of water, the construction of the wall is a simple affair. Proper construction, however, demands that the outlet be submerged, or, if the sewer is a combined one, that that portion which carries the dry-weather flow be submerged. This may conveniently be done by taking out a smaller pipe from the invert of the large sewer, for the dry-weather flow. This small pipe can be carried out to deep water, or to a point where it is submerged in a good current, far more easily than could the larger sewer. In Harrisburg, Pa., for example, the sewers end at the foot of a bank, at the edge of the Susquehanna River. In summer, there is only a foot or so of water flowing over the rocky bed. It would be manifestly impossible to carry out a 4-foot sewer to be submerged in a foot of water, but two lengths of

¹ Ithaca, N.Y., 1892.

10-inch pipe carry out the house sewage, and the large sewer discharges the storm water, and both operate without producing any nuisance.

Fig. 170 shows a design for an outfall of this sort in Binghamton. The combined sewer is 4 feet in diameter, and the outfall pipe is 12 inches. To secure a freedom from flow out of the big sewer except in time of storm, a concrete dam is built in the big sewer, 6 inches high, to force the sewage to drop through

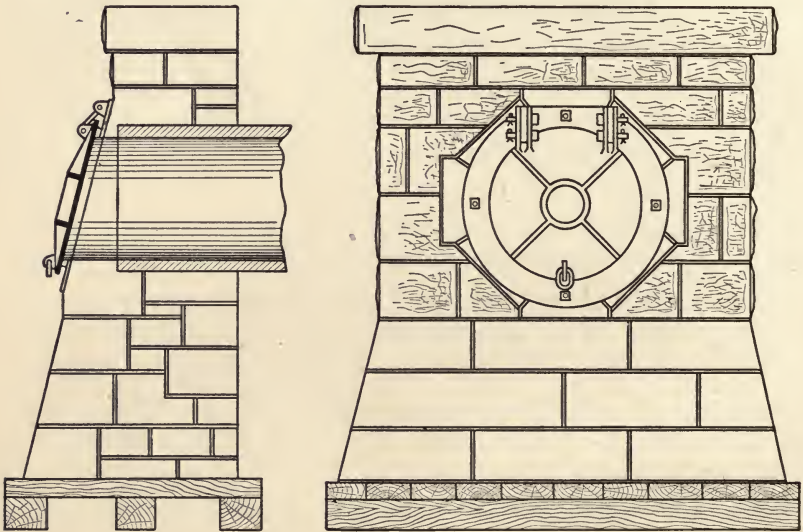

Fig. 169

the opening into the smaller pipe. This dam is not usually necessary, however, unless the grade is very high. This plan is often adopted to avoid the necessity of building a large sewer in a deep trench or down a steep bank.

Fig. 171 shows a conventional design recommended by Moore, and Fig. 172 shows the actual construction of the Niagara Falls outlet. The main trunk sewer is 38×48 -inch brick, and at the disposal point a shaft 5×7 feet is sunk below the sewer to a point level with the bottom of the cliff, exposed in the gorge a depth of about 50 feet. A sump hole allows the

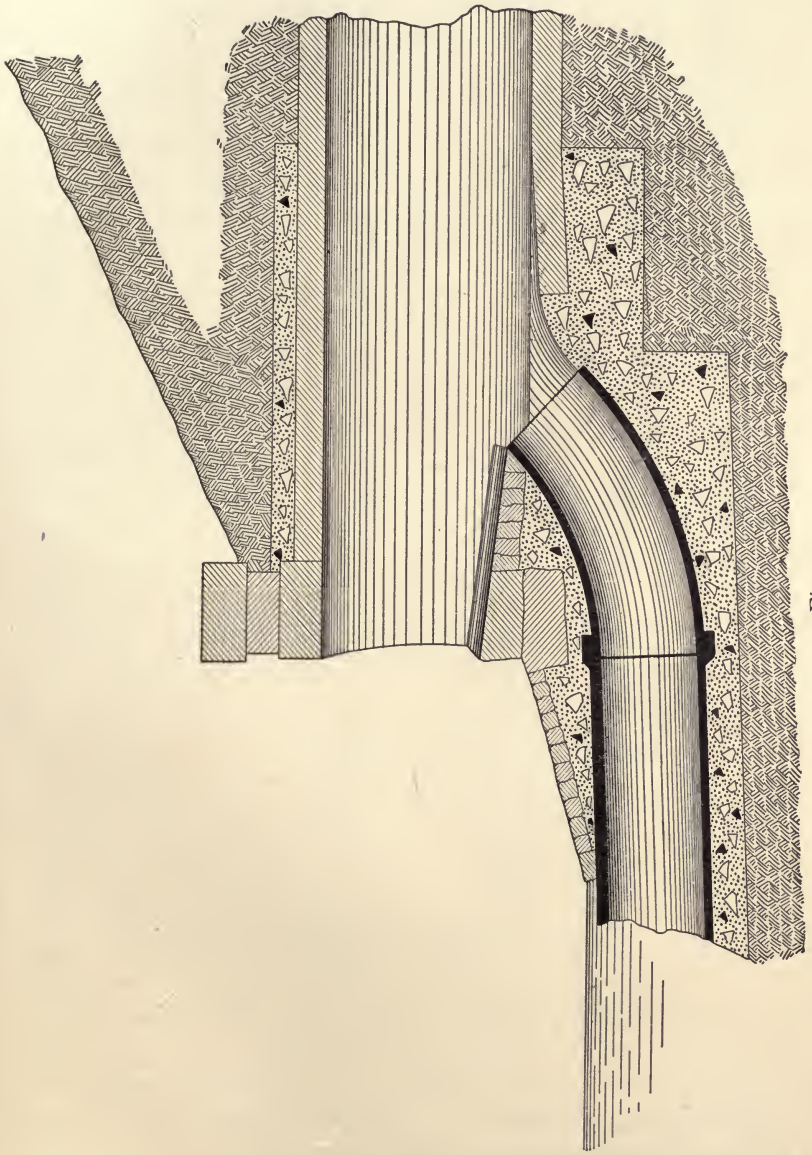

Fig. 170

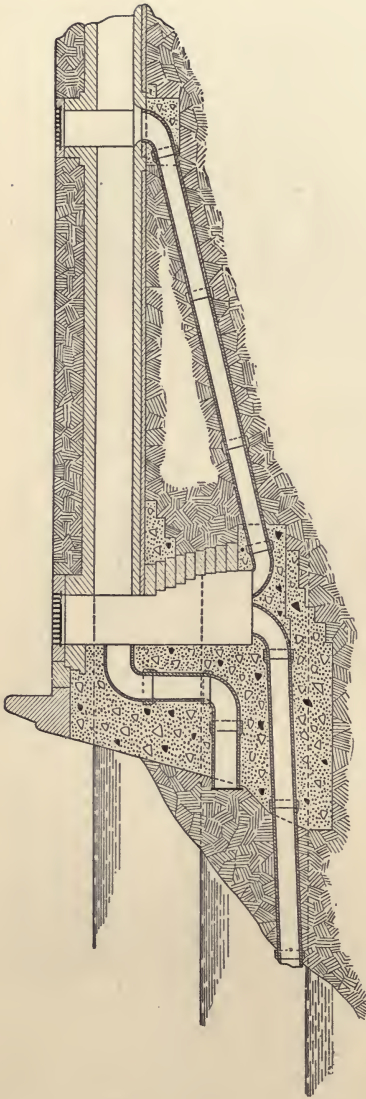

Fig. 171

falling water to strike without causing damage. From the face of the cliff a tunnel is driven 5×6 feet in section to the bottom of the shaft, on a 10 per cent grade. This tunnel is smoothed up on the bottom with concrete and brick into a semicircular channel, but the arch is left unlined. The mouth of the tunnel is protected by a heavy masonry arch and retaining wall. Then down the slope at an angle from the horizontal of 38 degrees is laid a 3-foot circular wood pipe. This pipe is anchored at the bottom of a mass of 70 cubic yards of stone masonry thoroughly tied together with iron straps and collars. A water cushion is provided at the lower end of the pipe.

Figs. 173¹ and 174 show a more elaborate construction at the mouth of the Aramingo Canal Sewer in Philadelphia, the invert at the outfall being three feet below low water. Piles were driven in bents in a trench from which the soft mud had been dredged and which was then refilled with gravel and cobbles. On top of the cobbles was a cement mattress made of two sheets of burlap with

¹ Eng. Rec., Vol. 44, p. 614.

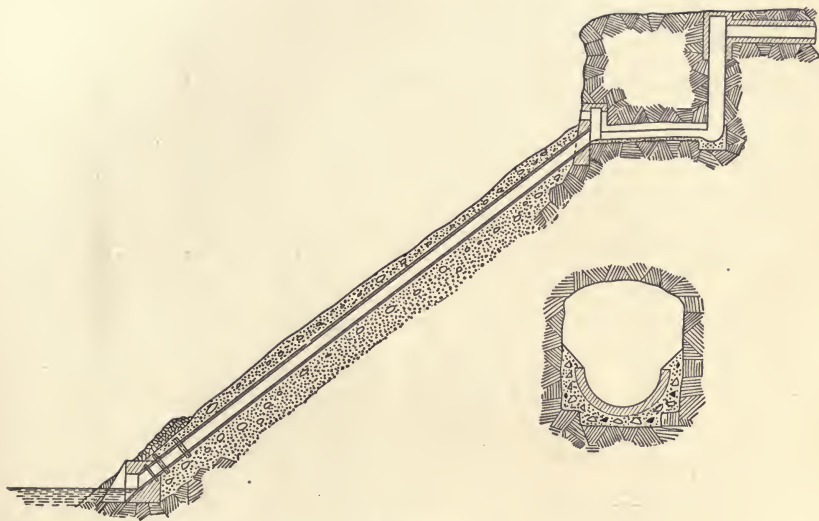

Fig. 172

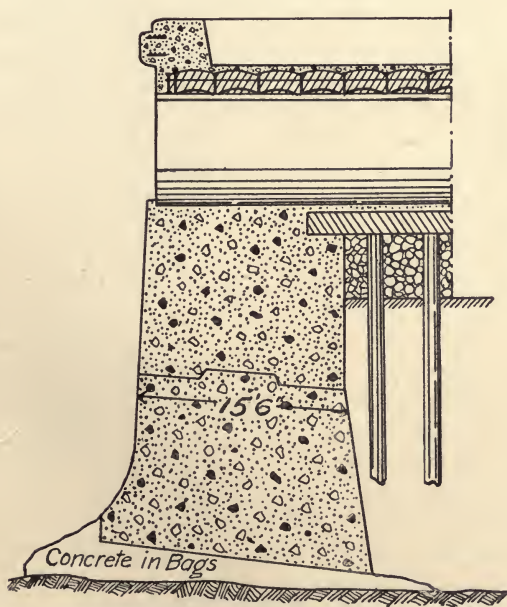

Fig 173

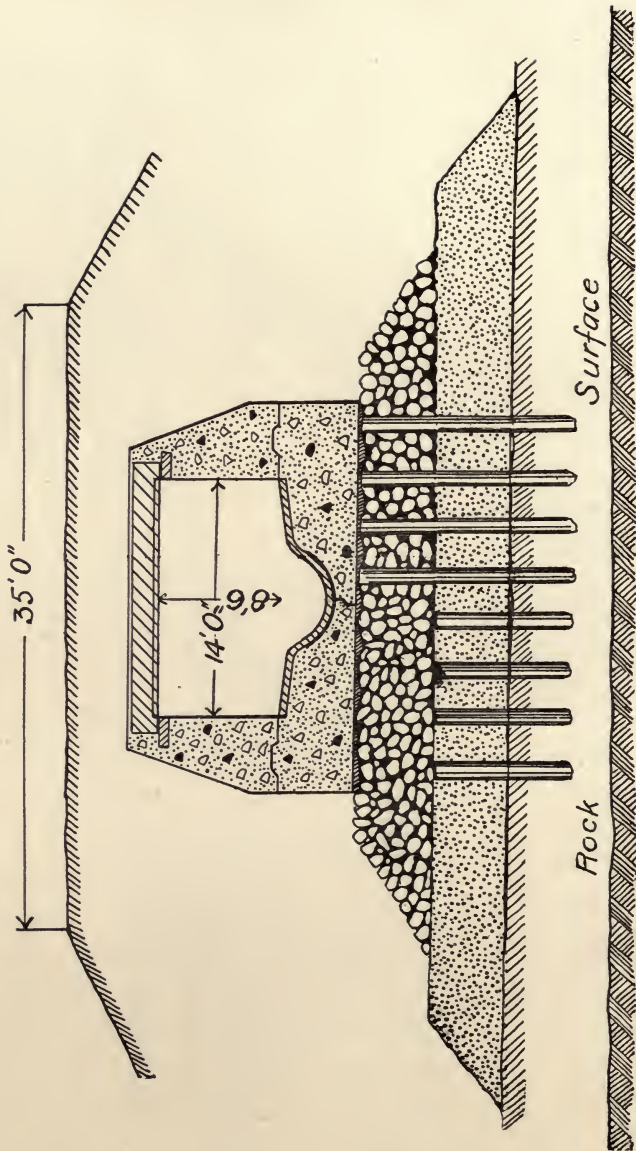

Fig. 174.

a layer of cement and sand between. Then on this mattress concrete blocks, already formed, $6 \times 11 \times 4$ feet, weighing about 16 tons each, were set by a derrick, two blocks forming the entire bottom. The top of these blocks was above low water, and concrete *in situ* was used for the side walls. At the extremity an end wall was carried to the bottom, 24 feet below low water. For this, large molded concrete blocks, weighing 88 tons, were used, the third row of blocks bringing the surface well above water.

The sewer outlet of the South Metropolitan District of Boston¹ is an example of a submerged outfall of unusually large size. (See Fig. 175.)² From the outlet end of the main sewer on Nut Island, five 60-inch cast-iron pipes extend out into the tide water to a depth of about 38 feet at high water. These pipes are standard 12-inch lengths of ball and socket pipes, weighing 12,000 pounds each, and extend out from low-water line about one mile. The pipes were jointed in 48-foot sections, and floated out to place under a specially designed caisson. When at the proper point, the pipe was slowly lowered into the trench dredged for it. The joint is a conical lead joint, and the pipes were aligned and drawn together by divers who had powerful ratchet jacks for that purpose. To aid in guiding the pipe into place, short piles were driven 6 feet apart longitudinally, and 5 feet apart transversely. The outer end fits into a special 60-inch elbow surrounded by a rectangular timber casing resting on piles. The horizontal flange of the outlet pipe is capped by a cut granite ring, and outside of this, resting on piles, is heavy slab paving.

The Broadway outfall sewer of New York, discharging into the Harlem River at 192d Street,³ is a twin horseshoe-shaped sewer, the combined capacity of which is equal to that of a 16-foot circular sewer. This section was adopted because the sewer grade was for long distances above the level of the ground, and a low, flat sewer reduced the amount of filling necessary.

¹ Eng. Rec., Vol. 48, p. 217.

² Report 1899, Plate 5.

³ Eng. Rec., Vol. 52, p. 550.

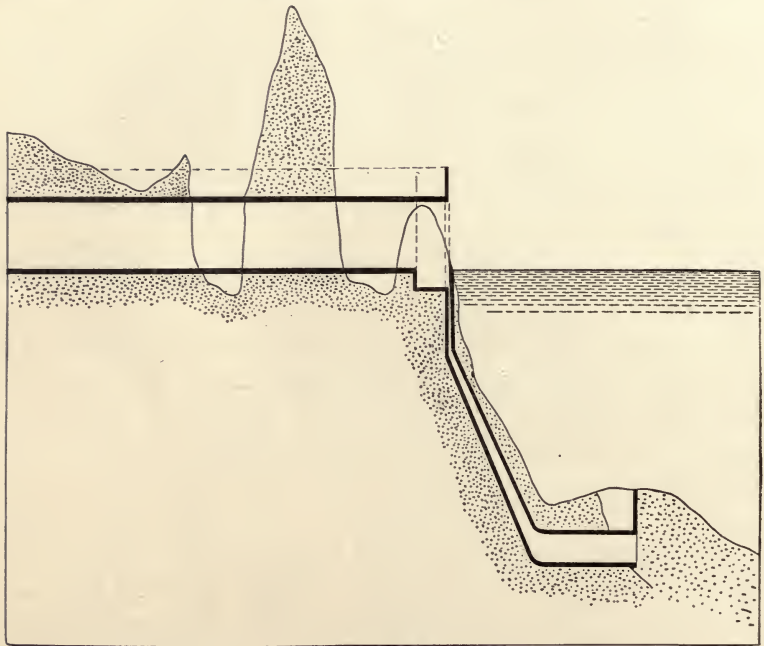

ELEVATION

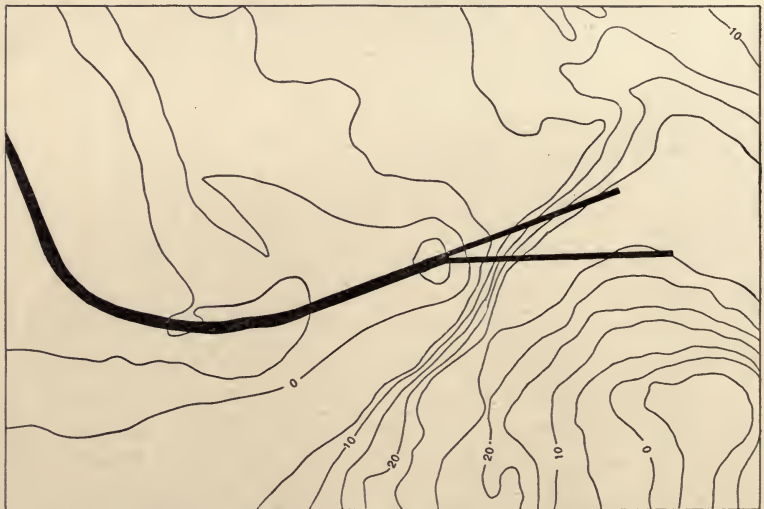

PLAN

Fig. 175

A concrete cradle is built under the invert with two layers of brick forming the invert. At the extremity, and at intermediate points, piles are freely used to support the weight of the masonry. A large outlet chamber has been built at the end, so arranged that the discharge openings are submerged 1 foot at low tide and 7 feet at high tide. The chamber (see Fig. 176) is trapezoidal in form, 57 feet long on its outer side, 41 feet long

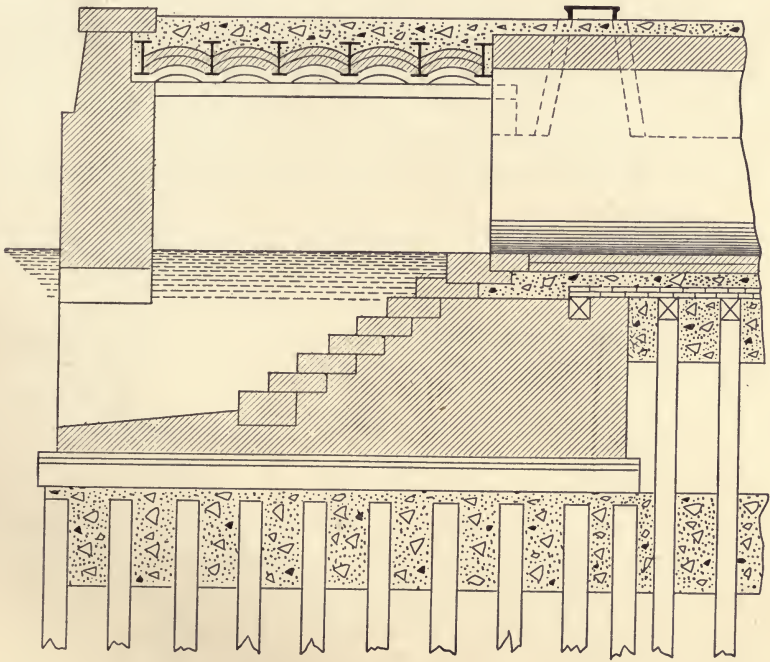

Fig. 176

on its inner side (the width of each sewer is 15 feet), and 21.5 feet wide. The height is 22 feet, the heavy concrete roof being carried on I beams. The inverts of the sewers are at mean low water, but in the chamber a flight of steps brings the sewage down and out through openings in the face of the chamber which are entirely submerged. The masonry chamber was built in a timber caisson, floated out to place, and sunk on to the

concrete and pile foundation, which had been previously placed directly in the water.

New Rochelle,¹ situated on an arm of Long Island Sound, has carried its outfall sewer across Echo Bay and through tidal flats whose surface is only a few feet above low water. The outlet, a 30-inch cast-iron pipe with ordinary lead joints, was laid by a diver. Four lengths of pipe were placed on planks between two scows and the three joints made up. A chain sling was provided for each pipe so that by attachment to overhead cross-timbering the pipes were lifted off the plank and then lowered into the trench. The joints between the sections were made, by the diver, with jute and cold lead.

A small outlet discharging on to an ocean beach was installed

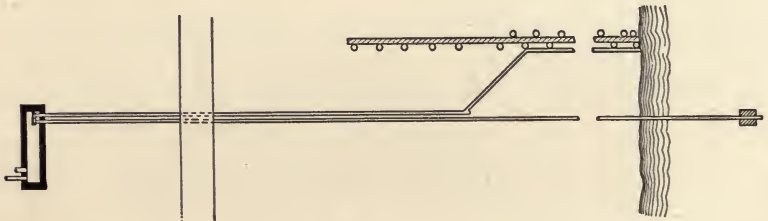

Fig. 177

at Spring Lake, N.J.² (See Fig. 177.) The outlet pipe is 8-inch wrought iron with screw connections, provided with flexible joints at intervals of 40 and 80 feet. It is 650 feet long and ends in 20 feet of water. At the outer end is a heavy cast-iron anchor plate, weighing $\frac{3}{4}$ ton. The construction is simplicity itself. The joints were made on shore, and the pipe was floated out, supported on buoys, and sunk by cutting loose the floats. An emergency 10-inch wrought-iron pipe is also provided, its outer end fastened to a timber pile work at about low water level. Connection with the city water supply is provided, so that if necessary a strong flush of water may be had through the outlet.

A wooden pipe has been employed where the outfall is to be carried out into deep water, as, for example, at New London in

¹ Eng. Rec., Vol. 52, p. 443.

² Eng. Rec., Vol. 42, p. 617.

1892, and at Ithaca in 1894. The advantages are that wood pipe is, or has been, cheaper than cast iron, and that it lends itself to launching and floating into place more readily. Fig. 178 shows a cross-section of the New London pipe. At Ithaca, the outfall pipe extended 6000 feet into Cayuga Lake, into a depth of water of 27 feet. The pipe was built on ways at

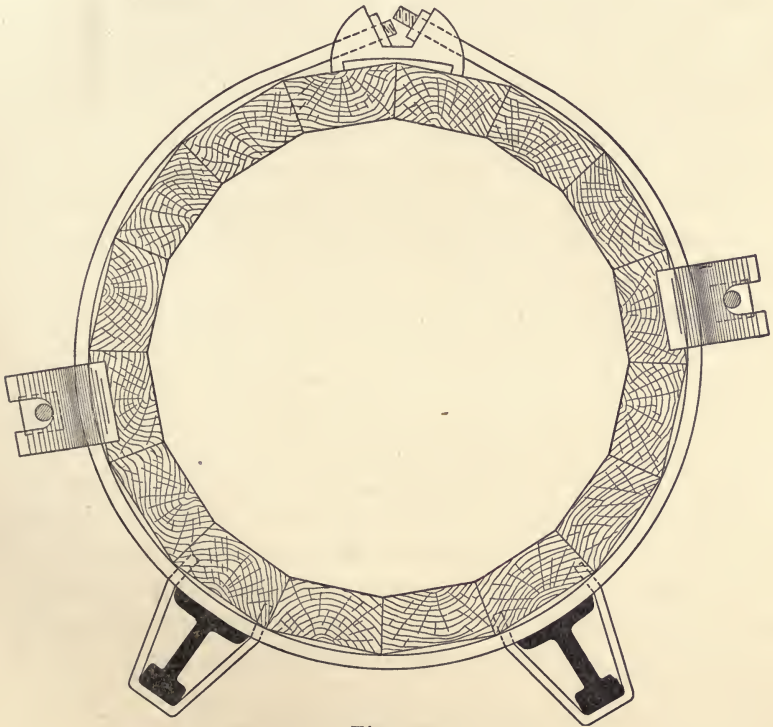

Fig. 178

right angles to the shore line and the forward end carried out into the lake as fast as the pipe was built in the rear. The pipe was loaded with railroad rails for sinking, and temporarily held up by oil barrels, which were cast off when it had reached its place and was ready for sinking. It was shoved forward from behind and was lined up with temporary piles. A detached section, 1500 feet long, was readily pulled around by a man in a

row-boat. At New London, the end of the wood pipe ended in a heavy anchor plate, and an elbow with a conical diverter. In Ithaca the end of the pipe was raised on a box of stones, just high enough to give a clearance of three feet above the bottom.

The original outfall pipe at Old Orchard Beach, Me., was a six-inch cast-iron pipe, joints leaded in ordinary fashion, and the line of pipe 500 feet in length held together by a chain fastened to each pipe and running from end to end. A steamer off shore, by means of a long hawser, and the aid of small toboggans placed underneath the bells to make the sliding easier, pulled the pipe down the beach, where it had been put together, until the outer end was in about 8 feet of water at low tide, and there it was left.

It is important that the outer end of the pipe be so arranged that the flow of sewage does not cut into the beach and undermine the pipe.

At Burlington, Iowa, for example,¹ where the main trunk sewer discharges into the Mississippi River, a stone spillway was entirely washed away in 1898. The sewer in two parts, one 10 feet and one 12 feet in diameter, ended about 200 feet back from the water's edge, and about 20 feet above low-water stage. The sewage was supposed to flow from the sewers down a specially prepared spillway into the river. A number of piles were irregularly driven into the slope, and stone filling placed between. The piles were capped by stringers, and a wooden floor of 3 × 12-inch pine planks laid on top. Then paving stones on edge were laid on the plank, the spillway thus formed being 25 feet wide and about 100 feet long. The side walls were 4 feet thick. A summer rainstorm gorged the sewers, and tore out the flume completely, the estimated velocity of the sewage down the spillway being 20 feet per second. The repairs were most thorough, and the construction is shown in Fig. 179; 438 piles were driven under the new spillway, with an average length of 137 feet. Riprap was then placed by hand between the piles, and the voids were filled with gravel. Above the riprap was a bed of concrete, 3 feet thick, with paving blocks for the wearing surface. Heavy

¹ Paving, Vol. 19, p. 267.

side walls 8 feet thick were built to confine the flow, and a segmental arch cover turned between, the whole carried down to low water. The flow line was in the form of a reversed curve instead of an inclined line, in order to deliver the flow horizontally, and not cut into the bottom. Such a structure is expensive, the published cost of this being \$22,419.

At Los Angeles, the outfall was a line of 24-inch cast-iron flanged pipe extending 600 feet into the ocean, laid on the sloping beach. Rings of pure rubber $\frac{3}{4}$ inch square were laid between the flanges of these pipes. The pipe was put together on timber stringers, resting on rollers, so that by capstans the whole could be forced out into the water. No method of anchoring or fastening the pipe was adopted, although it was exposed to the full action of the Pacific Ocean. The outer end was submerged in about 20 feet of water. This pipe was put in place in November, 1893, but within two years the strong littoral currents shifted the pipe 15 feet out of alignment, and broke it at a point about 100 feet from shore. The sewage, coming through the pipe at high velocity, due to the 8 per cent grade, cut out a large basin, into which section after section of the pipe fell, finally affecting the brick sewer on land and the very bluff itself, which was rapidly undermined. The cutting was temporarily stopped by driving sheet piling at the toe of the bluff, and carrying the sewage out through a wooden trough into deep water. Within the past few years an entirely new outlet has been laid in connection with an overhauling of the long outfall from the city to the ocean.

Fig. 180 shows a riveted steel pipe 4 feet in diameter, built in Toronto in 1892, to carry the Parliament Street sewer out into the deep waters of Lake Ontario. The entire structure is below water and was put together by a diver. The author has seen similar construction used to carry sewers into Lake Michigan.

As the summary of this chapter it may be said that there are a number of ways of making the final discharge of sewage into the body of water which is to receive it.

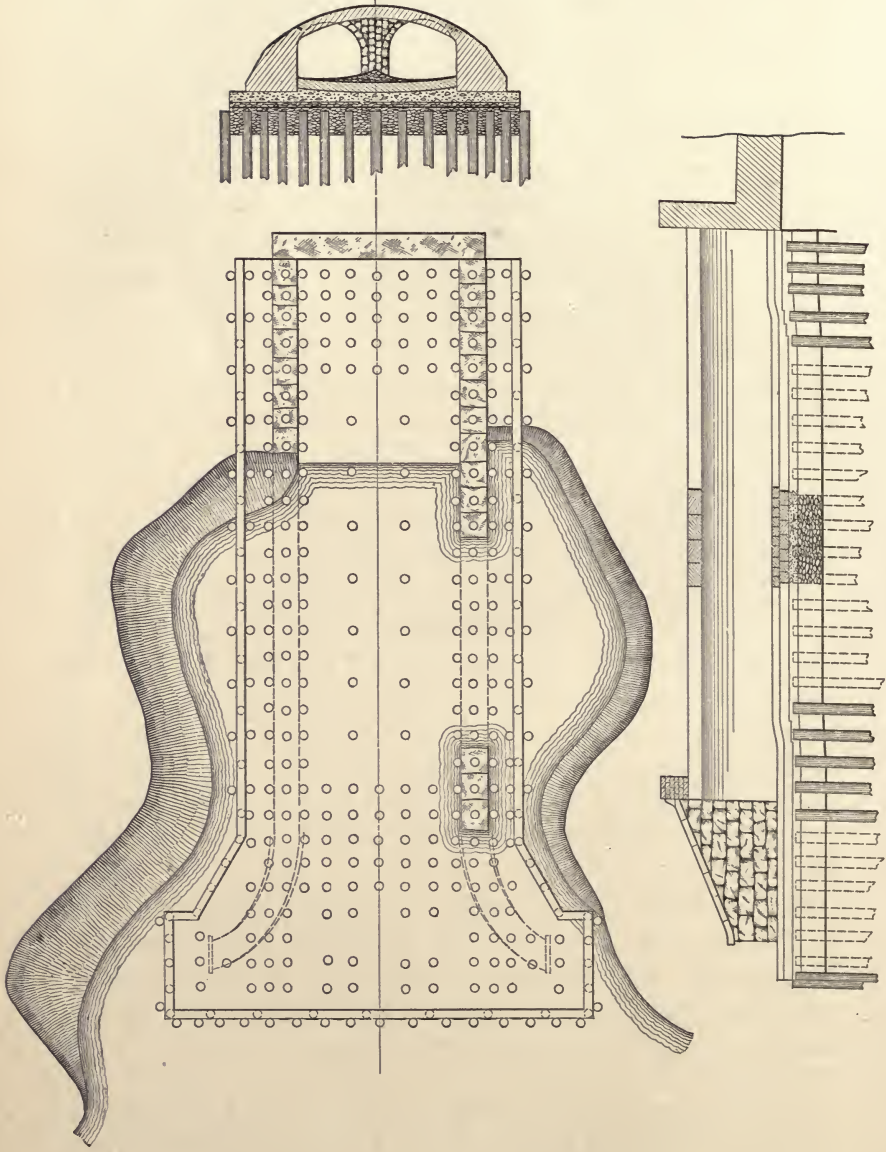

Fig. 170

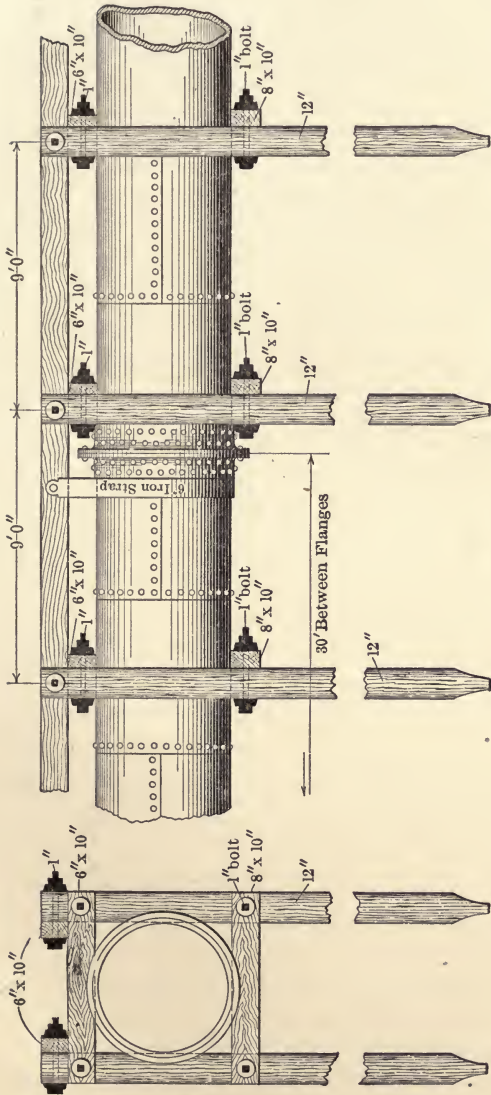

Fig. 180

It may be enough to let the sewer project through a small retaining wall on the bank of the stream.

It may be necessary to enter the invert of the main sewer with a small pipe in order to carry the dry-weather flow out under water.

It may be necessary to carry the sewer full size out into deep water, supporting the sewer on piles and grillage, or laying one or more large submerged pipes.

Submerged pipes may be jointed on shore and pulled out into the water lengthwise, or they may be put together from scows and sunk, or they may be jointed in sections, floated out to place in caissons, sunk and jointed by divers.

By the use of wooden outfalls for small sewers, some advantage is gained over iron pipe, since the wood pipe can be floated in great lengths. It has to be weighted, however, to sink it. The author remembers one large box sluice built a half-mile long to carry sewage from the end of the pipe sewer to the dry-water channel across a mud flat. It was supposed that the box was properly fastened down, but a high tide lifted it from its fastenings and floated it out to sea.

Finally, the sewer may end at the bank, and a pipe or a paved incline may be built, but care must be taken or the velocity of the flow will tear out the structure. There is also danger that in shallow water the flow will undermine the bank and so endanger the structure, even if a pipe line is used extending many feet out from the water's edge.

CHAPTER XV.

HOUSE CONNECTIONS.

THE purpose of a sewer system is the removal of storm water from the streets and the removal of domestic sewage from the houses. For the former purpose catch-basins in the streets as already described afford the connection. For the latter, lines of pipes known as house drains must be built from the street sewer to the house plumbing. The house drains are usually of sewer pipe and connect with the sewer by means of a Y or a T branch. The latter, while more convenient in laying, does not permit as smooth an entrance of the house drainage into the sewer, and Y branches are therefore always to be preferred. To connect properly such a branch, a one-eighth-bend must be used, and the house drain is thereby set over sideways about fifteen inches, as shown in Fig. 181, due allowance for which must be made in opening the house-drain trench. For this reason it is important to record the kind of branch used, whether Y or T, for the benefit of drain layers. The preliminary location of the branches is largely a matter of estimate, but before the contractor orders his material he must be given the exact number. The general rule is to place a branch for each lot on each side of the street, and for a preliminary estimate the distance apart of the branches on each side of the sewer may be taken as the average width of the city lots. For exact determination the number of lots must be counted for each line of sewers, keeping those of each block separate. In undeveloped areas the probable future width of the lots must be assumed. A final statement can then be prepared giving the number of branches for each size of pipe.

For brick sewers the house connection is made by means of

“slants” built into the brickwork at the proper points. These are properly located above the horizontal diameter of the sewer, that is, in the arch, and should slant in the direction of the flow of the sewer, so that a one-eighth-bend is also needed here. In the brick sewers as well as in pipe, the branch should be inclined upward slightly, both to save excavating in the house-drain trench and to give the house drainage a good entering velocity. In both cases the refilled earth must be well tamped under the branch to prevent its breaking off, and if the trench is

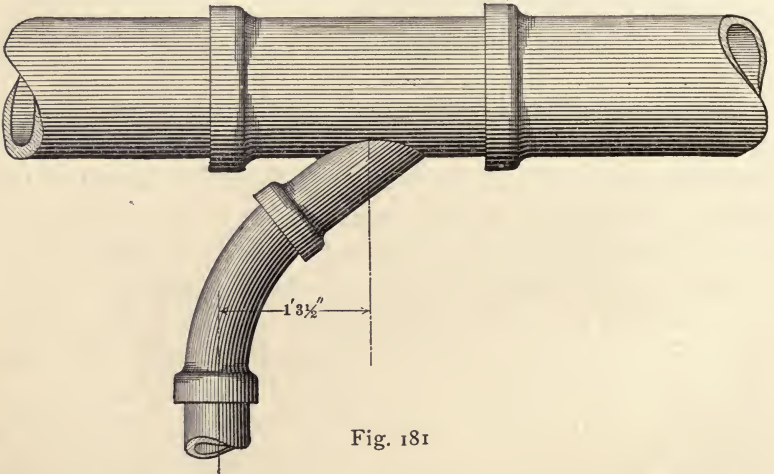
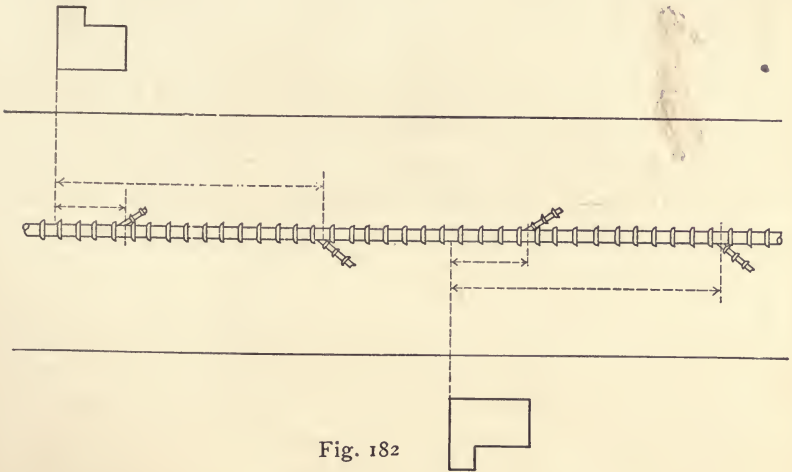

Fig. 181

deep or the ground soft, a shovelful of concrete should be added under the branch. The one-eighth-bend is not laid until the house connection is made, since it extends out beyond the sides of the trench, and the Y branch is closed with a tile cap. These caps are cemented in, either by means of a narrow fillet around the edge, or by filling in over the entire cap, first with a thin layer of clay, and then with cement mortar. Where clay is used the cap is easily removed when necessary. In wet ground the cap should be carefully set and never omitted, since a large amount of ground water may enter the sewer through Y's unless they are made water-tight. Since, presumably, all the Y's will be dug up later, their location must be exactly recorded. This

is best done by measurement from the center of the nearest manhole up stream. It is of great service further to stand a piece of wood edging, or a piece of 2×4 vertically in the trench directly in front of the Y, the top 4 or 5 inches below the surface. In this way the Y is located at the surface and the strip of wood can be followed down to the Y. A piece of wire has also been used for this purpose. On a curbed street a mark cut in the curb opposite the Y will aid in the recovery.



The record is sometimes made by noting the distance up stream from where the side lines of a house or where a fence line produced cut the sewer line. (See Fig. 182.) The objection to this method is that in the record the houses and their respective side lines are apt to be confused.

The size of the house drain is determined by experience and not by computation. Probably a 2-inch pipe would carry off the sewage of the average house at a reasonable rate, but it has been found that the danger of obstruction in small drains, both from grease and from cloths, brushes, etc., is very great, and the minimum size may therefore be taken at 4 inches. Five-inch drains are common, that size being a compromise between a four-inch and a six-inch pipe and also just large enough to

admit the 4-inch cast-iron soil pipe and give a good joint. Probably 6-inch pipe is most used, however, since, it is argued, if the pipe is to be large enough to prevent obstructions, there ought to be no half-way measure about it. The Y branches on the sewer line must, of course, correspond to the size of house drain adopted. In cities where plumbing regulations are in force, the size of the house drain is a matter of law, and is determined by the board making those regulations. The grade of the house drain should be at least 2 per cent, or $\frac{1}{4}$ inch, to one foot, although the drain will work (but with constant danger of stoppage), at half that grade. The drain should be as carefully laid as for a sewer, true to line and grade. In England running traps at the houses are made of terra cotta, and are provided with a clean-out branch located in a manhole, so that rods can be run down the drain — an admirable construction, especially on flat grades. In this country the running trap is made of iron, and if the drain gets stopped up, the trench must be reopened, the pipe taken up, cleaned out, and relaid. In passing, it may be noted that there is little or no danger of house drainage freezing and if the house fixtures permit, and the grade of the drain makes it desirable, the pipe may with safety come to within a foot of the surface of the ground.

Where the street sewer is deep, i.e., 10 feet or more below the surface, it is customary to extend the Y connections by means of a vertical pipe up to within about 6 feet of the surface in order to make the matter of house connections more economical. This is done either by using T's on the main pipe, and setting one or more lengths of vertical pipe on them (Fig. 183), or by using vertical elbows on the Y branches (Fig. 184), which are then set horizontally. The author prefers the former method, although, theoretically perhaps, the latter commends itself. Where the Y and elbow are used, the weight of the vertical pipe is eccentric to the main sewer and tends to break away, thus letting ground water readily enter the sewer. If the side connection is used, concrete should be well tamped in under each Y and elbow, so that they are firmly held in position to carry away the vertical load. Then

again, the side connection in a trench which is sheeted will usually extend out into the sheeting, requiring a wide trench at the start, or else much cutting and waste of lumber to set the connection. With T branches on the top, on the other hand, no such difficulty occurs. Again, a T branch on top can be used for a connection from either side of the street, and no confusion in the records can be made by substituting a Y on one side for one on the other. A

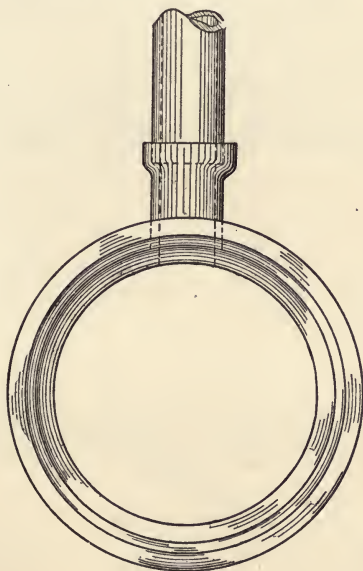

Fig. 183

double Y may be used, as shown in Fig. 185, from plans for Manila, P.I.

Since Y or T pipes are expensive, since the number of house connections that will be used is uncertain, and since the vertical pipe needed with a deep sewer adds to the cost, it is possible that the construction of house connections at the time the main sewer is built may involve a large and perhaps unnecessary expense. The author has occasionally built a deep outfall sewer without house connections, and later, when the growth of the city demanded it, built a shallow 6-inch line, one block at a time, emptying into the deep sewer at the manhole, and so saved money. For exam-

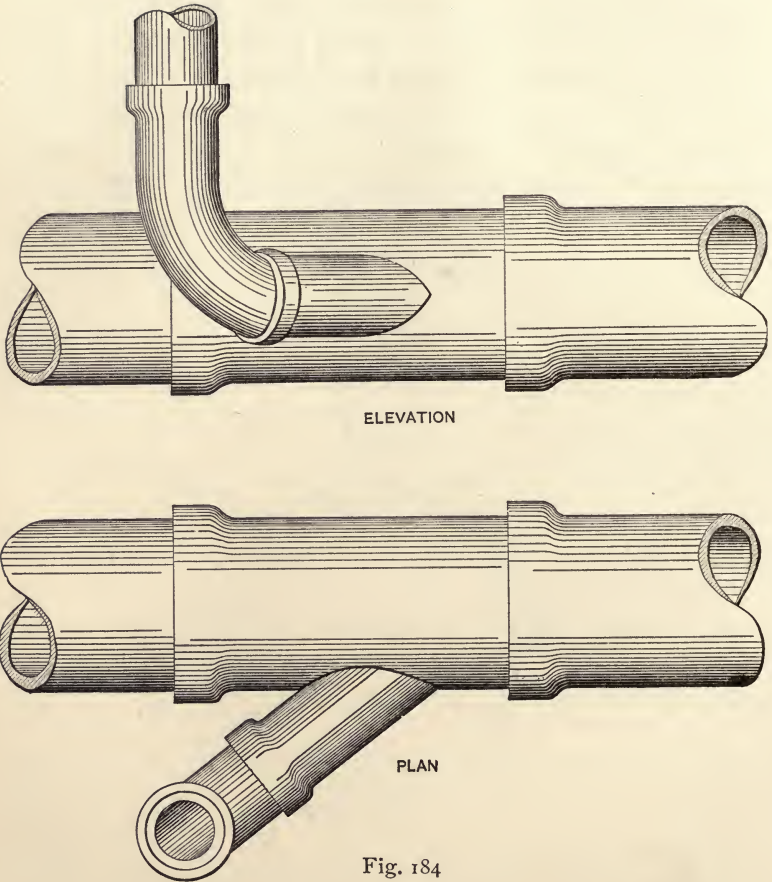

Fig. 184

ple, a 4-inch branch out of a 2-foot length of 24-inch sewer costs about \$5.00. A block 600 feet long, the sewer 15 feet deep, would require

24 branches at \$5.00 each	\$120.00	
24 elbows at 50 cents each	12.00	
24 risers, 9 feet long, at 10 cents per foot	21.60	
Concrete, $\frac{1}{3}$ yard each at \$6.00 per yard	48.00	
Extra excavation	50.00	\$251.60
Interest for 10 years	125.80	<u>125.80</u>
		\$377.40
Small lines, 552 feet of 6-inch pipe laid at 30 cents	\$165.60	
24 Y's at 50 cents	12.00	
24 elbows at 50 cents	12.00	\$189.60

The author believes that in many cases economy would be served if no connections were provided for at the time of construction, but that a two-story line should be built, the construction of the upper pipe being deferred until the development of the territory demanded it.

Where the trench is in rock and shallow, so that Y branches are to be built, it is well to put a charge of blasting powder into the side of the trench, where the house connection will come. Otherwise, when the blasting for the house-connection pipe is done, the main sewer may be injured. If, on the other hand, the rock for three or four feet from the main sewer is all broken, though undisturbed otherwise, this loose rock protects the main sewer from future operations.

Where the street in which the sewer is ordered is to be paved in the near future, the house-connection pipes should be laid to a point just within the line of the proposed curb. This causes

some loss, since not all of the connections will be used, but the territory will be well built up if paving is contemplated; and if

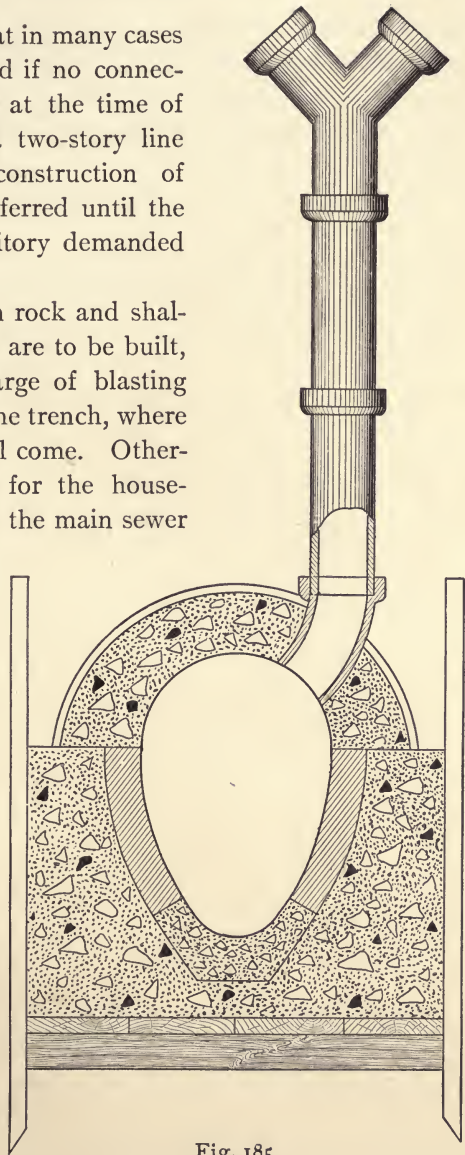

Fig. 185

the wishes of the property owners are considered, the connections will, for the most part, be adapted to immediate use. If these cross-pipes are not laid, the pavement will have to be torn up for each connection made, which destroys the value of the pavement.

CHAPTER XVI.

SURVEYING.

THE methods of surveying outlined in this chapter are those to be practiced by the constructing engineer. The chapter will, therefore, exclude the topographical methods required to prepare the maps from which the design is made.

The first task of the engineer is to locate the sewer line on the ground, guided by the paper location which has been made on a scale of about 40 feet to an inch, such a map showing, as far as possible, all the underground structures.* The sewer line is located with due reference to other pipes, in some streets coming between the gas and water, in others on one side, avoiding also as far as may be the storm water drains, the electrical ducts, and any other subsurface pipes. Under ordinary conditions, for an intermediate trench, there ought to be about 8 feet between pipes already laid, in order that the new trench may not cause caving. If the old trenches were each 3 feet wide there would be 5 feet of undisturbed earth between them, and a 3-foot intermediate trench would give on each side one foot only of stable earth. In material like sand, which needs close sheeting under all conditions, width enough for driving the sheeting is all that is necessary. In a gravelly loam or hard-pan, the undisturbed solid earth will probably stand up without sheeting, but if such material is refilled into the side trenches, it will all cave into the intermediate trench unless a wall of undisturbed earth intervenes.

The manhole location is determined by the position of the pipe lines of the side streets. For convenience, with the new sewer located on the map, the distances to the curb or to the housefronts are scaled and noted, and then, by making these measurements on the street, stakes may be set on line. The approximate location

* See Plate II of Sewer Design.

of the point of intersection can be found by marking the lines in the cross street by a couple of stones or even by pieces of sod, and lining in these two points by eye as the engineer stands on the line of the main sewer. A variation of a foot is not important, and the proper location of the manhole with reference to the laterals can easily be made to a less distance than this. A nail is driven in the street to mark the center of the manhole thus determined, and the sewer line is carefully chained, beginning at the lower end of the sewer and recording the location of the manholes as + stations. After the main sewer from end to end has been chained, then each lateral is chained, starting at the junction manhole on the main sewer.

The nails marking the manholes should be carefully referenced to nearby objects, so that they may be easily recovered. At least three ties should be taken with the distances recorded to tenths of a foot. The points of reference should be clearly defined, for example, not merely a telegraph pole, but the center of the head of a nail driven well into the side of the pole.

The nails at the manholes will be dug up when the trenches are opened, and it is a waste of time to leave permanent marks on the sewer line. Some engineers, however, line in this chaining with a transit, leaving nails driven at the 50 or 25-foot points, and also drive offset spikes, which are measured over from these center line nails. The stationing of such spikes will of course not be accurate, but no very great discrepancy should exist. A better method, the author believes, is to have on the sewer line only the nails marking the manhole centers, and have the intermediate points marked altogether on the offset line. To do this, a point is located on an offset equal to two feet more than the half width of the trench, that is, for a 6-foot trench, the offset would be 5 feet, always on the same side, going up grade. The transit is then set up over the offset point and spikes lined in at 25-foot distances, to a point measured over at right angles as near as can be estimated from the nail at the next manhole. When the distance to that manhole has been measured, the transit must be set over the manhole center again, the new offset point set, the transit set up over the point and the next block lined in. If there were no angles

at the manholes, the chaining and stationing would not have to be interrupted, but as there always is an angle, greater or smaller, the offset chaining is always broken. (See Fig. 186.) It is convenient to have the two offset spikes, necessary at each manhole, set when the first chaining is done, if a transit is used then. But if no transit is used, it must be done when the offset lines are established. It saves a large amount of time later, if the trenching is soon to follow, to protect the offset spikes and enable them readily to be found, and if sewer pipe has been brought onto the ground, a pipe set vertically around and over each nail keeps it from being covered or injured. The contractor may be confused in opening the trench by working from offset spikes, and he must be watched until his understanding has been made perfect.

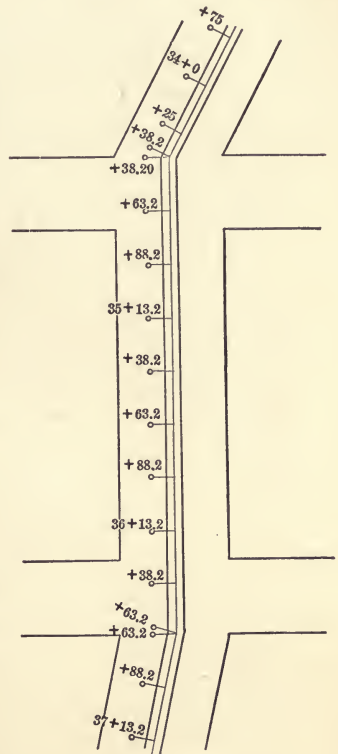

Fig. 186

To mark the offset point the author has found railroad spikes the most convenient for macadam and asphalt, although a 40-penny wire nail will answer. In brick and stone block pavement, a small movement of the point in distance may be allowed to bring the spike into a crack, although the line must be held, since this line is used to give the sewer line. In dirt streets a spike may not be stable enough and pins a foot long—made of one-quarter inch iron—may be necessary. If the road has been metalled at all, the 40-penny nails will stay in place when driven well into the metal.

The trench is opened from these offset spikes and the contractor should be furnished with a profile to good scale showing the depth,

marked in figures, to which the trench is to be dug. When the trench is within a foot or so of bottom, grade boards should be set, but it is not desirable to set them earlier, since they are in the way.

In a narrow and stable earth trench no sheeting may be required. In that case the grade boards are independent of the sheeting. There are a number of methods of placing these boards. The simplest is to place on edge across the trench a two-inch plank long enough so that it may have about two feet on the solid ground on each side. These ends are then covered with dirt, or piled up with stone to hold the boards firmly in place. Sometimes, in order to get these planks and the grade line attached to them up out of the way of the shovellers, the planks are set up on top of pipes which are placed vertically, and filled with dirt in which are set 2-inch by 4-inch sticks well down into the pipes. The planks are then rested on the pipes and fastened to the 2 by 4-s. Sometimes a frame is made as shown in the sketch, Fig. 187. The base of the frame gives stability, large stones are superimposed, if necessary, and the plank are held by pins. Sometimes, instead of the ends of the plank being held by earth or stones, stakes are driven into the ground, one on each side of the trench, and the plank fastened by nails. (See Fig. 188.) An iron rod is preferable, since a stake may disturb the ground sufficiently to cave the bank of the trench. Usually the plank is allowed to rest directly on the ground and to take its slope. But when stakes are driven on each side, points are often marked on these stakes at the same level, a definite and convenient integral number of feet above the sewer invert. The plank is then nailed with its top edge on these marks and therefore having its entire edge uniformly at the level desired. With square iron pins a clamp screw is used to fasten the plank to the pins, the grade having been first marked on both pins. The plank in all cases should be about 25 feet apart, although this may be increased to 50 feet on a good grade. The sag of even a light line in 50 feet is quite appreciable, and if the grade is low, one-eighth inch in 50 feet, the effect of the sag on the grade is very apparent. If offset spikes have been driven every 25 feet and grade boards are

placed by these spikes, the line is easily obtained by simply measuring over with a tape from the spikes. Otherwise, a transit must be used either on the offset line to cut in intermediate

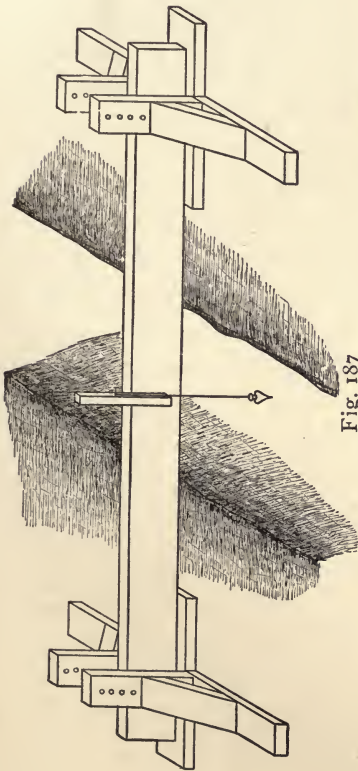

Fig. 187

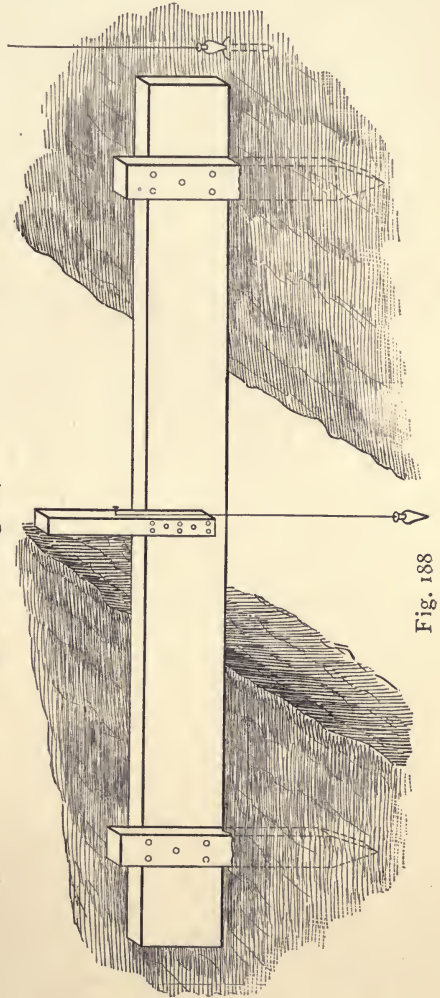

Fig. 188

points or by setting up ahead to line in points directly on the grade boards. Where the planks have not been set level, a vertical board must be nailed onto the plank, one edge on line. This is readily

The preceding shows a page of the author's notebook for setting grades on Washington Street. At station 0 + 50, the bottom of the rod, for an 8-foot cut has reached the top of the stake, and it is necessary to decrease the rod reading and increase the length of grade rod each by a foot. The cut to be used at each nail or notch ought to be plainly marked on the stakes, especially where two nails for two cuts are driven into the same stake. On steep grades it is more rapid to use a transit, setting up on the sewer line ahead of the work on solid ground, getting the elevation of the instrument and its height above grade, and sighting on a point down grade set at the same distance above grade. Intermediate points are all set with the same rod reading, which is the distance above grade less the distance desired for the grade line to be above the invert grade.

It often happens that, using one bench mark in one block and another in the next, some discrepancy is introduced into the grade by the lack of agreement between bench marks, and it cannot be too thoroughly urged that the bench marks be checked and adjusted before any construction is begun.

Where the sewer is wide, or where bracing is used it is often more convenient to nail the vertical grade boards to the bracing instead of to the cross planks set for that purpose. Indeed it is usually impossible with both sides of the trench lined with sheeting to find any place to put the cross planks. The line on the pieces of bracing is found just as before described, and the vertical strips nailed on, and the grade line set — all as in the other case. The only complication comes from the fact that the distance between grade boards is irregular, that the bracing will settle as the sheeting is driven, and so the grade points must be reset after each driving. A soft bottom or caving banks will also carry these grades out of position, and in quicksand the level must be in constant use to revise the grades set even on the same day.

The preparation of estimates is the remaining work to be considered in the way of surveying. Specifications generally read that on or about the first of each month an estimate shall be made

of the work done by the contractor during the month just past. This involves the measurement of the number of feet of pipe laid and the number of cubic yards of excavation made both of earth and rock, with the number of manholes, lampholes and other appurtenances. The method of computing the excavation depends on the specifications, but the most reasonable method is for the specifications to prescribe the width of the trench that will be paid for, in terms of the diameter of the pipe and of the depth of the pipe invert. There should be room on the outside of the bell for the workman's hands, with a small margin for alignment of the pipe, a width of 12 inches more than the outside diameter of the bells being a reasonable amount. The outside diameter of the bell for a 12-inch pipe is 17 inches, so that the trench width for a 12-inch pipe should be 29 inches, the width to be used in estimating. A 6-inch pipe would in the same way be estimated as $21\frac{1}{4}$ inches and a 24-inch pipe as 43 inches. These are minimum widths and would probably be narrower than the trench would actually be dug. This would be particularly applicable if sheeting were used, since sheeting as ordinarily driven requires for one row 6 inches additional on each side. Strictly, then, two feet should be added where sheeting is to be used, and one foot where the trench is stable without it. The specifications might therefore well differentiate except for the opportunity of collusion with the contractor, who by sticking up an occasional brace in the trench could secure a measurement of an additional foot, the engineer being willing. It would introduce, without collusion, an uncertainty, the contractor being able to claim the additional foot whenever he decided sheeting was necessary and placed, even if it were placed only for the purpose of getting the extra measurement. It is better then, in ground where sheeting will probably be used, to make the additional width two feet, but where the ground is stable to reduce this to one foot. This will hold to depths of about 10 feet. Below this two rows of sheeting would have to be driven, so that the upper sheeting would require another foot of width, adding three feet to the diameter of the outside of the bell. It is probably fair also, since the cost of excavation increases with the

depth, to assume this width to continue to the bottom of the second row of sheeting, even though the actual width of the trench is reduced. In rock, where no sheeting is needed, it is simplest and at the same time is perfectly fair to assign some width for all sizes of pipe up to 12 inches, the width varying with the depth of the trench. In sedimentary rock this can properly be made 3 feet for depths up to 8 or 10 feet. For greater depths, that is 8 to 16 feet, $4\frac{1}{2}$ feet and over 16 feet 6 feet are fair widths to be used in computation, irrespective of the actual width of excavation, provided the specifications have been so drawn. For sizes 12 to 24 inches, $1\frac{1}{2}$ feet should be added to the above. With the widths thus fixed by the specifications, the computation of earth work consists of multiplying this width by the length of trench excavated and by the depth. The latter is usually taken from the profile.

Records of Y branches is another important part of the surveying to be done during construction, and accuracy here is most important. There are two methods in use. One is to measure carefully from the nearest manhole up grade, afterwards giving the proper station number to the Y with an R or L to indicate which way it looks. The objection to this is that usually the Y's are laid before the manhole is built, and the mason, in building up the manhole, may bring the center of the cover, presumably the center of the manhole, a foot or more out. Measurements, therefore, taken from the assumed center before building, and the cover center after building will not agree, and will make Y's hard to find. A stake may be driven at the assumed center from which measurements are made, or the offset spikes may be used to locate the Y's, but the center of the cover, or the stake driven, must have the correct station number determined or recorded before the stationing of the Y's is made.

Another method of locating the Y's is by reference to side lines of houses which are built near the Y. The record book would then show a sketch as in Fig. 182 and to recover the Y's the side line of the house shown is produced by eye to the middle of the street or to a point about over the sewer pipe, and then the

proper distance measured. For greater certainty, strips of wood such as edgings from a saw mill, or pieces of lath or pieces of telegraph wire, are often left vertically in the trench at the Y so that subsequent excavation may first find the upper end a few inches below the ground surface and then follow down to the Y with perfect certainty of finding it.

CHAPTER XVII.

TRENCHING.

ORDINARILY the methods used in laying pipe interest the engineer only in so far as the safety of the pipe line and the watertightness of the joints are concerned. Since, however, it is sometimes required that the engineer act as contractor and immediately supervise the work, some reference to this part of construction may be made.

The variations in methods of trenching depend on the character of the soil, on the depth of the trench, and on the amount and depth of the ground water. The center line of the trench being laid out, the side lines are marked with a pick, making grooves in the surface, and the laborers are strung out to open up. The width of the trench is determined by the diameter of the pipe, and by the size of the sheeting, if used. The full outside width of an 8-inch sewer pipe at the hubs is 12 inches, and since room must be left outside the hubs for making joints and for correcting the alignment of the trench, a trench two feet wide is the least width to be opened. If sheeting has to be used, assuming 2-inch sheeting with 4-inch rangers, another foot is added, making a 3-foot opening, the narrowest where sheeting is used.

Some contractors, in order to minimize the danger of banks caving, open the trench about 4 feet wide on top, narrowing to 18 inches at the bottom of an 8-foot trench, thus adding about 6 cubic feet of excavation per linear foot, or 22 cubic yards per 100 foot length, an additional cost of about \$10.00. The sheeting for 100 feet may be estimated to cost about \$50.00, so that the additional excavation is apparently justified, if the sloping banks allow sheeting to be discarded. But practically any trench that will stand with side slopes at such an angle will stand with ver-

tical sides and if sheeting is needed with the vertical trench it will also be needed with the sloping sides. It is better, then, to have the trench sides always truly vertical, and then, if bracing becomes necessary, it can be put in.

In rock trenches, the width depends on the character of the rock, on the depth of trench, and on the manner of excavation. If the rock is granite, or igneous formation, without seams, blasting will remove large irregular masses, and the width on top will be nearly equal to the depth of the trench. In sedimentary rock, the strata may be kept broken off so that the width is but little more than that of an earth trench. In deep trenches, however, a batter is gradually acquired, a trench 10 feet deep having a top width of about 4 feet. If blasting is freely resorted to, with deep holes and large charges, the width becomes greater than with shallow holes and small charges, though it is possible without any blasting, in soft sedimentary rock, to carry down a trench, with picks, bull points, wedges, and hammers, and have a trench of about the same width from top to bottom. If the soil is dry clay, or dry clay loam, a trench can be carried down without any sheeting, but a rain storm may flood the trench, soften the clay, and cause the banks to fall in. A dry gravel, or sand without any clay mixture, will need tight sheeting to hold up the banks. Wet clay, or sand, will also need tight sheeting, and in the latter cases a considerable pressure is exerted. A wet trench will always need sheeting, which, in running sand, should be tongue-and-grooved, or provided with splines.

In placing the sheeting, the trench is first excavated to a depth of about three feet, or through the top soil and into the water-bearing strata. Then the two rangers, usually 16 feet long, their size dependent on the estimated pressure, and varying from 4 by 4-inch to 10 by 12-inch, are laid along the trench, one on each side. Between each of these and the side of the trench are placed three pieces of sheeting plank, vertical, one at each end and one in the middle; the rangers are crowded back against the three planks and cross struts, or braces, wedged in tightly and driven into place. Then the trench sides are lined with vertical plank driven down

behind the rangers. When these are all in, the plank standing up out of the trench 5 or 6 feet, they are driven down, one by one, as fast as the trench is excavated, special care being taken to have the sides dug vertical, and to keep the bottom ends of the plank back. When the trench is about 7 feet deep, another set of rangers or braces is put in to hold the bottom back, and the plank may be driven two or three feet below these. About 12 feet is the maxi-

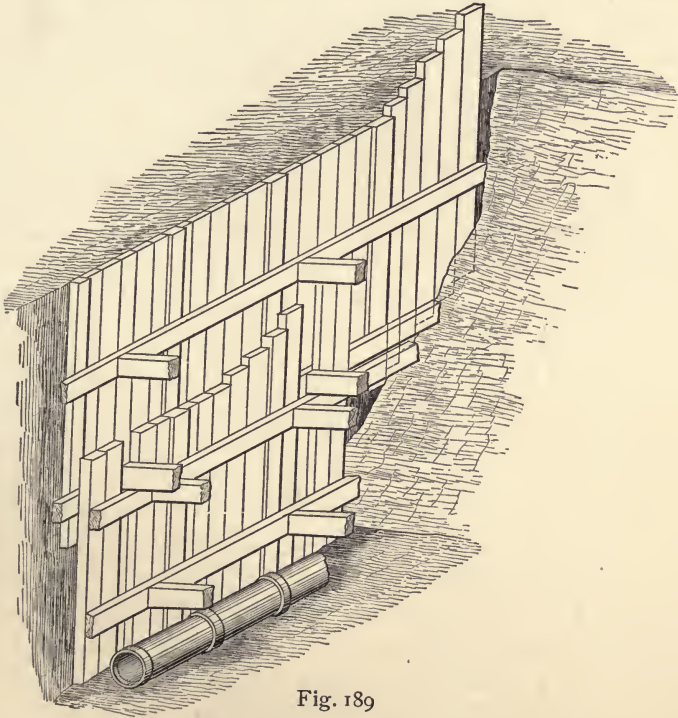

Fig. 189

mum depth for a trench with one row of sheeting. For a greater depth an inner row must be driven with the first ranger of the second sheeting holding the sheeting back against the bottom ranger of the first sheeting. The excavation is narrowed up in this way and the width of the top has to be increased on this account. Figure 189 shows a perspective sketch of the sheeting arranged as described. For ordinary sewer work 2-inch sheeting

is generally used, and for the braces patented screw posts are frequently used. Where the driving is heavy, as in quicksand, 3 or 4-inch sheeting is often necessary, particularly if the sheeting has to be driven ahead of the excavation. The bottoms of the sheeting plank are usually sharpened on one corner and along one side, so that the driving forces them sideways against the last plank driven, and back against the bank. An iron cap is often used to protect the ends of the plank from brooming; without the caps, a wooden maul is essential; with the caps, particularly when a hard wood block forms the head, an iron maul may be used, or the plank may be driven with a small pile driver rigged for the purpose.

In beginning excavation, it is often possible to reduce the labor cost of the top three feet, where the width permits, by using horse scrapers, ploughing and scraping, instead of picking and shoveling. When the sheeting and bracing is in, hand work is necessary, although machinery may be used for conveying the dirt. Machinery used to facilitate sewer excavation is usually of the conveying rather than of the excavating type, although rapid advances are being made in the effectiveness of the latter. The former machines are employed to raise loaded buckets from the bottom of a trench, carry them the necessary distance along the trench, and dump the contents wherever backfilling is desired. These machines are of three types illustrated by the Carson Machine, the Lidgerwood Machine, and the Moore (or Potter) Machine. The Carson machine (see Figure 190)¹ consists of a series of "A" frames which straddle the trench and are connected at the top by an "I" beam, which serves as a track on which the travellers run. A hoisting engine at one end of the track, with a return pulley at the other end, supplies power by which the buckets attached to the travellers can not only be moved back and forth, but also raised and lowered from the trench. On account of the rental and maintenance charges it is not profitable to use this machine until the trench is over 8 feet deep, and a greater saving is effected the deeper the trench, since the excavation costs, with the machine, very nearly the

¹ From Catalogue of Carson Trench Machine Co.

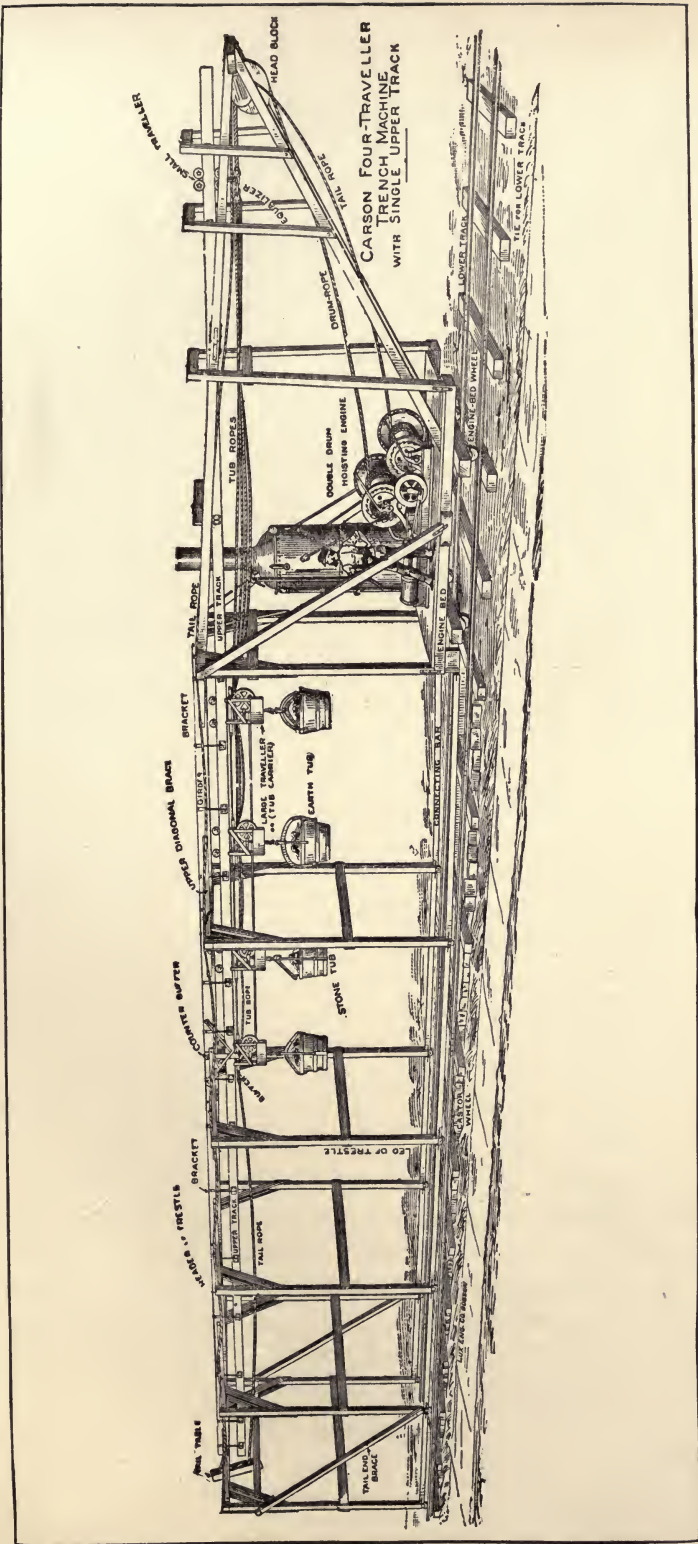

Fig. 190

same amount per lineal foot of trench without regard to depth. The back-filling is done without additional cost, since each load of the machine, instead of being deposited on the bank, is carried to the rear and dumped back into the trench. The cost of excavating and refilling by these machines is, in deep trenches, much less than the cost by hand work. The Carson catalogue gives the following non-committal statement:

"The rate per cubic yard at which material has been handled by our machines is a matter of much interest to contractors, and several customers have told us that they have excavated and refilled sand, gravel, and clay trenches at rates varying from fifteen to twenty-five cents per cubic yard. These figures, however, cannot be taken as a basis for general estimates, as they were deduced from short observations only, and do not include the cost of sheeting and bracing the trench, pumpage, loss and wear on plant, tools, wastage of lumber, or miscellaneous expenses, all of which items properly come under the head of excavation."

"Again, on the same trench there is often considerable difference in the amount of work accomplished from day to day, and on a trench in one locality, where the excavation was in damp sand, we have seen the "Bolt Machine" pushed to above its rated daily capacity (three hundred cubic yards) by eight shovellers, yet on the same trench further along, where clay was encountered, it took sixteen men, or four to each tub, to enable the machine to handle one hundred and fifty cubic yards per day. It may thus be seen that in one case each man shovelled nearly four yards per hour, while in the other, less than one yard, due wholly to geological variation."

"As the ability of those using the machine to keep it in running order is another important item, it can easily be seen that, while we can give figures as to the cost per cubic yard on certain jobs, there is no safe general average, on account of variation in soil and circumstances."

"We have had several contractors tell us that upon the same trench they found that with our machine they could handle excavation at about one-third of the rate per yard which it cost them in their experience previous to using machinery."

The Lidgerwood Cableway may be advantageously used where the trench is too wide to span with the "A" frames of the Carson Machine, or where for any reason the use of the frames is not permissible. Figure 191¹ shows the general arrangement. A frame or tower at the rear carries a loose pulley and supports the main cable, which is anchored somewhere in the rear of the frame. The head end has its tower and anchor and has a hoisting engine which moves the carriage back and forth with the tub. The usual span is from 225 to 300 feet, so that the apparatus on a large sewer does not have to be moved frequently. It is not difficult to move,

¹ From Catalogue of Carson Trench Machine Co.

a few hours sufficing to make the necessary change. It is particularly useful where blasting has to be done, since the cable is not likely to be damaged, and nothing else is in danger. Then, too, in cities it is possible to cover a large part of the sewer, leaving open only that part where excavation is being carried on and that part where dumping is done. It does not place any load on the sides of the trench, either from the excavated dirt, or from the weight of the apparatus. There is side motion enough so that material can be placed on the side of the trench, or material can be picked up from the side and placed in the bottom. It can even be used to draw a plough or scraper and excavate the trench without picks and shovel. The objection to its use, aside from the expense of installation, is that it can handle only one thing at a time, and that it is possible, without good superintendence, for the men filling a bucket at one point in the trench to do a good deal of waiting for their bucket to be lifted. The machine is capable of making 30 or 40 trips per hour, but without good management it may stand idle half the time. For wide trenches, for rock cuts, and for excavation in quicksand, the cableway has manifest advantages over the Carson Machine.



Fig. 191

The Moore Machine and the Potter Machine are similar to each other, and partake of both of the characteristics of the machines already described, that is, they require a rail laid on each side of the trench to form a track as in the Carson Machine, and the operation is limited to one action at a time as in the Lidgerwood Machine. Instead of providing an aerial cableway on which the single car can move, a tower car, with a wheel at each corner post, is provided to run on the track over the trench. The car is moved back and forth by an endless rope attached to a hoisting engine at the front end supported on wheels, and to a dead man at the rear end. The Moore Machine has a carriage about 8 feet square and 15 feet high, which carries a bucket man, who directs operations, and is responsible for the economical use of the time of the machine. The velocity of motion attainable is high, a round trip of the carriage being made in about one minute, including the time necessary to raise the bucket from the trench and to dump its load. The Potter Machine differs from the Moore in that the track on which the carriage runs is elevated, requiring a more expensive track and a less extensive carriage. They make a so-called surface track car, which then in principle is practically the Moore Machine. In a lawsuit between the two companies, tried before the United States Circuit Court of Appeals, March 5, 1901, the Potter patents were upheld, so that no danger is to be feared in using their machines. Figure 192 shows a photograph¹ of a Moore Machine track in use at Binghamton, N.Y. The advantages of these machines over the others is chiefly in the greater simplicity of the machinery, most marked in the Moore Machine. The hoist is simple and the engine so easily handled that any engineer can operate it. These machines handle only one bucket or two together, but they are more easily moved ahead, on account of the lighter engines needed.

The matter of trenching in rock introduces uncertainty on several points. The cost, the time, and the proper method of excavation are all, in the minds of many engineers, indefinite and uncertain. The kind of rock determines the character and fre-

¹ Furnished by Thos. F. Moore, President Moore Machine Co.

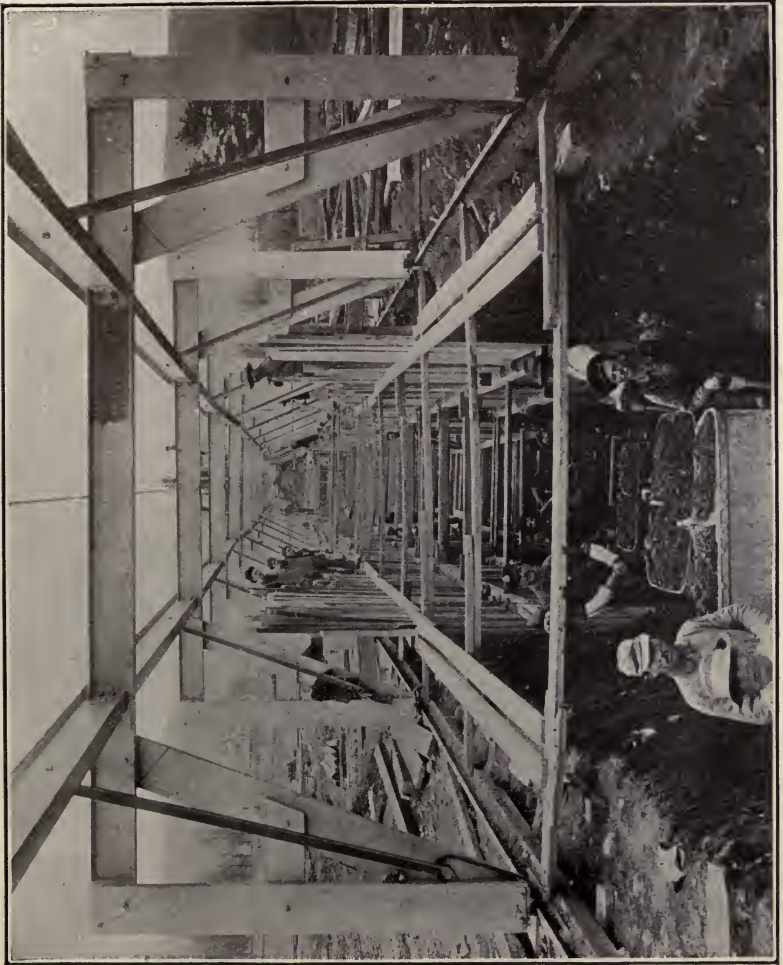

Fig. 192

quency of the seams, which greatly affect the ease of excavation. Limestones and shales have horizontal strata, usually with a hard layer overlying a softer one. The vertical joints are regular and close together, so that it is possible by the use of wedges, bars, and picks to excavate in sedimentary rock without blasting. Igneous rocks, on the other hand, have their joints so far apart that blasting is necessary. For preparing the drill holes for blasting two methods of drilling by hand are available, viz., by a churn drill, and by a hammer drill.

The churn drill is a bar of iron about 6 feet long with steel bits at both ends and weighted with a ball of iron in the middle. It is a matter of some skill to start a hole with a churn drill, but once started the drilling proceeds very rapidly. The weight of the drill furnishes the necessary impact, and in sizes of drill rod over three-quarters of an inch two or three men are required to lift the weight of the rod.

Trautwine gives the following table for the rate of drilling vertical holes 3 feet deep, one man drilling with a $1\frac{3}{4}$ -inch bit.

Solid quartz.....	4 feet in 10 hours.
Tough hornblend.....	6 feet in 10 hours.
Granite.....	7.5 feet in 10 hours.
Limestone.....	8.5 feet in 10 hours.
Sandstone.....	9.5 feet in 10 hours.

In hammer drilling, one-hand drilling or two- or three-hand drilling may be employed for holes up to 3 feet deep. One man with a $4\frac{1}{2}$ -pound hammer can usually drill small holes more cheaply than when one man holds the drill and one or two men are striking. In very hard rock, however, the latter may become cheaper.

Gillette says that with one man holding the drill and two men striking, the depth of hole per man is as follows for a 6-foot hole:

Granite.....	$2\frac{1}{2}$ feet in 10 hours.
Trap (basalt).....	$3\frac{3}{4}$ feet in 10 hours.
Limestone.....	$5\frac{3}{4}$ feet in 10 hours.

In hard porphyry, the same author gives 2 feet to 3 feet per man per day in holes 20 feet deep — one man holding and two striking;

and in tough sandstone, one-hand drilling averaged about 6 feet per day of 8 hours.

The spacing and depth of the holes, as well as the amount of the charge, will depend on the methods employed and on the specifications followed. The behavior of different kinds of rocks is most confusing to the foreman who meets a new formation. In soft rock and in sedimentary rock in thin layers, properly distributed blast holes will carry down a trench with regular and smooth sides, but granite and igneous rocks are broken out in irregular and uncertain lines, often loosening the dirt cover for many feet on each side of the trench, if not actually filling the trench with such dirt. Most specifications require excavation in rock to be carried to a depth six inches below the bottom of the pipe. In sedimentary rock, in thin layers, or when a thick layer comes just above the excavation bottom, it is only necessary to drill the blast holes to the bottom of the desired trench. But in tough granites and thick, hard limestones, with strata disadvantageously placed, it is frequently necessary to drill a foot below the trench bottom in order to have every point of the bottom at least 6 inches below the pipe. The usual practice of placing the holes in a trench is to space them about three feet apart longitudinally and transversely about the same distance. Thus, in a trench 3 feet wide, two holes are drilled, one on each side of the trench. In a trench 6 feet to 8 feet wide, three holes would be used, one on each side and one in the middle. In a trench 14 feet wide, in Newark, N. J.¹, five holes in each row were used, the distance apart, longitudinally, of the rows being 4 feet. In soft limestone the author has for trenches for 6-inch pipe not over 8 feet deep, particularly when only the bottom of the trench was in rock, put down a single row of holes in the middle of the trench, but a large amount of picking and hammering is always necessary to finish up the work.

As to the depth of the hole, the necessity of avoiding accidents, excessive noise, and rattling in nearby houses, limits the amount of the charge. Usually the depth of the holes is made the same

¹ Gillette.

as the distance between the holes, although in tough rock the depth can with advantage be made greater than that distance. The deeper the holes, the cheaper the work, since frequent changing of drilling machines means loss of time. Gillette gives the following (theoretical) table to show the effect of spacing of holes upon the cost of excavation, tabulating the number of feet of hole drilled per cubic yard excavated:

Distance Apart of Holes.	1	2	3	4	5	6	8	10
Cubic yards per foot of hole.....	.04	.15	.33	.59	.93	1.33	2.37	3.70
Foot of hole per cubic yard.....	27.	6.8	3.0	1.7	1.08	.75	.42	.27

Since drilling costs from 10 cents to 50 cents per lineal foot, an unwise or unforeseen combination of high cost drilling with shallow holes near together, may very easily add from \$1.00 to \$3.00 to the cost of a cubic yard of rock excavation. In loose seamy shale, shallow holes near together are necessary to retain the force of the explosion.

The kind of explosive which may be used varies from the slow low-power black powder to the rapid high-power nitroglycerine, the many forms of dynamite and high grade powder in use being combinations of nitroglycerine and some absorbent. The slow explosives are used to quarry dimension stone, to break out large blocks, and to lift clay, hardpan, or shale. The rapid explosives, on the other hand, are used in tough rock, particularly in rock which is afterwards to be shoveled, and therefore needs to be broken into small pieces. Rapid explosives are also used where the rock is seamy, or cracked, when the slow-forming gases might escape without shattering the rock. The most efficient blasting is that in which both the depth and spacing of the holes and the grade of the explosive are properly adjusted to the work in hand. Further details of the methods of placing and firing the blast will be found in the standard books on tunnelling and on rock excavation.

CHAPTER XVIII.

ESTIMATES AND COSTS.

THE matter of making up a preliminary estimate of the cost of sewer construction is usually most unsatisfactory for the engineer himself, for the city officials, and for the contractors who may bid on the work. Unless the engineer has had large experience in this line of work and in the particular locality where the sewer system is to be built, the estimates may vary largely from the actual cost and from the bids, and if the cost must come within an appropriation, an estimate which is too small is certain to lead to future difficulties. The variation in the estimate as a whole is caused by the uncertainty of the estimates of the items of the work. Without a series of borings or test pits the character of the soil and the cost of its excavation is mere guesswork. For example, if rock is found near the bottom of the trench, it will increase the cost of the trench perhaps 50 cents per lineal foot. The engineer's estimate may overlook the rock and count the trench at perhaps 35 cents per running foot, whereas with the rock he would estimate the cost of excavation at 80 cents per lineal foot. Similarly, the cost of sheeting an ordinary trench with single sheeting may be 15 cents per running foot, and while the contractor may figure on sheeting, the engineer may omit that cost. Again the amount of ground water to be encountered and the consequent cost of pumping is most uncertain. The contractor may figure that he will need a steam pump running day and night at a daily cost (including rent of boiler and pump,) of \$18.00 per day, or an additional cost for pumping of 10 cents per lineal foot of sewer. The estimated cost of excavation per lineal foot for a small lateral sewer, then, may run from about 30 cents in good ground to \$1.25 in bad ground, the difference being all due to a different opinion as to the amount of rock, amount of sheeting, and amount of pumping.

The cost of excavation of earth in a trench is somewhat greater than in a large open cut. The loosening must all be done by pick, and some extra time is taken in trimming and preserving the line and sides of the trench.

According to Gillette's figures revised to a scale of wages of \$1.50 for 8 hours, the cost of loosening earth with a pick ranges from 1½ cents per cubic yard for very easy earth to 15 cents per cubic yard for very stiff clay or cemented gravel, and for average earth the cost of picking may be taken at 5 cents per cubic yard. He gives the cost of shoveling dirt which has been loosened at 13 cents per cubic yard.

The cost of picking and shoveling, per cubic yard, then, from a trench will be as follows, the cost of shoveling increasing also with the kind of soil:

	Picking.	Shoveling.	Total.
Easy earth, sand, and loam.....	1½ cts.	13 cts.	14½ cts.
Average earth.....	5 "	15 "	20 "
Tough clay.....	10 "	17 "	27 "
Hardpan.....	30 "	23 "	53 "

These figures are confirmed by data from different cities and are generally applicable. The figures do not, however, include any sheeting, bracing, pumping, foreman, contractor's profit, or office expenses, and are for trenches 6 feet deep or less.

The cost of back-filling is usually, in estimates and bids, included in the cost of excavation, and should therefore be added to the figures given. The cheapest method of returning the dirt to a trench is to scrape it back, the horses staying on the side of the trench opposite the bank, the scraper having a rope attached. In good soil, this may cost as little as 1½ cents per cubic yard if no ramming is required. The cheapest hand-filling will cost without ramming about 13 cents, or the bare cost of shoveling. A table from the *Technic*,¹ 1896, gives the cost of back-filling clay, not including ramming as 21 cents, 27 cents, 28 cents, and 34 cents, this

¹ University of Illinois.

work apparently being very inefficient. However, if clay is dug wet and piled, and allowed to dry, it becomes so hard that it has to be picked or ploughed before it can be shoveled, which may account for these high prices. The author, refilling trenches in the fall, has found that a heavy frost adds decidedly to the cost of refilling, in that the frozen crust has to be picked loose.

If the trench has to be consolidated by ramming or puddling, something more has to be added to the cost. A common specification is that there shall be one rammer to each shoveler employed in back-filling, in which case the cost would be increased by at least 13 cents per cubic yard. In city streets, where the consolidation is thorough and complete, and where the material is clay rammed in four inch layers, the cost may be from two to four times this amount, in fact there is no limit to the amount of ramming that may be put into a clay back-fill. The following summary may be given:

Excavation.....	\$0.14½	to	\$0.53
Refilling.....	.01½	to	.30
Ramming, if done.....	<u>.13</u>	to	<u>.60</u>
Total.....	\$0.29	to	\$1.43

In gravel or sand, trenches may be well consolidated by refilling into water. A firehose may be allowed to run as the refilling is in progress, or the trench may be half filled before the water is turned on. Or, again, the empty trench may be half filled with water before the refilling is begun. It has been stated by an experienced engineer that workmen will work noticeably faster in the latter case on account of the gratification at hearing the splash of the dirt.

In Vols. 27 and 28 of the periodical, "Engineering-Contracting," some complete analyses of the costs of trenching and back-filling were given for Centerville and for Atlantic, both in the state of Iowa. The figures were compiled by Mr. M. A. Hall, engineer in charge, and are discussed at length in No. 20 of Vol. 27, and in Nos. 8, 12, 16, and 24 of Vol. 28. For complete understanding of the conditions the reader is referred to the periodical, and the following summary is given chiefly to show how great a variation

exists in the cost of trenching and back-filling, even where the conditions are apparently approximately uniform.

At Atlantic¹ on eighteen different parts of the work, the cost of trenching per cubic yard varied from \$.131 for a 10-inch pipe in a 6.6-foot trench to \$.347 for a 15-inch pipe in a 12.6-foot trench. The back-filling was done chiefly by scrapers, and cost from \$.017 for a 10-inch pipe in a 9.1-foot trench to \$.066 for an 8-inch pipe in a 9.6-foot trench. The labor of pipe-laying cost from \$.013 for a 10-inch pipe to \$.085 for a 15-inch pipe.

At Centerville² on thirty-six different parts of the work, the cost of trenching per cubic yard varied from \$.239 for an 8-inch pipe in a 6.6-foot trench to \$.864 for a 12-inch pipe in a 12.2-foot trench. The former was in yellow sand clay, easily spaded, and the latter in dry, hard clay. The back-filling cost from \$.041 for an 8-inch pipe in an 8.7 foot trench to \$.212 for a 10-inch pipe in an 8.8-foot trench. The labor of pipe-laying cost from \$.017 for an 8-inch pipe to \$.099 for a 12-inch pipe in a 13-foot trench.

On thirty-nine other parts of the work at Centerville³ the cost of trenching per cubic yard varied from \$.173 for a 15-inch pipe in a 5.6-foot trench to \$1.04 for a 12-inch pipe in a 9.9-foot trench. The former was in black loam and the latter was through boulders in a wet ditch. The back-filling cost from \$.033 for a 15-inch pipe in a 7.3-foot trench to \$.244 for an 8-inch pipe in a 10.5-foot trench, this latter being done in wet weather. The labor of pipe-laying cost from \$.036 for a 15-inch pipe to \$.172 for a 10-inch pipe in a 12-foot trench.

On fifty-three other parts of the work⁴ the cost of trenching per cubic yard varied from \$.141 for a 15-inch pipe in a 7.7-foot trench to \$.639 for an 8-inch pipe in a 9.1-foot trench. The former was in good easy digging and the latter was in wet ground with some quicksand. The back-filling cost from \$.026 for a 12-inch pipe in an 8.2-foot trench to \$.187 for an 8-inch pipe in a 10-foot trench, the latter being due to wet weather.

¹ Engineering-Contracting, Vol. 27, page 218.

² Engineering-Contracting, Vol. 28, page 114.

³ Loc. cit. page 170.

⁴ Loc. cit. page 223.

The labor cost of pipe-laying varied from \$0.035 for a 10-inch pipe to \$0.124 for an 8-inch pipe in an 11.6-foot trench in hard clay.

The material in nearly all the above cases was clay, very hard when dry, and very slippery when wet. The laborers worked 10 hours per day and labor is computed at the rate of 20 cents per hour.

The excavation for the sewer work at South Bend referred to on page 85, was done largely with a Potter Trench Machine. With wages at 18.5 cents per hour for laborers, and 30 cents per hour for the engineer on the machine, the cost of excavation per cubic yard was given as follows:¹

Pipe for sub-drain	\$0.047
Labor laying this pipe	0.050
Pumping water	0.065
Excavation and back-filling	0.400
Sheeting and shoring	0.150
Tools and general expenses	<u>0.035</u>
	\$0.747

This does not include the rent of the machine nor apparently the cost of coal, which items would add nearly 50 per cent to the cost given.

This same kind of machine was used for the deep trenching on Lawrence Avenue, Chicago, where a sewer was built in 1907.² Here laborers were paid at the rate of 34 cents per hour and the engineer on the machine 75 cents per hour. One-half ton of coal was consumed each day by the machine and the rent of the machine was given as \$4.80 per day. The total daily expense was as follows.

One engineer	\$ 6.00
One fireman	2.50
One carriage-man	2.50
One carriage-man	3.25
20 bottom men	55.00
One dump-man	2.75
Foreman	3.50
Coal and rent	<u>7.30</u>
	\$82.80

¹ Engineering-Contracting, Vol. 29, page 70.

² Engineering-Contracting, Vol. 28, page 212.

On the basis that 175 cubic yards of material were excavated each day, the cost would be about 47 cents per cubic yard, with no allowance for sheeting.

For excavating a trench for a water pipe for the city of Greeley, Colorado, a Buckeye Traction digger was used with great success.¹ The trench was 36 miles long, eight of it through a stratum of gravel containing many stones, some of the gravel cemented together. The material in the rest of the trench was clay, rather hard but through which the machine dug with great ease. The trench throughout was 30 inches wide and 4½ feet deep. The description of the work allows \$6.00 per day for repairs and renewals, for interest and depreciation on the machine, and the machine is said to have used on an average one ton of coal per day. Four men were needed, the man running the machine receiving \$5 per day and the other three, \$3 each. In the gravel, the machine excavated from 600 to 1000 feet of trench; while in the clay as much as 2500 feet was dug in one day of ten hours. The cost per cubic yard for the work was as follows:

Engineer.....	\$0.021
Helpers.....	0.040
Coal.....	0.021
Plant.....	0.025
	<hr/>
	\$0.107

The author has been informed that in excavating for water pipes in the city of Corning, N.Y., a Chicago Sewer Excavator, of the Chicago Municipal and Contracting Company averaged about 600 feet daily through a hard clay with many boulders, and that the maximum distance excavated in any one day was 1200 feet, all trenches five and a half feet deep.

If the trench is in rock, the following items are to be considered: drilling, explosives, shoveling, and refilling. Gillette gives the cost of hand drilling as follows: one man holding and two men striking: granite, 83 cents; trap, 55 cents; limestone, 38 cents, per lineal foot.

¹ Engineering-Contracting, Vol. 29, page 103.

The cost of churn drilling is given by Gillette as follows: solid quartz, 55 cents; granite, 30 cents; limestone, 26 cents; sandstone, 22 cents.

In Engineering-Contracting¹ are given some figures of the cost of drilling in open cuts on the Grand Trunk Pacific Railroad. The rock encountered was granite, trap, and diabase. Three men drilling 10 to 14 foot holes in hornblende averaged 29 lineal feet per day, or 23 cents per foot, labor being \$2.25 per 10 hours. In red granite, three men averaged 20 feet per day, or 34 cents per foot. In trap and diabase, 18 feet per day was the average rate, or the cost was 37 cents per foot. The cost of sharpening the drills amounted to 9 cents per foot of hole drilled. The total cost therefore varied from 32 cents to 46 cents per foot. In shallower holes the cost of drilling per foot increased, reaching 74 cents per foot for shallow block holes in granite.

In the same volume² are given similar costs for drilling in sandstone. Here, as before, three men constituted a gang and the daily average varied from 12 to 17 feet per day with the different gangs. The entire average cost of drilling per lineal foot, including 8½ cents for sharpening drills, was 40.3 cents.

On page 199 are given additional values for the cost of drilling into the mica schist in New York City. In the work referred to, 15 lineal feet was the average day's work, and the cost of drilling alone was 40 cents per lineal foot.

If a steam drill is available these costs can be much reduced, although the shallow depth of the holes in sewer trenches does not bring out the full economy.

A steam drill operated by a driller and helper will drill holes as follows:³

In granite	45 to 50 feet in 10 hours.
In mica schist	50 to 60 feet in 10 hours.
In hard trap	40 feet in 10 hours.
In red sandstone	90 feet in 10 hours.
In limestone	70 feet in 10 hours.

¹ Engineering-Contracting, Vol. 28, p. 301.

² Engineering-Contracting, Vol. 28, p. 197.

³ Gillette.

The cost of operation is given as follows:¹

Driller and helper.....	\$ 4.75
Fireman.....	2.00
600 pounds coal.....	.90
Water hauled.....	.75
Hauling and sharpening bits.....	1.20
Repairs to drill and steam piping.....	.75
Total for 10 hours.....	<u>\$10.35</u>

If more than one drill is to be run by the same boiler the cost of fireman and coal will be distributed. But the rent or depreciation of the boiler and drills should be added. If these are taken at \$3.00 per day the total cost would be \$13.35. The cost then will vary from 14 cents to 34 cents per lineal foot, much less than the cost of hand drilling. In the open cut work of the Grand Trunk Pacific Railroad above referred to the daily expense of working one steam drill from a boiler, including repairs and all incidental expenses, was \$14.43, and the average number of feet drilled daily was 30, making a cost, including sharpening, of 48 cents per foot. If two drills were run from the same boiler, the engineer reports that this amount would be reduced by about 10 cents per foot.

The amount of explosive to be put into each hole varies with the depth of the hole and the kind of rock. Estimates are usually made on the basis of a certain amount per cubic yard of rock loosened, less explosive being needed per hole the more closely the holes are drilled. The amount of 40 per cent dynamite needed per cubic yard for limestone varies from one-half to 2½ pounds per cubic yard, the larger amount being used in shallow holes in tough rock. If we assume a trench 3 feet wide — holes staggered on the center line and three feet deep — there will be 3 feet of hole per cubic yard, costing about 75 cents for drilling. The dynamite at 15 cents a pound will cost about 20 cents, or 95 cents for drilling and explosive. About 5 cents more should be added for placing a mat over the hole, or \$1.00 per yard for loosening the stone. In throwing the stone out of the trench the amount depends largely on the size of the pieces, the large pieces taking a great deal of time,

¹ Gillette.



especially if a bar has to be used to work loose any separate stones. One man ought to throw out a cubic yard an hour, according to Gillette, although loading stone into cars on the Chicago Drainage Canal required an hour for three-quarters of a cubic yard. Not less than 30 cents per cubic yard should be allowed for throwing out and about 20 cents for refilling, making the labor cost 50 cents. To this should be added cost of superintendence, office expenses, and contractor's profit.

The cost of sheeting is determined by the amount of lumber used, in the first instance and in succession, and by the cost of the labor for placing it. It is seldom worth while to use anything less than 2-inch material, although in gravel, when little driving has to be done, 1-inch stuff can often be used to advantage. A trench 8 feet deep would have, if close sheeted, the following lumber in 16 lineal feet:

Sheeting.....	2 inches × 8 feet	× 16 feet	× 2 =	648 B.M.
Rangers.....	4 inches × 6 inches	× 16 feet	× 4 =	128 B.M.
Braces.....	4 inches × 6 inches	× 3 feet	× 6 =	36 B.M.
Total for 16 feet				<u>812 B.M.</u>

or 51 feet B.M. per running foot of trench.

The cost of placing lumber of this sort varies from \$8.00 to \$15.00 per 1000, so that if lumber costs \$30.00 per 1,000, the cost in place will be about \$40.00 and the sheeting driven would cost 20 cents per lineal foot; but the lumber would be used two or more times so that 10 cents per lineal foot may be regarded as the minimum cost of sheeting. Larger trenches should be estimated in the same manner, although in wider trenches the braces must be heavier, 10 by 12 being sometimes necessary. With care, the rangers and braces may be used three or even four times, but the sheeting seldom more than twice. For comparison the following figures are given.

At Peoria, Ill.,¹ in a trench 13 feet wide by 45 feet deep, the labor cost of sheeting was \$3.00 per lineal foot when work was all done by hand, and \$2.08 per foot when steam power was used for driving and pulling the sheeting.

¹ Engineering News, Vol. 37, p. 50.

There were about 230 feet B.M. per lineal foot, or the cost of placing and pulling the sheeting was about \$13.00 in the first case and about \$9.00 in the second case per 1000 feet B.M.

Gillette says that small trenches 8 to 16 feet deep in sand cost from 10 to 25 cents per lineal foot for labor of sheeting with 2 by 8 inch hemlock.

The cost of excavation in tunnels exceeds and bears but little relation to the cost of excavation in open cut. The laborers work at a disadvantage, the cost of spoiling the material is large, and the cost of sheeting or timbering is heavy. The following examples are given as a guide for estimates of this kind.

At St. Louis, Mo., for a brick sewer 30 by 42 inches, with 9 inches of brickwork, the cost per cubic yard was as follows,¹ the material being a plastic clay which would drop out in the arch following the shovel:

Foreman at 50 cents	\$0.225
Bottommen at 50 cents571
Laborers at 30 cents	1.946
Carpenters at 50 cents359
Labor, timbering161
Timber at \$20381
Watchman at 17½ cents079
Wasting dirt, 585 loads at \$1506
	<u>\$4.228</u>

For the same sewer 880 cubic yards were in rock tunnel and the cost of this was given as follows:

Foreman at 50 cents	\$0.568
Bottommen at 50 cents	1.477
Laborers at 30 cents	3.402
Engineer at 50 cents909
Blacksmith070
Watchman at 17½ cents318
Dynamite at 15 cents per pound682
Caps and fuse030
Wasting dirt, 445 loads at \$1500
	<u>\$7.956</u>

The rock was a stratified limestone, irregular and gnarly. It varied in hardness in some places to a flinty appearance. No

¹ Engineering Contracting, Vol. 28, p. 28.

charge has been made in the above costs for plant, coal, oil or depreciation; nor are office expenses or insurance included.

In Syracuse, in the tunnel sewer, which was built in clay rock with some slate, most of which was thrown down by blasting, the costs are given as follows:¹ The entire cost of the tunnel in the first section was \$6.68 per cubic yard, of which \$1.67 was for sheeting, almost equally divided between labor and material. The size of the opening was 6 feet wide by 7 feet 9 inches high. In the second section, where the material was chiefly a gypsum rock of a flinty nature, and where there was a large amount of water, the cost of excavation, exclusive of sheeting, was \$7.00 per cubic yard, the additional cost of sheeting being \$.66 for lumber and \$.40 for labor. In the third section² the material was clay and easily handled. The total cost of excavation is given as \$4.21 per cubic yard, of which \$1.28 was for sheeting, \$.84 for labor, and \$.44 for material.

In driving a small tunnel in Colorado,³ the material being like ordinary granite and the size of the tunnel being 7 feet high by 4.5 feet wide, the costs per cubic yard were given as follows:

	Sec. 1.	Sec. 2.
Machine men at \$4.....	\$0.95	\$1.40
Machine helpers at \$3.....	.78
Trammers at \$3.....	.48	.70
Pipe and track men at \$3.....	.04	.07
Operating machines.....	.87	.65
General tramping cost.....	.02	.02
Explosives.....	1.35	1.10
Pipe and track.....	.27	.35
Hoisting.....	.48	.57
Supplies.....	.01	.01
General expenses.....	.48	.57
Total.....	\$5.73	\$5.44

The cost of pipe is determined by referring to the list price issued by the Eastern or Western Pipe Manufacturing Association and

¹ Engineering-Contracting, Vol. 26, p. 139.

² Loc. cit., page 196.

³ Engineering-Contracting, Vol. 26, p. 6.

then deducting the proper discount. The following are the list prices referred to:

Standard Sewer Pipe.			Double Strength Pipe.		
Diameter.	Weight per Foot.	Price per Foot.	Diameter.	Weight per Foot.	Price per Foot.
	lbs.			lbs.	
6	15	\$0.30
8	23	.50
9	28	.60
10	35	.75
12	43	1.00
15	60	1.35	15	75	\$1.35
18	85	1.70	18	118	1.70
20	100	2.25	20	138	2.25
24	140	3.25	24	190	3.25
30	252	5.50	30	290	5.50
36	350	7.00	36	375	7.00

The discount (1907) is about 75 per cent for standard pipe, so that 8-inch pipe, for example, listed at 50 cents will actually cost 12½ cents delivered. If deep and wide socket pipe are desired, the discount is about 70 per cent, or the cost per foot is 15 cents. If double strength pipe is wanted, the discount is about 60 per cent, or the cost is 20 cents per foot. In estimating the cost of the pipe laid, the cost of hauling must not be overlooked, the estimate on this being made by the distance hauled and the weight as given in the table. A team will walk on fairly level ground at the rate of 2½ miles per hour, not including time for loading or unloading, nor time taken for resting or hills, which in summer is frequently extravagant. On a long hill, for example, the author has often seen a hired team take an hour to go up a half-mile hill on a 10 per cent grade. The cost of lowering the pipe into the trench, placing it and packing the cement into the joint may be estimated from figures already given on page 260. The amount of cement and sand needed for making the joints can be determined from the following table,¹ and, knowing the cost of both, the cost of the joints is easily obtained.

¹ From Engineering News.

Inside Dia. of Pipe.	Thickness of Pipe.	Depth of Hub.	Cement Space.	Cu. Yds. Mortar for 500 Joints (1000 ft. of 2-Foot Lengths).	Proportions Based on Prof. Baker's Table of Material for One Cubic Yard of Mortar, viz.:								
					7.14	6.43	4.16	3.74	0.58	2.85	2.57	0.80	
					Neat Cement.		One Cement to One Sand.			One Cement to Two Sand.			
					Bbls. Port.	Bbls. Ros.	Bbls. Port.	Bbls. Ros.	Cu. Yds. Sand.	Bbls. Port.	Bbls. Ros.	Cu. Yds. Sand.	
Standard.													
3	1 1/4	1 1/4	0.03	0.142	1.01	0.91	0.59	0.53	0.08	0.4	0.36	0.11	
4	1 1/4	1 1/4	0.03	0.174	1.24	1.1	0.7	0.7	0.1	0.5	0.5	0.1	
5	1 1/4	1 1/4	0.03	0.252	1.8	1.6	1.1	0.9	0.2	0.7	0.7	0.2	
6	1 1/4	1 1/4	0.03	0.290	2.1	1.9	1.2	1.1	0.2	0.8	0.7	0.2	
8	1 1/4	1 1/4	0.03	0.437	3.1	2.8	1.8	1.6	0.3	1.3	1.1	0.4	
9	1 1/4	1 1/4	0.03	0.514	3.7	3.3	2.1	1.9	0.3	1.5	1.3	0.4	
10	1 1/4	1 1/4	0.03	0.618	4.4	4.0	2.6	2.3	0.4	1.8	1.6	0.5	
12	1	2	0.03	1.056	7.5	6.8	4.4	4.0	0.6	3.0	2.7	0.9	
15	1	2 1/2	0.03	1.487	10.6	9.6	6.2	5.6	0.9	4.2	3.8	1.2	
18	1	2 1/2	0.03	1.912	13.7	12.3	8.0	7.2	1.1	5.5	4.9	1.5	
20	1	2 1/2	0.03	2.399	17.1	15.4	10.0	9.0	1.4	6.8	6.2	1.9	
24	1	2 1/2	0.03	3.347	23.9	21.5	13.9	12.5	1.9	9.5	8.6	2.7	
30	2	3	0.03	5.495	39.2	35.3	22.9	20.6	3.2	15.7	14.1	4.4	
Deep and Wide Socket.													
6	1 1/4	2 1/4	0.03	0.585	4.2	3.8	2.4	2.2	0.3	1.7	1.5	0.5	
8	1 1/4	2 1/4	0.03	0.907	6.5	5.8	3.8	3.4	0.5	2.6	2.3	0.7	
10	1 1/4	2 1/4	0.03	1.134	8.1	7.3	4.7	4.2	0.7	3.2	2.9	0.9	
12	1	3	0.03	1.594	11.4	10.3	6.6	6.0	0.9	4.5	4.1	1.3	
15	1	3 1/2	0.03	2.172	15.5	14.0	9.0	8.1	1.3	6.2	5.6	1.7	
18	1	3 1/2	0.03	2.843	20.3	18.3	11.8	10.6	1.7	8.1	7.3	2.3	
20	1	3 1/2	0.03	3.466	24.8	22.3	14.4	13.0	2.0	9.9	8.9	2.8	
24	1	4	0.03	4.797	34.3	30.8	20.0	17.9	2.8	13.7	12.3	3.8	
Double Strength.													
15	1 1/4	2 1/4	1/2	1.796	12.8	11.6	7.5	6.7	1.0	5.1	4.6	1.4	
18	1 1/4	2 1/4	0.03	2.499	17.8	16.1	10.4	9.4	1.5	7.1	6.4	2.0	
20	1 1/4	3	0.03	3.162	22.6	20.3	13.2	11.8	1.8	9.0	8.1	2.5	
24	2	3 1/2	0.03	4.801	34.3	30.9	20.0	18.0	2.8	13.7	12.3	3.8	
30	2 1/2	4	0.03	9.095	64.9	58.5	37.8	34.0	5.3	25.9	23.4	7.3	
B. & P. Standard.													
27	2 1/4	4	0.03	7.847	56.0	50.5	32.6	29.4	4.6	22.4	20.2	6.3	
30	2 1/4	4	0.03	10.183	72.7	65.5	42.4	38.1	5.9	29.0	26.2	8.2	
33	2 1/4	4 1/2	I	13.541	96.7	87.1	56.3	50.6	7.9	38.6	34.8	10.8	
36	2 1/4	5	I	16.007	174.3	102.9	66.6	59.9	9.3	45.6	41.1	12.8	
B. & P. Double Strength.													
27	2 1/4	4	0.03	8.333	59.5	53.6	34.7	31.2	4.8	23.8	24.4	6.7	
30	2 1/4	4	0.03	11.371	81.2	73.1	47.3	42.5	6.6	32.4	29.2	9.1	
33	2 1/4	4 1/2	I	14.943	106.7	96.1	62.2	55.9	8.7	42.6	38.4	12.0	
36	2 1/4	5	I	17.571	125.5	113.0	73.1	65.7	10.2	50.1	45.2	14.1	

The cost of brickwork in sewer construction must be estimated from the unit prices of the material and labor, the amount of brickwork per lineal foot of sewer having already been given on page 34. The cost of brick runs from \$8.00 to \$12.00 per thousand for ordinary building brick, and from \$16.00 to \$20.00 per thousand for paving brick. They must be hauled to the sewer, 1000 brick being a load on level ground over good roads, and 500 brick a load on average dirt roads. The added cost per thousand, therefore, on a dirt road is about 80 cents per mile of haul, to which should be added the time lost on each trip while waiting for loading and unloading — or 50 cents more — if the wait is half an hour at each end and the haul is a mile. In laying, a good sewer-brick mason will lay 2000 to 3000 brick in 8 hours, instead of about a thousand as in house-laying. Gillette notes a case of a man laying 600 brick an hour, but this is too many for an average or an estimate.

From three-tenths to four-tenths of a cubic yard of mortar are needed for each cubic yard of brickwork, and the materials needed for each yard of mortar are given in the table on page 269.¹

The cost of cement and of sand will vary in different places, and would be locally determined in preparing an estimate as follows, the supposed sewer being 4 feet diameter, two rings thick:

Brick — 4 feet dia. 2 ring at .415 cubic yard per foot × \$10.00 =	\$5.00
Hauling, \$1.30 per 500 brick, or 1 cubic yard =	1.08
Mortar .17 cubic yard requires	
.39 barrel cement at \$2.00	\$0.78
.17 cubic yard sand at \$1.0017
	<hr/>
Labor $\frac{1}{2}$ day of mason at \$4.80.....	.96
Labor $\frac{2}{3}$ day of helper at 1.75.....	.70
	<hr/>
Centers cost of 100 feet used ten times, \$120.00, or about 12 cents per foot	.15
	<hr/>
Total cost per cubic yard =	8.84
Total cost per lineal foot = \$8.84 × $\frac{4}{30}$ =	7.34

In shallow trenches two laborers may be able to supply two masons, or three laborers may supply two masons, but it is always wise to estimate for and expect a large number of helpers in sewer

¹ See also Baker's "Masonry Construction."

work. The brick have to be lowered by hand and often carried by hand in the bottom of the trench. The mortar board has to be frequently shifted and its position is usually hard to reach, and since the mason should not be expected to stop his work, it is necessary to provide helpers in abundance.

A small brick egg-shaped sewer was built in Worcester, Mass., in 1905¹ in a trench whose average depth was 9.8 feet. The soil was gravel, and tight sheeting was used throughout. The invert of the sewer was 8-inch brickwork and the arch was 4-inch work, plastered outside with a 1-inch coat of cement mortar. The brick cost \$9.20 per 1000 and the cement \$1.55 to \$1.75 per barrel; the masons were paid 70 cents per hour and the helpers 30 cents. There were 57,200 brick used, and the total cost of masons and helpers was \$375.20, or \$6.56 per 1000 brick, equivalent to \$3.33 per cubic yard of brickwork.

At St. Louis, in 1906-1907, a 30-inch by 42-inch brick sewer was built in 13th Street.² The work was in tunnel and the cost of the brickwork might be expected to be greater than at Worcester; it was, in fact, considerably less. The thickness of the ring was 9 inches, and some additional brickwork was used to fill in the open spaces above the arch. The brick cost \$9.00 per 1000 and the cement \$1.80 per barrel; the masons were paid \$1.00 per hour and the helpers 30 cents. There were 340,000 brick used and the total cost of masons and helpers was \$1900.00, or \$5.58 per 1000 brick, equivalent to \$2.46 per cubic yard of brickwork. The cost of the masonry complete was given as \$7.99 per cubic yard.

The cost of concrete in sewer work is high because it is often difficult to place and because, in thin layers, the cost of forms and finishing is a large proportion of the total. The cost of materials and the labor cost of mixing are easily estimated, the amount of each ingredient being computed separately as follows:

Assume a 1 : 2 : 5 concrete — cement at \$2.00 per barrel, sand

¹ Engineering-Contracting, Vol. 27, p. 28.

² Engineering-Contracting, Vol. 28, p. 28.

at \$1.00 per cubic yard, and broken stone at \$1.50 per cubic yard. The cost per cubic yard of concrete then is:

1.3 barrels cement at \$2.00.....	\$2.60
.36 cubic yard sand at \$1.00.....	.36
.90 cubic yard stone at \$1.50.....	1.35
Mixing the concrete by hand.....	.75
	<hr/>
	\$5.06

This is a fair price for the concrete mixed and ready to be put in place. If gravel and sand are used, in the same combination in which they come from the bank, the cost of sand and stone, \$1.71, may, under favorable conditions, be cut in two, reducing the cost of the mixed concrete to \$4.20. If a mixing machine is used the cost of mixing per cubic yard may be as little as 5 cents, with 10 cents added for interest and depreciation, making the cost of the gravel concrete, machine mixed, \$3.60 per cubic yard. The cost of carrying the concrete to the place where it is required, the cost of ramming into place, and the costs of forms are uncertain and difficult to estimate, although they form a large part of the total cost of the concrete.

Shoveling¹ into wheelbarrows will cost 16 cents per cubic yard. The cost of wheeling is 1 cent for every 25 feet + 4 cents for lost time, or 21 cents if the haul is 25 feet and 24 cents for 100 feet.

Dumping down a chute which has to be frequently moved will cost at least 8 cents per cubic yard, and additional shoveling of the concrete at the foot of the chute will cost 10 cents per cubic yard, adding to the cost given above of \$5.06, 42 cents, or a total of \$5.48 for the concrete in place, a cost which may be modified in the several items by the judgment of the engineer.

The cost of forms is largely influenced by the cleverness of the constructor. If the ground is stable there need be no forms for the invert, only frames for the screed boards every 8 feet. The centers for the arch can be used over and over, and it is necessary to build enough to last for that time during which the arch must be supported, usually a length equal to two days' work. The

¹ These estimates are taken from Gillette.

quantity of lumber needed may be computed at the local price per 1000, with about \$10.00 per 1000 added for carpenter work.

At Wilmington, Del., the cost of forms for a concrete-steel sewer, ranging from 9 feet 3 inches to 6 feet 6 inches radius, through the 1800 lineal feet of sewer, was 8.2 cents per cubic yard of concrete laid, and the cost of setting the forms was 4.5 cents per cubic yard, or a total of only 12.7 cents per cubic yard, a very small amount.

In building a 5-foot concrete steel conduit near Newark, N.J., the cost of labor in merely moving the forms is given at 60 cents per cubic yard. If no outside forms are used on the arch, a good deal of material is often wasted by having the thickness greater than was intended, so that it may be cheaper to provide some outside forms even if these are only boards held out from the sides of the trench by stakes or props.

In the construction of the Harlem Creek sewer in St. Louis, in 1906,¹ about 1600 cubic yards of concrete were used in connection with 43 tons of steel rods. The sewer is 29 feet wide by 18.6 feet high and the thickness of the arch ring is thirty inches. The concrete was cement, sand, and broken limestone in the proportions of 1 : 3 : 6 for the invert and 1 : 2 : 5 for the arch. It was machine mixed in cube mixers. The cement cost \$1.80 per barrel, the sand \$0.75 per cubic yard, the broken stone \$1.00 per cubic yard, and the steel 2 cents per pound. Wages ran from 17.5 cents for the poorest to 30 cents for the best labor per hour. The cost of the concrete per cubic yard was as follows:

1.30 barrels cement at \$1.80	\$2.34
0.44 cubic yard sand at 75 cents33
1 cubic yard broken stone at \$1	1.00
55 pounds steel at 2 cents	1.10
Mixing and placing concrete74
Forms, labor and material	1.25
Placing steel at 0.2 cent per pound11
Bending steel at 0.06 cent per pound03
Moving forms25
	<hr/>
	\$7.15

¹ Engineering-Contracting, Vol. 27, p. 76.

The figures given do not include interest or depreciation on the extensive plant which was installed nor the cost of running the plant. The latter item was \$2000 for this part of the work, or \$1.25 per cubic yard if this cost is distributed over the 1600 yards. This is not accurate, however, as the plant was used for purposes of excavation as well as for building the masonry.

At South Bend, Ind., where a half mile of 66-inch reinforced concrete sewer was built in 1906, already described on page 85, the concrete was made with gravel and mixed in a Smith mixer.¹ The disposition of the force of men mixing and placing concrete and the wages were as follows:

- Six wheelers at 18.5 cents per hour.
- One mixer at 22.5 cents per hour.
- One dumper at 18.5 cents per hour.
- Four placers at 22.5 cents per hour.

The cost of the concrete per cubic yard was given as follows:

Cost of —	
gravel	\$0.774
sand36
cement	1.50
steel rods84
labor, placing and mixing concrete	1.094
forms, templates, etc.589
moving forms, templates, etc.757
finishing, plastering, etc.639
tools and general expenses841
	<u>\$7.395</u>

During the summer of 1906, Mr. O. P. Chamberlain built a number of concrete culverts, using 4 foot concrete pipes molded in the form of hollow cylinders with square ends. The pipes were 6 inches thick and were made of limestone screenings and crushed limestone that had passed through a $\frac{3}{4}$ -inch screen and was caught on a $\frac{1}{2}$ -inch screen. The forms were of wood, the inner form having a wedge-shaped loose stave which could be withdrawn after the concrete had set. The outer form was in two parts, held together by pins which could be removed to separate the forms.²

¹ Engineering-Contracting, Vol. 26, p. 49.

² Engineering-Contracting, Vol. 27, p. 68.

Mr. Chamberlain estimates the cost of molding the four-foot pipes as follows:

Depreciation of forms, 2 per cent of \$40.....	\$0.80
1.1 cubic yards stone and screenings at \$1.85.....	2.04
0.8 barrel cement at \$2.10.....	1.68
10 hours labor at 28 cents.....	2.80
	<u>\$7.32</u>

There were 1.05 cubic yards per length of pipe, or the cost of concrete molded in the form of pipe was \$7.00 per cubic yard.

The cost of manholes must be estimated from the separate parts. It takes a yard of concrete for the bottom, i.e., a barrel and a third of cement, or usually five bags, a yard of broken stone, and a half yard of sand, or a yard of gravel containing the proper amount of sand. The brick side walls are laid by a mason who ought to lay 1000 brick in a day of 8 hours, a manhole containing about 175 brick in each vertical foot or 1000 brick for 6 feet depth. The brick, mortar, and labor make the cost of the brickwork in a 6-foot manhole about \$16.00, and the frame and cover will cost from 1 $\frac{3}{4}$ cents to 3 cents per pound, or about \$8.00. The total cost then is, for a 6-foot manhole, approximately:

Bottom.....	\$ 4.00
Sides.....	16.00
Cover.....	8.00
	<u>\$28.00</u>

For deeper manholes add \$3.00 per lineal foot of depth greater than 6 feet.

The cost of cast iron and steel is usually estimated at a certain price per pound, the cost of shop work being added to the cost of the raw material. Pig iron is quoted at about \$20.00 per ton, and any foundry has always to meet that cost plus the cost of the labor put on the castings. The cost of the latter depends on the cost of the pattern in proportion to the cost of the castings, on the size and weight of each separate casting, and on the intricacy or simplicity of the casting itself. For example, the patterns for a cast-iron gate might easily cost, for labor alone, \$25, while the gate

itself might weigh only 150 pounds and cost about \$5.00. The apparent cost of the iron involved, therefore, would be the quotient of 25 plus 5, or 30, divided by 150, or 20 cents per pound. Patterns for single castings, therefore, ought to be avoided in the interests of economy, and where required the design should be very simple, without curved lines or surfaces and the pattern adapted to rapid carpenter work.

Then again the cost of molding per pound is less on large, heavy castings than on small and light ones. The hand labor involved in repeated moldings of a small casting of one pound, making up one ton, for example, is much greater than in a single length of water pipe which weighs a ton in one piece. Again, a simple rectangular solid can be molded more quickly and cheaply than a complicated assemblage of pieces requiring cores to be made and several flasks to be used to form the required casting. All these points, as well as the degree of finish called for, affect the cost per pound, and the estimated cost of the finished casting will vary between 2 cents per pound on large orders of simple castings to 10 cents, or even 20 cents per pound, on single and elaborate castings. This does not include machine finishing, which must be liberally allowed for in the time of the machinist at 50 cents per hour. The ordinary price for manhole covers varies from 2 to 4 cents per pound, depending on the size of the order, the form of the section, and the finish required.

Cast iron in the form of pipes costs about 2 cents per pound delivered at the work. But the current price of pipe should always be looked up (*Engineering News* publishes the current prices of steel and iron regularly each month), and the cost of freight, hauling and laying added.

Trautwine gives careful analyses of the cost of laying cast iron pipe, as does also Gillette, to whom the reader is referred for greater detail.

The cost of steel used in concrete reinforcement should also be carefully investigated for each estimate. Its cost is usually not far from 2 cents per pound delivered at the work, and the cost of placing is to be added. Expanded metal is sold by the square

foot, and the same necessity for market quotations exists in this case. Five cents per square foot will ordinarily pay for and place this material.

The cost of flush tanks should be divided into the cost of the manhole and the cost of the discharging apparatus. The cost of the manhole has already been discussed. The cost of the Miller Automatic Siphon, which may be taken as a fair type of discharging apparatus, is given in the following table, about 20 per cent discount being allowed (1906).

Diameter of Siphon, Inches.	Diameter of Sewer, Inches.	Size and Capacity of Tanks.			Water Required to Fill 100 Lineal Feet of Sewer, Cubic Feet.	Price f. o. b. Chicago, Siphons of Standard Length.
		Diameter, Feet.	Discharging Depth, Inches.	Discharging Capacity, Cubic Feet.		
3	4-6	2	18	4.5	8.7-20	\$20.00
5	6-8	4	28	25	20-35	26.00
6	8-10	4½	37	42	35-55	30.00
8	12-15	5	42	65	80-122	40.00

The cost of a flush tank, therefore, equipped with a Miller siphon and proper water connection, will be from \$50.00 upward. If the flush tank is fitted with a water supply faucet and a flap valve to be operated by hand, this cost may be reduced to about \$10.00 more than the cost of the manhole.

The amount of the contractor's profit should be added in making the estimate, and also a sum for contingencies. The percentage for profit ought to be different on material and on labor. If the contract is a large one, involving a large amount of material, and but little labor to place it, as, for example, where the pipe are estimated separately, a profit of from 5 per cent to 10 per cent is proper and ample. But when the contract is for labor alone, as in trenching, the percentage ought to be not less than 15 per cent, and with uncertain ground even more than this. Contingencies are usually estimated at a certain percentage of the entire estimate, although it is more reasonable to base the contingencies on that part of the work only where contingencies may arise. Ten per cent

is an average percentage for the purpose, being less when the conditions are certainly known and more when uncertainties of soil, of water, and of weather will seriously affect the cost of the work.

The cost of engineering is difficult to predict. About 6 per cent of the estimated cost of the work is commonly supposed to cover the cost of necessary surveys, design, superintendence, and construction. With a sewer system costing \$100,000 the \$6,000, or 6 per cent, would then be divided up as follows:

Surveys and maps — 25 miles of street at \$30	\$ 750.00
Design, including detail plans	1500.00
General superintendence	2000.00
Inspection and office work	1750.00
	<u> </u>
	\$6000.00

CHAPTER XIX.

CONTRACT AND SPECIFICATIONS.

SIDE by side with the preparation of the detail plans should go the drawing up of the specifications, which are the verbal description of the plans, and along with the construction of the work must go the interpretation and application of those specifications. Much has been written on this subject, and Johnson's "Specifications" or Wait's "Engineering Jurisprudence" or Waddell and Wait's "Specifications and Contracts" may be referred to for detailed discussion of the various questions which may arise both as to the form of the contract and specification clauses and as to their effect upon the progress of the work which they control. There is a growing tendency to make specification clauses more definite and to give up the time-honored phrase, so comforting to the engineer who was preparing to direct work of the details of which he knew little or nothing, that the work was to be done "according to the satisfaction of the engineer." A capable engineer knows before the work begins exactly what he wishes and how the work should be done, and the substitution of exact definition for the former uncertainty is certainly desirable. One exception is made whenever the contract is designed to allow the contractor full liberty of method and material so long as the results desired are gained, and then the result must be properly obtained to the satisfaction of the engineer.

The form of contract and specification following is one that has been used by the author for several pieces of work and which has stood the test of dishonest contractors and of unreasonable lawsuits. It is not perfect, as the author himself recognizes and as he has indicated by some of the comments, but it will serve as a guide to the inexperienced engineer who is undertaking for the first time to prepare such a document for work

under his direction. It would be wise, after it has been carefully written out, to have it submitted first to a local attorney to be sure that it conforms to all the local legal requirements, and second to a competent engineer experienced in municipal or sanitary work. Each clause should be carefully scrutinized before its incorporation to make sure that it applies to the work in hand, that it will secure just the results desired, and that it conforms to local usage. The specific items for the contractor's unit prices are not given and care must be taken that none be omitted from Section O, and the specification clauses should be carefully compared with those items to make sure that the description of each item is incorporated in the specifications.

CONTRACT AND SPECIFICATIONS.

FOR BUILDING SECTION.....OF THE SEWERAGE SYSTEM OF THE
CITY OF ———, —,

THIS AGREEMENT, made and entered into this.....
day of.....in the year one thousand nine hundred
and....., by and between the Board of Sewer Commis-
sioners of the City of....., party of the first part, and.....
.....
..... party...of the second part,

WITNESSETH, That the parties to these presents, each in consid-
eration of the undertakings, promises, and agreements on the part of the
other herein contained, have undertaken, promised and agreed, and
do hereby undertake, promise and agree, the party of the first part, for
themselves, their successors and assigns, and the party...of the
second part...for.....and.....heirs, executors and
administrators as follows:

This introductory clause is the legal form which is generally used. The "party of the first part" is conventionally applied to the person who contracts to have performed the subject-matter of the contract, and "the party of the second part" is applied to the person agreeing to perform the contract. These terms are frequently omitted and in the body of the contract

the names or titles of the parties are substituted, or reference is made by such terms as "said contractor," "said city," etc.

The word "assigns" should be omitted if the contract contains a clause prohibiting an assignment, or if the contract is for special work in the successful prosecution of which the personal skill and experience of the contractor are considered essential.

That whenever and wherever in this agreement the word "Board" or a pronoun in the place of it is used, the same is understood to refer to the Board of Sewer Commissioners of the City of, and refers to and designates the parties of the first part to this agreement.

That whenever the word "Engineer" is used in these specifications or in this contract, it refers to the Engineer employed by the Board for the special purpose of directing and having in charge the work, the said Engineer acting either directly or through any assistant or inspector in immediate charge of a portion of the work, limited by the particular duties intrusted to him.

That whenever the word "Contractor" or a pronoun in the place of it is used, the same shall be taken and deemed to mean and intend the party or parties of the second part to this agreement.

These three clauses are generally inserted, it being considered prudent to explain who is intended to be included within the terms.

A. The Contractor shall at his own cost and expense, and in direct conformity to the hereinafter contained specifications, furnish all the materials as specified, and all labor necessary or proper for the purposes; and in a good, substantial, and workmanlike manner, construct Section of the Sewerage system of the City of do all earth, rock, and lumber work, construct all masonry, build in, or in connection with said masonry, all iron, timber and other work required or ordered to be so built, lay all pipes and iron work, and do all work necessary for taking care of any water that may interfere with the operations of construction, and do all work necessary to construct the said work in accordance with the plans in the manner and under the conditions herein specified.

This is a general clause summarizing the work to be done. It should clearly state what is expected of the contractor and should indicate what material, if any, is to be furnished by the

party of the first part. The paragraph given above is unusually condensed.

B. To prevent all dispute and litigation, it is further agreed by and between the parties to this contract that the Engineer shall in all cases determine the amount or quality of the several kinds of work which are to be paid for under the contract, and he shall determine all questions in relation to said work and the construction thereof; he shall, in all cases, determine every question which may arise relative to the fulfillment of this contract on the part of said Contractor; and his estimate and decision shall be final and conclusive upon said Contractor; and in case any question shall arise between the parties hereto, touching this contract, such estimate and decision shall be a condition precedent to the right of the Contractor to receive any money under this agreement.

This clause, or a similar one, is invariably found in engineering contracts, although, of late years particularly, much opposition to the clause has been expressed.¹ The courts are not fully agreed upon what ground to support it, and in some exceptional cases whether to support it at all. The clause does not prevent the contractor from applying to the courts for relief if he believes that the engineer has acted dishonestly or has been guilty of gross mistakes. The courts are inclined to require the engineer's estimate and certificate before taking up the question of his accuracy and honesty, and the United States courts have held that slight errors in an engineer's estimates are not sufficient to imply fraud or bad faith, and that his estimate is conclusive upon questions of count, measurement, or distance, provided he has exercised an honest judgment. In spite of the apparently one-sided character of this clause, making the agent of one party the umpire for both, the clause, through the sense of fair dealing which most engineers have, seldom works harm; occasionally there is an instance of outrageous wrong under its authority.

C. And it is further agreed by the parties to this agreement that whenever the Engineer aforesaid shall be unable to act, in consequence

¹ Trans. Am. Soc. C. E., Vol. 58, p. 345 *et seq.*, p. 380.

of absence or other cause, then such other Engineer or assistant as the Board of Sewer Commissioners shall designate, shall perform all the duties and be vested with all the power herein given to said Engineer.

There are certain duties which the engineer of a company cannot delegate, especially if the work is of considerable importance and magnitude and the engineer has been selected with special reference to his personal skill, judgment, or discretion. Such work as drafting, setting grade stakes, or other mechanical work may properly be assigned to assistants, custom permitting it and no special judgment being exercised, but the higher engineering functions, properly called judicial acts, cannot be delegated.

D. It is expressly understood and mutually agreed by the parties hereto that the quantities of the various classes of work to be done and materials to be furnished under this agreement, which have been estimated as stated in the proposal of this work, are approximate, and only for the purposes of comparing on a uniform basis the bids offered for the work; and the Contractor further agrees that neither the City nor the Board is to be held responsible that any of the said estimated quantities be found even approximately correct in the construction of the work; and that the said Contractor will make no claim for anticipated profits, or for loss of profit, because of difference between the quantities of the various classes of work actually done, or of materials actually delivered, and the quantities stated in the bids, and the Contractor hereby undertakes and agrees that he will complete the entire work to the satisfaction of the Board and in accordance with the specifications and plans herein mentioned at the prices herein agreed upon and fixed therefor.

When an erroneous preliminary estimate has been made by an engineer, and when the contractor has based his proposal on such an estimate, thereby being put to additional expense, it would seem in justice as if the company represented by the engineer should bear the additional expense. To avoid this, however, the clause given is inserted, under which the contractor must be assumed to take all risk of the quantities turning out larger than the engineer had represented. When payment is made on a unit price basis, and where the bids on the separate

items represent fair values for the work, the interpretation of this clause is not often questioned. Statements of quality are more uncertain, and an engineer always hesitates to make any statements about the quality of earth supposed in a trench, lest, for example, other material be found and he be asked for extra compensation because of his misstatement. A substantial change in the quantities, in spite of this clause, might operate to extinguish the contract, or the contractor might recover for the additional work at the unit prices named in the contract. The most equitable proceeding is certainly for the engineer to prepare a careful and complete statement of quantities and of conditions and then to make additional compensation if changes are made.

E. And it is further expressly agreed that all the work, labor and materials to be done and furnished under this contract shall be done and furnished strictly pursuant and in conformity to the following specifications and to the direction of the Engineer as given from time to time during the progress of the work under the terms of the contract and specifications, which said specifications form part of this agreement.

The plans and specifications are intended to be explanatory of each other, but should any discrepancy appear or any misunderstanding arise as to the import of anything contained in either, the parties hereto further agree that the explanation and decision of the Engineer shall be final and binding on the Contractor, and all directions and explanations required, alluded to, or necessary to complete any of the provisions of this contract and these specifications and give them due effect shall be given by the Engineer. Corrections of errors or omissions in drawings or specifications may be made by the Engineer when such correction is necessary for the proper fulfillment of the intention of such drawings or specifications, the effect of such correction to date from the time that the Engineer gives due notice thereof to the Contractor.

In order that the specifications shall be equally binding with the contract, some such clause as the above is necessary. The clauses of the specifications are often general, applicable to the performance of the contract rather than to the prosecution of the construction, and no uncertainty should exist. Often the specifications and plans are not attached to the contract, are not signed nor

described nor even referred to in the contract. In such cases they have no bearing on the interpretation of the contract.

There is a tendency to give more weight to the written contract than to the specifications or plans, should discrepancies occur. Between the plans and specifications there is no room for choice. Both are prepared presumably by the same engineer and with the same care. Specifications being changed more easily, it is reasonable to expect that they would more exactly represent the true intentions of the two parties. Written matter in law prevails over printed matter, and punctuation is interpreted so as to make the instrument rational and self-consistent. Care must be taken not to make changes in the plans or specifications after they have been signed, without the consent or knowledge of both parties, since such tampering with the documents may be legal forgery. Where plans are incomplete or insufficient, the contractor in general is not relieved from his obligation to carry out the evident intention of the contract, but neither is the contractor liable if the work fails or proves worthless after having been faithfully executed according to the plans. It cannot be too strongly urged that complete detailed plans be provided far enough in advance of the execution of the contract so that they may be thoroughly checked and all inconsistencies with the specifications eliminated.

F. It is further agreed that the said Engineer may make alterations in the line, grade, plan, form, position, dimensions, or material of the work herein contemplated or of any part thereof, either before or after the commencement of construction and that said Board may at any time order that any portion of the sewer shall not be built. If such alterations diminish the quantity of work to be done they shall not constitute a claim for damages or for anticipated profits on that portion of the work dispensed with; if they increase the amount of work such increase shall be paid for according to the quantity actually done, at the price established for such work under the contract.

Even with this clause, if the character of the work to be done is so changed that the terms of the contract are not applicable, making it impossible to say to what part of it the new work should be applied, the contractor would be entitled to recover for the

value of all the work as if there had been no contract. A verbal agreement to certain changes may substitute an oral agreement for the original instrument, and the authority of this clause does not allow the engineer to arbitrarily annul the contract. The contractor, to an extent, loses his rights to claims for extra compensation by proceeding to execute alterations without protest, and his right to recovery often depends upon his having given notice to the company that he considers his rights invaded. Where extra work is the result of the engineer's mistakes in lines and levels, and the contractor is required to follow those lines, the company which employs the engineer should pay for it, and the contractor is not limited to any rate fixed by the contract. Care must be taken in making changes that they are not of such a character as to release the surety bond which guarantees the performance of an express contract under certain definite circumstances.

SPECIFICATIONS.

G. (1) The Contractor shall make all requisite excavation for construction of foundation walls, screening chambers, pump wells, sewer and drain pipes and all appertaining structures; do all pumping, bailing and draining; all sheeting and shoring; all fencing, lighting and watching; furnish and drive all piles required and as directed; put in place all masonry and concrete; construct the brick sewer as shown on the drawings; erect, in entire conformity to the plans and specifications, the brick and wooden building to be used as a pumping station; furnish and put in place the cast iron force mains; furnish and put in place the wrought iron air pipes; furnish and put in place the ejector chamber; furnish and put in place the ejector complete; furnish and put in place the flushing and overflow pipes from the pumping station to the creek; construct the chimney complete, as specified; refill all trenches and excavation, as directed; clear away all rubbish and surplus material, unless claimed by the Board, and bring all excavated material, not used for refilling, to a smooth, even grade; and furnish all materials, tools, implements and labor required for the complete construction and operation of Section . . . of the Sewerage system of the City of . . . with all its appurtenances.

This is an introductory and general clause of the specifications, rehearsing the general obligation of the contractor.

(2) All necessary lines, levels and grades will be given by the proper marks, and the Contractor shall provide, at his own expense, such forms, stakes, plank and such assistance at all times as may be required by the Engineer for giving the same. Material ready for immediate use in setting grades shall be at hand when required by the Engineer or his assistants; otherwise they may pass on to other parts of the work and the Contractor shall make no claim for damages from consequent delay. If the Contractor, through wilfulness or carelessness, removes or causes the removal of said marks before the prosecution of the work requires it, the replacing of the same shall be at the expense of the Contractor.

This requirement that the contractor shall provide the engineer with stakes, etc., is customary. The second sentence of the clause is for the purpose of expediting the work of a level party with many duties. In the experience of the author it has been very useful. The third sentence is useful rather to act as a restraint than to cause expense to the contractor, and it is rarely operative as it reads.

(3) All work during its progress shall conform truly to the lines and levels given by the Engineer and shall be built in accordance with the plans and directions given from time to time by him, subject to such modifications and additions as shall be deemed necessary by him during its execution, and in no case shall work in excess of the plans and specifications be paid for unless ordered in writing by him.

This clause is often made a part of the clause just preceding, except for the last phrase. Section H of the contract deals with extra work more specifically.

(4) The Contractor shall not (except after consent from the proper parties) enter or occupy with men, tools, or materials, any land except that belonging to or taken by the city. The Contractor shall, whenever so required by the Engineer, erect fences along the roadways and around the ground occupied by him and of such a character as will be sufficient for the protection of the adjoining property.

This clause is really included in clause Q, since a violation involves a suit for trespass, for which among others clause H is provided. The party of the first part should be sure that rights of way are secured before the contractor begins work; otherwise the contractor may recover for the inevitable delay. Without this

clause, the contractor is personally liable for trespass if he deposits earth or rubbish on an adjoining lot, and the party of the first part is liable only when the work done according to the specifications becomes a nuisance or a permanent injury to such estates.

(5) Whenever it is necessary to interfere with roads or railroads the Contractor shall, at his own expense, provide suitable and safe bridges or other sufficient accommodation for the travel on said roads and shall maintain the same in good and safe condition until the roads shall be restored, when he shall remove all bridges and other temporary expedients and restore said road to conditions suitable for use, all to be satisfactory to the Engineer.

This clause, while apparently placing the burden of maintaining traffic on the contractor and relieving the city of its natural obligation to keep its streets in a safe condition for travel, has been variously interpreted by the courts on the ground that any accident may be the result of the work itself and not of its unskillful performance. The courts have held that the city is liable if injuries occur on account of neglect of proper precautions. This does not, however, relieve the contractor of liability if he or his servants have been negligent or careless in the performance of his contract.

The Contractor shall give reasonable notice to the owners of railroads and private ways before interfering with them. He shall provide watchmen, red lights, and fences, at his own expense, and take such other precautions as may be necessary to protect life and property, and shall be liable for all damages occasioned in any way by his act or neglect or that of his agents, employees, or workmen.

This second part of the clause is probably unnecessary. The liability for accidents or damages is referred to in clause Q of the contract, and carelessness or negligence would make him liable in the eyes of the law, without such a clause.

EXCAVATION.

(6) Trenches for sewers and appurtenances shall be excavated in all cases in such manner and to such depths and widths as will give proper and sufficient room for building the structures they are to contain and for sheeting, pumping, draining, or placing any artificial foundation for the structure.

It is questionable if this is necessary. The contractor ought to be allowed to open and dig his trenches as he thinks best, provided the structures they contain are not interfered with.

Trenches shall be opened in accordance with the lines and grades given for the work, on such locations, at such times, and only so far in advance of the work as may be required by the Engineer. But no trench shall be at any time open for a length greater than three hundred feet from the point where the back filling is complete to the solid ground at the end of the trench, without the written permission of the Engineer.

Here again it is questionable whether the engineer ought to be allowed to dictate to the contractor how the work shall be prosecuted, in what order, or in what length of trench. The author, however, had great trouble with one contractor, who paid subcontractors for trenching and pipe-laying and filled in the trenches himself at his convenience. This resulted at times in an unnecessary interference with travel throughout the city, and this clause has been used with good effect to prevent such a recurrence. In streets with heavy traffic the open trench distance might properly be reduced to one hundred or even fifty feet.

All excavations shall be open cut from the surface and no tunneling will be allowed except permission be previously obtained from the Engineer.

This clause is intended to preserve the integrity of the street. In some soils it saves the cost of sheeting to dig an open trench about eight feet long, then pass by four feet and dig again, tunneling through the four feet of solid earth, which acts as a brace to keep the trench from caving. The objection is that the tunnel is not refilled solidly and may afterwards settle. If it does not settle, it gives a different surface from the trench part, making the street uneven.

(7) All surfacing materials from excavations, including pavement, paving, gravel, road-metal, soil, turf, etc., shall be carefully removed and kept separate, to be used in repairing or resurfacing the streets, road, or ground.

This clause requires the contractor to throw out on one side of the trench the surface material, whether that be loam or street

surface, so that it may be used separately when the trench is refilled. It usually costs the contractor nothing but a little foresight.

(8) The materials excavated and those used in construction shall be so placed as not to endanger the work, and so that free access may be had at any time to all parts of the trench and to all hydrants and gates in the vicinity. They shall be neatly piled and trimmed so as to inconvenience as little as possible the public travel or the adjoining residents. All streets, roads, railroads, and private ways shall be kept open for the usual travel, and the materials excavated shall be so handled and placed as not to unnecessarily interfere therewith.

This clause has to do with the convenience and æsthetic feelings of the public rather than with actual dangers. Sometimes the contractor is obliged by this clause or by one similar to place boards or canvas on a lawn before excavation is begun. Ready access to hydrants and water gates is imperative, although without oversight laborers will bury a hydrant completely if placed suitably. The private ways are usually driveways into private property which may be blocked by a pile of dirt.

(9) The bottom of the trench, when the nature of the earth permits, shall be excavated to the exact form and size of the pipe to be laid therein. Additional excavation shall be made at the joints of pipe sewers so that the pipes shall have a continuous and even bearing and the pressure from above be distributed through them equally and evenly.

The provisions of this clause ought to be carried out, but in the case of pipe sewers it is rarely done. With brick and concrete sewers, it is for the interest of the contractor to have a solid bearing for the masonry, and the excavation is made as desired. But it is an exception even with this clause to have any other than a flat bottom for the trench and satisfactory bell holes are equally rare. Nevertheless they should be required.

(10) Should excavation below grade line be considered necessary for foundation by the Engineer, such extra excavation shall be done by the Contractor, for which he shall be paid as provided in Article O, item —.

Other material shall be deposited in place of that removed, as provided in Article G, item —.

It is manifestly unfair to require a contractor to bind himself to excavate an unknown amount of soft material from the bottom of a trench at the bidding of the engineer. This clause provides that he shall do such excavation if required, that he shall be paid for it at a definite prearranged rate, and that material shall be substituted for that removed, also at a definite price.

(11) When rock is encountered it shall be uncovered and after it has been measured, shall be taken out so to be at no point at a depth less than six (6) inches below the grade of the sewer.

This is a common requirement. It is supposed to give a better bearing for pipe than if the pipe were allowed to rest at one point upon rock and at another on earth. There should be no ambiguity possible, however, as to the amount of rock excavation which is to be paid for nor as to the cost of furnishing and placing the dirt necessary for the six inches of refill, neither of which is here mentioned.

(12) All excavation will be measured or estimated either as earth or rock, the latter to include all boulders of one-half ($\frac{1}{2}$) cubic yard or more in volume. All other materials found in excavation, however hard, stiff and compact, including soft and disintegrated rock, which can be removed with a pick, will be estimated and paid for as earth.

In some cases where a contract for excavation of earth at a fixed rate per cubic yard has been made and where it has been shown by contractors and engineers that the material excavated was "hardpan," a material known and recognized as entirely distinct from common earth, and that it is customary for contractors to receive extra compensation for excavating it, the courts have allowed the contractor to recover what it is reasonably worth to excavate it.

(13) All excavation of rock, and of earth over rock, will be estimated and paid for as three (3) feet in width for all sizes of pipe. No allowances will be made for additional width at manholes or elsewhere.

This width should vary with the size of the pipe to be laid and with the depth of the trench. In shallow trenches for 6-inch pipe $2\frac{1}{2}$ feet width may be more equitable. For 24-inch pipe in a 10-foot trench, 4 feet would be nearer the width actually dug. It is self-adjusting, however, since the contractor will have a larger price per cubic yard if he thinks the width given is not as wide as he will excavate. The kind of rock also affects the width to be allowed, the sedimentary rocks allowing a narrower trench than the igneous rocks.

(14) The prices of earth excavation shall include the cost of removal, of delay from or damage occasioned by any timber or masonry structures, logs, trees or other obstacles, except rock as hereinbefore specified.

This clause makes (12) more specific, although it is not likely that a contractor would attempt to secure extra compensation because of buried logs. An old corduroy road a few feet below the surface, however, would be a great temptation to a contractor for a claim for "extras" except for this clause.

(15) Blasts shall be covered with mats and heavy timber, chained together, and other necessary precautions shall be taken for the protection of the works, buildings, and travel; caps or other exploders shall in no case be kept in the same place in which dynamite or other explosives are stored; and, in general, the precautions against accident from blasting shall be entirely satisfactory to the Engineer. No blasting shall be done within thirty (30) feet of the finished sewer.

The courts have held that an owner cannot perform any act on his own premises which is intrinsically dangerous and where the damage would be a necessary, probable or natural consequence. On the other hand, they have held that injury occasioned by negligent blasting of rocks by a contractor did not make the city liable. Probably under ordinary conditions the contractor would be liable for damages due to blasting without this clause, and it is wrong in principle for the engineer to direct the work of the contractor. The last sentence is due to the one instance of the fracture of a lot of pipe already laid, by the concussion of air in a deep

trench due to a heavy blast. A good many blasts are fired, however, within five feet of a finished sewer, the end being covered, without injury to the sewer.

(16) The Contractor shall be liable for all damages to persons or property caused by blast or explosives, or from neglect in properly guarding the trenches, and no compensation to said Contractor will, under any circumstances, be allowed for losses thus incurred.

The comment on the preceding clause applies also here. The clause is a good one in that it places definitely the responsibility. The author remembers a case of a gas main ignorantly broken, just before work stopped for the night, and how the claim of the contractor that it was inevitable on account of the location and that the large bill of the gas company should be paid by the city, was effectually resisted by reference to this clause.

(17) The Contractor shall at his own expense furnish, put in place, and maintain such sheeting, bracing, etc., as may be required to support the sides of all excavation (whether above or below the sewer grade) and to prevent any movement which could in any way diminish the width necessary for proper drainage or otherwise injure or delay the work; all slides and caves shall be at his cost.

Custom and usage would probably require a contractor who agreed to excavate a trench at a certain price per cubic yard to furnish the labor and material for sheeting without this clause. However, it is useful as making the sheeting a definite part of the contractor's work.

(18) If it is necessary to interfere in any manner with any water or gas pipes, drains, catch-basins, culverts, or other similar structures, public or private, the Contractor shall, at his own expense, sling, shore up, and secure and maintain a continual flow in said structures, and shall repair any damages done to any of said structures and keep them in repair until the final acceptance of the completed work, leaving them in as good condition as they were previous to this interference, and the said Contractor shall be liable for all damages or claims against the city arising from neglect or carelessness, or in any way arising from any interference with said pipes. While it is supposed that the location and size of pipes, drains, etc., are accurately shown

on the maps in the Engineer's office, it is not so guaranteed, and no claim shall be made by the Contractor on account of any pipe being found not in the position shown on the map.

The larger the city in which the work is to be done the more important does this clause become. In connection with the work on the New York subway, for example, the cost of keeping water pipes, gas pipes, sewers, etc., all properly working was no small item, and there should be no question as to the responsibility therefor.

(19) Care shall be taken not to move without the consent of the proper parties any water or gas pipes, culverts, telegraph, telephone, and electric poles or wires, buildings or other structures; and in crossing these, or in running parallel with, or near them, they shall be sustained securely in place until the work is complete and shall then be so treated as to render their condition as safe and permanent as before. If so directed by the Engineer, the location of any existing work shall be changed to meet the requirements of the sewer and appurtenances and new work shall be added, when necessary, to leave all in good working order. All the cost of such changes will be paid for as extra work solely on the valuation of the Engineer and depending on his decision as to whether the work is or is not incurred under this contract in the work required of the Contractor.

The clause discriminates between ordinary care of structures referred to in (18) and the work necessary to move any structure into a new location for the better construction or maintenance of the new work. It gives opportunity for an engineer to materially assist the contractor. For example, if a water pipe line is curved, bringing a part of it into the sewer trench where it must be supported, the engineer might direct the contractor to relay the water pipe in a straight line, taking it away from the sewer. In such a case the cost would be paid for as extra work. Otherwise the contractor would not only have the cost of slinging the pipe in his trench, but of the excavation in his trench, at a higher rate on account of the obstruction of the water pipe.

(20) The Contractor shall furnish sufficient pumping plant, and provide and maintain drainage in the trench satisfactory to the Engineer. In wet gravel or at such places as the Engineer may direct,

drain tile, to be furnished by the city, shall be laid by the Contractor along a graded bottom, the laying to be paid for according to Article O, item. Water shall not be allowed to rise on any masonry until the mortar has set at least twenty-four (24) hours, and no stream of water shall flow through newly laid pipes or over masonry until such time as the Engineer may direct. Sufficient pumping in the immediate vicinity of the new pipe joints shall be at all times maintained so that no joint shall be laid in water or have water on or around it until the cement shall have received its initial set.

The more the risk to the contractor can be eliminated, the nearer the proposals and the contract prices will be to the actual cost. The contractor should not be required to furnish an unknown number of feet of drain tile without special compensation therefor. It is unfortunate, however, that the clause as it stands gives opportunity for collusion between the engineer and contractor. If the former orders drain tile, the trench drainage costs the contractor nothing. If the engineer refuses to order drain tile, the drainage must be done by pumps at the expense of the contractor. It is to be hoped that in a clause of some future specifications the cost of pumping will be allowed the contractor at so much per thousand gallons, so that there may be no inducement to the engineer to require pumping or drain tile other than the effect on the quality of the work.

(21) All water from the sewer trench, and from any sewers, drains, water courses, etc., which may be interfered with, shall be conveyed to a suitable place of discharge in a manner satisfactory to the Engineer.

This requirement might seem unnecessary except that a contractor pumping water from a trench is not usually particular as to what becomes of that water. The clause authorizes the engineer to exercise supervision.

CEMENT.

(22) American hydraulic or Portland cement, as directed, will be furnished to the Contractor for use in the work.

This clause assumes that the city will furnish the cement. If the contractor is to furnish the cement, proper specifications may be found in Baker's "Masonry and Foundations" or in Engineering

Record for June 25, 1904, page 791, where the standard specifications proposed by the American Society for Testing Materials are given. Excellent specifications for the care and control of cement on work are given in Engineering Record, Vol. 50, p. 243, being those used on a concrete arch bridge in the city of Hartford, Conn.

(23) The Contractor shall keep all cement delivered to him raised above the ground several inches by blocking or otherwise, and properly and tightly covered from exposure to the weather and dampness. The Contractor will be held responsible for any loss or damage to the cement after its delivery to him at the railroad, steamboat or storehouse, as the Sewer Board may select, and all haulage from station, wharf or storehouse shall be at the expense of the Contractor.

This clause is essential if the contractor does not furnish the cement, since otherwise he will not properly care for it after it has been brought on the work.

SAND.

(24) The sand for use in the mixture of cement mortar shall be furnished by the contractor. It shall be clean, screened, sharp sand, free from loam, vegetable matter or other foreign substances, and satisfactory to the Engineer.

There is a growing tendency to make this clause more definite by naming the per cent of foreign matter allowable in the sand, thus taking from the engineer the absolute power given by the clause as it stands. Five per cent of clay has been named as a suitable maximum amount.

MORTAR.

(25) The sand and cement used to make mortar shall be thoroughly mixed, dry, and unless otherwise directed by the Engineer, in the following proportions: for sewer pipe joints, one part by measure of cement to one part of sand; for covering pipe joints, one part by measure of cement to three parts of sand; and for all other purposes one part by measure of cement and two parts of sand. A moderate amount of water shall afterwards be added to produce a paste of proper consistency, and the whole shall be thoroughly worked with hoes or other tools. A fair compensation, as determined by the Engineer, will be made to the Contractor for variations of the above

proportions. The Contractor shall at his own expense furnish the water for mixing mortar and for all other purposes. The mortar shall be freshly mixed when used, that is, shall be made only in sufficient quantity for the work in hand in proper boxes made for the purpose. No mortar shall be used that has begun to set or become hard. All such mortar shall be thrown away and not used in any capacity on the work.

It is far better to have the proportions fixed beforehand than to name one mixture in the specifications and then use another on the work, the engineer deciding what extra compensation the contractor is entitled to because of the change. See also comment on (22).

CONCRETE.

(26) Concrete shall be used in the foundations, around pipes, and for other purposes wherever required by the Engineer. All material necessary to make the concrete, except cement, shall be furnished by the Contractor.

Since this contract assumed a unit price for the concrete it was important to specify where the concrete would be used, since its cost would vary with the location. In some kinds of work there should be a number of items in the contract, each giving the price of concrete for a different place.

(27) The concrete shall consist of pebbles or broken stones of various sizes; and shall be mixed in the following proportions: five (5) parts by measure of broken stone to two (2) parts of sand and one (1) part of cement. The broken stone shall be firm and sound and free from clay and other objectionable material. No piece shall be greater than two (2) inches or less than one-quarter ($\frac{1}{4}$) inch in diameter. The above proportion shall be varied, if so desired by the Engineer, and a fair compensation given the Contractor for said change, as determined by the Engineer.

This again allows the engineer to vary the proportions and to be the sole judge of the compensation, if any, to be granted the contractor—a bad principle. This is not a complete specification, no distinction being made between gravel and broken stone and no statement being made as to whether the cement is to be measured in the original package or loose.

(28) The mixing shall be done in proper boxes, in a manner satisfactory to the Engineer, and after the materials are wet the work must proceed rapidly until the concrete is in place and so thoroughly rammed that water flushes to the surface and all the interstices between the stones are entirely filled with mortar. Should voids be discovered, when the forms or molds are removed, the defective work shall be removed and the space refilled with suitable material, satisfactory to the Engineer. It shall be allowed to set for a sufficient time, to be determined by the Engineer, before walking over or working upon it will be permitted. Where forms are required to hold the concrete in place they shall be set true to the line and shall be securely fastened so that they will not get out of place while the concrete is being laid.

This clause is entirely inadequate for any large work. The method of mixing, or some test for its thoroughness, should be specified.

(29) The quantity of concrete to be paid for will be determined by measurements of the number of cubic yards of concrete deposited in place, in conformity with the plans and directions of the Engineer. An account shall be kept of the number of barrels of cement used, mixed as above specified, and the Contractor will not be allowed for the concrete at a greater rate than twenty-one cubic feet of concrete per barrel of cement used.

This clause is inconsistent with itself. It was so written because it was expected that a large part of the concrete would be used in and around sewer pipes where exact measurements of the volume of concrete in place would be impossible, but it was not satisfactory. It would be better to have the amount used actually measured in a box if place measurement is not feasible.

BRICKWORK.

(30) All brick shall be of good quality, hard burned, common red brick. The brick shall be thoroughly wet just before laying, every brick being completely bedded in mortar on its bottom, sides, and top, at one operation. The joints shall not exceed $\frac{3}{8}$ inch.

The outside of all walls or sides of all arches, foundations, or man-hole walls, or where directed by the Engineer, shall be plastered with Portland cement mortar, at least $\frac{3}{8}$ inch thick. All internal joints

shall be raked in and thoroughly smoothed with mortar. All brick courses shall be kept level, bonded, and laid to line, either plumb or to the batter required by the drawing.

This clause was intended for manhole brickwork and is inadequate for the brickwork of a large sewer. The quality of the brick ought to be more specific. The thickness of joints named is not possible on the outside of a manhole wall, much less of a small brick sewer. The surfaces to be plastered ought not to be named by the engineer, but should be all named in the contract.

IRON.

(31) The cast iron used for manhole covers shall be tough and have a tensile strength of not less than 18,000 pounds per square inch, with a light gray fracture. The castings shall be free from cracks, blow-holes or other imperfections, straight, true to pattern, and have a workmanlike finish. The castings shall be thoroughly cleaned and coated with asphalt varnish, of approved composition, and shall be of the weight, shape and dimensions shown on the drawings.

This is a customary clause but poor in many respects. No provision is made for test pieces and therefore it is not likely that the tensile strength of the iron will ever be examined. The strength as a whole might well be tested by dropping a weight of specified amount on the center of the cover as it rests in place on the frame. The possible variation in weight or dimensions from those shown on the drawings should be stated so that no question of the proper rejection of light-weight castings can arise.

SEWER PIPE.

(32) The main sewer shall be constructed of the best quality of salt-glazed, vitrified, stoneware sewer pipe, and all special pieces or specials which may be required in the work shall be of the same description and quality. The pipes and specials must be submitted to a careful inspection and must conform to the following conditions, viz.:

(33) All hubs or sockets must be of sufficient diameter to receive for their full depth the spigot end of the next following pipe or special without any chipping whatever of either, and also to leave a space of

not less than $\frac{1}{8}$ inch in width all around for the cement mortar joint. Pipes and specials which cannot be thus freely fitted into each other will be rejected.

(34) All pipe shall be in sections not less than two and one-half ($2\frac{1}{2}$) feet in length, and preference will be given to sections three (3) feet in length. The sockets for six (6) and eight (8) inch pipe shall be at least two and one-half inches deep, and no divergence from a truly circular cross section will be allowed.

(35) Any pipe or special which exhibits fire cracks of a size calculated, in the opinion of the Engineer, to injure the pipe, will cause said pipe to be rejected.

(36) Any pipe or special which is found to be cracked through its whole thickness from any other cause except the process of burning in the kiln shall be rejected at once, regardless of the extent of such crack. This refers particularly to damage done by transportation, by cooling, or by frost.

(37) Irregular lumps or unbroken blisters on the interior surface of a pipe or special, of sufficient size and number to form an appreciable obstruction to the free flow of the sewage, will be cause for rejection. Small broken blisters placed at the top of the pipe will not be cause for rejection, but large broken blisters, even if the pipe be so laid as to bring such blisters on the top of the sewer, shall be cause for rejection.

(38) Any pipe or special which betrays in any manner a want of thorough vitrification or fusion, or the use of improper materials and methods in its manufacture, shall be rejected.

(39) All pipe and specials which are designed to be straight shall not exhibit any material deviation from a straight line and shall not vary more than three-eighths ($\frac{3}{8}$) inch from a straight line in a length of two and a half ($2\frac{1}{2}$) feet. Special curves and bends shall substantially conform to the degree of curvature and general dimensions that may be required.

(40) If a piece be broken out of the rim forming the hub or socket of a pipe or special without injuring the body of such pipe, the latter shall be rejected if the length of said broken piece, or the gap left thereby, is greater than one-tenth of the circumference of said hub. In case a defect of this nature and within the limits just defined occurs in a pipe or special, the latter shall also be rejected unless it can be so fitted in the sewer as to bring said defect on the upper part thereof.

(41) Pipe to be used in the work shall be inspected when being laid, and the Contractor may not require inspection at any other time or place nor shall an inspection at any other time relieve the Contractor from his responsibility to use only pipe as specified.

In Johnson's "Specifications" may be found details of the permissible size of fire cracks and of blisters, the original specifications having been formulated by Emil Kuichling of Rochester. (35) and (37) would by his specifications be perfectly definite and not subject to the opinion of an individual. If the clauses above given are used, the Kuichling detailed definitions might well be given to the inspectors to guide them in knowing, for example, what are "large blisters." (41) is inserted because the contractor, to get his rebate on pipe broken in transit, often wishes the pipe inspected as they are taken out of the freight car. Then he demurs if pipe accepted then are afterwards rejected, although transportation by wagon from car to trench cracks and breaks many pipe.

PIPE LAYING.

(42) The pipes and specials shall be so laid in the trench that after the sewer is completed the invert shall conform accurately to the grades and alignments fixed and given by the Engineer.

This is a poor clause. The pipe is continually tested as it is being laid by the inspector or engineer's assistant, and the contractor might very well say, if in some way it should be found that the pipe after being laid was not true to grade, that he had exercised no control and therefore could not be held responsible. Again, if settlement occurs, the contractor, under the specifications, should not be held responsible, since the engineer, not he, is charged with pronouncing on the character of the foundation. This question led to an interesting lawsuit in New Orleans (1907) in which the opinion of the contractor was upheld by the courts.

(43) All pipes and specials shall be laid to the grade given by the Engineer and in such manner as he directs, with joints close and even, butting all around, special care being taken that there is no sagging of the spigot end in the hub, and that a true, even surface is given to the invert throughout the entire length of the sewer. A narrow gasket of jute shall be provided by the Contractor, to be well soaked in neat

cement grout and introduced between the hub and spigot, and well and properly rammed. It shall in all cases be driven to the bottom of the hub to leave room for the mortar as specified. The space between the spigot and hub shall then be entirely filled with mortar thoroughly pressed in on the bottom, sides, and top, and every precaution taken to secure a water-tight joint. The mortar shall be applied with a rubber mitten and rammed or compacted with a wooden calking tool. The joint shall be finished with a neat and generous bevel made with the mitten. After the joint is thus made, a covering of cement mortar (one to three) shall be placed around and under the joint, said covering to be at least two inches in thickness from the bell entirely around the pipe. The interior of each joint shall be scraped clean of all projecting mortar, and, when the size of pipe permits, pointed. No length of pipe shall be laid until the previous length laid has had sufficient fine earth filled and tamped around it to securely hold it in place so as to prevent any movement or disturbance. If, in making any joints, previous lengths are moved or disturbed so as to break joints made and covered, the pipe and joints shall be uncovered and the joints remade.

For pipe sewers, this is the most important clause in the specifications. The value of the sewer system depends on the tightness of the joints. Yet contractors usually assume that so long as the pipe are placed in the trench and a little cement wiped over the top of the joint, the engineer ought to be satisfied. If only the mortar were made barely plastic and then rammed into the joint with a wooden stick until the joint space was filled, a tight joint might be expected. Similarly, the provision that pipes newly laid shall not be disturbed is rarely observed, although freedom from disturbance is essential if the joints, once made, shall set without cracks or breaks.

(44) When necessary, in order to facilitate the work and prevent disturbance of pipe already laid, pipes and specials shall first be properly fitted together in the order in which they are to be used, and marked before being lowered into the trench.

This is seldom done, although if two pipes were fitted together on the bank and cemented together, and after the joints had set, lowered into the trench as pieces six feet long, the number of poor joints would be much reduced.

(45) The drainage of the trench shall be so effected as not to allow a stream of water to run through the newly laid pipe, washing the mortar out of the joints.

This clause prohibits what is a very common practice with contractors. The clause should be strictly enforced.

(46) The price for laying sewer pipe shall include the placing and laying and properly plugging with stoppers of all branches or other specials in the manner and at the points required by the Engineer.

In wet ground a large amount of leakage comes from poorly plugged Y's. Special care should be taken to see that every Y and T is plugged and that not any are overlooked.

(47) Before leaving the work at any time the sewer shall be securely closed at its open end, and after the work is completed the pipe shall be carefully and thoroughly cleaned of all refuse, earth, stones and rubbish.

To this clause might properly be added the requirement that a cleaner of some definite description be kept in the pipe and dragged ahead as the work progresses.

(48) The length of pipe to be paid for will be determined by measurements of the number of lineal feet actually laid, except that no deduction will be made for pipe left out at manholes.

This is incomplete in two respects. It does not say whether the measurements are to be made horizontal or on the grade of the sewer, the latter being proper, nor does it say whether the lengths of Y's and T's are to be included. In section O the price for Y's is stated to be "in addition to the cost of straight pipe," but a statement to that effect should properly be included here.

(49) The right is reserved to connect any lateral sewer or sewers with the sewers herein specified or to grant permits to any person or persons to make house connections therewith at any time before the final completion of the work, and said Contractor shall not interfere with or place obstruction in the way of such persons as may be employed in building such sewer or sewers or in making such connections.

Such a practice as is suggested by this clause is a mistake because it gives the contractor ground for claiming that his work has been

accepted when connections are made to it, and because it may allow the contractor to claim damages or avoid his own obligations, in the case, for example, of a connection bringing a deposit of mud into a sewer line which has itself not been properly cleaned out.

(50) Manholes of hard brick laid in cement mortar shall be constructed at such points as may be designated, by and according to directions and plans given. The brick shall have a crushing strength of at least 5,000 pounds per square inch and shall be laid with lines and templates to agree with the drawings provided by the Engineer. The manholes will generally be four (4) feet in diameter at the bottom in the clear and diminish to two (2) feet in diameter at the top of the masonry, which shall be eight (8) inches below the grade of the street, and they shall be fitted with a cast-iron head and cover, and such other metal work shall be used as may be directed. The Contractor shall furnish the iron and metal work as provided in Section 31 according to the drawings of the Engineer, the manhole covers to be paid for according to section O, item —.

Some of this is included in section 30, and except that it is desirable to have a section specifying the use of manholes, this whole clause might be omitted. The first and last sentences are the important ones.

(51) The Contractor shall build into each manhole, at points as directed, one or two lengths of eight (8) inch pipe for future connections with the lateral sewers, to be closed with a stoneware cap set in cement. The cost of such pipes and caps and all the labor connected therewith shall be included in the cost of the manhole and no additional compensation will be allowed therefor.

This clause applies to trunk sewers where the connecting laterals are not to be built at the same time. The matter of steps should be included in this clause or in the one preceding.

(52) The floor and invert shall be built of concrete or brick, as directed by the Engineer, the invert having a cross section of the exact shape of the inverts of the sewers which it connects; changes in size shall be made evenly and gradually, and shall in all ways conform to the drawings furnished.

It might be desirable to specify whether the contractor would be allowed to form the inverts by hand or whether the engineer

would require the use of forms. The use of split pipe might also be included.

(53) The brickwork in the walls shall be eight (8) inches thick throughout, unless otherwise ordered by the Engineer, and shall be smoothly plastered on the outside with a three-eighths ($\frac{3}{8}$) inch coating of Portland Cement mortar.

If manhole walls thicker than 8 inches are to be used with deep manholes, it ought to be specified and not left to the engineer, who by this clause might require the contractor to build them all with 12-inch walls, although the contractor's price was based on 8-inch walls.

(54) Each manhole, on its completion, shall be thoroughly cleansed of all refuse or rubbish and shall be so kept until the final acceptance of the completed work.

This is to prevent the dirt being gradually washed into the sewer pipe where it may lie undiscovered.

BACK FILLING.

(55) The trench and other excavations shall be refilled with such excavated material, and in such order, as may be from time to time directed by the Engineer. In covering the sewers and filling around manholes, the earth shall be brought up evenly on both sides of the sewers and around manholes so that no unbalanced pressure is brought to bear upon the masonry or pipe. The filling about all pipes, and for a depth of two (2) feet over them, shall be made of earth, free from stones, thoroughly and carefully rammed, in layers not exceeding four (4) inches, and special care shall be taken in filling, about and under as well as over all pipe, that the earth is thoroughly compacted to the full width of the trench, and no voids or pockets of soft, compressible material left under or about the sewer. Back filling shall be spread in layers not exceeding one (1) foot in thickness, unless otherwise specified, and shall be well watered and rammed. Or, when an abundance of water can be obtained and the Engineer so directs, the filling shall be thrown into the trench and allowed to settle into place through a suitable depth of water. A careful and thorough settling of the earth back into the trench, by ramming or otherwise, will be insisted upon, and the amount of surplus dirt over the refilled trench shall not be such at any time as to offer any obstruction to

driving or to such a complete use of the street as was had before the excavation. No stones larger than one foot in diameter shall be used in back filling, and all stones used in filling must be separately surrounded with earth filling. No frozen earth shall be used for filling.

This clause is not entirely satisfactory but neither is any other on this subject. Some engineers specify the number of rammers to be employed; others require all the dirt excavated or a certain part of it to be replaced; and others require the contractor to keep the surface in good order for a long period. It is impossible in a rock trench to have the stones used in filling separately surrounded with earth, though it is a proper requirement for boulders found in clay loam. The last sentence also has to be often violated, although, when the lumps thaw out, the trench generally settles.

(56) That portion of the sheeting extending below the top of the pipe must be withdrawn, unless otherwise ordered by the Engineer, and before the back filling has been carried more than one foot above the top of the pipe. As the trench is being refilled, the sheeting, etc. shall be so removed as to avoid the caving in of the trench. The vacancies left by the sheeting shall be carefully refilled by ramming with tools especially adapted for the purpose, and by watering or otherwise as may be directed.

This clause is intended to prevent holes being left on one side of the pipe so that by unbalanced pressure the pipe might be crowded out of line. If the sheeting is not withdrawn before the filling has progressed very far, the holes left will not be well filled. In a recent case which came to the attention of the author, the contractor was allowed to leave about \$4000 worth of sheeting in a trench, where this clause might have been enforced and that amount saved.

(57) When the Engineer decides that the sheeting or bracing cannot be removed without injury to the work, it shall be left in place and the Contractor will be paid for the same as provided in Article O, item 13. But no sheeting will be paid for unless a bill for the same accompanied by the written order of the Engineer be presented within one month from the time that the sheeting is placed in the trench.

The question of extra work, to which this clause pertains, is taken up under Section H. A contractor will leave sheeting in

place rather than draw it if he has hopes that the engineer may approve his bill for it. The engineer on construction ought to make it very clear whether he means to indorse such a claim, since silence is often taken by the courts to mean assent.

(58) In case sufficient suitable material for the refilling is not furnished by the excavation of the trenches, that which is suitable will be provided by the city and shall be hauled and placed by the Contractor. If the haulage of such material exceeds a distance of five hundred feet an allowance of three-quarters of a cent per cubic yard will be made for each one hundred feet of haul over and above five hundred feet.

This clause is a logical necessity if the provisions of (55) and (11) requiring the pipe to be bedded in earth even in rock trenches where excavation has been carried six inches below the pipe are to be carried out. Practically it is seldom enforced. If frozen clay should be objected to for back filling, this clause might be used to have the filling made with sand or gravel.

(59) All surplus earth or other material shall be removed by the Contractor unless claimed by the city. If such extra material be claimed by the city, it shall be hauled and deposited at such points as the Engineer may direct, within a distance of five hundred (500) feet, without extra compensation to the Contractor. If the length of such haulage exceeds five hundred (500) feet, an allowance of three-quarters ($\frac{3}{4}$) of a cent per cubic yard will be made for each one hundred feet of haul over and above the five hundred (500) feet. If excavated rock or sand be removed by the city, making a deficiency of back filling at those particular points, such deficiency of back filling will be made good by the city.

As a matter of law, any extra material excavated by the contractor is the property of the abutters if their title extends to the center of the street, and this clause would hold only by the waiver of the abutter's rights. If the contractor, for example, should dig up a lot of sand or gravel to use on other parts of the work, the abutters could appropriate it, pile it up on their lots, and defy both the city and the contractor to touch it.

(60) The surface of the ground in streets and elsewhere shall in all cases be left in as good condition as it was before the commencement of the work, and except by written permission of the Engineer, the street surface in a given block shall not be disturbed for a longer time than six days, and no new trench in any part of the work called for in this contract shall be opened without special direction from the Engineer, should the surface of the street within said block be disturbed for more than the specified period of six days. When the surface is of gravel or broken stone, it shall be well rolled with a heavy roller; the whole work of refilling and resurfacing, of relaying brick or other pavement with their foundations, shall be done in a manner to prevent, as far as possible, after-settlement. The Contractor shall keep the street service over and along the trench and other excavations in a safe and satisfactory condition, and shall be responsible for any accident that may occur on account of any defective condition of said surface. All fences and other structures in the vicinity shall be repaired or replaced. All trees in the vicinity shall be protected.

This requirement that work shall be completed within six days in one block cannot be strictly adhered to and therefore perhaps should not be included. But it is of great service in the case of a contractor who finds one part of the work difficult and therefore wishes to let it drag while he pushes other and more profitable parts of the work to completion.

(61) Whenever the sewer is laid under a brick pavement which is required to be taken up and relaid, an allowance to the Contractor of eight (8) cents will be made for each linear foot of pavement relaid.

It was expected that eight cents would be a fair compensation for relaying the pavement, but it was too low. Probably twelve cents would be a better estimate of its cost.

(62) As the work progresses, all rubbish and refuse and all unused material and tools shall be removed at once from the ground. Whenever this cleaning of rubbish from the street, or the repairing of the street surfaces, fences, or other damages is neglected, the Engineer will give notice to that effect to the Contractor, and if such rubbish is not removed, or if said repairs are not done within two days thereafter, or if the said Contractor does not at once take the necessary precautions to ensure the safety of travel, the Engineer may employ other parties to do such work and the expense thus incurred will be deducted from any money due or that may become due the Contractor.

The process of cleaning up is one which seems generally obnoxious to a contractor. The clause gives to the engineer power to remedy dangerous conditions, but he should be slow to do anything not immediately needed. Otherwise the contractor may claim excessive cost or undue refinement in the work, and it is a temptation sometimes for the engineer to make the street surface even better than at the beginning at the expense of the contractor.

(63) When for any reason the work is left unfinished, all trenches and excavations shall be filled and the roadway and sidewalks be left unobstructed and with the surface in a safe and satisfactory condition.

If this happens on account of a change of plans or is the fault of the city or its engineer, the city should pay for it. Nothing is said in the clause about who is to pay for the refilling.

GENERAL.

(64) The Contractor shall use such appliances for the performance of all the operations connected with the work embraced in this contract as will secure a satisfactory quality of work and maintain a rate of progress which, in the opinion of the Engineer, will secure the completion of the work within the time herein specified. If at any time before the commencement or during the progress of the work such appliances appear to the Engineer to be inefficient or inappropriate for securing the quality of work required, or the said rate of progress, he may order the Contractor to increase their efficiency or to improve their character and the Contractor must conform to such order. But the failure of the Engineer to demand such increase of efficiency or improvement shall not relieve the Contractor from his obligation to secure the quality of work and the rate of progress established in these specifications.

This clause is a warning clause of which section P is the logical sequence if no improvement is secured. It is a useful club, although of itself it probably would have but little weight.

(65) Whenever the Contractor is not present on any part of the work where it may be necessary to give directions, orders will be given by the Engineer to, and will be received by, the superintendent, overseer, or foreman of the Contractor who may have charge of the particular work in relation to which the orders are given.

In spite of this clause, directions should always be given to the contractor rather than to his employees. Responsibility for the work hinges upon its control, and if the contractor is to be held responsible he must not be unwisely interfered with, nor orders given to his employees differing from those he has already given except by virtue of pressing necessity.

(66) Any unfaithful or imperfect work that may be discovered before the final acceptance of the work shall be corrected immediately on the requirement of the Engineer, notwithstanding that it may have been overlooked or approved by the proper inspector.

(67) The inspection of the work shall not relieve the Contractor of any of his obligations to perform sound and reliable work as herein described. And all the work, of whatever kind, which during its progress and before it is finally accepted may become damaged for any cause, shall be properly taken up or removed, so much of it as may be objectionable, and be replaced by good and sound work satisfactory to the Engineer.

The courts have held that if the inspectors are clothed with the authority usually bestowed upon engineers in construction contracts and the work has been accepted and no fraud has been practiced by the contractor, the city cannot recover for defective work or materials afterwards discovered. But the failure of an inspector to note defects, or the monthly certificates of the engineer, do not constitute a waiver of defects in quality.

(68) And it is further agreed that if the work, or any part thereof, or any material found or brought on the ground for use in the work, shall be condemned by the Engineer as unsuitable or not in conformity with the specifications, the Contractor shall forthwith remove such materials from the work, and rebuild or otherwise remedy such work as may be directed by the Engineer.

In order to make this clause effective, there must be definite specifications as to the quality required. If the materials or workmanship meet the spirit of the specifications, the engineer cannot order changes when he finds that the results are not as good as he wished.

(69) The Contractor shall neither bring nor allow others to bring any spirituous or fermented liquor or other intoxicants upon the ground occupied for the prosecution of the work. Neither shall he furnish or allow others to furnish liquor or other intoxicants to the workmen in his employ or to any person or persons in the vicinity.

This clause is probably not usually justifiable. The police power of a city can deal with drunkenness, and the engineer needs this clause only when the employment of a drunkard endangers the quality of the work.

(70) Any workman, in the employ of the Contractor, who shall be, in the opinion of the Engineer, either detrimental to the good of the work by willful disobedience or careless disregard of orders, or who shall be persistently offensive to the community where work is being carried on, in his language or habits, shall be dismissed by the Contractor and not again be employed.

“If the party of the first part retains the power to select and discharge the workmen and can control them in the discharge of their duties, it may justly be regarded as responsible for their misconduct and negligence” and this in spite of clauses to the contrary. The *results* of the work may properly be specified, and the engineer may give directions from time to time if necessary to secure such results, but the engineer should not retain present control of the mode, manner, or means of doing the work. This principle should be well established in mind before advantage is taken of this clause. Work badly done is justification for complaint by the engineer, and if the bad work is due to incompetent workmen, the clause may be properly enforced. It is questionable if it would be wise to insist upon the clause against profane workmen who did their work well, but recourse should be had to city ordinances bearing on profanity, indecent language, etc.

(71) Necessary conveniences, properly secluded from public observation, shall be constructed on the work wherever needed for the use of the laborers.

With some contractors this is not necessary; with others it has to be rigidly enforced by the engineer.

H. No claim for extra work shall be considered or allowed unless the same is approved and ordered by the Engineer and the Board shall authorize in writing such extra work. All claims for extra work done in any month shall be made to the Engineer, in writing, before the 15th day of the following month, or if a specific claim is not then possible, a written notice shall be made that extra work has been done for which a claim will be made as soon as is practicable.

And the said Contractor further agrees that if he and the said Board are unable to agree on the value of such extra work, the said Contractor will not in any way interfere with or molest such other person or persons as the said Board may employ to do such work; and that the said Contractor will suspend such part of the work herein specified, or will carry on the same in such manner as may be ordered by the said Engineer, so as to afford all reasonable facilities for doing such extra work; and no other damages or claim by the said Contractor will be allowed therefor, other than an extension of the time specified in this contract for the performance of said suspended work as much as the same may have been, in the opinion of the Engineer (to be certified in writing), delayed by reason of the performance of such extra work.

In spite of this clause, the courts have held that this agreement may be rescinded by mutual consent and a new oral agreement entered into as to changes or extras. This parol agreement to rescind may even be inferred from the acts and declarations of the parties. The mere fact of assenting to extra work does not necessarily render the party of the first part liable to extra charges, but if it has been informed or must necessarily have known from the nature of the work that the alterations would increase the expense, silent assent may be assumed to be an agreement to the waiver of this clause. The request of the party of the first part for the extra work is, however, essential. In the matter of the second part of the clause, it is not generally wise to employ workmen who may come in contact with, or affect in any way the work of, the contractor or his workmen. See comment on (49). If extra work is done under the direction of the engineer, it ought to be entirely separate and distinct and away from the work under contract.

I. And the said Contractor hereby further agrees to give personal attention to the faithful prosecution of the work, and that he will not assign or sublet the work, or any part thereof, without the previous written consent of the Board endorsed on this agreement, but will keep the same under his personal control, and will not assign, by power of attorney, or otherwise, any of the moneys payable under the agreement, unless by and with the like consent of the Board signified in like manner; that no right under this contract, nor to any moneys due or to become due hereunder, shall be asserted against the Board, or any person acting under them, or against the city of or any representative of said city, by reason of any so-called assignment in law, or equity, of this contract, or any part thereof, unless such assignment shall have been authorized by the written consent of the said Board, endorsed on this agreement; that no person, other than the party signing this agreement as the party of the second part hereto, now has any claim hereunder; that no claim shall be made, excepting under a specific clause of this agreement, by any person whatever; and that the said Contractor will punctually pay the workmen who shall be employed on the work.

This clause is commonly inserted and almost as commonly neglected. It has been held by the courts that if it can be proved that the engineer knew that subcontractors were at work, and had given estimates involving their work, a waiver of this clause was shown. An installment of money not yet due may be assigned to material men, for example, with due notice to the party of the first part, and subsequent creditors of the contractor can receive no advantage therefrom, in spite of this clause. The subject of mechanics' liens is pertinent in this relation and an engineer should have a general understanding of the subject. See legal books on liens.

J. The Board reserves the right of suspending the whole or any part of the work herein contracted to be done, if they shall deem it for the best interests of the city of so to do, without compensation to the Contractor for such suspension other than extending the time for completing the work as much as it may have been delayed by such suspension.

The courts have held that even with this clause the party of the first part may be liable for any injury which the contractor suffers by reason of the suspension of the work. The contractor by

promptly protesting against an order to suspend work puts himself in a better position to be awarded damages. It is manifestly unfair, when once a contractor has put in place an expensive plant and perhaps done a small amount of work, to suspend operations causing direct loss to the contractor, and an arbitrary suspension may be regarded as a breach of contract under which the contractor would be entitled to recover the cost of the work actually done with any prospective profits.

K. And the said Contractor further agrees to employ only competent, skillful men to do the work, giving preference, when other conditions are equal, to the employment of residents of the city of And that whenever the Engineer shall inform said Contractor, in writing, that any man on the work is, in his opinion, incompetent, or unfaithful, or disorderly, such man shall be discharged from the work and shall not again be employed on it.

See also comment on (70) of Section G.

The contractor is in any case bound by all laws and statutes of the state and by all ordinances of the city in which the work is to be done. Such clauses as those relating to the employment of citizens only, to the length of a day, to payment for extra time, etc., he must observe without specific clauses in the contract.

L. And the said Contractor further agrees that he will commence the work herein contracted to be done, within twenty days from the date of this contract; that the rate of progress shall be such and that he will so conduct the said work that on or before the whole work covered by this contract and specifications will be entirely completed.

And if said work is not completed on said date (or within such further time as may be allowed by the Board for such performance and completion) the Contractor will pay to the city the cost of all engineering, and all inspection and superintendence, that the Engineer may have found it necessary to incur after the time fixed for the completion of the work, as aforesaid, all of which shall be determined by the Engineer, and certified by him in writing, and such certificate, when made, shall be conclusive upon the Contractor, and the Board shall be and they are hereby authorized to deduct and retain the amount so certified, out of the monthly approximate estimate for work done, and out of the final estimate for the work when completed.

There is no doubt but that such a clause as this, the date being clearly expressed, is binding on the contractor. A specified sum as liquidated damages is usually regarded as a penalty by the courts and will seldom be upheld. The courts prefer to inquire into the actual value of the damages incurred, which, except for the reasons given in this clause, are often visionary and unsatisfactory.

M. In case the said Contractor shall fail to fully and entirely, and in conformity with the provisions and conditions of this agreement, perform and complete the said work, and each and every part and appurtenance thereof, within the time hereinbefore specified for such completion, or within such further time as may be allowed by the Board for such performance and completion, the said Contractor shall and will pay to the city the sum of ten dollars (\$10) for each and every day that the said Contractor shall be in default, in addition to the sum agreed to be paid for additional cost of inspection and superintendence, as provided in clause L hereof, which said sum of ten dollars per day is hereby agreed upon, fixed and determined by the parties hereto as the damages (over and above the additional cost of engineering, inspectors, and superintendence) which the city will suffer by reason of such default and not by way of penalty. And the said Board may deduct and retain said sum of ten dollars per day out of any moneys that may be due or become due under this agreement.

If an amount stipulated as damages be so exorbitant that to enforce its payment would be to inflict a penalty on the party in default, instead of making good the injury sustained by reason of the breach, it will not be enforced. If an additional compensation is allowed by the contract for completion before a certain date, then a reduction for non-completion is proper and will hold in law.

Waddell ("Specifications and Contracts," page 71) says that a clause such as this is seldom enforced owing mainly to the characteristic good nature of engineers and to the aversion of courts and juries to its enforcement. The engineer objects to taking advantage of a contractor who has worked faithfully but has been unfortunate.

N. But neither an extension of time, for any reason, beyond that fixed herein for the completion of the work, nor the doing and acceptance of any part of the work called for by this contract, shall be deemed

to be a waiver, by the said Board, of the right to abrogate this contract for abandonment or delay, in the manner provided in the paragraph marked P in this agreement.

This clause is intended to take away from the contractor the possibility of the claim that, because he had been granted an extension of time, or because a part of the work had been completed and accepted, therefore it was tacitly agreed that his work was satisfactory and any operation of clause P would be without reason. It is a delicate matter at best to legally enforce clause P without giving the contractor a good basis for a claim for damages, and this clause makes the operation of P more safe.

O. And the Board hereby agrees to pay or cause to be paid, and the Contractor hereby agrees to receive the following prices, in full compensation for furnishing all the materials and labor, and for completing all the work which is necessary or proper to be furnished or performed in order to complete the entire work in the contract as described and specified and in said specifications and plans as described and shown, to-wit:

For about.....cubic yards of rock excavation in trenches from the surface to a depth not exceeding six (6) feet, including the disposal of the material by removal or otherwise as may be required and all work incidental thereto, the sum of (\$.....) per cubic yard.

For furnishing and laying about.....lineal feet of 6" cast iron pipe, including all excavation and refilling and the disposal of all surplus material; all handling and laying of all pipe, furnishing all lead, yarn and other material needed for making proper joints; all pumping or bailing or otherwise disposing of water; all protection of water and gas pipes, bridges, culverts, drains, etc.; all resurfacing and repaving of streets, and all other incidental work, the sum of (\$.....) per lineal foot.

For laying complete about.....feet of six (6) inch pipe in trench from the surface to a depth not exceeding six (6) feet, including excavation for manholes and other structures appertaining to the sewers or drains and the disposal of the material by removal, or the refilling of the trenches (rolling, ramming and watering where required), including sheeting and shoring, bridging and fencing, and removal of same; all pumping or bailing or otherwise disposing of

water; all protection and restoration of buildings, bridges, fences, cisterns, culverts, drains, water and gas pipes, house drains, etc.; all resurfacing and repaving of streets, accommodation of travel and all other incidental work; including the furnishing of the corresponding number of lineal feet of first quality, salt-glazed, vitrified sewer pipe of size and quality specified, six (6) inches internal diameter, including all haulage and storage necessary before putting pipe in trench; including the laying of the corresponding number of lineal feet of pipe sewer including branches or inlets, gasket and tile stoppers (cement to be furnished by the Board), furnishing all tools, labor, and materials except cement, the sum of

..... (\$.....)
per lineal foot.

For excavation below the sewer grade for the purpose of placing timber, concrete or gravel foundations under the pipe to a depth not greater than one foot below said sewer grade, the sum of

..... (\$.....)
per cubic yard.

For about..... pounds of iron castings for manhole covers and frames, as per detail drawings, including the furnishing all patterns or molds necessary, the sum of

..... (\$.....)
per pound.

This clause must not be omitted, since it expresses the obligation of the party of the first part and without it there would be no contract. Five items only are given, but there should be an item for every unit price asked for in the work, such as each size of pipe, excavation at different depths, concrete for different purposes, etc.

P. The said Contractor further agrees that if the work to be done under this agreement shall be abandoned, or if the conditions as to the rate of progress hereinbefore specified are not fulfilled, or if this contract shall be assigned by the Contractor otherwise than is hereinbefore specified, or if at any time the Engineer shall be of the opinion, and shall so certify in writing to the Board, that the said work or any part thereof is unnecessarily or unreasonably delayed, or that the said Contractor is violating any of the conditions or covenants of this Contract, or executing said contract in bad faith, or if the work be not fully and entirely completed within the time herein stipulated for its completion,

the said Board shall have power to notify the aforesaid Contractor to discontinue all work or any part thereof, as said Board may designate; and the said Board shall thereupon have the power to place such and so many persons, and obtain by purchase, or hire, such materials, animals, carts, wagons, implements and tools, by contract or otherwise, as the said Board may deem necessary to complete the work herein described, or such part thereof; and to charge the expense of said labor and materials, animals, carts, wagons, implements and tools, to the aforesaid Contractor. And the expense so charged shall be deducted and paid by the city out of such moneys as either may be due, or may at any time thereafter be due to said Contractor, under and by virtue of this agreement, and in case such expense is less than the sum which would have been payable under this contract if the same had been completed by said Contractor, the Contractor shall forfeit all claim to the difference, and in case such expense shall exceed the first sum, then the said Contractor will pay the amount of said excess to the city on notice of said Board of the excess so due.

Wait says that the procedure contemplated by this clause should be used only as a last resort. Arguments, persuasion, coaxing, and threats and almost every expedient should be used to bring the contractor into line with the terms of his contract before this final step is taken. It practically amounts to the annulment of the contract by the party of the first part, which may be to the great advantage of the contractor. Haste in the matter is certain to be regretted, and every legitimate means should be employed to keep the contract whole. Otherwise expensive litigation and trouble even with the protection of this clause is almost certain to follow.

Q. And the said Contractor agrees, during the performance of the work, to take all necessary precautions and to place proper guards for the prevention of accidents, and to put and keep at night suitable and sufficient lights, and to indemnify and save harmless the said parties of the first part from all damages and costs to which they may be put by reason of injury to the person or property of another resulting from negligence or carelessness in the performance of the work, or on guarding the same, or from any improper materials used in its construction, or by or on account of any act or omission of the said Contractor or the agents thereof, and the Contractor hereby agrees that the whole or so much of the money due him under the agreement as may be considered necessary by the Board may be retained by the

city until all suits or claims for damages, as aforesaid, have been settled and evidence to that effect furnished, to the satisfaction of the Board.

Even with this clause, the party of the first part cannot entirely absolve itself from liability for injuries that ordinarily result from the work itself. The liabilities assumed by a contractor are usually those which can be avoided by the skillful, careful, and prompt performance of the contract or by the foresight, experience, and knowledge which a contractor is supposed to possess. If damages result from the performance of the work in the manner required by the contract, and not from any negligence on the part of the contractor, he would probably not be held liable by the courts, even with this clause.

R. And it is further agreed by the Contractor that he will furnish the Board with satisfactory evidence that all persons who have done work or furnished materials under this agreement, and who may have given written notice to the Board before or within 20 days after the final completion and acceptance of the whole work under this contract, that any balance for such work and materials is due and unpaid, have been fully paid or satisfactorily secured. And in case such evidence is not furnished, as aforesaid, such amounts as may be necessary to meet the claims of the persons aforesaid may be retained from the money due the Contractor until the liabilities aforesaid shall be fully discharged or such notice withdrawn.

This clause is required by ordinance to be inserted in New York City contracts. The right of a municipality to interpose between employers and the persons with whom they deal for the purpose of compelling the performance of contract obligations which the employers and the employees have assumed has been questioned. But there can be no doubt of the popularity of this clause in the case of an out-of-town contractor who is inclined to neglect to pay his local workmen and material men. See also comment on "I."

S. The said Contractor hereby further agrees that the said Board is hereby authorized to retain, out of the moneys payable to the said Contractor under this agreement, the sum of five per cent on the amount of the contract, and to expend the same as provided in

clause T in making such repairs on the line of said work as the Engineer may deem expedient.

The amount here given should vary with the character of the work. If there is competent inspection and no opportunity for hidden defects to show themselves there is no object in arbitrarily retaining money which the contractor has earned. But if trenches may settle, if a test of the work can only be had by actual trial under working conditions, then enough money to repair possible defects may properly be retained.

T. The said Contractor further agrees that if, at any period within six months from the first day of or from the date of the final completion of the work contemplated in this contract, if such final completion be delayed beyond that date, any part of said work shall, in the opinion of the said Engineer, require repairing, and the said Engineer shall notify the said Contractor in person, or by mail, to make the repairs so required, and if the said Contractor shall neglect to make such repairs to the satisfaction of the Engineer, within five days from the date of giving or mailing of such notice to the said Contractor, his agent or attorney, then the said Engineer shall have the right to employ such other persons as he may deem proper to make the same, and the said Board shall pay the expenses thereof out of the sum retained by it for that purpose as above mentioned. And the said Board further agrees that, upon the expiration of the said period of six months, provided the work at the time shall be in good order, the Contractor shall at that time receive the whole or such part of the sum last aforesaid as may remain after the expense of making the said repairs, in the manner aforesaid, shall have been paid therefrom.

Care must be taken to have the repairs under the meaning of this clause such repairs only as are due to negligence of the contractor. It would not be allowable, after a practical acceptance of a line of sewer pipe, with no previous objection to the character of the work, to re-excavate the trench for the purpose of improving the joints of the pipe. The repairs needed must be obvious and reasonable. The period of six months is a proper one for sewer work, since it generally allows the lapse of the winter between the final completion of the work and the final acceptance. On other work it might be either too long or too short.

U. In order to enable the Contractor to prosecute the work advantageously, the Engineer shall once a month, on or about the last day of each month, make an estimate in writing, of the amount of work done, and materials delivered, and of the value thereof, according to the items of this contract. The first such estimate shall be of the amount or quantity and value of the work done and materials delivered since the Contractor commenced the performance of this contract on his part. And every subsequent estimate except the final one shall be of the amount and value of the work done since the last preceding estimate was made. And such estimate shall not be required to be made by strict measurements or with exactness, but this shall be considered as approximate only. Upon such estimate being made, the Board will thereupon pay to the Contractor eighty per cent of such estimated value. And whenever the Contractor shall have, in the opinion of the Engineer, completely performed this contract on his part, the said Engineer shall so certify, in writing, to the Board and in his certificate shall state from actual and exact measurements the whole amount of work done by the said Contractor, and also the value of this work according to the terms of the contract. And on the expiration of thirty-one days after the acceptance by the Board of the work herein agreed to be done by the Contractor, the said Board will pay to said Contractor the amount remaining after deducting from the amount or value named in the last mentioned certificate all such sums as shall previously have been paid to said Contractor under any of the provisions of the contract, and also such sums of money as by the terms they are authorized to reserve or retain, provided that nothing herein contained shall be construed to affect the right hereby reserved by said Board to reject the whole or any portion of the aforesaid work, should the said certificate be found or known to be inconsistent with the terms of this agreement, or otherwise improperly given.

The percentage to be paid each month should depend on the work, whether it can be accurately measured, whether of itself it is of value, or whether, except as a part of the completed work, it is preparatory and incomplete in nature. A higher percentage may be paid for material than for labor. The engineer should not yield to importunities of the contractor for a large estimate on any occasion, since retribution for such partiality is sure to follow. It is especially unfortunate to have allowed the estimates to overrun if the work should be suspended or the contract broken.

V. The said Contractor further agrees not to demand or be entitled to receive payment for the aforesaid work or materials except in entire accordance with the manner set forth in the agreement, nor unless each and every one of the promises, agreements, specifications, forms and conditions herein set forth to be observed by said Contractor have been so far kept, observed and fulfilled; and the said Engineer shall have given his certificate to that effect, and the Board shall have accepted his work.

This is in effect saying that the contractor agrees to be bound by the terms of his contract, an entirely unnecessary statement. The clause is apparently superfluous, but is a proper legal provision to secure a prior performance on the part of the contractor, and to absolve the party of the first part from any obligation until after the performance by the party of the second part.

W. It is further expressly understood and agreed by and between the parties hereto, that the action of the Engineer by which the said Contractor is to be bound and concluded according to the contract shall be that evidenced by this final certificate; all prior payments being made merely upon estimates subject to the correction of such final certificate; which final certificate may be made without notice to the Contractor thereof, or by the measurements upon which the same is based.

Wait says that however much doubt there may be that a contractor can agree to abide the decision of an engineer, and that his decision shall be final, it is fully settled that he can make the payment for his work dependent upon the occurrence of some event; and a person may covenant that no right to payment shall accrue to the contractor and no liability attach to the company until a third person (engineer) has decided the amount due. If the contractor believes the certificate to be withheld by fraud, impossibility of performance, hindrance by the city, inducements to the engineer, or a refusal to act on the part of the engineer, he may appeal to the courts and if his belief is substantiated, recover at law.

X. And it is hereby expressly agreed and understood by and between the parties hereto, that the said Board shall not, nor shall any department or office of the city of . . . , be precluded or estopped

by any return or certificate made, or given, by any Engineer, inspector, or other officer, agent or appointee of said Board, or said party of the first part, under or in pursuance of anything in this agreement contained, from at any time showing the true and correct amount and character of the work which shall have been done, and materials which shall have been furnished by the said Contractor or by any other person or persons under this agreement.

This clause is hardly necessary, since if the party of the first part can show that the certificate of the engineer has been fraudulently given they would not be bound in any case. Otherwise the engineer's certificate, made honestly, though inexactly, has been held to be equally conclusive upon both parties. If for example his certificate includes extra work it is binding and conclusive, although the extra work may not have been ordered in writing as required by the contract. Since the engineer's certificate is in the nature of an arbitrator's award, it is generally held that he cannot revise it. If a mistake is found, a court of equity on application of the engineer or by suit may recommit the award to the engineer, or both parties may agree to abandon the award and resubmit the questions to the decision of another engineer. If there is no fault on the part of the engineer and a mistake is one arising from error in judgment, the certificate cannot be recalled.

IN WITNESS WHEREOF the said city of , by its Board of Sewer Commissioners duly authorized, has caused these presents to be signed, and has hereunto set its corporate seal as party of the first part, and the said part. of the second part ha. . . . also hereunto set. . . . hand. . . and seal. . , and said city of , and part. . . . hereto of the second part, have executed this agreement in triplicate; one part of which is to remain with said Board, one other to be filed with the Clerk of the city of , and the third to be delivered to said party of the second part; the day and year herein first written.

.....

Board of Sewer Commissioners.

.....

Contractor.

Signed and sealed in the presence of

.....

Witnesses.

INDEX

	PAGE
Adams, tests of pipe.....	13
Advantages of terra-cotta sewer pipe.....	2
three-foot pipe lengths.....	10
Altoona, brick and concrete sewer at.....	70
Analyses of sewer pipe clay.....	3
Archer joint.....	26
Area of screens.....	153
Asphalt joints.....	25
Auburn, cover for lamphole.....	112
manhole at.....	104
Babcock's invert block.....	33
Ball and socket joints.....	23
Barbour's experiments on earth pressure.....	37
strength of pipe.....	16
Bell mouths.....	185
alternate construction for.....	193
at Philadelphia.....	187
at Providence.....	191
near Boston.....	187
Binghamton, outlet sewer at.....	212
Birmingham, screen at.....	168
Blaw sections of concrete sewers.....	63
Bond for brick sewers.....	48
Boston, automatic regulator at.....	178
bell mouth near.....	187
catch-basin at.....	123
pile foundation at.....	203
screen chamber at.....	154
sewer outlet at.....	217
Bottoms of manholes.....	90
Bowser, alternate construction for bell mouths.....	193
Boxing in pipe against frost.....	137
Branches for house drains.....	227
Breslau, direct siphon at.....	135
Brick and concrete aqueduct at Boston.....	74
sewer at Altoona.....	70
sewer at Medford.....	68
sewer at Melbourne.....	70

	PAGE
Brick and concrete sewer on platform.....	69
Brick for brick sewers.....	29
sewers.....	29
Bricks required for sewers.....	34
Brickwork, cost of.....	270
Bridge for crossing gully.....	135
Brockville, failure of manhole at.....	90
Brookline, automatic regulator at.....	182
Brooklyn, section of brick sewer at.....	47
Buenos Ayres, direct siphon at.....	148
inverted siphon at.....	147
Burlington, catch-basin at.....	127
sewer outlet at.....	222
Cambridge, pile foundation at.....	198
Caps for Y connections.....	228
Carson trenching machine.....	248
Castings for manhole covers.....	104
Catch-basins.....	113
at Boston.....	123
at Burlington.....	127
at Columbus.....	121
at Louisville.....	130
at Michigan city.....	122
at Peoria.....	125
at Philadelphia.....	128
at Providence.....	122
at Washington.....	130
at Wilmington.....	124
cleaning of.....	132
gratings for inlets to.....	116
size of.....	116
traps in.....	119
Cement joints in sewer pipe.....	20
sewer pipes.....	54
Chenoweth process for concrete sewers.....	52
Chicago section of concrete sewer.....	57
Cleaning of catch-basins.....	132
Cleveland, deep manhole at.....	102
overflow weir at.....	174
reinforced concrete sewer at.....	88
Cloth used with cement joints.....	26
Coffin's support for pipe joints.....	21
Coffin Valve Company, automatic regulator of.....	182
Coldwater, arch blocks for sewer at.....	56
Columbus, catch-basin at.....	121
screens at.....	169

	PAGE
Composition of sewer pipe.....	2
Concentrated load test on sewer pipe.....	15
Concrete and brick sewers.....	67
Concrete, cost of.....	271
for sewer foundation.....	197
Y branches.....	228
pipe, porosity of.....	55
sewers.....	52
sewer section at Chicago.....	57
New York.....	57
Swampscott.....	63
Truro.....	61
Victoria.....	59
Washington.....	57
sewer sections of Blaw Collapsible Steel Centering Co.....	63
Concrete steel, <i>see</i> Reinforced concrete.	
Construction of brick sewer.....	50
Contract and specifications.....	279
Contractor's profit.....	277
Corrugations on sewer pipe.....	7, 12
Cost of brickwork.....	270
cement pipe.....	56
concrete.....	271
earthwork.....	258
engineering.....	278
flush tanks.....	277
manholes.....	275
mortar.....	270
rock excavation.....	262
sewer pipe.....	267
sheeting.....	265
tunnel excavation.....	266
Cover for lamphole.....	112
Covers for manholes.....	102
Cradle for brick sewer.....	51
sewer foundations.....	196
Cranston, screen at.....	161
Cross-section of manholes.....	90
Croyden, Eng., failure of pipes at.....	11
Deep sewers, house connections with.....	230
Density of concrete for sewers.....	63
Denver section of brick sewer.....	46
Depth of drill holes.....	255
Des Moines, reinforced concrete sewer at.....	81
Die for sewer pipe.....	6
Dirt pans under manhole covers.....	109

	PAGE
Drilling in rock.....	254
Drop tests on sewer pipe.....	15
Earth pressure on sewer arch.....	37
Egg-shaped pipe.....	8
Engineering, cost of.....	278
Estimates and costs.....	257
Estimates, preparation of.....	241
Excavation, cost of.....	258
estimate of.....	242
Experiments on strength of pipe.....	13
Explosives.....	256
Failure of bell mouth at Nashville.....	193
manhole at Brockville.....	90
walls.....	94
pipe at Cambridge.....	18
Halifax.....	18
Oberlin.....	19
Toronto.....	18
Floor area of manholes.....	93
Flush tanks, cost of.....	277
Form of notes.....	240
Forms for concrete sewer at Medford.....	68
New York.....	59
South Bend.....	85
sewers at Chicago.....	57
Swampscott.....	63
Truro.....	63
Victoria.....	61
of steel ribbon.....	52
Formula for the thickness of pipe.....	16
Foundation for manhole.....	96
Foundations.....	195
Frames and covers for manholes.....	102
Frost, to protect pipes against.....	137
Fuertes, manhole cover designed by.....	104
Glaze on sewer pipe.....	8
Grade boards for sewer construction.....	238
Grade of house drains.....	230
Gratings for storm water inlets.....	116
Gravel for pipe foundations.....	195
Harrisburg, automatic regulator at.....	180
reinforced concrete sewer at.....	79
Hassal joint.....	26

INDEX

329

	PAGE
Hastings on failure of pipes.....	18
Hering, bridge for crossing gully, designed by.....	137
lock for manhole, designed by.....	108
House connections.....	227
drains, grade of.....	230
size of.....	229
traps on.....	230
Howe, tests of sewer pipe.....	14
Hydrostatic tests of pipe.....	14
Inlets for catch-basins.....	113
Inlet to storm sewer at Warsaw.....	130
Tarrytown.....	131
Intersection of manhole and sewer.....	96
sewers.....	185
Invert blocks.....	30
Ithaca, dirt pans at.....	109
inverted siphon at.....	147, 151
lock for manhole at.....	108
outfall sewer at.....	220
rod screen at.....	164
screen chamber at.....	154
Jackson Reinforced Pipe Company.....	75
Jersey City reinforced concrete aqueduct.....	79
Joints made on bank.....	21
of asphalt.....	25
pine tar.....	25
sulphur and sand.....	22, 24
Junction chamber at Minneapolis.....	193
Keating on failure of pipe.....	18
Kilns for sewer pipe manufacture.....	7
Lampholes.....	111
Latham's formula for thickness.....	36
invert block.....	31
Leakage through cement joints.....	21
concrete pipes.....	55
Leaping weir at Milwaukee.....	172
Leaping weir, theory of.....	172
Length of sewer pipe.....	10
Lidgerwood cableway.....	250
Location of manholes.....	89, 236
storm water inlets.....	113
Y branches.....	229

	PAGE
Locks for manhole covers	107
at Ithaca	108
Salt Lake City	109
Los Angeles, inverted siphon at	148
sewer outlet at	223
Louisville, catch-basin at	130
Lynn, pile foundation at	199
Manchester, screen chamber at	157
Manhole cover at Auburn	104
Manholes	89
Manhole at Cleveland	102
Melbourne	101
bottoms of	90
cost of	275
cover at Santos	104
cross-sections of	90
dirt pans under covers	109
failure of walls of	94
floor area of	93
for sewers on different levels	97
shallow sewers	90
foundation for	96
frames and covers	102
location on sewer line	235
locks for covers	107
on large brick sewers	96
Sessions Iron Foundry cover	104
thickness of walls of	94
Manilla, timber foundation for sewer at	196
Map for sewer location	235
Marlborough, screen at	160
Maximum and minimum strength of pipe	17
Medford, brick and concrete sewer at	68
Melbourne, brick and concrete sewer at	70
deep manhole at	101
Mesh for screens	163
Mexico, reinforced concrete aqueduct at	75
Michigan City, catch-basin at	122
Milwaukee, leaping weir at	172
Minneapolis, junction chamber at	193
Moore machine	252
Moore's design for outfall sewer	212
theory of leaping weir	172
Mortar, cost of	270
Mortar for brick sewers	50

INDEX

33 I

	PAGE
Nashville, failure of bell mouth at.....	193
Newark, plate screen at.....	164
New London, sewer outlet at.....	220
New Orleans, inverted siphon at.....	140
section of brick sewer.....	45
New Rochelle, sewer outlet at.....	220
Newton, failure of sewer at.....	36
inverted siphon at.....	140
New York, inverted siphon at.....	146
pile foundation at.....	204
reinforced concrete sewer at.....	80
section of concrete sewer.....	57
sewer outlet at.....	217
Niagara Falls, outfall sewer at.....	212
Norfolk, direct siphon at.....	133
Notes for sewer construction.....	240
Number of bricks in sewers.....	34
house connections.....	227
Oakland, concrete conduits at.....	53
Offset line to sewer.....	237
Old Orchard Beach, outfall sewer at.....	222
Ontario Insane Hospital, screen at.....	166
Ottawa section of brick sewer.....	45
Outfall sewers.....	211
at Binghamton.....	212
at Boston.....	217
at Burlington.....	222
at Ithaca.....	221
at Los Angeles.....	223
at New London.....	220
at New Rochelle.....	220
at Niagara Falls.....	212
at New York.....	217
at Old Orchard Beach.....	222
at Philadelphia.....	214
at Spring Lake.....	220
at Toronto.....	223
designed by Moore.....	212
Overflows for storm water.....	170
Overflow weir at Cleveland.....	174
at Providence.....	176
at Rochester.....	170, 177
Parker on failure of pipe.....	18
Paving brick for invert.....	30

	PAGE
Peoria, catch-basin at.....	125
Philadelphia, bell-mouth at.....	187
catch-basin at.....	128
reinforced concrete sewer at.....	82
sewer outlet at.....	214
sections of masonry.....	38
Pile foundation at Boston.....	203
Cambridge.....	198
Lynn.....	199
New York.....	204
St. Paul.....	206
Troy.....	199
Piles for sewer foundation.....	198
Pine tar joints.....	25
Pipes, cost of.....	267
Pipes for sewers, <i>see</i> Sewer pipe.	
Plank for pipe foundations.....	195
Plates, perforated for screens.....	164
Platform for sewer foundation.....	196
foundation at Manilla.....	196
Providence, bell-mouth at.....	171
catch-basin at.....	122
inverted siphon at.....	149
overflow weir at.....	176
reinforced concrete sewer at.....	76
screen chamber at.....	159
wooden screen at.....	167
Portland, Me., sewer pipe plant at.....	2
Potter machine.....	252
on failure of pipe.....	19
Press for sewer pipe.....	6
Profit of contractor.....	277
Pug mill for pipe manufacture.....	3
Pullman, screen at.....	167
Ramsome process for concrete sewers.....	53
Richmond, screen at.....	167
Records of house connections.....	229
Y branches.....	243
Regulator at Boston.....	178
Brookline.....	182
Harrisburg.....	180
Worcester.....	180
of Coffin Valve Company.....	182
Reinforced concrete sewers.....	75
at Cleveland.....	88
aqueduct at Jersey City.....	79

	PAGE
Reinforced concrete aqueduct, Mexico	75
sewer at Des Moines	81
sewer at Harrisburg	79
sewer at New York	80
sewer at Philadelphia	82
sewer at Providence	76
sewer at St. Louis	82
sewer at South Bend	85
sewer at Wilmington	76
Roanoke, inverted siphon at	140
Rochester, overflow weir at	170, 177
sections of brick sewers	47
Rock excavation, cost of	262
Rock trenches, house connections in	233
Rock trenching	252
Rods for screens	164
Roll mill for pipe manufacture	4
Rowlock bond for brick sewers	48
Rust on failure of pipe	18
Saddle piles	198
St. Louis, manufacture of sewer pipe at	2
reinforced concrete sewer at	82
steps in sewer at	101
St. Paul, pile foundation at	206
Salt, used in pipe kilns	8
Salt Lake City, lock for manhole at	109
Santos, manhole cover at	104
Screens	153
at Birmingham	168
at Columbus	169
at Cranston	161
at Ithaca	164
at Marlborough	161
at Newark	164
at Ontario Insane Hospital	166
at Providence	167
at Pullman	167
at Richmond	167
at Wayne	163
at White Plains	160
at Worcester State Hospital	164
Screen chambers	154
at Boston	154
at Ithaca	154
at Manchester	157
at Providence	159

	PAGE
Sections of Philadelphia sewers.....	38
Sessions Foundry Co., manhole cover of.....	104
Settlement of sewer embankment.....	208
Sewer pipe, advantages of.....	2
analysis of material for.....	3
composition of.....	2
length of.....	10
sizes of.....	10
thickness of.....	10
Shedd, tests of pipe.....	13
Sheeting, cost of.....	265
Sheeting for trenches.....	246
Shrinking of pipes in burning.....	8
Siphons.....	133
at Breslau.....	135
at Buenos Ayres.....	147
at Ithaca.....	147
at Los Angeles.....	148
at New Orleans.....	140
at Newton.....	140
at New York.....	146
at Norfolk.....	133
at Providence.....	149
at Roanoke.....	140
at Springfield.....	142
at Woonsocket.....	142
Size of catch-basins.....	116
Size of house drains.....	229
Sizes of pipe.....	10
Slants for house connections.....	228
Socketts, sizes of.....	11
South Bend, reinforced concrete sewer at.....	85
thickness of sewer at.....	36
Specifications, forms of.....	286
Spikes to mark offset line.....	237
Springfield, inverted siphon at.....	142
thickness of sewer at.....	36
Spring Lake, sewer outlet at.....	220
Stanford joints.....	22
Steel outfall sewer at Toronto.....	223
Steps in sewer at manhole.....	101
Storm water overflows.....	170
Strap iron bond for brick sewers.....	50
Strength of double strength pipe.....	16
Strength of standard pipe.....	16
Sudbury river aqueduct.....	74
Sulphur and sand joints.....	22, 24

INDEX

335

	PAGE
Surveying.....	235
Swampscott section of concrete sewer.....	63
Sykes joint.....	26
Table of reinforcement for cement pipes.....	76
Table of socket space.....	12
Table of thickness of pipe.....	11
Talbot's invert block.....	30
Tarrytown, storm water inlet at.....	131
Temperature of pipe kilns.....	8
Tensile strength of vitrified clay.....	14
Thickness of brick sewers.....	35
Thickness of cement pipe.....	56
Thickness of manhole walls.....	94
Thickness of sewer pipe.....	10
Toronto, steel outfall sewer at.....	223
Trap in catch-basin at Columbus.....	121
for catch-basins.....	119
on house drain.....	230
Trenching.....	245
Troy, pile foundation at.....	199
Truro section of concrete sewer.....	61
Tunnel excavation, cost of.....	266
Uniform load tests on sewer pipe.....	15
U. S. G. S. experiments on concrete pipe.....	55
Victoria section of concrete sewer.....	59
Warsaw, storm water inlet at.....	130
Washington, catch-basin at.....	130
Washington sections of brick sewers.....	45
Washington sections of concrete sewers.....	57
Wayne, screen at.....	163
White Plains, screen at.....	160
Width of trench.....	245
Wilmington, catch-basin at.....	124
reinforced concrete sewer at.....	76
Woburn, automatic regulator at.....	185
Wooden pipes for outfall sewer.....	220
Woonsocket, inverted siphon at.....	142
Worcester, automatic regulator.....	180
Worcester State Hospital, screen at.....	164
Y branches, records of.....	243



SHORT-TITLE CATALOGUE

OF THE

PUBLICATIONS

OF

JOHN WILEY & SONS,

NEW YORK.

LONDON: CHAPMAN & HALL, LIMITED.

ARRANGED UNDER SUBJECTS.

Descriptive circulars sent on application. Books marked with an asterisk (*) are sold at *net* prices only. All books are bound in cloth unless otherwise stated.

AGRICULTURE—HORTICULTURE—FORESTRY.

Armsby's Manual of Cattle-feeding.....	12mo,	\$1 75
Principles of Animal Nutrition.....	8vo,	4 00
Budd and Hansen's American Horticultural Manual:		
Part I. Propagation, Culture, and Improvement.....	12mo,	1 50
Part II. Systematic Pomology.....	12mo,	1 50
Elliott's Engineering for Land Drainage.....	12mo,	1 50
Practical Farm Drainage.....	12mo,	1 00
Graves's Forest Mensuration.....	8vo,	4 00
Green's Principles of American Forestry.....	12mo,	1 50
Grotenfelt's Principles of Modern Dairy Practice. (Woll.).....	12mo,	2 00
*Herrick's Denatured or Industrial Alcohol.....	8vo,	4 00
Kemp and Waugh's Landscape Gardening. (New Edition, Rewritten. In Preparation).		
* McKay and Larsen's Principles and Practice of Butter-making.....	8vo,	1 50
Maynard's Landscape Gardening as Applied to Home Decoration.....	12mo,	1 50
Quaintance and Scott's Insects and Diseases of Fruits. (In Preparation).		
Sanderson's Insects Injurious to Staple Crops.....	12mo,	1 50
*Schwarz's Longleaf Pine in Virgin Forests.....	12mo,	1 25
Stockbridge's Rocks and Soils.....	8vo,	2 50
Winton's Microscopy of Vegetable Foods.....	8vo,	7 50
Woll's Handbook for Farmers and Dairymen.....	16mo,	1 50

ARCHITECTURE.

Baldwin's Steam Heating for Buildings.....	12mo,	2 50
Berg's Buildings and Structures of American Railroads.....	4to,	5 00
Birkmire's Architectural Iron and Steel.....	8vo,	3 50
Compound Riveted Girders as Applied in Buildings.....	8vo,	2 00
Planning and Construction of American Theatres.....	8vo,	3 00
Planning and Construction of High Office Buildings.....	8vo,	3 50
Skeleton Construction in Buildings.....	8vo,	3 00
Briggs's Modern American School Buildings.....	8vo,	4 00
Byrne's Inspection of Material and Workmanship Employed in Construction.....	16mo,	3 00
Carpenter's Heating and Ventilating of Buildings.....	8vo,	4 00

Freitag's Architectural Engineering.	8vo	3 50
Fireproofing of Steel Buildings.	8vo,	2 50
French and Ives's Stereotomy.	8vo,	2 50
Gerhard's Guide to Sanitary House-Inspection.	16mo,	1 00
* Modern Baths and Bath Houses.	8vo,	3 00
Sanitation of Public Buildings.	12mo,	1 50
Theatre Fires and Panics.	12mo,	1 50
Holley and Ladd's Analysis of Mixed Paints, Color Pigments, and Varnishes		
Large	12mo,	2 50
Johnson's Statics by Algebraic and Graphic Methods	8vo,	2 00
Kellaway's How to Lay Out Suburban Home Grounds	8vo,	2 00
Kidder's Architects' and Builders' Pocket-book.	16mo, mor.	5 00
Maire's Modern Pigments and their Vehicles	12mo,	2 00
Merrill's Non-metallic Minerals: Their Occurrence and Uses.	8vo,	4 00
Stones for Building and Decoration.	8vo,	5 00
Monckton's Stair-building.	4to,	4 00
Patton's Practical Treatise on Foundations.	8vo,	5 00
Peabody's Naval Architecture.	8vo,	7 50
Rice's Concrete-block Manufacture	8vo,	2 00
Richey's Handbook for Superintendents of Construction.	16mo, mor.	4 00
* Building Mechanics' Ready Reference Book:		
* Building Foreman's Pocket Book and Ready Reference. (In Press.)		
* Carpenters' and Woodworkers' Edition.	16mo, mor.	1 50
* Cement Workers and Plasterer's Edition.	16mo, mor.	1 50
* Plumbers', Steam-Filters', and Tinners' Edition.	16mo, mor.	1 50
* Stone- and Brick-masons' Edition.	16mo, mor.	1 50
Sabin's House Painting	12mo,	1 00
Industrial and Artistic Technology of Paints and Varnish.	8vo,	3 00
Siebert and Biggin's Modern Stone-cutting and Masonry.	8vo,	1 50
Snow's Principal Species of Wood.	8vo,	3 50
Towne's Locks and Builders' Hardware.	18mo, mor.	3 00
Wait's Engineering and Architectural Jurisprudence	8vo,	6 00
Sheep,		6 50
Law of Contracts.	8vo,	3 00
Law of Operations Preliminary to Construction in Engineering and Architecture.	8vo,	5 00
Sheep,		5 50
Wilson's Air Conditioning.	12mo,	1 50
Worcester and Atkinson's Small Hospitals, Establishment and Maintenance, Suggestions for Hospital Architecture, with Plans for a Small Hospital.		
12mo,		1 25

ARMY AND NAVY.

Bernadou's Smokeless Powder, Nitro-cellulose, and the Theory of the Cellulose Molecule.	12mo,	2 50
Chase's Art of Pattern Making.	12mo,	2 50
Screw Propellers and Marine Propulsion.	8vo,	3 00
* Cloke's Enlisted Specialist's Examiner	8vo,	2 00
Gunner's Examiner	8vo,	1 50
Craig's Azimuth.	4to,	3 50
Crehore and Squier's Polarizing Photo-chronograph.	8vo,	3 00
* Davis's Elements of Law.	8vo,	2 50
* Treatise on the Military Law of United States.	8vo,	7 00
Sheep,		7 50
De Brack's Cavalry Outpost Duties. (Carr).	24mo, mor.	2 00
* Dudley's Military Law and the Procedure of Courts-martial.	Large 12mo,	2 50
Durand's Resistance and Propulsion of Ships.	8vo,	5 00

* Dyer's Handbook of Light Artillery.....	12mo,	3 00
Eissler's Modern High Explosives.....	8vo,	4 00
* Fiebigger's Text-book on Field Fortification.....	Large 12mo,	2 00
Hamilton and Bond's The Gunner's Catechism	18mo,	1 00
* Hoff's Elementary Naval Tactics.....	8vo,	1 50
Ingalls's Handbook of Problems in Direct Fire.....	8vo,	4 00
* Lissak's Ordnance and Gunnery.....	8vo,	6 00
* Ludlow's Logarithmic and Trigonometric Tables.....	8vo,	1 00
* Lyons's Treatise on Electromagnetic Phenomena. Vols. I. and II..	8vo, each,	6 00
* Mahan's Permanent Fortifications. (Mercur).....	8vo, half mor.	7 50
Manual for Courts-martial.....	16mo, mor.	1 50
* Mercur's Attack of Fortified Places.....	12mo,	2 00
* Elements of the Art of War.....	8vo,	4 00
Metcalf's Cost of Manufactures—And the Administration of Workshops..	8vo,	5 00
Nixon's Adjutants' Manual.....	24mo,	1 00
Peabody's Naval Architecture.....	8vo,	7 50
* Phelps's Practical Marine Surveying.....	8vo,	2 50
Putnam's Nautical Charts.....	8vo,	2 00
Sharpe's Art of Subsisting Armies in War.....	18mo, mor.	1 50
* Tupes and Poole's Manual of Bayonet Exercises and Musketry Fencing.	24mo, leather,	50
* Weaver's Military Explosives.....	8vo,	3 00
Woodhull's Notes on Military Hygiene.....	16mo,	1 50

ASSAYING.

Betts's Lead Refining by Electrolysis.....	8vo,	4 00
Fletcher's Practical Instructions in Quantitative Assaying with the Blowpipe.	16mo, mor.	1 50
Furman's Manual of Practical Assaying.....	8vo,	3 00
Lodge's Notes on Assaying and Metallurgical Laboratory Experiments...	8vo,	3 00
Low's Technical Methods of Ore Analysis.....	8vo,	3 00
Miller's Cyanide Process.....	12mo,	1 00
Manual of Assaying.....	12mo,	1 00
Minet's Production of Aluminum and its Industrial Use. (Waldo).....	12mo,	2 50
O'Driscoll's Notes on the Treatment of Gold Ores.....	8vo,	2 00
Ricketts and Miller's Notes on Assaying.....	8vo,	3 00
Robine and Lenglen's Cyanide Industry. (Le Clerc).....	8vo,	4 00
Ulke's Modern Electrolytic Copper Refining.....	8vo,	3 00
Wilson's Chlorination Process.....	12mo,	1 50
Cyanide Processes.....	12mo,	1 50

ASTRONOMY.

Comstock's Field Astronomy for Engineers.....	8vo,	2 50
Craig's Azimuth.....	4to,	3 50
Crandall's Text-book on Geodesy and Least Squares.....	8vo,	3 00
Doolittle's Treatise on Practical Astronomy.....	8vo,	4 00
Gore's Elements of Geodesy.....	8vo,	2 50
Hayford's Text-book of Geodetic Astronomy.....	8vo,	3 00
Merriman's Elements of Precise Surveying and Geodesy.....	8vo,	2 50
* Michie and Harlow's Practical Astronomy.....	8vo,	3 00
Rust's Ex-meridian Altitude, Azimuth and Star-Finding Tables.....	8vo,	5 00
* White's Elements of Theoretical and Descriptive Astronomy.....	12mo,	2 00

CHEMISTRY.

* Abderhalden's Physiological Chemistry in Thirty Lectures. (Hall and Defren)	8vo,	5 00
* Abegg's Theory of Electrolytic Dissociation. (von Ende).....	12mo,	1 25
Alexeyeff's General Principles of Organic Syntheses. (Matthews).....	8vo,	3 00
Allen's Tables for Iron Analysis.	8vo,	3 00
Arnold's Compendium of Chemistry. (Mandel).....	Large 12mo,	3 50
Association of State and National Food and Dairy Departments, Hartford, Meeting, 1906	8vo,	3 00
Jamestown Meeting, 1907	8vo,	3 00
Austen's Notes for Chemical Students	12mo,	1 50
Baskerville's Chemical Elements. (In Preparation.)		
Bernadou's Smokeless Powder.—Nitro-cellulose, and Theory of the Cellulose Molecule.	12mo,	2 50
Biltz's Chemical Preparations. (Hall and Blanchard). (In Press.)		
* Blanchard's Synthetic Inorganic Chemistry.	12mo,	1 00
* Browning's Introduction to the Rarer Elements.	8vo,	1 50
Brush and Penfield's Manual of Determinative Mineralogy.	8vo,	4 00
* Claassen's Beet-sugar Manufacture. (Hall and Rolfe).....	8vo,	3 00
Classen's Quantitative Chemical Analysis by Electrolysis. (Boltwood).....	8vo,	3 00
Cohn's Indicators and Test-papers.	12mo,	2 00
Tests and Reagents.	8vo,	3 00
* Danneel's Electrochemistry. (Merriam).....	12mo,	1 25
Dannerth's Methods of Textile Chemistry.	12mo,	2 00
Duhem's Thermodynamics and Chemistry. (Burgess).....	8vo,	4 00
Eakle's Mineral Tables for the Determination of Minerals by their Physical Properties	8vo,	1 25
Eissler's Modern High Explosives.	8vo,	4 00
Effront's Enzymes and their Applications. (Prescott).....	8vo,	3 00
Erdmann's Introduction to Chemical Preparations. (Dunlap).....	12mo,	1 25
* Fischer's Physiology of Alimentation.	Large 12mo,	2 00
Fletcher's Practical Instructions in Quantitative Assaying with the Blowpipe.	12mo, mor.	1 50
Fowler's Sewage Works Analyses.	12mo,	2 00
Fresenius's Manual of Qualitative Chemical Analysis. (Wells).....	8vo,	5 00
Manual of Qualitative Chemical Analysis. Part I. Descriptive. (Wells).....	8vo,	3 00
Quantitative Chemical Analysis. (Cohn) 2 vols.....	8vo,	12 50
When Sold Separately, Vol. I, \$6. Vol. II, \$8.		
Fuertes's Water and Public Health.	12mo,	1 50
Furman's Manual of Practical Assaying.	8vo,	3 00
* Getman's Exercises in Physical Chemistry.	12mo,	2 00
Gill's Gas and Fuel Analysis for Engineers.	12mo,	1 25
* Gooch and Browning's Outlines of Qualitative Chemical Analysis.	Large 12mo,	1 25
Grotenfelt's Principles of Modern Dairy Practice. (Woll).....	12mo,	2 00
Groth's Introduction to Chemical Crystallography (Marshall).....	12mo,	1 25
Hammarsten's Text-book of Physiological Chemistry. (Mandel).....	8vo,	4 00
Hanausek's Microscopy of Technical Products. (Winton).....	8vo,	5 00
* Haskins and Macleod's Organic Chemistry.	12mo,	2 00
Helm's Principles of Mathematical Chemistry. (Morgan).....	12mo,	1 50
Hering's Ready Reference Tables (Conversion Factors).	16mo, mor.	2 50
* Herrick's Denatured or Industrial Alcohol	8vo,	4 00
Hinds's Inorganic Chemistry.	8vo,	3 00
* Laboratory Manual for Students	12mo,	1 00
* Holleman's Laboratory Manual of Organic Chemistry for Beginners.		
(Walker).....	12mo,	1 00
Text-book of Inorganic Chemistry. (Cooper).....	8vo,	2 50
Text-book of Organic Chemistry. (Walker and Mott).....	8vo,	2 50

olley and Ladd's Analysis of Mixed Paints, Color Pigments, and Varnishes.	Large 12mo,	2 50
Hopkins's Oil-chemists' Handbook.....	8vo,	3 00
Iddings's Rock Minerals.....	8vo,	5 00
Jackson's Directions for Laboratory Work in Physiological Chemistry.....	8vo,	1 25
Johannsen's Determination of Rock-forming Minerals in Thin Sections.....	8vo,	4 00
Johnson's Chemical Analysis of Special Steel. Steel-making. (Alloys and Graphite.) (In Press.)		
Keep's Cast Iron.....	8vo,	2 50
Ladd's Manual of Quantitative Chemical Analysis.....	12mo,	1 00
Landauer's Spectrum Analysis. (Tingle).....	8vo,	3 00
* Langworthy and Austen's Occurrence of Aluminium in Vegetable Products, Animal Products, and Natural Waters.....	8vo,	2 00
Lassar-Cohn's Application of Some General Reactions to Investigations in Organic Chemistry. (Tingle).....	12mo,	1 00
Leach's Inspection and Analysis of Food with Special Reference to State Control.....	8vo,	7 50
Löb's Electrochemistry of Organic Compounds. (Lorenz).....	8vo,	3 00
Lodge's Notes on Assaying and Metallurgical Laboratory Experiments.....	8vo,	3 00
Low's Technical Method of Ore Analysis.....	8vo,	3 00
Lunge's Techno-chemical Analysis. (Cohn).....	12mo,	1 00
* McKay and Larsen's Principles and Practice of Butter-making.....	8vo,	1 50
Maire's Modern Pigments and their Vehicles.....	12mo,	2 00
Mandel's Handbook for Bio-chemical Laboratory.....	12mo,	1 50
* Martin's Laboratory Guide to Qualitative Analysis with the Blowpipe.....	12mo,	60
Mason's Examination of Water. (Chemical and Bacteriological).....	12mo,	1 25
Water-supply. (Considered Principally from a Sanitary Standpoint.	8vo,	4 00
Mathewson's Chemical Theory for First Year College Students. (In Press).		
Matthews's Textile Fibres. 2d Edition, Rewritten.....	8vo,	4 00
* Meyer's Determination of Radicles in Carbon Compounds. (Tingle).....	12mo,	1 25
Miller's Cyanide Process.....	12mo,	1 00
Manual of Assaying.....	12mo,	1 00
Minet's Production of Aluminum and its Industrial Use. (Waldo).....	12mo,	2 50
Mixer's Elementary Text-book of Chemistry.....	12mo,	1 50
Morgan's Elements of Physical Chemistry.....	12mo,	3 00
Outline of the Theory of Solutions and its Results.....	12mo,	1 00
* Physical Chemistry for Electrical Engineers.....	12mo,	1 50
Morse's Calculations used in Cane-sugar Factories.....	16mo, mor,	1 50
* Muir's History of Chemical Theories and Laws.....	8vo,	4 00
Mulliken's General Method for the Identification of Pure Organic Compounds.		
Vol. I.....	Large 8vo,	5 00
O'Driscoll's Notes on the Treatment of Gold Ores.....	8vo,	2 00
Ostwald's Conversations on Chemistry. Part One. (Ramsey).....	12mo,	1 50
“ “ “ “ Part Two. (Turnbull).....	12mo,	2 00
* Palmer's Practical Test Book of Chemistry.....	12mo,	1 00
* Pauli's Physical Chemistry in the Service of Medicine. (Fischer).....	12mo,	1 25
* Penfield's Notes on Determinative Mineralogy and Record of Mineral Tests.	8vo, paper,	50
Tables of Minerals, Including the Use of Minerals and Statistics of Domestic Production.....	8vo,	1 00
Pictet's Alkaloids and their Chemical Constitution. (Biddle).....	8vo,	5 00
Poole's Calorific Power of Fuels.....	8vo,	3 00
Prescott and Winslow's Elements of Water Bacteriology, with Special Reference to Sanitary Water Analysis.....	12mo,	1 50
* Reisig's Guide to Piece-dyeing.....	8vo,	25 00
Richards and Woodman's Air, Water, and Food from a Sanitary Standpoint.....	8vo,	2 00
Ricketts and Miller's Notes on Assaying.....	8vo,	3 00
Rideal's Disinfection and the Preservation of Food.....	8vo,	4 00
Sewage and the Bacterial Purification of Sewage.....	8vo,	4 00

Hayford's Text-book of Geodetic Astronomy.	8vo,	3 00
Hering's Ready Reference Tables. (Conversion Factors).	16mo, mor.	2 50
Howe's Retaining Walls for Earth.	12mo,	1 25
* Ives's Adjustments of the Engineer's Transit and Level.	16mo, Bds.	25
Ives and Hilts's Problems in Surveying.	16mo, mor.	1 50
Johnson's (J. B.) Theory and Practice of Surveying.	Small 8vo,	4 00
Johnson's (L. J.) Statics by Algebraic and Graphic Methods.	8vo,	2 00
Kinnicutt, Winslow and Pratt's Purification of Sewage. (In Preparation.)		
Laplace's Philosophical Essay on Probabilities. (Truscott and Emory)	12mo,	2 00
Mahan's Descriptive Geometry.	8vo,	1 50
Treatise on Civil Engineering. (1873.) (Wood).	8vo,	5 00
Merriman's Elements of Precise Surveying and Geodesy.	8vo,	2 50
Merriman and Brooks's Handbook for Surveyors.	16mo, mor.	2 00
Nugent's Plane Surveying.	8vo,	3 50
Ogden's Sewer Construction.	8vo,	3 00
Sewer Design.	12mo,	2 00
Parsons's Disposal of Municipal Refuse.	8vo,	2 00
Patton's Treatise on Civil Engineering.	8vo, half leather,	7 50
Reed's Topographical Drawing and Sketching.	4to,	5 00
Rideal's Sewage and the Bacterial Purification of Sewage.	8vo,	4 00
Riemer's Shaft-sinking under Difficult Conditions. (Corning and Peele).	8vo,	3 00
Siebert and Biggin's Modern Stone-cutting and Masonry.	8vo,	1 50
Smith's Manual of Topographical Drawing. (McMillan).	8vo,	2 50
Soper's Air and Ventilation of Subways.	Large 12mo,	2 50
Tracy's Plane Surveying.	16mo, mor.	3 00
* Trautwine's Civil Engineer's Pocket-book.	16mo, mor.	5 00
Venable's Garbage Crematories in America.	8vo,	2 00
Methods and Devices for Bacterial Treatment of Sewage.	8vo,	3 00
Wait's Engineering and Architectural Jurisprudence.	8vo,	6 00
Sheep,	6 50	
Law of Contracts.	8vo,	3 00
Law of Operations Preliminary to Construction in Engineering and Architecture.	8vo,	5 00
Sheep,	5 50	
Warren's Stereotomy—Problems in Stone-cutting.	8vo,	2 50
* Waterbury's Vest-Pocket Hand-book of Mathematics for Engineers.	2 $\frac{1}{2}$ \times 5 $\frac{3}{8}$ inches, mor.	1 00
Webb's Problems in the Use and Adjustment of Engineering Instruments.	16mo, mor.	1 25
Wilson's (H. N.) Topographic Surveying.	8vo,	3 50
Wilson's (W. L.) Elements of Railroad Track and Construction.	12mo,	2 00

BRIDGES AND ROOFS.

Boller's Practical Treatise on the Construction of Iron Highway Bridges.	8vo,	2 00
Burr and Falk's Design and Construction of Metallic Bridges.	8vo,	5 00
Influence Lines for Bridge and Roof Computations.	8vo,	3 00
Du Bois's Mechanics of Engineering. Vol. II.	Small 4to,	10 00
Foster's Treatise on Wooden Trestle Bridges.	4to,	5 00
Fowler's Ordinary Foundations.	8vo,	3 50
French and Ives's Stereotomy.	8vo,	2 50
Greene's Arches in Wood, Iron, and Stone.	8vo,	2 50
Bridge Trusses.	8vo,	2 50
Roof Trusses.	8vo,	1 25
Grimm's Secondary Stresses in Bridge Trusses.	8vo,	2 50
Heller's Stresses in Structures and the Accompanying Deformations.	8vo,	3 00
Howe's Design of Simple Roof-trusses in Wood and Steel.	8vo,	2 00
Symmetrical Masonry Arches.	8vo,	2 50
Treatise on Arches.	8vo,	4 00

Johnson, Bryan, and Turneure's Theory and Practice in the Designing of Modern Framed Structures.....	Small 4to,	10 00
Merriman and Jacoby's Text-book on Roofs and Bridges:		
Part I. Stresses in Simple Trusses.....	8vo,	2 50
Part II. Graphic Statics.....	8vo,	2 50
Part III. Bridge Design.....	8vo,	2 50
Part IV. Higher Structures.....	8vo,	2 50
Morison's Memphis Bridge.....	Oblong 4to,	10 00
Sondericker's Graphic Statics, with Applications to Trusses, Beams, and Arches.	8vo,	2 00
Waddell's De Pontibus, Pocket-book for Bridge Engineers.....	16mo, mor,	2 00
* Specifications for Steel Bridges.....	12mo,	50
Waddell and Harrington's Bridge Engineering. (In Preparation.)		
Wright's Designing of Draw-spans. Two parts in one volume.....	8vo,	3 50

HYDRAULICS.

Barnes's Ice Formation.....	8vo,	3 00
Bazin's Experiments upon the Contraction of the Liquid Vein Issuing from an Orifice. (Trautwine).....	8vo,	2 00
Bovey's Treatise on Hydraulics.....	8vo,	5 00
Church's Diagrams of Mean Velocity of Water in Open Channels.	Oblong 4to, paper,	1 50
Hydraulic Motors.....	8vo,	2 00
Mechanics of Engineering.....	8vo,	6 00
Coffin's Graphical Solution of Hydraulic Problems.....	16mo, mor,	2 50
Flatler's Dynamometers, and the Measurement of Power.....	12mo,	3 00
Folwell's Water-supply Engineering.....	8vo,	4 00
Frizell's Water-power.....	8vo,	5 00
Fuertes's Water and Public Health.....	12mo,	1 50
Water-filtration Works.....	12mo,	2 50
Ganguillet and Kutter's General Formula for the Uniform Flow of Water in Rivers and Other Channels. (Hering and Trautwine).....	8vo,	4 00
Hazen's Clean Water and How to Get It.....	Large 12mo,	1 50
Filtration of Public Water-supplies.....	8vo,	3 00
Hazlehurst's Towers and Tanks for Water-works.....	8vo,	2 50
Herschel's 115 Experiments on the Carrying Capacity of Large, Riveted, Metal Conduits.....	8vo,	2 00
Hoyt and Grover's River Discharge.....	8vo,	2 00
Hubbard and Kiersted's Water-works Management and Maintenance.....	8vo,	4 00
* Lyndon's Development and Electrical Distribution of Water Power... 8vo,	3 00	
Mason's Water-supply. (Considered Principally from a Sanitary Standpoint.)	8vo,	4 00
Merriman's Treatise on Hydraulics.....	8vo,	5 00
* Michie's Elements of Analytical Mechanics.....	8vo,	4 00
* Molitor's Hydraulics of Rivers, Weirs and Sluices.....	8vo,	2 00
Richards's Laboratory Notes on Industrial Water Analysis. (In Press).		
Schuyler's Reservoirs for Irrigation, Water-power, and Domestic Water-supply.....	Large 8vo,	5 00
* Thomas and Watt's Improvement of Rivers.....	4to,	6 00
Turneure and Russell's Public Water-supplies.....	8vo,	5 00
Wegmann's Design and Construction of Dams. 5th Ed., enlarged.....	4to,	6 00
Water-supply of the City of New York from 1658 to 1895.....	4to,	10 00
Whipple's Value of Pure Water.....	Large 12mo,	1 00
Williams and Hazen's Hydraulic Tables.....	8vo,	1 50
Wilson's Irrigation Engineering.....	Small 8vo,	4 00
Wolff's Windmill as a Prime Mover.....	8vo,	3 00
Wood's Elements of Analytical Mechanics.....	8vo,	3 00
Turbines.....	8vo,	2 50

MATERIALS OF ENGINEERING.

Baker's Roads and Pavements.	8vo,	5 00
Treatise on Masonry Construction.	8vo,	5 00
Birkmire's Architectural Iron and Steel.	8vo,	3 50
Compound Riveted Girders as Applied in Buildings.	8vo,	2 00
Black's United States Public Works	Oblong 4to,	5 00
Bleining's Manufacture of Hydraulic Cement. (In Preparation.)		
* Bovey's Strength of Materials and Theory of Structures.	8vo,	7 50
Burr's Elasticity and Resistance of the Materials of Engineering.	8vo,	7 50
Byrne's Highway Construction.	8vo,	5 00
Inspection of the Materials and Workmanship Employed in Construction.		
	16mo,	3 00
Church's Mechanics of Engineering.	8vo,	6 00
Du Bois's Mechanics of Engineering.		
Vol. I. Kinematics, Statics, Kinetics.	Small 4to,	7 50
Vol. II. The Stresses in Framed Structures, Strength of Materials and Theory of Flexures.	Small 4to,	10 00
*Eckel's Cements, Limes, and Plasters.	8vo,	6 00
Stone and Clay Products used in Engineering. (In Preparation.)		
Fowler's Ordinary Foundations.	8vo,	3 50
Graves's Forest Mensuration.	8vo,	4 00
Green's Principles of American Forestry.	12mo,	1 50
* Greene's Structural Mechanics.	8vo,	2 50
Holly and Ladd's Analysis of Mixed Paints, Color Pigments and Varnishes		
	Large 12mo,	2 50
Johnson's (C. M.) Chemical Analysis of Special Steels. (In Preparation.)		
Johnson's (J. B.) Materials of Construction	Large 8vo,	6 00
Keep's Cast Iron.	8vo,	2 50
Kidder's Architects and Builders' Pocket-book.	16mo,	5 00
Lanza's Applied Mechanics.	8vo,	7 50
Maire's Modern Pigments and their Vehicles	12mo,	2 00
Martens's Handbook on Testing Materials. (Henning) 2 vols.	8vo,	7 50
Maurer's Technical Mechanics.	8vo,	4 00
Merrill's Stones for Building and Decoration.	8vo,	5 00
Merriman's Mechanics of Materials.	8vo,	5 00
* Strength of Materials	12mo,	1 00
Metcalf's Steel. A Manual for Steel-users.	12mo,	2 00
Morrison's Highway Engineering	8vo,	2 50
Patton's Practical Treatise on Foundations.	8vo,	5 00
Rice's Concrete Block Manufacture	8vo,	2 00
Richardson's Modern Asphalt Pavements.	8vo,	3 00
Richey's Handbook for Superintendents of Construction.	16mo, mor.	4 00
* Ries's Clays: Their Occurrence, Properties, and Uses.	8vo,	5 00
Sabin's Industrial and Artistic Technology of Paints and Varnish.	8vo,	3 00
* Schwarz's Longleaf Pine in Virgin Forest	12mo,	1 25
Snow's Principal Species of Wood.	8vo,	3 50
Spalding's Hydraulic Cement.	12mo,	2 00
Text-book on Roads and Pavements.	12mo,	2 00
Taylor and Thompson's Treatise on Concrete, Plain and Reinforced.	8vo,	5 00
Thurston's Materials of Engineering. In Three Parts.	8vo,	8 00
Part I. Non-metallic Materials of Engineering and Metallurgy.	8vo,	2 60
Part II. Iron and Steel.	8vo,	3 50
Part III. A Treatise on Brasses, Bronzes, and Other Alloys and their Constituents.	8vo,	2 50
Tillson's Street Pavements and Paving Materials.	8vo,	4 00
Turneure and Maurer's Principles of Reinforced Concrete Construction.	8vo,	3 00
Waterbury's Cement Laboratory Manual	12mo,	1 00

RAILWAY ENGINEERING.

Andrews's Handbook for Street Railway Engineers.	3x5 inches, mor.	1 25
Berg's Buildings and Structures of American Railroads	4to,	5 00
Brooks's Handbook of Street Railroad Location.	16mo, mor.	1 50
Butt's Civil Engineer's Field-book.	16mo, mor.	2 50
Crandall's Railway and Other Earthwork Tables.	8vo,	1 50
Transition Curve.	16mo, mor.	1 50
* Crockett's Methods for Earthwork Computations.	8vo,	1 50
Dawson's "Engineering" and Electric Traction Pocket-book	16mo, mor.	5 00
Dredge's History of the Pennsylvania Railroad: (1879).	Paper,	5 00
Fisher's Table of Cubic Yards.	Cardboard,	25
Godwin's Railroad Engineers' Field-book and Explorers' Guide	16mo, mor.	2 50
Hudson's Tables for Calculating the Cubic Contents of Excavations and Embankments.	8vo,	1 00
Ives and Hilts's Problems in Surveying, Railroad Surveying and Geodesy	16mo, mor.	1 50
Molitor and Beard's Manual for Resident Engineers.	16mo,	1 00
Nagle's Field Manual for Railroad Engineers.	16mo, mor.	3 00
Philbrick's Field Manual for Engineers.	16mo, mor.	3 00
Raymond's Railroad Engineering. 3 volumes.		
Vol. I. Railroad Field Geometry. (In Preparation.)		
Vol. II. Elements of Railroad Engineering.	8vo,	3 50
Vol. III. Railroad Engineer's Field Book. (In Preparation.)		
Searles's Field Engineering.	16mo, mor.	3 00
Railroad Spiral.	16mo, mor.	1 50
Taylor's Prismatical Formulæ and Earthwork.	8vo,	1 50
* Trautwine's Field Practice of Laying Out Circular Curves for Railroads.	12mo, mor.	2 50
* Method of Calculating the Cubic Contents of Excavations and Embankments by the Aid of Diagrams.	8vo,	2 00
Webb's Economics of Railroad Construction.	Large 12mo,	2 50
Railroad Construction.	16mo, mor.	5 00
Wellington's Economic Theory of the Location of Railways.	Small 8vo,	5 00

DRAWING.

Barr's Kinematics of Machinery.	8vo,	2 50
* Bartlett's Mechanical Drawing.	8vo,	3 00
* " " " Abridged Ed.	8vo,	1 50
Coolidge's Manual of Drawing.	8vo, paper,	1 00
Coolidge and Freeman's Elements of General Drafting for Mechanical Engineers.	Oblong 4to,	2 50
Durley's Kinematics of Machines.	8vo,	4 00
Emch's Introduction to Projective Geometry and its Applications.	8vo,	2 50
Hill's Text-book on Shades and Shadows, and Perspective.	8vo,	2 00
Jamison's Advanced Mechanical Drawing.	8vo,	2 00
Elements of Mechanical Drawing.	8vo,	2 50
Jones's Machine Design:		
Part I. Kinematics of Machinery.	8vo,	1 50
Part II. Form, Strength, and Proportions of Parts.	8vo,	3 00
MacCord's Elements of Descriptive Geometry.	8vo,	3 00
Kinematics; or, Practical Mechanism.	8vo,	5 00
Mechanical Drawing.	4to,	4 00
Velocity Diagrams.	8vo,	1 50
McLeod's Descriptive Geometry.	Large 12mo,	1 50
* Mahan's Descriptive Geometry and Stone-cutting.	8vo,	1 50
Industrial Drawing. (Thompson).	8vo,	3 50

McLeod's Descriptive Geometry.....	Large 12mo,	1 50
* Mahan's Descriptive Geometry and Stone-cutting.....	8vo,	1 50
Industrial Drawing. (Thompson).....	8vo,	3 50
Moyer's Descriptive Geometry for Students of Engineering.....	8vo,	2 00
Reed's Topographical Drawing and Sketching.....	4to,	5 00
Reid's Course in Mechanical Drawing.....	8vo,	2 00
Text-book of Mechanical Drawing and Elementary Machine Design.....	8vo,	3 00
Robinson's Principles of Mechanism.....	8vo,	3 00
Schwamb and Merrill's Elements of Mechanism.....	8vo,	3 00
Smith's (R. S.) Manual of Topographical Drawing. (McMillan).....	8vo,	2 50
Smith (A. W.) and Marx's Machine Design.....	8vo,	3 00
* Titsworth's Elements of Mechanical Drawing.....	Oblong 8vo,	1 25
Warren's Drafting Instruments and Operations.....	12mo,	1 25
Elements of Descriptive Geometry, Shadows, and Perspective.....	8vo,	3 50
Elements of Machine Construction and Drawing.....	8vo,	7 50
Elements of Plane and Solid Free-hand Geometrical Drawing.....	12mo,	1 00
General Problems of Shades and Shadows.....	8vo,	3 00
Manual of Elementary Problems in the Linear Perspective of Form and Shadow.....	12mo,	1 00
Manual of Elementary Projection Drawing.....	12mo,	1 50
Plane Problems in Elementary Geometry.....	12mo,	1 25
Problems, Theorems, and Examples in Descriptive Geometry.....	8vo,	2 50
Weisbach's Kinematics and Power of Transmission. (Hermann and Klein).....	8vo,	5 00
Wilson's (H. M.) Topographic Surveying.....	8vo,	3 50
Wilson's (V. T.) Free-hand Lettering.....	8vo,	1 00
Free-hand Perspective.....	8vo,	2 50
Woolf's Elementary Course in Descriptive Geometry.....	Large 8vo,	3 00

ELECTRICITY AND PHYSICS.

* Abegg's Theory of Electrolytic Dissociation. (von Ende).....	12mo,	1 25
Andrews's Hand-Book for Street Railway Engineering.....	3×5 inches, mor.	1 25
Anthony and Brackett's Text-book of Physics. (Magie).....	Large 12mo,	3 00
Anthony's Theory of Electrical Measurements. (Ball).....	12mo,	1 00
Benjamin's History of Electricity.....	8vo,	3 00
Voltaic Cell.....	8vo,	3 00
Betts's Lead Refining and Electrolysis.....	8vo,	4 00
Classen's Quantitative Chemical Analysis by Electrolysis. (Boltwood).....	8vo,	3 00
* Collins's Manual of Wireless Telegraphy.....	12mo,	1 50
Mor.		2 00
Crehore and Squier's Polarizing Photo-chronograph.....	8vo,	3 00
* Danneel's Electrochemistry. (Merriam).....	12mo,	1 25
Dowson's "Engineering" and Electric Traction Pocket-book.....	16mo, mor.	5 00
Dolezalek's Theory of the Lead Accumulator (Storage Battery). (von Ende).....	12mo,	2 50
Duhem's Thermodynamics and Chemistry. (Burgess).....	8vo,	4 00
Flather's Dynamometers, and the Measurement of Power.....	12mo,	3 00
Gilbert's De Magnete. (Mottelay).....	8vo,	2 50
* Hanchett's Alternating Currents.....	12mo,	1 00
Hering's Ready Reference Tables (Conversion Factors).....	16mo, mor.	2 50
* Hobart and Ellis's High-speed Dynamo Electric Machinery.....	8vo,	6 00
Holman's Precision of Measurements.....	8vo,	2 00
Telescopic Mirror-scale Method, Adjustments, and Tests.....	Large 8vo,	75
* Karapetoff's Experimental Electrical Engineering.....	8vo,	6 00
Kinzbrunner's Testing of Continuous-current Machines.....	8vo,	2 00
Landauer's Spectrum Analysis. (Tingle).....	8vo,	3 00
Le Chatelier's High-temperature Measurements. (Boudouard—Burgess).....	12mo,	3 00
Löb's Electrochemistry of Organic Compounds. (Lorenz).....	8vo,	3 00
* Lyndon's Development and Electrical Distribution of Water Power.....	8vo,	3 00

* Lyons's Treatise on Electromagnetic Phenomena. Vols. I. and II. 8vo, each	6	00
* Michie's Elements of Wave Motion Relating to Sound and Light.....	8vo,	4 00
Morgan's Outline of the Theory of Solution and its Results.....	12mo,	1 00
* Physical Chemistry for Electrical Engineers.....	12mo,	1 50
Niaudet's Elementary Treatise on Electric Batteries. (Fishback).....	12mo,	2 50
* Norris's Introduction to the Study of Electrical Engineering.....	8vo,	2 50
* Parshall and Hobart's Electric Machine Design.....	4to, half mor.	12 50
Reagan's Locomotives: Simple, Compound, and Electric. New Edition.		
	Large 12mo,	3 50
* Rosenberg's Electrical Engineering. (Haldane Gee — Kinzbrunner)...	8vo,	2 00
Ryan, Norris, and Hoxie's Electrical Machinery. Vol. I.....	8vo,	2 50
Schapper's Laboratory Guide for Students in Physical Chemistry.....	12mo,	1 00
* Tillman's Elementary Lessons in Heat.....	8vo,	1 50
Tory and Pitcher's Manual of Laboratory Physics.....	Large 12mo,	2 00
Ulke's Modern Electrolytic Copper Refining.....	8vo,	3 00

LAW.

Brennan's Handbook: A Compendium of Useful Legal Information for Business Men.....	16mo, mor.	5 00
* Davis's Elements of Law.....	8vo,	2 50
* Treatise on the Military Law of United States.....	8vo,	7 00
*	Sheep,	7 50
* Dudley's Military Law and the Procedure of Courts-martial... Large	12mo,	2 50
Manual for Courts-martial.....	16mo, mor.	1 50
Wait's Engineering and Architectural Jurisprudence.....	8vo,	6 00
	Sheep,	6 50
Law of Contracts.....	8vo,	3 00
Law of Operations Preliminary to Construction in Engineering and Archi- tecture.....	8vo,	5 00
	Sheep,	5 50

MATHEMATICS.

Baker's Elliptic Functions.....	8vo,	1 50
Briggs's Elements of Plane Analytic Geometry. (Böcher).....	12mo,	1 00
* Buchanan's Plane and Spherical Trigonometry.....	8vo,	1 00
Byerley's Harmonic Functions.....	8vo,	1 00
Chandler's Elements of the Infinitesimal Calculus.....	12mo,	2 00
Coffin's Vector Analysis. (In Press.)		
Compton's Manual of Logarithmic Computations.....	12mo,	1 50
* Dickson's College Algebra.....	Large 12mo,	1 50
* Introduction to the Theory of Algebraic Equations.....	Large 12mo,	1 25
Emch's Introduction to Projective Geometry and its Applications.....	8vo,	2 50
Fiske's Functions of a Complex Variable.....	8vo,	1 00
Halsted's Elementary Synthetic Geometry.....	8vo,	1 50
Elements of Geometry.....	8vo,	1 75
* Rational Geometry.....	12mo,	1 50
Hyde's Grassmann's Space Analysis.....	8vo,	1 00
* Johnson's (J. B.) Three-place Logarithmic Tables: Vest-pocket size, paper,		15
	100 copies,	5 00
*	Mounted on heavy cardboard, 8 × 10 inches,	25
	10 copies,	2 00
Johnson's (W. W.) Abridged Editions of Differential and Integral Calculus		
	Large 12mo, 1 vol.	2 50
Curve Tracing in Cartesian Co-ordinates.....	12mo,	1 00
Differential Equations.....	8vo,	1 00
Elementary Treatise on Differential Calculus.....	Large 12mo,	1 50
Elementary Treatise on the Integral Calculus.....	Large 12mo,	1 50
Theoretical Mechanics.....	12mo,	3 00
Theory of Errors and the Method of Least Squares.....	12mo,	1 50
Treatise on Differential Calculus.....	Large 12mo,	3 00

Johnson's Treatise on the Integral Calculus.....	Large 12mo,	3 00
Treatise on Ordinary and Partial Differential Equations..	Large 12mo,	3 50
Karapetoff's Engineering Applications of Higher Mathematics. (In Preparation.)		
Laplace's Philosophical Essay on Probabilities. (Truscott and Emory)..	12mo,	2 00
* Ludlow and Bass's Elements of Trigonometry and Logarithmic and Other Tables	8vo,	3 00
Trigonometry and Tables published separately	Each,	2 00
* Ludlow's Logarithmic and Trigonometric Tables	8vo,	1 00
Macfarlane's Vector Analysis and Quaternions.....	8vo,	1 00
McMahon's Hyperbolic Functions.....	8vo,	1 00
Manning's Irrational Numbers and their Representation by Sequences and Series	12mo,	1 25
Mathematical Monographs. Edited by Mansfield Merriman and Robert S. Woodward.....	Octavo, each	1 00
No. 1. History of Modern Mathematics, by David Eugene Smith.		
No. 2. Synthetic Projective Geometry, by George Bruce Halsted.		
No. 3. Determinants, by Laenas Gifford Weld. No. 4. Hyperbolic Functions, by James McMahon. No. 5. Harmonic Functions, by William E. Byerly. No. 6. Grassmann's Space Analysis, by Edward W. Hyde. No. 7. Probability and Theory of Errors, by Robert S. Woodward. No. 8. Vector Analysis and Quaternions, by Alexander Macfarlane. No. 9. Differential Equations, by William Woolsey Johnson. No. 10. The Solution of Equations, by Mansfield Merriman. No. 11. Functions of a Complex Variable, by Thomas S. Fiske.		
Maurer's Technical Mechanics.....	8vo,	4 00
Merriman's Method of Least Squares.....	8vo,	2 00
Solution of Equations	8vo,	1 00
Rice and Johnson's Differential and Integral Calculus. 2 vols. in one.		
Large 12mo,	1 50	
Elementary Treatise on the Differential Calculus.....	Large 12mo,	3 00
Smith's History of Modern Mathematics	8vo,	1 00
* Veblen and Lennes's Introduction to the Real Infinitesimal Analysis of One Variable.....	8vo,	2 00
* Waterbury's Vest Pocket Hand-Book of Mathematics for Engineers.		
2 $\frac{1}{2}$ × 5 $\frac{3}{8}$ inches, mor.	1 00	
Weld's Determinations.....	8vo,	1 00
Wood's Elements of Co-ordinate Geometry.....	8vo,	2 00
Woodward's Probability and Theory of Errors.....	8vo,	1 00

MECHANICAL ENGINEERING.

MATERIALS OF ENGINEERING, STEAM-ENGINES AND BOILERS.

Bacon's Forge Practice.....	12mo,	1 50
Baldwin's Steam Heating for Buildings.....	12mo,	2 50
Barr's Kinematics of Machinery.....	8vo,	2 50
* Bartlett's Mechanical Drawing.....	8vo,	3 00
* " " " Abridged Ed.	8vo,	1 50
Benjamin's Wrinkles and Recipes.....	12mo,	2 00
* Burr's Arcient and Modern Engineering and the Isthmian Canal.....	8vo,	3 50
Carpenter's Experimental Engineering.....	8vo,	6 00
Heating and Ventilating Buildings.....	8vo,	4 00
Clerk's Gas and Oil Engine.....	Large 12mo,	4 00
Compton's First Lessons in Metal Working	12mo,	1 50
Compton and De Groodt's Speed Lathe.....	12mo,	1 50
Coolidge's Manual of Drawing.....	8vo, paper,	1 00
Coolidge and Freeman's Elements of General Drafting for Mechanical Engineers.....	Oblong 4to,	2 50

Cromwell's Treatise on Belts and Pulleys.....	12mo,	1 50
Treatise on Toothed Gearing.....	12mo,	1 50
Durley's Kinematics of Machines.....	8vo,	4 00
Flather's Dynamometers and the Measurement of Power.....	12mo,	3 00
Rope Driving.....	12mo,	2 00
Gill's Gas and Fuel Analysis for Engineers.....	12mo,	1 25
Goss's Locomotive Sparks.....	8vo,	2 00
Greene's Pumping Machinery. (In Preparation.)		
Hering's Ready Reference Tables (Conversion Factors).....	16mo, mor.	2 50
* Hobart and Ellis's High Speed Dynamo Electric Machinery.....	8vo,	6 00
Hutton's Gas Engine.....	8vo,	5 00
Jamison's Advanced Mechanical Drawing.....	8vo,	2 00
Elements of Mechanical Drawing.....	8vo,	2 50
Jones's Gas Engine. (In Press.)		
Machine Design:		
Part I. Kinematics of Machinery.....	8vo,	1 50
Part II. Form, Strength, and Proportions of Parts.....	8vo,	3 00
Kent's Mechanical Engineers' Pocket-book.....	16mo, mor.	5 00
Kerr's Power and Power Transmission.....	8vo,	2 00
Leonard's Machine Shop Tools and Methods.....	8vo,	4 00
* Lorenz's Modern Refrigerating Machinery. (Pope, Haven, and Dean).....	8vo,	4 00
MacCord's Kinematics; or, Practical Mechanism.....	8vo,	5 00
Mechanical Drawing.....	4to,	4 00
Velocity Diagrams.....	8vo,	1 50
MacFarland's Standard Reduction Factors for Gases.....	8vo,	1 50
Mahan's Industrial Drawing. (Thompson).....	8vo,	3 50
Oberg's Screw Thread Systems, Taps, Dies, Cutters, and Reamers. (In Press.)		
* Parshall and Hobart's Electric Machine Design.....	Small 4to, half leather,	12 50
Peele's Compressed Air Plant for Mines.....	8vo,	3 00
Poole's Calorific Power of Fuels.....	8vo,	3 00
* Porter's Engineering Reminiscences, 1855 to 1882.....	8vo,	3 00
Reid's Course in Mechanical Drawing.....	8vo,	2 00
Text-book of Mechanical Drawing and Elementary Machine Design.....	8vo,	3 00
Richard's Compressed Air.....	12mo,	1 50
Robinson's Principles of Mechanism.....	8vo,	3 00
Schwamb and Merrill's Elements of Mechanism.....	8vo,	3 00
Smith's (O.) Press-working of Metals.....	8vo,	3 00
Smith (A. W.) and Marx's Machine Design.....	8vo,	3 00
Sorel's Carbureting and Combustion in Alcohol Engines. (Woodward and Preston).	Large 12mo,	3 00
Thurston's Animal as a Machine and Prime Motor, and the Laws of Energetics.	12mo,	1 00
Treatise on Friction and Lost Work in Machinery and Mill Work... 8vo,	3 00	
Tillson's Complete Automobile Instructor.....	16mo,	1 50
	mor.	2 00
Titworth's Elements of Mechanical Drawing.....	Oblong 8vo,	1 25
Warren's Elements of Machine Construction and Drawing.....	8vo,	7 50
* Waterbury's Vest Pocket Hand Book of Mathematics for Engineers.	2 $\frac{1}{4}$ × 5 $\frac{3}{8}$ inches, mor.	1 00
Weisbach's Kinematics and the Power of Transmission. (Herrmann—Klein).....	8vo,	5 00
Machinery of Transmission and Governors. (Herrmann—Klein).....	8vo,	5 00
Wood's Turbines.....	8vo,	2 50

MATERIALS OF ENGINEERING

* Bovey's Strength of Materials and Theory of Structures.....	8vo,	7 50
Burr's Elasticity and Resistance of the Materials of Engineering.....	8vo,	7 50
Church's Mechanics of Engineering.....	8vo,	6 00
* Greene's Structural Mechanics.....	8vo,	2 50

Holley and Ladd's Analysis of Mixed Paints, Color Pigments, and Varnishes.	Large 12mo,	2 50
Johnson's Materials of Construction.	8vo,	6 00
Keep's Cast Iron.	8vo,	2 50
Lanza's Applied Mechanics.	8vo,	7 50
Maire's Modern Pigments and their Vehicles.	12mo,	2 00
Martens's Handbook on Testing Materials. (Henning)	8vo,	7 50
Maurer's Technical Mechanics.	8vo,	4 00
Merriman's Mechanics of Materials.	8vo,	5 00
* Strength of Materials	12mo,	1 00
Metcalf's Steel. A Manual for Steel-users.	12mo,	2 00
Sabin's Industrial and Artistic Technology of Paints and Varnish.	8vo,	3 00
Smith's Materials of Machines.	12mo,	1 00
Thurston's Materials of Engineering.	3 vols., 8vo,	8 00
Part I. Non-metallic Materials of Engineering and Metallurgy.	8vo,	2 00
Part II. Iron and Steel.	8vo,	3 50
Part III. A Treatise on Brasses, Bronzes, and Other Alloys and their Constituents.	8vo,	2 50
Wood's (De V.) Elements of Analytical Mechanics.	8vo,	3 00
Treatise on the Resistance of Materials and an Appendix on the Preservation of Timber	8vo,	2 00
Wood's (M. P.) Rustless Coatings: Corrosion and Electrolysis of Iron and Steel.	8vo,	4 00

STEAM-ENGINES AND BOILERS.

Berry's Temperature-entropy Diagram.	12mo,	1 25
Carnot's Reflections on the Motive Power of Heat. (Thurston)	12mo,	1 50
Chase's Art of Pattern Making.	12mo,	2 50
Creighton's Steam-engine and other Heat-motors.	8vo,	5 00
Dawson's "Engineering" and Electric Traction Pocket-book.	16mo, mor.	5 00
Ford's Boiler Making for Boiler Makers.	18mo,	1 00
* Gebhardt's Steam Power Plant Engineering	8vo,	6 00
Goss's Locomotive Performance.	8vo,	5 00
Hemenway's Indicator Practice and Steam-engine Economy.	12mo,	2 00
Hutton's Heat and Heat-engines.	8vo,	5 00
Mechanical Engineering of Power Plants.	8vo,	5 00
Kent's Steam boiler Economy.	8vo,	4 00
Kneass's Practice and Theory of the Injector.	8vo,	1 50
MacCord's Slide-valves.	8vo,	2 00
Meyer's Modern Locomotive Construction.	4to,	10 00
Moyer's Steam Turbines. (In Press.)		
Peabody's Manual of the Steam-engine Indicator.	12mo,	1 50
Tables of the Properties of Saturated Steam and Other Vapors.	8vo,	1 00
Thermodynamics of the Steam-engine and Other Heat-engines.	8vo,	5 00
Valve-gears for Steam-engines.	8vo,	2 50
Peabody and Miller's Steam-boilers.	8vo,	4 00
Pray's Twenty Years with the Indicator.	Large 8vo,	2 50
Pupin's Thermodynamics of Reversible Cycles in Gases and Saturated Vapors. (Osterberg).	12mo,	1 25
Reagan's Locomotives. Simple, Compound, and Electric. New Edition.	Large 12mo,	3 50
Sinclair's Locomotive Engine Running and Management.	12mo,	2 00
Smart's Handbook of Engineering Laboratory Practice.	12mo,	2 50
Snow's Steam-boiler Practice.	8vo,	3 00
Spangler's Notes on Thermodynamics.	12mo,	1 00
Valve-gears.	8vo,	2 50
Spangler, Greene, and Marshall's Elements of Steam-engineering	8vo,	3 00
Thomas's Steam-turbines.	8vo,	4 00

Thurston's Handbook of Engine and Boiler Trials, and the Use of the Indicator and the Prony Brake.	8vo,	5 00
Handy Tables.	8vo,	1 50
Manual of Steam-boilers, their Designs, Construction, and Operation..	8vo,	5 00
Thurston's Manual of the Steam-engine.	2 vols., 8vo,	10 00
Part I. History, Structure, and Theory.	8vo,	6 00
Part II. Design, Construction, and Operation.....	8vo,	6 00
Steam-boiler Explosions in Theory and in Practice.....	12mo,	1 50
Wehrenfenning's Analysis and Softening of Boiler Feed-water (Patterson)	8vo,	4 00
Weisbach's Heat, Steam, and Steam-engines. (Du Bois).....	8vo,	5 00
Whitham's Steam-engine Design.	8vo,	5 00
Wood's Thermodynamics, Heat Motors, and Refrigerating Machines..	8vo,	4 00

MECHANICS PURE AND APPLIED.

Church's Mechanics of Engineering.	8vo,	6 00
Notes and Examples in Mechanics.	8vo,	2 00
Dana's Text-book of Elementary Mechanics for Colleges and Schools. .	12mo,	1 50
Du Bois's Elementary Principles of Mechanics:		
Vol. I. Kinematics.	8vo,	3 50
Vol. II. Statics.....	8vo,	4 00
Mechanics of Engineering. Vol. I.	Small 4to,	7 50
Vol. II.	Small 4to,	10 00
* Greene's Structural Mechanics.....	8vo,	2 50
James's Kinematics of a Point and the Rational Mechanics of a Particle.		
Large	12mo,	2 00
* Johnson's (W. W.) Theoretical Mechanics.....	12mo.	3 00
Lanza's Applied Mechanics.	8vo,	7 50
* Martin's Text Book on Mechanics, Vol. I, Statics.	12mo,	1 25
* Vol. 2, Kinematics and Kinetics ..	12mo,	1 50
Maurer's Technical Mechanics.	8vo,	4 00
* Merriman's Elements of Mechanics.....	12mo,	1 00
Mechanics of Materials.....	8vo,	5 00
* Michie's Elements of Analytical Mechanics.	8vo,	4 00
Robinson's Principles of Mechanism.	8vo,	3 00
Sanborn's Mechanics Problems.....	Large 12mo,	1 50
Schwamb and Merrill's Elements of Mechanism.....	8vo,	3 00
Wood's Elements of Analytical Mechanics.	3vo,	3 00
Principles of Elementary Mechanics.....	12mo,	1 25

MEDICAL.

* Abderhalden's Physiological Chemistry in Thirty Lectures. (Hall and Defren)		
8vo,		5 00
von Behring's Suppression of Tuberculosis. (Bolduan).....	12mo,	1 00
* Bolduan's Immune Sera	12mo,	1 50
Bordet's Contribution to Immunity. (Gay). (In Preparation.)		
Davenport's Statistical Methods with Special Reference to Biological Variations.....	16mo, mor.	1 50
Ehrlich's Collected Studies on Immunity. (Bolduan).....	8vo,	6 00
* Fischer's Physiology of Alimentation	Large 12mo, cloth,	2 00
de Fursac's Manual of Psychiatry. (Rosanoff and Collins).....	Large 12mo,	2 50
Hammarsten's Text-book on Physiological Chemistry. (Mandel).....	8vo,	4 00
Jackson's Directions for Laboratory Work in Physiological Chemistry ..	8vo,	1 25
Lassar-Cohn's Practical Urinary Analysis. (Lorenz).....	12mo,	1 00
Mandel's Hand Book for the Bi-Chemical Laboratory.	12mo,	1 50
* Pauli's Physical Chemistry in the Service of Medicine. (Fischer)....	12mo,	1 25
* Pozzi-Escot's Toxins and Venoms and their Antibodies. (Cohn).....	12mo,	1 00
Rostoski's Serum Diagnosis. (Bolduan).....	12mo,	1 00
Ruddiman's Incompatibilities in Prescriptions.....	8vo,	2 00
Whys in Pharmacy.....	12mo,	1 00

Salkowski's Physiological and Pathological Chemistry. (Orndorff).....	8vo,	2 50
* Satterlee's Outlines of Human Embryology	12mo.	1 25
Smith's Lecture Notes on Chemistry for Dental Students.....	8vo,	2 50
Steel's Treatise on the Diseases of the Dog.....	8vo,	3 50
* Whipple's Typhoid Fever.....	Large 12mo,	3 00
Woodhull's Notes on Military Hygiene	16mo,	1 50
* Personal Hygiene.....	12mo,	1 00
Worcester and Atkinson's Small Hospitals Establishment and Maintenance, and Suggestions for Hospital Architecture, with Plans for a Small Hospital	12mo,	1 25

METALLURGY.

Betts's Lead Refining by Electrolysis	8vo,	4 00
Bolland's Encyclopedia of Founding and Dictionary of Foundry Terms Used in the Practice of Moulding	12mo,	3 00
Iron Founder	12mo,	2 50
“ “ Supplement	12mo,	2 50
Douglas's Untechnical Addresses on Technical Subjects.....	12mo,	1 00
Goesel's Minerals and Metals: A Reference Book	16mo, mor.	3 00
* Iles's Lead-smelting	12mo,	2 50
Keep's Cast Iron	8vo,	2 50
Le Chatelier's High-temperature Measurements. (Boudouard—Burgess)	12mo,	3 00
Metcal's Steel. A Manual for Steel-users	12mo,	2 00
Miller's Cyanide Process	12mo,	1 00
Minet's Production of Aluminium and its Industrial Use. (Waldo)	12mo,	2 50
Robine and Lenglen's Cyanide Industry. (Le Clerc)	8vo,	4 00
Ruer's Elements of Metallography. (Mathewson) (In Press.)		
Smith's Materials of Machines	12mo,	1 00
Tate and Stone's Foundry Practice. (In Press.)		
Thurston's Materials of Engineering. In Three Parts	8vo,	8 00
Part I. Non-metallic Materials of Engineering and Metallurgy	8vo,	2 00
Part II. Iron and Steel.....	8vo,	3 50
Part III. A Treatise on Brasses, Bronzes, and Other Alloys and their Constituents.....	8vo,	2 50
Ulke's Modern Electrielytic Copper Refining	8vo,	3 00
West's American Foundry Practice	12mo,	2 50
Moulder's Text Book	12mo,	2 50
Wilson's Chlorination Process	12mo,	1 50
Cyanide Processes.....	12mo,	1 50

MINERALOGY.

Barringer's Description of Minerals of Commercial Value.....	Oblong, mor.	2 50
Boyd's Resources of Southwest Virginia.....	8vo,	3 00
Boyd's Map of Southwest Virginia... ..	Pocket-book form.	2 00
* Browning's Introduction to the Rarer Elements.....	8vo,	1 50
Brush's Manual of Determinative Mineralogy. (Penfield).....	8vo,	4 00
Butler's Pocket Hand-Book of Minerals.....	16mo, mor.	3 00
Chester's Catalogue of Minerals.....	8vo, paper,	1 00
	Cloth,	1 25
* Crane's Gold and Silver.....	8vo,	5 00
Dana's First Appendix to Dana's New "System of Mineralogy:."	Large 8vo,	1 00
Manual of Mineralogy and Petrography.....	12mo	2 00
Minerals and How to Study Them	12mo,	1 50
System of Mineralogy.....	Large 8vo, half leather,	12 50
Text-book of Mineralogy.....	8vo,	4 00
Douglas's Untechnical Addresses on Technical Subjects.....	12mo,	1 00
Eakle's Mineral Tables.....	8vo,	1 25
Stone and Clay Products Used in Engineering. (In Preparation.)		

Egleston's Catalogue of Minerals and Synonyms.	8vo,	2 50
Goesel's Minerals and Metals: A Reference Book.	16mo mor.	3 00
Groth's Introduction to Chemical Crystallography (Marshall)	12mo,	1 25
* Iddings's Rock Minerals	8vo,	5 00
Johannsen's Determination of Rock-forming Minerals in Thin Sections.	8vo,	4 00
* Martin's Laboratory Guide to Qualitative Analysis with the Blowpipe.	12mo,	60
Merrill's Non-metallic Minerals: Their Occurrence and Uses	8vo,	4 00
Stones for Building and Decoration.	8vo,	5 00
* Penfield's Notes on Determinative Mineralogy and Record of Mineral Tests.	8vo, paper,	50
Tables of Minerals, Including the Use of Minerals and Statistics of Domestic Production	8vo,	1 00
* Pirsson's Rocks and Rock Minerals	12mo,	2 50
* Richards's Synopsis of Mineral Characters.	12mo, mor.	1 25
* Ries's Clays: Their Occurrence, Properties, and Uses.	8vo,	5 00
* Tillman's Text-book of Important Minerals and Rocks.	8vo,	2 00

MINING.

* Beard's Mine Gases and Explosions.	Large 12mo,	3 00
Boyd's Map of Southwest Virginia.	Pocket-book form,	2 00
Resources of Southwest Virginia.	8vo,	3 00
* Crane's Gold and Silver	8vo,	5 00
Douglas's Untechnical Addresses on Technical Subjects.	12mo	1 00
Eissler's Modern High Explosives.	8vo,	4 00
Goesel's Minerals and Metals: A Reference Book.	16mo, mor.	3 00
Ilse's Manual of Mining.	8vo,	5 00
* Iles's Lead-smelting.	12mo,	2 50
Miller's Cyanide Process.	12mo,	1 00
O'Driscoll's Notes on the Treatment of Gold Ores.	8vo,	2 00
Peele's Compressed Air Plant for Mines	8vo,	3 00
Riemer's Shaft Sinking Under Difficult Conditions. (Corning and Peele)	8vo,	3 00
Robine and Lenglen's Cyanide Industry. (Le Clerc).	8vo,	4 00
* Weaver's Military Explosives.	8vo,	3 00
Wilson's Chlorination Process.	12mo,	1 50
Cyanide Processes.	12mo,	1 50
Hydraulic and Placer Mining. 2d edition, rewritten	12mo,	2 50
Treatise on Practical and Theoretical Mine Ventilation.	12mo,	1 25

SANITARY SCIENCE.

Association of State and National Food and Dairy Departments, Hartford Meeting, 1906.	8vo,	3 00
Jamestown Meeting, 1907.	8vo,	3 00
* Bashore's Outlines of Practical Sanitation.	12mo,	1 25
Sanitation of a Country House.	12mo,	1 00
Sanitation of Recreation Camps and Parks.	12mo,	1 00
Folwell's Sewerage. (Designing, Construction, and Maintenance).	8vo,	3 00
Water-supply Engineering.	8vo,	4 00
Fowler's Sewage Works Analyses.	12mo,	2 00
Fuertes's Water-filtration Works.	12mo,	2 50
Water and Public Health.	12mo,	1 50
Gerhard's Guide to Sanitary House-inspection	16mo,	1 00
* Modern Baths and Bath Houses.	8vo,	3 00
Sanitation of Public Buildings.	12mo,	1 50
Hazen's Clean Water and How to Get It.	Large 12mo,	1 50
Filtration of Public Water-supplies.	8vo,	3 00
Kinnicut, Winslow and Pratt's Purification of Sewage. (In Press.)		
Leach's Inspection and Analysis of Food with Special Reference to State Control.	8vo,	7 00

Mason's Examination of Water. (Chemical and Bacteriological).....	12mo,	1 25
Water-supply. (Considered Principally from a Sanitary Standpoint) ..	8vo,	4 00
* Merriman's Elements of Sanitary Engineering	8vo,	2 00
Ogden's Sewer Design.	12mo,	2 00
Parsons's Disposal of Municipal Refuse.....	8vo,	2 00
Prescott and Winslow's Elements of Water Bacteriology, with Special Reference to Sanitary Water Analysis.	12mo,	1 50
* Price's Handbook on Sanitation.	12mo,	1 50
Richards's Cost of Cleanness. A Twentieth Century Problem.....	12mo,	1 00
Cost of Food. A Study in Dieteries.....	12mo,	1 00
Cost of Living as Modified by Sanitary Science.	12mo,	1 00
Cost of Shelter. A Study in Economics.....	12mo,	1 00
* Richards and Williams's Dietary Computer.....	8vo,	1 50
Richards and Woodman's Air, Water, and Food from a Sanitary Standpoint.	8vo,	2 00
Rideal's Disinfection and the Preservation of Food.	8vo,	4 00
Sewage and Bacterial Purification of Sewage.....	8vo,	4 00
Soper's Air and Ventilation of Subways	Large 12mo,	2 50
Turneaure and Russell's Public Water-supplies.	8vo,	5 00
Venable's Garbage Crematories in America.....	8vo,	2 00
Method and Devices for Bacterial Treatment of Sewage.....	8vo,	3 00
Ward and Whipple's Freshwater Biology.....	12mo,	2 50
Whipple's Microscopy of Drinking-water.	8vo,	3 50
* Typhod Fever.....	Large 12mo,	3 00
Value of Pure Water.	Large 12mo,	1 00
Winslow's Bacterial Classification.....	12mo,	2 50
Winton's Microscopy of Vegetable Foods.	8vo,	7 50

MISCELLANEOUS.

Emmons's Geological Guide-book of the Rocky Mountain Excursion of the International Congress of Geologists.	Large 8vo,	1 50
Ferrel's Popular Treatise on the Winds.	8vo,	4 00
Fitzgerald's Boston Machinist	18mo,	1 00
Gannett's Statistical Abstract of the World.	24mo,	75
Haines's American Railway Management.	12mo,	2 50
* Hanusek's The Microscopy of Technical Products. (Winton).....	8vo,	5 00
Owen's The Dyeing and Cleaning of Textile Fabrics. (Standage). (In Press.)		
Ricketts's History of Rensselaer Polytechnic Institute 1824-1894.		
	Large 12mo,	3 00
Rotherham's Emphasized New Testament.	Large 8vo,	2 00
Standage's Decoration of Wood, Glass, Metal, etc.....	12mo,	2 00
Thome's Structural and Physiological Botany. (Bennett).....	16mo,	2 25
Westermaier's Compendium of General Botany. (Schneider).....	8vo,	2 00
Winslow's Elements of Applied Microscopy.....	12mo,	1 50

HEBREW AND CHALDEE TEXT-BOOKS.

Green's Elementary Hebrew Grammar.....	12mo,	1 25
Gesenius's Hebrew and Chaldee Lexicon to the Old Testament Scriptures. (Tregelles).	Small 4to, half mor.	5 00



uso . s-a

2.55

UNIVERSITY OF CALIFORNIA LIBRARY
BERKELEY

THIS BOOK IS DUE ON THE LAST DATE
STAMPED BELOW

Books not returned on time are subject to a fine of 50c per volume after the third day overdue, increasing to \$1.00 per volume after the sixth day. Books not in demand may be renewed if application is made before expiration of loan period.

NOV 20 1919

OCT 16 1927

DEC 19 1927

19Ja'591 W

REC'D LD

JAN 13 1959
SENT ON ILL

NOV 04 1994

U. C. BERKELEY

YC 68949



Order
281345

01c

T11645
04

