



Class TK6540

Book R35

GPO

Scanned from the collections of The Library of Congress



Packard Campus
for Audio Visual Conservation
www.loc.gov/avconservation

Motion Picture and Television Reading Room
www.loc.gov/rr/mopic

Recorded Sound Reference Center
www.loc.gov/rr/record

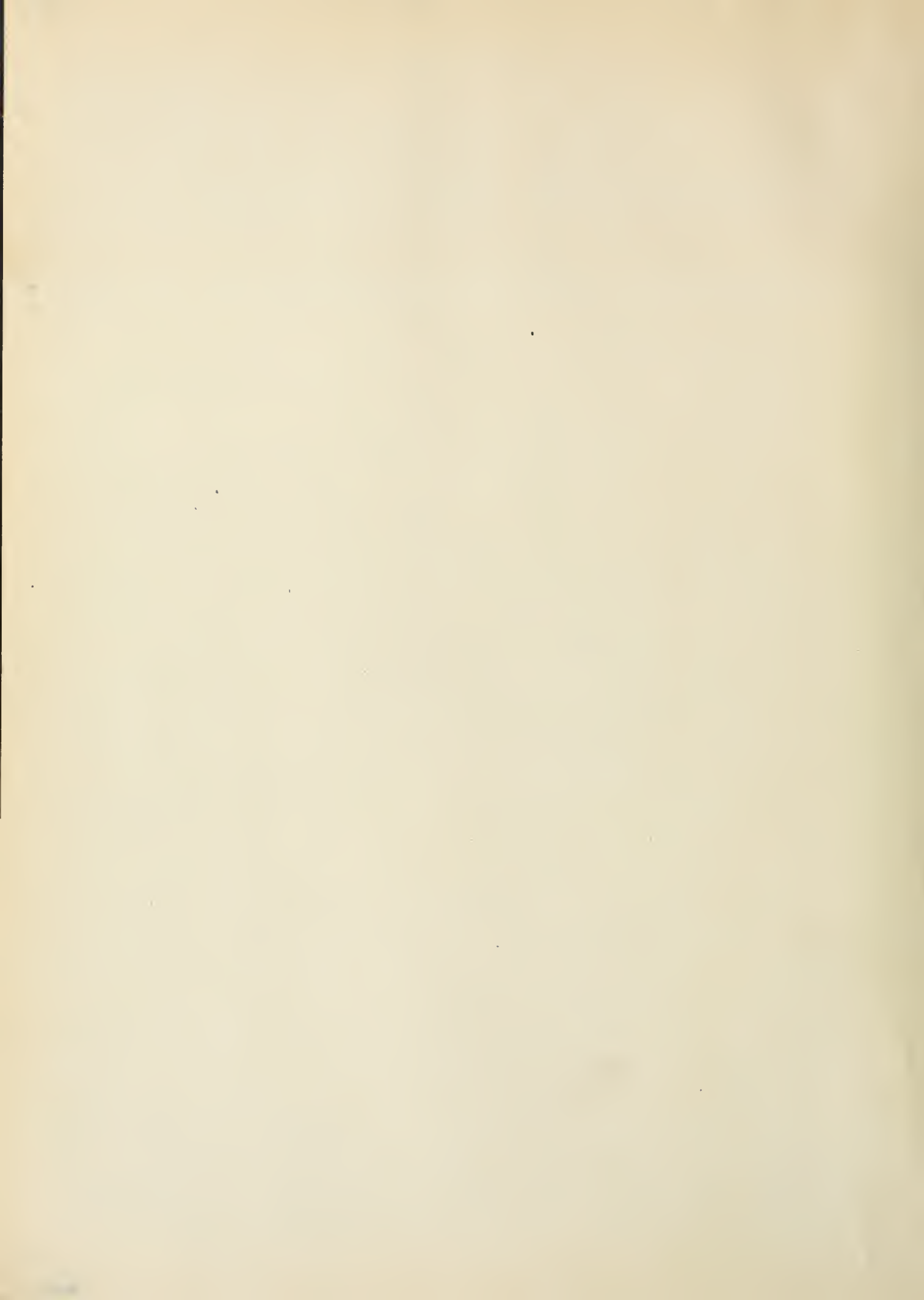

The RADIO DEALER

Vol. 2 No. 1

OCTOBER, 6 1922

One Dollar The Year

Entered as Second Class Matter, at the Post Office at New York, N. Y., under the Act of March 3, 1879

Make the Most
of the
Holiday Trade!

ORDER NOW A Full Line
of **Nationally Advertised Products**



96833
K.C.
13

THE HOLIDAYS are your big opportunity to recoup the losses of a dull summer and get a fresh start. Dodge that costly last minute rush to get stock. You can't afford to wait too long. Everybody will want to select their radio gifts from a wide assortment of well known, standard merchandise. Order early and completely.

We can handle your order now, promptly, carefully and fully. Anything in any quantity from the lines of 16 nationally important manufacturers. Every possible advantage to you in discounts, shipments and accommodating methods.

**THERE IS NO PROFIT IN WAITING
PREPARE NOW FOR A SURE THING!**



*Try an Order of
These Staples*

Koehler 3-Plate Vernier Variable Condensers

Heavy aluminum plates, thick Bakelite ends, other parts of brass, nickel-plated. .000075 Mfd. capacity. Accurately manufactured and carefully tested. Koehler Condensers have made good. Also made in other sizes.

LIST
\$1.50

GREWOL Crystal Detectors

No trouble selling this fixed detector. Stays adjusted. Guaranteed tested crystal and dust-proof glass cup.

LIST
\$2.00

Test our service with a trial order of these two standard sellers

**DISTRIBUTORS
FOR**

- Acme
- Baldwin
- Bradleystat
- Chelsea
- De Forest
- Eveready
- Federal
- Homcharger
- Jefferson
- Klosner
- Magnavox
- Murdock
- Paragon
- Thordarson
- Tuska
- Western Electric

**WHOLESALE
ONLY**

Write for Attractive Discounts on Our Complete Line

Wholesale Radio Equipment Co.

24 WILLIAM STREET, NEWARK, N. J.

TK 6540
R35



PHONES

Made to Serve—Not to Sell

Built by a German manufacturer for government wireless use, cost did not enter into the construction of "N & K" phones. They were built to serve, not to sell. It was a matter of making the most scientifically perfect head set possible and the "N & K" phone is the result.

Only Phones with Oversize Ear Cups

The ear cups on "N & K" phones are $2\frac{3}{4}$ inches in diameter, nearly a third larger than any other phone made. This permits their being used for hours without the least fatigue, eliminates all outside noises and increases the clarity of reception. Highly supersensitive, the tone quality of "N & K" phones is marvelous. Comparison is all that is needed to prove superiority. Note the features below.

Attractive Proposition to the Trade

We are the sole U. S. distributors for "N & K" phones. Their advent in the American market offers the trade an opportunity to meet the ever increasing demand of the radio public for quality instead of cheapness. Just a demonstration of "N & K" phones sells them. Our advertising creates the demand. Be ready to supply it. Have "N & K" phones in stock and display them. Order from your jobber. If he cannot supply you, write or wire us direct. The turnover is fast. The profits are sweet. To handle "N & K" phones is to build for permanent business and satisfied radio patrons.

N. & K. Telephone Receivers
Of German manufacture, this headset was found to have a resistance of 6160 ohms. In crystal and tube receiving circuits, the sensitivity was unusually good. The construction is very neat and rugged. Cases are turned from brass, nickel plated inside and out, $2\frac{1}{4}$ inches in diameter at the diaphragm and $\frac{5}{8}$ inch in thickness. Two-piece magnets are used, in two semicircular sections, with very neat small bobbins, rectangular in shape and cloth covered. Soldering and connections are well done. Internal metal parts are nicked, and a thin metal washer is employed as a spacer between the case rim and the tinned diaphragm. Caps are of polished hard rubber, fitting comfortably. A 6-foot cord is connected to the cases outside. Two spring bands are used in the headband assembly, black leather covered, fastened by two knurled adjustment nuts through the center of which the supporting rods pass.
Awarded The Evening Mail Certificate of Excellence

Illustrations are Actual Size

Be the First in Your Territory to Show A Real Head Set

6000 OHMS

LIST PRICE

\$14.50

HERBERT & HUESGEN CO.,
18 EAST 42nd ST.,
NEW YORK CITY

Between Fifth Ave. and Grand Central



Note these Features

- 6,000 ohms resistance.
- Each magnet has 3,800 turns of wire.
- Each magnet has 1,500 ohms D. C. resistance.
- Magnets made of laminated magnet steel, the best steel made in Germany.
- Coil winding protected by triple covering of insulating material.



Note these Features

- The thin steel diaphragms are only .02 MM. in thickness.
- The impedance is 20,000 ohms at 800 cycles
- All leather head bands, no webbing used.
- Cases turned from brass, nickel plated inside and out, $2\frac{1}{4}$ inches in diameter at the diaphragm and $\frac{5}{8}$ inch in thickness.
- Caps of polished hard rubber.



Scene from the Opera "Faust"

MOMENTOUS events in the arts and sciences are the result of rising above out-worn principles, independent of the tools of mediocrity. Beginning where others have been content to finish, a forward-looking group of radio engineers, comprising the Mu-Rad Laboratories, have designed and successfully constructed radio apparatus which is as advanced as the twenty-one-jewel watch is over the key-winder. Prices of this apparatus insure that great numbers will benefit from their achievements. Descriptive literature upon request.



MU-RAD
LABORATORIES
 INCORPORATED
 ASBURY PARK
 NEW JERSEY



The New
 Star in
 the Radio
 World

Electric Service Engineering Co.

105 West 47th Street

New York City

Bryant 2743-2744-2080

Amrad

Fada

Chelsea

Federal

Dubilier

General Apparatus

Make *ESECO* Your
HEADQUARTERS
"It Will Pay You!"

The advice of the Electric Service Engineering Co. to its dealers is equally as valuable as the promptness of deliveries and the reliability of its supplies. Eseco experience antedates the existence of the majority of its competitors.

"We don't guess—we know."

A Complete Stock of HARD-TO-GET Accessories

Retailers and Jobbers Take Notice!

NOTE: The coupon at the left will appear in our advertisement in November Radio News.

This advertisement will be read by over quarter of a million Radio enthusiasts. We are spending thousands of dollars in this way to make your sales easier.

...presents now many Condensers As You

NEW HAVEN RADIO COMPANY, Chapel and Hamilton Streets, NEW HAVEN, CONN.

Coupon good until November 10, anywhere in the world. Order today as many condensers as you need as we will not make this offer again.

Messrs..... (Dealer's name and address) (Date).....

Please deliver to me the Marshall Variable Air Condensers I have checked, (Write in square number of each desired)

<input type="checkbox"/>	<input type="checkbox"/>	<input type="checkbox"/>	<input type="checkbox"/>	<input type="checkbox"/>	<input type="checkbox"/>	<input type="checkbox"/>	<input type="checkbox"/>	<input type="checkbox"/>	<input type="checkbox"/>
3 Plate	5 Plate	9 Plate	17 Plate	23 Plate	35 Plate	43 Plate	67 Plate	5-23 Plate	Outfit Radio Expert Size

and accept this coupon in payment of.....dollars and.....cents of the cost of same, (10% of the retail price) the balance to be paid for in cash.

Name..... Address.....

RETAILERS AND JOBBERS:—We, the New Haven Radio Company, authorize you to accept this coupon. We will accept it from you at its face value when properly filled out and signed, in partial payment on any order for assembled Marshall Variable Air Condensers, placed with us either by the retail dealer direct or through his jobber, until December 1, 1922. Our references: Dun or Bradstreet, or any bank in New Haven. NEW HAVEN RADIO CO., NEW HAVEN, CONN.

Prepare to Meet the Demand for MARSHALL CONDENSERS Created by This Unique, Sensational Offer

READ the above special coupon offer on Marshall Condensers which will appear in Radio News for November. The coupon is worth a full 10% reduction off the retail price. It does not matter whether you order one or one thousand Marshall Condensers, there is 10% off just the same.

JOBBERS: Put this information IMMEDIATELY in the hands of road men, and order samples for them.

DEALERS: Run this coupon in your advertising and announce that you will accept all Marshall Condenser coupons on above terms.

Marshall Condensers have passed every test and are proved the highest grade condensers on the American market. It pays to sell the best.

Read, think, and act before the "other fellow" does.

NEW HAVEN RADIO COMPANY, New Haven, Connecticut, U. S. A.
Canadian Factory : 20 Hayter Street, Toronto, Canada

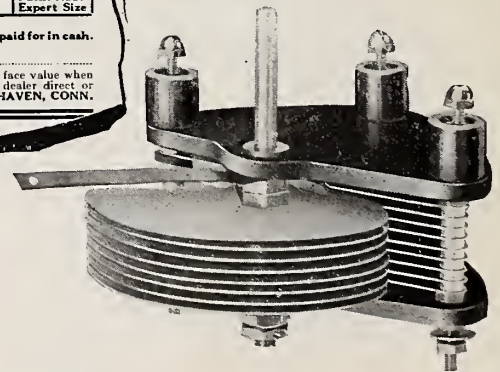

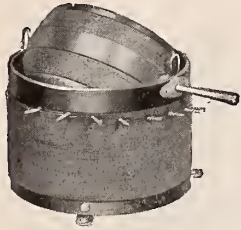

VARIOCOUPLER — Acknowledged standard in design and material. Exceptionally finished throughout. Contains seven unit taps and seven taps of seven turns each. Price \$4.00.

**New York Coil Company Radio Products
Are Built to Work—Not Just to
Sell**

NOTE REDUCED PRICES

The leadership they enjoy is due to correct design, exceptional workmanship and eighteen years' experience in the manufacture of wireless and precision electrical devices. Two especially equipped factories and quantity production is responsible for our low prices and *popularity with the dealer and jobber*. A set constructed of New York products is certain to give satisfaction and highest possible efficiency. Why experiment with untried devices?

Jobbers and Dealers—Satisfactory discounts and a line that will increase your business.

NEW YORK COIL COMPANY
338 Pearl St., New York City, N. Y.

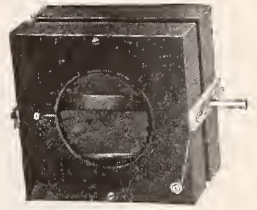

VARIOMETER — Widely copied, yet unequalled. This is an extremely large instrument containing proper number of turns and exact proportions throughout. Maximum results are assured by its using, as proven by thousands of satisfied customers. Must be seen to be fully appreciated. Price \$4.00.

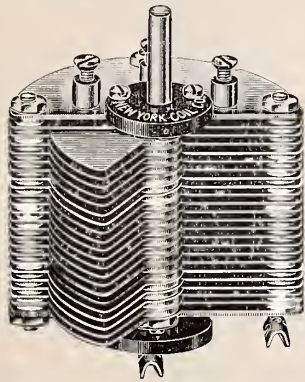

VARIABLE CONDENSERS — Design originated by us. Has proven its value under all conditions and must not be compared with many flimsy, poorly made and assembled imitations. Template for attaching accompanies each instrument. Made in three sizes:

11 Plate.....	\$1.50
23 Plate	2.00
43 Plate.....	3.00
Three Plate Veneer.....	1.25

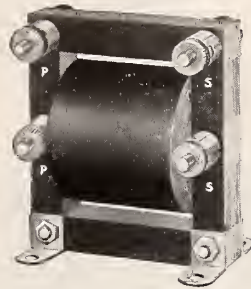

AUDIO FREQUENCY TRANSFORMERS—Choice of leading manufacturers and radio engineers. Guaranteed to give high magnification, less distortion and better all round efficiency. No howling. Price \$4.00.

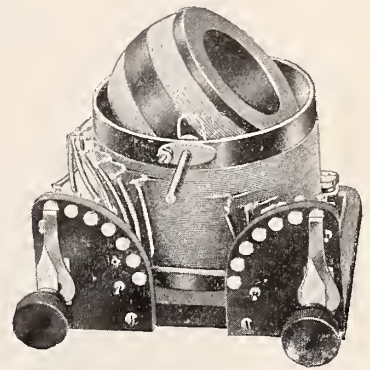

COMBINED MOUNTED VARIOCOUPLER—The only Variocoupler on the market that allows panel or table connection and eliminates the connecting of taps, soldering, drilling, etc. A great advantage in Radio. Nothing like it on the market. Handsomely finished. Price \$8.00.

COMBINED VARIOMETER & TUNING INDUCTANCE—Wave length 150 to 600 meters. Very popular with the more advanced wireless constructor. Contains primary and secondary windings, properly attached to New York standard Variometer. Allows large variety of hook-ups. Price \$6.00.

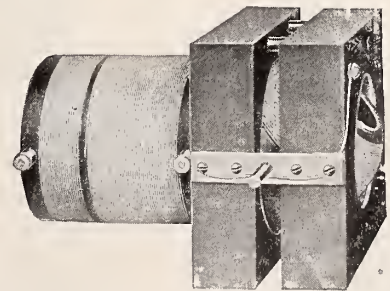

NEW YORK ENTERTAIN-A-PHONE RECEIVING SET No. 2—Complete with detector and two stages of amplification, all in one cabinet. Contains a non-regenerative two circuit hook-up with two stages audio amplification. Results are simply a revelation. It must be operated and heard to be appreciated. Workmanship and design and material of exceptional character throughout. Of unusual interest to the jobber. Price \$50.00, fully guaranteed.



Type B, Keystone Radio Arrester. Retail Price, \$2.00

KEYSTONE

LIGHTNING ARRESTERS

Listed as Standard by Underwriters' Laboratories (No. 362 A-4)

You can sell hundreds of Keystone Arresters for these reasons—Small in size; weatherproof; entirely enclosed and sealed; foolproof; constructed by a Company having 30 years' experience in lightning arrester design; low capacity and high resistance; no vacuum to lose and so reduce the efficiency of the arrester to a point where it is practically valueless.

Get your order in before there is a possible scarcity. Liberal Dealer discounts. Write for complete information.

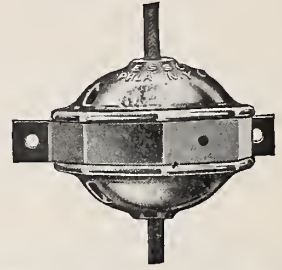

Type A, Keystone Radio Arrester. Retail Price, \$2.00

Simplex Panel Units

and
Unmounted
Variometers
and
Vario-Couplers

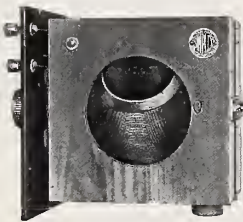

No. 47488
Simplex Variometer,
Showing Side View of
Panel Mounted Type

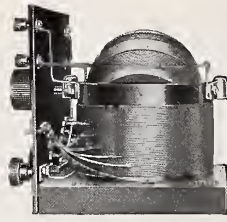

No. 47489
Simplex Vario-Coupler,
Showing Side View of
Panel Mounted Type

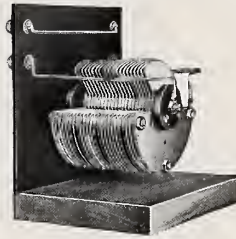

No. 47541
Simplex Condenser
Panel—Side View

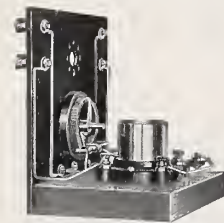

No. 47490
Simplex Detector Panel
Side View

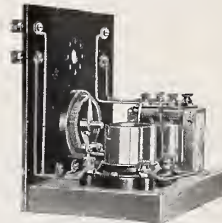

No. 47491
Simplex Amplifier Panel
Side View

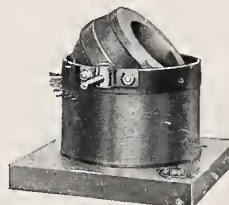

No. 47483
Simplex Vario-Coupler,
Unmounted



No. 47482
Simplex Variometer,
Unmounted



Manufacturer of
Lightning Arresters for 30 years
Distributors for
SIMPLEX RADIO CO.

There is a big demand for Simplex Panel Units among your customers because they permit trying-out many different hook-ups and thus determining the best for their certain locality without having to disassemble a complete outfit. This is a decided advantage, but of no less interest is the fact that the beginner can first purchase one Vario-Coupler Panel and one Detector Panel and have a fairly good receiving set at minimum cost with the advantage of later adding additional units to obtain greater sensitivity and selectivity. Thus the user can add to his Simplex outfit and when he has purchased it complete it is unquestionably one of the most attractive and efficient receiving sets now offered to the public. This is a very attractive line for Jobbers and Dealers. Write for new descriptive circular and discounts on Panel Units and Unmounted Variometers and Vario-Couplers. Simplex Material is high grade in every respect.

ELECTRIC SERVICE SUPPLIES CO.

PHILADELPHIA
17th and Cambria Streets

NEW YORK
50 Church Street

CHICAGO
Monadnock Bldg.

Branch Offices: Boston, Scranton, Pittsburgh
Canadian Distributors: Lyman Tube & Supply Co., Ltd., Montreal, Toronto, Winnipeg, Vancouver

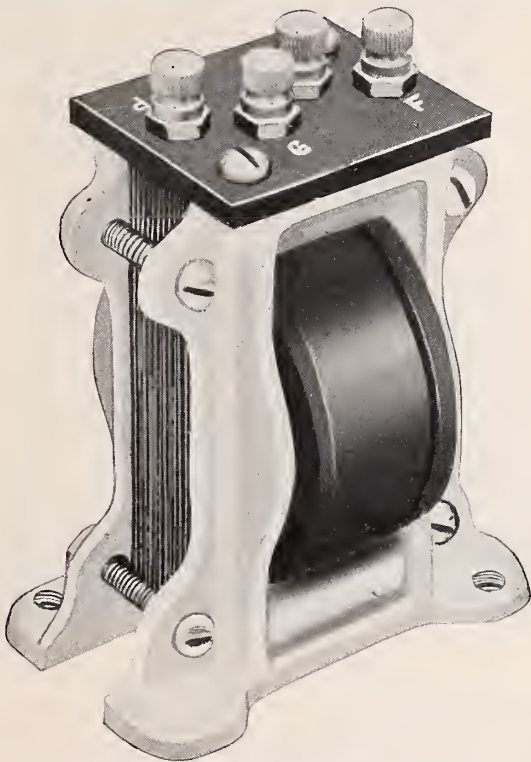

RETAIL PRICE, \$6.00
ORDER FROM YOUR
JOBBER

What Jobbers Say About 3 Y Q

“We find that they are all that you claim.”

Pittsburgh, Pa. Jobber & Mfgr.

* * *

“The transformers certainly have quality. Please ship the order at once.”

Mfgr. & Jobber, Newark, N. J.

* * *

“Have tried these transformers out and find them perfectly satisfactory. Please send at once fifty transformers.”

Mfgr. & Jobber, Baltimore, Md.

* * *

Names and addresses of above furnished on request.

3 Y Q Transformer Sales Prove That Radio Fans Appreciate Quality and Scientific Efficiency

More and more Radio Fans decide that the 3 Y Q Audio Frequency Transformer is the only transformer they care to use. Our sales sheet shows that dealers are moving 3 Y Q Transformers.

And that shows that the Fans appreciate *Amplification without distortion* and that they have accepted the 3 Y Q Transformer as the most efficient of all amplifying devices, young as it is.

Dealers who intend to help make Radio a permanent and growing business cannot afford to overlook the 3 Y Q Transformer—it builds good will, repeat orders and sends new customers into the store.

Order from your jobber. We are taking space in consumer magazines to tell the fans to buy from the dealer.

Descriptive literature for free counter distribution sent free upon request.

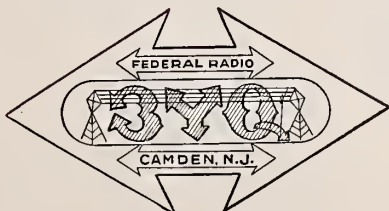

Federal Institute of Radio Telegraphy
 Second and Federal Streets
CAMDEN, N. J.

Your Trade Wants This Set

THE
Simple-X
Crystal Radio Receiver

*Superior to Sets Costing Five Times the
Price of This Wonderful Set*

PRICE **\$4.75**

READ THE FACTS:—

1. Will receive Broadcast Concerts within a radius of 25 miles.
2. The only set equipped with the Simple-x (fool-proof) Detector.
3. The only set with the Mul-Ti-Tec Crystal—a thousand crystals in one. No fussing to find a sensitive spot. No loss of time or interruption of the programme.
4. Built with Roller Sliders to give a smooth, constant contact.
5. No wearing or short-circuiting of coil wires due to frictional scraping.
6. The only set having a flat Coil and indicating sliders.

Awarded Certificate of Excellence by N. Y. Evening Mail, and approved by Tribune Institute.

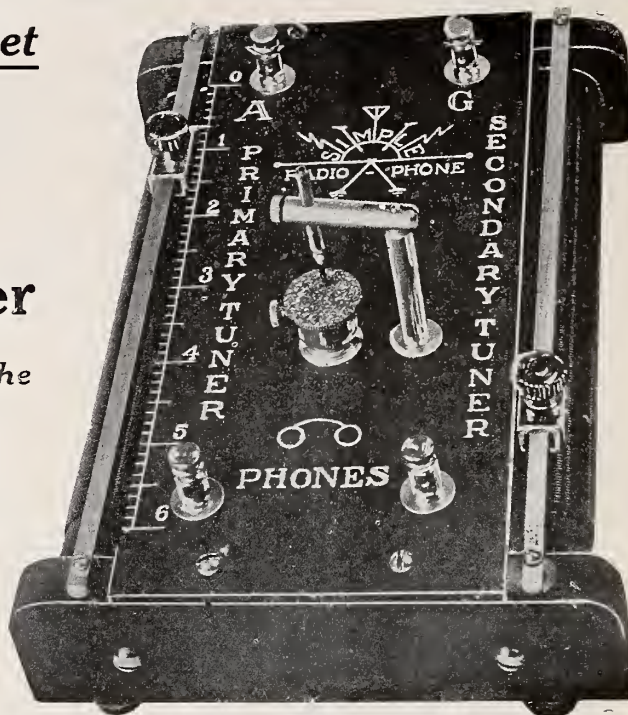

(Patent Applied For)

For Discount Schedule, wire, write, or call

CARAGOL-CLARKE CO., Inc.

82 Beaver St. (Tel. Bowling Green 1990-1-2) New York City

The DeLuxe U. S. Navy Type Radio Receiver

List \$595.00

FOR IMMEDIATE DELIVERY

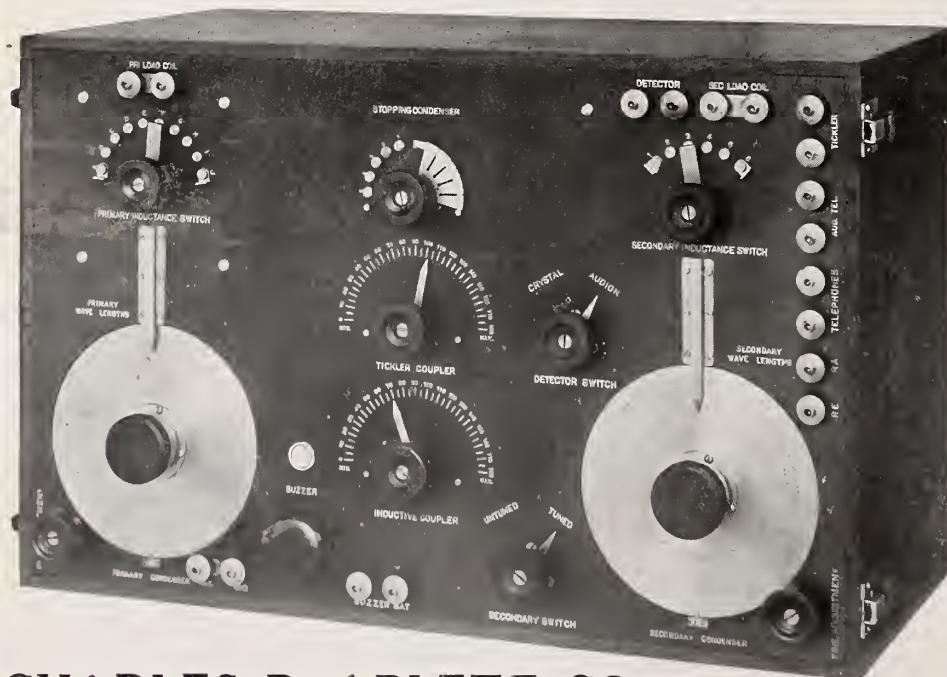

Best of its type—must not be confused with instruments selling for from \$200 to \$300. Highly selective. Will pick up messages, music, lectures, etc., that lower priced instruments will not hear. This receiver is equipped with binding posts which are normally short circuited for 300 to 6800 meters by which wave lengths up to 23,000 meters may be received by the attachment of loading coils. Capacities of proper loading coils for above are: Primary 50; Secondary 50; Tickler 30 millihenries. While the receiver is provided with a "standby" or untuned circuit, it also has an unusual degree of selectivity. Although primarily designed for the more advanced fields of Radio work, or the laboratory, the simplicity of arrangement and beauty of finish make it unusually desirable for the radio club or for the individual who desires the finest equipment obtainable for his home or office. In the receiver, Bakelite tubes, threaded, provide the forms on which inductance coils of high frequency cable are bank-wound. After assembling, the coils are impregnated with an insulating compound, in vacuum, and thoroughly baked. The inductance switch controls a mechanism whereby the different sections may be connected, completely disconnected and opened, or completely disconnected and individually short circuited. This arrangement is important for, by it, each coil has a natural period when connected which is less than the shortest wave length in the receiver's range. The reception of parasitic signals is overcome, the absorption of desired signals by the coils is minimized, more energy is forced to the detector and on all wave lengths the interference is reduced.

CHARLES R. ABLETT CO.

199 Fulton St., NEW YORK CITY

Dictograph Radio Loud Speaker Proves Sensational Success!

A NOTHER success for Dictograph! Here at last is the Loud Speaker the radio public has been waiting for—the Loud Speaker for the home—backed by a name known the world over—and sold at a low price within the reach of all!

From the very first announcement, the success of the Dictograph Radio Loud Speaker was assured. Orders poured in—in advance of production—and in such volume that original production plans were increased and the price reduced! Instead of \$25 as first announced, the LIST PRICE IS NOW ONLY \$20—complete with 5ft. flexible cord.

The Public has been waiting for this perfect Loud Speaker for the home

Everyone knew that a Radio Loud Speaker made by the Dictograph Products Corporation would be the BEST LOUD SPEAKER THAT COULD BE MADE at the price. Its superiority was GUARANTEED by Dictograph resources, Dictograph experience, and by the world-wide reputation of all Dictograph products—the "Acousticon" for the deaf, the Detective Dictograph, the Dictograph System of Loud-Speaking Telephones.

At the list price of ONLY \$20, the Dictograph Radio Loud Speaker is a real opportunity for dealers.

Here is the most perfect reproduction of sound known to radio engineering—clear, natural tones, in full volume, and absolutely FREE FROM DISTORTION OR



List Price \$20

NOISE. Perfect results with any vacuum tube receiving unit. No extra batteries required.

Another strong selling feature—the handsome appearance of the Dictograph Radio Loud Speaker: highly burnished French lacquered spun copper bell horn 11 inches in diameter attached to die cast black enamel tone arm, finished with nickel trimmings. Cabinet of solid ebony-finished hardwood, size 6 x 5 inches base, 4 inches high, mounted on rubber knobs to avoid marring of polished tables. List price \$20 complete with 5 ft. flexible silk cord and standard terminals.

PROTECT YOUR PROFITS on the Dictograph Radio Loud Speaker. Wire your jobber or communicate direct for names of authorized distributors.



3000 ohms

List Price \$12

THE STANDARD OF THE WORLD

Electrotypes for catalogs, advertising, etc., are available and will be furnished on request

DICTOGRAPH Radio HEAD SET

Bigger and bigger sales every month are the best proof in the world of the established demand for the Dictograph Radio Head Set. A product of unmatched quality. 3,000 ohms. For any receiving set, crystal detector or vacuum tube. No radio dealer can afford NOT to carry the Dictograph Head Set—it means quick turnover and SURE PROFITS. If you have not already stocked, get your order in NOW to your jobber or communicate direct for names of authorized distributors. The best Head Set in the world regardless of price! Regularly furnished as Standard Equipment with the Leading Receiving Sets made.

DICTOGRAPH PRODUCTS CORPORATION

220 WEST 42nd STREET

BRANCHES IN ALL PRINCIPAL CITIES

NEW YORK CITY

VARIO COUPLER

VARIOMETER

SHORT WAVE
UNIT

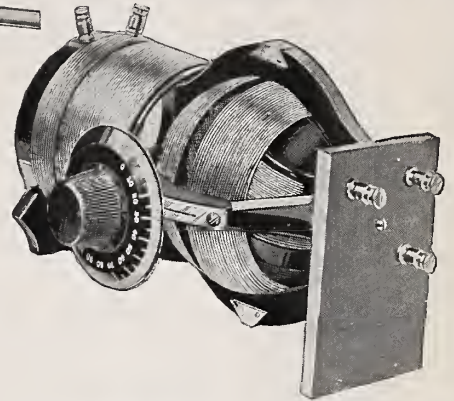
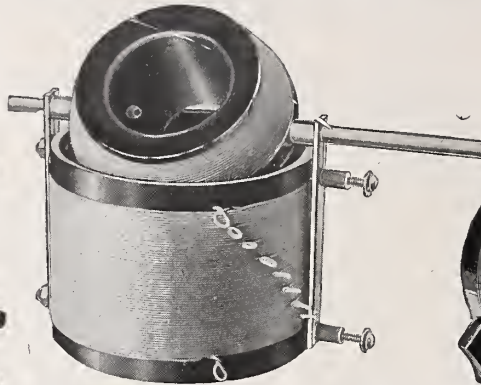
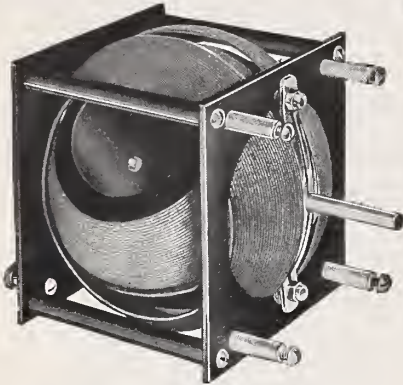

List Price - - - \$3.50

Unique in Design—Efficient in
Operation

*Dealers and Jobbers
Write for Particulars*

An Exclusive Utility Combination

List Price - - - - \$4.50

List Price - - - - \$10.00

NELSON RADIO PARTS CO.

89 ACADEMY STREET,

NEWARK, N. J.

*Dependable Equipment Must Answer
FALL DEMAND*

WE DISTRIBUTE FOR

RADIO CORPORATION OF AMERICA,
MURDOCK, RHAMSTINE, FADA,
BRANDES, DE FOREST, SIGNAL,
CLAPP-EASTHAM, CUTLER-HAMMER

AND OTHERS

THE RADIO  **ELECTRIC CO.**
Manufacturers and Jobbers in

RADIO EQUIPMENT

1427-29 LIBERTY AVENUE
PITTSBURGH, PA.



"VICTOR PRODUCTS"



TUNER, DETECTOR AND TWO-STAGE AMPLIFIER
—Type 115—

WE manufacture a complete line of Radio Sets and Parts, consisting of:
 Receiving Sets,
 Tuners,
 Tuners and Detectors,
 Tuner, Detector and Two Stage Amplifiers,
 Tuner, Detector and Three Stage Amplifiers,
 Two Stage Amplifiers,
 Variometers,
 Variocouplers,
 V. T. Sockets,
 Rheostats,
 Grid Condensers,
 Variable Condensers,
 Knobs,
 Dials,
 Binding Post,
 Etc.

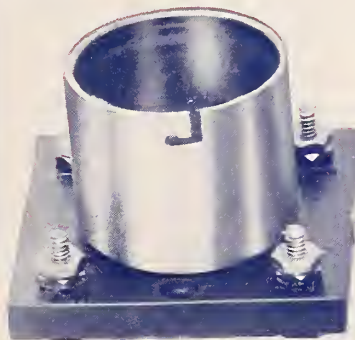

SOCKET
Type 109

EVERYTHING —IN RADIO—

MR. JOBBER AND DEALER: Does years of experience in manufacturing Radio Transmitting and Receiving Apparatus for the **UNITED STATES GOVERNMENT** mean anything to you?

VICTOR engineers and workmen have had this experience and are capable of producing highly satisfactory apparatus.

JOBBERS AND DEALERS are invited to write us for complete information regarding our attractive proposition.

CATALOGUE SENT ON REQUEST.



VICT-RA-PHONE CONSOLE TABLE

VICTOR RADIO CORPORATION

799 East 135th Street, New York City

Manufacturers of Complete Radio Sets and Parts



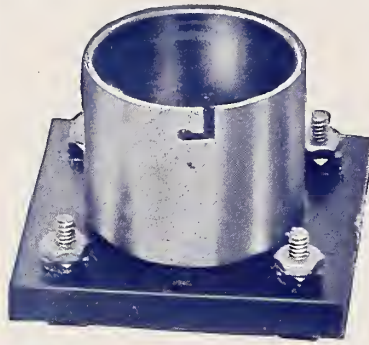

V. T. SOCKET
Type R104
Price, 85 cents

“RECO PRODUCTS”

**PUT 'EM IN STOCK
AND WATCH 'EM MOVE**

“Reco Products” Are Constructed of the Best Materials Obtainable.

We Guarantee These Products and Will Gladly Replace any Goods Which Are Not to Your Satisfaction.

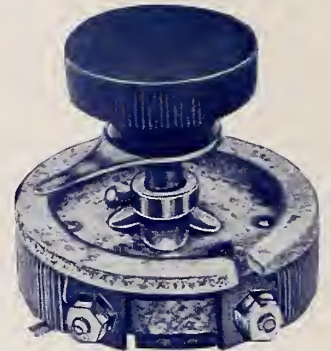

RHEOSTAT
Type R101
Price, \$1.00

**We Can Make
Prompt Deliveries**

JOBBERS AND DEALERS

Are Invited to Wire or Write Us for **Attractive Proposition and Liberal Discounts.** We Will Gladly Submit Samples for Your Inspection.

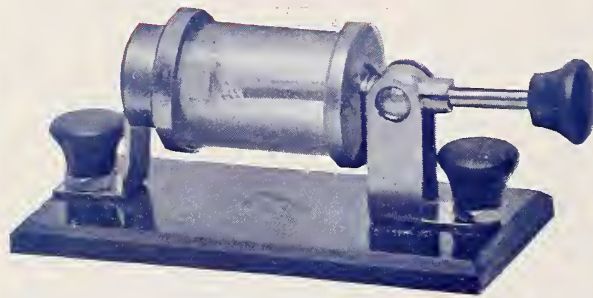

CRYSTAL DETECTOR
Type R102. Price, \$1.30

RECO RADIO ENGINEERING CO.

16 UNION AVE.

NEW ROCHELLE, N. Y.

The Better Kind of Radio Sets That Everybody Is Clamoring For



A WIDELY different radio public, educated and alive to the essentials of value, is demanding better made, more easily operated, medium priced sets. Dealers, of their own accord, have written us that *Erasing* Sets meet this demand to a “T.” The best evidence of this quality is our unconditional money-back guarantee on every set. Every dealer who is earnestly interested in lining up with the general demand for better apparatus should get our proposition on *Erasing* Sets.



CONSIDER THESE SELLING POINTS

Simple, non-regenerative sets. Such devices as efficient condensers and vari-couplers of manufacturers own design; with separate jacks and rheostats for independent use of steps, make a strong appeal. The wide wave length range of *Erasing* Sets, from 150 to 2,500 meters, allows for any changes in wave length and increases the number of stations which can be heard.

- Type X3, single circuit, as illustrated, list.....\$100
- The R-3 “standard” Tuner, Detector and 2 Stage Amplifier, sells for only, list..... 75
- Type L-2, list..... 30

Write for Very Interesting Proposition and Literature

ESSEX RADIO SERVICE, Inc.

Main Office and Factory: 56 SUMMER AVENUE, NEWARK, N. J.

DOES YOUR RADIO DEPARTMENT PAY?

LET "FRANCO" SHOW THE WAY

"FRANCO" Is The BRAND To Know—It Means THE BEST IN RADIO

"FRANCO" SELLS BECAUSE IT EXCELS

FRANCO SHORT WAVE RECEIVER

"The customer's choice—for Music and Voice"



"UNSURPASSED TO RECEIVE BROADCAST"

This receiver is the result of careful and thorough research work.

No. RT 132.....List \$35.00

FRANCO RADIO FREQUENCY TRANSFORMER

"RENOWNED FOR SOUND"

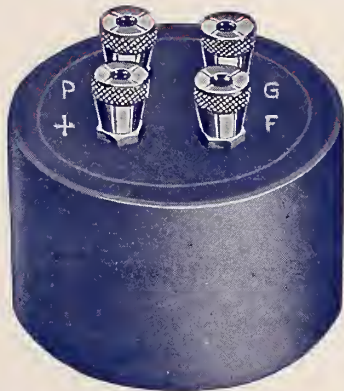

HAS NO PEER FOR RECEIVING CLEAR

Scientifically tested—150 to 500 meters. Guaranteed to give service—or your money back.

No. R₁200.....List \$3.00

FRANCO POTENTIOMETER

Electrically and mechanically perfect. Your set deserves a Franco. Bakelite base—phosphor bronze contact lever. 250 Ohms resistance.

No. P 205.....List \$1.65

FRANCO TRIPLE COIL MOUNTING

"A FRANCO MOUNTING WILL BEHAVES—REGARDLESS OF THE LENGTH OF WAVES"

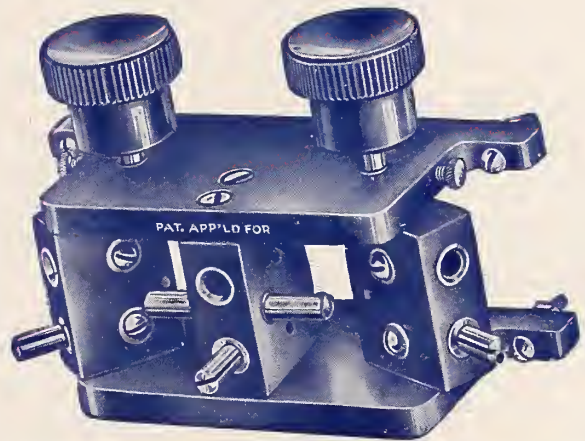

Made of polished Bakelite, with patented screw adjustment.

No. 303—Triple.....List \$5.00

No. 302—Double.....List 3.50

No. 301—Single.....List .55

FRANCO QUALITY PRODUCTS

- Porcelain Rheostats
- Composition Rheostats
- Composition Dials
- Unbreakable Dials
- Crystal Detectors
- Moulded Sockets
- V. T. Sockets
- Crystal Receiving Sets
- Federal Phones
- Federal Apparatus
- Turney Phones
- Dictograph Phones
- Thordason Transformers
- Klosner Vernier Rheostats
- Variable Condensers
- Phone Condensers

FRANCO SELLS BECAUSE IT EXCELS

FRANK RADIO CO.

Manufacturers

Distributors

122 Fifth Avenue

Dealers and Jobbers write for catalogues and attractive discounts. . . .

Samples gladly sent on request — without obligation. . . .

**Tone
Tells
Sound
Sells**



MODEL XL

PATENTS PENDING

Reg. U. S. Pat. Office

THE Oranola

PATENTS-PENDING

NO AERIAL USED

LOOP ANTENNA self-contained in artistic piano-finished cabinet eliminates any wiring by purchaser.

COMBINATION RADIO and PHONOGRAPH

RADIO ENGINEERS universally agree that radio and audio frequency transformation of energy received is best for receiving broadcasting.

That is why we use the radio and audio frequency amplification.

NO EXPENSE has been spared to make our product the best in every detail. Having passed through the experimental stage, we are prepared to stand behind each instrument with our unqualified guarantee.

OUR TALKING MACHINE (well known as THE PERFECT TALKING MACHINE), combined with our radio instrument, provides a universal means of sound reproduction without equal. Purity of tone in ample volume without distortion makes the ORANOLA almost human.

OUR KEYNOTE is simplicity of operation. No knowledge of electricity or wireless is required.

SEVERAL MODELS with or without talking machine combination, listing from \$150 to \$450. Descriptive circulars and discounts on application. WIRE OR WRITE for exclusive territory proposition. DEMONSTRATIONS at our office during broadcasting periods.

ORANOLA RADIO CORPORATION
228 SEVENTH AVENUE
NEW YORK CITY

The Radio Fan
Has Been Waiting For This

RADIO FREQUENCY RECEIVING APPARATUS

THE MOST SENSITIVE INSTRUMENTS YET DEvised

We are now ready to place on the market
Our Latest Product

RADIO FREQUENCY AMPLIFYING EQUIPMENT

Which will undoubtedly prove to be the best seller of the season

Including

- NO. 57.—RADIO RECEIVER.
- NO. 58.—D. X. RADIO RECEIVER
- NO. 55.—TWO-STAGE RADIO FREQUENCY AMPLIFIER
- NO. 56.—ONE-STAGE RADIO FREQUENCY AMPLIFIER AND DETECTOR

For Further Information
WRITE FOR

BULLETIN NO. 119-W

IT IS A TEXT BOOK ON RADIO FREQUENCY AMPLIFICATION

**GET IN
ON THIS**

Federal Telephone and Telegraph Company
BUFFALO, N. Y.



NO. 57.—RECEIVER

At Last! — High Efficiency Receivers at a Down-to-Earth Quick-Sale Price



*"Comin' In
Great!"*

ELEVEN years in the manufacture of delicate electrical units and apparatus—eleven years concentrated in the production of one line of equipment—all electrical, means something in accumulated experience and facilities.

That's the answer to how we have been able to place on the market this super-sensitive radio head set for \$6.00.

RADIO
Basco
Receivers
"Hear" More and Cost Less

All the high-priced qualities—extreme sensitiveness, perfect balance, natural voice pitch, no scratching—are all Basco Receiver refinements. Light weight, aluminum case—solid horse shoe type magnet, no laminations—bus-bar connections, no loose, hairlike wires.

Light, extra sensitive diaphragm, set to thousandths-of-an-inch accuracy from magnet poles. Clean cut, rugged design throughout—easy on the head—comfortable on the ears and good to look at. Compare them with any other head set, irrespective of price—then you'll be convinced they're what you want, for quick turnover.

*Write for exceptional dealer proposition and list of Basco Radio Equipment
Ask for name of our nearest local factory representative.*

Briggs & Stratton Co.
Milwaukee **Basco** PRODUCT Wisconsin



\$6.00

Put up in attractive
orange-colored
cartons

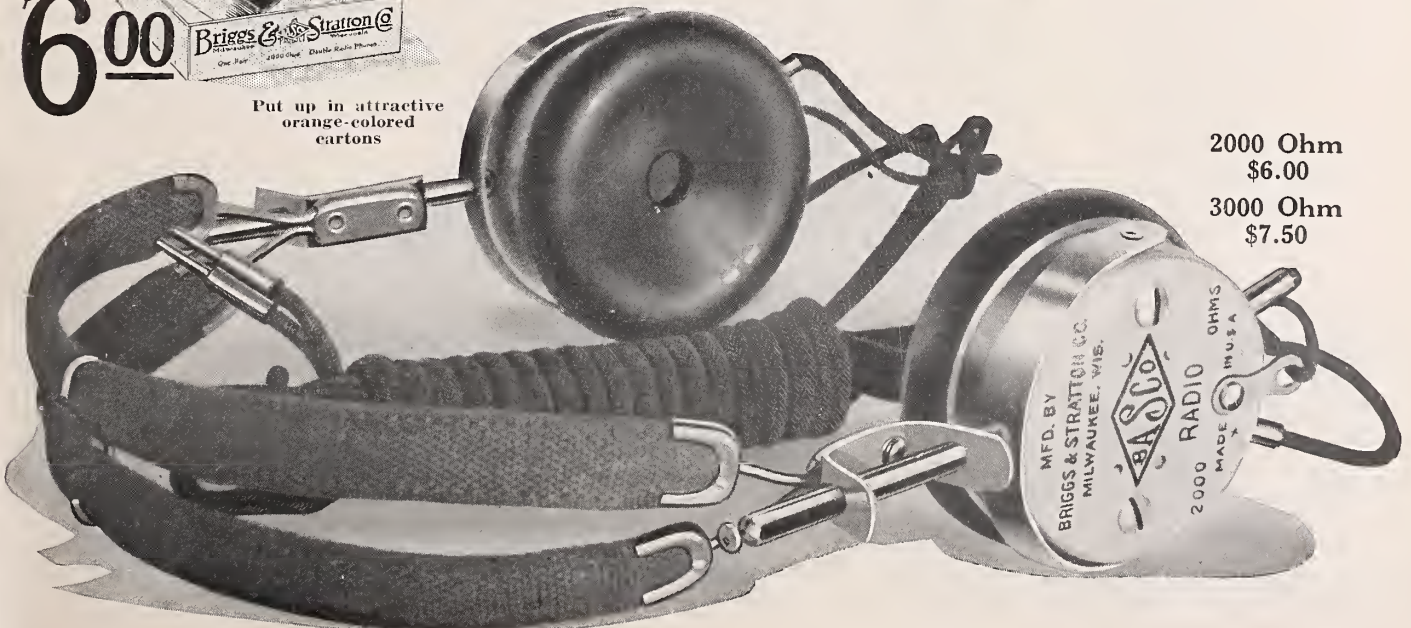

2000 Ohm
\$6.00

3000 Ohm
\$7.50



Paul F. Godley, designer of Paragon Radio Products, listening in

Godley Warns Radio Operators of Trouble This Winter

Paul F. Godley expects a chaotic situation in radio receiving this winter. Due to the delay in governmental regulation of broadcasting, operators of single circuit receivers are bound to have serious trouble. Mr. Godley says:—

“The coming season will see from ten to twenty times as many broadcasting stations as there were last year, all concentrating on one narrow band of wavelength. With a single circuit receiver, jamming and mixed messages are bound to result. Market reports, election returns, time signals, musical selections—all will be jumbled together in hopeless discord.

“The only way to cope with a situation like this is to use a three circuit regenerative receiver.

“For example, the Paragon three circuit receiver can select between broadcasting stations of about the same signal strength with less than one per cent differential.”

It is scarcely necessary to point out the remarkable opportunity this situation offers Paragon dealers. It would be difficult to imagine a more convincing selling argument for Paragon receivers in particular and Paragon Radio Products in general.

We shall appreciate it if you will let us know your requirements as early as you can to prevent possible disappointment later in the season.

ADAMS-MORGAN CO., 12 Alvin Ave., Upper Montclair, N. J.

Also Manufacturers of PARAGON

Radio Telephone
Transmitters
V. T. Control Units
Rheostats
Potentiometers
V. T. Sockets
Amplifier Transformers
Detectors
Control Dials
Amplifiers
Receivers
Switches
Variometers

PARAGON

Reg. U. S. Pat. Off.

RADIO PRODUCTS

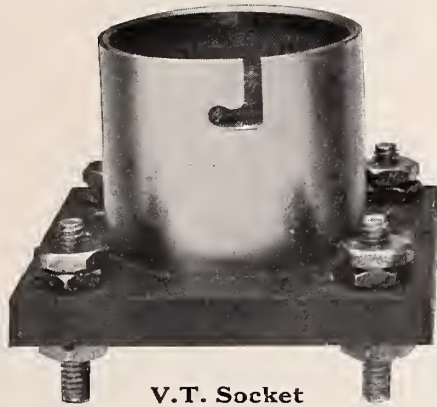

V.T. Socket

Single	\$1.00
Double	1.90
Triple	2.80
Quadruple	3.70

**THRADIO
CONDENSERS
HEAD SETS
SOCKETS
RHEOSTATS
TRANSFORMERS**



Manufactured by
THRESHER RADIO CORP.

476-484 Eighteenth Ave.
Newark, N. J.

The discriminating buyer is insisting upon Apparatus of the HIGHEST MERIT in Electrical and Mechanical Design and Workmanship.

*Attractive Discounts to
Distributors and Jobbers*

"AEREX" Long Range Radio Receiver Model RA-4

2 Stages Radio Frequency Amplification

2 Stages Audio Frequency Amplification

Using Only Two Amplifier Tubes

Features

1. Longer mile range
2. Supersensitive
3. Quality workmanship
4. Quality material
5. Saving of batteries
6. Saving of vacuum tubes, only three required to perform the work of five

Features

7. Adapted for use of loop or outside aerials
8. All binding posts on back, no messy wiring
9. Four stages of amplification.
10. Attractive appearance

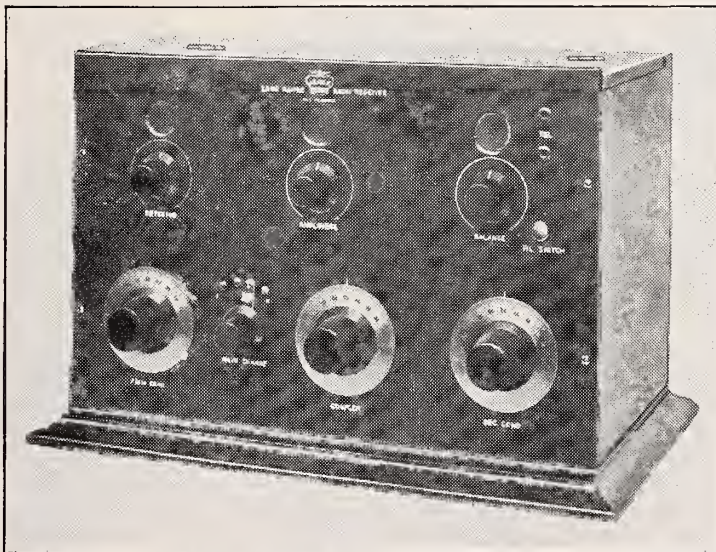

SPECIFICATIONS

Cabinet—Solid Mahogany. Rubbed piano finish. 16x11x7.
Panel—Genuine Bakelite beautifully engraved.
Dials—Three-inch metal engraved.
Knobs—Tapered Bakelite Knobs.

Condensers—Permanent capacity.
Rheostats—Specially designed, positive contact, smooth action.
Transformers—2 Radio Frequency and 2 Audio Frequency.
Sockets—Standard moulded Bakelite.

Binding Posts—Hard rubber composition. All mounted on back panel, plainly marked.
Circuit—Patents pending. 2 stage radio frequency amplifications, 2 stage audio frequency amplifications, one detector using only three vacuum tubes to perform the work of five.

This set is guaranteed to receive broadcasting within a radius of 400 miles. Provision is made for using a loop aerial.
The marvel set. Equal to super-regeneration.
A long range radio receiving set which is also adapted for use with a loop antenna for local broadcasting.

Long Range sets will be in demand this year. Will you be able to supply such a set in a THREE TUBE UNIT.
Some territories still open for live dealers.

LIST PRICE, \$125.00 *Discounts Upon Request*

AEREX RADIOPHONE CORP., 342 Madison Avenue, NEW YORK CITY

MORE SENSITIVE

THAN THE

ARMSTRONG SUPER REGENERATIVE

REPORTS a reliable manufacturer who has built a number of the new Armstrong Sets and made comparative tests.



EXTERIOR VIEW

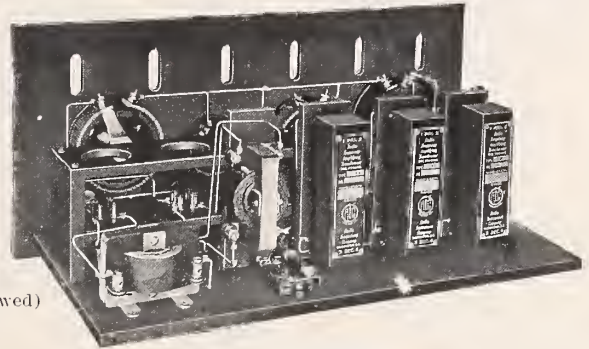

INTERIOR VIEW

(Patent Allowed)

The JM-6

Price \$130.00

RADIO-AUDIO DETECTOR AMPLIFIER

FOR THE PAST TEN MONTHS HAS MAINTAINED ITS REPUTATION OF BEING THE MOST SENSITIVE AND DEPENDABLE RECEIVING INSTRUMENT ON THE MARKET

This Instrument Is Ideal For Indoor Coil Aerial Reception

The DX Radio Frequency Transformer is the "heart" of the JM-6. The remarkable results obtained with the DX RF Transformer throughout the country, as evidenced by the hearty response from amateurs, dealers, jobbers and manufacturers.



(Patents Pending)

Gives absolute assurance of its superior quality and dependability. One amateur station is hearing broadcasting stations in *SIXTEEN STATES* and *HAWAII* by using three stages of DX RF TRANSFORMERS.

WAVELENGTH RANGE

DX-1	170- 450	\$8.00
DX-S	400-1200	8.00
DX-2	900-3000	8.00

WRITE FOR BULLETIN No. 12
Curves and Data on Coil Aerials. .50c
All Prices F.O.B. Factory

"IT PAYS TO HAVE THE BEST"

RADIO
INSTRUMENT COMPANY, INC.
WASHINGTON, D. C.



NATIONAL SEAMLESS TUBING

In Large Diameters

For Vario-couplers, Vario-meters, Tuning Coils and wherever you use large diameter fibre tubing, National Seamless Tubing is less expensive and infinitely superior.

National Seamless Tubing is a specially developed, laminated tubing that retains its form and will not warp, swell or shrink. Exact in both diameters and easily worked.

Can be furnished in dark gray fibre or black fibre. Any quantities, diameters from 3" to 4½" I. D. Any wall from 3/32 up.

Give us your specifications. We'll send samples and prices.

National Fibre for Panels

Hard Black Panel Stock of good dielectric strength. Gives satisfaction for condenser tops and bottoms, rheostat bases, washers bushings, etc. Let us quote on the stock itself, or on completed parts machined to order.

Peerless Insulation

The standard thin weight fibre insulation or "fish paper."

National Fibre & Insulation Co.
Box 453 Yorklyn, Delaware

New York, Chicago, Philadelphia, Detroit, San Francisco, Cleveland, Omaha, Pittsburgh, Boston, Rochester, Birmingham, St. Louis, Baltimore, London, England
In Canada, National Fibre Co. of Canada, Ltd., Toronto

\$10

A TUBE SET

—*that really performs*

- ☞ THE HAWK JR. *receives as efficiently as the highest priced set.*
- ☞ THE HAWK JR. *is mechanically perfect.*
- ☞ THE HAWK JR. *is well and substantially made.*
- ☞ THE HAWK JR. *is built of the very best of materials.*
- ☞ THE HAWK JR. *is the simplest set on the market to operate.*



HAWK JUNIOR
DETECTOR TUBE SET

A LIBERAL PROFIT FOR DEALERS

Dealers, jobbers and distributors wanted to tie up with our national advertising campaign.

Hawk Radio Manufacturing Co.

150th St. and Melrose Ave.

New York City

!!!THE PREMIER RADIOVOICE!!!

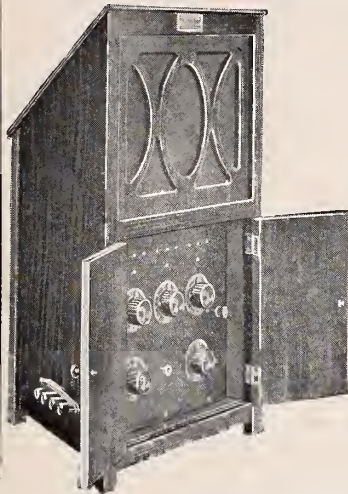

Is the first practical and commercial accomplishment of meeting the public's requirements and demand for a *Complete, Simple, Compact, Attractive and Efficient Loud Talking-Detector and 2-Stage Radio Receiver* at a Popular Price, Simple in Control — Wide in Range.

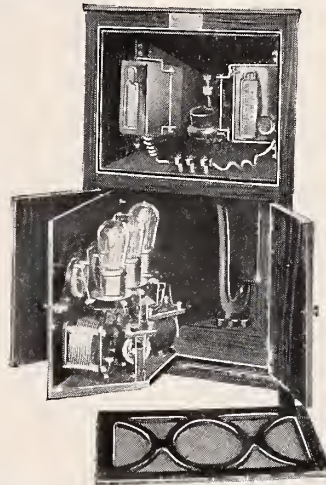

Mounted on a Bakelite Panel are

Premier Built and Tested Radio Condensers, Rheostats, V. T. Sockets, Transformers, Tuning Coils, Jacks, etc.; the panel being hinged within the beautiful 5 ply Mahogany Veneer Loud Talker Cabinet, measuring 21" in height by 12" in width, weighing, completely equipped with "B" Batteries and Loud Talking Phone as shown, only 17 lbs. Can be set in a corner of the living room, on library or end table, or on a piano, blending into the richest of furnishings with equal attractiveness. Price complete, excluding only bulbs and "A" battery—\$95.00.

Where an even lower priced equipment is desired, eliminating the phone and loud talker cabinet, our Type P equipment, including "B" batteries, mounted in cabinet as shown, parts, hookup and panel being identical to that used in the Premier Radiovoice, is priced at \$55.00.

The Premier Radio Corporation is an old electrical manufacturing concern, which has turned its entire resources and equipment to production of high class radio parts and receiving sets. The Premier line is handled and is available to only the highest class of dealer, jobber or distributor, and to such is offered discounts to permit profitable merchandising. Descriptive bulletins sent on request.

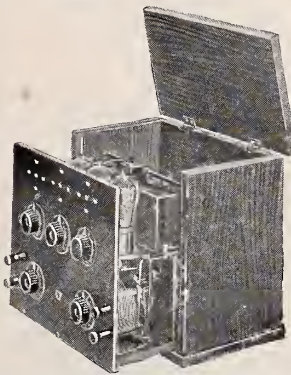

**Premier
Radio
Corporation**

6800 Bostwick Ave.
Detroit, Mich.

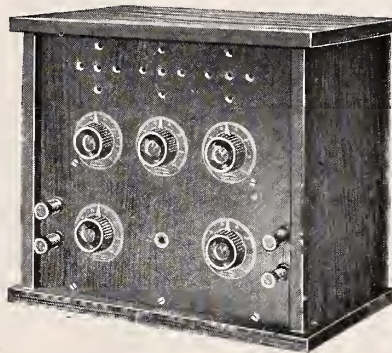

SPECIAL AUGUST PRICES

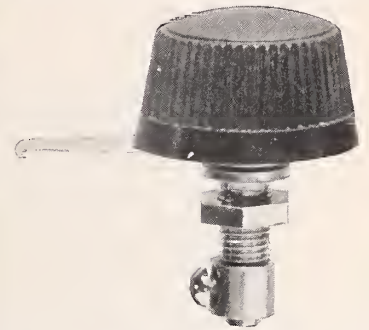

Hard Vulcanized Rubber Polished Knob

**Hand Buffed—Nickel Parts
Non-Binding Bearing
500 Lots, 16c Each**



Composition Knob

**Tapered and Highly Polished
500 Lots, 14c Each**



Composition Knob

**Hand Polished and Buffed
500 Lots, 12c Each**

*Further Reductions on Larger Quantities
Pink-a-tone Receiving Set Complete
\$12.50*

*Special Prices on Filament
Rheostats*

CHAMPLIN MFG. CO.

90 WEST BROADWAY
NEW YORK

Tel. Barclay 8676

Established 1860

The National Trade Survey Now Being Published in

The Radio Dealer Weekly

Should be of interest to

EVERY MANUFACTURER

Subscription to the WEEKLY

One Dollar the Year, payable in advance

Sample free on request

THE RADIO DEALER WEEKLY

1133 Broadway

New York, N. Y.

INSURE YOURSELF AGAINST TUBE "COME BACKS"

AND WIN SATISFIED CUSTOMERS BY INSTALLING A W-B-L VACUUM TUBE TESTER



Type 1001
Showing a Tube Mounted for Test.

The only instrument made which will tell you in a simple, direct, and not-to-be-disputed manner the true characteristics of the tubes you are buying and selling—whether they oscillate; how well they detect; how well they amplify; the best operating plate voltage and filament current—and many other things you have wanted to know about your tubes.

Complete in itself, not dependent on broadcasting, it eliminates all guess work. Simple to operate.

The cost?—A negligible sum considering the money it will save you and the satisfied customers it will win. The salvage of a few supposedly-defective tubes will alone pay for it.

Manufactured by W-B-L Radio Co., exclusively for



845 BROAD STREET, NEWARK, N. J.

WESTERN SALES DEPT.: 8405 DETROIT AVE., CLEVELAND, O.

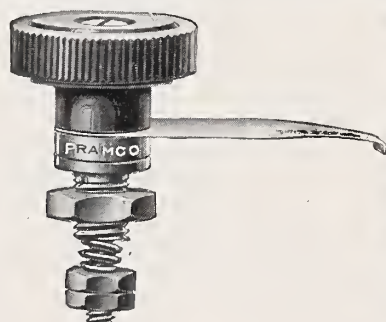

WHY "PRAMCO"?

Made to a Standard

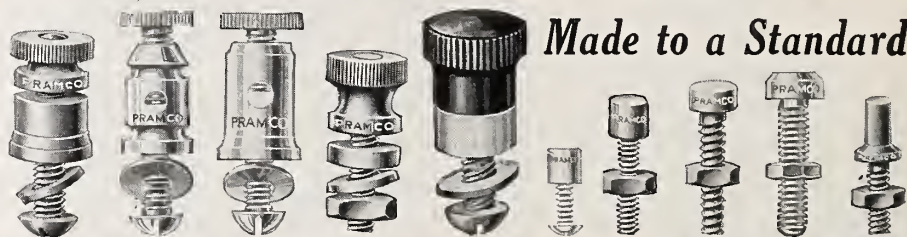

Largest Variety

GUARANTEED BY TRADE MARK ON EACH ITEM.

STANDARD PRICES THAT LEAVE YOU A GOOD MARGIN OF PROFIT.

NATIONAL ADVERTISING AND CIRCULAR MATTER THAT WILL HELP YOUR SALES.

A LINE FOR RELIABLE JOBBERS AND DEALERS WITH A REPUTATION TO MAINTAIN.

PREMIER RADIO MFG. CO.

1900 No. 6th Street

Philadelphia, Pa.

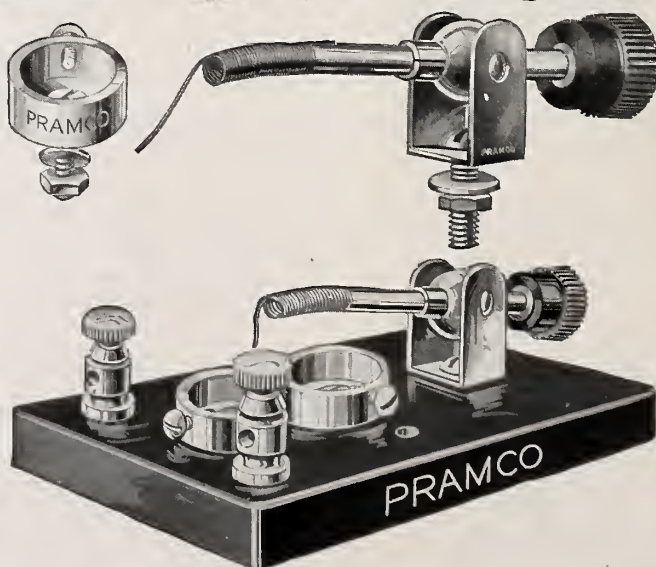

Are You Making Money Out of Radio ?

THE RADIO TELEPHONE HANDBOOK

By H. G. Cisin, M.E.

TELLS YOU HOW

It Contains the Following Facts About Radio You Want To Know

What Radio Apparatus to Stock
 What Class of Radio Sets to Handle
 The Operating Principles of Radio
 The Various Types of Radiophone Receivers—the Best Methods of Adjusting Them
 How Crystal Detectors Work
 What Crystals Work Best
 How the Vacuum Tube Works
 What Is Meant by Cascade Amplification

The Principles of Regeneration
 How to Select Telephone Head Sets
 Types and Uses of Tuning Devices
 The Meanings of Everyday Radiophone Terms
 How to Select and Install the Demonstration Set
 What Service to Give in Connection with the Sale of Radiophones
 How to Utilize Newspaper and Other Publicity

With This Book You Can Tell Your Customer

The Best Way to Erect His Aerial Which Is Preferable, a One or a Four-Wire Aerial
 What Determines the Length of the Aerial
 Underwriters Requirements
 License Requirements
 How Best to Protect Against Lightning
 Why Some Radio Sets Are Simple and Others Are Complicated
 Which Sets to Recommend
 What Batteries, if Any, Are Necessary
 How High to Put the Aerial
 When an Indoor Aerial Can Be Used
 Under What Circumstances Ground Connection May Be Dispensed With
 When a Loud Speaker May Be Used
 What the Loop Aerial Is

How Amplification May Be Obtained

Whether a Vacuum Tube May Be Used in Conjunction With a Crystal Detector
 Whether More Than One Radio Receiving Set May Be Connected to the Same Aerial
 The Correct Way to Measure Aerial Length
 When Shielding Is Necessary
 How to Check Up the Condition of the Storage Battery
 How to Eliminate Howling
 Causes and Remedies for Weak Signals and Local Noises in Connection with Vacuum Tube Sets
 How to Locate Faults in Vacuum Tube Radiophone Receiving Sets

Why the Radio Telephone Handbook is Authentic
Facts about its Author
 GRADUATE OF CORNELL UNIVERSITY, ELECTRICAL AND MECHANICAL ENGINEER.
 GRADUATE OF MARCONI RADIO INSTITUTE, FORMERLY INSTRUCTOR OF ELECTRICAL ENGINEERING AT:
 CORNELL UNIVERSITY, JOHNS HOPKINS UNIVERSITY, U. S. NAVY ELECTRICAL SCHOOL, STEVENS INSTITUTE OF TECHNOLOGY, LICENSED RADIO OPERATOR.
 RADIO OPERATING EXPERIENCE AT SEA DURING WAR.
 ENSIGN, U. S. NAVY DURING WAR.
 AUTHOR OF PRACTICAL ELECTRICAL ENGINEERING.

Single Copies.....Price \$1.00
 One Dozen Lots.....33% discount
 Four Dozen Lots.....40% discount

Special Discounts on Quantity Orders

Attractive Exclusive Proposition for Distributors

Published By

THE ALLIED ENGINEERING INSTITUTE
 1400 Broadway, .. NEW YORK CITY

THE ALLIED ENGINEERING INSTITUTE
 NEW YORK, N. Y.
 GENTLEMEN:
 SEND.....COPIES OF THE RADIO TELEPHONE HANDBOOK FOR WHICH FIND ENCLOSED \$.....
 We will pay postman \$.....
 NAME.....
 ADDRESS.....
 CITY.....
 STATE.....

FILL THIS OUT. TEAR OFF AND MAIL

U. S. GOVERNMENT RECEIVING SETS

Special Proposition on
Limited Quantities

Write for Particulars

Also: 500 Pairs CONNECTICUT
U. S. Government 'Phones. **\$3.45**
CAN BE RETAILED AT



MORSCAN RADIO CO.

196 Market Street, NEWARK, N. J.

TRIPLE TEST TRANSFORMERS

THE TRIPLE TEST

What do they mean to you?

In a market glutted with new radio products, some well made, some poorly and cheaply constructed, a few articles stand out prominently from the rest because the manufacturer employs highly competent engineers, the best of material and skilled workmanship. The Radio Service Laboratories goes a step further and submits each individual transformer to its famous triple test before shipping same to the jobber, dealer and ultimate user.

THE TRIPLE TEST

First—Test of Windings.

The bobbins when wound and sealed are tested for continuity of winding and for shorts and leaks.

Second—Test for Inductance of Windings.

After assembly of the bobbin within the container a careful test is made of the inductance of the primary and secondary windings to insure the consumer against any wrong connections or hasty careless construction.

Third—Test for Amplification.

After the iron core is assembled and the transformer sealed, each transformer is given an actual circuit test in a radio amplifier; the gain in signal strength being noted over that of the detector tube alone and required to meet the gain of our standard laboratory model.

THE RESULT

is a Radio Frequency Transformer that increases the strength of Radio Signals or waves before they are applied to the detector tube where they are made audible—

“Louder Signals with less noise
Greater Range with same equipment”

Radio Service Laboratories Transformers by actual test are superior to any domestic or foreign make in the market. For sale at any electrical shop or store where Radio supplies are sold.

ATTENTION OF DEALERS

TRIPLE TEST TRANSFORMERS are steadily advertised in the leading radio magazines and readers are urged to purchase from their local dealer. The Rasla Sales Corporation will gladly supply counter, window or wall display cards to dealers on request and urges them to obtain a supply of their transformers from their jobbers. In order to facilitate such orders, we append a list of jobbers handling this product.



The only completely shielded iron core.

BALTIMORE, MD.
Chesapeake Electric Co.
Ship Owners Radio Service, Inc.
BOSTON, MASS.
A. P. Merchant & Co.
Ship Owners Radio Service, Inc.
CEDAR RAPIDS, IA.
Western Auto Specialty Co.
CHICAGO, ILL.
Ship Owners Radio Service, Inc.
CLEVELAND, OHIO
Elliott Electric Company
Erner Electric Company
DALLAS, TEXAS
C. C. White Electric Co.
FORT DODGE, IA.
Standard Radio Equipment Co.
FORT WAYNE, IND.
Luxam Electrical Supply Co.
INDEPENDENCE, KANSAS
Daniels Radio Supply Co.
KANSAS CITY, MO.
American Radio Mfg. Company
NEWARK, N. J.
Wholesale Radio Equipment Co.
NEW YORK CITY
J. H. Bunnell & Company
Royal-Eastern Electrical Co.
Ship Owners Radio Service, Inc.
Stanley & Patterson
NEW ORLEANS, LA.
Electron Engineering Co.
Ship Owners Radio Service, Inc.
NORFOLK, VA.
Ship Owners Radio Service, Inc.
PHILADELPHIA, PA.
Quaker Light & Supply Company
Schimmel Electric Supply Company
Frank H. Stewart Electric Company
PITTSBURGH, PA.
Ludwig Hommel & Company
Robbins Electric Company
Union Electric Company
ROCHESTER, N. Y.
Wheeler-Green Electric Co.
SAN ANTONIO, TEXAS
Alamo Radio Electric Company
SAN FRANCISCO, CAL.
Ship Owners Radio Service, Inc.
SAVANNAH, GA.
Ship Owners Radio Service, Inc.
SCRANTON, PA.
Scranton Electrical Construction Co.
SEATTLE, WASHINGTON
Ship Owners Radio Service, Inc.
ST. LOUIS, MO.
McGraw Company
TROY, N. Y.
Hinsdill Electric Co.

*Western Jobbers desiring distributing proposition
Communicate with our Western Sales Agents*

DETSCH & COMPANY

555 Turk Street, San Francisco, Calif.

WESTERN RADIO DISTRIBUTING CO.

1114 L. C. Smith Bldg. Seattle, Washington

Special circular sent on request by the

Rasla Sales Corporation

National Distributors

10 East 43d Street

New York City



The Set that Grows

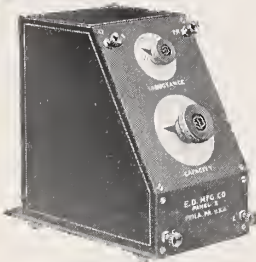

Front View
Panel No. 2

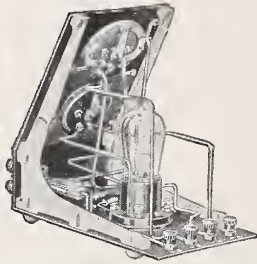

Rear View, with Cover
Removed, Panel No. 9

The two panels shown are only the beginning of a most elaborate receiving set. While they form a complete set with a wave length range of from 150 to 3000 meters, embodying bank wound inductance, potentiometer, interchangeable grid leak, etc., your customer will want to match his original purchase from time to time with radio frequency, audio frequency, loop or honeycomb mounting panels and so on, and he will ask you to supply him with them.

Why not find out more about this novel set—developed by engineers that know how and built completely in a plant with thirty years of manufacturing experience in this line of highest grade electrical instruments?

Our Bulletin No. 302 describes these panels

Write for a copy!

THE E-D-MANUFACTURING CO.
PHILADELPHIA, PA.

"LISTEN IN WITH ED."

NULOID

Scientific Chemical Compound Especially
Adaptable For Radio Parts and Panels

For panel work and other radio parts Nuloid is fast taking the place of hard rubber and other materials.

Its light weight and smooth polished surface combined with its high resistance powers make it particularly adaptable for radio requirements.

Approved and Tested

Tested by leading radio and electrical engineers and by the Columbia University laboratory, Nuloid was found to resist warping, water, oil, heat and cold, and to resist a 23,300 high frequency voltage on a 3/16th inch thickness.

All Colors

Nuloid is manufactured in mahogany, and all colors, plain

and mottled, and its attractiveness adds materially to the appearance of receiving sets and all exposed parts.

Retains High Polish

Regardless of climatic conditions, Nuloid retains its high polish, and under all conditions it can be easily worked, as it does not chip, crack or break, and can be engraved, cut, drilled, threaded and polished.

Nuloid prices are no higher than hard rubber and substitutes, but being lighter in weight Nuloid costs less in the final analysis.

Let us estimate on your specifications
and send you some samples of Nuloid.

NULOID CORPORATION

119 Chambers Street

Phone: Worth 0156

New York, N. Y.

LABORATORIES AND FACTORY, KENILWORTH, N. J.

HOMCHARGE

Your
**RADIO
 BATTERY**
 for
A NICKEL



THIS slogan, Mr. Dealer, has made the HOMCHARGER the most popular rectifier in the entire radio and automobile field.

Its popularity is being further increased thru dominating HOMCHARGER advertisements appearing regularly in thirty-one of the leading radio, automobile and national publications.

In addition, an entirely new and greatly augmented series of attractive sales helps are now available for your use. The

RADIO HOMCHARGER DE LUXE

is the simplest, the most efficient and most reliable battery charger on the market, and the only rectifier combining the following essential HOMCHARGER features:

- 1—Simplicity itself. Attach to any lamp socket and connect to battery.
- 2—SELF-POLARIZING. Battery may be connected either way and it will always charge.
- 3—Fully automatic in operation—gives taper charge—cannot overcharge or injure your battery.
- 4—Safe, all parts entirely enclosed, no danger from fire. APPROVED BY UNDERWRITERS EVERYWHERE.
- 5—Silent in operation. May be used in the home.
- 6—Constructed of the best material—genuine Bakelite Panel, Jewell Ammeter, Closed Core Silicon Steel Transformer. No castings used, only the finest stampings throughout.
- 7—Only one moving and two wearing parts. Replaceable as a unit at small cost.
- 8—Uses standard 15-ampere plug fuse obtainable at any electrical store.
- 9—CHARGES ANY "A" OR "B" BATTERY OVER NIGHT. UNQUALIFIEDLY GUARANTEED.

AN ORNAMENT FOR THE LIVING ROOM

Beauty has been combined with utility in the new RADIO HOMCHARGER DE LUXE. The body is beautifully finished in rich Antique Mahogany, the base and fittings in handsome Dull Gold. Equipped with rubber feet, it cannot mar polished surfaces. It harmonizes with the finest living room.

OVER 50,000 HOMCHARGERS

were sold by live dealers and jobbers last spring. Over 150,000 will be sold this fall and winter. Our special dealer booklet, "Homcharger Business Builders", shows how you can obtain your share of this business, and illustrates the many and various sales helps and other co-operation given HOMCHARGER dealers. Send for your copy today, or, better yet, order a case of one-half dozen or so from your jobber, and cash in on this fast-selling and profitable radio and automobile accessory. Furnished complete with attachment cord and plug, charging cable and battery clips. No extras to buy. \$18.50 U. S. A., \$25.00 in Canada.

RADIO FANS, AUTO OWNERS, ETC.

See the new RADIO HOMCHARGER DE LUXE at your nearest dealer. If he does not carry it, send for our free Bulletin 637 illustrating the new RADIO HOMCHARGER DE LUXE in actual colors, or your order will receive prompt attention if sent direct to the factory.

The Automatic Electrical Devices Co.

West Third Street

Cincinnati, Ohio

Largest Manufacturers

of

Vibrating Rectifiers in the World

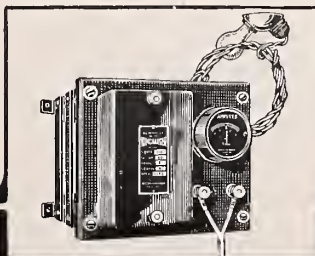

BRANCH OFFICES

New York Chicago Pittsburgh
 Detroit Dallas
 Philadelphia Los Angeles
 Baltimore Minneapolis Kansas City
 St. Louis Atlanta

TYPE "A" FOR WALL MOUNTING

~ OVER 50,000 IN USE ~

Adjustable Coil Mountings for Armstrong's Super-Regenerative Circuit

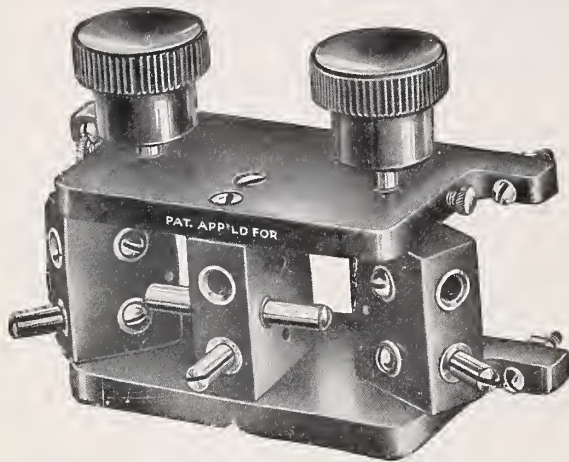

Single and Double Coil mountings adapted for use with the new Armstrong super-regenerative circuits. These mountings are adjustable. Made of genuine Formica, with high polish and fine finish. All metal parts heavily nickel plated. Not a moulded affair. **The Unbreakable Dial**

- Triple Coil Mounting, List Price.....\$5.00
 - Two Coil Mounting, List Price..... 3.50
 - Single Coil Mounting, List Price..... .55
 - 3" UNBREAKABLE Dial, List Price..... .70
 - 3½" UNBREAKABLE Dial, List Price.... .90
 - Amco Radio Plug, List Price..... 1.00
- Our production is large and your orders will receive immediate attention.



The New Triple Coil Mounting with the following features:

- 1—A patented feature; locks the coil in place. This prevents the coil from being thrown out of adjustment once the station is tuned in.
- 2—The simplest mounting to install on your set. No rear mounting. Mounts on front of panel.
- 3—The tension on specially constructed bearings is adjustable.
- 4—Constructed of the highest grade of insulation material.

Its high polish and fine finish give it a very attractive appearance. All metal parts heavily nickel plated. Not a moulded affair.

Jobbers write for special discount

ASTORLOID MFG. CO., INC.

416 Marcy Ave., Brooklyn

Price
\$2.00
Post Paid

Triphone Plug

The most convenient and practical accessory since the advent of **Broadcasting**

Triphone is an accommodation plug that enables you to plug in one or two headsets besides the one headset or loudspeaker that is permanently connected to it. In appearance the TRIPHONE is an addition to any set.

The body is a highly polished moulded material.

Internal jacks are constructed with nickel silver springs and the short circuiting contacts are of solid silver. It is perfectly insulated throughout.



REMEMBER TO ASK FOR TRIPHONE. THE ORIGINAL MULTIPLUG

Send for Descriptive Circular

Attractive Propositions to Jobbers and Dealers



METRO JACKS

"Metro Jacks" Nickel Silver Springs, Coin Silver Contact points. Screws insulated. High Class finish made in 5 types;

- No. 1 Single Open\$0.55
- No. 2 Single Circuit65
- No. 3 Double85
- No. 4 3 Spring Filament Control... .95
- No. 5 5 Spring Filament Control... 1.15



Moulded Base



Fibre Base

No. 24 Single V. T. Socket Moulded Base — Brass tube heavy-nickel plated counter sunk contacts\$1.00

V. T. Sockets Made in Three Styles Fibre Base
No. 32 Single V. T. Socket, .75
No. 33 Double V. T. " 1.50
No. 34 Triple V. T. " 2.25
These Sockets have heavily nickel-plated brass tubes.



ELECTRIC MFG. CO. INC.

121 PRINCE ST.
NEW YORK

U S C
TRADE MARK

RADIO SPECIALTIES



The Little Gem
(cut half size)

The dealer will at once appreciate the potential sales possibilities of this wonderfully efficient and beautiful little crystal receiving set. Has a large receiving radius. Test it yourself. You can then recommend it with the same confidence that we do. Stand and all other metal parts of solid brass and nickel plated.

The Multilistener

The Multilistener is furnished either with rubber ear tips as shown, or with ear plates. With one set of double Head Phones this outfit provides listening facilities for eight persons. When used with Vacuum Tube Sets, the Multilistener permits that degree of adjustment for perfection in natural and musical tone effects, as is unsurpassed by any other means.

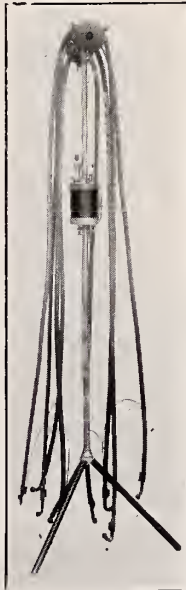

Model 8-T Multilistener with Little Gem

List Prices

- Little Gem Receiving Set\$6.50
- Little Gem with Multilistener15.00
- Multilistener only, Model 8-T with 8 tubes and 46" adj. stand10.00
- Model 4-T, with 4 tubes, short stand, using one receiver only 5.00

Order through your jobber or communicate direct with us.

United Specialties Co., Inc.
Manufacturers & Distributors
57 Spring St., Newark, N. J.

A Wonderful Seller
Because it is
Such a Wonderful Buy



The LITTLE GIANT

Trade Mark

Radio Receiving Outfit

The Ideal Gift!

SELLS AT A POPULAR PRICE, attractively put up in holiday box. A gift for anyone because there isn't a person who can't use the *Little Giant*, it's so simple. It's complete ready to put together and use. Nothing extra needed to enjoy the program. Easily demonstrated and fool-proof. Its beautiful cabinet, neat workmanship and compactness help its sale immensely. Make the *Little Giant* your leader for holiday trade.

Write Today for Propostioon

Complete

With Metro Head-phones, Aerial, Insulators, Ground Wire, Ground Clamp and all Accessories.

In Holiday Box \$15 Net

METROPOLITAN RADIO CORPORATION

70-74 Goble St., -:- Newark, N. J.

THE PATHÉ LOUD SPEAKER

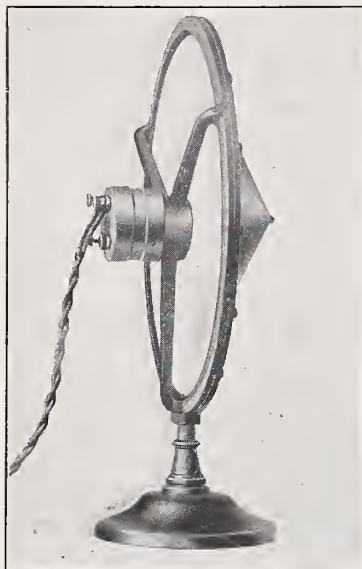

IS NOW READY FOR DELIVERY. SEND ORDERS AT ONCE FOR STOCK FOR THE SEASON'S BUSINESS.

List Price

\$24.00 Nickel Finish

\$22.00 Japan Finish

THE SOUND WAVE CORPORATION
30 GRAND AVENUE, BROOKLYN, N. Y.

MICA RADIO INSULATION BUSINESS BUILDING PRODUCTS

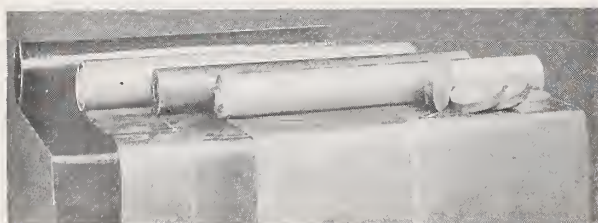

EMPIRE OILED TUBING (CALLED SPAGHETTI) .

Empire (Spaghetti) Tubing is a Business Building Product because amateurs who buy it come back for more. Empire Tubing provides perfect insulation for all wiring connections. Very flexible, durable, smooth, and of great dielectric strength. All colors, all sizes, 36 inch lengths.

EMPIRE OILED CLOTH AND TAPE

Remarkable for its insulating properties electric and mechanical strength. Its resistance to heat and moisture makes it of great value in mounting tube sockets, rheostats, transformers, couplers, and in high powered transmitting stations where the voltage is very high. Empire Oiled Cloth practically sells itself to amateurs, experimenters, and experts. Supplied in a variety of thicknesses in sheets 36 inches square, in tape widths from $\frac{3}{8}$ ".

Call and talk it over or send today for samples and quotations

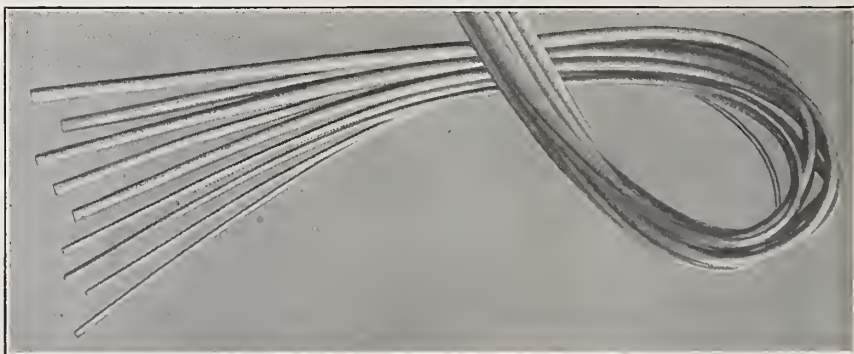

2020-F

MICA INSULATOR COMPANY

68 Church Street, New York.

542 So. Dearborn Street, Chicago.

Works: Schenectady, N. Y.

Agencies—Monroe Brass & Wire Co., Cincinnati; G. Arthur Morrell, Cleveland; Electrical Specialty Co., San Francisco and Los Angeles

Dealers!

Every person interested in wireless will hail this marvelous Receiver as the missing factor in the complete realization of radio's possibilities.

It will stand the most rigid tests.

It is being nationally advertised.

Discounts afford excellent profits.

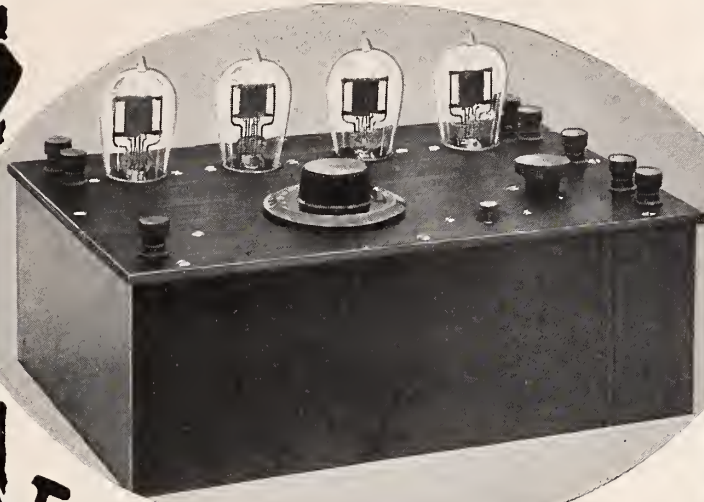

**Now the
100% Receiving Set**

Destined to be the Greatest Seller on the Market

Five years of untiring effort—engineering, NEW inventions, experiments—then this 100% instrument, head and shoulders above any other receiving set on the market. This is the story of the splendid achievement found in the WARE 3-step RADIO FREQUENCY Amplifier-Detector-Set.

It affords a higher degree of amplification and wider tuning range than ever before obtainable. With clear, crisp and perfect tone reproduction the Ware Type AD2 Receiver readily brings in broadcasted programs hundreds of miles on 1-foot indoor coil aerial.

Ware
TYPE AD2

R-F AMPLIFIER - DETECTOR

RECEIVER

Price \$110—(without tubes)

Unquestionably the **MOST SENSITIVE RECEIVING SET** on the market. *Makes genuine loose-coupling practicable.* For absolutely faithful long or short distance reception—free from distortion, static, induction and interfering transmitters—it has never been equaled.

Simple to operate—beautiful—compact—guaranteed. One demonstration is all that is necessary to convince the amateur as well as the most expert radio enthusiast.

WARE RADIO CORP'N
160-162 Duane Street New York City

Get this Business

Our national advertising, liberal discounts and cooperation—plus the genuine merit of this great set, make it the best dealer proposition of the year.

Write now for descriptive folder and full particulars.

RADIO EQUIPMENT SERVICE

Announces

A Sure Sales Builder,

RADIOLITE

Registered U. S. Patent Office

A Sensation in the World of Advertising

Receives Market Reports, Current Events, News Items,
Lectures and Entertainment from Famous Broadcasting Stations

COAST TO COAST

And Flashes Your ADVERTISING

“BROADCAST”

With Force and Dignity

**ESPECIALLY ADAPTED TO INDOOR OR OUTDOOR
ADVERTISING OR THE HOME BEAUTIFUL**

Name, Construction and Design
Protected by Patents Pending

For Proposition to The Trade, Write or Wire at Once

RADIO EQUIPMENT SERVICE

National Distributors

500 Fifth Avenue, New York City

For the Livest Business Man in Your Town

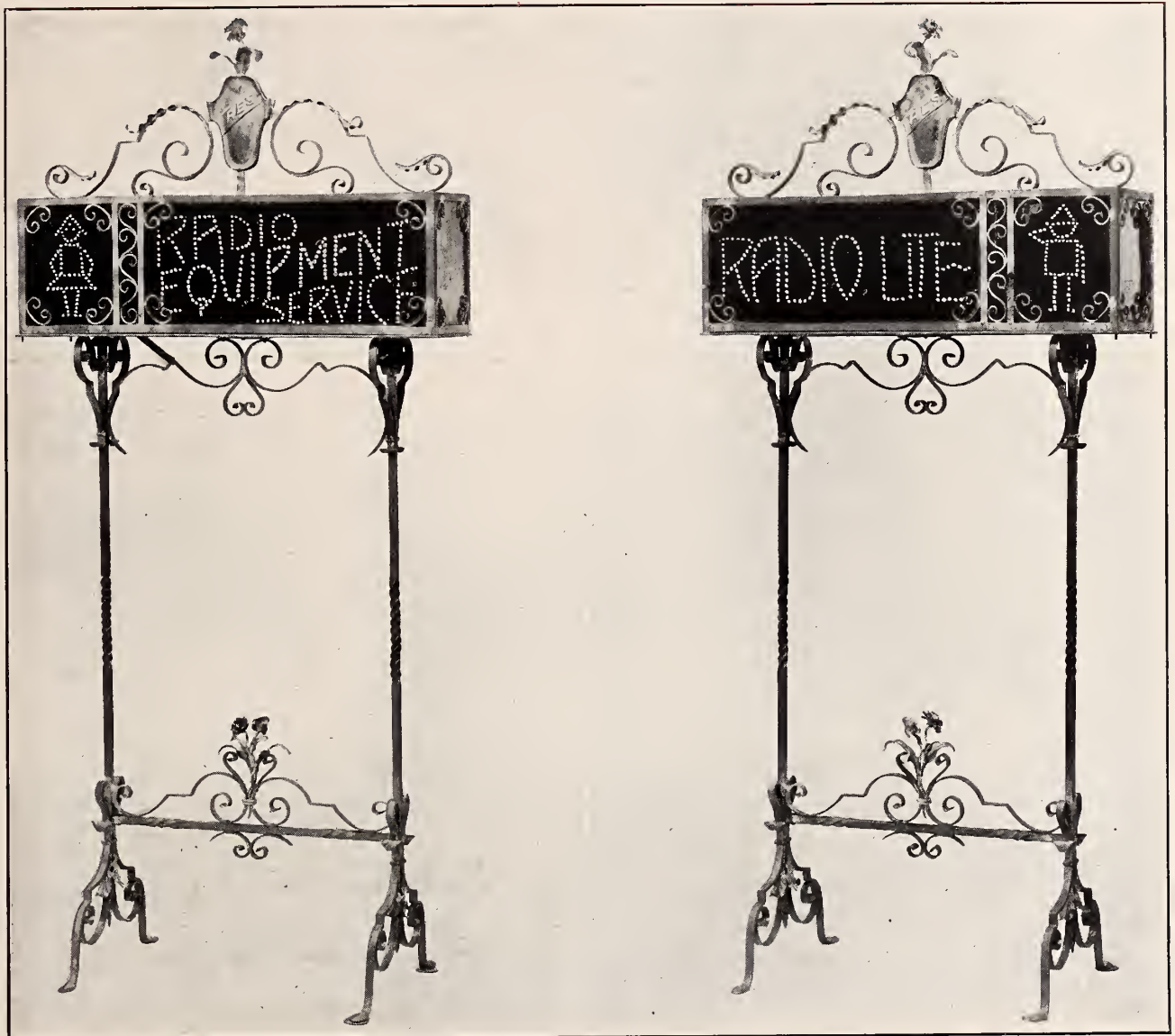

The RADIOLITE sign and talker pictured here will sell quickly to the livest business man in every town. He will buy on sight. Take this advertisement out of the paper and show the design to the owner of your best hotel, to the president of the new bank, to the publisher of the daily newspaper. Show it to a real live-wire and you will begin to find out just how easy it will be to sell this latest novelty in the radio business.

Here's some of the selling points that will make this a winner for you--

A flashing electric sign.—A different design on either side, a flashing figure on the side of the sign that assumes half a dozen different positions—every sign made to special order according to the wishes of the buyer—a wrought iron model that is indeed a thing of beauty.

Special designs for indoors with seven-foot stand as pictured, or outdoor types that can be hung just like any other electric sign.

Equipped with a high grade radio set that will bring in broadcasting perfectly. The set sold complete with all batteries, and plug for wiring in the sign. Screw in the socket and hook up the aerial.

Watch the crowd hunt for the loud speaker—it's in "the sign that talks."

Regular Discounts for live wires,—and NOT high-priced. Trade name registered U. S. Patent Office.

RADIO EQUIPMENT SERVICE

Manufacturers

500 Fifth Ave.

New York, N. Y.



The Gould Radio "B" Battery is uniquely designed, compact and attractive. Provides 24 volts variable in 2-volt steps. Non-slopping hard rubber case. A battery that does not detract from the appearance of the finest set and assures a steady, continuous, noiseless service. Retail price, \$8.50.

Patents Applied For

A Radio "B" Battery You Can Back to the Limit

MANY receiving troubles variously attributed to "static," weak broadcasting, etc., disappear when a Gould Radio "B" Battery is placed in the circuit.

When once the proper voltage for tubes is ascertained there is no change required in the adjustment. Gould Radio "B" Batteries maintain a constant voltage while in operation, and give a steady, continuous, noiseless service.

Compact, non-fragile, free from danger of buckling or short circuiting of plates or from acid creepage, Gould Radio "B" Batteries represent the highest attainment in storage "B" battery design and construction.

Gould Radio Batteries are distributed through leading electrical jobbers. You are probably doing business with the Gould jobber for your territory. If you want a reliable source of supply for Radio Batteries bearing a nationally-advertised name, write us for name of nearest Gould jobber and attractive dealer proposition.

*On Sale by Radio Dealers and
over 3000 Gould Service Stations*

GOULD STORAGE BATTERY COMPANY
30 East 42nd St., New York Works: Depew, N. Y.

Gould

Gould Radio "A" Batteries are used by the various Radio Branches of the U. S. Government. Built for dependable continuous service. Made in sizes from 60 A.H. to 160 A.H.

Retail Prices
\$17.00 to \$29.00
(f.o.b. factory)

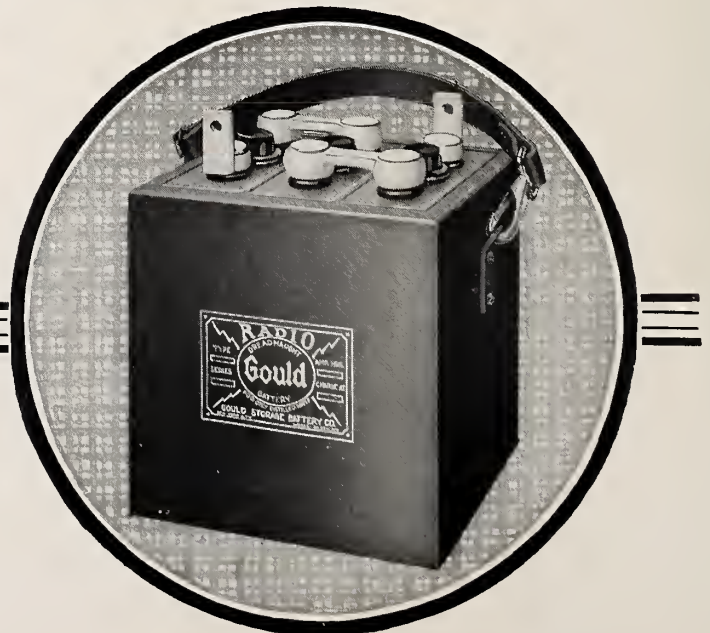

NO STORAGE BATTERY REQUIRED

OPERATES ON ONE DRY CELL

FOR AT LEAST
80 HOURS

THE BRU No. 3

Vacuum Receiving Set
Sold under our unconditional guarantee



A HARD PROBLEM —

THE SIMPLE SOLUTION - →

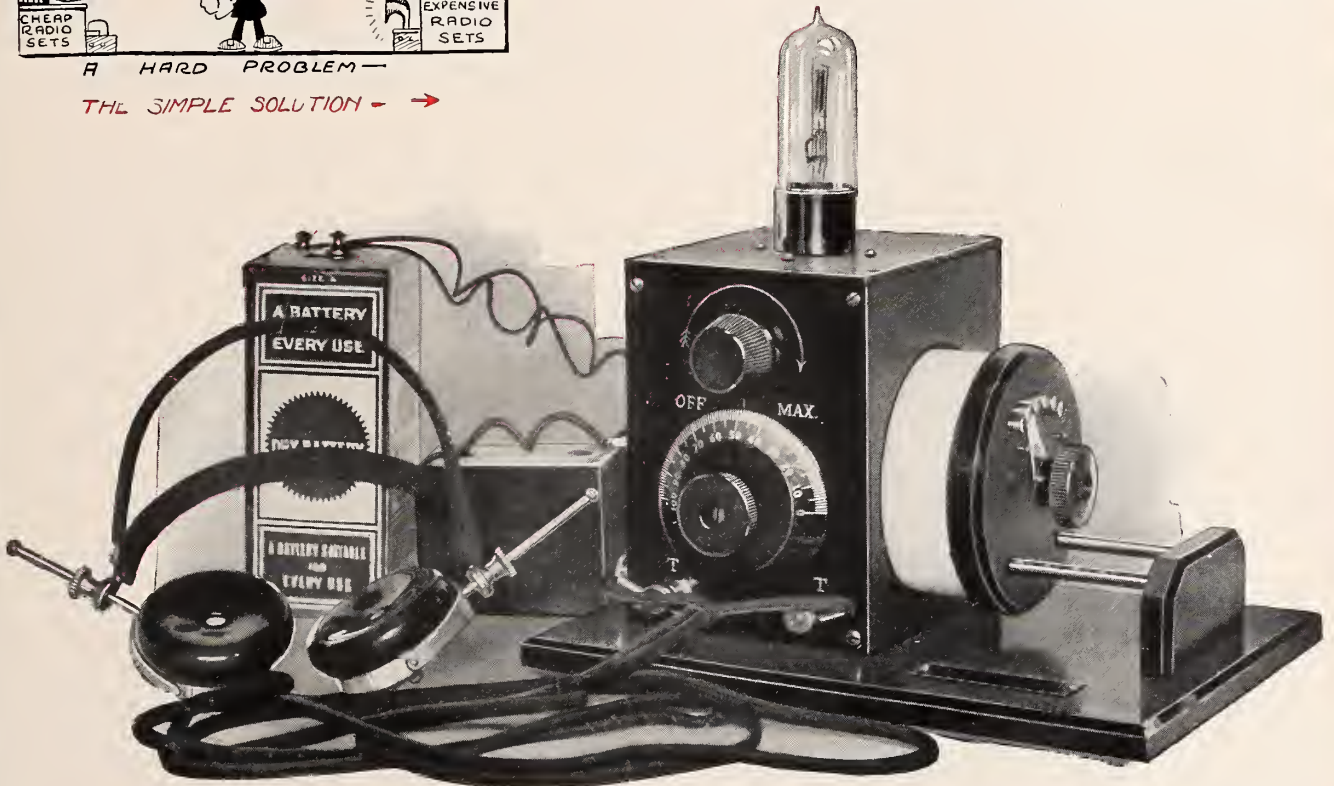

Designed to meet the demand for a "tube set," that is a combination of EFFICIENCY, SIMPLICITY, NEATNESS and ECONOMY OF OPERATION.

BRU No. 3 Specifications. Cabinet is of piano finish mahogany, with bakelite panels. Trimings are of highly polished, nickel plated brass. Normal wave length of 150 to 600 meters. Binding posts are provided to "load" the primary and secondary inductances, so that the reception of almost all wave lengths is possible.

BRU No. 3 Receiving Unit, List Price..\$30

BRU No. 3C Receiving Unit.....\$49

Complete including WD II Detector Bulb, phones, "A" and "B" batteries, aerial, lead in, ground wires, ground clamp, insulators, nails, screws, etc. Absolutely nothing else required.

A GOOD MARGIN OF PROFIT FOR THE DEALER

Complete instructions with each set

BRUNO RADIO CORPORATION

152 West
NEW



14th Street
YORK

JOBBERs, DEALERs and DISTRIBUTORs wanted to tie up with our national advertising campaign.

In Response to Demand

THE RADIO DEALER WEEKLY

Published by The Service Bureau

of THE RADIO DEALER

announces:

A SPECIAL OFFER

Effective September 1st,—

listings in the WHERE TO BUY RADIO EQUIPMENT guide appearing in THE RADIO DEALER WEEKLY each week, will be sold at the very low rate of .

TEN DOLLARS PER TWO LINE LISTING

from Now until October 1, 1923. Less than THREE CENTS A DAY. To include a free subscription to the WEEKLY.

The Radio Dealer Weekly Where to Buy Guide reaches the widest range of any similar list on the market today.

Where a number of these listings can be handled at one time the cost of changes, etc., will be materially reduced, and it is only thru the savings thus effected that this special offer can be made.

THIS OFFER IS FOR A LIMITED TIME ONLY AND WILL BE WITHDRAWN AT AN EARLY DATE. After which the regular charge will be twenty-five dollars per year.

USE THIS COUPON

~~~~~  
THE RADIO DEALER WEEKLY,  
1133 Broadway, New York, N. Y.

Please list us as manufacturers of ..... in THE RADIO DEALER WEEKLY until October 1, 1923, beginning with the next issue, for which we agree to pay *ten* dollars for each two line listing. It is understood we are to receive the WEEKLY free as long as this listing appears.

Signed ..... (Pres., etc.)

Firm name and address.....  
.....  
.....

Please typewrite or print exactly as it should appear in the WEEKLY

\$5.00



\$5.00

## A Wonderful Phone at a Wonderful Price



NOTE OUR NEW  
AND  
ATTRACTIVE BOX

We maintain that the public will demand a phone that is capable of giving good results on crystal detector sets; and that will not cost more than \$5.00.

We recommend our "ROYALFONE" King of All," \$5.00 List. It is of exceptional quality in material and workmanship. It is the only phone that will give best results on crystal and bulb detector sets.

Let us send you a sample for trial and advise you of our attractive jobber discounts.

**Be prepared to meet the demand for a crystal phone for a crystal set.**

ROYAL ELECTRICAL LABORATORIES  
MANUFACTURERS OF  
*Electrical and Radio Equipment*

207 MARKET STREET, NEWARK, N. J.

# Royalphone

## *Gilbert Radio Apparatus*

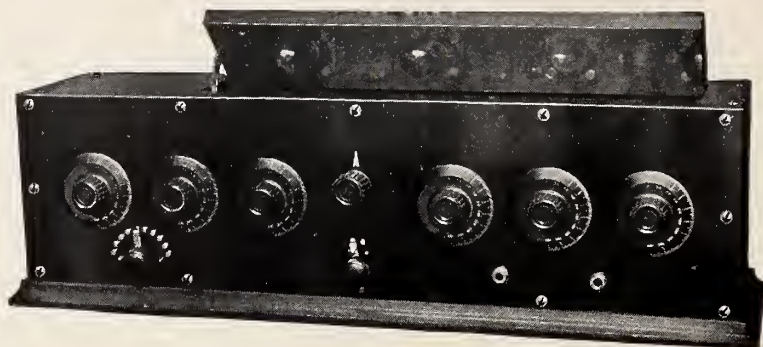

No. 4023

### **RADIO FREQUENCY**

#### **Long Distance Receiving—Splendid Tone Quality**

For long distance receiving and splendid tone quality this new Radio Frequency Set is unrivalled at anywhere near the price. It is based on the wonderful principle of Radio Frequency Amplification, the highest type of receiving set yet produced.

This and other outfits together with a number of the most advanced radio parts go to make up the Gilbert Line—a line of good, serviceable radio apparatus, efficient and at the same time priced to meet the popular demand—with good profit to yourself.

Send for catalog No. 54 illustrating and describing this new Radio Frequency Set with all other Gilbert Radio Apparatus.

**THE A. C. GILBERT COMPANY**

DEPT. C

NEW HAVEN, CONN.

In Canada: The A. C. Gilbert Menzies Co., Ltd., Toronto

# THE RADIO DEALER

*The Radio Trade Journal*  
For The Radio Retailer

---

## CONTENTS OCTOBER, 1922

---

### SPECIAL ARTICLES

|                                                   |                       |     |
|---------------------------------------------------|-----------------------|-----|
| Display Hangers.....                              | By Karl M. Jones      | 53  |
| Dealers Err in Rating Receiver.....               | By Frederick Dietrich | 103 |
| Development of Radio Frequency Amplification..... | By R. J. Whitawe      | 46  |
| Etherola Aerial Equalizer.....                    | By Bernard Freedman   | 53  |
| Explains Proper Hook Up for Loop Aerial.....      | By Thomas S. Loeser   | 54  |
| International Trade-Mark Registration.....        | By Chauncey P. Carter | 48  |
| Merchandising in the Radio Business.....          | By John L. Simmons    | 55  |
| Moffat Radio Lock Protects Receiving Sets.....    | By W. L. Moffat, Jr.  | 59  |
| New Tester Characterizes Tubes.....               | By William B. Brough  | 64  |
| Optimistic Outlook Shown by Radio Research.....   | By John R. Hall       | 41  |
| Origin and Growth of Cambrie Tubing.....          | By A. W. Stringham    | 49  |
| Oranola Talking Machine De Luxe.....              | By R. C. Hull         | 94  |
| Passing of the Unfit Tradesman.....               | By Henry L. Seidman   | 47  |
| Public Demands Guaranteed Products.....           | By W. S. Lemmon       | 56  |
| Rely on Quality—Not Price.....                    | By A. L. Strassburger | 45  |
| Radio Interference Obviated by Towers.....        | By S. W. Hull         | 68  |
| Radio Securities of Value.....                    | By Frank T. Stanton   | 54  |
| Small Space Socket Slotless.....                  | By Milton Alden       | 99  |
| The Development of the Loud Speaker.....          | By Herbert E. Metcalf | 44  |
| Vulcanized Fibre in Radio Manufacture.....        | By A. P. Southworth   | 45  |
| Wooton Headsets Tested Before Shipped.....        | By S. J. Williams     | 100 |

### DEPARTMENTS

|                                       |     |
|---------------------------------------|-----|
| Baltimore .....                       | 117 |
| Book Review.....                      | 87  |
| Editorial .....                       | 50  |
| Pittsburgh Paragraphs.....            | 72  |
| Philadelphia .....                    | 73  |
| Trade-Mark Department.....            | 114 |
| Washington Waves.....                 | 97  |
| What the Manufacturers Are Doing..... | 62  |

THE RADIO DEALER, THE RADIO TRADE JOURNAL, published monthly on the first, at 1133 Broadway, New York, N. Y., by THE RADIO DEALER COMPANY, in the interest of dealers in Radio Supplies. HARRY M. KONWISER, Publisher; LAURENCE A. NIXON, Managing Editor; JOHN L. SIMMONS and BERNARD J. FARRELL, Editors; A. L. KONWISER, B.S., Technical Editor; N. B. ZIMMERMAN, BERNARD FREEDMAN and EUGENE J. SCANLON, Associates; R. DESREAU, Circulation Manager; M. JAY KLEIN, Research Manager; B. B. STERN, Manager Service Bureau.

REPRESENTATIVES IN THE TRADE: ELMER W. MOORE, JOHN R. HALL, H. E. BENNETT, WM. B. WILKINSON, JR., J. MAURICE CASPER, J. A. DOUCET, H. L. KRENZ, M. A. CLARK, C. L. GEESBY, S. A. FRANK, C. M. MINIER, M. P. MCNEELEY, W. H. OKE, C. B. CABANISS, R. C. HULL.

PUBLICATION OFFICE  
1133 Broadway, New York, N. Y.  
Telephone Watkins 8926-8927

SOUTHERN STATES  
730 Gravier Street, New Orleans, La.

PITTSBURGH  
Suite 570, Union Arcade, Pittsburgh, Penna.  
PACIFIC COAST  
Suite 510, 456 S. Spring St., Los Angeles, Calif.  
Telephone Los Angeles 12052

CANADIAN OFFICE  
23 Lily Street, Winnipeg, Manitoba

CENTRAL STATES  
35 South Dearborn Street, Chicago, Ill.  
Telephone Dearborn 4053

NEW JERSEY  
845 Broad Street, Newark, N. J.  
Telephone Market 4659

Advertising Rates and detailed statement of circulation and other information for advertisers furnished on application. Advertising forms close the 15th of the month prior to date of issue.

Circulation restricted to manufacturers, jobbers and retailers in wireless equipment. Subscription in the United States, one dollar the year, payable invariably in advance. Subscription in foreign countries, two dollars the year, payable invariably in advance.



Not like the rest

They are the best

—the very best

### The Finch Automatic Code Recorder Brings a New Pleasure to the Radio Fan

Live dealers are now extending sales by stocking this wonderful new device which may be used in connection with any vacuum tube receiver.

Fastest Code Messages Recorded with Ease and Read  
at Leisure

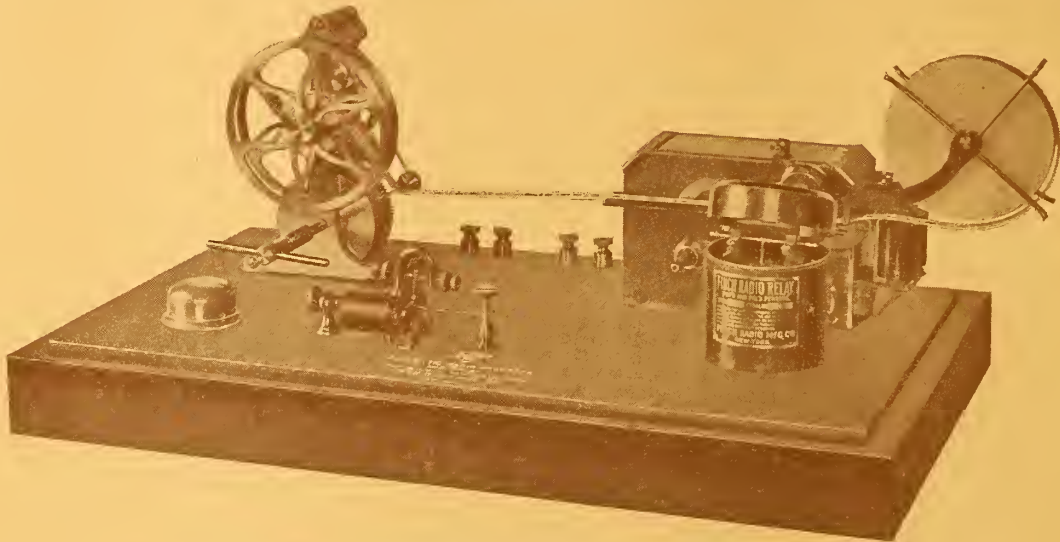

FINCH AUTOMATIC RADIO RECORDER AND RELAY MOUNTED AND WIRED  
READY FOR IMMEDIATE USE—LIST \$200 COMPLETE

#### INSTRUMENTS SEPARATE

|                              |         |
|------------------------------|---------|
| Finch Radio Relay.....       | \$75.00 |
| Std. Tape Register.....      | 60.00   |
| Telegraph Relay .....        | 7.00    |
| Tape Winder .....            | 10.00   |
| Paper Tape, per roll.....    | .10     |
| Register Ink, 2 oz. bot..... | .50     |
| Register Ink, pt. bot.....   | 2.00    |

Prices of other auxiliaries on  
request

#### FASTEST CODE MESSAGES RECORDED WITH EASE AND READ AT LEISURE

Every radio fan would like to be able to read the code messages that his instrument picks up, but this would require a great deal of time and study. How nice it would be if he could hook some kind of a device up to his receiver that would copy the code signals on a tape. Then it would be possible to "listen in" on the big commercial and trans-Atlantic stations. The Finch Automatic Code Recorder does exactly this; it makes a visible and lasting record of code signals no matter how fast they are sent. It is reliable and positive in its operation and although highly sensitive it is at the same time rugged and foolproof. No special knowledge is required to operate it and any radio fan can connect it to his receiver and have it in operation in five minutes. Costs nothing to run and will last a lifetime.

This marvelous device is one of the outstanding developments of the year. When set up and in operation, it will bring a crowd to any store and many amateurs will buy it on sight.

Wire or write for literature, prices, and proposition

#### Other Things You Can Do by Radio with the Finch Relay

- 1.—Automatically Receive and Record.
- 2.—Operate a Telegraph Sounder.
- 3.—Ring a Bell.
- 4.—Ignite Explosives by Radio.
- 5.—Control a Moving Vehicle.
- 6.—Visible Indication.
- 7.—Radio Burglar Alarm.
- 8.—Simultaneously Record and Re-transmit Messages.

Tested by the New York "Evening Mail" Radio Institute, approved and awarded Certificate of Excellence.

#### GREATEST TUBE EVENT IN RADIO

We have secured a quantity of genuine Western Electric V.T. 1 and V.T. 2 Vacuum Tubes. They are not rejects, but are Signal Corps surplus stock. These tubes are superior in every way to other tubes on the market, and heretofore were impossible to obtain at any price.

These tubes were tested by the New York "EVENING MAIL" RADIO INSTITUTE, APPROVED AND AWARDED THEIR CERTIFICATE OF EXCELLENCE.

WESTERN ELECTRIC V.T. 1 (J) TUBE, made for the U. S. Signal Corps; excellent detector and amplifier. Regular price \$10.00; List, \$7.50.

WESTERN ELECTRIC V.T. 2 TUBE, made for the U. S. Signal Corps; excellent amplifier and power tube. Regular price, \$12.00; List, \$8.50.

#### Representatives

**DOMESTIC**  
Automotive Electric Co., Dallas, Texas  
Baldwin-Stewart Electric Co., Hartford, Conn.  
Hallock & Watson, 192 Park St., Portland, Ore.  
John J. Reiger, 15 Fairview Place, Buffalo, N. Y.  
J. A. Comer, 1035 Merchants National Bank Bldg., Los Angeles, Cal.  
Electrical Supply Co., 324 Camp St., New Orleans, La.  
Radio Manufacturing Co., 416 Pecore Ave., Houston, Texas  
Schmelzer Company, Kansas City, Mo.  
Engineering Sales Co., 220 North State St., Chicago, Ill.

#### FOREIGN

S. SARASOLA, Colegio de San Bartolome, Bogota, Colombia, South America  
CHARLES W. KERWOOD, c/o Equitable Trust Co., 23, rue de la Paix, 23, Paris, France  
ORIENTAL RADIO COMPANY, No. 16 Bluff, Yokohama, Tokyo, Kobe, Osaka, Japan; Shanghai, China  
NEUSTADT COMPANY, 24 California St., San Francisco, Cal. (Representative for Honolulu)

When you VISIT NEW YORK, call and see our EXHIBIT at the PERMANENT RADIO FAIR—RED ROOM, HOTEL IMPERIAL, Broadway and 32nd Street

"Madame Radora," the Feature Attraction at the RADIO FAIR,  
is operated through the instrumentality of the Finch Radio Relay

Fully protected by our Patents and Manufactured only by

FINCH RADIO MFG. CO.,

303 Fifth Avenue, New York, N. Y.

# The Radio Dealer

THE RADIO TRADE JOURNAL

*Edited and Published at*

1133 Broadway, New York, N. Y.

FOR THE RADIO RETAILER

VOL. 2. NO. 1

OCTOBER, 1922

ONE DOLLAR THE YEAR

## Optimistic Outlook Shown By Radio Research

Analysis of Reports Show That The Industry Has Prepared  
For Increased Business

By JOHN R. HALL

Research Editor, The Radio Dealer

The result of the very recent research completed by the Research Department of THE RADIO DEALER should prove a boon to many manufacturers, jobbers and dealers who have been ailing from a chronic attack of pessimism nourished by the recent slump in the radio business. The keynote of optimism rings through the hundreds of reports that go to show business conditions improving rapidly.

The main facts brought out by this research were several. The exit from the field of a number of get-rich-quick members was evident from the first returns. Those that have remained are particularly the old concerns who have either been in the radio field for several years or those who have been long established in some line for which a field has been found in the Radio industry; there are those also, who are new to the industry both as to name and product but who have proven themselves of business acumen that warrants their staying in the field. These remaining are out to boost radio as their business and to turn out products that will stand up under normal use. In so far as manufacturers, jobbers, and dealers are concerned the field has been fairly well cleared up and the fittest have survived.

The products themselves have seen the same sweeping out. Those of poor quality are disappearing rapidly. True there were

a number of reliable firms that manufactured what now would be considered a low grade product but nearly all have seen fit to improve their products as fast as possible, until at present the market is well stocked with equipment that is of high calibre. Several radical changes have been brought about by new inventions and a better knowledge of radio itself. This improvement of equipment is continuing rapidly and it bids fair to soon place radio in a lime light that will be the envy of many long established industries.

The lower cost of equipment has been brought about by systematic quantity production on the part of large manufacturers together with increased competition and the falling off of the abnormal demand of last spring. This drop in price has helped along the increased demand that is now being experienced.

Of course, the main cause of the craze that came last spring has also aided greatly in reviving the interest of the public, that is the broadcasting stations. The improvement in programs, the increased number of stations and the recent announcement of having a few special stations in each district has given radio the needed impetus to bring back the demand that was partly destroyed by poor equipment and service that was handed out to the public some months back.

(Continued on page 123)

**THREE THOUSAND**  
*manufacturers in the radio*  
*field employ over SIXTY-*  
**FIVE THOUSAND people**  
*in their factories, thus sup-*  
*porting over SIXTY*  
**THOUSAND FAMILIES.**  
**RADIO IS A REAL IN-**  
**DUSTRY, one of the**  
*largest in the country to-*  
*day.*

**RADIO IS HERE TO**  
**STAY.**

# Radio Station KSD of Good Public Service

## St. Louis Post-Dispatch Is First Station to Be Licensed to Broadcast on 400 Meters—The New Class B

By N. B. ZIMMERMAN

"This is the radio broadcasting station KSD, the St. Louis Post-Dispatch."

This phrase has a real meaning to the radio enthusiasts of the St. Louis section, because the St. Louis Post-Dispatch has gone to great expense to establish a proper broadcasting station.

A brick structure on the roof of the Post-Dispatch building houses this transmitting station and the radio waves depart and travel to the enjoyment of thousands.

The full beauty and perfection of modern radio is demonstrated by Station KSD.

Broadcasting was begun by this St. Louis paper in the middle of last winter and the results were so pleasing that the present elaborate installation was made.

A radio plant, for powerful broadcasting, is only built to order for the reason that geographical location and service requirements modify certain details of construction. And then, after being built, there are many tests to be made before the station can be installed. An engineer surveyed the Post-Dispatch location, specifications were drawn up, and then began a three months' manufacturing, testing and installation job.

And this new station—what is it? Compared with the station KSD had been using, the new apparatus is like the latest battleship alongside a tug-boat. It can be stated in another way: On the set just abandoned, the power tubes used as oscillators had an output of 15 watts; the tubes in the new transmitter have an output of 500 watts. The same figures are true of the tubes used as modulators. In other words, while the old transmitter has a total output of 30 watts the new one has an output of 1,000 watts. That, however, is one detail of the new station which indicates size merely; there are others, showing far greater points of superiority, which will be explained later.

Let us first, however, visit the radio studio on the second floor of the Post-Dispatch building while a test is being made. One leaves the elevator and steps into the office directly fronting the visitor. This is a reception room only, where those who are to take part

in the evening's program can await the call to the studio.

A door between the reception room and the studio shortly opens and an attendant gives the signal to a singer and an accompanist that the time for their number has arrived. They walk into a room the like of which cannot be found in St. Louis.

First of all, it will be noticed that the voice has a most strange quality, so unusual, in fact, as to be uncanny. This is due to the fact that every inch of hard surface in the studio has been treated so as to prevent any reflection of sound waves. Strike one note on a piano in your home and you hear the true sound wave followed by countless reflections—reverberations—from walls, floors, ceilings, windows, doors. Strike a note on the piano, in the studio, and you hear just the tune sound wave—that is all.

Everything in the studio has been made reverberation proof.

The next thing that attracts attention are the four red lights—one in each wall. Under each red light is a neatly framed warning which reads:

When the light is burning any sound of any kind in this studio goes out broadcast by radio.

The program director—the red lights are turned off—gives a few suggestions to the vocalist, places a microphone on a little stand and touches a button.

This gives a code signal to the radio operator in the building on the roof, the red lights are turned on, the program director makes his announcement and the entertainment begins.

Concluding, another button is pressed, the red lights are turned off, conversation is permitted—and the same procedure is followed for the next "act."

It is interesting to note just how the entertainer's voice gets to the roof and then out by wireless. The little microphone provides the first stage of travel. It is a small affair, about the size of a round mantel clock and perfectly helpless in appearance. It is delicate, unbelievably so, and picks up sound waves.

These sound waves, no matter how feeble, are translated, so to speak, into electric waves of absolutely identical character and these travel an electric circuit to the roof.

These waves are carefully guarded—they must be—by having the wires encased in a conduit all the way to the top of the building, and this conduit is grounded every 20 feet.

It is not necessary to go to the top

(Continued on page 107)

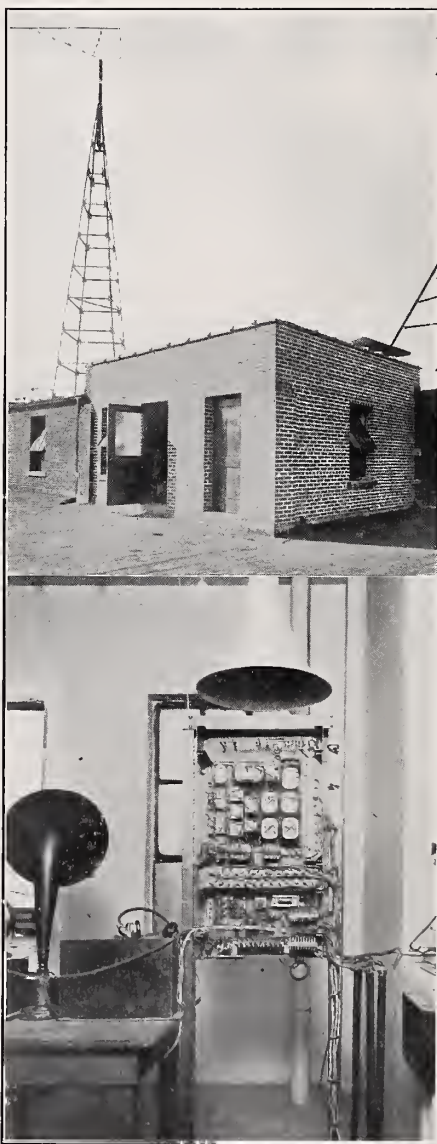

STATION KSD

Top—Brick Structure on the Roof of the Post-Dispatch Building Which Encloses the Transmission Apparatus

Bottom—Rear View of Speech Input Panel with Protecting Guards Removed



# The Milliken Radio Tower

Radio Towers Can Be Sold by Dealers Without Carrying a Stock  
—That's the Milliken Way

By J. E. JENNINGS, M. Am. Soc. C. E.

Vice-President, Milliken Brothers Mfg. Co., Inc.

In the September issue of THE RADIO DEALER, mention was made of a new and attractive catalog recently issued by the Milliken Brothers Mfg. Co., Inc. This book contains a large amount of useful data pertaining to the antenna and its supporting tower and it is believed to be the first publication of its kind in the radio field.

In addition to this data, the catalog illustrates many of the large eastern broadcasting stations that are equipped with Milliken Radio Towers. For want of space, other large stations similarly equipped have not been shown.

These large installations show that the design and construction of the Milliken Radio Tower meet the approval of engineers to the exclusion of any other construction.

This article is written, however, for the smaller operator and to show him that his antenna requirements are bet-

ter served by the use of a properly constructed steel radio tower than with a wood construction on the one hand or by an improvised steel tower of the "windmill" or "transmission" type on the other.

The special requirements of a radio tower are, fundamentally, good design with properly proportioned steel members of high elastic strength, security of connections and provision for simple erection.

Because structural steel is usually associated with construction of magnitude, radio dealers and operators look upon steel towers as a subject requiring special skill in the installation and erection. The fact is that the Milliken Tower is an assembly of light steel angles of high elastic strength, each one of which can be easily handled by one or two men.

For an antenna, say, fifty or sixty feet from the ground, the support may be a tree, the corner or ridge of a house or a wood pole or steel pipe properly guyed to the ground. When you extend beyond this height, available supports are difficult to find, and

if a pole is used, the multiplicity of necessary stays and guys is not only unsightly and expensive, but in most cases is really unsafe.

One can visualize what may be called the curve of mental or actual hazard in terms of height of supports. At the low end, the family clothes post; at the other end the 900 ft. towers at Bordeaux, France; the Eiffel Tower in Paris, etc. Between these extremes, there are well defined divisions of height which variously affect the mind. We step from the clothes post to the flag pole and without difficulty carry this to a height of, say, 30 ft.; then with the aid of top guys we can go to, say, 60 or 70 feet. With additional intermediate guys and stayed splices, we may extend this to one hundred feet, but beyond that height we resort to steel.

But with the use of steel, one type of construction may be used up to, say, 200 ft. in height. Another type extends to 300 ft. and still others are higher, until we reach the maximum

One may answer that the mechanics

(Continued on page 118)

## John E. Jennings Expert on Transmission Structures

When steel structures first came into prominence for high tension transmission to the present day experiment and development have been important factors.

Specialists have come forward, men who not only were engineers but who had a proper appreciation of the necessity for continuity of electric service. Prominent among those who have contributed to the development of the industry in the economical adaptation of structural steel to high-tension systems is J. E. Jennings, vice-president and chief engineer of the Milliken Brothers Manufacturing Company of New York. In 1907 the Great Western Power Company adopted his design for a double-circuit steel tower for a portion of its system. This marked the entrance of Mr. Jennings and his company into the electric power transmission field.

(Continued on page 102)



J. E. JENNINGS

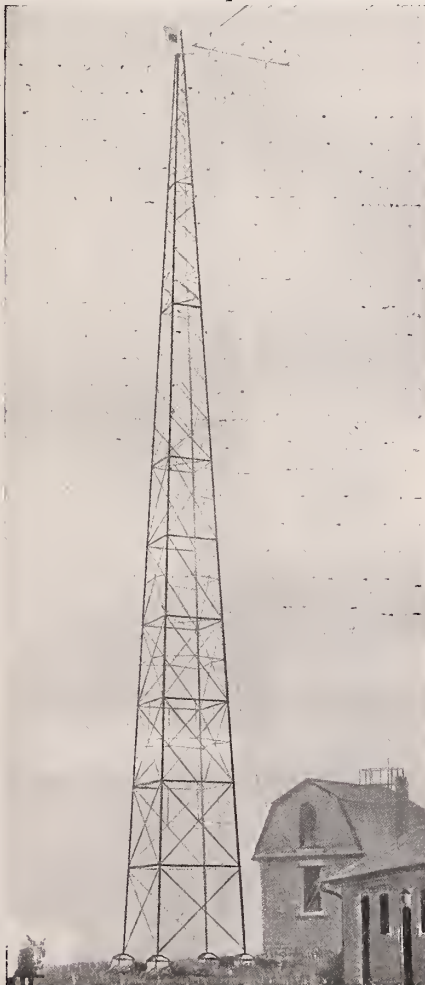

# Development of Loud Speaker Idea for Radio

## Years of Experimental Work Gave Radio Its Present Efficient Instrument for Amplifying Reception

By **HERBERT E. METCALF**  
Radio Engineer, Magnavox Company

The story of the development of the electro-dynamic, loud-speaking reproducer, so popular now for the reception of broadcasted speech and music, gives an example of the struggles of a new art to make itself known and successful.

In 1909 Edwin S. Pridham, at that time a graduate student of electrical engineering at Stanford University, became associated as engineer with a group of other engineers and capitalists who purchased for their company the United States rights in the Poulsen Arc Patents. As would naturally be supposed, Dr. Poulsen sent over to the United States the initial instruments with which to erect several pioneer stations, and also sent along with them a young Danish engineer by the name of Peter L. Jensen. Thus started the beginning of a friendship and co-partnership between Edwin S. Pridham and Peter L. Jensen which has become permanent. These two men supplemented each other and invariably they worked together.

After a short stay with the Poulsen interests, in the course of which a large amount of experimental work was done on the arc and its receiving apparatus, Jensen and Pridham left the Poulsen people and became the chief engineers of a new company known as the Commercial Wireless & Development Company. A site was chosen for a laboratory in Napa, California, and a wireless station erected and an experimental shop opened. As one of the many problems which had been interesting them during their stay with the Poulsen interests had been the recording of radio signals, they had made a very exhaustive study of all existing forms of telephone receivers. They became fully aware of the inherent defects in all existing types, which were then the magnetic attractive, or what is properly known as the electro magnetic receiver.

As is commonly known, inventors often work for years and years to perfect an existing type of apparatus with but little success, because certain types of apparatus can be refined only, any great radical change being

impossible. Jensen and Pridham, however, were determined to make a telephone receiver which would be not only better than the ones in use but which would operate along absolutely different lines and on a different principle. They started out by making experiments with an Einthoven String Galvanometer. The Einthoven String Galvanometer, as most of us know, is composed of a very fine quartz fibre, silver plated, which is placed in the field of a very powerful electro-magnet. If a current is passed along this quartz string conducted by the silver, the string will have a tendency to be

attracted into or repelled from this magnetic field. By making the field very strong and the quartz fibre very thin, great sensitiveness can be obtained from this instrument, the finest of which are used for recording the actual currents of electricity generated by the heart muscle during its beating. The co-inventors substituted a heavier wire for the quartz string and then attached the middle of this wire to a telephone diaphragm. Then by using a transmitter and battery in series with the string the voice was reproduced,—very, very weak, it was true, but after careful experimentation, it was found that the reproductions, particularly those of the consonants "T," "P," and "S," were far better than the ordinary type receiver. Upon working out the formula of this type of instrument it was found that the force acting on the diaphragm was proportional not only to the strength of the field and the amount of current flowing in the wire, but was also proportional to the length of the wire in the magnetic field. The next step was, therefore, to lengthen the amount of wire by winding a many-layered annular coil and then placing this annular coil in a strong magnetic field. So this was done, and the first true electro-dynamic receiver had been created. This instrument consisted of two very heavy electric magnets and a circular coil wound to an impedance of 70 ohms, rigidly attached to a diaphragm. The floating coil was about three inches long by one and one-half inches wide, and the complete instrument weighed in the neighborhood of sixty pounds. The sound box was so designed that a listening tube could be brought out from each side of the diaphragm and the tube was then led to each ear so that one ear listened on one side of the diaphragm and the other ear listened on the opposite side. In this way the air vibrations on each side of the diaphragm would be utilized. As the floating coil was then wound so that the instrument could be used on telephone lines, many trials were conducted in which



**HERBERT E. METCALF**

*Radio engineer of the Magnavox Company, who has written this interesting story of the loud speaker especially for the Radio Dealer. This photo was taken while Mr. Metcalf was in the Service as an officer of the Radio Corps. Mr. Metcalf is acknowledged to be an authority on the subject he writes about.*

(Continued on page 74)

# Vulcanized Fibre in Radio Manufacture

## Importance of This Material is More Apparent to Those Who Are Well Informed About Vulcanized Fibre Uses

By A. P. SOUTHWORTH

New England Representative National Fibre and Insulation Co.

The most of us are fairly well informed regarding materials most commonly used in the manufacture of radio equipment, but there are few who know and appreciate the many varied uses of materials that have recently been approved for more efficient use. The lack of knowledge concerning the use of vulcanized fibre is apparent. Like a great many things about which there is little known, the use of vulcanized fibre is looked upon with scorn by many. Some dealers and jobbers have refused to purchase fibre material, preferring to stock the more expensive material though this has proven to be no more efficient. With this thought in mind a few enlightening remarks about this much abused material would not be amiss.

Vulcanized fibre is a material which is made from a cotton paper base. Layer upon layer of paper is used until the fibre is built up to the proper thickness, whereupon the material is reduced to a cellulose and becomes one homogeneous mass. Upon drying, this material is pressed in huge steam-heated presses and becomes a very hard, tough sheet.

Fibre can be furnished in a number of colors, the most common of which are red, black and gray. Thicknesses can be obtained running from .005 in. to about 2 in. Vulcanized fibre can also be obtained in tubes and rods of a great many characteristics which make it especially desirable for radio work. Its shearing strength of 13,000 lbs. per square inch, together with its crushing strength of 43,000 lbs. per square inch and tensile strength of 13,000 lbs. per square inch, make this material strong enough for almost any use to which it might be put. Fibre is an excellent insulator and stands a breakdown voltage of approximately 25,000 volts per  $\frac{1}{8}$  in. in thickness.

It is interesting to note the number of ways vulcanized fibre is used in the manufacture of radio apparatus. Invariably, rheostats of the wire-wound type use a fibre strip to support their winding. The flexibility of the fibre enables the winding to be bent to a sufficiently small diameter to make a compact rheostat. The combustion point of fibre of 650 degrees Fahrenheit is more than sufficient to withstand the heat. Inductances of many

different types use fibre tubing to support the windings. One fibre manufacturer has succeeded in perfecting a tube which is excellent for this purpose. This tube is made by wrapping thin-weight fibre around a mandrel and securing the layers in place by an adhesive. This process of manufacturing tubing prevents the finished tube from shrinking or warping, thus causing the wire to loosen. Vari-

couplers, tuning coils, and loose couplers come in this class. Honeycomb coils are usually secured to their mounting with a perforated fibre strip. It might be well to mention here that fibre used on honeycomb coils has been severely criticized in the past, due to the fact that an improper grade of fibre was used. Fibre which had been made flexible by impregnating it  
(Continued on page 82)

## Rely On Quality, Not Price, to Sell Your Goods

By A. L. STRASSBURGER

Tri-State Products Co. of Philadelphia

The radio dealer who desires to make a success and build up a business for the future must bear in mind that the public, while having a general knowledge of the various parts necessary to make up a receiving set, knows very little about quality and it is up to the dealer to instruct his trade.

There was a time when a customer coming into a store selling radio supplies had no idea as to just what he wanted. He knew he needed this and that to make up his set but had to take the advice of the dealer as to what make of article to choose. In many cases the dealer was ignorant of the right make of article to sell him. This brought about a peculiar situation, the customer could not get his

set to work properly and in some cases he lost heart and cast it aside, always feeling that he had been stung; this was true to a more or less extent, but the dealer had no intention of giving him anything but what was right. Not having the proper knowledge parts were sold, made by irresponsible concerns who sold parts not properly constructed and therefore gave poor results, if any.

It is therefore necessary for the manufacturer of radio parts of quality to impress the dealer with the standing of his company. In this way the dealer will get to recognize those companies making only quality products which he can guarantee to his customers.

Where a dealer is selling a complete receiving set it is a simple matter to demonstrate how it works and have the customer listen in; but where the customer wants to make the set himself, it is then that the dealer should instruct and impress upon the customer the importance of buying well known parts which are backed up by the manufacturer. It is only the financially responsible makers who will stand back of their products.

It is the duty of the manufacturer to instill in the mind of the dealer that he must not buy price but quality. In turn the dealer must instruct the customer that the best results can only be had by the use of well constructed

(Continued on page 93)



A. L. STRASSBURGER  
Prominent Philadelphia Radio Man who  
urges quality above all

# Development of Radio Frequency Amplification

## Detailed Information on Neat Radio Frequency Amplifying Unit Made by Nationally Famous Radio Pioneers

By R. J. WHITAWE

The application of radio frequency amplification for the reception of broadcasting for the amateur work has been greatly developed by Amrad.

Before making a practical explanation of amplification, it is proper to generalize. There are two kinds of amplification—audio frequency and radio frequency.

The ordinary kind of amplification is audio frequency amplification. This increases the audibility of the music or speech that is barely heard with a V.T. Detector.

Audio frequency amplification is very useful. For a while it was the only kind available. It is still useful, but its usefulness has been increased by the development of radio frequency amplification which increases the radio impulses picked up by the receiving set before they pass through the V.T. Detector.

Under ordinary circumstances two stages of A.F. amplification represent the greatest increase that can be satisfactorily added to the V.T. Detector.

Where an extremely sensitive receiving outfit is desired, the only

alternative is the use of radio frequency amplification. A radio frequency amplifier, as stated above, amplifies the radio frequency caught by the antenna and tuner before it is applied to the detector tube. It amplifies the radio frequency only; hence it does not increase the intensity of audio frequency noises impressed on the antenna, such as some forms of static, nor does it increase the hissing or sizzling of the detector tube. It simply increases the strength of the incoming impulses before they reach your detector.

The Amrad R. F. Amplifiers are available in two types—No. 3071, particularly for use with Amrad Short Wave Tuner No. 2596 and Amrad Detector 2-Stage Amplifier No. 2634; and No. 3045 for use with any of the Amrad Units comprising the well-known Amrad unit system.

It is the established Amrad policy never to bring out new and improved equipment that would render obsolete previous Amrad products. Accordingly, the new Amrad R. F. Amplifiers are especially designed to work with the Amrad equipment noted above.

The trade may safely purchase Amrad Radio with the assurance that their equipment will not become inferior due to progress in the art.

Amrad R. F. Amplifier No. 3045 may also be employed with any tuner or detector units now available according to a recent bulletin.

Both types are identical, except that No. 3071 is encased in a cabinet with rounded corners while No. 3045 is provided with square corners.

R. F. Amplifiers should be so designed as to permit use of radio frequency amplifying transformers suitable for various wave length bands. Both Amrad R. F. Amplifiers No. 3071 and No. 3045 permit use of different wave length range radio frequency amplifying transformers, or Radiformers—the Amrad designation.

The unique design of Amrad Radiformers, a product of Amrad research, has been carefully tested, assuring highest possible efficiency in the operation of either Amrad R. F. Amplifier.

The two Radiformers, shown herewith, are inserted in specially molded

(Continued on page 65)

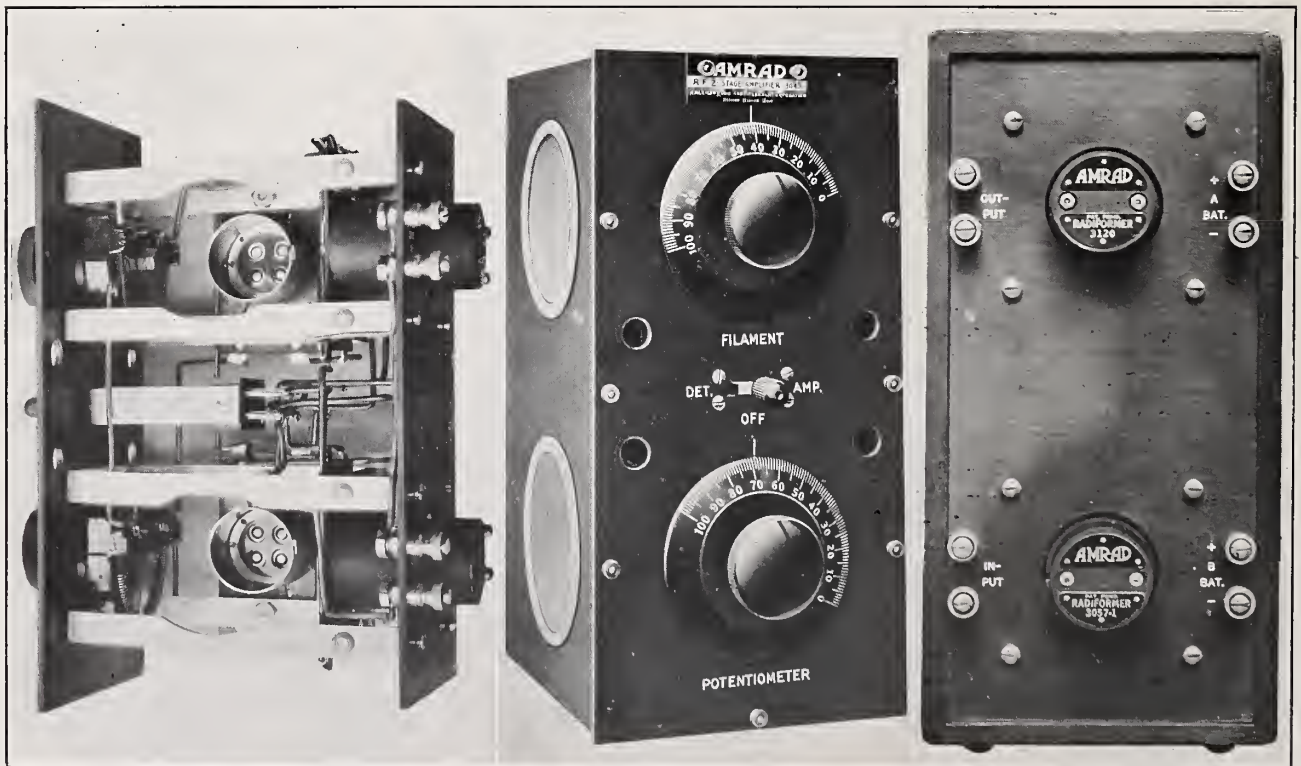

Three Views of the Amrad New Radio Frequency Amplifying Unit

# The Passing of the Unfit Tradesman

## Accounting Methods of Many Radio Firms Very Lax, Inviting Almost Certain Failure.

By HENRY L. SEIDMAN  
Certified Public Accountant

An examination of the recent bankruptcies which occurred among the manufacturers and dealers of radio apparatus, brings to light one of the most chaotic and appalling conditions that ever existed in any industry. Because of these conditions there is being waged among a certain class of dealers, one of the most serious cut-throat wars that ever took place; and these "warriors" are enabled to sell their merchandise at prices considerably below cost because the manufacturers who made them did not know what they cost to manufacture. It is obvious that there is only one end for such men—the bankruptcy courts.

The industry seems to have attracted men who are woefully unfit to be in it; whose experience, or rather, lack of it, in wireless work is pitifully inadequate. One case I know of is a typical example. A man who had been an electrician once upon a time, working for electrical contractors,

quit such work and went to work for a metal stamping concern where his job was to operate certain machines

### Cisin Added to Staff of Dictograph Products

#### Expert Is Placed in Charge of Radio Department

The Dictograph Products Corporation recently secured the services of H. G. Cisin, author of "The Radio Telephone Handbook." Mr. Cisin has been placed in charge of Dictograph radio sales promotion, advertising and publicity. He was formerly engineering editor of *Electrical Record*.

Mr. Cisin is a Cornell graduate, holding the degree of mechanical engineer and certificate of electrical engineer. In addition to being the author of "The Radio Telephone Handbook," he has written a number of other books, including "Radio Phone Terms Simply Explained" and "Practical Electrical Engineering." He has taught electrical engineering at Cornell University, Johns Hopkins University, U. S. Navy Electrical School and Stevens Institute of Technology. During the war he served in the U. S. Navy as ensign, and his radio knowledge was gained through practice as well as theory.

Since Mr. Cisin has joined the Dictograph Products Corporation, there has been great expansion in its radio department. The Dictograph Company has been manufacturing sound transmission and reception apparatus for many years, being makers of the world famous "Acousticon" for the deaf, the Dictograph office intercommunicating system and the well-known Detective Dictograph. However, the reputations achieved by the Dictograph Radio Head-Set and the Dictograph Radio Loud Speaker have served to place these in a class by themselves and have resulted in making the radio branch of the Dictograph Corporation one of its most important departments.

which stamped out tin discs which were used as covers for small tin cans.

He had been away from the electrical line for five years when the radio boom came along last fall. This man, because he saw some plate condensers and some sockets, became convinced that manufacturing radio apparatus was just the thing for him to engage in. Did he not know the electrical business? Had he not followed wiring diagrams for years? And what else was a 43-plate condenser but a series of stamped metal plates fitted together, about one-quarter of an inch apart?

He set up in business for himself. He lasted three months—and was one of the bankrupts mentioned above.

What were his troubles? A great many. First, was his absolute ignorance of the technical theory of radio; second, his inability to figure the cost of his article; he was wrong on the quantities of material, wrong on labor, and he never heard of such a thing as manufacturing and general overhead expenses. If his material cost him 50 cents and his labor another 50 cents, he could make a pile

(Continued on page 80)

Henry L. Seidman, whose article appears on this page, desires to call attention to the value of proper bookkeeping. Mr. Seidman is an expert public accountant and auditor of Bettman & Seidman, 276 Fifth avenue, New York, and will answer questions put to him regarding bookkeeping and accounting problems, as well as income tax matters.

In future articles Mr. Seidman will deal specifically with the following subjects:

- Costs of manufacturing.
- Overhead.
- Inventories.
- Selling costs.
- Administrative costs.

Through the medium of these articles the readers of THE RADIO DEALER will acquire a clearer understanding of the principles underlying their business as seen through the eyes of an accountant who is familiar with the radio industry.



H. G. CISIN

# International Trade-Mark Registration

## Advisability of Securing Early Protection in Foreign Countries for Trade Marks for Salable Apparatus

By **CHAUNCEY P. CARTER**  
Trade-mark Specialist

It is believed that the slump in exports from the United States has passed the low mark and that from now on gradual but sure recovery may be expected. Owing to the publicity talents born in the average American, practically every well-known trade-marked article on the market here sooner or later finds its way into foreign markets to some extent. Consequently, the owner of every trade-marked product that is enjoying or may enjoy any popularity in this country should early turn his thoughts to the possibilities of foreign markets.

While it is often said that the same qualities of salesmanship that act to "put across" a product in this country will do the same in any foreign country and that in the last analysis buyers of all nationalities are alike in fundamental psychological reactions, it must be admitted that the idiosyncracies of every buyer influences his action and should therefore be taken into consideration in trying to "sell" him, and that there are idiosyncracies common to all buyers in certain localities even in the United States.

Examples are legion of the failure of advertising copy and campaigns directed to the American public to influence the English or Australian buyer and it is, of course, unnecessary to even refer to the folly of sending to a list of South American prospects literature not translated into the native language of the country to which it is directed.

Thus, in the matter of trade-mark protection, we find that each country has sufficient ideas concerning this, and whereas in the United States the condition of our common and statute law is such as to protect even the most lazy and short-sighted trade-mark owner from aggression, the laws of foreign countries, particularly those wherein the English language and customs do not prevail, are not so kind.

In the United States, a man may use a trade-mark for years without complying with any formalities for registration, etc., and still be entitled

to the full protection of the courts when infringement arises. In Cuba, however, the registration of a trade-mark is obligatory prior to use, and the use of the trade-mark in any form but that in which it was registered affords sufficient grounds for cancellation of the trade-mark right as evidenced by registration.

In Argentina and most Latin countries, anyone may acquire the right to the exclusive use of another man's trade-mark by simply registering the same and being the first to do so. It is not at all uncommon in such countries for a local merchant to register in his own name well-known American trade-marks advertised in our leading magazines and trade papers, and then demand the local exclusive agency for such products.

From this it will be seen that the foresighted trade-mark owner will not even be content with applying for registration of his trade-mark in for-

foreign countries as soon as shipments are made but will make his application in those countries where the law permits piracy of foreign marks as soon as he has any reason to believe that his goods will eventually be shipped to such countries.

It is, of course, expensive from the standpoint of initial outlay to register a trade-mark throughout the world, but the expense of such registration has in recent years been considerably lowered by the coming into operation of the Buenos Aires Trade-mark Convention of 1910. Under this convention there has been established in Havana, Cuba, an international bureau where any trade-mark registered in the United States Patent Office may be deposited and thereafter enjoy the benefits of registration in some fourteen Latin-American countries that have ratified this convention. This protection may be had at an average cost of 35 cents per annum per country, and no trade-mark owner should be without it.

## Amendment Creates New Class of Broadcasting Station

The Department of Commerce recently authorized an amendment to the regulations governing radio broadcasting that introduces a new class of broadcasting station to be known as Class B stations. The Class B stations are designated by certain fixed rules that, of the 500 broadcasting stations located throughout the country, about 15 are equipped to fulfill. Not only does the amendment specify the general equipment of the station to be allowed in this class but it also permits supervision of the broadcasting program. One of the rules specifies that no "canned music" will be allowed except in an emergency.

The Amendment reads as follows: To radio inspectors and others concerned: Regulation 57, page 55, amended August 8, 1922, to read: Class 2—Limited commercial stations are not open to public service and are licensed for a specific commercial service defined in the license. Stations of this class must not transmit to or accept public messages from other stations. No rates are authorized. Licenses of this class are required for all transmitting radio stations used for broadcasting news, concerts, lectures and such matters. A wave length of 360 meters is authorized for such service, and a wave

(Continued on page 78)

# Origin and Growth of Cambric Tubing

## "Spaghetti" and "Macaroni" for General and Varied Purposes Has a Sound Foothold in the Radio Field

By A. W. STRINGHAM

Mail Sales Department, Mitchell Rand Mfg. Co.

It is only of comparatively recent date that the present form of insulating tubing has been used in the electrical field. Until about ten years ago the standard method of covering short terminal and connecting wires was by the use of a cotton sleeving or braided tubing then known as stockinet; after having been put in place this sleeving was given a coating of varnish to produce a smooth surface. However, the material was not satisfactory, as it was readily effected by moisture or oil, as in motors, dynamos, transformers, etc., and the dielectric strength of the varnish gradually weakened and finally broke down. Where high temperatures also prevail the disintegration process was so rapid that the insulation afforded only temporary protection. In other instances the sleeving was used more as a finish than an insulation, (such as inside of meters and similar instruments,) and with quite satisfactory results, although the varnishing process was time-consuming, inasmuch as it had to be done after the instrument was assembled and care had to be exercised to keep it off adjacent parts.

Then a new style of tubular insulation was introduced to the trade by the name of impregnated varnished tubing, in the form of sleeving properly treated and ready for use. Different colors aided in marking polarity, etc., and, because of its flexibility, its oilproof, waterproof, acid, alkali and heat resisting properties, many uses were at once found for it in electrical construction (particularly in instances where a dependably flexible insulation had been sought to confine high potentials,) and an assortment of various sizes ultimately became "stock" in every shop where highest standards prevailed in both new construction and general repair work. Someone, possibly preferring a shorter name to impregnated varnished tubing, and aided by the resemblance of the material itself, dubbed it "Macaroni," and the name stuck. Since the smaller sizes became popular, "Spaghetti" has been the designating shop term.

During the war the U. S. Government tested several makes of "spaghetti." The "impregnated" style stood highest in every test and many thousands of feet were used in

radio and other work by the various bureaus of our own government as well as those of foreign countries.

When manufacturers of electrical apparatus took up the production of radio sets they naturally used spaghetti on leads of exposed wiring, primarily as a protection against "shorts," although the "dressed up" appearance thus attained was at once recognized as an aid to selling; and notwithstanding the fact that cheaper substitutes are available, the manufacturers of practically all of the highest grade sets continue to use the "impregnated" style.

However, from makers of the lower priced sets, and from amateurs, came a growing demand for something less expensive, something that would serve mostly as a mechanical protection, yet have sufficient finish to impart the desired appearance. This call was immediately met by a "dipped" tubing and, quite recently, by "radio" tubing. The three styles of spaghetti now on the market may be briefly described as follows:

The style has a base of cotton sleeving impregnated through and through with varnish and baked, then given from eight to ten additional coats, each coat being baked and rubbed down. This is known as macaroni in the larger diameters and spaghetti in the smaller sizes. The wall around the sleeving is thus built up of nearly a dozen layers of varnish, is homogeneous and of tremendously high insulating value. As the final coat is also rubbed down the finish is smooth but not brilliant. The dielectric value is approximately 7,000 volts.

In the "dipped" tubing the cotton tubing is treated with a dressing, or filler, instead of varnish, dried and dipped five or six times in varnish, each coat being baked dry before the succeeding one is applied. This method produces a tube with a high gloss that is moisture proof, oil resisting and, when properly made, will withstand breakdown tests up to an average of 5,000 volts. There are several makes of dipped style and while some are quite suitable for radio and similar work, there are others that quickly bleach and dry out, crack, powder and sooner or later become utterly worthless as an insulator. And it is difficult to determine quality

by either price or appearance, as some of the most highly polished are built up entirely of collodion, cellulose, or other gun cotton compound, to which castor oil is added to retard hardening, and as they contain absolutely no varnish whatever they soon become hard, brittle and crack; then, too, some are highly inflammable, burn with an intense heat and, when carried in stock, introduce a fire hazard that warrants most serious thought.

The "radio" tubing is white or colored cambric cloth cut in narrow bias strips, rolled lengthwise to form a tube 36" long, and covered with an insulating compound resembling (but not containing) rubber. To produce yellow tubing amber colored compound is used over white cloth, whereas both cloth and compound are of the same color when other shades are made. In every case the coating is transparent, permanently flexible and will give excellent electrical protection up to about 1,000 volts in ordinary apparatus where it does not come in contact with water or oils. This form of "spaghetti" is ideal for radio instruments, inasmuch as it offers insulating protection with a factor of safety many times in excess of that required; its low cost permits of its liberal use and where more than one color is employed to trace out different circuits the result is an improvement in appearance that has repeatedly proven to be of no small assistance in selling.

As "radio" tube is somewhat softer than the other types, care should be taken to prevent its being cut by sharp pliers when the covered wires are bent at the turns.

Space does not permit going into a description of the many and varied uses of "spaghetti." Suffice it to say that, though the manufacturers have seen fit to use it extensively, yet there is the large and ever increasing so-called class of amateurs that has not as yet been thoroughly educated to the use of this material in the construction of their sets. What is needed in this line, as in many others that have a field in radio that is not fully realized, is an extensive education of the public regarding the facts by manufacturer, jobber and dealer.

# With The Editor

## Service to Trade Has Made This Paper Trade's Leading Periodical

Many people in the radio and electrical field have marvelled at the growth of this paper. They have seen trade papers come and go but ne'er have they witnessed so astonishing a success as THE RADIO DEALER appears to be.

THE RADIO DEALER is a success and has achieved the top spot in the radio trade, following the fact that it was first in the field, because we have employed one especial policy—service to advertisers and readers generally.

Every effort has been made to serve the trade.

This pleasant programme has developed a large part—for subscription. No trade paper in recent years—we believe—can point to a bigger paid-for list in the seven months that have ensued since THE RADIO DEALER was first launched.

THE RADIO DEALER has succeeded where others have failed, because this paper has day by day gone about its own business—to serve the radio trade.

In our first issue we plainly stated THE RADIO DEALER would have but one master—the radio trade—and we have hewed to that mark very, very carefully.

THE RADIO DEALER represents no faction; has no promotions to put over; has no axes to grind of any kind, but is merely a response to a demand.

Why are we telling this? Merely to put ourselves on record as believing, not in Santa Claus, but in the patent fact that THE RADIO DEALER achieved its rank as the trade's leading paper, as well as the trade's first paper, because THE RADIO DEALER extended real service in months passed when so many of our tradesmen were groping in the dark.

In those days many newspapers, featuring (?) radio departments excited the minds of many business men, pointing out the great business in sight—all to be gobbled up by the first comers.

THE RADIO DEALER advised caution. THE RADIO DEALER convinced many business men. THE RADIO DEALER adduced facts to seekers.

THE RADIO DEALER paid-for circulation has been achieved because of the dollar subscription price. That price has been the real bait that has acquired for this paper what amounts to almost the entire field.

THE RADIO DEALER covers the retail and jobbing field, being

read by radio dealers, electrical dealers, phonograph dealers, department store radio managers, hardware dealers and drug chain system heads.

THE RADIO DEALER circulation will increase as new dealers in radio equipment develop—no faster. This paper has no newsstand circulation, every copy being mailed out to retailers, jobbers and manufacturers.

Pardon this talking about ourselves, but we do want you to know that our success is built upon the solid rock of service and that word Service is to remain our one special creed for ever and the next day.

What can we do for you?

## Sure-thing Stock Sellers Have Been Unsuccessful

A great deal has been written about the sure-thing promoters who have stopped selling oil stocks in order to acquire easy money via radio stock-selling.

It is doubtful whether the radio stock selling lads have acquired great quantities of wealth, because the newspapers—which helped materially in developing radio usage—were alert and pounded away at promoters.

Some of our newspapers even refused to print the advertising offered them by radio concerns obviously created for the purpose of stock-selling. (*The Radio Dealer* has declined advertising from such concerns.)

One of the reasons for the apparent indifference on the part of the easily-beguiled public lies in the fact that there are but a few radio concerns listed in Wall Street.

The daily newspapers report transactions on the New York Stock Exchange, as well as on the Curb Market—but these exchanges have become critical in recent years, due to public outcry, and they are not wont to hastily permit trading in stock issued by new and untried organizations.



## Cheap or Reasonable Prices

The difference between cheap goods and reasonably priced goods is so slight for the manufacturer that it is hard to understand some of the apparatus on the market to-day.

To do a good job of wiring on a set costs very little more than a poor set of connections, while a cent a pound more of certain kind of materials will often mean fifty per cent better operation for the part.

Retailers throughout the country are finding that the best goods that give the best service are often but a little higher than shoddy goods made by irresponsible firms. A retailer has to stay in business to make any money and more and more they are refusing to buy anything but the best. Quality brings repeat orders while poor material often loses a radio fan for the game.

Dealers are becoming educated to recognize quality, and the wise makers are quick to read the handwriting on the wall that warns them that "quality tells."

There is no room in the radio industry today for manufacturers that do not produce goods of high quality, and the trade is rapidly convincing the last of the fly-by-nights that the time has come for them to turn to some other field of endeavor.

## The Coming Business And One Price to All

Business is on the upward trend in radio circles, judging from reports being received from many centres of broadcasting activities.

It is likely that last year's rush will be duplicated this fall, but the bulk of the business will go to those concerns who have established some sort of a "Rep" for their wares or their firm names.

The unknown — the get-it-quick manufacturers of last year—might as well close up shop. They haven't much of an opportunity to put over hastily-made wares.

Retailers and jobbers have learned their lessons. They will not buy without guarantees. There are to-day thousands of dollars' worth of poorly-made radio apparatus on the shelves of some retailers who are also wholesalers.

Some of last year's new folks in the radio business knew very little about electrical equipment. They imagined, for instance, that a 'phone head set if it looked the part served its purpose. Some head set "manufacturers" have achieved financial headaches rather than real business.

There have been failures, financial and otherwise, in abundance and some of the larger radio concerns have been hard-pressed to control their jobbers and retailers who became scared at the very recent summer slump.

Cool heads have won out, thanks to the larger concerns who have not oversold the market and the fall and winter business season will open up very soon with a genuine demand on the part of retailers and jobbers for practical radio apparatus that can be sold on a guaranteed basis, at a living wage profit.

The manufacturers and jobbers who are legitimately engaged in the sale of radio apparatus are extending proper terms to their customers. These manufacturers must succeed.

There is one rule that insures success to every business house and that is to treat every customer the same. Extending special prices to certain dealers is not good business; it does not make for trade stability.

The best concerns in the radio trade are treating their customers alike. No other rule will satisfy the present retailers and jobbers in the radio field.

## Test May Eliminate Radio Interference

Judging from the new schedule in effect for the radio broadcasting stations in the Metropolitan area, announced to go into effect today (October 1st), Arthur Batcheller, Radio Inspector for the Second New York District, is to make a test that may eliminate radio interference.

It is planned to send out programs simultaneously on 400 and 360 meter wave-bands.

The General Electric Company, in Schenectady, broadcasting station is to operate on a 400-meter wave length on the first, while the Rensselaer Polytechnic Institute, at Troy, will operate on the customary 360-meter wave length.

This is an interesting experiment and it will be watched very closely by every one of the five hundred broadcasting stations, as it is sure to have an important bearing on all future broadcasting. (For reports see **Radio Dealer Weekly**.)

Persons in the capital district of New York will listen and determine if they can satisfactorily separate the programs so there will be no interference with either.

WGY—the Schenectady station—will operate under the experimental license granted to the General Electric Company, starting at 8:45 o'clock, daylight saving time.

WHAZ—the Troy station—will start its program at 8:15 o'clock, daylight saving.

This will give persons one-half hour to listen to Troy before Schenectady starts.

Listeners are invited to render reports to Inspector Batcheller.

Representatives of the General Electric Company, in a statement rendered to newspapers, say that the outcome of this test will have an important bearing in solving one of the greatest problems that has arisen since broadcasting started. There are about twenty broadcasting stations in the second district, all operating on a 360-meter wave length. Inspector Batcheller arranged with the Department of Commerce for an additional wave length of 400 meters to be assigned the larger and more powerful stations equipped to maintain a high standard of programs and prepared to maintain a regular program throughout the year.

The question arose whether persons with receiving sets could satisfactorily tune out a station on a wave length of forty meters difference, and to settle the question the test between the Troy and Schenectady stations for Monday night was decided upon.

## Radio and Radio Failures

The race is for the strong, and the old law of the survival of the fittest is purging the radio industry as other lines were cleared during the general depression after the war. The increased number of failures among radio firms during the past summer, while hard on some of us, will work for the general good.

Makers of inefficient equipment, firms with poor merchandising policies and with profit ideas out of proportion with justice, under-capitalized concerns, and those with inefficient management, wild stock selling companies, all these are falling by the wayside, working for the general betterment of the industry for those remaining.

The march of radio should be speeded—among the trade—by this weeding out of inefficient.

## The Fly-by-Night Radio Retailer

When the boom came on last spring every corner store put in a radio stock, charged high prices and sold the public what they asked for—as long as it could be found in a jumbled stock.

The summer slump gave these would-be dealers a chance to discover that radio supplies, like everything else in the world, required a little bit more knowledge about their selling than the vending of newspapers on the street corner.

The radio retailer must carry sufficient stock to supply demand, and he must be able to give a certain amount of service to his customers. The live dealer reads up on his business and is prepared to tell customers what to buy—and why.

The cigar store radio dealer, the drug store counter, the hardware man, the electrical man, in fact every dealer in radio equipment has found that radio retailing requires thought and study, and the weaker dealers are slowly fading away.

# Air Programs Meet Today's Public Requirements

Criticism, in goodly quantities, has been directed at the many prevailing radio programs, and a great deal of this caviling is of the capricious type.

The present type of radio programs are serving their clientele, and it is safe to record that when the great American public demands programs of another type the broadcasting folks will make proper changes—in accordance with public demand.

It has been declared that the current styles of programs are not of the uplift sort; that they pander to the simpler tastes; that like the movies they are "undermining America" because of their featureless arrangements.

Environment, it is agreed, makes us. So it is with the radio broadcasting folks. Just as long as their clientele is pleased with concerts, with Wall Street prices, with baseball scores and the other features daily served, just so long will they be broadcasted.

When the public begins to cry for Ibsen and Shaw or mayhap editorials from the New Republic, then will another era of air service become the vogue.

It may even develop that the radio enthusiasts will ask for original fiction stories, supplemented by

readings from the classics. Why not?

Radio broadcasting managers can take heed from the activities of the movie folks. These mercenary entertainers give the public what they think the public will want—at box office prices.

Movie magnates do not, as a rule, force high-brow entertainment down into the public's sight, because the major part of our people really seem to enjoy custard-throwing comedy—viewed from the box office results. And the spoken drama is not much different. Even the famed Guild of New York can attest to the fact that high-brow plays do not land the food coupled with eggs.

It is barely possible that too many radio broadcasters have taken the plaints of the comparatively few too seriously.

There is an art to radio broadcasting, but it's in an indefinite shape, but it needs no apologists as yet.

In the play houses the public demand the custard-pie and the sob stuff—the things generally favored by the mentality of the average person—and it is tendered them.

So it is with the radio programs. When the demand, from the big public, arises the broadcasters will heed that demand. The present programs are ample for the day.

On one New York street of less than six blocks at one time there flourished over a dozen radio stores, all flourishing on the face of things. Today, with a public educated to better things only three stores are to be seen in this section. They are not as busy as before, but the dealers say gross sales are higher.

Just as the fly-by-night makers have folded their tents and silently fled, the fly-by-night retailer has sold his stock of junk to a cut rate dealer and put back the cigars and

light bulbs that occupied the radio section this time last year.

Less junk dealers and more radio dealers bring better business for better manufacturers, to say nothing of advancing the use of radio sets among the general public.

Radio retailing is a business, today, and business men are in the large majority among those remaining in the trade.

After all, sometimes, slumps help!

# The New Etherola Aerial Equalizer

By **BERNARD FREEDMAN**

The writer has been watching the development and tests of the Etherola aerial equalizer and the Etherola ground separator tubes, for replacing the usual high long aerial and water pipe and other ground connections, so commonly used and which pick up and convey to the amplifier so much interference.

Many radio men have been developing "equalizers" and "separator tubes" for replacing the usual high, long aerial and water pipe ground connections.

The Etherola aerial equalizer and the Etherola ground separator tubes are the results of tests, properly made for connections so commonly used and which pick up and convey to the amplifier so much interference.

These equalizers and separator tubes seem to solve the many aerial problems as well as doing away with the necessity of a ground connection, which, of course, eliminates the so-called danger from lightning.

The tubes are made of sheet aluminum, in tubular form, from  $4\frac{3}{4}$  inches to  $9\frac{1}{4}$  inches in diameter and 20, 24 and  $38\frac{1}{2}$  inches long and are suspended by insulators either in or out doors as desired by their purchasers.

They are effective on almost any make of receiving sets of one stage of amplification and over on head phones and on four stages of amplification on loud speakers; can be suspended in almost any convenient spot at any height, and seem to be free from the usual directional quality, with which all loop aerials have to contend.

The contents of the tubes and their arrangement and capacity has not been made public as yet and will not be until the pending patents as to basis, operation and design are granted, but it is understood that they contain a large number of different metallic discs, so made and connected that they pick up the carrier wave in its greatest strength, clarify and equalize it and separate it from most of its bad parts, and pass it to the receiver in nearly perfect form for detection and amplification. And it would seem that whatever the tubes do to the wave (judging from the clear tones produced), that a point has been covered by "doing it in the

aerial" which others have been doing or attempting to do after the wave enters the receiving apparatus.

It looks as though the system used is the correct one, and the Etherola Corporation, 6216 Broad Street, Pittsburgh, Penna., who are manufacturing the tubes, under license of patentee, apparently have a device which radio fans have been looking for, as it requires no change in one's receiving set to use them.

Jobbers and dealers would do well to look carefully into these devices, as they look like real "best bets" in aerials and grounds. The company is reliable, well financed and ready to "deliver the goods" and guarantee results.

The Etherola Corporation also manufactures a self-contained cabinet of unique design to contain these tubes. This cabinet is called the "Etherola" and the tone results are said to be amazing.

## Chicago Show for October

### National Show Plans on Having Manufacturers' Exhibits Only

The Chicago Radio Show to open October 14 is planned to be exclusively a manufacturers' radio show. According to recent reports the majority of large manufacturers had arranged for representation and it is expected that there will be a high class showing of radio apparatus that will bid fair to eclipse that of any show held thus far. Big interest in the show has been expressed by numerous dealers throughout the Middle West, who are anxiously inquiring as to the accommodations to be had at the city hotels.

Most of the space has already been reserved and reports have it that several foreign countries will have representative exhibits. The directors are seeing to it that no undesirable exhibits gain admission, by carefully scrutinizing the status of all applicants for space.

The plans call for a big attendance like all shows, but the difference between this show and many of those of the past is that all indications point to a successful carrying out of the plan. As one writer puts it and as it is hoped, "the Chicago Radio Show will be the largest and finest radio exposition ever held anywhere."

## Display Hangers

### A Valuable Form of Advertising That Costs Very Little

By **KARL M. JONES**  
Vice-President of Mercury Radio Products  
Co., Little Falls, New Jersey

The importance of an attractive display hanger shown on the dealer's counter, or in the window cannot be spoken of too highly. A good display hanger with the right selling message in a few words and the proper illustration, will bring immeasurable returns in dollars and cents. This has proven to be an inexpensive form of publicity, besides, it adds to the attractive appearance of the store.

It would, perhaps, do to use a standard size hanger, 10 x 14 inches, preferably made of four-ply cardboard, and provided with two eyelets at the top for the purpose of putting a piece of cord through. It costs far less to use cord at the top than an easel back for displaying the card. If a cardboard easel is used in the back for standing the card in an upright position, so much the better, but this will add approximately a half cent to each display. The majority of easels in use, however, have proved practical with the string attached.

The most practical colors to use for such an easel are black as a basis, and orange or red for certain parts to be emphasized. The suggestion is to use plenty of black, and not too much red for emphasis, and for getting a strong contrast. Plenty of white should be used around the border, as a black, white and orange combination is very harmonious to the eye. For example, a clever selling slogan should be emphasized in orange; the name of a product should also be so emphasized. An illustration and the brief descriptive or specification matter should be in black.

To sum up, a few thousand display hangers judiciously distributed among dealers will do far more good to back up the consumer demand than any amount of salesmanship or circularizing could do—besides a display hanger is a silent salesman that works continuously twenty-four hours a day, and costs negligibly little, as compared with selling to the consumer by word of mouth.

### GLOBE ELECTRIC SET

The Globe Electric Company of Milwaukee, Wis., manufacturers of a two-unit set consisting of a regenerative Detector and Tuner Unit No. 610, and a Two-Stage Amplifier Unit, No. 615. The Detector Unit consists of a vario-coupler, variable condenser, detector tube, rheostat, grid condenser and leak.

# Explains Proper Hook Up for Loop Aerial

## Expert Gives Sound Advice to Dealers and Jobbers in Connection with Loop Aerial Sales

By THOMAS S. LOESER

Radio Research Department, Eagle Radio Company

It has been continually said of loop aerials that they were not quite as efficient as outdoor aerials under conditions permitting the use of both kinds. The loop aerial has ever been considered in disfavor by the radio public because those whose duty it was to inform them accurately have themselves been misinformed. There is no good and sufficient reason why loop aerials should not come into their own with a little educational propaganda spread by the dealers and jobbers who handle this product.

A loop aerial accomplishes the same effect as a suspended aerial but they should not be connected in the same manner, when used with the ordinary type of receiver and audio frequency amplifier now on the market, except in a few cases. It is because of this difference that there are continual complaints that loop aerials are not what is claimed for them. In many cases the interested party cannot erect an outdoor aerial, with the result that they suspend their efforts to operate a set until such time as they can erect an outdoor aerial or until they obtain a set that can be operated on a loop. The result is that there are many purchasers of radio sets lost to the market because of the lack of knowledge of proper connection for the loop aerials.

The following suggestions are given to dealers and jobbers that they may in turn pass them on to the public and thereby make a greater market for their products among those who are in such a position that does not permit their erecting an outdoor aerial.

In so far as the connection of a loop aerial to a radio frequency set is concerned there is little need for explanation, so that no consideration need be given it here. With those sets using merely an audio frequency amplifier, detector and any type of tuner, regenerative or not, loop aerials should always be connected in the secondary circuit of the tuner; not to the "aerial" and "ground" posts, or in the primary circuit as so many people believe. Once the aerial is so placed, about ninety-five per cent. of loop aerial "trouble" will be eliminated, the other five per cent. will disappear when the aerial is connected efficiently and the operator has learned

the proper method of tuning. The only occasion when the loop aerial may be connected to the aerial and ground posts is when the set in use is near the transmitting station and even then some trouble will be experienced. Even many of those who have been in the radio field for several years and who have a fair knowledge of radio technique commit this error, and when the set refuses to receive broadcasted news or music they decide that the use of a radio frequency amplifier is necessary to permit reception with a loop aerial. Tell them that they are wrong and you are labelled as a novice or just crazy, haven't they tried it? The story changes when they are shown how easy it is done; then they recall that they had seen it explained some time ago in a back issue of some radio magazine.

One more point to remember in connection with the proper installation of a loop aerial is that if it should be necessary to place it in series with the secondary of the variocoupler fewer turns of wire should be used

than if the variocoupler secondary were removed and the aerial put in its place. The reason for this is that the variocoupler secondary, if placed in series with the loop will raise the wave length of the circuit to such an extent that it will be practically impossible to tune in a low wave length station efficiently, if at all. The lowest wave length of the loop together with its leads, tuning condenser or variometer and the wire used in connecting it to the detector tube should be approximately one-half to one-third the wave length to which the set is to be operated. If this conditions does not exist the set will work, but not with a satisfactory degree of efficiency.

In some cases it will be found advantageous to connect a wire from the negative terminal to the "A" battery to a good ground.

Let the public be informed of these facts and a noticeable increase in the sale of loop aerials and receiving sets will result. Let the cry against loop aerials be stilled.

## Some Radio Securities that Are of Value

By FRANK T. STANTON

During the past few weeks, the radio industry has passed a crisis. Many concerns which were brought out on the crest of the broadcasting wave, some with inferior equipment and others with the sole purpose of selling stock, are being relegated to the scrap heap. The sound organizations were never in a better position, both from a property and stock market standpoint.

During the summer months, co-ordinated efforts on the part of the manufacturers, developed radio from a craze to an enthusiastic industry. They improved designs, wisely planned constructive advertising campaigns, in short laid a sound foundation for the coming radio boom, which seems so clearly defined. The stock market, functioning as a barometer, is beginning to discount by advancing

quotations, the indicated boom, which in my judgment should materialize this winter. In substantiation of this possibility I might mention that extensive radio expositions are planned this fall, in all important cities of the country, varied broadcasting programs arranged, etc., further assuring the utility and popularity of radio and creating an enormous demand for representative equipment. Securities of reliable companies should be purchased now in order to benefit by the large earnings which will be reported early in 1923.

For the information and guidance of prospective investors in radio securities, I am outlining below interesting data on several leading concerns.

**RADIO CORPORATION:** Under an agreement announced recently, all the land lines and several thousand

(Continued on page 119)

# Merchandising in the Radio Business

## The Successful Jobber and Retailer Will Study His Turnover and Watch His Step

By JOHN L. SIMMONS

Any commercial activity which has distribution for its principal object, has as its fundamental factor the matter of merchandising. While merchandising may not be the most important phase in commerce, it is a very necessary and vital business link and upon its understanding and proper conception the individual in the jobbing and retail trade must rise or fall. It is a subject often too little thought of and the sooner the radio trade pays it the attention it deserves, the better for that trade.

Merchandising, briefly stated, is the providing of merchandise or "goods" in certain quantities, qualities and assortments as to supply the tastes, desires and wants of the consuming or buying public. Thus, the function of merchandising includes the many varied operations of business which results in the journey of the goods from the manufacturer to the consumer. We are concerned primarily with an inner trip of this journey and we shall try to consider those general factors most useful from the standpoint of the jobber or wholesale distributor. And we shall confine ourselves mainly to one important part of merchandising—the turnover of stock.

Of course, the beginning of a jobbing business is the purchase of stock at the lowest price consistent with good judgment. Once the initial stock is in, there comes merchandising's most vital and fundamental factor, the "turnover." Turnover, of course, has financial profit for its direct object, so its importance may be easily realized. Its purpose is the use of the least possible amount of business capital as investment in stocks on hand, consistent with always having enough to fill orders promptly. Its value is best judged if we take the element of speculation out of consideration and assume that goods are plentiful and may be readily obtained.

In the radio business at the present time we find most severe competition and an almost total absence of the speculative element. Due to this keen competition, the margin of gross profit is not large and therefore dealers and jobbers must find their salvation in solving the prob-

lem of how to obtain sufficient net returns on their volume of business—or, in other words, on their stock turnover.

Let us judge this importance of turnover from a typical case. Mr. "A." buys radio equipment valued at \$10,000 and does a business of \$30,000 annually at cost figures. He therefore turns over his stock three times. Meantime, Jobber "B.," handling a similar line of radio goods, has on hand a stock valued at only \$7,500, but does the same volume of business as Mr. "A.," namely, \$30,000 a year. His turnover is therefore four times a year, and thus, other things being equal, Jobber "B." saves a carrying charge on \$2,500 a year (the difference in the stocks on hand), or about \$300 a year because of a greater turnover. There is also another factor of importance, namely, that the \$2,500 saved because of more rapid turnover, may be invested, if desired, in stock on hand to increase the stock

to that extent and thus earn an average rate of profit. The more rapid the turnover the greater the profits and the less the losses on investments.

Some jobbers, figuring that prices are low, stock up for a long period on what they term a "rising" market, believing that they are doing a smart piece of work. They put all their capital out and get goods in return, without figuring turnover, carrying charges and the loss of interest on their money. Other jobbers, paying no heed to the probabilities of a "rising" market, buy sufficient goods for immediate needs, sell these promptly, turn over the money for new stock and so keep an original small investment constantly working and turning over. It is this class of jobbers who in the end will be successful, for they know the value of the rapid turnover.

The radio trade, being in its in-

(Continued on Page 122)

## Newark Radio Show to Have Dealers' Night, Oct. 6

Newark's second radio show is to be held at the Robert Treat Hotel, October 4 to 7, inclusive, and it is predicted that this exhibition will show some startling displays.

Each booth will be decorated in gold and blue, so as to be strictly in the color scheme and in keeping with the magnificence of the ballroom. The Japanese and Chippendale rooms, adjoining the main ballroom, will be devoted entirely to the demonstration of loud-speaking apparatus, where their qualities can be gone over by the prospective dealer without interference from the activities in the main ballroom. Loud speakers will not be allowed to operate in the main exhibition room.

The McCarter Gallery will be devoted exclusively to the exhibition of the sets submitted by amateurs for the amateur prize-winning contest. Young and old radio fans have been signing up rapidly for the exhibition of their sets. From

all indications this will be a great feature of the show. All types of sets have already been qualified to enter the contests, from the simple "oatmeal box tuner" to the "Armstrong Super-Regenerative Set." The usual prizes in the form of loving cups will be awarded to the winners.

The judges for the amateur radio contest are: H. T. Hunt of the Dreyfuss-Sales Corporation; Bernays Johnson, Westinghouse Lamp Company; H. Thompson, De Forest Radio Telephone and Telegraph Company; E. M. James of the De Forest Radio Telephone and Telegraph Company, M. B. Sleeper of the Sleeper Radio Corporation, Robert Hand of the "Star-Eagle" and Albert E. Sonn of the "Newark Sunday Call."

A dealers' night has been set aside for Friday, October 6, at which time all of the dealers of Newark and vicinity, will come to—  
(Continued on page 60)

# Public Demands Guaranteed Products

## Production of Inferior Products Has Brought About a Demand For Approved Apparatus

By W. S. LEMMON  
Radio Engineer, Malone-Lemmon Laboratories

The manufacture of radio apparatus in the days preceding the craze brought about by general broadcasting of news and music was synonymous with good engineering practice. The sudden boom in the sale of radio parts and sets brought about a change that wrought considerable harm to the industry; a harm that lost many customers to the trade; a harm that will be paid for in the many dollars of advertising necessary to regain the goodwill of these same customers. What was this change that proved so harmful to the industry? It was not the summer slump, that is already overloaded with blame for many things, nor was it the migration of the public to the country and seashore; the fault lay with the industry itself. The cause can be laid directly to those manufacturers who produced equipment that was not of a standard that good design would approve. Anything that would sell to a public that was greedy for anything that sold under the name "radio" was shoved on the market. Once again the gullible public was imposed upon, and now the same public demands restitution in cold cash. Restitution has already started. Many concerns that were doing a thriving business last spring have already been forced out of business. Much money has already been spent for propaganda to regain the favor of valued customers.

Finally, the public is going to take no more chances with "radio" and the immediate future will doubtless find our "dear" public asking for guarantees, certificates of merit and many other requisites that would not have been necessary had the manufacturers started out on the right foot. Nor were manufacturers the only ones guilty of this grave offense to economy and good business. Let us consider the case of jobbers and dealers.

Jobbers and dealers in a measure were not entirely responsible for their part in this offense. A plea for leniency could well be entered in their case. Some, however, urged many manufacturers into the radio field; manufacturers of responsibility in their own fields but who knew little or



### WALTER S. LEMMON, E.E.

*Began experimenting with Radio in 1908.*

*Became a member of the Radio Club of America in 1909 and the Institute of Radio Engineers in 1913. Engaged in shipboard Radio work during 1914 and 1915. Graduated from Columbia University as Electrical Engineer in 1917 and was awarded Trowbridge Research Fellowship in the same year. Left Columbia to join the Naval Reserve and was commissioned Lieutenant. Placed in charge of Radio and Signal Instruction at Pelham Bay Naval Station. Later placed in charge of administration and development of Radio Telephones at the Navy Bureau of Engineering. Organized long range radio telephone tests aboard the U.S.S. "George Washington" during Presidential trips. Resigned from Navy Department in 1919 to join the Sales Engineering Staff of the S K F Industries, Inc., New York. Appointed Division Sales Manager in 1920 and resigned in the Spring of this year to return to Radio and assist in the organization of the Malone-Lemmon Laboratories.*

nothing of radio and therefore took the dealer's or jobber's word for the design and use of material of the parts manufactured. Dealers and jobbers found much dead stock on their shelves upon the advent of the summer season and many started to unload on the public at reduced prices; they, too, will pay for that, and in fact already are paying for it.

To sum up, the radio industry is accused of having tricked the public, and the public has pronounced sentence in the form of certain require-

ments. These requirements are several, the more important being a guarantee of some sort, a certificate of merit from some recognized source or convincing proof that the manufacturer has made every effort possible to design and produce an efficient article.

Realizing that a number of manufacturers have entered the radio field and wish to remain in it and live up to requirements testing laboratories are becoming more and more important. They are functioning to assist the manufacturer of radio apparatus.

These organizations, thoroughly capable of designing, testing and merchandising radio apparatus, can greatly aid the manufacturer and the dealer. Through laboratory co-operation manufacturers can be assured of development in their plans of apparatus of the highest quality workmanship and electrical efficiency. The trade more and more demands tested apparatus and soon the user will look for the official stamp of approval before buying.

### CHARGING "B" BATTERIES

The Mueller Electric Company of Cleveland has placed on the market a rectifier for use in charging "B" storage batteries. It requires from 15 to 20 hours to charge the battery and the set needs little attention during the charging period. The Mueller Rectifier Set is intended primarily for use with a source of 100 volts to 115 volts alternating current such as is quite generally afforded by the lamp socket in the home. It may, however, be used for charging from direct current. The set consists of the necessary lamp cord, an attachment plug, two clips, a wooden mounting block, a lamp socket, a charge of borax, an aluminum and a lead rod and wooden supporting cleat for the two rods. It is necessary for the user to furnish a common drinking glass and an incandescent lamp.

The lamp, the rectifier and the battery to be charged are connected in a simple electrical series circuit across a 110 volt a. c. line.

# THE-ONLY-KNOB-AND-DIAL-WITHOUT-A-SET-SCREW

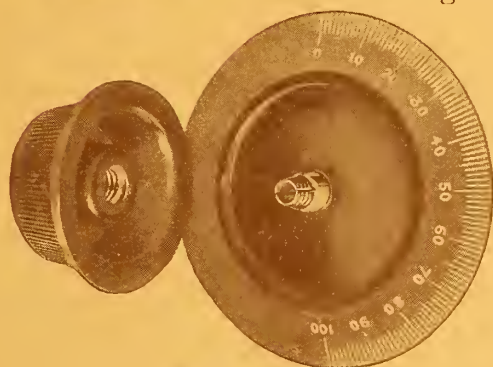

Patented June 20, 1922

The unsightly and troublesome SET-SCREW is at last eliminated. No more loosening of dials, splitting the head of the set-screw, or stripping of threads, perhaps ruining the dials.

To mount the TAIT KNOB AND DIAL simply hold the dial with one hand and screw on the knob with the other; a few seconds does it. No tools are necessary; when fastened it is self centering and self aligning. Numerals at correct angle for the best visibility.

This beautifully patterned KNOB AND DIAL is made of the best grade of BAKELITE.

MANUFACTURERS—It will greatly beautify your receiving sets, also reduce your labor costs in assembly.

JOBBERs—This product is merchandized to the trade strictly through you. It sells on sight and is revolutionary in its field.

Dealers—write us and we will notify you of nearest jobber

List Price  
4 in.—\$1.50  
3 in.—\$1.00

## TAIT-KNOB-AND-DIAL-CO., Inc.

MANUFACTURERS

11 EAST 42nd STREET

NEW YORK

# NOW READY!

## ACE WIRELESS BATTERIES



No. 115

They sell on prestige.  
They mean more profit.  
They are bigger sellers now!

THE CARBON PRODUCTS CO.  
LANCASTER, OHIO

The greatest sales stimulator for wireless business. Not only sells more ACE Wireless Batteries but sells your other radio supplies as well.

## THE ACE RADIO BOOK

Get Your Supply — Costs you nothing

|                           |                           |
|---------------------------|---------------------------|
| ACE RADIO BOOK            | ACE RADIO BOOK            |
| A BOOK ON RADIO RECEIVING | ONE FREE TO EACH CUSTOMER |

Give One Away With Every ACE Wireless Battery

Have **YOU**

Done this Yet

?

**READ** →

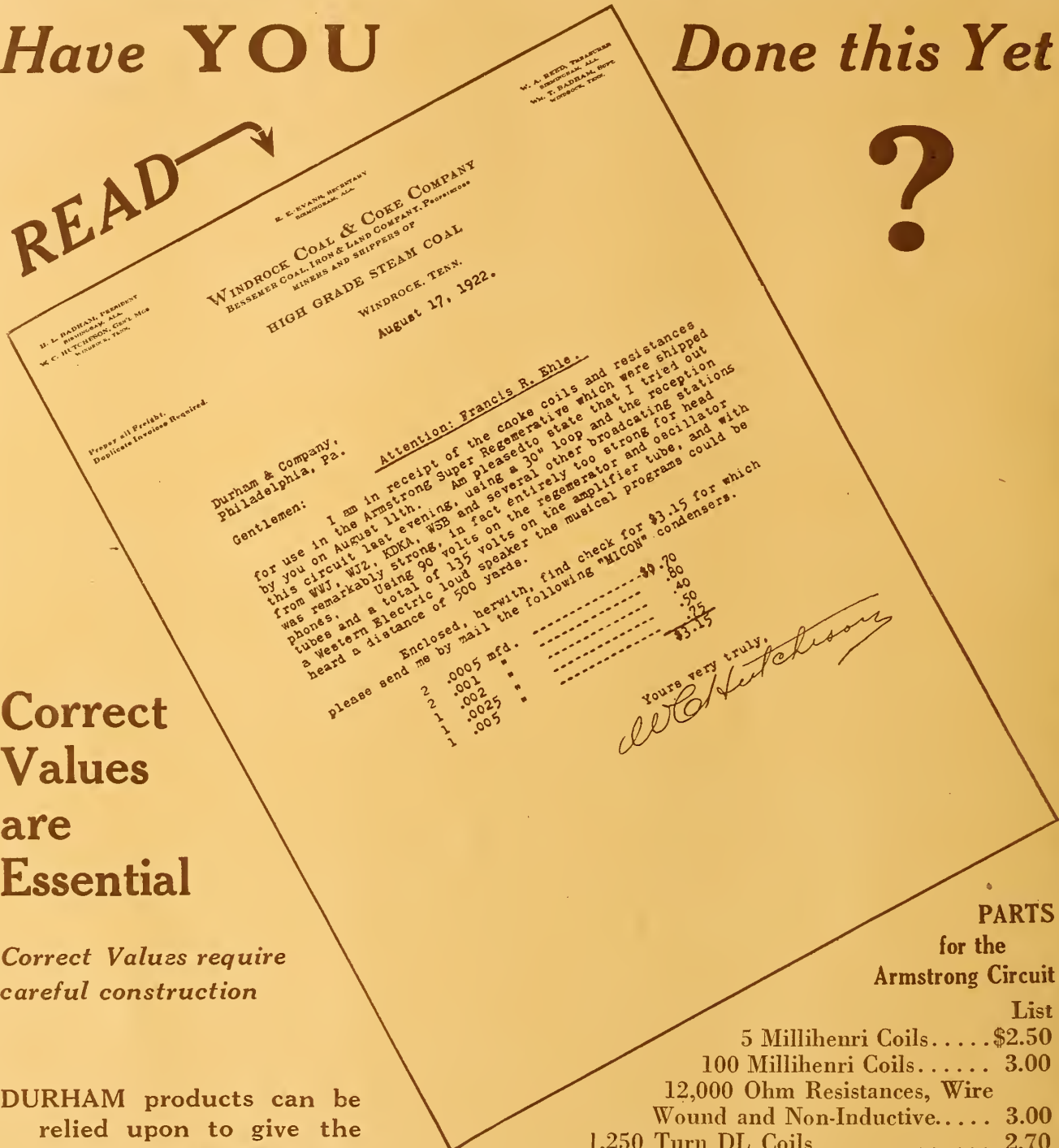

**Correct Values are Essential**

*Correct Values require careful construction*

DURHAM products can be relied upon to give the utmost in service in all respects.

**PARTS for the Armstrong Circuit**

|                                                           | List   |
|-----------------------------------------------------------|--------|
| 5 Millihenri Coils.....                                   | \$2.50 |
| 100 Millihenri Coils.....                                 | 3.00   |
| 12,000 Ohm Resistances, Wire Wound and Non-Inductive..... | 3.00   |
| 1,250 Turn DL Coils.....                                  | 2.70   |
| 1,500 Turn DL Coils.....                                  | 3.30   |
| .0025 Micon Condensers.....                               | .50    |
| .005 Micon Condensers.....                                | .75    |
| Variocouplers—Especially Wound.....                       | 7.00   |

Diagram of Our Own Demonstrating Set Furnished WITH ALL ORDERS

**DURHAM & COMPANY**  
Radio Engineers

1936 Market Street

Philadelphia, Pa.



# Moffat Radio Lock Protects Receiving Sets

## Owner of Valuable Receiving Set Now Enjoys Practical Insurance Against Damage to His Set

By W. L. MOFFAT, Jr.

Vice-President, Joseph Ross & Co.

Radio has opened an entirely new field of work for persons of an inventive mind.

It is as true in radio as in all other sciences that a very large number of articles which have and will be offered to radio users will be found to be of no practical value.

Protection of the valuable instruments composing a radio set has long been desired, but other than placing them in a locked wooden cabinet, no method had been devised.

The Moffat Radio Lock completely solves this important problem and has at once become a necessity for the radio user. It is being manufactured by Joseph Ross & Co., of Irvington, N. J.

The owner of a radio set, having invested in costly and delicate instruments, has never had insurance against the use of his property by curious or meddlesome people who, without knowledge of radio, nevertheless will attempt to adjust the set so they may listen in, if the opportunity offers. The result of this ignorant use is always injurious and often very costly.

It was to give the owner absolute protection against the unauthorized use of his instruments that the Moffat Radio Lock was produced after many months of experimental work. The lock is positive in its action, of simple design and strongly constructed. It is adapted for use in all radio parts operated by a shaft. It is made as a lock only; as a complete lock and rheostat and as a lock circuit switch. The lock rheostat and circuit switch are complete in themselves and ready to install on a set.

To attach the lock only, to a rheostat already mounted, is but a few moments' work, the knob and shaft of the original rheostat being removed, and the knob and shaft containing the Moffat Radio Lock inserted in its place.

To operate, the key is inserted and the knob turned until the key engages. The position of the pointer on the panel will then correspond to the position of the contact blade on the rheostat or circuit switch. When



### W. L. MOFFAT, JR.

*the designer of the Moffat Radio Lock, served as 1st Lieutenant in the Signal Corps and later was transferred to the General Staff as Captain. At present he is working on an automatic wire winding machine which, when perfected, will be suitable for winding transformers.*

the key is withdrawn, the contact blade remains in its final adjustment. The knob will now rotate on the shaft without turning it.

Just imagine the safety this provides for the tubes, the most expensive and easily damaged part of a set! An owner may now turn off his set in one of two ways and be certain no one will use it. Either all the rheostats are turned off and the keys withdrawn, or the adjustments are locked by withdrawing the keys and the whole circuit locked off by means of the circuit switch. By this latter method, when the circuit switch is again turned on, the rheostats are properly adjusted for the stations broadcasting when the set was turned off.

Here are only three of the savings that the Moffat Radio Lock accom-

plishes: First, it protects the tubes from damage by being operated by meddlesome or unskilled persons; second, it saves time in readjusting the tuning of a set, and third, it saves the A Battery from being run down because someone has forgotten to turn the rheostat completely off.

All of these are real savings besides the added security afforded.

The Moffat Radio Lock will also be added to dials for vario-couplers, variometers, variable condensers. This means that the set may be tuned in all its parts, and that no part of set can be disturbed. All that is necessary to obtain instant response to broadcasting is to unlock the circuit switch. This method permits of a set being tuned and left for any length of time although ready on the instant to give service. The owner simply unlocks the switch, adjusts the head set or the loud speaker and the set is in action.

How many owners have put on their head set wishing to hear the baseball scores or the closing prices of stocks, only to find that the set was out of adjustment and by the time they had tuned it, the news they desired to obtain had been finished by the broadcasting station? Information which might mean a large financial gain or loss had escaped him through someone having used his set and left it out of adjustment. The Moffat Radio Lock insures against any such occurrence and against many others of similar nature.

Besides appealing to the average radio novice, this lock is certain to be most popular with the amateur of twelve to fifteen years of age. We all know that he will go to any extreme to make certain that no one will use anything of which he is particularly fond during his absence, and now he can go away and know that none of his brothers, sisters or friends will be able to operate his set. The older person may also go to business and know that his set is secure. The radio dealer may have his sets for demonstrating purposes on the counter, and be sure that the adjustments he has made will not be changed or the set damaged.

# Mortimer J. Salzman Urges Association

## Head of Wholesale Radio Equipment Company Dines Radio Business Men and Starts Jersey Dealers' Association

Radio dealers all over the land recognize that one of the crying needs of the century's newest mercantile industry is proper organization among the tradesmen in the radio field.

There isn't a man more sold on this proposition than is Mortimer J. Salzman, head of the Wholesale Radio Equipment Company of Newark, N. J.

To prove it—to promote his keen appreciation for an organization of the tradesmen in and about New Jersey's biggest city, Mr. Salzman asked some of his business friends to meet him, at a dinner at Achtelstetters Restaurant, one night last week, and it was decided to meet again next week to properly organize the New Jersey Radio Dealers' Association.

"The foundation for a real organization of radio tradesmen has been laid," said Mr. Salzman after the meeting, "and we do expect to accomplish the difficult proposition of acquiring the membership of every bona fide radio wholesaler in our state."

Speaking to a representative of the RADIO DEALER, Mr. Salzman said:

"Every business man in the radio industry in New Jersey is invited to tender his application for membership.

"Just what the association will do or can do is not the point—now. The main thing is to organize for the betterment of the trade.

"An association of business men can surely be of service.

"An association of this character can establish standards for the manufacturer and for themselves.

"The legitimate manufacturer can save himself a lot of money if the selling trade is a recognized factor—for if it's that they will know what they ought to sell. They will not care to sell inferior wares, not if they're properly organized.

"Referring to regulation, of course an association of business men in our industry, will supervise shows, co-operate with amateur bodies in movements for the betterment of the science of radio.

"An association of our kind, properly working, will have a laboratory affiliation. This technical service should prove of good to everyone—except the fakers, who must be put out of the radio industry.

"An association of the best radio people will co-operate to acquire and maintain proper publicity.

"An association of this sort will help us in neutralizing the present

trouble-making tendencies of patent holders and patent infringers. We dealers are the innocent victims of patent litigants.

"Naturally, an association of business men cannot benefit itself or its membership without doing something real for each member and it hardly is necessary to point out that this proposed body of New Jersey's foremost radio wholesalers will benefit each member."

"But," added Mr. Salzman, "that does not mean that this association of ours is to serve only its members—for if we cannot benefit the entire industry our object for organization is not achieved."

Any business in which an exchange of ideas and co-operation in meeting merchandising problems, is better for such mutual action.

An association is the one logical means for developing such a condition.

There's a lot of meat in the statement above printed. And Mr. Salzman and some of his business friends have an all-abiding belief in the statement.

At the dinner meeting Mr. Salzman spoke upon the present conditions in the radio industry, showing that the activities, at this time, can properly remain in the hands of *the business men* in the radio industry.

Mr. Salzman pointed to the fact that some retailers and jobbers, in and about Newark and New York City, as well, were running sales, but losing money; that these same dealers were losers in business in the end because they could not afford to give real service.

"And no business," says Mortimer J. Salzman, "which does not give real service can get far ahead."

When the Jersey trade body is properly organized it will probably meet at least once each week, around a meal—a good idea—to talk over trade matters in an informal way.

Mr. Salzman's ideas about an effective organization for the radio industry are ideal and worthy of every radio man's attention. He says that he'd enjoy explaining the idea to each and every radio business man in New Jersey.

### BAYLEY CONDENSER

The salient feature of the Bayley Condenser, manufactured by the Bayley Condenser Co., of Brooklyn N. Y., a die-cast product, is the permanent spacing of the plates. Movable plates are cast solid on a centre spindle, and stationary plates are cast as in one piece on three upright supports. The spacing, due to its rigidity, is very close, which, it is claimed, allows sharp tuning.

## Radio Regulations Based on Rules of Fire Underwriters

Newark, N. J., has issued specifications for radio receiving, as follows:

**ANTENNA.**—No antenna shall be erected over or under any wire of more than 600 volts, or fastened to any pole supporting light or power wires. If erected over an electric light or power wire of 600 volts or less the separation distance between the antenna and the wires shall exceed the distance spanned by the antenna.

If erected under an electric light or power wire of 600 volts or less the separation distance shall exceed the distance between the supports of the electric light or power wire.

All splices and joints should be soldered. All wires used to support the antenna should be galvanized or of copper to prevent rusting.

**LEAD IN WIRES.**—Lead in wires shall be not less than No. 14 B & S gauge copper or No. 17 B & S gauge copper clad steel.

The distance between electric light or power wires and the lead in wire on the building shall be not less than four inches and the lead in wire shall have enough supports spaced close enough to prevent the lead in wire from coming in contact with the electric light or power wire.

A porcelain, fiber or composition tube shall be provided for the lead in wire where it enters the building.

No special distance is required for spacing the lead in wire from the building. It should, however, be

(Continued on page 98)

**PANDORA CRYSTAL SET**

The Brooklyn Metal Stamping Company of Brooklyn, N. Y., have placed on the market a novel, compact and readily portable crystal set called the Pandora. The set as shown by the accompanying photograph is enclosed in a metal case on which are placed aerial, ground and

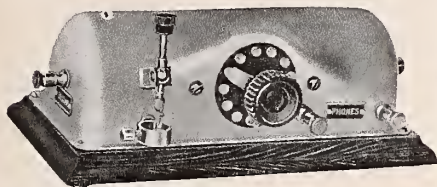

phone connections. The operation of a single dial is the only effort necessary to tune in the nearby broadcasting station once the crystal has been adjusted. The set covers a wave length of from 300 to 600 meters which are brought in by merely turning the knob. The set has brought in broadcasted music at a distance of 25 miles from the transmitting station. The company claims that the set has been well received by the trade.

**C. & W. RECEIVER TYPE 14**

The Pioneer Radio Corporation of New York City are distributors for the Cutting and Washington receiving-set Type 14 and special indoor coil aerial. Though designed primarily for persons who, because of restrictions or location cannot use a conventional outdoor aerial, this receiving system possesses certain advantages which appeal even to those who may not be so restricted.

Easy to install and readily portable; a large reduction in "static" annoyance.

The company claims that with the larger of the two coils supplied, the receiving range is comparable to that of a conventional regenerative detector and two step amplifier connected to an outdoor aerial, coupled with which is an elegance of control, quietness and lack of interference which to those unaccustomed to coil aerial reception is truly desirable.

This apparatus is the result of much experimentation and research and marks a distinct advance in the design of super-sensitive receiving apparatus for popular use. The addition of a loud speaker completes the equipment.

*How Science has bridged with wireless the miles between city and country*

**THOUSANDS** of families have only "gone in for wireless" after hearing demonstrations of Magnavox Radio—the *Reproducer Supreme*. Magnavox Radio offers the dealer an ample profit margin and a quality product essential to complete radio supply service. In perfection of mechanism, quality of manufacture and satisfaction in actual service, Magnavox Radio has absolutely no competition.

Write for prices and information regarding Magnavox advertising and sales helps.

**THE MAGNAVOX COMPANY**  
 Home Office and Factory: Oakland, California  
 New York Office: 370 Seventh Avenue

**MAGNAVOX**  
*Radio*  
*The Reproducer Supreme*

R-3 Magnavox Radio with 14-inch horn (here illustrated), is ideal for use in homes, offices, etc.  
 R-2 Magnavox Radio with 18-inch horn for those who wish the utmost in amplifying power; for large audiences, dance halls, etc.  
 Model "C" Magnavox Power Amplifier insures getting the largest possible power input for your Magnavox Radio.

# What the Manufacturers Are Doing

## New Vernier Potentiometer Made By Mid-West Firm

### VERNIER POTENTIOMETER

The vernier potentiometer, recently placed on the market by the Central Radio Laboratories of Milwaukee, represents a new development in the radio field and is meeting the demand of those who have been looking for



Potentiometer Made by Central Radio Laboratory

a very fine control for vacuum tubes used for experimental work and for sets on which extreme sensitiveness is desired according to its makers.

The resistor consists of a machine winding, the turns of which are anchored firmly on a substantial insulated core. This wound core is retained in a groove between insulating discs. The use of enameled wire makes short-circuiting of the ad-

acent turns impossible. This design insures smooth, noiseless action and a uniform change of circuit resistance.

The vernier wire for the fine adjustment is six inches long and is carried

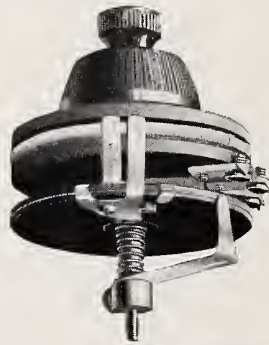

View of Vernier Potentiometer

on the outer edge of a separate disc on which two contact shoes, which ride on the main winding, are mounted. This vernier wire shunts those turns of the main potentiometer winding which lie between the two contact shoes and thus provided for very accurate adjustment of the potential.

A small thermoplex knob, located in front of the main knob, operates the vernier shoe. The relative sizes and shapes of the two operating knobs are such that they are easily manipulated.

A potentiometer of the plain type, manufactured by the same company, is of the same general design and construction as the vernier potentiometer already described, minus the vernier attachment. Both potentiometers have an advertised resistance of 250 ohms.

### PACENT DETECTOR STAND

The Pacent Electric Company, of New York City, have recently placed on the market a new detector stand known as the Pacent Universal Detec-

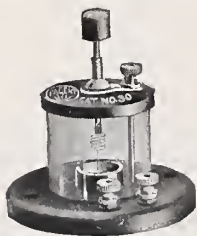

tor Stand. The construction insures against dust and rust. The top and base are moulded and a substantial glass covering protects the crystal. The binding posts and all metal parts are machined. The accompanying photograph attests to the fine appearance of this product.

### LOUD-SPEAKER SETS FLUSH ON PANEL

Double Radio Co., 57 Dey street, New York City, are manufacturing a compact Amplifying set. It is made in two types, one with a loud-speaker which sets flush on the panel.

### DAVISTONE DISTRIBUTER

Henry Paulson & Company of Chicago are distributing the Davistone loud-speaker that attracted considerable attention at the recent National Radio Show in Chicago.

### COMBINATION VARIO-COUPLER

The New York Coil Company of New York City in their recent circular claims that they have the only variocoupler on the market that allows panel mounting or table connection, which eliminates one of the most difficult and tedious operations in building a set, namely, taking off of taps and mounting switches and switch buttons. The instrument consists of a high-grade insulating tube  $4\frac{1}{8}$  inches in diameter and  $3\frac{1}{3}$  inch rotor. Seven single turn taps are brought out on one side and seven taps on opposite side, each tap containing seven turns. Two switch levers make contact with these taps. By an ingenious arrangement the simple loosening of a setscrew allows the shaft of each switch to be pulled out bodily without disturbing the switch lever.

A template accompanies each instrument to enable the constructor to get the correct position of the three holes through the panel—one for rotating secondary and one hole for each of the switch shafts.

It is therefore necessary in panel mounting to drill but three holes through the panel—eliminating all soldering, all laying out of switch buttons and drilling for same.

This instrument has a particular appeal to those who desire to try out various circuits before their set is built in cabinet form, as when coupler



is purchased, same may be used instantly by simply making connections to two binding posts provided.

The variocoupler is mounted on  $\frac{1}{2}$  inch hard wood black finished base. Switch buttons are mounted on strong insulating material. Handsome knobs are equipped with nicked pointers included. The workmanship and finish is extra fine.

## Freshman Products

### Antenella Plug and Micon Condensers

Antenella manufactured by Charles Freshman Company, Inc., of 290 Hudson Street, New York, N. Y., is a high grade product designed for attachment to the ordinary light socket. The strength of signals received through this device is as great as with an ordinary outside antenna, according to the manufacturers.

Antenella is licensed under the Jones patents applied for. The con-



densers used are of the proper capacity to replace the ordinary antenna and the timing elements of an ordinary receiver give all adjustments necessary.

The condensers are constructed of ruby India mica, incased in the seamless brass tubing licensed under the Micon patents applied for of Charles E. Vawter of the Thompson Levering Co., Philadelphia. The design of the condensers insures constant capacity and practically no noises at all. No current is consumed as a result of the attachment to the lighting wires and the results obtained justify the statements that not only are the antenellas very convenient, but due



to extreme selectivity of wave lengths, static is almost entirely eliminated.

Reports from Seattle, Washington, made public by the manufacturers recently, state that Antenella successfully received signals from Catalina Island fifteen hundred miles distant.

The plug is very pleasing in appearance and careful workmanship is displayed. The interior is exceptionally neat and it is altogether a high grade article.

The officers of the Freshman corporation are Charles Freshman, president; Myron Goldsoll, vice-president and sales manager; Ernest Walker Sawyer, secretary and chief engineer.



New ABC Tuner No. 5750—a dependable apparatus that meets the big demand for a quality tuner at a very low price.

## The Ideal Tuner for Popular Broadcast Reception

**A**FTER intensive study of the needs of radio users Professor Morecroft of Columbia University has designed the ABC Radio Tuner No. 5750 to fit into the ABC Standardized Radio Units System.

The tuning in is done by means of two 21-plate ABC variable condensers and a vario-coupler of compact and radically new design.

This vario-coupler has a lower distributed capacity, by actual test, than any other on the market. ABC Tuner No. 5750 is ideal for receiving the programs sent out by the broadcasting stations. It is made for the quick, profitable market.

The perfect hookup of ABC Units is illustrated below. Send today for full information about ABC Units and Parts, and how we help you sell them.

### Jewett Manufacturing Corp.

312 Madison Ave., (Dept. F. 10) New York City

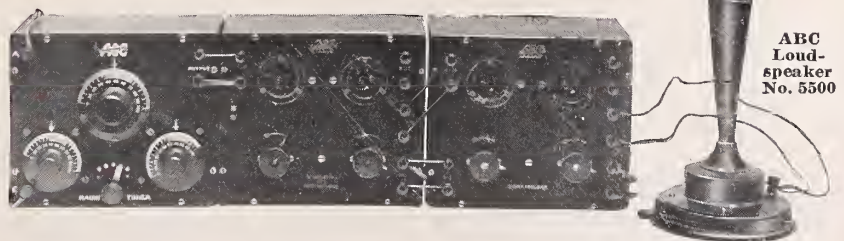

ABC Radio Tuner No. 5750

ABC Detector and One Step Amplifier No. 5013

ABC Two Step Amplifier No. 5014

ABC Loud-speaker No. 5500

**\$4.75 CONDENSERS \$1.25**

Finest 43 Plate. .001 M. F. Perfect insulation. Amply separated and accurately spaced hard aluminum plates.

|                                               |        |
|-----------------------------------------------|--------|
| \$4.00 23 plate same as above                 | \$1.10 |
| 5.00 Variometers, A-1 sellers                 | 1.75   |
| 1.00 Phone cords, double                      | .35    |
| 7.00 Switch points, N. P. with nuts, thousand | 4.00   |
| .75 Finest million point mounted crystals     | .10    |
| .10 Square tinned copper bus wire, foot       | .02    |
| 1.00 Double covered head bands                | .35    |
| .75 Crystal detectors                         | .20    |
| 2.50 Lightning arresters                      | 1.00   |
| 1.25 Phone slugs, good seller                 | .45    |
| .15 Copper ground clamps, complete            | .05    |
| .15 Special antenna insulators                | .06    |

All strictly fresh "B" batteries, discount, 50%

**\$6.50 TURNEY PHONES \$3.25**

Highly sensitive. Matched tone receivers. Awarded N. Y. Mail Certificate of Merit.

|                                                 |        |
|-------------------------------------------------|--------|
| \$0.35 Condensers, asstd. capacities, all types | \$0.06 |
| .25 Crystal cups with set screw                 | .08    |
| 1.00 Asstd. screws, washers and nuts, hundred   | .50    |
| 5.00 Transformers, radio frequency              | 2.00   |
| 5.00 Transformers, audio frequency              | 2.75   |
| 18.50 "Homechargers" for "A" or "B" batteries   | 12.50  |
| .25 Spaghetti, extra tough, foot                | .03    |
| .50 Sockets for base or panel mounting          | .20    |
| 3.00 Phonograph attachments                     | 1.50   |
| .75 Honeycomb coil mountings                    | .30    |
| 10.00 Loud speaker horns, very good             | 4.00   |
| Binding posts, N. P., complete, hundred         | 2.00   |
| 10.00 Name plates, asstd., very neat, hundred   | 3.00   |

**\$4.50 VARIO COUPLERS \$1.25**

Baldwin Type. 14 Taps. Green wire.

|                                          |        |
|------------------------------------------|--------|
| \$1.75 Potentiometers, bakelite          | \$0.75 |
| 4.00 8" Tuning coils, 2 slides           | 1.75   |
| 1.50 Unmounted tuning coils, 8"          | .50    |
| .40 Tubing, asstd. sizes, A-1            | .12    |
| 10.00 Switch stops, with nut, thous.     | 5.00   |
| All Radio Corporation mdse. less         | 30%    |
| .75 Dials, beautiful tapered knob        | .15    |
| .75 Switch levers, tapered knob, A-1     | .17    |
| 1.25 Phone plugs, good quality           | .45    |
| 1.00 Jacks, open 25c, closed 30c, double | .40    |
| .30 Sliders rods, 3 16x12, drilled       | .07    |
| .30 Sliders, brass and rubber, for above | .10    |
| Experimenter's Manual, very good         | .10    |

**IMMEDIATE DELIVERY**

Good Honest Merchandise. Everything Guaranteed.

**TERMS:**

10% with order. Balance C. O. D.

**RADIO ENGINEERING CO.**

Fifth Ave. at 28th St.

New York City

Standardized Radio Supplies

# New Tester Determines Characteristics of Tubes

By WILLIAM B. BROUGH  
Consulting Radio Engineer, W-B-L Radio Co.

"Does this tube oscillate?" "Is it a good detector?" "What is the best plate voltage at which to operate it?" "Is it 'hard' or 'soft'?" "Does it amplify as it should?"—These and many other similar questions arise sooner or later in the mind of the jobber or dealer handling vacuum tubes; questions that are prompted often by the more or less frequent return of customers with tubes which they claim do not perform and upon which they demand replacement.

True, it is to be assumed that reputable makes of vacuum tubes are properly tested by their makers and are not allowed to leave the factories until it has been definitely determined that they conform with an established standard, but at their best vacuum tubes lack a uniformity in characteristics which gives rise at times to decided differences of opinion as to the true worth of some individual tube. I dare say there is hardly a dealer in existence who has not at some time or another had to handle a delicate situation arising from the complaint of some customer whose tube has failed to function properly. To replace the tube without question is costly to the dealer, yet with no definite means at his command to convince the customer that the fault lies, not with the tube in question but with some other factor, is not always an easy task for the dealer, and rather than embark on thin ice with the possibility of losing a valued customer, more than one dealer has chosen the easiest way out by giving the customer a new tube and pocketing the loss.

In the W-B-L Vacuum Tube Tester we believe that we have just the instrument needed. To all intents and purposes this instrument, which was developed by the writer and is now being manufactured by our company exclusively for the Mydar Radio Company, of 843 Broad Street, Newark, N. J., general distributors, may be described as a transmitter, detector and amplifier in one. By placing a tube in the standard socket and connecting it up with the necessary "A" and "B" batteries it is possible in less than two minutes time to determine in a non-disputable manner every essential and important characteristic the tube may



WILLIAM B. BROUGH  
Consulting Engineer, W-B-L Radio Co.,  
Newark, N. J.

possess: whether it detects and how well; the best operating filament current, a factor which varies with every tube; the best operating plate voltage, another variable factor of extreme importance, as a variation of as little as 5 volts in the plate current has been known to seriously affect the operation of a tube; whether or not the tube oscillates, a matter of increasing importance with the increased use of regenerative, super-regenerative and super-hetrodyne circuits, a tube which does not oscillate being of no value in these hook-ups.

In amplifying tubes the "amplifying constant" or what is known technically as the Mu of the tube is of interest and importance. The Mu is the ratio of the plate to grid voltage and is a factor which determines to some degree the amplifying qualities of the tube. The average tube now being sold for amateur use has an amplifying constant of between 6 and 7. A tube which falls short of this figure may be designated as a poor amplifier. Where the W-B-L tester is used this characteristic is determined by a direct dial reading and leaves nothing to the imagination.

**RADIO FREQUENCY**

*(Continued from page 46)*

sockets at the rear of the Amplifier. They are as readily removable as a V. T. Tube. As no R. F. amplifier is better than its transformer, great care should be exercised in the selection of this device. The Amrad R. F. amplifiers employ only radiformers and have been designed for use with U.V. 201 Radiotron amplifying tubes.

Both Amrad R. F. amplifiers are encased in polished solid mahogany cabinets and mounted on standard engraved formica panels 10"x5" in size. Two dial adjustments only are necessary. Complete operating instructions accompany each instrument.

Each Amrad R. F. amplifier is provided with an insulated switch for cutting out the radio frequency amplification, thus permitting use of the detector together with any audio frequency amplification with which the receiving set may be equipped.

Both radio frequency amplifiers are intended for use on non-regenerative receivers.

The Amrad 2-stage R. F. amplifier when added to a non-regenerative receiver, will give results considerably in excess of these obtainable by the use of regeneration.

Where several stages of radio frequency amplification are desired, the Radiformer in the first stage should differ from those in subsequent stages. At present there are two Radiformers available, No. 3057-1 and No. 3120. Both are intended for 360 meters reception, although amplification is obtained over a wavelength range from 300 to 600 meters. Peak intensity is secured at 360 meters, which is the broadcasting wave band.

In receiving 360 meter broadcasting, Radiformer No. 3057-1 is used in the first stage of amplification, and Radiformer No. 3120 in all subsequent stages. Other types will be available later for higher and lower wavelength bands.

Wiring diagrams and instructions are supplied with each Radiformer.

**FILAMENT CONTROL**

The Radiall Company of New York City recently issued a five-page folder that explains carefully and clearly the structure and action of the vacuum tube filament. This information should prove enlightening to any owner of a tube set. The folder deals with the advantages of the use of a filament control which heats the filament to its best working temperature at the moment the current is turned on, in much the same manner that the ordinary house electric lamp is operated.



*Send For*  
**The Bestone Radio Catalog**

THE Bestone catalog illustrates and describes a complete line of the latest and most scientifically-designed radio apparatus, produced by a leading manufacturer.



**BESTONE 3000 OHM HEAD SET**  
(Navy Type)

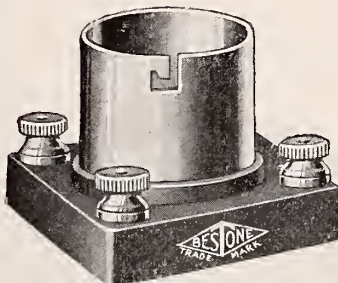

**BESTONE V. T. SOCKET**



**BESTONE PHONE CONDENSER**

We offer you an exceptionally high-grade Radio line at popular list prices, and a plan of sales co-operation that will mean attractive profits for you.

*Write for Catalog "R"*

**HENRY HYMAN & CO., Inc.**

Manufacturers

EXECUTIVE OFFICES  
476 Broadway, New York

BRANCH OFFICE  
212 W. Austin Ave., Chicago, Ill.

## SHELTONE LOUD SPEAKER



Patent Applied For

Dealers, here is the profitable and quick selling Loud Speaker.

## SHELTONE

*Equipped with one*

# Baldwin Receiver

TYPE C

Most satisfactory of all Loud Speakers for home use  
Low in price

The Sheltone is shaped like a shell. At its base is an open tone chamber over which any two standard receivers fit. This chamber carries the sound to the curved surface of the Sheltone, causing each note to marvelously swell in volume.

No tubing to rob the sound of its fullness; no horn, as on ordinary loud speakers, to destroy or distort the most delicate notes. Every sound is true, sweet, mellow and distinct to everyone in the room.

### RETAIL PRICES

Sheltone, with Baldwin Receiver...\$12.50  
Sheltone, without Receiver..... 5.00

Big Discounts Allowed.

Made of special light non-metallic sounding metal. Beautiful colors.

**THE SHELTONE COMPANY**  
20 CLINTON ST., NEWARK, N. J.

## SPECIALISTS ENTER RADIO FIELD WITH POLICY

The Connecticut Instrument Company of Stamford, Connecticut, have entered the radio field as specialists in acoustic development and manufacture. The first product the company is to place on the market is a head-set with a non-metallic diaphragm designed to produce correct reproduction of music and an adjustment claimed to insure the utmost in sensitivity.

The company is well known and long established. The personnel is as follows: R. E. Gillmor, president (formerly vice-president of the Sperry Gyroscope Co.); G. B. Crouse, chief engineer (formerly chief engineer of the Ford Instrument Co.); J. B. Allen, factory superintendent (formerly plant superintendent of the Sperry Co.); and G. M. Fischer, sales manager, who has had many years' experience in manufacturing, jobbing and retailing.

The policy of the company has been reported to be: (1) specialization in one thing at a time, with a view to qualitative rather than quantitative production results; (2) representation and distribution solely through exclusive jobbers for each territory; (3) liberal jobbers' discount with no variation for quantity.

## AMES RADIO PRODUCTS

The Picard Radio Corporation of New York are exclusive national distributors of the Ames Radio Products manufactured by the Heinze Electric Company.

## REGAL DISTRIBUTERS

The Radio and Mechanical Trading Company of New York City are distributors of the "Regal" products, manufactured by the American Specialty Company of Bridgeport, Con-

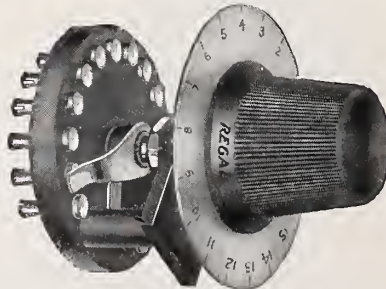

necticut. An idea of the high-class products sold under the name "Regal" may be had from the photograph shown herewith of the Regal Inductance Switch.

The features of the switch are that it has 15 points in one unit, only one hole is needed in the panel for mounting and its construction does away with all switch points.

## Economical Equipment Finishes

Zeller Lacquers constitute the most economical finishes on the market today for radio equipment of all kinds. They are easily applied either by dipping, brushing or spraying and completely dry in normal room temperatures within 15 minutes.

Zellac is made in all colors and can be applied to all materials. Beside the standard natural wood finishes, our Hard Rubber Black has become popular among manufacturers for finishing instrument bases as well as cabinets while our White is used exclusively by many organizations for the graduations on dials and knobs, as well as for panel work. Our bronzing solutions and enamels assist materially in reducing distortion and vibration in loud speakers. A thin coat of our material, which has a high dielectric strength, applied to coil windings, holds them permanently in place without causing the usual undesirable effects.

We welcome the opportunity to discuss finishing problems with radio equipment manufacturers. May we be of assistance to you? In any event, write today for a copy of our free booklet, "250 Lacquer Questions Answered," using your business stationery.

## ZELLER LACQUER MFG. CO., Inc.

342 Madison Ave., New York



**"IDEAL" SWITCH LEVERS**

The Newark Radio Supply Company, Newark, N. J., is manufacturing very neat and attractive looking switch levers, known as the "Ideal" switch levers with the mirror-like knobs.

The knobs are made of genuine Thermoplas, a cold molded heat-resisting composition, strong and tough. They are hand-buffed and have a very high polish, that maintains its brilliancy no matter how much handling the knob gets.

The levers are blue nickled and unusually highly polished. All parts are made of brass and nickled. All parts are made so as to insure good contact on all points, and easy working leverage.

The switches are made in two sizes Senior and Junior. The Senior is made with a lever of a radius of  $1\frac{3}{8}$  inches or  $1\frac{1}{2}$  inches while the Junior has a radius of 1 inch.

The company also manufactures "Ideal" Tuning Coils, made in two sizes, 6 and 8 inches, each 3 inches in diameter. These coils are made solid and very attractive in appearance. They are baked and treated with bakelite varnish, and are wound with No.

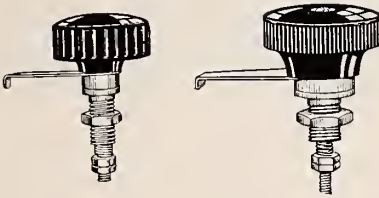

20 enamel wire. The ends are finished off with varnished tape, thus giving them a glossy finish.

In addition to these products the company handles a complete line of variable condensers, rheostats, sockets, plugs, jacks, variocouplers, variometers, transformers, etc.

**MANUFACTURES PHONE CORDS**

The Runzel-Lenz Manufacturing Company, of Chicago, are manufacturers of cords used for many standard types of head phones and loud speakers. The specifications of Style Y state that conductors are of multiples of stranded quality electric thread; each conductor has double insulation consisting of braids of quality cotton thread; respective conductors are marked for polarity and the finish braid is of first quality mercerized black thread. A special feature is found in the reinforcement applied where branches for the head phones leave the main body of the cord.

**ATWATER  
KENT**

**2-STAGE AMPLIFIER**

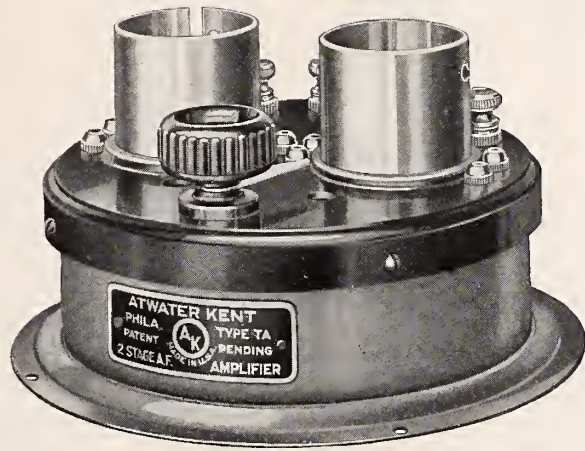

Price \$16<sup>00</sup>

THE OUTSTANDING *Advantages* OF THIS INSTRUMENT are

- § Excellence of reproduction.
- § Amplification regulation by small steps.
- § A complete instrument in itself.
- § Compactness.
- § Regulation entirely by knob, no jacks to equip.
- § Transformers protected by steel housing.
- § Short wiring connections eliminate capacity effect.
- § Hermetically sealed, absolutely no moisture troubles.

THE LOW PRICE IS MADE POSSIBLE AS A RESULT OF  
20 YEARS' EXPERIENCE IN QUANTITY MANUFACTURE  
OF SCIENTIFIC ELECTRICAL INSTRUMENTS

*An Excellent Merchandising Proposition*

ATWATER KENT MANUFACTURING COMPANY  
4941 STENTON AVE. Radio Department PHILADELPHIA, PA.

# Wotton

## Radio Headsets



Retail Price

**\$6<sup>50</sup>**

3000 Ohms

All Wotton headsets are sold on an absolute "satisfaction or money back" guarantee.

This is not a new product—thousands have been placed in the hands of users in the past year and with an unbroken record of perfect satisfaction.

The phones are high grade, highly sensitive, with a light aluminum shell, and at a record low price for a head set of this kind.

Every phone is tested on a receiving set—and all sets are perfectly matched and packed in attractive corrugated boxes.

Note the unusual permanent adjustment of the phones in the military head band, all parts of which are absolutely rustproof.

Write for our proposition and a sample set for inspection and test.

This Company established in 1908.

**The Electric Products Company**

1715 Clarkstone Road

Cleveland, Ohio

New York Office—30 Church Street

# Radio Interference Obviated by Properly Erected Towers

By S. W. HULL

The radio tower, with its antenna seventy-five to one hundred feet above the ground, might be compared with small indoor loop antenna much as our modern six-cylinder automobiles compare with the small one-cylinder vehicles of twenty years ago.

Those little vehicles were always out of order and not running for one reason or another. At that time we all had our own idea of what the reason was, but as long as the principle of design was incorrect the effort to get results was useless.

So it is with the radio tower at this time. We know that to receive clearly or send efficiently we cannot get results as long as there is serious interference such as buildings.

It is important to get above this interference, and this can only be done by means of a steel pole or tower. It has been found that to raise a steel pole one hundred feet high from the ground to a perpendicular position is impossible without heavy tackle and a lot of help. Whereas, to build a light weight, wide base tower up, piece by piece, is a simple matter. This had to be learned from experience.

For years S. W. Hull & Company have been building transmission towers for power companies in all parts of the country. With the coming of radio development they were among the first to realize the importance of building an inexpensive tower to meet the popular demand. At great expense a series of tests were conducted to test the tower against high winds and ice loads.

The result of these tests formed the keystone for the design of the standard Hull Radio Towers.

When the first Hull towers were erected for the Shaw Technical High School of Cleveland, many radio enthusiasts would bring their sets and hook them on the high antenna. The results were very satisfactory, and in many cases where no results were being obtained at all at home, the owner would be made happy by hearing clearly.

Many of these young men could not afford to buy a tower, but were handy with tools and with the right kind of blueprints could make one in a short



*S. W. Hull, engineer and manufacturer executive, a pioneer and specialist on steel radio towers. He is the president of S. W. Hull & Company, steel tower specialists, Cleveland, O. The strictly technical phases of Mr. Hull's activities have brought about many economics and practical advances in radio tower design. He has designed towers for all climates and wind conditions, at the same time keeping in mind that many of these towers were to be erected without skilled labor. This study and practical experience has developed into the design of the standard Hull Radio Tower now in use in all parts of the country.*

time at a nominal cost. With a set of radio tower plans that are drawn in perspective, many have built their own tower, each piece being detailed by itself and marked to tally with an erection diagram. These Hull radio tower blueprint plans are now obtainable at most any radio dealers' establishment.

**NEWARK RADIO SHOW**

*(Continued from page 55)*

gether under one roof to listen to speeches, policies and general discussions regarding the future of radio. Here they will view the new sets under ideal conditions. The subject of "How to Merchandise Radio" will be a subject of interest to all dealers.

The speakers of the evening will be William Davis of the Magnavox Company; H. C. Gawler, Radio Corporation of America; M. B. Sleeper of the Sleeper Radio Corporation and H. Thompson of the De Forest Radio Telephone and Telegraph Company.

Members of the committee are as follows: M. Salzman, Wholesale Radio and Equipment Company, chairman; M. Krich, Krich Light and Electric Company; George Ollendorf, National Light and Electric Company; William Nevins, Radio Distributing Company; T. Ryan, American Radio and Equipment Company; M. Rost, Newark Electrical Supply Company; Mr. Viall, Premier Accessory and Specialty Company; P. M. Dreyfuss, Dreyfuss Sales Corporation; H. Denburg, Royal Electric Laboratories; Mr. Anderson, Irvington Varnish and Insulator Company, and M. Shields of the Mercury Radio Products Company.

**YALE STORAGE BATTERY**

The Yale Storage Battery, the product of the Yale Storage Battery Company of Indianapolis, Ind., is compact and enclosed in a mahogany finished case that is specially treated to resist acid.

The battery proper is provided with excess gassing chamber beneath the cover, and with vent caps of suitable design to prevent leakage of acid. The plates are thick, strong and durable, and are produced under strict laboratory control, and under supervision of experts who have had vast experience in producing batteries of this and similar types. The terminals are efficient and conveniently arranged and a suitable handle is provided so that battery can be carried in one hand. The batteries are provided in a sufficient range of sizes to suit the individual requirements of any radio equipment.

**ECHO-TONE IS DIFFERENT**

A novel radio horn manufactured by the Ampli-Radio Company of Toledo, Ohio, employs a construction different from other horns on the market. It consists primarily of a resonance chamber at the neck of the horn.

**PARADEX UNITS**

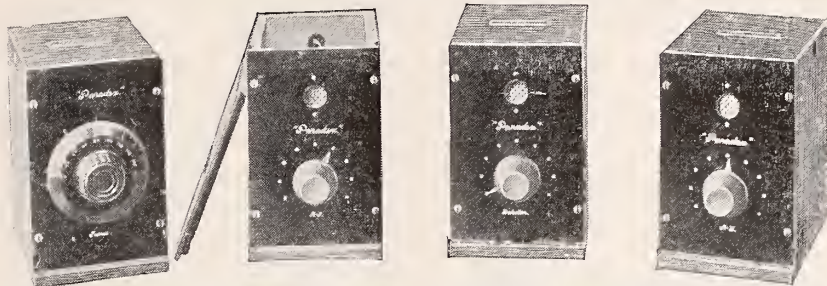

Write for Dealers' and Jobbers' Proposition  
 TUNER (Pat. Applied for).....\$20.00      AUDIO FREQ. AMP.....\$18.00  
 DETECTOR ..... 10.60                      RADIO FREQ. AMP..... 20.60

Manufactured by

**PACIFIC RADIO EXCHANGE**

439 CALL BUILDING

SAN FRANCISCO, CAL.

**All American Audio and Radio Frequency Transformers Now—Completely Shielded**



Radio Frequency Transformers R-10—\$4.50

When you hear the man who knows talk about Radio and Audio Frequency Transformers he will be pretty sure to say "That looks good, but how does it compare with the "All-American?"—More and more manufacturers are adopting these transformers as standard equipment—radio fans all over the country prefer them for their home made sets.

All of this has been brought about by the unusual results in competitive tests that these transformers have given.

Both transformers are enclosed in highly polished nickel plated shields. They are attractive-looking as well as mechanically perfect, and the best sellers on the market.

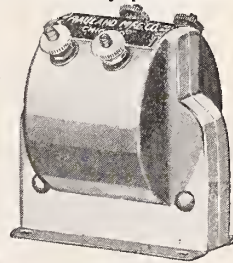

Audio Frequency Transformers R-12 Ratio 3 to 1—\$4.50 R-13 Ratio 10 to 1—\$4.75

SEND FOR ILLUSTRATED BULLETIN NO. 22 AND DISCOUNTS.

**RAULAND MFG. CO.**  
 35 So. Dearborn St., Chicago, Ill.

**DEALERS AND JOBBERS**

Our new Fall Catalogue No. 25 is ready, consisting of new featured Sets and Accessories. Our prices are right. Send for catalogue.

*Manufacturers and Distributors of*

- |             |                 |                 |
|-------------|-----------------|-----------------|
| Condensers  | Potentiometers  | radio Frequency |
| Vacuum Tube | Plugs           | Transformers    |
| Sockets     | Jacks           | Audio Frequency |
| Honeycomb   | Tube Sets       | Transformers    |
| Mountings   | Crystal Sets    | Switch Levers   |
| Dials       | Knock-Down Sets | Binding Posts   |
| Rheostats   | Headphones      |                 |

DISTRIBUTORS WANTED



78 Fifth Avenue

New York

**ELECTRIC TESTING**

Of all materials entering into Radio Construction. Meters repaired or calibrated

**CHEMICAL ANALYSES  
STRENGTH TESTS**

Investigation or Development of New Materials. Routine Tests at Special Rates

**NEW YORK TESTING  
LABORATORIES**

80 Washington Street

Bowling Green 7016

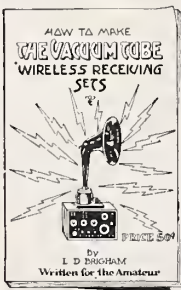
**The RADIO  
BOOK of  
BOOKS****Contents :**

1. Detector Hookup.
2. Two-stage Amplifier Hookup.
3. Radio Amplifier Hookup.
4. Radio Audio Amplifier Hookup.
5. Armstrong Regenerative Detector Hookup.
6. Same with Amplifiers.
7. Armstrong's New Super-Regenerative Hookup.

**Dealers! YOU make 66 $\frac{2}{3}$ %  
on every dollar you invest.**

**ARCHWAY BOOKSTORE**

224 Pike St.

Seattle, Wash.

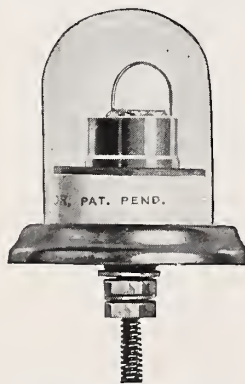
**THE FAMOUS GREWOL  
FIXED DETECTOR**

**PRICE \$2.00**

In using the

**GREWOL**

you don't have to find the spot.

**THIS DETECTOR IS  
ALWAYS SET AND READY**

completely protected from dust.

Gives the best results

If your dealer does not handle the Grewol send us \$2.00 and we will mail one to you.

**A Good Proposition  
For Every Radio Dealer**

**RANDEL WIRELESS CO.**

9 Central Ave.

Newark, N. J.

**DOUBLELL ETHERTROLA**

The Ethertrola, a receiving set manufactured by the Doublell Radio Company, New York City, is built compactly in a 10 x 15 inch highly polished mahogany-finished cabinet. The panel is of grade XX Bakelite and is hand-engraved. It is built on the two-story plan, transformers, tubes and tube controls are in the upper section, and the tuning units in the lower section. All parts are moulded. Everything in the set is mounted on the front panel and an inside bakelite shelf, permitting the removal of the entire set from the cabinet for inspection.

The Ethertrola is wired throughout by the Telfunken Bus Bar method. All battery connections are made from the rear of the set so that no unsightly, straggly wires mar its appearance.

An added feature is the push-and-pull switch on the front of the panel that controls both A and B batteries, so that when the set is not in use neither of the batteries is being discharged.

For long distance reception the Doublell Company recommends the outdoor aerial, but for nearby stations and where an outdoor aerial can not be erected, a loop aerial is suitable. No change is necessary in the construction of the set for use of either type of aerial.

**C & W SET GOES ABROAD**

Rodman Wanamaker took with him on his recent trip abroad, an American-made receiving set for the purpose of showing it in Paris and London as representative of America's progress in the manufacture of radio apparatus. Much interest has been shown abroad in America's rapid development of efficient radio apparatus.

Mr. Wanamaker, who was accompanied abroad by Commissioner Enright and Doctor Harris, used the set aboard the Olympic to receive entertainment from stations on both sides of the Atlantic as they left the American shore and approached Europe.

The set taken by Mr. Wanamaker was a Cutting & Washington Type 11 Regenerative Receiver and Amplifier. It was especially procured and rushed through for Mr. Wanamaker by the Pioneer Radio Corporation, who are distributors for C. & W.

**INCORPORATIONS**

The "list of new radio companies" has had but few additions this past month—in comparison to other months. Can it be that the ex-cil stock promoters are out of numbers? Or are their sucker lists bringing poor results? The RADIO DEALER believes the public isn't buying much of the new radio stock offered. The honest-to-goodness Wall Street records prove it.

**Na-ald  
De Luxe  
V.T. Socket**

Contact strips of laminated Phosphor bronze press firmly against contact pins, regardless of variation in length. No open current trouble possible. Socket moulded from genuine Condensite. Practically unbreakable. Special protected slot, with exterior reinforcement. Unaffected by heat of bulbs or soldering iron. All excess metal eliminated, aiding reception. May be used for 5 Watt power tube. Highest quality throughout. Price 75c.

Special proposition to dealers and jobbers

**ALDEN-NAPIER CO.**

52 Willow St. Dept. H Springfield, Mass.

**DEALERS**

Have you tried "PRACO" Service?

We are distributors to the trade for all representative manufacturers, and specialize in the cutting of panels and tubing to your order.

Have you our latest price list and discount sheet?

**PITTSBURGH RADIO AND  
APPLIANCE CO., Inc.**

Desk D

112 Diamond St., Pittsburgh, Pa.

**DEALER  
SECURITY**

When the dealer buys, he must know he is getting goods which will give his customers complete satisfaction.

Write for details on the Aerovox line—radio equipment that satisfies. We are supplying our dealers with complete Armstrong Super Regenerative Booklets for distribution.

The new circuit will increase the sale of Duo-Lateral Honeycomb and Remler Coils, 12,000 ohms resistance and 100 mil-henry iron core choke coils.

We have this material ready for immediate shipment. Write for prices and Armstrong Regenerative wiring diagrams.

**BRADY**  
ELECTRIC MFG. CO.  
PITTSBURGH, PENNA. U.S.A.  
415 S. Highland Ave.

**ROYAL ELECTRIC PHONES**

The Royal Electric Laboratories of 207 Market St., Newark, N. J., are manufacturers of a radio headset known as the Royalfone. The phone is the result of two years of effort. It is well constructed and the best of materials are used in producing this high grade and sensitive phone. Charles Lehrfeld, the designer, who is well known to the trade, having been in radio for a number of years, first became interested in radio when he was about 10 years old and followed radio as an amateur until he enlisted in the navy. He was then stationed at the Newport Radio School as an instructor and also fulfilled the duty there as an operator. After serving in this capacity for a time he was transferred to special light ship duty as an aid to sub-chasers in the Atlantic. C. Lehrfeld is in charge of activities at the laboratories and reports a national advertising campaign soon under way to place the Royalfone in its well deserved place among the leading headsets on the market.

**WESTPHAL ADAPTER**

The Westphal Adapter, an instrument for using the phonograph as a loud speaker, is the product of the Westphal Manufacturing Company, of Chicago, Ill. The company claims that the adapter may be attached to 95 per cent. of the phonographs on the market without harming the instrument in any way and may be connected or removed in a moment. Only one of the phones is used in connection with the adapter, the other being shorted with a piece of solder or wire, the contention being that in the use of two phones there is conflict of sound. The Westphal Company claims an increase of 50 per cent. in volume of sound with the use of the adapter. It is constructed of a non-magnetic alloy which takes a very high polish and adds to the general appearance of the phonograph.

**LORGNETTE PHONE HANDLE**

The Globe Lorgnette Handle, a device for holding a receiver to the ear, is the product of the Globe Phone Manufacturing Company of Reading, Mass. The handle is properly insulated, having a hard rubber grip, is light in weight and of convenient length to hold in absolute comfort. The purpose of this instrument is to permit a convenient method of holding one receiver when the head bands are not used. The company claims a big demand for the single handle having a telescopic or extension handle. The Globe Lorgnette Handle may be attached to any standard phones.

**THE MARK  OF QUALITY**

**"REGAL" No. 80 Variable CONDENSER**  
Precision Built

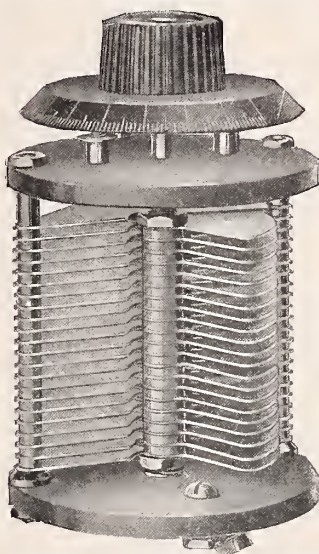

|                        |              |
|------------------------|--------------|
| 43 Plate, .001-MF..... | \$4.50       |
| 23 " .0005-MF.....     | 3.50         |
| 11 " .00025-MF.....    | 3.00         |
| 3 " Vernier.....       | 2.50         |
| Knob and Dial.....     | \$1.00 extra |

**"REGAL" MOULDED TUBE SOCKET—No. 205**

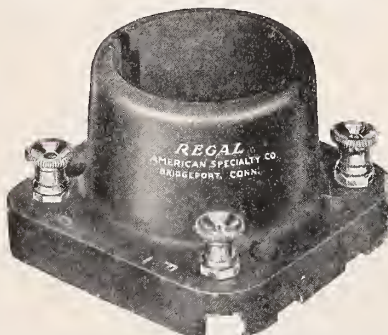

A fine moulded Socket—different from others. Popular with all radio operators.  
Price .....\$0.75

**"REGAL" TELEPHONE CONNECTOR—No. 162**



Does away with all Binding Posts. Permits use of three sets of phones. Only two connections to be wired.  
For Panel Mounting.....\$1.50  
With Plug as shown..... 2.50

Jobbers and Dealers are making real money selling "REGAL" Quality Radio Products. The reason—Precision Made Instruments Honestly Priced and Guaranteed. Send for our handsome new Catalog No. 10 showing our full line.

**"REGAL" INDUCTANCE SWITCH—No. 164**

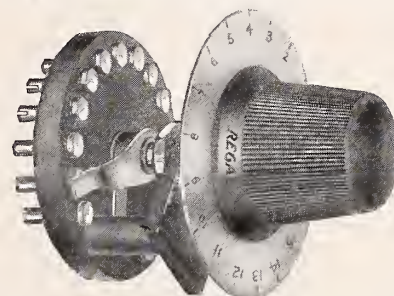

15 point switch complete in one unit. Does away with all switch points. Requires but one hole to mount on panel. **BIGGEST HIT IN RADIO.**  
Price (complete with Knob and Dial).....\$2.00

**"REGAL" FILAMENT RHEOSTAT—No. 140**

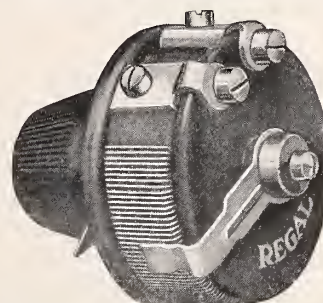

**HANDSOME—EFFICIENT—SCIENTIFIC**

Exposed resistance wire, giving smooth working, even tension control at all times. 6 Ohms—2-2 Amperes. Ask any radio engineer.  
Price (complete with Knob).....\$1.25

**"REGAL" VARIO COUPLER—No. 165**

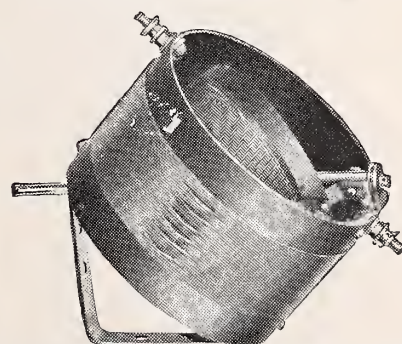

Precision wound—perfect alignment and positive contact. A wonderfully efficient instrument.  
Price .....\$5.00

Home of "REGAL" Radio Products

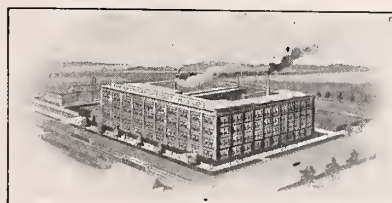

We still have some territory open for distributors.

Our co-operation with our jobbers, dealers and distributors is the talk of the trade.

**THE AMERICAN SPECIALTY MFG. COMPANY—BRIDGEPORT, CONN.**



## Mercury Radio Sets

A PROFITABLE line to handle, from the dealers' standpoint. A reasonably priced line to buy from the consumers' standpoint.

The low price is made possible by quantity manufacture in our large factory where every part is made, not merely assembled.

*Write for details  
and trade prices.*

**MERCURY RADIO  
PRODUCTS CO.**

LITTLE FALLS NEW JERSEY

## "ETHEROLA"

**AERIAL  
EQUALIZER TUBES  
AND  
GROUND  
SEPARATOR TUBES**

Replaces Long Wire Aerials and  
Water Pipe or Other Grounds.

**USED INDOOR OR OUTDOOR**

**TO DEALERS  
JOBBER**

Demonstrate a Set and Get the  
Biz. Selling Rapidly Wherever  
Shown.

Assist you greatly in sale of high  
grade Receiving Sets

**GET YOUR TERRITORY O.K.**

*Write us now. Results guaranteed*

**THE ETHEROLA  
CORPORATION**

6216 Broad Street  
PITTSBURGH, PENNA.

### PITTSBURGH PARAGRAPHS

Etherola Corp. are putting out an antenna that is new in principle and cylindrical in shape. For tube sets only, it has given remarkable results, eliminating the many and varied noises that interfere with clear and uninterrupted reception. It also has the advantage of not being directional. The Etherola Corp. has recently taken up new quarters at 6216 Broad St., Pittsburgh, Pa., where they have excellent facilities for demonstration.

Pittsburgh Radio and Appliance Co. are among the largest manufacturers of panels in the industry. They are preparing for a volume business in the panel business. They have also a large business built up on their Vernier Condenser, which is somewhat of a departure from the general assembly of plate condensers.

A very attractive crystal detector set enclosed in an attractive wood case, and retailing for \$9.00, without phones, was recently put on the market by the Radio Apparatus Co., located at 6600 Hamilton Ave.

### TRIANGLE LOUD SPEAKER

The Triangle Phono-Parts Company of New York City have perfected and will soon market a new loud speaker of the hornless type. The instrument consists primarily of an amplifying chamber. It is very compact, being only seven inches high and about six inches wide. It can be hooked up to any tube set and will give sufficient volume to be clearly heard in the average home. The sound is adjustable without impairing the quality of the tone.

### CLARIPHONE ATTACHMENT

The Colytt Laboratories of Chicago is producing an attachment for headsets for which they claim amplification without static or distorting noises. The attachment consists of a light screen or auxiliary diaphragm made to screw adjacent to the diaphragm on the telephone receiver. This auxiliary diaphragm has a trap arranged so that any confusing sounds or vibrations of the receiver diaphragm are cut out or trapped in the Clariphone. This device is made of aluminum, is exceedingly simple and is sold under guarantee to give satisfaction.

*Recommended for Reliability*

**RADIO STORES CORP.**  
VARIABLE CONDENSERS—  
PLUGS—RESISTANCE UNITS, ETC.  
222 West 34th Street, New York

The Sign of  **QUALITY-PLUS** Instruments  
**ARROW RADIO CO.** MARK  
Mfrs. of Quality-Plus Instruments  
Hackensack New Jersey

**DEALERS ATTENTION! !**  
Most complete licensed crystal set in market—RADIOPHONA No. 1—equipped with 23-plate condenser and loose coupler. Includes Mesco double headset and aerial equipment. Buy direct from manufacturer, save money and make big profits. Write for prices and discounts.  
**M. P. RADIO CO.**  
453 W. 53rd St. New York City

### Maclite Vario-Coupler

Price \$5.00

Is, in the opinion of experts, the most efficient on the market.

All Other Maclite Parts are equally efficient, including the Maclite Variometer, Double Slide Tuner, Variable Condensers and Crystal Detectors. The Maclite Single Tube set at \$25.00 is the best buy we have ever seen. Let us tell you more about this set, also all other Maclite parts.

Dealers and Jobbers Write for Discounts

**MACLITE RADIO CO.**  
701 Maclite Bldg., Claredon St.  
Boston, Mass.



Radio  
Supplies  
of  
Exceptional  
Character  
at  
Correct Price  
and  
Liberal Discount

*Write for Descriptive  
Catalogue*

**Harold M. Schwab, Inc.**  
419 West 42nd Street  
New York City

## Philadelphia

### DIAMOND GRID BATTERY

The Philadelphia Storage Battery Company has placed on the market a new radio "B" battery, which has unusual features. The battery is of a shape that is easy to handle and use, and is neatly and compactly sealed in a one-piece hard rubber case. Several units can be grouped on a shelf or table, occupying a very small space, and the projecting lugs provide for convenient and unlimited voltage taps.

A new feature about the battery is that the battery is fully charged, and shipped to the dealer absolutely dry.

It requires no initial charge and is ready for use upon adding the necessary electrolyte solution. This does away with loss of charge or wasting on the dealer's shelf. The dealer may remove the battery from its original carton and add the electrolyte solution in the presence of the customer at the time of the sale. This means that storage "B" batteries, fresh and fully charged, can be sold without waiting for the initial charge to be given.

### MUSIC MASTER SPEAKER

The Music Master loud speaker, manufactured and distributed by the General Radio Corporation, is a new product in this field for which its makers claim wonderful possibilities. It is designed and built on principles which have been used in highly priced phonographs, and is proudly designated by its makers as the "Stradivarius of radio amplifiers." The tone is enriched and mellowed through the resonance of sonorous wood, increasing the volume of sound while refining and clarifying every vibration. It requires no additional batteries or current, and will fit any tube set.

The Music Master is fully covered by patents held by the General Radio Corporation. The material used in its construction is the finest quality mahogany.

The Beaumont Radiophone Company, of 1326 Arch Street, has recently changed hands, and is now being operated as the Noble, Wacker and De Arellano Radiophone Company. The new proprietors are doing volume business in wholesale and retail channels.

The Rubicon Company have decided to market their new micrometer control rheostat under the trademark, "Micontrol Rheostat."

# Killing the Goose—

that laid golden eggs, and selling cheaply made, disappointing Radio sets amount to one and the same thing.

And if you, Mr. Dealer, would make your business what you want it to be—permanently profitable—then shun "claptrap" instruments as you would the plague.

## ONE-KNOB CONTROL CUSTOM BUILT CONQUEROR RECEIVING SETS

are sets that are built like Packard "Twin-Sixes," mechanically perfect in every detail, simple to operate and capable of super-sharp tuning.

—Unconditionally guaranteed as to quality, materials and workmanship—and to give as good or better results than any instrument at any price. And that holds good for any tuner, detector and two-stage amplifier made—bar none.

THIS IS HOW A CONQUEROR IS BUILT

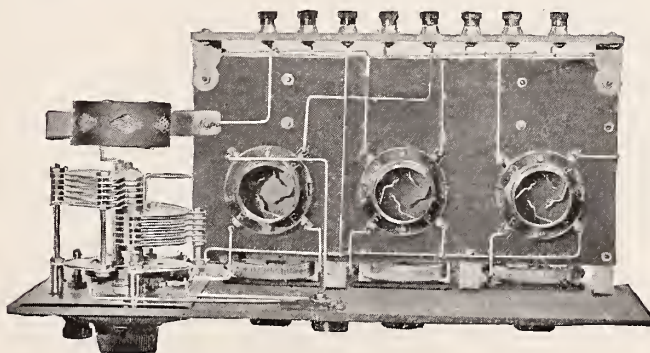

—BUT you have to see, operate and listen in on a *Conqueror* to truly appreciate what perfection in receiving sets means.

TWO MINUTES TAKEN TO WRITE US  
WOULD BE TIME PROFITABLY SPENT

## LEWIS & DEROY RADIO CORP.

MAKERS OF  
CONQUEROR  
PRODUCTS



560 Seventh Avenue  
NEW YORK CITY

Phone BRYANT 7759

## "UNITED" Radio Products

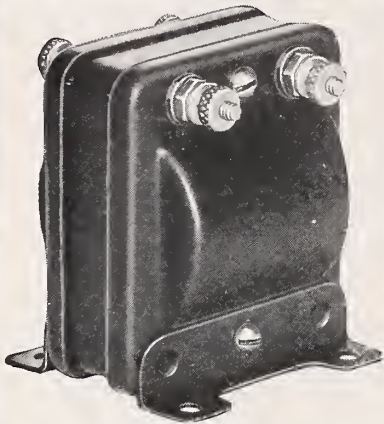

Two Finishes—Black Enamel or Buffed Nickel Plated ..... \$4.50

### "UNITED" Audio Frequency Transformers

Radio dealers will find in the "United" Transformer the same high grade workmanship and engineering skill which have made the "United" Condensers the standard in the variable condenser field.

### "UNITED" Variable Condensers

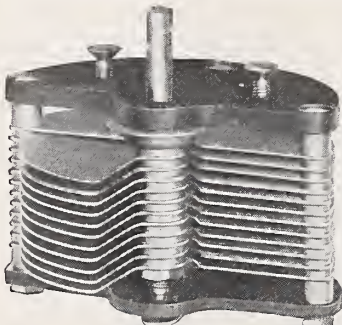

In every field there is a standard by which everything else is compared. The fact that "United" Variable Condensers have been accepted as the standard is sufficient in itself to warrant your not buying any other until you have made a comparison.

| Prices         |        |
|----------------|--------|
| 43 plate ..... | \$4.50 |
| 23 " .....     | 4.00   |
| 11 " .....     | 3.50   |
| 5 " .....      | 2.75   |
| 3 " .....      | 2.25   |

Without dial or knob.  
Write for Discounts

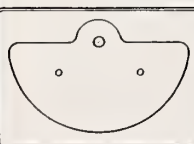

Mounting made easy by our template for locating panel holes packed free with each condenser.

**NOTE**

Any advertised claim of having an arrangement with us to sell our product at special prices, is fraudulent.

## United Mfg. & Distributing Co.

536 Lake Shore Drive Chicago, Ill.

## Development of The Loud Speaker

(Continued from page 44)

this pioneer instrument competed directly with the ordinary telephone instrument, and in all cases it was found that the reproduction was far better. When they came to use this instrument on phone lines, however, they found that, due to the fact that the little coil was almost entirely surrounded by iron, the impedance of the coil was very small. This gave the instrument an excellent degree of efficiency and sensitiveness. In fact, conversation was held over a direct copper line between Denver and New York City, using this instrument when the ordinary phone was unintelligible.

Patents having been taken out on this instrument, experiment was then carried further in order to refine the mechanical details, and it was during these further experiments that it was found that if the floating coil was wound to a low value and a large amount of current passed through it, this instrument would act as a true loud-speaking reproducer. Consequently, the design of the coil was changed, and at present the floating coil has a direct current resistance of 8 ohms and an impedance at 800 cycles of only 20 ohms. During the experimentation a loud-speaking transmitter or really heavy current transmitter was developed, and the transmitter was then placed so that a phonograph could play directly into it. Modulation of the current was sufficient when passed through the floating coil to give such a volume of sound that early in 1915, music was heard in the Napa Valley over nine miles away from the reproducer, which had been placed on top of the laboratory chimney. It was then that the two inventors had a new inspiration. They called the instrument "Magna Vox," meaning "great voice," because it had the inherent quality of being able to reproduce the voice or any other sound with volume limited only by the means to supply the necessary energy.

For a while most of the inventors' energy was turned to the use of this instrument for the amplification of public speeches or the amplification of phonograph music, and on Christmas Eve, 1915, the first public demonstration of the Magnavox took place in San Francisco, where the community speakers spoke to 50,000 people with perfect ease, this being the largest crowd that had ever satisfactorily

## "RADIO" VARIABLE CONDENSERS

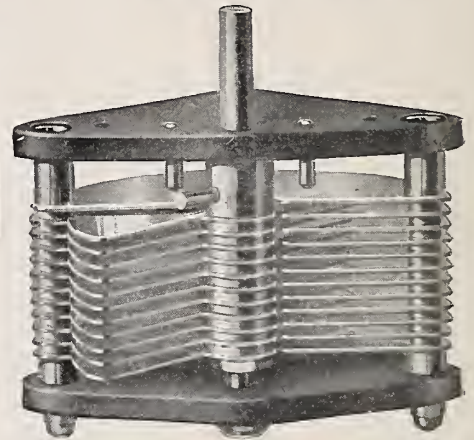

These condensers are the Standard of Quality. Carefully tested, inspected, balanced and adjusted to give maximum satisfaction.

|                       |        |
|-----------------------|--------|
| 3 plate Vernier ..... | \$1.50 |
| 23 plate .....        | 4.00   |
| 43 plate .....        | 5.00   |

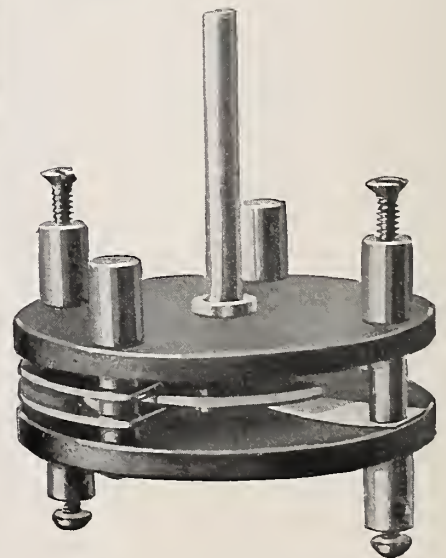

Jobbers and Dealers write or wire for the biggest proposition in Radio—TODAY!

## FREDERICK H. PRUDEN

INCORPORATED  
LERNER BUILDING  
991 Bergen Ave.  
JERSEY CITY, N. J.



heard a public speaker at the same time. Since that time, as everyone knows, the Magnavox has been used by practically every prominent public speaker in the United States when addressing large audiences.

Here, then, was an instrument altogether different in principle from the magnetic attractive receiver. Here was an instrument which not only was sensitive but which would reproduce sound in any volume. There were no pole pieces to interfere with diaphragm motion. The diaphragm could be made of soft material and could vibrate freely and with great latitude.

The inventors then associated themselves with a new company which was formed to take over the interests of the Commercial Wireless and Development Company, the new company being known as The Magnavox Company. Almost immediately the Magnavox, in addition to its phonograph application, was developed to be used as a receiver for wireless signals. This was easily done by using a step-down coil which would adapt the impedance of the Magnavox to the output impedance of the receiving set.

However, the war stopped most of this work, as the Magnavox Company became very busy making anti-noise transmitters—also a product of Pridham's and Jensen's inventive genius—and almost nothing was done with the loud-speaker until the close of the war. The radio loud-speaker, then known as the radio telemegafone, was put on the market with a horn for loud signals and ear pieces for weaker signals. Various mechanical refinements were worked out and incorporated in this instrument, but even then the instrument was high in price and not within the reach of the average radio amateur. In early 1921 there were approximately only 10,000 receiving sets in the United States, and most of these stations were operated by amateurs, the great majority of whom were young and who had no great amount of money to spend.

The Magnavox Company then decided to redesign its radio telemegafone so that it might be put into quantity production and the price placed at a figure which would allow the owners of these 10,000 stations to own a real loud-speaking reproducer, and in March, 1921, the new product, known as Magnavox Radio Type R-3, was placed on the market, selling for \$45. There was an instant response, although broadcasting, of course, had not yet taken its present hold upon the public. Throughout 1921, a large

ESTABLISHED 1888



## SENSORY CABINET UNITS

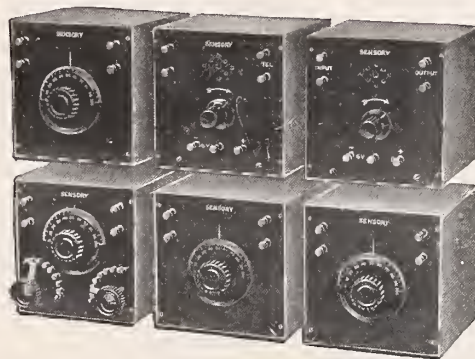

The most flexible method of adding to, or obtaining a variety of hook-ups, and giving an appearance equal to any single cabinet set. Each cabinet contains a "Sensory" element.

THE FULL LINE OF "SENSORY" ACCESSORIES IS SHOWN IN OUR NEW BULLETIN NO. 12  
WRITE FOR IT TODAY



**HEINEMANN ELECTRIC COMPANY**  
*Manufacturers*

Radio Division

Philadelphia, Pa.

**KING QUALITY**  
ALL THE NAME IMPLIES  
**RADIO APPARATUS**

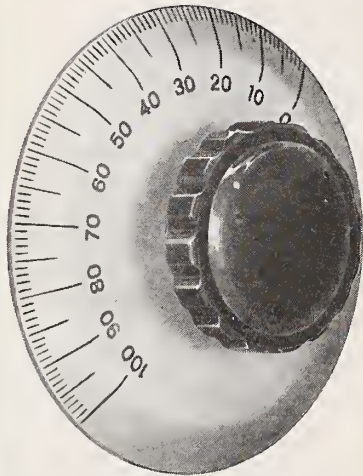

**KNOBS AND DIALS**

**T**HE development of these dials has brought another mark of perfection to KING QUALITY Radio Apparatus. These dials are the neatest, most durable and most practical dials being made today.

KING QUALITY dials are finished with a high permanent polish which improves the appearance of every outfit. They are unbreakable, will not warp, being accurate in design with high dielectric properties.

The knob is moulded Bakelite and is fastened to the dial by a special brass bushing. The bushing is drilled for 1/4" or 3/16" shaft and the set screw passes through both knob and dial.

*Sold only to recognized distributors, Jobbers and Manufacturers.*

Manufactured by Radio Apparatus Division  
**KING SEWING MACHINE  
COMPANY**  
BUFFALO :: :: :: N. Y.

number of instruments were sold and when it was decided to broadcast the returns of the Carpentier-Dempsey fight from the ringside at Jersey City, there was an unprecedented demand for Magnavox Radio. It is interesting to note that at the same time the "big brother" to the Magnavox Radio, the Magnavox public speaking and announcing equipment, was used at the ringside to announce introductions, etc., to the 93,000 fight fans present. At that time Magnavox Radio was a comparatively unimportant part of the Magnavox Company's activities, but just before the Carpentier-Dempsey fight great activity was seen and approximately 600 instruments were turned out quickly with overtime work for this occasion alone. From that time on, as we all know, the growth of broadcasting was rapid, and in exact proportion the Magnavox Radio production was increased. Dealers all over the country used Magnavox Radio to demonstrate the radio concerts for their customers, but even then the deliveries of the Magnavox Radio equipment could not keep up with the orders which poured in. Raw materials of certain kinds in the spring of 1922 became almost unobtainable and the ingenuity of the two inventors was kept continually exerted to keep up the standard of quality necessary.

At the same time development was started on power amplifiers to give to the Magnavox as much volume as could be wished for by any one. Today the activities of Magnavox Radio and its allied amplifiers has grown into a business of most impressive importance until it is now of international scope.

Great credit must be given to the two chief engineers of the Magnavox Company, Messrs. Pridham and Jensen, for their efforts. They have appreciated and solved the many problems of a radio loud-speaker because they are essentially radio men, as well as being pioneers, and are said by many to be the best-posted and well-informed scientists on problems of sound engineering in the world today.

As an interesting story to conclude, we might say that Peter L. Jensen was the first man in the world to hear voice modulated arc continuous waves used for wireless telephone transmission, this occurring in the fall of 1906 when he was working for Dr. Poulsen. How little did Jensen realize at that time, as he excitedly told Dr. Poulsen of what he had heard, that he would be one of the inventors of a new principle which helped to establish the popular use of wireless telephone in the home so many years later!



The  
**Portabloop Tuner  
and  
Portabloop Receiver**  
are Now Ready

Write Us For Prices  
and Details

**Radio Frequency  
Here at Last**



212 Central Avenue

**DUKANE VARIABLE CONDENSER THOROUGHLY TESTED**

The Duquesne Radio & Mfg. Co., 6426 Hamilton Avenue, Pittsburgh, are concentrating their efforts towards the manufacture of a good substantial and compact variable condenser.

This condenser—the DuKane—is built for durability. It features die-cast aluminum end plates, non-warping screws and is of high capacity.

The DuKane has been tested thoroughly, it is stated by the makers, by competent engineers and also at the Carnegie Institute of Technology.

**DETECTOR AND TWO STAGE**

The States Radio Corporation of Chicago are producing a detector and two stage amplifier set that is neat and attractive in appearance and embodies the latest designs of efficient receivers. The feature of the set is parts that are easily detached in much the same manner that the ordinary bulb is removed from its socket. There are no binding posts to come loose, no loose wires, everything being compactly and firmly placed. The panel is of metal, an innovation that minimizes disturbance caused by the manipulation of dials. The transformers are incased in the tube sockets to reduce wiring, and are easily replaceable in case of a change in broadcasting wave length. All parts are easily accessible from the rear of the panel.

**CLUB RESUMES ACTIVITY**

The Hudson City Radio Club, Inc., of 37 Sherman avenue, Jersey City, N. J., announces that the club will reopen for the "big fall rush." Harry A. Bremer, Chairman of the Publicity Committee, reports that the regular wireless course, held four nights a week, will "push the code very strongly." "Harry A." requests that radio manufacturers send their catalogs to the club. He would also appreciate having their radio engineers make arrangements with the club to address the members on practical radio topics.

The club is out to push radio and should receive the earnest co-operation of the trade.

**DETROIT ELECTRIC CATALOG**

Catalog No. 10 issued by the Detroit Electric Company of Detroit, is attractively and concisely arranged between two covers that please the eye. The photographs are neatly arranged and prices tabulated for easy reference. The back cover shows the symbols of the International Morse Code.



ESTABLISHED 1911

**The Original and Genuine Mica Diaphragm Amplifying Loud Speaker**

**NEW LIST PRICE \$25.00**

**CHEAPER THAN THE WORTHLESS IMITATIONS**

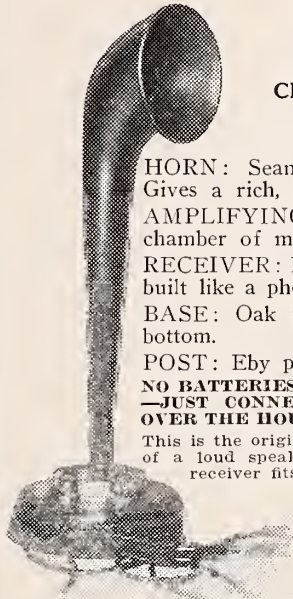

**SPECIFICATIONS**

**HORN:** Seamless brass, triple lacquer, scientifically correct. Gives a rich, clear tone, not a metallic rasp.

**AMPLIFYING CHAMBER:** Exclusive "Modern" amplifying chamber of machined aluminum, polished and lacquered.

**RECEIVER:** Highest grade mica diaphragm amplifying receiver, built like a phonograph reproducer.

**BASE:** Oak wood base finished in early English, green felt bottom.

**POST:** Eby patented binding post.

**NO BATTERIES ARE NEEDED TO OPERATE THIS LOUD SPEAKER—JUST CONNECT IT TO YOUR SET—PRESTO—HEAR 'EM ALL OVER THE HOUSE.**

This is the original and genuine loud speaker—designed to do the work of a loud speaker—and is not an empty horn or shell that "any" receiver fits.

The Makers of the "FIRST" are Makers of the "BEST"

**HORNING EXPERIMENTAL LABORATORIES**

Sole Distributors of "Modern Apparatus"

Elizabeth Trust Company Bldg.

ELIZABETH, N. J.

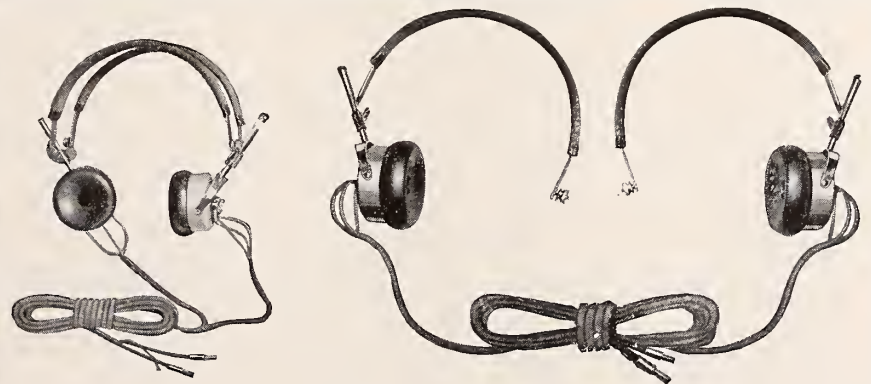

**The Band Splits Into Two Parts. Each Having an Overhead Strip, Is Very Convenient for Two Persons**

**Premier Duplex**

PATENTS APPLIED FOR

Phones

2000 Ohms \$6.50

3000 Ohms \$8.00

Discount to Dealers

**PREMIER ACCESSORY & SPECIALTY CORP.**

27 CONGRESS STREET

NEWARK, N. J.



## The B & P INSULATOR Should Be Included In Your Line of Staple Sellers

**S**UCCESSFUL radio dealers follow the wise practise of stocking small staple sellers to produce a steady, dependable profit rather than tying up all this capital in higher priced, more expensive merchandise. They find it worth their while to carefully consider the quality of these staples.

The B & P Insulator, in every store, where it's handled, has gone plugging ahead turning over a very satisfactory profit on a small investment.

They look GOOD. That starts the buying! They stand the tests and actual use by amateurs. That spreads the advice that the best insulators are for sale at your store.

Our prices give you plenty of room for your idea of a fair profit. May we quote you on the quantities you could use?

*Wholesale Only*

**BANISTER & POLLARD CO.**  
204 Market St. Newark, N. J.

## New Broadcasting Station Wave Length

(Continued from page 48)

length of 485 meters is authorized for broadcasting crop reports and weather forecasts, provided the use of such wave lengths does not interfere with ship to shore or ship to ship service.

A new class of radiotelephone broadcasting station license is hereby established, to be known as Class "B." A license will not be issued for a station in this class which does not comply in every respect with the specifications hereunder. Specifications covering the requirements governing the construction, licensing, operating and service of Class "B" radiotelephone broadcasting stations:

**Wave Length**—The wave length of 400 meters only will be assigned for the use of stations of this class, which must be reasonably free from harmonies.

**Power**—The power supply must be dependable and non-fluctuating. The minimum required will be 500 watts in the antenna and the maximum shall not exceed 1,000 watts in the antenna.

**Modulation**—The system must be so arranged as to cause the generated radio frequency current to vary accurately, according to the sound impressed upon the microphone system.

**Spare Parts**—Sufficient tubes and other material must be readily available to insure continuity and reliability of the announced schedule of service.

**Antenna**—The antenna must be so constructed as to prevent swinging.

**Signaling System**—Some dependable system must be provided for communication between the operating room and the studio.

**Studio**—The radio equipment in the studio must be limited to that essential for use in the room. The room shall be so arranged as to avoid sound reverberation and to exclude external and unnecessary noises.

**Programs**—The programs must be carefully supervised and maintained to insure satisfactory service to the public.

**Music**—Mechanically operated musical instruments may be used only in an emergency and during intermission periods in regular program.

**Division of Time**—Where two or more stations of Class B are licensed in the same city or locality a division of time will be required if necessary.

Licenses issued for the use of the

## Scott Detector

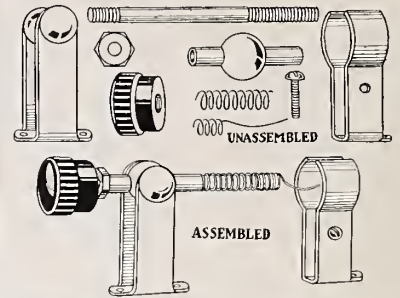

Complete parts as illustrated. Brass. Nickel Plated.  
Ready for mounting. **List 40c**



Manufacturers, Jobbers and Dealers

Write

**SCOTT NOVELTY CO.**  
33 Springfield Ave. Newark, N. J.

## It pays to advertise—ask our advertisers.

If you have something to sell the Radio Trade, fill in the blank below—an ad this size would only cost \$18.60 per issue on contract

### ADVERTISING ORDER

**THE RADIO DEALER,**  
1133 Broadway, New York City.

You may insert our advertisement, copy attached, in the next 12 issues of the RADIO DEALER, to occupy space of six inches, for which we agree to pay you at the rate of \$18.60 per issue.

(Signed) .....

(Address) .....

(City and State) .....

Minimum order, four inches

400-meters wave length shall specifically provide that any failure to maintain the standards prescribed for such stations may result in the cancellation of the license and requiring the station to use the 360-meters wave length.

The advantages of this ruling are obvious. It eliminates a great deal of the interference heretofore experienced in broadcasting and will allow at least one good program in every district.

**“USL” APPOINTS VICE-PRESIDENT**

John A. White, who is well known as one of the pioneers in the battery industry in the United States, has been appointed a vice-president of the U. S. Light & Heat Corporation, manufacturers of “USL” storage batteries. Mr. White has been continuously engaged in storage battery sales work for more than twenty-three years. After graduating at Harvard with the degree of A. M., he entered the employ of the Electric Storage Battery Company in 1898 and was successively connected with the Boston, Chicago and St. Louis offices, and later became manager of the Pittsburgh office of the Electric Storage Battery Company. In December, 1908, he went with the National Battery Company as manager of its Boston office, continuing as manager of this office when the National Battery Company was absorbed by the United States Light & Heating Company. He remained at Boston until 1916 and was then made manager of the Chicago office of the U. S. Light & Heat Corporation. On January 1, 1917, he was appointed sales-manager of the battery department, with headquarters at the USL factory in Niagara Falls, where he will continue to be located as vice-president, in charge of sales to manufacturers.

**MUSIO'S CIRCULARS**

Two circulars recently distributed by the Musio Radio Company, Inc., of Pittsburgh, Pa., can scarcely be described in words that will do them justice. Printed in folder form with an open spread of about 14 by 21 inches, in three colors, the story of the Musio crystal detector and crystal set is told completely and convincingly. The set itself is shown in actual size and color, while the features of the set and the opportunity for dealers is clearly told. A more attractive “business-getter” display has yet to come to the attention of the RADIO DEALER office. If in doubt, see it for yourself.

**Marconi says:**

**T**HIS country is far in advance of any other in the radio development—so does NYCO; we ought to know, because we are supplying dealers and amateurs throughout the country with the best standard equipment.

*A complete set—or any part of it!  
“Write for our latest price booklet”*



507 PENWOOD AVENUE

WILKINSBURG, PA.

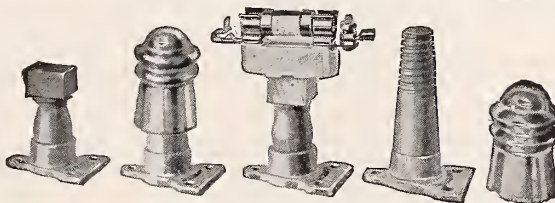

**X-RAY INSULATOR ADAPTER**

fills a long felt want for a lead in insulator—approved, up-to-date, complies with every regulation, both national and local, made in two styles—one for lead in, one for lightning arrester.

**Aeroplane Wire**

19 Strand Silicon Bronze Aerial Wire. Each strand (tinned.) Guaranteed to give 100 per cent satisfaction. This wire was used during the war by the U. S. Government for aeroplane and trench work and was the only wire to stand up under these conditions.

We have the entire supply and are prepared to make immediate shipments.  
Cory Phones 2000 Ohms Connecticut Phones 3000 Ohms Turney Phones 3000 Ohms

*Liberal Dealers' Proposition*

**HINTZE BROS., Inc., 459 Central Ave., Newark, N. J.**



Junior List \$0.35

**“IDEAL” SWITCH LEVERS**

Look “IDEAL” on any panel  
The switch levers with the  
“Mirror-Like Knob”

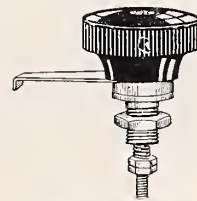

Senior List \$0.50

What looks more ideal than “Ideal” Switch Levers on a panel? The knobs are made of genuine THERMOPLAX, a cold molded composition. Each and every knob is hand buffed, thus giving it a very high polish. AND THE POLISH LASTS. The levers are blue-nickeled, and all the parts are highly polished. They are really perfect products that will improve the appearance of any set.

Made in two sizes, both with plain, highly polished surface knobs.

JUNIOR—Radius of lever 1”.

SENIOR—Radius of Lever, 1 3/8” and 1 1/2”.

Write for Attractive Discounts and Circulars.

**“IDEAL” Variable Condensers**

Bakelite tops and bottoms. ALL parts nickel-plated brass. Can be used for either table or panel mounting. Highly efficient and all capacities are strictly guaranteed.

|                   |         |        |                  |         |        |
|-------------------|---------|--------|------------------|---------|--------|
| 43 plate Cap..... | .001    | \$3.50 | 5 plate Cap..... | .000095 | \$1.75 |
| 21 plate Cap..... | .0005   | 2.75   | 8 plate Cap..... | .000075 | 1.25   |
| 11 plate Cap..... | .000025 | 2.25   |                  |         |        |

We carry a complete line of radio supplies in stock. Transformers, rheostats, potentiometers, sockets, variometers, variocouplers, coil mountings, dials, spaghetti, etc.

Write for Price Lists and Discounts.

**NEWARK RADIO SUPPLY CO.**

Manufacturers and Distributors Radio Supplies and Equipment  
284 Market Street Newark, N. J.

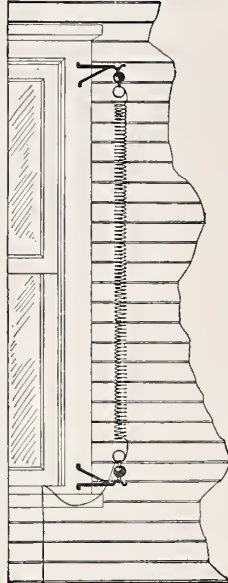

**"K-N"**  
**HELIX ANTENNA**

Only 6 feet of space required to install  
100 feet of wire

The "K-N" is adjustable to any space

The ideal aerial, made from ideal Antenna Wire

The "K-N" is a spirally wound aerial and is therefore adjustable to the available space, either on the roof, outside the window or within the home.

*Jobbers and Dealers write for special discounts*

Receptive area in all directions.  
Remains taut—no swaying.  
Installed with greater ease.

**RETAIL PRICE, \$1.60**

*Manufactured by*  
**WALTER S. KRENZ**

339 So. Central Park Blvd. CHICAGO, ILL.

Forms for the  
**NOVEMBER ISSUE OF THE RADIO DEALER**  
Close at New York, October 15th. Advertisers desiring proofs should have copy in considerably earlier  
**ADVERTISING DEPT., THE RADIO DEALER**  
1133 Broadway, New York, N. Y.

## QUALITY-PLUS INSTRUMENTS



Type 711

### HOME Radiophone Receiver

A vacuum tube set with wave length range of 150 to 2600 meters. Wonderful reception; simplicity of operation and extremely attractive appearance.

**List Price, \$35**

### ADD-A-STEP DETECTORS AND AMPLIFIERS

Handiest instrument for station or laboratory ADD-A-STEP at any time. Extremely efficient, neat and compact.

PRICE: Detector, 704, \$5.75; Amplifier, 705, \$10.50. These instruments awarded the Mail Radio Institute Certificates of Excellence, May 20, 1922.

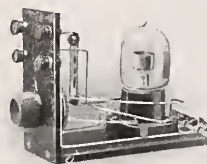

Type 704

### DEALERS, JOBBERS, DISTRIBUTERS

Liberal discounts, quick turnover and hearty co-operation  
Does this interest you? Wire or write immediately

## ARROW RADIO CO.

*Manufacturers of QUALITY-PLUS Instruments*  
**HACKENSACK NEW JERSEY**

## Passing of Unfit

*(Continued from page 47)*

of money by selling the article for \$1.10, so he reasoned. He knew nothing of the executive end of a business; scientific production, cutting waste, salesmanship, financing, all these were foreign to him. Yet he went into the radio business! And out again, as a matter of course.

This type of man is being weeded out by the law of the survival of the fittest. The men who are remaining are those who have all the requirements he lacked.

Years ago the pioneer in a new industry could get no help from other sources than his immediate associates. He was compelled, by the force of his own brain-power to solve his own problems and overcome the obstacles he continually met.

The pioneer in the radio business to-day has better chances for success. He can call to his aid more men trained in the principles of the business world, trained in that bugaboo of manufacturing—costs, and trained in finance.

These men are the Certified Public Accountants of each state, whose profession is one of great assistance to the business man.

One of the things most astonishing to me was that none of the bankrupts employed an accountant, or even had a competent system of accounts.

It is a deplorable fact, and one well known, that few concerns in the radio field, be they manufacturers or dealers, made any real money within the past year; this in spite of the fact that for a period of six months or so merchandise was hard to get, and brought a large sum when sales were made. Why?

In my opinion it was simply a case of men working blindly, with nothing to guide them or to throw some light on where they were and where they were going.

Take the question of purchasing alone. A simple system of inventory-keeping can keep a man from either filling up his shelves with unsalable merchandise or from being caught without any merchandise when he most needs it.

Mr. Manufacturer and Mr. Dealer, your books are a veritable "gold mine" of information if you will but use them. An analysis of them will prevent you from doing things that will hurt your chances of making money, and will aid you to realize the direction in which you are headed.

The profits of a business can be substantially increased, its operations greatly simplified, and the "inevitable" uncertainties eliminated by the installation of a simple system of accounts.

Do you know just what your overhead expenses are for manufacturing, for selling, for administering the business? Are you figuring the proper rate of depreciation on your machinery or the cost of financing the business?

The radio business is fast getting to a point where its stability will be the same as in other businesses, where growing efficiency makes for keener, more legitimate competition, and when "feeling your way" will be eliminated.

### FOLDER CATALOG

The McConnell Cable and Specialty Company of Chicago have distributed a compact circular-catalog that opens in a manner that invites perusal. Printed on firm stock, the circular lies flat when opened and remains in sight thus, defying the inattention of the more ordinarily disinterested customer.

### NEW MOUNTING FOR CRYSTALS

The Radial Electric Company of Passaic, N. J., reports that it has a method of mounting crystals that does away with the use of the heat necessary for mounting with woods metal. The company uses a special conducting compound that has all the appearance of a metal. This process covers the general objection often raised that the use of heat is injurious to the crystal.

### LINGA VARIABLE CONDENSERS

The Linga Variable Air Condensers, the product of the General Radio Laboratories of Chicago, are made of high-grade materials and are high-class in value, appearance and efficiency. The panel mounting type is furnished complete with large composition dial and knob. The scale reading in hundredths aids in making fine adjustments.

The peculiar construction of the Linga condensers adds greatly to their efficiency and appearance. The stationary plates, machine spaced, are riveted into the tubular posts and the movable plates are cast into the center posts, making perfect electrical contacts throughout the various units of the condenser thereby eliminating current leaks due to inefficient or faulty spacing between plates.



## A Sales Room in New York for a Dollar a Day

at the

## Permanent Radio Fair

(Located in the "Buying Hub" of the United States)

Under the personal direction of

**Raymond Francis Yates**

Radio Editor, New York Evening Mail

**GEORGE T. KEEN,**  
*Business Manager*

**MORTON STERNS, I.R.E.,**  
*Technical Director*

At the present time the radio industry is badly in need of a centralized exhibition of reliable merchandise, where buyers may come and make their purchases with a feeling of security. The Permanent Radio Fair is such a place; it is the official radio buying center of the United States. Buyers from every part of the country are visiting the Fair, because it saves them time and worry in selecting their merchandise. Only apparatus of recognized standing is being displayed and nothing will be accepted that does not meet with the approval of Mr. Yates, Director of the Fair. The Fair is open only to buyers during the morning. General public admitted during afternoon and evening.

The Permanent Radio Fair is being held in the famous Red Room of the Hotel Imperial, where 165 glass-covered compartments ranging in size from 24 x 24 x 36 inches to 36 x 36 x 36 inches have been provided. These spaces rent at a charge of from \$1 to \$3 a day.

### Send for Literature

A partial list of the exhibitors follows:

|                                    |                                   |
|------------------------------------|-----------------------------------|
| DeForest Telephone & Telegraph Co. | W. E. Supply & Service Corp.      |
| A. H. Grebe & Co.                  | Norman W. Henley Pub. Co.         |
| C. Brandes, Inc.                   | Finch Radio Co.                   |
| Multiple Storage Battery Co.       | Radio Winding Co.                 |
| Pacent Electric Co.                | Victor Radio Co.                  |
| Signal Electric Co.                | Mercury Radio Co.                 |
| Federal Telephone & Telegraph Co.  | Post Electric Co.                 |
| Dubilier Condenser & Rad'co Corp.  | Metropolitan Radio Corp.          |
| Cutting & Washington               | Wireless Press.                   |
| Horne Manufacturing Co.            | Electrad Corp.                    |
| Radio Corporation of America.      | Globe Radio Co.                   |
| Hopewell Insulation & Mfg. Co.     | Bruno Radio Corp.                 |
| Jewett Manufacturing Co.           | Radio Laboratories of New Jersey. |
| Man-Day Radio Corp.                | National Airphone Co.             |
| Acme Apparatus Co.                 | Cairns Radio Corp.                |
| Arrow Radio Co.                    | And many others.                  |

Fair Opened Sept. 30th—Closes May 30th

**PERMANENT RADIO FAIR, Inc.**

Hotel Imperial

32nd Street and Broadway

New York City

## COMPOSITION

LIST PRICE

DIALS 50<sup>c</sup> DIALSAdjustable Switchlevers  
Knobs

NEW YORK-RADIO-DIAL CO.

316 Holden Bldg.,

Detroit, Mich.

Ask Our Service Bureau

Sell Ray-O-Vac  
"B" BatteriesBecause they Reduce  
Receiving Noises

Your customers will notice the difference as soon as they start using Ray-O-Vacs. Ray-O-Vacs are unusually quiet because of their special construction—the thorough cell insulation, hand-soldered connections, perfect binding compound which holds cells absolutely rigid, the patent wire-spring clip that holds the smallest wire tight without cutting it.

Ray-O-Vacs are made by the same battery experts that have made French Ray-O-Lites famous for their quality and long life. You can build up a big circle of satisfied customers with Ray-O-Vacs. 22½, 45 and 100-volt sizes. Send for Bulletin 225 and prices.

## French Battery &amp; Carbon Co.

Madison, Wisconsin

Chicago Dallas Atlanta New York  
Denver Minneapolis Kansas CityFrench FAY-O-VAC  
"B" Batteries

## Vulcanized Fibre

(Continued from page 45)

with glycerine was originally used on honeycomb coils. In hot weather the glycerine was drawn out of the fibre in a manner that the radio amateur called "sweating." This caused a loss of energy in the honeycomb coils and since has been done away with by the use of a proper grade of fibre. Black fibre sheet can be polished to present a good appearance and is oftentimes used for panels on the cheaper sets. After being secured in place by screwing the panel to the cabinet, it shows no tendency whatsoever to warp. Fixed condensers made of tinfoil and paraffin paper are often wound around a fibre strip, which in this case acts as a support and also allows the use of a terminal at either end. Fibre sheet can be readily machined to the proper shapes for use as variable condenser tops and bottoms. Thin weight fibre, commonly known to the trade as "fish paper," is frequently used in transformers. Radio manufacturers making transmitting transformers oftentimes use this fish paper to insulate their windings from the core and also from each other. Amplifying transformers of the radio frequency type sometimes are enclosed in a fibre tube and the audio frequency type often uses fish paper for its insulation. Telephone receivers use fibre for their magnet heads. Plugs and jacks use vulcanized fibre for their insulation. Polished fibre tubing can be used to form the handle of a plug and small fibre punchings are used to insulate the contact springs of the jacks. The sparking points of lightning arresters are oftentimes enclosed in a fibre tube. Fibre sheet, when cut to size, makes a nice base for crystal detectors and other instruments. At least one manufacturer in this country makes a horn for his loud speaker out of thin-weight fibre. Sliders used on tuning coils are sometimes made from fibre. In this case, a square fibre rod is milled out to the proper size so it will fit over the brass rod. The contact of the operator's hand in adjusting a slider of this type causes no loss in the signal strength. In attempting to show the use of vulcanized fibre in radio construction, it has been quite impossible to more than roughly cover the field and a great many small fibre parts are used which it would be impossible to enumerate.

## States Radio Corporation

Manufactures

## RADIO EQUIPMENT

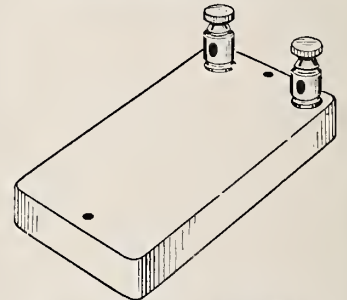

501 S. Jefferson St., Chicago, Ill.

Attention  
Radio Dealers  
and Jobbers  
Sercos Radio  
ProductsSerco Fixed Condensers,  
moulded, 70 centsSerco Fixed Condensers,  
moulded, 90 cents

Serco Crystal Detector, \$1.25

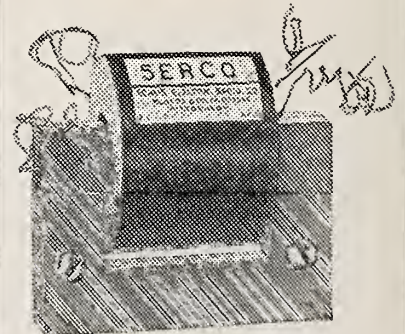
Serco Amplifying Trans-  
former, 10 to 1 ratio, \$3.25We are Manufacturers  
of  
Serco Radio Products

Write for Trade Discounts

## Scheib Elec. Radio Co.

6243 Station Street  
Pittsburgh, Pa.



**"N & K" NAVAL PHONES**

The Herbert and Huesgen Company of New York City have obtained the sole distributing rights in the United States for the "N & K" phones, which were originally designed and constructed by a German manufacturer for naval use. Not being made for commercial use, but as the best possible product for the German naval service, the phones embody the latest items of scientific phone construction.

A detailed description of the phones gives definite proof of the superior workmanship embodied in their manufacture. They are of 6,000 ohms, two-and-three-quarter inches in diameter, with over-sized ear-cups for ease and comfort to the wearer; brass turned cases, nickel-plated inside and out; two-piece magnets in two semi-circular sections; small neat bobbins, rectangular in shape and cloth covered. The soldering and connections are neatly made. The internal metal parts are nickel-plated. A thin metal washer is used as a spacer between the case rim and the diaphragm. Leather head bands are carefully stitched and a six-foot cord is connected to the outside of the cases.

This company has announced its intention of conducting an extensive advertising and selling campaign to inform the public of the many features and quality of the "N & K" phones.

**NEW VACUUM TUBE**

A vacuum tube capable of supplying 100,000 watts, or 200 times the power required for the ordinary radio broadcasting station of 100 mile range, has been developed in the Bell Telephone system laboratories of the Western Electric Company, it was recently announced.

"The significance of these big tubes," says the company, "is that only a very few of them would be necessary to operate the largest radio stations now in service. The combination of vacuum tube and its current supply, it is expected, will be less costly, more rugged and more easily adapted to various wave lengths than any other source of radio power now in use."

The biggest problem was making the tube airtight. W. G. Houskeeper, a Western Electric engineer, solved it by discovering a way to seal copper to glass which would make an airtight joint that would not crack at any ordinary working temperature.

# AMES

## RADIO PRODUCTS

Manufactured by Heinze Electric Company, one of New England's foremost and oldest electrical organizations. Noted for its skill, quality of workmanship and efficiency for nearly one quarter of a century.

All radio products bearing the Ames trade mark are manufactured complete by the Heinze Electric Company and distributed nationally exclusively by Picard Radio Corporation.

Each product is uniformly guaranteed and due to large production prices are generally lower than competing articles of similar quality.

Distributors, jobbers and manufacturers write Picard Radio Corporation, 16 West 46th Street, New York City, at once for special discounts.

### AMES Audio Frequency Transformer



Completely encased in non-magnetic metal, it is perfectly shielded.

Appearance and performance of the Ames Audio

Transformer are second to none. The round casing enables placing of the cores at right angles without detracting from the appearance of the set.

List price, \$5.00  
Write for discounts

### AMES Vario-Coupler

The appearance of this coupler alone is a guarantee of its salability.

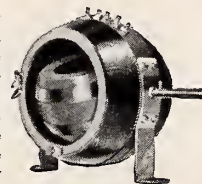

Dealers everywhere pronounce it not only the best in appearance, but in performance.

All connections may be made without soldering if so desired. This is practically an exclusive feature.

Effective range 150-600 meters.  
List price, \$6.00  
Write for discounts

### AMES Variable Condenser

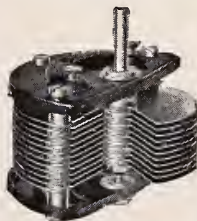

In this condenser special attention has been paid to accurate spacing of the plates and to rigidity of construction, which is achieved by our own pat-

ented brass enameled end mountings. Thus the annoyance of "shorts" between plates has been practically eliminated, as well as unequal variations in capacity.

All insulation is genuine Micarta.  
11 plate, list price.....\$2.00  
23 plate, list price..... 2.50  
43 plate, list price..... 3.00

Write for discounts

### Genuine Picardite Dials

"Fit any shaft"

A real man's size clean-cut dial without our exclusive interchangeable center bushing of brass, made



to fit either 3/16" or 1/4" shaft, thereby reducing the stock necessary to be carried by radio dealers.

Write for sample dial sent post-paid, 25c

List prices 2 1/2" size, \$0.60  
3" size, .75  
4" size, 1.00

Maximum discounts on minimum quantities

Sold only to recognized distributors, jobbers and manufacturers  
Distributed nationally only by

**PICARD RADIO CORPORATION**  
16 West 46th St. New York

These four cards, each 10 x 15 inches, sell the idea of radio to the people who pass your store.



This map, size 19x28 inches, on heavy board, with easel.

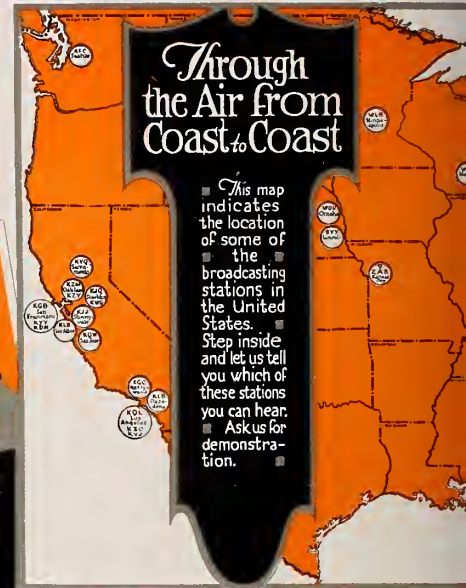

# DEALERS! DEALERS! DEALERS!

This Complete

# 10-Piece Window Display

is YOURS—if you mail the Coupon—NOW!

A COMPLETE display—a real knock-out! Eye catching map, cards and streamers, in bright colors. Hand lettered by Millard, famous New York Artist. Originals worth nearly \$1,000. (See detailed description at right.)

The quantity is limited. Case of "first come, first served." If you want this big, classy, colorful material for your windows you must

act quickly. This announcement may not appear again.

Every dealer who has seen or used this display outfit says, "It pulls 'em to the window quicker than my loud-speaker. Gets 'em interested. 'Nough stuff in this one outfit for two big windows or for two showings in small window."

CLARK & TILSON, - - - 51 E. 42nd Street, New York

# RADIO

This big strip, size 9 x 45 inches, to paste on the glass of your show window.



These four cards, each 10 x 15 inches sell merchandise for you—of any make.



## Detailed Description

This outfit consists of ten pieces as follows:

- 4 Cards, each 10 x 15 inches. Subjects, Dancing Concerts, Bed Time Stories, Time Signals, etc.
- 4 Cards, each 10 x 15 inches. Subjects, Make Your Own Receiving Sets, Complete Radio Outfits, Books and Magazines, and Miscellaneous Parts.
- 1 Large Map, size 19 x 28 inches, showing all of the Broadcasting Stations.
- 1 Large Streamer for Plate Glass, size 9 x 45 inches, (over yard long). Word "RADIO" in lightning effect letters.

Original paintings by Millard, New York Artist, who makes displays for famous Rivoli and Rialto Theatres and many well-known stores.

Lithographed in three bright colors on heavy cardboard. Each piece has heavy easel mounted in back to make piece stand upright in show-window.

All ten pieces, neatly finished and completely packed in single shipping container, ready for mailing to you.

## SEND NO MONEY!

To get this beautiful set of window display material you must mail your order in to us. No salesman will call on you. This is a mail-order proposition. The supply is limited. If you want to be sure of a set,

TEAR OFF AND MAIL THIS COUPON—NOW!

CLARK & TILSON

51 East 42nd Street, New York City

We want one of the 10-piece Window Display Outfits described in the October RADIO DEALER. We believe it will help us get more people interested in Radio, and will greatly stimulate our sales.

Enter our order for shipment as soon as possible; we are sending no money—just this coupon. When the mail man brings our outfit we will pay him \$6, which is to cover the complete cost. It is understood that the outfit is to be sent us prepaid.

Name .....

Address .....

Town .....

State .....

A BEAUTIFUL RECEIVING SET—SIZE 8 x 2¾ x 4 INCHES  
SPECIAL COMPOSITION METAL, CABINET FINISHED IN HIGH GLOSS, BLACK JAPAN, WITH POLISHED NICKEL TRIMMINGS

# “PANDORA”

A GREAT HOLIDAY LEADER WITH A LARGE PROFIT

SELECTIVE TUNING AND EXCELLENT REPRODUCTION, COMPACT AND DURABLE, WORKING PARTS PROTECTED FROM MOISTURE AND DUST

**LIST PRICE**  
**\$5.00**

WRITE FOR ATTRACTIVE DISCOUNTS

**LIST PRICE**  
**\$5.00**

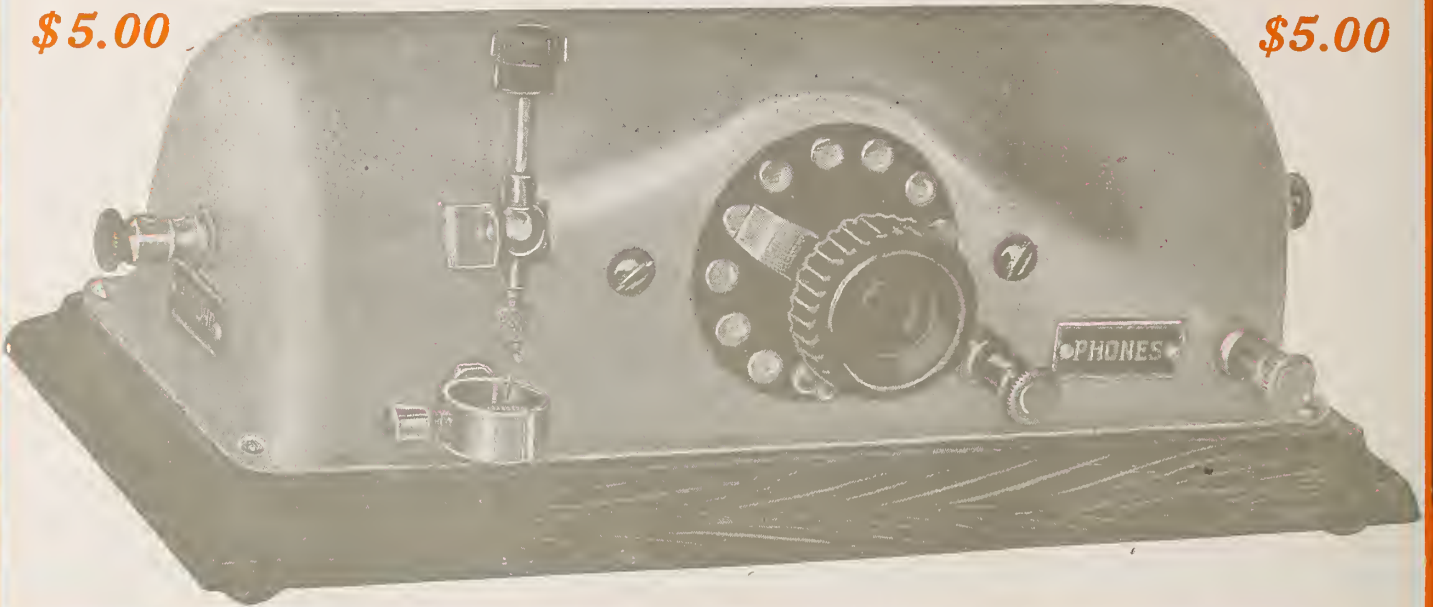

BROOKLYN METAL STAMPING CO., 718-728 ATLANTIC AVE., BROOKLYN, N. Y.



## THE RIGHT SET IN A “SELLING MARKET”

Vacations are over! The public is again taking up Radio—greatest of indoor sports.

They are now radio-wise—they know what they want and at what price. They will buy only machines of highest quality—and STANDARD MERIT.

Be sure the sets you sell will stand the acid test of a “selling market”!

Our unique sales policy will make biggest profits for you. Write for it—Now!

Aerial-A surpasses in selectiveness and strength of tone machines of twice its price. Neat, compact, light in weight and

beautifully finished, Aerial-A sells at sight! A demonstration is a clincher!

Simple and easy to operate. Dealers have no difficulty in selling “Aerial-A.”

Manufactured by

# W.E. Supply & Service Corp.

18 Murray Street, New York

Fisk Building, Broadway at 57th St., New York

**Book Review**

By **BERNARD JEROME FARRELL**

The Editors of the *RADIO DEALER* will be glad to review new publications in this field as they may be issued. Address them attention **BOOK REVIEW EDITOR**, the *RADIO DEALER*, 1133 Broadway, New York City.

**THE A B C OF VACUUM TUBES USED IN RADIO TRANSMISSION.** By E. H. Lewis. Published by Norman Henley Publishing Co., New York City.

The book explains thoroughly and clearly the use of the vacuum tube. It is extremely suitable for the beginner who knows little or nothing about radio and electricity. Starting with an explanation of elementary electrical terms and a list of symbols, the functioning of various vacuum tubes as detector and amplifier is explained completely and in an easily understandable manner. Speech distortion is thoroughly covered and a clear explanation of its elimination is discussed. Many practical circuits are shown and explained. The use of technical terms has been used only after their explanation has been given. The last chapter is devoted to the answering of a number of practical questions.

**THE RADIO EXPERIMENTERS' HANDBOOK.** By M. B. Sleeper. Published by Norman Henley Publishing Co., New York City.

For the amateur who is experimentally inclined this book should prove a valuable text book. It covers in a clear and concise manner the "Why" of radio, what makes it work, how to build simple transmitting and receiving sets. In the chapters on radio receivers the simple crystal, the simple tube and the regenerative types of receivers are explained in some detail. The questions of antenna is covered thoroughly and numerous suggestions are offered for experimentation. For those who desire to construct transmitters there is sufficient information given for the complete construction of a spark set, a C W set and a small radio telephone set.

**RADIO, HOW AND WHY.** E. G. Macay. 25 cents. 47 pages. The Radio Handbook Publishing Co., Philadelphia.

"This book is dedicated to the juvenile 'fan' and his Dad, who want to know how and why their receiving set works." This dedication explains the *raison d'etre* of this interesting little handbook.

**MANUFACTURERS — JOBBERS — DEALERS**



PLACE YOUR ORDERS FOR

**EBY BINDING POSTS**

**NOW**

Commander "H" Ensign "H"

Sergeant "SS" Buddy

To satisfy the tremendous demands for EBY posts, we have arranged with responsible jobbers everywhere to carry a complete stock.

Write for Bulletin 11 and latest discounts

**THE H. H. EBY MANUFACTURING COMPANY, PHILADELPHIA, PENNA.**

**WALD ELECTRIC COMPANY**

Manufacturers

**"MICROSTAT"**

A VERNIER THROUGHOUT ITS RANGE

INDISPENSABLE FOR NEW ARMSTRONG-SUPER-REGENERATIVE CIRCUIT, WILL ELIMINATE NOISES USUALLY MISTAKEN FOR STATIC

7 OHMS

2 AMPERES

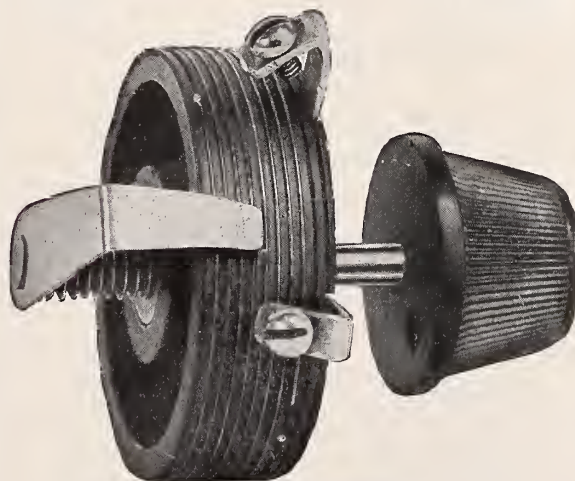

**STEPLESS FILAMENT CONTROL**

List Price

**\$1.50**

An Instrument of Merit

(PATENT PENDING)

**HIGH HEAT RESISTING MOULDED V.T. SOCKET PHOSPHOR BRONZE CONTACT SPRINGS, 60c LIST.**

DEALERS AND JOBBERS—WRITE FOR DISCOUNTS AND LIST OF RADIO PARTS WE MANUFACTURE

Sales Department

**LOUIS A. STAFF CO.**

1755 Broadway

NEW YORK



**Worth More, Yet  
Costs Less**

\*\*\*

**"TRUE-TONE" Phones Perform**  
Perfectly with all types of apparatus. Every factor of Scientific Design is coupled with **3000 Ohms Resistance.**

**Backed by a Guarantee—**

\*\*\*

**JOBBERS—DEALERS**

"True-Tone" Phones assure  
**Quick, Profitable Turn-Over**  
Our Advertising Backs You Up

Write or **\$5.00**  
Wire— List  
**NOW** 3000  
Ohms

**TRUE-TONE RADIO MFG. CO.**

186 No. La Salle Ave., Chicago, Ill.

**The Essentials of a  
Successful Radio  
Business Are  
Complete Sets  
and Phones**

We are now making deliveries  
of

- Clapp-Eastham H-R—H-Z. \$80.00
- Grebe CR-9..... 130.00
- Grebe CR5-RORK..... 135.00
- Westinghouse RC..... 132.50
- Westinghouse RA-DA.... 138.00
- Frost Fones No. 162..... 5.00
- Murdock, No. 56, 2000  
ohms ..... 5.00

Send for our complete catalog  
of standard makes of Radio Sets,  
Parts and Supplies, and Dealers'  
Discounts. We have a big stock  
for you to draw from.

**Julius Andrae & Sons Co.**

*In Business Since 1860*

—114 Michigan St., Milwaukee, Wis.—

Mr. Macay starts with the history of Radio from the Electromagnetic theory of light to the present time, and unfolds the steps by which Radio attained its present growth. The fundamentals of Radio are then taken up, and by the aid of diagrams the various kinds of currents, resistance, capacity, and inductance are studied.

Mr. Macay's book leads the fan gradually into the study of circuits, which are fully explained by the use of a multitude of circuit drawings and cuts of various parts. The Radio Laws and Regulations of the United States, and the regulations of the fire underwriters, are included in the volume.

WIRELESS TELEGRAPHY AND TELEPHONY SIMPLY EXPLAINED. By Alfred P. Morgan. Published by the Norman Henley Publishing Co., New York City.

This is a most comprehensive treatise on the subject, and a close study of its pages will enable one to master all the details of the wireless transmission of messages. The author has filled a long-felt want and has succeeded in furnishing a lucid, comprehensive explanation in simple language of the theory and practice of wireless telegraphy and telephony.

This book treats the subject from an entirely new standpoint. It is well illustrated by over one hundred and fifty interesting photographs and drawings. All diagrams have been made in perspective, showing the instruments as they actually appear in practice. The drawings are carefully keyed and labelled. Many of the photographs are accompanied by phantom drawings which reveal the name and purpose of each part.

**WHITALL CATALOG**

The Whitall Radio Company, of Springfield, Mass., have issued a catalog that is both interesting and complete. The first few pages are devoted to an explanation of the principles of radio and a short history of the progress of the company, together with a list of the popular broadcasting stations, a key to symbols used in drawings and the international code and conventional signs. The catalog shows hook-ups of various sets from a two-slide crystal set to a detector and two-stage amplifying set, giving with each hook-up a list of the equipment necessary for assembling and the price of the respective parts. The reader can readily determine which set is best suited to his taste and pocketbook

**100% Radio**

**Altadena Radio Laboratory**

**560 E. Colorado Street  
Pasadena, Calif.**

*Jobbers of All Standard Radio  
Apparatus, including*

- A-C Electrical Mfg. Company
- Acme Apparatus Company
- Adams-Morgan Company
- American Hard Rubber Company
- Automatic Electrical Devices Company
- Nathaniet Baldwin, Inc.
- L. S. Brach Supply Company
- Burgess Battery Company
- Blank Radio Call Book
- Central Radio Laboratories
- Edison Storage Battery Company
- Everett Electric Corporation
- Federal Telephone & Telegraph Company
- General Apparatus Company
- General Radio Company
- Jewell Electrical Instrument Company
- Colin B. Kennedy Company
- Magnavox Company
- Karlowa Radio Company
- Parkin Mfg. Company
- Radio Corporation of America
- John A. Roebblings Sons Company
- Splitdorf Electrical Company
- Thordarson Electric Mfg. Company
- C. D. Tuska Company
- Western Electric Company
- Westinghouse Electric & Mfg. Company
- Weston Electrical Instrument Company
- The Wireless Shop

**PAUL FRANKLIN JOHNSON**

**THE KENTONE RADIO  
AMPLIFYING HORN**



Made of brass, highly polished and nickel plated. Fifteen inches high, six inch bell

**RETAILS FOR \$6.00**

Write for particulars

**F. C. KENT CO.**

**IRVINGTON**

**NEW JERSEY**

without spending much time shopping for this information. The latter half of the catalog is devoted to parts of various makes in detail. It permits the reader to decide just what set is best suited to his needs and all that remains for him to do is to place his order. It is seldom that a more complete, yet compact, catalog finds its way to the dealer's store.

CONSTRUCTION OF RADIOPHONE AND TELEGRAPH RECEIVERS FOR BEGINNERS. By M. B. Sleeper. Published by the Norman Henley Publishing Co., New York City.

The man who wants to feel the real thrill of accomplishment, and who is not satisfied in the merely making use of what others have done for him, builds his own radio apparatus. Experimenters and novices must take their instructions from reliable sources, however, to assure the success of their work. Radio men can follow the data in "Radiophone and Telegraph Receivers" in full confidence because each piece of apparatus described was first made, tested, and found efficient before the final design was accepted, according to the publishers. Special receivers, both crystal and audion, are shown in detail. Regenerative circuits as well as audio and radio frequency amplifiers are described and illustrated by clear photos, diagrams, and working drawings prepared especially for the novice and the man who wants to receive what is being broadcasted daily by the broadcasting station. A special feature is the phonograph type radio set and the loud speaker which is suitable for installation in the parlor or living room of the home.

EXPERIMENTAL WIRELESS STATIONS. By P. E. Edelman. Published by Norman Henley Publishing Co., New York City.

The theory, design, construction and operation is fully treated, including Wireless Telephony, Vacuum Tube, and quenched spark systems. The new and enlarged edition is just issued and is up to date, correct and complete. This book tells how to make apparatus to hear not only all telephoned and telegraphed radio messages, but also how to make simple equipment that works for transmission over reasonably long distances. There is a host of new information included. This volume anticipates every need of the reader who wants the gist of the art, its principles, simplified calculations, apparatus dimensions, the understandable directions for efficient operation. Vacuum tube circuits; amplifiers; long-distance sets; loop,



No. 410. Cut  $\frac{3}{4}$  Size.  
Pat. Applied For

"THE BEST IN RADIO"



This new panel mounting Rotary Dial SWITCH is absolutely the BEST. Just what you're looking for. Fully Guaranteed. Money back if you are not satisfied.

LIST PRICE \$1.00

Very Attractive Proposition to Dealers and Jobbers

**VIRGINIA RADIO CORPORATION**

Manufacturers—Jobbers  
Charlottesville, - Virginia

**MANUFACTURERS!**

If you have not seen a copy of

**The Radio Dealer Weekly**

write for one today

Address: **The Service Bureau  
The Radio Dealer**

1133 Broadway

New York City



2200 Ohms

List Price

Only

\$9.00

"East and West, the Globe is Best"

**GLOBE RADIO HEAD PHONES**

Highly sensitive Matched receivers Natural in tone. Each receiver tested by radio. Light weight (11 oz.). Comfortable to wear. Specially designed adjustable headband. Will not distort signals when amplified. Articulation is perfect.

There are many types of head sets on the market but not too many good ones. The GLOBE RADIO HEAD SET incorporates a knowledge of acoustics not possessed by other companies. It embodies correct design with the best of materials.

THE GLOBE PHONES ARE FOR THOSE WHO DISCRIMINATE.

Ask about the Globe Antenna Attachment Plug for using electric light wire

**GLOBE PHONE MFG. CO.**

EARL C. HANSON, Technical Radio Expert

Reading, Mass., U. S. A.

# ANTENELLA



Forms perfect receiving aerial.

No outside wires necessary.

Plugs into any light socket.

Uses no current.

Eliminates most static.

Saves cost of lightning arrester.

Receives in any room of the house.

Gives sharper tuning than an outside antenna.

The New York Mail says: "An exceptionally neat plug, well designed and well constructed. Awarded the Evening Mail Certificate of Excellence."

**Price \$2.00**

**Jobbers: Wire or write for Proposition**

*Manufactured only by*

**Chas. Freshman Company, Inc.**  
Dept. RD

290 Hudson St. New York City

coil, and underground receivers; tables of wave-lengths, capacity, inductance; such are a few of the subjects presented in detail that satisfies. It is independent and one of the few that describe all modern systems.

**CONSTRUCTION OF NEW TYPE TRANS-ATLANTIC RECEIVING SETS.** By M. B. Sleeper. Published by the Norman Henley Publishing Co., New York City.

In addition to the listening to ships and broadcasting stations on short wave-lengths there is a peculiar fascination about listening to the high-power telegraph stations of England, France, Germany, Russia and Italy as well as those located in the Pacific Ocean and the Oriental Countries. The sending is very slow, a feature of assistance to the beginner in telegraphy. Several types of receiving sets for this task are described. Detectors, amplifiers, oscillators, etc., for long-distance reception are also described. Suggestions for the operation of relays by the signals and the reproduction of them on a phonograph are given. In addition there is some valuable data on home made wave-meters for testing and experimenting.

## LEFAX HANDBOOK

Lefax, Incorporated, of Philadelphia, report the sale of ten thousand copies of their loose-leaf Radio Handbook, and are following up this useful handbook with a file of neat "Apparatus Sheets" that should prove very useful to the trade. This apparatus file is made up of separate sheets that tell in a clear and concise manner the equipment manufactured by various radio concerns. It is the intention of the company to list only those firms whose apparatus meet a definite standard. The file is continually added to so that the buyer is well informed as to what new and worth-while equipment is on the market.

**HOW TO MAKE COMMERCIAL TYPE RADIO APPARATUS.** By M. B. Sleeper. Published by the Norman Henley Publishing Co., New York City.

For the man who builds and designs his own equipment there is a lot of satisfaction in knowing that his apparatus is comparable to that of commercial design. The book describes in detail many commercial types of transmitting spark and vacuum tube sets, both telephone and telegraph and receiving equipment of all kinds. The experimenter will be able to get a world of ideas for the design and construction of his next piece of radio equipment from the very clear descriptions and the many clearly illustrated figures.

TRADE **HPMCO** MARK

*Reg. U. S. Patent Office*

Molded fixed Condensers are best by test. The newcomers to radio invariably want this type. Experienced amateurs demand them as the molding process.

**No. 20  
Fixed Condenser  
70c.**

insures permanent capacity.

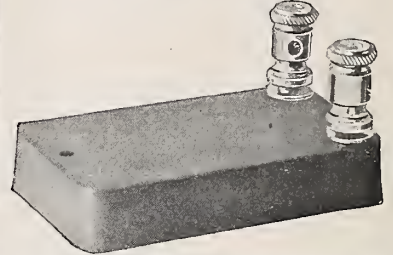

Duplex Binding Post Clips are just what your customers demand when using two pairs of headsets. 5c each. Each Clip adds two extra connections.

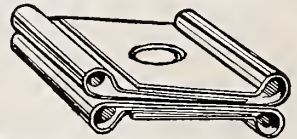

*Write for Our Liberal Discounts.*

**HEDDEN PLACE MACHINE CO.**

44 HEDDEN PLACE  
EAST ORANGE, N. J.



**Dealers All Over the  
Country Handle Our**

**STANDARD  
RADIO GOODS**

**OUR TRADE PRICES  
AFFORD GOOD MARGIN**

*Write for catalogue  
and price list*

**WIENER WIRELESS  
SPECIALTY COMPANY**

21 ACADEMY ST.  
NEWARK NEW JERSEY

# "BECO"

**RADIO FREQUENCY  
SETS**

145 TO 600 METERS

**\$160.00**

**"BROADCASTER"  
MODEL VARIO METER**

Lightest and Most  
Compact on the Market

**"RIEHL"**

**AUDIO FREQUENCY  
TRANSFORMERS**

**\$4.50**

**HIGH GRADE CONDENSER  
PLATES**

**DUO-LATERAL COILS**

**BISSELL  
ENGINEERING CO.**

161-67 WEST 64th ST.  
NEW YORK



DESIGN DATA. By M. B. Sleeper. Published by the Norman Henley Publishing Co., New York City. There are few books on the market that deal with the designing of radio transmitting and receiving sets without the use of advanced mathematics. The system used is that which permits an intelligent effort in the construction. Many experiment aimlessly until they strike upon something. With the use of this book the experimenter and designer are taken step by step through the elementary stages of approved design. When they have finished only the first twenty pages they are in a position to work with a more intelligent and directive effort. There is not a single freak diagram in the book.

**KING RADIO CATALOG**

Among the many catalogs which have come to the office of THE RADIO DEALER, one that stands out as distinctive and efficient is that of the King Sewing Machine Company of Buffalo, N. Y. The catalog has a sturdy and attractive cover and is of loose leaf type. Sheets are issued at various periods that are to be included in the catalog in the form of bulletins dated and numbered for the convenience of the reader.

**ADD-A-UNIT RECEIVER**

The Sieffert Radio Laboratories of Evansville, Indiana, are manufacturing a receiving set that is of the progressive unit type which has been appropriately named Add-A-Unit. The units consist of Variometer, Variocoupler, Detector, Single and Two Stage Amplifiers. Separate variometers and variocouplers are produced under the Sieffert name together with a special six volt "A" battery.

**A. R. R. L. AMATEUR TESTS**

Announcement has been made by F. H. Schnell, traffic manager of the American Radio Relay League with executive headquarters at Hartford, Conn., that the Third Series of Trans-Atlantic Tests will be conducted by that organization in conjunction with the Wireless Society of London. The tests are to be conducted from December 12th to 31st, inclusive.

There is to be an elimination contest held from October 25th to November 3rd inclusive to determine which stations will be permitted to transmit to the foreign amateurs, one requisite for qualification being that the transmitter must have been heard over an air line distance of 1,200 miles.

**JOBBERs and DEALERS**

*Our Motto: Service and Quality*

25 years in the Electrical field. We are in full production on 50 Standard Radio parts. Engineered and designed right, and manufactured under minimum overhead.

Our prices will interest you

*Write for Catalog No. 50*

**ALDINE RADIO & MFG. COMPANY**  
 Dept. B10                      Aldine Square                      Chicago, Ill.

**WHAT HAPPENS  
 When You Get Our Franchise!**

WE have built our business on the sound belief that it is better to supply a few good dealers, with all they need than it is to take orders from Tom, Dick and Harry and fill as many of these as high speed production and not too careful methods will permit.

Instead—we make our retail organization fit our actual production. We work ceaselessly to increase production; yet we work just as ceaselessly to see that every product of this increased production will mean a satisfied user and an enthusiastic and permanent dealer.

In the face of the terrific demand for Radio Sets, ours in particular, it is no easy matter to turn down orders. But we find that it pays us extremely well. Every one of our retailers knows that all of his orders will be filled on time. And he knows that every piece of Radio apparatus will be of highest quality, fully inspected, rigidly guaranteed by us and worthy of his own personal endorsement.

Each week sees an increase in our production of the right kind of Essential Radio parts and Complete Sets. Each week we have a real connection to offer a few good dealers. It will pay you to learn all details of our remarkable proposition. Write us NOW. Be in line to get our service when our production warrants this step.

*We are one of America's soundest financed manufacturing concerns. To our dealers this means responsibility, permanence and a continually more valuable and profitable connection.*

The Public Knows  
 The Value of This  
**TRADE MARK**  
 This distinguished mark on any Radio Apparatus means "A Quality Product Worth More Than Its Price." It makes steady customers for the retailer and for us.



*Makers of Radio Quality Products*

**GRAND RAPIDS - - MICH., U. S. A.**

## ZETA RADIO FREQUENCY TRANSFORMER

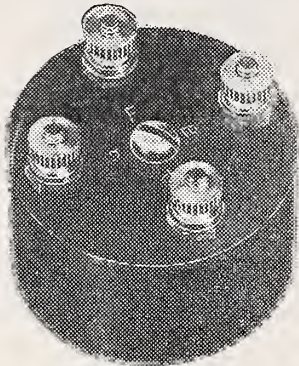

SCIENTIFICALLY TESTED  
FOR ALL CHARACTERISTICS

**LIST PRICE, \$3.50**

*Satisfaction Guaranteed*

**JOBBERs and DEALERs**

WRITE FOR DISCOUNTS

**CLARK & TILSON**

51 East 42nd St. New York

# Conquerer Radio Set Built by Lewis DeRoy

The Lewis-DeRoy Radio Corporation of New York City have presented to the market a receiving set that is the product of their knowledge gleaned

set are the shielded bakelite panels solid mahogany piano finish cabinet, balanced type single bearing variable condensers, special designed air-

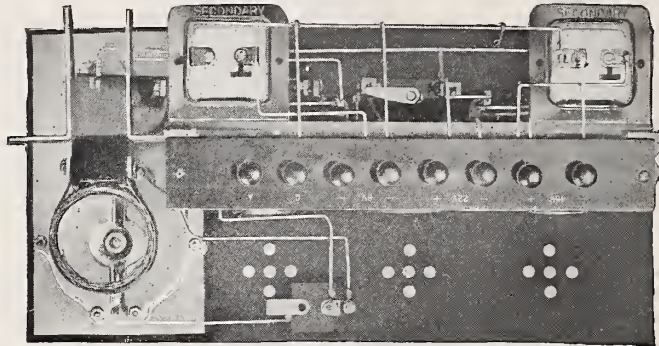

The Conqueror

from 17 years' experience in radio, under the appropriate name of Conquerer. The set is attractively and efficiently constructed and simple to operate. Among the features of the

cooled rheostats, sockets with positive locked contacts, transformers that give volume without distortion. A wave length range of from 150 to 15,000 is claimed for the set.

## Stories in the Air

### W O R Has a Short Story Contest as Feature

Short story writers, past and present, professional and amateur, have been submitting short stories for the past two weeks in a contest arranged by WOR, the radio broadcasting station of L. Bamberger & Co., of Newark, N. J.

There were no restrictions as to the subject matter of the short stories eligible for this contest, except that the stories should be short enough to be read in twenty minutes.

The winning story will be broadcasted just as soon as the judges have made their selections.

Score another for radio.

### VERNIER RHEOSTAT

The Cutler-Hammer Manufacturing Company of Milwaukee, Wisconsin, are manufacturers of the Vernier rheostat now on the market. The instruments comprise the result of the long experience of Cutler-Hammer in the manufacture of electric controlling devices. The material used in the rheostats is the best that good usage ordains and the workmanship is of the best.

## The Gelman Plug



The GELMAN UNIVERSAL RADIO PLUG fills a long felt want for a simple substantial plug which can be used with telephone cords having pin tips, spade tips or plain wire ends. All METAL PARTS heavily nickel plated. NO SOLDERING NECESSARY. List price, \$1.00.

AGENTS WANTED THROUGHOUT THE U. S.

Sample Sent C.O.D. Upon Request

Jobbers and Distributors

Write for Our Proposition

**S. S. NOVELTY CO.**

255 Bowery

New York, N. Y.



## 24 Hour Service!

A reality — your order shipped within one day after we receive it. No needless delay—no broken delivery promises to your customers. Our stock is large and complete — standard, well known apparatus only being carried. Each article accurately tested in our own laboratory by expert radio engineers.

We are distributors for the Radio Corporation of America and also handle everything necessary for the construction and operation of the Armstrong Super-Regenerative Receiver.

*Write for our booklet!*

**Radio & Mechanical  
Trading Corporation**

23 Warren Street, New York City

Phone Barclay 0926

**RELY ON QUALITY**

(Continued from page 45)

parts made by manufacturers of recognized merit.

The writer has noted in getting around to the stores of radio dealers that dealers were willing to sell an inferior article when they knew it would not give proper satisfaction and where, with good salesmanship and right instruction the buyer would get better results and lasting satisfaction by making his set with quality products, and a better sale would result and a satisfied customer assured the dealer.

Therefore, it is necessary for all manufacturers of radio parts and sets of quality to have their salesman start a "campaign" of instruction for the dealer. They should be taught to recognize the importance of handling only well known makes of standard quality and pass this on to the consumer who will profit thereby in the satisfaction derived from their sets.

**LEE PRODUCTS COMPLETE**

The Lee Radio Corporation of Haddonfield, N. J., are producing several combinations of sets that include everything from a simple crystal detector set to a two stage audio-frequency amplifier. The sets are attractively built and enclosed in solid mahogany cases and some are also of the panel type.

The single circuit non-regenerative receiver and bulb detector is mounted on a formica panel and enclosed in a solid mahogany case. Two aerial binding posts are provided, one for long and the other for short wave lengths. By connecting the grid condenser binding posts and hooking in a radio frequency transformer, the detector bulb may be used as a radio frequency amplifier.

The company claims that this instrument has received 'phone messages over a distance of more than 500 miles.

**THE ACMESTAT**

The Acme Electric Company, of Milwaukee, manufacture a vacuum tube filament control rheostat known as the Acme-stat which is a radical change from the popular wire resistance rheostat that is found on the market today. The principle of operation is a resistance material in which is placed a crumbling spring operated by a screwed knob. A feature of the Acme-stat is the addition of a switch which permits the resistance setting to remain in position when the current is turned off and the set not in use.

ESTABLISHED 1909

**DEPENDABLE  LINE**



**NO. 41 VARIOMETER**

**INSTRUMENTS  
WITH  
100% RADIO  
EFFICIENCY**

*Correspondence Solicited*



**NO. 42 VARICOUPLER**

**THE EASTERN SPECIALTY CO.**

3551 N. FIFTH STREETPHILADELPHIA

# STOP-LOOK-WRITE

**DEALERS, JOBBERS AND MANUFACTURERS**

Before placing orders, write us first and get samples and our big discount sheet.

|                          | List   |                       | List   |
|--------------------------|--------|-----------------------|--------|
| Condensers 43-Plate..... | \$3.50 | Turney Head Sets..... | \$6.50 |
| “ 23- “ .....            | 2.75   | Dials 3" .....        | .75    |
| “ 11- “ .....            | 2.25   | Variometers .....     | 3.50   |
| “ 7- “ .....             | 2.00   | Varicouplers .....    | 3.50   |
| “ 3- “ .....             | 1.50   |                       |        |

**SPIRO BROTHERS, Manufacturers and Distributors**  
519 Real Estate Trust Building Philadelphia, Pa.

**LATEST and MOST POPULAR**

# Radio Books

|                                                                                                                                                                         |        |
|-------------------------------------------------------------------------------------------------------------------------------------------------------------------------|--------|
| <b>Radio Hook-Ups</b> , by M. B. Sleeper .....                                                                                                                          | \$ .75 |
| <small>An indispensable book to the radio amateur who designs or builds his own receiving apparatus.</small>                                                            |        |
| <b>Radio Design Data</b> , by M. B. Sleeper .....                                                                                                                       | .75    |
| <small>A book giving tables and data for designing receiving and transmitting apparatus.</small>                                                                        |        |
| <b>Construction of New Type Trans-Atlantic Receiving Set</b> , by M. B. Sleeper ..                                                                                      | .75    |
| <small>Tells how to listen to the high-power telegraph stations of foreign countries.</small>                                                                           |        |
| <b>Construction of Radiophone and Telegraph Receivers for Beginners</b> , by M. B. Sleeper .....                                                                        | .75    |
| <small>Tells in detail the building of radio apparatus.</small>                                                                                                         |        |
| <b>How to Make Commercial Type Radio Apparatus</b> , by M. B. Sleeper ..                                                                                                | .75    |
| <small>Describes in detail many commercial types of transmitting spark and vacuum tube sets, both telephone and telegraph and receiving equipment of all kinds.</small> |        |
| <b>Wireless Telegraphy and Telephony Simply Explained</b> , by A. P. Morgan .....                                                                                       | 1.50   |
| <small>A book the Radio experimenter cannot afford to be without.</small>                                                                                               |        |
| <b>Experimental Wireless Stations</b> , by P. E. Edelman .....                                                                                                          | 3.00   |
| <small>A book describing all modern improvements.</small>                                                                                                               |        |
| <b>A B C of Vacuum Tubes Used in Radio Reception</b> , by E. H. Lewis ..                                                                                                | 1.00   |
| <small>A book explaining in detail all about vacuum tubes.</small>                                                                                                      |        |

*FREE! Catalogue of Wireless, Automobile and Other Books Sent Free on Request*

**The Norman W. Henley Publishing Co.**  
2 West 45th Street, New York

**Liberal Discount to Supply Houses. Write for full particulars and dealer's proposition.**

# Oranola Perfection Talking Machine De Luxe

Properly Perfected Combination Radio and Talking Machine Produced  
by Talking Machine Makers of Genuine Repute

By R. C. HULL

Music is both a comfort and solace, aye, it is a universal language which reveals inspiring thoughts to an inner human consciousness, and when music can be brought to our homes from hundreds of miles distant, without wires—the wonder is supreme.

That's the thought that comes to mind as one views the Oranola.

It is not necessary to make many complimentary statements about the Oranola, regarded by many as "the perfect talking machine" because "seeing is believing" and I have seen and heard the Oranola.

These perfect receiving sets, carrying the title, Oranola, are of three different designs, ranging in retail price from \$150 to \$450.

The model known as "De Luxe" is hailed as the utmost in present day radio receiving sets, inasmuch as it is a combination radio and talking machine. Each is complete in itself. Coupled it is a masterpiece production. And so the "De Luxe" title is no misnomer.

The Oranola De Luxe is of the Console type, Cabinet, mahogany, piano finish and as a piece of furniture would be considered an ornament in any drawing room.

So wonderful are the sounds that are emitted from this radio talking machine that listeners are not certain they're not hearing the real concert—rather than a reproduction.

The Oranola, it is apparent, makes for another era in radio for it couples the phonograph with radio definitely and indicates the path of success to many phonograph manufacturers. The Oranola is a pioneer in this and congratulations should be extended the makers for their activities.

A brief description of the Oranola, illustrated herewith, will not be amiss.

The Oranola includes radio and audio frequency transformation of the energy received from the transmitting stations, so proportioned that the volume of sound is obtained without distortion. The current supplied to the vacuum tubes is controlled by a single push button switch.

Tuning is accomplished by a single adjustment. Signal strength is regulated by a potentiometer gradually to

a maximum with a detector and filament current controlled by rheostats.

Wave length adjustment is 200 to 500 meters.

Binding posts and connections are provided for outdoor aerial. Connections are provided for battery charge, so that batteries may be recharged without removal from the cabinet.

The Oranola was first displayed to the public at the recent National Merchandise Fair, at New York. The models were properly admired and the host of visitors were treated to real entertainment—for the Oranola does produce perfect music.

One reason for the successful Oranola is due to the knowledge had by the makers, the Perfection Talking Machine Company, of 228 Seventh Avenue, New York City. This organization has been identified with the talking machine industry since its inception and have had large experience in sound reproducing machines.

The Oranola is built by these men—these proven experts in the talking machine field and is not the result of any haphazard experimentation.

The president of the company making the Oranola is Edward B. Jordan, Jr., and Edward B. Jordan is its treasurer. The latter gentleman is well known in fraternal circles, being the founder of the famous Lu Lu Temple of Philadelphia and of which body he was its first Potentate.

## CROSLY STATION OPEN

The new broadcasting station of the Crosley Manufacturing Company, of Cincinnati, Ohio, was officially opened on September 22nd, with an elaborate program. Powel Crosley, Jr., president of the company, and Mayor G. P. Carrel were among those who addressed the listeners of WLW's powerful station.



The Oranola Combined Set

## New Distributor

### Central States Engineering Company to Operate on Large Scale

J. Donald Vandercook who has been identified with radio since 1907, in the commercial end as manufacturer and retailer since 1914, has organized the Central States Engineering Company, 184 West Washington Street, Chicago.

This organization is to represent manufacturers of non-conflicting lines and will act as a distributor throughout the Middle West territory.

Speaking to a RADIO DEALER representative, Mr. Vandercook said:

"Briefly, my plan is to secure the representation of your products and a few other non-conflicting lines, and actively promote their wholesale distribution to my present clientele and to all other prospects in this territory. This I propose to do through several methods.

"First, by personal contact with my present clientele.

"Second, by circularizing a list of over 2600 potential purchasers in a manner that will 'tie-up' with the national advertising of the products, and as this list is one which I personally compiled during my recent trip, it contains the very minimum of 'dead timber' and the returns from it will assuredly be greater than usual.

"Third, I have associated with me several young men of real sales ability, who are also radio technicians.

"This organization will personally follow up all leads secured from the circularizing, not only to take orders but to assist these new clients in a semi-technical way. This sort of service has proved its worth many times and will hold the client as a regular purchaser.

"Fourth, within a short time I will have a centrally located Sales Office in Chicago, and in addition to the above I will exhibit all products I handle at every important radio show or exhibition in this territory."

Mr. Vandercook, it might be stated, also is an officer in the Technical Development Section of the Signal Reserve Corps, U. S. A., and is also an Associate of the Institute of Radio Engineers.

### A GOOD THING

Mitchell-Rand Manufacturing Co., of New York City, employ the slogan "Everything In Insulation" and prove this slogan to their customers and to those who receive the circulars and bulletins. The best thought for today: Ask to be placed on the Mitchell-Rand mailing list.

## "TUNING IN"

To the right tune is very simple when your connections are soldered with the

### NEW "POST SOLDERING IRON"

(The iron with the platinum heating unit)

Removable Soldering Tip

Designed especially to cover every requirement for delicate work.

The smallest practical-efficient instrument on the market.

Attaches to any socket, Universal Current.

Fully Guaranteed.

From your jobber or write

POST ELECTRIC COMPANY

30 EAST 42nd STREET

Office 509

NEW YORK

(1/2 actual size)  
List \$6.00

## SPECIALTY SERVICE COMPANY

Manufacturers of

### RITE RADIO PRODUCTS

Distributors for

### LAWSAM LINE

### OF QUALITY RADIO PRODUCTS

and Other Standard Equipment

Write for Prices and Discounts

Cor. 4th Ave. and Pacific St.

Brooklyn, N. Y.

Want to Buy Radio Equipment?

Ask Our Service Bureau

See Page Eighteen

## KEYSTONE

FILAMENT RHEOSTAT

V. T. SOCKET

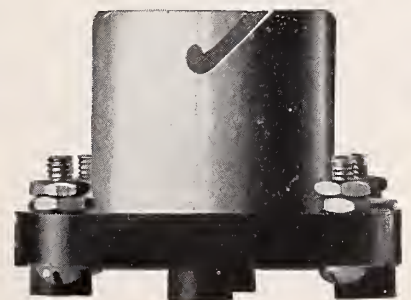

Resistance, 6 Ohms.  
Carrying Capacity, 1 1/2 Amps.  
Base, made of black moulded Bakelite.  
All parts made of brass and nickel plated.  
Large Knob, and polished pointer.  
List Price, \$1.00

BASE and feet of moulded natural color Bakelite.

Contact Springs, Heavy Phosphor Bronze.

Heavy binding post.

Tube of heavy, polished Aluminum.

All brass parts nickel plated.

List Price, 90 Cents

Dealers and Jobbers, wire or write for discounts—Immediate Delivery

MANUFACTURED BY

### KEYSTONE RADIO COMPANY

GREENVILLE, PENN.

Dept. D.

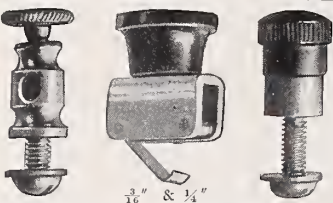

**CRYSTALS**      **GALENA SILICON**

CRYSTAL DETECTORS      List \$2.00  
 CRYSTAL RECEIVERS      List \$9.00

**RADIO APPARATUS CO.**  
 6600 Hamilton Ave.      Pittsburgh, Pa.

**Prompt Deliveries**

Jet black high finish panels, .01 per inch, 3" nonbreakable, flexible dial with knob .....\$ .70  
 3 1/2" Vario-Coupler.. 2.00  
 Complete Receiving Set, \$25.00

**Beau Ivorie Novelty Co., Inc.**  
 127-129 Van Buren Street  
 Newark, N. J.



**THE BEST HEAD SET AS YET LIST \$5.75**

Distributors—Jobbers  
 Dealers—Write

**STANDARD ELECTRIC MFG. CO.**  
 843 Broad Street  
 NEWARK, N. J.

**SPRAGUE RADIO MODELS**

The Sprague Radio Corporation of New York City, is manufacturing several models of radio receiving sets that bring to the radio field a pronounced touch of the artistic in so far as cabinet design is concerned. The sets themselves are the result of the experience the company has enjoyed in designing and building many successful transmitting stations for marine and land service, and as one of the principal suppliers of the Government and commercial companies. Sprague home sets are manufactured with all the care and precision used in the construction of their fine professional equipment.

Besides the set enclosed in a Queen Anne Period Console, the company markets a sectional receiving set consisting of a detector battery case, three stage amplifier and a Spragaphone loud speaker. The assembled units occupy comparatively little room and are mounted two units long and two high.

The officers of the company are C. W. Sprague, president; A. W. Duckett, secretary and treasurer. W. H. Knowles, well known in radio circles is in charge of the factory at Portchester, N. Y. Other men in charge of radio at the company's factory are H. Shoemaker and George Farrand, who were for many years connected with Marconi in the capacity of consulting engineers.

**SALES TIPS BY RADIO**

The latest trade promoting stunt devised by the Commerce Department to get the jump on America's competitors for the world's market is the broadcasting by radio of the inquiries for American goods coming into the Bureau of Foreign and Domestic Commerce from consuls, commercial attaches and other government representatives in foreign countries.

Selling American goods in foreign markets through the help of ether waves can be readily extended to other parts of the United States, in the opinion of Dr. Julius Klein, Director of the Bureau of Foreign and Domestic Commerce. Director Klein pointed out that his Bureau maintains 34 district and cooperative offices in this country, in addition to the Boston branch. The sending out of the information in each case is a problem for the local manager to arrange with some nearby broadcasting station, as all of them have been authorized to undertake the work.

**RADION HARD RUBBER PANELS**  
 Cut to Any Size  
**DISCS, WASHERS, BUSHINGS, ETC.**  
 Made to Order  
**New York Hard Rubber Turning Co.**  
 212 Centre Street, N. Y. C.

**WOOD PARTS**  
 Variometers, Cabinets, Rotors, Coil Ends, Etc.  
 Mill Established 1849  
 Lowest Prices  
**THE R. C. MILLS**  
 Executive Offices 30 E. 23d St., N. Y. C.

**RACONY PLUG**  
 Genuine Mica Dielectric      \$3.00      Made to Stand 2500 Volts  
 4 Outlet Plug with 14 Combinations  
**THE RACONY CORP.**  
 799 Broadway      New York City

**MANUFACTURERS—DISTRIBUTORS**  
 You Haven't Seen Our Line of  
**VERNIER and VARIABLE CONDENSERS**  
 Tell us who and where you are and we will show the best line on the market.  
**ELECTRIC PRODUCTS CO.**  
 11 Pemberton Sq.      Boston, Mass.

**American Radio & Electric Co.**  
 1133 Broadway      New York City  
 WRITE FOR OUR CATALOG  
 JUST OFF THE PRESS

**GANAERITE**  
**Detector Crystals**

Twenty years of practical mineralogy gave us the material to produce the highest quality crystal.

We are now undertaking the largest single order for mounted crystals in the market.

We individually test and guarantee to replace or refund on any unsatisfactory Ganaerite crystal.

**The Harris Laboratory**  
 26 Cortlandt St., New York City

**Washington Waves**  
By 3BSB  
DX Transformer

The Radio Instrument Company, of this city, have had wonderful success with the DX radio frequency transformer, which differs widely in design from other transformers now on the market. A great aid in selling this article has been the diagram of a set built with the aid of these transformers, which is furnished free with each purchase.

The primary and secondary coils are so wound on a special iron core that the capacity effect between coils is reduced to a minimum. The coupling takes place through the core and is of the electro-magnetic type giving the greatest voltage transformation. The iron core is made up of thin tissue iron laminations, each insulated from the other so that losses from eddy currents and hysteresis are practically eliminated. The great advantage of the iron core coupling is to be found in the wide range of wave lengths over which the transformer will function efficiently. The use of an iron core makes possible small primary and secondary coils, thus preventing feed-back effects between transformers. Below 600 meters air core transformers are efficient only over a very limited range of wave lengths. Another feature of this transformer is the distance between the primary and secondary terminals, eliminating the loss due to capacity effects between these two sets of terminals.

There are three types of DX transformers, the DX-1, with a range of 170-450 meters; the DX-S, 400-1200 meters, and the DX-2, 900-3000 meters.

The Central Armature Works have placed on the market an unique, neat, and highly efficient crystal set on which they hold several patents. This concern was among the pioneers in radio in the Capitol City, and have profited by their experience with crystal sets, as is shown by the efficiency of their new set.

White and Boyer are doing an extensive wholesale and distributing business in Washington as well as throughout the south and southwest. Their broadcasting station is among the most powerful in Washington.

Thomas J. Williams is another experienced retailer and wholesaler who is doing a volume business in standard apparatus.

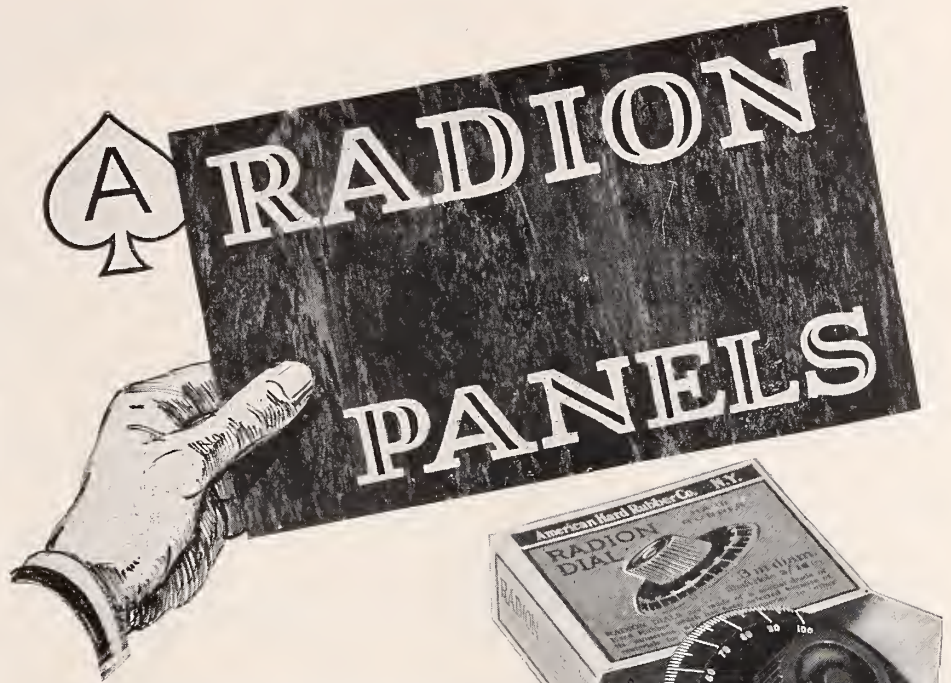

**The Ideal Insulation**

Every RADION part moulded by us has been designed only after a survey of the needs of the radio industry with a view to our future position in this field, and due regard to the protection of our reputation as oldest and largest specialists in Hard Rubber.

**RADION Standard Parts include Panels, Dials, Sockets, Knobs, Insulators, Tubes, Rods, Discs, Bases, etc.**

RADION PANELS in black, brown and mahogany are admittedly superior in finish, resistance to warping, and easy working qualities. In insulation value RADION is supreme. Competitive tests by the highest electrical authorities have established this fact.

**Dealers** will want our RADION illustrated circular, just issued. Write today.

**Manufacturers**—We are prepared to mould hard rubber pieces in quantity to exact specifications, such as Ear Caps, Condenser Bases, Knobs, etc.

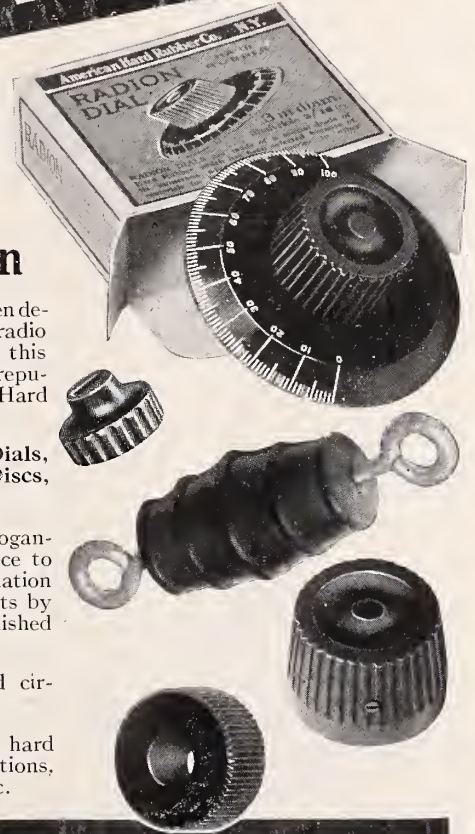

**American Hard Rubber Co.**  
11 Mercer St., New York



**VERNIER VARIABLE CONDENSER**

With a capacity of .00001 to .003 MED. and the finest adjustment on the market today.

If you want to hear the far off concerts use this condenser.

**Retail Price \$3.50**

**BUNTING STAMP CO.**  
713 Liberty Ave. Pittsburgh, Pa.  
Manufacturers of Bakelite Dials  
Fixed—Phone and Grid Condensers

**RADIO REGULATIONS**

(Continued from page 60)

spaced 5 inches if possible from grounded metal gutters, leaders, etc.

**PROTECTIVE DEVICE.**—Each lead in wire shall be provided with a protection device. This device shall be a lightning arrester of a type approved by this bureau.

It shall be located at the point the wire enters the building and properly connected. It may be inside or outside the building and mounted directly on the building, no separation distance being required.

It shall not be placed near inflammable gases or vapors or flyings of combustible materials such as gasoline, lace curtains, etc.

Antenna grounding switches are not approved unless a lightning arrester is also used, in which case the switch when closed shall form a shunt around the arrester.

**PROTECTIVE GROUND WIRE**—This ground wire may be bare or insulated and shall be not less than No. 14 B & S gauge copper or No. 17 B & S gauge copper clad. This wire should not have any sharp turns or kinks and should be run as direct as possible to the ground.

This ground should be a cold water pipe whenever possible. Gas piping should not be used under any circumstances.

If a driven pipe ground is used the pipe must be galvanized, 1 in. inside diameter and driven down at least 6 feet (the deeper the better).

When a ground wire is run outside, care should be taken to protect it from injury. This can be done by the use of wooden moulding or flexible non-metallic tubing fastened directly to the building. (Never use iron pipe to protect ground wire.)

When a cold water pipe or a driven ground is not possible this Bureau should be consulted as to method of grounding. An approved ground clamp shall be used to connect the wire to the pipe.

**WIRES INSIDE BUILDING.**—Wires inside building shall run in a workmanlike manner and spaced no nearer than two inches to any electric light or power wire unless encased in porcelain or flexible tubing.

**APPARATUS GROUND WIRE.**—This wire may be bare or insulated not less than No. 14 B & S gauge or No. 17 B & S copper clad. It may be run inside or outside. If run in full compliance with rules for protective ground wire it may be used as the ground conductor for the protective device.

**CLEARER  
BETTER  
Purer TONE**

NOISES ELIMINATED

Send for  
**Circular No. 26**

*Liberal Discounts*



THE FASTEST  
SELLING PRODUCT  
IN RADIO

**EVERY FAN  
WILL BUY THEM**

Made for all phones

*Immediate Shipments*

Adjustable

**RADIO MICA PRODUCTS CO., Sole Mfrs., 156 E. 43rd St., New York City**

**Ask Our Service Bureau**



**Standard**  
2500 Ohm  
Headset

**Retails at \$5.75**

**Guaranteed** to be equal to any phone on the market retailing at \$8.00

Polished aluminum shell—excellent appearance.  
Duranoid cap—strong and durable.  
Laminated magnets—maximum flux density.  
Enameled diaphragm—prevents corrosion.  
Adjustable pole pieces—no rattling as loud speaker.  
Perfect workmanship—backed by 15 years electrical instrument manufacturing experience.

**JUDGE FOR YOURSELF**

*Dealers and Jobbers Write*

**THE MILLS RADIO & ELECTRIC CO.**

Distributors for: **STANDARD headset**  
Irvington SPA-GHETTI  
**KENTONE Amplifying Horn**  
U. S. Variable Condensers

Manufacturer of AER-WIN Products:  
Vernier Adjuster  
Variometer and Variocoupler  
Model "A" Receiving Unit  
Special Detector Crystal

1010 Springfield Ave. Irvington, N. J.

**SUNRAID**

**Rheostats**

List

*Patent Pending*



**\$1.25**

**PRODUCTS**

Radio men who want a Rheostat of high class workmanship that gives a maximum amount of service will find it worth their while to buy the **SUNRAID RHEOSTAT**. It gives perfect contact against winding at all times. (See spring attachment in above photograph.)

Windings guaranteed not to jump out.

SUNRAID PRODUCTS are guaranteed. Distributors wanted for all parts of the country.

DISTRIBUTORS — Samples will be sent to you C.O.D. upon request.

Also Manufacturers of 3" and 4" All-Condensite Dials.

**SUNRAID**

534 EIGHTH AVENUE



*Trade Mark*

**RADIO CO.**

NEW YORK CITY, U.S.A.

The SUNRAID RHEOSTAT has been tested in all the best Radio Testing Laboratories, and has been awarded the Stamp of Excellence.



## Small Space Socket Slotless

By MILTON ALDEN

Alden-Napier Co., Springfield, Mass.

To the user, we think that the newsy part of the DeLux Socket story lies in the patent clip. This clip makes a positive connection to the prongs of the vacuum tube under any and all conditions, as when the tube slips into place there is a wiping action across the bottom, and wiping contact is also made at the side. The operator using these sockets in his set can be sure that he is free from open circuit troubles in this part of his apparatus. As this socket is slotless and made of genuine condensite, it is practically unbreakable. It serves equally well for 5-watt power tubes, as there is ample spacing between the contact strip and the bottom of the base.

The interesting part of the small space socket is that we have produced a quality article, due to quantity production, at a very low price. It also takes up very little room, making it particularly valuable where two and three tubes are to be used. This is also moulded of genuine condensite and is unaffected by the heat of the bulbs or the heat of the soldering iron in soldering connections.

The dial has quite a number of outstanding qualities besides its low price. As it is made of genuine condensite, it cannot warp and runs true. It is also one of the few 3" dials on which the fingers can be placed on the knob without covering the numerals. The shape of the knob and the numerals on the bevel has accomplished this result. We have also been advised by some radio engineers, but we do not know how true it is, that our dial is unique, in that we have eliminated excess material, which reduces the absorption losses to a minimum.

The "newsy" part of our proposition to the dealer and jobber, besides the fact that we are producing extra quality articles at a low price, is that we are supplying dealer helps. With each 100 dials the dealer is supplied, without charge, with a hand-painted display card on which is mounted a dial. These are proving very effective in producing sales and can be used for both counter and window display. The small space socket is packed 20 in a lithographed Brooks display container, which acts as a silent salesman. The DeLux Socket is packed in a quality lithographed box.

## "Red Star" Head Phones are Quick and Easy Sellers — and They STAY Sold

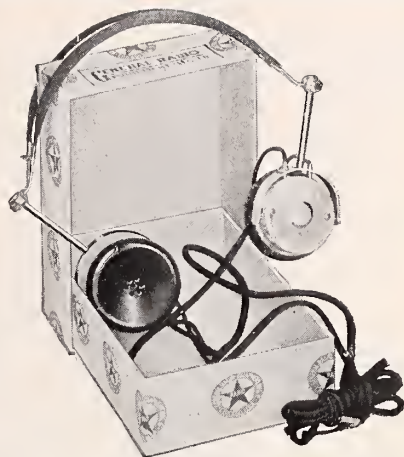

Each set is packed in an attractive box that makes a fine showing on shelf or counter.

The set itself is so light in weight and so handsomely finished that buyers quickly give it the preference.

Then, when they USE it, they find it so comfortable to wear, and its messages so clear, that every customer becomes a booster.

**Monocoil - - - (2000 ohms) - \$5.00**

**Long Distance - (3200 ohms) - \$8.00**

including a head band and 6 ft. of cord.

Liberal discounts to recognized jobbers and their dealers.

Order ONE for inspection and comparison.

**GENERAL RADIO EQUIPMENT MFG. CO.**

1131½ Diversey Parkway

Chicago, Ill.

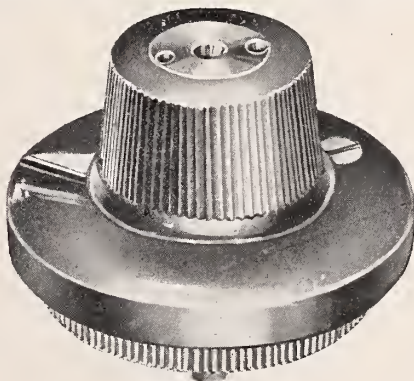

ACTUAL SIZE

### MOFFAT RADIO LOCK RHEOSTAT

LOCKS OFF CURRENT  
LOCKS ADJUSTMENT



### LOCK

PATENT PENDING

### MOFFAT RADIO LOCK CIRCUIT SWITCH

LOCKS ALL  
TUBES

## LOCKS ANY SET

NO MORE TUBES DAMAGED BY MEDDLESOME PERSONS  
NO MORE TIME LOST IN READJUSTING TUNING  
NO MORE LOSS OF BATTERY CURRENT

FITS ANY STANDARD INSTRUMENT OPERATED BY A SHAFT

JOBBER WRITE

**JOSEPH ROSS & CO., IRVINGTON, N. J.**

ESTABLISHED 1875

**DEALERS:—**

WE are Jobbers for  
*Grebe Receiving Sets*  
*Murdock Products*  
*Baldwin Phones*  
*Federal, Fada and*  
*Radio Shop Products*

Write for Our Special Proposition A

**The Radio Shop  
 OF NEWARK**

41 South Orange Ave., Newark, N. J.

**Whirco Square  
 Tinned Bus Wire**

In 2 Feet Lengths or in Hun-  
 dred to Thousand Pound Lots  
 Quoted.

Shipments *F. O. B. Mill*

**WHITE RADIO CO.**

123 East 23rd Street  
 New York City

**Quick Sales and  
 Lots of Them**

Every owner of a tube  
 set needs a CHASLYN  
 Ball Battery Tester.

And the moment you show  
 it and explain how this set  
 enables him to test bis acid  
 at a glance for both condition  
 and depth, *out comes his dollar!*  
 Sinking of white, green or red  
 ball shows whether battery is  
 right, lean or dead.

**Special Introductory Offer**  
 Send one dollar for TWO sets.  
 That's below our wholesale  
 price.

**THE CHASLYN CO.**  
 4323 Kenmore Ave. Chicago



Green-Lean  
 White-Right  
 Red-Dead



Immediate delivery on anything in  
 the Radio line. Our U. S. Eagle  
 crystals mounted and unmounted are  
 positively guaranteed to be sensitive.

Write for prices

**U. S. Radio Co. of Penna., Inc.**  
 Pittsburgh, Pa.

**THORNTON  
 AUDIO FREQUENCY  
 AMPLIFYING TRANSFORMERS**

*Supreme Test Transformer*  
 These transformers are supplied in  
 either mounted or unmounted types.  
*Special attention paid to the manu-  
 facturer of receiving sets.*

**THORNTON  
 TRANSFORMER CO., Inc.**  
 30 Church Street, New York City

**Wooton Headsets  
 Tested Before Shipped**

Does Not Depend Solely on  
 Laboratory Equipment

By S. J. WILLIAMS

Secretary, The Electric Products Company  
 Cleveland, O.

The Wooton headset is of the 3,000  
 ohm type, the coils being wound on  
 soft iron cores, very specially insu-  
 lated, each coil wound to 750 ohms,  
 1,500 ohms per receiver, or 3,000  
 ohms for the headset.

The shell is of drawn aluminum,  
 highly polished, machine finished, in-  
 destructible, and light in weight. The  
 magnets are made from the very best  
 grade of magnet steel.

We claim for our phones maximum  
 sensitivity and we are always glad to  
 submit sample sets to jobbers and  
 dealers for their inspection and any  
 tests they may wish to make.

We test every phone on a receiving  
 set, not depending upon laboratory  
 equipment in the approval of our  
 phones for the user. We prefer to  
 test every phone under the actual con-  
 ditions under which it will be used,  
 and every set is perfectly matched.  
 The phones are packed in very attrac-  
 tively labeled corrugated cartons,  
 these cartons being of the very sub-  
 stantial type approved for mailing.  
 This makes it possible for the dealer  
 to simply remove a set from his  
 shelves and attach his shipping tag  
 and mail, without any cost of packing.

The headband is of the military  
 type, but is so designed that it will  
 not drop off the head of the wearer,  
 even though one bends to the floor.  
 All exposed metal parts are made of  
 brass, nickel-plated, while the wire is  
 of phosphor bronze. This means that  
 all parts of the headband are abso-  
 lutely rust-proof. The webbing is of  
 the tubular type, and the highest grade  
 that can be obtained.

The cord is of the standard five-  
 foot type, arranged so that either  
 phone may be removed from the head-  
 band to enable two persons to listen  
 in simultaneously. And in addition to  
 all of this our phones are beautiful  
 in appearance, a factor which no one  
 can lose sight of.

The Wooton is made and sold by  
 the Electric Products Company, of  
 Cleveland, Ohio, who also market  
 other electrical lines which they manu-  
 facture. They are a fourteen-year  
 "young" concern.

Ask Our  
 Service Bureau

*We Specialize in*

Brass Rod and Tubing  
Sheet Copper, Aerial Wire  
and Binding Posts

**McKenna Brass and Mfg. Co.**

First Ave. and Ross St., Pittsburgh, Pa.

'Phone, Court 637

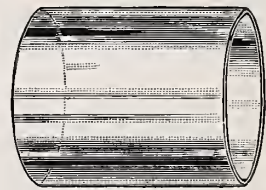

Glass  
 Tubes  
 for  
 Crystal  
 Detector  
 Sets

*Special Prices in Quantity*

Vineland Scientific Glass Co.  
 New York Office 1133 Broadway  
 Factory Vineland, N. J.

**ROCKY MOUNTAIN CRYSTALS**

*Better Than Galena*

The most sensitive mineral rectifier known.  
 Can also be used with one or more stages of  
 amplification.

Mounted 35c. Unmounted 20c. Postpaid

Manufacturers, Jobbers, Dealers, Clubs.  
 Apply for Special Prices.

**Rocky Mountain Radio Products, Inc.**  
 9 Church Street, New York, N. Y.

**Variable Condensers**

**SEMI-CIRCULAR TYPE**

|               |        |
|---------------|--------|
|               | List   |
| 43 Plate..... | \$3.75 |
| 23 Plate..... | 3.00   |
| 11 Plate..... | 2.75   |
| 3 Plate.....  | 1.50   |

**BALANCE TYPE**

|                |        |
|----------------|--------|
| .001 Mfd.....  | \$5.50 |
| .0005 Mfd..... | 4.75   |
| .0025 Mfd..... | 4.00   |

**SQUARE LAW TYPE**

|                 |        |
|-----------------|--------|
| .0015 Mfd.....  | \$6.50 |
| .001 Mfd.....   | 5.50   |
| .00075 Mfd..... | 4.50   |
| .0005 Mfd.....  | 3.50   |

**Montrose Mfg. Co.**

1200 Bedford Ave. Brookl'n. N. Y.

## Vermica Condenser

**Valuable for Sharp Tuning and Gives Perfect Control**

A particularly good and inexpensive variable condenser is now being put on the market by C. S. Cherpeck, of 3125 Davlin Court, Chicago, Illinois.

By means of a special screw adjustment, fine, accurate tuning, is made possible. In fact, with only a single knob or dial, what is essentially vernier control is obtained.

Another big feature of this condenser, is that it can be knocked around considerably without being put out of order or having its efficiency impaired. This makes it a handy and ideal piece of equipment for experimental, amateur, and general all-around radio work.

Its convenient size makes it readily adaptable for either table or panel mounting. It can be mounted on any size panel up to 1/2".

The Vermica variable condenser is neat and attractive. Its appearance is sure to draw the attention of the purchaser, and its high efficiency, reliability, and low price, will make it a highly desirable addition to any radio set.

It is sold under the slogan "a better condenser for less money." The capacity is .0005 MFD.

### BREMER-TULLY CONDENSER

A micrometer adjusting condenser is the product recently placed on the market by the Bremer-Tully Company of Chicago, Ill. The condenser is attractive in design and among many features of the instrument is the novel way in which the micrometer is operated and attached. The micrometer plate is at the far end of the shaft away from the dial and is operated by a special small knob that protrudes slightly beyond the main knob. This smaller knob moves independent of the larger and has a small arrow engraved on it which shows the position of the micrometer plate. Among other features that the company claims is the intermediate insulating plate that makes the short circuiting of the vernier plate impossible, vernier plate has but one active face which makes for greater sensitivity, compensating double spring which gives perfect action of main rotor, complete independence of vernier and positive electrical contacts, and shafts adjustable to different panel thicknesses.

# A SUPERIOR AUDIO FREQUENCY TRANSFORMER

USED AND  
RECOMMENDED  
by  
LEADING  
REPUTABLE  
MANUFACTURERS  
of  
RADIO  
APPARATUS

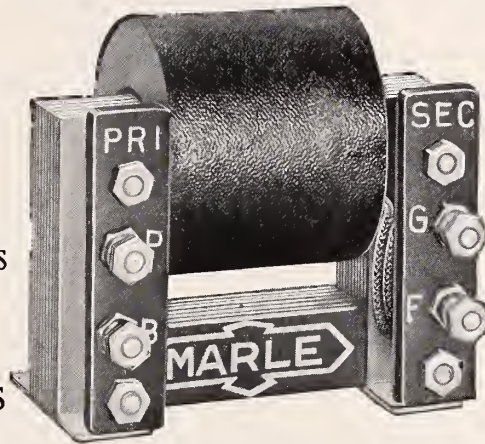

LIST  
3.75  
MOUNTED

Write for  
Information  
and Discounts

Jobbing  
Concessions  
Restricted

Manufactured by

**MARLE ENGINEERING CO., ORANGE, N. J.**

*Special Prices Quoted On Unmounted Type To Manufacturers*

# Milliken Radio Towers

Are the choice of important wireless stations in different parts of the country. Made of galvanized steel, self-supporting, standard types and heights. Dealers can broaden their markets by selling these towers. Let us explain our proposition.

### AGENTS WANTED

Send for Catalog No. 16

MILLIKEN BROTHERS

MFG. CO., INC.

Woolworth Building  
New York, N. Y.



STATION WVP



STATION WBZ



STATION 2XJ

# EVEREADY

## RADIO "A" BATTERY

Immediate Delivery from Stock

Manhattan

Storage Battery Co., Inc.

204 West 76th Street

New York City

## ELCO RADIO SUPPLY CO.

Manufacturers'  
Distributors

2728 Broadway, New York City

The Loop  
Uncovered

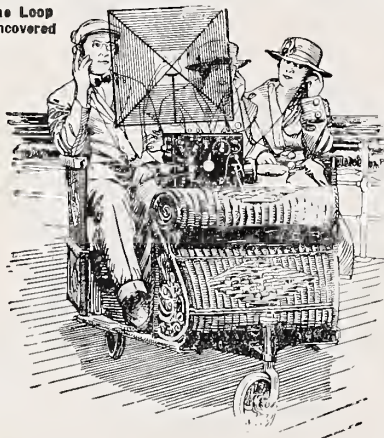

More Warren Radio Loops  
Being Sold Than Ever.

For Use With—

Armstrong Receiver Portable  
Sets—Sets on Moving Vehicles  
—Powerful Tube Sets—Displace  
Outside Aerials.

### The Warren Radio Loop

That Made Famous the Radio  
Rolling Chair at Asbury Park  
as featured on front cover of  
Radio News and Wireless Age.

A very superior instrument. Wound  
on new principle. Entirely enclosed.  
Directional. With honeycomb coil, tunes  
to high power long wave length stations.

With the growing use of more power-  
ful sets, the demand for the Warren  
Radio Loop is increasing rapidly. Get  
your share of this business. Write for  
Bulletin P-102, price lists and discounts.

V-DE-CO RADIO MFG. CO.

Dept. D.

Asbury Park, N. J.

## JOHN E. JENNINGS

(Continued from page 43)

Mr. Jennings was born in Brooklyn in 1875 and attended public school until fifteen years of age, when he started work in the construction department of a large Eastern railroad. At the same time he continued his studies at Cooper Union, from which he was graduated in 1896. With his railroad structural experience for a background, he then began a career of more than twenty-five years devoted to technical structural steel work, during the last fifteen of which he has specialized in transmission-tower development. In this time he has personally supervised the design and manufacture of steel towers for use on thousands of miles of high-tension transmission systems operating now in almost every quarter of the globe.

Mr. Jennings' activities have brought about many economies and practical advances in tower design. His original method of arriving at a safety factor by increasing by a suitable percentage the calculated actual field forces arising from climatic and mechanical conditions of service has become the general practice of many large power companies for obtaining the test loads to which a full-size tower must be subjected. His design work has embodied many original features concerning the economic relation of sag, wire stress and span.

Mr. Jennings has been employed in a consulting capacity by a number of large power companies and syndicates as well as by the government of Norway. His work in connection with tower design for the Norwegian authorities called him from the United States in 1920 and resulted in a trip around the world for transmission-line study, inspection and business in an engineering and contracting capacity for his company. His travels led him as far as Australia, where his skill as a designer will soon be evident in a 100-mile line extending from Melbourne to the Morwell brown-coal fields, which are to play a large part in electrical development.

As an expert in transmission structures Mr. Jennings has designed the radio towers in use at important wireless stations in many parts of the world. Here as in his transmission-tower work he has striven to reduce his designs to a general standard permitting recognition of the peculiarities of each system.

### MANUFACTURERS OF

Receiving Sets Complete

Unites Mounted and Unmounted

Send for Description and Prices

**RADIO OUTFITTING CORP.**

Mfg. High Grade Radio Apparatus

410-412 East 34th St. New York, N. Y.

To Manufacturers and Distributors

A SPECIFIC GUARANTEE

Backs **CONTAINA CRYSTAL** Setting

(Patent Pending)

**MAXIMUM SENSITIVE AREA**

AVAILABLE

Awarded Evening Mail Certificate of  
Excellence

**CURTIS G. CULIN**

366 Broadway New York City

# GROWING AND GROWING GREATER

You are a member of a great  
industry and here is an op-  
portunity to advertise in the  
only publication of its kind  
in the RADIO Field.

## A Trade Directory and Buyers' Guide

Purely a business proposition—Re-  
ferred to at all times by buyers.

Reaches every dealer, manu-  
facturer and jobber including  
hardware, phonograph, de-  
partment store and electrical  
dealers.

A Wealth of interest for the buyer

National in scope

Circulation 10,000

WRITE FOR RATES

Mailing list service to our advertisers

## The Radio Red Book Pub. Co.

406 West 31st Street, New York, N. Y.

"The Radio Trade Directory"

Watkins 5987-88

## Dealers Err in Rating Receiver

Resistance Not Indicative of Sensitivity of Phones

By FREDERICK DIETRICH

President, C. Brandes, Inc.

(Statement made to the RADIO DEALER by Mr. Dietrich)

"Yes, this is a very good receiver. It has a resistance of four thousand ohms." This is a sales talk that many clerks in the radio shops give to unwary purchasers of headsets. In doing so, they not only show their ignorance concerning 'phone construction and design, but they help to create an impression that is entirely wrong. They are responsible for the notion that the sensitivity of a headset is indicated by the resistance of the receivers.

In commenting upon this, Frederick Dietrich, president of C. Brandes, Inc., recently said: "This policy of selling headsets on the strength of their resistance is wrong and should be discouraged by dealers. It not only hoodwinks a badly mis-informed public but it is a gross injustice to manufacturers who, for sound technical reasons, do not wish to carry the d.c. resistance of their headsets to such a high value. One might just as well measure the horsepower of an automobile by the size of its carburetor. The average two-thousand ohm headset is as sensitive and in many cases more so than the receiver with a resistance of four thousand ohms. Radio receivers should be rated by their impedance. The Brandes headset is designed to have the same impedance as the average circuit in which they are used, since it has been found that this gives maximum efficiency. This impedance varies, of course, with the frequency of the current. The Brandes Company have taken as a standard one thousand cycles and at this frequency their headsets have an impedance of 22,000 ohms. It has been found that this is the resistance of the average crystal or tube circuit. This in itself, however, does not guarantee the efficiency of a headset, since there are many other requirements and features that determine the operating efficiency and sensitivity of a radio headset."

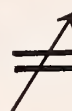
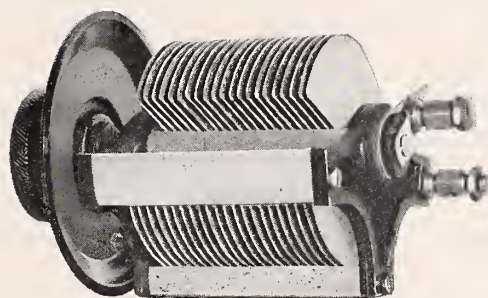
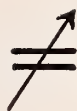

## Radio Finds a Better Condenser

Bayley's 23-0005 and 43 Plate 0011 Variable Condenser is what Radio has found.

Its plates spaced close give it the finest tuning qualities.

The plates are assembled as a solid integral part of the whole by the die cast process. It is impossible for any plates to loosen in service.

Solid rubber end pieces finished like black morocco leather, make it beautiful.

It is of good design and high grade workmanship. In an official test measures up to 0011 M.F.D. capacity and is uniform, it does not vary.

Each condenser has our guarantee, backed with a manufacturing record of more than forty years.

A sample order will convince you of its value.

And Make You, Certainly, A BAYLEY CONDENSER BOOSTER

We want business from houses that appreciate real value. It will give satisfaction and stay sold

Price, 23 Plates \$3.25 each. 43 Plates \$3.75 each. Dials 75c. each, extra

TO JOBBERS AND DEALERS A SPLENDID PROPOSITION

**BAYLEY CONDENSER CO.**

105-109 Vanderveer Street

Brooklyn, New York

Mt. Tamalpais, California, in the shadow of whose lofty peak PARKIN Parts are made.

"The Peak of Perfection"



**3**  
big  
advantages

## DIAL-TYPE RHEOSTAT

(Patented August 1, 1922)

In the Parkin Dial-Type Rheostat the resistance element is placed outside the cabinet in a recessed groove in the back of a three-inch moulded Bakelite dial. This patented construction gives the Parkin Dial-Type Rheostat three big exclusive advantages found in absolutely no other rheostat.

1. It saves the cost of an extra part.
2. It gives far more cabinet space.
3. It eliminates resistance heating from inside the cabinet.

An off position is provided, and a stop on the dial engages stationary contacts at the extreme positions. Polished Bakelite dial and knob, 0° to 180° graduation from right to left for clockwise rotation. Resistance, 5 ohms; carrying capacity, 1½ amperes. Retail price, complete with screw for mounting, \$1.50.

Quality Jobbers and Dealers write for complete catalog (No. 10) of Parkin Peak of Perfection Parts, and Proposition.  
**PARKIN MFG. CO., SAN RAFAEL, CALIF.**

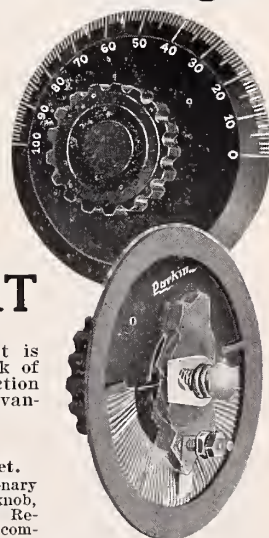

**Price, \$1.50**  
Complete

# Best by Test!



Hundreds of manufacturers, dealers and owners of receiving sets everywhere have tested and found our crystals the most sensitive and efficient obtainable.

Double your pleasure and increase the efficiency of your set by using our ALL-SENSITIVE GALENA CRYSTALS

Galena Crystal, Mounted - 35c  
Galena Crystal, Unmounted - 25c

IMMEDIATE DELIVERY

Every Crystal

GUARANTEED PERFECT

Manufacturers, Jobbers, Dealers, write for quantity prices

**GALENA CRYSTAL MFG. CO.**

463 Bushwick Ave.

Brooklyn, N. Y.

## CRYSTAL SET

"The Little Wonder" **\$4**  
To Retail at

UNMOUNTED AT \$2.50

Thousands of them in use in all parts of the United States and giving perfect satisfaction.

Good Profit for Dealers

Write for interesting proposition. "Little Wonders" sell fast and are good profit makers for live dealers.

SEND FOR FREE CATALOG

It lists our high grade line of radio parts and supplies at prices allowing you a juicy profit.

Holloway Elec. Supply Co., Inc.  
238 Third Ave. New York City

# DEPEND ON CRAMER RADIO



### SPECIAL

FOR LIMITED TIME

This \$80 Receiver at 50% Discount

The CH5 receiver needs no introduction. Judged by any standard it is without equal anywhere. Simple in control; handsome in appearance; super-efficient in operation. Includes in its 150 to 3000 meter range, amateur, commercial and Navy waves, special land stations, ship stations and Arlington "time." Employees latest inventions. Especially efficient for radiophone concert reception. Guaranteed in writing for one year. Regular price \$80 with 25% discount—and worth it. SPECIAL DISCOUNT—50%.

EVERY DEALER SHOULD HAVE AT LEAST ONE! Send cash only—no CODs or charges. Not more than 6 sold to one dealer.

W. R. CRAMER, DEPT. 3, OMAHA, NEB.  
"Pioneer Radio Manufacturers"

## Boston Exposition

### New England Folks to Boom Radio in Big Way

The Boston Radio Exposition and New England Amateur Convention will be held in Mechanics' Building, Boston, from October 30 to November 4.

At a recent luncheon at the Boston City Club, attended by S. H. Fairbanks, general manager of the Exposition, and members of the advisory committees, composed of leading manufacturers, dealers, distributors and radio editors, important matters of policy were decided upon.

An absolute rule that no more than one demonstration of broadcast reception be permitted at one time, was adopted and a sub-committee appointed to pass on the qualifications of exhibitors to protect the public from fakers and manufacturers of inferior apparatus.

At a subsequent meeting of the New England Executive Radio Council, formerly the Boston Executive Radio Council, Phillip F. Robinson, division manager of the American Radio Relay League, was appointed chairman of the banquet committee, and E. B. Dallin was made chairman of the publicity committee.

The First District Amateur banquet will be held on Saturday, November 4, the closing day of the Exposition.

O. C. Roos, Fellow of the Institute of Radio Engineers, is again technical director of the Exposition, and Chester I. Campbell, nationally known through his direction of war exhibits and the national auto show held in Boston, is advisory director.

Manufacturers represented on the advisory committee are: Acme Apparatus Co., American Radio & Research Corporation, Clapp-Eastham Company, General Radio Company, Wm. J. Murdock Co., Radio Corporation of America, Sleeper Radio Corporation, Stern & Co. and Wireless Specialty Apparatus Co.

An even more extensive educational and entertainment program than that which was a feature of the first Boston Exposition held last May has been planned and the leading radio amateurs and engineers of New England are co-operating with Mr. Roos to this end.

At the first exposition more than 100 manufacturers, dealers and distributors were represented by exhibits.



### PRECISION

#### GRID LEAKS AND MOUNTINGS

Resistance ranges from .05 megohms to 5. megohms. Accuracy guaranteed.

Grid Leaks .....75c  
Mountings .....50c

Radiophone Equipment Co.

45 New Street

Newark, N. J.



Echophone Loud Speaker Sets

### IMMEDIATE DELIVERY

Discounts to jobbers and dealers  
**AERIAL WIRE.**

19 strand tinned silicon bronze  
**VARIABLE CONDENSERS**

11-21-23-43 Plate

**EISEMANN HEAD PHONES**

Super-sensitive

Variometers Variocouplers  
Binding Posts Contact Points

**General Auto Electric Co.**

231 Halsey St.

Newark

New Jersey

# BRACH

## VACUUM LIGHTNING ARRESTER

Sells On Its Merits

The Brach Arrester protects radio and home—frees the radio fan from concern over static interference—commends itself by its 16 years performance in railroad, telegraph and U. S. Army service.

Dealers never need force the sale of the Brach Arrester—it sells itself.



Listed by the Underwriters' Laboratories

**L. S. BRACH MFG. CO.**

Newark, N. J.

Makers of Solderall—Mends Metals.

Connects Wires.

Coast Representatives—Pacific States Elec. Co., San Francisco, Los Angeles, Oakland, Seattle, Portland, Spokane.

## Aerex Receiver

### Greater Sensitivity Achieved in New Instrument

The Aerex Radiophone Corporation of New York City, are now marketing what they claim to be an achievement in the radio field in their Model RA-4 Long Range Radio Receiver.

It has been produced after months of constant research in their laboratory with the idea of providing the maximum in radio telephony. Greater sensitivity than has ever been obtained before in any radiophone receiving instrument has been developed.

The set has been constructed of standard quality materials, beautifully and scientifically designed to conform to the highest engineering standards.

It has been designed for use of both the loop antenna in local broadcasting and the outside aerial for long range reception.

Separate binding posts are provided on the back of the instrument when an outside aerial is used and when it is desired to use a loop. When a loop is used the wiring is so arranged that most of the tuning inductance is cut out with only a variable condenser across the loop.

The circuit is unusual, inasmuch as it consists of two stages of radio frequency amplification and two stages of audio frequency amplification and one detector and it has been so designed for use of only three tubes, one detector and two amplification tubes instead of the five tubes.

### "A REAL HOME"

Walter C. Jacobs, President of the Central Electrotype Foundry Company, is proudly proclaiming the fact that when they are installed in their new home at 69-71 Warren Street, Newark, they will be operating from a factory that is really "most modern" in every respect for the proper production of electrotypes, amalgatypes and stereotypes.

### MUELLER'S NEW FACTORY

The Mueller Electric Company have announced to the trade the opening of their new office building and factory at 1583 East Thirty-first Street, Cleveland, Ohio. The new brick factory and office building was a necessity which grew out of increased business that the favor of their high class products warranted.

# CONDENSITE CELORON

## Sets a New Standard in Radio Panels and Parts

Cut your panels from Condensite Celoron. This strong, handsome, jet-black, insulating material will give your customers a surface and volume resistivity greater than they will ever need. It is the ideal panel material because it machines readily, engraves with clean, cut characters and takes a high, natural polish or a rich, dull mat finish.

Give your customers Quality  
and they will give you orders

Condensite Celoron—approved by the Navy Department, Bureau of Engineering—offers a sales opportunity unequalled to the live wire dealer who is keen on building his business on a quality basis. Write us today for our Special Dealer's Proposition and let us give you all the facts.

### Diamond State Fibre Company

Bridgeport (near Philadelphia), Pa.

Branch Factory and Warehouse, Chicago

Offices in Principal Cities

In Canada: Diamond State Fibre Co., of Canada, Ltd., Toronto

## Ask Our Service Bureau



\$3.75

MADE  
IN  
NEWARK  
N.J.

**Rad'O** Crystal  
Attachment

**For Your Crystal Set Use One Ear Phone, a RAD'O and the Whole Family Can Listen In**

Made of Aluminum—and designed according to the laws of acoustics, and guaranteed to give satisfaction. Tubes of best quality rubber, with heavy walls; the ear tubes made of hard rubber and easily kept in sanitary condition. By the use of the Rad'O all distortion is eliminated.

Jobbers  
Communicate

RAD'O, P. O. BOX 418, NEWARK, N. J.

Dealers Ask  
Your Jobber

**Variable Condenser—Tested and Guaranteed. Immediate Deliveries.**

|          |       |         |        |
|----------|-------|---------|--------|
| 43 plate | ..... | .001    | \$3.50 |
| 23 "     | ..... | .0005   | 2.75   |
| 13 "     | ..... | .0003   | 2.50   |
| 11 "     | ..... | .00025  | 2.25   |
| 3 "      | ..... | Vernier | 1.25   |

*Liberal Discounts to Dealers*

**DETROIT RADIO SUPPLY CO., MFRS.**  
228 East Baltimore Detroit, Michigan

**RECEIVERS REWOUND AND REPAIRED**

Any make, copper wire, any resistance  
Work guaranteed  
Commissions to Dealers

**MONTCLAIR RADIO CO.**  
272 Bloomfield Avenue Montclair, N. J.

**M-R FLEXIBLE VARNISHED TUBING THE GENUINE**

**“ SPAGHETTI ”**  
TWO STYLES—BEST GRADES MADE—ALL SIZES—ALL COLORS

Varnishes, Waxes, Compounds, Papers, etc.  
**MITCHELL-RAND MFG. CO.**  
14 VESEY STREET NEW YORK, N. Y.

**KRAMER RADIO COMPANY**

4713 Sheridan Road, CHICAGO, ILL.  
MIDWEST DISTRIBUTORS  
Of Quality Radio Products

Write Us for Catalog and Discounts

**BEFORE you adopt a trade-mark**

Have the Radio Dealer Trade-mark Bureau give you a report on its novelty based on registrations in the Patent Office AND IN THE RADIO DEALER TRADE-MARK BUREAU.

AFTER you have adopted a novel trade-mark Register it at once in the

**RADIO DEALER TRADE-MARK BUREAU**

4907 Potomac Ave., N. W.  
Washington, D. C.

**GOOD WIRELESS BATTERIES****Air Pockets Provide for Escaping Gases**

The Ace Wireless Batteries are especially constructed with air pockets which provide space for escaping gases and eliminate the common defect with many batteries, namely blown seals.

The Ace factory have made thousands of these batteries and have never experienced difficulty of this sort.

Another feature in the Ace Wireless Battery is that the batteries are constructed from individual cells made from seamless drawn zinc cans of extra thickness so that the chemicals of the cell will not eat through to waste and corrode the battery. Also, especially selected materials are used which give unusually high voltage, which is one of the most important things in making wireless batteries.

These batteries are made by The Carbon Products Company of Lancaster, Ohio, and the retailer and jobber who “ties up” with the Ace makers makes no mistake.

**VERNIER CONDENSER**

The Electric Products Company of Boston, Mass., are manufacturing variable condensers that are suitable for panel or table mounting. They are of four classes, 5, 9, 15 and 29 plates. The company is also manufacturing a vernier variable condenser which has a maximum capacity of .001 mfd. The condensers have two patent adjustments which enable them to be of efficient service for considerable time. To quote the company's representative, “although they are not gotten up at all fancy, or not in any way meant to attract the eye, they are extremely efficient, and when installed do the work they are built for.”

Ask Our

**Service Bureau**

See Page 18

**“COPPERWELD”**

TRADE MARK REG. U.S. PAT. OFF.

**ANTENNA WIRE**

50% stronger than either solid or stranded copper

**ELIMINATES SAGGING**

Adopted by Largest Radio Corporations  
100, 150, 200 ft. per Carton

**LEAD-IN and GROUND WIRE**

has the Underwriters' O. K.  
Rubber Insulated—Brown Braid  
25, 50, 100 ft. per Carton

**BUY IT IN CARTONS**  
with construction directions**COPPER CLAD STEEL COMPANY**

New York Chicago  
Braddock P. O., Rankin, Pa.

**NOTE TO THE TRADE:**

Quote us prices, terms, discounts and deliveries

WE ARE  
NATIONAL  
DISTRIBUTORS

**Complete sets  
Radio Equipment  
SPECIALTIES****Manufacturers**

Desirous of New York Representation communicate at once

**RADIO EQUIPMENT SERVICE**

500 FIFTH AVENUE  
NEW YORK CITY



## STATION K-S-D

*(Continued from page 42)*

of the building on the roof to see what happens to these electric waves.

The path takes them directly to a "speech input" panel where they are amplified several hundred thousand times passing through various devices which preserve the original purity of tone and perfect modulation. This assures true transmission of whatever goes into the microphone in the studio.

That was not a typographical error, by the way, in the last paragraph. "Amplified several hundred thousand times" is correct. Listen to a few notes played on a violin by Kreisler and then let the same notes be repeated by an amateur. So far as the string vibrations are concerned both may have been the same and yet the trained ear would discern a difference—not measurable, but a real difference nevertheless. Now translate that difference into tiny electric waves; amplify those electric waves several hundred thousand times; send them out through the air, through rain and snow and sleet, through clouds, stone walls, windows, brick, and steel; through trees, our bodies, and everything else; then hundreds, perhaps a thousand miles or more away pick up those wireless waves on your receiving set and turn them back into sound waves, and you could tell which was Kreisler and which one the amateur, just as if you had been in the room where they were playing—that, indeed, is the marvel of wireless.

From the speech input panel, just described, the electric current, now much amplified goes to the transmitter set. It first enters a 50-watt tube for further amplification, then into the circuit which leads finally to the antennae and out into the air—to be picked up in Texas, Florida, Minnesota, Pennsylvania—wherever within range an adequate receiving set is properly tuned into pick up the KSD program.

When you first arrived on the roof, your attention is surely attracted to the two steel towers. These are 14 feet square at the base and rise to a height of 70 feet. From the top extends a wooden mast 10 feet long. The legs of the towers go down through the roof to rest on the steel framework of the building itself.

The antennae consist of phosphor bronze wires—four of them—spaced six feet apart. The length from mast to mast is 131 feet. The lead in comes from the center, giving a "T" aerial.

A look around the transmission room in the building on the roof is worth while. In a sound-proof com-

## It Will Be a Radio Christmas

# BOSTON RADIO EXPOSITION

and

# N. E. AMATEUR CONVENTION

Mechanics Building

Entire Week October 30—November 4

*Covers New England with  
One Exposition*

**SPACE AVAILABLE NOW**

*Executive Offices: 5 Park Square, Boston, Mass.*

## LET OUR FREE SERVICE BUREAU

Help You Buy Your Supplies  
SEE PAGE EIGHTEEN

NATIONAL DIRECTORY OF RADIO  
DEALERS, MANUFACTURERS, ETC.

SUPPLEMENTARY SERVICE OF  
ADDITIONS, REVISIONS, ETC.

## Sydell's Radio Directory and Service

557 SCHENCK AVENUE

BROOKLYN, NEW YORK

Card Catalog Directory of Radio Dealers

Sent upon APPROVAL

(Also available on SHEETS)

No comparison between this directory and similar commercial  
"mailing lists"

No mailing list companies offer to send theirs upon approval

## WHY?

Names in our directory are annotated to indicate wherever possible the distinction between exclusive dealers in RADIO equipment; those who handle RADIO only as a side line, as dealers in electrical supplies, hardware stores, jobbers, manufacturers' distributors, etc.

This list has been compiled from information secured from State Chambers of Commerce, current RADIO periodicals and newspapers having RADIO departments, and contributions from Manufacturers, Dealers, Jobbers, etc.

Dealers desiring inclusion please send particulars without obligation.

In Preparation

A similar directory of RADIO MANUFACTURERS

Please send descriptive literature

# RADIO DEALERS

*We Are Manufacturers of*

**AUDIO AMPLIFYING  
TRANSFORMERS,  
SENSITIVE CRYSTALS,  
EYELET TYPE MICA  
CONDENSERS,  
LOOSE COUPLERS,  
DOUBLE SLIDE  
TUNING COILS**

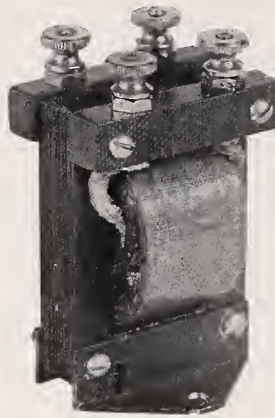

*Dealers and Jobbers  
Write Us for Proposition*

**IMMEDIATE DELIVERY**

**FORD MICA CO., Inc.**

14 CHRISTOPHER ST.

NEW YORK CITY

USE THIS COUPON TO JOIN

## THE RADIO TRADE ASSOCIATION

THE RADIO DEALER,

1133 Broadway,  
New York City.

Please count us in as charter members of

THE RADIO TRADE ASSOCIATION

and send us all bulletins regarding same as they are issued.

We are jobbers ..., retailers ..., manufacturers ... of radio equipment.

Name .....

Town .....

State .....

Date .....

generator set, a three unit design. This, weighing more than a ton, rests upon heavy felt so as to keep the vibration of the motor from affecting the amplifiers and transmission. The motor is of five horsepower. One generator develops 1,600 volts for what is known as the plate circuit in the 250-watt power tubes—of which there are four. The other generator develops 16 volts for the filament circuit in the tubes.

In the operator's room you hear the program. Connected with the circuit from the studio is a monitor system, the principal parts of which are an amplifier and loud speaker. This gives the operator proper knowledge of tone qualities and imperfections can quickly be corrected.

The transmitter proper is a cabinet about six and one-half feet tall.

The various pieces of apparatus that make up each unit are mounted on a black finished angle iron framework, rectangle in shape, in order to provide a rigid and compact structure. The vacuum tubes, coils, filters, relays, resistances and other auxiliary apparatus which ordinarily do not require observation are mounted inside the frame. The antenna relay is on top of the framework.

The four ammeters which serve to indicate respectively the antenna current, the oscillator plate current, the oscillator grid current, and the modulator plate current, are mounted on the insulating panel, at the top front of the radio transmitter.

The cases of the oscillator slate current milliammeter and the modulator plate current milliammeter are covered with a grounded guard, in view of the fact that these instruments are subjected to the full voltage of the plate circuit generator, whose voltage may be either 1,600 or 800.

The radio transmitter is essentially a generator of radio frequency energy (an oscillation generator), which means for modulating this energy in accordance with current variations produced by the microphone operating in conjunction with the amplifier and certain other auxiliary equipment. The oscillator comprises vacuum tubes, previously described, and a tuned circuit which includes the antennae system. This tuned circuit determines the frequency or wave length of the radiated energy.

The modulating system provides means whereby the alternating currents corresponding to speech or music are supplied in amplified form direct to the oscillator circuit. The operation of this system may be understood by considering that the plate circuit of the oscillator is supplied with speech currents directly from the modulator.

currents directly from the modulator. The combined circuits provide a sort of mixing chamber in which the speech currents are combined with the steady carrier wave supplied by the oscillator to produce the modulated wave required.

The frequency of the transmitted energy (wave length) is controlled by the value of the inductance in the oscillatory circuit which includes the antennae. The inductance is adjusted by means of a variometer. To provide this feature a portion of the oscillator coil included in the antennae circuit is arranged to turn on an axis at right angles to its normal axis, so that the inductance of the movable coil either aids or opposes the inductance of the remainder of the coil.

The movable coil also serves to vary the coupling between the antennae circuit and that portion of the coil system which is connected to the plates and grids of the oscillator tubes in a manner to insure satisfactory operating conditions throughout the frequency range for which the transmitter is designed.

A variable condenser connected across the plate coil controls the plate current through the oscillator tubes, and to a large extent the output of these tubes. This condenser consists of a variable unit in parallel with two fixed units which may be switched in or out of the circuit as required. The variable unit is controlled by a knob on the front of the set and is designated "Oscillator Adjustment."

Both the adjustable inductance and the adjustable condenser are provided with graduated dials so that after the transmitting set has once been calibrated in connection with its associated antennae, wave length adjustments can be made without a wave meter.

The antennae relay is operated by means of push buttons and is used while the equipment is in operation to change connections from "send" to "receive" and vice versa. When the relay is in "receive" position an auxiliary contact is opened which renders the transmitter inactive and prevents it from interfering with local reception.

In order that the vacuum tubes used for modulating and speech amplifying purposes may operate under the most favorable conditions to prevent distortion, the grid circuits of these tubes are given a negative bias by means of a resistance connected between the negative terminal of the high potential generator and the filaments of the tubes.

The plate circuits of the vacuum tubes are supplied with direct current from a high potential generator. A

## For CORRECT RADIO MAILING LISTS Use THE POCKET LIST

Of Radio Manufacturers, Jobbers and Dealers in the United States and Canada. Issued quarterly—January, April, July and October. October, 1922, issue corrected to September 15th, 1922. Classified under three different headings—Manufacturers, Jobbers and Dealers—and alphabetically arranged by states, cities, towns and names of firms. Containing over 15,000 names and addresses.

We have been exceptionally careful to see to it that every manufacturer, jobber and dealer is listed and, under the PROPER CLASSIFICATION. Most mailing list concerns charge more than \$100 for a list of this kind, and, as a rule, those supplied are far from being correct. Compare this list with any other and you will find it to be the very best obtainable anywhere at any price.

October number ready for distribution September 25th. Price \$5.00 per copy or \$10.00 per year (four issues, including monthly supplements which keep the list absolutely correct and up to date at all times). October edition limited, send in your order with remittance today.

1021 Carrington Street F. D. PICKENS JANESVILLE, WISCONSIN

## "EURACO" MICA GRID CONDENSERS AND LEAKS

Price 60 cents  
(Designed to fit Standard Grid Leak Base)

GRID LEAK VALUES:

.5—1.0—1.5  
2.0—2.5—3.0  
Megohms

Price, 60 Cents

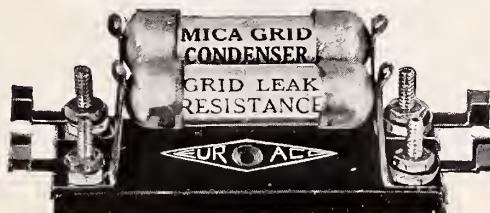

COMPACT,  
INTER-  
CHANGEABLE,  
HANDY,  
MOST  
EFFICIENT

"Euraco" Condensers are composed of Copper Sheet and Best Grade India Ruby Mica, and are entirely Hand Made.

Manufactured in following capacities:

.000025 Mfd.—Correct for Myers Radio-Audion RAC-3  
.0001 " —For Special or Experimental Circuits  
.00025 " —Correct for Super-Hetrodyne & UV 201  
.0005 " —Correct for Radiotron UV 200

Condenser—Leak Mountings

Bakelite Base with Single Mounting .....\$ .40  
Bakelite Base with Double Mounting ..... .60  
Bakelite Base with Triple Mounting ..... .80

## SHIP OWNERS RADIO SERVICE, Inc., DISTRIBUTORS

80 Washington St., New York

Interesting Proposition to Dealers

(Mfd. By EUROPEAN RADIO CO., 1342 East 22d St., Brooklyn, N. Y.)

# NOVO "B" Batteries



for Radio Outfits

NOISELESS—DEPENDABLE—GUARANTEED

All Sizes—Plain and Variable

22½, 45 and 105 Volts

Send for Catalogue and Discounts

## NOVO MANUFACTURING CO.

424 W. 33rd St.  
NEW YORK

531 So. Dearborn St.  
CHICAGO

**DIAMANT**  
**VARIABLE CONDENSERS**  
**AND CRYSTAL DETECTORS**

Electrically and Mechanically Guaranteed  
 Diamant Tool & Mfg. Co., Inc.  
 93 Runyon Street Newark, N. J.

**BUY DIRECT**  
*for greater profits*  
**ROGERS RADIO RECEIVER**

Type B, complete short wave tuner detector and two stage amplifier in mahogany cabinet, no jacks, rear connections, list \$60.00. Liberal discounts.

**Rogers Radio Co.**  
 5133 Woodworth St. Pittsburg, Pa.

**LOOK WHAT WE HAVE TO OFFER**

Variable air condensers, no junk, 43 plate, list at..... \$4.00  
 Variable air condensers, no junk, 23 plate, list at..... 3.00  
 Discount, 50% of the list price.  
 Rheostats and Bulldog Plugs for immediate delivery.  
 Ducon aerial plugs and Novo Batteries, always on hand.

**TUBES**  
 UV 200 and UV 201, U. S. Signal Corps Tubes, VT 1 and VT 2 also in stock.  
 Western Electric Loud Speakers and Magnavoxs.

*Liberal Discounts to Dealers*  
 Small orders receive the same attention as large orders.

Write—Wire  
**WHITE RADIO CO.**  
 141 West 33d Street New York City

G U A R A N T E E D T O W O R K A N Y W H E R E

J O B B E R S A N D D I S T R I B U T O R S W A N T E D

**\$1.25 List Price**  
*One of the Best*

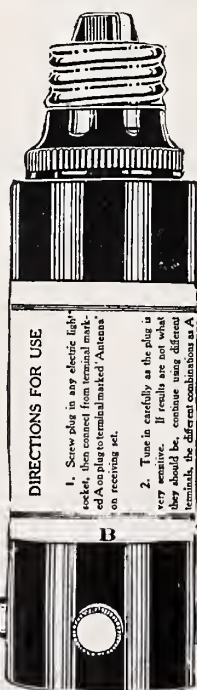

**DIRECTIONS FOR USE**

1. Screw down in any electric light socket, then connect from terminal marked A to the filament marked Plate on receiving set.
2. Tune in carefully as the plug is very sensitive. If results are not what they should be, combine using different terminals, the different combinations are A B

**MALTZ ELECTRIC CO.**  
 158 Belmont Avenue  
 Newark, N. J.

noise filter is used to eliminate commutator noises and is mounted on the framework of the radio transmitter.

Under certain conditions, if the plate circuit is closed before the filament circuit, a destructive rush of current through the tubes may occur. To prevent damage due to this cause, a delayed action relay is provided. This relay which is operated by the filament current requires approximately 20 seconds to operate and its contacts are so arranged that the full plate potential is not applied to the tubes until the filaments have been lighted for this period of time.

The motor of the motor generator set is started or stopped by means of momentary contact push buttons. The main push buttons are located on the power switchboard, but similar push buttons connected in parallel are located at the operator's desk.

Two voltmeters are provided on the power switchboard. One of these is used to indicate the potential delivered to the filament circuit of the vacuum tubes; the other the potential of the high voltage generator.

The case of the high potential voltmeter is connected to ground, and it is not necessary, therefore, to use an insulated guard to protect the operator. The low potential voltmeter mounted on the power switchboard is not connected direct to the terminals of the low voltage machine, but is wired to the filament circuit on the radio transmitter. Under these conditions, the reading of the voltmeter indicates the actual voltage across the terminals of the tubes, and it is not necessary to make allowance for voltage drop in the wiring, etc.

A circuit breaker mounted on the power switchboard is provided for the plate current supply circuit. It is usually adjusted to open under an overload of about 25 per cent.

Field rheostats are included in the field circuits of both generators, but only the low voltage generator rheostat may be adjusted from the front of the panel. The rheostat of the high voltage generator is adjusted from the rear. This rheostat requires infrequent settings since when properly set and the potential of the low voltage machine is correctly adjusted, the potential of high voltage machine is established at the correct operating value.

Current to operate the microphone is supplied by an 18-volt storage battery, and is regulated by a rheostat on the input amplifier by a rheostat on input amplifier panel. Filament current for the input amplifier is obtained from the same 18-volt storage battery that supplies the current to the mi-



**HALL-MARK OF QUALITY**

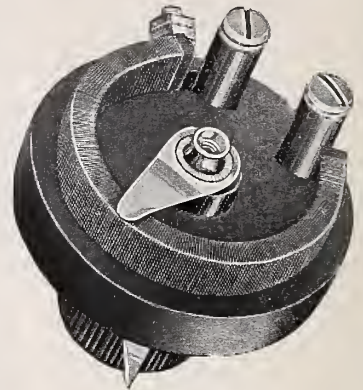

MODEL—A205

**POTENTIOMETER**  
 230 OHMS 0-2 AMPS

SPECIFICATIONS

- Condensite Base
- Ideal Resistance Unit
- Phosphor Bronze Contact
- Brass Posts
- Highly Nickered

SEND FOR OUR BOOKLET  
**"WHY WE USE CONDENSITE"**



MODEL—A101

**RHEOSTAT**

**ADVANCE METAL STAMPING CO.**

MANUFACTURERS  
 Department RE  
 19 THOMPSON ST., NEW YORK

crophone. Suitable provision is made for charging this battery.

Current for the plate circuit of the amplifier is supplied from dry cells. A total of 130 volts is required.

Station K S D, the St. Louis Post-Dispatch, was the first broadcasting station in the United States to be authorized by the Department of Commerce to transmit on a wave length of 400 meters.

This priority in the new "Class B" radio field, we feel justified in believing, was merited by the record KSD had made in July and August in the transmission of news bulletins and market reports by day and varied programs of a high order at night. As all radio enthusiasts know, those hot summer months provide the severest test of the efficiency of a broadcasting station.

The most notable achievement of KSD was the sending out, three times a week, of the entire operatic performances of the series of light operas given in the open-air Municipal Theater, Forest Park, by the organization of public-spirited citizens of St. Louis who guaranteed the expenses of the season.

The Municipal Theater in Forest Park seats more than 9,000 persons. The stage is between two giant oaks, 150 feet wide. Naturally, a very large orchestra and chorus is necessary to produce opera on so magnificent a scale.

The perfect broadcasting of these operas by wireless from Station KSD was an achievement not expected by even the most sanguine. As a matter of solemn fact, however, and as can be attested by thousands of hearers, these performances—orchestra music, dialogue, solos and chorus singing—were sent out so exquisitely that those listening on radio sets heard everything as well, and often better, than those seated in the auditorium. As a radio fan in a neighboring state wrote in: "I had a seat in the fifth row of your Municipal Theater last evening, listening to 'The Spring Maid.'" Only those in the very front seats, in the open-air theater, heard the dialogue as well as those who formed the radio audiences.

**1/8** Automatic Screw Machine Products **2**

**MERIT MACHINE MFG. CORP.**  
465 Greenwich Street  
New York, N. Y.  
Phone CANal 9128  
9th Ave. L. Desbrosses St. Station

**RADIO PANELS  
XX BAKELITE**

Manufacturers and dealers: Immediate delivery—any quantity. Panels cut—drilled and engraved. Ready for mounting

Write for free sample and prices

**POSTER & CO.**  
552 SEVENTH AVE., NEW YORK  
PHONE BRYANT 2572

Ask Our Service Bureau

|                                                                                    |                                                                                      |
|------------------------------------------------------------------------------------|--------------------------------------------------------------------------------------|
| INDUCTANCE<br><b>SWITCH</b>                                                        | 6 Ohms, 1 1/2 Amp.<br>FILAMENT<br><b>RHEOSTAT</b>                                    |
|  |  |
| Catering to Jobbers and Distributors Exclusively. Unusual Discount Rate            | List Price, \$1.00                                                                   |
| Switch, Complete, 50c. Without Contact Points and Stops, 35c.                      |                                                                                      |
| <b>ACORN RADIO SUPPLY CO.</b>                                                      |                                                                                      |
| 15 WEST 30th STREET                                                                | NEW YORK                                                                             |

**RADIO PANELS**

And other insulation for Wireless Work

**BAKELITE-DILECTO**

Grade XX Black was used by the Government during the war for this purpose. It is the

*Standard of the World*

**THE CONTINENTAL FIBRE COMPANY**  
NEWARK, DEL.

|                                        |                                           |
|----------------------------------------|-------------------------------------------|
| New York, 233 Broadway                 | Chicago, 332 S. Michigan Ave.             |
| Pittsburgh, 301 Fifth Ave.             | San Francisco, 75 Fremont St.             |
| Los Angeles, 411 S. Main St.           | Rochester, N. Y., 85 Plymouth Ave., South |
| Seattle, Wash., 1927 First Ave., South |                                           |

**Buy Apparatus**  
From a Reliable Manufacturer

**FREED-EISEMANN RADIO CORP.**  
255 Fourth Ave., New York City

**Radak**  
*Reg. U. S. Pat. Off.*

**RELIABLE RADIO EQUIPMENT**  
made by America's oldest and largest manufacturers of radio equipment exclusively. Sold by the best electrical and radio dealers.

**CLAPP-EASTHAM CO.**  
133 Main Street Cambridge, Mass.

**RADIO MAILING LISTS**

|                                                                |          |        |
|----------------------------------------------------------------|----------|--------|
| 9270 Radio dealers by states.....                              | per M.   | \$7.50 |
| 1164 Radio mfrs. ....                                          | per list | 10.00  |
| 1330 Radio supply jobbers.....                                 | per list | 12.50  |
| 260 Radio stations.....                                        | per list | 4.00   |
| 267 Mfrs. appliances, who make and assemble complete sets..... | per list | 4.00   |
| 14000 Radio amateurs and managers of Radio stations.....       | per M.   | 7.50   |

All Typewritten and Ready To Send on Receipt of Remittance

**TRADE CIRCULAR ADDRESSING CO.**  
166 W. Adams Street Chicago, Ill.

**Solder Your Connections**

for best results. Get the "Wonder" a Self Heating Iron. Use it anywhere without stove. No workshop complete without it. Cheap to operate. Generates own vapor in two minutes. Absolutely safe—a child can operate. Nothing to get out of order. Use it as a blow torch also. Boxed complete with solder, salamoniac and full soldering directions. **Send No Money**—just your name and address on a post card. When the postman delivers, pay him \$2.50.

*Dealers—a big seller, write for proposition.*

**North Shore Radio Works, Dept. 6017**  
810 Davis Street, Evanston, Ill.

**PATENTS**

**PROTECT YOUR INVENTION TODAY**

Write for 1922 illustrated book free. Radio-Electrical, chemical and mechanical experts; over 20 years' experience.

**A. M. WILSON, INC., (Radio 3 ARH)**  
309-20 Victor Building, Washington, D. C.  
(Successors to business established 1891 by A. M. Wilson)

**JOY-KELSEY CORPORATION**  
*Manufacturers*  
**RADIO EQUIPMENT**  
4021 West Kinzie St. Chicago Ill.

**ESSEX BUS WIRE NO. 14**  
Square Tinned—Specially Prepared and Will Give Entire Satisfaction. \$1.00 Per Hundred Feet.

**ESSEX LIGHTNING ARRESTERS**  
\$1.00 Each. List Price, \$1.50.  
*Send for Dealers' Quantity Prices*

**ESSEX MANUFACTURING CO.**  
117 Mulberry Street, Newark, N. J.



**DEALERS:** Get our Price List before placing your orders

We are distributors of Federal, Patent, National, Miraco, Uradiola, etc., lines of Quality Radio Apparatus.

**THE EDW. J. GOETZ CO.**  
604 Race Street Cincinnati, Ohio

**CAP SCREW AND NUT CO.**  
OF AMERICA

318 West 47th Street New York  
Manufacturers of Screws, Bolts, and Nuts of Every Description

In Stock for Immediate Delivery  
Switch Stops, Binding Posts, Contact Points

## Cutler-Hammer Make Good Radio Parts

Pioneer Rheostat Builders Enter  
Radio Field

The Cutler-Hammer Mfg. Company of Milwaukee, one of the pioneer rheostat builders, are soon to place on the market their latest development, the C-H Vacuum-Tube Rheostat. It will be furnished in two styles, with vernier adjustment for control of detector tubes, or without vernier for control of tubes. They are designed to carry one ampere and have an operating range of from zero to four ohms. Two amperes may, however, be carried in an emergency.

These new rheostats are built along entirely new lines and incorporate many novel features. A "full off" position is provided, eliminating the necessity of additional switches in the "A" battery circuit. A "full on" position is also provided which makes total battery potential available, rendering charging unnecessary until its full voltage has dropped below tube requirements. A nicked pointer indicates at all times the amount of resistance in the circuit.

The spring contact fingers are adjustable, and are so mounted as to lie in the direction of travel of the resistor, insuring smooth, quiet, positive regulation. The number of turns of low resistance each cut out or in, one at a time, provides fine graduation of control, minimizing clicking in the receivers during filament adjustment.

The rheostats are designed for panel mounting and are readily adjustable for panels ranging from one-eighth to one-half inch in thickness. Cone-shaped knobs of genuine Thermoplox are provided which are of excellent appearance and do not cramp or tire the fingers. All metal parts throughout are finished in highly polished nickel.

### L'ART IN CATALOGS

A catalog that encourages one to look through it from cover to cover—and then to read it through again—is one issued by the Widdicomb Furniture Company of Chicago. It is not a catalog that deals with radio, yet it is one deserving of mention. However, it is appropriate in that its contents could readily be used in the radio field and its photographs give range to the imagination of things that remain undone in the radio industry insofar as artistic catalogs are concerned. Each picture is a "home setting" accompanied by a short, appropriate word sketch.

**Condensers—Guaranteed—Tested—Perfect**  
*Order now for immediate or fall delivery*

|                                           |         |        |
|-------------------------------------------|---------|--------|
| 43 plate .....                            | .001    | \$2.00 |
| 21 " .....                                | .005    | 1.35   |
| 11 " .....                                | .0025   | 1.10   |
| 3 " .....                                 | Vernier | .80    |
| .005 variable for Armstrong circuits..... |         | 6.00   |
| Fixed Phone Grid—Grid Leak.....           |         | .07    |

Special Offer to Jobbers  
**DUKE RADIO CO.**  
1758 Bergen Street Brooklyn, N. Y.

**PATENTS**  
on radio inventions apply to  
**OTTO K. ZWINGENBERGER**  
38 Park Row, New York  
Cortlandt 3207

**PATENTS**  
ELECTRICAL MECHANICAL  
RADIO

SEND SKETCH AND DESCRIPTION  
FOR OPINION

**EMIL ALEXANDER KERN**  
328 SOUTH SEVENTH STREET  
NEWARK, N. J.

**PATENT**

your Ideas. Protect your rights by U. S. and Foreign Patents and Trade-Marks. Moderate rates. CALL, WRITE or send us your invention.

May one of our representatives call on you?  
**FREE CONSULTATION**  
Phone: Vanderbilt 7212.

**ASK MANUFACTURERS PATENT CO.**  
FOR 520 FIFTH AVE. NEW YORK

**AEREX** King of the Air  
COMBINATION RECEIVING SET  
CRYSTAL—DETECTOR—TWO STEP

**Aerex Radiophone Corporation**  
342 MADISON AVENUE, New York City

**SCREW MACHINES IDLE**  
Battery of Seven Automatic Screw Machines for Making Parts for Radio Equipment.

SEND BLUE PRINTS AND SPECIFY QUANTITY

The Carlyle Johnson Machine Co.  
MANCHESTER, CONN.

Fine Cuts for Illustrating  
**CENTRAL ELECTROTYPE  
FOUNDRY COMPANY**

Electrotyping and Engravings  
9 Campbell Street Newark, N. J.  
Telephone: Mulberry 1698

**Moss Radio Company**  
Jobbers in  
**Radio Sets and Equipments**  
202 West 23rd Street  
New York City  
Phone Watkins 5078

**BOUDOIR SET ATTRACTIVE**

Novelties in the radio business seem to be coming thick and fast. The smallest set has made its debut, the largest set is also with us, and a hundred-and-one other novelties are to be seen everywhere. The W. E. Supply Co., of New York City, are bringing out a set specially designed to interest the lady of the house, called a "Boudoir" set.

It is claimed that the Aerial A, as this set is called, is one of the simplest of vacuum tube sets to operate, and is specially designed to harmonize with the surroundings of boudoir or home, and besides being a thing of beauty, it is an efficient set.

One of the features of this set is the fact that there are only two dials to operate, and one rheostat for filament control. All wiring is concealed and is connected from the back of the machine. The set is durably and attractively built.

The simplicity of the design, together with the fact that the best of standard parts are used throughout, assures the radio buyer that he is getting a set that is as efficient as good practice warrants.

The Aerial A was found to have a wave length of from 150 to 750 meters when tested by a well-known New York laboratory.

**COLUMBIA VARIOMETER**

The Columbia Moulded Variometer, the product of the Columbia Radio Corporation of Chicago, Ill., is the result of labor spent to perfect a mechanically and electrically efficient instrument. The specifications cover stators moulded in two halves with maximum diameter of 5 1/4 inches. The rotor is also moulded and highly polished, the maximum diameter being 4 inches. Large dimensions permit the use of low resistance wire. The rotor fits into the stator with minimum clearance. There is no possibility of shrinkage or warping in these moulded parts. No shellac or paraffine is used in the wiring. Perfect contact is assured by a spring tension on the bearing. Width across stator 3 inches. Shaft 3/16 inch diameter. Polished nicked hardware and terminal binding posts. Base and panel mounting is provided for. Wave length is 175-650 meters.

The complete instrument is a thing of beauty and symmetry.

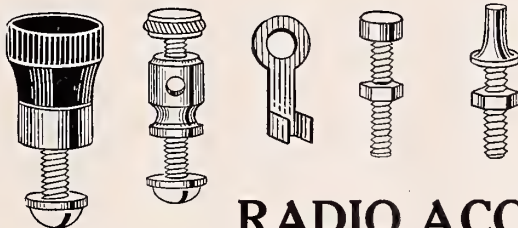

**IMMEDIATE SHIPMENT**

*Also*

**All Other Radio Needs**

*WRITE FOR PRICE LIST*

**RADIO ACCESSORIES CO.**

**220 West 42nd Street**

**New York**

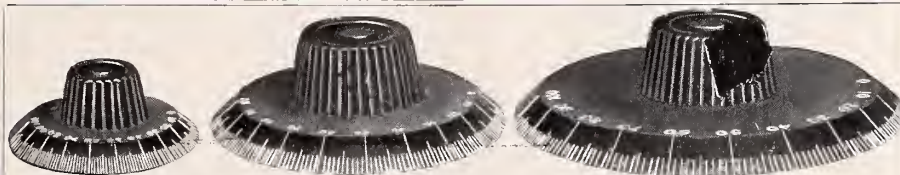

**EMELOID DIALS—2"—3"—4"**  
**2" 35c—3" 50c—4" 60c**

**MANUFACTURERS—JOBBER—DEALERS**

**WRITE FOR DISCOUNTS**

**EMELOID CO., INC., 536 JUNIUS ST., BROOKLYN, N. Y.**

**MR. RADIO RETAILER!**

**You NEED This Paper. Do you think it will be worth a dollar to get THE RADIO DEALER every month for the next year? Use the blank below, rubber stamp or print your name and address, then mail to us. Do it today.**

-----  
**HARRY M. KONWISER, *Publisher,***  
***The Radio Dealer,***  
**1133 Broadway,**  
**New York City.**

**Please send THE RADIO DEALER to the following address for one year**

**for which** { we enclose one dollar  
 { we will send one dollar on receipt of bill.

(Name) .....

(Address) .....

(City and State).....

**Make remittance by check, money order or registered mail**

**STRAHS ALUMINUM CO.**  
 announce their removal from 53  
 Grand Street to much larger premises.  
 New Address  
 48 FRANKLIN STREET  
 NEW YORK CITY

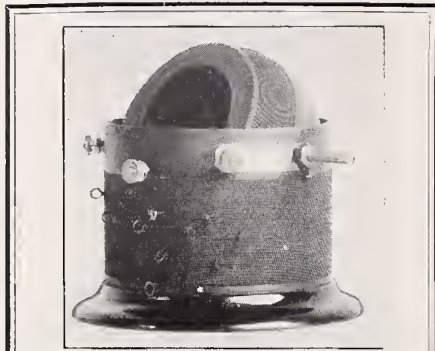

**The EMBE Variocoupler**  
 List Price \$4.50  
 Attractive Trade Proposition  
 Manufactured by  
**Marvin B. Fallgatter**  
 Waupaca, Wisconsin

**Stanton's WIRELESS Bulletin**



**The Authority on Wireless Stocks**

**Reynolds Spring Co.**  
**Radio Corp. of America** Spanish Marconi  
**American Marconi** Canadian Marconi  
**English Marconi** Federal Tel. & Tel.  
**De Forest Radio Tel. & Tel.**

**FRANK T. STANTON & CO.**  
 Broad 5819 35 Broad St., N. Y. C.

**Free Will help YOU increase sales**

This catalog will show you how to secure the names of your best prospective customers, those you want to reach most. Counts and prices are given on thousands of different Lists, covering business concerns, professions and individuals, such as Noodle Manufacturers, Druggists, Coal Mines, Farmers, etc. Personalized sales letters and descriptive literature mailed to live prospects will increase your sales by creating direct orders or inquiries.

**99% Guaranteed Mailing Lists backed by our \$5 refund**

Insure your getting up-to-date information, for our Lists must be compiled from latest sources to avoid heavy losses through the guarantee.

**Send for FREE Reference Book today**  
 A postcard will bring this valuable sales help.  
 ROSS-GOULD CO., N.10th, St. Louis.

**Ross-Gould Mailing Lists St. Louis**

**Trade - Mark Department**  
 Conducted by **Chauncey P. Carter**, Trade-mark Specialist of Washington, D. C.

**Radio Trade-Marks Recently Accepted by the Patent Office**  
 ACCEPTED AUGUST 15

**BKUMA YRLSBUG** — Code-memorizing charts for radio beginners and pamphlets and books relating to radio-telegraphy published from time to time.—Cheever K. Dodge, Mamaroneck, N. Y.

**DREADNAUGHT** — Attachment plugs—Cutler-Hammer Mfg. Co., Milwaukee. Oct. 28, 1921.

**MICADONS** — Electrical condensers—Dubilier Condenser Co., New York, N. Y. March 28, 1922.

**DURASNAP**—Electrical box connectors—Tubular Woven Fabric Co., Pawtucket, R. I. March 25, 1922.

**ETHEROLA** — Cabinet receiving outfits.—Ralph A. McKinney, Pittsburgh. February 1, 1922.

**LISSENIN**—Receiving sets.—Lissenin Radio Parts Co., Ridgefield Park, N. J. January 20, 1922.

**SOCOSTAT**—Tube mountings.—J. Roy Hunt, Inc., Long Island City. April 15, 1922.

**SUPERADIO** — Receiving and sending sets and parts.—DeWitt LaFrance Co., Cambridge, Mass. May 10, 1922.

**CHAMPION**—Jacks and plugs and bulb sockets.—Champion Radio Co., Detroit. April 6, 1922.

**MINATRON**—Vacuum tubes and valves.—Radio Corp. of America, New York. May 27, 1922.

**RADIOLETTE**—Vacuum tubes and valves.—Radio Corp. of America, New York. May 27, 1922.

**KAPACITON**—Condensers. Meirowsky Bros., Jersey City, N. J. May 1, 1922.

**PROTEX**—Antenna plugs.—Genl. Radio Mfg. Co., Pittsburgh. Sept. 30, 1921.

**VOCAROLA**—Loud speakers and amplifiers.—Westinghouse E. & M. Co., East Pittsburgh. December 1, 1921.

**DUCON**—Condensers. — Dubilier Condenser & Radio Corp., New York. May 20, 1922.

**RADIOSTAT** — Controlling devices.—Allen Bradley Co., Milwaukee. April 1, 1922.

**UNIVERSAL**—Connector plugs.

**KNOCKDOWN APPARATUS**  
 Variometer with brass fittings, boxed.  
 Variocoupler with brass fittings, boxed.  
 Crystal set with complete instructions for hook up and assembly.  
 Rotors, stators, and coil ends always on hand.  
*Write for circular and discounts*  
**RITTER WOOD WORK CO.**  
 118 Walker St., New York City

**The Comet Battery Co.**  
*Manufacturers*  
**Radio "B" Batteries**  
 Cleveland, Ohio

**RADIO BOXES AND CABINETS**  
 Send us your specification and let us figure on your requirements.  
**PROMPT DELIVERIES.**  
**THE WEIS MFG. CO.**  
 Monroe, Mich.

**SHIPPED FROM STOCK**

*Prices Net to Dealers Only*

Variometer, complete ..... \$2.00  
 Variometer Parts, all necessary parts except wire..... 1.00  
 Variocoupler, complete ..... 1.50  
 Variocoupler Parts, complete set of parts, except wire.... .85  
 Thordarson Amplifying Transformer ..... 2.75

**Scientific Dealers Supply Co.**  
 2727 Fullerton Ave., -- Chicago, Ill.



—Pacent Electric Co., New York, N. Y. May 18, 1921.

ACCEPTED AUGUST 29

HIGH-10-SHUN — Resistors, lightning arrestors and fuses.—High Tension Supplies Co., Wilmington, Del. Oct. 18, 1920.

TELERADIO—Wireless and electrical equipment. — Teleradio Engineering Corporation, New York. March 11, 1922.

AMPERITE—Automatic filament control adjuster.—Radiall Co., New York. March 15, 1922.

AUDIOLA—Receiving and transmitting sets and parts.—Audiola Radio Co., Chicago. March 31, 1922.

RADION—Battery jars, receiver cases, horns, etc.—American Hard Rubber Co., Hempstead, L. I. April 14, 1922.

RA-FONE—Receiving sets and other radio parts.—Ra-Tone Electric Co., Detroit. March, 1922.

**Recent Registrations in Radio Dealer Trade-Mark Bureau**

ALL SENSITIVE—Galena Crystal Mfg. Co., 464 Bushwick Avenue, Brooklyn, N. Y.—for Galena. Adopted June 15, 1922. First used June 22, 1922.

SERCO — Condensers, detectors and transformers.—Scheib Electric Radio Co., 6243 Station Street, East Liberty, Pittsburgh, Pa. Adopted and first used April 1, 1920.

**SIMPLE-X NOVEL SET**

Among the new and novel crystal receiving sets that are being brought out by manufacturers, because of the increase in broadcasting, is one known as the Simple-X, the construction of which is out of the ordinary. This set is the invention of Charles Hanington and Joseph Gallow.

The Simple-X consists of a flat coil, which is a feature that is patented, and not to be found in any other set, regardless of price, according to the makers. A standard two-slide tuner circuit is employed. The coil of the set is mounted on a well insulated wooden panel, with neat white lettering. Highly polished nickel-plated trimmings are used, and both sliders have rolling contacts, thus assuring good spring action.

The detecting unit of this set is very novel and unique, because the ordinary "catwhisker" is replaced by a wire brush of many strands, and acts on the "multitek" flat crystal, which is a flat area of galena granules bound together with a conducting material.

Clarke-Caragol & Co., of 82 Beaver street, New York City, are distributors of this set.

**WHY EXPERIMENT—MR. MANUFACTURER?**

For years we have been cutting, drilling, machining, grain-ing and polishing Bakelite Dilecto.

Put this experience to work on your panels. Write us for proposition and sample.

**STANDARD WIRELESS PANEL COMPANY**

49 MECHANIC STREET

NEWARK, N. J.

**Binding Posts—Contact Points**

Knock-down Detector Sets



**VARIABLE CONDENSERS**

with patented adjustable tension



**JOHN A. COZZONE & CO.**

61 Arlington Street

Newark, N. J.

**INTERESTED IN RADIO PATENTS?**

Radio Business men and Manufacturers who are interested in the patents issued by the U. S. Patent office may find this information each week in

**THE RADIO DEALER WEEKLY**

One dollar the year. Sample free on request

Address

THE RADIO DEALER WEEKLY, 1133 Broadway, New York, N. Y.

**Trade-Marks Secure Trade**

**Registrations Secure Trade-Marks**

**I Secure Registrations**

**CHAUNCEY P. CARTER**

*Radio Trade-Mark Specialist*

4907 Potomac Avenue, N. W. Washington, D. C.

Correspondents in all countries

# P. D. JACKSON

Direct Factory Representative  
Radio Equipment Manufacturers  
HEAD SETS A SPECIALTY  
1441 So. State Street Chicago, Ill.

## VACUUM TUBE DETECTOR \$5.50

Including complete cabinet with all instruments wired ready for use.

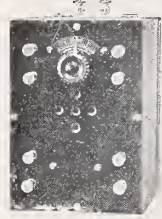

DETECTOR A N D  
TWO STAGE AM-  
PLIFIER \$22.50

With transformers and all other instruments in cabinet, ready for operation. This equipment is of high quality, and distances of as high as 3000 miles have been obtained with ease.

BATTERIES AND TUBES EXTRA

2000 Ohm receivers \$5.00

SUPERIOR CRYSTAL RECEIVING SET \$4.75

Attractive dealers proposition

STEINMETZ WIRELESS MFG. CO.  
5706 Penn Ave., Pittsburgh, Pa.

## Mr. Dealer: Tie up to High-Grade FROST RADIO Merchandise

A well-known National Reputation for Satisfactory Service guarantees you a Quick Turnover.

### FROST - RADIO LEADERS

- |                                                                                                                                                                                                                                                                                                                                                                                                                                                                                                                                                                                                                                                                                                                                                                                                 |                                                                                                                                                                                                                                                                                                                                                                                                                                                                  |
|-------------------------------------------------------------------------------------------------------------------------------------------------------------------------------------------------------------------------------------------------------------------------------------------------------------------------------------------------------------------------------------------------------------------------------------------------------------------------------------------------------------------------------------------------------------------------------------------------------------------------------------------------------------------------------------------------------------------------------------------------------------------------------------------------|------------------------------------------------------------------------------------------------------------------------------------------------------------------------------------------------------------------------------------------------------------------------------------------------------------------------------------------------------------------------------------------------------------------------------------------------------------------|
| <p><b>Frost-Fones</b><br/>A Quality Achievement. Ideal Receivers for use with Home Radio Sets. Combine maximum efficiency with permanent sensitiveness.</p> <p><b>Frost-Radio Extension Cord and Plug</b><br/>Comes in lengths from 10 to 100 ft. Loud speaker can be placed anywhere and connected with Radio set with Frost-Radio Extension Cord.</p> <p><b>Frost-Radio Receiving Transformers</b><br/>Will tune in all stations up to 3,500 meters. Hand rubbed mahogany finish. Wound with green silk covered wire. Immediate deliveries.</p> <p><b>Frost-Radio Protector</b><br/>Listed by Underwriters' Laboratories under April, 1922 regulations. No interference with clear Radio receiving. Never Grounds. Mounts indoors. Price \$1.50. Good deliveries on this approved device.</p> | <p><b>Frost-Radio Improved Plugs and Jacks</b><br/>Specially designed for Radio Panel Work. Plugs are interchangeable with other standard makes.</p> <p><b>Cunningham Vacuum Tubes</b><br/>Nationally recognized as the Ideal Detector or Amplifier Tubes for use with Radio Receiving Sets.</p> <p><b>Remler Radio Apparatus</b><br/>Radiates Quality. Every Remler item is first studied and tested for its practical Radio utility before being marketed.</p> |
|-------------------------------------------------------------------------------------------------------------------------------------------------------------------------------------------------------------------------------------------------------------------------------------------------------------------------------------------------------------------------------------------------------------------------------------------------------------------------------------------------------------------------------------------------------------------------------------------------------------------------------------------------------------------------------------------------------------------------------------------------------------------------------------------------|------------------------------------------------------------------------------------------------------------------------------------------------------------------------------------------------------------------------------------------------------------------------------------------------------------------------------------------------------------------------------------------------------------------------------------------------------------------|

Like Postage Stamps Used Everywhere

**HERBERT H. FROST**  
NATIONAL FACTORY DISTRIBUTORS TO THE ELECTRICAL-RADIO JOBBER  
154 W. LAKE ST. CHICAGO, ILL.

# Crosley Publicity

Cincinnati Folks Furnish Live Wire Radio News

R. F. Stayman, publicity manager for the Crosley Manufacturing Company, is to be commended for his practical efforts to boost radio.

The Crosley folks are doing things and the publicity matter sent out by this progressive house is adaptable for use by daily newspapers and must be appreciated by the radio editors who are on the Crosley mailing list.

A regular weekly sheet of short items just suitable for the daily press is a feature of their service.

## "QUALITONE" RADIO HORN

The Dual Tool Company of Cleveland are producing a new radio horn known as the "Qualitone." W. E. Disbrow, president of the company, in writing of the horn says, "The secret of the success of the 'Qualitone' is due to the built-in double tone chambers more than anything else. Without the rings which form the tone chambers this horn would be like a megaphone. Many months of experimenting were required for determining the right number of rings, their size and the spacing, in order to produce the quality of tone for which this horn is named."

The company has recently started production on another horn of the same type which can be used with a single head piece, believing that there is an increasing demand for this style of horn.

## MAIN RADIOPHONE SET

The Main Radiophone Receiving Set, the product of the Main Radio Company of Cleveland, consists of three separate units, in genuine solid mahogany cabinets, finished in natural color, and hand rubbed finish. Panels polished black formica, with high grade dials 3 inches in diameter.

The tuning unit contains a 23 plate variable condenser, with 3 in. dial, a separate vernier condenser with knob, 180° type variocoupler. Wave length switch and contact points with stops, for up to over 600 meters.

The detector unit consists of high grade rheostat of 200 steps of 6 ohms, good sized knob and indicator hand. Socket, using little metal and a jack.

The units permit the use of a loud speaker and for sharp tuning, the jacks provide a means of quick attachment of the head set.

# CABINETS

Write for quotations

MARVIN B. FALLGATTER  
Waupaca, Wisconsin

## Ask Our Service Bureau

Radio Reception Explained

**HOW TO BUILD**

- Double Slider Type Crystal Receiving Set
- Lease Coupler Type Crystal Receiving Set
- Single Circuit Vacuum Tube Receiving Set
- Vacuum Tube Receiver and Two Step Amplifier
- Lease Coupler Tuner and Vacuum Tube Detector
- Short Wave Long Distance Variometer Regenerative Tuner
- Radio Frequency Amplifier and Variometer Regenerative Tuner
- Combined Radio-Audio Frequency Amplifier Circuit

Great Lakes Publishing Company  
Detroit, Michigan

**BUILD BUSINESS**

Sell more parts by creating interest in radio matters. Distribute an inexpensive book which not only explains radio reception but also tells how to build eight separate types of receiving outfits out of parts you are selling. Complete bills of material given for each type listed and described. This will be of great help to your customers and profitable also.

List, 50c Sample, 20c Very liberal discounts

Desk 4—Great Lakes Publishing Co., Park Place, Detroit, Mich.

# VOLTA PRODUCTS

- VARIOMO-COUPLER.... \$3.85 List  
No taps, the only coupler with sharp primary tuning.
- VARIOMETER..... \$3.25 List  
Low distributed capacity, high range.
- CRYSTAL SET..... \$8.50 List  
Sharp tuning, triple range.

### VACUUM TUBE SETS

Write for Trade Discounts

VOLTA ENGINEERING CO.  
172-4 Lorimer St. Brooklyn, N. Y.

# FRANKLIN VARIOMETER

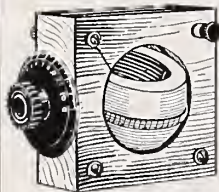

Made of selected hardwood. Permanent contacts assure smoothness of operation, unsurpassed by any other make.

Price \$4.50

Sample sent prepaid \$3.50

Dealers Write for Discounts

FRANKLIN RADIO MFG. CO.  
711 Penn Ave. Wilkensburg, Pa.

## GUARANTEED QUALITY radio supplies at LOW PRICES and PROFIT allowing discounts.

- Variometers ..... \$3.75 up
- Vario Couplers.... 2.50 "
- Vario Condensers... 2.00 "
- B Batteries..... 1.75 "

Wire, Parts and Supplies  
Special Purchasing Service

McCormell Cable & Specialty Co.

426 1/2 S. Clinton St., Chicago, Ill.

## Baltimore

The Autovoix Company, of Lexington Street, are completing plans for extensively marketing a new loud speaker which has been shown by tests to be 100% efficient. The new speaker combines the best acoustic and electrical properties and is distinctive in design. The price is one to fit everyone's pocket.

The Jones Radio Manufacturing Company, constructing all small parts as well as complete sets, and having their hands full making the output of their large plant meet even local design. Among other products, this company has devised and is producing a tube socket built especially for the "peanut" tube, which is being used so widely.

Reuben S. Baldwin, of the Fidelity Trust Building, is distributing nationally, a complete set which is made by a firm of repute in the electrical instrument field. Plans for national advertising and merchandising of this set are now under way, and it will soon be on the market.

### NEW GROUNDING DEVICE

The Fargo Manufacturing Company, Poughkeepsie, N. Y., are producing a new grounding device that bids fair to find a ready market. The device secures a perfect connection of a grounding wire with seven full turns around a grounding pipe or rod, and is fastened by hexagonal semi-finished clamping bolts through a clearance hole in one clamp and threaded hole in the other clamp, and locked with a hexagonal jam nut.

The clamps are made of malleable iron well reinforced with bosses hot galvanized.

This device can be applied easily and quickly.

### BOOK REVIEW

**The Radio Pathfinder**, by R. H. Ranger. Published by Doubleday-Page and Co., Garden City, N. Y.

R. H. Ranger, who is an engineer on the staff of the Radio Corporation of America, has covered the path of the broadcasted wave from the moment it strikes the aerial until it is intercepted in the receiver and horn. The book contains more than fifty line drawings, aiding greatly in making the written description clearly and easily understood.

## A Vernier Condenser That Has No Equal

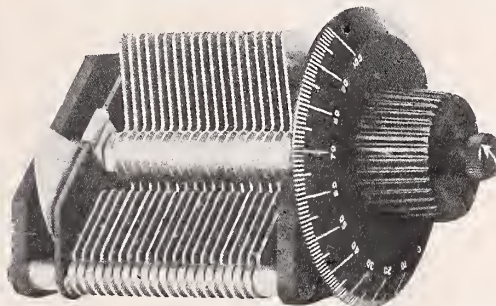

.0005 - \$5.00 .001 - \$6.00

WITH 3-INCH DIAL  
Special Sizes Made to Order

ALSO PLAIN CONDENSERS,  
SPAGHETTI, RUBBER TUBING,  
KNOBS, DIALS, GRID  
LEAKS, GRID CONDENSERS

**BREMER-TULLY RADIO CO., Manufacturers**  
532-536 S. CANAL ST. CHICAGO, ILL.

**MANUFACTURERS!**

**DEALERS!**

## RADIO PANELS

of Genuine XX Grade Black

## BAKELITE—DILECTO

*Cut to Any Size*

**STANDARD RADIO PARTS CO.**

30 Church Street, Room 2013 (Phone Cortlandt 2515) New York

### "ASK OUR SERVICE BUREAU"

Dealers, Jobbers and Manufacturers who are not heeding this advice are missing a service that works with speed and efficiency, and in addition costs nothing.

*If you want to buy anything in Radio*

"Ask Our Service Bureau"

*(Advertisement on Page EIGHTEEN, this issue)*



**VERNIER DIAL  
ATTACHMENT**

### "BROUN"



**DOUBLE CIRCUIT JACK**  
Made in Single Open, Single Closed  
and Double Circuit Jacks

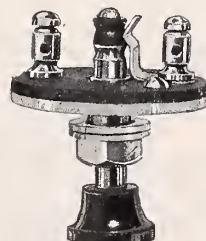

**BATTERY  
SWITCH**

The above Jacks and Battery Switch manufactured by the Radio Improvement Co. and the Vernier Dial Attachment manufactured by us are essential parts for the perfect operation of a Radio Receiving Set.

As manufacturers and manufacturers' representatives we have a complete line of Radio Apparatus, each part of which is backed up by our guarantee.

Many advancements in design and sales features will be found in all of our apparatus.

*Write for new catalogue.*

## BROUN RADIO COMPANY

Sales Office, 552 Seventh Avenue, New York City

## RADIO CONCERTS CORACO

America's Greatest Radio Receiver  
*No Inside or Outside Connections*  
**GOTHAM THEATRE BUILDING**  
Broadway at 138th Street

## T-B-H PHONES

Speak for Themselves  
Pure Natural Tones, Light Weight  
Ornamental Appearance

A Sturdy Reliable Head Set That Will  
Sell and Stay Sold

Let us send a sample set for your  
inspection

List \$7.00

Substantial Discounts to Jobbers and Dealers

**T. B. H. CORPORATION**  
Dansville, N. Y., U. S. A.



## HONEYCOMB COILS

| Size    | Price   |           |
|---------|---------|-----------|
|         | Mounted | Unmounted |
| DL-25   | \$1.54  | \$0.50    |
| DL-35   | 1.54    | .50       |
| DL-50   | 1.65    | .60       |
| DL-75   | 1.65    | .60       |
| DL-100  | 1.71    | .65       |
| DL-150  | 1.76    | .70       |
| DL-200  | 1.82    | .75       |
| DL-250  | 1.87    | .80       |
| DL-300  | 1.93    | .85       |
| DL-400  | 1.98    | .90       |
| DL-500  | 2.20    | 1.00      |
| DL-600  | 2.37    | 1.15      |
| DL-750  | 2.59    | 1.35      |
| DL-1000 | 2.86    | 1.60      |
| DL-1250 | 3.30    | 2.00      |
| DL-1500 | 3.85    | 2.50      |

Both the mounted and unmounted coils are perfectly wound and have the proper inductances, capacities, etc.

### Mountings

This is an article which we have originated to meet the demand for a device suitable for mounting unmounted honeycomb coils. It consists of a plug, which has been drilled and tapped and prepared for soldering, and which is equipped with two plates and two screws and a perforated fiber band, long enough to encircle the largest size honeycomb coil. It sells at 80c.

*Special Discounts to Dealers and Jobbers*

**VIKING RADIO CO.**  
26-D Cortlandt Street  
New York City

## MILLIKEN TOWERS

(Continued from page 43)

of construction involved will in itself safely accommodate these various conditions. This is partially true when we come to the higher towers, but not entirely, because, unfortunately, the forces of nature, in the form of wind, sleet and ice, and the fallibility of man, make it impossible to limit the corresponding effects. The qualified designing engineer will provide a factor of safety against these elements, but the degree of this will be influenced by the height of the tower.

In the earliest days of bridge building, the first was probably a tree thrown across a stream or gully; then it was found, quite obviously, that two trees side by side would carry twice the load, and that two trees, one on top of the other and fastened together, would carry more than twice the load. From this the development extended to wood trusses, until some very massive wood bridges were finally constructed, some of which still exist.

This development, however, was by a method of extending the service of wood from step to step by more or less empirical formula. Sometimes the extension was carried too far and the bridge collapsed.

Likewise, in wood pole construction, up to certain heights, experience has shown that it is quite satisfactory, but beyond these limits there is always danger of an extension too great.

In the previously mentioned height curve, the Milliken Brothers Mfg. Co., Inc., supply galvanized steel towers for two of the divisions—namely, that extending from 66 ft. to 165 ft. in one and from 200 ft. to 300 ft. in the other. For the division below 66 ft., it is suitable and perhaps more economical to use a wood construction. Above 300 ft., the construction requires a type of riveted steel tower that is beyond the practicable possibilities of galvanizing and consequently outside of the class of the company's products.

Both types of the Milliken Radio Tower are standardized, made to fixed designs fully illustrated by the catalog. The material is shipped knocked down, in pieces easily handled and erected. All connections are made with bolts and lock nuts. The problem of foundations is very simple and these can always be made with local labor. The catalog shows the details of the foundations as well as the details of the tower, but in addition, with each tower order is mailed a complete erection diagram that shows the mark and location of every member in the tower.

Telephones: 5454 Beekman 2787

**NAME PLATE COMPANY**  
ETCHED OR LITHOGRAPHED METAL  
NAME PLATES, SIGNS, DIALS  
125 FULTON ST., NEW YORK

## MELCHIOR RADIO EQUIPMENT CO.



MANUFACTURERS OF  
THE SMALLEST TUBE  
SET ON THE MARKET

A well made set using a reliable condenser, rheostat, vario-coupler and a variometer.

**MELCHIOR EQUIPMENT CO.**  
306-308 E. 34th Street New York City  
Dealers—Write for our Proposition.

Ask Our Service Bureau

See page 18



35c. each.

3 for \$1.00

**Na-ald**  
GENUINE  
CONDENSITE DIAL

*The Dial that Runs True*

Numerals engraved on bevel and knob so shaped that fingers do not hide them. Thin edge with clear graduation to make accurate reading easy. Concealed set screw in metal insert. Will not warp or chip. Finish and enamel permanent. Low price with this quality possible only through quantity production.

*Special dealer and jobber proposition. An opportunity.*

**ALDEN-NAPIER CO.**  
52 Willow St. Dept. J Springfield, Mass.

## Do You Know

We are the recognized authorities on wireless securities. Our Information and Analytical Departments are unexcelled. Let us know what company you are interested in and we will furnish without obligation, detailed information and opinion respecting its merits

**FRANK T. STANTON & CO.**  
Specialists in Wireless Securities  
Since 1915  
35 Broad St. New York  
Phone: Broad 1670-3641-5819

**RADIO STOCKS**

(Continued from page 54)

stations of the Postal Telegraph-Cable Company in this country are to be placed at the disposal of the Radio Corporation of America, for the delivery and collection of radio messages between America and all parts of the world where radio service is possible. This agreement places speedy and cheap radio service in virtually every town and hamlet in the United States and direct competition with the cable service to foreign countries. The importance of this agreement cannot be overestimated. It places the final stamp of approval on radio as a means of better communication. Additional announcements of a constructive character are expected, which should further stimulate increased buying of Radio Corporation shares.

**ENGLISH MARCONI:** The broadcasting craze is now sweeping England. As the pioneer radio concern and having a practical monopoly of the business in England, English Marconi should come in for a large share of equipment buying. This is a dividend paying stock with good possibilities for capital appreciation. A Lisbon message says that the Portuguese Parliament has approved a contract with the Marconi Company for the erection of wireless stations in Lisbon, Madeira, the Cape Verde Islands, Angola and Mozambique, to be ready in four years.

**CANADIAN MARCONI:** As in the case of England, Canada is beginning to appreciate broadcasting possibilities. Heavy demand is reported for radio licenses. Theatres, hotels, etc., are installing radio equipment for the entertainment of the fans.

**DE FOREST RADIO:** This company recently announced that Dr. Lee De Forest, who has been in Germany for the past year, is returning to America to demonstrate his perfected talking movies. This invention is bound to revolutionize the motion picture industry which has through lack of novelty, declined considerably in entertainment value. This billion dollar industry opens up a vast profitable field for the De Forest development, since practically every producer is a potential buyer of this equipment. Aside from the profits to be derived by this new invention, the company is showing satisfactory earnings from its radio business.

**WESTERN ELECTRIC:** The directors of the Western Electric Company at a recent meeting

**ELECTRICAL TESTING**

Of all materials entering into Radio Construction. Meters and apparatus calibrated and repaired.

**CHEMICAL ANALYSES  
STRENGTH TESTS**

Investigation or Development of New Apparatus and Materials. Routine Tests at Special Rates.

**NEW YORK TESTING LABORATORIES**

80 Washington Street

Bowling Green 7016

**SEABOARD**

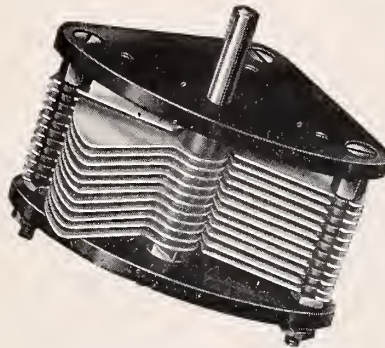

No. 1 Variable Condenser for Panel Mounting. IMMEDIATE DELIVERY. Jobbers and retailers—write for discounts. 23 plate—list price, \$3.00.

CAREFUL construction in all SEABOARD products, courteous attention to all SEABOARD clients, and full-of-value prices for all SEABOARD parts have combined to make an organization efficient and dependable. Send us your radio-needs and let us "talk turkey" on some of the lowest prices on the radio market.

Every part tested and inspected before shipment. Our guaranty stands behind all SEABOARD products.

**SEABOARD RADIO CORPORATION - 266 GRAND STREET NEW YORK CITY**

SERVICE TO THE RADIO TRADE PROMPTS THE PUBLICATION OF

**The Radio Dealer Weekly**

1133 BROADWAY

NEW YORK, N. Y.

**RADIO CABINETS**

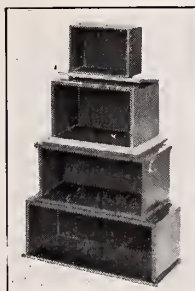

We manufacture a complete line of radio cabinets, of mahogany, walnut, oak, and white wood, in all sizes, and in any finish. Best of construction. Dirt, dust and moisture proof. Quick deliveries—quantity production prices. Send us your specifications, or a sample of your cabinets, and get our prices. We also make indoor loop aerials.

CABINET WORK SINCE 1900

**E. ESHOO CABINET WORKS**

635 HERKIMER ST. BROOKLYN, N. Y.

TELEPHONE LAFAYETTE 2324

declared the regular quarterly dividend of  $1\frac{3}{4}$  per cent. on the preferred stock of the company, payable Sept. 30th to stock of record Sept. 16th. A dividend of \$2.50 per share was also declared on the common stock, similarly payable.

AMERICAN TEL. & TEL.: This company opened America's first Radio news service on September 1st. A digest of the day's important news will be supplied to the owners of radio sets within short distance of New York. In addition to general news, the digest will feature information pertaining to new inventions in radio and will conduct a department of questions and answers for the benefit of its "listeners in." Company recently issued \$115,000,000 of 9% stock.

WESTINGHOUSE ELECTRIC: There is no let-up in the demand for the Company's products. Earnings show a healthy increase. Company is extensively experimenting for the further advancement of radio. The stock looks materially higher.

GENERAL ELECTRIC: General Electric's July bookings were at annual rate of \$270,000,000 against \$260,000,000 for the first half of this year and \$208,000,000 for the first quarter. Increase since first of the year has been about \$10,000,000 a month. Strong financial position is indicated by investments in securities not classed as cash approximating \$75,000,000. Cash at end of first quarter exceeded \$63,500,000. By 1923, despite carrying charges of heavy goods, cash will probably be above \$80,000,000.

The stock recently made a new high selling at \$188. This represents an advance of more than fifty points above its low last year.

REYNOLDS SPRING: Reports from the company's plant at Jackson, Michigan, show a great increase in the volume of business handled for the month of August, particularly in the spring department. Production was increased 50% above that of July. In the Radio department the new installed bakelite plant which is the largest plant of its kind in the state of Michigan has proven a valuable accessory to the spring business, and have already received a large order from the Dodge Brothers Co. for automobile caps. They are figuring on other orders for material that their bakelite plant can produce. They also have started work on new models for the De Forest Radio Tel. & Tel., who are looking forward for large volume of business this fall. The stock on the New York Stock Exchange for the past month has ranged between 26

## ANNOUNCING

*The Latest and Most Efficient Non-Regenerative Receiving Circuit*

**The GRIMES combination of RADIO and AUDIO frequency insures both DISTANCE and VOLUME.**

### *3 Models for October Delivery*

- |            |                                                                                                                                                                                                        |
|------------|--------------------------------------------------------------------------------------------------------------------------------------------------------------------------------------------------------|
| TYPE G-A-2 | Consists of Tuner, Detector, 1 Stage Radio, 1 Stage Audio Frequency Amplification.                                                                                                                     |
| TYPE G-A-3 | Consists of Tuner, Detector, 2 Stages Radio and 2 Stages Audio Frequency Amplification.                                                                                                                |
| TYPE G-D-4 | Consists of Tuner, Detector, 3 Stages of Radio and 3 Stages Audio Frequency Clear Speaker, A and B Batteries, Charger, etc. Complete in mahogany cabinet (illustrated on page 100 of September issue). |

Types G-A-2 and G-A-3 are designed to operate either on aerial or indoor loop. Type G-D-4 requires no aerial-ground or loop, the receiving element being enclosed in the cabinet.

**GRIMES RADIO ENGINEERING CO., INC.**  
Grasmere, Borough Richmond NEW YORK CITY

### Revised Radio Dealer List

Do not attempt to do without the best radio dealer list—you cannot save your money that way.

Buy our list, recently revised from local sources. It will make money for you and get you there first. Write for prices and details.

### Revised Radio Jobber List

This is a fully inclusive one, with many recent names. You cannot fail to find it valuable. Write for prices and details.

### Unique New Mounted Broadcasting Map

Ready to hang on wall, large size, colored pins marking government, newspaper and private stations; circles, marking crystal and tube set range, \$37.50. Also special large sizes.

### Radio Merchandising Research

This is 100 typewritten page analysis of situation; illustrated with charts; up-to-date, expert sales and distribution analysis. Price \$150.00. New or old radio firms should not fail to buy it.

## **The Business Bourse**

International, Inc.

For 14 Years the National Clearing House of Business Data

15 W. 37th St., New York City

Telephone, Fitzroy 6720

and 32 and has reached the level where it can be bought for higher prices.

**MANHATTAN ELECTRICAL SUPPLY:** The annual report for the year ended December 31, 1921, shows total assets of \$6,173,126.53 of which current items amounted to \$2,662,268.83 against current liabilities of \$435,869.43 (ratio of 6 to 1), leaving a substantial working capital. Surplus amounted to \$737,257.10; cash on hand at \$409,255.55 and inventories \$1,519,054.72. Altogether, the report is considered a favorable one. The company's business consists of electrical and radio equipment, for which there is reported, a heavy demand. Dividends of \$4 per share annually are being paid on the 70,000 shares of no par outstanding. Stock sold for \$30 this time last year and on the radio boom subsequent reached \$60. Present quotations, \$53.

|                                | Bid  | Asked |
|--------------------------------|------|-------|
| All Amer. Cables .....         | 116  | 118   |
| Amer. Tel. & Cable .....       | 62¼  | 63    |
| Amer. Marconi Stamped ....     | 5c.  | 25c.  |
| Amer. Marconi Unstamped ..     | 7    | 9     |
| Amer. Tel. & Tel. ....         | 123¾ | 123½  |
| Canadian Marconi .....         | 2¼   | 3¼    |
| De Forest Radio Tel. & Tel. .  | 7    | 10    |
| English Marconi Common ...     | 10   | 14    |
| English Marconi Preferred ..   | 10   | 14    |
| Federal Tel. & Tel. Calif. ... | 7    | 7½    |
| Federal Tel. Co. New York ..   | 8    | 12    |
| General Electric .....         | 180  | 183   |
| International Tel. & Tel. .... | 55   | 65    |
| Mackay Co. Common .....        | 101½ | 103   |
| Manhattan Electric Supply ..   | 52   | 55    |
| Marconi Int. Marine .....      | 6    | 8     |
| New York Tel. 6½% Pfd. .       | 109½ | 110   |
| Pacific Tel. and Tel. ....     | 56   | 62    |
| Radio Common .....             | 4¾   | 5     |
| Radio Preferred .....          | 3¾   | 3¼    |
| Reynolds Spring Common ...     | 26   | 29    |
| Spanish Marconi .....          | 1    | 3     |
| United Fruit .....             | 152  | 153   |
| Western Union .....            | 64   | 65    |
| Westinghouse E. & M. ....      | 63   | 64    |
| Westinghouse E. & M. 1st Pfd.  | 75   | 77    |

I will be pleased to answer any inquiries concerning radio securities.

**MYDAR NOVEL CATALOG**

The Mydar Radio Company of Newark, N. J., have recently compiled a catalog of radio devices, which is a good example of what radio manufacturers can do in the way of supplying their trade with a really useful catalog.

It is called a perpetual, ready reference catalog. Bound in a good quality cover, and pages "loose-leafed," all items are carefully thumb-indexed on the lower right hand corner. Complete and detailed information is found on each page regarding the article described, and nothing is left to imagination.

Additional pages for the catalog are sent to all dealers who are on the company's mailing list, each time a new item is produced.



**R-D-5 Tuner \$75    PARAGON A-2 Two-step Amplifier \$50**

Wave length 510 meters. Same circuit as in R-A-10-1000 meters with the same finish and workmanship. Very selective. Get your order in now. Best service and discounts.

**E. M. WILSON & CO., 11 Lafayette St., NEWARK, N. J.**



In lots of 100, \$3.50 each. In smaller lots, \$4.00 each.

Retail prices optional, so that special sales may be held.

A superior receiving set with a vocal and musical range of from 38 to 45 miles—code range, 150 to 200 miles

MAHOGANY CASE, BAKELITE PANELS, NICKEL FIXTURES  
8½" COIL AND TWO-SLIDE TUNER

**STANDARD PRODUCTS CO.**  
93 WILSEY STREET                      NEWARK, N. J.

**Ask Our Service Bureau**

**Positive Contact      Permanent Capacity**

**KOMPRESSED, BAKED, SEALED**

**KAPACITON**

**INDIVIDUALLY TESTED**

**KONDENSERS**

**ARE BETTER CONDENSERS !**

'Phone \* Grid \* Grid with built-in leak \* Grid with detachable and variable leak \* (Pat. pend.) All capacities.

**Meironsky**                      Jersey City, N. J.

Established 1910

## "Aerovox Products"

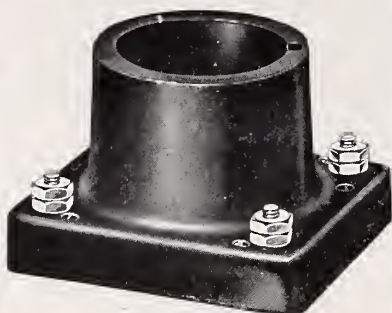

No. 1011 V. T. Socket

The "AEROVOX" Vacuum Tube Socket adds to the quality of any vacuum tube set. It is well designed and attractive in appearance.

### A FEW INTERESTING FACTS:

1. Highly polished moulded tube socket, with 3/16" wall which eliminates the danger of cracking.
2. Contact springs are of heavy phosphor bronze, nickel plated, set in grooves moulded in the base. This prevents slipping.
3. Connection symbols moulded into the base.

Awarded Certificate of Merit, N. Y. Evening Mail Laboratory.

SPECIALISTS IN PARTS FOR VACUUM AND CRYSTAL SETS

**JOBBERS! ATTENTION!**

Wire or write for open territory

**Radiola Wireless Corp.**

208 West 17th St., New York City

## MERCHANDISING RADIO

(Continued from page 55)

fancy, has to contend with the constant improvements in equipment that are being made right along. The man who stocks up for a long time ahead may find himself facing a big loss due to newly discovered improvements being sold. Jobbers and dealers would do well to take heed of this factor.

Buy what you need, don't be niggardly in your purchases, but don't overstock. In the radio business we may expect "something new under the sun" every little while. In the early stages of America's business, success came to those who not only had the vision to see the future, but to those gifted with that rare quality of seizing opportunities and of making a fortune at the flood. Soon the pioneer days passed and opportunity had to be created. Today we are faced with the alternative of using scientific methods to create opportunities or of going to the wall. Yet in this particular business, just developing and slowly getting to a standardized and staple basis, there are opportunities galore for the man who combines the art of seizing opportunities and of creating them.

The successful radio merchant will first of all take heed of how he stocks his place and then he will watch closely his turnover and its relation to his investment. He will not be led into the error of oversupply by the plea of "low prices now but higher next month"; he will keep his finger on the market pulse, buy steadily what he needs and follow certain sound business principles.

### SUCCESSORS TO F. C. MANNING CO.

Announcement has been made by F. C. Manning, of the F. C. Manning Company, Newark, N. J., that the United Specialties Company, Inc., are successors to the Manning Company. The new firm is marketing a novel crystal set called the Little Gem Receiving Set, which has been developed by the company's radio engineer, Edward Moore. This set consists of a vertical tuning coil, on the upper end of which is placed the detector and aerial binding post. The binding posts for ground and phones are on the opposite end. The set is supported by a small tripod in much the same manner that a camera is mounted on its tripod. This concern also manufactures and distributes the Multilistener, a device permitting two or more people to listen in with a single pair of phones.

## ADBRI LABORATORIES

Manufacturing all kinds of Crystals in Wood's Metal. Guaranteed Tested.

469 Broad St., Newark, N. J.

We manufacture 7 different styles of **VARIO COUPLERS**

To Sell from \$1.25 up

All Guaranteed Perfect (JEWELL'S) **JOBBERS—DEALERS—AGENTS**

Write for Discounts

**JEWELL RADIO SALE CO.**

90 West St., New York City

Phone Rector 1035

## TUNING COILS

Double Ply—Dull and Bright Finish—2x3 1/2, End Pieces Made of Composition Fibre.

**REGULAR \$3.50 - NOW \$1.30**

**BERSHAW RADIO & MFG. CO.**

82 Barclay St.

Newark, N. J.

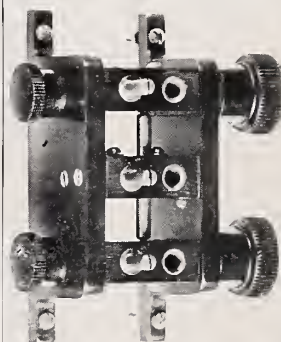

**TRIPLE DOUBLE and SINGLE COIL MOUNTS**

not moulded, fully dielectric, special lock knob, preventing any moving of

coils after being set, assures closest tuning.

List Price

TRIPLE COIL MOUNTS.....\$5.50  
DOUBLE COIL MOUNTS.....3.75  
SINGLE COIL MOUNTS......50

Trade Discounts Allowed

**OSLAND, INC.**

122 Fifth Ave.

New York City



Our Radio Department is conducted by electrical engineers which assures you with dependable and highly efficient Radio equipment, either in complete sets or separate units, such as Head Receivers, Varicouplers, Variometer, Cabinets, Detectors, Antennas, Rotary Spark Gaps, Sliders, Panels, Dials, Knobs, Condensers, Grid Leaks, Contacts, Galena Crystals, etc. For a popular home receiving set we recommend the RESODON. This set comes in a beautiful mahogany finished cabinet. Write for literature.

**PAUL G. NIEHOFF & CO., Inc.**

Electrical Laboratories and Manufacturers

238 E. Ohio Street

Chicago



**OPTIMISTIC OUTLOOK**

*(Continued from page 41)*

Of course, some credence must be given the fact that the public is returning from its out-of-door life, and radio will prove a source of entertainment during the cold months; this is helping to increase the logical demand. Static, continual reference to radio and lighting in many news articles, circulars, etc., and continual mention of a "slump" helped bring on a real slump, but these things have all proven mythical, and it is doubtful if the radio industry will ever know another sudden drop as has been recently experienced. Now that this sort of myth has been dispelled and only facts remain, the campaign for continued good business will be more energetic. Manufacturers, jobbers and dealers throughout the country are of the opinion that the industry has been tested and found to be a necessity, not a toy or a passing fancy.

Radio has shaken off the parasites; has forced out poor equipment; has entered into a real competition; has learned to discern fact from fancy all on a rising market that bids well to bring radio into its proper and deserving place among the industries of the world.

**PRACO CONDENSER**

The Pittsburgh Radio & Appliance Company of Pittsburgh have placed a new and novel variable condenser on the market. The condenser is said to be the best to be obtained, insofar as material and high-grade construction is concerned.

The "Praco Service," for those who are acquainted with the distributors, is fast becoming a trade by-word. The company is specializing in panels and tubing.

**"SPECIAL TYPE" COUPLER**

After careful research and experimentation Theo. Marine, of the Marine Radio Co., of New York City, has finally completed a special type coupler which he claims will work superior to the old type variocoupler and variometer combination. When put in circuit with a .0014 condenser it gives very selective tuning and volume.

The company is marketing these coils separately as well as in complete tuning units.

DEALERS—This ad in consumer papers will bring you orders. Write us today. Get your's now. Packed 24 in an attractive display carton

HOLE FOR ANY SIZE PIN TIP

NICKEL PLATED  
**35¢ PER PAIR**

NUT FOR WIRE OR SPADE TIP

SET NUT

THE PLUG-A-POST BINDING POST TAKES PHONE PIN TIPS, SPADE TIPS, OR PLAIN WIRE

One turn of the nut gives a death-like grip—Each **PLUG-A-POST** is a miniature chuck—made on precision machines - a beautiful piece of Workmanship--  
*made with Watchmaker's accuracy*

**PLUG-A-POST**  
The New Way  
A MINIATURE JACK FOR PHONE TIP  
The Old Way

**PLUG-A-POST**

JOBBER AND MANUFACTURERS WRITE FOR DISCOUNTS

Dealers - Send for name of nearest Jobber

**RADIO TECHNICAL LABORATORIES INC.**  
9-15 CLINTON ST. NEWARK, N. J.

Every **QUEENS** instrument inspected before it leaves our factory

**QUEENS Vario Coupler**

The **BEST THERE IS!**

Not because we say so, but facts prove that Queens Variocouplers are the best to be had regardless of price. They are designed and manufactured by men who have made radio their life work—beginning long before the days of broadcasting. This priceless experience, coupled with huge production have made such a low price possible. The real proof of the efficiency of Queens Variocouplers is comparison. Compare them with any other variocoupler on the market. Examine the fine workmanship and be convinced that what we say of the Queens' is so. None are so good at anywhere near the price of the Queens.

**\$5**

**IT'S COLLEAGUE,**  
the variometer, matches the coupler in quality as well as appearance and is an equally efficient instrument. When used together with the coupler, the utmost in clear and distinct reception of speech and code is obtained. Queens Variocouplers and Variometers are perfectly adapted for use in the Armstrong regenerative and super-regenerative circuits.

If you sell Queens instruments, you will retain pleased customers and enjoy good profits. Attractive discounts to dealers and jobbers. Backed by national advertising, these instruments will be big sellers. Write today and let us tell you more about ourselves and our instruments. Cash in on big profits with real efficient apparatus. Order your stock of Queens Variocouplers and Variometers today.

**QUEENS RADIO COMPANY, Inc.**  
12A Forest St. Winfield, L. I.

**\$5**

**QUEENS Vario Meter**

Look for our Inspection Tag on every **QUEENS** instrument

## IMMEDIATE DELIVERY

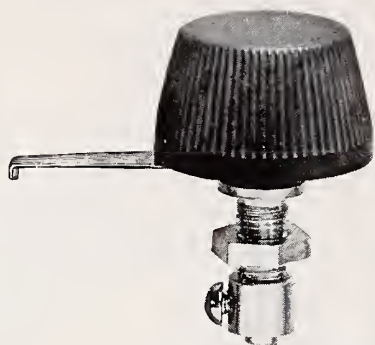

Pointer Radius 1", 1 1/4", 1 1/2" 

500 Lots, 14c each 

Parallel Series

500 Lots, 18c

A Detector that STAYS PUT

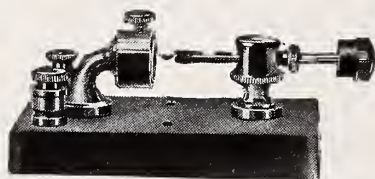

Beauty of line, smoothness of operation and velvet strength in every part 

100 Lots, 50c

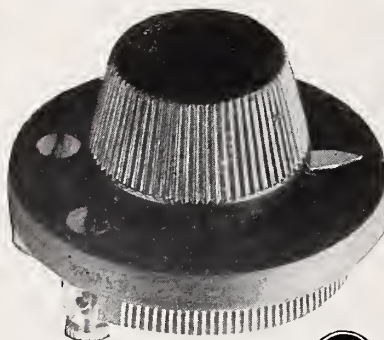

Delivery Two Weeks 

Quantity Price 32c

2" Dials, 18c

C. C. Binding Posts

\$22.50 per M

HAYDON  FENTON

Manufacturers

167 Chambers Street - New York

Agents Write. Some territory still open

## The Dubilier Variadon

Compact, Variable Mica Condenser Having a Movable Plate

By P. W. SMITH

Dubilier Condenser & Radio Corporation

Because a very sharp tuning is necessary for continuous wave reception with vacuum tubes, variable condensers are generally used. The dielectric of a variable condenser is air. A set of semi-circular plates is rotated between a corresponding set of fixed plates forming alternate layers of air dielectric with adjacent conductors of opposite polarity. A variable air condenser is bulky; it consists of many fixed and rotatable plates which must be fastened with small, light screws, difficult to handle.

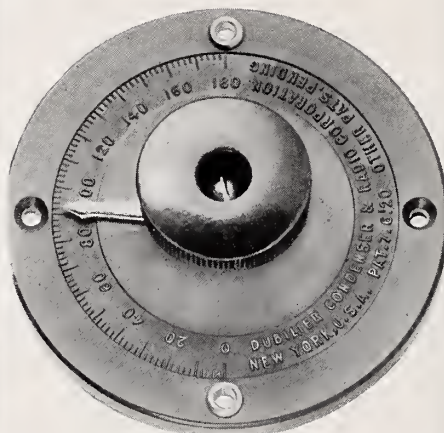

Despite the care taken in mounting, the plates of the ordinary air condenser sag in time. Vibrations and shocks destroy the adjustment, so that short circuits may occur.

With the introduction of the Dubilier Variadon these objections and difficulties disappear.

In the first place, the Variadon is a variable mica condenser. It contains but one moving element. Hence it is not only light, but compact as well—so compact, in fact, that it is no thicker than the mere three-inch dial of the ordinary variable air condenser.

There is nothing to sag or warp in the Variadon. It is always in perfect balance. The adjustment cannot be destroyed by either the shock of a fall or by vibration. Hence short circuits are practically impossible. The Variadon actually improves with use; its life is indefinite.

In the Variadon, mica and not air is the dielectric, and mica is generally conceded to be the best dielectric for condensers of any type. Because mica is relied upon instead of air, the



DUCON

\$1.50 Retail

No outside antenna; simply place plug in any electric socket.

The original (patented) DUCON plug, variable condensers, crystals, Dubilier Micadons, etc.

### KING QUALITY RADIO EQUIPMENT

Dials, switch levers, knobs, contact points, sockets. There is no other equipment of such quality at such a price.

Invincible crystal sets that are a thing of beauty and a joy forever. Super-radio vacuum tube sets.

Write, phone or write for prices and discounts

THE INVINCIBLE PRODUCTS CO., INC.

159 N. State St. Chicago, Ill.

"The clouds roll by, but the blue sky remains."

## TITAN-O-TONE \$10

WITH HEADSET and AERIAL

Same with Double Titan-O-Tone Headset - - \$12



A well made and very efficient outfit mounted in genuine mahogany cabinet. Discounts 40 and 10.

For Jobbers and Manufacturers!

- Per 100 net
- 3" Aluminum Dial with Knob \$8.00
- Large Contact switch 8.00
- Large Knob with set screw . . . 2.50
- Crystal Detector, Knocked Down . . . 13.00
- Mounted Gallium Crystal, Tested 4.50
- Crystal Wash, 1 oz. Bottle, 8.00



T-F RADIOPHONE CO., Inc.

Manufacturers "Titan-O-Tone" Products

667 Coney Island Ave., Brooklyn, N. Y.

plates of the Variadon can be very close together, with the result that an extremely compact variable condenser is produced.

Multiple plate air condensers are generally used in the primary circuit and a small variable condenser or "vernier" is connected in parallel with it. The vernier aids in tuning sharply. The Variadon, however, requires no vernier. It is so made that it permits fine tuning in itself.

The Variadon enables amateurs and manufacturers to make small, compact, inexpensive sets which can be tuned as sharply as the larger and more cumbersome receivers equipped with variable condensers and verniers.

Existing sets can be equipped with it and the reception greatly improved.

The terminals are so insulated that it can be mounted on either metal or insulated cases. The terminal screws can be used for mounting if necessary.

The maximum capacity of the Variadon is .0006 mfd. This means that the capacity is equivalent to that of a twenty-three plate air condenser of wheel design.

**"DE LUXE" RADIO RECEIVER**

**Sold by Ablett**

The Charles R. Ablett Co. announce that they are now ready to distribute their De Luxe Navy Type Receiver. This receiver combines in a compact case the latest developments in radio and, Mr. Ablett claims, will pick up music, voice, etc., on any wave length. The normal wave length is from 300 to 6,800 meters, but a loading coil attachment permits reception on wave lengths up to 23,000 meters. Capacities of proper loading coils are: primary, 50; secondary, 50; tickler, 30 millihenries. It is claimed that this receiver has an unusual degree of selectivity.

It is pointed out that, although this receiver was primarily designed for laboratory and experimental work, where the greatest efficiency is required, its simple arrangements and unusually beautiful finish make it highly desirable for clubs, hotels and homes where the last word in radio equipment is demanded.

The operation of a switching mechanism permits the use of either two tuned circuits or an untuned secondary.

The handsome containing case is of heavy mahogany, in which the receiver is mounted on bakelite-dilecto panel. A switch is provided for protection of detector during transmission and also reception.

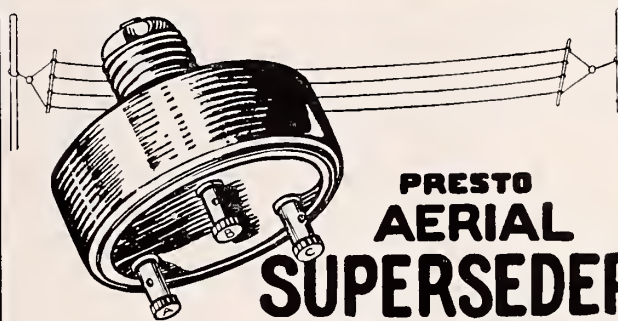

Patents Pending

**PRESTO  
AERIAL  
SUPERSEDER  
ADJUSTABLE**

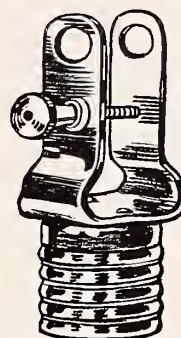

Patents Pending  
Phone Attacher

Eliminates need of inside or outside antennas or aerials for radio receiving sets.

Lessens static, improves and amplifies tone. Equally efficient with A. C. or D. C.

Makes the receiving set really portable. It can be instantly moved from room to room.

Just attach to any electric socket or to telephone by means of special "phone attacher" included, and connect to the set—simplicity itself, and superior results.

Guaranteed not to short circuit, blow fuses or shock. No electric current passes through the Presto Aerial Superseder—it is a conductor of radio waves only.

For use with electric socket (as illustrated below).

Seven methods (or adjustments) of connecting are provided: to binding post, A or B or C—to A & B—to B & C—to A & C; or to A, B & C.

Very good results are frequently obtained without a ground connection. The aerial terminal of set can also be connected to binding post A or B and the ground terminal of set to C.

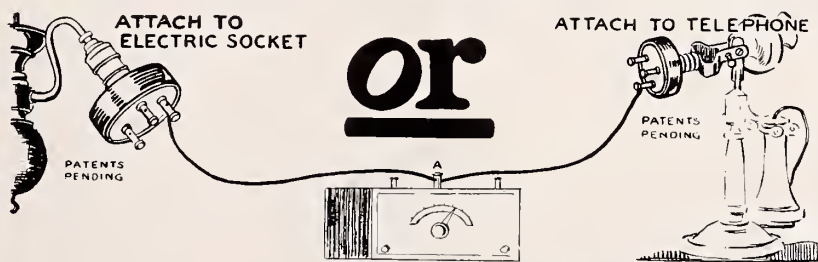

For use with telephone (as illustrated above).

Radio reception can be enjoyed and the telephone used at the same time without interference to either.

Be safe and be satisfied. The Presto Aerial Superseder—adjustable—retails for only \$2.75.

*Jobbers and Dealers Inquiries Welcomed*

**PRODUCTS DISTRIBUTING CORPORATION**

360 Madison Avenue  
New York

Phone Murray Hill 2048



Presto Aerial Superseders—Presto Super Head-Phones—Presto Bull-Dog Detectors

## BALDWIN HEADSETS

### NEW MASTER BALDWIN DOUBLE HEADSET

LIST PRICE \$16.00

(The Master Baldwin is 40% better than Type C)

### NEW MASTER BALDWIN SINGLE HEADSET

LIST PRICE \$9.00

The Master Baldwin is 40% better than Type C)

### MASTER BALDWIN CLAROPHONE

LIST PRICE \$22.50

DEALERS—Write, Wire or Phone Your Order Today

## CLARK & TILSON

51 East 42nd Street, New York

Meet us at

## Booth 68

Week of October 7th to 14th

New York Electrical and Industrial Exposition

Grand Central Palace  
New York City

## American Radio and Electric Co.

1133 Broadway  
New York City

## Bru No. 3

### New, Novel Set Placed on the Market

A recent addition to the many novel receiving sets on the market is that of the "Bru No. 3" which is manufactured by the Bruno Radio Corporation of New York City.

The "Bru No. 3" is a vacuum tube set that uses a W D 11 bulb, thereby eliminating the expensive storage battery, which has always been the bugaboo of the radio fan. In the place of the storage battery, an ordinary dry cell is used which the manufacturers claim will supply enough current to light up the filament for eighty hours.

A few of the features that the manufacturers claim are that the tube is mounted on top of the cabinet, and that a loose coupler is employed, enabling much finer tuning. The flexibility of the circuit, which enables loading on both the primary and secondary circuit, makes this set ideal for long wave reception. The wave length of the "Bru No. 3" is from 150 to 600 meters, and is specially adaptable for radio phone broadcasting reception.

The Bruno Radio Corporation is headed by William A. Bruno, a member of the Society of Electrical Engineers; and Nathan Litwin, who is in charge of the selling end of the corporation. This company is about to launch many new things in radio, and the fact that "Bill" Bruno is quite fussy about things that will bear his name, the name Bruno will stand for the best in radio.

### CORACO RECEIVER

The Coraco Super-Radiophone, the invention of Arthur C. Olsen of New York City, has just been added to the many wonderful developments in the radio field.

The idea of the Coraco Super-Radiophone was first conceived and designed in 1919 but only recently was it brought out in its present form.

It is claimed that the instrument requires no aerial or ground, and as demonstrated before an audience of technical experts, can be moved from one room to another with very satisfactory results. It is reported to have worked satisfactorily in a moving steel passenger elevator, much to the surprise of some radio authorities.

Demonstrations have proven that while the instrument is in a receptive state, and no concerts are being received, absolutely no static, howling or whistling noises can be heard, the instrument remaining perfectly quiet.

## SOCKET-RHEOSTAT

Registered U. S. Patent Office

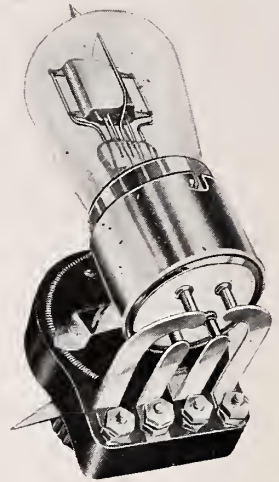

Type A-5 ohms, suitable for detector bulb  
Type B-2 ohms, suitable for power bulb

**\$2.00**  
TWO IN ONE. A socket and rheostat so combined as to form a single unit. No more unnecessary leads between socket and rheostat. Just connect your leads to the four posts marked P F G and you are hooked up as far as the SOCKET-RHEOSTAT is concerned.

MANUFACTURED BY

**Ajax Radio Corporation**

Telephone, Bigelow 4097  
538 SOUTH 10th STREET  
NEWARK, N. J.

## S & S

### VARIOMETERS VARIO-COUPPLERS

**\$3** each

Unsurpassed for Efficiency  
Workmanship and Design

Liberal Discounts to  
Dealers and Jobbers

Write for Descriptive Folder

**Sunday & Scholtz Co.**

2638 West Cabot Street  
Philadelphia, Pa.

## \$10 Tube Set

Hawk Mfg. Co. Offers Low Priced Tube Set That "Works"

Up in the Bronx, New York City, where the subway becomes elevated, and where the elevated becomes a nuisance, and every car line passes one spot, is located the factory and laboratory of the Hawk Radio Manufacturing Co. The reader can just imagine the "fun" that can be had at this spot when trying to get music from the air, but Olan Hawk, the genial head of this concern, overcomes all obstacles and tests all of his sets in this place. (The only howl he hears is that of young Olan, Jr., who is now getting his teeth, and who is a daily visitor at the shop.)

Mr. Hawk in his experiments has recently brought out a tube set that will sell for ten dollars which he claims will get just as good results as many of the higher-priced ones. This set is called the "Hawk, Jr.," and is a well-made set that compares favorably with other sets now on the market, in so far as reception is concerned.

Though young in years, Mr. Hawk has a radio experience that is vast and is the inventor of many new things used in radio. He was formerly connected with the United States Navy and had charge of one of the radio stations during the war.

List  
**AIR-MUSE, COMPLETE, \$20.00**  
WITH 3,000 OHM DOUBLE PHONES

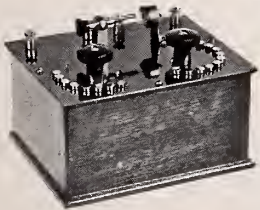

Lightning  
Arrester  
Approved By  
National Board  
of Fire  
Underwriters.  
And All  
Accessories

Air-Muse will receive thirty-five miles or more. It is perfectly balanced, there being eight course leads off and ten selective. All joints are soldered. The detector has a backward and forward spring movement. The case is polished oak—all metal parts are nicked. Only Insulite and Bakelite used. Packed complete in box. Write, wire or phone.

MANUFACTURED BY  
**DETROIT RADIO COMPANY**  
One West 34th Street,  
NEW YORK CITY  
Fitzroy 2114

# "SUPERIOR PRODUCTS"

## The ROLLS-ROYCE of RADIO

Our ideal is to establish a permanent clientele by selling products which reflect credit to the industry and to the dealers who handle them, and by this policy, to establish ourselves as permanent factors in the industry.

### GUARANTEE

To every purchaser of Superior Products we guarantee that our radio instruments are of the highest electrical efficiency and that they will give absolute satisfaction—or money back.  
**SUPERIOR PRODUCTS MFG. CORP.**

To enable us to extend our guarantee, we have selected for our line the finest articles of their kind. Each is tested for superiority in workmanship, material, appearance and electrical efficiency.

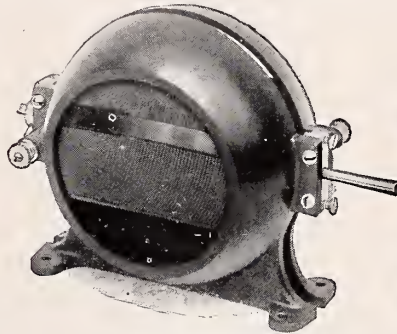

**VARIOMETER**

The inherent beauty of our moulded variometer, the smooth rotation of its perfectly balanced rotor, the close limits of accuracy in construction, the maintenance of minimum clearance between stator and rotor, the wide range of inductance with minimum resistance, make this a "Superior Product." Price, \$7.50.

The Superior variocoupler has the same general appearance as the variometer. The rotor is slightly smaller and employs spaced winding. Designed for 150 to 500 meters. Price \$8.00.

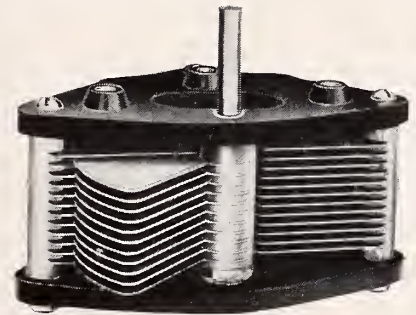

**VARIABLE CONDENSER**

A Superior Variable Condenser selling at but little above average price. Machine assembly permits of accuracy in spacing to a degree impossible with hand assembled washer types. Positive rigid three point suspension by three heavy posts accurately slotted. Very low capacity at zero point. Moulded bakelite top and base with ample insulating space between fixed and moveable plates.

|          |           |        |
|----------|-----------|--------|
| 13 plate | .00083 MF | \$3.75 |
| 23 "     | .0006 MF  | 4.00   |
| 43 "     | .001 MF   | 4.50   |

### HEADPHONES

Superior Headphones automatically adjust themselves to fit comfortably any shaped head. No protruding horn-like bars. One-piece headband of heavily plated nickel. Nothing to catch the hair. No cloth or fabric used and hence no accumulation of germs, dandruff or grease. Weight, twelve ounces. Accurately matched for tone quality. Comparison tests with other headsets for sensitiveness and tone quality prove ours a "Superior Product." Price, \$8.00.

Superior Dials are manufactured under Tait Patents, for which we are exclusive distributors in eight states. The Tait dial has no set screw; no capacity effect; no trouble; absolute bull dog grip. Three inch, \$1.00; Four inch, \$1.50.



Dealers! Write for Proposition

**SUPERIOR PRODUCTS MFG. CORPORATION**  
1080 Springfield Avenue  
Irvington, N. J.

# MORADIO Every Wire Contact COUPLER

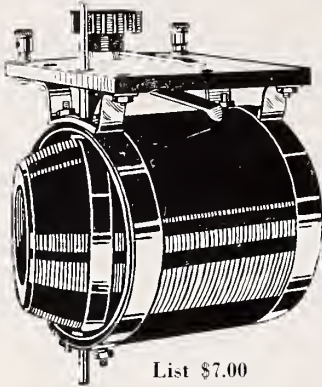

List \$7.00

Its adaptability to any panel set or hookup makes it popular.

Write for descriptive circular and dealers prices.

**MORELAND SALES CORP.**  
30 Ogden St., Newark, N. J.

Got a good idea on selling radio equipment? Send it along, help the other fellow and he'll help you.



## 100% PROFIT Mr. Dealer

Radio Research Buttons for your trade will bring customers back to your store.

As a premium for your set buyers or as a sales proposition this can't be beat.

## 100% PROFIT Mounted on a neat three color display card

Write for full particulars as to exclusive proposition.

**Radio Research Guild**  
11 Clinton St., Newark, N. J.



## Radiphono Adapter - \$3.00

Add quality of tone and volume to your radio concerts

Designed for Edison, Victrola, Brunswick and other makes of phonographs. With this adapter you can eliminate distorted and metallic sounds and improve your receiving. This is a real adapter built along proper lines of a reproducing musical instrument. It gives better results than self-contained, expensive amplifying loud speakers.

Jobbers Dealers Ask  
Communicate Your Jobber

Manufactured by

**Industrial Sales Engineering Co.**  
671 BROAD ST., NEWARK, N. J.

## TUNING COILS

Cross Weave Tuning Coils the heart of a receiving set just the coils for bringing in the Radiophone Broadcasting stations 180-500 Meters. Price \$1.25 each, or set of three coils Primary, Secondary and Ticker Coils, \$3.50 per set with circuit diagram.

## CONDENSERS

Phone and Grid built of the best material obtainable. Price \$1.00 each.

## MOTOR-GENERATOR SET

250 Volt DC 175 Watt Generator and 110 Volt AC 60 Cycle (Any Cycle) Motor. The best there is. Price \$78.00 complete.

## AERIPHONE

The wireless telephones. Price \$35.00 to \$300.00.

## PANELS

Treated with a special process made by us. Will not Warp or Shrink and is not affected by Temperature changes. Waterproof and possesses High Dielectric properties. Easily machined and will not Crack or BREAK. Looks as good as Bakelite. We are prepared to ship promptly the following sizes:

|                                |        |
|--------------------------------|--------|
| 6" x 6" x 1/4" thick.....      | \$6.00 |
| 6" x 7" x 1/4" thick.....      | 75     |
| 6" x 10 1/2" x 1/4" thick..... | 1.09   |
| 6" x 12" x 1/4" thick.....     | 1.25   |
| 9" x 12" x 1/4" thick.....     | 1.50   |
| 9" x 14" x 1/4" thick.....     | 1.75   |
| 12" x 14" x 1/4" thick.....    | 2.20   |
| 12" x 21" x 1/4" thick.....    | 3.00   |

Strips 3 1/2 x 6; 3 1/2 x 8, \$4.00 each; 3 1/2 x 10, 3 1/2 x 12, \$6.00 each; 3 1/2 x 18, \$7.75 each.

Add postage for 1 lb. for Panels up to 6 x 12 x 1/4; and 2 lbs. for larger sizes.

We will be pleased to quote prices on these panels cut to a different size on receipt of your specifications. NO FREE SAMPLES.

**NATIONAL RADIO CO.**  
MARSHALL, MINN.

# RT-4

## Radio FREQUENCY Transformer



Wave length range 250-450 meters with full amplification at both extremes

Air core, untuned type, giving highest possible amplification for this type of transformer.

Adapted for both regenerative and non-regenerative circuits.

Can be used with one, two or three stages of radio frequency amplification.

Can be used with any vacuum tubes.

LIST \$2.00

Also ADAPTERS for the NEW W-B-11 tubes, helps you move your old V. T. Sockets, Variable Antenna Plugs, Coils, Sockets, Rheostats, Jacks, Couplers, etc.

We are the exclusive distributors of the Planet Loud Speaker—no batteries and as good as a Magnavox.

See the new Plan-a-Phone, \$3.50 list

Dealers write for Discounts

National Distributors

## GENERAL MERCHANDISE CO.

142 Market Street, Newark, N. J.

# The New Thumtune Radio Receiver

One of the outstanding features of the many new designs of radio equipment on display this fall is the "Thumtune," a new and compact radio receiving outfit manufactured by The Radiaud Corporation of New York City. This instrument is a radical departure from the "hackneyed" type of construction now prevalent.

According to its designer, the "Thumtune" is the result of much experimental work and was tested under actual operating conditions for over a year before it was finally placed in quantity production. While entirely different from the commonly accepted idea of radio receiving apparatus, this newcomer in the radio market avoids any freakishness of de-



sign. On the contrary, it makes use of standard parts wherever possible.

It is the belief of the Radiaud Corporation officials that a great many of the radio outfits now offered for sale to the general public are far too complicated to meet with popular favor, therefore the design of the "Thumtune" was simplified to the utmost detail. The object kept in view was to produce an instrument which even a child could operate, intelligently, and in the "Thumtune" this object seems to have been achieved.

Instead of tuning with dials or switches, the "Thumtune" tunes with a touch of the thumb—that is, tuning is accomplished by merely running the thumb over the two knurled knobs which protrude from the lower corner of the case. This case is of molded construction and is made in the shape of a sector of a circle, of a size to fit easily into the palm of the hand.

The detector, which is always a vital part of any set, is of accepted standard design in the "Thumtune." The method of mounting this detector, however, is decidedly novel. The detector crystal-holder and the detector post are mounted upon a molded base hinged to the side of the case,

so that the entire detector swings into the case when not in use. Not only does this novel and original procedure permit of great reduction in size of the entire set, but it also keeps dust from the detector crystal.

Binding posts are entirely done away with in the construction of the "Thumtune." Four holes are provided in the side of the case, two on each side, for making antenna, ground and head-set connections. The wires and phone tips are pushed through these holes and connection is thus automatically established on the inside.

From all reports, the "Thumtune" aroused considerable interest since the first moment it was introduced to the radio market.

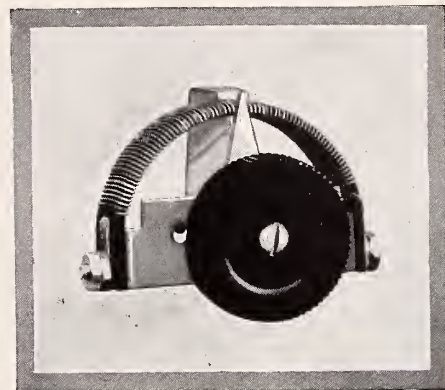

## A BETTER RHEOSTAT

A nicer looking, smoother working and better made rheostat than you have ever seen before.

Furnished with or without vernier this instrument will improve the operation of any radio equipment.

The many valuable features coupled with national advertising make this an instrument every dealer and jobber should stock—liberal discounts give ample margin of profit and low list means quick turnover. Order now.

**List Prices**  
123A Plain..... 80c  
Type 123B Vernier..... \$1.40

**THE WILCOX LABORATORIES**  
LANSING MICHIGAN

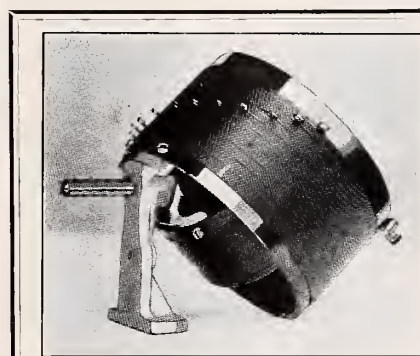

Shamrock Vario-Coupler

## LIST \$4.50

Both  
Primary and Secondary Tubes  
Are Made of

### BAKELITE

Also Manufacture a Complete Line of  
RADIO JACKS

and  
VARIABLE CONDENSERS

Dealers and Jobbers Write for  
ATTRACTIVE DISCOUNTS

**SHAMROCK RADIO CO.**  
GENERAL OFFICE AND FACTORY

152 Sussex Avenue Newark, N. J.

# TRESCO RADIO

Licensed under Armstrong U. S. Patent 1,113,149

The simplicity of the Tresco Receiving Set means everything to the dealer.

Few parts, practically indestructible, easy to learn to operate.

Once sold it *stays* sold and requires no service by the dealer.



Orders are now being placed for fall delivery—are you ready? Better write us for our discounts.

Remember the "Tresco" is a regenerative set, manufactured under the Armstrong License.



# LIST OF ADVERTISERS

(Advertisements Indexed by Products will be found on Pages 132 and 133 of this issue.)

|                                                                   |                                               |                                               |                                                |                                                |  |
|-------------------------------------------------------------------|-----------------------------------------------|-----------------------------------------------|------------------------------------------------|------------------------------------------------|--|
| <b>A</b>                                                          |                                               | Eshoo Cabinet Works, E..... 119               | Mica Insulator Co..... 30                      | Randel Wireless Co..... 70                     |  |
| Ablett Co., Charles R..... 8                                      | Essex Mfg. Co..... 112                        | Michigan Radio Corp..... 91                   | Milliken Bros. Mfg. Co., Inc..... 101          | Rasla Sales Corp..... 25                       |  |
| Acorn Radio Supply Co..... 111                                    | Essex Radio Service, Inc..... 12              | Mills Radio & Electric Co., The... 98         | Mills, The R. C..... 96                        | Rauland Mfg. Co..... 69                        |  |
| Adams-Morgan Co..... 16                                           | Etherola Corp., The..... 72                   | Montclair Radio Co..... 106                   | Moreland Radio Co..... 100                     | Reco Radio Engineering Co..... 12              |  |
| Adrin Laboratories..... 122                                       | European Radio Co..... 109                    | Montrose Mfg. Co..... 100                     | Morscon Radio Co..... 24                       | Ritter Wood Work Co..... 114                   |  |
| Advance Metal Stamping Co..... 110                                | <b>F</b>                                      |                                               | Moss Radio Co..... 112                         | Rocky Mountain Radio Products, Inc. .... 100   |  |
| Aerex Radiophone Corp..... 17, 112                                | Fallgatter, Marvin B..... 116                 | Federal Institute of Radio Teleg-raphy .. 7   | Multiple Storage Battery Corp. .... Back Cover | Rogers Radio Co..... 110                       |  |
| Ajax Radio Corp..... 126                                          | Federal Telephone & Teleg. Co.. 14            | Finch Radio Mfg. Co..... 40                   | Mu-Rad Laboratories, Inc..... 3                | Ross & Co., Joseph..... 99                     |  |
| Alden-Napier Co..... 118, 70, 122                                 | Ford-Mica Co., Inc..... 108                   | Frank Radio Co..... 13                        | Mydar Radio Corp..... 22                       | Ross-Gould Co..... 114                         |  |
| Aldine Radio & Mfg. Co..... 91                                    | Franklin Radio Mfg. Co..... 116               | Freed-Eisemann Radio Corp..... 112            | <b>N</b>                                       |                                                |  |
| Allied Engineering Institute... 23                                | French Battery & Carbon Co..... 82            | Freshman Co., Inc., Chas..... 90              | National Fibre & Insulation Co.. 20            | Sealord Radio Corporation..... 119             |  |
| Altadena Radio Laboratories... 88                                 | Frost, Herbert H..... 116                     | <b>G</b>                                      |                                                | Scott Novelty Co..... 79                       |  |
| American Hard Rubber Co..... 97                                   | <b>G</b>                                      |                                               | National Radio Co..... 128                     | Shamrock Radio Co..... 129                     |  |
| American Radio & Electric Co... 126                               | Galeua Crystal Mfg. Co..... 104               | General Auto. Electric Co..... 104            | Nelson Radio Parts Co..... 10                  | Shelton Co., The..... 66                       |  |
| American Specialty Mfg. Co., The. 71                              | General Merchandise Co..... 128               | General Radio Equipment Mfg. Co. 99           | Newark Radio Supply Co..... 79                 | Ship Owners Radio Service, Inc.. 109           |  |
| Andrae & Sons Co., Julius..... 88                                 | General Radio Equipment Mfg. Co. 99           | Gilbert Co., A. C..... 38                     | New Haven Radio Co..... 4                      | Sound Wave Corp., The..... 30                  |  |
| Archway Bookstore..... 70                                         | Globe Phone Mfg. Co..... 89                   | Goetz Co., The Edw. J..... 112                | New York Coil Co..... 5                        | Specialty Service Co..... 95                   |  |
| Arrow Radio Co..... 80                                            | Gould Storage Battery Co..... 34              | Gould Storage Battery Co..... 34              | New York Hard Rubber Turning Co. .... 96       | Spiro Brothers..... 93                         |  |
| Astorloid Mfg. Co., Inc..... 28                                   | Great Lakes Publishing Co..... 116            | Grimes Radio Eng. Co., Inc..... 120           | New York Radio Dial Co..... 82                 | S. S. Novelty Co..... 92                       |  |
| <b>Atlantic-Pacific Radio Supplies Co. .... Inside Back Cover</b> |                                               | <b>H</b>                                      |                                                | Staff Co., Louis A..... 87                     |  |
| Atwater Kent Mfg. Co..... 67                                      | Harris Laboratory, The..... 96                | <b>H</b>                                      |                                                | Standard Electric Co..... 96                   |  |
| Automatic Electrical Devices Co.. 27                              | Hawk Radio Mfg. Co..... 20                    | Haydon & Fenton..... 124                      | New York Testing Laboratories.. 70, 119        | Standard Products Co..... 121                  |  |
| <b>B</b>                                                          |                                               | Hedden Place Machine Co..... 90               | New York Testing Laboratories.. 70, 119        | Standard Radio Parts Co..... 117               |  |
| Bannister & Pollard..... 78                                       | Heinemann Electric Co..... 75                 | Henley Publishing Co., The Nor-man W. .... 93 | Niehoff & Co., Inc., Paul G..... 122           | Standard Wireless Panel Co..... 115            |  |
| Bayley Condenser Co..... 103                                      | Henley Publishing Co., The Nor-man W. .... 93 | Herbert & Huesgeu Co... Inside Cover          | North Shore Radio Works..... 112               | Stanton & Co., Frank T.... 118-114             |  |
| Beau Ivorie Novelty Co., Inc..... 96                              | Hintze Bros., Inc..... 79                     | Holloway Elec. Supply Co., Inc.. 104          | Novo Manufacturing Co..... 109                 | States Radio Corp..... 82                      |  |
| Bershaw Radio Mfg. Co..... 122                                    | Hornung Experimental Labora-tories .. 77      | Hornung Experimental Labora-tories .. 77      | Nuloid Corporation..... 26                     | Steinmetz Wireless Mfg. Co..... 116            |  |
| Bissell Engineering Co..... 90                                    | Hyman & Co., Inc., Henry..... 65              | <b>I</b>                                      |                                                | Straus Aluminum Co..... 114                    |  |
| Boston Radio Exposition..... 107                                  | <b>I</b>                                      |                                               | Nyco..... 79                                   | Sunday and Scholtz..... 126                    |  |
| Brach Mfg. Co., L. S..... 104                                     | Inviucible Products Co., Inc., The 124        | <b>J</b>                                      |                                                | Sunraid Radio Co..... 98                       |  |
| Brady Electric Mfg. Co..... 70                                    | Jackson, P. D..... 116                        | Jewell Radio Sales Co..... 122                | Osland, Inc..... 122                           | Superior Products Mfg. Corp..... 127           |  |
| Bremer-Tully Radio Co..... 117                                    | Jewett Mfg. Co..... 63                        | Joy Kelsey Corp..... 112                      | Pacific Radio Exchange..... 69                 | Sydell's Radio & Directory Ser-vice .. 107     |  |
| Briggs & Stratton Co..... 15                                      | Joy Kelsey Corp..... 112                      | <b>K</b>                                      |                                                | <b>T</b>                                       |  |
| Brooklyn Metal Stamping Co... 86                                  | Keut Co., F. C..... 88                        | Kern, Emil Alexander..... 112                 | Parkin Mfg. Co..... 103                        | Tait-Knob-Aud Dial Co..... 57                  |  |
| Broun Radio Co..... 117                                           | Keystone Radio Co..... 95                     | King Sewing Machine Co..... 76                | Permanent Radio Fair, Inc..... 81              | T. B. H. Corporation..... 118                  |  |
| Bruno Radio Corp..... 35                                          | King Sewing Machine Co..... 76                | Kramer Radio Co..... 106                      | Picard Radio Corp..... 83                      | T. F. Radiophone Co..... 124                   |  |
| Bunting Stamp Co..... 97                                          | Krenz, Walter S..... 80                       | Krenz, Walter S..... 80                       | Pickens, P. D..... 109                         | Thornton Transformer Co..... 100               |  |
| Business Bourse Int. Inc., The.. 120                              | <b>L</b>                                      |                                               | Pittsburgh Radio & Appliance Co., Inc. .... 70 | Thresher Radio Corp..... 17                    |  |
| <b>C</b>                                                          |                                               | Lewis & DeRoy Co..... 73                      | Post Electric Co..... 95                       | Trade Circular Addressing Co... 112            |  |
| Cap Screw & Nut Co. of America 112                                | <b>M</b>                                      |                                               | Poster & Co..... 111                           | Tresco Radio..... 129                          |  |
| Caragol-Clarke Co., Inc..... 8                                    | MacIte Radio Co..... 72                       | McConnell Cable & Specialty Co.. 116          | Premier Accessory & Specialty Corp. .... 77    | True-Tone Radio Mfg. Co..... 88                |  |
| Carbon Products Co., The..... 57                                  | Magnovox Co..... 61                           | McKenna Brass & Mfg. Co..... 100              | Premier Radio Corp..... 22                     | <b>U</b>                                       |  |
| Carlyle-Johnson Machiue Co... 112                                 | Maltz Electric Co..... 110                    | McKewsky..... 121                             | Premier Radio Corp of America.. 69             | United Mfg. & Distributing Co.. 74             |  |
| Carter, Chauncey P..... 115                                       | Manhattan Storage Battery Co.. 102            | Melchior Equipment Co..... 118                | Products Distributing Corp..... 125            | U. S. Radio Co. of Penna., Inc.. 100           |  |
| Central Electrotyping Co..... 112                                 | Manufacturers Patent Co..... 112              | Mercury Radio Products Co... 72               | Pruden, Frederick H..... 74                    | Union Radio Co..... 128                        |  |
| Champlin Mfg. Co..... 21                                          | Marle Engineering Co..... 101                 | Metro Elec. Mfg. Co., Inc..... 28             | <b>Q</b>                                       |                                                |  |
| Chaslyn Co..... 100                                               | McConnell Cable & Specialty Co.. 116          | Metro Politan Radio Corp..... 29              | Queens Radio Co., Inc..... 123                 | United Radio & Electric Co..... 89             |  |
| Clapp-Eastham..... 112                                            | McKewsky..... 121                             | M. P. Radio Co..... 72                        | <b>R</b>                                       |                                                |  |
| Clark & Tilson..... 84, 85, 92, 126                               | Melchior Equipment Co..... 118                | <b>R</b>                                      |                                                | United Specialties Co., Inc..... 29            |  |
| Comet Battery Co..... 114                                         | Mercury Radio Products Co... 72               | Racony Corp., The..... 96                     | Pacific Radio Exchange..... 69                 | V-DE-CO Supply Mfg. Co..... 102                |  |
| Continental Fibre Co., The..... 111                               | Metro Politan Radio Corp..... 29              | Rad'O..... 105                                | Parkin Mfg. Co..... 103                        | Victor Radio Corp..... 11                      |  |
| Copper Clad Steel Co., The..... 106                               | M. P. Radio Co..... 72                        | Radio Accessories Co..... 113                 | Permanent Radio Fair, Inc..... 81              | Viking Radio Co..... 118                       |  |
| Coraco Co., The..... 118                                          | Melchior Equipment Co..... 118                | Radio Apparatus Co..... 96                    | Picard Radio Corp..... 83                      | Vineland Scientific Glass Co... 100            |  |
| Cozzone & Co., John A..... 115                                    | Melchior Equipment Co..... 118                | Radio Dealer Trade-Mark Bureau 106            | Pickens, P. D..... 109                         | Virginia Radio Corp..... 89                    |  |
| Cramer Co., W. R..... 104                                         | Melchior Equipment Co..... 118                | Radio Dealer Weekly..... 21-36                | Pittsburgh Radio & Appliance Co., Inc. .... 70 | Volta Engineering Co..... 116                  |  |
| Curtis C. Culin..... 102                                          | Melchior Equipment Co..... 118                | Radio Electric Co., The..... 10               | Post Electric Co..... 95                       | <b>W</b>                                       |  |
| <b>D</b>                                                          |                                               | Melchior Equipment Co..... 118                | Poster & Co..... 111                           | Ware Radio Corp..... 31                        |  |
| Detroit Radio Co..... 127                                         | Melchior Equipment Co..... 118                | Melchior Equipment Co..... 118                | Premier Accessory & Specialty Corp. .... 77    | Weis Mfg. Co..... 114                          |  |
| Detroit Radio Supply Co..... 106                                  | Melchior Equipment Co..... 118                | Melchior Equipment Co..... 118                | Premier Radio Mfg. Co..... 22                  | W. E. Supply and Service..... 86               |  |
| Diamond Tool & Mfg. Co., Inc... 110                               | Melchior Equipment Co..... 118                | Melchior Equipment Co..... 118                | Premier Radio Corp..... 21                     | White Radio Co..... 100                        |  |
| Diamond State Fibre Co..... 105                                   | Melchior Equipment Co..... 118                | Melchior Equipment Co..... 118                | Products Distributing Corp..... 125            | Wholesale Radio Equipment Co. .... Front Cover |  |
| Dictograph Products Corp..... 9                                   | Melchior Equipment Co..... 118                | Melchior Equipment Co..... 118                | Pruden, Frederick H..... 74                    | Wiener Wireless Specialty Co... 90             |  |
| Doublell Rado Co..... 113                                         | Melchior Equipment Co..... 118                | Melchior Equipment Co..... 118                | Queens Radio Co., Inc..... 123                 | Wilcox Laboratories..... 129                   |  |
| Duke Radio Co..... 112                                            | Melchior Equipment Co..... 118                | Melchior Equipment Co..... 118                | Racony Corp., The..... 96                      | Wilson, Inc., A. M..... 112                    |  |
| Duquesne Radio & Mfg. Co..... 115                                 | Melchior Equipment Co..... 118                | Melchior Equipment Co..... 118                | Rad'O..... 105                                 | Wilson & Co., E. M..... 121                    |  |
| Durham & Co..... 58                                               | Melchior Equipment Co..... 118                | Melchior Equipment Co..... 118                | Radio Accessories Co..... 113                  | Wintner Radio Corp..... 131                    |  |
| <b>E</b>                                                          |                                               | Melchior Equipment Co..... 118                | Radio Apparatus Co..... 96                     | <b>Z</b>                                       |  |
| Eagle Radio Co..... 76                                            | Melchior Equipment Co..... 118                | Melchior Equipment Co..... 118                | Radio Dealer Trade-Mark Bureau 106             | Zeller Lacquer Mfg. Co., Inc.... 66            |  |
| Eastern Specialty Co., The..... 93                                | Melchior Equipment Co..... 118                | Melchior Equipment Co..... 118                | Radio Dealer Weekly..... 21-36                 | Zwingerberger, Otto K..... 112                 |  |
| Ely Mfg. Co., The H. H..... 87                                    | Melchior Equipment Co..... 118                | Melchior Equipment Co..... 118                | Radio Electric Co., The..... 10                |                                                |  |
| E. D. Mfg. Co., The..... 26                                       | Melchior Equipment Co..... 118                | Melchior Equipment Co..... 118                | Radio Engineering Co..... 64                   |                                                |  |
| Eico Radio Supply Co..... 102                                     | Melchior Equipment Co..... 118                | Melchior Equipment Co..... 118                | Radio Equipment Service, 32, 33, 106           |                                                |  |
| Electric Products Co., Ohio..... 68                               | Melchior Equipment Co..... 118                | Melchior Equipment Co..... 118                | Radio Instrument Co..... 19                    |                                                |  |
| Electric Service Supplies Co... 4                                 | Melchior Equipment Co..... 118                | Melchior Equipment Co..... 118                | Radio Laboratories of N. J..... 114            |                                                |  |
| Electric Service Engineering Co.. 4                               | Melchior Equipment Co..... 118                | Melchior Equipment Co..... 118                | Radio Mica Products Co..... 98                 |                                                |  |
| Emeloid Co., Inc., The..... 113                                   | Melchior Equipment Co..... 118                | Melchior Equipment Co..... 118                | Radio Outfitting Corporation... 102            |                                                |  |
|                                                                   | Melchior Equipment Co..... 118                | Melchior Equipment Co..... 118                | Radiophone Equipment Co..... 104               |                                                |  |
|                                                                   | Melchior Equipment Co..... 118                | Melchior Equipment Co..... 118                | Radiola Wireless Corp..... 122                 |                                                |  |
|                                                                   | Melchior Equipment Co..... 118                | Melchior Equipment Co..... 118                | Radio Red Book Pub. Co., The.. 102             |                                                |  |
|                                                                   | Melchior Equipment Co..... 118                | Melchior Equipment Co..... 118                | Radio Research Guild..... 128                  |                                                |  |
|                                                                   | Melchior Equipment Co..... 118                | Melchior Equipment Co..... 118                | Radio Shop of Newark, The..... 100             |                                                |  |
|                                                                   | Melchior Equipment Co..... 118                | Melchior Equipment Co..... 118                | Radio Stores Corp..... 72                      |                                                |  |
|                                                                   | Melchior Equipment Co..... 118                | Melchior Equipment Co..... 118                | Radio Technical Lab., Inc..... 123             |                                                |  |
|                                                                   | Melchior Equipment Co..... 118                | Melchior Equipment Co..... 118                | Radio & Mechanical Trading Corp. .... 92       |                                                |  |



## Metro Multi-plug

### Permits Several People to Listen In at the Same Time

The Metro Electric Manufacturing Company of New York City are producing a plug which does away with headsets can be used at the same time the necessity of "shorting" when using two or more phones. The plug is known as the Triphone. Three from the single jack of any receiving set. The Triphone is an accommodation plug which fits any standard jack. One headset or loud-speaker is permanently connected to the Triphone as connected to any phone plug. On either side of the cord is a separate jack built in the body of the Triphone, each of which accommodates a standard plug or, if desired, another Triphone, making it possible to use a half dozen or more headsets. When the extra headsets are removed the internal jacks of the Triphone automatically "short" and enable the operator to use single headset or loud-speaker as in the case of the single phone plug.

In appearance the Triphone is an addition to any set. The body is of highly polished moulded material. Perfectly finished and not much larger than the average plug. The contact stem is perfectly insulated, making short circuits impossible. The internal jacks are constructed with nickel silver springs and the short-circuiting contacts are of solid silver. In addition each plug is tested before leaving the factory.

### WINTNER RECEIVING SET

The Wintner Radio Corporation of New York City has begun an extensive campaign on its Wintner Type DA-2 receiving set. This set received the certificate of excellence from the *New York Evening Mail* Radio Institute Laboratories.

The outfit utilities audio frequency principles, being a detector and two stage amplifier unit, assembled from high grade, standard radio parts, completely wired, and including three 22½ volt cyclone B batteries, placed within the cabinet so that connections on face panel are unnecessary. In addition, included in the equipment are Turney 3,000 ohm double head phones,—so that all that has to be done in order to listen in, is to hook up antenna and ground and make connections to the storage battery. There is no complex system of controls or wiring and the Wintner Radio Corporation expects to do a very large volume of business on this set alone.

GUARANTEED



WINTNER RADIO CORP.  
115 W. 30th ST., N.Y.C.  
Manufacturers and Distributors

PRODUCTS

## a standard radio set

We'll back it against the "other" kind any time—  
and when you consider the following facts concerning

# WINTNER



### TYPE DA-2

- † High grade standard parts throughout, completely wired and enclosed in a beautiful cabinet made in tinted walnut and mahogany.
- † Assembled in our laboratories by real radio men.
- † WDA-2 has a wave length range of from 175 to 2,000 meters, and will tune sharply throughout this scale.
- † Three 22½ volt "Cyclone" B Batteries built into the set.
- † A set of Turney 3,000 ohm double headphones included with the outfit.
- † And, most important of all, our best guarantee of proper construction and efficiency of operation is that this is the set which was certified for its excellence by the Mail Radio Institute Laboratories of the "New York Evening Mail."

we have no doubt that you will then agree with us that it would be an attractive buy, at a price a good deal higher than our advertised retail price,—

**\$90.00**

NOTE—Of course, we have so scaled our discounts to the jobbing and retail trade that a fine margin of profit can be realized. We will be very pleased to quote our discounts, upon application, and mail you our illustrated folder describing the set.

WE ARE NATIONAL DISTRIBUTORS  
OF STANDARD RADIO PRODUCTS

### WINTNER RADIO CORPORATION

117 West 30th Street

New York, N. Y.

# Where to Buy

## A Handy Guide for the Convenience of Our Readers

|                                     |            |                                     |        |                                              |     |
|-------------------------------------|------------|-------------------------------------|--------|----------------------------------------------|-----|
| <b>AERIALS</b>                      |            | <b>CABINET SETS</b>                 |        | <b>Electric Service Supplies Co.</b> ..... 6 |     |
| Walter S. Krenz                     | 80         | Heinemann Electric Co.              | 75     | Frank Radio Co.                              | 13  |
| <b>"A" BATTERIES</b>                |            | Oranola Radio Corporation           | 14     | The Edw. J. Goetz Co.                        | 112 |
| Manhattan Storage Battery Co., Inc. | 102        | Premier Radio Corp.                 | 21     | Herbert H. Frost                             | 116 |
| <b>AERIAL EQUALIZER TUBES</b>       |            | <b>COIL MOUNTINGS</b>               |        | Julius Andrae & Sons Co.                     | 88  |
| The Etherola Corp.                  | 72         | Osland, Inc.                        | 122    | Kramer Radio Co.                             | 106 |
| <b>ARMSTRONG CIRCUIT PARTS</b>      |            | Astorloid Mfg. Co.                  | 28     | Moss Radio Co.                               | 112 |
| Durham & Co.                        | 58         | <b>COMPLETE LINE</b>                |        | New York Coil Co.                            | 5   |
| <b>ARMSTRONG HOOK-UP</b>            |            | American Radio & Electric Co.       | 96     | Nyco                                         | 79  |
| Brady Electric Mfg. Co.             | 70         | The American Specialty Mfg. Co.     | 71     | P. D. Jackson                                | 116 |
| <b>AMPLIFIERS</b>                   |            | Adams Morgan Co.                    | 16     | Pittsburgh Radio & Appliance Co.             | 70  |
| F. C. Kent Co.                      | 88         | Clapp Eastham Co.                   | 112    | Premier Radio Corp. of Amer.                 | 69  |
| Magnavox Co.                        | 61         | Curtis, C. Culin                    | 102    | Radio Electric Co.                           | 10  |
| Sheltone Radio Sales Co.            | 66         | Freed-Eisemann Radio Corp.          | 112    | Radio Engineering Co.                        | 64  |
| <b>AMPLIFIER UNITS</b>              |            | Frank Radio Co.                     | 13     | Radio Equipment Service                      | 106 |
| Atwater Kent Mfg. Co.               | 67         | A. C. Gilbert Co.                   | 38     | Ship Owners' Radio Service, Inc.             | 109 |
| <b>ANTENNA WIRE</b>                 |            | Maclite Radio Co.                   | 72     | Specialty Service Co.                        | 95  |
| Hintze Bros.                        | 79         | New Haven Radio Co.                 | 4      | Schwab, Harold M.                            | 72  |
| Copper Clad Steel Co.               | 106        | Reco Radio Engineering Co.          | 12     | The Radio Shop of Newark                     | 100 |
| <b>ANTENNA LIGHT WIRE PLUGS</b>     |            | Superior Products Mfg. Co.          | 127    | United Mfg. & Distributing Co.               | 74  |
| Maltz Electric Co.                  | 110        | Picard Radio Corporation            | 83     | Weiner Wireless Specialty Co.                | 90  |
| Products Distributing Corp.         | 125        | Victor Radio Corp.                  | 11     | Wholesale Radio Equipment Co.                | 11  |
| Chas. Freshman Co., Inc.            | 90         | Union Radio Corp.                   | 128    | Front Cover                                  |     |
| <b>BAKELITE PANELS</b>              |            | <b>COMPOSITION</b>                  |        | <b>ELECTRIC TESTING</b>                      |     |
| Standard Wireless Panel Co.         | 115        | Diamond State Fibre Co.             | 105    | New York Testing Laboratories..79-119        |     |
| <b>BATTERY CHARGERS</b>             |            | Nuloid Corp.                        | 26     | <b>ELECTROTYPERS</b>                         |     |
| The Automatic Elec. Devices Co.     | 27         | <b>CONDENSERS</b>                   |        | Central Electrotyping Co.                    |     |
| <b>"B" BATTERIES</b>                |            | Duke Radio Co.                      | 112    | <b>EXPOSITIONS</b>                           |     |
| Gould Storage Battery Co.           | 34         | European Radio Co.                  | 109    | Boston Radio Exposition..... 107             |     |
| <b>BATTERIES</b>                    |            | Hedden Place Machine Co.            | 90     | Permanent Radio Fair..... 81                 |     |
| Carbon Products Co.                 | 57         | Meirowsky Bros.                     | 121    | <b>FINISH</b>                                |     |
| Comet Battery Co.                   | 114        | Radio Laboratories of New Jersey    | 114    | Zeller Laquer Mfg. Co., Inc.                 |     |
| French Battery & Carbon Co.         | 82         | Scheib Elec. Radio Co.              | 82     | <b>GLASS</b>                                 |     |
| Manhattan Storage Battery Co.       | 116        | <b>CONDENSER PARTS</b>              |        | Vineland Scientific Glass Co.                |     |
| Multiple Storage Battery Corp.      | Back Cover | New Haven Radio Co.                 | 4      | <b>GRID LEAKS</b>                            |     |
| Novo Manufacturing Co.              | 109        | <b>CONTRACT WORK</b>                |        | Radiophone Equipment Co.                     |     |
| <b>BATTERY TESTERS</b>              |            | Carlyle Johnson Machine Co.         | 112    | Radio Mechanical Trading Corp.               |     |
| The Chaslyn Co.                     | 100        | <b>CRYSTALS</b>                     |        | <b>HEAD SETS</b>                             |     |
| <b>BESTONE PRODUCTS</b>             |            | Adbrin Laboratories                 | 122    | Briggs & Stratton Co.                        |     |
| Henry Hyman & Co., Inc.             | 65         | Galena Crystal Mfg. Co.             | 104    | Dictograph Products Corp.                    |     |
| <b>BINDING POSTS</b>                |            | Harris Laboratory                   | 96     | The Electric Products Co.                    |     |
| The H. H. Eby Mfg. Co.              | 87         | Rocky Mountain Radio Products, Inc. | 100    | General Radio Equipment Mfg. Co.             |     |
| McKenna Brass & Mfg. Co.            | 100        | U. S. Radic Co. of Penna., Inc.     | 100    | Globe Phone Mfg. Co.                         |     |
| Premier Radio Mfg. Co.              | 22         | <b>CRYSTAL DETECTORS</b>            |        | Herbert & Huesgen Co. Inside Front Cover     |     |
| Radio Accessories Co.               | 113        | Brooklyn Metal Stamping Co.         | 86     | Royal Electrical Laboratories                |     |
| Radio Technical Laboratories, Inc.  | 123        | Diamant Tool & Mfg. Co., Inc.       | 110    | Standard Electric Co.                        |     |
| <b>BOOKS</b>                        |            | Randel Wireless Co.                 | 70     | Mills Radio & Electric Co.                   |     |
| Allied Engineering Institute        | 23         | Scott Novelty Co.                   | 79     | <b>HONEYCOMB COILS</b>                       |     |
| Archway Bookstore                   | 116        | <b>CRYSTAL SETS</b>                 |        | Viking Radio Co.                             |     |
| Great Lakes Publishing Co.          | 116        | Aerex Radiophone Corp.              | 17-112 | <b>INFORMATION</b>                           |     |
| Norman W. Henley Pub. Co.           | 93         | Caragol-Clarke Co., Inc.            | 8      | Service Bureau                               |     |
| Radio Red Book Publishing Co.       | 102        | T. F. Radiophone Co.                | 124    | <b>INSULATORS</b>                            |     |
| <b>BOXES</b>                        |            | Holloway Elec. Supply Co., Inc.     | 104    | Bannister & Pollard                          |     |
| Weis Mfg. Co.                       | 114        | M. P. Radio Co.                     | 72     | <b>KNOBS &amp; DIALS</b>                     |     |
| <b>CABINETS</b>                     |            | W. E. Supply & Service Co.          | 86     | King Sewing Machine Co.                      |     |
| E. Eshoo Cabinet Works              | 119        | <b>DIALS</b>                        |        | Tait Knob & Dial Co.                         |     |
| Marvin B. Fallgatter                | 116        | Alden-Napier Co.                    | 118    | <b>LIGHTNING ARRESTERS</b>                   |     |
|                                     |            | New York Radio Dial Co.             | 82     | L. S. Braeh Mfg. Co.                         |     |
|                                     |            | The Emeloid Co., Inc.               | 113    | Essex Mfg. Co.                               |     |
|                                     |            | <b>DISTRIBUTORS</b>                 |        | Electric Service Supplies Co.                |     |
|                                     |            | Altadena Radio Laboratories         | 88     | <b>LOCKS</b>                                 |     |
|                                     |            | Arrow Radio Co.                     | 80     | Joseph Ross & Co.                            |     |
|                                     |            | Broun Radio Co.                     | 117    |                                              |     |
|                                     |            | Elco Radio Supply Co.               | 102    |                                              |     |
|                                     |            | Electric Service Engineering Co.    | 4      |                                              |     |

SEE ALPHABETICAL INDEX OF ADVERTISERS ON PAGE 130

# Where to Buy

## A Handy Guide For the Convenience of Our Readers

|                                             |        |                                                          |        |                                       |    |
|---------------------------------------------|--------|----------------------------------------------------------|--------|---------------------------------------|----|
| <b>LOOP AERIALS</b>                         |        | <b>RADIO TOWERS</b>                                      |        | <b>SWITCH STOPS</b>                   |    |
| Eagle Radio Co.....                         | 76     | Milliken Bros. Mfg. Co., Inc.....                        | 101    | Newark Radio Supply Co.....           | 79 |
| V-De-Co.....                                | 102    | <b>RECEIVING SETS</b>                                    |        | Virginia Radio Corporation.....       | 89 |
| <b>LOUD SPEAKERS</b>                        |        | Atlantic-Pacific Radio Supplies Co.<br>Inside Back Cover |        | <b>TESTING LABORATORIES</b>           |    |
| Dictograph Products Corp.....               | 9      | Arex Radiophone Co.....                                  | 17     | N. Y. Testing Laboratories.....       |    |
| Horning Experimental Laboratories.          | 77     | Beau Ivorie Novelty Co., Inc.....                        | 96     | <b>TOWERS</b>                         |    |
| The Magnavox Co.....                        | 61     | Bruno Radio Corp.....                                    | 35     | Milliken Bros. Mfg. Co., Inc.....     |    |
| The Sound Wave Corp.....                    | 30     | Bissell Engineering Co.....                              | 90     | <b>TRADE MARKS</b>                    |    |
| <b>LOUD SPEAKER SETS</b>                    |        | Brooklyn Metal Stamping Co.....                          | 83     | Chauncey P. Carter.....               |    |
| General Auto Electric Co.....               | 104    | Caragol-Clarke.....                                      | 8      | Radio Dealer Trade Mark Bureau...     |    |
| Radio Equipment Service.....                | 32, 33 | Charles R. Ablett Co.....                                | 8      | <b>TRANSFORMERS</b>                   |    |
| <b>MAILING LISTS</b>                        |        | Coraco Corp.....                                         | 118    | Clark and Tilson.....                 |    |
| Business Bourse Int., Inc.....              | 120    | Doublell Radio Co.....                                   | 113    | Federal Institute of Radio Telegraphy |    |
| Trade Circular Addressing Co.....           | 112    | Essex Radio Service, Inc.....                            | 12     | Ford Mica Co.....                     |    |
| F. D. Pickens.....                          | 109    | Federal Tel & Teleg. Co.....                             | 14     | Marle Engineering Co.....             |    |
| Ross-Gould Co.....                          | 114    | Grimes Radio Engineering Co., Inc..                      | 120    | Rauland Mfg. Co.....                  |    |
| Sydell's Radio Directory & Service..        | 107    | The E. D. Mfg. Co.....                                   | 26     | Rasla Sales Corporation.....          |    |
| <b>MANUFACTURERS' REPRESENTA-<br/>TIVES</b> |        | Lewis & DeRoy Co.....                                    | 73     | Thornton Transformer Co.....          |    |
| Radio Equipment Service.....                | 106    | Melchior Equipment Co.....                               | 118    | <b>UNIT TYPE SETS</b>                 |    |
| <b>METALS</b>                               |        | Mercury Radio Products Co.....                           | 72     | Jewett Mfg. Co.....                   |    |
| Strahs Aluminum Co.....                     | 114    | Metropolitan Radio Corp.....                             | 29     | Pacific Radio Exchange.....           |    |
| <b>MICA</b>                                 |        | Michigan Radio Corp.....                                 | 91     | <b>VACUUM TUBE SOCKETS</b>            |    |
| Mica Insulator Co.....                      | 30     | Mu-Rad Laboratories, Inc.....                            | 3      | Radiola Wireless Corp.....            |    |
| <b>MICA DIAPHRAGMS</b>                      |        | Neihoff Co., Paul G.....                                 | 122    | <b>VACUUM TUBE TESTER</b>             |    |
| Radio Mica Products Co.....                 | 98     | Radio Outfitting Corp.....                               | 102    | The Mydar Radio Co., Inc.....         |    |
| <b>MULTILISTENER</b>                        |        | Radio Instrument Co.....                                 | 19     | <b>VARIABLE CONDENSERS</b>            |    |
| United Specialties Co., The.....            | 29     | Joy Kelsey Corp.....                                     | 112    | Bayley Condenser Co.....              |    |
| <b>PANELS</b>                               |        | Rogers Radio Co.....                                     | 110    | Bunting Stamp Co.....                 |    |
| American Hard Rubber Co.....                | 97     | States Radio Corp.....                                   | 82     | John Cozzone Co.....                  |    |
| New York Hard Rubber Turning Co.            | 96     | Steinmetz Wireless Mfg. Co.....                          | 116    | Duquesne Radio & Mfg. Co.....         |    |
| Poster & Co.....                            | 111    | W. R. Cramer Co.....                                     | 104    | Detroit Radio Supply Co.....          |    |
| Standard Radio Parts Co.....                | 117    | United Radio & Electric Co.....                          | 89     | Electric Products Co.....             |    |
| Standard Wireless Panel Co.....             | 115    | Wintner Radio Corporation.....                           | 131    | Electric Service Engineering Co.....  |    |
| The Continental Fibre Co.....               | 111    | W. E. Supply & Service Corp.....                         | 86     | Montrose Mfg. Co.....                 |    |
| <b>PART MAKERS</b>                          |        | Ware Radio Corp.....                                     | 31     | Radio Stores Corporation.....         |    |
| Aldine Radio Mfg. Co.....                   | 91     | E. M. Wilson & Co.....                                   | 121    | Frederick H. Pruden.....              |    |
| Premier Accessory & Specialty Corp.         | 77     | <b>RHEOSTATS</b>                                         |        | Seaboard Radio Corporation.....       |    |
| Radio Apparatus Co.....                     | 96     | Acorn Radio Supply Co.....                               | 111    | Spiro Bros.....                       |    |
| <b>PATENTS</b>                              |        | Parkin Mfg. Co.....                                      | 103    | <b>VARIO-COUPERS</b>                  |    |
| A. M. Wilson, Inc.....                      | 112    | Reco Radio Engineering Co.....                           | 12     | Marvin B. Fallgatter.....             |    |
| Emil Alexander Kern.....                    | 112    | Louis A. Staff Co.....                                   | 87     | Queens Radio Co., Inc.....            |    |
| Manufacturers Patent Co.....                | 112    | Keystone Radio Co.....                                   | 95     | <b>VARIOMETERS</b>                    |    |
| Otto K. Zwingenberger.....                  | 112    | Sunraid Radio Co.....                                    | 98     | Eastern Specialty Co.....             |    |
| <b>PHONES</b>                               |        | <b>SCREW MACHINE PRODUCTS</b>                            |        | Franklin Radio Mfg. Co.....           |    |
| Clark and Tilson.....                       | 126    | Cap Screw & Nut Co. of America...                        | 112    | McConnell Cable and Specialty Co...   |    |
| The Mills Radio & Elec. Co.....             | 98     | <b>SIGNS</b>                                             |        | Nelson Radio Parts Co.....            |    |
| T-B-H Corporation.....                      | 118    | Clark & Tilson.....                                      | 84, 85 | Ritter Wood Work Co.....              |    |
| True-Tone Radio Mfg. Co.....                | 88     | <b>SOCKET RHEOSTAT</b>                                   |        | Sunday and Scholtz.....               |    |
| <b>PLUGS</b>                                |        | Ajax Radio Corp.....                                     | 126    | Volta Engineering Co.....             |    |
| Invincible Products Co., Inc., The...       | 124    | <b>SOCKETS</b>                                           |        | <b>VARIOMETERS AND PARTS</b>          |    |
| Metro Electric Mfg. Co., Inc.....           | 28     | Alden-Napier Co.....                                     | 70     | Scientific Dealers' Supply Co.....    |    |
| Racony Corp., The.....                      | 96     | Thresher Radio Corp.....                                 | 17     | <b>VERNIER CONDENSERS</b>             |    |
| S. S. Novelty Co.....                       | 92     | <b>SOLDERING IRONS</b>                                   |        | Bremer-Tully Radio Co.....            |    |
| <b>POTENTIOMETERS</b>                       |        | North Shore Radio Works.....                             | 112    | <b>WINDING</b>                        |    |
| Advance Metal Stamping Co.....              | 110    | Post Electric Co.....                                    | 95     | Montclair Radio Co.....               |    |
| <b>PUBLICATIONS</b>                         |        | <b>SPAGHETTI TUBING</b>                                  |        | <b>WIRE</b>                           |    |
| Radio Dealer Weekly.....                    | 36     | Mitchell Rand Mfg. Co.....                               | 106    | White Radio Co.....                   |    |
| <b>RADIO CRYSTAL ATTACHMENT</b>             |        | <b>STOCK BROKERS</b>                                     |        | <b>WOOD PARTS</b>                     |    |
| Rad'O.....                                  | 105    | Frank T. Stanton & Co.....                               | 114    | R. C. Mills.....                      |    |
|                                             |        | <b>SWITCH LEVERS</b>                                     |        |                                       |    |
|                                             |        | Haydon & Fenton.....                                     | 124    |                                       |    |

SEE ALPHABETICAL INDEX OF ADVERTISERS ON PAGE 130

# Association of Radio Dealers Formed

## Metropolitan Radio Dealers Organized for Betterment and Protection of Radio Business Men

By WILLIAM J. MOSES

Secretary of the Metropolitan Radio Dealers' Association

Business economics recognize that in the development of an industry real efficiency requires some basis of organization, by which united effort can be made supplement to individual effort. The solution of the problem that faces the radio industry to-day is co-operation and competition each in its proper place, guided by recognized leaders.

On September 20th a meeting of men prominent in the radio retail trade of New York City was held at the Hotel McAlpin for the purpose of discussing the formation of an organization composed of radio dealers in the metropolitan area. The purpose of the association is to promote, by means of co-operation among retail dealers, a more stable condition in the radio trade.

The need for such an organization has been severely felt during the past several months not only in New York City but throughout the entire country. After the meeting was called John W. Griffin, of the Griffin Radio Service, Inc., was unanimously elected president of the new organization and William J. Moses of the Manhattan Hardware Company was elected secretary.

Mr. Griffin gave a short talk on the need for such an organization and the benefits derived both for the dealer and the public. Following Mr. Griffin's interesting talk Mr. Moses laid stress on the need of all members entering into the building up of the organization with earnestness of purpose and assured all present that he would fill the office conferred on him with the utmost of his ability and effort.

After a brief and lively discussion regarding the more important questions needing immediate consideration, the chairman appointed several committees to submit reports at the next meeting to be held at an early date.

The committee on price cutting was advised that they report, after careful consideration, the policy of the organization with regard to the unfair marketing of goods at cut rates. The general opinion of the members assembled was that each dealer be allowed to advertise a sale on but one article, and only one at any time, all other sets or parts to be sold at regular list price.

The second committee was advised to report on what was to be constituted as fair advertising. This question was brought out as a result of unfair methods that have been used by some dealers in making misleading statements through error or direct intent in their respective advertisements.

The committee on public information was appointed to determine ways and means of best instructing the public on the subject of radio and to co-operate with the broadcasting stations to promote such education and to aid in the bettering of broadcasting programs will also be a duty of this committee.

Committee number four has for its duties the standardization of radio parts in so far as is possible. The belief of the meeting was that there are too many small and needless dif-

ferences in similar parts. Standardization makes for efficiency.

Committee number five is to consider what shall be recognized as a fair margin of profit on all radio goods.

The last committee was appointed to report on the establishment of co-operation among the members and mutual aid in various matters pertaining to the trade.

The association also determined that for the present the dues shall be ten dollars for the year. All members present at the recent meeting were made charter members. The temporary headquarters will be at 497 Third Avenue, New York City.

If the interest and activity shown at the recent meeting is any criterion of the future of the association we may rest assured that the Metropolitan Radio Dealers' Association is heading for big things.

## New Tube Socket

A vacuum tube socket built upon entirely new lines, and being adopted by many manufacturers of high grade receiving sets is manufactured by the Thresher Radio Corporation of Newark, N. J., as part of its line of Thradio Products, and has many features of design that entirely eliminate the difficulties from structural weakness and loose and faulty connections, which are the source of so much noise, causing poor reception and amplification.

The body of the socket is of seamless brass tubing, drawn to exact internal diameter to give proper clearance for the tube base, and is heavily nickel-plated and polished.

The base is of bakelite dilecto sheet  $\frac{1}{4}$ " thick, grain finish. It is bored to a less diameter than the outer diameter of the brass tube, which is turned down, leaving a shoulder that rests upon the base. The lower edge of the tubing is spun over a shoulder counterbored in the under side of the base and firmly riveted in place, so that it can neither turn nor pull out of the base but is held rigidly in position.

This construction brings the bottom of the tubing well up into the base and leaves a space of  $\frac{1}{8}$ " between its lower edge and the contact strips, giving a very high resistance and proportionately reducing the leakage at this point.

The contacts are punched from Tobin spring bronze and have ample contact surface, so that when in position the contact points rest in the center of the contact surface and have a true bearing. They are held securely in place by the terminal stud and in addition are keyed to the base, making it impossible for them to become loose or get out of position.

The contact studs are of ample length for securing the wiring connection, which can be made either above or below the base.

The bayonet lock is so designed that the tube, when once in position, will not jar loose. The form of construction employed makes it possible to mount these sockets in any multiple. The design is neat, well finished and adds greatly to the appearance of the receiving set in which they are installed.

# The A-P Special

A marvelous new A-P

## Receiver

which  
requires

# no ground

# no aerial

The set thousands have been waiting for, made possible by a recent scientific development—"The Oard Phantom No-ground Circuit." The set whose wonderful achievements are astounding the radio world. The set that operates at full efficiency over short or long distances without aerial or ground connection—



"It's all inside"

*It sells both as a home set and as a portable. Ideal for automobile use, because it is so compact, easily transported, and quickly placed in operation.*

## The Oard Phantom Receptor

"Marvelous" is really the word that best describes this A-P Special—*The Oard Phantom Receptor*. For general receiving it requires only a single short antenna wire which may be concealed in the picture moulding, suspended at some convenient point, laid on the floor or ground, fastened to the bows of your automobile top, or wound around the cabinet of the instrument. It does not require either ground or aerial, *it operates best without them*. It enables the operator to eliminate static and other interference almost entirely. It has all the apparent advantages of radio frequency amplification without its delicate or complicated adjustments. With equal ease and efficiency it receives either broadcasted programs or spark signals over short or long distances. And it works just as effectively in a speeding automobile as on the table at home. Wave length range 300 to 1,000 meters.

*The tremendous selling possibilities of such a set should be obvious to every alert and aggressive dealer. In addition to these inherent advantages it is being nationally advertised. Write us for Bulletin D-2 and our special co-operative merchandising plan.*

### Atlantic-Pacific Radio Supplies Co.

Radio  
Supplies

646-50 MISSION ST.,  
SAN FRANCISCO, CAL.

Receiving  
Sets

## Hook Your Radio Sales to this Revolutionary Battery Principle!

You can give permanent satisfaction to your customers and build up enduring good will for yourself by equipping all the radio sets you sell with Radiobats.

RADIOBATS are not merely batteries with improvements. They are built on radically new and different principles that put the old automobile type "A" battery and dry cell "B" battery out of date.

Radiobats, both "A" and "B," have nothing to leak. They contain the first successful and semi-solid electrolyte. This revolutionary principle plus the rugged strength of the exclusive Radiobat reinforced grid has made the use of any kind of separators unnecessary.

Radiobat "B" is a genuine 22 volt storage battery which is rechargeable at

home from either A.C. or D.C. It is compact and rugged. Most important of all—it is utterly noiseless in operation.

Radiobat "A" is smaller, lighter in weight and easier to handle than any other "A" battery of equal rating. It maintains a steady discharge rate throughout its entire life.

"A" and "B" Radiobats used together form "The Permanent Radio Power Unit." Any standard radio set equipped with Radiobats will give a new experience of dependability and complete satisfaction with radio.

The Radiobat policy is to distribute through radio stores and not through service stations. You should have the radio battery business service stations are now getting. You can get it with Radiobats — designed exclusively for radio use.

Radiobats have the backing of a tremendous national advertising campaign—the most powerful in radio. Prices are fair—discounts liberal. Write or wire for complete description and outline of sales plan.

**Multiple Storage Battery Corp.**  
352 Madison Avenue, N. Y. C.

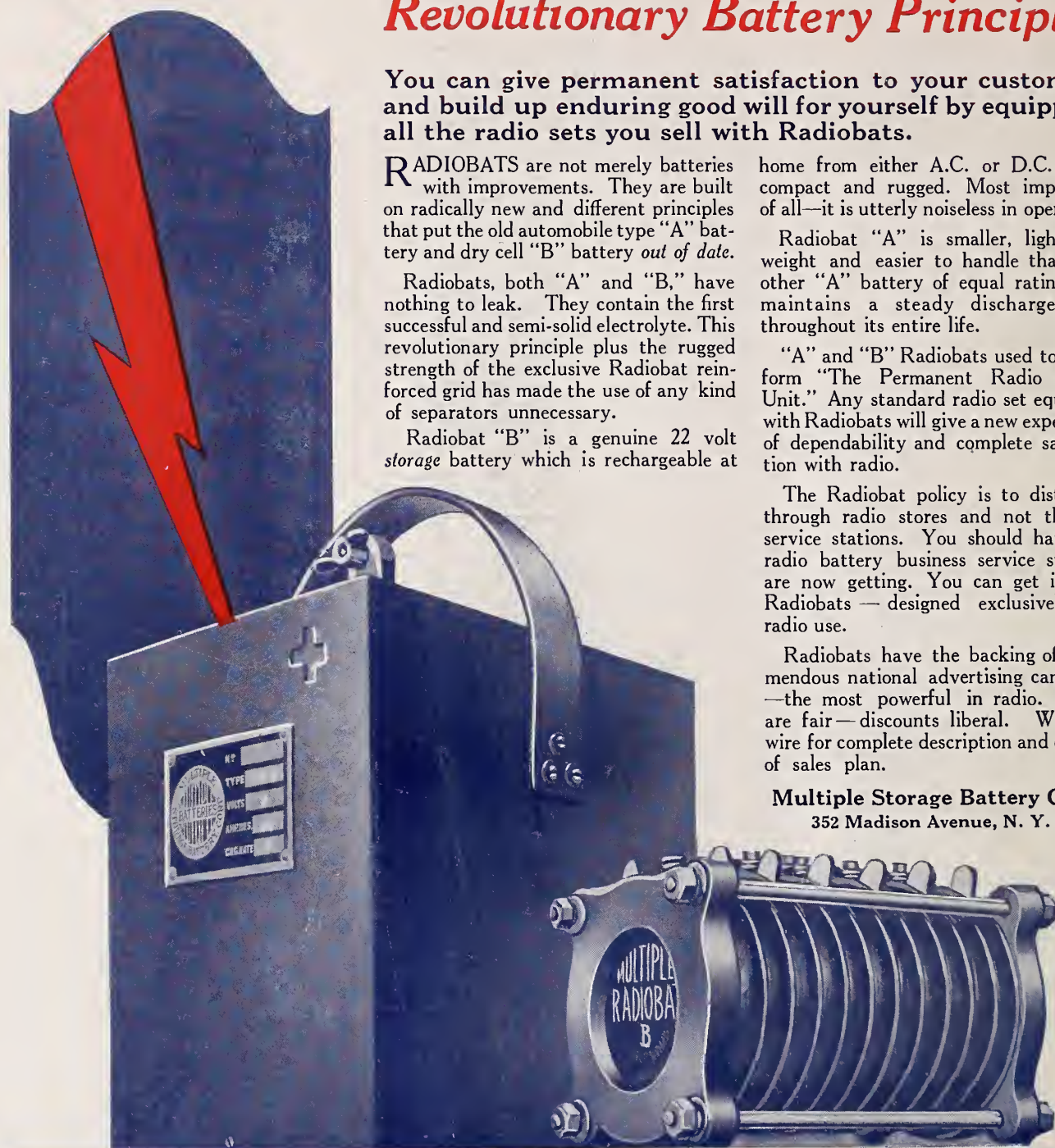

"A"  
and  
"B"

# RADIOBATS

*The Permanent Radio Power-UNIT*

# The RADIO DEALER

Vol. 2 No. 2 NOVEMBER, 1922 One Dollar The Year

Published monthly at 1133 Broadway, New York, N. Y., by The Radio Dealer Company. Entered as Second Class Matter, at the Post Office at New York, N. Y., under the Act of March 3, 1879

Last Minute Orders  
of Nationally Adver-  
tised, STANDARD  
**RADIO MERCHANDISE**

**For the Christmas Harvest**  
**Promptly Shipped from Ample Stocks**

NOT too late, even yet, to get in a full line of radio gifts for the holiday buying. You can select your stock from the products of America's best manufacturers and have everything delivered to you in plenty of time. But you should send in your order immediately.

The Holiday season is going to be one of the most profitable so far. Those who take full advantage of it will push their business far ahead of those who neglect this great wave of buying. Let Wholesale Radio Equipment co-operate with you.

*Products of 22 or More of the Best Known Manufacturers*

Order some of these famous  
**ALL WAVE COUPLERS**

Combination

Flat and Bank Wound Coupler

*Guaranteed Wave Length 150 to 3000 meters*



Eliminates use of variometers, vario couplers and loading coils because it does the whole tuning job. Bought by amateurs everywhere for building small, compact, simplified receiving sets. They want its advantages of maximum clear reception over a wide range of wave lengths.

Their very low cost keep your stock of All Wave Couplers turning over frequently, so that you make a generous profit without tying up any large capital.

Lots being sold to makers of Holiday Receiving Sets. Just a small order of All Wave Couplers will prove their profitability.

LIST  
**\$9<sup>00</sup>**

*Write Us For Attractive Discounts*



**DISTRIBUTORS  
FOR**

Acme  
American Trans-  
former  
All Wave Coup-  
lers  
Baldwin  
Bradleystat  
Brandes  
Chelsea  
De Forest  
Dubilier Electri-  
cal  
Eveready  
Federal  
Homcharger  
Jefferson  
Klosner  
Magnavox  
Murdock  
Paragon  
Radio Service  
Laboratories  
Thordarsen  
Tuska  
Western Electric

**WHOLESALE  
ONLY**

## Wholesale Radio Equipment Co.

24 WILLIAM STREET, NEWARK, N. J.

**\$5.00**

13,000  
Ampere turns



**\$7.50**

16,000  
Ampere turns

**“PIGS IS PIGS”—But All phones  
are not “ROYALFONES”**



*Every “Royalfone” comes packed  
in our new and attractive box.*

**ROYAL ELECTRICAL LABORATORIES**

MANUFACTURERS OF  
*Electrical and Radio Equipment*  
NEWARK N-J-

Because we—

are manufacturers of headsets, and  
not mere assemblers.

manufacture every integral part of  
our “Royalfone” at our own plant  
from the best possible materials.

make phones with the purpose of  
making them sensitive and powerful.

wind our coils to get the greatest  
number of ampere turns, and not  
mere resistance.

match each pair of coils in every  
pair of phones to get uniform tone  
quality.

thoroughly inspect every pair of  
phones before they leave our factory  
to see that they function properly on  
various types of sets.

only manufacture the “Royalfone”  
and it is King of All.

guarantee every “Royalfone” and  
our guarantee is printed on the box.

make immediate shipments, and our  
discounts are attractive.



**Royalfone**



*The Leaders Will Be There*

# AMERICAN RADIO EXPOSITION

*The Official Exposition for American Manufacturers.*

This first really comprehensive Radio Show staged in a manner worthy of this Great Industry

*will be held in*

**GRAND CENTRAL PALACE**  
**NEW YORK**

**DECEMBER 21st to 30th**

*(Sunday excepted but Christmas Day included)*

At this remarkable exposition, representative manufacturers will be invited to display and demonstrate their goods to thousands of visitors and potential buyers. More than 40,000 square feet of floor space will be available for a great educational and trade exhibition covering the entire field of radio.

Coming at the holiday season, schools and colleges will be closed, making it convenient for students, parents, teachers and holiday-seekers to attend.

***This Is A Radio Christmas!***

*For further particulars, write or wire*

**AMERICAN RADIO EXPOSITION CO.**  
120 BROADWAY NEW YORK

*Telephone John 0009*

**THIS WILL BE A RADIO CHRISTMAS!**

NO. 57  
RADIO RECEIVER



—the most sensitive receiver that has yet been built.

—→ \$98.00

## THE Federal No. 57 RADIO FREQUENCY RECEIVING SET

is not only the most sensitive receiver that has yet been devised, but it gives its extraordinarily high degree of amplification with a pureness of tone and beauty of reproduction beyond comparison. It constitutes one stage of radio frequency, detector and two stages of audio frequency.

### RADIO FREQUENCY AMPLIFICATION

HAS BEEN TALKED ABOUT BUT NEVER FULLY REALIZED UNTIL NOW.

### WRITE FOR BULLETIN No. 119-W

IT IS A TEXT BOOK ON RADIO FREQUENCY AMPLIFICATION.

**Federal Telephone and Telegraph Company**

BUFFALO, N. Y.

# Dictograph *Radio* Loud Speaker Proves Sensational Success!

**A**NOTHER success for Dictograph! Here at last is the Loud Speaker the radio public has been waiting for—the Loud Speaker for the home—backed by a name known the world over—and sold at a low price within the reach of all!

Orders have been received in such volume that original production plans have been increased and the price reduced! Instead of \$25, the LIST PRICE IS NOW ONLY \$20—complete with 5 ft. flexible cord.

The world-famous DICTOGRAPH name and the Dictograph reputation for producing sound-transmission and loud-speaking devices of supreme quality GUARANTEE the superiority of the Dictograph Radio Loud Speaker.

For use with any vacuum tube receiving set. No extra batteries required. Reproduces every sound in full, clear tones, free from distortion. The handsome appearance of this quality instrument harmonizes with any home.

Protect your profits now. Wire your jobber or communicate direct for names of authorized distributors.

Electrotypes for catalogs, advertising, etc., are available and will be furnished on request.

### DICTOGRAPH *Radio* HEAD SET

Bigger and bigger sales every month. The best Head Set in the world at any price. 3000 ohms. Standard equipment on leading Receiving Sets. Quick turn-over and sure profits. If not yet stocked, order NOW from your jobber or communicate direct for names of authorized distributors.



3000 Ohms

List Price

**\$20**

Complete with 5 ft. flexible cord

Another strong selling feature—the handsome appearance of the Dictograph Radio Loud Speaker. Highly burnished French lacquered spun copper bell horn. 11 in. in diameter, attached to die cast black enamel tone arm, nickel trimmings. Cabinet of solid, ebony-finished hardwood, 6 x 5 in. base, 4 in. high, mounted on rubber knobs.



DICTOGRAPH PRODUCTS CORPORATION

Branches in all principal cities

New York City

220 West 42nd Street

THIS WILL BE A RADIO CHRISTMAS!

# New York Coil Company's Radio Products

THE LEADING LINE OF THE MOST SUCCESSFUL JOBBERS AND DEALERS IN RADIO

Our products embrace only the most needed and rapidly moving articles. Quality, engineering and workmanship the best obtainable.

Our extensive advertising *and worth-while discounts* cannot be overlooked.

**STANDARD VARIOCOUPLER, - - - \$4.00**  
**STANDARD VARIOMETER, - - - 4.00**

These items are large, full size proven products, the value of which is seen at a glance. Our Unequaled Variable Condensers contain precision, workmanship found in no other similar instruments.

**LIST PRICES:**

|                 |   |   |   |   |        |
|-----------------|---|---|---|---|--------|
| 3 Plate Vernier | - | - | - | - | \$1.25 |
| 11 "            | - | - | - | - | 1.50   |
| 23 "            | - | - | - | - | 2.00   |
| 43 "            | - | - | - | - | 3.00   |

**REAL RADIO FREQUENCY AT LAST.** Solution—our Condenser tuned Radio Frequency Transformers. An entirely new principle employed. Extraordinary results guaranteed. Price, \$4.00

Special Condensers for same, \$1.50.

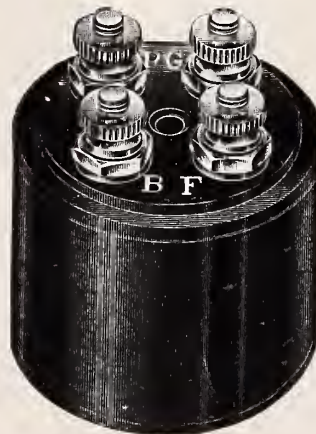

**COMBINED MOUNTED VARIOCOUPLER**—The only Variocoupler on the market that allows panel or table connection and eliminates the connecting of taps, soldering, drilling, etc. A great advantage in Radio. Nothing like it on the market. Handsomely finished. Price \$8.00.

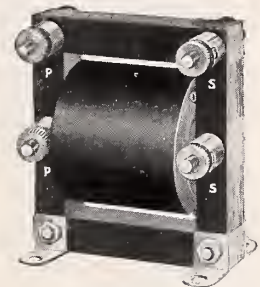

**AUDIO FREQUENCY TRANSFORMERS**—Choice of leading manufacturers and radio engineers. Guaranteed to give high magnification, less distortion and better all round efficiency. No howling. Price \$4.00.

**NEW YORK ENTERTAIN-A-PHONE RECEIVING SET No. 2**—Complete with detector and two stages of amplification, all in one cabinet. Contains a non-regenerative two circuit hook-up with two stages audio amplification. Results are simply a revelation. It must be operated and heard to be appreciated. Workmanship and design and material of exceptional character throughout. Of unusual interest to the jobber. Price \$50.00, fully guaranteed.

## NEW YORK COIL COMPANY, Inc.

338 Pearl Street

New York City, N. Y.

THIS WILL BE A RADIO CHRISTMAS!



Type B, Keystone Radio Arrester. Retail Price, \$2.00

# KEYSTONE

## LIGHTNING ARRESTERS

Listed as Standard by Underwriters' Laboratories (No. 362 A-4)

You can sell hundreds of Keystone Arresters for these reasons—Small in size; weatherproof; entirely enclosed and sealed; foolproof; constructed by a Company having 30 years' experience in lightning arrester design; low capacity and high resistance; no vacuum to lose and so reduce the efficiency of the arrester to a point where it is practically valueless.

Get your order in before there is a possible scarcity. Liberal Dealer discounts. Write for complete information.



Type A, Keystone Radio Arrester. Retail Price, \$2.00

# Simplex Panel Units

and  
Unmounted  
Variometers  
and  
Vario-Couplers



No. 47488  
Simplex Variometer,  
Showing Side View of  
Panel Mounted Type

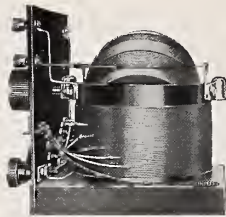

No. 47489  
Simplex Vario-Coupler,  
Showing Side View of  
Panel Mounted Type

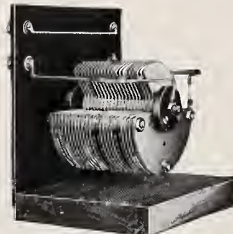

No. 47541  
Simplex Condenser  
Panel—Side View

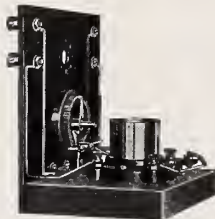

No. 47490  
Simplex Detector Panel  
Side View

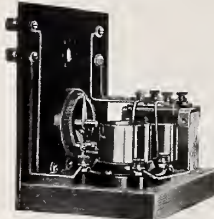

No. 47491  
Simplex Amplifier Panel  
Side View

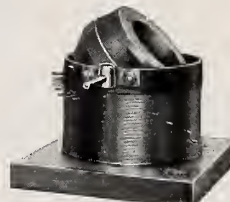

No. 47483  
Simplex Vario-Coupler,  
Unmounted



No. 47482  
Simplex Variometer,  
Unmounted

There is a big demand for Simplex Panel Units among your customers because they permit trying-out many different hook-ups and thus determining the best for their certain locality without having to disassemble a complete outfit. This is a decided advantage, but of no less interest is the fact that the beginner can first purchase one Vario-Coupler Panel and one Detector Panel and have a fairly good receiving set at minimum cost with the advantage of later adding additional units to obtain greater sensitivity and selectivity. Thus the user can add to his Simplex outfit and when he has purchased it complete it is unquestionably one of the most attractive and efficient receiving sets now offered to the public.

This is a very attractive line for Jobbers and Dealers. Write for new descriptive circular and discounts on Panel Units and Unmounted Variometers and Vario-Couplers. Simplex Material is high grade in every respect.



Manufacturer of  
Lightning Arresters for 30 years  
Distributors for  
SIMPLEX RADIO CO.

## ELECTRIC SERVICE SUPPLIES CO.

PHILADELPHIA  
17th and Cambria Streets

NEW YORK  
50 Church Street

CHICAGO  
Monadnock Bldg.

Branch Offices: Boston, Scranton, Pittsburgh

Canadian Distributors: Lyman Tube & Supply Co., Ltd., Montreal, Toronto, Winnipeg, Vancouver

THIS WILL BE A RADIO CHRISTMAS!



# RADIO MAGNA-TONE PRODUCTS



Lift the switch and this **MAGNA-TONE** Two-stage Amplifier is in operation with filaments under fixed control. Circuit is automatically rearranged for one stage by lifting the first tube—at the left. Size, 13 x 5 x 5½ inches. Ebony finish.

**JOBBERS AND DISTRIBUTORS**—There's a big demand for this radio essential. Write at once for our special proposition.

List Price **\$24**

## MAGNA INSTRUMENT COMPANY

340 West 42nd Street  
New York City

**MAGNA-TONE** Vacuum Tube Receiver—a radio set without fussy adjustments. Only two adjustments necessary. Provided with Fahnestock terminals which insure positive connections throughout. Size 13 x 5 x 5½ inches. Ebony finish.

**DEALERS**—Radio fans want simpler apparatus. Here it is. Discounts are generous. Big sales reported. Get in touch with your Jobber.

List Price **\$16**



Catalog on Request

THIS WILL BE A RADIO CHRISTMAS!

# Broadcasting the Convenience of HOMCHARGING to 10,000,000 Prospects



Dominating HOM-CHARGER Advertisements appear regularly in over thirty leading radio and automobile publications—the most comprehensive campaign in the entire radio field.

In addition, HOM-CHARGER Dealers are supplied with a variety of attractive window cards, counter displays, circulars and other sales helps, all of which will help make the HOMCHARGER the fastest selling and most profitable accessory you have ever handled.

The new RADIO HOMCHARGER DE LUXE is the sensation of the radio industry, and is the only battery charger on the market, regardless of selling price—combining the following essential HOM-CHARGER features:

*ONE—Self-polarizing*—Otherwise battery may be ruined through reverse charging.

*TWO—Five Ampere Charging Rate*—Will fully charge any battery over night. A lower charging rate (2 amperes) necessitates approximately fifty hours for a full charge.

*THREE—Underwriters' Approval*—The various municipal electrical bureaus, and the Insurance Underwriters are daily becoming more strict regarding the use of only approved electrical apparatus. The Homcharger is one of the few battery charging rectifiers on the market that has this approval.

Packed in neat, individual, red and green checked corrugated cartons, which can be conveniently and attractively displayed. Furnished with attachment cord, plug, charging cable, battery clips, etc., at a uniform price of \$18.50 for both direct and alternating current circuits of any frequency or voltage.

Over forty thousand HOMCHARGERS were sold to jobbers and dealers last spring. Over one hundred and fifty thousand will be sold this fall and winter.

Will you get your share of profit from this fast moving, easily sold, and nationally advertised radio and automobile accessory?

Send today for the HOMCHARGER Selling Plan and your copy of "Homcharger Business Builders," which will convince you that the HOMCHARGER presents the liveliest opportunity ever presented to the trade for cashing in on a popular priced, no service, over the counter article, with enormous sales possibilities.

## The Automatic Electrical Devices Co.

144 West Third Street

Cincinnati, Ohio

Largest Manufacturers

of

Vibrating Rectifiers in the World

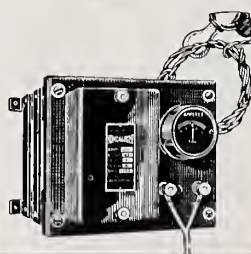

BRANCH OFFICES

New York Chicago Pittsburgh  
 Detroit Dallas  
 Philadelphia Los Angeles  
 Baltimore Minneapolis New Orleans  
 St. Louis Atlanta

TYPE "A" FOR WALL MOUNTING

~ OVER 50,000 IN USE ~

THIS WILL BE A RADIO CHRISTMAS!

# Here They Are At Last!

## Two Non-Technical Books Answering Every Question of the Radio Fan

### THE RADIO TELEPHONE HANDBOOK

By H. G. CISIN, M. E.

A Book of Authentic Information About Radio. It explains—

- The Operating Principles of Radio*
- How Crystal Detectors Work*
- How the Vacuum Tube Works*
- The Principles of Regeneration*
- How Amplification May Be Obtained*
- How to Check Up the Condition of the Storage Battery*
- Causes and Remedies for Weak Signals and Local Noises in Connection with Vacuum Tube Sets*
- When an Indoor Aerial Can Be Used*
- What the Loop Aerial Is*
- What Batteries, If Any, Are Necessary*
- When Shielding Is Necessary*

and many other important branches of Radio. It defines in language which the novice can understand.

- |                               |                        |                      |
|-------------------------------|------------------------|----------------------|
| Aerial                        | Ball-Type Variometer   | Coil Receiver        |
| Alternating Current           | Bakelite               | Compass              |
| Alternation                   | Bellini-Tosi Direction | Condenser            |
| Alternator                    | Finder                 | Connection Block     |
| Ampere                        | Blacking Condenser     | Caunterpaise         |
| Amplifier                     | Bridging Condenser     | Caupling             |
| Ammeter                       | Broadcasting           | Caupling Condenser   |
| Anode                         | Buzzing                | Caupling Transformer |
| Antenna                       | By-Pass Condenser      | Crystal Detector     |
| Antenna Coil                  | "C" Battery            | Cycle                |
| Atmaspheric Disturbance       | C.W.                   | Detector             |
| Audibility                    | Capacity               | Diaphragm            |
| Audible Frequency Transmitter | Carburundum            | Di-Electric          |
| Audion                        | Cascade Amplification  | Direct Current       |
| Audiotone Receiver            | Cathode                | Discharge            |
| Auto-Transformer              | Cat-Whisker            | Dummy Aerial         |
| "B" Battery                   | Change-Over Switch     | Dynamotor            |
|                               | Charging Rectifier     | Dynation             |
|                               | Choke-Coil             | Earth Connection     |

#### AND NUMEROUS OTHERS

Mr. Hall of Ludwig Hochmel & Co., Pittsburgh, Pa., says "We have given The Radio Telephone Handbook careful study and we believe that it is a very good publication. It should meet with very popular demands among those interested in radio."

### PRACTICAL ELECTRICAL ENGINEERING

By H. G. CISIN, M. E.

The easiest book to understand which has ever been written on electrical engineering. No higher mathematics—no symbols—no Greek letters—no algebra. It tells in simple language the basic principles of direct current electrical engineering.

Among the many well-known concerns that have ordered PRACTICAL ELECTRICAL ENGINEERING are the following:

- |                                            |                                           |
|--------------------------------------------|-------------------------------------------|
| The American Tobacco Co., Baltimore        | Maryland Casualty Co., Baltimore, Md.     |
| The Wahl Co., Chicago, Ill.                | Delaware County Tel. Co., Manchester, Ia. |
| National Blank Book Co., Holyoke, Mass.    | Gates Rubber Co., Denver, Colo.           |
| Coes Wrench Co., Worcester, Mass.          | Willard Storage Battery Co., Cleveland    |
| Elgin National Watch Co., Elgin, Ill.      | Graham Glass Co., Evansville, Ind.        |
| American Car and Foundry Co., N. Y.        | Ludwig Baumann & Co., New York            |
| Pittsburgh Plate Glass Co., Ford City, Pa. | Denver & Salt Lake R. R., Denver, Colo.   |
| Hammermill Paper Co., Erie, Pa.            | Kentucky Wagon Mfg. Co., Louisville, Ky.  |
| Hanna Paper Corp., New York                | W. F. Hall Printing Co., Chicago, Ill.    |
| National Cloak & Suit Co., New York        | Humble Oil & Refining Co., Houston, Tex.  |
| Morse Dry Dock & Repair Co., Brooklyn      | Ashtabula Dock Co., Ashtabula, Ohio       |
| Ward Baking Co., Brooklyn, N.Y.            | Florence Thread Co., Florence, N. J.      |
| Bohn Refrigerator Co., St. Paul, Minn.     | Cottage Planing Mill Co., Everett, Pa.    |
| Ward Baking Co., New York                  | National Electric Water Heater Co., N. Y. |
| Thos. G. Plant Co., Boston, Mass.          | General Realty Co., Philadelphia, Pa.     |
| Dominion Textile Co., Ltd., Montreal       | Ohio State University, Columbus, Ohio     |
| Western Clock Co., La Salle, Ill.          | Loews Theater, New York                   |
| Hotel Astor, New York                      | 14th Street Theater, New York             |
| J. M. Horton Ice Cream Co., New York       | Shuberts' Crescent Theater, Brooklyn      |
| Westinghouse Building, Pittsburgh, Pa.     | Keith's Jefferson Theater, New York       |
| United Piece Dye Works, Lodi, N.J.         | Grove Park Inn, Asheville, N. C.          |
| Jamestown Worsted Mills, Jamestown, N. Y.  | Elton Hotel, Waterbury, Conn.             |
| R. J. Reynolds Tobacco Co., Lexington, Ky. |                                           |

#### AND NUMEROUS OTHERS

## A WONDERFUL COMBINATION

### PRACTICAL ELECTRICAL ENGINEERING, \$2.00

(Bound in cloth—324 pages—71 Illustrations)

### THE RADIO TELEPHONE HANDBOOK, \$1.00

(Bound in Flexible Buckeye—90 pages—Illustrated)

## COMBINATION OFFER

# \$2.50 FOR BOTH!

THIS WILL BE A RADIO CHRISTMAS!

FILL THIS OUT, TEAR OFF AND MAIL.

ALLIED ENGINEERING INSTITUTE  
1400 Broadway, N. Y. City

Gentlemen:  
Send  
..... Practical Elec. Eng.  
..... The Radio Telephone Handbook  
Find Enclosed \$.....

Name.....  
Address.....  
City.....  
State.....

# MICR-O-PHONE Radio Equipment



238

Micr-O-Phone Reproducer with modifying sounding board. Can be adjusted to any sound desired. Pure cast aluminum 21½ high, 11" wide. Price complete with loud speaker cord and plug, \$15.00.



Micr-O-Phone Listener-In. Six phones in one for crystal or tube sets. One head-phone connected to this instrument and the whole family can listen in. Pure cast aluminum highly polished. Complete as illustrated, with six hose connections ready for use. Price, \$5.00.

Send 10 cents in stamps for 40 of the Latest Radio Hookups with full descriptions

## ALDINE RADIO & MFG. COMPANY

Aldine Square

(Dept. B.—10)

Chicago, Ill.

# G-M-PRODUCTS

## TWO PROFITABLE SPECIALS



ACTUAL SIZE

### RADIO FREQUENCY TRANSFORMER

The Best at Any Price—Wave length range 200 to 500 meters with full amplification at both extremes.

Special core, untuned type, giving highest possible amplification for this type of transformer, bringing in distant stations inaudible by any other method.

Particularly adapted for non-regenerative circuits.

Can be used with one, two or three stages of radio frequency amplification.

Can be used with any available vacuum tubes.

RETAIL PRICE, \$2.00

### ROLLER BEARING SWITCH LEVER

HAS SPECIAL FEATURES

Switch Arm can be adjusted to 1⅛" or 1¼" Radius. Roller Bearing prevents cutting of Switch Points. Special Fada Type Knob. Highly Nicked.

RETAIL PRICE, \$0.50



ACTUAL SIZE

Distributors For  
Thorndarsen  
Levre Mfg. Co.  
Baldwin  
U. S. Tool Co.  
Rooker & Barron  
Eveready

## GENERAL MERCHANDISE CO.

Manufacturers and Distributors

142 MARKET STREET,

NEWARK, N. J.

Distributors For  
Planet Radio Corp.  
Magnavox  
Western Electric  
Hom charger  
Inso-Lite Products  
Tillman Products

THIS WILL BE A RADIO CHRISTMAS!





## "VICTOR PRODUCTS"



TUNER, DETECTOR AND TWO-STAGE AMPLIFIER  
—Type 115—

**WE** manufacture a complete line of Radio Sets and Parts, consisting of: Receiving Sets, Tuners, Tuners and Detectors, Tuner, Detector and Two Stage Amplifiers, Tuner, Detector and Three Stage Amplifiers, Two Stage Amplifiers, Variometers, Variocouplers, V. T. Sockets, Rheostats, Grid Condensers, Variable Condensers, Knobs, Dials, Binding Post, Etc.

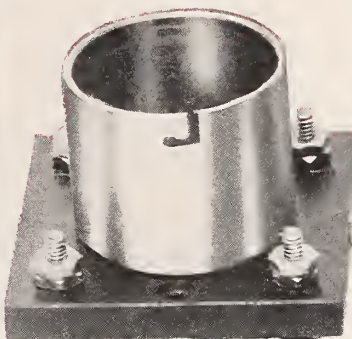

SOCKET  
Type 109

### EVERYTHING —IN RADIO—

**MR. JOBBER AND DEALER:** Does years of experience in manufacturing Radio Transmitting and Receiving Apparatus for the **UNITED STATES GOVERNMENT** mean anything to you?

**VICTOR** engineers and workmen have had this experience and are capable of producing highly satisfactory apparatus.

**JOBBERS AND DEALERS** are invited to write us for complete information regarding our attractive proposition.

**CATALOGUE SENT ON REQUEST.**



VICT-RA-PHONE CONSOLE TABLE

## VICTOR RADIO CORPORATION

799 East 135th Street, New York City

*Manufacturers of Complete Radio Sets and Parts*



THIS WILL BE A RADIO CHRISTMAS!

# KING QUALITY

ALL THE NAME IMPLIES

## RADIO APPARATUS

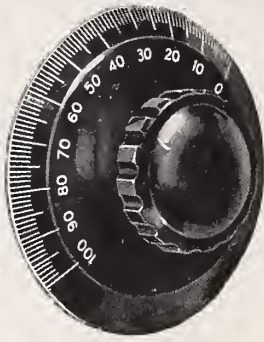

**KING QUALITY DIALS**  
In black or white

Neatest, most durable and practical on the market. Moulded Bakelite knob fastened to dial by special brass bushing.

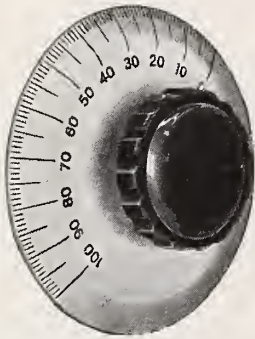

**QUALITY** counts today in the sale of Radio Products. People everywhere are demanding it—and rejecting inferior articles.

### KING-QUALITY your BUY-WORD

Only the Best is good enough to bear the name of KING QUALITY. Our reputation for 15 years has been built around Quality. That is why KING QUALITY Radio Apparatus now offers you a clear channel to increased sales and profits.

KING Quality Radio products are designed by our own Radio engineers; guaranteed to be made of best materials; accurate in design and workmanship, excellent in appearance.

*We Maintain our own Bakelite Plant and use genuine Bakelite exclusively.*

#### JOBBERS AND DEALERS:

Write today for the King-Quality proposition; for catalog, prices, discounts, etc. Some valuable assignments of territory are still available to "live-wires."

Radio Apparatus Division

**KING** Sewing Machine Co.  
Buffalo, N. Y.

*Lower in Price — Highest in Quality*

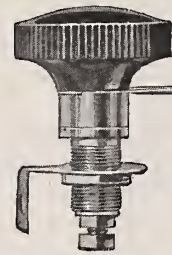

**KING QUALITY SWITCH LEVER**  
With perfect mechanical and electrical features. Mirror finish Bakelite knob with polished knurl that glows like a diamond. 3 sizes: 1 in., 1 1/4 in., 1 1/2 in.



**KING QUALITY BINDING POSTS**  
of genuine Bakelite  
An article of unsurpassed beauty and service—the peak of perfection in design. Diamond finished knurl predominates as an exclusive feature. Highly polished finish.



R 73

R 75

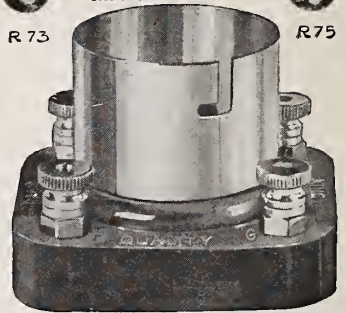

**KING QUALITY VACUUM TUBE SOCKET**

Base of genuine moulded Bakelite with mirror finish; tube and terminal binding posts of brass, nickel plated and highly polished. Black or mahogany finished Bakelite Base.

## GREGG SERVICE

For the manufacturer:

Gives an accurate rating and test of your equipment  
Aids in the designing of instruments and parts  
Checks costs and production methods

## GREGG SERVICE

For the jobber and dealer:

Tells you instantly—the quality product  
Assures you of saleable merchandise  
Guarantees performance  
Eliminates guess work

**The GREGG O. K. on radio equipment identifies quality merchandise**

*Executives interested should write for appointment, with officials of our RADIO DEPARTMENT*

## GREGG & COMPANY

ENGINEERS

Radio Department

St. Louis, Mo.  
Newark, N. J.

Washington, D. C.  
Los Angeles, Cal.  
Mexico City, Mexico

165 Broadway

New York

*THIS WILL BE A RADIO CHRISTMAS!*

# Special Offer to Radio Dealers

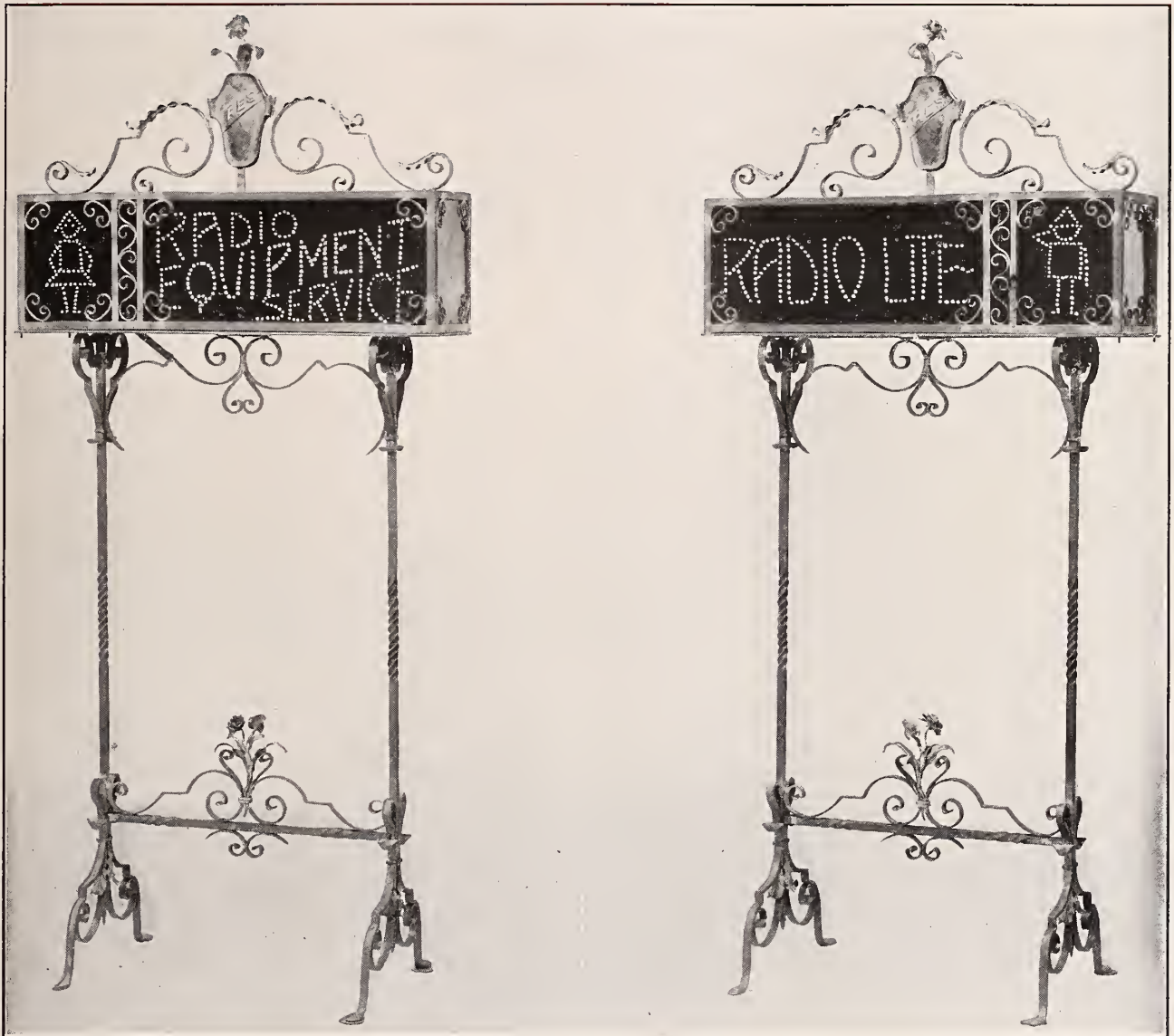

A flashing sign for outdoor, indoor or show window advertising. Your advertising matter may be changed in a few seconds, simply by inserting the slide with the desired wording into the space left for this purpose.

Dimensions: 25 x 12 x 5 for window display (showing moving figure and advertisement on one side only).

40 x 12 x 12 for outdoor or indoor display (showing moving figures and advertisement on both sides),

With or without stand or equipped for hanging.

Especially adapted for Radio dealers (a standing or hanging flashing sign) as it can be equipped with a loud speaker and connected to any radio set.

Dealers will benefit from our patents by buying the sign and with our permission installing their own Radio set.

Negligible upkeep. Total consumption of house current—75 Watts, not more than the cost of burning one 75 Watt lamp.

No motors, no heat, no attention.

|                                                   |               |            |
|---------------------------------------------------|---------------|------------|
|                                                   |               | Additional |
| Complete single sign (plain) with Controller..... | \$125.00..... | Sign       |
| “ double sign (plain) “ “ .....                   | \$150.00..... | \$ 50.00   |
| “ as pictured .....                               | \$250.00..... | \$ 75.00   |
|                                                   |               | \$175.00   |

3 Single or 2 Double signs can be operated with one Controller.

Remember this is the only sign with a moving figure that is operated by a low voltage control, consequently eliminating any fire risk and contact trouble, minimizing expense of upkeep and repair.

## RADIO EQUIPMENT SERVICE

*Manufacturers*

500 Fifth Ave.

New York, N. Y.

THIS WILL BE A RADIO CHRISTMAS!

**Tone  
Tells  
Sound  
Sells**



MODEL XL

PATENTS PENDING

Reg. U. S. Pat. Office

# THE Oranola

PATENTS - PENDING

## NO AERIAL USED

LOOP ANTENNA self-contained in artistic piano-finished cabinet eliminates any wiring by purchaser.

## COMBINATION RADIO and PHONOGRAPH

RADIO ENGINEERS universally agree that radio and audio frequency transformation of energy received is best for receiving broadcasting.

That is why we use the radio and audio frequency amplification.

NO EXPENSE has been spared to make our product the best in every detail. Having passed through the experimental stage, we are prepared to stand behind each instrument with our unqualified guarantee.

OUR TALKING MACHINE (well known as THE PERFECT TALKING MACHINE), combined with our radio instrument, provides a universal means of sound reproduction without equal. Purity of tone in ample volume without distortion makes the ORANOLA almost human.

OUR KEYNOTE is simplicity of operation. No knowledge of electricity or wireless is required.

SEVERAL MODELS with or without talking machine combination, listing from \$150 to \$450. Descriptive circulars and discounts on application. WIRE OR WRITE for exclusive territory proposition. DEMONSTRATIONS at our office during broadcasting periods.

## ORANOLA RADIO CORPORATION

228 SEVENTH AVENUE

NEW YORK CITY



Not like the rest

They are the best

—the very best

The Finch Automatic Code Recorder Brings a New Pleasure to the Radio Fan

Live dealers are now extending sales by stocking this wonderful new device which may be used in connection with any vacuum tube receiver.

FASTEST CODE MESSAGES RECORDED WITH EASE AND READ AT LEISURE

**INSTRUMENTS  
SEPARATE**

- Finch Radio Relay \$75.00
  - Std. Tape Register 60.00
  - Telegraph Relay... 7.00
  - Tape Winder..... 10.00
  - Paper Tape, per roll .10
  - Reg. Ink, 2 oz. bot. .50
  - Reg. Ink, pt. bot.. 2.00
- Prices of other auxiliaries on request

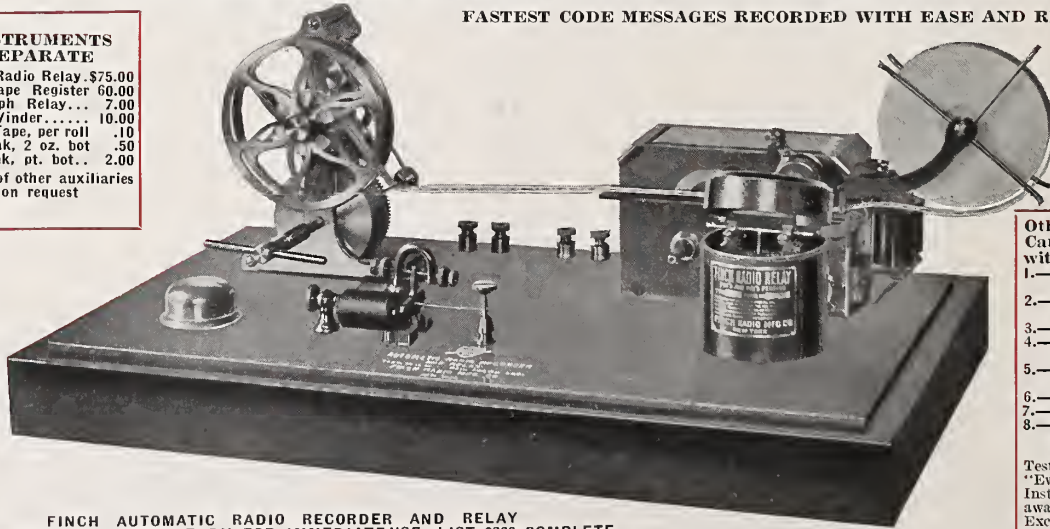

**Other Things You  
Can Do by Radio**

- with the Finch Relay
- 1.—Automatically Receive and Record.
  - 2.—Operate a Telegraph Sounder.
  - 3.—Ring a Bell.
  - 4.—Ignite Explosives by Radio.
  - 5.—Control a Moving Vehicle.
  - 6.—Visible Indication.
  - 7.—Radio Burglar Alarm.
  - 8.—Simultaneously Record and Re-Transmit Messages.
- Tested by the New York "Evening Mail" Radio Institute, approved and awarded Certificate of Excellence.

FINCH AUTOMATIC RADIO RECORDER AND RELAY  
MOUNTED AND WIRED READY FOR IMMEDIATE USE—LIST \$200 COMPLETE

When you VISIT NEW YORK, call and see our EXHIBIT at the PERMANENT RADIO FAIR—RED ROOM, HOTEL IMPERIAL, Broadway and Thirty-second Street

"Madame Radora," the Feature Attraction at the RADIO FAIR, is operated through the instrumentality of the Finch Radio Relay

Fully protected by our Patents and Manufactured only by

**FINCH RADIO MFG. CO., 303 Fifth Avenue, New York, N. Y.**

THIS WILL BE A RADIO CHRISTMAS!

# The Tower of Babel will be Sending this Winter

Forty powerful broadcasting stations, all operating on one narrow wave band—that's the situation confronting the radio fan this winter. With the ordinary single circuit it will be like listening in on the Tower of Babel.

The PARAGON three circuit receiver, because of its greatly superior selectivity and sensitivity, can pick and choose between broadcasting stations of about the same signal strength with less than one per cent differential.

PARAGON three circuit receivers are always easier to sell because they are more satisfactory to operate. This winter any other kind of a receiver is obsolete and practically useless. If you want your share of business, you should sell a modern receiver—the PARAGON.

ADAMS-MORGAN COMPANY

12 Alvin Avenue

Upper Montclair, N. J.

Also Manufacturers  
of  
**PARAGON**  
Radio Telephone  
Transmitters  
V. T. Control Units  
Rheostats  
Potentiometers  
V. T. Sockets  
Amplifier Transformers  
Detectors  
Control Dials  
Amplifiers  
Receivers  
Switches  
Variometers

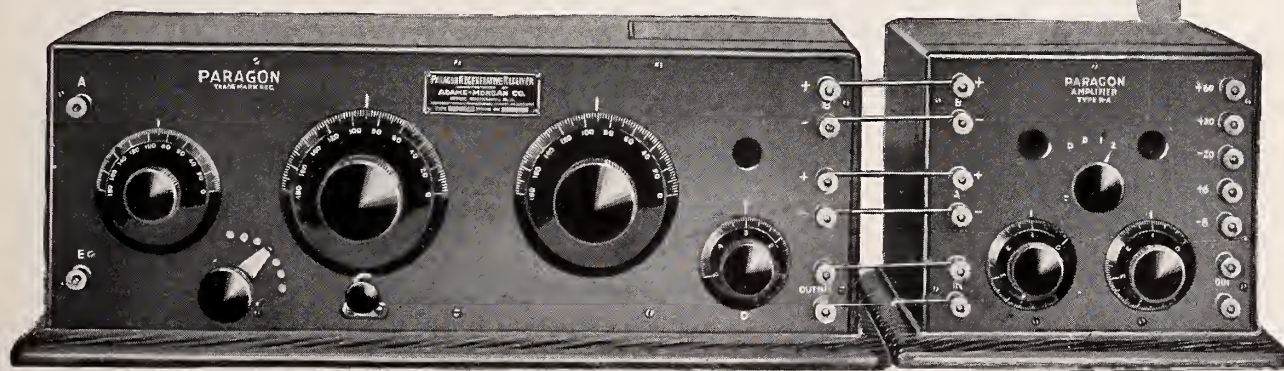

Type RD-5 Regenerative Receiver (including Detector)

Type A-2 Two-Stage Amplifier

(Licensed Under the Armstrong Patents)

# PARAGON

Reg. U. S. Pat. Off.

## RADIO PRODUCTS

THIS WILL BE A RADIO CHRISTMAS!

# First In The Field

The Radio Dealer (monthly edition) leads the field of Radio publications *because it has the circulation.*

The following analysis is of PAID Circulation, note printer's statement of press run.

## Circulation By States THE RADIO DEALER

|                        |                        |
|------------------------|------------------------|
| Alabama..... 21        | East Orange..... 10    |
| Arizona..... 11        | Elizabeth..... 17      |
| Arkansas..... 5        | Jersey City..... 44    |
| California..... 286    | Newark..... 191        |
| Los Angeles..... 34    | Paterson..... 19       |
| Oakland..... 13        | Trenton..... 27        |
| San Francisco..... 67  | New Mexico..... 2      |
| Colorado..... 28       | New York..... 1094     |
| Denver..... 14         | N. Y. City..... 710    |
| Connecticut..... 185   | Brooklyn..... 144      |
| Bridgeport..... 12     | Buffalo..... 28        |
| Hartford..... 17       | North Carolina..... 27 |
| New Haven..... 12      | North Dakota..... 5    |
| Waterbury..... 12      | Ohio..... 236          |
| Delaware..... 11       | Cleveland..... 34      |
| Wash., D. C..... 34    | Cincinnati..... 18     |
| Florida..... 25        | Columbus..... 13       |
| Georgia..... 42        | Toledo..... 22         |
| Idaho..... 13          | Oklahoma..... 15       |
| Illinois..... 537      | Oregon..... 11         |
| Chicago..... 337       | Pennsylvania..... 240  |
| Indiana..... 87        | Pittsburgh..... 84     |
| Indianapolis..... 18   | Philadelphia..... 68   |
| Iowa..... 35           | Rhode Island..... 14   |
| Kansas..... 33         | Providence..... 12     |
| Kentucky..... 5        | South Carolina..... 9  |
| Louisiana..... 23      | South Dakota..... 2    |
| Maine..... 12          | Tennessee..... 14      |
| Maryland..... 10       | Texas..... 75          |
| Massachusetts..... 224 | Dallas..... 43         |
| Boston..... 88         | Utah..... 13           |
| Michigan..... 183      | Vermont..... 12        |
| Detroit..... 109       | Virginia..... 20       |
| Minnesota..... 41      | Washington..... 37     |
| Mississippi..... 14    | West Virginia..... 19  |
| Missouri..... 195      | Wisconsin..... 106     |
| Montana..... 18        | Milwaukee..... 63      |
| Nebraska..... 24       | Wyoming..... 2         |
| New Hampshire..... 10  | Canada..... 41         |
| New Jersey..... 662    | Foreign..... 185       |
| Atlantic City..... 19  |                        |
| Camden..... 18         |                        |

Tot. Pd. Circ't'n . 4958

## The Williams Printing Company

Complete Manufacture of Publications  
Eleventh Avenue, 36th to 37th Streets  
New York City

October 2, 1922.

The Radio Dealer  
1133 Broadway,  
New York City.

Attention Mr. L. A. Nixon

Dear Sir:

I, Roy L. Atwood, Manager of The Williams Printing Company, hereby testify that we have printed and bound Eight Thousand (8000) copies of the current issue of the "Radio Dealer".

Very truly yours,

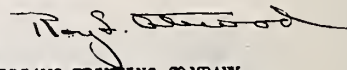

FOR THE WILLIAMS PRINTING COMPANY.

State of New York )  
                          ) Ss;  
County of New York)

On this second day of October 1922, before me came Roy L. Atwood to me known to be the person who subscribed the foregoing instrument and acknowledged that he executed the same freely and for the purposes therein set forth.

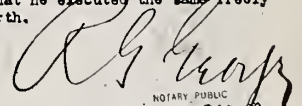

NOTARY PUBLIC  
N. Y. COUNTY CLERK'S N. 92  
N. Y. COUNTY REGISTER N. 1224  
BY COMMISSION EXPIRES MARCH 30, 1924

## First In The Field

# THE RADIO DEALER

1133 Broadway, New York, N.Y.

35 South Dearborn St., Chicago, Ill.

# !!!THE PREMIER RADIOVOICE!!!

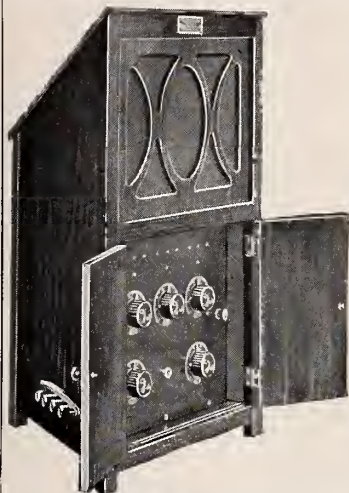

Is the first practical and commercial accomplishment of meeting the public's requirements and demand for a *Complete, Simple, Compact, Attractive and Efficient Loud Talking-Detector and 2-Stage Radio Receiver* at a Popular Price, Simple in Control—Wide in Range.

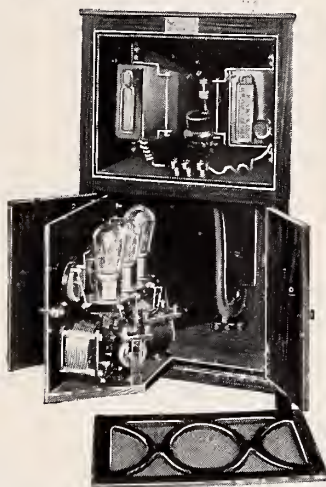

Mounted on a Bakelite Panel are

Premier Built and Tested Radio Condensers, Rheostats, V. T. Sockets, Transformers, Tuning Coils, Jacks, etc.; the panel being hinged within the beautiful 5 ply Mahogany Veneer Loud Talker Cabinet, measuring 21" in height by 12" in width, weighing, completely equipped with "B" Batteries and Loud Talking Phone as shown, only 17 lbs. Can be set in a corner of the living room, on library or end table, or on a piano, blending into the richest of furnishings with equal attractiveness. Price complete, excluding only bulbs and "A" battery—\$95.00.

Where an even lower priced equipment is desired, eliminating the phone and loud talker cabinet, our Type P equipment, including "B" batteries, mounted in cabinet as shown, parts, hookup and panel being identical to that used in the Premier Radiovoice, is priced at \$55.00.

The Premier Radio Corporation is an old electrical manufacturing concern, which has turned its entire resources and equipment to production of high class radio parts and receiving sets. The Premier line is handled and is available to only the highest class of dealer, jobber or distributor, and to such is offered discounts to permit profitable merchandising. Descriptive bulletins sent on request.

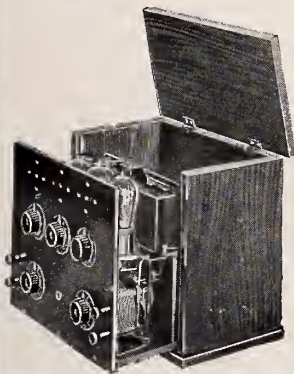

**Premier  
Radio  
Corporation**

6800 Bostwick Ave.  
Detroit, Mich.

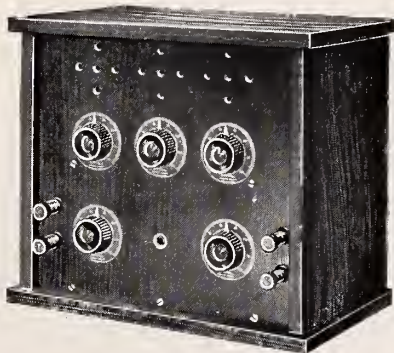

Patent Applied For

Dealers, here is the profitable and quick selling Loud Speaker. At a price every one can afford.

## SHELSTONE Equipped with one Baldwin Receiver

Don't sell noise—sell real music. Demonstrate in your shop with Shelstone. You will not drive away the Radio prospect.

Most satisfactory of all Loud Speakers for home use

The Shelstone is shaped like a shell. At its base is an open tone chamber over which any two standard receivers fit. This chamber carries the sound to the curved surface of the Shelstone, causing each note to marvelously swell in volume.

No tubing to rob the sound of its fullness; no horn, as on ordinary loud speakers, to destroy or distort the most delicate notes. Every sound is true, sweet, mellow and distinct to everyone in the room.

**RETAIL PRICES**

Shelstone, with Baldwin Receiver...\$12.50  
Shelstone, without Receiver..... 5.00

Big Discounts Allowed.

Made of special light non-metallic sounding metal. Beautiful colors.

**THE SHELSTONE COMPANY**  
20 CLINTON ST., NEWARK, N. J.

## The National Trade Survey Now Being Published in The Radio Dealer Weekly

Should be of interest to

**EVERY MANUFACTURER**

Subscription to the **WEEKLY**

One Dollar the Year, payable in advance

Sample free on request

**THE RADIO DEALER WEEKLY**

1133 Broadway

New York, N. Y.

THIS WILL BE A RADIO CHRISTMAS!

*Most Quoted*

*Most Complete*



THE CONSTRUCTION AND OPERATION  
OF  
SUPER REGENERATIVE RECEIVERS

By Kenneth Harkness

With an introduction by Dr. Henry Smith Williams

**The Radio Guild, Inc.**  
256 WEST 34TH STREET  
NEW YORK, N. Y.

MORE THAN FOUR HUNDRED NEWSPAPERS AND EVERY RADIO MAGAZINE HAVE PUBLISHED ARTICLES ON SUPER-REGENERATION BY KENNETH HARKNESS AND ADVERTISEMENTS OF HIS NEW BOOK. The new edition of "The Construction and Operation of Super-Regenerative Re-

ceivers' by Kenneth Harkness is now off the press. It contains 48 PAGES AND THIRTY MECHANICAL DRAWINGS, WIRING DIAGRAMS AND PHOTOGRAPHS giving complete details of the best sets developed by Mr. Harkness. His explanation of the theory of super-regeneration is a revelation.

LIST PRICE, 50 Cents.

Write for special discounts and catalogue of Radio Guild receivers.

**The Radio Guild, Inc.**  
256 West 34th Street      New York City  
Manufacturer of the VOX-HUMANA and THE DASHBOARD SPECIAL

THIS WILL BE A RADIO CHRISTMAS!





**NERCO**  
Matched Tone Head Set  
2200 Ohms



The CLEAR VELVETY MATCHED TONE correctly reproducing the HUMAN VOICE or the most delicate CADENCE of MUSICAL HARMONY is CHARACTERISTIC of NERCO HEADSETS.

Produced with the same exactness in all Electrical and Mechanical Details that is recognized in all THRADIO PRODUCTS.

**CONDENSERS**  
**RHEOSTATS-TRANSFORMERS**  
**V-T SOCKETS**

**THRESHER RADIO CORP.**

476-484 Eighteenth Avenue  
Newark, N. J.



# METRO SOCKETS

for Westinghouse Aeriotron  
1½ Volt Dry Cell Tube

This socket is perfectly finished, using a 2" square highly polished moulded base. This base is supported with insulated legs. Springs are of nickel silver insuring perfect contact. Price.....60c

**MOULDED BASE**

Single V. T. Socket—Brass tube heavy nickel plated and countersunk contacts. ....\$1.00

**FIBRE BASE**

Single V. T. Socket .....\$0.75  
Double V. T. Socket ..... 1.50  
Triple V. T. Socket ..... 2.25

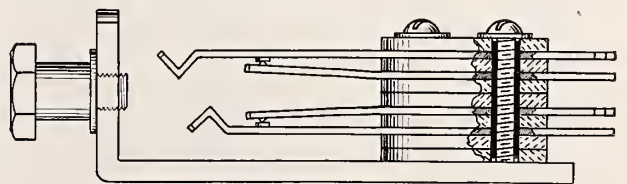

**"METRO JACKS"**

Nickel silver spring, coin silver contact points, all insulation is high grade bakelite. High class finish, made in 5 sizes:

- No. 1—Single Open .....\$0.55
- No. 2—Single Circuit ..... .65
- No. 3—Double ..... .85
- No. 4—3 Spring Filament Control ..... .95
- No. 5—5 Spring Filament Control ..... 1.15

*Send for Descriptive Circular*



**ELECTRIC MFG. CO. INC.**

121 PRINCE ST.  
NEW YORK

Attractive Propositions  
to Jobbers and Dealers

THIS WILL BE A RADIO CHRISTMAS!

# AERIAL-A

TRADE MARK

## THE RIGHT SET IN A "SELLING MARKET"

Vacations are over! The public is again taking up Radio—greatest of indoor sports.

They are now radio-wise—they know what they want and at what price. They will buy only machines of highest quality—and STANDARD MERIT.

Be sure the sets you sell will stand the acid test of a "selling market"!

Our unique sales policy will make biggest profits for you. Write for it—Now!

Aerial-A surpasses in selectiveness and strength of tone machines of twice its price. Neat, compact, light in weight and beautifully finished, Aerial-A sells at sight! A demonstration is a clincher!

Simple and easy to operate. Dealers have no difficulty in selling "Aerial-A."

Manufactured by

# W.E. Supply & Service Corp.

18 Murray Street, New York

## "AEREX" Long Range Radio Receiver Model RA-4

2 Stages Radio Frequency Amplification

2 Stages Audio Frequency Amplification

Using Only Two Amplifier Tubes

### Features

1. Longer mile range
2. Supersensitive
3. Quality workmanship
4. Quality material
5. Saving of batteries
6. Saving of vacuum tubes, only three required to perform the work of five
7. Adapted for use of loop or outside aerials
8. All binding posts on back, no messy wiring
9. Four stages of amplification.
10. Attractive appearance

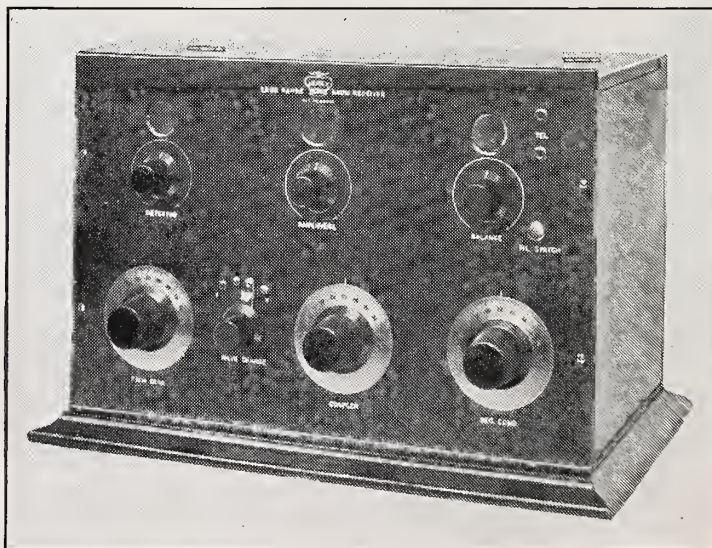

This set is guaranteed to receive broadcasting within a radius of 400 miles. Provision is made for using a loop aerial.

The marvel set. Equal to super-regeneration.

A long range radio receiving set which is also adapted for use with a loop antenna for local broadcasting.

Long Range sets will be in demand this year. Will you be able to supply such a set in a THREE TUBE UNIT.

Some territories still open for live dealers.

**LIST PRICE, \$125.00** Discounts Upon Request

### SPECIFICATIONS

Cabinet—Solid Mahogany. Rubbed piano finish. 16 x 11 x 7.

Panel—Genuine Bakelite beautifully engraved.

Dials—Three-inch metal engraved.

Knobs—Tapered Bakelite Knobs.

Condensers—Permanent capacity.

Rheostats—Specially designed, positive contact, smooth action.

Transformers—2 Radio Frequency and 2 Audio Frequency.

Sockets—Standard moulded Bakelite.

Binding Posts—Hard rubber composition. All mounted on back panel, plainly marked. Circuit—Paten's pending. 2 stage radio frequency amplification, 2 stage audio frequency amplifications, one detector using only three vacuum tubes to perform the work of five.

**AEREX RADIOPHONE CORP., 342 Madison Avenue, NEW YORK CITY**

THIS WILL BE A RADIO CHRISTMAS!

# A Real Radio Show at a Real Place at the Right Time

~~~~~

New York's Second National Radio Show

Will Be Held

November 20th to 25th

At The

Madison Square Garden

~~~~~

This Show will be properly advertised and promoted under the management of E. C. Buchignani

~~~~~

Dealers Will Meet Manufacturers For Business at This Show

~~~~~

### *Radio Fans Will Attend in Big Numbers*

~~~~~

Exhibitors Are Receiving Space Allotment in the Order of the Receipt of Their Signed Contracts

~~~~~

*Get in Touch With*

**E. C. BUCHIGNANI, Manager,  
NATIONAL RADIO SHOW**

Executive Office: HOTEL VANDERBILT, NEW YORK

Phone, Vanderbilt 7100

THIS WILL BE A RADIO CHRISTMAS!



## MORSCAN INSULATORS—

“the standard in the Radio Industry”

Jobbers are Invited to Feature  
These Insulators because they are the  
Very Best Radio Insulators and give  
The Wholesaler and Retailer a Profit

# MORSCAN RADIO CO.

202 MARKET STREET

- -

NEWARK, N. J.



*THIS WILL BE A RADIO CHRISTMAS!*

Your Trade Wants This Set

THE  
**Simple-X**  
Crystal Radio Receiver

*Superior to Sets Costing Five Times the  
Price of This Wonderful Set*

PRICE **\$4.75**

READ THE FACTS:—

1. Will receive Broadcast Concerts within a radius of 25 miles.
2. The only set equipped with the Simple-x (fool-proof) Detector.
3. The only set with the Mul-Ti-Tec Crystal—a thousand crystals in one. No fussing to find a sensitive spot. No loss of time or interruption of the programme.
4. Built with Roller Sliders to give a smooth, constant contact.
5. No wearing or short-circuiting of coil wires due to frictional scraping.
6. The only set having a flat Coil and indicating sliders.

Awarded Certificate of Excellence by N. Y. Evening Mail, and approved by Tribune Institute.

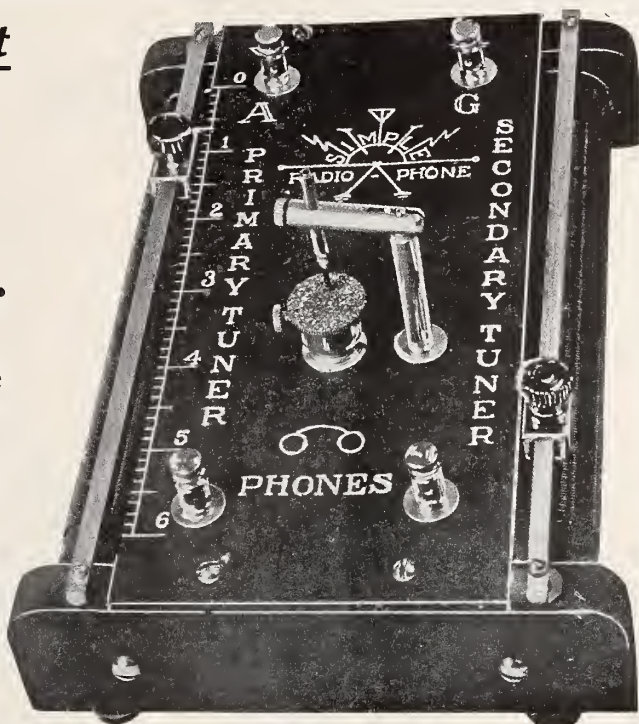

(Patent Applied For)

For Discount Schedule, wire, write, or call

**CARAGOL-CLARKE CO., Inc.**

82 Beaver St. (Tel. Bowling Green 1990—1—2) New York City

# EMPIRE OILED TUBING

*sometimes called spaghetti*



PERFECT  
**EMPIRE**  
INSULATOR  
REG. U.S. PAT. OFF.

Empire Tubing builds solid business for Radio Dealers. It brings both amateur and professional back for more, because the purchaser and his friends like its superior flexibility, durability, smoothness, high dielectric strength and insulating value. Empire Tubing is a standard product among engineers throughout the electrical industry. Made in black and white, yellow and other colors, in all radio sizes, 36 inch lengths.

Send today for Empire Tubing samples and quotations on 500, 1,000, 5,000, 10,000, 20,000 foot lots. Get acquainted with our other time tested radio insulation products

**MICA INSULATOR COMPANY**

68 Church Street, New York. 542 So. Dearborn Street, Chicago. Works: Schenectady, N. Y.  
Agencies—The Monroe Brass & Wire Co., Cincinnati; G. Arthur Morrell, Cleveland; Electrical Specialty Co., San Francisco and Los Angeles

2022-F

THIS WILL BE A RADIO CHRISTMAS!



# Fiber Radio Horns for Loud Speakers

Designed on Recognized Principles of Acoustics

THE fiber horn is the latest advance in the perfection of the loud speaker. After months of unceasing experiment, we have succeeded in bringing out fiber horns with the musical virtues of wood horns and yet which sell at popular prices.

The shape of the horns gives the fullest amplification without blast, countervibration or other distortion. The volume of sound is accordingly larger and far more clear than ordinarily.

## The Products of Experienced Manufacturers

Manufacturers of the leading loud speakers use our horns. They put a loud speaker at its very best. Quality of workmanship and material is evident in every detail.

No glued joints or rivets to loosen—absolutely seamless. Do not dent up as tin horns do. Practically indestructible. Brass base, with rich black rubber finish. Their fine appearance makes sales; their performance keeps them moving.

*Metal ferrule provides for use with Magnavox Loud Speaker*



## You Can Do a Large Business with These Fiber Horns

When a good fiber horn costs so little, few people are contented with the old, unsatisfactory metal or composition horn. All new equipment will use horns. The demand for fiber horns has only begun.

### States Rights to Responsible Jobbers

You've seen what it meant to others to have exclusive territory on a radio leader. You have the same chance to corner a lot of steady, well paying business in horns. Now is the opportune time. Write for territory.

**TWO SIZES OF HORNS**

Horn No. 1  
Bell 10" Diameter, 23" High.

Horn No. 2  
Bell 14" Diameter, 29½" High.

Horns sold with or without base and ferrule for attachment to Magnavox. Every horn packed in individual corrugated paper cartons.

### Horns Stamped with Your Name or Made to Specifications

You can build up a fine reputation with these horns sold under your own name or trade mark. It's the very best advertising you can do. We are equipped to meet the specifications of manufacturers of loud speakers. These horns have made good on the highest grade loud speakers. Upon receipt of blueprints giving dimensions of your horn, we will gladly submit estimates.

Write Today for Price List and Full Particulars

**FIBER PRODUCTS CO.**  
240 North 10th Street, Newark, N. J.

## Spee-Dee "QUALITY" Products

40 to 80% off list according to quantity



Filament rheostat; heatproof moulded unbreakable base; special resistance filament that will withstand unusual hard usage. List Price, \$1.00.



3 inch composition reinforced dial. List Price, \$75.



1½" radius knob lever, with laminated or single lever. Finely knurled ¼" knob of unbreakable composition. List Price, \$75.

Tapered knob switch lever to match dial and rheostat, furnished in 1 and ¼" radius. List Price, \$50.



A practical Glass Enclosed Dust Proof Detector on a composition unbreakable base. Rigid construction with German silver cat's whiskers. List Price, \$1.50.

Descriptive Catalogue Upon Request

**SPEE-DEE SPECIALTY COMPANY**

271 Canal St., New York, N. Y.

THIS WILL BE A RADIO CHRISTMAS!

# Triple Test Transformers

## What do they mean to you ?

In a market glutted with new radio products, some well made, some poorly and cheaply constructed, a few articles stand out prominently from the rest because the manufacturer employs highly competent engineers, the best of material and skilled workmanship. The Radio Service Laboratories goes a step further and submits each individual transformer to its famous triple test before shipping same to the jobber, dealer and ultimate user.

### The Triple Test

#### First—Test of Windings.

The bobbins when wound and sealed are tested for continuity of winding and for shorts and leaks.

#### Second—Test for Inductance of Windings.

After assembly of the bobbin within the container a careful test is made of the inductance of the primary and secondary windings to insure the consumer against any wrong connections or hasty, careless construction.

#### Third—Test for Amplification.

After the iron core is assembled and the transformer sealed, each transformer is given an actual circuit test in a radio amplifier; the gain in signal strength being noted over that of the detector tube alone and required to meet the gain of our standard laboratory model.

### The Result

is a Radio Frequency Transformer that increases the strength of Radio Signals or waves before they are applied to the detector tube where they are made audible—

“Louder Signals with less noise  
Greater Range with same equipment”

Radio Service Laboratories Transformers by actual test are superior to any domestic or foreign make in the market. For sale at any electrical shop or store where Radio supplies are sold.



The only completely shielded iron core

### RETAIL PRICE

# \$6<sup>00</sup>

We absolutely and unconditionally guarantee our transformers.

Special circular sent on request by the

**Rasla Sales Corporation**  
National Distributors  
Dept. E. 10 East 43rd St.  
New York City

## Attention of Dealers

TRIPLE TEST TRANSFORMERS are steadily advertised in the leading radio magazines and readers are urged to purchase from their local dealer. The Rasla Sales Corporation will gladly supply counter, window or wall display cards to dealers on request and urges them to obtain a supply of their transformers from their jobbers. In order to facilitate such orders, we append a list of jobbers handling this product.

#### BALTIMORE, MD.

Chesapeake Electric Co.  
Ship Owners Radio Service, Inc.

#### BOSTON, MASS.

A. P. Merchant & Co.  
Ship Owners Radio Service, Inc.

#### CEDAR RAPIDS, IA.

Western Auto Specialty Co.

#### CHICAGO, ILL.

Ship Owners Radio Service, Inc.

#### CLEVELAND, OHIO

Elliott Electric Company  
Erner Electric Company

#### DALLAS, TEXAS

C. C. White Electric Co.

#### FORT DODGE, IA.

Standard Radio Equipment Co.

#### FORT WAYNE, IND.

Luxam Electrical Supply Co.

#### INDEPENDENCE, KANSAS

Daniels Radio Supply Co.

#### KANSAS CITY, MO.

American Radio Mfg. Company

#### NEWARK, N. J.

Wholesale Radio Equipment Co.  
American Radio Equipment Co.

#### NEW YORK CITY

J. H. Bunnell & Company  
Stanley & Patterson  
Royal-Eastern Electrical Supply Co.  
Ship Owners Radio Service, Inc.  
20th Century Radio Corp.

#### NEW ORLEANS, LA.

Electron Engineering Co.  
Ship Owners Radio Service, Inc.

#### NORFOLK, VA.

Ship Owners Radio Service, Inc.

#### PHILADELPHIA, PA.

Quaker Light & Supply Company  
Schimmel Electric Supply Company  
Frank H. Stewart Electric Company

#### PITTSBURGH, PA.

Ludwig Hommel & Company  
Robbins Electric Company  
Union Electric Company

#### ROCHESTER, N. Y.

Wheeler-Green Electric Company

#### SAN ANTONIO, TEXAS

Alamo Radio Electric Company

#### SAN FRANCISCO, CAL.

Ship Owners Radio Service, Inc.

#### SAVANNAH, GA.

Ship Owners Radio Service, Inc.

#### SCRANTON, PA.

Scranton Electrical Construction Co.

#### SEATTLE, WASH.

Ship Owners Radio Service, Inc.

#### ST. LOUIS, MO.

McGraw Company

#### TROY, N. Y.

Hinsdill Electric Co.

*Western Jobbers desiring distributing proposition Communicate with our Western Sales Agents.*

#### DETSCH & COMPANY

555 Turk Street, San Francisco, Calif.  
WESTERN RADIO DISTRIBUTING CO.  
1114 L. C. Smith Bldg., Seattle, Wash.

THIS WILL BE A RADIO CHRISTMAS!

# Are You Making Money Out of Radio ?

## THE RADIO TELEPHONE HANDBOOK

By H. G. Cisin, M.E.

### TELLS YOU HOW

It Contains the Following Facts About Radio You Want To Know

- What Radio Apparatus to Stock
- What Class of Radio Sets to Handle
- The Operating Principles of Radio
- The Various Types of Radiophone Receivers—the Best Methods of Adjusting Them
- How Crystal Detectors Work
- What Crystals Work Best
- How the Vacuum Tube Works
- What Is Meant by Cascade Amplification
- The Principles of Regeneration
- How to Select Telephone Head Sets
- Types and Uses of Tuning Devices
- The Meanings of Everyday Radiophone Terms
- How to Select and Install the Demonstration Set
- What Service to Give in Connection with the Sale of Radiophones
- How to Utilize Newspaper and Other Publicity

### With This Book You Can Tell Your Customer

- The Best Way to Erect His Aerial Which Is Preferable, a One or a Four-Wire Aerial
- What Determines the Length of the Aerial
- Underwriters Requirements
- License Requirements
- How Best to Protect Against Lightning
- Why Some Radio Sets Are Simple and Others Are Complicated
- Which Sets to Recommend
- What Batteries, if Any, Are Necessary
- How High to Put the Aerial
- When an Indoor Aerial Can Be Used
- Under What Circumstances Ground Connection May Be Dispensed With
- When a Loud Speaker May Be Used
- What the Loop Aerial Is
- How Amplification May Be Obtained
- Whether a Vacuum Tube May Be Used in Conjunction With a Crystal Detector
- Whether More Than One Radio Receiving Set May Be Connected to the Same Aerial
- The Correct Way to Measure Aerial Length
- When Shielding Is Necessary
- How to Check Up the Condition of the Storage Battery
- How to Eliminate Howling
- Causes and Remedies for Weak Signals and Local Noises in Connection with Vacuum Tube Sets
- How to Locate Faults in Vacuum Tube Radiophone Receiving Sets

#### Why the Radio Telephone Handbook is Authentic

##### Facts about its Author

GRADUATE OF CORNELL UNIVERSITY, ELECTRICAL AND MECHANICAL ENGINEER.  
 GRADUATE OF MARCONI RADIO INSTITUTE, FORMERLY INSTRUCTOR OF ELECTRICAL ENGINEERING AT:  
 CORNELL UNIVERSITY, JOHNS HOPKINS UNIVERSITY,  
 U. S. NAVY ELECTRICAL SCHOOL,  
 STEVENS INSTITUTE OF TECHNOLOGY.  
 LICENSED RADIO OPERATOR.  
 RADIO OPERATING EXPERIENCE AT SEA DURING WAR.  
 ENSIGN, U. S. NAVY DURING WAR.  
 AUTHOR OF PRACTICAL ELECTRICAL ENGINEERING.

- Single Copies.....Price \$1.00
- One Dozen Lots.....33% discount
- Four Dozen Lots.....40% discount

Special Discounts on Quantity Orders

Attractive Exclusive Proposition for Distributors

Published By

**THE ALLIED ENGINEERING INSTITUTE**  
1400 Broadway, NEW YORK CITY

FILL THIS OUT, TEAR OFF AND MAIL

**THE ALLIED ENGINEERING INSTITUTE**  
NEW YORK, N. Y.

GENTLEMEN:  
 SEND.....COPIES OF  
 THE RADIO TELEPHONE  
 HANDBOOK FOR WHICH  
 FIND ENCLOSED \$.....  
 We will pay postman \$.....

NAME.....  
 ADDRESS.....  
 CITY.....  
 STATE.....

THIS WILL BE A RADIO CHRISTMAS!



# No Speculation In Buying 3 Y Q Transformers

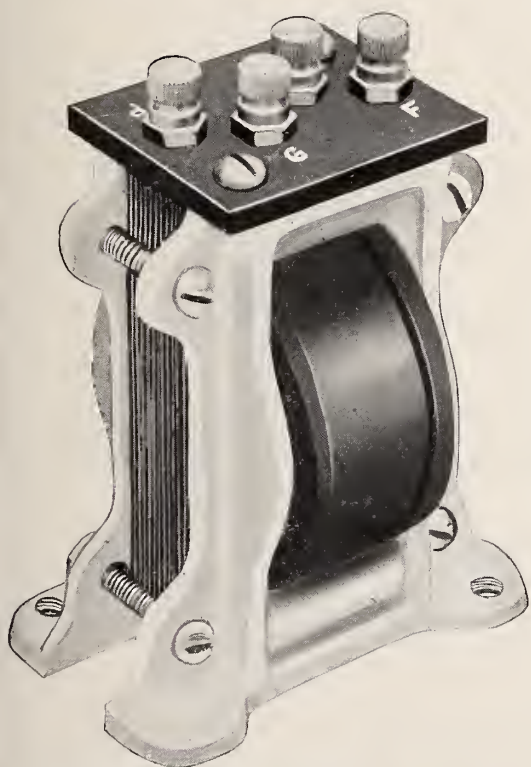

**RETAIL PRICE, \$6.00**

**ORDER FROM YOUR  
JOBBER**

3 Y Q Transformers are for dealers who go in business for a generation—not just for a day.

Made right, priced fairly, sold to the trade on liberal discounts, 3 Y Q Transformers promote growth, build good-will and help to establish your reputation as a dealer who is in business to stay.

Radio is not helped by the fly-by-night dealer and neither is it helped by the manufacturer who is out to make a "clean-up."

The manufacturers of the 3 Y Q Transformer were in the radio business long before it underwent the startling boom we have all witnessed. They intend to still be in the radio business after it has settled itself to a condition as firm and staple as the automobile industry.

And the fact that serious, progressive retailers of radio equipment are buying—and selling—and re-ordering 3 Y Q Transformers is the best proof that the 3 Y Q Transformer is a good investment, not a speculation.

The frequency of the re-orders we receive proves our claim of exceptionally rapid turnover.

The 3 Y Q retails for \$6.00. Order from your Jobber—his discount to you is just and fair.

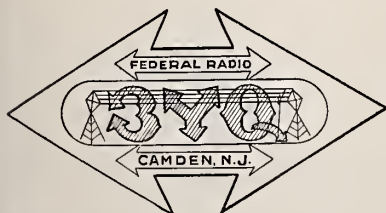

## Federal Institute of Radio Telegraphy

Second and Federal Streets

CAMDEN, N. J.

THIS WILL BE A RADIO CHRISTMAS!

*This will be a* **RADIO** *Christmas!*

---

and the wise Retailer and Jobber will

**CASH IN**

on the Christmas Business in every way possible

Close co-operation on the part of everyone in the trade will help to make it a bigger RADIO Christmas than if half of us held back and let the other fellow do the work.

START NOW! Begin today! Boost the idea! Spread the News! **THIS WILL BE A RADIO CHRISTMAS!** Use the line in your advertising, repeat it every day. Radio sets and radio parts make the most acceptable gifts for the holiday season. **CASH IN!**

**NATIONAL RADIO WEEK**

has been set for the Christmas week

**December 23 to 30**

The National Radio Week idea is gaining favor and the week will be observed in every city of any importance. Every dealer is urged **NOW** to start planning stunts for this week to push **RADIO** more strongly into the public eye.

**National Radio Week! National Radio Xmas! More Business for All!**

NATIONAL RADIO WEEK COMMITTEE,

J. ANDREW WHITE, Chairman,  
326 Broadway, New York City.

---

*This will be a* **RADIO** *Christmas!*

*THIS WILL BE A RADIO CHRISTMAS!*

## "I Picked Winners"

Was the answer of a prominent business man to a question as to the secret of his remarkable success.

### UNITED Variable Condensers and Transformers are WINNERS

Back of them is a half-million-dollar equipment and a staff of real Radio Engineers.

#### "UNITED" VARIABLE CONDENSERS

with Vernier,  
Dial and  
Knob  
Like Cut  
46 plate \$6.50  
26 plate \$5.50  
Only stop  
Vernier  
with stop.

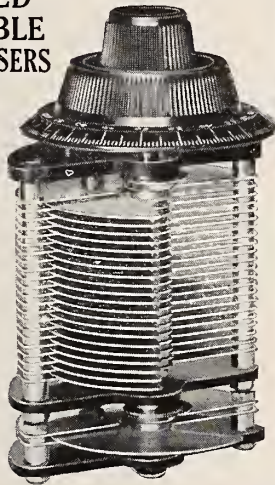

#### United Variable Condensers

|                     |                     |
|---------------------|---------------------|
| 43 plate.....\$4.50 | 11 plate.....\$3.50 |
| 23 plate..... 4.00  | 5 plate..... 2.75   |
| 3 plate.....\$2.25  |                     |

Without Vernier Dial or Knob.

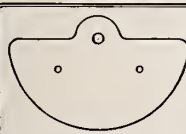

Mounting made easy by our template for locating panel holes, packed free with each condenser.

UNITED  
Transformer  
Fully mounted  
as shown  
Black Enamel  
or buffed nickel  
plated, \$4.50



Pat. Appd. For

Liberal Discount to Jobbers  
Send for Circular.

### United Mfg. & Distributing Co.

536 Lake Shore Drive Chicago, Ill.



## Even Steel Buildings Bow to This Receiver!

The tremendous amplifying power the Ware AD2 Receiver insures a 100% operation on a small indoor coil aerial in any location, steel buildings included. For local stations this is a guarantee!

1000 Mile Reception  
Practically the Year Around!

Selectivity—In'er-  
ference Vanished Forever!

It is simple to operate—beautiful—compact—guaranteed by a highly skilled and strongly organized corporation. One demonstration is all that is necessary to convince the amateur as well as the most expert radio enthusiast.

National advertising, liberal discounts and cooperation—plus the genuine merit of this great set, make it the best dealer proposition of the year. Write now for descriptive booklet and full particulars.

On an outdoor antenna this and greater feats are daily accomplishments of this marvelous Receiver.

Nothing but the pure, perfect reception of the broadcasted programs is enjoyed with this Receiver.

# Ware

## TYPE AD2

R-F AMPLIFIER-DETECTOR

## RECEIVER

## Here are the Facts:

Here are but a few of the reasons for the supremacy of the Ware Type AD2 Receiver:

1. It embodies NEW and exclusive inventions, perfected after five years of rigid tests.
2. It affords higher radio frequency amplification per stage and wider tuning range than ever before obtainable.
3. Easily receives signals which are totally inaudible on the usual regenerative type receivers.
4. Makes genuine loose coupling possible. In congested broadcasting centers easily selects desired program without slightest interference from the others.
5. Is ideal for loud speaker.
6. For faithful long or short distance reception — free from distortion, static, induction and interfering transmitters — it has never been equaled.

LIST PRICE  
**\$110<sup>00</sup>**

without tubes

Get one—use it—then you will know what real radio enjoyment is and why it sells in face of all competition.

## WARE RADIO CORP'N

160-162 Duane Street  
New York City

Dealers—Jobbers—Manufacturers—Broadcasters

are all interested in

## NATIONAL RADIO WEEK

which has been set for December 23-30, 1922

Everyone in the trade can help make this week a big success

Full particulars may be obtained of

NATIONAL RADIO WEEK COMMITTEE

J. Andrew White, Chairman

326 Broadway

New York City

THIS WILL BE A RADIO CHRISTMAS!

# THE PATHÉ LOUD SPEAKER

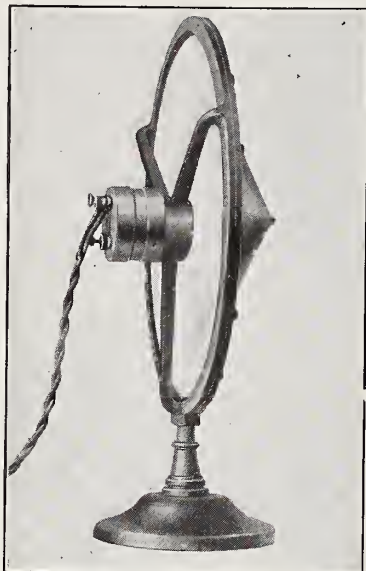

IS NOW READY FOR DELIVERY. SEND ORDERS AT ONCE FOR STOCK FOR THE SEASON'S BUSINESS.

List Price

\$24.00 Nickel Finish

\$22.00 Japan Finish

THE SOUND WAVE CORPORATION  
30 GRAND AVENUE, BROOKLYN, N. Y.

# THE CHANGE FROM A 6-VOLT TO A 1½-VOLT TUBE

CAN NOW BE ACCOMPLISHED IN 30 SECONDS WITH THE

## BURKE SOCKET ADAPTER

FOR WD-11 TUBES  
(Patents Pending)

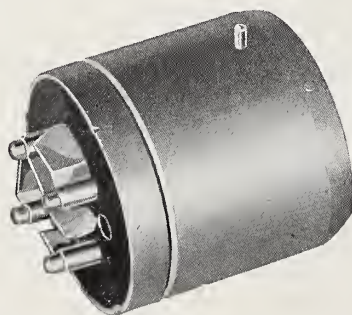

Fits Any Standard Open Base Socket  
As Easy to Insert as a Tube  
No Change of Hook-Up Necessary  
Raises Tube Less Than 1/8th Inch  
Made of Best Materials and Absolutely Guaranteed

DISTRIBUTORS, JOBBERS, DEALERS—The Burke Adapter is in demand everywhere. Act immediately and make some liberal profits. Orders are being filled strictly in rotation as received.

NATIONAL DISTRIBUTORS



845 BROAD STREET NEWARK, N. J.  
WESTERN SALES DEPT., 8905 DETROIT, AVE., CLEVELAND, O.

THIS WILL BE A RADIO CHRISTMAS!



# Dealers

## Farmers Will Buy Sets and Parts

America's 25 million farmers—our largest single buying group—have been remarkably prosperous this year.

They have plenty of money and will spend it for Radio sets and parts, if you will but make an earnest effort for their business.

Tell them about the Aeriola Senior—which was designed particularly to meet the farmers' needs; it requires no storage battery, yet has a range of about 100 miles—tell them also about other sets.

If you are interested in getting the farmers' business, our Dealers' Service Department will tell you how to go about it—write to them for their plan, "How to Sell Radio to the Farmer."

How about your stock? We can take care of your orders for sets and parts at once.

Write for our new illustrated catalog 200-D.

### DISTRIBUTORS FOR

Radio Corp. of America (Westinghouse, General Electric), Frost, Remler, Fada, Murdock, General Radio, Brandes, Baldwin, Burgess, Hipco, Chelsea, Holtzer-Cabot, Kellogg, Acme, Brach, Homchager, Signal, Pacent, Rhamstine, Connecticut, Arkay, Radio Service, Tuska, Clapp-Eastham and other leading manufacturers.



# LUDWIG HOMMEL & CO

530-534 FERNANDO ST.



PITTSBURGH, PENNA

THIS WILL BE A RADIO CHRISTMAS!

# Let Our Free Service Bureau Help You Supply Your Needs

Tell us your needs and we'll put you in touch with reputable firms to the end that you will receive information on the latest and best equipment. A post card will do or use the coupon below.

- |                          |                           |                            |                            |                          |
|--------------------------|---------------------------|----------------------------|----------------------------|--------------------------|
| <b>A</b>                 | 62 Condensers, mica       | <b>I</b>                   | 182 Patent wire            | 238 Switches             |
| 1 "A" Batteries          | 63 Condensers, loading    | 126 Indicators             | 183 Patent wire terminals  | 239 Switch levers        |
| 2 Aerials                | 64 Connection blocks      | 127 Inductances, C. W.     | 184 Plans                  | 240 Switch points        |
| 3 Aerial wire            | 77 Contract work          | Transmitting               | 185 Phonograph attach-     | 241 Symbols              |
| 4 Aerial protectors      | 65 Control panels         | 128 Insulators             | ments                      |                          |
| 5 Aerial switches        | 66 Condenser parts        | 129 Insulation             | 186 Plate condensers       | <b>T</b>                 |
| 6 Aerial insulators      | 67 Copper wire            | 130 Invention develop-     | 187 Porcelain              | 246 Tapes                |
| 7 Aerials, loop          | 68 Cords                  | ments                      | 188 Porcelain cleats       | 247 Telephone cord       |
| 8 Air condensers         | 69 Cord tips              |                            | 189 Porcelain insulators   | 248 Telephone plugs      |
| 9 Adapters               | 70 Crystals               | <b>J</b>                   | 190 Porcelain mountings    | 249 Telephone receivers  |
| 10 Amplifiers            | 71 Crystal detector units | 131 Jacks                  | 191 Porcelain tubes        | 250 Telegraph keys       |
| 11 Amplifying units      | 72 Crystal receiving sets |                            | 192 Porcelain V. T. recep- | 251 Telegraph teachers   |
| 12 Aluminum wire         | 73 C. W. Transmitter      | <b>K</b>                   | tables                     | 252 Testing instruments  |
| 13 Ammeters              | sets                      | 132 Knock down units       | 193 Porcelain V. T. sock-  | 253 Testing clips        |
| 14 Amplifying tubes      | 74 C. W. Filament heat-   |                            | ets                        | 254 Terminals            |
| 15 Amplifying horns      | transformers              | <b>L</b>                   | 194 Precision instruments  | 255 Thermometers         |
| 16 Amplifying transform- | 75 C. W. Inductances      | 136 Lead-in wire           | 195 Polarity indicators    | 256 Tools                |
| mers                     | 76 C. W. Power trans-     | 137 Lead-in switches       | 196 Plate connectors       | 257 Trade marks          |
| 17 Antennae, cage        | formers                   | 138 Lead-in bushings       | 197 Paste solder           | 258 Transformers         |
| 20 Antenna light wire    |                           | 139 Lead-in insulators     | 198 Phosphor-bronze wire   | 259 Transmitters         |
| plugs                    | <b>D</b>                  | 140 Levers, Switch         | sheets                     | 260 Transmitting sets    |
| 18 Audio frequency       | 81 Detectors              | 141 Lightning arrestors    |                            | 261 Towers               |
| transformers             | 82 Detector panels        | 142 Lightning switches     | <b>Q</b>                   | 262 Three coil mounting  |
| 19 Automatic transmit-   | 83 Detector tubes         | 143 Lighting coils         | 307 Quenching spark gaps   | 263 Tin foil             |
| ters                     | 84 Detector minerals      | 144 Loading inductance     |                            | 264 Tuning coils         |
| <b>B</b>                 | 85 Detector units         | 145 Loose couplers         | <b>R</b>                   | 265 Tubes, amplifier     |
| 21 "B" Batteries         | 86 Dictionary, Radio      | 146 Loud speakers          | 308 Radio books            | 266 Tubes, detector      |
| 22 Batteries, "A"        | 87 Dials                  | 147 Locked lever switches  | 309 Radio schools          | 267 Tubing, flexible     |
| 23 Batteries, dry        | 88 Dial switches          | 148 Lock nuts              | 310 Radio publications     | 268 Tube sockets         |
| 24 Batteries, storage    | 89 Dry batteries          | 149 Loop aerials           | 199 Radio frequency        | 269 Tubes                |
| 25 Battery chemicals     | 90 Drawings               | 150 Lugs                   | transformers               | 270 Tuner and detector   |
| 26 Battery chargers      | 90 Diagrams               |                            | 200 Reactor, plate circuit | cabinets                 |
| 27 Battery testing in-   | <b>E</b>                  | <b>M</b>                   | 201 Reactor, filter        | 271 Two stage cabinets   |
| struments                | 91 End mountings          | 313 Mailing lists          | 202 Receiving sets         | 272 Two stage amplifier  |
| 28 Battery switches      | (tubes)                   | 314 Metals                 | 203 Receiving head sets    | unit                     |
| 29 Battery rheostats     | 92 Engraving              | 151 Magnetic modulator     | 204 Receiving transform-   |                          |
| 30 Battery clips         | 93 Electrotypes           | 152 Modulation transform-  | ers                        | <b>U</b>                 |
| 31 Battery handles       |                           | 153 Machine screws         | 205 Receptors              | 276 Unit type receiving  |
| 32 Battery potentiom-    | <b>F</b>                  | 154 Magnet wire            | 206 Receiver magnets       | sets                     |
| eters                    | 95 Fibre spools           | 155 Magazines, Radio       | 207 Rectifiers             | 277 Unassembled sets     |
| 33 Binding posts         | 96 Fan switches           | 156 Mica                   | 208 Rectifying tubes       |                          |
| 34 Books                 | 97 Filter reactors        | 157 Mica diaphragms        | 209 Regenerative sets      | <b>V</b>                 |
| 35 Boxes                 | 98 Fixed condensers       | 158 Mica condensers        | 210 Rheostats              | 281 Vacuum tubes         |
| 36 Bushings              | 99 Fire extinguishers     | 159 Mica diaphragm trans-  | 211 Rheostat wire          | 282 Vacuum tube sockets  |
| 37 Bulbs                 | 100 Filament rheostat     | formers                    | 212 Rods                   | 283 Variable condensers  |
| 38 Buzzers               | 101 Filter coils          | 160 Microphone transform-  | 213 Rotary lever switches  | 284 Variometers          |
|                          | 102 Flashlights           | 161 Milliammeters          | 214 Rotary spark gaps      | 285 Variometers          |
| <b>C</b>                 | 103 Fuse terminals        | 162 Milli-voltmeters       | 215 Rotary variable con-   | 286 Variable grid leak   |
| 41 Cabinets              |                           | 163 Motors                 | densers                    | 287 Vernier adjusters    |
| 42 Cam switches          | <b>G</b>                  | 164 Motor generators       | 216 Rubber parts           | 288 Vibrators            |
| 43 Carbon potentiomet-   | 106 Gaps, Spark           | 165 Mounting coils         | 217 Rotors                 | 289 Vocalouds            |
| ers                      | 107 Generators            | 166 Minerals               | <b>S</b>                   | 290 Voltmeters           |
| 44 Change-over switches  | 105 Glass                 | 167 Mountings              | 221 Safety switches        | 291 Vulcanized fibre     |
| 45 Charging rectifiers   | 108 Grid condensers       |                            | 222 Safety fuses           | sheets                   |
| 46 Choke coils           | 109 Grid leaks            | <b>N</b>                   | 223 Sliders and rods       | 292 V. T. receiving sets |
| 47 Cat whiskers          | 110 Grid leaks, variable  | 171 Name plates            | 224 Sockets                | 293 Variogrid leak       |
| 48 Cap nuts              | 111 Grid coils            | 172 Nickel parts           | 225 Soft metal             | 294 V. T. detector units |
| 49 Carbon walls          | 112 Grid coils            | 173 Nuts                   | 226 Shielded dials         | 295 V. T. control units  |
| 50 Cardboard tubes       | 113 Ground clamps         |                            | 227 Short wave sets        | 296 V. T. receptacle     |
| 78 Charts                | 114 Ground switches       | <b>O</b>                   | 228 Solder                 |                          |
| 51 Chopper, rotary       |                           | 176 One stage amplifier    | 229 Solder, bar            | <b>W</b>                 |
| 52 Clamps                | <b>H</b>                  | units                      | 312 Soldering irons (elec- | 297 Washers              |
| 53 Clips                 | 116 Headsets and bands    | 177 Oscillation transform- | trics)                     | 298 Watch case receivers |
| 54 Coils                 | 117 Honeycomb coils       | mers                       | 230 Spark transformers     | 299 Wattmeters           |
| 55 Coll mountings        | 118 Honeycomb mount-      | <b>P</b>                   | 231 Spark coil selectors   | 300 Wvmmeters            |
| 56 Coil plugs            | ings                      | 178 Panels                 | 232 Spaghetti tubing       | 301 Wave tuner           |
| 57 Coils, spark          | 119 Honeycomb plugs       | 179 Panel plugs            | 233 Special apparatus      | 302 Wire                 |
| 58 Condensers            | 120 Hook switches         | 180 Panel controls         | 234 Spark gaps             | 303 Wire, aerial         |
| 59 Condensers, fixed     | 121 Horns                 | 181 Paper tubes            | 235 Spring clips           | 304 Wire phosphor bronze |
| 60 Condensers, variable  | 122 Hydrometers           | 311 Patent registration    | 236 Storage batteries      | 305 Wire, copper clad    |
| 61 Condensers, air       |                           |                            | 237 Sectional receiving    | 306 Wire, magnet         |
|                          |                           |                            | sets                       |                          |

Note the number of the item you want to buy—then check the corresponding number in the coupon below and mail to us.

TEAR OFF HERE

|     |     |     |     |     |     |     |     |     |     |     |     |     |     |     |     |     |     |     |     |     |
|-----|-----|-----|-----|-----|-----|-----|-----|-----|-----|-----|-----|-----|-----|-----|-----|-----|-----|-----|-----|-----|
| 1   | 2   | 3   | 4   | 5   | 6   | 7   | 8   | 9   | 10  | 11  | 12  | 13  | 14  | 15  | 16  | 17  | 18  | 19  | 20  | 21  |
| 22  | 23  | 24  | 25  | 26  | 27  | 28  | 29  | 30  | 31  | 32  | 33  | 34  | 35  | 36  | 37  | 38  | 39  | 40  | 41  | 42  |
| 43  | 44  | 45  | 46  | 47  | 48  | 49  | 50  | 51  | 52  | 53  | 54  | 55  | 56  | 57  | 58  | 59  | 60  | 61  | 62  | 63  |
| 64  | 65  | 66  | 67  | 68  | 69  | 70  | 71  | 72  | 73  | 74  | 75  | 76  | 77  | 78  | 79  | 80  | 81  | 82  | 83  | 84  |
| 85  | 86  | 87  | 88  | 89  | 90  | 91  | 92  | 93  | 94  | 95  | 96  | 97  | 98  | 99  | 100 | 101 | 102 | 103 | 104 | 105 |
| 106 | 107 | 108 | 109 | 110 | 111 | 112 | 113 | 114 | 115 | 116 | 117 | 118 | 119 | 120 | 121 | 122 | 123 | 124 | 125 | 126 |
| 127 | 128 | 129 | 130 | 131 | 132 | 133 | 134 | 135 | 136 | 137 | 138 | 139 | 140 | 141 | 142 | 143 | 144 | 145 | 146 | 147 |
| 148 | 149 | 150 | 151 | 152 | 153 | 154 | 155 | 156 | 157 | 158 | 159 | 160 | 161 | 162 | 163 | 164 | 165 | 166 | 167 | 168 |
| 169 | 170 | 171 | 172 | 173 | 174 | 175 | 176 | 177 | 178 | 179 | 180 | 181 | 182 | 183 | 184 | 185 | 186 | 187 | 188 | 189 |
| 190 | 191 | 192 | 193 | 194 | 195 | 196 | 197 | 198 | 199 | 200 | 201 | 202 | 203 | 204 | 205 | 206 | 207 | 208 | 209 | 210 |
| 211 | 212 | 213 | 214 | 215 | 216 | 217 | 218 | 219 | 220 | 221 | 222 | 223 | 224 | 225 | 226 | 227 | 228 | 229 | 230 | 231 |
| 232 | 233 | 234 | 235 | 236 | 237 | 238 | 239 | 240 | 241 | 242 | 243 | 244 | 245 | 246 | 247 | 248 | 249 | 250 | 251 | 252 |
| 253 | 254 | 255 | 256 | 257 | 258 | 259 | 260 | 261 | 262 | 263 | 264 | 265 | 266 | 267 | 268 | 269 | 270 | 271 | 272 | 273 |
| 274 | 275 | 276 | 277 | 278 | 279 | 280 | 281 | 282 | 283 | 284 | 285 | 286 | 287 | 288 | 289 | 290 | 291 | 292 | 293 | 294 |
| 295 | 296 | 297 | 298 | 299 | 300 | 301 | 302 | 303 | 304 | 305 | 306 | 307 | 308 | 309 | 310 | 311 | 312 | 313 | 314 | 315 |

Service Bureau The Radio Dealer,  
1133 Broadway, New York City.

We are interested in buying radio equipment and have circled the numbers on this coupon of the items we are ready to buy now. Please have manufacturers of these lines quote us dealers' prices.

Name.....

Address.....

..... 1922  
We are  
—Retailers  
—Jobbers  
—Manufacturers

THIS WILL BE A RADIO CHRISTMAS!

# THE DIFFERENCE

## The **DX** RADIO FREQUENCY TRANSFORMER

is *different* from other radio frequency transformer principally in that, it is highly efficient over the *entire wave length range* instead of operating at only *one* or *two* wave-lengths as is the case with other radio frequency transformers now on the market. *This* is of great importance in view of the fact that broadcasting stations are now transmitting on several different wave-lengths.



(Patents Pending)

| Wave-<br>Type     | length   | Range     | Price  |
|-------------------|----------|-----------|--------|
| DX-1              | 170-450  | meters... | \$8.00 |
| DX-S              | 400-1200 | meters... | 8.00   |
| DX-2              | 900-3000 | meters... | 8.00   |
| Standard Mounting |          |           | 1.00   |

Some of the foremost amateurs are getting in readiness for record breaking *Trans-Atlantic* reception this winter by using

## **DX** RADIO FREQUENCY TRANSFORMERS

Many manufacturers of highest quality apparatus are now standardizing their sets, using DX R.F. Transformers.

## The **FIRST** and **BEST** RADIO FREQUENCY TRANSFORMER on the market

The DX Transformer is a Real Radio Frequency Transformer--

## The **JM-6**

### RADIO-AUDIO DETECTOR AMPLIFIER

Employing the "plug in" D-X Radio Frequency Transformers

The result of years of *expert* research work in Radio Frequency Amplification. Super-Sensitive, simple in dependable operation.



(Patent Allowed)

The Ideal Instrument for Coil Aerial Reception. This Amplifier is now being used by three of the most prominent Consulting Engineers in the U. S.

**"IT PAYS TO HAVE THE BEST"**

Curves and Data on Coil Aerials 50 Cents

**RADIO INSTRUMENT COMPANY, INC.**  
 WASHINGTON, D. C.

HUTCHINS BLDG., 10TH AND D STS., N. W.

Write for Literature

THIS WILL BE A RADIO CHRISTMAS!

# "SIGNAL TRIUMPH"

## COUPLER - METER

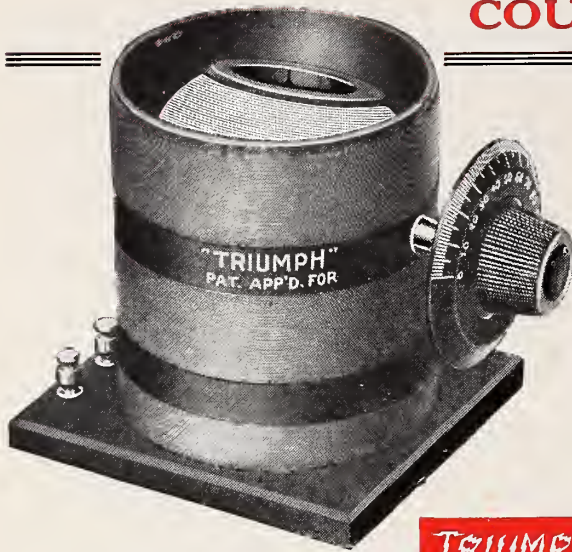

**TRIUMPH**

The "Two-in-One" Instrument

**T**HIS instrument makes a new stride toward the ultimate in Radio perfection. It is a combination of variocoupler and vario-meter; it is simplicity itself, it is efficient to a surprising degree, there are no taps, no solder and no complications.

**DEALERS**—Stock it now—there is no end to the demand. Retail at \$6.50, including 3-in. dial. Sample will be sent on memo to any rated concern upon request.

We also manufacture complete V. T. Receiving Sets with or without amplification—fixed and variable condensers, dials, V. T. sockets, binding posts, etc. Write for discounts and full details. Do it now.

**SIGNAL RADIO & ELECTRIC CORP. 64 UNIVERSITY PL. NEW YORK CITY**

### NO STORAGE BATTERY REQUIRED OPERATES ON ONE DRY CELL

FOR AT LEAST 120 HOURS



**THE BRU No. 3 Vacuum Receiving Set**

Designed to meet the demand for a "tube set," that is a combination of **EFFICIENCY, SIMPLICITY, NEATNESS and ECONOMY OF OPERATION.**

BRU No. 3 Specifications. Cabinet is of piano finish mahogany, with bakelite panels. Trimmings are of highly polished, nickel plated brass. Normal wave length of 150 to 600 meters. Binding posts are provided to "load" the primary and secondary inductances, so that the reception of almost all wave lengths is possible.

**BRU No. 3 Receiving Unit, List Price .....\$30**

**BRU No. 3C Receiving Unit.....\$49**

Complete including WD 11 Detector Bulb, phones, "A" and "B" batteries, aerial, lead in, ground wires, ground clamp, insulators, nails, screws, etc. Absolutely nothing else required.

**A GOOD MARGIN OF PROFIT FOR THE DEALER**

Complete instructions with each set

Sold under our unconditional guarantee

*Eliminates Storage Battery*

by using the **BRU No. 4 SOCKET**

You can change your crystal set or your tube set to a Dry Cell tube set. One dry cell will operate it for 120 hours.

**SOCKET**

**\$1**

list price



*Dealers, take advantage of the demand for these sockets. A fair margin of profit*

**BRUNO RADIO CORPORATION**

152 West NEW



14th Street YORK

THIS WILL BE A RADIO CHRISTMAS!





"Comin' In Great!"

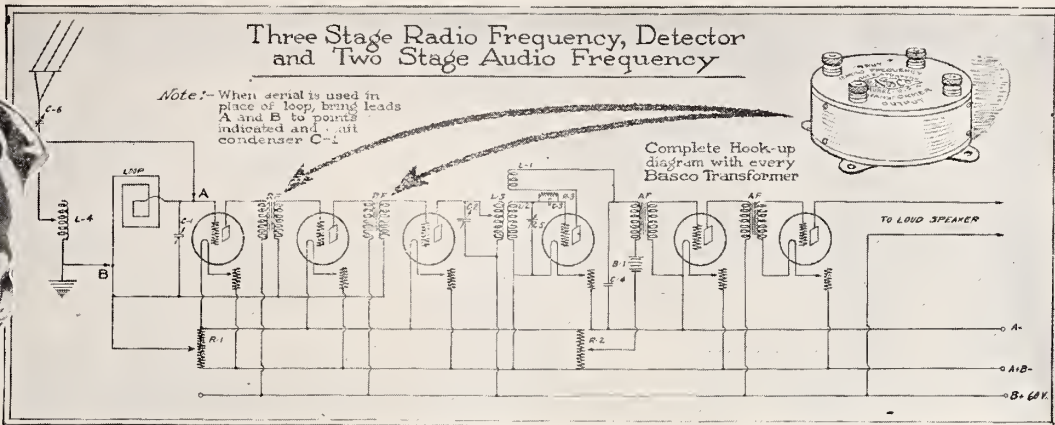

## Don't Let That Term— "Radio Frequency," Scare You Out of Doubling Results

**N**O bugbear about it. Thousands of amateurs are accomplishing wonders with Radio Frequency. The greatest radio development of the day. A loop aerial and three stages of radio frequency hooked right to your regenerative outfit—doubles your signal strength, day or night—greatly increases your range and eliminates most of the static. Two stages are nearly as gratifying. Results will surprise you.

Study the diagram shown above. And here's the ideal transformer for the job—the

**BASCO**  
Super-Sensitive  
Receivers



**Radio Frequency  
Transformer**  
"The Element of Certainty"

Thoroughly proved—for any well balanced circuit. Efficient. Operates over wave band of 200 to 600 meters. Affords great selectivity. Employs non-capacity winding—double silk covered wire—no enamel. Maximum transfer of energy. Clean cut—neat. High-grade workmanship throughout. Encased in bakelite. Binding posts and base-mounting silver plated. No higher grade transformer can be built. Basco Radio Frequency Transformers are the first step toward a better outfit. Insist on a Basco. If your dealer can't supply you write us direct and we will see that you are promptly supplied.

*Jobbers and Dealers.* Write for particulars and list of other Basco Radio Equipment. No better, trade building transformer built. Gets results—gets business. We have local factory representatives. Write for name of one nearest you.

**Briggs & Stratton Co.**  
MILWAUKEE, WISCONSIN  
PRODUCT

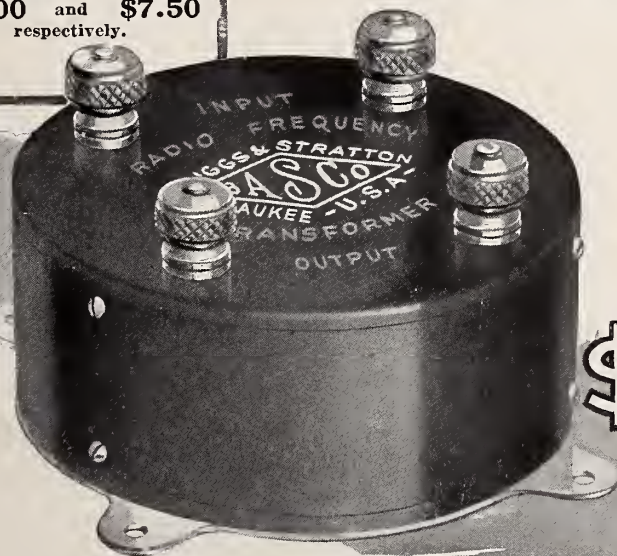

\$500

THIS WILL BE A RADIO CHRISTMAS!

# Where to Buy

## A Handy Guide For the Convenience of Our Readers

|                                          |  |                                         |                                        |
|------------------------------------------|--|-----------------------------------------|----------------------------------------|
| <b>AERIALS</b>                           |  | Adams Morgan Co..... 15                 | Pittsburgh Radio & Appliance Co... 110 |
| Walter S. Krenz..... 127                 |  | Clapp Eastham Co..... 86                | Radio Equipment Service..... 108       |
| <b>"A" BATTERIES</b>                     |  | Freed-Eisemann Radio Corp..... 100      | Radio Shop of Newark, The..... 96      |
| Manhattan Storage Battery Co., Inc. 90   |  | Henry Hyman Co. .... 71                 | Radio & Mech. Trading Corp..... 94     |
| <b>AERIAL EQUALIZER TUBES</b>            |  | Gilbert Co., A. C. .... 42              | Specialty Service Co.....105, 109      |
| The Etherola Corp..... 94                |  | Jerome Radio Corp..... 100              | Schwab, Harold M..... 86               |
| <b>ALUMINUM</b>                          |  | States Radio Corp..... 124              | Virginia Radio Corp..... 115           |
| Strahs Aluminum Co..... 110              |  | Victor Radio Corp..... 11               | Weiner Wireless Specialty Co..... 92   |
| <b>AMPLIFIERS</b>                        |  | <b>COMPOSITION</b>                      |                                        |
| Arrow Radio Co..... 126                  |  | Diamond State Fibre Co..... 99          | Wholesale Radio Equipment Co....       |
| F. C. Kent Co..... 114                   |  | Nuloid Corp. .... 93                    | Front Cover                            |
| Magnavox Co. .... 67                     |  | <b>CONDENSERS</b>                       |                                        |
| Save Sales Co..... 44                    |  | Bayley Condenser Co..... 125            | <b>DISTRIBUTORS WANTED</b>             |
| <b>AMPLIFIER UNITS</b>                   |  | Duke Radio Co..... 119                  | Arrow Radio Co..... 96                 |
| Atwater Kent Mfg. Co..... 75             |  | European Radio Co..... 109              | <b>ELECTRICAL TESTING</b>              |
| <b>ANTENNA WIRE</b>                      |  | Ford Mica Co., Inc..... 116             | New York Testing Laboratories..... 107 |
| Copper Clad Steel Co..... 112            |  | Hedden Place Machine Co..... 118        | <b>ELECTROTYPERS</b>                   |
| <b>ANTENNA LIGHT WIRE PLUGS</b>          |  | Meirowsky Bros. .... 127                | Central Electrotyping Co..... 104      |
| Steinmetz Wireless Mfg. Co..... 102      |  | New Haven Radio Co..... 93              | <b>ENGRAVING</b>                       |
| <b>BATTERY CHARGERS</b>                  |  | Scheib Elec. Radio Co..... 102          | Paramount Machine Co..... 90           |
| The Automatic Elec. Devices Co.... 8     |  | Thresher Radio Corp..... 19             | <b>EXPOSITIONS</b>                     |
| <b>"B" BATTERIES</b>                     |  | <b>COUPLERS</b>                         |                                        |
| Gould Storage Battery Co..... 110        |  | Moreland Sales Corp..... 90             | American Radio Exposition Co..... 3    |
| Novo Mfg. Co. .... 105                   |  | <b>COUPLED CIRCUIT TUNER</b>            |                                        |
| <b>BATTERIES</b>                         |  | Atwater Kent Mfg. Co..... 75            | National Radio Show..... 21            |
| Carbon Products Co..... 62               |  | <b>CRYSTALS</b>                         |                                        |
| Comet Battery Co..... 102                |  | Adbrin Laboratories ..... 96            | Permanent Radio Fair..... 88           |
| French Battery & Carbon Co..... 106      |  | Galena Crystal Mfg. Co..... 104         | <b>FINISH</b>                          |
| Multiple Storage Battery Corp.....       |  | Harris Laboratory..... 90               | Zeller Laquer Mfg. Co., Inc..... 70    |
| .....Back Cover                          |  | Rocky Mountain Radio Products, Inc. 112 | <b>GLASS</b>                           |
| <b>BESTONE PRODUCTS</b>                  |  | Rusonite Products Corp..... 126         | Vineland Scientific Glass Co..... 100  |
| Henry Hyman & Co., Inc..... 71           |  | Standard Crystal Co..... 125            | <b>GRID LEAKS</b>                      |
| <b>BINDING POSTS</b>                     |  | U. S. Radio Co. of Penna., Inc..... 108 | Durham & Co..... 125                   |
| The H. H. Eby Mfg. Co..... 113           |  | <b>CRYSTAL DETECTORS</b>                |                                        |
| McKenna Brass & Mfg. Co..... 102         |  | Continental Electric Co..... 80         | Freshman Co., Inc., Chas..... 116      |
| Radio Accessories Co..... 87             |  | Diamant Tool & Mfg. Co., Inc..... 96    | Radiophone Equipment Co..... 112       |
| Radio Technical Laboratories, Inc... 123 |  | Premier Radio Mfg. Co..... 117          | Radio Mechanical Trading Corp..... 94  |
| <b>BOOKS</b>                             |  | Randel Wireless Co..... 91              | <b>HEAD SETS</b>                       |
| Allied Engineering Institute..... 9      |  | <b>CRYSTAL SETTING</b>                  |                                        |
| Archway Bookstore ..... 103              |  | Curtis C. Culin ..... 110               | Briggs & Stratton Co..... 35           |
| Great Lakes Publishing Co..... 108       |  | <b>CRYSTAL SETS</b>                     |                                        |
| Norman W. Henley Pub. Co..... 101        |  | Aerex Radiophone Corp..... 20           | Dictograph Products Corp..... 4        |
| Radio Red Book Publishing Co..... 104    |  | T. F. Radiophone Co..... 120            | Globe Phone Mfg. Co..... 76            |
| Technical Book Co..... 62-62A            |  | <b>DIALS</b>                            |                                        |
| <b>CABINETS</b>                          |  | Alden-Napier Co. .... 100               | Livermore, Inc., John..... 124         |
| E. Eshoo Cabinet Works..... 126          |  | Emeloid Co., Inc., The..... 105         | Mills Radio & Electric Co..... 120     |
| Marvin B. Fallgatter..... 100            |  | New York Radio Dial Co..... 102         | Pruden, Fred. H..... 80                |
| The Miho Co..... 90                      |  | <b>DISTRIBUTORS</b>                     |                                        |
| <b>CABINET SETS</b>                      |  | Altadena Radio Laboratories..... 114    | Royal Electrical Laboratories.....     |
| Heinemann Electric Co..... 73            |  | American Electro Phone Co., Inc... 120  | Inside Front Cover                     |
| Oranola Radio Corporation..... 14        |  | Julius Andrae & Sons Co..... 92         | Triangle Electro Trading Co..... 97    |
| Premier Radio Corp..... 17               |  | Arrow Radio Co..... 80                  | <b>HYDROMETERS</b>                     |
| <b>CODE RECORDERS</b>                    |  | Central States Engineering Co..... 120  | Hafner Mfg. Co..... 111                |
| Finch Radio Co..... 14                   |  | Electric Service Supplies Co..... 6     | <b>INFORMATION</b>                     |
| <b>COIL MOUNTINGS</b>                    |  | Herbert H. Frost..... 108               | Service Bureau ..... 36                |
| Astorloid Mfg. Co..... 62                |  | The Edw. J. Goetz Co..... 104           | <b>INSULATORS</b>                      |
| Crown Radio Mfg. Corp..... 61            |  | Invincible Products Co..... 117         | Bannister & Pollard..... 74            |
| Osland, Inc..... 80                      |  | Jackson, P. D..... 100                  | Morsecan Radio Co..... 22              |
| <b>COMPLETE LINE</b>                     |  | Kramer Radio Co..... 100                | <b>KNOBES &amp; DIALS</b>              |
| American Radio & Electric Co..... 50     |  | Ludwig Hommell ..... 31                 | King Sewing Machine Co..... 12         |
| American Specialty Mfg. Co., The... 111  |  | New York Coil Co..... 5                 | Tait Knob & Dial Co..... 38            |
|                                          |  |                                         | <b>LIGHTNING ARRESTERS</b>             |
|                                          |  |                                         | Electric Service Supplies Co..... 6    |
|                                          |  |                                         | <b>LOCKS</b>                           |
|                                          |  |                                         | Joseph Ross & Co..... 130              |

SEE ALPHABETICAL INDEX OF ADVERTISERS ON PAGE 40

THIS WILL BE A RADIO CHRISTMAS!

# Where to Buy

## A Handy Guide for the Convenience of Our Readers

|                                        |          |                                     |     |                                       |     |
|----------------------------------------|----------|-------------------------------------|-----|---------------------------------------|-----|
| <b>LOOP AERIALS</b>                    |          | <b>RADIO RELAYS</b>                 |     | <b>STOCK BROKERS</b>                  |     |
| Eagle Radio Co.....                    | 74       | Finch Radio Mfg. Co.....            | 31  | Frank T. Stanton & Co.....            | 104 |
| V-De-Co. ....                          | 106      | <b>RADIO TOWERS</b>                 |     | <b>SWITCH STOPS</b>                   |     |
| <b>LOUD SPEAKERS</b>                   |          | Milliken Bros. Mfg. Co., Inc.....   | 103 | Virginia Radio Corporation.....       | 115 |
| Aldine Radio & Mfg. Co.....            | 10       | <b>RECEIVING SETS</b>               |     | <b>TESTING LABORATORIES</b>           |     |
| Dictograph Products Corp.....          | 4        | Albert Co., Chas. R.....            | 61  | Gregg & Co.....                       | 12  |
| Fiber Products Co.....                 | 24       | Andrae Co., Julius.....             | 126 | N. Y. Testing Laboratories.....       | 107 |
| Hörning Experimental Laboratories..... | 98       | Atlantic-Pacific Radio Supplies Co. |     | <b>TOWERS</b>                         |     |
| Magnavox Co., The.....                 | 67       | Inside Back Cover                   |     | Milliken Bros. Mfg. Co., Inc.....     | 103 |
| Planet Radio Corp.....                 | 116      | Arrow Radio Co.....                 | 122 | <b>TRADE MARKS</b>                    |     |
| Shelton Co., The.....                  | 17       | Arex Radiophone Co.....             | 20  | Chauncey P. Carter .....              | 109 |
| Sound Wave Corp.....                   | 30       | Beau Ivorie Novelty Co., Inc.....   | 96  | Radio Dealer Trade Mark Bureau...     | 110 |
| Winkler-Reichman Co.....               | 91       | Brady Elec. Mfg. Co.....            | 114 | <b>TRANSFORMERS</b>                   |     |
| <b>LOUD SPEAKER SETS</b>               |          | Bruno Radio Corp.....               | 34  | Federal Institute of Radio Telegraphy | 27  |
| Radio Equipment Service.....           | 103, 13  | Bissell Engineering Co.....         | 92  | Ford-Mica Co. ....                    | 122 |
| <b>MAILING LISTS</b>                   |          | Caragol-Clarke .....                | 23  | General Merchandise Co.....           | 10  |
| F. D. Pickens.....                     | 105      | Coraco Co., The.....                | 90  | Marle Engineering Co.....             | 99  |
| Ross-Gould Co. ....                    | 103      | Cramer, W. R. ....                  | 100 | Radio Instrument Co.....              | 33  |
| Trade Circular Addressing Co.....      | 100      | E. D. Mfg. Co., The.....            | 38  | Rasla Sales Corporation.....          | 25  |
| <b>MANUFACTURERS' REPRESENTA-</b>      |          | Federal Tel. & Teleg. Co.....       | 4   | Rauland Mfg. Co.....                  | 113 |
| <b>TIVES</b>                           |          | Holloway Elec. Supply Co., Inc..... | 110 | Thornton Transformer Co.....          | 102 |
| Radio Equipment Service.....           | 13       | Joy Kelsey Corp.....                | 90  | United Mfg. & Distributing Co.....    | 82  |
| <b>MICA</b>                            |          | Lewis & DeRoy Co.....               | 83  | <b>TUNING COILS</b>                   |     |
| Mica Insulator Co.....                 | 23       | Mercury Radio Products Co.....      | 86  | Bershaw Radio & Mfg. Co.....          | 126 |
| <b>MICA DIAPHRAGMS</b>                 |          | Metropolitan Radio Corp.....        | 79  | <b>UNIT TYPE SETS</b>                 |     |
| Radio Mica Products Co.....            | 85       | Michigan Radio Corp.....            | 123 | Jewett Mfg. Co.....                   | 129 |
| <b>PANEL ENGRAVERS</b>                 |          | Mu-Rad Laboratories, Inc.....       | 39  | Magna Instrument Co.....              | 7   |
| Poster & Co.....                       | 103      | Oranola Radio Corp.....             | 14  | Pacific Radio Exchange.....           | 101 |
| <b>PANELS</b>                          |          | Radio Guild, Inc., The.....         | 18  | <b>V. T. SETS</b>                     |     |
| American Hard Rubber Co.....           | 87       | Radio Outfitting Corp.....          | 90  | Queens Radio Co., Inc.....            | 130 |
| Continental Fibre Co., The.....        | 113      | Ross & Co., Joseph.....             | 130 | <b>VACUUM TUBE SOCKETS</b>            |     |
| National Fibre & Insulation Co.....    | 78       | Save-Sales Corp. ....               | 44  | Alden-Napier Co. ....                 | 110 |
| National Radio Co.....                 | 122      | Seaboard Radio Corp.....            | 102 | <b>VACUUM TUBE TESTER</b>             |     |
| New York Hard Rubber Turning Co.       |          | Standard Products Co.....           | 89  | The Mydar Radio Co., Inc.....         | 30  |
| Pittsburgh Radio & Appliance Co....    | 110      | Signal Radio & Elec. Corp.....      | 34  | <b>VARIABLE CONDENSERS</b>            |     |
| Standard Radio Parts Co.....           | 117, 125 | T. F. Radiophone Co.....            | 126 | Bayley Condenser Co.....              | 103 |
| Standard Wireless Panel Co.....        | 115      | Tresco Radio.....                   | 128 | Cozzone Co., John A.....              | 123 |
| <b>PART MAKERS</b>                     |          | United Specialties Co., Inc.....    | 96  | Montrose Mfg. Co.....                 | 114 |
| Aldine Radio Mfg. Co.....              | 10       | W. E. Supply & Service Corp.....    | 20  | Radio Stores Corporation .....        | 96  |
| <b>PATENTS</b>                         |          | Ware Radio Corp.....                | 29  | Spiro Bros. ....                      | 107 |
| Emil Alexander Kern.....               | 104      | Wilson & Co., E. M.....             | 91  | Standard Appliance Mfg. Corp.....     | 94  |
| Owen, Richard B.....                   | 106      | Winkler, Inc., Chas.....            | 95  | Universal Stamping & Mfg. Co.....     | 115 |
| Manufacturers Patent Co.....           | 100      | <b>RHEOSTATS</b>                    |     | <b>VARIO-COUPLERS</b>                 |     |
| Wilson, Inc., A. M.....                | 100      | Acorn Radio Supply Co.....          | 127 | Essex Mfg. Co.....                    | 80  |
| Zwingerberger, Otto K.....             | 100      | Parkin Mfg. Co.....                 | 97  | Jewell Radio Sales Co.....            | 84  |
| <b>PHONES</b>                          |          | Radiola Wireless Corp.....          | 126 | Maclite Radio Co. ....                | 90  |
| Mills Radio & Elec. Co.....            | 120      | Reco Radio Engineering Co.....      | 12  | Marvin B. Fallgatter.....             | 90  |
| Premier Accessory & Specialty Corp.    | 119      | Louis A. Staff Co.....              | 117 | Nelson Radio Parts Co.....            | 118 |
| T-B-H Corporation .....                | 80       | Keystone Radio Co.....              | 98  | Quens Radio Co.....                   | 130 |
| Tower Mfg. Co.....                     | 106      | Spee Dee Specialty Co.....          | 24  | Shamrock Radio Co.....                | 112 |
| True-Tone Radio Mfg. Co.....           | 95       | Sunraid Radio Co.....               | 124 | Viking Radio Co.....                  | 86  |
| <b>PLUGS</b>                           |          | The Wilcox Laboratories .....       | 86  | <b>VARIOMETERS</b>                    |     |
| Metro Electric Mfg. Co., Inc.....      | 10       | <b>SHIELDS</b>                      |     | Eastern Specialty Co.....             | 107 |
| Racony Corp., The.....                 | 122      | Orange Research Lab.....            | 121 | Radio Products Mfg. Co.....           | 89  |
| S. S. Novelty Co.....                  | 92       | <b>SOCKET RHEOSTAT</b>              |     | Ritter Wood Work Co.....              | 93  |
| <b>POTENTIOMETERS</b>                  |          | Ajax Radio Corp.....                | 116 | Sunday and Scholtz.....               | 94  |
| Advance Metal Stamping Co.....         | 82       | <b>SOCKETS</b>                      |     | Superior Products Mfg. Corp.....      | 77  |
| Royhele Mfg. Co.....                   | 80       | Franklin Radio Mfg. Co.....         | 104 | Volta Engineering Co.....             | 110 |
| <b>RADIPHOÑO ADAPTER</b>               |          | Metro Elec. Mfg. Co., Inc.....      | 19  | <b>VERNIER CONDENSERS</b>             |     |
| Industrial Sales Engineering Co.....   | 122      | <b>SOCKETS FOR DRY CELL TUBES</b>   |     | Electric Products Co., Mass.....      | 100 |
| <b>REPAIRS</b>                         |          | Radio Electric Service Station..... | 92  | <b>WIRE</b>                           |     |
| Montclair Radio Co.....                | 80       | <b>SOLDERING IRON</b>               |     | White Radio Co.....                   | 90  |
|                                        |          | Post Electric Co.....               | 107 |                                       |     |
|                                        |          | <b>SPAGHETTI TUBING</b>             |     |                                       |     |
|                                        |          | Mitchell Rand Mfg. Co.....          | 100 |                                       |     |

SEE ALPHABETICAL INDEX OF ADVERTISERS ON PAGE 40

THIS WILL BE A RADIO CHRISTMAS!



# The Set that Grows



Front View  
Panel No. 2

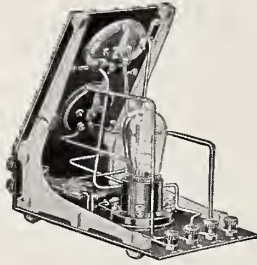

Rear View, with Cover  
Removed. Panel No. 9

THE two panels shown are only the beginning of an elaborate receiving set. They alone form a complete set with a wave length range of from 150 to 3000 meters. They embody bank wound inductance, potentiometer, interchangeable grid-leak, etc.

Your customer will want to match his original purchase from time to time. Radio frequency, audio frequency, loop or honeycomb coil mounting panels and other units of the E. D. line are sure to follow the first sale.

A set developed and built by engineers combined with a manufacturing organization of over thirty years experience in the construction of the highest grade electrical instruments.

Your sales will climb with "The Set that Grows."

Write for our bulletin No. 302

**THE E·D· MANUFACTURING CO.**  
**PHILADELPHIA, PA.**

**"LISTEN IN WITH ED."**

## THE-ONLY-KNOB-AND-DIAL-WITHOUT-A-SET-SCREW



The unsightly and troublesome SET-SCREW is at last eliminated. No more loosening of dials, splitting the head of the set-screw, or stripping of threads, perhaps ruining the dials.

To mount the TAIT KNOB AND DIAL simply hold the dial with one hand and screw on the knob with the other; a few seconds does it. No tools are necessary; when fastened it is self centering and self aligning. Numerals at correct angle for the best visibility.

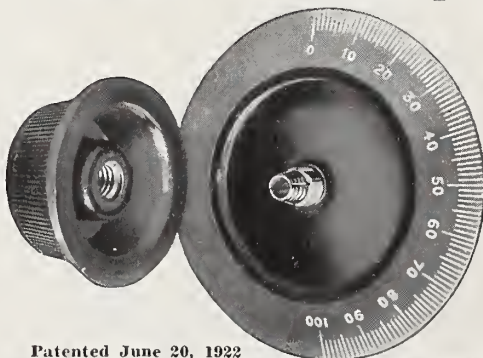

This beautifully patterned KNOB AND DIAL is made of the best grade of BAKELITE.

**MANUFACTURERS**—It will greatly beautify your receiving sets, also reduce your labor costs in assembly.

**JOBBER**—This product is merchandized to the trade strictly through you. It sells on sight and is revolutionary in its field.

**Dealers**—write us and we will notify you of nearest jobber

Patented June 20, 1922  
Also Licensed Under Grebe Design Patent No. 57900

List  
Price  
4 in.—\$1.50  
3 in.—\$1.00

**TAIT-KNOB-AND-DIAL-CO., Inc.**

MANUFACTURERS

11 EAST 42nd STREET

NEW YORK

THIS WILL BE A RADIO CHRISTMAS!



ACT 4 OPERA CARMEN

The New  
Star in  
the Radio  
World

**L**EADERS use the accepted rules and precedents, by which the majority bind their efforts, only as starting points for higher achievements. Mu-Rad Apparatus, embodying new principles, is the achievement of such a group of leading radio engineers. The very moderate prices of this apparatus make the accomplishment the more noteworthy. Bulletin upon request.



**MU-RAD**  
**LABORATORIES**  
INCORPORATED  
ASBURY PARK  
NEW JERSEY



THIS WILL BE A RADIO CHRISTMAS!

# LIST OF ADVERTISERS

(Advertisements Indexed by Products will be found on Pages 36 and 37 of this issue.)

|                                                              |                                                              |                                                   |                                                |                                   |                                                |  |
|--------------------------------------------------------------|--------------------------------------------------------------|---------------------------------------------------|------------------------------------------------|-----------------------------------|------------------------------------------------|--|
| <b>A</b>                                                     |                                                              | Fiber Uroducts Co..... 24                         | Morscau Radio Co..... 22                       | <b>S</b>                          |                                                |  |
| Ablett Co., Chas. R..... 61                                  | Acorn Radio Supply Co..... 127                               | Finch Radio Mfg. Co..... 14                       | Moss Radio Co..... 112                         | Save Sales Co..... 44             | Scheib Elec. Radio Co..... 102                 |  |
| Adams-Morgan Co..... 15                                      | Adbrin Laboratories..... 96                                  | Ford-Mica Co., Inc..... 116                       | Multiple Storage Battery Co.,<br>Back Cover    | Schwab, Harold M., Inc..... 86    | Seaboard Radio Corporation... 102              |  |
| Advance Metal Stamping Co.. 82                               | Aerex Radiophone Corp..... 20                                | Franklin Radio Mfg. Co..... 104                   | Mu-Rad Laboratories, Inc..... 39               | Shamrock Radio Co..... 112        | Signal Radio & Elec. Corp.. 34                 |  |
| Ajax Radio Corp..... 116                                     | Aldine Radio & Mfg. Co..... 10                               | Freed-Eisemann Radio Corp... 100                  | Mydar Radio Corp., The..... 30                 | Sound Wave Corp., The..... 30     | Specialty Service Co..... 105, 109             |  |
| Alden-Napier Co..... 100, 110                                | Allied Engineering Institute... 9                            | French Battery & Carbon Co... 106                 | <b>N</b>                                       |                                   |                                                |  |
| Aldine Radio & Mfg. Co..... 10                               | Allied Engineering Institute... 9                            | Freshman Co., Inc., Chas..... 116                 | National Fibre & Insulation Co.. 78            | Spee-Dee Specialty Co..... 24     | Spiro Brothers..... 107                        |  |
| Allied Engineering Institute... 9                            | Altadena Radio Laboratories... 114                           | Frost, Herbert H..... 108                         | National Radio Co..... 122                     | S. S. Novelty Co..... 92          | Staff Co., Louis A..... 117                    |  |
| Altadena Radio Laboratories... 114                           | American Electro Phone Co..... 120                           | <b>G</b>                                          |                                                |                                   | Standard Crystal Co..... 125                   |  |
| American Electro Phone Co..... 120                           | American Hard Rubber Co..... 87                              | General Merchandise Co..... 10                    | National Radio Show..... 21                    | Standard Appliance Mfg. Corp.. 94 | Standard Radio Parts Co..... 121               |  |
| American Hard Rubber Co..... 87                              | American Radio Exposition Co.. 3                             | Gilbert Co., The A. C..... 42                     | Nelson Radio Parts Co..... 118                 | Stanton Co., Frank T..... 104     | Steinmetz Wireless Mfg. Co.. 102               |  |
| American Radio Exposition Co.. 3                             | American Radio & Elec. Co..... 80                            | Globe Phone Mfg. Co..... 76                       | Newark Radio Supply Co..... 118                | Strahs Aluminum Co..... 110       | States Radio Corp..... 124                     |  |
| American Radio & Elec. Co..... 80                            | American Specialty Mfg. Co., The 111                         | Goetz Co., The Edw. J..... 104                    | New Haven Radio Co..... 93                     | Sunday and Scholtz..... 94        | Superior Products Mfg. Corp... 77              |  |
| American Specialty Mfg. Co., The 111                         | Andrae & Sons Co., Julius.. 126, 92                          | Gould Storage Battery Co..... 110                 | New York Coil Co..... 5                        |                                   |                                                |  |
| Archway Bookstore..... 108                                   | Arrow Radio Co..... 126, 96, 122                             | Great Lakes Publishing Co..... 108                | New York Radio Dial Co..... 102                | <b>O</b>                          |                                                |  |
| Arrow Radio Co..... 126, 96, 122                             | Astorloid Mfg. Co., Inc..... 62                              | Gregg & Co..... 12                                | New York Testing Laboratories. 107             | Orange Research Lab..... 121      | Oranola Radio Corp..... 14                     |  |
| Astrolloid Mfg. Co., Inc..... 62                             | Atlantic-Pacific Radio Supplies<br>Co..... Inside Back Cover | <b>H</b>                                          |                                                |                                   | Owen, Richard B..... 106                       |  |
| Atlantic-Pacific Radio Supplies<br>Co..... Inside Back Cover | Atwater Kent Mfg. Co..... 75                                 | Hafner Manufacturing Co..... 111                  | Novo Manufacturing Co..... 105                 | <b>T</b>                          |                                                |  |
| Automatic Electrical Devices Co. 8                           |                                                              |                                                   | Nuloid Corporation..... 93                     | Tait-Knob-And Dial Co..... 38     | T. B. H. Corporation..... 80                   |  |
| <b>B</b>                                                     |                                                              | Harris Laboratory, The..... 90                    |                                                |                                   |                                                |  |
| Bannister & Pollard..... 74                                  | Hedden Place Machine Co..... 118                             | Henley Publishing Co., The Nor-<br>man W..... 101 |                                                |                                   |                                                |  |
| Bayley Condenser Co..... 125                                 | Heinemann Electric Co..... 73                                | Henry Hyman Co..... 71                            |                                                |                                   |                                                |  |
| Beau Ivorie Novelty Co..... 96                               | Henley Elec. Supply Co., Inc. 110                            | Holloway Elec. Supply Co., Inc. 110               |                                                |                                   |                                                |  |
| Bershaw Radio Mfg. Co..... 126                               | Horning Experimental Labora-<br>tories..... 98               | Hornig Experimental Labora-<br>tories..... 98     |                                                |                                   |                                                |  |
| Bissell Engineering Co..... 92                               | Hyman & Co., Inc., Henry..... 71                             | <b>I</b>                                          |                                                |                                   | Pacific Radio Exchange..... 101                |  |
| Brady Electric Mfg. Co..... 114                              |                                                              |                                                   | Invincible Products Co., Inc.,<br>The..... 117 | Paramount Machine Co..... 90      | Parkin Mfg. Co..... 97                         |  |
| Briggs & Stratton Co..... 35                                 |                                                              |                                                   | Industrial Sales Engineering Co. 122           | Permanent Radio Fair..... 88      | Pickens, F. D..... 105                         |  |
| Bruno Radio Corp..... 34                                     |                                                              |                                                   | <b>J</b>                                       |                                   |                                                |  |
| <b>C</b>                                                     |                                                              | Jackson, P. D..... 100                            |                                                |                                   |                                                |  |
| Caragol-Clarke Co., Inc..... 23                              | Carbon Products Co., The..... 62                             | Jerome Radio Corporation..... 100                 |                                                |                                   |                                                |  |
| Carbon Products Co., The..... 62                             | Carter, Chauncey P..... 109                                  | Jewell Radio Sales Co..... 84                     |                                                |                                   |                                                |  |
| Carter, Chauncey P..... 109                                  | Central Electrotyping Co..... 104                            | Jewett Mfg. Co..... 129                           |                                                |                                   |                                                |  |
| Central Electrotyping Co..... 104                            | Central States Eng. Co..... 120                              | Joy Kelsey Corp..... 90                           |                                                |                                   |                                                |  |
| Central States Eng. Co..... 120                              | Clapp-Eastham..... 86                                        | <b>K</b>                                          |                                                |                                   | Queens Radio Co., Inc..... 130                 |  |
| Clapp-Eastham..... 86                                        | Comet Battery Co..... 102                                    | Kent Co., F. C..... 114                           |                                                |                                   |                                                |  |
| Comet Battery Co..... 102                                    | Continental Elec. Co..... 80                                 | Kern, Emil Alexander..... 104                     |                                                |                                   |                                                |  |
| Continental Elec. Co..... 80                                 | Continental Fibre Co., The..... 113                          | Keystone Radio Co..... 98                         |                                                |                                   |                                                |  |
| Continental Fibre Co., The..... 113                          | Copper Clad Steel Co., Tbe... 112                            | King Sewing Machine Co..... 12                    |                                                |                                   |                                                |  |
| Copper Clad Steel Co., Tbe... 112                            | Coraco Co., The..... 118                                     | Kramer Radio Co..... 100                          |                                                |                                   |                                                |  |
| Coraco Co., The..... 118                                     | Cozzone & Co., John A..... 123                               | Krenz Walter S..... 127                           |                                                |                                   |                                                |  |
| Cozzone & Co., John A..... 123                               | Cramer Co., W. R..... 100                                    | <b>L</b>                                          |                                                |                                   | Racony Corp., The..... 122                     |  |
| Cramer Co., W. R..... 100                                    | Crown Radio Mfg. Corp..... 61                                | Lewis & DeRoy Co..... 83                          |                                                |                                   |                                                |  |
| Crown Radio Mfg. Corp..... 61                                | Curtis C. Culin..... 110                                     | Livermore, Inc., John..... 124                    |                                                |                                   |                                                |  |
| Curtis C. Culin..... 110                                     | <b>D</b>                                                     |                                                   |                                                |                                   |                                                |  |
|                                                              |                                                              | Ludwig Hommel..... 31                             |                                                |                                   |                                                |  |
|                                                              |                                                              | <b>M</b>                                          |                                                |                                   | Radio Accessories Co..... 87                   |  |
|                                                              |                                                              | Maclite Radio Co..... 90                          |                                                |                                   |                                                |  |
|                                                              |                                                              | Magna Instrument Co..... 7                        |                                                |                                   |                                                |  |
|                                                              |                                                              | Magnovox Co..... 67                               |                                                |                                   |                                                |  |
|                                                              |                                                              | Manhattan Storage Battery Co.. 90                 |                                                |                                   |                                                |  |
|                                                              |                                                              | Manufacturers Patent Co..... 100                  |                                                |                                   |                                                |  |
|                                                              |                                                              | Marle Engineering Co..... 99                      |                                                |                                   |                                                |  |
|                                                              |                                                              | McKenna Brass & Mfg. Co..... 102                  |                                                |                                   |                                                |  |
|                                                              |                                                              | Meirowsky..... 127                                |                                                |                                   |                                                |  |
|                                                              |                                                              | Mercury Radio Products Co... 86                   |                                                |                                   |                                                |  |
|                                                              |                                                              | Metro Elec. Mfg. Co., Inc..... 19                 |                                                |                                   |                                                |  |
|                                                              |                                                              | Metropolitan Radio Corp..... 79                   |                                                |                                   |                                                |  |
|                                                              |                                                              | Mica Insulator Co..... 23                         |                                                |                                   |                                                |  |
|                                                              |                                                              | Michigan Radio Corp..... 123                      |                                                |                                   |                                                |  |
|                                                              |                                                              | Milho Co., The..... 90                            |                                                |                                   |                                                |  |
|                                                              |                                                              | Milliken Bros. Mfg. Co., Inc.. 103                |                                                |                                   |                                                |  |
|                                                              |                                                              | Mills Radio & Electric Co..... 120                |                                                |                                   |                                                |  |
|                                                              |                                                              | Mitchell-Rand Mfg. Co..... 100                    |                                                |                                   |                                                |  |
|                                                              |                                                              | Montclair Radio Co..... 80                        |                                                |                                   |                                                |  |
|                                                              |                                                              | Montrose Mfg. Co..... 114                         |                                                |                                   |                                                |  |
|                                                              |                                                              | Moreland Sales Corp..... 90                       |                                                |                                   |                                                |  |
|                                                              |                                                              | <b>N</b>                                          |                                                |                                   | Rauland Mfg. Co..... 113                       |  |
|                                                              |                                                              |                                                   |                                                |                                   | Ritter Wood Work Co..... 96                    |  |
|                                                              |                                                              |                                                   |                                                |                                   | Rocky Mountain Radio Products,<br>Inc..... 112 |  |
|                                                              |                                                              |                                                   |                                                |                                   | Rogers Radio Co..... 110                       |  |
|                                                              |                                                              |                                                   |                                                |                                   | Ross & Co., Joseph..... 130                    |  |
|                                                              |                                                              |                                                   |                                                |                                   | Ross-Gould Co..... 108                         |  |
|                                                              |                                                              |                                                   |                                                |                                   | Royal Electric Lab.,<br>Inside Front Cover:    |  |
|                                                              |                                                              |                                                   |                                                |                                   | Royhele Mfg. Co..... 80                        |  |
|                                                              |                                                              |                                                   |                                                |                                   | Rusolite Products Corp..... 126                |  |
|                                                              |                                                              |                                                   |                                                |                                   | <b>Z</b>                                       |  |
|                                                              |                                                              |                                                   |                                                |                                   | Zeller Lacquer Mfg. Co., Inc... 70             |  |
|                                                              |                                                              |                                                   |                                                |                                   | Zwingerberger, Otto K..... 100                 |  |

# Radio Displays of the Month



One of the most attractive window displays of the month was that of the Wholesale Radio Equipment Company at 22 William Street, Newark, N. J. As shown in the above photograph, it will be seen that this window contains reliable supplies that interest the radio men. It has been successful in drawing customers into the store, and has produced much favorable comment. Radio merchants would do well to remember that more good windows will make more good sales.

Below is shown the booth of the Winkler-Reichmann Company of Chicago at the recent Chicago Radio Show. It will be noted that the feature of the display is the Thorophone which is made by this company.



One of the most pleasing and popular exhibits at the Newark Radio Show which was held last month was that of the General Merchandise Company, whose office and warehouse are located at 142 Market Street, Newark, N. J. Frederick W. Germer, the president and general manager of the company, is shown in the foreground examining a head set.

## *Gilbert Radio Apparatus*



No. 4023

### **RADIO FREQUENCY**

#### **Long Distance Receiving—Splendid Tone Quality**

For long distance receiving and splendid tone quality this new Radio Frequency Set is unrivalled at anywhere near the price. It is based on the wonderful principle of Radio Frequency Amplification, the highest type of receiving set yet produced.

This and other outfits together with a number of the most advanced radio parts go to make up the Gilbert Line—a line of good, serviceable radio apparatus, efficient and at the same time priced to meet the popular demand—with good profit to yourself.

Send for catalog No. 54 illustrating and describing this new Radio Frequency Set with all other Gilbert Radio Apparatus.

**THE A. C. GILBERT COMPANY**  
DEPT. C NEW HAVEN, CONN.

In Canada: The A. C. Gilbert Menzies Co., Ltd., Toronto

*THIS WILL BE A RADIO CHRISTMAS!*



# THE RADIO DEALER

*The Radio Trade Journal*

For The Radio Retailer

---

## CONTENTS NOVEMBER, 1922

---

### SPECIAL ARTICLES

|                                                                      |                          |        |
|----------------------------------------------------------------------|--------------------------|--------|
| About Retail Price Cutters.....                                      | By Eugene J. Scanlon     | 50     |
| Aggressive Publicity Aids Dealer in Selling.....                     | By John R. Hall          | 60     |
| Business Static Slowly Eliminating.....                              | By C. E. Godley          | 57     |
| Conditions in Radio Security Market.....                             | By Frank T. Stanton      | 56     |
| Costs Must Be Known Before Fixing Selling Price.....                 | By Henry L. Seidman      | 58     |
| Davenport and Dashboard Special Touring U. S.....                    | By J. McKerchar          | 72     |
| Doing Away With a Radio Battery Problem.....                         | By Clarence E. Ogden     | 52     |
| Efficient Operation of Detector Tubes.....                           | By Sterling G. Sears     | 53     |
| Engineer Makes Interesting Survey.....                               | By George F. Shecklen    | 50     |
| Everybody in the Radio Industry Must Help to Eliminate Weaklings.... | By H. S. Johnson         | 48, 49 |
| Exposing Frauds and Fakers in Radio Industry.....                    | By Harry M. Konwiser     | 63     |
| Jobbers and Retailers Must Render Service.....                       | By M. W. Kunkel          | 47     |
| King Symbol Used by King Sewing Machine Co.....                      | By Bernard J. Farrell    | 60     |
| Klosner Rheostat.....                                                | By Thos. J. McElroy, Jr. | 100    |
| National Survey Shows Condition of Radio.....                        | By N. Beesey             | 45     |
| Old Established Electrical Manufacturers.....                        | By L. N. Allen           | 66     |
| Possibilities of Work for Association.....                           | By Laurence A. Nixon     | 59     |
| Radio Industry is Stabilizing.....                                   | By Raymond Francis Yates | 51     |
| Radio Instruction by Experts.....                                    | By Robert E. Autrey      | 65     |
| Report on Sale of Radio Parts and Supplies.....                      | By Milton B. Sleeper     | 46     |
| Trade-Marks for Trade Associations.....                              | By Chauncey P. Carter    | 57     |

### DEPARTMENTS

|                                       |                       |        |
|---------------------------------------|-----------------------|--------|
| Book Review.....                      | By Bernard J. Farrell | 128    |
| Concerning the Radio Retailers.....   |                       | 70     |
| Editorial.....                        |                       | 54, 55 |
| Radio Displays of the Month.....      |                       | 41     |
| Trade-Mark Department.....            |                       | 112    |
| What the Manufacturers are Doing..... |                       | 68     |

THE RADIO DEALER, THE RADIO TRADE JOURNAL, published monthly on the first, at 1133 Broadway, New York, N. Y., by THE RADIO DEALER COMPANY, in the interest of dealers in Radio Supplies. HARRY M. KONWISER, Publisher; LAURENCE A. NIXON, Managing Editor; HERBERT M. WILLIAMS, C. C. MINIER and J. FARRELL, Editors; A. L. KONWISER, B.S., Technical Editor; N. B. ZIMMERMAN, BERNARD FREEDMAN and EUGENE J. SCANLON, Associates; R. DESHEAU, Circulation Manager; M. JAY KLEIN, Research Manager; B. B. STERN, Manager Service Bureau.

REPRESENTATIVES IN THE TRADE: ELMER W. MOORE, JOHN R. HALL, H. E. BENNETT, WM. B. WILKINSON, JR., J. MAURICE CASPER, J. A. DOUCET, H. L. KRENZ, M. A. CLARK, C. L. GEESSEY, S. A. FRANK, C. C. MINIER, M. P. MCNEELEY, W. H. OKE, C. B. CABINISS, R. C. HULL, B. J. FARRELL.

|                                                                                            |                                                                                                                                                                              |                                                                                             |
|--------------------------------------------------------------------------------------------|------------------------------------------------------------------------------------------------------------------------------------------------------------------------------|---------------------------------------------------------------------------------------------|
| <b>PUBLICATION OFFICE</b><br>1133 Broadway, New York, N. Y.<br>Telephone Watkins 8926-8927 | <b>PITTSBURGH</b><br>Suite 570, Union Arcade, Pittsburgh, Penna.<br><b>PACIFIC COAST</b><br>Suite 510, 456 S. Spring St., Los Angeles, Calif.<br>Telephone Los Angeles 12052 | <b>CENTRAL STATES</b><br>35 South Dearborn Street, Chicago, Ill.<br>Telephone Dearborn 4053 |
| <b>SOUTHERN STATES</b><br>730 Gravier Street, New Orleans, La.                             | <b>CANADIAN OFFICE</b><br>23 Lily Street, Winnipeg, Manitoba                                                                                                                 | <b>NEW JERSEY</b><br>845 Broad Street, Newark, N. J.<br>Telephone Market 4659               |

Advertising Rates and detailed statement of circulation and other information for advertisers furnished on application.

Advertising forms close the 15th of the month prior to date of issue.

Circulation restricted to manufacturers, jobbers and retailers in wireless equipment. Subscription in the United States, one dollar the year, payable invariably in advance. Subscription in foreign countries, two dollars the year, payable invariably in advance.



*You were Right!*

**\$70.00 List**

Shortly after we placed on the market the MELCO Type 400 Tuner and Detector and 2 stage amplifier, we heard from a great number of dealers and distributors of the remarkable results obtained with this set. Atlanta hears Detroit. Chicago hears Birmingham, Ala. St. Louis hears Newark. Precision workmanship, proper design and the New Litz Wire Wound Super-sensitive Vario-coupler tell the story. Perhaps you were one of the dealers who wrote us. If you were, you will not be surprised at the

official endorsement of the MELCO type 400 set by the Tribune and Evening Mail Radio Institutes. It HAD to come. Dealers who do not know MELCO Units will find in these certificates concrete proof that the quality which we claim for them is actually there! Quantity production enables us to offer MELCO sets at prices which are so astoundingly low that sales are sure to result. Write us today for our attractive offer which will enable you to secure some of the most satisfying profits in the radio field.

## Save Sales Company

*Sales Engineers*

City Hall Building, New York City  
(Broadway and Warren Street)

*Manufactured by Mortimer Radio Corp., New York City*

# MELCO

TYPE 400

Tuner and Detector Unit

Two-Stage Amplifier

—with the Litz Wire Wound Super-sensitive Vario Coupler

*THIS WILL BE A RADIO CHRISTMAS!*

# The Radio Dealer

THE RADIO TRADE JOURNAL

*Edited and Published at*

1133 Broadway, New York, N. Y.

FOR THE RADIO RETAILER

VOL. 2. NO. 2

NOVEMBER, 1922

ONE DOLLAR THE YEAR

## National Survey Shows Condition of Radio

Newspaper and Jobber Reports Indicate Soundness of Industry and  
Bright Future

By N. BEESEY

What are conditions today in the radio industry?

As the result of a nation-wide questionnaire, going to newspaper and jobbers throughout the country, the RADIO DEALER is able to give a survey of the facts and problems as they are being faced by every radio dealer in the country, who knows his business and is alive to its possibilities.

A glance through the sheaves of answers to the questionnaires is sufficient to indicate that radio in the United States is moving inland and covering the whole country. Two states, New Jersey and California, where a tremendous development of broadcasting has taken place, are like the positive and negative poles, while from these poles radio has been constantly spreading north, south, east and west. The stage of radio development tapers off as one approaches the centre of the country.

Another broad principle which the reports indicate is that the success of radio depends, not merely on the number of broadcasting stations in a community, but on the quality of the broadcasting programs as well. The Pittsburgh district with its homes averaging thirty per cent. exists from a radio point of view because almost from the inception of public broadcasting it has had excellent programs. Those districts throughout the United States reporting programs "considered poor" also report radio ownership in less than five per cent. of the homes, sometimes less than one per cent. A question to be answered is, Which must come first, radio owners or good broadcasting programs? Figures showing that 75 per cent. of the states have less than five per cent. of their homes equipped with radio sets reveal

the falsity of the rumor that radio has been oversold. In no place has radio been oversold, not even Los Angeles, Detroit or Newark (highly developed centres). A business slump has been mistaken for a saturated market.

There has been a business slump. It began about the fifteenth of June. One reason for it is that radio, as at present constituted, is a seasonal business. It will remain such a one until radio retailers have sufficiently organized their business to make it otherwise. The mere elimination of static by improvements, such as Dr. McCaa, of Ephrata, Pa., has announced, is not sufficient. Business fell off anywhere from 50 to 75 per cent. during the Summer in most radio districts, although certain sections in the South reported a gain over June. With a unanimity that is born of certainty, jobbers in almost every section of the country felt that things would take a turn upward again during October.

Judging from the reports of jobbers all over the country, based on past experience, the demand from now on will be for medium and high-priced tube sets and parts. The day of the radio outfit that was cheap in quality, but not necessarily in price, is gone. Crystal sets will always have a demand in large centres, where the presence of broadcasting stations at short distances allow the crystal sets to give satisfactory performances. But tube sets will predominate in rural communities, which, in the coming Christmas trade, will do most of the radio buying. The most backward states in radio today are those containing a predominant agricultural population. In many places this will be the first radio Christmas.

*(Continued on page 84)*

# Report on Sale of Radio Parts and Supplies

## Survey of Radio Retailing Made Especially For a Boston Department Store Shows Thorough Appreciation of Conditions

By **MILTON B. SLEEPER**  
Of Sleeper Radio Corporation

At the time when the large part of dealers installed radio departments they knew very little about methods for selling the things they bought. In fact, it was not necessary for them to, because the buying public sold itself. Fortunately the Radio Corporation of America realized that this condition could not long exist, and they set out to train their dealers not merely to sell radio apparatus but to make sales.

Because complete receiving sets form the major portion of their output, they have concentrated their efforts along this line, to the exclusion of parts and supplies. Unfortunately dealers looking to the Radio Corporation for guidance have inferred that it is their conviction that profits are to be made only on complete sets. This impression has been given weight by the statements of some editorial writers who, in misguided efforts to infect their personalities into the industry, have offered solutions for the dealers problems when they know as much about their subjects as the average failures who write books on success.

While I have no official authority for the statement, it is my belief that the Radio Corporation does not feel that only complete sets can be sold profitably. So far as my own experience is concerned, and that of dealers with whom I have worked intimately, this is not true, tho' I am forced to admit that the careful attention to the instruction of dealers has not been given in the case of parts and supplies as with complete sets.

Let me point out to you the difference in your attitude toward the two classes of merchandise. When, nine months ago, you sent your buyers out to get hold of every piece of radio equipment they could find, you allotted a space in your store for the display of various sets, instruments and parts. You put behind the counter a radio amateur and an ex-navy operator. You remember that they spent most of their time talking to customers about almost everything except the goods you were paying them to sell, and much of their selling talk was actually directed against the merchandise you wanted them to dispose of.

The preliminary work done by



*Photo by Bachrach*

**MILTON B. SLEEPER**  
Of Sleeper Radio Corporation

manufacturers and jobbers to help train these men to think strictly in terms of sales and dollars was wasted partly because your salesman was too much interested in radio to think of money, and because they had nothing to learn about radio anyway.

Gradually, however, you improved the personnel, getting in men who knew less about radio, perhaps, and were more concerned with sales. Their minds were receptive to suggestions made by outsiders who wanted to help them. They learned how to demonstrate complete receiving sets; how to show a customer the way to operate the controls, that the quality of speech and music was more important than volume. With experience they consciously concentrated their efforts on three or four types of sets which they could sell easily and quickly, and they learned how to sell a customer one of those four sets even tho' he had intended to buy a similar outfit of a different make. As those sets became more plentiful on the market, you concentrated your buying, for you found it more profitable to specialize on those sets and keep them moving.

It wasn't long, you remember, before you had demonstrating spaces

and special signs made up frequently to keep up interest in those outfits. That helped to sell the sets and refreshed, periodically, the ideas of your salesmen.

To-day you are pleased with your accomplishments in the sales of complete receiving sets.

And now, you wonder what to do about separate instruments and parts. I have reviewed the development of your radio department, in so far as it concerns complete sets partly to bring out to you changes which were so gradual that you may not have them clearly in mind, and for the purpose of making comparisons with the efforts put into the sale of parts.

Nine months ago you put in a stock of parts, arranging them neatly in boxes in the show case and distributed the separate instruments attractively on the shelves, on stands, and in the case. If a customer wanted to make something and knew what parts to buy, your salesman made the sale unless he advised the customer against making whatever he had in mind.

One day, when I was in your store, I asked a clerk for the parts to build a regenerative receiver. He showed me a variocoupler of one make and two variometers of another. When I inquired further as to other parts required, he got them out, one by one, tho' he was so impatient about my questions that if I had been a regular experimenter I would have gone somewhere else or quit altogether. If I hadn't known what I needed, I wouldn't have been able to find out from your salesman. Moreover, it took nearly twenty minutes of his selling time. When I was all thru' I had just a slip of paper with some prices scribbled on it to take home and think about. At least ten different manufacturers were represented by the parts he showed me for that set.

After selling instruments and parts for nine months, you haven't learned a single thing about that branch of your radio business. You don't know any more about that class of trade than you did at the beginning, which is nothing. Let me tell you something about the man who builds his own apparatus.

*(Continued on page 86)*

# Jobbers and Retailers Must Render Service

## Manufacturers Have Their Obligation, the Jobber Must Carry Proper Merchandise and Retailers Must Be Alert

By M. W. KUNKEL

Secretary, Pittsburgh Radio & Appliance Co., Pittsburgh, Pa.

The other day the writer was in receipt of a visit from a representative of one of our prominent manufacturers, and put this to him: "What do you think of the prospects of radio business for the coming fall and winter?" The reply, quick and snappy was: "You will see a bigger and better business in radio this year than ever before." This statement leaves much food for reflection over radio conditions as existing in the Pittsburgh territory.

The so-called summer slump hit this territory the same as it hit all other sections of the country, yet the writer feels that a great deal of the slowing up in business was due to the dealers themselves, as they have apparently lost sight of the fact that they could go to the tourist, the vacationist and the camper and find a ready outlet for radio apparatus during the summer months, just as well as he can to the stay-at-homes during the winter months.

This past summer found a great many of the jobbers overstocked but making few sales to dealers. In some instances these conditions were caused by the manufactures themselves.

Let us for a minute reflect on three types of outlets for radio material; that is the manufacturer, jobber and dealer and study the relationship that exists between themselves. Some concerns have adopted the policy of selling only through their recognized distributors and jobbers, referring all inquiries and orders directly to them, but a great many more attempt to handle both the dealer and jobber business.

The manufacturer who attempts to do business with that policy will sooner or later discover the error in it, for the reason that if he does any business at all, he will find not only a difficult task, but an expensive undertaking to handle the vast number of dealer and jobber accounts all over the country.

This leads up to the question of "The why of a radio jobber?" A jobber's position in any business is

something more than merely buying merchandise from a manufacturer and selling it at a discount to the dealer.

There are a great many so-called jobbers, but a real jobber is one who stocks in quantity sufficient to render real service to the dealer, the material of those manufacturers whom he represents. After all, the jobber is the warehouse representative of the manufacturer and in such capacity it is up to him to render real service in quality merchandise at fair prices, at fair discount and delivery. He should also maintain a corps of trained radio men who can give the dealer those suggestions and advices which are necessary in this business, on account of its newness to the people who are in it.

A great many jobbers try to carry everything that is being manufactured for radio use and in doing so they

do it to the detriment of the dealers whom they are to serve. You do not find an automobile, phonograph or piano agency trying to carry six or seven different makes. They find that one or two of those six are the best for them to carry and concentrate their efforts behind those makes.

In the radio business we find a great many trying to sell a half a dozen different makes of rheostats, sockets, receiving outfits, etc. No doubt this condition will be remedied. It will have to be before the long-heralded rush sets in. The jobber who will concentrate his entire energy on those lines which he feels are the best he can offer will not only be showing true representation to the manufacturers who supply them but will also render a real service to the dealer.

The retailer in turn must also limit the number of makes.

Picture for yourself a retail store and a customer asking for a transformer. The clerk asks him what kind he wants and the customer says "A good one." The clerk immediately displays a half a dozen different makes inviting the customer to take his choice. Due to the fact that he is carrying so many different makes the dealer cannot claim that one is a good one and the other a poor one. The dealer who carries only one or two makes can readily point out the advantages of those lines he carries over those of a competitive line and thereby create confidence in his customer.

Referring to prospective or proposed radio organizations it is my opinion that an organization made up of the representative manufacturers, jobbers and dealers of the radio industry will help greatly in stabilizing this young giant industry—for that is what it is, a giant.

In glancing through various radio magazines one notes that a great many dealers are advertising in them and for a fact that a great many of those advertising who are attempt-

(Continued on page 108)



M. W. Kunkel is one of Pittsburgh's leading radio wholesalers and as secretary and manager of the Pittsburgh Radio & Appliance Company has acquired a worth-while reputation in the Radio industry. The article, by Mr. Kunkel, on this page, is interesting and instructive.

# Everybody in the Radio Industry

## Firm Credits, Not Merely Optimism, Must Establish Business on Sound Basis For the Future.

By H. S. JOHNSON

General Superintendent, Ship Owners Radio Service, Inc.

It is a common practice for a certain kind of business man to insist that "business is good" when it is actually very bad, and to assume a worried expression and announce that "it could be a whole lot better" when he is enjoying the greatest prosperity of his life.

The habitual optimist believes that if the words "business is good" are repeated often enough, everyone including himself will sooner or later believe them and he cherishes a hope that the confidence so created will loosen up credit, encourage manufacturing, influence advertising and stimulate buying, and thus bring about a revival.

There may be some merit to this argument, but it somehow reminds me of a man who has a very bad cold, meeting his friends daily and repeating over and over "I am feeling fine, I am feeling fine," at the same time exposing them to his affliction. He may in time overcome his cold, by pure stubbornness, but on the other hand he may start an epidemic of colds and develop pneumonia himself. It seems to me that it would be much wiser for him to say "I have a bad cold, but I am going to take the day off and doctor it, and will be back tomorrow feeling fine. I advise you not to stand too close or you may catch my cold."

It seems to me that the wholesaler or retailer who is experiencing a dull business season might better say "business is rather dull, but I am doing what I can to improve the situation. I have stopped buying for the time being in order to reduce my inventory and collect the money due me. At the present rate I expect to be in good liquid condition within six weeks. I cannot pay what I owe you now, but I can pay you fifty dollars each week for six weeks, and if business does not pick up by that time I can reduce expenses and go ahead on a smaller scale or liquidate. If business does improve, as I expect it will, I will be in fine shape to take advantage

of it. I shall be prepared for anything."

A story something like this, if based on the truth, sounds much better to a creditor than an admission of inability to pay, accompanied by glowing optimism concerning the future, and promises of full payment, "when the boom arrives."

Real optimism is a fine and a valuable quality, but not the kind of optimism that blindly insists that black is white. Business optimism should be based on reason and judgment, not on a stubborn refusal to recognize a fact when confronted

with it. If business is poor, a merchant should look for the causes, study them, and make an intelligent estimate of probable future developments. Then he should make a careful inquiry into the state of his own affairs to see whether, without attempting to work miracles, he can pilot his business through. If this systematic investigation shows that it is possible, then he should become an optimist, and should never doubt for a moment that he is going to succeed.

If, however, this same investigation indicates that accounts receivable, plus probable sales, can by no stretch of the imagination be made to equal accounts

payable, plus running expenses, within the length of time that obligations must be satisfied, then he should not continue blindly, trusting to luck for an avalanche of business, and insisting that "business is good" while he dissipates his remaining assets in a hopeless attempt to survive. Instead, he should immediately call a conference of his creditors, explain the situation to them in detail, and abide by any reasonable decision, giving the creditors every opportunity to salvage what they can of the remains of the business.

Let us get both feet on the ground and look a few facts in the face.

Business is not rushing. Neither is it bad. It is just moderately good.

### *The Basis for Optimism*

*"Business optimism should be based on reason and judgment, not on a stubborn refusal to recognize a fact when confronted with it. If business is poor, a merchant should look for the causes, study them, and make an intelligent estimate of probable future developments. Then he should make a careful inquiry into the state of his own affairs to see whether, without attempting to work miracles, he can pilot his own business through. If this systematic investigation shows that it is possible, then he should become an optimist, and should never doubt that he is going to succeed."*

# Must Help Eliminate Weaklings

## How Stringent Measures Will Do Away With Bankrupt Stocks and Unfair Competition.

Neither is it likely to pick up with a bang on any particular date, as so many seem to think. The public is not at all likely to be stampeded by radio this year. They may, and doubtless will be stampeded by something, but not by homebrew, radio, or toddle-tops. It will have to be something entirely new. Radio will continue strong, of course, but it is past the sensational stage. I believe that what we can reasonably expect will be a good, normal increase as the season advances, with a good share of the holiday buying around Christmas time.

This applies to public buying, but there is another very important factor that will tend to delay revival of normal trading this year, so far as the manufacturers and wholesalers are concerned, and that, of course, is the amount of manufactured goods now in wholesale and retail stocks. A recent but very limited survey indicated that approximately a six weeks' or two months' supply might be on hand, which would mean that it will be a month or six weeks before retailers' sales are fully reflected in their buying. From the manufacturers' viewpoint, the length of time may be even greater, as many wholesalers have at least a month's supply on hand, and it may be well along in December before the manufacturers will feel the full effect of public buying.

The conclusion is that there will probably be no abrupt transition. The wholesalers and retailers will not all run out of stock at the same time, but the change will be a gradual one.

There are at this moment hundreds of radio retailers and wholesalers whose financial statements would reveal insolvency, who are hanging on, operating at a loss, piling up further obligations and dissipating their remaining assets in a childless optimism that on some certain date, not far distant, the public will again go radio mad and fight to buy their wares. Retailers such as these are doomed to failure before another year goes by. They are dropping out now, one by one as their burdens become too heavy or as their

creditors become aware of their actual conditions, and those who succeed in hanging on through the winter are not likely to retrieve their losses and are even less likely to survive another summer.

This is not pessimism. Radio is a real business and is here to stay, but the days of spectacular profits and mushroom growth have gone. Radio is going to support a great many successful manufacturing, distributing and retailing enterprises, but the difference will be that these enterprises will have to be adequately financed and properly managed. This being the case, there will be fewer of them.

I believe that the slipshod method of granting credit, and its frequent misuse by grantees is responsible for the greater portion of our radio business ills.

At the present time it is possible for almost anyone who has a few dollars in the bank, a few friends, and a printed letterhead, to obtain a very fair line of credit from many manufacturers and wholesalers. He starts out by writing a letter to a certain wholesaler or manufacturer, giving the bank and one or two of his friends as references. His friends assure the inquirer that Mr. Blank comes from a good family and is an honest and ambitious young man. The banker acknowledges that he maintains an account at

the bank, and as long as he has never been convicted of forgery, the bank says nothing against him.

Wholesaler Number 1 then opens up a credit of, say, fifty dollars, and ships goods which Mr. Blank receives, sells and pays for. He then orders another fifty dollars' worth from Wholesaler Number 1 and writes Wholesaler Number 2, giving Number 1 as reference. Number 2 finds that Number 1 extended fifty dollars credit, and therefore takes a chance on Mr. Blank for fifty or a hundred dollars. Then wholesalers Numbers 3, 4, 5 and 6 get letters giving Numbers 1 and 2 as references, and each grants fifty to two

(Continued on page 85)

### Merchants and Credit

*"The sound merchant should welcome strict credit requirements. He will be able to pass them, while his unworthy competitor will not. Thus a strict observance of business principles in the granting of credit would aid and not impede the reliable merchant. Proper and intelligent supervision of credit by manufacturers and wholesalers would lessen the likelihood of dealers over-stocking, and thereby lessen their chances of becoming victims of the brokers. This would benefit the sound merchant also, as he would not have to compete with so many bankrupt stocks."*

# What About the Retail Price Cutters?

## Present Orgy of Price Cutting Menace to Every Retailer, Jobber and Manufacturer

By EUGENE J. SCANLON

Morscan Radio Co., Newark, N. J.

Every reliable radio retailer is interested in making a proper percentage of profit, and for that reason every reliable retailer today looks with askance at the price-cutting orgy apparently in evidence in every fair sized city in the United States.

What's to be done about this? Something must be done to prevent it, lest the great mass of buyers acquire the thought that radio can always be bought at cut prices.

The first answer is co-operation between the retailers themselves. Having achieved that, they will soon be enabled to seek the support of the best manufacturers in the radio trade.

It is obvious today that quite a few concerns of magnitude in the radio industry have made reasonable efforts to curtail cut prices. They are advertising "retail prices," expecting their branded wares to sell at the advertised prices.

When they do less they brand themselves as get-it-while-it-lasts manufacturers. Their future in the radio business is obvious. Responsible retailers and jobbers cannot be compelled to feature articles which enjoy universal cut rates.

I am not aiming to place the price-cutting stigma on any manufacturer. I know several of the large manufacturing organizations are fighting this present day evil in every possible manner. I do not urge the organized retailers of any section to boycott branded, standard apparatus just because they are being offered at cut prices.

Some of us know that many of the cut-price stores are retailing apparatus of inferior quality, together with their special prices on products of merit. Some of these retailers, located in the high rental districts of their cities, it is likely, prefer to reckon turnover rather than discount.

It has truly been said that a retailer doing a business of five hundred dollars weekly, on a twenty-five per cent basis, has what appears to be a profit of one hundred and twenty-five dollars per week.

The same students of economics or business study then state that the

same retailer, with no additional clerical expense, can do a business of one thousand each week—provided he cuts his prices, say, ten per cent. And, as it is figured, fifteen per cent on one thousand is one hundred and fifty dollars.

So, as a retailer, you are the best judge of how you care to conduct your business!

But—there is another side to the story.

As a retailer, have you the right to endanger the entire retail field? Have you the right to damage the manufacturer of standard brands?

Possibly—business is business; but there surely is a moral side to business, and if the moral side is to be considered, what is to be said anent the obvious fact that if everyone cuts prices no one will gain—not even the manufacturer.

There are many men in business who maintain that some of the manufacturers of the land, in radio as in other industries, care not what becomes of their wares once they are shipped to jobber or retailer.

This isn't so. Stabilized jobbing and equally pleasant conditions in

retailing make for continued sales for the manufacturer, and make it in the modern business way.

No real manufacturer will produce merchandise for cut price markets, because under such conditions no manufacturer is enabled to foresee his future.

Even though radio merchandising was to become a mere price cutting campaign—some of our present large sized manufacturers would be privileged to produce a great amount of merchandise *and see to it that their wares were sold at cut prices.*

The result: In a short while they would have the market glutted with merchandise and with cut price retailers they would have the entire radio field to themselves, for the small folk and the newer concerns in the radio industry would be just ordinarily busted.

Inasmuch as there is no apparent desire on the part of the larger radio organizations to pre-empt the field to themselves, the price-cutting orgy is one that commends itself to the serious thought of the best minds in the radio fold.

(Continued on page 91)

## Survey Made by Engineer Uncovered Pertinent Facts

By GEORGE F. SHECKLEN

Manager, Pacific Radio Exchange, San Francisco

The Pacific Radio Exchange has recently made a series of field investigations, under the direction of their engineer, P. J. Townsend, and this exhaustive research uncovered some pertinent facts.

These facts should be known by all radio tradesmen. They are, as follows:

*First:* That the novice who contemplates buying equipment is a bit skeptical about spending a large amount of money for something about which he knows little or nothing.

*Second:* He does not care to purchase goods that he will have to junk

or turn in at a great sacrifice when he wants to increase the volume and range of his station.

*Third:* A vast number of potential buyers of radio receiving equipment are not in a position to lay down \$200, \$300, or \$400 at one time for elaborately constructed apparatus.

*Fourth:* That the purchaser of a completely assembled receiving set almost invariably falls back on the dealer with the query, "Can my set be wired to give me better results?" or "Can this or that be added to my

(Continued on page 98)



# Radio Industry Is Stabilizing

## Big Christmas Trade This Season and Far Greater Sales Next Year Are Predicted

By RAYMOND FRANCIS YATES

The year of 1922 will ever be looked upon as the Great Year of Experience in radio. We have made many mistakes this year that we will not make next year. For instance, we know that radio is going to be a more or less seasonal business until the importance of broadcasting reaches a point where it will take a more necessary position in our daily lives. The experience that we have gained over the past year should be worth millions of dollars to us next year. It is an experience that has been dearly bought. Dealers, jobbers and manufacturers alike may profit by it.

What is going to happen during the cold months? That is the question that is uppermost in the minds of those associated with the radio industry. Although the writer does not wish to take the position of an optimist with more imagination than common sense, he is inclined to believe that the radio sales of the coming year will far surpass those of the past year. We live in a very, very large country. True, perhaps, we have a million radio receivers in use, but what is this in a country with a population of 110,000,000 people? It is nothing but an insignificant fraction. The sales possibilities are astounding.

We often hear the question, "Is radio coming back?" Has it ever left? Sales have fallen off to be sure, but there is nothing alarming in that when we consider that radio is a form of entertainment and instruction. The phonograph dealers as well as the correspondence schools do very little business during the summer months. Even in this period the number of our broadcasting stations was increased and millions of capital was invested in the industry.

When business dropped off last spring, many thought that buying would begin in September. Then it was October. Next year we will know that it will take the first few weeks of cold weather to revive public interest and stimulate buying. As this article is written the shelves of the dealers are groaning and the warehouses of the distributors and jobbers are full. Some say we have enough merchandise to last for months. A little sober reflection will reveal the fallacy of this statement. Two weeks of inten-



### RAYMOND FRANCIS YATES

*Radio Editor, New York Evening Mail; Director, Permanent Radio Fair; Author, "Complete Radio Book;" Member I.R.E., A.S.M.E. and A.I.E.E.; Member Executive Committee, Radio Section of Associated Manufacturers of Electrical Supplies.*

sive buying will sweep the shelves of the dealers clean. Following this there will come a period of furious buying on the part of the dealer. This will find the manufacturer more or less unprepared since he is going to work closer to his orders this year after having such bitter experience last year in over-producing.

This is going to be the first "Radio Christmas." Last year radio was not firmly established in the mind of the public. This Christmas there will be more radio sets on the gift list. If some of our dealers wait until the last minute and then beseege our manufacturers with orders for early delivery there is going to be more than a normal shortage of equipment.

The author does not want to be accused of rhapsodizing, but he would also like to say something about the price-cutting situation. It is a situation that was simply brought about

as the result of a glutted market with its attending bankruptcies and business failings not only on the part of manufacturers but dealers and jobbers as well. Bankrupt stocks were sacrificed and quite naturally this merchandise was bought up and offered at ridiculous prices. Although this price cutting did a great deal of harm to the industry as a whole, it was positively inevitable. It will continue just as long as we have excessive merchandise. With the reawakening of public interest this cutting will automatically disappear. Every dealer who can sell a variable condenser for \$4.00 is not going to sell it for \$1.90. In passing over this situation it is interesting to note that it was not only dealers who cut prices, but in many cases manufacturers and distributors as well. The need for ready cash is a serious thing and this was the situation that confronted many legitimate houses that cut prices. It is the old story of "any port in a storm."

There is another angle of the radio situation that the writer would like to comment upon. It is that of the time payment plan. Time payments on the more costly instruments must come. The great buying public of the United States cannot afford to pay from \$75 to \$150 for a vacuum tube receiver in one lump sum. It is this very situation that has stimulated the parts business. Buying parts is one way of buying radio sets on the installment plan. When time payments come, parts will be purchased only by those who have the experimental urge. Then, too, there is a feeling on the part of many individuals that they can buy \$20 worth of parts and assemble a broadcast receiver that will do the work of a \$200 instrument.

Time payments will greatly reduce the sale of parts. The sale of parts has also done a little damage to the cause of a radio in a certain way. Assembling a receiver from a collection of miscellaneous instruments is not as easy a task as many would believe. Many sets have been assembled that did not bring the results anticipated and many novices have become discouraged in their initial effort to "roll their own."

While commenting upon the sub-  
(Continued on page 94)

# Doing Away With a Radio Battery Problem

## Telling Customers of Recharging Simplicity Improves Sales on High Grade Sets

By CLARENCE E. OGDEN

President and General Manager, Automatic Electrical Devices Co.

Many a new radio customer with the desire of owning a two-or three-stage amplification set, balks when he is informed that a battery is a necessary adjunct. He imagines all sorts of difficulties in charging and recharging his "A" battery, and pictures himself tugging it along to the nearest garage or service station every once in a while. Of course, he may finally decide upon a high grade receiving set operating on dry cells, and then again, this fear of batteries may cause him to buy a cheaper set than he had otherwise intended.

The moral behind all this is one that applies in almost every phase of radio merchandising. It is the dealer's duty to dispel many of the fears and illusions to which the uninitiated customer is heir. There is no real reason, for instance, why the customer should not be told how simple it is to recharge a battery, thus doing away with the necessity of having it recharged away from home.

There are many makes of home chargers or rectifiers on the market retailing at a popular price, which enable the radio fan to charge his battery at home at practically no expense, and without removing them from the receiving room.

While many of those devices require some electrical knowledge for their successful operation, the majority of them are extremely simple in the construction, and can be successfully operated by any one. The more efficient of these rectifiers will fully recharge any "A" battery overnight with a current consumption of less than one K.W. hour, which, based on the average cost of electrical current throughout the United States amounts to but five cents.

In the purchase of such a rectifier it is important that the buyer consider the following points:—

First, If the rectifier has a self-polarizing feature the battery may be connected either way and it will always charge. Otherwise, it requires considerable knowledge and skill to determine proper battery and rectifier polarity, and should battery be connected the wrong way, it is likely to be ruined, or, at least, seriously harmed through reverse charging.

Second, With a charging rate of

five amperes or more any battery of eighty ampere hour, or less, capacity may be fully charged overnight. Where a lower charging rate is employed a correspondingly greater time is required. For instance, with a rectifier delivering but two amperes about fifty hours continuous operation is required to fully charge a battery, during which time, of course, it is impossible to use the receiving set.

Third, The National Board of Fire Underwriters are becoming more strict in the enforcement of rules covering the use of only approved electrical apparatus. Any rectifier having the Underwriters' approval has been carefully tested by them and possesses practically no fire hazard. Considerable difficulty may be experienced in effecting an adjustment with the insurance company in case of fire, if the rectifier you are using has not been approved by them.

After a rectifier has been purchased, it is advisable to secure a hydrometer

for telling when the battery needs recharging. This instrument can be purchased for 50c. to \$1.00, and will pay for itself many times over through elimination of unnecessary charging.

A new storage battery should always be given an overnight charge before being used, since it has most likely been several months since recharged at the factory.

Maximum receiving range and strong, clear signals are obtained best when the battery is fully charged. For this reason it is always well to keep the battery in as near full charged condition as possible.

By taking a hydrometer reading after an evening's use of a receiving set, if the specific gravity of battery is below 1200, it is best to connect your rectifier and charge battery overnight. It will then possess maximum power, be ready for a long period of use, and will bring in the signals stronger and increase the receiving range of the set.

## To Study Broadcasting To Eliminate Conflict

"To aid the Government and the American people in peace or war, to eliminate the confusion of rapid development, to work with the Federal departments to devise a rational scheme of broadcasting for the Nation, to promote on a universal scale effective organization of all radio instrumentalities, and in general to undertake at once the solution of the pressing problems of the industry, now leading to conflict," are the declared purposes of the National Radio Chamber of Commerce.

William H. Davis, president of the Chamber, sums up the associations' attitude towards broadcasting, as follows:

"The only scheme of broadcasting which can prevail in any real sense is one in which the end to be attained

reconciles all conflicting elements, even to the submerging of private interests.

"A plan of regional organization has been adopted by the chamber. Broadcasting is receiving probably greater consideration than any other activity in the radio world today.

"The very nature of radio in the present phases suggests broadcasting. Until our wireless is brought to a point nearer to perfection than at present, radio will not be at its best in any form except in broadcasting. This is being internationally recognized. That there should be at this early stage of the art's development a considerable amount of conflict is natural.

"It is recognized, of course, that near the seacoast particularly, navy  
(Continued on page 95)

# Efficient Operation of Detector Tubes

## The First of Three Installments on Vacuum Tubes as Detectors, Voltage Amplifiers and Power Amplifiers

By **STERLING G. SEARS**

Radio Department, Stanley & Patterson

After about a year of general radio broadcasting, the men who have taken up this new sport are more or less familiar with the various types of radio apparatus in use. There is no doubt, however, that it will be some time to come before they know what each device does in operation and why one instrument works better than another. There are now a number of newspapers and periodicals undertaking the problem of educating these men and perhaps women too. Apparently they are progressing quite rapidly with their task. But, there seems to be one device that has escaped treatment quite effectively notwithstanding the fact that it is about the most important component of any good set. This device—popularly known as “lamp,” “bulb” or “tube”—is more accurately termed “vacuum tube.” Like other apparatus used in radio, there are several types and sizes, each for a little different purpose and each with peculiarities all its own.

The purpose of this series of three papers is to help further educate those who buy, sell or use vacuum tubes, along the various lines of their operation in an nearly a non-technical manner as possible. And since, to the radio man, the “detector” tube is the most important, and usually the most difficult to operate at its point of greatest efficiency, this first article will be devoted to detector tubes.

In the accompanying illustration three of the most commonly used detectors are shown, namely, the Radiotron UV-200, the Western Electric VT-1, and the Westinghouse WD-11. Each of these is a perfect detector when properly adjusted and each has quite different characteristics.

Taking them up one at a time, we will consider first the UV-200. This tube is known as a “soft” detector because it is evacuated only a little better than a good electric light bulb. A “hard” tube is one that is pumped out to a very much better vacuum and contains but an exceedingly small amount of gas or air. These are more difficult to make and of course are more expensive, but are not necessarily better as detectors than the cheaper ones. A low degree of evacu-



**STERLING G. SEARS**  
Stanley & Patterson

ation is very desirable for detection when properly used, just as a high degree of evacuation is desirable for amplification. Because of this “softness” a UV-200 makes a very efficient detector for both weak and strong signals, telegraph or telephone. On the other hand, this “softness” makes the tube more critical, and somewhat difficult to adjust to the point of maximum signal intensity and good stability. We find that, as a general rule the men who are receiving from great distances and getting exceptional re-

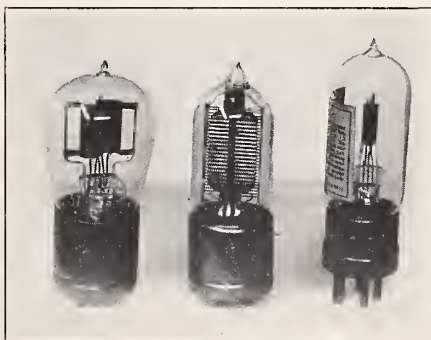

**GENERALLY USED DETECTORS**

*At the Left Is Shown the Radiotron UV-200, in the Center the Western Electric VT-1, at the Right the Westinghouse WD-11*

sults are using properly adjusted detectors of the “soft” type.

In the operation of these tubes, the filament current must be quite accurately adjusted, and being a tungsten filament it should be used at about bright yellow incandescence—requiring about nine-tenths (0.9) of an ampere for this condition. Some, however, work better at eight-tenths (0.8) of an ampere, some require a full ampere, and the proper setting can only be found by experimentation. In general, the filament should be slightly lower for distant signals than for local loud signals, and while the best point is dependent to some extent on the “B” battery or plate voltage, it can be determined after a little juggling of both.

The “B” battery should be adjusted to 1½ volts, which can be done with the ordinary tapped “B” battery. If a potentiometer is used still better accuracy will, of course, be obtained. These tubes are designed to operate at about 18 volts, and while the larger percentage of them do, some require 22½ volts, or even 28 volts. Beyond this point they will “blue-haze,” or show blue inside the bulb. This action will be explained later.

When once adjusted no further attention is necessary until either the “A” (filament) or “B” battery runs down. If accurately adjusted, these tubes make very fine detectors for both local and long distance reception, this latter, because they have a small amount of residual gas which makes them more responsive to weak signals than those of the “hard” type.

“Blue-haze,” as it is generally known, is caused by the residual gas in a bulb, and while all vacuum tubes may be made to blue-haze at some value of plate voltage (usually very high) “soft” tubes do so on relatively low voltages. This condition technically known as “ionization” is very harmful to any tube, rendering it valueless if allowed to continue any length of time. For this reason, it is important that the plate voltage be immediately reduced or the filament turned off, whenever a bulb gets a blue hazed appearance around the plate or between the plate and filament. Care should be taken never to

*(Continued on page 118)*

## Amateurs Must Stay on Own Wave Lengths

Complaint is still being made that the zealous Radio fan is on a rampage, despite the efforts of the great majority to keep this amateur enthusiast in due bounds.

Amateur broadcasting stations are very, very numerous and increasing daily, but too many—it is claimed—disregard the governmental regulations regarding their broadcasting wave lengths.

The many thousands now regularly patrons of the air are very often inconvenienced by the thoughtlessness or mischievousness of the few.

It is agreed that the amateurs have a right to the air—just like the professional broadcasting stations, but it is to be remembered that the big stations make possible the conveying of all sorts of lecturers, sporting events, music, lectures, etc., and the enthusiastic amateurs will have to bear up for the good of the majority.

Isn't it possible for the amateur societies—the radio fan clubs—to take care of this matter? Why should it be necessary to file complaints with air inspectors? Since when has the intelligent American boy become obsessed with any monopolistic air ideas?

We think the situation—to radio amusement—is not fraught with great danger. Most of us believe that when the American boys realize the condition they will remedy the interruptions to regulated programs. They will, themselves, take care of the offenders.

## Speed the Day of the Radio Specialist

There appear to be too many manufacturers of radio parts of all kinds—that is too many factories “make everything.”

Raymond Francis Yates, editor of the *New York Evening Mail Radio Review*, recently spoke on this matter, in this manner:

“The manufacturers of radio parts are in a mad rush these days. After the big storm blows over and things settle down a bit, the day of the spe-

## Co-operation Among Large Radio Manufacturers Will Develop More Broadcasting Stations

Radio broadcasting stations by general agreement are still serving the radio industry, properly and without disagreement among themselves.

A continuation of such arrangement will make for increased confidence in the part of the public for radio.

There is no disguising the fact that thousands of high-priced sets are *not* being bought right now because the potential buyer has no means of knowing absolutely that genuine broadcasting programs will be continued.

Radio dealers must assure the buyer of receiving sets, and the dealer in turn should have some assurances from the broadcasting stations.

That sounds like the proper manner, but it is patent that many of the present broadcasting stations are not being operated by radio apparatus manufacturers and so the dealer cannot exact any promises, nor can he buy apparatus conditional upon continued broadcasting.

Sensible tradesmen have reached the logical conclusion that each wave length will have its broadcasting very soon.

Air programs will become quite common. By this time next year there will be more than one thousand broadcasting stations. Every large city in the land will have at least one broadcasting station.

Where broadcasting is staple; where the programs are attractive—the radio industry is bound to increase.

Because of this fact it would appear as if the folks mainly interested at this time—the leading makers of apparatus, would combine to develop proper broadcasting stations and interesting programs.

It is not unfeasible. The biggest companies could call for a conference of manufacturers and could develop some means of taxing themselves to pay for broadcasting stations and programs for a period of, say, one year—to be renewed under certain conditions.

Most of the big fellows are spending considerable sums of money in divers ways, to put over their apparatus and yet appear to be neglecting their means and ways of popularizing themselves and at the same time helping the entire industry.

There are those who will argue that the larger companies in the radio field are already doing more than their share. Granted, but is that any reason why they shouldn't cooperate with the other fellows in the field and by mutual arrangement reduce their expense, per station, to increase the number of stations.

No danger lies in any of the so-called anti-trust laws, it is supposed, in the co-operation of broadcasting stations for the general public good.

Who will lead the way to more broadcasting stations?

specialists will arrive. Manufacturers, except the larger ones who have the necessary research facilities, will stop being jacks-of-all-trades so to speak. They will not manufacture every radio part that is used. We will have specialists in transformers, specialists in resistances, specialists in telephones, specialists in loud speakers, specialists in condensers and all of the various devices and instruments. Then each manufacturer will be able to concentrate all efforts in developing and producing one good thing. Doing one thing well is a plenty. The trouble with many manufacturers of today is that they are trying to do too many things.”

## Publicity and Radio

Radio manufacturers all over the country are missing an opportunity that seldom comes to an industry—an opportunity to secure volumes of valuable publicity at practically no expense or without serious difficulty.

Daily newspapers all over the country are conducting radio columns because their readers want them and are hard put to secure reading matter to fill their columns. This is unique in the average newspaper office where several times as much matter as is printed is thrown away for lack of room.

Manufacturers of every other line flood the editorial rooms with publicity matter galore, carefully prepared articles on a wide variety of topics fill the mail of the editor of the automobile section, the pure food page, the household section, even the market and sporting editors get enough "publicity" to fill an issue.

With the radio editor, however, the reverse is true. Outside of half a dozen firms in this industry practically no effort has been made to secure real publicity. Only three firms in the industry are known to have organized publicity departments, while out of the daily grist of trade letters that come to THE RADIO DEALER only one or two are prepared so that they do not have to be rewritten and revised.

Newspapers are interested in knowing news of the industry, in receiving interesting pictures of new and novel items, etc. The average bit of radio publicity is filled with superlatives that cause the newspaper man to smile and throw the matter away because he cannot take the time to re-write it.

The radio manufacturers must take a lesson from the automobile and even the phonograph people and give more attention to the preparation of publicity for the daily press—publicity that will reach the people and give radio a real boost.

## Mistake to Broadcast Advertising

"At its new station atop the Walker Street telephone building, the American Telephone and Telegraph Company has the latest apparatus, and a plan for broadcasting advertising to all radio fans—of selling time to soaps, home builders, razor blades, cocoa, hair tonics, and politicians, at so much an hour."

This quoted paragraph appeared in the *New York Times*, in a radio news story, which it ran in a recent Sunday issue.

It is to be hoped that the *New York Times* is in error, for the time is not quite here for conserving the air for advertising. The one million set owners haven't paid out money for radio for the purpose of listening to reasons why this or that product should be purchased.

Air advertising, meaning the use of the air for advertising purposes will develop, but this is not the time and New York City is not the place for any experiment, and though the *Times* carried this item it is hardly likely that the air advertising plans are really consummated.

It is doubtful whether the Government will allocate any especial time for the use of broadcasting stations established to create a new style of publicity—at this time.

The radio industry itself, the makers of sets as well as parts, and the wholesalers as well as retailers are opposed to the use of the air for advertising purposes.

Possibly when every home has its radio set broadcasting will be handled in other fashion than at present but as most of the present air entertainment

is of the gratis type it hardly is fitting for any commercial proposition to interfere with the pleasure of millions of people.

Radio will suffer a severe set back if direct advertising is broadcasted. There is no need for the sale of air rights and it is a matter of regret, to most of those who realize that the radio art is in its infancy to learn that the commercial minds of the community are already prepared to take advantage of a condition developed for them—not by them.

It is unfair to the industry—to every person in radio today and unfair to the American public, which supports radio, to talk of employing any part of the day for air advertising.

The Government can have no legal or moral right to permit the monopolistic use of the air for direct advertising.

The establishment of air concessions, for the sale of advertising, will—at its start—develop the natural resentment of the listeners—in; then will come opposition from many public sources and the broadcasting stations, themselves can expect interference from the thousands of amateurs who are licensed to send messages.

Trouble is bound to develop, not only for the broadcasting station but for the trade itself.

If the men who entertain the hope of broadcasting general advertising are in any manner justified in their ambition; if their desire is based upon service; if they have logical reasons to advance for desiring to monopolize the air—why don't they tell us about it?

## Sixteen Million Need Radio

Eight million homes in the United States are said to be wired now for electricity.

Six million homes are not now wired.

Keep these figures in mind in thinking of the future of radio as a business.

Everyone of the eight million should have a radio receiving set.

The same fact applies to the other six million homes. Opportunity knocks!

# Conditions in Radio Security Market

## Many Now Are Selling at High Prices and the Outlook Is Described as Bright

By FRANK T. STANTON

The great enthusiasm created by the successful broadcasting of World Series reports leaves no doubt as to the utility and popularity of radio. Prior to this event, the leading radio concerns, such as Radio Corporation of America, De Forest Radio, etc., instituted country-wide advertising campaigns, to stimulate buying of equipment for receiving these reports. I learn that results have more than exceeded the greatest expectations. In addition, the extensive radio exhibitions planned in the principal cities of the country, as witness the recent event at Chicago, are bound to develop increased buying power, which with the Christmas period ahead, should result in a revival of the radio boom. The industry was never in a stronger position nor faced with such promising prospects, as today.

Shares representing companies interested in radio, telephone and telegraph have been in great demand owing to the encouraging outlook ahead for the respective industries. Many stocks have made new high records and a continuation of the advance is confidently expected. Radio common, in reflection of increased buying of equipment and traffic over its international communication circuits, was particularly strong and active, touching  $4\frac{7}{8}$ . The preferred stock held firm around  $3\frac{3}{4}$ . General Electric reached  $188\frac{1}{2}$ , a new high, apparently discounting in part the strong physical and financial condition of the company and the great profits being derived from its electrical and radio activities. Other stocks shared correspondingly in the upward movement.

Latest developments of the leading securities in the radio, telephone and telegraph divisions are outlined below:

**RADIO CORPORATION:** Through negotiations just completed the United States, through the Radio Corporation of America, becomes the clearing house of radio communication—a vast system of international wireless plants which is fast becoming the big and controlling feature of commercial communication.

Through an alliance, the receiving

station of the corporation at 68 Broad street, Manhattan, becomes the central control station of the radio traffic handled by the world's five largest wireless stations, capable of handling thousands of words an hour within a radius which encompasses the principal marts of the world. The big transoceanic station at Rocky Point, L. I.; the Carnarvon (Wales) station of Great Britain, France's powerful station at Ste. Assis, near Paris; the famous German POZ at Nauen and the new Argentine station at Monte Grande, near Buenos Aires, now nearing completion at a cost of \$16,000,000, the largest and most powerful radio station in the world, are the stations now centrally controlled by the American firm.

The combined companies represent an investment of \$170,000,000. In order to effectively operate the combined units, the Radio Corporation purchased a \$1,000,000 building in the New York financial district, which will be known as the "Radio House." The building is in the centre of the financial and commercial district and close to the principal cable and telegraph forwarding offices and particularly near the Postal Telegraph Company's office, with which the Radio Corporation has recently entered into a traffic agreement whereby the Postal company collects and distributes trans-Atlantic radiograms from and to all points in the United States.

Radio has reached a far more advanced stage in public service than is ordinarily supposed. For example, at the present time radio companies are handling 24 per cent. of the trans-Atlantic telegraph business. Under the arrangement outlined above increased efficiency and economy of administration will double this figure within a brief period.

As the representative radio organization, Radio Corporation stock issues look particularly attractive.

**GENERAL ELECTRIC:** As previously mentioned, General Electric sold up to a new high. The company received orders for the three months ended September 30, 1922, of \$58,914,620, as compared with \$41,-

608,332 for the same quarter in 1921. This represents an increase of 42 per cent. For the first nine months of the year, orders have totaled \$176,171,194, as compared with \$135,256,462 in 1921, an increase of 30 per cent. General Electric is one of the world's largest manufacturers of electrical machinery and appliances, incandescent lamps and radio equipment. Organized in 1892, the company's history has been one of consistent growth and expansion. Considering its fundamental strength, established earning power, remarkable dividend record and assured future of the industry it represents, the stock meets the requirements of the most discriminating investor or trader. Current dividend rate is \$8 cash and 5 per cent. in 6 per cent. cum. special stock, annually.

**ENGLISH MARCONI:** The company proposes to raise additional funds by creating £3,000,000 short term convertible debenture stock of which £1,500,000 is to be issued at once and remainder when required. Proposals involve extension of borrowing powers and an increase in ordinary capital to provide for conversion rights. A special meeting has been called to pass resolutions, one of which provides for increasing capital to £4,000,000 by creating 1,000,000 ordinary shares at one pound each. Apparently the company does not deem it advisable to wait until final settlement of its large claim against the British Government, but intends to carry out at once its ambitious plans for expansion. The management realizes that the industry is firmly established and possesses extraordinary possibilities and by taking advantage of present opportunities will be able to maintain its dominant position in the industry. In this connection, the company plans the erection of high-powered wireless stations in Australia, Africa and Spain and has under consideration a program, which when completed will double present earning power. Increase in capitalization should very likely result in valuable rights to stockholders as well as create further heavy buying of the shares.

(Continued on page 124)

# Trade Marks for Trade Associations

## Every Association Should Have a Distinguishing Insignia Which Should Be Frequently Used

By **CHAUNCEY P. CARTER**  
Trade Mark Specialist

Notwithstanding the activities of the Department of Justice and the Federal Trade Commission against associations of competitive units in the trade field, the number and strength of such associations is steadily increasing under the friendly counsel and patronage of the business man's department in the Government, the Department of Commerce.

One of the latest to enter the field is an association of slate producers who have just announced a contest for a slogan and trade-mark or insignia for their association.

Every association should have a distinctive emblem or insignia that should not only be used in its advertisements, letterhead, booklets, etc., but should also be used by the members on their letterhead, advertisements, etc., and on the articles or packages.

After an emblem has been chosen by an association as a result of a contest or otherwise, the officers of the association usually set out at once to secure protection for the same. How protection may be properly secured cannot be decided, however, until it has been decided how the mark is to be used.

Until a mark has been actually applied to shipments of goods in commerce, i.e., either directly to the goods themselves or to the packages containing the goods, it cannot be held to be a trade-mark, since a trade-mark is a sign which distinguishes the goods of one factory or association of factories or traders from those of another factory or association of factories or traders. If the mark is to be used by members of the association in connection with the goods themselves, i.e., applied to the goods or the packages for the purpose of distinguishing the products of members of the association from similar products of others, it is best to treat the mark at once from that standpoint, make some marked shipments as early as possible and register the mark whenever possible as a trade-mark in the name of the association.

Strange to say, while the United States is probably the foremost nation in the matter of the organization

and maintenance of trade associations, it is one of the most backward in the matter of providing facilities for the registration of trade-marks of such associations. It is now eleven years since the United States adhered to an International Convention under which it is bound to provide registration facilities for collective or association trade-marks of associations domiciled in any of the other nations that have adhered to this convention, and yet not only have such facilities not been provided but we have not even as yet provided for the registration of marks belonging to our own trade associations. Hence, trade associations, the emblems of which are used by members as trade-marks, must rely on the common law for protection of such use until Congress provides facilities for statutory registration of such marks.

Where the mark is only to be used on letterheads, in advertisements, etc.,

and is not to be applied to the goods or the packages, it is usual to invoke the copyright law for protection, but in such cases the mark must of itself have literary or artistic merit or else registration will be refused and protection denied.

Some copyrights are registrable only in the Library of Congress, i.e., those that relate to the finer arts, while other copyrights, namely, those covering subject-matter that is used or to be used in connection with articles of manufacture, are registrable in the Patent Office as "prints" or as "labels," depending upon their use.

Emblems that are neither copyrightable or subject to trade-mark registration may still be registered in the Patent Office as mere "emblems," and such registrations will operate to prevent the registration of the same or devices by others as trade-marks for any articles whatsoever.

## Business Static Slowly But Surely Being Eliminated

By **C. E. GODLEY**

Business conditions in the radio field today may be likened in a general way to the difference between the rank radio amateur and the professional man.

The new amateur gets a sudden inspiration, that if another man can make a set which will do all that can be expected he can too. With the result that he goes ahead and buys a great many parts makes an effort to duplicate the instrument of the professional, making a complete failure of the whole thing and then blames the failure on the impracticability of radio, static, improper diagrams by the expert, or a thousand other reasons, any one of which is preposterous. He has completely overlooked the fact that by vocation he is perhaps a blacksmith, a bookkeeper or ribbon clerk, and that if he had spent the amount of money and time in the interest of his own vocation, or an instrument made by an

expert he would be 100 per cent. better off, and have been money in pocket.

This sort of man has learned a sore lesson but is not willing to admit it, so he claims radio is not practicable and will sell his parts and equipment for any thing he can get.

Finally he does sell them to some one else. This second buyer is a man with some experience in radio. He takes the same instruments and tries to construct them into an efficient set and when he has completed it, he finds they have been so badly mutilated by the inexperienced man that they are useless.

Now man number two has learned a lesson he too is a loser, but unlike the first man he does not "holler" or welch. He knows the results are due only to inferior materials, so he goes right ahead and gets the proper ma-

(Continued on page 83)

# Learn Costs Before Fixing Selling Price

## Importance of First Accurately Determining Factory Costs Is Impressed on Manufacturers

By HENRY L. SEIDMAN  
Certified Public Accountant

I submit the simple proposition that a man cannot fix a selling price unless he first knows his costs. So elementary is this proposition that to dwell much on it is to insult the intelligence of the readers; and yet the principle most ignored is that same, simple one just stated.

In a new industry, such as the radio field is today, when manufacturers and dealers are blindly and hesitatingly groping in the dark, feeling out before them like so many lost souls, to know how to arrive at one's costs, and to know what they consist of and how much, is to tear away the cloud that darkens, to bring a searchlight to bear, so that one can see clearly and distinctly.

How many men really know their costs and how to arrive at them? The majority of those whom I have met did not; and those who did were invariably the successful ones. Each man seems to have his own way of figuring his costs, and yet the operations may be reduced to a few simple rules.

Usually, when I get this far in a discussion my client will invariably raise the objection that "knowing your costs does not avail where the prices of my commodities are fixed by competition; why, if they know their costs do my competitors set so low a selling price, sometimes far below my cost of manufacture?"

There are two replies that I make in answer to such an argument: First, that some of his competitors are able to set a lower price than he because they know from their cost systems just what it costs to manufacture the article, just what elements of cost enter into it, and knowing these, they can, by closely watching the tabulated reports they get, quickly determine which of these elements are too costly, and consequently where the leaks are. Then, stopping these leaks is only a matter of time and energetic watchfulness. Secondly, there are men in every field who care not a rap about costs, and the bankruptcy courts are their inevitable end.

These latter men are being fast weeded out; competition must become more legitimate, and when that time arrives the most welcome competitors



HENRY L. SEIDMAN  
Certified Public Accountant

are those who know the cost of the articles they sell. Of these men no competitor need be afraid; for them the competition is not one of price, but of quality and service of product.

To lay down rules for arriving at

costs for everyone to follow is impossible. No two manufacturers have the same conditions, equipment, purchasing or manufacturing ability, to start with. Secondly, the financial ability to buy in large quantities is of great importance. The writer, therefore, can but make suggestions which seem to him to be of importance to all dealers, and if he can but set them thinking about the matter of costs he feels that some good will have been accomplished.

The cost of an article must of necessity include all of these elements:

Material.

Labor.

Manufacturing overhead.

Commercial expenses, consisting of:

(a) Receiving and shipping.

(b) Selling.

(c) Administrative.

(d) Cost of financing business.

Our discussion is simple where a manufacturer makes or deals with only one article. But it becomes more complex and involved where he manufactures or deals with a number of articles, all different in shape or materials. The first man can readily follow a discussion involving the latter.

## Asks Injunction

### Omaha Man Sues Radio Corporation, General Electric and Others

A charge that the Radio Corporation of America, the General Electric Company and others have entered a conspiracy to obtain a monopoly of wireless service and prevent individual use of the radio is made in a suit filed in the United States District Court at Omaha, recently by John O. Yeiser, Jr. of Omaha, who asks an injunction to restrain the defendants from interfering with his right to broadcast.

Mr. Yeiser alleges that "there are 25,000 wave lengths that may be used in transmitting distinct non-interfering radio service, and yet the said defendants, by conspiring with unknown underlings in the department of the Government assuming to exercise authority over the radio service, have

crowded all broadcasting stations sending music, lectures and educational matters to waves of 360 meters."

The Radio Corporation, General Electric Company, the American Telephone and Telegraph Company, the Northwestern Bell Telephone Company and the Westinghouse Electric and Manufacturing Company and other persons and corporations unknown to Mr. Yeiser, he avers, "intend to erect distinct sending stations and commercialize the same by charges for broadcasting."

He alleges that the first amendment to the Constitution, which says, "Congress shall make no law abridging the freedom of speech or of the press," is being thereby violated. A jury to determine damages, which he alleges to be \$25,000, is requested, with treble damages under the Sherman anti-trust law and an attorney's fee of \$25,000.



# Possibilities of Work for Association

## Radio Trade Association Has Vast Possibilities for Improving Conditions in the Radio Industry

By L. A. NIXON

The Radio Trade Association has great possibilities for bettering conditions in the industry, according to reports recently made to that body covering some of the work outlined for the association.

At a recent mail vote of the membership of the association it was decided that dues of one dollar be assessed to cover the cost of operation of the association until early in January when the first national meeting will be held. Special membership certificates have been secured for the membership and new members are daily being added to the rolls.

Announcement of the officers of the association recently elected by the body in a mail vote will be made in THE RADIO DEALER WEEKLY, possibly before this article is in print. Early reports on the balloting show that the officers of the association will include some of the representative firms in the industry, jobbers, retailers and manufacturers from every section of the country comprising those now leading in the balloting.

One of the most interesting reports given the association was that covering the possibilities of the establishment of some definite standards for equipment with the possible granting of the association trade mark to the manufacturers whose apparatus passes certain standards. The report follows:

### REPORT ON STANDARDS

The Radio Trade Association, being as it is, the largest organization in the trade, can be of great benefit to the industry at large if it will endeavor to show the buying public where and what to buy.

Radio has acquired considerable of a black eye due to the mass of cheaply made apparatus thrown on the market during the slump last summer and it is felt that some measures are required to restore confidence and remove the stain.

A large percentage of the apparatus on the market today is of superior worth and the makers prove their confidence in their goods by guaranteeing it to give service and to be up to a certain definite standard.

It has been suggested that the committee on standards pass on apparatus made by manufacturers who are members of this association, issue specifications for the apparatus and in cases of merit, permit the use of the association trade mark on the goods in question.

Due to the great mass of the work to be done by this committee were this work undertaken, the proposal has been made

that a testing company of established merit be called upon as aid. The plan today calls for submission of the apparatus to certain testing laboratories that are approved by the committee, the report of the laboratory to be made up in a form to be designed by the committee.

When the manufacturer receives his report if he so desires this report may be submitted to the committee for approval. From the report the committees will make up the specification sheet covering the apparatus which will be furnished every member of the association, and, if the article is considered of merit, a permit to use the association trade mark will be granted.

The manufacturer would be called upon to furnish to the committee a guarantee covering the apparatus reported on, which guarantee will be incorporated on literature accompanying the goods or otherwise displayed so that the buyer may know that the maker stands back of the goods.

Any case of failure on the part of the manufacturer to live up to the guarantee or to maintain the standards for the apparatus as set forth in the specifications, upon due proof, will result in the loss of the license to use the association mark, and expulsion from the association at the discretion of the board of directors.

Positively no publicity shall be given to the refusal to grant any permits by this committee, nor is the manufacturer required to submit any report made by a testing laboratory to the committee, the application being subject to withdrawal at any time.

Several testing laboratories which have been approached in regard to this proposition state their willingness to make special rates for association tests if a sufficient volume of business can be promised them. The specifications for each piece of equipment, if desired by the manufacturers, may be printed on loose leaf sheets, and mailed to the membership of the association at actual cost to the manufacturer.

It is expected that a number of manufacturers will avail themselves of this opportunity and that retailers and jobbers will preserve the specification sheets for daily reference. The printing of the specification sheets will be entirely optional with the manufacturer, though the committee will be required to report to the association membership at regular intervals announcing the parts and sets passed upon favorably by them.

This plan has the merit of adding reliable manufacturers not only with the public through the advertising benefit of the use of the trade mark, but through the trade because of the publication and benefit it will be to have on file complete technical details as to the products of manufacturer-members.

It has been felt that this committee can be of great value to manufacturers, after a time, through furnishing them with reports as to the various size screw parts in general use, etc., with the end in view of establishing definite standards that will help keep production and handling costs at a minimum.—J. R. H.

Another point where the association can be of great value is in the matter of credits. One of the drawbacks to doing business in this industry today is the difficulty with which credit lines are drawn and the inability of many jobbers and manufacturers to secure proper information about firms that they wish to do business with.

As the report, which follows, points out, this is a difficult problem for any association and one that possibly might better be delayed for a time, the association can be of great value to its members in this way, better credits resulting from closer study and better knowledge among the trade, one of another.

The report says:

### REPORT IN REGARD TO CREDITS AND CREDIT RATINGS

The matter of credits and the furnishing of credit ratings has been carefully considered for the Radio Trade Association and the conclusion seems that for the association to undertake the business of furnishing credit reports on members would be little short of folly at this time.

In some of the smaller national associations of manufacturers in other lines it has been advantageous to furnish members with a more or less accurate credit service, but due to the necessity for members of the trade being on the committee that would have access to credit records it has been thought unfair for one member to be asked to give out intimate facts about his business for fellow members who might be competitors.—R. C. H.

It has been suggested that while there is no national organization of broadcasters there are already several well established associations of firms conducting broadcasting stations covering various sections of the country. There is no doubt that a common meeting place for these associations will result in closer co-operation and better results for the industry as a whole. It seems the opinion of a number of members that broadcasting stations be invited to membership in the association. The importance of the broadcasting station cannot be overestimated at this time, as only as long as the stations maintain a high standard of excellence does public interest grow and continue. A series of poor programmes will do more to injure radio interest in one section than static or continued electric storms or

(Continued on page 116)

# Aggressive Publicity Aids Dealer in Selling

## Window Displays and Co-operation of Manufacturer Are Ways to Help Radio Sales

By JOHN R. HALL

Radio dealers are learning fast that the business of handling radio sets requires salesmanship just as in any other business. The day when radio was expected to sell itself is past. In spite of all the publicity radio is getting, in spite of the peculiar advantages that free broadcasting offer to the dealer, in spite of the attraction of radio itself, the ultimate question which one asks to find out whether or not a radio dealer is a success is, "Does he know how to sell? Does he take advantage of the advertising possibilities of radio?"

It is true that radio dealers the country over are now awake to the need of setting forth the merits of the wares they sell. In radio this amounts to an explanation of the uses of each piece of equipment as well as the setting forth of the reasons why one brand of equipment is superior to others.

In this manufacturers are also beginning to help. The Connecticut Instrument Co., Inc., of Stamford, for instance, has grasped the principle of publicity helping to clinch sales. How better can you clinch a sale than by putting arguments in verbal form on the very goods themselves? The accompanying illustration shows the

Should the diaphragm of a headset be metallic or non-metallic? This is admittedly an important question in

diaphragm is preferable because:  
"1. It suppresses the free periods which cause the sudden blasts

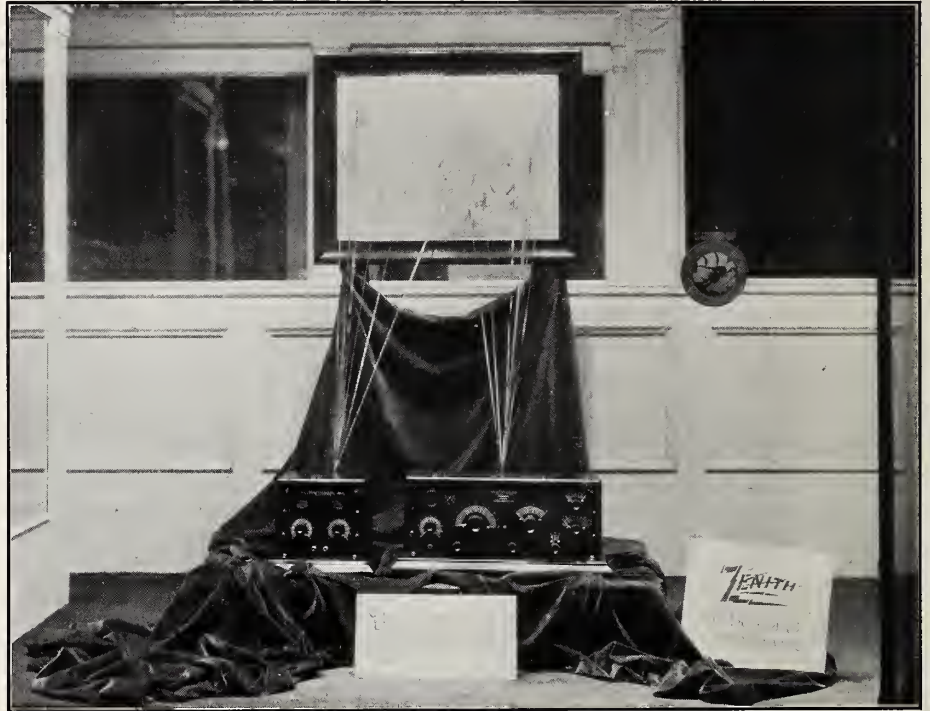

Zenith Window Display made by the Cable Company at Chicago



Connecticut Instrument Company Box Cover

use to which the Connecticut Instrument Co. is putting the boxes enclosing their headsets. Artistically printed, the cover lists the strongest selling points of the C. I. C. headset.

the purchase of a headset. The cover of the Connecticut headset box proceeds to answer that a non-metallic

and overloading on certain notes.  
"2. It counteracts the transmits or  
(Continued on page 125)

# King Symbol Used by King Sewing Machine Company

By B. J. FARRELL

The radio apparatus division of the King Sewing Machine Company of Buffalo, N. Y., was established in May of this year, under the direct supervision of Edward H. Striegel, who is recognized as a real radio engineer, with sixteen years of commercial radio experience as a guide and guarantee.

King Quality is the symbol of their radio product. The symbol of King Quality for years, has been the standard of their manufacture in small and accurate parts for sewing machines and other products. This standard

of quality together with large production facilities, underlies the King Quality radio apparatus, which really means that only the best is good enough to bear the King Quality symbol.

King radio apparatus is designed by King radio engineers, who are thoroughly skilled in the design of radio apparatus of highest merit. The important factors of accuracy, ruggedness, exclusive design, efficiency, quality and appearance, all blend in construction to bring about the basis  
(Continued on page 84)

# The DeLuxe U. S. Navy Type Radio Receiver

List \$595.00

FOR IMMEDIATE DELIVERY

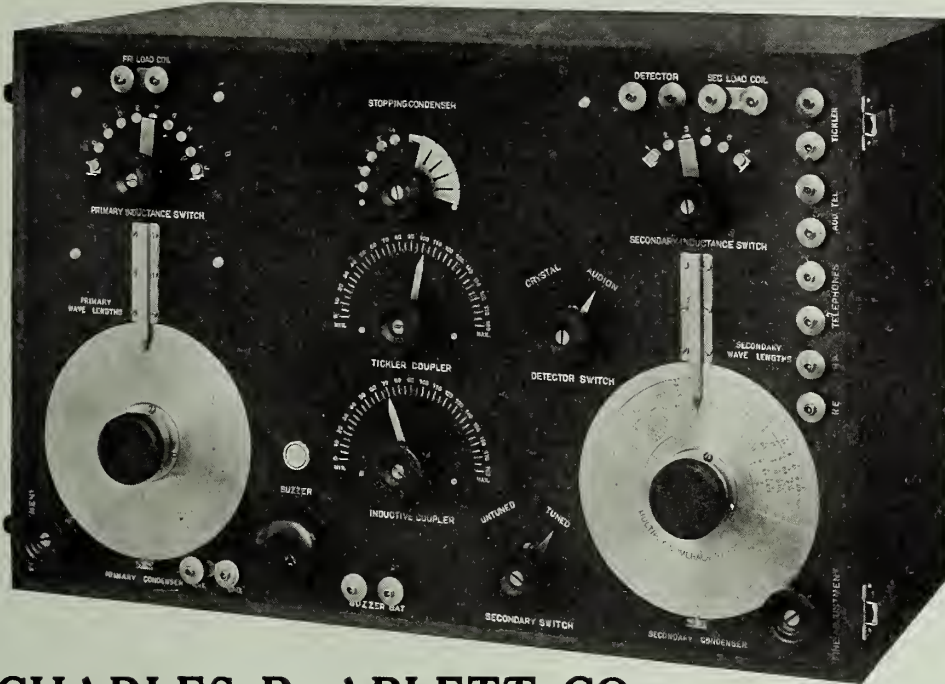

Best of its type—must not be confused with instruments selling for from \$200 to \$300. Highly selective. Will pick up messages, music, lectures, etc., that lower priced instruments will not hear. This receiver is equipped with binding posts which are normally short circuited for 300 to 6800 meters by which wave lengths up to 23,000 meters may be received by the attachment of loading coils. Capacities of proper loading coils for above are: Primary 50; Secondary 50; Tickler 30 millihenries. While the receiver is provided with a "standby" or un-tuned circuit, it also has an unusual degree of selectivity. Although primarily designed for the more advanced fields of Radio work, or the laboratory, the simplicity of arrangement and beauty of finish make it unusually desirable for the radio club or for the individual who desires the finest equipment obtainable for his home or office. In the receiver, Bakelite tubes, threaded, provide the forms on which inductance coils of high frequency cable are bank-wound. After assembling, the coils are impregnated with an insulating compound, in vacuum, and thoroughly baked. The inductance switch controls a mechanism whereby the different sections may be connected, completely disconnected and opened, or completely disconnected and individually short circuited. This arrangement is important for, by it, each coil has a natural period when connected which is less than the shortest wave length in the receiver's range. The reception of parasitic signals is overcome, the absorption of desired signals by the coils is minimized, more energy is forced to the detector and on all wave lengths the interference is reduced.

**CHARLES R. ABLETT CO.**

199 Fulton St., NEW YORK CITY

## We present to the Radio public a new Triple Coil Calibrated Mounting

There is nothing more fascinating than the reception of Radio messages from high power stations located thousands of miles away. These stations use wave lengths between 1,000 and 25,000 meters. This is far above the receiving range of the average receiver designed for amateur broadcast reception.



This "Crown" Mounting has the following special features:

1. Made of Thermoplax, a high grade insulating material; it possesses the advantage over rubber of resisting heat to a far greater degree. It has high dielectric and mechanical strengths, is non-hygroscopic, is unaffected by atmospheric agents and will not deteriorate with age.

2. Special Locking Device to keep the coil in place, thus preventing it from being thrown out of adjustment.

3. Special Adjustable Bearing feature.

4. Special constructed Bushing, preventing wear on top and bottom plates.

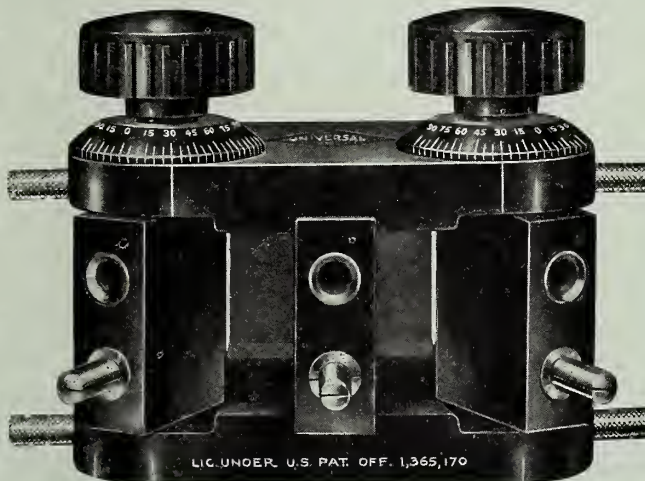

Licensed under DeForest U. S. Patent, No. 1,365,170

5. Special constructed Calibrated Dial, showing the stations tuned.

6. Positive Connections on rear of blocks.

7. Complete with Flexible Leads.

8. All Metal Parts of brass and highly nickel plated. Its high polish and fine finish give it a very attractive appearance.

9. The simplest Mounting to install on your set.

List Price

- Triple Coil Mounting . . . \$5.00
- Double Coil Mounting . . . 3.50
- Single Coil Mounting . . . .50
- Telephone Plugs . . . . . 1.00
- Telephone Jacks . .65c, 80c, 95c
- Dials 2", 3", 3 1/2" .35c, 50c, 75c

DISTRIBUTORS WANTED WRITE FOR OUR PROPOSITION AT ONCE

**CROWN RADIO MFG. CORPORATION**

78 FIFTH AVENUE

NEW YORK

THIS WILL BE A RADIO CHRISTMAS!

WE ARE NOW IN A POSITION TO SHIP YOUR

# Text Book on Radio

By JAMES R. CAMERON

A book that covers the subject of Radio from A to Z. Written in such a manner that it is easily understood.

350 Pages, over 200 Illustrations. Cloth, \$2.50, Flexo Leatho, \$3.00. Sold on a Money Back Basis.

HERE ARE A FEW OF THE PUBLICATIONS THAT WE ARE USING IN OUR EFFORT TO HELP YOU RE-SELL

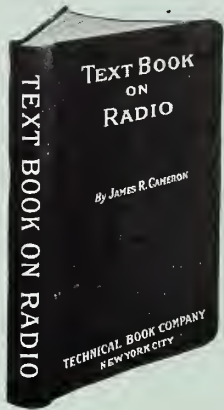

## TECHNICAL BOOK COMPANY, 130 W.

N. B.—Just as THE RADIO DEALER goes to press we learn that within the York City (name on request) six copies of THE TEXT BOOK ON RADIO the original order was

THIS WILL BE A RADIO CHRISTMAS!

**ORDER THE SAME DAY WE RECEIVE IT**



Behind the rapid selling of this remarkable text-book stands our program of continuous advertising. We not only sell to you, but help you re-sell.

*The Discounts we now offer Jobbers and Dealers warrant immediate purchase. They could not be larger.*

We will be glad to offer any merchandising ideas and suggestions that you request. With aggressive methods, you can put the "TEXT BOOK ON RADIO" over big in a comparatively short time.

**WRITE US FOR SAMPLE COPY WITH OUR DEALERS DISCOUNT SHEET. BOTH WILL GREATLY INTEREST YOU.**

**42nd Street, New York City, Dept. F.**

First hour of its being on sale in one of the most exclusive shops in New York (Flexo-Leatho Edition) were sold, and a repeat order more than doubling was received from this concern.

*THIS WILL BE A RADIO CHRISTMAS!*

Temporarily Inconvenienced By

**FIRE!**

Lest  
You  
Forget :--

**ACE  
WIRELESS  
BATTERIES  
ARE  
COMING BACK**

Factory destroyed by fire on Sept. 24th but CPC prestige, spirit, and battery-manufacturing knowledge remains imperished. We regret that this unavoidable incident should react to your own inconvenience but remember we will soon be back on the job with a still better line of batteries and carbon products.

Our new factory is now being equipped with greater facilities and improved machinery.

WE EARNESTLY INVITE ORDERS FOR FUTURE DELIVERY AT THE EARLIEST POSSIBLE MOMENT.

**THE CARBON PRODUCTS CO., LANCASTER OHIO**

**Adjustable Coil Mountings for Armstrong's Super-Regenerative Circuit**



Single and Double Coil mountings adapted for use with the new Armstrong super-regenerative circuits. These mountings are adjustable. Made of genuine Formica, with high polish and fine finish. All metal parts heavily nickel plated. Not a moulded affair.

The Unbreakable Dial

- The New Triple Coil Mounting with the following features:
- 1—A patented feature; locks the coil in place. This prevents the coil from being thrown out of adjustment once the station is tuned in.
  - 2—The simplest mounting to install on your set. No rear mounting. Mounts on front of panel.
  - 3—The tension on specially constructed bearings is adjustable.
  - 4—Constructed of the highest grade of insulation material. Its high polish and fine finish give it a very attractive appearance. All metal parts heavily nickel plated. Not a moulded affair.

- Triple Coil Mounting, List Price..... \$5.00
- Two Coil Mounting, List Price..... 3.50
- Single Coil Mounting, List Price..... .55
- 3" UNBREAKABLE Dial, List Price..... .70
- 3½" UNBREAKABLE Dial, List Price..... .90
- Amco Radio Plug, List Price..... 1.00

Our production is large and your orders will receive immediate attention.

Jobbers write for special discount



**ASTORLOID MFG. CO., INC.**

**416 Marcy Ave., Brooklyn**

THIS WILL BE A RADIO CHRISTMAS!

# Exposing Frauds and Fakirs in Radio Industry

## Some of the Schemers in Radio Industry Have Been Exposed and Ejected and Some of the Other Smug Sure-thing Folks Are On the Way Out

By HARRY M. KONWISER

Investigation into the recent mercantile failures in and about New York in the radio industry, clearly indicates that the business which found their way into the bankruptcy courts—their total is not very large—failed to score financial success because of certain conditions, none of which in the slightest degree, can be attributed to radio itself or to the industry.

The major cause of failures were caused by insufficient capital, together with impracticable business operations. There appeared to be a lack of managerial ability together with the mistake of starting in business improperly financed.

A few of the recent failures developed from the lack of interest displayed by the public in the buying of neatly printed radio stock certificates. Not every "promoter" made enough to pay for any of his labors. One outstanding failure, in the radio promotion field, a million-dollar capitalization, hasn't sold enough stock to pay the president's salary, nor the rental and other necessary incidental expenses that are required in every business.

Another stock company, after six months of strenuous effort, in and about Greater New York, has sold just eighteen hundred dollars' worth of shares in their half-million dollar stock corporation.

Proving, merely that the way of the radio stock promoter is not one of roses—at this time, thanks to the timely warnings sent out by a number of public-spirited folks.

Incidentally, not every newspaper in the country, so-called trade papers included, have been over careful in not soliciting advertising from companies apparently organized to make and sell radio apparatus—but really organized to sell stock certificates at prices that are ridiculous. THE RADIO DEALER points with pride to its clean advertising columns. Stock promotions, no matter how large, are barred from the advertising portions of this paper.

Referring to stock promotions, it may interest our readers to learn that of the recent promotions developed in this manner:

A concern, with small capital, was operating in a small manner. Mr. Promoter came along and offered the small concern ten thousand dollars in cash and forty thousand dollars in certificates in a new corporation to be started. Agreed.

The small concern had accounts payable to the total of almost ten thousand and the partners paid their bills and turned over their lease to the newer company.

Mr. Promoter now came along to the new company—capitalized at a million—and proposed to sell some of their stock, to the total of not more than \$500,000, agreeing to give the company 20 per cent. of the amount received from the sale of such stock.

This promoter sold stock to the total of about \$150,000 and turned over \$30,000 to the new million-dollar company.

Something happened right about this time. Unfortunately THE RADIO DEALER cannot go into further details, but it might be stated that the company itself is behind in its rental, does not meet past due bills of small size, has only an office boy in sight and really is close to bankruptcy.

Creditors who have recently made an effort to collect their accounts do not deem it worth the while to place the concern in bankruptcy, first because their assets are nil and their closing up but a matter of days.

There have been in the radio industry, as in other lines, dishonest newcomers who have opened stores or offices, posed as retailers or jobbers, bought goods for which they have paid; then, having purchased merchandise in greater proportion, have skipped.

There have appeared in the radio industry, men who have posed as manufacturers of radio parts and apparatus generally who are no more manufacturers than is Hearst president of these United States. They have taken orders at extremely low prices and in some cases, and having taken cash deposits or five or ten per cent., have forgotten their customers! THE RADIO DEALER has reports on some of these gippy gentlemen.

One or two smart frauds, posing as manufacturers, have sold wares "as per sample." Then they have offered the customer a special five per cent. off for cash upon delivery. The customer, agreeing, he, in a little while, receives a C. O. D. shipment. When he opens the package the gentlemen who acquired a special five per cent. learns he has been stung—for the wares are of inferior quality, and hardly up to sample.

"Try to get your money back; the postal laws don't permit this sort of stealing." That's the advice a New York City lawyer tendered his client, who had been stung in the manner above narrated, by a New England "factory."

The legal gentlemen are familiar with the story about the man in jail, assured by his attorney that the laws do not permit a man to be jailed for the act alleged to have been committed by the man in jail. "But I'm in jail," cries the man in jail. So it is with the victim in the poor shipment case.

Of the legitimate mercantile failures a few are traceable in this manner:

Retailers have failed because they have acquired poor stocks and have made purchases out of line with their requirements.

One retailer in the suburbs of a manufacturing city, in a section inhabited by workers in a tannery and dye works, made a mistake by buying fifty tube sets. He could have sold one hundred crystal sets.

Several New York retailer-jobbers failed because their purchases of poor apparatus lost them the patronage of fan as well as retailer who, having made one purchase, never returned.

In the manufacturing field the failures have developed almost entirely from a lack of knowledge of radio.

There are today men in the manufacturing line who know very, very little about the industry. Their engineers are not capable. Their factories are not properly equipped. These men must learn and the first lesson they will learn and the real men in the trade will not buy hastily prepared, indifferently gotten

(Continued on page 107)

# New De Forest Set

## Two-Circuit Tuner, Three-Stage Radio, Frequency Amplification and Other Features Announced

After many weeks of silence regarding their much-rumored new receiving set, the De Forest Radio Tel. & Tel. Co. has at last released photographs and the details regarding this new apparatus.

In a cabinet measuring 10" x 10" x 8" the De Forest engineers have embodied a two-circuit tuner, three stages of radio frequency amplification, detector and two stages of audio frequency amplification. Due to a recently patented circuit to which De Forest has sole rights for manufacture, only three tubes are necessary to give the results usually necessitating six tubes.

Provision is made for the use either of a loop aerial or of an outside aerial and ground. The base of the loop is a phone plug which is inserted, through a hole in the cover of the set, into a two-circuit jack beneath. When the loop is withdrawn and the outside aerial is in use, the condenser is connected across the secondary of the vario-coupler; when the loop is inserted, the condenser is across the loop and vario-coupler is automatically disconnected.

Another innovation is the long-sought-for jar-proof crystal detector. Tests proved conclusively that, with the circuit in use, a galena detector was vastly superior, but the type in general use up until now was too easily knocked out of adjustment. The detector incorporated in D-7, which is the name of this set, can be dropped and jarred almost without limit yet it is adjustable.

Connection, with the exception of aerial and ground, are made to binding posts mounted on a shelf about midway of the panel vertically, and inside, the wires to batteries being brought out through eyeletted holes in the rear of the cabinet. The set is extremely simply to operate as there are no ticklers or variometers to adjust. With the loop in use, all tuning is done with the condenser. Filaments are all controlled with but a single rheostat and once this and the potentiometer are adjusted, the ultimate in tuning is available—a single knob.

The results of tests with several sets may be summed up as follows: In the heart of New York City's power lines and steel buildings, using a two-foot loop, nearby stations, such as WBAY, WJZ, WEAJ and WOR

may be put directly into any type loud speaker; Springfield and Schenectady

dom from tube noises and distortion is wonderful," said Mr. Gilbert. "There is none of the hissing, howling or complexity of operation of a regenerative set. All I have to do is point the loop, set the condenser at 50 and turn on filaments. This set brings radio reception down to an absolute certainty." The whole De Forest organization is justly enthusiastic

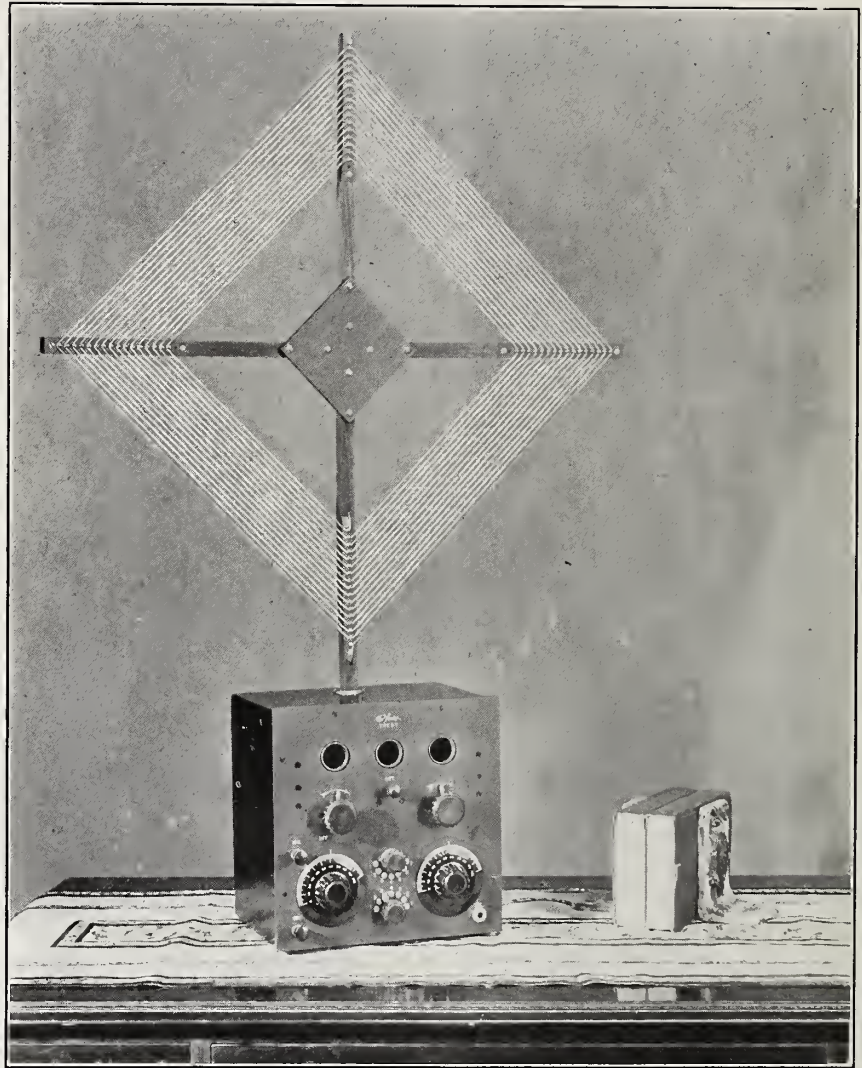

De Forest Three-Tube Reflex Set

can also be put on the loud-speaker but not in the tremendous volume of the others; Atlanta, Louisville and Chicago are heard clearly in the head receivers. With outside aerial all results are increased 30%. The D-7 is designed to use six volts on the filaments and sixty seven volts on the plates. Phones or loud-speaker are, as usual, plugged into a jack. Appearance was not overlooked in designing this set. The panel is of engraved bakelite-dilecto and cabinet is of mahogany with hinged cover.

Charles Gilbert, president of the De Forest Company, is enthusiastic on the subject of the new set. "The free-

over this new baby and is satisfied that D-7 is what the American public wants. The price is \$100.

### THINGS TO REALLY NOTE

When you have to tell a customer, "I'm out of this; will have another shipment in tomorrow," what does the customer say? Does he come back?

When you say to a customer, "I'm sorry, but we don't carry the Soandso Part, but we have Bestleys', what does the customer say?"

Note these things and profit accordingly.



# Advertising by the Local Radio Dealer

## Plain, Human Interest, Non-technical Publicity Appeals to Residents of Smaller Places

By PAUL S. WEIL  
Of Frank Kiernan & Co.

What type of advertising by the dealer in radio apparatus will be the most productive? How can public interest in radio be best aroused to its pleasures and benefits? Without a doubt these two questions are most prevalent in the minds of radio dealers all over the country today.

The radio industry is still in its infancy and is gradually establishing itself on a firm business foundation. Price wars have been rampant, markets flooded with merchandise far exceeding public demand—much of it hastily manufactured and of inferior quality. In spite of these handicaps which were created through the tremendously rapid growth radio interests are nevertheless in a healthy condition today and require among other things absolute dealer co-operation.

In this article we are considering only the radio dealer. How can he arouse interest in radio in his individual locality?

As stated before radio is still very new and only a small percentage of the population of the country know the least thing about it. The great mass know merely what the word radio means and nothing more. It is up to the dealer to assist the manufacturer in educating this mass to the advantages of radio. Public interest is the basis of all business, and radio certainly is not an exception to the rule. How can this interest be aroused? Only by advertising in a common sense, intelligent manner.

Human interest must predominate in consumer advertising, and not technical matter that the average man or woman knows nothing about, and cares less. You cannot sow the seed of radio interest in a man's mind by stating the type of a condenser, or rheostat, or variometer the set you have for sale is equipped with. What he wants to know most of all is what pleasures and benefits he will derive by installing your set. Tell him about the wonderful concerts, the sporting dope, the lectures, and general information that are broadcasted every day. Explain to him how broadcasting stations are controlled and operated, how they are financed, the artists that are engaged to entertain. Show conclusively that



PAUL S. WEIL  
Of Frank Kiernan & Co.

he cannot afford to miss the wonderful daily programs. Impress upon him that the long winter evenings can be made enjoyable and pleasurable for the whole family by means of radio.

Show him in everyday language just what radio is—but above all eliminate all technical and mechanical matter in your advertisements, as they only tend to confuse the mind of the uninitiated.

The writer had occasion to see an advertisement in a small Pennsylvania newspaper, the day after the Leonard-Britton fight some time back, which impressed him as being full of human interest. The advertisement measured 6 inches, single column and read as follows:

"Were you 'listening-in' last night? You certainly missed something good, if you were not. We received all the dope on the Leonard-Britton fight, right from the ringside. Just exactly as it happened. Heard the crowd yell, the gong ring, and even thought we heard the thud of leather on human flesh. The announcing was so clear that it was just about as good as a ringside seat—without having to dig down for the exorbitant prices charged.

"Something just as good every day now—you certainly cannot afford to miss anything more.

"Drop around and look over our  
(Continued on page 96)

## Radio Instruction by Experts

By ROBERT E. AUTREY  
Of National Radio Engineering Co.

Announcement is made by the National Radio Engineering Company, of Atlanta, Ga., one of the South's oldest radio concerns, that they are offering absolutely free of charge, a complete course in radio and radio operating. This course is given by one of the oldest radio instructors in America, who has trained operators for several years to U. S. Shipping Board service. The course which may be completed within a few weeks will qualify the student for Government commercial license if desired. Code instruction will be transmitted daily from various broadcasting stations throughout the country.

The offer is made after consideration of present-day radio, and upon the request of many novices. There are but few dealers and radio salesmen, to say nothing of the owners of radio

receiving sets, that understand the operation of radio apparatus. Many people think all you have to do with a single tube receiving set is light the filament, turn a couple of dials and hear KDKA, KSD, WWJ, and others anywhere in the United States, and after they have tried this, finding the set not receiving such stations, they begin kicking to the dealer from whom the set was bought, who in many cases knows as much about the set as they.

Again, with all the broadcasting stations in operation the novice hears one of them, and when they get to coming through every QSA, some spark station starts more music. The novice wonders what pleasure an amateur gets out of breaking up concerts in this manner. Sometimes the busy  
(Continued on page 84)

# Old Established Electrical Manufacturers

## Briggs & Stratton, Long Known by the Basco Trade-Mark are Building Equipment

By L. N. ALLEN

Realizing the kinship between the radio and automotive industries in organization, in business methods and in the function of both fields to provide both pleasure and profit for the American public, many manufacturers of automobile parts are entering the



radio field. It is a tribute to essential soundness of radio that it should attract the shrewd business men of a sister industry, as well as a compliment to the motor parts men that they are capable of realizing the great possibilities of radio.

On the list of automotive firms in radio field must be added Briggs & Stratton Company, of Milwaukee, Wisconsin. For eleven years this firm has built automotive electrical units for some 75 well-recognized makes of automobiles and trucks. What is more important is that they have entered the field in earnest.



Their line is being marketed under the Basco trade-mark, which did yeoman service in the automotive field.

A visit through this modernly equipped plant and the radio enthusiast quickly becomes imbued with the Briggs & Stratton thorough methods of manufacture and the spirit of precision which expresses itself in the keen attention given to details—details which, to the laymen, seem almost of minor importance. Adequate machinery, light, airy rooms, systematic handling of raw material and products—every process shows the mark of up-to-the-minute facilities in the hands of skilled workmen—the highest type of plant efficiency.

The first process takes place in one of the main sections of the punch press department where radio parts are stamped out of raw material. Next comes the drill press room



where these stampings are drilled and made ready for the assembly room.

Another interesting department is where a big battery of automatic screw machines eat up raw material at one end and turn out thousands of little knurled and threaded finished parts at the other.

When finally all of the various parts arrive in the assembly room, skilled workmen fit them together, mount them on panels, connect up wiring, and soon we have before us complete Basco radio products.

But before we forget, somewhere these intricate units had to be conceived, designed, drafted and tried-out. In a neatly equipped modern experimental laboratory up on the roof, the germ of each unit is born, developed, tested and thoroughly proved out under expert radio direction, then given to the draftsmen for refinements and in turn to the manager of production.

One year of intensive preparation and designing has already resulted in the placing on the market of a highly commendable pair of sensitive receivers, a radio frequency transformer which has proved exceptionally efficient, a vernier rheostat and plain



rheostat that have aroused no little comment for excellence in workmanship, and a number of other units—variable air condensers, fixed condensers, tube sockets, a complete crystal outfit, tuning coils, switch levers, crystal set cabinets, crystal detectors, binding posts, etc.

The old deeply imbedded policy of a fixed standard of quality in all Briggs & Stratton products has not been overlooked in the making of their radio equipment. Quality is sharply pronounced in every article from the outer finish to the inner construction. It appears evident that this company is looking ahead with the idea of establishing their radio products as a standard in price as well as quality—a policy which promises a surer future in this great new field than the popular policy of getting rich while the game is



new and "getting out" when true quality and price become the buying factors.

## Radio Saves City

### Firemen, in Homes, Told of Fire by Broadcaster

"Radio saved Atlanta from destruction," declares Fire Chief William B. Cody, commenting on the latest accomplishment of the radio in rising to the emergency.

Fire broke out in a block of retail stores in the city's chief shopping district, a few hundred yards from the *Atlanta Journal* building one evening recently. It gained great headway before it was discovered and threatened the entire business section of the city.

Lambdin Kay, radio director for the *Journal*, was conducting the paper's regular late evening program. He sent out a bulletin on the fire and followed with other announcements of its progress.

From all parts of the city firemen who were off duty for the night rushed to join their companies battling the blaze. They had heard Kay's broadcasted announcement of the seriousness of the fire and rushed to aid their comrades.

The extra firemen enabled the department to check the fire.

"Radio saved Atlanta," says Chief Cody. "If I had not secured the services of all my men the flames might not have been checked, and Atlanta's business district would have suffered one of the worst fires in its history. As it was, the flames were confined to the block in which they originated.

"I'm going to have every fireman in Atlanta install a radio set in his home so that in future I can notify them all at once."

### REPORT GOOD SALES

The Ritter Wood Work Co., of 232 Canal street, New York, reports wonderful sales of their \$3.00 retail crystal receiving set. They report they are now shipping on an average of four hundred sets weekly, the majority of which are repeat orders.

Mr. Ritter states that out of 32 requests for samples in the past four weeks, 29 concerns sent in orders for 12 or more sets, and one jobber telegraphed an order for one hundred sets one-half hour after he received their sample crystal set. Mr. Ritter also reports favorable results with their knockdown variometer and variocoupler. The Ritter Wood Work Company are old-timers in the manufacture of wood variometer and variocoupler parts, having made thousands of them for A. H. Grebe back in 1917.



After the  
**THANKSGIVING  
DINNER** *hear the voice  
of the Outer World*

THE above illustration appearing in Magnavox National Advertising in November (a total of more than seven millions of circulation) carries a strong selling thought which you can profitably use with your trade.

Magnavox Radio, the Reproducer Supreme, is not manufactured to help sell any one make of receiving set, but to complete the service rendered by every set of good quality.

**R-2 Magnavox Radio** with 18-inch horn: this instrument is intended for those who wish the utmost in amplifying power; for large audiences, dance halls, etc. . . \$85.00

**R-3 Magnavox Radio** with 14-inch horn: the ideal instru-

ment for use in homes, offices, amateur stations, etc. \$45.00

**Model C Magnavox Power Amplifier** insures getting the largest possible power input for your Magnavox Radio.

2 stage AC-2-C . . \$80.00  
3 stage AC-3-C . . 110.00

Our publication, THE MAGNAVOX, tells you clearly and definitely how we help you build a bigger Radio business. If you have not received your copy, write for it today.

The Magnavox Co., Oakland, California  
New York: 370 Seventh Avenue

**MAGNAVOX**  
Radio  
*The Reproducer Supreme*

THIS WILL BE A RADIO CHRISTMAS!

# What the Manufacturers Are Doing

## Duo-Coupler

Can Be Used on Victrola or Wireless Receiver

The radio Duo-Coupler when attached can be used for victrola or wireless, automatically utilizing the

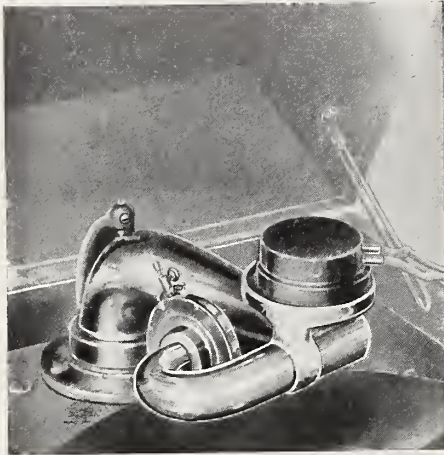

Radio-Receiving Position

tone arm and violin box of the victrola for the radio receiving set without interfering in the slightest with its intended operations.

This Duo-Coupler is made of cast aluminum, beautifully polished. The receiver cup is lined with soft live rubber, which effectively seals the cup



Record-Playing Position

against sound leaks without deadening or dampening the sound.

Made and sold by the Beaver Machine & Tool Co., 50 Church Street, New York, retailing at \$3.75.

When in position for radio receiving the sound box or reproducer is

turned back in its normal rest position and the receiver cup presents itself for the ear phone. The passageway back to the sound box is automatically sealed, preventing even the possibility of the radio signals reverberating on the diaphragm of the sound box. The sound as it passes from the cup to the victrola box is gradually broadened and rounded out. In designing the sound passage the structure of the human ear was constantly kept in mind.

When the sound box or reproducer is turned down in position to play a record the passageway from the sound box to the tone arm is automatically opened and that to the receiver cup is automatically closed so that no sound can leave or leak through the radio receiver cup. The music reproduced is exactly the same with the "Duo-Coupler" so attached. The receiver cup turns under entirely out of the way, the lid can be closed if desired. The Victrola remains the perfect musical instrument that it is.

## NEW CIRCUIT TUNER

The Atwater Kent Manufacturing Company of Philadelphia, have developed a new coupled circuit tuner with the idea of simplifying operation and still retain maximum performance.

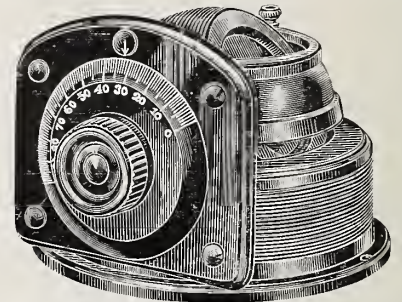

It is designed to take the place of a variometer and variocoupler in a coupled-circuit receiver, accomplishing the results with but one adjustment.

Tuning of antenna circuit is unnecessary, the makers say. Three  
(Continued on page 115)

## Westphal Adapter Beautifies and Enlarges Radio Tone

The Westphal Manufacturing Laboratory, 80 East Jackson Boulevard, known as the "Westphal Adapter." One of the outstanding features is

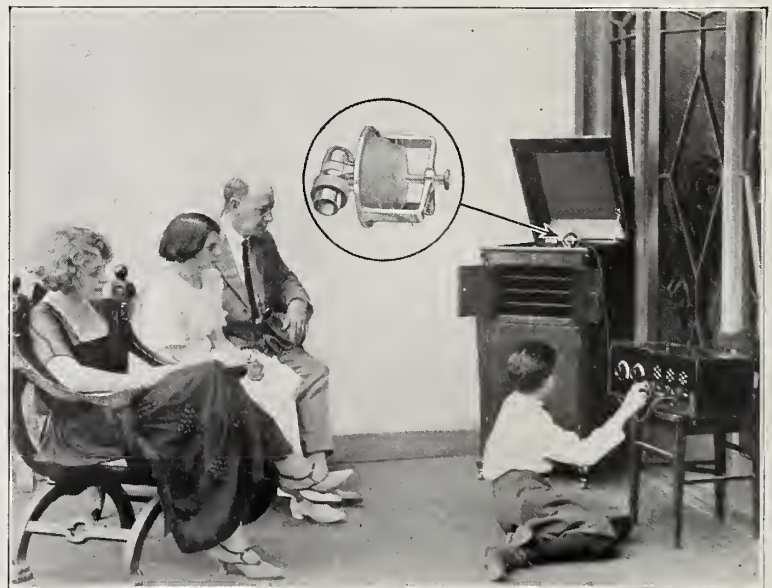

Westphal Adapter Fits Phonographs and Radio Phones

Chicago, Illinois, have recently perfected a radio phonograph attachment

that it is constructed in one unit and  
(Continued on page 115)

## New Potentiometer

### Allen-Bradley's Latest Addition in Radio Field

Another application of the compression resistance principle has been made by the Allen-Bradley Company, Milwaukee, in the Bradleyometer, a new potentiometer embodying graphite discs operating under pressure. In placing the Bradleyostat filament control on the market, the Allen-Bradley Company had applied a principle that they have used for twenty years in the manufacture of rheostats and motor starters for industrial purposes. The smooth current control obtainable in this type of resistor was especially desirable for radio circuits, where the sensitive units require the finest of adjustment.

In the Bradleyometer this same idea has been utilized. Two columns of discs are assembled in the porcelain container, each column with a separate and independent pressure plug extending through the top cover plate. The pressure knob rotates through 180 degrees, and through a special shaped cam applies pressure to one column in one direction of rotation and to the other column in the other direction. As pressure is applied to one of the columns the pressure is released on the other.

The resistance of a column of the discs varies with pressure, so that the action of the Bradleyometer is to decrease the resistance in one column and simultaneously increase the resistance in the other column. The total resistance of the two columns remains constant, as in any wire wound potentiometer while a connection between the two columns serves the same purpose as the slider of a wire potentiometer.

The Bradleyometer controls the resistance gradually as the pressure is increased or decreased on the discs. This provides for an absolutely even balancing of the potential in the plate or grid circuits, wherever the potentiometer may be connected. No foreign noises are introduced into the circuit. The Bradleyometer accomplishes the full range in control with 180 degrees rotation of the knob. It is made in 200 and 400 ohm capacity.



Bradleyometer

## CROWN RADIO PRODUCTS

The Crown Radio Manufacturing Corp., 78 Fifth Avenue, New York, is manufacturing a complete line of radio apparatus under the trade name of "Crown."

Some idea of the excellency of the design of the "Crown" products may be had from the accompanying illustrations of the Crown triple coil calibrated mounting and the telephone plug. This mounting, which is made of Thermoplox, a high grade insulating material which resists heat far better than rubber and has high dielectric and

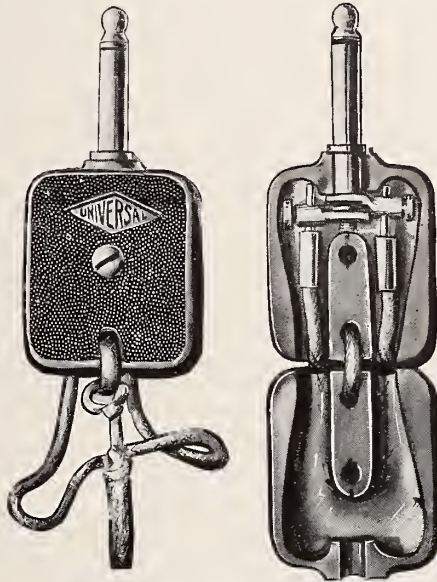

Crown Plug Closed and Open

mechanical strengths, is non-hydroscopic, is not affected by atmospheric agents and will not deteriorate with age. It will be noted that a special locking device is provided to hold the coil in position, thus preventing it from being thrown out of adjustment. Other features to which attention have been called are the special adjustable bearing, bushings preventing wear on the top and bottom plates, special calibrated dial showing stations tuned in and positive connections on rear of blocks. All parts are of brass, nickel plated. The entire apparatus is highly polished and its fine finish produces an attractive appearance.

The Crown telephone plug is designed to fit all standard jacks and has arrangement for making positive electrical connections using either cord tip, wire, lug or any type of terminal without soldering. The handles are made of Thermoplox and the grips are matched and held together with a substantial screw arrangement which does not interfere with the electrical connections. A hole in the end of the plug is pro-

vided for the cord tie to relieve the electrical connections of all strain. The surface of the grips is matted to prevent the fingers from slipping. Another point that is claimed is that the conductor may be removed without changing the adjustment of the

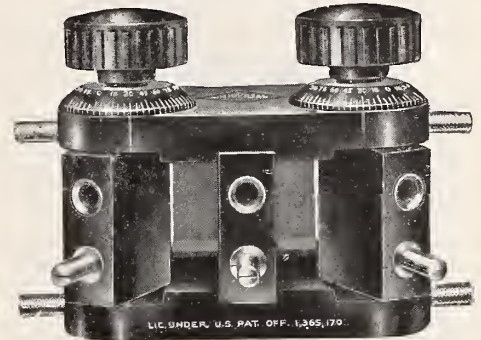

Crown Triple Coil Calibrated Mounting

plug, and as there is practically no wear, this adjustment remains constant.

## NEW GLOBE HEAD PHONE

The Globe Phone Manufacturing Company, Reading, Mass., has developed a new radio headset which it is reported is meeting with ready favor.

These phones are claimed to be highly sensitive and will stand ampli-



Globe Head Phone

fication without distortion. They are strictly high grade appliances and are backed by the experience of 15 years in manufacturing highly sensitive sound producing and receiving instruments. The highest grade of materials are used throughout. Magnets are of tungsten steel and every part is treated to prevent rusting. These head phones are not only highly efficient but are very attractive in appearance, the manufacturer having given thought to style as well as technical art in their design.



**ZELLAC**

## Manufacturers Attention

Zeller Lacquers constitute the most economical finishes on the market today for radio equipment of all kinds. They are easily applied either by dipping, brushing or spraying and completely dry in normal room temperatures within 15 minutes.

Zellac is made in all colors and can be applied to all materials. Beside the standard natural wood finishes, our Hard Rubber Black has become popular among manufacturers for finishing instrument bases as well as cabinets while our White is used exclusively by many organizations for the graduations on dials and knobs, as well as for panel work. A thin coat of our material, which has a high dielectric strength, applied to coil windings, holds them permanently in place without causing the usual undesirable effects.

Distortion and metallic ring largely removed from loud speaking horns and phone diaphragms where our special material is applied. Write today for more information.

**ZELLER LACQUER  
MFG. CO., Inc.**

342 Madison Ave., New York

## Concerning the Radio Retailer

# Why Cannot Radio Retailers Cooperate for Self Benefit?

By M., a New York City Retailer

(Mr. M. is modest and asks that his name shall not appear in connection with his brief article.—Editor, RADIO DEALER.)

Can the Radio retailer join in the movement to buy Radio apparatus in a co-operative way.

If not, why not? If yes, why doesn't it happen?

Economists generally and many business men have been watching the recently developed group selling.

Co-operation has been successful in the marketing of many farming products and this despite the fact that these farming organizations are handicapped in the fact that membership is maintained under difficulties and benefits, to the individual, are considered slight, in proportion to the benefits that might develop to the individuals in other lines of endeavor.

Co-operation for buying retailers in Radio has not been accomplished. A group of department store managers,

it is said, have agreed to buy jointly in order to acquire some of the so-called standard brands at factory prices, omitting the jobber, but whether this idea will prevail remains to be seen.

Department stores, in this case, buy at from fifteen to twenty-five per cent lower than the average retailer.

The Radio retailer and jobber naturally resents this. Time alone can tell whether the manufacturers who, by this plan, apparently favors department stores—with cut price tendencies—as against legitimate Radio dealers and jobbers are to succeed.

That's not the present subject, however. It's a pointer. If department stores can get together why cannot retailers generally? If group selling by farmers has proven practical, why not group selling by Radio manufacturers?

And beyond all, why not group buying on the part of retailers?

## General Publicity

### Every School Can Have a Real Big Radio Night

Every storekeeper can devise ways and means of acquiring local interest or sectional interest in not only radio but his own business.

For instance: There's a school nearby. Has that school many radio enthusiasts? Of course. Why not offer the principal to operate a "Radio Night?"

On this occasion procure a couple of experts—from your manufacturing friends—and these men will demonstrate to the scholars and to others, just how and why a radio set operates.

Manufacturers in the radio field will supply the experts, if you will do the rest.

The obvious answer is publicity for your store.

In advertising, in daily newspapers, as well as circulars, it does not pay to tie up your radio apparatus advertising with other lines.

## On Advertising

### Can a Radio Retailer Use the Daily Newspapers?

Every retailer, as well as jobber, should have some well defined policy about advertising.

Of course the first advertising any retailer does is when he opens his store, when he prints his store and announces that his name is So and So.

What then?

Shall the retailer use space in daily newspapers? Is his store in the centre of the town? Is it near to other advertisers? Is the suburban trade worth going after?

Advertising—in newspapers—is, as a rule, a problem that can be solved by the salesmen who represent the newspapers. They ought to be able to convince certain radio dealers that advertising, of certain kinds, can be made to pay.

Mr. Retailer: Put the query flat up to the solicitor. Make him prove his claims.

THIS WILL BE A RADIO CHRISTMAS!

### RETAIL ADVERTISING

Under this heading the *Radio Dealer* will discuss copy of advertisements which appear in daily newspapers, submitted by readers. Retailers who desire copy criticized are invited to tender us same, for which there will be no charge to subscribers.

### WORLD SERIES DOPE

The W. E. Supply Co. put over some interesting as well as profitable advertising just prior to the recent World Series by advertising their \$25 Aerial-A vacuum tube receiving set in nicely worded display advertising, clinching its selling talk with these words:

"The local ball clubs have set the price for unreserved World Series seats at \$3.30 each, or \$22.10 for seven games. Aerial-A is \$25. Hook it up. Pick out your favorite chair and you will miss nothing but the crowd."

### PLAUSIBLE ADVERTISING

Frederick Loeser & Co., Brooklyn Department Store, employs intelligent advertising in the sale of radio. A recent ten-inch advertisement of two columns of five inches depth, illustrated a boy with a head set and the caption "R-A-D-I-O, the best there is and at bottom prices." Then followed the following:

"Money won't buy better than Loeser's has for you. And Loeser's low prices will not buy as good in most places. You can 'bank' on any equipment you buy here. Everything is the *best*, but don't ask 'everything'.

The copy concluded:

"WITHOUT CHARGE—A complete Radio Receiving Crystal Outfit, including two crystals, with every purchase of a pair of A. C. Gilbert 2000 Ohm Sensitive Phones. The Receiving Set is small, but works well if directions are followed."

### SOUND SALES TALK

Herbert & Huesgen Co. recently advertised a special on the N. K. 6000 ohms, an imported head set, offering these head sets, together with a 45-volt \$5.00 Ever-Ready radio B battery or a \$5.00 N. & K. Precision variometer, all for \$14.50.

The H. & H. folks then told of the super-sensitive tone quality of their imported phones and announced the special offer was made to introduce the new phone.

A coupon was used for out-of-town orders and a money back condition appeared in the interesting copy.



## Increase Christmas Sales with BESTONE RADIO SETS

*Everyone will want a Radio Set for Christmas—everyone will give a Radio Set. Translated into terms of demand and profit this will create an unusual opportunity for those Jobbers and Dealers who distribute quality Wireless Apparatus.*



BESTONE No. 707 Combination Crystal and Vacuum Tube Set

With tube connection this set has receiving capacity of 300 miles. Crystal Detector mounted on Bakelite panel eliminates use of "A" or "B" Batteries. All apparatus enclosed in beautiful mahogany finished cabinet. Wave length—600 metres. Dimensions:  $7\frac{1}{8}$ " x  $5\frac{3}{8}$ " x  $5\frac{1}{4}$ ". List price (including BESTONE 2200 Ohm Headset), \$25.00.

We manufacture a comprehensive line of Crystal and Vacuum Tube Receiving Sets at popular list prices.

Send for Illustrated Catalogue "R"

**HENRY HYMAN & CO., Inc.**

Manufacturers

EXECUTIVE OFFICES  
476 Broadway, New York

BRANCH OFFICE  
212-216 W. Austin Ave., Chicago, Ill.

THIS WILL BE A RADIO CHRISTMAS!

# Davenports and Dashboard Special Touring U. S.

## Special Receiving Set Equipment for Automobiles to "Listen In" on Mountain Peaks and Deserts

By J. McKerchar

"Taking radio to the people" in a literal sense is what is being done by Mr. and Mrs. J. C. Davenport and their "Dashboard Special," who recently left New York for an automobile trip into every state in the Union. According to a letter received by the RADIO DEALER they are now in Washington, D. C.

During this trip of some forty thousand miles, thousands of people will be confronted with the marvels of radio through the medium of both Davenports and the "Dashboard Special," which, it may be explained, is an automobile receiving set with a loop aerial in front of the windshield and the receiving apparatus on the dashboard. The primary purpose of the trip is to arouse the good citizens of the United States to the miracle in their midst.

As a merchandising stunt, it has originality and the taste of imagination. Here are two travellers, who are going to cover the forty thousand miles they had once before crossed, equipped to keep in touch with civilization whether they are in the Mohave desert or on the highest peak of the Sierra Nevadas.

"Forty thousand miles by automobile haven't cured us of gypsying" said Mrs. Davenport, in the letter received by this office.

"We left New York City to follow the old trail again, the trail we first took October 1, 1920. We will travel first through the South, visiting Miami and other Florida towns, and from there we will sail to Cuba and the West Indies. I wonder if they have broadcasting stations there. After this visit we will take the Argonauts' trail to the West. We'll speed along the wonderful Lincoln Highway to Denver and Salt Lake City to the jubilant strains of our Dashboard Special. There we'll hope for a more pensive tune as we take

the Oregon Old Trails to Portland and Seattle. The Puget Sound country will be our next sight and after that south through Washington and Oregon to California. The San Francisco Bay section is a veritable nest of broadcasting stations, I have heard, and we'll be able to 'pick and choose' our music for the journey toward Los Angeles and Old Mexico. On our last trip we attended a bull fight in Mexico and this time we'll repeat the visit and incidentally we may take away the bull's audience by giving a concert if there is any Mexican music about on American wave lengths.

"I am curious to hear music when we cross the Salten Sea, which is 267 feet below sea level. And the Mohave Desert, we'll put up our portable aerial there and surely we will feel that we are in tune with the infinite. Then we'll go up to the mountains till, at the Great Divide, we attain our greatest altitude, 14,500 feet above sea level. Then back again through the fruitful Middle West and up to the New England states. After that—well Mr. Davenport and I waited over thirty years for this honeymoon trip and I don't think that

either of us will be in a hurry to terminate it. We've been in forty-three states and have been under four flags in the last twenty-three months. We've been out on the Mohave Desert one day with the temperature 132 and the next day we've been snowbound at Flagstaff, Arizona, in 7 feet of snow. And in the month of May, too!

"But now with our 'Dashboard Special,' we shall always be in touch with the world and with its pleasures. And that'll help some.

"Again thanking the RADIO DEALER and Mr. Wallenstein of the Radio Guild for their assistance."

The Radio Guild, of New York, installed the "Dashboard Special," which is a type of the set known as the Vox Humana, for use by the Davenports. This new product of their laboratories is designed to find instant favor with those who desire an efficient receiver for the automobile. The "Dashboard Special" is designed in such a manner that it will fit on the dashboard of automobiles. For this reason it is only six inches deep and nine inches high. Provision is made for reception either with a loop or an outside aerial. The aerial

may be strung over the top of the car or a loop may be erected in front of the wind shield. The set requires six vacuum tubes, two as radio frequency amplifiers, one as a detector and three as audio frequency amplifiers. The telephone jack may be plugged in to cut out the last stage of amplification, if desired. A battery switch is provided to switch off the filament current. The binding-posts for the batteries are conveniently arranged at the right side of the front panel. At the left side of the front panel are the binding-posts for antenna and ground while the connections from a loop may be plugged in a jack. The entire set is built very solidly to withstand the wear and tear of travel and is assembled on



© General Photographic Service, N. Y.

Mr. J. C. Davenport, Owner of the Radio Car, Equipped with the "Dashboard Special," with Which a Tour Over the United States Is Being Made Under the Auspices of the Radio Guild and the RADIO DEALER



panels of  $\frac{1}{4}$ " bakelite. The operation is exceedingly simple as the tuning is entirely accomplished with a single control. Another control is provided to increase or decrease the amplification.

Such a merchandising stunt as this might be copied in spirit by other manufacturers and dealers. The Radio Guild, at least, seems to have grasped the truth that the function of all concerned in the radio business is not merely to make or distribute radio sets but also to create a demand for them. And the fascination of radio makes it about the easiest thing to create a demand for, if only the radio business would use its imagination.

### THE RADIPHONO ADAPTER

This newly designed phonograph adapter, manufactured by the Industrial Sales Engineering Company, of Newark, New Jersey, and placed on the market by them within the last thirty days, is one of the most universal adapters on the market as it is adaptable to various types of phonographs such as the Edison, Victrola, Brunswick, etc., and will also hold almost any type of receiver from the largest Baldwin Type "C" to the small Western Electric Watchcase type.

The most important feature, in connection with this adapter, is in its musical qualities. It is in true name, a musical instrument of moulded composition similar to bakelite or hard rubber, so designed that it will carry the sound waves from the vibrating diaphragm of the receiver to the phonograph horn, doing away with all metallic, distorted and unpleasant sounds and when used in connection with the phonograph, clear musical tones of volume are obtainable, eliminating the necessity of an expensive loud speaker.

The manufacturer of the Radiophone adapter has received many compliments on the excellent quality of the product and every indication points to a ready market for this adapter during the ensuing radio season.

### ATLANTA SHOW

The Southeastern Radio Exposition is to be staged at the Auditorium Armory, Atlanta, Georgia, December 4th to 9th, and as this is the first radio exposition staged in the South the interest aroused should be of good proportion.

This show has the support of the Chamber of Commerce, the *Atlanta Journal*, the *Atlanta Constitution* and the *Atlanta Georgian*.

ESTABLISHED 1888



## SENSORY CABINET UNITS

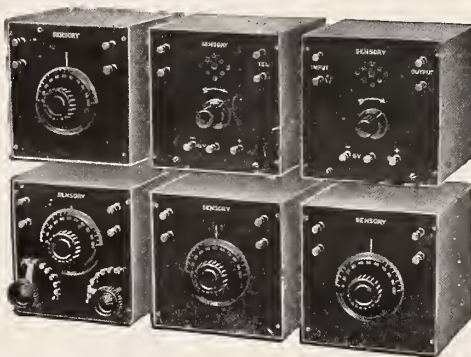

The most flexible method of adding to, or obtaining a variety of hook-ups, and giving an appearance equal to any single cabinet set. Each cabinet contains a "Sensory" element.

THE FULL LINE OF "SENSORY" ACCESSORIES  
IS SHOWN IN OUR NEW BULLETIN NO. 12  
WRITE FOR IT TODAY



**HEINEMANN ELECTRIC COMPANY**

Manufacturers

Radio Division

Philadelphia, Pa.

THIS WILL BE A RADIO CHRISTMAS!

## The Portabloop TUNER

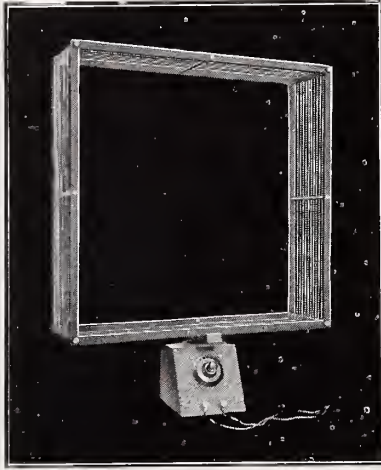

*Ready For  
Shipment*

**THE  
PORTABLOOP  
PORTABLOOP TUNER  
PORTABLOOP RECEIVER**

**Write Us For Our  
Special Agency  
Proposition  
To Dealers**



210 Central Avenue

## "Homcharger" Note

**Have Three Plants to Take Care  
of Trade Requirements**

E. C. Ogden is President of the Automatic Electrical Devices Co., Cincinnati manufacturers of the "Homcharger," which has proven so popular in the radio field. They have recently been compelled to add a third plant to take care of the unprecedented demand for this device, and Mr. Ogden tells us that these three factories, all located in Cincinnati, have a capacity of over 1,000 Homchargers per day, which, it is expected, will enable dealers and jobbers to obtain prompt shipments on their orders for this necessary radio device.

The Homcharger is unquestionably popular in the radio field and has attained this by proper performance, construction and aggressiveness of the company's Sales and Advertising Departments.

### NEW SWITCH LEVER

A switch lever called the Rotary Dial Switch, in which great care has been paid to detail, is manufactured by the Virginia Radio Corporation, Charlottesville, Virginia.

The main feature of this switch is the construction of the stud. The washer which holds the switch blade to the knob is made integral with the stud, thereby eliminating all possibility of the washer ever working loose and binding the switch. The bearing surface is highly polished and nickel plated throughout. The switch is secured to the panel bushing by a hexagon locknut which is run up to a shoulder against the tension spring thereby making adjustment unnecessary. It will work successfully on panels from 3-32 inches to 5-16 inches thickness. The switch blade is double, brass, nickel plated. The knob has been specially designed for appearance and ease of operation.

The Virginia Radio Corporation are also jobbers for many of the leading standard makers of radio apparatus.

### HENRY L. WALKER CO. ISSUES CATALOGUE

The Henry L. Walker Company, 27 East Jefferson avenue, Detroit, Mich., who have been in the electrical trade for over twenty-eight years and who, for the last ten years have been in the retail radio business, have issued a catalogue. Although the catalogue does not include all items carried in stock it is quite comprehensive.



*Above the Ordinary*

## B & P INSULATOR

True, there are a great many makes of aerial insulators. But that is all the more reason for careful choice of the one make which will give your customers the greatest satisfaction.

It's worth taking this trouble. Your customers judge your store as severely by the low priced staple as the most expensive set you sell.

The B & P Insulator has proven by its splendid sale everywhere the value of selling only the B & P make of insulator.

Dealers make a very satisfactory profit on our price. Why not send us a trial order?

*Wholesale Only*

**Banister & Pollard**  
206 Market Street  
NEWARK, N. J.

THIS WILL BE A RADIO CHRISTMAS!

## Exposition in December

### American Radio Exposition Co. to Stage Show at Grand Central

Scientists and engineers of national repute will speak on radio subjects at the American Radio Exposition to be held in Grand Central Palace, Dec. 21 to 30, under the direction of the American Radio Exposition Co. This company of which Frank Hitchcock, former postmaster-general is president, has the backing of the National Radio Chamber of Commerce and the Associated Manufacturers of Electrical Supplies in the venture.

Coming as it does during the holiday season, when schools and colleges are closed, the exposition will offer an excellent opportunity to students, teachers and parents to learn of the rapid progress made in wireless in the past few years. The educational features of the show will be many as the entire radio field will be covered, the exhibits comprising radio apparatus and equipment of all kinds as well as material and accessories of every description. Demonstrations for the instruction of radio users will be given and equipment for broadcasting musical numbers by widely known singers will feature the entertainment side of the show.

### SIMPLEX PANEL UNITS MAKE FINE RECEIVER SETS

Assembling a radio receiving set with Simplex panel units, made by the Electric Service Supplies Co., with offices at New York, Philadelphia, and Chicago, makes it possible to try out many hook-ups in order to determine the best for a certain district without disassembling the panels. The beginner can also have a fairly good receiving set at minimum cost by first purchasing a vario-coupler panel and a detector panel, later adding other units to obtain greater sensitiveness and selectivity.

The Simplex line of panels includes variometers, vario-couplers, condensers, detectors and amplifiers. The panels are black, polished formica or bakelite and are 5 $\frac{7}{8}$  inches square; the lettering is engraved and filled with permanent enamel.

### ELMCO SETS GUARANTEED

Elmco shielded apparatus is said to be the development of engineers after years of study to secure the highest receiving efficiency. Every Elmco tuner is guaranteed to be perfect in material and workmanship. Made by the Electric Machine Corporation, Indianapolis, Ind.

# ATWATER KENT

## COUPLED CIRCUIT TUNER

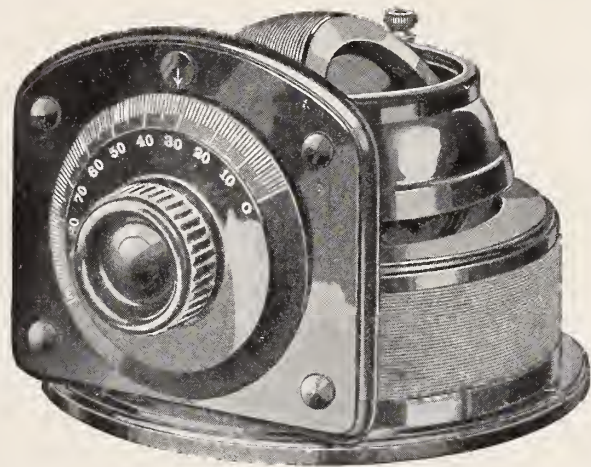

Price \$14<sup>00</sup>

- ‡ Simplest operation—maximum performance.
- ‡ Takes the place of variometer and coupler.
- ‡ Accomplishes the results with but one adjustment.
- ‡ It is absolutely unaffected by body capacity at dial knob.

ALL INSULATING PARTS ARE STURDILY MADE OF MOULDED CONDENSITE AND THE WORKMANSHIP THROUGHOUT IS OF THE HIGHEST QUALITY.

*An Excellent Merchandising Proposition*

ATWATER KENT MANUFACTURING COMPANY

4937 STENTON AVE. Radio Department PHILADELPHIA, PA.

THIS WILL BE A RADIO CHRISTMAS!

*New Model*  
**The Globe  
 Superior Head Set**

Globe Products are known the world over. The Globe name on any Radio product is your guarantee of high quality.



2200 ohms—Price \$8.00

The new model Globe Head Phones are highly sensitive, natural and clear in tone, and will not distort under high amplification.

Each set tested by radio and receivers matched perfectly. The new Globe Phones are polished nickel finish inside and out and are fitted with hard rubber caps. We also use the new Globe Broad Adjustable Headband made of flat stock, webbing covered and so spread and shaped to give the greatest comfort in use. The new Globe Head Set complete is the best value to be had at any price.

Fifteen years experience in making highly sensitive sound producing and receiving instruments is behind all Globe products, which include the *Vacutophone*, the only hearing instrument for the deaf using the vacuum tube amplifier, the Globe Geophone and the Globe Secret Phone.

Globe Jr. Head Set (aluminum cases), 2200 ohms, price \$6.50.

Globe Antenna Attachment Plug, Price \$2.50

We also manufacture microphone transmitters for broadcasting and experimental use.

**Globe Phone  
 Manufacturing Company**  
 Reading, Mass., U. S. A.

## Trade Associations to Enter Mennen Case

Application to File Brief as Amicus Curiae Has Been Made  
 By Attorney of Associations

Felix H. Levy, as attorney for the National Wholesale Dry Goods, Hardware, Supply and Machinery Dealers, Wholesale Jewelers', Floor Covering and American Brush Manufacturers' Associations, has filed a petition in the United States Circuit Court of Appeals, Second Circuit, requesting permission to file a brief in that court as amicus curiae in the case of the Mennen Company vs. the Federal Trade Commission.

This action resulted because of a ruling by the Federal Trade Commission that the Mennen Company must give the same price to all customers who purchase the same quality and quantity of merchandise.

If applied widely, the petitioning associations hold, this ruling would pre-

vent manufacturers from giving consideration to the value of the service which the jobber renders in the distribution of merchandise. It is further contended by the petitioners that the ruling, if allowed to stand, would force distribution costs and selling prices upward, as well as have the effect of discriminating against independent retailers in favor of chain stores.

This action will be watched closely by the radio industry. Some of the largest companies now favor a quantity price and many wholesalers, in the radio field, believe this policy is not a business-building policy. On the other hand some radio retailers espouse this one-price system.

## N. Y. Police Want Dealers to Co-operate With Them

In the very near future radio dealers and everyone having a radio receiving set within the radius of one hundred miles of New York City, will be surprised to hear something like this: "Station WLAW calling—Code Number 8—Peter Jones Number 64-8-15, WLAW signing off." This is a message coming from the New York City Police Department broadcasting station, and is in code and addressed to all police authorities within the radius of police headquarters.

Most messages that will be broadcast from this station will be in plain language, but strictly confidential police matters will be sent in code. The code messages will be sent in the case of general orders, etc., while reports of missing persons, stolen property, the apprehension of criminals will be broadcast in plain English.

M. R. Brennan, the official in charge of this station, who bears the title of superintendent of telegraph of the New York Police Department, is very enthusiastic over his new acquisition, and is certain that radio will play a very prominent part in the routine of police matters from now on.

At the recent convention of police officials that gathered in New York at the invitation of Richard Enright, the police commissioner of New York, the subject of radio was very earnestly discussed. The police commissioner urged the heads of police departments of cities and towns within the range of station WLAW to install radio in their cities or towns. If they could not get complete stations to at least install good receiving sets, in order to co-operate with New York City's department.

Mr. Brennan, in an interview with a representative of THE RADIO DEALER, asked that a little publicity be given to the fact that Station WLAW wants co-operation with dealers of radio equipment within the radius of the station, in making public all police alarms, etc. He recognizes the fact that most dealers are constantly at their "stations," and the fact that they are on the main streets and avenues, alarms posted by them will receive a very wide distribution among the general public.

THIS WILL BE A RADIO CHRISTMAS!

## The Radio Jobber

By **SIDNEY R. HAYDEN**  
Radio Dept., Disbecker & Co.

With the advent of interest in broadcasting and the purchasing of receiving sets by the public, the radio dealers and jobbers of radio apparatus naturally came into existence. Many of the established electrical houses entered the field together with many exclusive radio wholesalers, and in a way the difficulties of the distribution problem were solved for the manufacturers, or at least smoothed over.

It is generally recognized that at the present time there are too many jobbers for a profitable business for all concerned. Too many houses have made the mistake of loading up with the products of manufacturers who sprang up over night, as it were, many of whom were not acquainted with the manufacturing problems, let alone the design and construction of radio apparatus. The effect of the period of reckless buying that followed created a condition that is still being felt with the attendant price-cutting, due in no small way to the dissatisfaction of buyers.

It should be remembered that the best apparatus that can be procured cannot be too good to give satisfaction and make pleased customers. Wholesalers and retailers, too, would do well to take on only such lines as are made by old established manufacturers or new ones whose apparatus is of merit and is advertised.

From experience it is known that unadvertised goods are apt to remain on the shelves for a long time, tying up capital and taking valuable space. One mistake that is often made is to carry too many lines of material selling for about the same price. As to how large a stock it is profitable to carry is a question that the buyer must settle in consultation with the sales department.

It is good policy for a jobber to limit his territory to that which can be covered by a salesman at least once a month, or oftener if possible. It should be remembered that freight and express rates also play a part in restraining distant sales. The writer has found to his sorrow through experience that the man on the job once in two weeks gets more lines filled in the order book than the salesman who calls once a month. Of course, in sparsely settled districts, it is impossible to make as many calls as where there are more radio stores near at hand.

As to the situation of the combination manufacturer - jobber - retailer, particularly in the larger cities, it appears that they may sooner or later become involved in difficulties because of the different interests that they are bound to cater to. The old proverb that says "No man can serve two masters" is full of truth. If he tried it he is pretty apt to lose one job and lucky if not both.

### VAC-SHIELD INTRODUCED

One of the newest radio devices that has come out on the market is a non-magnetic shield for detector and amplifying tubes invented by E. H. Lerchen. The purpose of the shield is to prevent capacity effects between tubes to cut out howling and to also serve as a protection for the tube against breakage, provision is made on the tube shield for connection to ground circuit of set. This is probably one of the most unique and practical devices that has been put out since radio became popular and should find popular favor with the trade as same is being extensively advertised to the consumer. This shield is known and sold under the name of Vac-Shield. It is manufactured by the Orange Research Laboratories, East Orange, N. J.

## SUPERIOR PRODUCTS

*"The Rolls Royce of Radio"*

**DEALERS! Stock Our Christmas Special in a Christmas Box**

### OUR GOLD PLATED HEAD PHONE

is ready for immediate delivery

*Wire for your allotment*

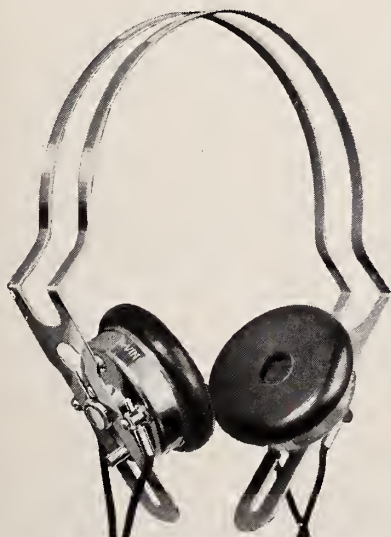

**COMFORT**—Our headphones automatically adjust themselves to fit any shaped head. No protruding horn-like bars. One piece headband, triple nickel plated, without thumbscrew or corners to catch the hair. Ear pieces fit snugly yet without fatiguing pressure.

**SANITARY**—No cloth or fabric to accumulate germs, dandruff and grease. Absolutely sanitary. Complies with the health laws of all states.

**TONE QUALITY**—Diaphragm of special material eliminating resonant frequency. Voice, violin and piano reproduced in full richness and mellowness. Any comparison test proves the superior tone quality of this headphone.

**VOLUME**—An excellent phone for loud speaker use. The special diaphragm handles large outputs without freezing or jamming on pole pieces. The best phone for use with Super-Regenerative sets and high voltage three stage amplifiers. Clear undistorted music under conditions in which other phones fail.

**SENSITIVENESS**—Constructed with painstaking accuracy and care. Close spacing of diaphragm results in utmost sensitiveness. The most adaptable phone on the market for both sensitiveness and capacity to handle large volume.

**LIGHT WEIGHT**—Suitable for use with both crystal and vacuum tube sets. Ear-pieces can be removed from headband in an instant so that two may listen without removing thumbscrews or using tools.

Our Superior variocouplers, variometers, variable condensers, dials and other products are characterized by the same mechanical and electrical excellence.

**DEALERS** Write for our prices and discounts. All Superior Products are sold on a money-back guarantee.

**SUPERIOR PRODUCTS MFG. CORP., - - -**

**1080 SPRINGFIELD AVENUE  
IRVINGTON, N. J.**

*THIS WILL BE A RADIO CHRISTMAS!*

## ADVERTISING RATES

### THE RADIO DEALER WEEKLY

Listings in "Where to Buy Radio Equipment" Guide, \$25 per listing, per year, payable in advance.

### DISPLAY ADVERTISING

#### TRIAL ORDER

10 to 14 inches.....\$1.80 per inch  
15 to 19 inches..... 1.70 per inch  
20 to 29 inches..... 1.60 per inch  
30 or more inches..... 1.50 per inch

#### Four Consecutive Insertions

5 to 9 inches.....\$1.80 per inch  
10 to 14 inches..... 1.70 per inch  
15 to 19 inches..... 1.60 per inch  
20 to 29 inches..... 1.50 per inch  
30 or more inches..... 1.40 per inch

#### Thirteen Consecutive Insertions

1 to 4 inches.....\$1.70 per inch  
5 to 9 inches..... 1.60 per inch  
10 to 14 inches..... 1.50 per inch  
15 to 19 inches..... 1.40 per inch  
20 to 29 inches..... 1.30 per inch  
30 or more inches..... 1.20 per inch

#### Twenty-six Consecutive Insertions

1 to 4 inches.....\$1.60 per inch  
5 to 9 inches..... 1.50 per inch  
10 to 14 inches..... 1.40 per inch  
15 to 19 inches..... 1.30 per inch  
20 to 29 inches..... 1.20 per inch  
30 or more inches..... 1.10 per inch

#### Fifty-two Consecutive Insertions

1 to 4 inches.....\$1.50 per inch  
5 to 9 inches..... 1.40 per inch  
10 to 14 inches..... 1.30 per inch  
15 to 19 inches..... 1.20 per inch  
20 to 29 inches..... 1.10 per inch  
30 or more inches..... 1.00 per inch

CLASSIFIED—Ten cents per word per insertion.

Note—Time contracts not subject to cancellation.

All bills payable weekly, subject to sight draft after thirty days.

Cuts and art work at cost.

Forms close Saturday prior to date of issue. Proofs on copy received up to Tuesday before closing date.

Special position 25% extra.

Pages 10 inches deep, three columns wide.

## Radio Wins

### Utah Broadcasting Permitted in Spite of Phone Company

Permission to operate a radio telephone system was granted by the Utah Commission over the objection of a telephone company that the enterprise could not be made a success and that the existence of such a system would greatly hamper the telephone company in raising money to build a line which had been authorized.

The Commission held that the only objection that could be consistent, and one upon which the Commission would feel called upon to act, was the question as to whether such a service was necessary and would add to the convenience and necessity of the people in getting in communication with those parts of the state at the present time having no such convenience.

Commissioner Stoutnour, dissenting from the majority opinion, called attention to the fact that the applicant's financial ability to carry forward the enterprise had not been demonstrated and that the applicant had no real conception of the cost of installing the necessary broadcasting station. He pointed out further that it would be necessary for the applicant to secure a license from the Federal Government. Re Dalton, Case No. 541, September 7th.

—Public Utility Reports.

### KNOCK-DOWN LOUD SPEAKER

The Thorophone complete, made by the Winkler-Reichmann Company of Chicago, Illinois, is in every respect a knock-down loud speaker, for when not in use, it may be taken apart, put into compact space, and concealed from view.

The Thorophone has a controlled mica diaphragm and carefully designed sound box, nickel plated throughout.

### SUPERIOR PRODUCTS

"Superior Products" is the title of an attractive little folder that has been issued by the Superior Products Manufacturing Co., 1078-80 Springfield Avenue, Irvington, N. J., which calls attention to the variometers and the vario-couplers that they manufacture. These, they state are "built with the accuracy of a watch." The instruments, it is stated, are wound for proper inductance and are balanced on wave lengths of 150 to 550 meters.



## NATIONAL SEAMLESS TUBING

### In Large Diameters

For Vario-couplers, Vario-meters, Tuning Coils and wherever you use large diameter fibre tubing, National Seamless Tubing is less expensive and infinitely superior.

National Seamless Tubing is a specially developed, laminated tubing that retains its form and will not warp, swell or shrink. Exact in both diameters and easily worked.

Can be furnished in dark gray fibre or black fibre. Any quantities, diameters from 3" to 4½" I. D. Any wall from 3/32 up.

Give us your specifications. We'll send samples and prices.

### National Fibre for Panels

Hard Black Panel Stock of good dielectric strength. Gives satisfaction for condenser tops and bottoms, rheostat bases, washers bushings, etc. Let us quote on the stock itself, or on completed parts machined to order.

### Peerless Insulation

The standard thin weight fibre insulation or "fish paper."

### National Fibre & Insulation Co.

Box 454 Wilmington, Delaware  
New York, Chicago, Philadelphia, Detroit,  
San Francisco, Cleveland, Omaha, Pitts-  
burgh, Boston, Rochester, Birmingham,  
St. Louis, Baltimore, London, England  
In Canada, National Fibre Co. of Canada,  
Ltd., Toronto

THIS WILL BE A RADIO CHRISTMAS!

## Stops Static

### New Device Functions on Any Wave Length

Prevention of static interference in reception of radio signals has been solved by an invention of Dr. B. Galen McCaa of Ephrata, Penna., according to statement made by Dr. McCaa, last week.

Dr. McCaa has been working on static problems for four and a half years at his home, in New York and in California.

"Two different systems have been developed that function on an antenna at any wave length," he said. "Either one, when combined with a tone selective device that has been developed, operates to eliminate static.

"In California this Summer the static of 6,000 audibility was reduced to five, at which time commercial signals were received 250 times the strength of the static."

The second system, developed in his laboratory since his return East, has produced results superior to those obtained in California, he declared, adding:

"Tests have been made on the latest development at 360 meters, on which a broadcasting telephone system is operated, and it is known that the device will operate on all radio systems at any wave length. The latest device is free from critical adjustments and is absolutely stable in operation, requiring no attention.

"The fact that it operates on an antenna makes it applicable for use on ships at sea, and it becomes another important factor in life saving by assuring absolute communication between vessels under conditions at which they cannot now operate.

### INDUSTRY NEEDS A FORD

The mass methods of Henry Ford, if applied to every part of the manufacturer - distributor - dealer chain, would result in great savings to the public, according to O. D. Street, general manager of distribution for the Western Electric Company.

"We need more men like Henry Ford," said Mr. Street.

Mr. Street made this statement at the recent meeting of the Associated Business Papers.

### BRITISH INTERESTED

British interest in broadcasting is increasing according to reports that are received here. It is said that the Prince of Wales is the first member of the royal family to take up radio. He is having a receiving set installed in St. James's Palace.



## Your Leader for Holiday Business The LITTLE GIANT (TRADE MARK) Radio Holiday Outfit

**E**VERY single thing needed to enjoy the radio programs, neatly packed in a substantial and attractive Holiday Box at a popular price.

The *Little Giant* Set itself is a wonderful seller. Its appearance, compactness, delightful efficiency and sheer simplicity of operation is just what they all want. Anyone can use it and everyone appreciates so timely a gift.

Place your order now. Our production requirements are rapidly reaching full capacity. You need the profits this big leader will win. Send immediately for sample outfit and our proposition.

### Little Giant Outfit Complete

With Metro Head-phones, Aerial, Insulators, Ground Wire, Ground Clamp and all Accessories.

In Holly  
Box \$15  
List

*Little Giant Receiving Outfit also put up in Plain Black Box*

## METROPOLITAN RADIO CORPORATION

70-74 Goble St.,    -:-    Newark, N. J.

THIS WILL BE A RADIO CHRISTMAS!

**QUALITY  
RADIO PRODUCTS**

**Dictograph  
Headsets and Loudspeakers**

**Universal  
3 plate Vernier, 23 and 43 plate  
Condensers**

**Keystone Variometers**

**Radio Storage Batteries**

**Ajax Socket Rheostats**

**Saturn Telephone Plugs, and  
Jacks, Sockets, Rheostats, Variocouplers (180°)**

**Everything That Goes to Make  
a Set**

**Jobbers and Dealers—Write or  
Wire for Prices—NOW!**

**We are authorized distributors for  
recognized standard products**

**FREDERICK H. PRUDEN**

**Incorporated**

**Lerner Building**

**991 Bergen Avenue, Jersey City, N. J.**

**TRIUMPH'S ADVANTAGES**

The Triumph combination variocoupler and variometer was designed to fill the need of an efficient and simple instrument, to enable the operator to work the two instruments in one operation. The turning of one dial performs the manipulation, which usually necessitates the use of several dials and complicated tuning regulations.

In the ordinary receiving sets having a radio-coupler and a radio-meter, four distinct manipulations are necessary while with the Triumph, it is claimed that only two manipulations are needed. Thus two operations are dispensed with. This instrument is made for wave lengths from 150 to 800 meters, using a variable condenser. It is said that the entire instrument is made of the best materials and embodies all that science, skill and experience can produce. The Triumph, equipped with a 3-inch dial, retails for \$6.50. It is manufactured by the Signal Radio & Electrical Corp., 64 University Place, New York.

**FIBRE HORNS**

The Fibre Products Co., 240 North 10th St., Newark, N. J., have brought out two sizes of horns. The No. 1 horn has a bell 10 inches in diameter and 23 inches high, while in the No. 2, the bell is 14 inches in diameter and 29½ inches high. These horns are made of a high quality fibre material which has the resonant qualities of wood and yet costs very much less. There are no joints or rivets to loosen. The horns are finished with a rich black enamel.

The Fibre Products Co. are selling these horns stamped with their own trademark or with the trademark of any distributor.

**THE PITTSBURGH SHOW**

The Pittsburgh Radio and Electrical Show will be held November 4 to 11 in the Motor Square Garden at Pittsburgh, Pa. It is announced that the many large exhibits will be of exceptional interest

**WARNING TO  
SWINDLERS**

**THE RADIO DEALER** endeavors to guard its advertisers against the unscrupulous who may attempt to swindle by replying to announcements. Post Office regulations are stringent against use of the mails for improper purposes.



**T-B-H PHONES**

**SPEAK FOR THEMSELVES  
Pure Natural Tones, Light Weight  
Ornamental Appearance**

**A Sturdy Reliable Head Set That Will Sell  
and Stay Sold**

*Let us send a sample set for your inspection*

**List \$7.00**

*Substantial Discounts to Jobbers and Dealers*  
**T. B. H. CORPORATION, Dansville, N. Y., U. S. A.**

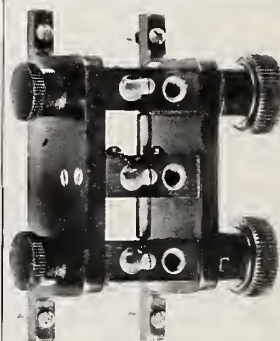

**TRIPLE  
DOUBLE  
and  
SINGLE  
COIL  
MOUNTS**

not moulded, fully dielectric, special lock knob, preventing any moving of coils after being set, assures closest tuning.

**TRIPLE COIL MOUNTS..... \$5.50**  
**DOUBLE COIL MOUNTS..... 3.75**  
**SINGLE COIL MOUNTS..... .50**

**List Price**

*Trade Discounts Allowed*

**OSLAND, INC.**

**122 Fifth Ave. New York City**

**RECEIVERS REWOUND AND  
REPAIRED**

**Any make, copper wire, any resistance  
Work guaranteed  
Commissions to Dealers**

**MONTCLAIR RADIO CO.**

**272 Bloomfield Avenue Montclair, N. J.**

**American  
Radio & Electric Co.**

**1133 Broadway New York City**

**WRITE FOR OUR CATALOG  
JUST OFF THE PRESS**



**"Essex" 150-600 meter  
180° variocoupler with  
3/4" molded dial.  
Price \$1.25 each**  
Essex square turned  
bus wire 2 foot lengths  
\$1.00 hundred feet  
**ESSEX MANUFACTURING CO.**  
117 Mulberry St.,  
Newark, N. J.

**Rheostats—Sockets  
Potentiometers  
Crystal Detectors**

**ROYHELE MFG. CO.**

*Mfrs. of Quality Products*

**167 Mercer Street New York, N. Y.**  
*Write for Prices. Representatives Wanted.*

**CRYSTAL DETECTOR STAND Crystal Detector Stand, No. 1230**

**Crystal Detector Stand, No. 1230 \$2.25**

**No. 1201—\$1.50**  
Nical plate or brass  
Feet  
Tested Galena in  
Wood's metal 20c.

**Get prices for other instruments and parts**

**Dust-proof. No vibration. Flexible adjustment. Can be set rigidly.**

**\$1.75 each—100—\$18.00**

**3 in. Bakelite Dials right and left rotation**  
45c. each—100—\$23.00

5c. ea. 25c. ea.  
100—\$3.50 100—\$17.00

**After 1 1/2" radius**  
Guaranteed not to  
work loose here  
shown. Note the  
shape.

**1 in. radius—100—\$13.00**

**Rheostat No. 1176 constructed like No. 1175 with 2 in. Dial \$1.25 ea. 100—\$60.00**

**Very good seller.**  
60c. ea. 100—\$21.00

**Radio Bulb Socket, No. 1150**  
latest in absolute reliable contacts. Study construction shown in diagram. "ON TOP OF ALL" quality, and sells for \$1.00 only. Highly nickel polished & polished black copper base.

**Rheostat, No. 1175**  
is constructed with metal bearing for shaft, therefore more durable than others. Designed for use on panel or table. Resistance 5 ohms. \$1.00 each.

**Nickel or Brass**

**No. 7160 \$1.80 C., \$7.20 M., No. 7188 \$1.30 C., \$5.20 M.**

**All styles of Binding Posts and Radio Parts manufactured and carried in stock. Get illustrated folder.**

**No. 7512—\$5.50 M.**

**CONTINENTAL ELECTRIC COMPANY**  
**119 East 129th Street New York, N. Y.**

*THIS WILL BE A RADIO CHRISTMAS!*



# Jersey Dealers and Wholesalers Confer

## Evils of the Distribution System and Wisdom of Forming a State Association Were Discussed

Nobody attempts to deny that the distributing agencies of the radio industry need a thorough overhauling to conform with the best business standards. The summer slump has given the dealers much food for thought along these lines. In a recent interview, Mortimer J. Salzman, manager of the Wholesale Radio Equipment Company, 24 William Street, Newark, N. J., gave hope that this house cleaning has started or will start before very long.

A short time ago he invited the dealers of Newark and adjoining towns, as well as several other wholesale concerns, to attend a dinner at Achtel-Stettens, for the purpose of discussing a dealer's organization in New Jersey. At that dinner, more was accomplished from the frank recognition of the evils in the distributing system and devising of ways of overcoming them, than had been, from months of futile talk by various individuals.

Mr. Salzman, commenting on this conference, very carefully called attention to the fact that this one meeting could not accomplish the complete purpose for which it was held. "There will have to be many more such meetings," he said, "before we will have formed a workable association, but we realize that the foundation must be firmly laid. This association is too important to be formed overnight. We have the dealers and other members of the industry interested in the association. That is about all you can ask at the present time."

This conference and succeeding conferences, it is believed, will have a very beneficial indirect influence upon the dealers of New Jersey. They are now thinking about these problems and doing their best to find a solution. Out of all this thought and getting together, there are bound to come more wholesome and more satisfactory relations which will benefit everybody in the industry.

He emphasized that one of the first benefits to be expected from such an association would be its effect upon the various manufacturers. When a body of dealers expresses their desire for a certain standard of goods, manufacturers

will understand more clearly what they must make and how they must make it in order to secure the co-operation of the distributor.

Quality will be raised and dealers will recognize that the manufacturer is very largely limited in his efforts to produce quality goods by the methods of various retailers. When dealers exert a united voice, radio merchandise will become standardized. These are just a few of the very evident benefits to manufacturer, wholesaler and retailer, and finally and most important of all, to the public—of this movement to improve retail conditions.

Mr. Salzman is not taking any narrow standpoint in this work. He has issued a broad minded call to all wholesale radio houses in New Jersey to join hands with him in making New Jersey a better radio market, and he is doing everything he can through his own organization to

promote the welfare of the dealers. Wherever possible, he gives the dealer a helping hand, counsels him wisely and tries to steer him in the paths that he knows will ultimately profit him the most.

Dealers always have a hearty welcome at the beautiful large show-rooms of the Wholesale Radio Equipment Company, on William Street, Newark, N. J. Apparatus for testing are always available and every facility for careful buying is offered them. Mr. Salzman takes the view that his position in distributing is that of an expert buyer for a great number of dealers. He must know the radio industry from A to Z, be able to look ahead and provide for future developments, be guided by the past and know every phase of the present. This is no small job but every dealer who buys from the Wholesale Radio Equipment Company realizes that Mr. Salzman fills the bill to a "T."

## Attractive De Forest Booth at Chicago's Big Radio Show



Displaying the complete line of radio parts manufactured by the De Forest Radio Telephone and Telegraph Company, the booth shown above at the Chicago Radio Show attracted much attention because it was the exhibit of one of the pioneer firms in radio development. During the week of show, October 14 to 21, many visitors stopped at the exhibit as if to pay homage to Dr. Lee De Forest.

In the exhibit the new De Forest sets were displayed to advantage, especially D-4, D-5, D-6 and D-7.



HALL-MARK OF QUALITY

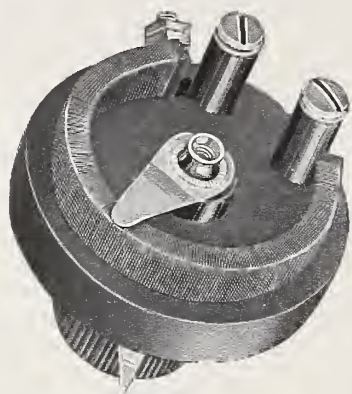

MODEL—A205

**POTENTIOMETER**

230 OHMS 0-2 AMPS

SPECIFICATIONS

**Condensite Base**  
**Ideal Resistance Unit**  
**Phosphor Bronze Contact**  
**Brass Posts**  
**Highly Nickeled**

SEND FOR OUR BOOKLET  
**"WHY WE USE CONDENSITE"**



MODEL—A101

**RHEOSTAT**

**ADVANCE METAL STAMPING CO.**

MANUFACTURERS  
 Department RE

19 THOMPSON ST., NEW YORK

**MACHEN AT RADIO SHOW**

Machen Radio Manufacturing Co., Inc., of 4639 East Thompson Street, Philadelphia, recently circularized all Radio dealers in that city, calling their attention to the fact that the Machen people were exhibiting at the Radio Show, which was held at Lu Lu Temple, Broad and Spring Garden Streets, from October 2nd to 7th.

The Machen "Clearad" radio parts were featured by the company in their display, number five. To demonstrate the truth of the assertion that "it is a pleasure to listen in with the Machen 'Clearad' receiving sets," the Machen people connected several sets in circuit, so that radio buyers could judge for themselves on hearing the clear tones and the pick up free from static.

Each "Clearad" receiving set is mounted in a mahogany cabinet and materials and workmanship are of a high quality. The company also makes a line of variometers and variocouplers, mounted and unmounted, amplifying and detector panels, rheostats, telephone plugs and jacks. The company has had twenty years' experience in the manufacture of electrical goods.

**ORANGE SEAL ARRESTER**

Built in strict accordance with the Underwriters' requirements, and selling at a price that allows the dealer a good profit are among the claims for popularity that are made for the Orange Seal lightning arresters by its manufacturers, the Brighton Radio Co., Beaver Falls, Pa. To install this arrester, it is suggested that the arrester be suspended from the lead-in wire just below the insulator. A wire connects the lower end of the receiver to a pipe driven into the ground. As the natural tendency of lightning is to reach the earth by the shortest available route, it will jump the arrester air-gap in a direct line to the ground rather than travel through the devious turns and coils of the radio outfit.

**NA-ALD COGSWELL CONDENSER**

The Na-Ald Cogswell variable condenser, manufactured by the Alden-Napier Company, 52 Willow street, Springfield, Ill., is said to have the smooth, easy movement of perfect bearings with a uniform increase in capacity as it is rotated, due to the special shaped plates—a Bureau of Standards design. In addition to several other features it has a pig tail connection which eliminates faulty contacts.

**"I PICKED WINNERS"**

Was the answer of a prominent business man to a question as to the secret of his remarkable success.

**UNITED**  
**Variable Condensers**  
**and Transformers are**  
**WINNERS**

Back of them is a half-million-dollar equipment and a staff of real Radio Engineers.

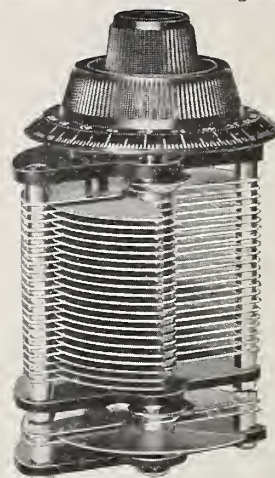

**United Variable Condensers**  
 WITH VERNIER ATTACHMENT DIAL AND KNOB

**United Variable Condensers**

|               |        |
|---------------|--------|
| 46 plate..... | \$6.50 |
| 26 plate..... | 5.50   |
| 43 plate..... | 4.50   |
| 23 plate..... | 4.00   |
| 11 plate..... | 3.50   |
| 5 plate.....  | 2.75   |
| 3 plate.....  | 2.25   |

As shown without dial or knob.

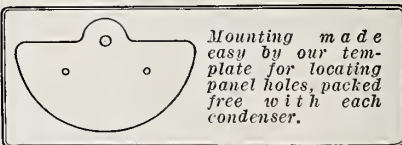

Mounting made easy by our template for locating panel holes, packed free with each condenser.

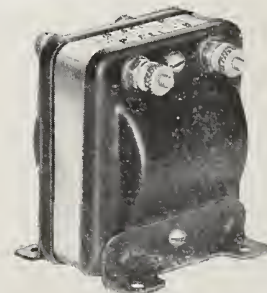

Pat. Appd. For

**United Transformer**  
 Fully Mounted as Shown  
 Black enamel or buffed nickel plated.....\$4.50

Liberal Discount to Jobbers  
 Send for Circular.

**United Mfg. & Distributing Co.**  
 536 Lake Shore Drive Chicago, Ill.

## Business Static Slowly Being Eliminated.

(Continued from page 57)

terials, and makes sure they are standard makes this time, with the result that his product is very gratifying and he is a booster of radio.

The foregoing reference conveys a good idea of business static. Man Number One is the so-called manufacturer who made so-called radio parts in the cellar, garret, shoe factory, lace mill, etc.

Man Number Two is the radio public who have suffered a loss, but realize that their disappointment is due to the experiment of man Number One and shun both him and his products

If one takes the time to look around a bit, a very short survey will prove that the standard articles are moving and have been moving and are selling at their list prices, while the just as good kind are selling for any thing they will bring, *when they sell.*

The public is becoming educated and now demands the best and are paying the price for the best.

So, let the man who understands radio and is making a good product take heart for the morning of his day is here and by the afternoon the horizon will be cleared both of inferior radio manufacturers and their products. These we refer to as business static and just so sure as science is removing electrical static, just so sure will clean business and perfect products remove business static.

### "BEST" VARIABLE CONDENSERS

A. C. Towne, Inc., Buffalo, N. Y., have placed a new line of variable condensers on the market to which they have given the name "Best." It is emphasized that these condensers require but one hole for panel mounting. The manufacturers also say that the rotating member is perfectly bushed, washer construction and counterbalance have been eliminated and the condensers are electrically and mechanically perfect.

### WESCO APPARATUS

The Wilmington Electrical Specialty Company, 912 Orange Street, Wilmington, Delaware, offer the trade Wesco detector and amplifier panels, type HR regenerative receivers, Dragon radio storage batteries, amplifying transformer, antenna wire, magnet wire and other apparatus of special merit.

# CONQUEROR

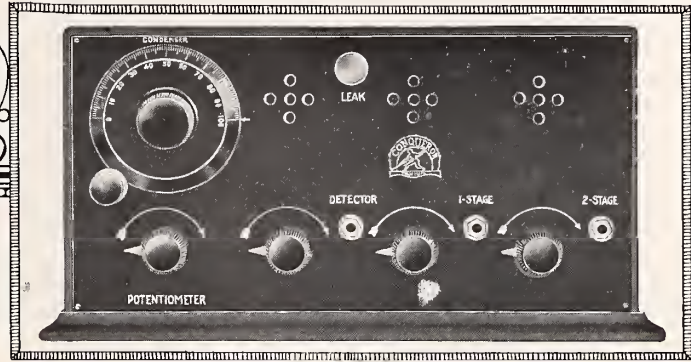

DO YOU BELIEVE  
IN SANTA CLAUS?

*Are you placing orders now in anticipation of the inevitable Christmas and winter boom in Radio Sales, or will you be obliged to say, "This is all we have?"*

BUY NOW

## CONQUEROR

Custom-Built, One-Knob Control

RECEIVING SETS

BECAUSE---

—They're the finest tuner, detector and 2 step amplifier sets made at any price—bar none.

—They're capable of an unprecedented degree of super-sharp tuning and render an undistorted tone as clear and voluminous as the finest talking machine made.

—They're so simple to operate and built of the finest units known to the science.

—They're the most beautiful looking sets you've ever seen—housed in a solid mahogany, piano finish case, sufficiently attractive to grace the most tastefully appointed home.

—There's an unconditional, bona-fide ONE YEAR GUARANTEE with every Conqueror Set we sell.

### DEALERS AND JOBBERS

*Write right now, for specifications, price and discounts—  
or demonstration.*

## LEWIS & DE ROY RADIO CORP.

560 SEVENTH AVE  
NEW YORK CITY

DESIGNERS AND  
BUILDERS OF



CONQUEROR  
RADIO SETS

THIS WILL BE A RADIO CHRISTMAS!

## National Survey Shows Condition of Radio

(Continued from page 45)

As to the stocks on hand, jobbers reported amounts invested at a range of from \$5,000 to \$150,000. Goods ordered for future deliveries ranged from \$5,000 to \$200,000. With the slump some jobbers resorted to a C. O. D. basis of business which retarded the outlet of goods. As a general rule, however, most jobbers worked on a ten days two per cent. off, thirty days net basis. Indications are that this will continue as the general basis for jobber-to-retailer business. Ninety per cent. of the jobbers stated in the reports that they believed that fifty per cent. off was the proper discount to jobbers.

From newspaper and jobbers' reports there are at least four thousand exclusive radio dealers in the country. But the actual number of firms engaged in handling radio is at least five times that number.

The figures as to the growth of broadcasting stations is one of the most startling, as well as reassuring, signs in the industry. At present, from reports compiled, there are 542 public broadcasting stations in the United States, providing programs daily or on schedules less regular. Every state has at least one station. Any town of any size has at least one within a range of twenty miles, and on an average of two more within seventy-five miles.

Radio stocks, then, will be adequate for the Christmas trade, broadcasting will be in sufficient quantity to inspire buying, the public has had a year to learn "what it's all about," newspapers have been instructing them right along in daily and weekly radio pages, dealers have profited by experience and are learning how to sell radio rather than handle it, and altogether it looks as if this is going to be a radio Christmas!

## Free Instruction

(Continued from page 65)

man who has just spent a few hundred dollars for a receiving set discards it, and tells all his friends that radio is absolutely unbearable. We want to show such people that radio telegraph is as interesting or more so than concerts. Let the amateur, the broadcaster, and the novice get together and have a good understanding about the matter, and business will be fine. Otherwise radio is bound to lose its attractiveness from the financial standpoint. Are we right?

## JEWELL VARIO COUPLER

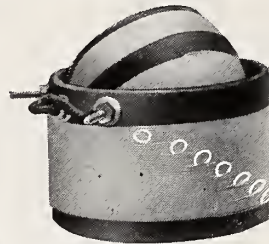

\$1.25 List

400 meters, 3" rotor, tested stator, 21 s. c. wire, 1/4" aluminum shaft, 14 taps, pigtails.

Sell More  
Popular Price  
Couplers

Positive Connections  
Positive Results

ROTORS SET LOW IN STATORS

WE MAKE OTHER STYLES  
TO 3000 METERS

DEALERS—JOBBER—AGENTS  
PLEASE WRITE FOR DISCOUNTS

MANUFACTURED BY

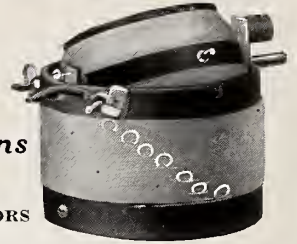

\$2.50 List

600 meters, 3 1/4" rotor, composition stator, 24 s. c. wire, 1/4" brass shaft, pigtails, 14 taps, brass uprights.

**JEWELL RADIO SALES CO. 90 West St., New York**

## Radiobat Grid Has Double Reinforced Construction

A group of "A" and "B" storage Radiobats which incorporate a number of new features of interest to radio fans are shown in the accompanying illustration. Both the "A" and "B" types of these new principle batteries contain a solid electrolyte which makes them absolutely nonspillable. This feature

ing mesh in the grid does not come to the surface of the plate, there is actually more active surface per square inch of plate area. In the case of the Radiobat "A," this results in a battery 25 to 30 per cent smaller and, consequently, easier to handle than any other "A" battery of equal rating.

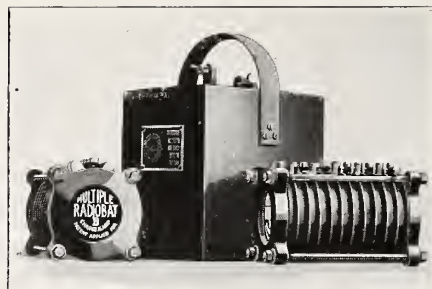

Radiobats

will be appreciated by every radioist who has ever spilled acid from his battery on his mother's or wife's best carpet.

According to a statement made by the manufacturers, one of the interesting features in design is the absence of separators which reduces internal resistance to a minimum. The Radiobat grid (the metal mesh into which is pressed the "active material," forming the "plate") has a double reinforced construction. This construction adds 25 to 30 per cent. more actual metal per square inch. The plate is, consequently, just that much more rugged and does not buckle. This reinforced strength plus the solid electrolyte renders the use of separators unnecessary. Due to the fact, however, that the secondary reinforce-

The Radiobat storage "B" is even more unusual and interesting. It is compact—only four inches square by seven inches long—scarcely larger than a large size dry cell "B." It has no glass jars to break, no liquid to leak. The most notable feature is its utter noiselessness of operation. It substitutes the steady, sustained voltage characteristic of a storage battery in place of the irregular constantly dropping voltage of a dry cell, thus eliminating all hissing and crackling noises with which all radio operators are familiar. Changing voltage in the plate circuit is the direct cause of most tube noises and most of what is blamed on static. Sustained voltage does away with this and results in a clear true-tone reproduction of each word and note.

The Radiobat storage "B" is economical as well. It is easily rechargeable at home from either AC or DC currents and outlasts its value in dry cell "B's" on each home charge.

The combination of "A" and "B" Radiobats forms a new principle in radio power supply which deserves the attention of radio enthusiasts. Additional information regarding the Radiobats will be supplied by the manufacturers, the Multiple Storage Battery Co., 350 Madison Ave., New York.

**THIS WILL BE A RADIO CHRISTMAS!**

## Everybody Must Help Eliminate Weaklings

(Continued from page 49)

hundred dollars credit, and in a short time our young merchant has seven or eight thousand dollars worth of merchandise on his shelves for which he owes the wholesalers six or seven thousand dollars. Everything is lovely until the rush is over, then he finds himself with about a thousand dollars in cash with which to pay for seven thousand dollars' worth of merchandise that he cannot sell. He had not figured on that. He expected to sell it all, and stop buying before the slump arrived, or maybe he thought there wouldn't be any slump. Anyway he fails; the auction sale brings about two thousand dollars and the wholesalers lose four thousand dollars among them. The bankruptcy brokers who purchase the seven thousand dollars' worth of merchandise for two thousand dollars proceed to throw it on the market at less than its manufacturing cost. As long as it is on the market the retailers' business is damaged, and the wholesalers and manufacturers suffer.

The wholesalers' and manufacturers' losses are therefore two-fold. They lose the money that is due them from the bankrupt dealer, and they lose further sales while the broker is capitalizing their misfortune by selling the merchandise at half price, but still at a generous profit to himself.

It is not always necessary for a dealer to actually fail for the brokers to get in their work. The dealer may find himself with accounts payable amounting to say two thousand dollars while his principal asset consists of five thousand dollars' worth of merchandise that he cannot sell. The brokers seek him out, and waving two thousand dollars in bills in his face, they purchase the greater part of his stock at a ridiculously low price and throw it on the market at a fraction of its worth. In this case, the dealer loses his year's profits, and becomes a weakling, while the manufacturers, wholesalers and other dealers suffer loss of further sales as long as the brokers are in the market.

Within the past few days there has been formed in New York a well financed company, for the specific purpose of capitalizing the misfortunes of overstocked and embarrassed manufacturers, wholesalers and retailers, and while they will prey mostly upon weak wholesalers and retailers, it is understood that they have already bought from a manufacturer

(Continued on page 88)



# TWO and ONE HALF MILLION CUSTOMERS

ARE WAITING FOR

## MICAPHONE

ADJUSTABLE A REAL SENSATION **MICA** MADE FOR EVERY MAKE OF PHONE

## DIAPHRAGMS

### CHRISTMAS BUSINESS

MICAPHONES are the ideal Christmas present. Thousands will be bought. Every fan has a head-set—every head-set needs MICAPHONES GET YOUR SHARE OF THIS BUSINESS-

#### SMALL INVESTMENT

Trial Assortment (12 pair)  
Costs only \$13.75, cash with order or C. O. D.  
Sells for \$24

You make \$10.25  
A Nice Big Profit

#### QUICK SALES

Average of our sales shows three reorders per month per dealer.

Send \$13.75 today for Trial Assortment.  
Satisfaction Guaranteed.

Just Slip Out the Metal Disc and Slip in the MICAPHONE

Soften Static Eliminate Noises  
Give Wonderful Tone  
Natural Clear Speech Sharp Signals  
No Distortion

PUT THIS SILENT SALESMAN IN YOUR WINDOW

It links your store with our advertising in all the leading radio magazines.

IMMEDIATE DELIVERIES



Radio Mica Products Co., 156 East 43rd St., New York City

SOLE MANUFACTURERS

THIS WILL BE A RADIO CHRISTMAS!



## Mercury Radio Sets

A PROFITABLE line to handle, from the dealers' standpoint. A reasonably priced line to buy from the consumers' standpoint.

The low price is made possible by quantity manufacture in our large factory where every part is made, not merely assembled.

Write for details  
and trade prices.

**MERCURY RADIO  
PRODUCTS CO.**

LITTLE FALLS NEW JERSEY



Radio  
Supplies  
of  
Exceptional  
Character  
at  
Correct Price  
and  
Liberal Discount

Write for Descriptive  
Catalogue

**Harold M. Schwab, Inc.**  
419 West 42nd Street  
New York City

## Report on Sale of Radio Parts and Supplies

(Continued from page 46)

John Jones is naturally clever with his hands, he has that sort of mind that responds to the idea of making things, and that kind of imagination that is intrigued by the fascinations of radio. He may be a boy just big enough to get his chin above the counter or an elderly man. He knows something of the technical side of radio, but his circumstances prevent him from putting sufficient time on it to make him able to grasp all the details which enter into the design of really first class equipment.

Every time he gets a new idea he wants to try it out. If he is successful, he is encouraged to take up the next one. If he fails, he does not blame his own lack of knowledge. He blames you and the parts you sold him. He brings in his failures to discuss with your salesmen, but they have no time to give him. He is filled with resentment and never goes to your store again. If he is successful, he may come back to buy more things when and if he finds something else to tackle.

We, at the Sleeper Radio Corporation, have adopted a slogan "Sell him ideas and you sell him supplies." In our service station, which we use as a selling laboratory, we carry both nationally advertised complete sets and our regular Sleeper standardized parts.

One thing we have definitely established, from our customers in the selling laboratory, is that the permanent trade that we built up last spring has not been with people with whom we sold complete receiving sets but with experimenters to whom we sold ideas and in consequence parts for constructing apparatus. Let me point out right here that a department of your radio business selling instruments and parts is of tremendous value in making good times better and stabilizing sales during the dull period.

Now for the ideas. I pointed out we found it necessary to supply experimenters with ideas for building instruments of parts which you sell for, left to their own resources, they have not sufficient knowledge to go ahead with the design of instruments of their own accord.

To summarize my answer to your question as to what methods must be pursued to handle profitably and with rapid turnover separate instruments and parts, you must apply real selling methods to parts just as you have

## Radak

Reg. U. S. Pat. Off.

RELIABLE RADIO EQUIPMENT  
made by America's oldest and largest manufacturers  
of radio equipment exclusively. Sold by the best  
electrical and radio dealers.

**CLAPP - EASTHAM CO.**

133 Main Street Cambridge, Mass.

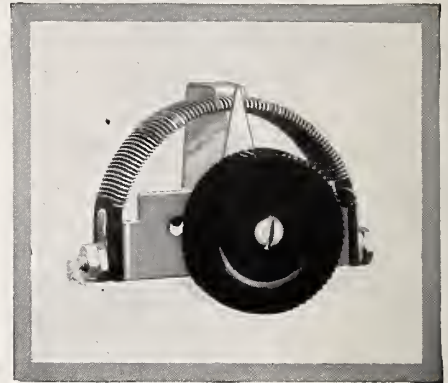

### A BETTER RHEOSTAT

A nicer looking, smoother working and better made rheostat than you have ever seen before.

Furnished with or without vernier this instrument will improve the operation of any radio equipment.

The many valuable features coupled with national advertising make this an instrument every dealer and jobber should stock—liberal discounts give ample margin of profit and low list means quick turnover. Order now.

123A Plain..... 80c  
Type 123B Vernier..... \$1.40

**THE WILCOX LABORATORIES**  
LANSING MICHIGAN

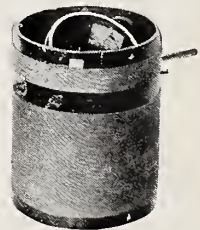

### VIKING VARIO-COUPLER

This Vario-coupler was originally designed for use in the Consolidated Radio Call Book Co.'s Pattern No. 1 for a Short Wave Regenerative Receiver. It may also be used in any other hook-up requiring a vario-coupler. This coupler, whose wave length range is 150 to 800 meters is filling a real demand, and its popularity is assured.

Price \$5.00

We are also the sole authorized distributors for the Consolidated Radio Call Book Co. and can offer at their regular discounts the following:

Radio Constructor Pattern No. 1  
Radio Constructor Pattern No. 2  
Radio Constructor Pattern No. 3  
20 Radio Phone Diagrams and Hook-ups  
14 Radio Formulae and Diagrams  
and the  
Consolidated Radio Call Book

Discounts to Dealers and Jobbers

**VIKING RADIO CO.**  
26-D Cortlandt Street  
New York City

THIS WILL BE A RADIO CHRISTMAS!

learned to supply selling methods to complete sets. It is not profitable to merely have on hand parts to meet the various requirements of experimenters but it is profitable to go right into the sale of parts with the same sort of psychology that you applied to complete sets if you will bear in mind the slogan, "sell him an idea and you will sell him supplies" and make your salesman work with that in mind and, as you have done with complete sets specialize on the fewest possible and yet the most complete lines of parts and separate instruments. You will find the profits from parts certainly equal and possibly exceeding in percentage, very likely two in volume the sale of complete instruments.

**SIMPLE-X CRYSTAL RECEIVER**

The Caragol-Clarke Co., Inc., 82 Beaver Street, New York, states it is obtaining gratifying results in the distribution of the Simple-X Crystal receiving set. The Simple-X is said to be all that its name implies—as simple as writing "X," and it is one of the smallest, most efficient and compact crystal sets on the market. There is nothing in its construction that requires mechanical knowledge to any degree, and it is, in fact, so simple that even a child can operate it. This receiver takes up but few square inches on window sill or table and will bring its broadcasting loudly and clearly within a radius of 25 miles.

A few points of interest as to the construction of the "Simple-X" follow:

- (1) The only set equipped with the Simple-X fool-proof detector.
- (2) The only set with the Multi-tec crystal—a thousand crystals in one. This crystal does away with the usual annoyance and delay of trying to find a sensitive spot on the crystal.
- (3) Roller sliders give a smooth constant contact.
- (4) No wearing or short circuits of coil wires due to frictional scraping.
- (5) The Simple-X is the only crystal set having a flat coil and indicating rollers.

This set has been awarded the "Certificate of Excellence" by the laboratory of the *New York Evening Mail* and has been approved by the *Tribune Institute*. The Simple-X claimed to be specially adapted for the home or office and appeals to "young America."

Distribution is progressing rapidly all over the country and within another month or so should be in full swing.

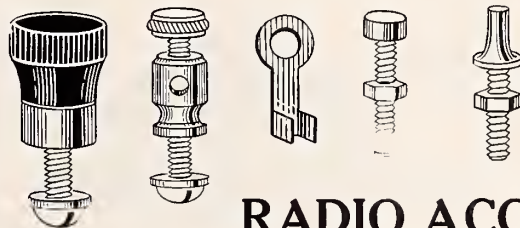

**IMMEDIATE SHIPMENT**

Also

**All Other Radio Needs**

WRITE FOR PRICE LIST

**RADIO ACCESSORIES CO.**

220 West 42nd Street

New York

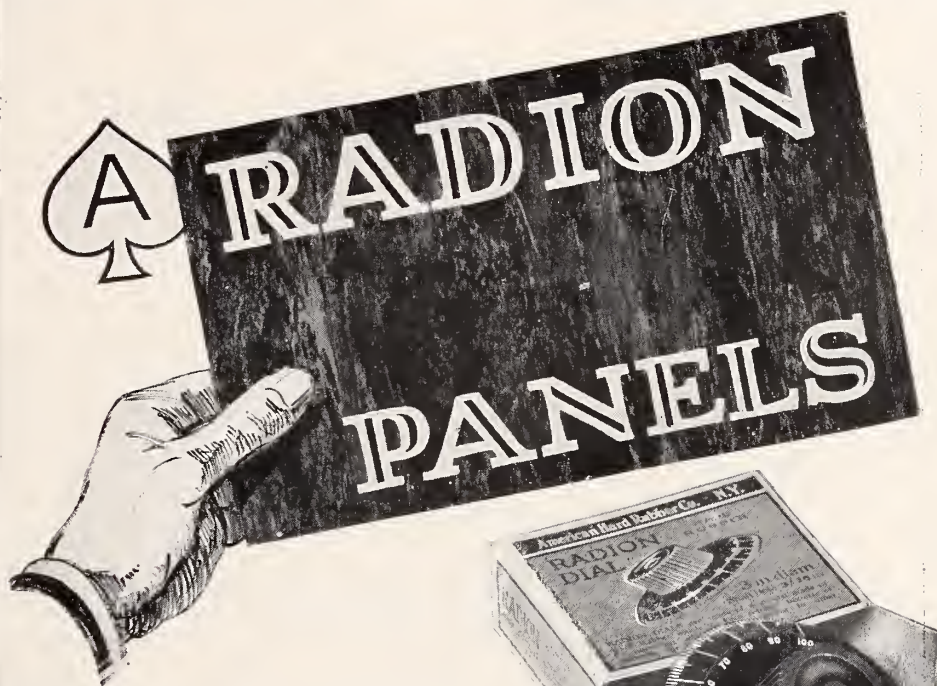

**Turnovers not Leftovers**

Ideal radio weather is here. Broadcasting from distant states is once again heard nightly by the listener-in. With each day bringing nearer cold evenings it behoves every dealer to stock well but *carefully*, for it is to be a good radio season.

**RADION**

Mahogany Panel is equipment which every fan will be pleased to own because of the beautiful mahogany grain finish, delightful satin like smoothness and supreme insulating properties. Hence RADION panels will turn over rather than be left over.

Also our line of RADION dials, knobs, sockets and other similar parts is complete. These, too, will sell because their properties are such that when the hand touches the RADION dial, for example, it does not cause those noises which are always present when parts made from inferior compositions are used. In short, RADION is superior for wireless application. It is a quality product needing no apology from radio dealers who sell it. Write today for all information.



**American Hard Rubber Co.**  
11 Mercer St., New York

THIS WILL BE A RADIO CHRISTMAS!



## A Sales Room in New York for a Dollar a Day

at the

# Permanent Radio Fair

(Located in the "Buying Hub" of the United States)

Under the personal direction of

**Raymond Francis Yates**

Radio Editor, New York Evening Mail

**GEORGE T. KEEN.**  
*Business Manager*

**MORTON STERNS, I.R.E.,**  
*Technical Director*

At the present time the radio industry is badly in need of a centralized exhibition of reliable merchandise, where buyers may come and make their purchases with a feeling of security. The Permanent Radio Fair is such a place; it is the official radio buying center of the United States. Buyers from every part of the country are visiting the Fair, because it saves them time and worry in selecting their merchandise. Only apparatus of recognized standing is being displayed and nothing will be accepted that does not meet with the approval of Mr. Yates, Director of the Fair. The Fair is open only to buyers during the morning. General public admitted during afternoon and evening.

The Permanent Radio Fair is being held in the famous Red Room of the Hotel Imperial, where 165 glass-covered compartments ranging in size from 24 x 24 x 36 inches to 36 x 36 x 36 inches have been provided. These spaces rent at a charge of from \$1 to \$3 a day.

### Send for Literature

A partial list of the exhibitors follows:

|                                    |                                   |
|------------------------------------|-----------------------------------|
| DeForest Telephone & Telegraph Co. | Marshfield Radio Corp.            |
| A. H. Grebe & Co.                  | Norman W. Henley Pub. Co.         |
| C. Brandes, Inc.                   | Westinghouse Elec. and Mfg. Co.   |
| Multiple Storage Battery Co.       | Finch Radio Co.                   |
| Pacent Electric Co.                | Radio Winding Co.                 |
| Signal Electric Co.                | Wilson Utensil Co.                |
| Federal Telephone & Telegraph Co.  | Victor Radio Co.                  |
| Dubilier Condenser & Radio Corp.   | Mercury Radio Co.                 |
| Cutting & Washington               | Post Electric Co.                 |
| Horne Manufacturing Co.            | Metropolitan Radio Corp.          |
| Radio Corporation of America.      | Wireless Press.                   |
| Hopewell Insulation & Mfg. Co.     | Electrad Corp.                    |
| Jewett Manufacturing Co.           | Globe Radio Co.                   |
| Man-Day Radio Corp.                | Bruno Radio Corp.                 |
| Acme Apparatus Co.                 | Radio Laboratories of New Jersey. |
| Arrow Radio Co.                    | National Airphone Co.             |
| Callophone Radio Products.         | Hartford Instrument Co.           |
| Chicago Radio Laboratory.          | Cairns Radio Corp.                |
| F. A. D. Andrea.                   | Lefax.                            |
| W. E. Supply & Service Corp.       | And many others.                  |

Fair Opened Sept. 30th—Closes May 30th

**PERMANENT RADIO FAIR, Inc.**

Hotel Imperial

32nd Street and Broadway

New York City

## Everybody Must Help Eliminate Weaklings

(Continued from page 85)

who approached them to remonstrate. The extent to which an organization of this sort might demoralize the market is apparent.

The manufacturers and wholesalers have it within their power to stop this, by exercising both preventive and combative measures, if they will recognize facts which confront them. The dealers, by force of numbers, can help as much, and their aid should be enlisted. It is important.

When a water pipe breaks, we first shut off the water, to prevent further leakage, and then repair the break.

The manufacturers and wholesalers should first stop extending credit on practically worthless interchange of experience, which permits a merchant with a thousand dollar rating to obtain a thousand dollars' worth of merchandise from as many different sources as he can find time to write to.

Financial statements and proper business references bearing upon the character and *ability* of the merchant, and the condition of his business should be insisted upon. It is amazing that business men, who would hesitate to lend five dollars to a man whom they have never seen nor heard of before, will ship him a hundred or a thousand dollars' worth of merchandise without even obtaining his verbal promise to pay. It is simply taken for granted. That a man is honest is not enough. Besides being honest, he should have a business, and be capable of running it successfully.

Reliable merchants should take no offense at being asked for tangible information bearing upon their desirability as credit risks. They should be proud to give it. If the merchant who objects to giving credit information concerning himself should apply for a life insurance policy, he would expect to submit to an examination, and would be proud to give information bearing upon his desirability as an insurance risk.

The sound merchant should welcome strict credit requirements. He will be able to pass them, while his unworthy competitor will not. Thus a strict observance of business principles in the granting of credit would aid and not impede the reliable merchant. Proper and intelligent supervision of credit by manufacturers and wholesalers would lessen the likelihood of dealers over-stocking, and thereby lessen their chances of becoming victims of the brokers. This would benefit the sound merchant

THIS WILL BE A RADIO CHRISTMAS!



also, as he would not have to compete with so many bankrupt stocks.

So much for shutting off the water. Now to repair the break.

There are, as has been said, hundreds of radio wholesalers and retailers doomed to fail during the next few months. Each failure will represent money losses by the creditors, i. e., the manufacturers and wholesalers, and by the failures themselves. The question of prime importance is this:

What will happen to the bankrupt stocks?

Will the manufacturers and wholesalers allow brokers to profit by their losses? It is the actual money losses taken by the creditors and by the failures themselves that make it possible for brokers to sell merchandise for less than it costs to make it. It is not superior marketing methods, or anything of the sort.

One possible solution of this problem might be the formation of a commercial or a cooperative credit association, with a membership composed of the credit-granting radio manufacturers and wholesalers of the country, for the purpose of collecting reliable credit information, and to whom wholesalers and retailers could appeal for assistance or relief when embarrassed by excessive inventories.

It should be the first duty of the credit association to make an investigation of the financial status and merchandising facilities of as many credit seekers as possible, and to keep this information up-to-date. This data would of course be strictly confidential, but all credit-granting members would have the privilege of requesting advice concerning any applicant. Monthly reports of amounts overdue from all customers would be forwarded to the association by members, and it would be possible to effectively check credit expansion and overstocking. Credit inquiries would state the amounts involved in each case, and an excessive number of inquiries concerning any one applicant would indicate that inflation was being attempted, and credit grantors would be so advised, unless of course, an investigation should indicate that the expansion was justified.

Up to this point, the association would function similarly to the credit associations of other industries, but the second and possibly the most important function of the proposed association would be to render assistance or service to embarrassed wholesalers or retailers. As mentioned previously, any wholesaler or retailer, whether member or non-member, would have the privilege of appealing

(Continued on page 92)

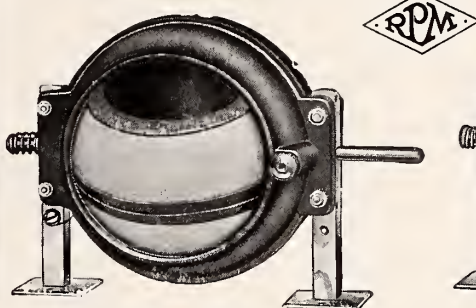

**Variometer**  
Price, \$6.50

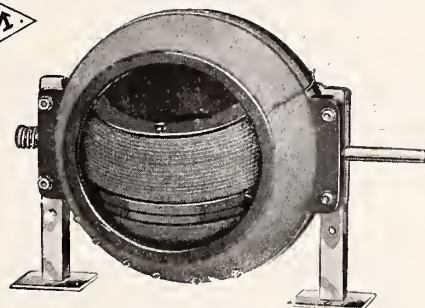

**Variocoupler**  
Price, \$6.50

**High Grade**

## RADIO APPARATUS

Twenty years in the electrical manufacturing field gives us the experience, organization and equipment to produce the highest grade of radio apparatus on the market.

Each unit is made complete in our own plant—from the moulding to the winding, assembling and final testing of the completed instrument.

The apparatus shown above is moulded from Redmanol, which is unaffected by water, oils, acids or other elements. It is a material which increases in resistance and strength with age. All joints and terminals are soldered, insuring perfect contact in all positions. These instruments are built to give unqualified service and satisfaction.

*Write us for full information*

**Radio Products Mfg. Co.**  
667 W. Fourteenth St.  
Chicago, Ill.

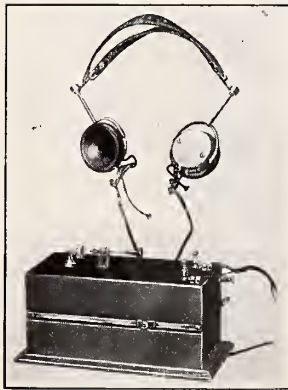

In lots of 100,  
\$3.50 each. In  
smaller lots,  
\$4.00 each.

Retail prices  
optional, so that  
special sales  
may be held.

A superior receiving set with a vocal and musical range  
of from 38 to 45 miles—code range, 150 to 200 miles

MAHOGANY CASE, BAKELITE PANELS, NICKEL FIXTURES  
8½" COIL AND TWO-SLIDE TUNER

**STANDARD PRODUCTS CO.**  
93 WILSEY STREET NEWARK, N. J.

THIS WILL BE A RADIO CHRISTMAS!

**MANUFACTURERS OF**  
Receiving Sets Complete  
Unites Mounted and Unmounted  
*Send for Description and Prices*  
**RADIO OUTFITTING CORP.**  
*Mfg. High Grade Radio Apparatus*  
410-412 East 34th St. New York, N. Y.

**THE PARAMOUNT**  
**ENGRAVING MACHINE**  
for Radio Panels  
*Greatest Production—Lowest in Price*  
**PARAMOUNT MACHINE CO.**  
207 Market Street Newark, N. J.

## Whirco Square Tinned Bus Wire

In 2 Feet Lengths or in Hundred to Thousand Pound Lots Quoted.

*Shipments F. O. B. Mill*

**WHITE RADIO CO.**  
123 East 23rd Street  
New York City

## Maclite Vario-Coupler

Price \$5.00

Is, in the opinion of experts, the most efficient on the market.  
All Other Maclite Parts are equally efficient, including the Maclite Variometer, Double Slide Tuner, Variable Condensers and Crystal Detectors. The Maclite Single Tube set at \$25.00 is the best buy we have ever seen. Let us tell you more about this set, also all other Maclite parts.

Dealers and Jobbers Write for Discounts  
**MACLITE RADIO CO.**  
701 Maclite Bldg., Claredon St.  
Boston, Mass.

## GANAERITE Detector Crystals

Twenty years of practical mineralogy gave us the material to produce the highest quality crystal.

We are now undertaking the largest single order for mounted crystals in the market.

We individually test and guarantee to replace or refund on any unsatisfactory Ganaerite crystal.

**The Harris Laboratory**  
26 Cortlandt St., New York City

## VERNIER VARIABLE CONDENSER

The Duntley Company, of Chicago, Ill., are manufacturers of a vernier variable condenser which permits finer adjustment of the capacity and operates very much on the order of the vernier on a micrometer. Its last plate rotates independently of the remainder and is adjusted by a small knob placed in front of the large knob which controls the movement of the other plates. The vernier makes possible selective tuning and little energy is lost in this type of condenser by brush discharges.

Without removing the fingers from the knob it is possible to tune to the proper wave length. When the spindle is turned to the proper position for clear reception it is only necessary to adjust the vernier knob (the smaller of the two) to eliminate foreign noises. It thus combines two instruments in one, which is an improvement over the plain variable condenser. Besides this it gives a clear and loud connection easily and quickly. The vernier attachment gives an adjustment many times as fine as is possible with a plain condenser. The back panel mounting and non-conducting operating shafts make shielding unnecessary and reduces fixed capacities to a minimum.

## PRECEL AUDION CONTROL UNIT

The Precel audion control unit manufactured by the Precel Radio Mfg. Co., Toledo, Ohio is said to be a very practical piece of apparatus which can be used by the enthusiast in the construction of any type of vacuum tube detector or amplifier. The unit can be easily mounted on the back of the panel as holes are provided for this purpose.

## THE AUTOVOIX

The Autovoix, a loud speaker, manufactured by the Autovoix Co., Baltimore, Md., is built on a new lever principle and carries a very large magnetic field in which the armature is suspended. It neither requires a storage battery in its operation nor attention or adjustment after being installed.

## ERLA PRODUCTS

Sturdy, dependable staple radio equipment at standard prices is the policy which guides the Electrical Research Laboratories, 2515 Michigan Ave., Chicago, makers of the "Erla" line. "Erla" products are profitable to handle.

## RADIO CONCERTS CORACO

America's Greatest Radio Receiver  
*No Inside or Outside Connections*  
**GOTHAM THEATRE BUILDING**  
Broadway at 138th Street

**JOY-KELSEY CORPORATION**  
Manufacturers  
**RADIO EQUIPMENT**  
4021 West Kinzie St. Chicago Ill.

## EVEREADY

### RADIO "A" BATTERY

*Immediate Delivery from Stock*

Manhattan  
**Storage Battery Co., Inc.**  
204 West 76th Street  
New York City

## IMMEDIATE DELIVERY

| CABINETS—                                | PANELS—                                 |
|------------------------------------------|-----------------------------------------|
| Imitation Mahogany or Flemish Oak Finish | Genuine Formica, $\frac{3}{16}$ " thick |
| 6 x 7 x 0                                | 6 x 10½                                 |
| 6 x 7 x 13½                              | 6 x 14                                  |
| 6 x 7 x 20½                              | 6 x 21                                  |

*Other Sizes to Order*

### COMPLETE RECEIVING SETS

*Jobbers and Dealers  
Get Our Discounts*

### THE MIHO COMPANY

8 East Third St. Cincinnati, Ohio

## MORADIO Every Wire Contact COUPLER

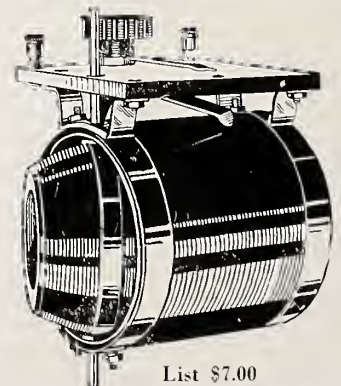

List \$7.00

Its adaptability to any panel set or hookup makes it popular.

*Write for descriptive circular and dealers prices.*

**MORELAND SALES CORP.**  
30 Ogden St., Newark, N. J.

THIS WILL BE A RADIO CHRISTMAS!

## What About the Retail Price Cutters

(Continued from page 50)

Something must be done, and one of the best plans, naturally, is for the organization and maintenance of retailers' associations, where the leaders in the local fields can foregather in a spirit of friendliness to show each other how futile it is to cut prices on everything all the while.

Many retailers are condemning department store activities in the radio field, and many of us realize that other retailers in other fields of commercial endeavor are up against this same proposition and have been for, lo—these many years. Department stores, by their co-operative buying arrangements, enjoy discounts not available to most retailers. This is a problem, too, for the radio trade to solve. THE RADIO DEALER staff holds some decided views on this subject and I understand they will be aired in proper manner for the benefit of the trade.

Price-cutting, as I've already stated, is not local to any city; it appears everywhere. New York, it is generally believed, sets the low price mark for radio retailers, and for the benefit of readers not in metropolitan section.

(NOTE: Mr. Scanlon followed the above with a list of cut prices prevalent on many so-called standard brands. Some of the prices indicate a reduction of forty per cent on the list price, showing consumers can buy good sets as low as retailers. On parts the reductions appear to be from between twenty-five to forty-five per cent.—Editor RADIO DEALER.)

### G. E. BONDS

The General Electric Company announced that it expected to call its 6 per cent. debentures due in 1940 on the next interest date, Feb. 1, 1923, at 105. No new financing, it was stated, is contemplated. All of which is testimony to the great strength of the General Electric in particular and to the prosperity of the electrical manufacturing companies in general.

### KENT MASTER ADAPTER

The F. C. Kent Co., Irvington, N. J., manufacturer of the Kentone radio amplifying horn has introduced the Kent Master adapter, an ingenious device which when applied to an Edison disc phonograph will enable it to play any disc record, whether it is one of the hill-and-dale type or of the lateral-cut style.

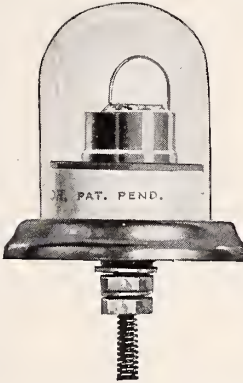

## GREWOL DETECTOR

**Nothing Like It  
Nothing as Good**

The Grewol Detector has taken its place among the standard, nationally advertised parts. In a class by itself because it does what no detector has yet been developed to do and still sells at a popular price.

*Asked for by name, sold by reputation.  
Write for Interesting Proposition*

**List \$2.00**

Permanent Adjustment  
—  
Always Set and Ready  
—  
Glass Enclosed

**LANDEL WIRELESS CO.**  
Sole United States Distributors  
**9 CENTRAL AVE. NEWARK, N. J.**

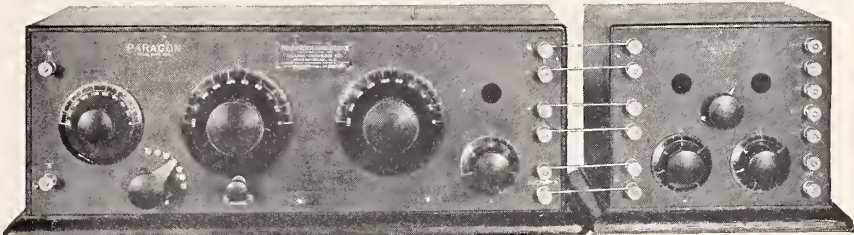

**R-D-5 Tuner \$75    PARAGON A-2 Two-step Amplifier \$50**

Wave length 510 meters. Same circuit as in R-A-10—1000 meters with the same finish and workmanship. Very selective.

Get your order in now. Best service and discounts.

**E. M. WILSON & CO., 11 Lafayette St., NEWARK, N. J.**

# THOROPHONE FOR TONE

TRADE MARK REG. U.S. PAT. OFFICE

**TYPE "S"  
HIGH POWER MODEL**



**S-5—\$60.00**

Shipping weight 30 lbs.

**The Thorophone is the Only Electro Magnetic Solenoid Loud Speaker with a Controlled Mica Diaphragm. It is Superior in TONE VOLUME APPEARANCE**

**JOBBER  
DEALER  
SET MANUFACTURER**

Send for full details of this newest and greatest of all radio loud speakers.

In volume it is several times louder than any other mica diaphragm loud speaker. It gives great volume on the ordinary two step amplifier. It does not require a power amplifier.

In tone quality the Thorophone "S" type is the final word. You can pick out each separate instrument in an orchestra selection.

The electrical element of the Thorophone "S" type uses an electro magnet and requires one ampere from a 6 volt storage battery in operation. It has a powerful solenoid action.

The S-5 consists of the Thorophone "S" type complete with concert horn. You will find in it the ideal radio loud speaker. The tone quality and volume are unrivaled. The height is 28". The base and pedestal tone arm are of wood, elaborately rubbed and finished in a very dark walnut.

The S-6 consists of the Thorophone "S" type mounted on its side in a low, flat, beautifully finished wooden container. It is arranged to operate on all the standard makes of phonographs. We furnish full instructions showing how to attach it to the different makes.



**S-6—\$40.00**

Shipping weight 15 lbs.

**IF YOU DESIRE THE BEST RESULTS IN RADIO USE THE THOROPHONE "S"**

To responsible firms we will be glad to send sample instruments on ten days' trial. Our production this winter will be limited. Prompt action is necessary.

**WINKLER-REICHMAN COMPANY**    MANUFACTURERS  
4801 South Morgan St., CHICAGO, ILL.

*The Oldest Manufacturers of Loud Speaking Telephones in America*

THIS WILL BE A RADIO CHRISTMAS!

# "BECO"

RADIO FREQUENCY SETS

145 TO 600 METERS

\$160.00

"BROADCASTER"  
MODEL VARIO METER

Lightest and Most  
Compact on the Market

"RIEHL"

AUDIO FREQUENCY TRANSFORMERS

\$4.50

HIGH GRADE CONDENSER PLATES

DUO-LATERAL COILS

BISSELL  
ENGINEERING CO.

161-67 WEST 64th ST.  
NEW YORK

## Everybody Must Help Eliminate Weaklings

(Continued from page 89)

to the association, submitting a financial statement and inventory. If it was apparent that an extension of terms by the creditors would be reasonably safe, and would be likely to save the business, the association could recommend it. If, however, it was apparent that liquidation was inevitable, the association would be in a position to communicate with the manufacturers who made the merchandise, or the wholesalers who sold it, to determine whether they were willing or able to buy it back, if paid for, or to accept its return if unpaid for, provided of course, that such return would not constitute an act of bankruptcy. If the manufacturers and wholesalers directly concerned in the case could not conveniently lend assistance, then the association could bulletin its entire membership, and even a large list of cooperating retailers, stating the material on hand. One merchant might be carrying a killing burden of a thousand condensers, for instance, while condensers might be badly needed by a hundred other merchants in quantities of six or a dozen each. Certainly it would be to the advantage of all legitimate members of the trade to have them kept within the regular channels, even if it involved a little trouble in doing so, rather than have them find their way into a brokerage pool. It might even be possible to accomplish this without revealing the name of the overstocked merchant, excepting possibly to those who actually purchase a part of his stock.

If sufficiently alert, the association might even be able to keep bankrupt stocks within the regular channels of trade, by advising members and interested merchants of impending sales, the materials to be offered, their actual worth, etc., so that brokers would have some competition at the sales. The brokers would lose interest, of course, as the merchandise was bid up to or near its actual worth. It might be possible for the association to bid at sales, acting as agent for interested members or merchants who, by reason of distance, were unable to attend.

The association might also render a valuable service in investigating certain failures, as it is common knowledge that there are one or more associations operating in New York for the specific purpose of establishing retailers, who, as soon as they have established credit and accumulated

## SOCKETS FOR THE New Dry Cell Tubes



BAKELITE BASE--  
PHOSPHOR BRONZE CONTACTS AND FLANGES  
ALL BRASS PARTS--  
LIST - - - - - \$ .75  
LIBERAL DISCOUNTS TO THE TRADE

Write or Wire for Particulars

Radio Electric Service Station  
151 Main St. Tottenville, Staten Island



Dealers All Over the Country Handle Our

# STANDARD RADIO GOODS

OUR TRADE PRICES AFFORD GOOD MARGIN

~~~~~  
Write for catalogue and price list

WIENER WIRELESS SPECIALTY COMPANY

21 ACADEMY ST.
NEWARK NEW JERSEY

The Gelman Plug



The GELMAN UNIVERSAL RADIO PLUG fills a long felt want for a simple substantial plug which can be used with telephone cords having pin tips, spade tips or plain wire ends. ALL METAL PARTS heavily nickel plated. NO SOLDERING NECESSARY. List price, \$1.00.

AGENTS WANTED THRUOUT THE U. S.
Sample Sent C.O.D. Upon Request
Jobbers and Distributors
Write for Our Proposition

S. S. NOVELTY CO.
255 Bowery New York, N. Y.

a stock of merchandise, arrange for bankruptcy proceedings and a sale, with the net result that the retailer makes a thousand or so, the association pockets a commission, and the brokers get the stock.

Manufacturers and some wholesalers may raise the objection to such a plan that the association, in promoting the sale of surplus stocks to legitimate retailers, would in a sense be competing with the members.

It is unavoidable that merchandise in the hands of the trade or of brokers compete with like merchandise until it is actually in the hands of the users or consumers. Even then, it satisfies a portion of the original demand.

The only way to overcome this objection would be to destroy the merchandise, and that would hardly be practicable, either in localizing or distributing the losses. The manufacturer cannot expect to sell more goods than the consumer market will absorb, in the long run.

Another objection might be raised by retailers that the association would become a guardian angel over incompetent merchants. If mismanaged, the association might become just that, but it must be assumed that the membership would elect and instruct the management in such a way as to ensure the association's functioning to serve the best interests of the industry as a whole, and not as a fountain-head of relief for incompetents.

It is, of course, an open question whether or not an organization such as that suggested could successfully combine the functions of a credit agency and a merchants' association, but there is at least room for serious thought. No attempt has been made in this article to work out the details of organization, administration or operation of such an association, nor to investigate the legal phases of the question, but if the plan is practical, details will be readily adaptable to it. The association would contemplate no unlawful practice, and therefore the details of operation would be worked out in such a way as not to be in violation of any State or Federal laws. That is a matter for an organization committee to handle, in collaboration with competent legal advisers, and after consultation with a representative delegation of interested parties.

CONFIRM ORDERS

When giving salesmen order ask him to give you a duplicate, or insist that the house send you a confirmation of your order. These things save a lot of time, trouble and expense.

PARAGON RD-5 RECEIVER

Unless a receiver possesses a high degree of selectivity a listener is apt to be forced to contend with interference between the many stations that have gone into operation on one very narrow band of wave-lengths, and those who are located in outlying sections or who wish to receive from various distant stations will find themselves greatly handicapped.

According to a recent bulletin recently issued by the Adams-Morgan Co., Upper Montclair, N. J., Paragon receivers are famed for their selectivity and sensitivity. The Paragon type RD-5 receiver and its companion 2-stage amplifier have been designed with the idea that the development of broadcasting demands not only ex-

treme sensitivity, but the greatest possible selectivity. This apparatus possesses the characteristics of the type RA-10 receiver, a professional type. The wave-length has, however, been reduced to between 160 and 510 meters, but includes within it the detector tube controls. While the RD-5 is a complete unit, most listeners find it desirable to add the companion amplifier known as Paragon type A-2.

The qualities of selectivity and sensitivity of the new receiver are the result of the low resistance of the circuits and the careful distribution and proportioning of the units. The proper proportioning and distribution of inductance and capacity of the circuits are said to provide a total freedom from body capacity effects.



**Completely Assembled
or Ready-To-Build.**

**Send for Circular of
Capacities and Prices.**

**MARSHALL VARIABLE
CONDENSERS**

Order Now For Christmas Business

NEW HAVEN RADIO CO., Mfrs., Chapel & Hamilton Sts., New Haven, Conn.

NULOID

**Scientific Chemical Compound
Especially Adaptable For
Radio Parts and Panels**

Nuloid's light weight and smooth polished surface combined with its high resistance powers make it particularly adaptable for radio requirements.

Approved and Tested

Tested by leading radio and electrical engineers and by the Columbia University laboratory, Nuloid was found to resist warping, water, oil, heat and cold, and to resist a 23,300 high frequency voltage on a 3/16th inch thickness.

All Colors

Nuloid is manufactured in mahogany, and all colors, plain and mottled, and its attractiveness adds materially to the appearance of receiving sets and all exposed parts.

Retains High Polish

Regardless of climatic conditions, Nuloid retains its high polish, and under all conditions it can be easily worked, as it does not chip, crack or break, and can be engraved, cut, drilled, threaded and polished.

Let us estimate on your specifications
and send you some samples of Nuloid.

NULOID CORPORATION

119 Chambers Street Phone: Worth 0156 New York, N. Y.
LABORATORIES AND FACTORY, KENILWORTH, N. J.

THIS WILL BE A RADIO CHRISTMAS!

"ETHEROLA"

AERIAL
EQUALIZER TUBES
AND
GROUND
SEPARATOR TUBES

Replaces Long Wire Aerials and
Water Pipe or Other Grounds.

USED INDOOR OR OUTDOOR

TO DEALERS
JOBBER

Demonstrate a Set and Get the
Biz. Selling Rapidly Wherever
Shown.

Assist you greatly in sale of high
grade Receiving Sets

GET YOUR TERRITORY
QUICK

Write us now. Results guaranteed

THE ETHEROLA CORPORATION

6216 Broad Street
PITTSBURGH, PENNA.

S & S

VARIOMETERS
VARIO-COUPPLERS

\$3 each

Unsurpassed for Efficiency
Workmanship and Design

*Liberal Discounts to
Dealers and Jobbers*

Write for Descriptive Folder

Sunday & Scholtz Co.

2638 West Cabot Street
Philadelphia, Pa.

Radio Industry is Stabilizing.

(Continued from page 51)

ject of merchandising the writer will briefly outline the purpose of the Radio Merchandise Fair which is now being held at the Hotel Imperial, New York City. With the large number of unreliable devices that have found their way upon the market, it is evident that there is a need for a centralized and permanent exhibit of reliable products where buyers and dealers may come to make choices and to examine new products. A buyer coming to New York at the present time arrives in town with a long list of calls to make. If he could come directly to a centralized display of reliable merchandise it would enable him to do in a few hours what would otherwise take him several days. At the Permanent Radio Fair he can examine the products of the various manufacturers and if he so desires a capable radio engineer will demonstrate any instrument to him. By carefully choosing the merchandise for exhibit a plan of this nature is bound to stabilize the industry by allowing dealers to become more familiar with the real reliable merchandise. The plan itself is not a new one. We have the Builders' Exchange in Philadelphia and the Furniture Exchange in New York. Both of these institutions serve a similar purpose in their respective fields.

The management of the Permanent Radio Fair is now conducting a campaign in South America. It is a known fact that South American buyers who come to this country do all of their buying in New York City, and if they know of the Permanent Radio Fair, this institution will do a great deal toward helping the American manufacturer in the South American field.

SENSITIVE ALL OVER

Sensitive over its entire surface is one of the claims made for Rusonite, a synthetic, multipoint radio crystal rectifier which it is said eliminates detector troubles and buzzer tests and increases sensitiveness, clearness and volume very materially. The manufacturers, the Rusonite Products Corp., 15 Park Row, New York, announce that through extensive scientific research they have been able to surpass the natural crystals and to produce Rusonite, a synthetic crystal rectifier that is reliable, efficient and durable. Signals detected with a Rusonite multipoint crystal rectifier may be amplified by means of an audio frequency transformer and tube.



Our line of recognized Radio apparatus comprises only standard merchandise of the following manufacture:

Regal
Dubilier
Radio Corp. of America
Turney
Weston Instrument
De Forest
Western Electric
Fada
Magnavox
American Hard Rubber Co.

and others of like reputation.

Complete stock on hand at all times
—24 hour delivery guaranteed.

Write for our price booklet

Radio & Mechanical Trading Corporation

23 Warren Street, New York City

"SAMCO" RADIO PRODUCTS of QUALITY

VARIABLE CONDENSERS

	List Price
11 Plate .00025 M. F. Capacity	..\$2.25
23 " .0005 " " "	.. 2.85
43 " .001 " " "	.. 3.60
63 " .0015 " " "	.. 5.50



	List
RHEOSTATS 6 Ohms - - - -	\$1.00
POTENTIOMETERS, 300 Ohms -	1.75
INDUCTANCE SWITCHES - -	.50
VERNIER DIAL ATTACHMENTS	.50

We Have a Special Proposition to
**DEALERS and
DISTRIBUTORS**

Samples sent Postpaid upon receipt of price.

STANDARD APPLIANCE MFG. CORP
428 East 71st St., New York City

THIS WILL BE A RADIO CHRISTMAS!

To Study Broadcasting to Eliminate Conflict

(Continued from page 52)

communication, easily the most important, must not be interfered with. Some excellent constructive work has been accomplished by the so-called Hoover conference in Washington. Considerable improvement in the New York district has centered around the office of inspector. The Broadcasting Committee of the Chamber asks the aid of corporations, clubs, individuals and all others interested. This is a task in which every one can help."

"Conditions in the radio industry now are such as to suggest that much information must be gathered and the views of many interests learned before even the immediately pressing problem can be solved," he said. "Meantime, we aim to do what we can in the direction of discussion and agreement, particularly in pushing those matters in which the departments of the Government have asked our assistance."

The trade generally must agree with the activities of Mr. Davis and his associates and their support should be extended, personally and through the present radio associations—amateur and professional.

The vice president of the Chamber is Harold J. Power, the secretary, George Lewis, and the treasurer Lloyd Marshall. The board of governors consists of A. H. Grebe, Richmond Hill, N. Y.; C. B. Cooper, New York; A. P. Morgan, New York; B. L. Moore, Buffalo; J. R. Crawford, Long Island City, N. Y.; E. R. Harding, Boston; Boden Washington, New York, and Gordon Sleeper, New York.

A plan of regional organization has been adopted with the following district vice presidents:

First district (Boston), O. K. Luscomb, Cambridge, Mass.; 2d district (New York and Northern New Jersey), to be elected; 3d district (Philadelphia, Baltimore, Washington), Atwater Kent, Philadelphia; 4th district (Atlanta, Savannah, Jacksonville), to be elected; 5th district (New Orleans, Memphis, San Antonio), to be elected; 6th district (San Francisco, Los Angeles, San Diego), Collin B. Kennedy, San Francisco; 7th district (Seattle, Portland, Tacoma), Robert H. Mariott, Seattle; 8th district (Pittsburgh, Cleveland, Toledo, Detroit, Cincinnati, Columbus), Powell Crosley, Jr., Cincinnati; 9th district (St. Paul, Milwaukee, Chicago, Indianapolis, St. Louis, Kansas City, Minneapolis, Denver), Harry Bradley, Milwaukee, and Dr. C. F. Burgess, Madison, Wis.

Quick, Profitable
Turn-Over



**TRUE-TONE
PHONES**

Embody every factor of scientific Design. Perfection in Performance and Appearance.

\$5.00
LIST
3000 Ohms

Worth More, Yet, Cost Less. Backed By a Real Guarantee of Quality.

Maximum Wire Turns. Super-strength Tungsten Magnets. Noiseless Tinsel Cords. Mercerized finish. Web covered Comfort Head Band. Cups and Caps of lustrous Black Composition.

"True Tone"
National Advertising
is behind You

Clear and Loud

JOBBERS [Write or wire—NOW—for "True-Tone" Discounts] **DEALERS**
They are liberal

TRUE TONE RADIO MFG. CO.
186 North La Salle Ave., CHICAGO, ILL.



Approved by
Santa Claus



**KNOCK-DOWN
RADIO
RECEIVING SET**

Contains all high grade parts of WINCO manufacture.

Neatly packed in an attractive hinged cover box. Makes a wonderful display. All parts firmly attached to box and will not loosen in shipping. Complete blue printed diagram for assembly included.

Retail Price—\$4.50

of high grade Radio equipment and supplies, also metal stampings, tools and screw machine products.

Can make immediate delivery on double slide tuning coils which retail at \$3.00 each and complete receiving sets which retail at \$8.00 each.

Liberal Discounts to Distributors and Jobbers

(Established 1871)

CHARLES WINKLER, INC., 178-182 Emmett St., Newark, N.J.

THIS WILL BE A RADIO CHRISTMAS!

NOTICE!

We have an extremely profitable and timely proposition for live Jobbers, Distributors, and Buyers. Immediate action is necessary

WRITE AT ONCE

ARROW RADIO CO.

Hackensack . . . New Jersey

KNOCKDOWN APPARATUS

Variometer with brass fittings, boxed. Variocoupler with brass fittings, boxed.

Crystal set with complete instructions for hook up and assembly. Rotors, stators, and coil ends always on hand.

Write for circular and discounts

RITTER WOOD WORK CO.
118 Walker St., New York City

DEALERS:—

WE are Jobbers for
Grebe Receiving Sets
Murdock Products
Baldwin Phones
Federal, Fada and
Radio Shop Products

Write for Our Special Proposition A

The Radio Shop
OF NEWARK

41 South Orange Ave., Newark, N. J.

Prompt Deliveries

Jet black high finish panels, .01 per inch, 3" nonbreakable, flexible dial with knob \$.70

3½" Vario-Coupler.. 2.00

Complete Receiving Set, \$25.00

Beau Ivorie Novelty Co., Inc.

127-129 Van Buren Street
Newark, N. J.

Advertising by Dealer

(Continued from page 65)

line of radio sets, Demonstration gladly given. We have one to fit your purse. Installed in your homes without additional charge."

At the top of this advertisement was a drawing showing two boxers in fighting pose. While at the bottom, naturally the name of the advertiser, his address and phone number were given.

That is a good example of the kind of advertising on the part of the local dealer that gets consumer business. It is loaded with human interest and very timely.

In small cities and towns where there are only a few radio dealers, the opportunity for co-operative advertising exists. Each dealer could be assessed an equal amount and the common fund used for local advertising campaign. The advertisements could be run once or twice a week in local papers, or as often as deemed necessary. The cost individually would be comparatively small, and by group advertising larger space can be afforded and more attention assured. At the bottom of each advertisement should be listed the name and address of each subscriber. By use of this method all the dealers involved would be benefited materially. Petty dissensions among competitors would be, no doubt, eliminated, and a good clean substantial business would result in the community.

Above all things be absolutely truthful in all your advertisements. Don't claim accomplishments for the apparatus you handle that are impossible. It is only bound to hurt your business in the future. People failing to obtain the results you promise or guarantee will naturally become disgruntled, and not only stop doing business with you but in many instances will lose their interest in radio altogether, thereby hurting the entire industry.

Direct by mail advertising is also very essential to the success of your business. It is the connecting link between your newspaper campaign and your store. A good mailing list is easily obtained. Your local directory or telephone book can be used to advantage. Sales letters that you send out should be written in simple everyday language, and easily readable. Here again all technical matter should be avoided. Base your letters on the same type of human interest ideas as suggested for the newspaper campaign. Include in your direct by mail campaign, also, the women folk in your locality occasionally. Impress upon them how radio would en-

DIAMANT VARIABLE CONDENSERS AND CRYSTAL DETECTORS

Electrically and Mechanically Guaranteed

Diamant Tool & Mfg. Co., Inc.
93 Runyon Street Newark, N. J.

ADBRIN LABORATORIES

Manufacturing all kinds of Crystals in Wood's Metal. Guaranteed Tested.

469 Broad St., Newark, N. J.

Recommended for Reliability

RADIO STORES CORP.
VARIABLE CONDENSERS—
PLUGS—RESISTANCE UNITS, ETC.
222 West 34th Street, New York

A WONDERFUL XMAS PRESENT



The Little Gem
(cut half size)

The dealer will at once appreciate the potential sales possibilities of this wonderfully efficient and beautiful little crystal receiving set. Has a large receiving radius. Test it yourself. You can then recommend it with the same confidence that we do. Stand and all other metal parts of solid brass and nickel plated.

PRICE, \$6.50 LIST

Manufactured by

United Specialties Co., Inc.

57-59 Spring St., Newark, N. J.

THIS WILL BE A RADIO CHRISTMAS!

certain and amuse them during the day while the children are at school and father at business. Tell them about the fashion and style talks by experts in that line of business which are broadcasted daily. "The Bed Time Stories" for the kiddies, will also be of interest to mother. Letters should be sent out regularly—under a two-cent stamp to assure attention,—and give them the personal touch that would not be obtained otherwise.

Among other things keep your demonstration set in an A1 condition. Nothing is as discouraging to the prospective buyer of a radio receiving set than to hear weird and nerve-wracking sounds pouring forth from your loud-speaker. Look at the psychological angle of it. Your prospect's trend of thought figures that if you, being an acknowledged expert in radio, cannot get away from this distortion, the chance for him as a mere novice to get good results would be mighty slim, and naturally his enthusiasm is suddenly chilled.

Another good method of creating local interest is to get well-known, distinguished and important personages in your town to attend a demonstration. Then ask them to send you a note or letter giving their opinion of radio, with permission to use the letter, or at least quote from it under their names. If you can arrange this, and incorporate the letter or quotation in your newspaper advertisements and circular letters, do so. This mode of advertising is usually very productive, especially in smaller communities.

In concluding, let us remember that radio is with us to stay. The field is tremendously broad, and as yet only sparsely developed. Real honest-to-goodness, common-sense merchandising is required to assure success for each individual dealer, and national consumer interest (procurable only through the cooperation of each and every local dealer) must be aroused to serve as the back-bone of the radio industry.

ELABORATE SETS

Several types of single circuit non-regenerative receiving sets are being placed on the market by the Lee Radio Corporation of Haddonfield, New Jersey. The list prices range complete with antenna wire, phones, bulbs and "B" batteries, \$30 to \$105.

Type L-2 of the series made by the Lee people is mounted on a Formica panel and enclosed in a solid mahogany set. Two aerial binding posts are provided, one for long and the other for short wave lengths. Type E-4 is a more elaborate outfit with two Thordarsen transformers. The company also makes crystal sets.

Reputation IS BUILT ON QUALITY



BERWICK

SUPREME

HEAD-SETS

Show Sound Mechanical and Electrical Construction, Good Materials and Painsstaking Craftsmanship

**Guaranteed 100%
For Efficiency
and Quality**

Aluminum Cups—2200 Ohms
Lightweight—Comfortable

WRITE FOR VERY
ATTRACTIVE PROPOSITION

TRIANGLE ELECTRO TRADING CO.

Incorporated

632-634 BROADWAY

NEW YORK CITY

DON'T stock up with out- of-date RHEOSTATS

Radio is advancing. Keep your stock up-to-date. The *PARKIN Dial-Type Rheostat* (Patd. Aug. 1, 1922) marks important improvements in rheostat development. Patented mechanical features enable the operator to maintain constant signal strength without the annoyance of constant adjustment. The resistance element is recessed in the back of a moulded Bakelite dial, *outside the cabinet*. It cannot overheat. The temperature remains constant. Thus, the tubes receive uniform flow of current and the signal strength does not vary. Resistance 5 ohms, carrying capacity 1½ amperes. Retail price, \$1.50. See special trade offer below:

PARKIN Dial-Type RHEOSTAT

(Patd. Aug. 1, 1922)

*Mt. Tamalpais, California,
in the shadow of whose
lofty peak PARKIN Parts
are made.*

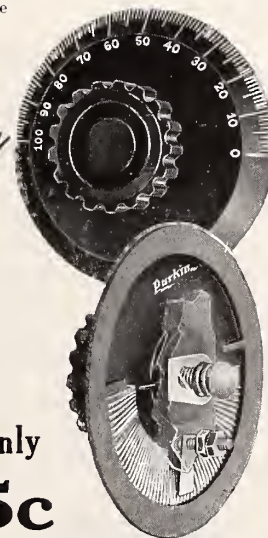

For 1 month only

—we will mail to any
dealer or jobber one
PARKIN Dial-Type
Rheostat complete
for—

75c

Request must be made on business stationery, and for one rheostat only, at this special introductory price. Complete PARKIN catalog also sent on request.

PARKIN MFG. CO., San Rafael, California

THIS WILL BE A RADIO CHRISTMAS!

KEYSTONE

FILAMENT RHEOSTAT



Resistance, 6 Ohms.
Carrying Capacity, 1½ Amps.
Base, made of black moulded Bakelite.
All parts made of brass and nickel plated.
Large Knob, and polished pointer.
List Price, \$1.00

Dealers and Jobbers, wire or write for discounts—Immediate Delivery

MANUFACTURED BY

KEYSTONE RADIO COMPANY

GREENVILLE, PENN.

Dept. D.

V. T. SOCKET

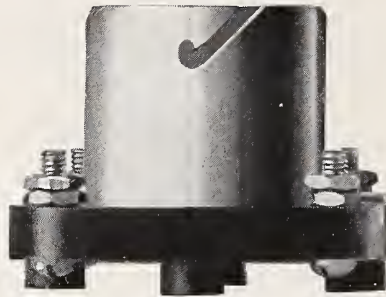

BASE and feet of moulded natural color Bakelite.

Contact Springs, Heavy Phosphor Bronze.
Heavy binding post.

Tube of heavy, polished Aluminum.

All brass parts nickel plated.

List Price, 90 Cents

Survey Made by Engineer

(Continued from page 50)

equipment?" and the answer is invariably, "Yes, but alterations will have to be made to your set to enable you to use the additional apparatus." The customer learns that additional apparatus is not so expensive, but added to the cost of the alterations he finds the total too great and lets the matter drop.

Summarizing the above facts we find a demand for the following:

First: Efficient apparatus of low initial cost so constructed that additional apparatus may be added without alteration or reconstruction.

Second: Additional apparatus, so constructed that it can be added to, and will harmonize with the initial set.

Third: Additional apparatus so constructed that it may be added stage by stage at a small investment.

Fourth: Apparatus so constructed as to enable the operator to hook his equipment up in any manner that he may desire to determine what circuit fills his requirements.

With the above knowledge in our possession the Pacific Radio Exchange set out to solve the problem, finally developing the Paradex Unit System.

The main difficulty encountered was to construct a tuner unit containing the proper amount of capacity and inductance with no dead ends, that could be incorporated in the same size cabinet as the other units. We also realized the necessity of developing a tuner unit containing capacity and inductance of such values as would permit the use of the tuner in various parts of the receiving circuit where an inductance or capacity and inductance might be utilized. This accomplished, the next step was the development of the different units, maintaining the Paradex standard of construction and at the same time concentrating on economy from the consumer's viewpoint.

"WOR" ACKNOWLEDGMENT

To those who have sent letters complimenting L. Bamberger & Co., Newark, N. J., on the service rendered by its broadcasting Station, WOR, an attractive acknowledgment is sent in the form of a post card, on the front of which is a picture of the Bamberger Store with the antenna on the roof. On the reverse side is a picture of the transmitting station, below which is a gracefully worded acknowledgment of the letter that has been received.

Ask Our Service Bureau

page 32

MODERN

RADIO EQUIPMENT COMPANY
TRADE MARK

ESTABLISHED 1911

The Original and Genuine Mica Diaphragm Amplifying Loud Speaker

NEW LIST PRICE \$25.00

CHEAPER THAN THE WORTHLESS IMITATIONS

SPECIFICATIONS

HORN: Seamless brass, triple lacquer, scientifically correct. Gives a rich, clear tone, not a metallic rasp.

AMPLIFYING CHAMBER: Exclusive "Modern" amplifying chamber of machined aluminum, polished and lacquered.

RECEIVER: Highest grade mica diaphragm amplifying receiver, built like a phonograph reproducer.

BASE: Oak wood base finished in early English, green felt bottom.

POST: Eby patented binding post.

NO BATTERIES ARE NEEDED TO OPERATE THIS LOUD SPEAKER—JUST CONNECT IT TO YOUR SET—PRESTO—HEAR 'EM ALL OVER THE HOUSE.

This is the original and genuine loud speaker—designed to do the work of a loud speaker—and is not an empty horn or shell that "any" receiver fits.

The Makers of the "FIRST" are Makers of the "BEST"

HORNING EXPERIMENTAL LABORATORIES

Sole Distributors of "Modern Apparatus"

Elizabeth Trust Company Bldg.

ELIZABETH, N. J



THIS WILL BE A RADIO CHRISTMAS!

New York Radio Show November 20 to 25

Madison Square Garden National Radio Exposition

"New York's second big National Radio Show will be held in Madison Square Garden the week of November 20th to the 25th.

"Answering the popular demand of the many leading manufacturers who were a part of the last successful Radio Show held at the Seventy-First Regiment Armory, the same management, assured of their hearty co-operation, has secured Madison Square Garden, New York's largest and most popular amphitheatre, with a view to staging an exhibition—the largest and most complete ever held in the Radio world, far surpassing anything of its kind ever arranged.

"Exhibitors will have the choice of location according to space required and receipt of signed contracts.

"The co-operation already assured the National Radio Show makes us feel certain of its tremendous success. We cannot too firmly advise your early decision should you desire to join us. Floor plan and contracts will be forwarded upon inquiry.

"The National Radio Show will be heralded by an avalanche of advertising and publicity many times greater than that which created such favorable comment during our last Radio Show."

Mr. Buchignani, is the managing Director of the National Radio Show and invites the co-operation of everyone in the industry.

USE CONDENSITE

The Shaw Insulator Company of Newark, New Jersey, are prepared to manufacture moulded parts for Radio equipment concerns. The material used by this company in the construction of mouldings is Condensite. A substance known as Shawlac is also used where the requirements are not of such rigidity involving heat resistance, high mechanical strength and inertness to acids and solvents.

Condensite, prepared by the Condensite Company of America, is well known to Radio manufacturers and Radio dealers. The Shaw company manufactures moulds and indeed furnishes everything connected with the construction of moulded parts once drawings have been submitted. All work is inspected before it leaves the factory.

CONDENSITE CELORON

Sets a New Standard in Radio Panels and Parts

Cut your panels from Condensite Celoron. This strong, handsome, jet-black, insulating material will give your customers a surface and volume resistivity greater than they will ever need. It is the ideal panel material because it machines readily, engraves with clean, cut characters and takes a high, natural polish or a rich, dull mat finish.

**Give your customers Quality
and they will give you orders**

Condensite Celoron—approved by the Navy Department, Bureau of Engineering—offers a sales opportunity unequalled to the live wire dealer who is keen on building his business on a quality basis. Write us today for our Special Dealer's Proposition and let us give you all the facts.

Diamond State Fibre Company

Bridgeport (near Philadelphia), Pa.

Branch Factory and Warehouse, Chicago

Offices in Principal Cities

In Canada: Diamond State Fibre Co., of Canada, Ltd., Toronto

A SUPERIOR AUDIO FREQUENCY TRANSFORMER

USED AND
RECOMMENDED

by
LEADING
REPUTABLE
MANUFACTURERS

of
RADIO
APPARATUS

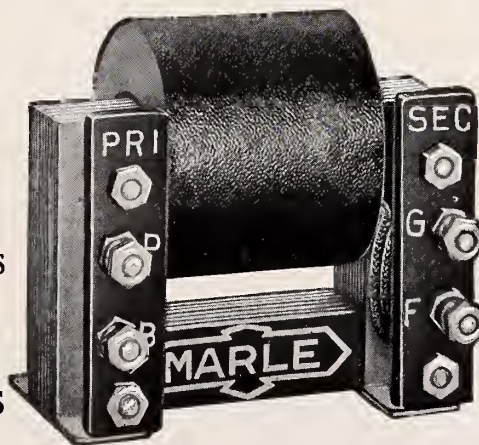

LIST
3.75
MOUNTED

Write for
Information
and Discounts

Jobbing
Concessions
Restricted

Manufactured by

MARLE ENGINEERING CO., ORANGE, N. J.

Special Prices Quoted On Unmounted Type To Manufacturers

THIS WILL BE A RADIO CHRISTMAS!



35c. each. 3 for \$1.00

Na-ald

GENUINE
CONDENSITE DIAL

The Dial that Runs True

Numerals engraved on bevel and knob so shaped that fingers do not hide them. Thin edge with clear graduation to make accurate reading easy. Concealed set screw in metal insert. Will not warp or chip. Finish and enamel permanent. Low price with this quality possible only through quantity production.

Special dealer and jobber proposition. An opportunity.

ALDEN-NAPIER CO.
52 Willow St. Dept. J Springfield, Mass.

RADIO MAILING LISTS

9270 Radio dealers by states.....	per M.	\$7.50
1164 Radio mtrs.	per list	10.00
1330 Radio supply jobbers.....	per list	12.50
260 Radio stations	per list	4.00
267 Mfrs. appliances, who make and assemble complete sets	per list	4.00
14000 Radio amateurs and managers of Radio stations	per M.	7.50

All Typewritten and Ready To Send on Receipt of Remittance

TRADE CIRCULAR ADDRESSING CO.
166 W. Adams Street Chicago, Ill.

PATENTS

on radio inventions apply to

OTTO K. ZWINGENBERGER

38 Park Row, New York
Cortlandt 3207

ESSEX BUS WIRE NO. 14

Square Tinned—Specially Prepared and Will Give Entire Satisfaction. \$1.00 Per Hundred Feet.

ESSEX LIGHTNING ARRESTERS

\$1.00 Each. List Price, \$1.50.
Send for Dealers' Quantity Prices

ESSEX MANUFACTURING CO.

117 Mulberry Street, Newark, N. J.



We manufacture 7 different styles of

VARIO COUPLERS

To Sell from \$1.25 up

All Guaranteed Perfect (JEWELL'S)
JOBBERS—DEALERS—AGENTS

Write for Discounts

JEWELL RADIO SALES CO.

90 West St., New York City
Phone Rector 1035

PATENTS

PROTECT YOUR INVENTION TODAY

Write for 1922 illustrated book free Radio-Electrical, chemical and mechanical experts; over 20 years' experience.

A. M. WILSON, Inc. (Radio 3 ARH)
309-20 Victor Building, Washington, D. C.
(Successors to business established 1891 by A. M. Wilson)

Wang

That's STATIC,
Take it Out with our

VERNIER CONDENSERS

That's another Station coming in. DITTO

Bang

ELECTRIC PRODUCTS CO.
11 Pemberton Sq. Boston, Mass.

Jerome Radio Corporation

Manufacturers

RADIO APPARATUS

Factory: 3136-8 W. Chicago Ave.
General Sales Office: 608 So. Dearborn
Chicago

Klosner Rheostat

New Amplitrol Simple Control Without Jack or Switch

By THOS. J. McELROY, Jr.

The Klosner Improved Apparatus Company has recently announced to the radio world the introduction of its two new pieces of apparatus, Klosner vernier rheostat model 200 and the Klosner Amplitrol.

The new rheostat is far ahead of many other instruments for controlling detector tubes. It has a vernier micrometer adjustment which makes it several times more sensitive than any ordinary rheostat. It permits getting exactly on the correct spot for loudest reception of speech and code.

It is made of genuine condensite with phosphor bronze contacts. It is equipped with a dial on which graduations are shown in white. Both coarse and fine adjustments are operated by one single knob.

The Klosner Amplitrol fills that long felt radio want—of controlling the vacuum tube circuit without the use of jacks, plugs or additional switches. With the Amplitrol in use, it is no longer necessary to plug in from one stage to the next. The phones or loud speaker are simply attached to binding posts and any stage is turned on at will.

The Amplitrol not only adjusts the filament to its maximum efficiency, but it also automatically switches on and off the plate circuit. Unlike automatic filament control, the Amplitrol does not put a sudden strain on the filament. It provides a gradual current increase for the filament, prolonging the life of the vacuum at least one third.

It is made of moulded condensite with phosphor bronze contacts. Its exposed metal parts are highly nickel plated. It has a new style knob and dial with graduations in white lettering.

HIGH-GRADE SET

The Continental Radiophone Co., with offices at 45th Street and Wells, Chicago, have high-grade sets. Their De Luxe Type ABC 110 is a set built on the radio frequency plan, consisting of six vacuum tubes, five transformers, A, B and C batteries, Magnavox and automatic self-charger. Retail at \$600. They also make other sets at from \$45 to \$55.

Ask Our
Service Bureau

Buy Apparatus
From a Reliable Manufacturer

FREED-EISEMANN RADIO CORP.

255 Fourth Ave., New York City

CABINETS

Write for quotations

MARVIN B. FALLGATTER

Waupaca, Wisconsin

P. D. JACKSON

Direct Factory Representative

Radio Equipment Manufacturers

HEAD SETS A SPECIALTY

1441 So. State Street Chicago, Ill.

M-R FLEXIBLE VARNISHED TUBING
THE GENUINE

"SPAGHETTI"

TWO STYLES—BEST GRADES MADE—ALL SIZES—ALL COLORS

Varnishes, Waxes, Compounds, Papers, etc.

MITCHELL-RAND MFG. CO.
14 VESEY STREET NEW YORK, N. Y.

KRAMER RADIO COMPANY

4713 Sheridan Road, CHICAGO, ILL.

MIDWEST DISTRIBUTORS

Of Quality Radio Products

Write Us for Catalog and Discounts

PATENT

your ideas. Protect your rights by U. S. and Foreign Patents and Trade-Marks. Moderate rates. CALL, WRITE or send us your invention.

May one of our representatives call on you?

FREE CONSULTATION

Phone: Vanderbilt 7212.

ASK FOR MANUFACTURERS PATENT CO. 520 FIFTH AVE. NEW YORK

DEPEND ON CRAMER RADIO



SPECIAL FOR LIMITED TIME

This \$80 Receiver at 50% Discount

The CH5 receiver needs no introduction. Judged by any standard it is without equal anywhere. Simple in control; handsome in appearance; super-efficient in operation. Includes in its 150 to 3000 meter range, amateur, commercial and Navy waves, special land stations, ship stations and Arlington "time." Employees latest inventions. Especially efficient for radiophone concert reception. Guaranteed in writing for one year. Regular price \$80 with 25% discount—and worth it. SPECIAL DISCOUNT—50%.

EVERY DEALER SHOULD HAVE AT LEAST ONE!

Send cash only—no CODs or charges. Not more than 6 sold to one dealer.

W. R. CRAMER, DEPT. 3, OMAHA, NEB.
"Pioneer Radio Manufacturers"

THIS WILL BE A RADIO CHRISTMAS!

They Cut Panels

**Pittsburgh Radio & Appliance Co.
Offer Real Panel Service**

The Pittsburgh Radio and Appliance Company, 112 Diamond Street, Pittsburgh, besides selling a standard line of radio equipment, in a wholesale way, specialize in the cutting of bakelite panels.

Few Radio jobbers render a service such as this real panel service to the trade. They especially cut panels to order and do not carry in stock sizes.

Genuine Formica and Condensite are used.

Retailers and jobbers can make money by getting in touch with this concern.

ASCO TUBE SOCKET RETAILS AT ONE DOLLAR

The Mook Electrical Supply Co. of Canton, Ohio, are justly pleased at the Asco Tube Socket, retailing at one dollar, made exclusively for them by the Akron Specialty Co.

This socket consists of two square blocks of paneling, the lower block $\frac{3}{8}$ -inch thick, the upper $\frac{1}{8}$ -inch. A square of an inch separates the two blocks.

Connected up to each brass corner post is a strip of spring bronze extending down into the socket holes of the lower block.

This socket unlocks the full utility of the Westinghouse Dry Battery Tubes. WD-11 Detector and WR-21 A Amplifier.

AN OFFER TO DISTRIBUTORS AND DEALERS

An assembly tube set having a double tuning circuit and Litz wound rotor in the variocoupler, giving very excellent results, is now being offered to dealers and distributors by Radio Courses, Inc., of 552 Seventh avenue, New York. An idea of the imposing size of the set is given by the size of the panel which is 7" x 18". The set lists in its complete assembly form at \$27.50 so it is a good proposition for the radio fan. The merits of the set and the discounts given make it an attractive proposition to the dealer in point of turnover and profit. Exclusive rights in various sections of the country will be given to distributors who can give the set good distribution.

Radio Courses, Inc., also put out The Radio Reading Course, a set of five instruction books listing at \$2.25, which offers an opportunity to dealers and distributors for profitable sales.

PARADEX UNITS

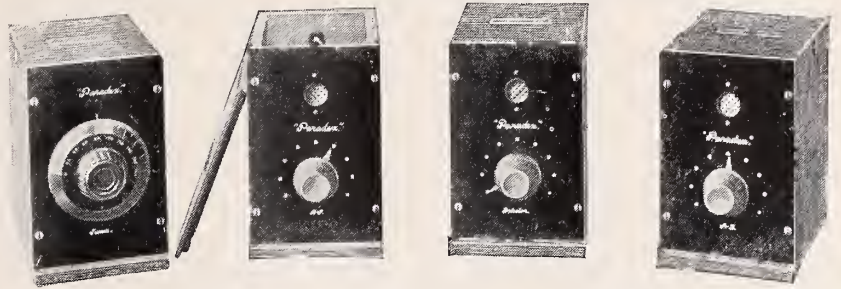

Write for Dealers' and Jobbers' Proposition
 TUNER (Pat. Applied for).....\$20.00 AUDIO FREQ. AMP.....\$18.00
 DETECTOR 10.00 RADIO FREQ. AMP..... 20.00

Manufactured by

PACIFIC RADIO EXCHANGE

439 CALL BUILDING

SAN FRANCISCO, CAL.

INTERESTED IN RADIO PATENTS?

Radio Business men and Manufacturers who are interested in the patents issued by the U. S. Patent office may find this information each week in

THE RADIO DEALER WEEKLY

One dollar the year. Sample free on request

Address

THE RADIO DEALER WEEKLY, 1133 Broadway, New York, N. Y.

LATEST and MOST POPULAR

Radio Books

- Radio Hook-Ups, by M. B. Sleeper.....\$.75
An indispensable book to the radio amateur who designs or builds his own receiving apparatus.
- Radio Design Data, by M. B. Sleeper..... .75
A book giving tables and data for designing receiving and transmitting apparatus.
- Construction of New Type Trans-Atlantic Receiving Set, by M. B. Sleeper .75
Tells how to listen to the high-power telegraph stations of foreign countries.
- Construction of Radiophone and Telegraph Receivers for Beginners, by M. B. Sleeper..... .75
Tells in detail the building of radio apparatus.
- How to Make Commercial Type Radio Apparatus, by M. B. Sleeper.. .75
Describes in detail many commercial types of transmitting spark and vacuum tube sets, both telephone and telegraph and receiving equipment of all kinds.
- Wireless Telegraphy and Telephony Simply Explained, by A. P. Morgan..... 1.50
A book the Radio experimenter cannot afford to be without.
- Experimental Wireless Stations, by P. E. Edelman..... 3.00
A book describing all modern improvements.
- A B C of Vacuum Tubes Used in Radio Reception, by E. H. Lewis. . . 1.00
A book explaining in detail all about vacuum tubes.

FREE! Catalogue of Wireless, Automobile and Other Books Sent Free on Request

The Norman W. Henley Publishing Co.

2 West 45th Street, New York

Liberal Discount to Supply Houses. Write for full particulars and dealer's proposition.

THIS WILL BE A RADIO CHRISTMAS!

THE WIRELESS WONDER

A Complete Aerial for \$1.50

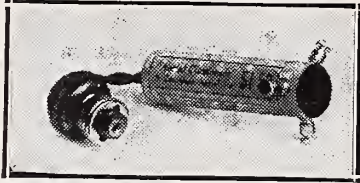

Simply screw in any lamp socket and turn key on. Better than an outdoor aerial. Nothing to get out of order. Eliminates lightning danger. Money back guarantee.

Radio Catalog free at your Dealers or
STEINMETZ WIRELESS MFG. CO.
 5706 Penn. Ave. Pittsburgh, Pa.
 Electrical Engineers and Manufacturers

THORNTON

AUDIO FREQUENCY
 AMPLIFYING TRANSFORMERS

Supreme Test Transformer

These transformers are supplied in either mounted or unmounted types. Special attention paid to the manufacturer of receiving sets.

THORNTON
 TRANSFORMER CO., Inc.
 30 Church Street, New York City

The Comet Battery Co.

Manufacturers

Radio "B" Batteries

Cleveland, Ohio

COMPOSITION

LIST PRICE

DIALS 50^c DIALS

Adjustable Switchlevers
 Knobs

NEW YORK-RADIO-DIAL CO.
 316 Holden Bldg., Detroit, Mich.

We Specialize in

Brass Rod and Tubing
Sheet Copper, Aerial Wire
and Binding Posts

McKenna Brass and Mfg. Co.
 First Ave. and Ross St., Pittsburgh, Pa.
 Phone, Court 637

Radio Photos

English Radio Engineers Devise Ways of Sending Radio Pictures

At no distant date photographs will be sent by wireless from all parts of the world direct into the newspaper offices, according to the General Radio Company of London, England.

In the research laboratory at the company's works at Twyford Abbey photographs already have been received by radio and though the invention has not yet gone beyond the experimental stage, remarkable results are stated to have been obtained.

Those who have seen the radiograph pictures say they are quite good and generally recognizable. Though the main criticism is that the clarity of the pictures leaves room for improvement, this it is said will be remedied in time.

The pictures which have been received by the General Radio Company were wirelessed direct on to a specially made sensitive celluloid film which afterwards was developed.

BENSONIA CONSOLE SET IN MAHOGANY, RETAILS \$250

The Benson Co., 2429 South Michigan Avenue, Chicago, feature the Bensonia, a beautiful mahogany finished Queen Anne console model, measuring 36 x 37 x 23 inches. Contains loud speaking chamber with grill front covered with grill cloth netting. Bakelite tuning panel, 12 x 14 inches neatly arranged in second chamber which is removable and provides room for "A" and "B" batteries.

This set includes all features of the Benson Tuner and Detector Unit and Three-Stage Amplifier with loud speaking arrangement; also includes heat set. Wave length 150 to 1250 metres. Normal range 1000 to 1500 miles. List price, \$250.

SOCKETS FOR NEW TUBES

A new socket for dry cell tubes is being introduced by the Radio Electric Service Station, of Tottenville, Staten Island, New York, sole distributors in the United States for this innovation.

The socket has a bakelite base and it is made of phosphor bronze. All the wearing parts are of brass. The chief feature of the new socket is that it requires no cup. The result is that it has a very neat appearance.

The socket lists at \$1. The address of the Radio Electric Service Station is 151 Main Street, Tottenville, Staten Island, New York.

SEABOARD

ANNOUNCING COMPLETE SETS

Made To Order

*Write for our list suggesting
 styles and prices*

SEABOARD RADIO CORPORATION
 266 GRAND STREET, NEW YORK CITY

Attention Radio Mfgr's and Jobbers

Serco Radio Products

These prices
 are net

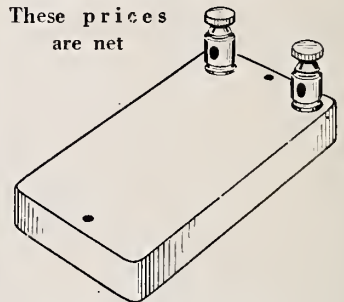

Serco Fixed Condensers,
 moulded, 42 cents

Serco Fixed Condensers,
 moulded, 54 cents

Serco Crystal Detector, 75 cents

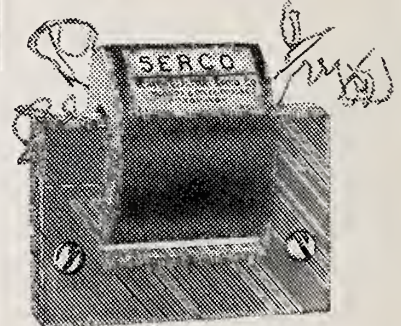

Serco Amplifying Trans-
 former, 10 to 1 ratio, \$1.75

We are Manufacturers
 of
 Serco Radio Products

Write for Trade Discounts

Scheib Elec. Radio Co.
 6243 Station Street
 Pittsburgh, Pa.

THIS WILL BE A RADIO CHRISTMAS!

Extols Air Music

Chicago Musical Man Approves of Radio Performances

Marquette A. Healy, of Lyons & Healy, the big Chicago music house, is quoted on radio, as follows:

"The most extraordinary thing in connection with wireless telephoning is the fact that the air can be filled with harmony.

"When we hear Galli-Curci at the opera at Chicago and a few minutes later a piano recital in Pittsburgh, we are only in the beginning of the art.

"It is like the time when we first began selling talking machines. They were such crude affairs that we were criticized for considering them musical instruments. But now that we know music may be had free of cost in much the same way as we obtain our daylight, the possibilities are fairly bewildering.

"Every development accentuates the importance of music to the human race.

"With the opportunity to hear great compositions will come a better knowledge of what is worthy in music."

LIGHT HEAD SET

With a total weight of 11½ ounces, the Rexo radio head set, made by the General Phonograph Mfg. Co., of Elyria, Ohio, is one of the lightest sets on the market. But lightness has not been sacrificed to sensitive pick-ups or strength.

The Rexo receiver cups are made of aluminum sheet, the magnets of tungsten steel, the coil cores of Norwegian iron. Each coil is wound with seven thousand turns of No. 40 enamelled copper wire.

The ear caps are of tough rubber finished in polished ebony. The caps are pierced with a number of small holes instead of one large hole, designed to prevent any possible damage to the diaphragm adjustment. A thin lacquer covers the entire interior of the receiver to prevent rusting from perspiration. The diaphragm itself is treated to prevent rust.

Each receiver coil is wound carefully and all four coils are balanced for resistance and tone so that both receivers talk exactly alike. The headset complete with cords is made to sell for \$10.

DEALERS' CONVENTION

The annual convention of the National Association of Electrical Contractors and Dealers, was held at Cleveland, Oct. 12th.

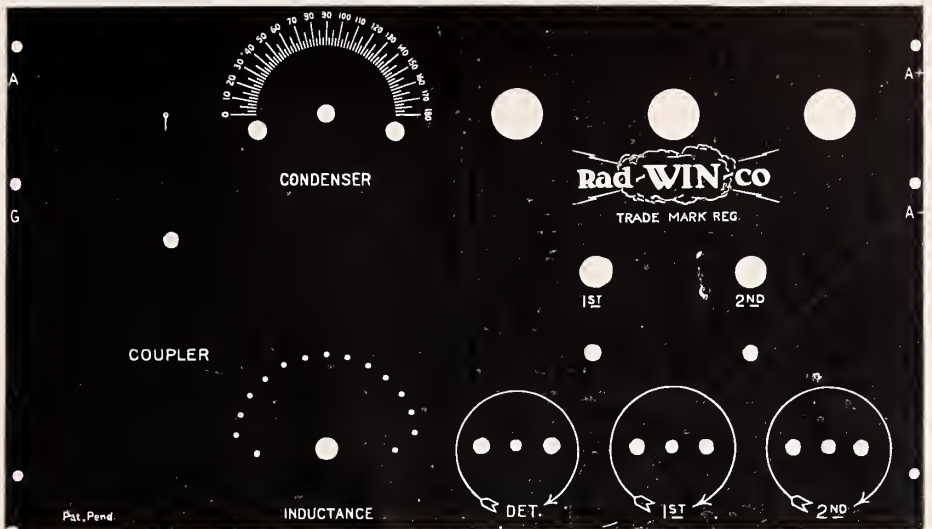

Panel Engraving

—on Bakelite, Rubber, Fibre or any other composition. Sharp white lettering—clean work—quick deliveries.

Our price in quantities, for engraving panels as above, size 7½x15", including condenser dial, trade mark and arrows, is..... **75c** each

Send us your specifications and note our surprisingly low prices

POSTER & CO.

552 SEVENTH AVE., NEW YORK

PHONE BRYANT 2572

Milliken Radio Towers

These towers are in service at principal radio stations in all parts of the country. Constructed of galvanized steel, self-supporting, standard types and heights.

AGENTS WANTED

Agencies are now being established in different localities. We have an attractive proposition—let us explain it to you.

Send for Catalog No. 16

MILLIKEN BROTHERS
MFG. CO., INC.

Woolworth Building
New York, N. Y.



STATION WVP



STATION WBZ



STATION 2XJ

THIS WILL BE A RADIO CHRISTMAS!

PATENTS
ELECTRICAL MECHANICAL
RADIO
SEND SKETCH AND DESCRIPTION
FOR OPINION
EMIL ALEXANDER KERN
328 SOUTH SEVENTH STREET
NEWARK, N. J.

Fine Cuts for Illustrating
**CENTRAL ELECTROTYPE
FOUNDRY COMPANY**
Electrotyping and Engravings
9 Campbell Street Newark, N. J.
Telephone: Mulberry 1698

GROWING AND GROWING GREATER

You are a member of a great industry and here is an opportunity to advertise in the only publication of its kind in the RADIO Field.

A Trade Directory and Buyers' Guide

Purely a business proposition—Referred to at all times by buyers.

Reaches every dealer, manufacturer and jobber including hardware, phonograph, department store and electrical dealers.

A Wealth of interest for the buyer
National in scope
Circulation 10,000
WRITE FOR RATES

Mailing list service to our advertisers

The Radio Red Book Pub. Co.

406 West 31st Street, New York, N. Y.
"The Radio Trade Directory"
Watkins 5987-88

Proudfoot, \$55.00

Super-Sensitive Detector and Two-Stage Amplifier

Proudfoot Super-Sensitive Detector and Two-Stage Amplifier, made by the Cruver Mfg. Co., 2456 West Jackson Blvd., Chicago, retails at \$55.00.

The Proudfoot specifications are:
Panel— $\frac{1}{4}$ inch, hand rubber Bakelite. Size $7\frac{5}{16}$ by $8\frac{1}{4}$.

Lettering—Engraved and white filled.

Cabinet—5 inch deep, of quarter-sawed oak with wax finish.

Rheostats—Built into panel.

Metal Finish—All Metal face parts of nickel finish, except binding posts which are finished in black.

Fixed Condensers—Built on the V.T. socket piece.

Grid Leak—Tested in laboratory for two megohms resistance, and short circuits the condenser in the Detector circuit.

Jacks—Copper with phosphor bronze prongs. Special design.

Automatic Filament Control—Designed with automatic filament control circuits.

Everything else that might be required is furnished in this set.

SIMPLE CHARGERS

Operating by attaching to light socket, the Fore battery chargers for Radio and automobile batteries are designed for home use to keep batteries at their full capacity at all times.

The chargers manufactured by the Fore Electrical Company of St. Louis are self-supporting. A battery may be charged during the night for the amperage charging rate reduces as the voltage of the battery rises so that there is no possibility of an over-charge.

The cost of current to charge the average Radio battery is less than five cents, and to charge the ordinary automobile battery from five to ten cents.

The combination of radio and battery charger is ideal for usually the home enjoying an automobile also has a radio set. The purchase of such a battery charger has thus a two-fold purpose.

The Fore company makes its chargers in two types, one with a capacity of charging a six-volt, six-ampere battery and another which will charge both six- and twelve-volt batteries. There are four styles of cycles for each of the two types.

DRY CELL ADAPTER

The Practical Appliance Company of New York City, is making a socket adapter for dry cells.

DEALERS: Get our Price List before placing your orders

We are distributors of Federal, Patent, National, Miraco, Uradiola, etc., lines of Quality Radio Apparatus.

THE EDW. J. GOETZ CO.
604 Race Street Cincinnati, Ohio

Best by Test!



Hundreds of manufacturers, dealers and owners of receiving sets everywhere have tested and found our crystals the most sensitive and efficient obtainable.

Double your pleasure and increase the efficiency of your set by using our

ALL-SENSITIVE GALENA CRYSTALS

Galena Crystal, Mounted - - 35c

Galena Crystal, Unmounted - 25c

IMMEDIATE DELIVERY

Every Crystal
GUARANTEED PERFECT

Manufacturers, Jobbers, Dealers write for quantity prices

GALENA CRYSTAL MFG. CO.

463 Bushwick Ave.

Brooklyn, N. Y.

Do You Know

We are the recognized authorities on wireless securities. Our Information and Analytical Departments are unexcelled. Let us know what company you are interested in and we will furnish without obligation, detailed information and opinion respecting its merits

FRANK T. STANTON & CO.

Specialists in Wireless Securities
Since 1915

35 Broad St.

New York

Phone: Broad 1670-3641-5819

FRANKLIN SOCKET



**FOR W-D-11
DRY CELL TUBE**

Holds tube firmly
Makes perfect contact

Price \$5.50

We also make an adaptor that fits standard sockets, Price, \$1.00.

Dealers write for discounts

FRANKLIN RADIO MFG. CO.

711 Penn Ave.

Wilksburg, Pa.

THIS WILL BE A RADIO CHRISTMAS!

The Amrad Station

American Radio and Research Corp. Doing Good Work

WGI, the high powered Amrad Broadcasting Station of the American Radio and Research Corporation at Medford Hills, Mass.—the world's pioneer broadcaster—sends out readable publicity to the daily press.

H. M. Taylor, advertising manager for WGI, is to be congratulated upon his good work for Radio.

The Taylor news stories are not of the hackneyed type.

The Amrad station broadcasting programmes are high-class, as might be expected from these folks.

More stations like WGI will make more Radio enthusiasts.

THREE "A" BATTERIES

A Minnesota firm, the American Accumulator Company of Owatonna, Minn., is in the Radio battery field with a new line of three batteries. They are standard sizes recommended for Radio use.

All three styles are put up in convenient and sanitary containers and are equipped with handles to make carrying easier. A cover supplied with each battery makes it more suitable in appearance for the home.

Style D-7, has a capacity of 60 ampere hours, D-9, 80 ampere, and D-10 has 120 ampere hour capacity.

The American Accumulator Company also makes a forty-eight volt compartment "B" battery.

A GOOD CRYSTAL SET

The Standard Products Co., 93 Wilsey St., Newark, N. J., offer a complete set, at \$10. This set includes earphones and Light socket aerials, is enclosed in a mahogany finished case, with 8½ inch two-slide tuning coil, bakelite panel and nickel-plated fixtures. It is said to have a range of music and voice of from 35 to 40 miles. No outside aerial is needed.

THE AEROVOX LINE

The Brady Electric Mfg. Co., Union Arcade, Pittsburgh, feature the "Aerovox" line.

Among the features are the Aerovox Amplifier, \$45; the Aerovox Audion Amplifier, \$14.50; Aerovox Receiver and Detector, \$35; Aerovox Loop, \$8.50 and \$10.50; Aerovox Air Condenser, \$3.25; Aerovox Dials, \$0.75; and Aerovox Pocket Companion; a unique pocket set, with phones and wire, \$17.

For CORRECT RADIO MAILING LISTS Use THE POCKET LIST

Of Radio Manufacturers, Jobbers and Dealers in the United States and Canada. Issued quarterly—January, April, July and October. October, 1922, issue corrected to September 15th, 1922. Classified under three different headings—Manufacturers, Jobbers and Dealers—and alphabetically arranged by states, cities, towns and names of firms. Containing over 15,000 names and addresses.

We have been exceptionally careful to see to it that every manufacturer, jobber and dealer is listed and, under the PROPER CLASSIFICATION. Most mailing list concerns charge more than \$100 for a list of this kind, and, as a rule, those supplied are far from being correct. Compare this list with any other and you will find it to be the very best obtainable anywhere at any price.

October number ready for distribution September 25th. Price \$5.00 per copy or \$10.00 per year (four issues, including monthly supplements which keep the list absolutely correct and up to date at all times). October edition limited, send in your order with remittance today.

1021 Carrington Street F. D. PICKENS JANESVILLE, WISCONSIN

SPECIALTY SERVICE COMPANY

Manufacturers of
RITE RADIO PRODUCTS
Distributors for
LAWSAM LINE
OF QUALITY RADIO PRODUCTS
and Other Standard Equipment

Write for Prices and Discounts

Cor. 4th Ave. and Pacific St.

Brooklyn, N. Y.



BLACK POINTER

EMELOID

KNOB and POINTER
COMBINATION

3/16 and 1/4 Bushings

20c List

Liberal Discounts for Manu-
facturer—Jobber—Dealer

ALSO 2"—3"—4" DIALS

EMELOID CO., INC.

536 Junius St.

Brooklyn

N. Y.



WHITE POINTER

NOVO "B" Batteries

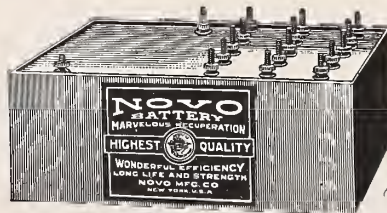

for Radio Outfits

NOISELESS—DEPENDABLE—GUARANTEED

All Sizes—Plain and Variable

22½, 45 and 105 Volts

Send for Catalogue and Discounts

NOVO MANUFACTURING CO.

424 W. 33rd St.
NEW YORK

531 So. Dearborn St.
CHICAGO

THIS WILL BE A RADIO CHRISTMAS!

3000 OHM SETS, \$3.98

Plus 20c Postage and Packing
Satisfaction Guaranteed or Money Back



We mail phones the day your order arrives. Every pair tested, matched and guaranteed as sensitive as \$8 to \$10 Sets. Circular Free.

TOWER MFG. CO.

103 Station St. Brookline, Mass.

G. E. Camp

General Electric Recreation Camp in Jersey

The General Electric Company has purchased a 175-acre plot of land at Parsippany, N. J. The move of the General Electric Company toward the purchase of this property has been considered for several years.

The Recreation Camp, as it is generally referred to, now operated and owned by the General Electric Company on Lake George, is too great a distance from its New York headquarters and it has thought it advisable to purchase a plot for such a purpose near its main headquarters.

There is a large house on the premises. A large bungalow type of building will be erected, which will be used for dancing and club-room purposes. It is expected that part of the property will be developed into a golf course.

PATENTS

To the Man with an Idea

I offer a comprehensive, experienced, efficient service for his prompt, legal protection, and the development of his proposition.

Send sketch or model and description, for advice as to cost, search through prior United States patents, etc. Preliminary advice gladly furnished without charge.

My experience and familiarity with various arts frequently enable me to accurately advise clients as to probable patentability before they go to any expense.

Booklet of valuable information, and form for properly disclosing your idea, free on request. Write today.

RICHARD B. OWEN
Patent Lawyer

82 Owen Building, Washington, D. C.
2276-10 Woolworth Building, New York City



Solid Construction of Ray-O-Vac "B" Batteries Gives Long Life

The individual cells of Ray-O-Vac "B" Batteries are sealed hard and fast into a strong, perfectly insulated unit. They cannot develop "battery noises." No jarring or moving can break the hand-soldered connections. The patent wire-spring clip holds the smallest wire tight without shearing.

Ray-O-Vacs have unusual recuperative powers, too, and radio fans are rapidly learning to demand the kind of service they get from Ray-O-Vacs always. 22½, 45, and 100 volts. Dealers who are in business to stay will find our Bulletin 225 interesting and profitable. Write for it.

French Battery & Carbon Co.

Madison, Wisconsin

Chicago Dallas Atlanta New York
Denver Minneapolis Kansas City



French RAY-O-VAC "B" Batteries

SPEER CRYSTAL RECEIVER RETAILS AT LOW PRICE

The Speer crystal receiver, manufactured by the Radio Apparatus Company, Pittsburgh, Pa., is designed especially to supply the demand for an efficient and handsome instrument at a moderate price. With an adjustment so simple that any tyro without the slightest knowledge of radio can operate it with the utmost ease to receive programs broadcasted on a wave length of approximately 360 meters within a radius of 25 miles or more, depending on the power of the transmitting station.

The Radio Apparatus Company also features the Speer crystal detector which is made with a moulded, polished base, a dust proof glass encasing tube which permits the easy removal of the crystal and a double spring action which makes for ease and rapidity of adjustment.

ATLAS PRODUCTS

Atlas variable condensers, the manufacturers say, are made in three sizes with and without metal balance suitable for all classes of radio, telegraph and telephone work. The plates are of heavy aluminum and only mica is used for insulation. The Atlas Amplitone loud speaking unit consists of a heavy duty phone, necessary cord and plug and a 14" bell horn and stand. Although it functions perfectly on any stage of amplification no extra batteries, tubes or other equipment is necessary as with some loud speakers. Atlas is the trade name for the radio products of the Multiple Electric Products Company, Inc.



The Loop is the Thing Today And The WARREN RADIO LOOP Is the Big Seller

It's the most highly developed loop that meets the exacting requirements of the Armstrong receiver, powerful tube sets, portable sets and sets on moving vehicles—the most popular apparatus.

All enclosed. Wonderfully well made. Directional. Very powerful.

Every day the demand for the Warren Radio Loop grows. You need this profitable trade. Send today for Bulletin P-102, discounts and price list.

- Type A-737 (300-700 meters) 6 inches square—non-directional.....\$10.00
- Type A-7236 (175-1000 meters) 6 inches square—non-directional..... 12.00
- Type B-2537 (300-700 meters) 18 inches square—directional..... 20.00
- Type BL-2520 (200-18,000 meters) with honeycomb coil, 18 inches square—directional..... 25.00

V-DE-CO RADIO MFG. CO.
ASBURY PARK, N. J.
Dept. D

Exposing Frauds

(Continued from page 63)

up radio apparatus. This is no junk line.

Of fraudulent folks there are many—in all commercial lines. The radio industry has acquired its share of get-it-in-any-manner folks. Some are sitting in the high spots posing in splendor as legitimate business men and as radio experts, but their records are known and early elimination is assured.

THE RADIO DEALER, like all people, detests the man who sets himself up as knowing everything, as being an authority upon every branch of the radio industry. This type of man grates upon the public's nerves.

The radio industry, already, has its great know-it-alls. These men are having their day in the sunlight; their press agents are taking their money, of course, and some of them are even operating honest-to-goodness factories.

This class, too, are to be included in the class known as the frauds and fakirs of the radio industry.

THE RADIO DEALER has made every effort to support every movement to expose the frauds and fakirs in our industry. Every legitimate organization has our support and we have personally expended our time and some of our money to aid in the extermination of the mercantile frauds in our trade.

This work is still going forward and this paper welcomes tips from its friends as well as the support of the honest tradesmen.

The gentlemen who are mere puppets for stock promotion schemes—those posing now as big men—cannot be readily reached, but public opinion can be exerted, it is hoped, and when the time is ripe the radio industry will arise and smash these fakirs as it has the out-and-out frauds and fakirs of the radio industry.

10 DAYS' FREE TRIAL

"Order a Hulbert Battery charger. Try it 10 days. Give it the hardest test. Convince your self that it is everything claimed for it. If you are not entirely satisfied, send it back and your money will be returned to you. This guarantee is positively unconditional."

That's the way the Hulbert Electric Mfg. Co., 7010 N. Ashland Ave., Chicago, advertise their \$20 battery charger.

STOP-LOOK-WRITE

DEALERS, JOBBERS AND MANUFACTURERS

Before placing orders, write us first and get samples and our big discount sheet.

	List		List
Condensers 43-Plate.....	\$3.50	Turney Head Sets.....	\$6.50
“ 23- “	2.75	Dials 3"75
“ 11- “	2.25	Variometers	3.50
“ 7- “	2.00	Variocouplers	3.50
“ 3- “	1.50		

SPIRO BROTHERS, Manufacturers and Distributors
519 Real Estate Trust Building Philadelphia, Pa.

ELECTRICAL TESTING

Of all materials entering into Radio Construction. Meters and apparatus calibrated and repaired.

CHEMICAL ANALYSES
STRENGTH TESTS

Investigation or Development of New Apparatus and Materials. Routine Tests at Special Rates.

NEW YORK TESTING LABORATORIES

80 Washington Street

Bowling Green 7016

“TUNING IN”

To the right tune is very simple when your connections are soldered with the

NEW “POST SOLDERING IRON”

(The iron with the platinum heating unit)

Removable Soldering Tip

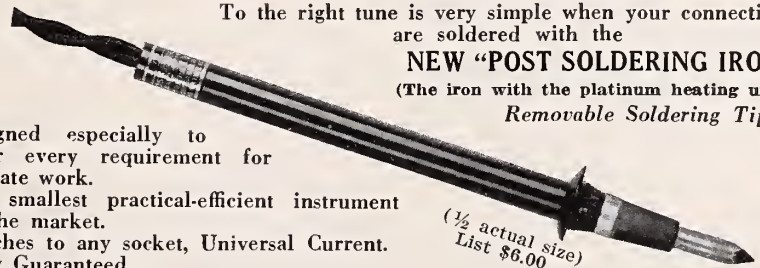

Designed especially to cover every requirement for delicate work. The smallest practical-efficient instrument on the market. Attaches to any socket, Universal Current. Fully Guaranteed. From your jobber or write

(1/2 actual size)
List \$6.00

POST ELECTRIC COMPANY

30 EAST 42nd STREET

Office 509

NEW YORK

ESTABLISHED 1909

DEPENDABLE  LINE



NO. 41 VARIOMETER

INSTRUMENTS
WITH
100% RADIO
EFFICIENCY



NO. 42 VARIOCOUPLER

THE EASTERN SPECIALTY CO.

3551 N. FIFTH STREET

PHILADELPHIA

THIS WILL BE A RADIO CHRISTMAS!



Why Pay

100 to 300

When you can get a book that covers the subject

For 50c

DEALERS YOUR CUSTOMERS WILL WANT THIS BOOK FOR A

Xmas Gift

It includes the New Armstrong Super Regenerative Hookup
You make 66 2/3% on investment

ARCHWAY BOOKSTORE
224 Pike St. Seattle, Wash.

Free

Will help YOU increase sales



This catalog will show you how to secure the names of your best prospective customers, those you want to reach most. Counts and prices are given on thousands of different Lists, covering business concerns, professions and individuals, such as Noodle Manufacturers, Druggists, Coal Mines, Farmers, etc. Personalized sales letters and descriptive literature mailed to live prospects will increase your sales by creating direct orders or inquiries.

99% Guaranteed Mailing Lists backed by our 5¢ refund

Insure your getting up-to-date information, for our Lists must be compiled from latest sources to avoid heavy losses through the guarantee.

Send for FREE Reference Book today
A postcard will bring this valuable sales help.
ROSS-GOULD CO., N. 10th, St. Louis.

ROSS-GOULD
Mailing Lists St. Louis

Ask Our Service Bureau

Mr. Dealer: Tie up to High-Grade

FROST RADIO Merchandise

A well-known National Reputation for Satisfactory Service guarantees you a Quick Turnover.

FROST-RADIO LEADERS

<p>Frost-Fones A Quality Achievement. Ideal Receivers for use with Home Radio Sets. Combine maximum efficiency with permanent sensitivity.</p> <p>Frost-Radio Extension Cord and Plug Comes in lengths from 10 to 100 ft. Loud speaker can be placed anywhere and connected with Radio set with Frost-Radio Extension Cord.</p> <p>Frost-Radio Receiving Transformers Will tune in all stations up to 3,500 meters. Hand rubbed mahogany finish. Wound with green silk covered wire. Immediate deliveries.</p> <p>Frost-Radio Protector Listed by Underwriters' Laboratories under April, 1922, regulations. No interference with clear Radio receiving. Never Grounds. Mounts indoors. Price \$1.50. Good deliveries on this improved device.</p>	<p>Improved Plugs and Jacks Specially designed for Radio Panel Work. Plugs are interchangeable with other standard makes.</p> <p>Cunningham Vacuum Tubes Nationally recognized as the Ideal Detector or Amplifier Tubes for use with Radio Receiving Sets.</p> <p>Remler Radio Apparatus Radiates Quality. Every Remler item is first studied and tested for its practical Radio utility before being marketed.</p>
--	--

Listed by Underwriters' Laboratories under April, 1922, regulations. No interference with clear Radio receiving. Never Grounds. Mounts indoors. Price \$1.50. Good deliveries on this improved device.

The best jobbers in your locality can supply you. See them now



HERBERT H. FROST

NATIONAL FACTORY DISTRIBUTORS TO THE ELECTRICAL-RADIO JOBBER
154 W. LAKE ST. CHICAGO, ILL.

Jobbers and Retailers

Manufacturers Have Obligations Like Jobbers

(Continued from page 47)

ing to advertise in a national way, are neglecting to advertise in their local papers.

How all these dealers expect to get the mail order business from all over the country is more than many of us can understand, especially when there is so much business to be had in their own territory.

Manufacturers are now beginning to spend large sums of money in advertising their merchandise in a national way and of course the good jobber realizes the advantage to him in handling merchandise that is being advertised in that manner and the dealer should see the big advantage to himself in tying up with this national advertising, by advertising in his local papers and using the literature, placards, cuts and other items of publicity prepared for him by the manufacturer.

The manufacturer, by making quality merchandise backed up with national advertising, selling only through recognized jobbers and distributors, is giving a real service to those jobbers and distributors.

The jobber by stocking quality merchandise, effecting prompt shipment and maintaining a corps of trained men for the benefit of the dealer is rendering real service. The dealer in turn must give real service to the public. He must do more than merely sell his customer a \$250 outfit, but must see that it is properly installed and where conditions warrant it, have a service man for this purpose. He should see that the customer is also properly instructed how to operate his set, in order to get the best results out of it. When one buys an automobile it is not merely sold to him, but he is thoroughly instructed in how to operate it and take care of it. The dealer must render a similar service.

The writer feels sure that this coming fall and winter will see a big business for all reliable manufacturers, jobbers and dealers who will in turn render to each other service.

Let Service be the watchword in the radio industry and I am sure that we will not see a repetition of the conditions, such as we experienced this summer.



Immediate delivery on anything in the Radio line. Our U. S. Eagle crystals mounted and unmounted are positively guaranteed to be sensitive.

Write for prices

U. S. Radio Co. of Penna., Inc.
Pittsburgh, Pa.



Radio Reception Explained

HOW TO BUILD

- Double Slider Type Crystal Receiving Set
- Loose Coupler Type Crystal Receiving Set
- Single Circuit Vacuum Tube Receiving Set
- Vacuum Tube Receiver and Two Step Amplifier
- Loose Coupler Tuner and Vacuum Tube Detector
- Short Wave Long Distance Vanometer Regenerative Tuner
- Radio Frequency Amplifier and Vanometer Regenerative Tuner
- Combined Radio-Audio Frequency Amplifier Circuit

Great Lakes Publishing Company
Detroit, Michigan

BUILD BUSINESS

Sell more parts by creating interest in radio matters. Distribute an inexpensive book which not only explains radio reception but also tells how to build eight separate types of receiving outfits out of parts you are selling. Complete bills of material given for each type listed and described. This will be of great help to your customers and profitable also.

List, 50c Sample, 20c Very liberal discounts

Desk 4—Great Lakes Publishing Co., Park Place, Detroit, Mich.

NOTE TO THE TRADE:

Quote us prices, terms, discounts and deliveries

WE ARE NATIONAL DISTRIBUTORS

Complete sets Radio Equipment SPECIALTIES

Manufacturers

Desirous of New York Representation communicate at once

RADIO EQUIPMENT SERVICE

500 FIFTH AVENUE
NEW YORK CITY

THIS WILL BE A RADIO CHRISTMAS!

SELF-STARTING CONDENSERS

What are described as "self-starting" condensers are made by W. O. Duntley Company, Chicago, Ill.

The manufacturers claim that the features of these new vernier and plain condensers are speed and accuracy in tuning up. Without removing the fingers from the knob, you can in a few seconds tune your instrument to the proper wave length. When the spindle is turned to the proper position for the station on which the operator is attempting to listen, all that is necessary to eliminate foreign noises is to adjust the vernier knob, which is placed at the end of hollow shaft carrying the regulator adjusting knob. Back panel mounting and non-conducting operating shafts make shielding unnecessary on Duntley condensers.

The Duntley Company also make Duntley switch levers with bushings. All knobs are of Formica.

MAKE ALL-WOOD HORN

An amplifying horn with a sound chamber is being put on the market by the Ampliphone Phonograph Company of Chicago. The entire device is made of wood, designed to ensure elimination of metallic sounds and to create resonant tones.

There is no metal throat in the construction of the Ampliphone, but it rather resembles some musical instrument. The sound box with a centre orifice to produce resonance supports the horn. At the top of the horn one receiver of an ordinary head set is attached, the other being "shorted."

When the sound waves traveling down the horn reach the opening in the sound box, they are diverted into the sound chamber, where each tone is given full chance to vibrate. The horn is finished in mahogany.

MILLIKEN CATALOGUE

Milliken Brothers Mfg. Co., Woolworth Building, New York City, have issued a catalogue, on their radio towers, in Spanish. This booklet is a credit to the company, same being nicely gotten up. This catalogue is being sent to Spanish speaking countries and will be of great benefit to the entire industry.

GOOD TRANSFORMER

The Uptegraff Electric & Mfg. Co. of Pittsburgh, are producing the Uptegraff transformer, which has a non-magnetic core, is neat in appearance and on account of its cylindrical form and small size lends itself to ease in mounting with other apparatus.

TOM BROWN'S RADIO SET

Manufactured by Lawsam

A complete knock down tube set, cabinet drilled, wires cut and shaped, everything ready to put together, in a handsome "take-me-with-you-looking" box. **\$21.75**
LIST

Buy now for the holidays

Write or wire for discount on radio's "best seller"

Also a complete line of parts

SPECIALTY SERVICE COMPANY

Cor. 4th Ave. and Pacific St. Brooklyn, N. Y.

Trade-Marks Secure Trade

Registrations Secure Trade-Marks

I Secure Registrations

CHAUNCEY P. CARTER

Radio Trade-Mark Specialist

4907 Potomac Avenue, N. W. Washington, D. C.

Correspondents in all countries

"EURACO" MICA GRID CONDENSERS AND LEAKS

Price 60 cents
(Designed to fit Standard Grid Leak Base)

GRID LEAK VALUES:

.5-1.0-1.5
2.0-2.5-3.0
Megohms

Price, 60 Cents



COMPACT, INTER-CHANGEABLE, HANDY, MOST EFFICIENT

"Euraco" Condensers are composed of Copper Sheet and Best Grade India Ruby Mica, and are entirely Hand Made.

Manufactured in following capacities:

- .00025 Mfd—Correct for Myers Radio-Audion RAC-3
- .0001 " —For Special or Experimental Circuits
- .00025 " —Correct for Super-Hetrodyne & UV 201
- .0005 " —Correct for Radiotron UV 200

Condenser—Leak Mountings

- Bakelite Base with Single Mounting\$.49
- Bakelite Base with Double Mounting60
- Bakelite Base with Triple Mounting90

SHIP OWNERS RADIO SERVICE, Inc., DISTRIBUTORS

80 Washington St., New York

Interesting Proposition to Dealers

(Mfd. By EUROPEAN RADIO CO., 1342 East 22d St., Brooklyn, N. Y.)

THIS WILL BE A RADIO CHRISTMAS!

WHY BE SATISFIED
With Single Surface Crystals
CONTAINA SETTING
(Patent Pending)

Makes Maximum Sensitive Area Available
Awarded Evening Mail Certificate of Excellence
CURTIS G. CULIN
366 Broadway New York City

Gould

Radio "A" and "B" Batteries

Write for Dealer Plan
Gould Storage Battery Co.
30 East 42d St., New York City

STRAHS ALUMINUM CO.

announce their removal from 53
Grand Street to much larger premises.

New Address
48 FRANKLIN STREET
NEW YORK CITY

XMAS PRESENTS

FOR BOYS AND GIRLS

CRYSTAL SET

"The Little Wonder" \$1.75
Unassembled - Net

Catches distinctly everything broadcasted within 30 miles. We also manufacture the "Little Wonder" assembled set to retail at \$4.00.

GUARANTEED
TESTED CRYSTALS

Galena 7½c Radiosite 8½c

SEND FOR FREE CATALOG

It lists all our radio parts and supplies.

Holloway Elec. Supply Co., Inc.
238 Third Ave. New York City

Praco Panel Service

We offer to the amateur and dealer

REAL PANEL SERVICE.

Our panels are cut to your order. Only genuine Condensite and Formica used.

1 8" per square in. 2c
3/16" per square in. 2½c
1/4" per square in. 3c

We also carry a complete line of radio essentials. Dealers will find it profitable to have our latest price list and discount sheet.

PITTSBURGH RADIO
AND

APPLIANCE CO., Inc.

"Pittsburgh's Radio Shop"

Desk D

112 Diamond St., Pittsburgh, Pa.

Selling Points

How Champion Company Gains Confidence

A system of distributing and selling that will appeal both to the retailer and the ultimate consumer is the ideal to which all manufacturers should aim to gain both prestige and profit. Such is the ideal of the Champion Radio Company of Detroit, Michigan, to judge from some of the ideas embodied in their selling system.

On an order of 10,000 phones from this company, for instance, instead of the name "Champion Junior" being stamped on each head phone, the Champion company will stamp the name of the retailer. Thus the company tries to assist the retailer.

With the consideration in mind that there are many cheap phones being dumped on the market to-day, the Champion company realized in its early stages of radio manufacturing that the radio user must be reassured as to the quality of the goods he is buying. What better way of re-establishing his faith, then, the officials of the Detroit company argued, than by giving him a guarantee practically amounting to free repairs during the life of any equipment made by them?

This company knew that cheap phones demagnetize very quickly; they are not made to act otherwise. But so confident are the members of this company in the quality of their goods that their "Champion Juniors" are guaranteed for life against loss of magnetism. At any time they chance to become demagnetized through faulty manufacture or through practical use by the owner, the company will recharge the magnet base of the phones free of charge, the owner paying transportation charges both ways.

The Champion Junior phones are said by the manufacturers to be exceptionally clear-toned, with 50 per cent. less parts than the average run of head phones. Thus less trouble is claimed for the Champion than for any other set. The phones complete with headbands and cord weigh thirteen ounces.

Soldering of joints is a very important feature in the construction of phones, since to use a soldering flux containing an acid will cause corrosion as soon as dampness arises as a result of human perspiration. The Champion company phones have no acid in soldering flux used. The core post is also protected from corrosion of the copper wire used in the coils by a special paraffin base paper which protects both coil and core post against perspiration.

VOLIA

PRODUCTS

VARIOMO-COUPLER.....\$3.85 List
No taps, the only coupler with sharp primary tuning.

VARIOMETER.....\$3.25 List
Low distributed capacity, high range.

CRYSTAL SET.....\$8.50 List
Sharp tuning, triple range.

VACUUM TUBE SET....\$29.00 List
Two circuit tuner, employing Vario-Coupler. Only one tuning adjustment.

Write for Trade Discounts

VOLTA ENGINEERING CO.
172-4 Lorimer St. Brooklyn, N. Y.

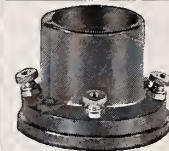

Na-ald

De Luxe

V. T. Socket

Contact strips of laminated Phosphor bronze press firmly against contact pins, regardless of variation in length. No open current trouble possible. Socket moulded from genuine Condensite. Practically unbreakable. Special protected slot, with exterior reinforcement. Unaffected by heat of bulbs or soldering iron. All excess metal eliminated, aiding reception. May be used for 5 Watt power tube. Highest quality throughout. Price 75c.

Special proposition to dealers and jobbers

ALDEN-NAPIER CO.
52 Willow St. Dept. H Springfield, Mass.

BEFORE you adopt a trade-mark

Have the Radio Dealer Trade-mark Bureau give you a report on its novelty based on registrations in the Patent Office AND IN THE RADIO DEALER TRADE-MARK BUREAU.

AFTER you have adopted a novel trade-mark

Register it at once in the

RADIO DEALER TRADE-MARK BUREAU

4907 Potomac Ave., N. W.
Washington, D. C.

THIS WILL BE A RADIO CHRISTMAS!

Thorophone

New High Powered Type of Loud Speaker

The Winkler-Reichmann Company, Chicago, listed among the pioneer manufacturers of loud speaking telephones, have brought out a new radio type of loud speaker which gives remarkable results. On account of its beautiful tone quality and great volume of tone on the ordinary receiving set, it is meeting with a most enthusiastic reception by radio engineers, set manufacturers and fans.

This high-powered Thorophone is made in two types, one with a horn, and another without horn, this latter type being arranged to lay in the phonograph. The artistic designs of these instruments are particularly appealing. In the phonograph type, the cost of the horn is of course eliminated, and it puts this high powered instrument, with its beautiful tone quality within the reach of the careful buyer at a very attractive price.

The Thorophone has a mica diaphragm set between rubber tubing, an amplifying lever with control features, while the electrical element is a powerful electro magnet with solenoid action, requiring external battery. The manufacturers claim that this combination of the most efficient of electrical elements with the phonograph type of sound box gives the perfect combination, beautiful tone with ample volume. Perfect tone reproduction makes for increased sales.

High ideals in radio reproduction deserve the well wishes and support of the radio public.

FADA HANDBOOK

The Fada Handbook of Radio-facts is a well compiled, neatly printed handbook, of 48 pages and cover, giving facts about Fada products. This booklet is thorough and practical, simplifying radio and offering helpful suggestions to the radio enthusiast who builds for efficiency in radio reception. Copies may be had upon request to Frank A. D. Andrea, 1581 Jerome Avenue, New York City.

HOME VACUUM SET

Designed to provide a vacuum set for the home at a moderate price, the Duntley Radio Receiver, got out by the W. O. Duntley Company with offices in New York and Chicago, is made to sell for \$45.

The Duntley is enclosed in an oak cabinet and the makers claim for it a wave-length range of 150 to 1,000 meters.

TWO FAST SELLING "REGAL" PRODUCTS

Write for Handsome New Catalog No. 10



INDUCTANCE SWITCH WITH KNOB AND DIAL
15 point switch complete in one unit. Requires but one hole to mount on panel. Smooth wiping contact over heads machined to same height on one piece contacts. Complete soldered assembly attached, or removed from panels by means of one threaded shaft bushing. Gives inductance regulation by dial contact.

\$2⁰⁰-



FILAMENT RHEOSTAT

Has full exposed resistance wire, giving critical adjustment so necessary to the efficient operation of a vacuum tube. Fine, smooth working control. Handsome knob, heat resistance base and highly nickel plated parts. \$1²⁵-
6 ohms resistance—2.2 amperes.

AMERICAN SPECIALTY MFG. CO., Bridgeport Conn.

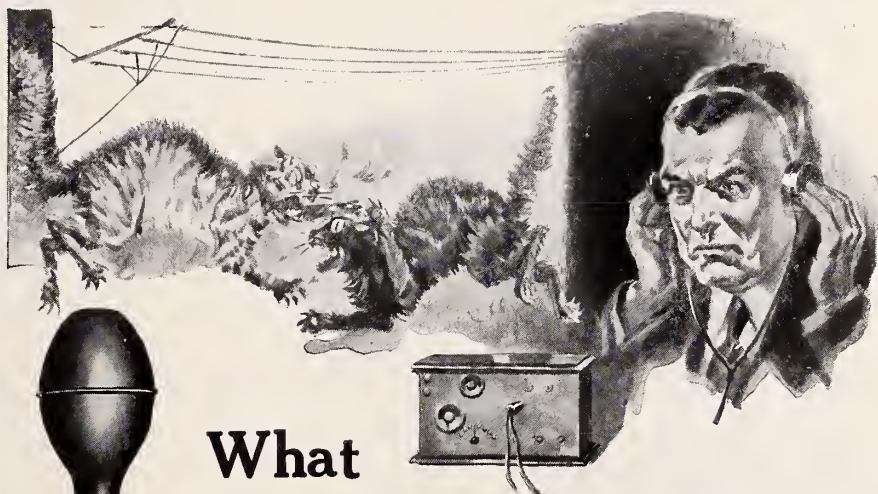

What Caused The "Catfight"

Many good radio outfits are condemned by the amateur because they do not receive clearly; because there is a "catfight" interference. "Static" should not be blamed for every receiving interference—it is often due to an unbalanced storage battery. Help your customers get good, smooth, clear messages by recommending that they test their batteries often with a *guaranteed*



This improved hydrometer readily retails for 75c; with a good profit margin for you. It is easy to read and accurate and scientific in construction. Rubber shield protects tube from easy breaking. Graduated for gravity reading—also simply and boldly marked to indicate if battery is empty, half-charged or full.

We have a good proposition ready for responsible jobbers and dealers—a sure winner. The Hafner Hydrometer is a high grade guaranteed instrument—priced to sell in a hurry.

We are forcefully telling over 2,250,000 consumers about the Hafner in the *Saturday Evening Post* every month. This means real sales for you.

Write us for Details and Prices.

HAFNER MANUFACTURING CO.
3130 Carroll Avenue Chicago, Ill.

THIS WILL BE A RADIO CHRISTMAS!

ROCKY MOUNTAIN CRYSTALS

Better Than Galena

The most sensitive mineral rectifier known. Can also be used with one or more stages of amplification.

Mounted 35c. Unmounted 20c. Postpaid

Manufacturers, Jobbers, Dealers, Clubs. Apply for Special Prices.

Rocky Mountain Radio Products, Inc. 9 Church Street, New York, N. Y.

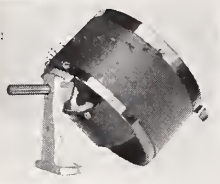

**Shamrock
180°**

**Vario
Coupler**

Retail Price
\$4.50

Both Tubes Are Made of

BAKELITE

Distributors, Jobber and Dealers Write for

ATTRACTIVE DISCOUNTS

SHAMROCK RADIO CO.

152 Sussex Ave., Dept. T, Newark, N. J.

T-B-H PHONES

Speak for Themselves
Pure Natural Tones, Light Weight
Ornamental Appearance

A Sturdy Reliable Head Set
That Will Sell and Stay Sold

Let us send a sample set for your
inspection

List **\$7.00**

Substantial Discounts to Jobbers and Dealers

T. B. H. CORPORATION

Dansville, N. Y., U. S. A.

"COPPERWELD"

TRADE MARK REG. U.S. PAT. OFF.

ANTENNA WIRE

50% stronger than either
solid or stranded copper

ELIMINATES SAGGING

Adopted by Largest Radio Manufacturers
100, 150, 200 ft. per Carton

**LEAD-IN and
GROUND WIRE**

has the Underwriters' O. K.

Rubber Insulated—Brown Braid

25, 50, 100 ft. per Carton

BUY IT IN CARTONS

with construction directions

COPPER CLAD STEEL COMPANY

New York Chicago

Braddock P. O., Rankin, Pa.

**Trade - Mark
Department**

Conducted by Chauncey P. Carter,
Trade-mark Specialist
of Washington, D. C.

Radio Trade-Marks Recently Accepted by the Patent Office

CHADBURN — Electrically-operated ships telegraphs—Chadburn (Ship) Telegraph Co., of America, Inc., Troy, N. Y. Jan. 1, 1885.

TELE-CALL — Electrically-operated code senders or transmitters of signals, used in automatic code signaling.—Mead Electric Signal Co., Cleveland, O. April 8, 1912.

ATLANTIC—Various radio apparatus—Atlantic Instrument Co., Inc., New York, N. Y. January 2, 1922.

LALLEY—On red and black disc - receiving sets.—Lalley Radio Corporation, Detroit, Mich. April 17, 1922.

BABY GRAND—Receiving sets.—Beaver Machine & Tool Co., Inc.—Newark, N. J. April 1, 1922.

AERIOLA GRAND — Various radio apparatus.—Westinghouse Electric & Mfg. Co., East Pittsburgh, Pa. December 23, 1921.

TRIANGLE—Receivers.—B. & C. Radio Mfg. Co., Boston, Mass. May 27, 1922.

RAD-O-PLUG — Condenser lighting circuit plugs.—Radio Products Corporation of Detroit, Mich. April 27, 1922.

BASCO—Various radio apparatus.—Briggs & Stratton Co., Milwaukee, Wis. June, 1922.

ALADDIN—Receiving sets and parts.—Phillip E. Edelman, New York, N. Y. December 22, 1921.

MAXOLOUD—Loud-speakers, receivers and reproducers.—Radio Improvement Co., Chicago. March 29, 1922.

HRC—Receiving sets and parts.—Heslar Radio Corp., Indianapolis. April, 1922.

JRH—Receiving sets and parts.—J. Roy Hunt, Inc., Long Island City. April 15, 1922.

MORADIO—Receiving sets and parts.—Morland Sales Corp., Newark, N. J. March 15, 1922.

OIDAR — Transmitters, receivers and parts.—Ludwig Hommel & Co., Pittsburgh. April 24, 1922.

AEROVOX—Receiving and sending sets and parts.—Radiola Wireless Corp., New York, N. Y. April 1, 1922.

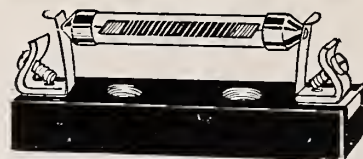

"PRECISION"

GRID LEAKS AND MOUNTINGS

Resistance Ranges from .25 Megohms to 5 Megohms. Accuracy Guaranteed

GRID LEAKS75c
MOUNTINGS50c

RADIOPHONE EQUIPMENT CO.

49 NEW STREET, NEWARK, N. J.

Maclite Vario-Coupler

Price \$5.00

Is, in the opinion of experts, the most efficient on the market.

All Other Maclite Parts are equally efficient, including the Maclite Variometer, Double Slide Tuner, Variable Condensers and Crystal Detectors. The Maclite Single Tube set at \$25.00 is the best buy we have ever seen. Let us tell you more about this set, also all other Maclite parts.

Dealers and Jobbers Write for Discounts

MACLITE RADIO CO.

701 Maclite Bldg., Clarendon St.
Boston, Mass.

It pays to advertise—ask our advertisers.

If you have something to sell the Radio Trade, fill in the blank below—an ad this size would only cost \$18.60 per issue on contract

ADVERTISING ORDER

THE RADIO DEALER,

1133 Broadway, New York City.

You may insert our advertisement, copy attached, in the next 12 issues of the RADIO DEALER, to occupy space of six inches, for which we agree to pay you at the rate of \$18.60 per issue.

(Signed)

(Address)

(City and State)

Minimum order, four inches

THIS WILL BE A RADIO CHRISTMAS!

SHRAMCO—Various radio apparatus.—Shotton Radio Mfg. Co., Albany, N. Y. August 1, 1919.

AMPLITONE—Antenna cable.—W. C. Shinn Mfg. Co., Niles, Mich. April 25, 1922.

ELMCO—Receiving sets and parts.—Electric Machine Corp., Indianapolis. April 25, 1922.

RADIANT—Couplers and jacks.—Heath Radio & Electric Mfg. Co., Newark. June 1, 1922.

Cole Condensers

Built on Best Engineering Design Properly

Cole variable condensers are the result of seventeen years of successful design and manufacture of radio apparatus combined with twenty years' experience in the manufacture and operation of electrical and mechanical apparatus.

A. B. Cole, of A. B. Cole, Inc., says:

"Long experience in the manufacture and use of condensers has shown that Condensite has all the qualifications for a first class condenser head, for it will not warp under any condition of heat or cold, it will not absorb moisture, it is mechanically strong and has very high insulating qualities. All our condenser heads are made of this material.

"Although heads made of fibre, shellac composition, or hard rubber are much less expensive, all these materials will warp and cause the plates to short circuit. In addition fibre absorbs moisture and causes leakage, shellac composition is very brittle and the heads are liable to break under ordinary handling and hard rubber loses its finish and you soon have a shabby looking condenser

"Metal heads depend on bushings for insulation and can not be made with a high enough degree of insulation for best results. They also have a capacity effect between the heads and plates which causes a non-uniform variation of capacity."

THORO-BRED CATALOGUE

The Marshall-Gerken Company, Toledo, Ohio, manufacturers of Thoro-bred products, have published an attractive catalogue of their products. In spite of the flood of untested, hastily constructed apparatus that has flooded the market this company maintains it has refused to sacrifice quality at any cost because they realize their success in the long run can never be secured without a reputation for high standards of manufacture.

A WARNING TO THE TRADE!

The popular line of EB Y Binding Posts known to the trade as MIDGET, CORPORAL, BUDDY, SERGEANT, SERGEANT "SS," SERGEANT "W," CAPTAIN, MAJOR and GENERAL, also COMMANDER "S" insulated post are all patented.

THE H. H. EB Y MANUFACTURING COMPANY as sole licensee under said patent hereby notifies and warns all manufacturers, jobbers, dealers or users not to make, sell or use infringing Binding Posts, and anyone so infringing either directly or as a contributory infringer will be vigorously prosecuted.

We therefore warn the trade not to buy imitations infringing such patent, and thereby avoid expensive patent litigation.

We are in better shape than ever to take care of your requirements for EB Y posts and in view of the outlook for big business during the coming Radio season, we cannot too strongly urge you to anticipate your orders.

THE H. H. EB Y MANUFACTURING CO., PHILADELPHIA, PA.

New "All-American" Completely Shielded Audio Frequency Amplifying Transformers

The cut shows our new method of shielding "All American" Audio Frequency Transformers, in a compact brass case, nickled and burnished.

The outward beauty of this line of transformer will greatly stimulate its sale.

This improvement in design will still further increase the leadership of the "All American" Transformers, which have already won the entire confidence of the leaders in the radio world.

Correct design, proper turn-ratio, effective shielding and the best of workmanship make "All American" Transformers very satisfactory to both dealer and user.

Our New R-21, can be used on as high as three stages without distortion or howling.

Send for Bulletin No. 22 and Liberal Discount Sheet.

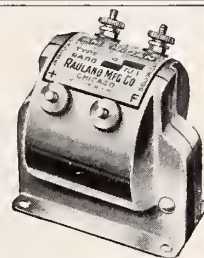

List Prices

Type R-12	\$4.50
Ratio 3-1	
Type R-13	\$4.75
Ratio 10-1	
Type R-21	\$4.75
Ratio 5-1	

RAULAND MFG. CO.
35 So. Dearborn St., Chicago, Ill.

Ask Our Service Bureau

RADIO PANELS

And other insulation for Wireless Work

BAKELITE-DILECTO

Grade XX Black was used by the Government during the war for this purpose. It is the

Standard of the World

THE CONTINENTAL FIBRE COMPANY

NEWARK, DEL.

New York, 233 Broadway
Pittsburgh, 301 Fifth Ave.
Los Angeles, 411 S. Main St.
Seattle, Wash., 1927 First Ave., South

Chicago, 332 S. Michigan Ave.
San Francisco, 75 Fremont St.
Rochester, N. Y., 85 Plymouth Ave., South

THIS WILL BE A RADIO CHRISTMAS!

THE KENTONE RADIO AMPLIFYING HORN



Made of brass, highly polished and nickel plated. Fifteen inches high, six inch bell

RETAILS FOR \$6.00

Write for particulars

F. C. KENT CO.

IRVINGTON NEW JERSEY



AEROVOX POCKET COMPANION

A Dealer Writes:—

"Your little pocket set is the best seller I have. Your panel design effect, the special crystal, the low price and the long range make selling it easy."

The set comes complete for operation.

Write for full description, discounts and our dealer co-operation feature.

BRADY
ELECTRIC MFG. CO.
PITTSBURGH, PENNA. U.S.A.
415 S. Highland Ave.

SENSORY CABINET UNITS

The variety of instruments used in radio permit of many combinations in hooking up the circuit. When these instruments are mounted on *one* panel and permanently interconnected for a particular circuit, it becomes very inconvenient to alter connections for some other scheme. In many cases a complete new panel is required. Realizing this situation, the Heine-mann Electric Company, of Philadelphia, have designed a line of units each with its own panel and cabinet, under the trade name of "Sensory" cabinet units. The different instruments are mounted in unit cabinets, and can be readily arranged for almost any style of hook-up desired. It is simply a matter of "ganging" the units, side by side, or in vertical gangs, or a combination of both methods, and making connections on the front to the binding posts, provided for such purpose. The assembly follows to a certain extent the well-known "sectional book case" scheme and looks equal to a continuous cabinet. There is also a decided advantage offered in that a few cabinet units can be purchased at the start to cover some simple hookup, and then added to, as the operator becomes more efficient, or desires a greater range or more sensitive installation.

The "Sensory" line of cabinet units includes variometer, variocoupler, variable condenser, detector, amplifier and other units. These units are furnished also without cabinets, as a panel unit, or completely unassembled. The "Sensory" line includes all standard parts and accessories sold separately.

A NEW DETECTOR

One of our readers advises us that he recently saw a new detector, for crystal receiving sets and having tried it out wants everyone to know about it. Says he:

"Better than any mineral; it is a reddish metal plate—a piece of pencil lead. It's a wonder."

Incidentally—our reader is an anonymous writer, signing himself "A Crystal Radio Fan."

MARING MAGNET WIRE

Magnet wires play an important part in the construction of wireless apparatus and far-sighted dealers carry stocks in hand to cover the demands for this staple. The Maring Wire Company, Muskegon, Michigan, have a good magnet wire and offer same on small spools for the amateur radio operator.

100% Radio

Altadena Radio Laboratory

560 E. Colorado Street
Pasadena, Calif.

Jobbers of All Standard Radio
Apparatus, including

Acme Apparatus Company
Adams-Morgan Company
American Hard Rubber Company
Automatic Electrical Devices Company
Nathaniel Baldwin, Inc.
Burgess Battery Company
Blank Radio Call Book
Edison Storage Battery Company
Everett Electric Corporation
Federal Telephone & Telegraph Company
General Radio Company
Colin B. Kennedy Company
Magnavox Company
Parkin Mfg. Company
Radio Corporation of America
Thordarson Electric Mfg. Company
Western Electric Company
Westinghouse Electric & Mfg. Company
Weston Electrical Instrument Company

PAUL FRANKLIN JOHNSON

Variable Condensers

SEMI-CIRCULAR TYPE

	List
43 Plate.....	\$3.75
23 Plate.....	3.00
11 Plate.....	2.75
3 Plate.....	1.50

BALANCE TYPE

.001 Mfd.....	\$5.50
.0005 Mfd.....	4.75
.0025 Mfd.....	4.00

SQUARE LAW TYPE

.0015 Mfd.....	\$6.50
.001 Mfd.....	5.50
.00075 Mfd.....	4.50
.0005 Mfd.....	3.50

Montrose Mfg. Co.

1200 Bedford Ave. Brookl'n, N. Y.

THIS WILL BE A RADIO CHRISTMAS!

Westphal Adapter

(Continued from page 68)

requires no extra attachments for the different phonographs. It will fit the Victrola, Columbia, Brunswick, Edison, Sonora, Pathe, Steger Aeolian-Vocalion Federal, Vitanola, Pooley Chorister, Standard, Electro-Phone, Mastertone, Silvertone, and as a matter of fact over 95 per cent of all phonographs and all radio head phones.

In connecting the radio to the phonograph only one of the head phones is used, the other being shorted with a piece of wire or solder. Two receivers conflict and neutralize each other. By actual test the Westphal Adapter with one receiver gives 50 per cent more volume. Another feature is that only a minute is required to change the phonograph from a record playing instrument to a radio loud speaker or vice versa.

At a list price of \$2.50 it will undoubtedly give the radio enthusiast a worthwhile addition to his outfit. This is a desirable feature in any radio dealer's store.

New Circuit Tuner

(Continued from page 68)

binding posts are provided on the back for adjusting the instrument to the particular type of antenna being used. Once this adjustment is determined, no further adjustment is necessary for broadcast reception. It is absolutely unaffected by body capacity at the dial knob. All insulating parts are sturdily made of moulded condensite, and the workmanship throughout is of the highest quality.

The manufacturers state that at their summer laboratory in Kennebunkport, Maine, using this tuner, in conjunction with a standard circuit and two stages of audio frequency amplification, broadcast concerts have been clearly received from Porto Rico, Davenport, Iowa; Chicago, and many other distant points.

The instrument can be used with a crystal detector and the crystal detector later discarded when a more pretentious set is desired.

TO OUR READERS

The RADIO DEALER has received a few communications extolling apparatus and quite a few condemning certain products. But as these letters are unsigned they cannot be used. Please attach your name and address to articles, not necessarily for publication, but as an evidence of good faith.

THE RADIO DEALER CO.



← THE SIGN OF GOOD SERVICE AND
GUARANTEED SATISFACTION

IMMEDIATE DELIVERIES ON:

CLAPP-EASTHAM	RADIO CORP. OF AMERICA
BALDWIN PHONES	MURDOCK APPARATUS
THORDARSON	DRAGON STORAGE BATTERIES
NOVO BATTERIES	FADA APPARATUS

And All Other Standard Lines

EXCEPTIONAL DEALER'S DISCOUNTS—WRITE AT ONCE

WILMINGTON ELECTRICAL SPECIALTY CO., Inc.
912 ORANGE STREET Dept. A-10 WILMINGTON, DEL.

This Letter Was Unsolicited

We are distributors for the complete "RADAK" line, made by Clapp-Eastham.

A. H. LAWFORD
292 Main St., Bar Harbor, Me.
VIRGINIA RADIO CORP.
Dear Sirs:

Our books show that your company was the first to deliver their order although your letter was mailed last of four different companies which I ordered my initial stock from and also you were the greater distance from this town. Therefore you may expect the full amount of my business from now on.

Respectfully yours,
AUTHOR H. LAWFORD.

LARGE STOCK



PROMPT SERVICE

VIRGINIA RADIO CORPORATION

Manufacturers—Jobbers
Charlottesville, Virginia

Ask Our Service Bureau

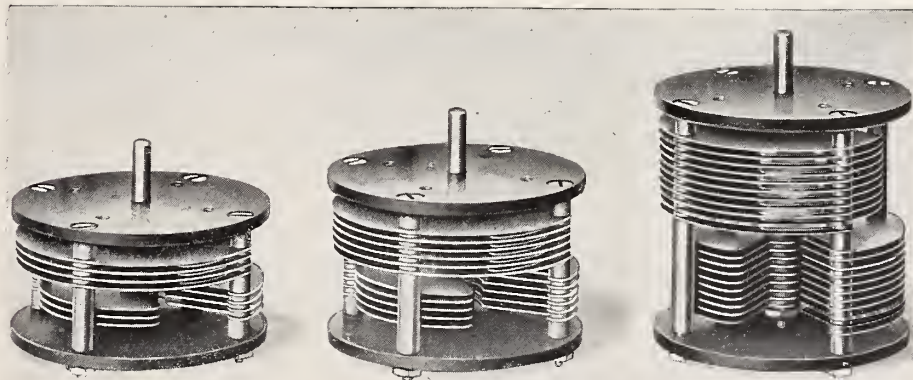

"Universal" Balanced Variable Condenser

All important mechanical and electrical features are embodied in the construction of the "Universal" Balanced Variable Condenser. The instrument is readily mounted on the back of panels and balanced. The "Universal" Balanced Variable Condenser is made in three sizes, as follows:

14 plates	—	.0003 M.F.	List Price, \$3.00
22 "	—	.0005 M.F.	" " 4.00
42 "	—	.001 M.F.	" " 5.00

Special discounts, according to quantity.

All condensers are guaranteed as to workmanship and material and tested before leaving factory.

Universal Stamping & Mfg. Co.
1925 South Western Ave., Chicago, Ill.

THIS WILL BE A RADIO CHRISTMAS!

SOCKET-RHEOSTAT

Registered U. S. Patent Office

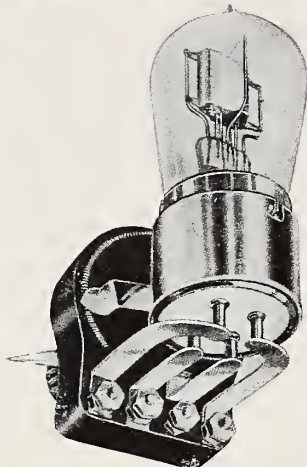

Type A-5 ohms, suitable for
detector bulb **\$2.00**
Type B-2 ohms, suitable for
power bulb
TWO IN ONE. A socket and rheostat
so combined as to form a single unit.

No more unnecessary leads between
socket and rheostat. Just connect your
leads to the four posts marked P-F-F-G
and you are hooked up as far as the
SOCKET-RHEOSTAT is concerned.

MANUFACTURED BY

Ajax Radio Corporation

Telephone: Bigelow 4097
538 SOUTH 10th STREET
NEWARK, N. J.

**Possibilities of Work
for Association***(Continued from page 59)*

any other of the evils that have slack-
ened demand in some sections.

The need for more and better pub-
licity for the newspapers and maga-
zines of the country that are anxious
to carry real accurate and reliable in-
formation on radio subjects points
the way for one of the most impor-
tant committees of the association,
that on publicity.

A report on the possibilities for
good for this committee follows:

**REPORT ON PUBLICITY NEEDS OF
THE RADIO TRADE**

The publicity committee of the Radio
Trade Association can do a great deal for
the industry at large by aiding the daily
press in securing sufficient and proper
reading matter of eternal interest for their
radio sections, as well as the mere hand-
ling of publicity about the association
with the idea of advertising the activities
of the organization.

The services of THE RADIO DEALER have
been offered the association for the prepa-

ration of publicity matter and its dissemi-
nation. Until the committee is able to
make preparations for paid work of this
kind, or until the employment of a paid
secretary there will be no charge for any
assistance given in this matter.

The matter of a national advertising
campaign for the association and radio in
general has been carefully considered and
the present conclusion seems to be that
there is no definite need for such a cam-
paign. The past experience of other or-
ganizations in the matter of national
co-operative advertising campaign shows
that only a very small percentage of these
campaigns are profitable.

It has been suggested, however, that
special efforts might be taken to arrange
for a central service of prepared adver-
tising for members, the illustrations and
copy layouts being furnished at a nominal
cost. This plan could be handled through
some of the companies in this field, who no
doubt will be very glad to make special
prices to members of the association who
wish to advertise in local newspapers and
who do not care to go to the expense of
having special illustrations and cuts made
up for their own use exclusively.

The matter of the publication of an as-
sociation organ, published by and for the
association was referred to a committee of
advertising men who regard the proposi-
tion with disfavor. A recent campaign
conducted by *Printers' Ink*, a well-known
publication in the advertising field, points
out that very few associations make any
profit on similar organs, and that adver-
tisers as a rule consider space used in such
organs more as a donation, and do not re-
ceive fair returns for the money invested.
—R. C. C.

The manufacturer and large dis-
tributor is considerably worried by the
multiplicity of radio shows that are
being announced every week or so.
These firms realize the advantage and
possibilities for good of real shows,
but are hard put to choose and pick be-
tween the various shows announced
for various dates.

Radio PLAN-O-PHONE

Loud Speaker \$3.50

The Plan-O-
Phone is the
most amazing value of
any Radio Loud
Speaker, on the mar-
ket. Remarkable

acoustics. Used with any 2 stage ampli-
fied receiving set. Fits any receiver.
Made of statuary bronze—handsome,
durable. Dealers: Write for special
proposition.

PLANET RADIO CORPORATION
1223 S. Wabash Ave., Dept. F2, Chicago, Ill.

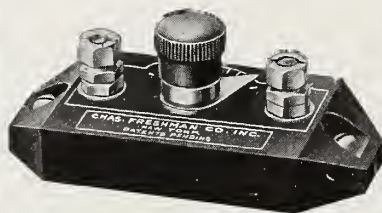
New Radio Inventions*Be sure to get the latest—*

**Combined Variable
Grid Leak and
Micon - Condenser**

Price \$1.00

Unbroken range from zero to
5 megohms—all intermediate
points. Fixed capacity .00025
M. F. Will improve your set
wonderfully.

Clarifies Your Signals
Lowers Filament Current
Increases Battery Life
Eliminates Hissing

Write for Terms and Discounts

CHAS. FRESHMAN CO., Inc.
97 Beekman Street, New York
Home of Micon and Antenella

RADIO DEALERS*We Are Manufacturers of***F. M. C.****Audio Amplifying Transformers****Radio Frequency****Mica Condensers****Sensitive Crystals***Dealers and Jobbers Write Us for Proposition***IMMEDIATE DELIVERY****Ford Mica Co., Inc.****14 Christopher St.****New York****THIS WILL BE A RADIO CHRISTMAS!**

The manufacturers of the country wish to lend their support to real shows and very likely will find the committee on shows and expositions of this association of great value to them.

The report follows:

*REPORT ON THE MATTER OF
SHOWS AND EXPOSITIONS*

As long as the present flood of shows open to the general public continues there seems to be no definite need for a national show for dealers only, although no doubt this need will come up at some future date.

For the present it seems the safe thing for the association to refuse its official endorsement to all shows of every character in the radio field, as no material good can come to the association by such endorsement, while considerable damage may be done to the association's reputation were official endorsement given to irresponsible promoters.

It would be unwise, however, for the association to take definite stand against any show unless the entire proposition be so ill-managed and so grossly poor as to require a warning to the trade. Radio shows serve a definite purpose and will be a great benefit to the industry and for such reasons should be encouraged. Every effort to bring radio into the eyes of the public should be praised, and aided, but it is unfair for promoters of shows or publishers of magazines or newspapers to ask the association to pass official endorsement for their schemes.

Should the occasion arise for a national dealers' show at the national meetings of the association it is felt that the management of these shows should be handled by the association as their success will not depend on paid admissions but rather on there being a large attendance at the meeting with a large number of exhibitors at the show.—B. J. F.

Considerable talk has been aroused over the matter of large quantities of inferior apparatus being thrown on the market due to failures, etc. The possibilities of the association establishing a clearing house for this apparatus which can pick between the poor apparatus that should not be offered the public and the good merchandise that is being held by firms pressed for cash. In the latter case it might be possible for the association members to relieve the market and at the same time aid the buying public by giving them a chance to buy superior merchandise at very reasonable prices. This matter is being carefully investigated and detailed reports will be made to the association at an early date.

The continued offering of standard merchandise at cut prices reduced public confidence in the articles so advertised. Manufacturers in the industry realize this better, perhaps, than the dealers, and it is believed that the trade will find the manufacturers ready to co-operate and aid the committee on price cutting in every way possible. Manufacturers who are

(Continued on page 120)

Dealers who want strictly high class quality
Radio Sets and Equipment,
we can serve you.

Distributors: General Radio Corp., King Quality,
Dubilier Condenser and Radio Corporation,
De Witt - La France Co. *All Guaranteed Lines.*

INVINCIBLE PRODUCTS CO., Inc.

159 N. State St.

Phone: Dearborn 2638

Chicago, Ill.

PRAMCO DUO - TECTOR

A Pramco
Duo - Tector
will outsell
any \$1.00
Crystal De-
tector on the
market.

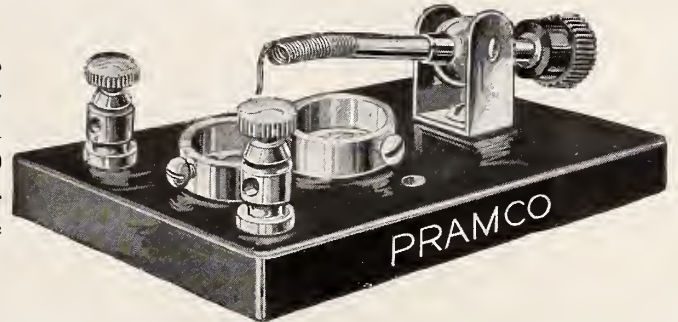

The two-cup arrangement allows a quick change from one crystal to another with very little interruption. It offers an opportunity to determine the relative value of different minerals under the same conditions.

All Metal Parts Standard Pramco Hand Polished and Plated

List \$1.00

LIBERAL DEALER AND JOBBER DISCOUNT

PREMIER RADIO MFG. CO.

1900 No. 6th St., Phila., Pa.

WALD ELECTRIC COMPANY

Manufacturers

"MICROSTAT"

A Vernier Throughout Its Range

7 Ohms
2 Amperes

Indispensable for New Armstrong-Super-Regenerative Circuit, will eliminate noises usually mistaken for static

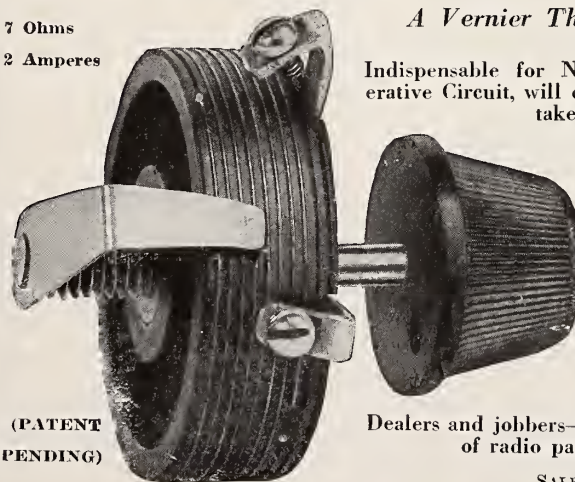

STEPLESS
FILAMENT
CONTROL

List Price

\$1.50

An Instrument of Merit

(PATENT
PENDING)

Dealers and jobbers—Write for discounts and list of radio parts we manufacture

SALES DEPARTMENT

LOUIS A. STAFF COMPANY

1755 Broadway

New York

THIS WILL BE A RADIO CHRISTMAS!

VARIO COUPLER

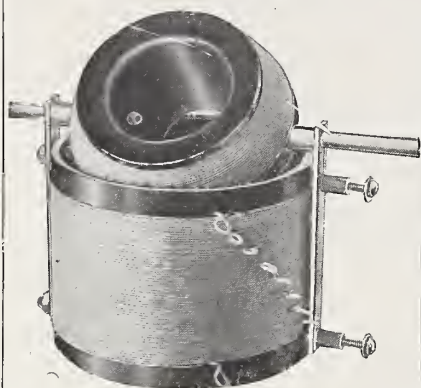

List Price . . \$3.50

Dealers and Jobbers
Write for Particulars

Nelson Radio Parts Co.

89 Academy Street
Newark, N. J.

TRADE **HPMCO** MARK

Reg. U. S. Patent Office

Molded fixed Condensers are best by test. The newcomers to radio invariably want this type. Experienced amateurs demand them as the molding process.

**No. 20
Fixed Condenser
70c.**

insures permanent capacity.

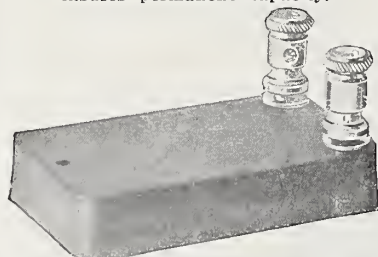

Duplex Binding Post Clips are just what your customers demand when using two pairs of headsets. 5c each. Each Clip adds two extra connections.

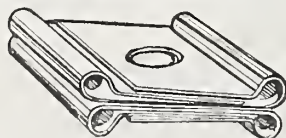

Write for Our Liberal Discounts.

HEDDEN PLACE MACHINE CO.
44 HEDDEN PLACE
EAST ORANGE, N. J.

Efficient Operation of Detector Tubes

(Continued from page 53)

put a detector tube in an amplifier circuit, nor in any circuit where the "B" battery is apt to be too high. Should it be done for a short time, the tube will usually require a different plate voltage for good detection.

The next tube we are interested in is the VT-1, which is of the "hard" type. It makes a good detector or amplifier for ordinary work and is used extensively in this universal capacity in army and navy radio equipment. It is very stable, easily adjusted and quite sensitive as a detector, although not as good for distant signals as is the "soft" tube. It works satisfactorily on any voltage between 18 and 45 for the plate, and will not "ionize" until about 100 volts. The normal filament temperature is a dull red glow, hardly noticeable in daylight, due to its special type of coated filament which works at a low temperature. The current should be about 1.1 amperes for good detection and this can be obtained on a 4-volt storage battery.

In some cases amplifier or "hard" tubes make better detectors than "soft" tubes, especially if receiving very near stations or when the circuit is not adjusted for the "soft" tubes. But, where distance work and efficiency are desired, a good "soft" tube is always preferable.

The Radiotron UV-201 is in the same class as the VT-1, except, having a tungsten filament, it requires a 6-volt battery for a filament current of between nine-tenths, and one and one-tenth amperes as does the UV-200.

There is one thing that must be adjusted when a "hard" tube is used as a detector and that is grid leak resistance. The "harder" the tube is the lower the resistance must be. For VT-1's or UV-201's it should be about 1 megohm (1 million ohms) or even ½ megohm, (assuming an average of .0005 microfarad grid condenser). The "soft" detectors require a higher value of 2 to 4 megohms or may even work without one. If the leak is too high for the tube used a slow "putt, putt, putt," will be heard in the phones with certain adjustments, and will render the tube inoperative to signals.

The last tube we have to discuss is the 1½-volt "dry cell" tube, which is growing rapidly in popularity because of its efficiency, low upkeep cost and sensitiveness. This tube, the WD-11, is a very satisfactory detector as may be determined from users of the

RADIO CONCERTS CORACO

America's Greatest Radio Receiver
No Inside or Outside Connections
GOTHAM THEATRE BUILDING
Broadway at 138th Street

GANAERITE Detector Crystals

Twenty years of practical mineralogy gave us the material to produce the highest quality crystal.

We are now undertaking the largest single order for mounted crystals in the market.

We individually test and guarantee to replace or refund on any unsatisfactory Ganaerite crystal.

The Harris Laboratory
26 Cortlandt St., New York City

"IDEAL" 180° Variocoupler

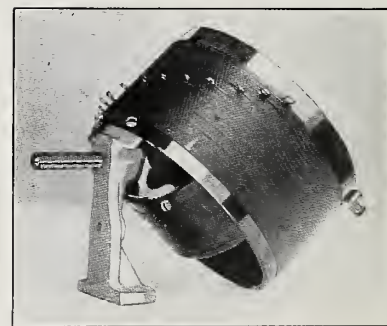

List Price \$4.50

Write for discounts

Secondary and primary wound on pure Bakelite Dilecto Tubing. Silk covered wire used throughout. Wave length 150 to 600 meters.

IDEAL SWITCH LEVERS

With the "mirror-like" knobs. Genuine Thermoplas Knobs used on our levers. Highly blue-nickel levers. Made in two sizes—Junior 1" radius. List 35c. Senior, 1½" and 1¾" radius. List 50c.

Send for samples and discounts.

NEWARK RADIO SUPPLY CO.

Manufacturers and Distributors "IDEAL"
Radio Supplies and Equipment.

284 Market St., Newark, N. J.

THIS WILL BE A RADIO CHRISTMAS!

"Aeriola Sr." It is of the "soft" type, although not as critical to plate voltage as the UV-200. It has an oxide coated filament of about the same type as the VT-1, although much smaller. It is quite stable in operation when the grid leak resistance is from one to two megohms. The operating filament current is about 0.3 ampere, which may be obtained on one dry cell, and the plate voltage can be from 22½ to 45 volts, with perfect results. Above this point the older type WD-11 would blue-haze and deteriorate rapidly, but the new WD-11's are quite satisfactory up to about 90 volts. They, therefore, make good amplifiers, but with limitations, which will be discussed in our next article of the series. We shall also take up several other types of voltage amplifier tubes.

NEW ESSEX CATALOG

A new loose-leaf catalog with printing on but one side of the pages which present a pleasing and unique appearance has been distributed to the trade by the Essex Manufacturing Co., 117 Mulberry Street, Newark, N. J. In it are illustrated and described the extensive line of radio parts and equipment that are made by the company which has been engaged in the electrical manufacturing business for many years and prides itself on the quality of the products it turns out.

While the Essex line is featured, consisting as it does of double slide tuning coils, inductance switches, an improved type of lightning arrester, bank wound variometers and couplers, rotors, panels, jacks and parts; other apparatus is shown such as condensers, detectors, receiving and transmitting sets, amplifier transformers, sockets, plugs, rheostats, potentiometers, controls, audiphones, radiophone adapter, batteries and other equipment and parts. In the back of the catalog is a list of parts with prices under the heading of "Build Your Own."

FRANKLIN SOCKET

The Franklin socket has just been placed on the market by the Franklin Radio Manufacturing Co., 711 Penn Avenue, Wilkesburg, Pa. This appliance which is intended to hold the WD-11 dry cell tube firmly and make perfect contact, retails at fifty cents. This socket should be appreciated by those who consider the convenience of the dry cell tube over those requiring a storage battery, and now that a socket can be readily obtained for the tube, an opportunity is offered to those who have crystal sets, to change over to audion sets for small expense.

LITTLE GIANT SET

The Little Giant receiving set is housed in a neat little American walnut cabinet about 4 by 3 by 6 inches deep, that you could hold in your hand and when opened up, discloses a crystal set of entirely new design, labelled with the trademark "Little Giant," and manufactured by the Metropolitan Radio Corporation, 67-71 Goble Street, Newark, N. J. Instead of the awkward, imperfect tuning coil, all that one has to do to time this set, is to pull out the rod until the signals are sharp and clear and then stop. A

little switch on the Bakelite panel board grounds any static or interference. The crystal detector maintains its adjustment almost indefinitely.

A set like this which includes a pair of Metro head phones might easily sell for a high price, yet this entire set can be had for only \$14.00.

When the Metropolitan people put the "Little Giant" into special holly boxes for the holidays, added aerial wire, ground wire and ground clamps all for \$15.00, the demand kept their plant working to full capacity, but increased production facilities allows for filling all orders.

CONDENSERS—GUARANTEED—TESTED— PERFECT

Your orders must be placed now—No waiting

43 Plate .0011	\$1.35 net
21 Plate .000590 net
11 Plate .0002572 net
3 Plate Vernier54 net

Fixed—Phone—Grid—Grid Leak, .05½ each net

To facilitate matters we have prepared set of samples of above at \$3.75, sent upon receipt of cash or money order only

DUKE RADIO CO., 1758 Bergen St., Brooklyn, N. Y.

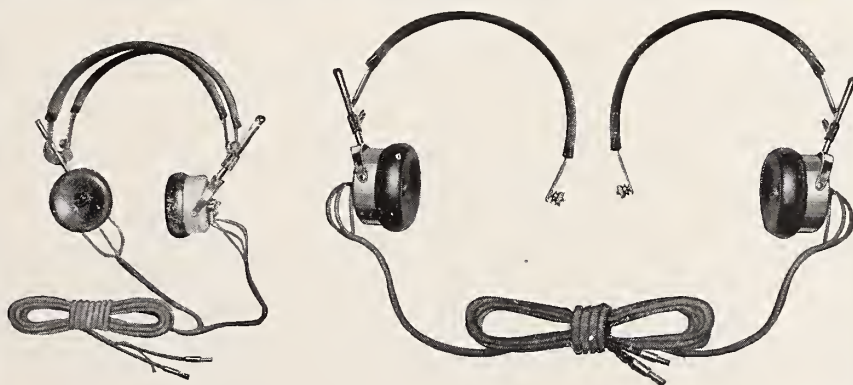

The Band Splits Into Two Parts. Each Having an Overhead Strip, Is Very Convenient for Two Persons

Premier Duplex

PATENTS APPLIED FOR
Phones

2000 Ohms \$6.50

3000 Ohms \$8.00

Discount to Dealers

PREMIER ACCESSORY & SPECIALTY CORP.

27 CONGRESS STREET

NEWARK, N. J.

THIS WILL BE A RADIO CHRISTMAS!

Possibilities of Work for Association

(Continued from page 117)

careful merchandisers will restrain from overloading any particular market with their goods, tending rather to sell the reliable jobbers and dealers only, restricting their sales to the better channels of the trade where the reputation of the goods will be upheld.

It is thought that the association, by bringing the manufacturers and dealers in closer touch will serve to identify the better class manufacturers in the eyes of the dealers with resulting profit and betterment for both. Several leading merchandising men in the industry are making a close study of the situation today with the view of making recommendations to the association as to how and when conditions can be bettered through the organization. This report will be transmitted to the membership at an early date.

There has been considerable talk among the membership about calling local meetings for the association to give the members opportunity of availing themselves of the power of the association. Present plans point to several sectional meetings.

The association has as its object close co-operation with sectional associations of retailers or manufacturers, believing that two strong bodies can work better when there is fuller understanding between them. Assurances of support and aid in any campaign for the betterment of the industry have been given by several of the local associations while there is no doubt that others will join the national body in any movement of national import.

The membership committee of the association is already hard at work and it is believed that in a short time the association will boast a membership that will compare favorably with any other national association representing another and older industry.

Headquarters of the association will remain at 1133 Broadway, New York City, until after the national meeting.

HOME RADIOPHONE

The Home radiophone receiver has been designed and built primarily for radiophone reception up to 1,450 meter wave length which the Army Signal Corps uses in transmission. It is said to be a quality plus instrument of high electrical efficiency, is well made of the best materials and is simple in operation as it has only three movable parts. The Home is manufactured by the Arrow Radio Company, Hackensack, N. J., and retails at \$35.

MUSIO New Radio Discovery

\$12.50

Retail



Perfection

Clarity

Range

Beauty

Improved, Perfected Crystal Detector
Sensation of Radio World.

Includes complete antenna equipment
Immediate Deliveries

Order your samples NOW

DISTRIBUTORS

American Electro Phone Company, Inc.
NEW YORK

512 Fifth Avenue

Longacre 3552

*Write us for attractive discounts on our complete
line of first class radio sets and accessories*

National Radio Week December 23 - 30

"If a man can write a better book, preach a better sermon, or make a better mouse trap than his neighbor, though he build his house in the woods, the world will make a beaten path to his door."—EMERSON.

We have organized a better service to the retailer, "CSE" Service,—and the trade is making a path to our door. Why not join in and let us help you to larger radio business.

"CSE" Service is controlled by men of many years' experience in radio merchandising whose experience is at your service without additional cost.

To the trade in the Central States, we can offer the most comprehensive service—Engineering—Sales—Merchandising—of any organization. It will pay you to get in line with "CSE."

Central States Engineering Company

224 No. Halsted Street

Chicago, Illinois

THIS WILL BE A RADIO CHRISTMAS!

King Symbol Used

(Continued from page 60)

of King Quality, which means perfection in design, material and workmanship.

One of the primary steps in the establishment of the King Sewing Machine Company radio apparatus division, was the addition to their manufacturing facilities of a complete modern bakelite plant. Their facilities for bakelite moulding are unlimited, and production methods of bakelite are to the highest point of efficiency. This efficiency was established by a bakelite engineer, C. E. Leffel, who for the past ten years has been very active in bakelite moulding. Mr. Leffel operated one of the first customs moulding bakelite plants in America. Through this experience, they have been able to produce bakelite parts of the highest quality and finish.

"Our one thought," says a King man, "in radio has been to manufacture something better. This thought has been accomplished on the following: dials, sockets, rheostats, binding posts, contact points, switch levers and condensers.

"We are at present in production on these parts, and the jobbers who have carried our line so far, have expressed entire satisfaction in their sales.

"We fully realize that the public is becoming more and more enthused and educated on radio phone reception, and are now demanding apparatus of quality and extreme merit. It is this fact that constantly concentrates in our manufacture."

It is obvious that a house of this sort is the right sort of a house—the kind that will become factors in the growing radio industry.

G-W UNMOUNTED COILS

After the flood of unknown, unadvertised, untrade-marked coils of more or less doubtful quality that have been offered to the public, the announcement of an unmounted coil bearing the trade-mark "G-W" is welcome. This is exactly the same coil as is used in the G-W 2 slide tuning coil, and is made of No. 20 Beldon enameled wire very tightly wound on a card board tube, and impregnated with a high dielectric insulating material.

The G-W line, led by the popular G-W slider, and now containing slider rods, detectors, 2 slide tuning coils and aerial insulator, has the reputation of making good on all claims of quality. The manufacturers, Gehman & Weinert, 42 Walnut Street, Newark, N. J. promise other products for the line as soon as they are perfected.

EBY BINDING POSTS

The slogan of the H. H. Eby Manufacturing Company of Philadelphia, Pa., the well-known manufacturers of

manufacture, including the Commander H, the Ensign H, the Sergeant SS, the Buddy, the Captain, the Commander S, the Corporal, the Junior H, the Ace and the Midget. Arrange-



binding posts is: "Use Eby posts and forget your binding post troubles." The accompanying illustration shows some of the types of posts that they

have been made with responsible jobbers in all parts of the country to carry complete stocks of the Eby binding posts.

MANUFACTURERS!

DEALERS!

RADIO PANELS

of Genuine XX Grade Black

BAKELITE — DILECTO

Cut to Any Size

and Drilled to Your Specifications if Desired

STANDARD RADIO PARTS CO.

30 Church Street, Room 2013 (Phone Cortlandt 2515) New York

NOT LIKE RIP VAN WINKLE

Trade
"VAC-SHIELD"
Mark



Patent Pend.
Price, \$1.00

We were awake to the possibilities for improvement in RADIO and now announce a new invention "THE VAC-SHIELD," the only device of its kind that has been put on the market since Radio became popular.

A Non-Magnetic Shield for Detector and amplifying tubes, which prevents stray capacity affects between tubes, cuts out howling, guards the Tube Against Breakage and makes reception worth while.

See our Advertisements in the Radio News. Now is your chance to get in line for something new in Radio and stimulate your sales. Distributors Wanted. Attractive Discounts.

Paramount Electrical Supply Co.

132 Church St., New York

Distributors for New York City

Orange Research Laboratories

Manufacturers

41 North 16th St., East Orange, N. J.

THIS WILL BE A RADIO CHRISTMAS!

RACONY PLUG

Genuine **\$3.00** Made to
Mica Dielectric Stand 2500 Volts
4 Outlet Plug with 14 Combinations
THE RACONY CORP.
799 Broadway New York City

YOU SHOULD KNOW ABOUT OUR



THE MILLS RADIO & ELECTRIC CO.
INCORPORATED
1008 Springfield Ave. Irvington, N. J.

Ask Our Service Bureau

A Nimble "Dollar-Seller"

The "Chaslyn" Sink-or-Swim Ball Battery Testing Outfit

Thirty thousand sold the first three months with practically no advertising. Our national advertising will multiply sales. Set consists of

1. Battery Tester, with 3 balls of different colors and weights. The way they sink or swim shows condition of acid instantly.
2. Depth Gauge for determining depth of acid.
3. Air-Controlled Bottle Stopper for adding distilled water.

Price of Set \$1.00
Special Offer to Dealers
Write on your business stationery, enclose one dollar for TWO of the above sets. This is below wholesale price. Only two Sets sold to each dealer at this price.

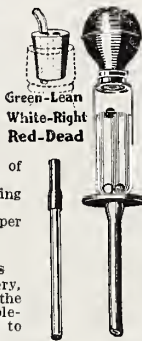

The Chaslyn Company, 4323 Kenmore Ave., Chicago

QUALITY-PLUS INSTRUMENTS

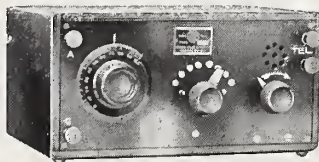

Types 711; 711A

THE

HOME Radiophone Receiver

Single Tube Set

Type 711, Wave length 150-2600 meters \$35

Type 711A, Wave length 150-800 meters \$28

Awarded Certificate of Excellence

Dealers! Jobbers! Distributors!
See Our Exhibit at the Radio Fair
Hotel Imperial, New York City

ARROW RADIO CO.

Manufacturers of Quality Plus Instruments

Hackensack New Jersey

Vacuum Tube Detector Uses Dry Battery

Newark Sunday Call Shows Latest Development in Tube Set

By H. E. BENNETT

Newark, N. J., retailers and radio men generally are interested in the set on display at the *Sunday Call* radio department for the past few weeks. Some retailers are already profiting by this display—as they're offering the various "parts" for sale.

This set was constructed by C. S. Ingraham, of Newark, N. J., and consists of a regenerative receiver, detector, and two-step amplifier.

From all appearances the dry cell tube as a detector is now in radio society.

For the past few weeks the single dry cell has given an hourly service of over twenty-six hours, operating all three tubes to full capacity.

Not only is the circuit very sensitive on long distance stations but it tunes sharply and regenerates all over the entire wave length scale, from 150 meters to 800 meters.

This set, tested on a phonograph horn and victrola cabinet, gives ample volume. In some cases distant stations have come in strong enough to be successfully reproduced upon the phonograph.

An examination of the set shows in detail the complete outlay for the regenerative receiving set and detector with two-step amplifier.

No parts other than the apparatus required for the building of an ordinary set with a two-step amplifier are necessary.

One or two little improvements have been added to the circuit, such as a grid leak across each transformer secondary, which aids greatly in the clarification of music and voices.

Note is made of the .002 fixed condenser inserted across the primary terminals of the first step amplifying transformer, as this condenser assists greatly in making the set oscillate over its entire range of 150 to 800 meters.

Telephone jacks have been included in the set. A "C" battery of 4½ volts is shown in the grid circuit of the third tube.

The circuit is regenerative and covers a wave length of 150 to 800 meters, depending upon the length of the aerial. Westinghouse aeration tubes are used and these tubes act as both detectors and amplifiers.

One dry cell is employed for all three tubes, but if the owner desires to operate the set continuously over



Radiphono Adapter - \$3.00

Add quality of tone and volume to your radio concerts

Designed for Edison, Victrola, Brunswick and other makes of phonographs. With this adapter you can eliminate distorted and metallic sounds and improve your receiving. This is a real adapter built along proper lines of a reproducing musical instrument. It gives better results than self-contained, expensive amplifying loud speakers.

Jobbers Dealers Ask
Communicate Your Jobber

Manufactured by

Industrial Sales Engineering Co.
671 BROAD ST., NEWARK, N. J.

TUNING COILS

Cross Weave Tuning Coils the heart of a receiving set just the coils for bringing in the Radiophone Broadcasting stations 180-500 Meters. Price \$1.25 each, or set of three coils Primary, Secondary and Ticker Coils, \$3.50 per set with circuit diagram.

CONDENSERS

Phone and Grid built of the best material obtainable. Price \$1.00 each.

MOTOR-GENERATOR SET

250 Volt DC 175 Watt Generator and 110 Volt AC 60 Cycle (Any Cycle) Motor. The best there is. Price \$78.00 complete.

AERIPHONE

The wireless telephones. Price \$35.00 to \$300.00.

PANELS

Treated with a special process made by us. Will not Warp or Shrink and is not affected by Temperature changes. Waterproof and possesses High Dielectric properties. Easily machined and will not Crack or BREAK. Looks as good as Bakelite. We are prepared to ship promptly the following sizes:

6" x 6"	x ¼"	thick	\$60
6" x 7"	x ¼"	thick75
6" x 10½"	x ¼"	thick	1.00
6" x 12"	x ¼"	thick	1.25
9" x 12"	x ¼"	thick	1.50
9" x 14"	x ¼"	thick	1.75
12" x 14"	x ¼"	thick	2.20
12" x 21"	x ¼"	thick	3.00

Strips 3½ x 6; 3½ x 8, \$40 each; 3½ x 10, 3½ x 12, \$60 each; 3½ x 18; \$75 each. Add postage for 1 lb. for Panels up to 6 x 12 x ¼; and 2 lbs. for larger sizes. We will be pleased to quote prices on these panels cut to a different size on receipt of your specifications. NO FREE SAMPLES.

NATIONAL RADIO CO.
MARSHALL, MINN.

THIS WILL BE A RADIO CHRISTMAS!

long periods, it is advisable to place three dry cells in multiples, not in series.

In order to connect three dry cells in multiple, the following plan must be followed out.

Connect the three center poles of the battery together. The outside or zinc poles must then be connected together, and leads taken just as if one cell were used.

In this matter the potential of one and one-half volts will remain constant, but there will be three times as much current available for the operation of the three tubes, thereby prolonging the life of the batteries. The center poles of the battery are the positive and the outside the negative.

Following is guide to the parts used in the circuits:

1. Primary of variocoupler, 75 turns No. 22 wire, tapped.
2. Secondary, or rotor of variocoupler, 44 turns No. 24 wire.
3. 23 plate variable condenser.
4. Grid condenser and grid leak.
5. Detector tube.
6. Plate variometer.
7. Federal amplifying transformer.
8. $\frac{1}{2}$ megohm grid leak.
9. Amplifier tube.
10. Telephone jack.
11. Amplifying transformer.
12. $4\frac{1}{2}$ volt "C" battery (flash-light cells).
13. Amplifier tube.
14. Single-way jack.
15. Ground.
16. .002 fixed condenser.
17. Rheostat.
18. One megohm grid leak.
19. Rheostat.
20. Dry cell.
21. B batteries.

The *Sunday Call* printed a diagram of this interesting dry-cell tube set in a recent issue, and a copy can be had—we feel certain—upon request to the genial Radio Editor, McNeary, the man who made the Man in the Moon popular.

BODINE MOTORS

The Bodine Electric Company, Chicago, Ill., is distributing a very attractive catalogue showing the application of fractional horse-power motors. It has been compiled for the convenience of manufacturers who desire to get the greatest possible efficiency in operating their machines and devices by electricity. Pictures of many devices operated by Bodine motors are shown. A chapter is devoted to the various types of motors in general use which gives the manufacturer a good idea as to what type motor is best adapted to his purpose.

Binding Posts—Contact Points Knock-down Detector Sets



VARIABLE CONDENSERS

with patented adjustable tension



JOHN A. COZZONE & CO.

61 Arlington Street

Newark, N. J.

ASK OUR SERVICE BUREAU

MICHIGAN



"Senior" Receiver

Equipment

The equipment of the Michigan Senior Receiver consists of tuner, detector and two stages of amplification. Wave length 150-650 meters. Cabinet richly finished in brown mahogany, representing the highest standard of Grand Rapids cabinet work. Size 18 $\frac{1}{4}$ " wide, 11 $\frac{3}{8}$ " high and 7 $\frac{1}{2}$ " deep. Weight, approximately 20 pounds.

Vernier dial adjuster.

Filament control jacks.

Molded variometer wound with special green silk magnet wire.

Binding posts located on rear sub-panel, not inside.

Michigan Vernier rheostat for detector tube control.

Michigan filament rheostats for amplifier tube controls.

Radiation hard rubber panel (shield over entire panel) on which are mounted all instruments, including rear sub-panel. This arrangement permits immediate accessibility to all instruments and wiring by removing four front panel screws.

The ease of operation and the wonderful performance of the Michigan "Senior" Receiver makes any amateur sure of obtaining satisfactory broadcasting.

An outstanding feature of the Michigan "Senior" Receiver is the Vernier Dial Adjuster. This means that a very fine adjustment may be made on each dial, which is necessary in tuning in on stations located at great distances.

Another superior feature is the Vernier Rheostat, which enables the operator to obtain extremely delicate adjustment of filament current on the detector tube.

A complete line of radio parts and accessories are manufactured in our own plant. Michigan "Junior" and "Senior" Receivers are not merely assembled sets, but are made complete by us. We are, therefore, enabled to guarantee, absolutely, everything we sell.

A connection with this Company will prove pleasant and profitable for you. Send for our catalogue of high grade, first quality merchandise.

MICHIGAN RADIO CORPORATION

GRAND RAPIDS, MICHIGAN

THIS WILL BE A RADIO CHRISTMAS!

MAGNA INSTRUMENTS

The Magna-Tone receiver is a scientifically designed instrument embodying the late improvements. It is a non-regenerative detector circuit to which is added an arrangement designed by means of which extra sharp tuning can be obtained. The set has a range of 150 to 750 meters.

The Magna-Tone two stage-amplifier is an instrument which for purity of tone, lack of distortion, am-

plitude of volume, and simplicity of operation, is to be compared with the highest priced units. With all ship-



Magna-Tone Receiver

ments of instruments the manufacturers, the Magna Instrument Company, 340 West 42d St., New York, sends a



Magna-Tone Amplifier

schematic hookup diagram which cannot be misunderstood.

Conditions in Radio Security Market

(Continued from page 56)

CANADIAN MARCONI: A continuation of the heavy demand for radio equipment in Canada, a virgin territory for this development, is reported by my correspondent there. Canadian Marconi is making preparations to handle a record-breaking volume of business. Buying of the stock for Canadian interest has recently developed. They realize the great possibilities for the company and in its shares.

WESTERN UNION: Earnings of the company for the first nine months of 1922 were almost as great as for the entire twelve months of 1921. The exact figures of net income are \$9,454,228 for the period from January 1 to September 30, 1922, and \$9,704,964 for the calendar year 1921. The Western Union makes its largest earnings in the last quarter of the year. Present indications are that the amount applicable to dividends this year will be in the neighborhood of \$13 a share, against \$9.65 a share a year ago.

Western Union is paying dividends of \$7 per share annually which we understand will be increased to an \$8 or \$9 rate. Dividends have been paid uninterruptedly for more than forty years. In addition to its investment qualities, the stock possesses good possibilities for price appreciation.

DE FOREST: Good demand is indicated for the company's radio apparatus. Company paid dividends of \$1 per share so far this year and with earnings reported much in excess of this requirement, talk is heard of another payment before the year is out. A purchase of the stock returns 10 per cent. on the present selling price without considering prospects for market enhancement.

NEW YORK TELEPHONE 6 1/2 PER CENT. PFD.: Investors in general are beginning to appreciate the investment qualities of this issue and the consistent buying of the stock has caused an advance to \$111 1/2, a new high record. This stock is a safe investment.

Stock.	Bid.	Asked.
All American Cables.....	\$117	\$120
American Tel. & Cable....	62	63
American Marconi Stamped 5c.		20c.
Amer. Marconi Unstamped	7	9
American Tel. & Tel.	123 1/4	123 1/2
Canadian Marconi	2 1/2	3
De Forest Radio	8	10
English Marconi, com.	11	14
English Marconi, pfd.	11 1/2	14 1/2
Federal Tel. Co. (Calif.)..	6 1/2	7 1/2
Federal Tel. & Tel.(N.Y.)	8 1/2	13
General Electric	184	185 1/2
Internat. Tel. & Tel.	56	62
Mackay Co. com.	102	103
Manhattan Elec. Supply..	52	53

SUNRAID RHEOSTATS
 A new principal—the contact is as a wheel-spoke to a rim. The contact point is forced against the filament wire by a spring inserted in the finger. Positive contact—can't come out.
 List, \$1.00 Standard Discounts
SUNRAID RADIO CO.
 534 Eighth Ave. New York City

States Radio Corporation
 Manufactures
RADIO EQUIPMENT

501 S. Jefferson St., Chicago, Ill.

Brunet Headsets

Made in France, approved and used by the French Army and Navy; 4000 ohms resistance. Highest type of material and workmanship throughout.



List Price \$8.00
 Discounts on Request

JOHN R. LIVERMORE, INC.

Importers

Established 1865

Exporters

50 Church St., New York City

THIS WILL BE A RADIO CHRISTMAS!

	Bid.	Asked.
Marconi Int. Marine.....	6½	8½
N. Y. Tel. 6½% pfd.	110	111
Radio Corporation, com..	45⅞	47⅞
Radio Corporation, pfd..	3⅞	3¾
Reynolds Spring	25	27
Spanish Marconi	1½	3½
United Fruit	155	156
Western Union	114	115
Westinghouse E. & M....	62	63

No doubt there are readers interested in concerns not covered in this article. I will be glad to furnish detailed information without obligation.

Aggressive Publicity

(Continued from page 60)

carry over vibrations which make the voice and music sound mushy.

"3. It filters out a great deal of the tube and static noises which distract the ear from the voice and music.

"Half an hour of use will convince anyone of the restful effect of these qualities." The cover then goes on to extol the qualities of sensitivity, comfort and ruggedness, the ear caps, the sanitary bands and the fact that the C. I. C. headset is guaranteed.

That is one form of aggressive publicity. Another form which dealers are using more and more to their advantage is that of the show window dressing. The window trim here reproduced shows how the Cable Company of Chicago displayed a Zenith set. The simplicity of the setting suggests that radio is simple. The ribbons leading from the sets to points on the map above representing radio stations thousands of miles away from Chicago give a graphic representation of what radio means to the average person.

These examples illustrate but two forms of publicity that are direct aids to salesmanship. The wise dealer seeks publicity support from the manufacturer, of course, but does some aggressive advertising himself. He takes advantage of every opportunity afforded him to put radio before the public—and keep it there.

RADISCO CURRENTS

A new monthly house organ has joined the ranks of the radio press. It is called *Radisco Currents* and is published by the Radio Distributing Company, Newark, N. J. The first issue is an attractively gotten up four page paper, is well illustrated and printed and contains matter that is of interest to the progressive radio dealer, including a talk by the sales manager, some business getters, an article headed on the Armstrong super regenerative receiver, and directions for dressing a show window with Radisco products.

STANDARD SPECIAL CRYSTALS

TESTED AND GUARANTEED

THEY TALK FOR THEMSELVES



Every STANDARD SPECIAL CRYSTAL is tested on the Radio Waves before and after mounting, which assures perfect satisfaction.

JOBBER AND DEALERS, be convinced. Send for a free sample of the STANDARD SPECIAL CRYSTAL and make your own test.

The STANDARD SPECIAL CRYSTAL is sold mounted and unmounted.

All Orders Shipped Same Day Order Is Received

STANDARD CRYSTAL CO.

274-A HALSEY ST.

NEWARK, N. J.

Canadian Agents: Sterling Specialties, 213 Somerset Bldg., Winnipeg, Man., Canada

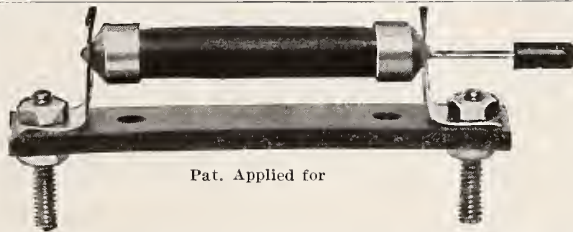

Pat. Applied for

The Only One in America

With the usual type of "Grid Leak," which is of fixed value, it is necessary to try a number of them to determine the one best suited.

The Durham Variable High Resistance (Adjustable Grid Leak)

is the only one of its kind now on the market, because it is adjustable over a wide range and will maintain its value permanently after initial setting—It is non-conductive and has negligible capacity.

Made in two sizes:—No. 100—1000—100,000 ohm range. No. 101—100,000—1,000,000 ohm range.

Resistance \$.75 Base \$.40

DURHAM & COMPANY

Radio Engineers
1936 Market Street Philadelphia, Pa.

Radio Finds a Better Condenser

BAYLEY'S 43
PLATE 0011 PORT-
ABLE PANEL
GLASS CASED
TABLE CO DENSER

It is made with glass panels set between four brass uprights, highly polished and presents the finished effort of precise workmen.

Solid rubber end pieces finished like black morocco leather add to its beauty.

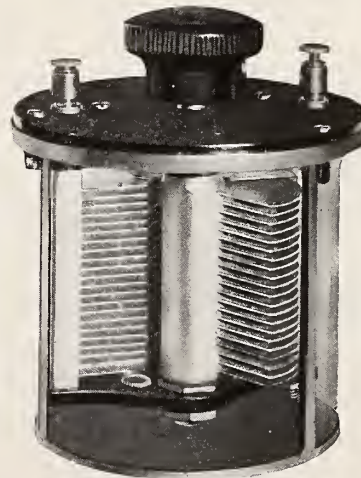

A DIE-CAST
PRODUCT WITHIN
THE CASE

Its plates spaced close give it the finest tuning qualities.

The plates are assembled as a solid integral part of the whole by the die cast process. It is impossible for any plates to loosen in service.

Each condenser has our guarantee, backed with a manufacturing record of more than forty years.

We want business from houses that appreciate real value. It will give satisfaction and stay solid

A sample order will convince you of its value

And Make You, Certainly, A BAYLEY CONDENSER BOOSTER

List Price \$5.00 Each, Complete

TO JOBBER AND DEALERS A SPLENDID PROPOSITION

BAYLEY CONDENSER CO.

105-109 Vanderveer Street

Brooklyn, New York

THIS WILL BE A RADIO CHRISTMAS!

ADD-A-STEP



DETECTORS AND AMPLIFIERS
See them at the RADIO FAIR
ARROW RADIO CO.
Manufacturers of Quality Plus
Instruments
HACKENSACK NEW JERSEY

RUSONITE

CRYSTAL RECTIFIER
MULTIPOINT (Patent Pending)

A synthetic CRYSTAL DETECTOR sensitive over its entire surface

Eliminates all detector troubles.
50% increase in clearness and volume.
Endorsed by Radio experts and press.
Awarded certificates of excellency.
Sets a new standard of efficiency.

List price mounted
Every package sealed **50c**

Dealers and Distributors quoted
Attractive Discounts

RUSONITE PRODUCTS CORP.
15 Park Row, N. Y. Room 2004

THE TITAN-O-TONE \$10

WITH HEADSET and AERIAL

Same with Double Titan-O-Tone Headset - - \$12



A well made and very efficient outfit mounted in genuine mahogany cabinet. Discounts 40 and 10.

Titan-O-Tone Products

Per 100 net

- 3" Alum. Dial with Knob \$8.00
- Large Contact switch 8.00
- Large Knob with set screw ... 2.50
- Crystal Detector, Knocked Down ... 13.00
- Mounted Galena Crystal, Tested 4.50
- Crystal Wash, 1 oz. Bottle. 7.00



T-F RADIOPHONE CO., Inc.
Manufacturers "Titan-O-Tone" Products
667 Coney Island Ave., Brooklyn, N. Y.

Radio on Train

Successful Test with No Outside Aerial

Receipt of wireless messages inside a steel car of a moving train with no outside aerial was successfully demonstrated recently by the Pennsylvania Railroad on the Broadway Limited, en route from New York to Chicago, according to the *New York Times*.

Radio messages have been received aboard trains before, but always an outside aerial was used. The instrument used on the Pennsylvania train was small, compact and placed on a table in the car. The aerial used was eighteen inches square.

The tests were conducted by Arno Zillger of Philadelphia, who came to Chicago to attend the radio show. J. D. Jones, Superintendent of Telegraph and Signals of the railroad, was present.

"The most remarkable feature of the program was that we were able to receive messages from broadcasting stations all over the country, even while traveling, under high tension wires," said Mr. Zillger. "The Pennsylvania system is electrified near Philadelphia and even while we were traveling over that section of the road the messages came with great clarity—a remarkable feature.

"I believe that all train orders, in fact, all important messages of the future, will be transmitted by wireless. A set may be put up in each end of a long freight train and the crews will be able to communicate without walking the length of the train.

"Another feature will be conversations between stations and moving trains. It is quite possible."

"It demonstrates that radio for receiving and transmitting messages from speeding trains can be employed successfully," said J. D. Jones, Superintendent of Telegraph and Signals, who acted as official observer for the Pennsylvania Railroad. "The traveling public in the near future may expect such service on railroads."

The outside form of antennae had been developed and was in use on the Chicago, Milwaukee & St. Paul Railroad until the shopmen's strike, and was then temporarily discontinued. The interior set is considered superior, however, because of the results of this latest experiment. No interference was found while receiving between Philadelphia and Paoli, a stretch where the road is paralleled by a power line of 11,000 voltage. Similarly there was no trouble due to elec-



RHEOSTATS
and Other
STANDARD PARTS FOR TUBE and CRYSTAL SETS
Dealers: Write for Price List and Proposition.
The Radiola Wireless Corp.
208 W. 17th St. New York City

TUNING COILS

Double Ply—Dull and Bright Finish—9x3½, End Pieces Made of Composition Fibre.

REGULAR \$3.50 - NOW \$1.30

BERSHAW RADIO & MFG. CO.
82 Barclay St. Newark, N. J.

RADIO CABINETS



We manufacture a complete line of radio cabinets, of mahogany, walnut, oak, and white wood, in all sizes, and in any finish. Best of construction. Dirt, dust and moisture proof. Quick deliveries—quantity production prices. Send us your specifications, or a sample of your cabinets, and get our prices. We also make indoor loop aerials.

Cabinet Work Since 1900

E. ESHOO CABINET WORKS
635 Herkimer St. Brooklyn, N. Y. Telephone Lafayette 2324



We Are Overstocked On Crystal Detector Sets

Owing to the failure of Local Broadcasting we have a large number of first-class sets to dispose of. To make a quick clearance we will sell them at the following

Exceptionally Low Prices

List price with Frost 2000 Ohm Phones, 100 ft. No. 14 Antenna Wire and two Insulators.....\$25

List price without Phones and Antenna material.....\$18

Discount 50%

Send \$9 for Sample Set

Julius Andrae & Sons Co.
In Business Since 1860
114 Michigan St., Milwaukee, Wis.

THIS WILL BE A RADIO CHRISTMAS!

tric lines, train generating equipment or the powerful locomotive while passing through a tunnel at Philadelphia.

The radio set was assembled after the train left New York, enroute to Chicago, and immediately was tuned into station WOR at Newark. The entire concert was heard during the run to Philadelphia where a second one was picked up.

Later Mr. Zillger tuned in on a ship on Lake Superior and, while still 200 miles from Chicago, listened to the naval spark signals from the Great Lakes station. Several amateur stations in Ohio and Pennsylvania also were copied.

The receiving equipment consisted of a tuned 18-inch loop antennae, three steps of radio frequency amplification, Audion detector and two steps of Audio frequency amplification. The vibration of the train, according to Mr. Zillger, did not affect the reception.

Statement of the Ownership, Management, Circulation, Etc., Required by the Act of Congress of August 24, 1912.

Of the Radio Dealer, published monthly at New York, N. Y., for October 1, 1922.
State of New York } ss.
County of New York }

Before me, a Notary Public in and for the State and County aforesaid, personally appeared Harry M. Konwiser, who, having been duly sworn according to law, deposes and says that he is the Publisher of the Radio Dealer, and that the following is, to the best of his knowledge and belief, a true statement of the ownership, management, etc., of the aforesaid publication for the date shown in the above caption, required by the Act of August 24, 1912, embodied in section 443, Postal Laws and Regulations.

1. That the names and addresses of the publisher, editor, managing editor and business managers are:

Publisher, Harry M. Konwiser, 1133 Broadway, New York City, Editor, Bernard J. Farrell, 1133 Broadway, New York City, Managing Editor, Laurence A. Nixon, 1133 Broadway, New York City.

2. That the owners are: Radio Dealer Co., 1133 Broadway, New York City; Harry M. Konwiser, 1133 Broadway, New York City; Laurence A. Nixon, 1133 Broadway, New York City.

3. That the known bondholders, mortgagees, and other security holders owning or holding 1 per cent. or more of total amount of bonds, mortgages, or other securities are: None.

4. That the two paragraphs next above giving the names of the owners, stockholders, and security holders, if any, contain not only the list of stockholders and security holders as they appear upon the books of the company but also, in cases where the stockholder or security holder appears upon the books of the company as trustee or in any other fiduciary relation, the name of the person or corporation for whom such trustee is acting, is given; also that the said two paragraphs contain statements embracing affiant's full knowledge and belief as to the circumstances and conditions under which stockholders and security holders who do not appear upon the books of the company as trustees, hold stock and securities in a capacity other than that of a bona fide owner; and this affiant has no reason to believe that any other person, association or corporation has any interest direct or indirect in the said stock, bonds, or other securities than as so stated by him.

5. That the average number of copies of each publication sold or distributed, through the mails or otherwise, to paid subscribers during the six months preceding the date shown is: Not required.

HARRY M. KONWISER, Publisher,
Sworn and subscribed before me this 25th day

(Seal) M. J. KLEIN,
(My Commission expires March 30, 1924)

INDUCTANCE
SWITCH

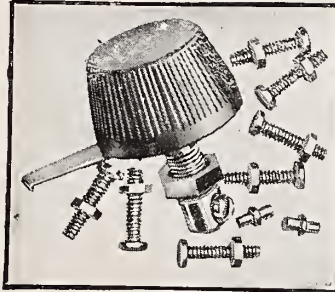

Switch, Complete, 50c. Without Contact Points and Stops, 35c.

6 Ohms, 1 1/2 Amp.
FILAMENT
RHEOSTAT



List Price, 75c.

Catering to Jobbers and Distributors Exclusively. Unusual Discount Rate

ACORN RADIO SUPPLY CO.

15 WEST 30th STREET

NEW YORK

Positive
Contact

COMPRESSED, BAKED, SEALED
KAPACITON
INDIVIDUALLY TESTED
KONDENSERS

Perma-
nent
Capacity

ARE BETTER CONDENSERS!

'Phone * Grid * Grid with built-in leak * Grid with detachable and variable leak * (Pat. pend.) All capacities.

Established 1910

Meirousky

Jersey City, N. J.

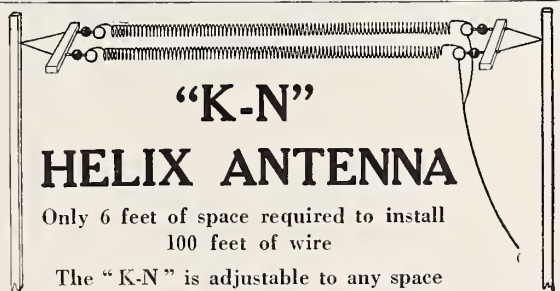
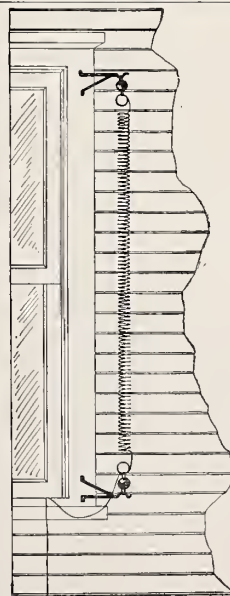

"K-N"

HELIX ANTENNA

Only 6 feet of space required to install
100 feet of wire

The "K-N" is adjustable to any space

The ideal aerial, made from ideal Antenna Wire

The "K-N" is a spirally wound aerial and is therefore adjustable to the available space, either on the roof, outside the window or within the home.

Jobbers and Dealers write for special discounts

Receptive area in all directions.

Remains taut—no swaying.

Installed with greater ease.

RETAIL PRICE, \$1.60

Manufactured by

WALTER S. KRENZ

339 So. Central Park Blvd.

CHICAGO, ILL.

THIS WILL BE A RADIO CHRISTMAS!

Book Review

By **BERNARD JEROME FARRELL**

The Editors of the RADIO DEALER will be glad to review new publications in this field as they may be issued. Address them attention BOOK REVIEW EDITORS, the RADIO DEALER, 1133 Broadway, New York City.

TEXT BOOK ON RADIO. By James R. Cameron. 338 pages. Published by the Technical Book Company, New York City.

This comprehensive treatise is intended for the man who is serious in the desire to secure accurate and trustworthy information regarding the practical and sufficient of the technical phases of radio installation, operation and construction for ordinary needs. The author of this excellent volume is well qualified for the work he has undertaken, having previously written "Radio for Beginners," "Radio Dictionary," "Motors and Motor Generators," "Electricity for Projectionists," and other books on electrical subjects.

In clear style and written so that one who knows practically nothing about the subject can readily understand it, the essentials of radio knowledge are told, beginning with the description of radio. This is followed by a description of electricity, its measurements, generation, alternating currents, resistance and transformers.

Other chapters are devoted to aërials, coupled circuits, damping, what happens in a transmitting set, tube transmitters, telegraphy and telephony, radio-telephony, vacuum tubes, the electron tube as a detector and as a generator.

Several chapters are devoted to the subject of receiving sets, and several types are described. In some cases instructions for installing same are given. Of course tuning and amplification are treated, as are condensers, vario-couplers, variometers, the double slide tuner, and the making of tuning coils. The super-regenerative receiving set is described and instructions for making one are given. Storage batteries receive attention as well as generator and motor troubles and their causes and remedy. Regulations for the installation of aërials, the requirements of the national electrical code for radio installation and the United States radio laws and regulations are each the subject of a chapter. The volume closes with a comprehensive glossary of radio words with lucid definitions.

THE BOOK OF RADIO. By Charles William Taussig. 447 pages. Published by D. Appleton & Company, New York City.

In a popular and lucid manner the author gives a description apparatus used in radio for radio reception and transmission including the outstanding features of the radio service to the public by private and governmental agencies. The interesting foreword is written by James C. Edgerton, superintendent of radio of the Post Office Department. The appendices include a description of how to make a simple home made receiving set, also a two-circuit receiving equipment with a crystal detector, a report of conference on radio telephony, proposed revision of Rule 86 of the National Electrical Code on radio equipment, market and crop estimates and a partial list of the broadcasting stations in the United States and Canada.

THE MARVEL OF THE WIRELESS TELEPHONE. Published by the Freed-Eisemann Radio Corporation, New York City.

This book is an elementary course in the principles of radio apparatus and the electrical laws upon which they depend. The text has been divided into lessons arranged in their logical sequence. Starting with magnetism, the theory of induction, battery phenomena and generation are explained. It contains lessons on the induction coil, the transformer, condenser, and the electromagnetic theory of light.

CORRECT METRO STORY

Through the proverbial pranks of the printer, the description of the Metro TRIPHONE appearing on page 131 of the October RADIO DEALER was made to say exactly what was NOT intended. The article, as written, said that the TRIPHONE "does away with the necessity of 'shorting' when using two or more phones. Three headsets can be used at the same time from the single jack of any receiving set." But some printer, after setting the words in type, switched the leads about and caused the notice to read to the effect that the TRIPHONE "does away with headsets."

The Triphone is an accommodation plug which fits any standard jack. One headset or loud speaker is permanently connected to any phone plug. On either side of the cord is a separate jack built in the body of the Triphone, each of which accommodates a standard plug or, if desired, another Triphone, making it possible to use half a dozen or more headsets.

The RADIO DEALER trusts that everybody, including the Metro Electric Manufacturing Company of New York, who make the Metro Triphone plug, will make allowance for printers, and feels that a quality article such as this attractive device, will succeed in a field where good products are coming more and more to be appreciated.

HELP THE SALESMEN

The greatest good that can develop for many advertisers is not the direct sales received, but the help it gives to the salesmen when they are calling in new territory, when they are making calls upon their old customers, and in giving an appreciation of what his firm stands for in the minds of a great many customers and possible customers.—B. J. FARRELL.

TRESCO RADIO

Licensed under Armstrong U. S. Patent 1,113,149

The simplicity of the Tresco Receiving Set means everything to the dealer.

Few parts, practically indestructible, easy to learn to operate.

Once sold it stays sold and requires no service by the dealer.



Orders are now being placed for fall delivery—are you ready? Better write us for our discounts.

Remember the "Tresco" is a regenerative set, manufactured under the Armstrong License.

TRESCO RADIO

J. Matheson Bell, Sales Mgr.

Davenport, Iowa, U. S. A.



THIS WILL BE A RADIO CHRISTMAS!

Germer is Optimistic

Interview with Manager of General Merchandise Company

The General Merchandise Company, as is evidenced by the picture of their booth at the Second Newark Radio Show held at the Robert Treat Hotel, Newark, N. J., recently, have taken rapid strides as distributors in radio apparatus. An illustration of the booth is shown on page 41.

Frederick W. Germer, the general manager of the General Merchandise Company in an interview given to a representative of the RADIO DEALER said: "The radio business was never so prosperous as now. If a good many more distributors and jobbers would take a more optimistic stand about the over-production of last summer, now on the market, and would help to clean up these items, we would have more business than we have today. When I mention 'we' that means distributors of radio apparatus.

"One way in which to discourage the influx of new ideas, that would never pass muster in a testing laboratory, is not to buy them. We're distributors for several well-known manufacturers of radio equipment, and all their products will stand the highest test of efficiency and worthiness."

This company also makes radio frequency sets, that have produced results on loud speakers over a distance of five hundred miles with only four tubes. They also make a new type of roller bearing switch which has the feature of being able to work on either one-inch and an eighth and one inch and a quarter radius, and further having a little roller bearing for running over the switch points, which eliminates the cutting of the switch stops, and also insures a positive contact.

Another special item which is taking the market with popular approval is the G.M. 4 radio frequency transformer. This transformer lists at \$2.00 and has brought in stations within the radius of nine hundred miles very clearly and distinctly using one stage of radio frequency and one detector, and two stages of audio-frequency. The curve runs fairly straight from 340 to 500 meters.

The General Merchandise Company's offices and ware rooms are located at 142 Market Street, Newark, N. J., and are operated under the personal supervision of Frederick W. Germer—at least judging from the picture of their booth, the average dealer can see for himself the thorough method and manner in which the General Merchandise Company handle and operate the radio department of their business.

A Sales Policy That Means Profit for You

TO meet the revival of radio demand which promises to equal that of last winter, the Jewett Manufacturing Company, manufacturers of ABC radio apparatus, announce to radio dealers a firm, definite sales policy that means real turn-over profits to dealers selling Jewett apparatus.

Jewett dealers are absolutely protected and assured of an exclusive sales territory having potential buying capacity sufficient to insure the dealer a profitable turn-over.

Jewett dealers are protected against competition on ABC apparatus within their territory, and Jewett salesmen will advise dealers honestly and efficiently as to the quantity of stock to buy to avoid over-stocking.

The Jewett Development Department, with Professor J. H. Morecroft of Columbia University as Consulting Engineer, is always conducting radio research, assuring dealers and users the latest and most up-to-date apparatus manufactured, of high quality design, material and workmanship.

Send for our catalog descriptive of ABC Radio Tuner as designed by Professor Morecroft

JEWETT MANUFACTURING CORPORATION

Herbert F. L. Allen, *President*

226 Sherman Ave.

Newark, N. J.

Makers of

ABC Receiving Sets
ABC Transformers

ABC Variable Condensers
and other radio parts

THIS WILL BE A RADIO CHRISTMAS!

Baseball Fans Receive Radio Reports

Crowds Heard Announcements While Watching Player Board

By FREDERICK H. KEEFE

General Manager, Newburgh (N. Y.) News

The *Newburgh Daily News*, in connection with its broadcasting station WCAB staged a race between the United Press wire, through which it regularly receives its news service, and the radio broadcasting of the World's Series by the big stations WIZ and WGY, both of which sent out the detailed play of this annual baseball classic each day as the game progressed. The *News* annually places a standard player board on the front of its building on which the action of the game is depicted.

Anticipating that the radio would be the faster, the *News*, with its antenna and receiving equipment and a loud speaker, prepared to give to the fans of Newburgh the benefit of both services. The loud speaker was placed alongside the player board and acted as announcer for the plays shown on the board.

How well the arrangement worked—and, "synchronized"—can best be expressed as "nip and tuck."

It was found that the two methods of transmission were absolutely simultaneous, but the action of the player board in showing the pitched ball was not detected by the crowd so quickly as the spoken words of the announcer on the Polo Grounds.

The reverse was true of important plays. The cheers and applause of the crowd on the Polo Grounds forecast the making of hits, runs and other important plays, which had been completely enacted by the player board before the noise had quieted down sufficiently to permit of the radio announcer being heard.

It is, therefore, obvious there can be no decision rendered as to which is the faster, each having its advantages.

AIR-WAY CATALOGUE

The Air-way Electric Appliance Corporation, Toledo, Ohio, for which the Zinke Company, 1323 South Michigan Avenue, Chicago, Ill., are the wholesale distributors, is sending a catalogue of its Air-Way Green Seal radio equipment. Included in the line are complete receiving sets of both one and two-stage amplification, variometers, vario-couplers, variable condensers, audio frequency and radio frequency transformers, tube sockets, etc.

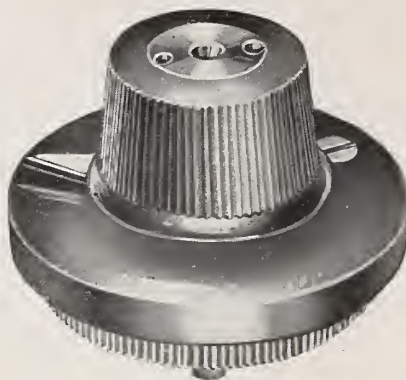

ACTUAL SIZE



LOCK

PATENT PENDING

MOFFAT RADIO LOCK RHEOSTAT

\$1.50 List

LOCKS OFF CURRENT
LOCKS ADJUSTMENT

MOFFAT RADIO LOCK CIRCUIT SWITCH

\$1.50 List

LOCKS ALL TUBES

**NO MORE TUBES DAMAGED BY MEDDLESOME PERSONS
NO MORE TIME LOST IN READJUSTING TUNING
NO MORE LOSS OF BATTERY CURRENT**

FITS ANY STANDARD INSTRUMENT OPERATED BY A SHAFT

JOBBERS AND MANUFACTURERS WRITE

JOSEPH ROSS & CO., IRVINGTON, N. J.

ESTABLISHED 1875



— AND NOW

THE QUEENS FIVE UNIT SYSTEM

Following in the popular wake of the Queens "Green Tag of Perfection" Variometers and Variocouplers, comes the Queens Five Unit System—a "Green Tag of Perfection" complete vacuum tube receiving outfit.

Popular demand is the reason for this. Radioists nation-wide requested it—so we perfected it for radioists, expressly to receive broadcasting.

The five units complete, embody a Queens Variocoupler in a single unit—two Queens Variometers in a unit each—a detector unit and a one step amplifier unit. Each unit is constructed of solid genuine mahogany with genuine bakelite panels. The binding posts are solid brass triple nickel plated. New style knobs are uniformly used throughout, made of genuine bakelite with dials to match. Size of each unit is 5 3/4" wide x 7 3/4" x 5 7/8" deep. The five unit set retails for \$70.00, minus batteries and tubes. Additional steps of amplification may be added for a loudspeaker.

From end to end, every inch of these units are manufactured right in our own factory. This fact and huge production account for the popular low price. In line with Queens requirements, each unit is personally inspected and tested by our engineers before being shipped from our factory. After this, the "Green Tag of Perfection" is placed upon each. This is your protection and our guarantee—look for it. Every unit leaves our factory individually packed in cartons, neatly labeled for attractive display on your shelves. Every label carries a complete description of the contents.

Units also sold individually:

Variocoupler Unit \$15.00 list
Variometer Unit \$12.50 list

Detector Unit \$12.50 list
Amplifier Unit \$17.50 list

Write today for our valuable catalog showing our complete line of "Green Tag of Perfection" radio apparatus, together with attractive discounts. It's free.

QUEENS INSTRUMENTS ARE NATIONALLY ADVERTISED

QUEENS RADIO COMPANY, INC.

12-A Forest Street

WINFIELD, L. I.

THIS WILL BE A RADIO CHRISTMAS!

no ground no aerial

The Oard Phantom Receptor



Carry one in your car

Thousands of additional sales made possible by this marvelous new—

A-P set

Many people live in locations where an aerial is impossible. Others object to their premises being disfigured by poles and wires. And many doubt their ability to operate sets with such complications. The Oard PHANTOM Receptor removes these objections completely, and opens to the radio trade this profitable new additional market of thousands of people.

The Oard PHANTOM Receptor requires neither aerial nor ground connection. With a single antenna wire not exceeding 50 feet in length, which may be concealed in the picture molding, laid on the floor or ground, or placed wherever most convenient, it will give better results over both short and long distances than other types of receivers requiring ground connections and elaborate aerials or loop systems. It is highly selective, and a marvel of beauty, simplicity, and efficiency. It is the ideal set for home, hotel or apartment house, business office, or automobile.

Get your share of the profitable business from the tremendous new market this set has created. Write us for Bulletin D-3 and full particulars, mentioning your jobber's name. Do it now. Be the first in your locality.



Pats. Pending

—performing new feats every day

As an example of the actual operating efficiency of the Oard PHANTOM Receptor, we cite the experience of J. F. Carpenter, Denver, Colo. On September 13th he received Dinwoody Institute, Minneapolis, 700 miles away, without either aerial or ground connection, using only a piece of lamp cord about 20 feet long. Other stations heard by Mr. Carpenter include—

- 1ZN—Chicago, Ill. 900 miles
- 5XA—Auburn, Ala. 1050 miles
- 7QD—Aberdeen, Wis. 800 miles
- SEK—Rochester, N. Y. 1300 miles
- 9BKK—Louisville, Ky. 1000 miles
- 6KA—Los Angeles, Cal. 800 miles

View Closed



"It's all inside"

Atlantic-Pacific Radio Supplies Co.

Radio Supplies

646 Mission St. San Francisco

Receiving Sets

the dawn of a new Era in Radio

27 Reasons why you should concentrate on Radiobats

Because—entirely distinct from *all* other batteries for radio use—Radiobats are *radio batteries*.

Radiobats are advertised more powerfully than any three of the other 27 battery advertisers in the leading Radio publications in October.

Radiobats "A" and "B" are *dry storage* batteries, with the only solid electrolyte. They eliminate battery noises absolutely.

Dealers will find both the list prices and the discounts liberally attractive.

Send for the intensely timely book, "The Permanent Power-UNIT for Radio"—free.

MULTIPLE STORAGE BATTERY CORP.

350 Madison Avenue, New York

"A"
and
"B" **RADIOBATS**
The Permanent Radio Power-UNIT

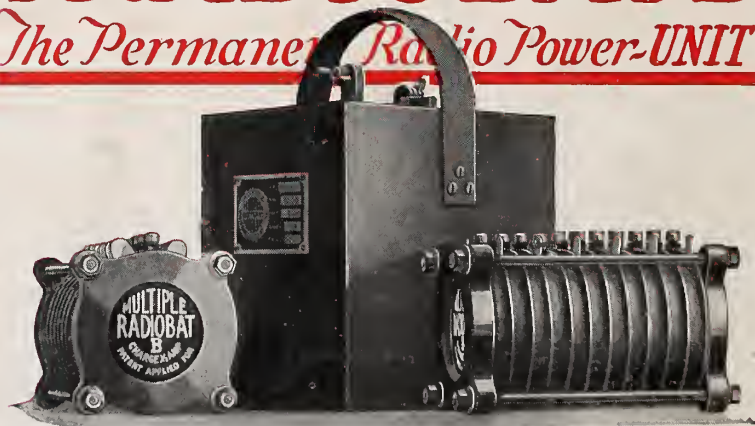

Radiobats outsell, outlast, *outplease*
They make more money for dealers

The RADIO DEALER

Vol. 2 No. 3 DECEMBER, 1922 One Dollar The Year

Published monthly at 1133 Broadway, New York, N. Y., by The Radio Dealer Company. *Entered as Second, Class Matter, at the Post Office at New York, N. Y., under the Act of March 3, 1879

Buy Nationally
Advertised Radio
Merchandise from the

Wholesale Radio Equipment Co.



OUR dealers are secure, confident, prospering. They sell high class merchandise that radio fans trust and readily purchase. We back them up with SERVICE—prompt shipment, immediate action on every request and various forms of valuable co-operation. You can promise customers and keep your promises when you tie up with Wholesale Radio Equipment Company.

Put it up to us to prove it on your very first order.



Nothing Demonstrates Like Sales—Order
The “Four-Way” Radio (Switch) Plug

Four Combinations Without Removing Plug from Jack

This combination switch and plug accommodates two head sets or a head set and a loud speaker, in series or in parallel. Switch operates without removing plug from jack. Takes the place of two plugs and a jack. Of course, it sells almost on sight. It is exactly what every fan wants. The price attracts—its excellent construction and materials build increasing demand.

LIST
\$1.50
DEC 3 1922
PERIODICAL

Products of 22 or More Radio Manufacturers of National Importance

Write TODAY for Attractive Discounts on Complete Line.

DISTRIBUTORS FOR

Acme
American Transformer
All Wave Couplers
Baldwin
Bradlevstat
Brandes
Chelsea
De Forest
Dubilier
Electrad
Eveready
Federal
Homcharger
Jefferson
Klosner
Magnavox
Murdock
Paragon
Radio Service Laboratories
Thordarsen
Tuska
Western Electric

WHOLESALE ONLY

Wholesale Radio Equipment Co.

24 WILLIAM STREET, NEWARK, N. J.

We make only the diaphragm

**THE FASTEST
SELLING PRODUCT
IN RADIO**

**MICA
DIAPHRAGMS
TO REPLACE
THE OLD STYLE
METAL DISCS IN
ANY STANDARD
HEAD PHONES**

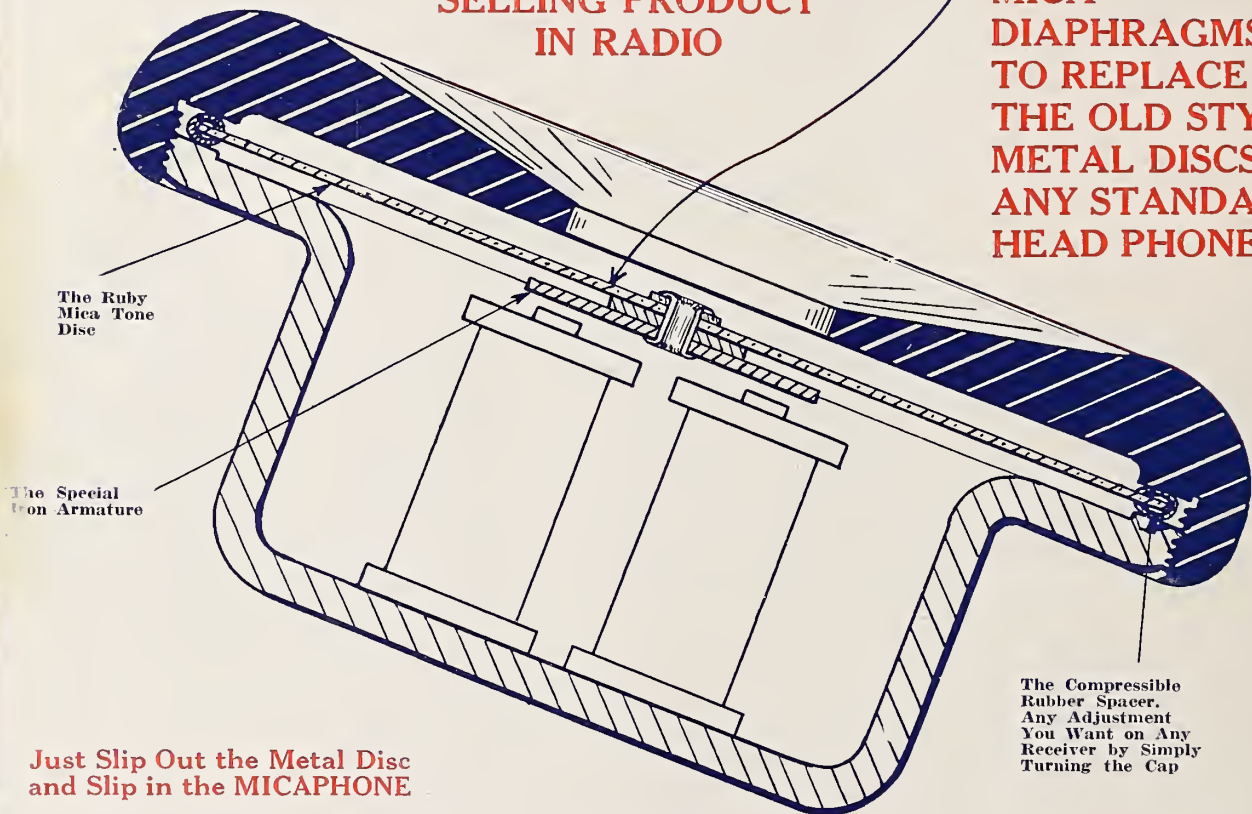

**Just Slip Out the Metal Disc
and Slip in the MICAPHONE**

**The Compressible
Rubber Spacer.
Any Adjustment
You Want on Any
Receiver by Simply
Turning the Cap**

There is as much difference in tone and clearness of reception between a head set equipped with MICAPHONE MICA DIAPHRAGMS and one with ordinary metal diaphragms as there is between the actual hearing of the concert or singer and an old worn out phonograph record.

TRIAL OFFER

SMALL INVESTMENT

Trial Assortment (12 pair)
Costs only \$13.75, cash with
order or C. O. D.
Sells for \$24 (\$2.00 per pair)
You make \$10.25

A Nice Big Profit

QUICK SALES

Average of our sales shows
three reorders per month per
dealer.

Send \$13.75 today for Trial
Assortment.
Satisfaction Guaranteed.

DEALERS: MICAPHONE mica diaphragms are made for
all makes of phones, so no matter what kind
of a head-set your customer has you can fit
him out with MICAPHONES and make a
sale.

IMMEDIATE DELIVERIES

Radio Mica Products Co., 156 East 43rd St., New York City

SOLE MANUFACTURERS



Look for us at the N. Y.
Show, D. c. 21-30. Space
83, Main Floor.

American RADIO Exposition

THE OFFICIAL EXPOSITION FOR
AMERICAN MANUFACTURERS

with the endorsement of the
National Radio Chamber of
Commerce and sanction of
the Radio Apparatus Section
of the Associated Manufac-
turers of Electrical Supplies

Grand Central Palace, New York

December 21st to 30th

(Sunday excepted but Christmas Day included)

This first really comprehensive Expo-
sition is to be staged in a manner
worthy of a great industry.

The leading manufacturers have con-
tracted for space. This opportunity to

display Radio products to thousands
of buyers during the holiday season is
an unusual one. The exposition will be
one of New York's big features in
connection with National Radio Week

For further particulars write or wire

AMERICAN RADIO EXPOSITION COMPANY
120 BROADWAY Telephone John 0009 NEW YORK

MAKE THIS A RADIO CHRISTMAS

DX TYPE NO. 58 R. F. RECEIVER

GREAT
SELECTIVITY
 AND
EXCEPTIONAL
LONG RANGE
 ARE SOME OF THE
CHARACTERISTICS
 OF THE

Federal

DX TYPE NO. 58 R. F. RECEIVER



If you don't like the program you are listening to—you may find another more suited to your taste

Literature Descriptive of Radio Frequency Apparatus Supplied Upon Request

WRITE FOR BULLETIN 119-W

Federal Telephone and Telegraph Company

MANUFACTURERS OF STANDARD RADIO APPARATUS

BUFFALO, N. Y.

DICTOGRAPH

Radio HEADSET

Was \$12.00 **NOW** →

\$8

Why This Sensational Reduction in Price?

An unprecedented opportunity for dealers! The announcement of the sweeping reduction of \$4.00 in the price of the Dictograph Radio Headset will bring a tremendous demand. At \$12.00 this supreme quality instrument was an established success; at \$8.00 it will be a sensation. No other headset of like quality has ever been sold at such a low price.

New production plans on a gigantic scale make this new price possible. If not already stocked, protect yourself on delivery now. Order through your jobber or write direct for names of authorized distributors. *Stock now for the Xmas demand.*

List Price
\$20.

The Standard of the World

DICTOGRAPH Radio LOUD SPEAKER

The Perfect Loud Speaker for the Home

One of the greatest successes in the radio field! A handsome instrument of Dictograph standard quality. For all vacuum tube receiving sets. Reproduces every sound in crystal-clear tones, full volume, free from distortion and noise. Retail at the popular price of only \$20.00, complete with 5 ft. flexible cord.

DICTOGRAPH PRODUCTS CORPORATION

(Branches in all principal cities)

New York, N. Y.



220 West 42nd Street



Note: Plans are now under way for the production of the new 4,000 ohm Dictograph SUPER-TONE Headset at a list price of \$12.00. The most perfect instrument that can be made to meet the most exacting requirements.

THIS IS A RADIO CHRISTMAS!

New York Coil Company's Radio Products

THE LEADING LINE OF THE MOST SUCCESSFUL JOBBERS AND DEALERS IN RADIO

Our products embrace only the most needed and rapidly moving articles. Quality, engineering and workmanship the best obtainable.

Our extensive advertising *and worth-while discounts* cannot be overlooked.

STANDARD VARIOCOUPLER, - - - \$4.00
STANDARD VARIOMETER, - - - 4.00

These items are large, full size *proven* products, the value of which is seen at a glance.

New York Coil Company's Variable Condensers have set a standard by which all others are judged. Plates are of extra heavy aluminum, accurately spaced. The frame work of the supporting elements is such that permanency results. Adjustable bearings with provision to take up wear and means for always insuring positive contact is provided.

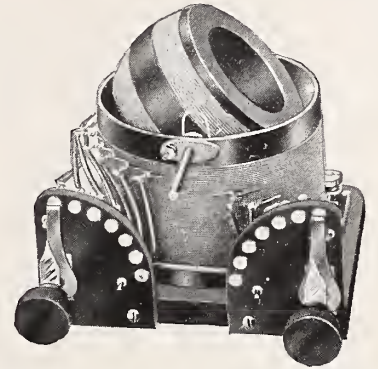

COMBINED MOUNTED VARIO-COUPLER—The only Variocoupler on the market that allows panel or table connection and eliminates the connecting of taps, soldering, drilling, etc. A great advantage in Radio. Nothing like it on the market. Handsomely finished. Price \$8.00.

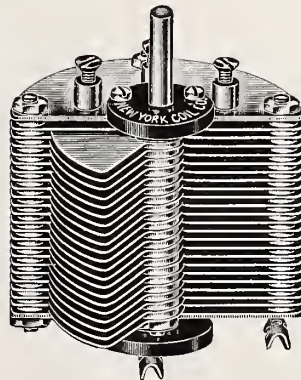

LIST PRICES:

3 Plate Vernier	-	-	-	-	\$1.25
11 "	-	-	-	-	1.50
23 "	-	-	-	-	2.00
43 "	-	-	-	-	3.00

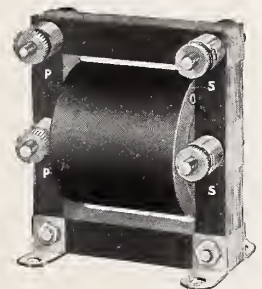

AUDIO FREQUENCY TRANSFORMERS—Choice of leading manufacturers and radio engineers. Guaranteed to give high magnification, less distortion and better all round efficiency. No howling. Price \$4.00.



NEW YORK ENTERTAIN-A-PHONE RECEIVING SET No. 2—Complete with detector and two stages of amplification, all in one cabinet. Contains a non-regenerative two circuit hook-up with two stages audio amplification. Results are simply a revelation. It must be operated and heard to be appreciated. Workmanship and design and material of exceptional character throughout. Of unusual interest to the jobber. Price \$50.00, fully guaranteed.

NEW YORK COIL COMPANY, Inc.

338 Pearl Street

New York City, N. Y.



Type B, Keystone Radio Arrester. Retail Price, \$2.00

KEYSTONE LIGHTNING ARRESTERS

Listed as Standard by Underwriters' Laboratories (No. 362 A-4)

You can sell hundreds of Keystone Arresters for these reasons—Small in size; weatherproof; entirely enclosed and sealed; foolproof; constructed by a Company having 30 years' experience in lightning arrester design; low capacity and high resistance; no vacuum to lose and so reduce the efficiency of the arrester to a point where it is practically valueless.

Get your order in before there is a possible scarcity. Liberal Dealer discounts. Write for complete information.



Type A, Keystone Radio Arrester. Retail Price, \$2.00

Simplex Panel Units

and
Unmounted
Variometers
and
Vario-Couplers

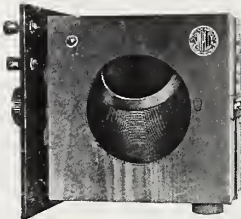

No. 47488
Simplex Variometer,
Showing Side View of
Panel Mounted Type

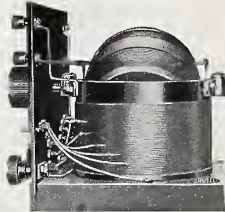

No. 47489
Simplex Vario-Coupler,
Showing Side View of
Panel Mounted Type

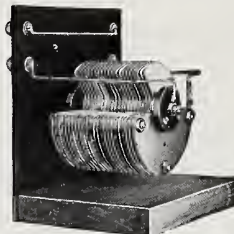

No. 47541
Simplex Condenser
Panel—Side View

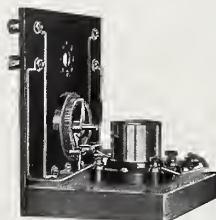

No. 47490
Simplex Detector Panel
Side View

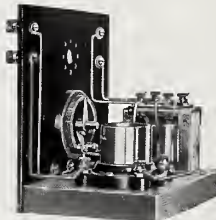

No. 47491
Simplex Amplifier Panel
Side View

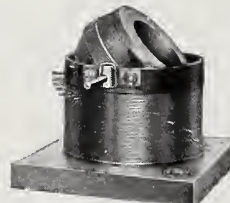

No. 47483
Simplex Vario-Coupler,
Unmounted



No. 47482
Simplex Variometer,
Unmounted

There is a big demand for Simplex Panel Units among your customers because they permit trying-out many different hook-ups and thus determining the best for their certain locality without having to disassemble a complete outfit. This is a decided advantage, but of no less interest is the fact that the beginner can first purchase one Vario-Coupler Panel and one Detector Panel and have a fairly good receiving set at minimum cost with the advantage of later adding additional units to obtain greater sensitivity and selectivity. Thus the user can add to his Simplex outfit and when he has purchased it complete it is unquestionably one of the most attractive and efficient receiving sets now offered to the public. This is a very attractive line for Jobbers and Dealers. Write for new descriptive circular and discounts on Panel Units and Unmounted Variometers and Vario-Couplers. Simplex Material is high grade in every respect.



Manufacturer of
Lightning Arresters for 30 years
Distributors for
SIMPLEX RADIO CO.

ELECTRIC SERVICE SUPPLIES CO.

PHILADELPHIA
17th and Cambria Streets

NEW YORK
50 Church Street

CHICAGO
Monadnock Bldg.

Branch Offices: Boston, Scranton, Pittsburgh

Canadian Distributors: Lyman Tube & Supply Co., Ltd., Montreal, Toronto, Winnipeg, Vancouver

THIS IS A RADIO CHRISTMAS!



RADIO MAGNA-TONE PRODUCTS



Lift the switch and this *MAGNA-TONE* Two stage Amplifier is in operation with filaments under fixed control. Circuit is automatically rearranged for one stage by lifting the first tube—at the left. Size, 13 x 5 x 5½ inches. Ebony finish.

JOBBER AND DISTRIBUTORS—There's a big demand for this radio essential. Write at once for our special proposition.

List Price **\$24**

MAGNA INSTRUMENT COMPANY

340 West 42nd Street
New York City

MAGNATONE Vacuum Tube Receiver—a radio set without fussy adjustments. Only two adjustments necessary. Provided with Fahnestock terminals which insure positive connections throughout. Size 13 x 5 x 5½ inches. Ebony finish.

DEALERS—Radio fans want simpler apparatus. Here it is. Discounts are generous. Big sales reported. Get in touch with your Jobber.

List Price **\$16**



Catalog on Request

THE PATHÉ LOUD SPEAKER

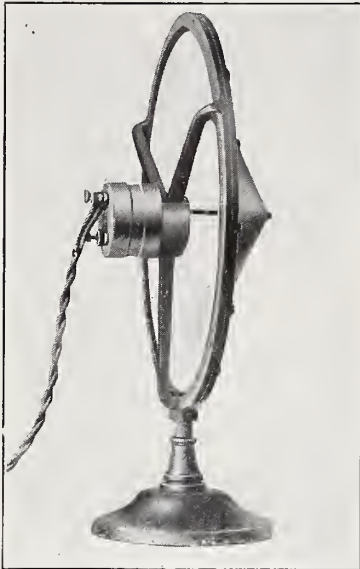

ORDERS MUST BE
PLACED AT ONCE
FOR DELIVERY PRIOR
TO CHRISTMAS.

List Price

\$24.00 Nickel Finish

\$22.00 Japan Finish

The Sound Wave Corporation has been consolidated with the Pathé Freres Phonograph Company and the new firm is known as

THE PATHE PHONOGRAPH AND RADIO CORPORATION
10-34 GRAND AVENUE, :: :: BROOKLYN, N. Y.

Radio's Most Attractive Merchandising Proposition



THE
HOMCHARGER

is unquestionably the most popular and the most successful battery charger on the market. A necessity to every Radio Fan and Auto Owner.

Over 50,000 Now in Use.

Homcharger dealers are backed by the most comprehensive advertising campaign in the entire field—over thirty-five publications regularly carry the Homcharger message to ten million prospects.

Attention compelling sales helps, window trims, streamers, counter cards, circulars, etc., will bring *these* prospects into *your store* to buy.

The Homcharger's exclusive selling points will make nearly every inquiry a sale—*self-polarizing—over five ampere charging rate—approved by Underwriters.* Finished in mahogany and gold, and furnished complete with Ammeter, Charging Cable and Battery Clips, at the popular price of \$18.50.

Our LIBERAL Discounts and close Dealer Cooperation insure more sales and greater PROFITS than any other Charger on the market. Write for proposition.

The Automatic Electrical Devices Co.

141 West Third Street, Cincinnati, Ohio

THIS IS A RADIO CHRISTMAS!

INSTANT—POSITIVE—NOISELESS

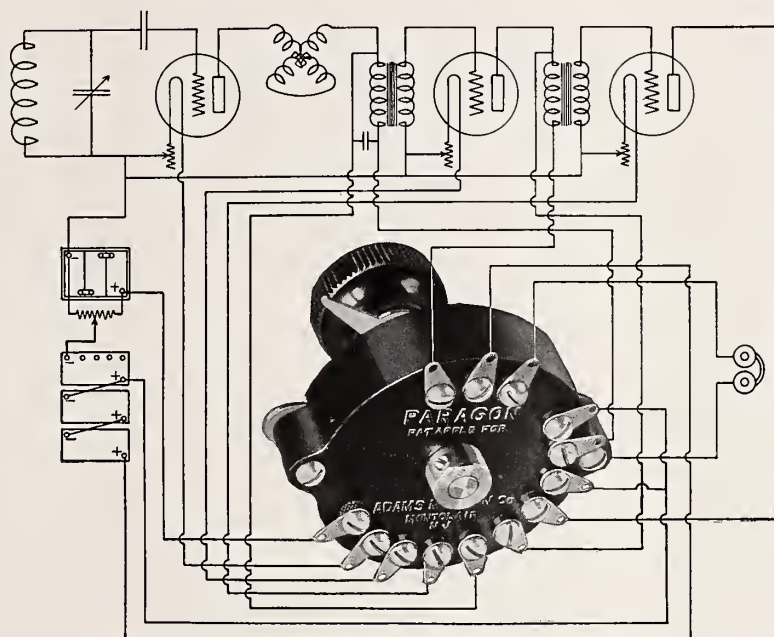

Paragon Stage Control Switch

Plugs and jacks are now obsolete. The PARAGON Stage Control Switch combines the functions of three multi-circuit jacks and the telephone plug. It controls, automatically and progressively, all the filament circuits, plate battery circuits and input and output circuits of the detector - two - stage amplifier.

Switching from stage to stage is instantaneous, positive, noiseless. All battery circuits are protected. The wiring of amplifier is simplified.

The switch base is made of molded Condensite. One piece serves as a commutator

support and housing. No moving switch parts are open to view when switch is in position on panel. A ratchet gives proper feel and locates switch position. The wiring diagram, illustrated above, shows the method of connection when this

new PARAGON switch is employed for control of detector and two-stage amplifier. The switch may also be used for an unlimited combination of vacuum tube circuits. $2\frac{3}{8}$ " in diameter, $\frac{3}{4}$ " in thickness. Price \$3.00.

We have just issued a new illustrated catalogue of Paragon radio parts. A copy is yours for the asking.

Also Manufacturers
of
PARAGON
Radio Telephone
Transmitters
V. T. Control Units
Rheostats
Potentiometers
V. T. Sockets
Amplifier
Transformers
Detectors
Control Dials
Amplifiers
Receivers
Switches
Variometers

ADAMS-MORGAN CO., 12 Alvin Ave., Upper Montclair, N. J.

PARAGON

Reg. U. S. Pat. Off.

RADIO PRODUCTS

NATIONAL RADIO WEEK, DECEMBER 23-30

THE AUDIOPHONE LOUD SPEAKER METHOD OF RECEIVING Makes You Forget It is Radio-Phone

SO LIKE THE ORIGINAL VOICE AND ORCHESTRAL INSTRUMENTS

the tone is big in volume, rich, round and free from mechanical distortion.

The result of over six years' work on "Sound Reproduction" in the laboratories of The Bristol Company, a world known engineering firm, the Audiophone is not a temporary piece of equipment, but a permanent contribution to the Radio Field.

NO AUXILIARY BATTERIES are required for magnetizing.

About one watt is necessary to give the Audiophone full volume.

Most amplifiers are two stage and designed to give good response in head phones, but there is not sufficient power to operate loud speaker, except for small audiences. For this reason it is desirable to provide another stage of power amplification and Bristol's One Stage Power Amplifier is available which will give volume enough to be easily heard in a room seating 500 persons and over, when added to one or two stage amplifier.

Our representatives are located in all parts of the country. We can come to you with demonstration. Shall we send bulletins?



AUDIOPHONE SR.
Horn 15 Inches Dia.
Price \$40.00



AUDIOPHONE JR.
Horn 11 Inches Dia.
Price \$22.50



ONE STAGE POWER AMPLIFIER
Price \$25.00

THE BRISTOL COMPANY
WATERBURY, CONN.

Santa's Taking His Orders by Radio
This Year—And They Are Demanding

FROST-RADIO



These Radio accessories are the big hit of the season. They win the whole-hearted approval of every Radio dealer. The reason is simply that every item is built to perform best the particular function for which it is intended—priced to satisfying trade-holding levels and quality unsurpassed.

FROST-RADIO Is the Front Door Key
to Radio Satisfaction!



HERBERT H. FROST

NATIONAL FACTORY DISTRIBUTORS
TO THE ELECTRICAL-RADIO JOBBER

154 W. LAKE ST. CHICAGO, ILL.

THIS IS A RADIO CHRISTMAS!

\$5.00

1500 Ohms
13,000 turns



\$7.50

2200 Ohms
16,000 turns

*Phones May Come, and Phones May Go, but
"Royalfones" Go on Forever*



*Orders may still be placed
for immediate delivery*

ROYAL ELECTRICAL LABORATORIES
MANUFACTURERS OF
Electrical and Radio Equipment
NEWARK N-J-

During the past year many phones have been advertised; but few have survived because they lacked one or another of the many qualities which are essential in the perfect phone.

Radio phones are not blanked out like sauce pans, nor are they assembled like toys. A phone is an electrical instrument. Precision and skill are required in its manufacture.

When we built the "Royalfone" we were equipped to manufacture electrical instruments. Our personnel consisted of men who know phones. These are the reasons why the "Royalfone" is mechanically perfect.

We know that every "Royalfone" will give entire satisfaction because every "Royalfone" is thoroughly tested before it leaves our factory.



Royalfone

NATIONAL RADIO WEEK, DECEMBER 23-30

"SIGNAL TRIUMPH"

COMBINATION COUPLER - METER



The "Two-in-One" Instrument

The "Triumph" Combination Coupler Meter fills the urgent need for a simple and efficient instrument to serve the purpose of both Coupler and Meter. We have solved the Problem. Our Coupler Meter is simple and efficient. There are no taps, no soldering and no complications. List Price, \$6.50 with Dial.



We are headquarters for Phone, Grid and Grid Leak Condensers. Price and quality are right. Free sample upon request.



"TRIUMPH" A1 V. T. Receiving Set
List Price \$30.00
Best Value in the Radio Market To-day

Write Us To-Day for Samples and Full Particulars

SIGNAL RADIO & ELECTRIC CORP. 64 UNIVERSITY PL. NEW YORK CITY

We present to the Radio public a new Triple Coil Calibrated Mounting

There is nothing more fascinating than the reception of Radio messages from high power stations located thousands of miles away. These stations use wave lengths between 1,000 and 25,000 meters. This is far above the receiving range of the average receiver designed for amateur broadcast reception.



This "Crown" Mounting has the following special features:

1. Made of Thermoplax, a high grade insulating material; it possesses the advantage over rubber of resisting heat to a far greater degree. It has high dielectric and mechanical strengths, is non-hygroscopic, is unaffected by atmospheric agents and will not deteriorate with age.
2. Special Locking Device to keep the coil in place, thus preventing it from being thrown out of adjustment.
3. Special Adjustable Bearing feature.
4. Special constructed Bushing, preventing wear on top and bottom plates.

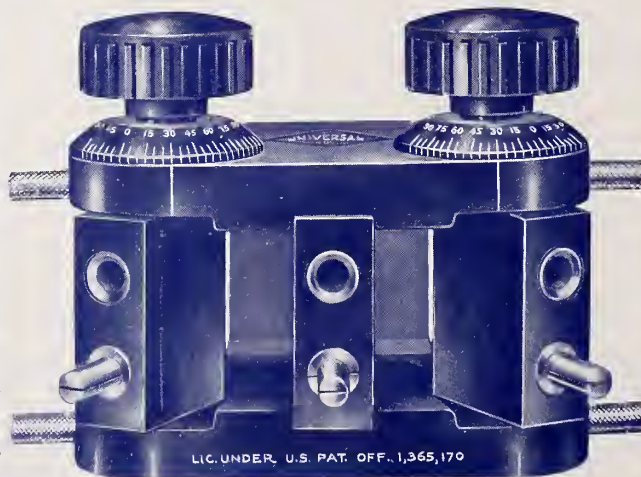

Licensed under DeForest U. S. Patent, No. 1,365,170

5. Special constructed Calibrated Dial, showing the stations tuned.
6. Positive Connections on rear of blocks.
7. Complete with Flexible Leads.
8. All Metal Parts of brass and highly nickel plated. Its high polish and fine finish give it a very attractive appearance.
9. The simplest Mounting to install on your set.

List Price

Triple Coil Mounting	\$5.00
Single Coil Mounting50
Telephone Plugs	1.00
Audio Transformer	5.00
Telephone Jacks65c, 80c, 95c
Dials 2", 3", 3 1/2"35c, 50c, 75c

DISTRIBUTORS WANTED. WRITE FOR OUR PROPOSITION AT ONCE.

CROWN RADIO MFG. CORPORATION

78 FIFTH AVENUE

NEW YORK

THIS IS A RADIO CHRISTMAS!

**Tone
Tells
Sound
Sells**



MODEL XI

PATENTS PENDING

Reg. U. S. Pat. Office

THE Oranola

PATENTS - PENDING

NO AERIAL USED

LOOP ANTENNA self-contained in artistic piano-finished cabinet eliminates any wiring by purchaser.

COMBINATION RADIO and PHONOGRAPH

RADIO ENGINEERS universally agree that radio and audio frequency transformation of energy received is best for receiving broadcasting.

That is why we use the radio and audio frequency amplification.

NO EXPENSE has been spared to make our product the best in every detail. Having passed through the experimental stage, we are prepared to stand behind each instrument with our unqualified guarantee.

OUR TALKING MACHINE (well known as THE PERFECT TALKING MACHINE), combined with our radio instrument, provides a universal means of sound reproduction without equal. Purity of tone in ample volume without distortion makes the ORANOLA almost human.

OUR KEYNOTE is simplicity of operation. No knowledge of electricity or wireless is required

SEVERAL MODELS with or without talking machine combination, listing from \$150 to \$450. Descriptive circulars and discounts on application. WIRE OR WRITE for exclusive territory proposition. DEMONSTRATIONS at our office during broadcasting periods.

ORANOLA RADIO CORPORATION

228 SEVENTH AVENUE

NEW YORK CITY

THE RADIO BUILDER SET



Shipped to customer in "knock-down" form and requiring only a screwdriver and a few moments to complete its assembly.

When finished it provides a vacuum tube set which is very selective, giving extremely loud and undistorted signals.

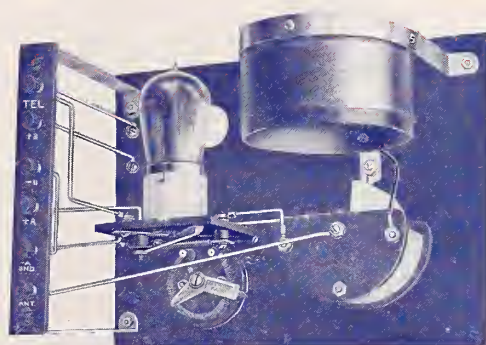

Price, \$20.00

SOME DISTRIBUTERS PROPOSITIONS STILL OPEN

ORANOLA RADIO CORPORATION

228 Seventh Ave.

::

New York City

WANTED MANUFACTURERS' AGENTS



We have still some territory open for real live personal representatives. We want men who can handle a really good proposition which gives a square deal to the buying public and at the same time ensures a good profit for themselves, and for the dealer.



Our line comprises **Rheostats, Switch Levers in all styles, including Series Parallel, Crystal Detectors, &c., &c.** These goods are all of the highest type of manufacture. They stand out. They also stand up and we stand back of them.



THE HOUSE OF PROMPT DELIVERY

That is what they call us. Orders are shipped the day they are received.

Write Now for our proposition.

We sell complete assemblies or individual parts for Rheostats and Switch Levers.

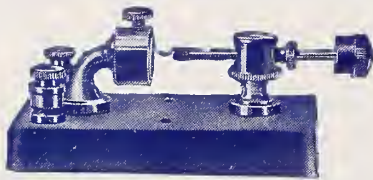

HAYDON  FENTON CO.

167 Chambers Street - New York



THE CHANGE FROM A 6-VOLT TO A 1½-VOLT TUBE

CAN NOW BE ACCOMPLISHED IN 30 SECONDS WITH THE

BURKE SOCKET ADAPTER

FOR WD-11 TUBES

(Patents Pending)

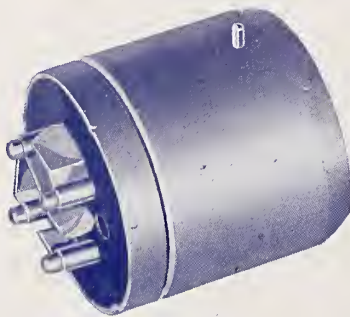

Fits Any Standard Open Base Socket
As Easy to Insert as a Tube
No Change of Hook-Up Necessary
Raises Tube Less Than 1/8th Inch
Made of Best Materials and Absolutely Guaranteed

DISTRIBUTORS, JOBBERS, DEALERS—The Burke Adapter is in demand everywhere. Act immediately and make some liberal profits. Orders are being filled strictly in rotation as received.

NATIONAL DISTRIBUTORS



845 BROAD STREET

NEWARK, N. J.

WESTERN SALES DEPT., 8905 DETROIT, AVE., CLEVELAND, O.

THIS IS A RADIO CHRISTMAS!

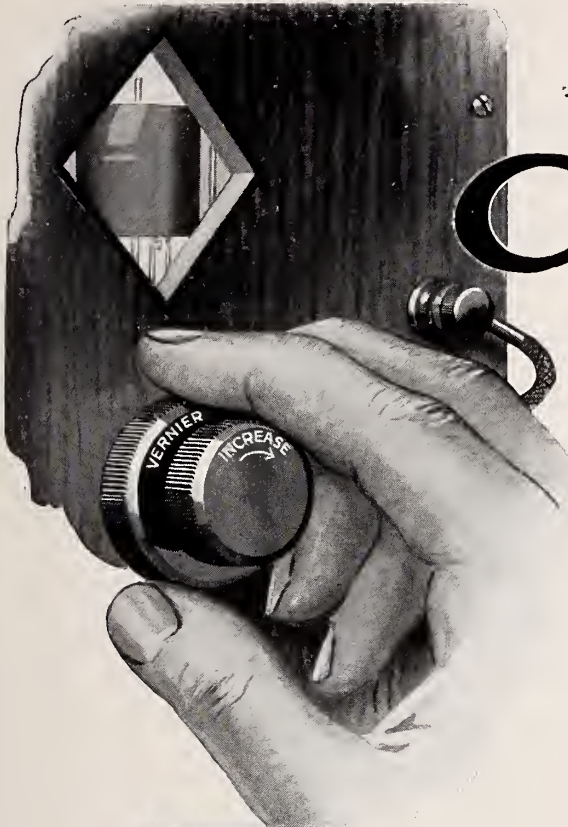

Critical!

It's that Sharp Filament Adjustment that Pulls in the Long Distance Stations

CRITICAL filament adjustment—too fine for ordinary rheostats. That's what turns those C. W. "squeals" into clear, distinct signals. Whether it's voice or code you're after—long distance or greater clarity of tone—close filament adjustment is half the battle. "Get their carrier wave and you've got their signals"—that's the sentiment of every radio fan who uses a



Vernier Rheostat

"Picks the Signals Out of Squeals"

Controls the most critical detector tube. Smaller knob gives coarse filament adjustment—larger one, an extra fine vernier adjustment. Smooth, easy action—positive contact always. Resistance coils rigidly inset in heat-resisting fibre—no shifting of coils when in operation. All metal parts, binding posts, etc., heavily nicked. The Basco Vernier Rheostat represents the highest type of workmanship in every detail.

Get more out of your set with a Basco Vernier—the super-delicate filament rheostat. Costs no more than ordinary rheostats. Ask your dealer to show you one. If your dealer or jobber can't supply you, write us direct.

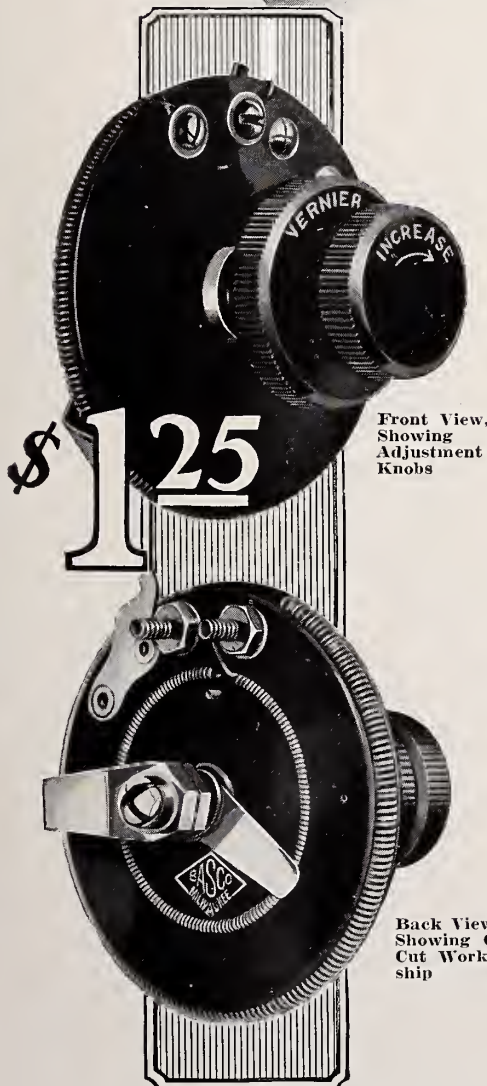

\$125

Front View. Showing Adjustment Knobs

Back View. Showing Clean Cut Workmanship

Other Basco Radio Equipment

- Super-sensitive Receivers.....(2000 Ohm).....\$6.00
 - (3000 Ohm)..... 7.50
 - Radio Frequency Transformers..... 5.00
- Also Variocouplers, Variable Air Condensers, Tube Sockets, Switch Assemblies, Crystal Sets complete or as parts, Binding Posts, etc.

Jobbers and Dealers: Write for extra liberal discount and name of our nearest local factory representative

Briggs & Stratton Co.
Milwaukee WISCONSIN

THE BEE RADIO SET

\$7.50
RETAIL



COMPLETE
For two to hear

No Phones Required. A Combined Crystal Set with
Phone and Sound Connections for Two Listeners.

*Can be used also with head phones. Can be used as an auxiliary
phone in connection with V. T. Sets for several persons to hear*

The Greatest Value on the Market
A Quick Seller. Regular Discounts to Dealers

F. W. MATTHEWS 167 Bloomfield Ave.
BLOOMFIELD, N. J.

RECORD BREAKING ACCOMPLISHMENTS!

by users of the DX Radio Frequency Transformer and JM-6
Radio-Audio Amplifier.

New York State man hears broadcasting stations in NINE-
TEEN different states using JM-6 Amplifier, which employs three
stages of DX Transformers. He used only a THREE FOOT
COIL AERIAL.

A third district amateur picked up over ONE HUNDRED
200 meter C W stations outside of 3rd and 8th districts in ONE
EVENING, USING HOUSE WIRING PLUG ATTACH-
MENT FOR AERIAL. He made his own amplifier, using three
stages of DX Transformers. Stations he heard were located in 1st,
2nd, 3rd, 4th, 5th, 6th, 8th and 9th districts.

A well known New York CONSULTING ENGINEER
made comparative tests of Radio Frequency Transformers and writes that he obtains
results with ONE STAGE of DX-1 RF Transformer equal to TWO STAGES of sev-
eral other well known makes of RF Transformers.

It Pays to Have the Best

RADIO
INSTRUMENT COMPANY, INC.
WASHINGTON, D. C.
TRADE MARK REG.

HUTCHINS BLDG., 10TH AND D STS., N. W.



Patents allowed

THIS IS A RADIO CHRISTMAS!

“Woodehorn” Loud Speaker

MAXIMUM AMPLIFICATION

NO METALLIC SOUND

NO DISTORTED TONES

\$7.50

List Price

Most Startling Loud Speaker

AT

MOST STARTLING PRICE

Stands 26" high
and has 10" bell

Complete with special
attachment for use in
connection with any
loud speaking phone.

LIBERAL DISCOUNTS
TO RECOGNIZED DIS-
TRIBUTORS AND
DEALERS

WRITE FOR
DISCOUNTS

MONEY REFUNDED IF
DISSATISFIED IN 10
DAYS

The name “Woodehorn” suggests without much effort the character of the Loud Speaker.

“Woodehorn” Loud Speaker brings you closer to the broadcasting station—the rich mellow tones are brought out in such natural clearness that you can almost feel the living breathing presence of the artist.

If you would have the tones of a rare violin—then do not hesitate to try a “Woodehorn” Loud Speaker. Its results will astound you.

Hear “Woodehorn” before you stock Loud Speakers.

MADE BY

INTER-OCEAN RADIO CORPORATION

1140 BROADWAY, NEW YORK CITY

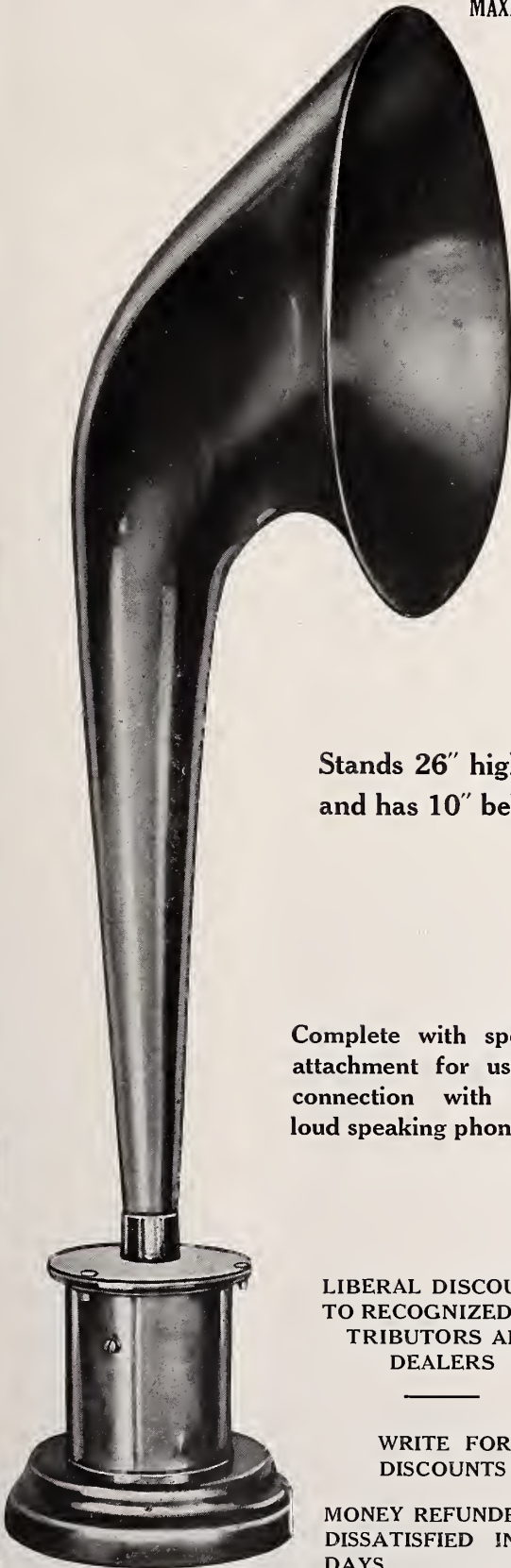

Let Our Free Service Bureau Help You Supply Your Needs

Tell us your needs and we'll put you in touch with reputable firms to the end that you will receive information on the latest and best equipment. A post card will do or use the coupon below.

- | | | | | |
|---------------------------------|---------------------------------------|---------------------------------|----------------------------------|---------------------------------|
| A | 62 Condensers, mica | I | 182 Patent wire | 238 Switches |
| 1 "A" Batteries | 63 Condensers, loading | 126 Indicators | 183 Patent wire terminals | 239 Switch levers |
| 2 Aerials | 64 Connection blocks | 127 Inductances, C. W. | 184 Plans | 240 Switch points |
| 3 Aerial wire | 77 Contract work | 128 Insulators | 185 Phonograph attachments | 241 Symbols |
| 4 Aerial protectors | 65 Control panels | 129 Insulation | 186 Plate condensers | T |
| 5 Aerial switches | 66 Condenser parts | 130 Invention developments | 187 Porcelain | 246 Tapes |
| 6 Aerial insulators | 67 Copper wire | J | 188 Porcelain cleats | 247 Telephone cord |
| 7 Aerials, loop | 68 Cords | 131 Jacks | 189 Porcelain insniators | 248 Telephone pings |
| 8 Air condensers | 69 Cord tips | K | 190 Porcelain mountings | 249 Telephone receivers |
| 9 Adapters | 70 Crystals | 132 Knock down units | 191 Porcelain tnbes | 250 Telegraph keys |
| 10 Amplifiers | 71 Crystal detector units | L | 192 Porcelain V. T. receptacles | 251 Telegraph teachers |
| 11 Amplifying units | 72 Crystal receiving sets | 136 Lead-in wire | 193 Porcelain V. T. sockets | 252 Testing Instruments |
| 12 Aluminum wire | 73 C. W. Transmitter sets | 137 Lead-in switches | 194 Precision instruments | 253 Testing clips |
| 13 Ammeters | 74 C. W. Filament heated transformers | 138 Lead-in bushings | 195 Polarity indicators | 254 Terminals |
| 14 Amplifying tnbes | 75 C. W. Inductances | 139 Lead-in insulators | 196 Plate connectors | 255 Thermometers |
| 15 Amplifying horns | 76 C. W. Power transformers | 140 Levers, Switch | 197 Paste solder | 256 Tools |
| 16 Amplifying transformers | D | 141 Lightning arrestors | 198 Phosphor-bronze wire sheets | 257 Trade marks |
| 17 Antennae, cage | 81 Detectors | 142 Lightning switches | Q | 258 Transformers |
| 20 Antenna light wire plugs | 82 Detector panels | 143 Loading coils | 307 Quenching spark gaps | 259 Transmitters |
| 18 Audio frequency transformers | 83 Detector tnbes | 144 Loading inductance | R | 260 Transmitting sets |
| 19 Automatic transmitters | 84 Detector minerals | 145 Loose complers | 308 Radio books | 261 Towers |
| B | 85 Detector units | 146 Loud speakers | 309 Radio schools | 262 Three coil mounting |
| 21 "B" Batteries | 86 Dictionary, Radio | 147 Locked lever switches | 310 Radio publications | 263 Tin foil |
| 22 Batteries, "A" | 87 Dials | 148 Lock nuts | 199 Radio frequency transformers | 264 Taping coils |
| 23 Batteries, dry | 88 Dry batteries | 149 Loop aerials | 200 Reactor, plate circuit | 265 Tubes, amplifier |
| 24 Batteries, storage | 89 Drawings | 150 Lugs | 201 Reactor, filter | 266 Tubes, detector |
| 25 Battery chemicals | 90 Diagrams | M | 202 Receiving sets | 267 Tubing, flexible |
| 26 Battery chargers | E | 313 Mailing lists | 203 Receiving head sets | 268 Tube sockets |
| 27 Battery testing instruments | 91 End mountings | 314 Metals | 204 Receiving transformers | 269 Tubes |
| 28 Battery switches | 92 Engraving | 151 Magnetic modniator | 205 Receptors | 270 Tuner and detector cabinets |
| 29 Battery rheostats | 93 Electrotypes | 152 Modulation transformers | 206 Receiver magnets | 271 Two stage cabinets |
| 30 Battery clips | F | 153 Machine screws | 207 Rectifiers | 272 Two stage amplifier unit |
| 31 Battery handles | 95 Fibre spools | 154 Magnet wire | 208 Rectifying tnbes | U |
| 32 Battery potentiometers | 96 Fan switches | 155 Magazines, Radio | 209 Regenerative sets | 276 Unit type receiving sets |
| 33 Binding posts | 97 Filter reactors | 156 Mica | 210 Rheostats | 277 Unassembled sets |
| 34 Books | 98 Fixed condensers | 157 Mica diaphragms | 211 Rheostat wire | V |
| 35 Brass parts | 99 Fire extingnshers | 158 Mica condensers | 212 Rods | 281 Vacuum tubes |
| 36 Bushings | 100 Filament rheostat | 159 Mica diaphragm transformers | 213 Rotary lever switches | 282 Vacuum tube sockets |
| 37 Bulbs | 101 Filter coils | 160 Microphone transformers | 214 Rotary spark gaps | 283 Variable condensers |
| 38 Buzzers | 102 Flashlights | 161 Milliammeters | 215 Rotary variable condensers | 284 Variometers |
| O | 103 Fuse terminals | 162 Milli-voltmeters | 216 Rubber parts | 285 Varlo couplers |
| 41 Cabinets | G | 163 Motors | 217 Rotors | 286 Variable grid leak |
| 42 Cam switches | 106 Gaps, Spark | 164 Motor generators | S | 287 Vernier adjusters |
| 43 Carbon potentiometers | 107 Generators | 165 Mounting coils | 221 Safety switches | 288 Vibrators |
| 44 Change-over switches | 105 Glass | 166 Minerals | 222 Safely fuses | 289 Vocalouds |
| 45 Charging rectifiers | 108 Grid condensers | 167 Mountings | 223 Sliders and rods | 290 Voltmeters |
| 46 Choke coils | 109 Grid leaks | N | 224 Sockets | 291 Vulcanized fibre sheets |
| 47 Cat whlskers | 110 Grid leaks, variable | 171 Name plates | 225 Soft metal | 292 V. T. receiving sets |
| 48 Cap nuts | 111 Grid coils | 172 Nickel parts | 226 Shielded dials | 293 Varlogrid leak |
| 49 Carbon walls | 112 Ground clamps | 173 Nuts | 227 Short wave sets | 294 V. T. detector nmits |
| 50 Cardboard tnbes | 113 Ground wires | O | 228 Solder | 295 V. T. control units |
| 78 Charts | 114 Ground switches | 176 One stage amplifier units | 229 Solder, bar | 296 V. T. receptacle |
| 51 Chopper, rotary | H | 177 Oscillation transformers | 312 Soldering irons (electric) | W |
| 52 Clamps | 116 Headsets and bands | P | 230 Spark transformers | 297 Washers |
| 53 Clips | 117 Honeycomb coils | 178 Panels | 231 Spark coil selectors | 298 Watch case receivers |
| 54 Coils | 118 Honeycomb mountings | 179 Panel plugs | 232 Spaghetti tnbing | 299 Wattmeters |
| 55 Coil mountings | 119 Honeycomb plugs | 180 Panel controls | 233 Special apparatus | 300 Wavemeters |
| 56 Coil plugs | 120 Hook switches | 181 Paper tubes | 234 Spark gaps | 301 Wave tuner |
| 57 Coils, spark | 121 Horns | 311 Patent registration | 235 Spring clips | 302 Wire |
| 58 Condensers | 122 Hydrometers | Q | 236 Storage batteries | 303 Wire, aerial |
| 59 Condensers, fixed | | 182 Patent wire | 237 Sectional receiving sets | 304 Wire phosphor bronze |
| 60 Condensers, variable | | 183 Patent wire terminals | | 305 Wire, copper clad |
| 61 Condensers, air | | 184 Plans | | 306 Wire, magnet |

Note the number of the item you want to buy—then check the corresponding number in the coupon below and mail to us.

---TEAR OFF HERE---

1	2	3	4	5	6	7	8	9	10	11	12	13	14	15	16	17	18	19	20	21
22	23	24	25	26	27	28	29	30	31	32	33	34	35	36	37	38	39	40	41	42
43	44	45	46	47	48	49	50	51	52	53	54	55	56	57	58	59	60	61	62	63
64	65	66	67	68	69	70	71	72	73	74	75	76	77	78	79	80	81	82	83	84
85	86	87	88	89	90	91	92	93	94	95	96	97	98	99	100	101	102	103	104	105
106	107	108	109	110	111	112	113	114	115	116	117	118	119	120	121	122	123	124	125	126
127	128	129	130	131	132	133	134	135	136	137	138	139	140	141	142	143	144	145	146	147
148	149	150	151	152	153	154	155	156	157	158	159	160	161	162	163	164	165	166	167	168
169	170	171	172	173	174	175	176	177	178	179	180	181	182	183	184	185	186	187	188	189
190	191	192	193	194	195	196	197	198	199	200	201	202	203	204	205	206	207	208	209	210
211	212	213	214	215	216	217	218	219	220	221	222	223	224	225	226	227	228	229	230	231
232	233	234	235	236	237	238	239	240	241	242	243	244	245	246	247	248	249	250	251	252
253	254	255	256	257	258	259	260	261	262	263	264	265	266	267	268	269	270	271	272	273
274	275	276	277	278	279	280	281	282	283	284	285	286	287	288	289	290	291	292	293	294
295	296	297	298	299	300	301	302	303	304	305	306	307	308	309	310	311	312	313	314	315

Service Bureau The Radio Dealer,
1133 Broadway, New York City.

We are interested in buying radio equipment and have circled the numbers on this coupon of the items we are ready to buy now. Please have manufacturers of these lines quote us dealers' prices.

Name.....

Address.....

.....
We are
—Retailers
—Jobbers
..... 1922. —Manufacturers



RADIO FREQUENCY AMPLIFICATION

MU-RAD Receiving Sets are the original product of independent experiments and experience of leading radio engineers. Five years intensive development of Radio Frequency Amplification have given Mu-Rad Sets exclusive points of difference—points that are well worth your consideration. First, unequalled **sensitivity**. Distances in excess of 1000 miles have been covered by Mu-Rad Sets using a 3-inch diameter, inside loop aerial. Second, the **selectivity** of Mu-Rad Sets which permits differentiation of stations 1% off tune, and third, the **simplicity of operation**. All tuning can be done with one hand. The high selectivity is retained by the use of patent circuits and Mu-Rad R F Amplifier Transformers.



The MA-12

Three stages of radio frequency amplification and detector. With 2 telephone plugs\$128.00

The MA-13

Three stages of radio frequency amplification, detector and two stages of audio frequency amplification. With 2 telephone plugs, \$160.00



SPECIFICATIONS

- Cabinet:** Solid mahogany, varnished piano finish.
- Panel:** Mirror polished black Radion.
- Dials:** Non-warping metal—prevent body capacity effects.
- Condenser:** 21 plate, permanent capacity.
- Modifier:** A circuit unit, dial operated from panel, for controlling signal strength and stabilizing circuits.
- Rheostats:** Special sector wound, smooth operation, positive contact.
- Filament Switch:** Special positive toggle knife-blade construction.
- Binding Posts:** Polished nickel, all in rear, plainly marked.
- Name Plates:** Extra deep reversed etched, black with satin silver high-lights.
- Wiring:** Tinned copper bus-wire, all interior metal white nickel finish.

1000 Mile Range Guaranteed

Each MU-RAD set is sold with an attached guarantee of 1000 mile reception under average conditions using a small loop aerial



Three Types

- Type T-11 for the first stage..\$6.00
- Type T-11A for the second stage 6.50
- Type T-11B for the third stage 7.00

MU-RAD R F AMPLIFYING TRANSFORMERS

200-600 Meters—Air Core

The same transformer that gives to MU-RAD Receivers their extreme R F Amplification. The skill of MU-RAD Radio engineers has been concentrated on this instrument until all the objections common to most transformers were entirely eliminated. The absence of the usual iron core increases efficiency through elimination of iron losses. No metal to produce undesirable capacity effects and eddy current loss. So very accurately are MU-RAD Transformers made that their performance varies less than half of one per cent.

MU-RAD Apparatus brings good will and better profit. Write for proposition

MU-RAD LABORATORIES, INC.

800 FIFTH AVENUE, ASBURY PARK, N. J.

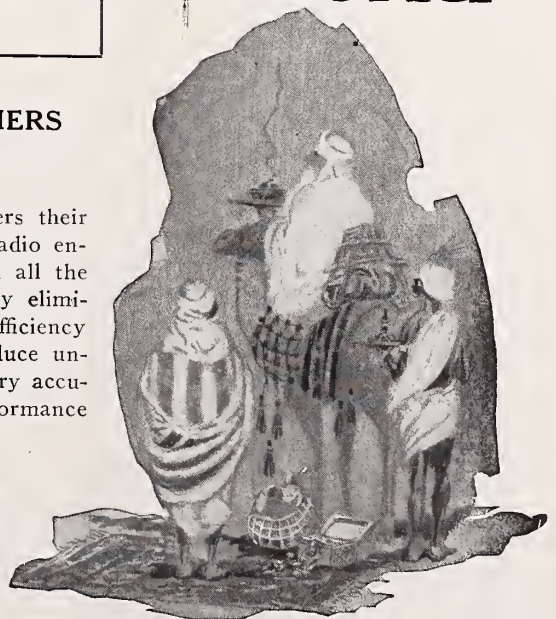

First In The Field

The Radio Dealer (monthly edition) leads the field of Radio publications *because it has the circulation.*

The following analysis is of PAID Circulation, note printer's statement of press run.

Circulation By States
THE RADIO DEALER

Alabama..... 21	East Orange.... 10
Arizona..... 11	Elizabeth..... 17
Arkansas..... 5	Jersey City.... 44
California..... 286	Newark..... 191
Los Angeles.... 34	Paterson..... 19
Oakland..... 13	Trenton..... 27
San Francisco.. 67	New Mexico..... 2
Colorado..... 28	New York..... 1094
Denver..... 14	N. Y. City.... 710
Connecticut..... 185	Brooklyn.... 144
Bridgeport.... 12	Buffalo..... 28
Hartford..... 17	North Carolina.... 27
New Haven.... 12	North Dakota.... 5
Waterbury.... 12	Ohio..... 236
Delaware..... 11	Cleveland.... 34
Wash., D. C..... 34	Cincinnati... 18
Florida..... 25	Columbus.... 13
Georgia..... 42	Toledo..... 22
Idaho..... 13	Oklahoma..... 15
Illinois..... 537	Oregon..... 11
Chicago..... 337	Pennsylvania.... 240
Indiana..... 87	Pittsburgh... 84
Indianapolis.. 18	Philadelphia.. 68
Iowa..... 35	Rhode Island.... 14
Kansas..... 33	Providence... 12
Kentucky..... 5	South Carolina... 9
Louisiana..... 23	South Dakota.... 2
Maine..... 12	Tennessee..... 14
Maryland..... 10	Texas..... 75
Massachusetts... 224	Dallas..... 43
Boston..... 88	Utah..... 13
Michigan..... 183	Vermont..... 12
Detroit..... 109	Virginia..... 20
Minnesota..... 41	Washington..... 37
Mississippi..... 14	West Virginia... 19
Missouri..... 195	Wisconsin..... 106
Montana..... 18	Milwaukee... 63
Nebraska..... 24	Wyoming..... 2
New Hampshire... 10	Canada..... 41
New Jersey..... 662	Foreign..... 185
Atlantic City.. 19	
Camden..... 18	
	Tot. Pd. Circ't'n.. 4958

The Williams Printing Company

Complete Manufacture of Publications

Eleventh Avenue, 36th to 37th Streets

New York City

October 2, 1922.

The Radio Dealer
1133 Broadway,
New York City.

Attention Mr. L. A. Nixon

Dear Sir:

I, Roy L. Atwood, Manager of The Williams Printing Company, hereby testify that we have printed and bound Eight Thousand (8000) copies of the current issue of the "Radio Dealer".

Very truly yours,

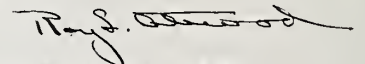

for THE WILLIAMS PRINTING COMPANY.

State of New York)
) Ss;
County of New York)

On this second day of October 1922, before me came Roy L. Atwood to me known to be the person who subscribed the foregoing instrument and acknowledged that he executed the same freely and for the purposes therein set forth.

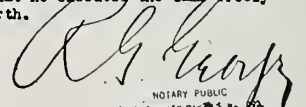

NOTARY PUBLIC
N. Y. COUNTY CLERK'S NO. 972
N. Y. COUNTY REGISTER NO. 4224
BY COMMISSION EXPIRES MARCH 31, 1924

First In The Field

THE RADIO DEALER

1133 Broadway, New York, N.Y.

35 South Dearborn St., Chicago, Ill.

THE FIRM BEHIND

1897

1922

The Set that Grows



FOR twenty-five years the firm behind the E-D radio sets has been manufacturing delicate, high-grade electrical appliances. Its reputation amongst dealers for its universal "square-dealing" policy is excelled only by the reputation of its products. Today, the Company stands solidly behind every switch and panel made on any one of the three floors in our own building shown here.

The E-D set comes in unit-panels matching each other as illustrated. The radio novice can begin his set with only two E-D panels and then purchase more as his pocketbook permits. This exclusive feature assures you of endless sales and re-sales. You can always "Sell 'em Some More" E-D equipment!

You'll never regret the day that you wrote E-D. Tell us NOW to send you full information—and the next time you're in Philadelphia drop in and inspect our plant. We want to meet you.

The E-D Manufacturing Co.
33rd and Arch Streets
PHILADELPHIA, PA.

"AEREX" Long Range Radio Receiver Model RA-4

2 Stages Radio Frequency Amplification

2 Stages Audio Frequency Amplification

Using Only Two Amplifier Tubes

Features

1. Longer mile range
2. Supersensitive
3. Quality workmanship
4. Quality material
5. Saving of batteries
6. Saving of vacuum tubes, only three required to perform the work of five
7. Adapted for use of loop or outside aerials
8. All binding posts on back, no messy wiring
9. Four stages of amplification.
10. Attractive appearance

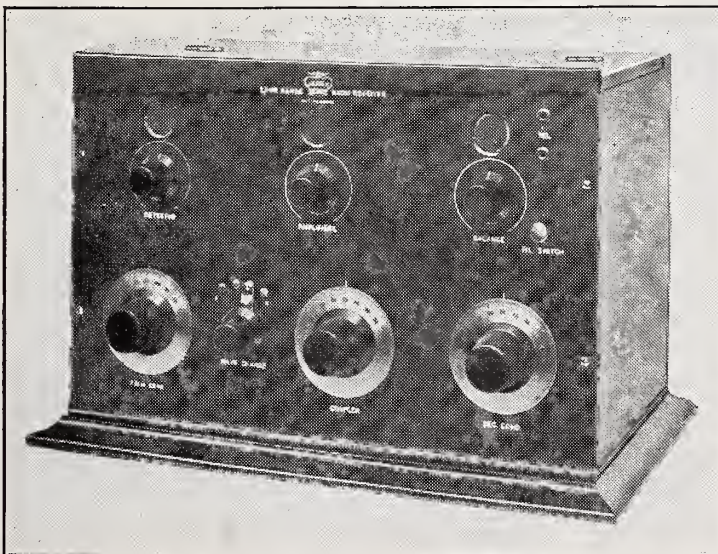

This set is guaranteed to receive broadcasting within a radius of 400 miles. Provision is made for using a loop aerial. The marvel set. Equal to super-regeneration. A long range radio receiving set which is also adapted for use with a loop antenna for local broadcasting. Long Range sets will be in demand this year. Will you be able to supply such a set in a THREE TUBE UNIT. Some territories still open for live dealers.

LIST PRICE, \$125.00 Discounts Upon Request

SPECIFICATIONS

- Cabinet—Solid Mahogany. Rubbed piano finish. 16 x 11 x 7.
- Panel—Genuine Bakelite beautifully engraved.
- Dials—Three-inch metal engraved.
- Knobs—Tapered Bakelite Knobs.
- Condensers—Permanent capacity.
- Rheostats—Specially designed, positive contact, smooth action.
- Transformers—2 Radio Frequency and 2 Audio Frequency.
- Sockets—Standard moulded Bakelite.
- Binding Posts—Hard rubber composition. All mounted on back panel, plainly marked.
- Circuit—Patents pending. 2 stage radio frequency amplifications, 2 stage audio frequency amplifications, one detector using only three vacuum tubes to perform the work of five.

AEREX RADIOPHONE CORP., 342 Madison Avenue, NEW YORK CITY

Still a Chance for the Xmas Trade

THERE are thousands of families in your community, who, though vitally interested in receiving Radio Broadcasting, are unable to spend a high price for vacuum tube receiving sets. It is to satisfy this great number of folks, primarily, that we have conceived the

Simple-X Crystal Radio Receiver

Superior to Sets Costing Five Times the Price of This Wonderful Set, Only **\$4.75**

THE Simple-X will receive broadcasting within a radius of 25 miles—the only set equipped with the Simple-X Fool-Proof Detector and the Mul-Ti-Tec Crystal—a thousand crystals in one. No fussing to find sensitive spot, no loss of time or interruption of program. Built with Roller Slides to give smooth, constant contact. No wearing or short-circuiting of coil wires due to frictional scraping. The only set having a flat coil and indicating sliders. Awarded Certificate of Excellence by N. Y. Eve. Mail and approved by the N. Y. Tribune Institute.

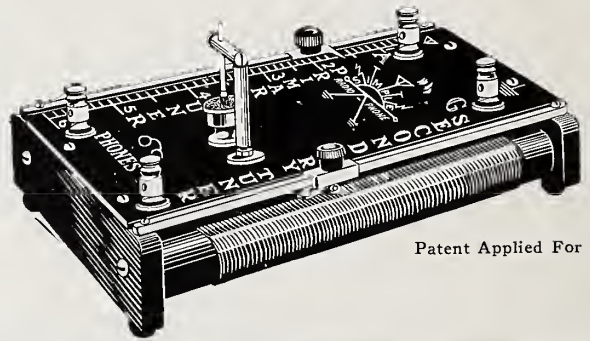

Patent Applied For

For Discount Schedule Write, Wire, or Call
CARAGOL-CLARKE CO., INC.
 82 Beaver Street :- New York City

KING QUALITY ALL THE NAME IMPLIES RADIO APPARATUS

The KING QUALITY Line Radiates Quality

KING QUALITY BINDING POSTS

of genuine Bakelite

An article of unsurpassed beauty and service—the peak of perfection in design. Diamond finished knurl predominates as an exclusive feature. Highly polished finish.

EVERY article in the King Quality line is the Best that modern machinery and human skill can produce.

The only character of radio goods you want to carry today are those made of finest materials, accurate in design and workmanship, superior in finish and excellent in appearance. You'll find all these in

the KING QUALITY line

We use genuine Bakelite Parts exclusively made in our own Bakelite plant.

JOBBER AND DEALERS:—Valuable territory now open. Write today for King Quality proposition.

RADIO APPARATUS DIVISION
 King Sewing Machine Co., Buffalo, N. Y.

Lower in Price :- Highest in Quality

KING QUALITY RHEOSTATS

The resistance value 6.5 ohms. Brass Panel Bushing Special feature, which insures smooth operation and solid construction. Bakelite Base and Knob. Resistance wire wound on heat resisting hard fibre strips.

KING QUALITY SWITCH LEVER

With perfect mechanical and electrical features. Mirror finish Bakelite knob with polished knurl that glows like a diamond. 3 sizes: 1 in., 1 1/4 in., 1 1/2 in.

THIS IS A RADIO CHRISTMAS!

Here They Are At Last!

Two Non-Technical Books Answering Every Question of the Radio Fan

THE RADIO TELEPHONE HANDBOOK

By H. G. CISIN, M. E.

A Book of Authentic Information About Radio. It explains—

- The Operating Principles of Radio*
- How Crystal Detectors Work*
- How the Vacuum Tube Works*
- The Principles of Regeneration*
- How Amplification May Be Obtained*
- How to Check Up the Condition of the Storage Battery*
- Causes and Remedies for Weak Signals and Local Noises in Connection with Vacuum Tube Sets*
- When an Indoor Aerial Can Be Used*
- What the Loop Aerial Is*
- What Batteries, If Any, Are Necessary*
- When Shielding Is Necessary*

and many other important branches of Radio. It defines in language which the novice can understand.

- | | | |
|------------------------------------|--------------------------------------|-----------------------------|
| <i>Aerial</i> | <i>Ball-Type Voltmeter</i> | <i>Coil Receiver</i> |
| <i>Alternating Current</i> | <i>Bakelite</i> | <i>Compass</i> |
| <i>Alternation</i> | <i>Bellini-Tosi Direction Finder</i> | <i>Condenser</i> |
| <i>Alternator</i> | <i>Blocking Condenser</i> | <i>Connection Block</i> |
| <i>Ampere</i> | <i>Bridging Condenser</i> | <i>Counterpoise</i> |
| <i>Amplifier</i> | <i>Broadcasting</i> | <i>Coupling</i> |
| <i>Ammeter</i> | <i>Buzzing</i> | <i>Coupling Condenser</i> |
| <i>Anode</i> | <i>By-Pass Condenser</i> | <i>Coupling Transformer</i> |
| <i>Antenna</i> | <i>"C" Battery</i> | <i>Crystal Detector</i> |
| <i>Antenna Coil</i> | <i>C.W.</i> | <i>Cycle</i> |
| <i>Atmospheric Disturbance</i> | <i>Capacity</i> | <i>Detector</i> |
| <i>Audibility</i> | <i>Carborundum</i> | <i>Diaphragm</i> |
| <i>Audio Frequency Transformer</i> | <i>Cascade Amplification</i> | <i>Di-Electric</i> |
| <i>Audion</i> | <i>Choke</i> | <i>Direct Current</i> |
| <i>Autodyne Receiver</i> | <i>Cat-Whisker</i> | <i>Discharge</i> |
| <i>Auto-Transformer</i> | <i>Change-Over Switch</i> | <i>Dummy Aerial</i> |
| <i>"B" Battery</i> | <i>Charging Rectifier</i> | <i>Dynamotor</i> |
| | <i>Choke-Coil</i> | <i>Dynatron</i> |
| | | <i>Earth Connection</i> |

AND NUMEROUS OTHERS

Mr. Hall of Ludwig Hommel & Co., Pittsburgh, Pa., says "We have given The Radio Telephone Handbook careful study and we believe that it is a very good publication. It should meet with very popular demands among those interested in radio."

PRACTICAL ELECTRICAL ENGINEERING

By H. G. CISIN, M. E.

The easiest book to understand which has ever been written on electrical engineering.

No higher mathematics—no symbols—no Greek letters—no algebra.

It tells in simple language the basic principles of direct current electrical engineering.

Among the many well-known concerns that have ordered PRACTICAL ELECTRICAL ENGINEERING are the following:

- | | |
|--|---|
| The American Tobacco Co., Baltimore | Maryland Casualty Co., Baltimore, Md. |
| The Wahl Co., Chicago, Ill. | Delaware County Tel. Co., Manchester, Ia. |
| National Blank Book Co., Holyoke, Mass. | Gates Rubber Co., Denver, Colo. |
| Coes Wrench Co., Worcester, Mass. | Willard Storage Battery Co., Cleveland |
| Elgin National Watch Co., Elgin, Ill. | Graham Glass Co., Evansville, Ind. |
| American Car and Foundry Co., N. Y. | Ludwig Baumann & Co., New York |
| Pittsburgh Plate Glass Co., Ford City, Pa. | Denver & Salt Lake R. R., Denver, Colo. |
| Hammermill Paper Co., Erie, Pa. | Kentucky Wagon Mfg. Co., Louisville, Ky. |
| Hanna Paper Corp., New York | W. F. Hall Printing Co., Chicago, Ill. |
| National Cloak & Suit Co., New York | Humble Oil & Refining Co., Houston, Tex. |
| Morse Dry Dock & Repair Co., Brooklyn | Ashtabula Dock Co., Ashtabula, Ohio |
| Ward Baking Co., Brooklyn, N.Y. | Florence Thread Co., Florence, N. J. |
| Bohn Refrigerator Co., St. Paul, Minn. | Cottage Planing Mill Co., Everett, Pa. |
| Ward Baking Co., New York | National Electric Water Heater Co., N. Y. |
| Thos. G. Plant Co., Boston, Mass. | General Realty Co., Philadelphia, Pa. |
| Dominion Textile Co., Ltd., Montreal | Ohio State University, Columbus, Ohio |
| Western Clock Co., La Salle, Ill. | Loews Theater, New York |
| Hotel Astor, New York | 14th Street Theater, New York |
| J. M. Horton Ice Cream Co., New York | Shuberts' Crescent Theater, Brooklyn |
| Westinghouse Building, Pittsburgh, Pa. | Keith's Jefferson Theater, New York |
| United Piece Dye Works, Lodi, N.J. | Grove Park Inn, Asheville, N. C. |
| Jamestown Worsted Mills, Jamestown, N. Y. | Elton Hotel, Waterbury, Conn. |
| R. J. Reynolds Tobacco Co., Lexington, Ky. | |

AND NUMEROUS OTHERS

A WONDERFUL COMBINATION

PRACTICAL ELECTRICAL ENGINEERING, \$2.00

(Bound in cloth—324 pages—71 Illustrations)

THE RADIO TELEPHONE HANDBOOK, \$1.00

(Bound in Flexible Buckeye—90 pages—Illustrated)

COMBINATION OFFER

\$2.50 FOR BOTH!

NATIONAL RADIO WEEK, DECEMBER 23-30

ALLIED
ENGINEERING
INSTITUTE
1400 Broadway, N. Y. City

Gentlemen:
Send
..... Practical Elec. Eng.
..... The Radio Telephone Handbook
Find Enclosed \$.....

Name.....
Address.....
City.....
State.....

FILL THIS OUT, TEAR OFF AND MAIL.

EISEMANN

THE advanced design of Eisemann radio units has met with instant favor wherever shown. The concave dial gives a mounting flush with panel. In appearance it is in marked contrast to the usual protruding knobs and dials. Another distinctive feature is the complete self-insulation of each part, making possible the use of a panel of wood, metal, or any other material.

Variometer

Both Rotor and Stator forms moulded of Bakelite. Extremely light in weight. Electrical losses reduced to a minimum.

Price each \$8.75



Variocoupler

The primary Tap Switch for tuning the antenna circuit is an integral part of the Variocoupler. No external switch, shielding, dial, or knob necessary.

Price each \$10.50



In addition to the units illustrated, other Eisemann products are Head phones, Vacuum Tube Sockets and Audio Frequency Transformers—all made to the highest electrical and mechanical standards.

Variable Condenser *Balanced type*

Rigidly constructed. Metal bearings front and rear. Rotary plates balanced, assuring constancy of setting. Vernier equipped.

Capacity .001 mfd.
Price each \$7.50

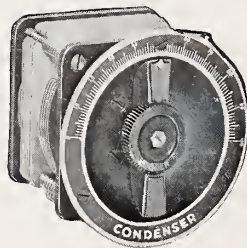

Variable Condenser *Unbalanced type*

Aluminum plates accurately spaced eliminating any possibility of "shorts" between plates and assuring a more constant air gap. Vernier equipped.

Capacity .001 mfd.
Price each \$7.00

Capacity .0005 mfd.
Price each \$6.50

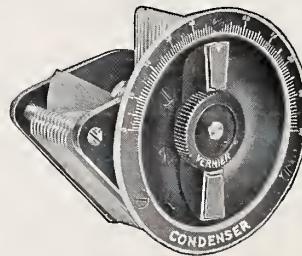

In preparation: Filament Rheostats, Potentiometers, etc.

Eisemann Products are distributed through the Jobbing Trade. If you are unsuccessful in obtaining Eisemann Products from your own jobber, write us direct.

EISEMANN MAGNETO CORPORATION

William N. Shaw, President

DETROIT

BROOKLYN, N. Y.

CHICAGO

THIS IS A RADIO CHRISTMAS!

3 Y Q Transformers for Christmas Profits — and all the rest of the year

We don't expect dealers to overload themselves with even such a high grade product as the 3 Y Q Audio Frequency Transformer and we thoroughly appreciate the fact that many dealers are still overstocked, due to dullness that has been so general in the radio business. But when you do place an order for more transformers, be sure to get the 3 Y Q, because

1. It is a high grade specialty built up to the highest quality and not down to a price.
2. It creates good will in your customers and proves to them that you are a dependable retailer of efficient radio parts and especially because

3. The 3 Y Q is a business getting profit maker *all* the year—not just a holiday sale catcher. You can't go wrong with the 3 Y Q—and you'll want a sufficient supply when business does open up, which we hope it will do soon for you. So remember the name—3 Y Q—and order from your jobber.

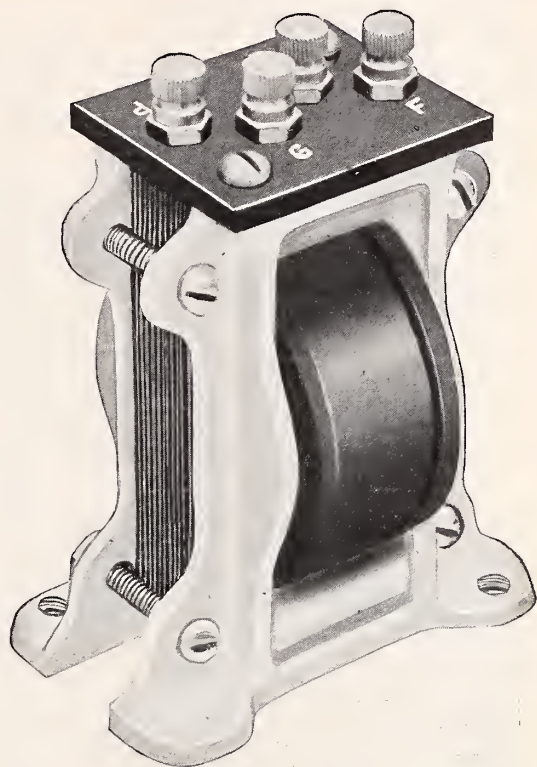

RETAIL PRICE, \$6.00

**ORDER FROM YOUR
JOBBER**

**“Amplification
without
Distortion”**

Federal Institute of Radio Telegraphy

Second and Federal Streets

CAMDEN, N. J.

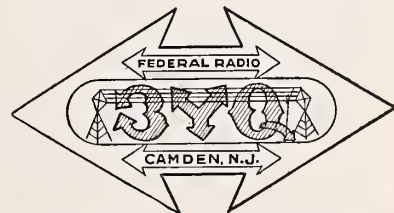



Extremely sensitive and distinct—pure and clear tonal qualities. 3000 ohms.
List \$8.00

Quick Service

in

WIRELESS



APPARATUS

Radio Apparatus

Also DICTOGRAPH Head Sets and Loud Speakers

Wire or phone us your orders now to ship by express for your Christmas Sales.

Be prepared to meet the certain demand for radio presents and that of the boys who receive cash for Christmas.

We are fully prepared to render you prompt service and attractive discounts on a full line.

Don't Delay

**Frederick H. Pruden
Incorporated**

991 F
Lerner Bldg.
Journal Sq.

Jersey City
New Jersey

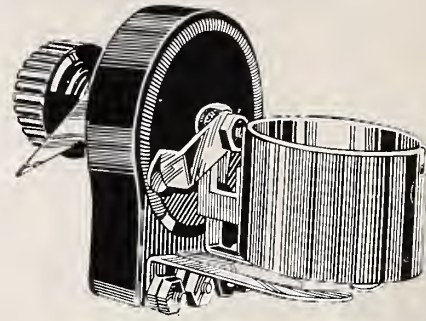

Ajax Socket Rheostat — A device for which amateurs and professionals have long been waiting. Eliminates wiring between socket and rheostat. List \$2.00.



Bestone Variocoupler—Moisture repellent, dielectric and is wound with double silk covered wire. Assures maximum selectivity.

712 with 3-inch dial, 150-600 meters.
List \$8.00.

714 with 3-inch dial, 150-580 meters.
List \$7.00.

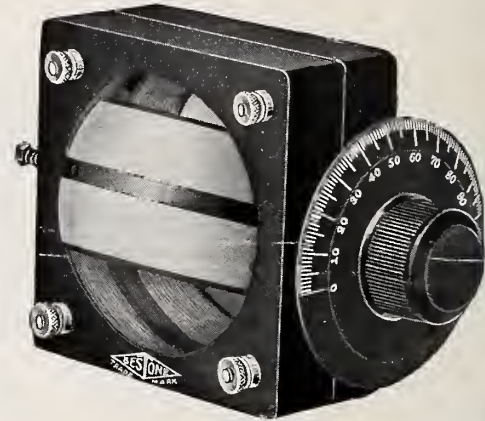

Bestone Variometer — Molded, extreme mechanical strength will not warp or shrink. No. 711. List \$6.25.



Bestone Potentiometer — A correctly designed potentiometer with 2-inch molded dial. 300 ohms resistance. List \$1.50.
Bestone Rheostat. With 2-inch dial assures accurate control of filament current.
List \$1.10.



“DICTOGRAPH” LOUD SPEAKER
The last word in simplicity and efficiency.
List \$20.00, including a five-foot cord.

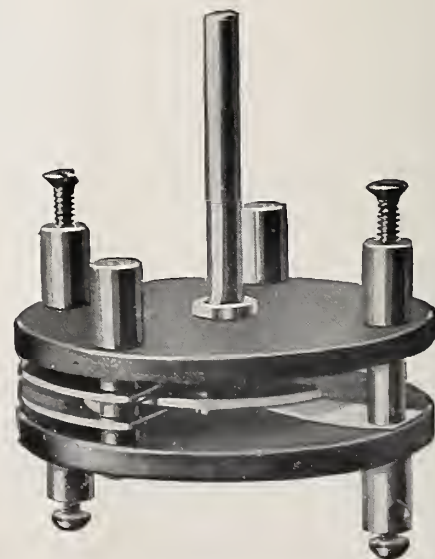

Vernier Condenser, the best of its kind. Capacity .000246 Mfd.
List without dial.....\$1.50
List with dial.....\$1.75

THIS IS A RADIO CHRISTMAS!

RADIO TRADE PICTURES



Photo by Bachrach

Gordon Sleeper

Through an error in a photograph gallery, THE RADIO DEALER last month printed the picture on the left over the caption of "M. B. Sleeper," when in fact it was his brother, Gordon, who is also associated with him in the Sleeper Radio Corporation. The portrait of Milton B. Sleeper, Jr. is shown on the right



© *Bachrach*

Milton B. Sleeper, Jr.

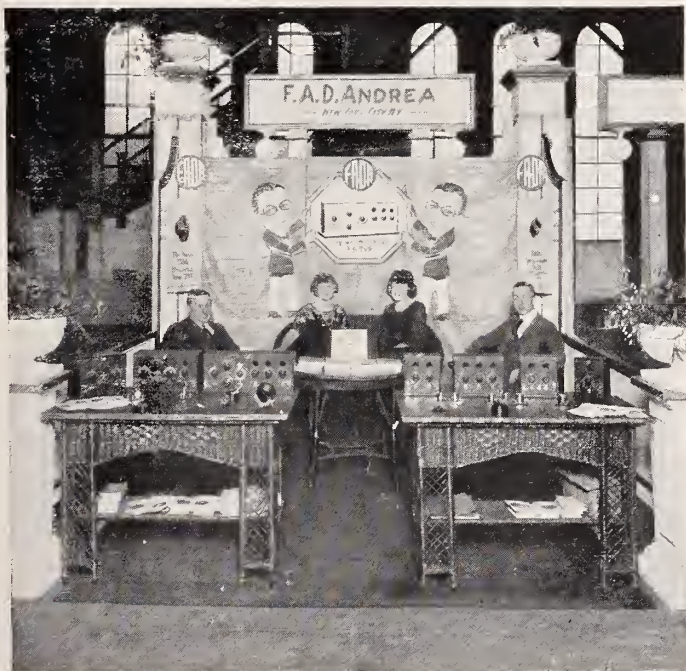

This illustration shows the booth of F. A. D. Andrea of 1581 Jerome Avenue, New York City, the manufacturer of Fada equipment, as it appeared at the recent Chicago Radio Show

Elmer E. Bucher, the sales manager of the Radio Corporation of America, heads the Dealers' Committee on National Radio Week



EMPIRE OILED TUBING

sometimes called spaghetti

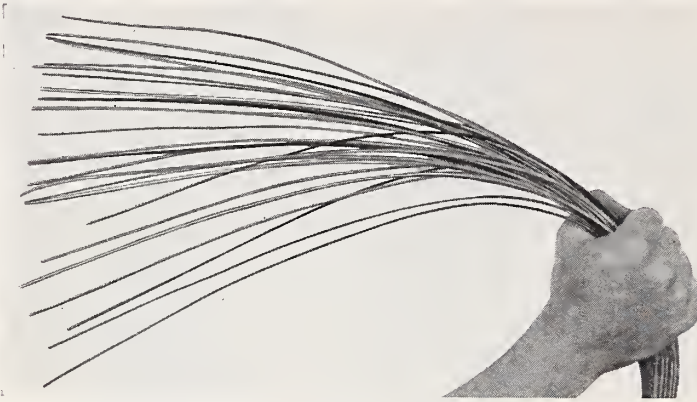

EMPIRE INSULATOR
REG. U.S. PAT. OFF.
MADE IN U.S.A.

Empire Tubing builds solid business for Radio Dealers. It brings both amateur and professional back for more, because the purchaser and his friends like its superior flexibility, durability, smoothness, high dielectric strength and insulating value. Empire Tubing is a standard product among engineers throughout the electrical industry. Made in black and white, yellow and other colors, in all radio sizes, 36 inch lengths.

Send today for Empire Tubing samples and quotations on 500, 1,000, 5,000, 10,000, 20,000 foot lots. Get acquainted with our other time tested radio insulation products

MICA INSULATOR COMPANY

68 Church Street, New York. 542 So. Dearborn Street, Chicago. Works: Schenectady, N. Y.
Agencies—The Monroe Brass & Wire Co., Cincinnati; G. Arthur Morrell, Cleveland; Electrical Specialty Co., San Francisco and Los Angeles

2022-F

THE - ONLY - KNOB - AND - DIAL - WITHOUT - A - SET - SCREW



The unsightly and troublesome SET-SCREW is at last eliminated. No more loosening of dials, splitting the head of the set-screw, or stripping of threads, perhaps ruining the dials.

To mount the TAIT KNOB AND DIAL simply hold the dial with one hand and screw on the knob with the other; a few seconds does it. No tools are necessary; when fastened it is self centering and self aligning. Numerals at correct angle for the best visibility.

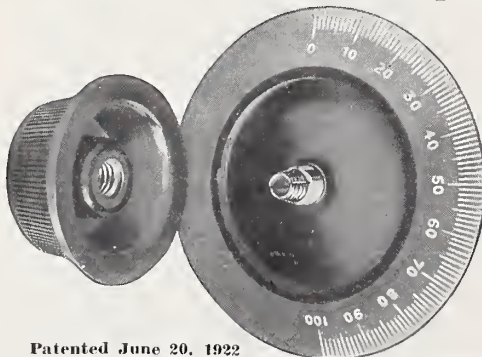

Patented June 20, 1922
Also Licensed Under Grebe Design Patent No. 57900

List
Price
4 in.—\$1.50
3 in.—\$1.00

TAIT - KNOB - AND - DIAL - CO., Inc.

MANUFACTURERS

11 EAST 42nd STREET

NEW YORK

THIS IS A RADIO CHRISTMAS!

For Christmas - Sell Radio Sets and Parts

Why? Because—

1. Your margin of profit is high and your turnover is quick.
2. You need not carry a large stock, but can use our stock to draw upon as you require it.
3. Each Set you sell is a living advertisement for you—it will sell other installations to neighbors and friends. It brings repeat orders for renewal parts and additions.
4. Radio is easy to sell. A man will buy his wife a Radio Set much more readily than a washing machine at the same price. His boy does not want stockings or shoes for Christmas—he wants Radio.
5. You can suit every purse—an expensive Set for those who wish it, a moderate priced Set or Parts for the others.
6. Radio gives you an entry into your customers' homes and brings you new customers. When you install a Set you pave the way for the sale of other apparatus.
7. A big demand for Radio exists—profit by it—get your share.



How? Because—

1. Radio brings to the home concerts, opera, lectures, speeches, election returns, sporting news, crop and weather reports, etc.
2. Radio keeps the family together in the home.
3. A home is incomplete without a Radio Set.
4. Radio is an ideal gift for the boy because it is education and fun combined. "Learn while you play."
5. Radio is a godsend to the aged and the sick.
6. There is a Set for each purse, for the grown-ups and for the young.
7. An inexpensive Set, or Parts for making a complete Set, can be purchased and additions made as the customer's interest and pocket-book may suggest.
8. Radio never stales. It is a fascinating present that is used daily and appreciated more and more as time goes on.
9. It appeals to the music lover, the sports fan, children, adults, everybody.

Tie Up With Ludwig Hommel & Co., Because—

1. Their discounts are liberal.
2. They are Distributors for Radio Corporation and all other leading manufacturers.
3. They carry an enormous stock of sending and receiving material, insuring you quick shipment and a positive source of supply.
4. They maintain a Dealers' Service Department to help you with your problems. This service is free and cheerfully given.
5. You can rely absolutely on Ludwig Hommel & Co., apparatus. It is guaranteed by the manufacturers, and by them.
6. They wholesale to dealers exclusively and do not compete with their dealers by retailing.
7. They do more advertising than any other distributor of radio apparatus and refer to their dealers, consumers' inquiries resulting from that advertising. They advertise for you.
8. They have been wholesale distributors for 16 years and play square with everybody at all times.

Wire Collect Trial Order
Write for our new illustrated Catalog No. 200

LUDWIG HOMMEL & CO
530-534 FERNANDO ST. PITTSBURGH, PENNA

Introducing
“VICTOR JUNIOR”

(A highly efficient tuner and detector at the price of a crystal set!)

and its

Two Stage Amplifier

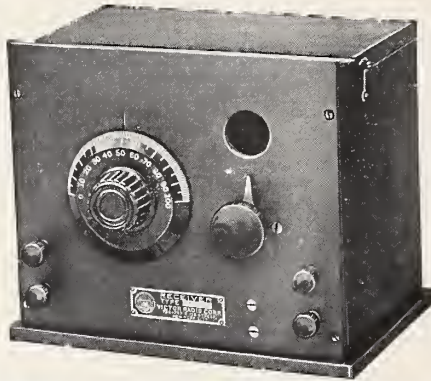

TUNER AND DETECTOR
 TYPE 600. PRICE **\$22.50**



TWO STAGE AMPLIFIER
 TYPE 625. PRICE **\$27.00**

Look at the prices—think of it—a *guaranteed* outfit for less than \$50.00! You can't beat it anywhere, and it is selling like wildfire.

The VICTOR JUNIOR demonstrates wonderfully. It is *there* on performance. Simplicity, efficiency and quality are its strong points and it is the simplest set to operate now on the market *at any price*. Tunes with only one dial. Interference is easily tuned out.

DISTANCE IS ONE OF ITS STRONGEST FEATURES

The tuner-detector has a wave length range of 150 to 600 meters. With the amplifiers it has brought in stations clearly up to 1,500 miles.

Built up to the VICTOR standard of quality, and at a price which *sells it*. Even the schoolboys can afford this—the cost is *less* than that of the *usual parts* required for a tube set.

VICTOR JUNIOR can be supplied with either WD-11, or Radiotron sockets—and it's a knockout!

Swing in on this for the XMAS trade. *Write or wire* for a sample and get started on this live one NOW!

LIBERAL DISCOUNTS TO JOBBERS AND DEALERS



VICTOR RADIO CORPORATION

795 East 135th Street, New York City

Manufacturers of Complete Radio Sets and Parts

THIS IS A RADIO CHRISTMAS!

THE RADIO DEALER

The Radio Trade Journal

For The Radio Retailer

CONTENTS DECEMBER, 1922

SPECIAL ARTICLES

Air Monopoly Is Real Future Possibility.....	By Harry M. Kouwiser	42
Dealer Lets Fans Prepare His Broadcasting Programs.....		38
Dealers Should Push Advertised Goods.....	By Thomas J. McElroy	34
Efficiency from the Amplifier Tube.....	By Sterling G. Sears	43
How to Determine Manufacturing Costs.....	By Henry L. Seidman	39
Importing American Agents May Register Trade-Marks.....	By Chauncey P. Carter	42
Major-General Harbord New Head for Radio Corporation.....		44
Make It a Radio Christmas This Year.....	By John R. Hall	38
Manufacturers Analyze Trade Conditions.....	By "Executive"	45
Miss Koewing in Charge of WOR.....		44
National Radio Week Brings Trade to Dealers.....	By Laurence A. Nixon	33
Panel Is Important.....	Interview with George J. Levy	53
Publicity and Its Effect on Market for Radio Securities.....	By Frank R. Stanton	94
Radio Trade Pictures.....		27
Retail Radio Salesman and Raspberries.....	By Edward H. Lerchen	46
Stations Improving Radio Programs.....	By L. N. Allen	47
Test Specifications for Radio Receivers.....		36
Twenty Receiving Sets Now to One a Year Ago.....	By Martin P. Rice	46
Vital Points in the Radio Business.....	By H. F. Jefferson	35
When and Where Dealers Meet Success.....	By R. P. Worden	37
White Bill Should Be Passed by Congress.....		48

DEPARTMENTS

Book Reviews.....	By Bernard J. Farrell	54
Editorial.....		40, 41
Service Bureau.....		18
What the Manufacturers Are Doing.....		50

THE RADIO DEALER, THE RADIO TRADE JOURNAL, published monthly on the first, at 1133 Broadway, New York, N. Y., by THE RADIO DEALER COMPANY, in the interest of dealers in Radio Supplies. HARRY M. KONWISER, Publisher; LAURENCE A. NIXON, Managing Editor; HERBERT M. WILLIAMS, Editor; A. L. KONWISER, B.S., Technical Editor; N. B. ZIMMERMAN, BERNARD FREEDMAN and EUGENE J. SCANLON, Associates; C. HOPPE, Circulation Manager; M. JAY KLEIN, Research Manager; B. B. STERN, Manager Service Bureau.

REPRESENTATIVES IN THE TRADE: ELMER W. MOORE, JOHN R. HALL, H. E. BENNETT, WM. B. WILKINSON, JR., J. MAURICE CASPER, H. L. KRENZ, M. A. CLARK, C. L. GEESBY, C. C. MINIER, M. P. MCNEELEY, W. H. OKE, C. B. CABINISS, R. C. HULL, BERNARD J. FARRELL.

PUBLICATION OFFICE
1133 Broadway, New York, N. Y.
Telephone Watkins 8926-8927

SOUTHERN STATES
610 Barome Street,
New Orleans, La.

CANADIAN OFFICE
23 Lily Street, Winnipeg, Manitoba

PITTSBURGH
Suite 570, Union Arcade, Pittsburgh, Penna.

PACIFIC COAST
Suite 510, 456 S. Spring St., Los Angeles, Calif.
Telephone Los Angeles 12052

BRITISH OFFICE:
Walter Dandie Company, Ltd.
173-175 Great Portland Street
London, W. I., England

CENTRAL STATES
35 South Dearborn Street, Chicago, Ill.
Telephone Dearborn 4053

NEW JERSEY
845 Broad Street, Newark, N. J.
Telephone Market 4659

CLEVELAND
1389 West 87th Street,
Cleveland, Ohio

Advertising Rates and detailed statement of circulation and other information for advertisers furnished on application.

Advertising forms close the 15th of the month prior to date of issue.

Circulation restricted to manufacturers, jobbers and retailers in wireless equipment. Subscription in the United States, one dollar the year, payable invariably in advance. Subscription in foreign countries, two dollars the year, payable invariably in advance.



Endorsed!

\$70.00 List

H. A. BRIGGS
ROCKY RIVER, OHIO.

QUINCY RADIO LABORATORIES,
654 HAMPSHIRE ST.,
QUINCY, ILL.

Mortimer Radio Corp.,
114 Fulton St.,
New York City.

Nov. 14th, 1922.

Mortimer Radio Corp.,
114 Fulton St.,
New York City.

Nov. 14th, 1922.

Dear Sirs:

Received the Radio set on Friday, Nov. 10th. It came in good shape.

IT IS A FINE SET. I have received concerts from:

- Detroit, Mich.
 - Atlanta, Ga.
 - New York City
 - Davenport, Iowa
 - Pittsburgh, Pa.
 - Cincinnati, Ohio
 - Schenectady, N. Y.
 - Louisville, Ky.
 - Newark, N. J.
- Please send me your catalogue.

Very truly yours,

H. A. BRIGGS,
Rocky River, O.
R. F. D. No. 1, Box 120.

Gentlemen:

Your set received last Sunday and tested Sunday night. This is the greatest place to argue in the world. The entire day of Saturday and Sunday were spent arguing on the practicability of a Detector Unit alone.

Upon actual test, we found that stations that could not be heard, due to interference in static, on the one stage and two stage amplifier, came through very clearly on the Detector alone. Newark, New Jersey, WJZ, was heard very plainly on the Detector, but due to interference from Davenport, it was impossible to hear them on the one stage or two stage.

You may expect to hear something definite regarding your unit in the very near future. IT CERTAINLY LOOKS GOOD SO FAR.

Very truly yours,

W. P. Lear,
QUINCY RADIO LABORATORIES

W. P. Lear/T. R.

Save Sales Company

Sales Engineers

City Hall Building, New York City

(Broadway and Warren Street)

Manufactured by Mortimer Radio Corp., New York City

MELCO

TYPE 400

Tuner and Detector Unit

Two-Stage Amplifier

—with the Litz Wire Wound Super-sensitive Vario Coupler

THIS IS A RADIO CHRISTMAS!

The Radio Dealer

THE RADIO TRADE JOURNAL

Edited and Published at

1133 Broadway, New York, N. Y.

FOR THE RADIO RETAILER

VOL. 2. NO. 3

DECEMBER, 1922

ONE DOLLAR THE YEAR

National Radio Week Brings Trade to Dealers

Monster Publicity Drive by Affiliated Publishers and Manufacturers
Will Bring Business to Every Live Dealer

By LAURENCE A. NIXON

Member National Radio Week Committee

National Radio Week, which has been set for December 23rd to 30th inclusive, promises a real opportunity for retailers all over the United States to cash in on a live demand for radio apparatus.

Directed by a committee composed of representatives of every radio publication this movement is assured of success, and the measure of local benefit will be gauged only by the amount of co-operation the local dealers and jobbers give the national committee.

Through the courtesy of the leading broadcasting stations throughout the country special programs of very great interest will be broadcasted from every station, the programs in each section being made up to conform to the general style judged most effective by the committee. One night will be devoted to one feature or class of program, while another night will cover another class, another another, etc.

Special publicity is being given the week and the programs by the general committee while a number of manufacturers have agreed to aid the committee by sending out considerable literature on the subject. The local dealer can do his share by using a portion of his newspaper advertising during this week to call attention to the programs and by displaying in his show window placards and signs calling attention to the week.

The dealer can also help the industry, and himself, by throwing his store open every night dur-

ing this period so that the general public—those who do not own sets—can gather and have radio demonstrated under the best of conditions. Live wire dealers will be quick to see the possibilities of increased sales during this period from these demonstrations.

One of the drawbacks to previous special concerts given by local dealers have been that only sporting events have been broadcasted as "special stunts" appealing only to a small class of people. With the varied appeals of the special nights of National Radio Week every class of people will be reached, and a higher class of prospects drawn into the dealer's store.

To aid the local dealer in his newspaper publicity the committee has prepared special advertisements for use in local dailies, while publicity about the week will be sent to daily newspapers on request.

Dealers having special plans for publicity for this week are invited to communicate with the committee at once so that the plans may be passed on to other dealers in other sections.

THE RADIO DEALER will be glad to receive photographs of special Radio Week windows for publication in an early issue of this journal.

Full information may be had by addressing the Service Bureau of this publication, or Major J. Andrew White, chairman, National Radio Week Committee, 320 Broadway, New York, N. Y.

Dealers Should Push Advertised Goods

Advertising Manufacturers Win Public's Confidence and Often Render Merchandising Helps to Dealers

By THOMAS J. McELROY, JR.
Lincoln Advertising Service

The dealer should get behind and push only the radio goods that are advertised by the manufacturers. This is a thing that a great many dealers have always frowned at, and will always frown at. They fail to see any benefit in it for them individually. They can see no farther than the size of profit they make on an individual sale. These dealers, one will find, are the small fellows and always will remain as such. They are the ones who are always looking for larger discounts in preference to quality—who are always claiming they are not making money. On the other hand, their competitor on the next corner is smiling—he is making money, and the reason? He is selling advertised goods.

Let us consider why it pays dealers to stock and push only advertised goods.

On account of the many new dealers who leaped into the category of radio dealers and also due to the newness of radio itself as applied to its use by laymen for entertainment purposes, general radio ignorance is crystal evident. In other words, many dealers themselves do not understand the art of radio. Such being the case, and it surely is, how in the name of heaven can they expect to explain this eighth wonder to their customers—the people who, too, know nothing of radio, but look to the radio dealer for enlightenment? It is very true, to be sure, that the dealer employs a radio amateur—a radio technician—to sell his radio goods and answer these very questions put to him by the customer. That is all very well, but so far as salesmanship is concerned this self same radio amateur or radio technician is a total loss. He is generally a fellow who has spent all his life with his radio instruments, but has never before sold anything. How, then, can the dealer expect him to sell radio goods?

Let us record one instance of how one of these radio amateurs explained the technical parts of a headset but could not answer a simple question on sales. In the first place, the writer is greatly interested in radio, but is far from being a technician. He had occasion recently to purchase a pair of headphones. He called on one of the

best known radio stores in New York and asked to be shown headphones. The clerk, who, by the way, was a dyed-in-the-wool radio amateur, showed him three or four pairs of phones, ranging in price from \$4.50 to \$14.00 per pair.

The writer asked why the difference in price and was told that the higher priced sets were made better. Natu-

printed word, the advertisement, will pound the story home to both the dealer and the customer. It will eliminate a great many of the questions now necessary to ask.

The manufacturer who advertises naturally tells the story of his product—why it is better and what it will do. He thereby furnishes valuable selling points to the dealer who sells his goods. He instructs the dealer to know more about his product. He proves to the dealer that he has faith in his product and tells him why. He shows the dealer by this constant advertising that he is no “fly-by-night” manufacturer, but is here to stay, and, lastly and of greatest importance, he creates a public demand for his apparatus.

It can be readily seen, therefore, why it pays both the dealer and the manufacturer for the latter to advertise. It is also crystal clear why the dealer should get behind and push these advertised goods.

Another question arises: Should the dealer stock all the apparatus that is advertised? Decidedly no. The dealer should carefully study the construction advantages of each piece of apparatus and should only stock the best apparatus at varying prices. In other words, in headsets, for example, he should stock a low-priced set, a middle-priced set and a high-priced set, of course, the best in each class. And these should be the products of high-class manufacturers who constantly advertise them and also who are always ready to assist the dealers in other ways.

The manufacturer should not feel that he has given the dealer enough co-operation by just advertising his apparatus in magazines and newspapers. He should go further and the dealer should insist that he go further. The manufacturer should keep up a constant advertising schedule to dealers and consumers. He should display in prominence in his advertisements not only his products but the retail prices of same.

The reason for this is obvious. He should investigate his trade before selling to every Tom, Dick and Harry dealer and in this way help to eliminate the cut-price fellows. Should

(Continued on page 75)

Customers Want Them

The general popularizing of goods through advertising is a development of recent years. Manufacturers have found it one of the most practical methods of assisting in the sale of a factory's products.

Advertised products are recognized by customers as possessing quality, for every one realizes that it does not pay to advertise anything that is not good. Such advertised merchandise does not have to be sold; it sells itself, for buyers want it and have confidence in it.

Is there any better reason why radio dealers should sell advertised goods than the fact that their customers want them?

rally they should be. The clerk informed the writer that this one had bakelite earpieces, while the earpieces of this one were made of hard rubber. This one had an eight-foot cord, while this one only had six. This one had a leather headband, while cotton was the material used in this one's headband. And the point he laid most emphasis on and continually mentioned was the fact that one was of 2,000 ohms resistance and another 6,000 ohms. After listening to him unravel a few paragraphs on technical radio points without any meaning whatever, so far as the writer was concerned, the writer then put the question to him this way: “I want a pair of phones that will receive the broadcasting the best. Now, why won't the \$4.50 pair receive it as well as the \$14.00 pair?” He couldn't answer.

And so it goes in all branches of the selling end of the radio business. The

Vital Points in the Radio Business

Better Broadcasting, High Quality Apparatus Properly Inspected and Good Service Are Essentials

By H. F. JEFFERSON

Vice-President and General Manager, Kilbourne & Clark Manufacturing Company

The summer slump brought to the radio trade in a forcible manner the necessity of good broadcasting. It is almost needless to say that the activity of the amateur radio trade is essentially bound up with good broadcasting.

Good broadcasting involves not only efficient transmitting apparatus and modulating systems, but programs of such a nature that they are really entertaining for the home. In every community where broadcasting has been active, there is a desire that an end be put to "canned music." Possibly on the Pacific Coast this was more noticeable than in the East because the eastern section has already had the advantage of some high class broadcasting stations.

Much activity has been noticeable among the radio trade on the Pacific Coast in an effort to obtain good broadcasting by co-operative plan, the formation of radio trade organizations, and a good deal of study has been given to what may be termed the economics of radio broadcasting. This is the most important phase of all, for unless it is proved definitely and conclusively that broadcasting is a profitable operation, either from a strictly commercial standpoint, or from a community benefit standpoint, broadcasting must eventually stop and with it the amateur radio trade will again languish to a comparatively unimportant business. It is daily being proved, however, that it is a profitable proposition.

Well managed and stable department stores, as well as conservative newspapers, are now purchasing and installing the most expensive broadcasting equipment. These installations are made only after they have been studied from a strictly economical standpoint. The first radio craze has been over for some time now, and consequently it is not emotion of the moment or a passing fad that brings about installations by such stable business organizations. That these installations are being made, and made in increasing numbers, is proof of the future of broadcasting and of the amateur radio trade.

Aside from the optimism this should



H. F. JEFFERSON

give us, it has a further benefit in its effect on the minds of bankers and financial men who have been disposed to regard the amateur radio business as a very uncertain and fleeting proposition. The fact that stable businesses enter the field of radio broadcasting is a plain intimation to financial men that the amateur radio trade has a future of no mean importance, and with this further knowledge, bankers will extend their assistance more readily in the development of the radio business.

Like the airplane and the automobile, radio telephony shows indications of its sphere of usefulness to the world in communicating with isolated groups of people and in the general dissemination of information and entertainment at a low cost.

There is no cheaper means known than radio broadcasting of reaching a large body of people for the purpose of disseminating general information.

Quality of Products

Radio merchandise, being technical in nature, demands engineering service and inspection in its manufacture as much, if not more, than any other electrical product. During the recent rapid growth of the industry, it has been considered by many that any in-

dividual or organization could manufacture radio equipment, but it is fast becoming obvious to the public that only those organizations that have the experience and engineering services available can produce radio apparatus of quality.

Every single piece of radio apparatus produced in a factory should be given a thorough electrical test, and in addition detailed inspection under the supervision of an experienced testing engineer. In our factory, standard tests are laid out for every piece of apparatus even if only mechanical in its function, as it is recognized that with the many small and numerous parts entering into radio equipment, the failure of one small piece will often spoil the equipment.

It is important for a manufacturer to provide for its dealers and customers as complete a line of radio apparatus as possible. Dealers, when purchasing radio equipment, naturally wish to avoid shopping around and if they can be assured of obtaining a complete line from one source, will naturally be more satisfied.

Service

The service feature is most vital in the radio trade, as so much education in radio is required by those entering the business and users new to the art. Service must extend from the manufacturer through to the jobber, dealer and to the customer. The whole line of distribution must co-operate in an educational effort with the object of giving the public, or ultimate consumer, the maximum enjoyment and value derivable from the radio art.

The manufacturer should be willing to assist his distributors with steady advertising, dealers' signs, leaflets, and all such assistance which has come to be recognized as a necessity in the merchandising of domestic electrical equipment. It is particularly necessary to lay stress on advertising and printed matter which assists in the education of the users of radio apparatus.

For successful and full enjoyment of radio, it is necessary that some skill be acquired in the use of the equip-

(Continued on page 76)

Test Specifications for Radio Receivers

Methods of Determining Sensitivity, Selectivity and Distortion Are Described

At the invitation of Gregg and Company a committee met on August 23 for the purpose of deciding on some methods for testing the overall efficiency of radio sets. The main purpose of these tests is to provide some figures for the comparison and rating of broadcasting receivers for the benefit of the manufacturer, dealer and purchaser.

It was agreed that such policy would greatly help to stabilize radio trade in effecting the valuation of products of different manufacturers, and in protecting the public.

In the determination of the sensitivity and selectivity of receiving equipment it is first necessary that we establish a definition for these two terms and the following are offered:

The sensitivity may be defined as the ratio of the signal voltage applied to the telephone to the voltage applied to the antenna circuits of the radio receiver under test, when this radio receiver is set up in connection with an antenna circuit having the constants of the average novice antenna, and where the output is supplied to a standard pair of head telephones. The selectivity of the radio receiver may be defined as the percentage change of telephone current to the percentage change in wave length or frequency as this latter is changed, the radio receiver being set up with a phantom antenna circuit having the constants of the average novice antenna and being supplied with a standard pair of head phones.

Both of these definitions assume a predetermined in-put and output circuit and for this purpose a series of measurements made on a number of novice antennas indicate that the constants of a representative antenna are: capacity .00025 mfd; resistance 20 ohms.

It is felt that some well known reliable phones may well be standardized upon as the output circuit.

Sensitivity Determination

For the actual measurement of sensitivity it is necessary that a known voltage be applied to the antenna circuit of the receiver under test and that the voltage available at the telephones be measured.

To accomplish this it is necessary

that a generator simulating a transmitting station be available and that some means be devised whereby the voltage on the telephones may be measured. The need for the former can be most easily met by means of a vacuum tube generator, modulated at audio frequency, such a generator consisting of two five-watt tubes, one of which is connected into one of the commonly used generator circuits, the other of which is supplied by the audio frequency source of power, care being taken to secure complete modulation; or if that is not advisable a constant degree of modulation as indicated by the ratio of the direct voltage being applied to the plate of the oscillator to the alternating voltage being applied to the modulator tube. A method of connections for modulation may be any of the many forms that are used in radio phone operation, the only essential being that means be available for measuring the output current and for the determination of the consistency of the degree of modulation.

The method for determining the voltage applied to the telephone is briefly this: A source of alternating current of the same frequency as that used for the modulation of the radio frequency supplied is passed through a potentiometer, means being provided for the measurement of the current, and by means of a transfer switch the telephones are made transferable from the radio receiver to the potentiometer in such a way that the audio frequency voltage across the telephone may be varied at will and may be determined from the value of the current flowing in the potentiometer and the resistance which shunts the telephone. The value of the voltage on the phones is then the product of these two quantities.

It is to be observed in this measurement that sufficient power must be available so that the power taken from the potentiometer by the telephones be so small in comparison with that available with the current in the potentiometer is not materially affected when the phones are connected to the potentiometer.

It is suggested that if the total resistance of the potentiometer is maintained at something of the order of 1,000 ohms, and the resistance across which the telephones are connected is

never made more than 10 ohms, the simple condition described above can be realized. The source of supply for the audio frequency to supply the potentiometer may well be a vacuum tube generator or an electrically driven tuning fork, the only requirement that it be of reasonably constant frequency and that its wave form depart not too seriously from the sinusoidal. A serious departure from good wave form will make manipulation more difficult and result in reduced precision. This may, however, be guarded against by the operation of the vacuum tube generator if that is used at a rather small part of this maximum output.

In setting up the receiver it is essential that it be thoroughly shielded from all electrical influences and that the voltage which is supplied to the antenna circuit be the only voltage being induced in it. This condition can be easily secured by housing the entire generator in a copper mesh box, shielding the coupling coil from which the excitation voltage is secured by means of copper sheet and providing electrostatic shields between it and the receiver proper so that only a known degree of electromagnetic coupling exists between the generator coupling coil and the receiver circuit. The coupling coil in the antenna circuit can best be made of a few turns of wire on a four or five inch tube, the coil itself being thoroughly shielded by means of copper sheet and the leads to the receiver proper being equally well shielded with copper.

Measurements will be found much simplified if the entire setup is made on metal covered table tops, preferably of copper sheet or mesh, the entire metal system being grounded to some common point. The coils, themselves, which are used for coupling should be raised above the metal sheet sufficiently to reduce the losses in these coils due to the nearness of the metal (about 5 inches) and not so much as to allow of electrostatic coupling between the coils proper.

It is preferable to remove the receiver itself eight or ten feet away from the coupling system and to bring the leads from the receiver coupling coil to the receiver through brass

(Continued on page 77)

When and Where Dealers Meet Success

It Pays to Stock Up for Christmas and Other Busy Seasons and Cultivate Good Customers

By R. P. WORDEN

Manager Radio Department, The Newman-Stern Company, Cleveland

The radio dealer today knows what class of merchandise he must carry to meet the demands of his trade and to build up a sound business. If he is a good merchant he also knows how to sell radio. The questions which now confront him are when and where he can expect his efforts to meet with success.

Regarding the former, the writer has observed a very definite cycle through which the radio business passes year after year. It is, of course, affected by general business conditions, and the actual volume of sales varies greatly. However, the ratio of summer trade to winter trade seems to be constant. In fact it seems to be about the same as it was when radio business merely meant supplying the needs of the radio-telegraph experimenter.

Summer is, naturally, the slack season. This is not due to market conditions or to the much maligned static. It is due to one thing only—human nature. No “indoor sport” enjoys widespread popularity while the weather is favorable for outdoor amusements. The cool days of October bring an increase in the demand for radio apparatus. The increase is gradual, but in our vicinity no heavy buying on the part of the consumer is noted before the latter part of November. Christmas trade is always good and, if properly merchandised, should show a nice profit.

We have always found the week from Christmas to New Year to be one of the busiest of the year. It is not uncommon to find that the sale of parts and accessories for this week exceeds even the weeks preceding Christmas. It is a school vacation. Then, too, a large number of boys and young men, feeling that their parents or friends cannot intelligently choose gifts for a Radio Christmas, ask that they be given money instead. Their request is usually granted and all through the week the retail stores are crowded with radio fans. They know what they want and they have the money right in hand. Tubes, batteries, amplifier parts, phones—in fact, anything to add to a radio set is always in demand at this time. The dealer will

do well to have a supply of such goods on hand after the Christmas rush. Of course, local conditions enter into this; we certainly would not recommend stocking up where the market is already over-supplied.

January and February are very profitable months. The demand for complete sets is heavy, the season for long distance radio-telegraphy is at its best, hence the experimenter is constantly buying and building. The time of the spring let-up cannot be set definitely, but it is about due when the first heavy thunder storms come. This past year the novelty of broadcasting and the shortage of apparatus kept the consumer demand heavy for nearly two months after a slump might have been expected. The dealer who is a radio fan, or who has several of them in his employ, is quick to notice the symptoms of decreasing interest.

The second question raised at the beginning of this article—where he can expect his efforts to meet with success—is hard to answer definitely. However, certain types of men are especially good prospects.

In the cities we find the well-to-do man who is in search of a new hobby. He is in many cases the head of some large business concern. Radio proves fascinating to a man of this type. He takes intelligent interest in it and will spend freely as long as he is getting satisfactory results. Furthermore, he is usually active in clubs and social organizations and his enthusiasm over radio is contagious. One sale, followed by good service if required, will often bring five or six friends in the place where the first set was bought. In most cases these new customers purchase expensive sets and in turn become boosters for the dealer who is giving service.

In the smaller towns we find the same type of man we have been discussing. Often he is a banker or a retail merchant. He is one of the leaders in his community. When a radio set is installed in his home the whole town knows it and is awaiting the outcome with interest. Hence it is very important that this man be sold a high grade set and that he be

given all the service and personal attention possible.

In the foregoing paragraphs we have considered the sale of complete sets only. The business in parts and accessories is large and to many dealers is the bread-winner. This is normal, and the sale of parts should by no means be neglected. We have placed the emphasis on complete sets because we believe there is a large market for them which has not been cultivated enough. The enterprising dealer can greatly increase his sales by consistent effort along this line.

In conclusion we wish to express our opinion as to the future of the radio business in our locality. We believe there will be a steady growth for several years at least, with the usual seasonal fluctuation. At present the market is over-supplied with parts and small instruments. On small items the chain store and the ten-cent store are factors to be considered, but they will never interfere with the sale of high grade receiving apparatus. We believe the future of radio is assured, provided broadcasting is properly regulated and good programs transmitted on a regular schedule.

Germer Manages States

Well-Known Newarker Connected with the States Electric Co.

Frederick W. Germer, former manager of the General Merchandise Company, Newark, N. J., has become a member of the States Electric Company, with offices at 20 Clinton street, Newark, N. J.

The States Electric Company have added a radio department of which Mr. Germer will assume sales-management. The company will act as selling agents for radio manufacturers and have already secured several attractive items. Arrangements have been made for their handling exclusively the sale of the Shelton loud speaker and other products of the Shelton Company and also the Hampson Company who manufacture radio frequency transformers.

Make It a Radio Christmas This Year

Dealers Using Windows and Newspapers Can Persuade Public to Make Radio Gifts

By JOHN R. HALL

The term "Christmas Season" is inclined to be misleading from the point of view of merchandising, and particularly so in connection with the radio trade. Too many retailers are apt to think that only the business occurring two or three days before Christmas is worth-while going after. As a matter of fact the Christmas trade can be made effective a month before the holidays and as long after Christmas as the ingenuity of the dealer and the conditions in his locality permit.

Though "Do your Christmas shopping early" is now a time worn phrase, its aptness, especially to the radio dealer, is none the less striking. To many people radio is still a mystery, and people are not anxious to give as presents the things which they themselves do not appreciate. This is not to say that people as a rule, Americans particularly, are satisfied to go through the same routine, year after year—a neck tie for Charlie, a box of chocolates for Lillian, a hot water bottle for the Smiths, etc., etc. On the contrary, they turn with relief to any new suggestion for a gift, if only for the reason that they may be known as givers of original gifts.

In grasping the opportunity presented by the average man's perplexity at what to give for Christmas, the radio dealer should drill in the idea of "Radio for Christmas" at least a month before the holiday.

A window display which immediately suggests itself is one showing the home circle gathered around a fireplace, each with a headset over his ears. The window should be illuminated by subdued lights, coming entirely from the fireplace if possible. A Christmas tree may be added to give more of the holiday atmosphere. Holly wreaths in the window spread the season's cheer and indicate that Christmas business is on.

To this, and to every window should be added a showcard to drive home some idea that the window is intended to impress on the passers-by. A card something like the following might serve the purpose, although it is recommended that the dealer prepare the text of each card he uses so as to appeal particularly to the conditions that exist in his locality:

WILL IT BE A RADIO CHRISTMAS IN YOUR HOME?

Will your family enjoy the best of music, humor, literature, sport, oratory and world events this winter, without stepping beyond your family circle?

Will your family be enabled to keep in touch with what the world is doing through radio?

They will thrill at the thought of radio! They will marvel with you at its wonder—and its simplicity! Let us explain.

This display may be too pretentious for certain dealers, and is offered only as a suggestion. It should be remem-

bered, however, that if at any season a pretentious window display is worth while it is at Christmas when the public is trying to spend money.

Another effective display can be made to illustrate the simplicity of radio. This is one of the arguments that dealers should always advance. It was tried out successfully by an Eastern retailer recently, and consisted of skeletonizing a radio set. A neat mahogany tube receiving set was displayed with a card at the bottom, reading "front view." The same model with panel removed, stood alongside, marked "back view." From each of the principal parts of the two receiving sets blue ribbons led to a large card at the back on which was neatly printed in bold letters: ALL THERE IS TO RADIO.

(Continued on page 80)

Dealer Lets Fans Prepare His Broadcasting Programs

The importance of good broadcasting to the radio industry is leading to much deliberation about the matter. Arguments in favor of the elimination of the smaller stations so that greater effort and pains may be concentrated on a few selected and powerful stations scattered throughout the country have been advanced from time to time. These arguments have been based on the belief that many small stations are of little value from the point of view of quality broadcasting.

A recent program sent out to listeners from a dealer's station in Newark, N. J., however, contraverts the popular theory that only the big stations can put on a worth-while program. This dealer is D. W. May, the proprietor of an old established firm in the radio city. With some of the biggest broadcasting stations in the country centred in Newark, Mr. May manages to make his program interesting to the large body of listeners-in who look forward to the May waves every day.

As an instance of the interest the May station arouses, the fact may be cited that fans have the privilege of

phoning in to the May station requesting that such and such a selection be put on the program. This statement may be put in another way: the May station's programs attract attention because the listeners-in are permitted to make up the programs.

A May program is not pretentious, but it is decidedly interesting; as the following sample program for an evening will testify:

7:30—8:30 P. M. Cornet Solos by Master Ludwig Guenther; Accompanist, Miss Julia Guenther.

1. Sing Me To Sleep.
2. Perfect Day.

Trombone Solos: By William Frances —Accompanist, Miss Helen Speckman.

1. At Dawn.
2. Answer.
3. Romance.

Vocal Solos by Peggie Keuchner. Anna Shaw's Ideal Girls' Jazz Orchestra.

The selections played by the orchestra were chosen by the listeners-in, who accepted the invitation of the broadcasting station to "Phone in your selection to Branch Brook 2700." The idea is a good one, and shows what the dealer can do to bring his name before the radio public.

How to Determine Manufacturing Costs

Simple Method Described to Enable Producers to Find Costs so They Can Properly Fix Selling Prices

By HENRY L. SEIDMAN
Certified Public Accountant

In arriving at the cost of an article one must take into consideration first, the material, and then the labor. At this point no one can help the estimator. He alone is the only one who can determine how much material is to be used, how long the labor time should be, and what the cost of it all should be. There are, however, some items which are part of the cost of materials, but which are usually ignored. The expressage paid on materials purchased or, if the merchandise is imported, the duty, ocean freight, insurance in transit, custom-house entry, broker's fees, etc., all these are as surely a part of the cost of the materials you purchase as the materials themselves.

A number of clients have contended again and again that the discounts deducted when materials are paid for within ten days should be deducted from the cost of the materials purchased and the discounts allowed to customers under similar terms are to be added to the merchandise costs.

It is the economist's and the accountant's contention that to do so would be grossly unjust, both to the factory manager and to the owner of the capital invested in the business. The theory of cash discounts is a simple one. It is that cash discounts are offered for payment of bills before the date on which they are due because there is a lack of capital in the firm that offers it; a form of interest for prepayment of bills; and an inducement to pay bills promptly. To the man who pays his bills promptly, and takes a discount for such payment, the discount so earned is earned because he has an abundance of cash with which to operate his business, and it is his abundance of capital that makes the extra profit, not that the merchandise costs less.

Surely, then, if a firm lacks capital, and in order to secure cash quickly offers a discount to its customers, shall that discount be charged to the cost of the material? Shall the manufacturing department show a higher cost because capital is lacking? And on the other hand, shall the manufacturing department show a lower cost

because the firm has an abundance of capital and discounts its bills?

The answer must be no; for to say otherwise would be to place the different manufacturers and dealers on unequal terms at the most vital point; or to give one man an immediate and powerful advantage over the other.

The materials purchased would cost less if a man bought them in large quantities; the dealer with less capital would at this point be at a disadvantage. But the large-lot purchaser is entitled to this advantage, because to purchase in quantities presupposes the ability to sell in quantities.

Another item often neglected when materials are figured is waste. For instance, if the material comes in square sheets and the article cut from it is circular, the cost of all the circular articles is equal to the cost of the entire sheet. Where circular articles are cut out of such a sheet, there must necessarily be left some parts of the sheet that cannot be used.

Having established the cost of the material, he next determines the labor cost. One of the items usually ignored is what, for want of a better term is called "idle time." Usually an estimator holds a stop-watch on a man who is manufacturing the article, and by practical experience determines the length of time required for each operation. He then determines how

many articles can be made in a working day. He leaves out, however, the fact that he cannot hope to secure every day the exact number of articles he figures on. Sometimes the materials do not arrive on time, or are defective, or are not the right kind, or the machine breaks down or the material is tougher than usual, and a thousand and one other reasons that cause delay, and higher labor costs.

The next thing to determine is the cost of Manufacturing Overhead. What is that?

Manufacturing Overhead consists of all expenses other than labor and materials incurred directly in the manufacture of the article. They may consist of: Indirect labor, as porters who clean the factory; heat, light and power used in the factory; superintendence; repairs to machinery and other equipment; supplies, like oil and waste, brooms, ash cans and other things of a similar nature.

At this point there always arises an argument between the man who insists that the rent of the factory and depreciation of the machinery are manufacturing costs, and the man who insists that they are not. Discussion and theorizing on this subject has gone on for years. The one insists that since the manufacturing is done within four walls, the rent of the factory is incurred only because of the manufacturing, and therefore is an added cost.

The other insists that rent is paid because it is necessary to protect the capital invested in the machinery from undue wear and tear of the elements.

The economist and the accountant have always been at loggerheads on this point, and because they cannot reach an agreement each accountant must formulate his own rule. We are firm believers in charging it to Manufacturing Overhead.

The same situation exists where where depreciation of machinery is involved. One man insists that the machinery is used for nothing else but manufacturing and the wear and tear on it is due to manufacturing, and therefore a proper charge to its cost.

(Continued on page 81)

SPECIAL ADVERTISEMENTS FOR RETAILERS

for use in local newspapers during National Radio Week have been prepared by the committee and may be had on application to this publication's Service Bureau or to the committee direct.

National Radio Week
December 23-30

can be made the biggest thing in every city—if the dealers will take advantage of the stunts planned for this time. Details on request.

National Radio Week Committee,

Major J. Andrew White, *Chairman*,
326 Broadway, New York City.

Mr. Radio Dealer, Study Your Business

Much as we dislike to admit it, there are a number of dealers who entered the radio business during the boom with the intention of closing up as soon as their sales slowed down and with little knowledge of radio or general retail merchandising. They looked upon their advent in the ranks of radio dealers as an experiment which could be conducted with comparatively small capital and little trouble.

Some of these dealers tired of the experiment and retired from the field poorer and yet no wiser. Others were carried along with the tide of popularity which caught the public. A few became imbued with the conviction that retail radio was a good business and settled down to hard work. They changed their window displays frequently and arranged them with an eye to artistry and attractiveness, realizing that the same good practices that applied to other businesses were applicable to their business also. They studied the trade journals devoted to radio; these dealers read the amateur radio papers and in every other way possible tried to keep up-to-the-minute. They were always glad to lend a helping hand to amateurs, to answer their questions.

As a result these wise dealers have built up growing stores and won for themselves an enviable prestige in their localities. No new dealer hiring a store in their vicinity has a great chance of successfully competing with them. These dealers are secure in their knowledge that the radio receiver is not simply an experiment or a toy but a recreational and utilitarian commodity, whose use is steadily growing. They do not consider their retail custom as temporary, as something they will drop at the first slump. Having found the retail radio trade a legitimate, dignified way of making a living and governed by the same broad principles of merchandising that govern other lines, they know that a well-established business weathers the little slumps which must be expected occasionally.

The Trade Can Sell a Million Crystal Sets

The advent of the many recently established broadcasting stations makes it possible for retailers, everywhere, to specialize in crystal sets. There are over 500 broadcasting stations now, and when crystal sets are sold to receive within a 25-mile radius it means that the residents of the territory covered by these broadcasting stations can easily be sold crystal sets.

Crystal sets have, in the mind of the radio expert, been cast aside. Your amateur scientist of yesterday glories in tube sets, in battery attachments and socket things—but the average person who knows none of the scientific things about radio wants the crystal set.

Crystal sets, once adjusted, once properly tuned, continue in operation indefinitely. What more need a buyer know. Too many of the new crop of manufacturers of radio equipment have overnight cast aside their crystal set business—aiming to sell to the technical radio enthusiast.

Well and good—but what about Mr. Neighbor and Mrs. Neighbor? They know nothing about radio. They ought to know they can purchase a simple crystal set, erect an outdoor aerial and presto—the concerts come forth!

Retailers must remember that there are more potential crystal set buyers than anything else? There

are twenty million homes in the United States. Sell to the majority. Don't all flock to sell to the experts. The retail and wholesale trade will err in commercial judgment if they do not make proper effort to sell crystal sets. That's where the trade volume is to be had.

After a person has had a crystal set that person becomes a radio enthusiast, in the majority of instances, and then come thoughts of tube sets and what they can bring in as entertainment. As the proposition now stands the broadcasting stations reach the larger centres of population. Crystal sets bring in the air entertainment.

Of course there is no real comparison between the tube set and the crystal, but it is better to start off with a crystal set; to learn a bit about radio and then acquire a tube set. This system means reaching the masses; means making sales in proper fashion means making business for radio. In its essence it makes for interest on the part of new devotees of radio, and that is what must be done to keep up the big radio industry.

The makers of tube sets and the makers of parts will best be served right now by the sale of, say one million crystal sets, and the trade can sell that one million by employing proper business methods.

Crosley Says, "Too Much Broadcasting"

Powel Crosley, Jr., president of the Crosley Mfg. Co. of Cincinnati, is of the opinion that there is too much broadcasting on the same wave lengths. We quote Mr. Crosley:

"Something should be done as quickly as possible to separate the stations over a broader band. As soon as this is done conditions will improve very materially.

"It requires today a sharp tuning set to separate the stations crowded

together on 360 and 400 meters. The heterodyning effect is awful at times, but nevertheless there is always something going on in the evening, and it is always possible to pick up one or more stations satisfactorily at any time.

"The present evil is merely a phase that will correct itself in the course of time. This cannot be done in a day, but it requires action at the earliest possible time by Congress, to allot a special band of wave lengths to broadcasting stations so that they can be separated, for the present arrangements are not at all satisfactory."

Political Hokum Not for Radio

Political broadcasting was indulged in, during the recent campaign, to the extent that the candidates of the leading political parties were requested to broadcast speeches on certain evenings.

Whether these air speeches were well received or not is a question. No one really knows whether these speeches had any effect upon the result.

Insofar as the average listener was concerned, it is judged, from personal investigation, that the political speeches "went cold," being received in an indifferent manner. Was this due to the presence of general apathy on the part of the public or to the speeches themselves? Both. That's fair.

The general public now listening-in to the very good air programs that have been in order in the East, particularly, cared not for the political bunkum, because these folks realized the politicians were using the air for advertising purposes.

Some of our big people in the radio industry haven't sensed the fact that the great American public will resent the use of the air for advertising purposes—political or otherwise.

Apart from this, it is best to warn the morons of political life that candidates incur danger from broadcasting their speeches. Political speeches, without any of the influences of the public meeting are bound to "go flat." Political speeches need—as supports—the distraction of judgment to cover weak arguments. Political speakers require unthinking enthusiasm from their audience. Political speeches need not stand on intrinsic merit. Radio speeches must stand upon intrinsic merit. The spoken speech, before a friendly group of fellow politicians, is one thing and putting the same sort of bunkum out in the air—to persons unseen and unheard—is quite another thing.

Obviously—to judge from the few facts discernible from the last election—air broadcasting is not a thing for the political folks. And so, let's thank someone for that—because it will help the art, and its commercial annex, wonderfully.

Double-Barreled Scheme to Popularize Radio

By H. Gernsback

Fundamentally there is nothing wrong with radio, but so far radio has struck only the big centers. Only in the immediate vicinity, within five or ten miles of a broadcasting station has radio shown any marked success. Seemingly, the point of saturation has been reached as far as these centers are concerned.

As soon as the distance from the broadcasting station is increased over 25 miles, the chances of having many receiving outfits becomes smaller and smaller. The reason is obvious: Within a radius of 25 miles a crystal set will do nicely. Only the man with money to spend can afford to get a vacuum tube outfit, and while, of course, vacuum tube outfits are superior to the crystal outfits, they cost a great deal more and are more complicated. The problem then becomes one of dollars and cents.

So we have the condition today that over one-half of the population of the United States is being deprived of radio entertainment for the reason that the farming and agricultural districts as a rule are out of range and are not in a position to invest in expensive vacuum tube outfits.

Suppose an up-to-date amateur, or business man for that matter, was told that with practically no outlay, he could make several thousand dollars a year out of radio broadcasting. Would he not jump at the chance?

We know that most of the large broadcasting stations at the present time are receiving Arlington time signals on a special aerial on a wave length of about 2,650 meters; a special receiving set is maintained for these time signals. These time signals are re-transmitted on a wave length of either 360 or 400 meters. The telephone of the receiving outfit is simply held against the microphone of the sending outfit at the broadcasting station and the signals are thus re-transmitted.

Why not do the same thing with broadcasting programs? Suppose we have a small town of 3,000 inhabitants 100 miles away from the nearest broadcasting station. Now then, suppose some wide-awake amateur should equip himself with a first-class vacuum tube receiving set. Then he would also install a low-power radio telephone sending outfit. This outfit would not have to be rated higher than 10 watts. Such an outfit would cost less than \$200 to assemble, including the receiver. Once the modulation problem was solved, it would be a very simple matter for the amateur to re-transmit from a wave length of 360 to 400 meters and re-broadcast the broadcast on a 200-meter wave length. He would have little trouble securing the necessary license for this purpose.

With a good 10-watt transmitter it should be possible to reach everybody within a radius of 10 miles, sufficient, in other words, to reach everybody in town.

The minute his station is completed, the amateur would take a simple crystal outfit and visit some of his friends. He would put up a temporary aerial and let his friends and acquaintances listen in to his evening programs.

He would not sell, or try to sell the crystal set to them—and here is suggested a new idea: HE WOULD RENT IT! A simple contract blank could be made out whereby the subscriber agrees that upon the installation of the outfit he will pay at the rate of \$2 per month.

It would not be necessary for the amateur to lay out a single dollar, for if he should be able to secure anywhere from 50 to 100 subscriptions, he could take these contracts to his bank and if the young man is at all in good standing in the community, he will have no trouble whatsoever in securing a loan from the bank with which to purchase the outfits, the bank holding the contracts as security.

The idea is sound economically as well as technically, and there is no reason why it should not be possible to put it into use immediately.

Air Monopoly Is Real Future Possibility

Enactment of Laws or Governmental Supervision Must Be Established So Broadcasting Can Help Radio Art and Industry

By HARRY M. KONWISER

Some of our leading radio business men appear not to believe that a monopoly of the air is likely to be developed by and for certain business interests.

There is no room for discussion in a matter of this sort. There is no second thought as to whether air space is to become the monopoly of any one person, or any group of persons.

It is possible to develop a monopoly today for air usage.

The Telephone Trust directly or through its various subsidiaries can cover the country by broadcasting stations if they have idealistic aims for entertaining the dear public.

All they need to do is to make proper application and presto—the thing is done and once having established their broadcasting stations; once having begun their daily concerts they will soon drive other firms, not so well equipped for service, out of the field.

This is a serious situation and must be remedied and when the matter of broadcasting is regulated by law or under governmental supervision, then and then only will radio broadcasting become the thing most of us see in the offing.

Talk all you like about broadcasting opera and real concerts—held in the larger cities of the land—but what avail to talk about these valuable adjuncts to further popularizing the radio art and industry? Before such talk can be developed there must be proper systematic supervision either for broadcasting arrangements or for broadcasting programs.

Some of the leading manufacturers in the field are interested in putting Metropolitan opera into the air—but they cannot make proper arrangements unless they are assured of means of proper support on the part of everyone.

If a person, today, made application for license for four hundred broadcasting stations and the stations were to be operated according to the requirements of the present law the Secretary of Commerce could not refuse to issue licenses to such person. That's no idle pen-made idea. Commissioner Carson, of the Bureau of

Navigation, is authority for the statement. How then—in view of this—can real efforts be made to develop real entertainment for the radio fans and the public at large?

Supposing some fanatical multimillionaire with a pallid penchant for political preferment aimed to establish a few hundred broadcasting stations?—why shouldn't he be granted licenses for these stations, just as they're granted to the Telephone Trust? What if the object of the one person is personal benefit, while the other aims to benefit the mass? The law cannot take cognizance of that little thing.

And suppose a group of newspapers, in various cities, collaborated in broadcasting service? Or an organization of department store owners? And later, suppose these persons have developed an air monopoly—what's to prevent that group from selling air advertising?

Supposing the Telephone Trust aimed to give its telephone patrons radio service? They'd make proper application for licenses and very properly would promptly receive permission to broadcast. Then they'd supplement their activities by broadcasting absolutely real programs—all the while. Result: The broadcasting stations would, by agreement, yield the

air to the Telephone Trust because of the general practice that the one to serve is the one who can best serve the most in proper manner. The Telephone Trust might do this as a sort of preliminary campaign to create air advertising. There's the danger, the real danger in extending unlimited permits to any person or persons.

Eventually the air will be used for advertising, of course—but radio will best be served by making it impossible for any one person or group of persons to establish monopolistic rights.

The time to stop the would-be air grabbers is now and the one way to aid in this is to urge your Congressman and Senator to develop early action for the White bill now before Congress.

This measure, agreed upon by a conference of various radio interests early in the current year, may require alteration before it can meet with the approval of everybody in radio—but getting it out into the limelight will help clarify the broadcasting situation a great deal and when the conditions that surround broadcasting are better understood, by statute or by governmental supervision, then there will be less complaint about broadcasting and the radio art and industry will be properly benefited and advanced.

Importing American Agents May Register Trade-Marks

By CHAUNCEY P. CARTER
Trade-Mark Specialist

Not long ago, a Federal court held that where a druggist purchased abroad, imported into and sold in the United States rice powder bearing the JAVA trade-mark and in the original packages put out by the owners of this mark in France, he did not infringe the rights of the exclusive agents in this country of the French producers of this trade-marked article because the public was not deceived, but was getting the genuine article. While

this decision was obviously in accordance with established principles of trade-mark law in this country, it worked a considerable hardship on importers of trade-marked products holding exclusive agencies for distribution in this country because under it their exclusive agencies become exclusive only to the extent of their being the only direct importers from the producers, others being permitted to

(Continued on page 89)

Efficiency from the Amplifier Tube

Theory of Operation and the Characteristics of the Usual Types of These Vacuum Tubes

By **STERLING G. SEARS**
Of Sterling Phonic Laboratories, New York

In the first paper of this series we discussed the detector tube with regard to its operating characteristics. It was mentioned that "hard" detectors or amplifiers were much more stable in operation when used as detectors than the "soft" type. This stability also holds good for "hard" tubes used as amplifiers, and since there is some relation between these two uses, we shall now take up the usual types of amplifier vacuum tubes.

The accompanying illustration shows the types of amplifier tubes now on the market, i.e., the Radiotron UV-201 (identical with Cunningham C-301), the Western Electric (Government) VT-1, and the new Westinghouse WD-11. These tubes all come under the classification of "hard" tubes, since they have a higher degree of evacuation than "soft" detectors and are therefore able to stand much higher plate voltage ("B" battery) without showing blue-haze or ionizing. The UV-201 is the hardest of this group and the average can be used up to about 120 volts with safety. Some, of course, may be used up to 150 volts, but around this point they become somewhat unstable and are liable to ionize unless care is taken in operating them.

The VT-1 comes next, standing up well on 100 volts. There are some

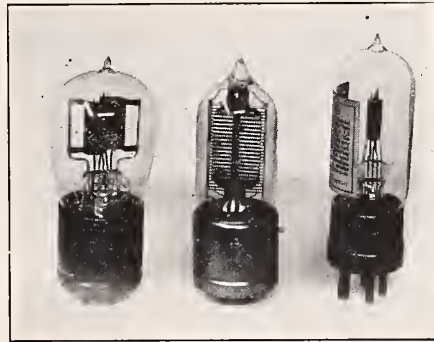

Types of Amplifier Tubes

VT-1 tubes that were made for detection only in existence (among them most of the "yellowtops"). These ionize around 40 volts and are therefore practically valueless as amplifiers, but the standard VT-1's are "hard" and stable. The WD-11 is somewhat softer than the VT-1, the average becoming unstable above 65 volts. These are being pumped a little better now for the Aeriola Sr. amplifier and make good amplifiers for weak signals if handled properly. They become, however, very "soft" if once ionized, and are then, if at all operative, good only for detection. Great care should therefore be exercised when adjusting the "B" battery or changing tubes.

In general, amplifiers are used with higher plate voltage than detectors, and likewise power tubes higher than either. This is because we are dealing with increased signal intensity as we go from detector to first stage of amplification, first to second, and so on to the last or power stage.

amplifier. If another gives its at low voltage and high amperage, it is a power amplifier. The former are technically known as "high impedance" tubes, and the latter as "low impedance" tubes.

Impedance means the same to an alternating current circuit as resistance does to a direct current circuit, and since we are dealing with voice frequency alternating current in ordinary amplifiers, we speak of the internal impedance of the tube. This can be made high, medium or low according to the size the plates are made, the capacity of the filament (to emit conducting particles or "electrons"), the size and fineness of the grid and the degree of evacuation ("hardness").

Of course, an endless series of combinations could be made and there are, no doubt, in existence several thousand different tubes, each suited to some particular use better than any other. For ordinary radio work, however, there are practically four different classes in general use—all those on the market coming under one of the following classifications:

1. High impedance, high vacuum. (Voltage amplifiers.)
2. Moderate impedance, high vacuum. (Voltage amplifiers.)
3. Low impedance, very high vacuum. (Power amplifiers.)
4. Moderate impedance, moderate vacuum. (Soft detectors.)

These classifications are naturally not sharply defined and we can list the commercial amplifier tubes that fall in classes 1 to 3 roughly as follows:

Tube	Approximate Impedance	Plate Volts Maximum	Watts Maximum
1. A-P (DeForest) amplifiers.....	50,000 ohms.	160	1¾
Westinghouse WR-21	40,000 "	120	1½
Mayers amplifiers (High Mu).....	35,000 "	100	1½
Westinghouse WD-11 (A)	35,000 "	65	¾
2. Western Electric VT-1 (Amp.)	20,000 "	120	2¼
Radiotron UV-201 (C-301)	15,000 "	120	2½
3. Radiotron UV-202 (C-302)	8,000 "	450	6
Western Electric VT-2	6,000 "	375	5½
Western Electric 216-A	4,000 "	160	3½

All vacuum tubes act, in a way, like transformers; that is, they will transform the input signal energy into practically any ratio of voltage and current. If a certain tube gives its output energy at high voltage and low amperage, it is considered a "voltage"

The A-P detectors and UV-200 come in class 4, but as we discussed them last issue, we shall spend no more time on them.

It will no doubt be noticed that the three tubes we have illustrated for
(Continued on page 84)

NATIONAL RADIO WEEK

Dec. 23-30

Offers Dealers All Over the Country a Real Opportunity to Cash in on Radio Demand and the Publicity This Week Will Receive

Special broadcasting programs—
Special newspaper publicity and special concerts at every dealer's store and at the homes of prominent fans are among the plans of the committee.

Every dealer who intends aiding in this special publicity effort is invited to communicate with the committee.

Major J. Andrew White, *Chairman*,
National Radio Week Committee,
326 Broadway, New York City.

Major-General Harbord New Head For Radio Corporation

Major-General John G. Harbord, who will become president of the Radio Corporation of America, is one of Uncle Sam's distinguished officers, ranking only below General Pershing as Deputy Chief of Staff.

The General is to retire from service on December 29th and the following week will take charge of his new duties with the Radio Corporation of America. Army and Navy circles are agreed the radio company has acquired a valuable man, well qualified to assume the position.

Equipped with a college education, General Harbord enlisted as a private in the Army at 23 years of age, and through sheer merit has been advanced to his present position. He is a former Rough Rider, a veteran of Cuba and Philippines, was chief of staff under Pershing in France and was in command of the fighting Marine Brigade of the Second Division at Belleau Wood, Bouresches and Chateau Thierry, when the German advance was stopped in June 1918.

He was made a Major-General and commanded the Second Division during the Soissons offensive. In 1918 he commanded the Service of Supply responsible for all the supplies of the A. E. F. Reappointed Chief of Staff in May, 1919, he served as such until sent by President Wilson to the Near East as Chief of the Military Mission to Armenia. He has been Deputy Chief of Staff since June, 1921. He will be 56 years old in March.

"Major General Harbord's experience as an organizer, administrator and executive will insure him success in the business world." That's the way General Pershing put it last week, and the General knows.

In connection with the appointment, the Radio Corporation made the following announcement:

"General Harbord succeeds Edward J. Nally, who has resigned as president of the Radio Corporation to become that corporation's managing director of International Relations, with headquarters in Paris.

"The creation of the office of managing director of International Relations for the Radio Corporation, the election of General Harbord as the new president took place at the regular meeting of the directors of the corporation in New York on November 17th. General Harbord takes over his new duties on January 1.

"The post to which General Harbord has been elected is regarded as of vital importance to the Government as well as to the public, since the Radio Corporation was formed at the suggestion of representatives of the United States Navy in order that that single, strong, world-wide wireless communication, free from foreign domination, might be built up under American ownership and control.

"General Harbord becomes head of a company whose activities include international wireless communication with all the principal countries of the world, the setting up, maintenance and operation of radio sets and apparatus on ships at sea, and the development and sale of broadcast receiving sets for the home.

"Mr. Nally has just returned from Europe after several months' visit there, during which he concluded arrangements with the great wireless concerns of England, France and Germany by which the radio interests of the four great nations will act together



Maj.-Gen. John G. Harbord

in creating and operating international wireless communication with all parts of the world, but especially with South America. The Radio Corporation of America has assumed the leadership of this consortium, which carries heavy responsibility to our own people and the world at large."

Miss Koewing in Charge of WOR Makes Good Programs

L. Bamberger & Co., Newark's famous department store, has gained an enviable reputation in the radio world through its broadcasting station, known as WOR, and a visit to WOR indicates that a great measure of credit is due to Miss Jessie E. Koewing, who is in charge. She has the happy faculty of knowing how to produce pleasing programs and the special nights, featured by WOR, are indeed wonderful.

The Bamberger broadcasting studio is located in the big Bamberger store and those who sit around the microphone in this studio are impressed with the artistic atmosphere developed. WOR is keen for radio enthusiasm and its programs are educational, as well as elevating.

One of the recent big nights featured the great Houdini who was interviewed by newspaper men on spiritualism. Houdini is a recognized critic of the spiritualistic cult and the questions and answers pleased the big listening public. Another feature on

the same bill was the broadcasting of the complete opera of Cavalleria Rusticana. A superb group of singers, with a large orchestra, rendered this favorite opera.

Broadcasting of good programs makes for increased interest in radio—both as an art and as a commercial trade. These are proper combinations. Art and industry, when properly combined, produce pleasing results for everyone.

There is one thing that comes to the mind of visitors to WOR—as well as to those familiar with this station—and that is that as long as L. Bamberger & Co. are broadcasting at least one real broadcasting station can be guaranteed to buyers of sets.

"The future will take care of itself," says Miss Koewing, "our aim today being the offering of entertainment of varied character. We feature friend McNeary's "Man in the Moon" and music and beyond that offer what we believe will interest the average person."

Manufacturer Analyzes Trade Conditions

Tabulation of Inquiries Shows Business Activity and Indicates When Orders May Be Looked For

By "EXECUTIVE"

In order for a manufacturer to sell his products on a competitive basis and still operate at a profit it is necessary for him to closely forecast the demands for his line and govern his production accordingly. In most established industries charts of actual demand are at hand, showing variations from month to month and from year to year. In the radio industry, however, there are at present no records available to show the manufacturer how to gauge his demands and thus to determine his production.

If he is optimistic and operates his factories at the maximum capacity, he runs the risk of serious loss through over-production resulting in unsold stock and an overflowed market. On the other hand, if he is unduly pessimistic, he may be caught in the tidal wave of a demand which he is unable to satisfy and as a result he will suffer both from the loss of orders which it is impossible for him to accept and also from cancellations on orders accepted but not filled in time.

A New York radio manufacturer, a national advertiser, has adopted the expedient of keeping a close watch on the inquiries coming in from all sections of the country. In this way he can tell in what sections demands are likely to increase. By watching the totals he can tell, in a general way, whether the interest in radio is increasing or decreasing. In fact by careful analysis and study of these inquiries he can very accurately forecast his production requirements. A careful analysis is also made of all orders and these are checked up so that the relation between inquiries and orders may be determined.

Thus, if the inquiries from a certain territory show a sudden marked increase, there may be no immediate orders from jobbers, but the manufacturer knows that within a certain time limit the jobbers in that section will begin to wire rush orders. In this case the manufacturer uses his inquiry statistics as a barometer to warn him of approaching demands.

The accompanying chart shows the location by states and the number of inquiries received by the radio manufacturer mentioned above, between October 23 and November 18. States are arranged in the order of the total inquiries received during these four

weeks, these figures being shown in the left-hand column. In the columns at the right are shown the number of inquiries received each week from each state. A partial analysis of this chart is given below although a good many more facts may be deduced from a close study of the various factors.

tered in thirteen states, New York, Illinois, Pennsylvania, Iowa, Michigan, Ohio, Texas, Kansas, Wisconsin, Minnesota, Missouri, Indiana and New Jersey. In eleven states, Oklahoma, Nebraska, Massachusetts, Kentucky, California, South Dakota, Tennessee, Connecticut, Florida, North Carolina,

CHART OF INQUIRIES

Total Inquiries	State	Oct. 23-28	Oct. 30-Nov. 4	Nov. 6-11	Nov. 13-18
110	New York	32	26	24	28
88	Illinois	20	10	22	38
86	Pennsylvania	30	16	12	28
66	Iowa	16	30	14	6
58	Michigan	24	10	14	10
48	Ohio	20	8	10	10
48	Texas	10	20	6	12
42	Kansas	16	12	8	6
42	Wisconsin	22	6	8	6
40	Minnesota	4	6	10	20
34	Missouri	8	8	6	12
32	Indiana	2	8	8	14
32	New Jersey	18	4	10	2
30	Oklahoma	10	8	10	2
24	Nebraska	8	0	6	10
24	Massachusetts	6	4	2	12
22	Kentucky	14	4	2	2
22	California	4	6	10	2
22	South Dakota	6	8	6	2
22	Tennessee	8	4	4	6
20	Connecticut	6	6	4	4
20	Florida	8	4	2	6
20	North Carolina	8	4	2	6
20	Virginia	8	6	2	4
16	North Dakota	2	4	4	6
14	Colorado	2	2	6	4
14	Georgia	4	4	4	2
12	Montana	4	2	2	4
12	Idaho	0	2	6	4
10	Arkansas	4	0	2	4
10	District of Columbia	0	9	2	0
10	Maryland	4	2	2	2
10	New Hampshire	2	4	2	2
10	Washington	4	6	0	0
8	Louisiana	6	0	0	2
8	Alabama	2	2	2	2
8	Mississippi	2	2	4	0
8	West Virginia	2	2	4	0
6	Oregon	2	2	2	0
4	Wyoming	0	2	0	2
4	Vermont	2	0	2	0
4	Maine	0	2	0	2
2	Arizona	0	0	0	2
1,142	TOTALS	350	262	246	284

It will be noted in a general way that the largest number of inquiries have been received from the most thickly populated states. Judged from this standpoint, Iowa shows up extremely well, while Ohio with more than twice the population of Iowa makes a comparatively poor showing. From this chart it would appear that present highest radio activity is cen-

and Virginia there is a moderate amount of activity. Inquiries from each of these eleven states have been less than one-fourth the inquiries received from New York.

By referring to the chart, it can be seen that in the remaining states radio is still in an unsatisfactory condition, at least as far as this particular manu-
(Continued on page 91)

Retail Radio Salesmen and Raspberries

Technical Men Employed as Salesmen in Radio Stores Should Receive Merchandising Training

By EDWARD H. LERCHEN
President of Orange Research Laboratories

We all know what radio is; we think we know what a radio dealer is; but as for the raspberries?

What is a radio dealer and who is a radio dealer? Is a radio dealer a man who conducts a retail establishment for the display and sale of radio sets, parts, etc., exclusively, or can the local bicycle dealer, druggist and the hardware man, be called radio dealers? To the first question I will say "Yes," and to the last question I am going to say "No"—and for this reason:

The first class of dealers are devoting their entire time and energy to selling only radio supplies, while the second group is only in the business as a secondary consideration. The first class as a rule have made a study of radio and understand the science of radio and merchandising the supplies, while the other group as a rule knows less about the business than their customers.

But the peculiar thing is, that of the two classes of radio dealers mentioned above, the latter seem to have been the most successful in the radio game outside of a few exceptions, and now comes the reason why, and here is where the raspberry comes in.

As this article is written for the purpose of trying to give constructive criticism I believe I will be pardoned, even by the raspberries, for some of the following statements:

In the beginning of the radio rush, the regular radio dealers hired as salesmen highly trained technical radio men, whose knowledge of radio was above reproach, but when it came to salesmanship and dealing with the general public these men as a rule, having had no selling experience and no experience in meeting the general public, were sadly lacking in the qualifications which go to make up a salesman. They caused the loss of hundreds of sales. Due to the fact that a great many of these clerks were so far above the average radio novice in knowledge it has frequently happened that when one of the customers came into a radio store to buy the clerk couldn't come down to earth long enough to sell a crystal set, but insisted on talking about potentiometers, radio frequency,

Edward H. Lerchen, president of the Orange Research Laboratories of East Orange, N. J., has been in the electrical industry for ten years. He is a native of Illinois, but has been located in the East for the past seven years. Mr. Lerchen is an inventor and has taken out and worked out a number of important electrical patents. One of these is the Vac-Shield for vacuum tubes, a new addition to the radio appliances.

etc., until the uneducated novice either walked out of the store in disgust, probably resolved never to return to it.

Salesmen of this type knew nothing about human nature nor understood how to approach the general public, and I want to say here that of all the generals I know about, "Old General Public" is the hardest to handle when it comes to selling merchandise. The result of all this failure to employ clerks who were unfamiliar with selling methods was that many a novice wandered around hunting for the radio article he wanted and needed, until he finally wandered into a store where he was able to purchase just what he was after without being held up to

ridicule for his lack of knowledge of radio. The reason was that they knew just about as little in regard to the radio business as he did, so there were no arguments.

The only one to blame for this condition was the radio dealer himself, who should have taken his trained radio men and given them a talk on selling merchandise before putting them behind the counter to deal with the public, as no better combination of a radio salesman could be obtained than a highly trained technical radio man who possessed a knowledge of salesmanship.

My suggestion to all radio dealers is that you conduct a sales meeting once a week for your salesmen and clerks, and have one of your technically trained radio men talk to them and explain the relative merits of certain condensers, variometers and other instruments. Have him describe how to mount them in a set in the best manner and in doing this to keep away from technical terms and explanations, telling them or showing them the best manner in which to drill a bakelite panel or to connect or solder the wiring in the set. Forget about radio frequency, mutual inductance, hysteresis, natural wave length and other tech-

(Continued on page 86)

Twenty Receiving Sets Now in Use to One a Year Ago

By MARTIN P. RICE
General Electric Company

Radio telegraphy appeared more than twenty years ago. Its dramatic accomplishments in summoning aid to ships in distress established it in popular favor and earned for it an immediate field of inestimable importance. Amateurs took it up, but one could not participate in telegraphy without a knowledge of the code and that necessitated months of study and practice, and so it had a relatively small following. The radio telephone made "wireless" available to all the

110,000,000 people in the United States and to others in adjoining countries, and nearly all of them seem to be interested.

A year ago there were hardly fifty thousand radio receiving sets in the United States; there are now nearly a million and there are sending stations of sufficient power to cover the entire area under favorable conditions. The aggregate number of those who listen-in on the eve-

(Continued on page 87)

Stations Improving Their Radio Programs

Survey Shows them Offering Bills of More Variety, Greater Interest and Better Talent

By L. N. ALLEN

The steady improvement in broadcasting programs points to advancement for the industry. Broadcasting stations are giving more attention to the quality of their programs, the owners realizing the necessity for better programs to hold the public interest.

This is no longer the day when mediocre programs attract the listeners-in because of the mere novelty of the thing. The directors of the great stations are quick to realize this and it is with considerable pride in the advancement they have made that the head of one of the largest corporations managing broadcasting stations announced a week's program with over twenty nationally famous characters in the list of those to appear.

While radio's greatest boost has been in the broadcasting of sporting events, the heavyweight championship last year, the world's series, which held crowds all over the country in front of loud speakers, the foot ball games broadcast play by play, etc., the directors of the broadcasting stations and those high in the industry have begun to realize the danger of too much of any one thing, even of interesting sports, and more and more effort is being made for varied programs.

One of the most important uses to which radio programs have been put is the broadcasting of election returns. Never in the history of this country have the election results all over the country been so quickly learned and disseminated as during the November elections this year. Within half an hour after the first results were compiled at election booths, those in tune with broadcasting stations throughout the country saw the tendencies of the political battle and a continuous running recital of results enabled the whole country to see which way the political wind was blowing. Radio broadcasters took advantage of the dramatic interest in the election results.

Radio chapel services have received national publicity in newspapers and magazines, and more and more of the better class stations have added one or two special Sunday church services to their regular schedules.

Between the two extremes lies a vast middle ground of broadcasting

possibilities that only of recent months have been utilized.

The possibilities of carrying music to listeners-in who seldom have opportunities of hearing the truly great singers who more and more are broadcasting their efforts, appealed to publicity men managing the great musicians and, one by one the stars of the music world are being numbered

"This is no longer the day when mediocre programs attract the listeners-in because of the mere novelty of the thing. The directors of the great stations are quick to realize this and it is with considerable pride in the advancement they have made that the head of one of the largest corporations managing broadcasting stations announced a week's programme with over twenty nationally famous characters in the list of those to appear."

among those who have performed through the air.

Grand opera and local light opera companies in several cities have gladly consented to their numbers and even entire programs being transmitted, while it is expected that considerable progress will be made in handling events of this kind in the metropolitan territory in a short time. Symphony orchestras and other great musical organizations are also joining the programs. One eastern station has its own opera company.

Prominent men, national and even international figures, are beginning to take advantage of radio to reach thousands who are unable to attend the various meetings they address from time to time.

Showing the wide variety of programs now being given, we quote from the schedule of a central state station. News of the day, health talks, fashion talks furnished by one of the leading fashion magazines of the country, bedtime story followed by an address by a prominent banker in the city on the Federal Reserve system. A short se-

ries of dance numbers and two acts from a famous opera constituted the musical end of the program, while a well known comedian and a local impersonator of note gave a touch of comedy to the day's entertainment.

Surely broadcasting programs are becoming more and more varied, for in this way, and only in this way, will radio become of interest to the great mass of the public who are yet to be converted into fans.

In surveying the programs furnished by the active stations of the country it was pleasing to note that out of several hundred sample programs submitted nearly seventy per cent. carried sufficient variety to appeal to the vast number of "home people" who would refuse to listen to sporting events or phonograph music which once made up the large proportion of the programs of the day.

Some of the programs presented by the smaller broadcasting stations are not pretentious, but they are nevertheless interesting and varied. A small station in Texas, for instance, recently had this program to offer:

1—Violin Quartette, The Largo (Handel), Misses Minnie B. Justice, Edna Brooks, Nellie Howland and Libbie Feinberg.

2—Song (selected), Miss Lillian Richards.

3—Saxophone Solo, Miss Velma Pittman.

4—Reading, Miss Emily Baggarry.

5—Song, *Dissi D'Arte Dissi*, from *Tosca* (Puccini), Mrs. Charles Chinski.

6—Whistling Selection, Mr. Bob Tate.

7—Popular Musical Selections, Victor Novelty Orchestra.

8—Reading, Mrs. Charles J. Rupp.

9—Interpretations, Sung and played by Mr. Lawrence Humason.

A program does not have to come from a great station to be interesting.

The day of the "radio program" which consists largely of phonograph reproductions of jazz and xylophone selections, is past. The discovery has been made that rather than listen to these, the radio public prefers the reporting of actual events, such as football games or political speeches.

Radio is developing a distinctive program of its own, with advantages offered by no other mode of entertainment and with an educational value that cannot be over-emphasized.

White Bill Should Interest Congress

Provides the Secretary of Commerce With Adequate Authority to Remove Restrictions

The election returns as broadcasted on Election night from one of the most prominent stations in the East were badly interfered with by the efforts of an amateur musical organization, whose sweet notes were put in the air at the time when a large public was interested in learning the results of the battle at the polls. From other parts of the country complaints are being registered of frequent interferences in broadcasting programs and there is an increasing and urgent demand for a real regulation of radio activities.

The only expedient through which the evils of the present situation can be done away with at an early date are thought by those who are in the know to be through Congressional action. It is believed that if the radio industry will evince sufficient interest that the White Bill, which has rested in the care of the House Committee on the Merchant Marine and Fisheries since May 6 of last year, can be brought out of the committee and passed during the present short session of Congress. To accomplish this it is necessary that the radio industry and the radio fans impress upon Congress that they are in favor of immediate action on this measure.

Congressman Wallace H. White, Jr., who introduced this bill, said to a representative of THE RADIO DEALER: "I cannot be at all sure what Congress will do. It is my personal belief that if the various interests would get back of this bill, it could be passed at this short session. If, however, every interest seeks to have it changed in some way more favorable to it, I do not regard as favorable the prospects for legislation. I do not think anything else can be passed at this short session."

From this it will be seen that it is imperative that every person who is seriously in favor of this bill should get back of it and make their demand that prompt action be taken. This should be done by every person who is interested in radio—the manufacturer, the jobber, the dealer and every owner of a radio receiving set. They—each and every one of them—should write to their congressman and to their senator, telling them the necessity of getting the

The White Bill Should Be Passed

The White Bill which is aimed to give the Secretary of Commerce better control over radio should be brought out of the Committee and passed by Congress during this session. It is a good bill and deserves the support of everybody interested in radio. There is apparently no objection to it from any source. All that is needed is that pressure be brought on Congress. Tell the lawmakers that there is a popular demand that it be enacted into a law. You must do your part. Write today to your congressman and your senator and get others to do so. Tell them that you want the bill passed and that your friends who are also their constituents want it.

bill out of the committee and on the floor of the Congress.

Broadcasting stations can help too. If they will spread the news to their listeners-in that they will have less interference, they, too, can be induced to write letters. From the number of letters and postal cards that the listeners-in send to the broadcasting stations, there is no doubt but that many appeals to Congress would through this agency reach the lawmakers in Washington.

If sufficient pressure is brought to bear on Congress there seems but little doubt but that the law can be written into the statute books this session. However, the popular demand for it must be made. Everybody must put on some of this pressure—and that means you and everyone else who is interested in radio.

Commissioner D. B. Carson states to THE RADIO DEALER that the White Bill is "intended to carry out as far as practicable the recommendations of the Radio Conference Committee and proposes to give to the Secretary of Commerce adequate authority to remove some of the restrictions now existing, particularly the reservation of bands of wave lengths from

600 to 1,600 meters, which can now be used by government stations only, and several other important features which should be helpful in bringing about more satisfactory operating conditions." He further states that as far as he knows that there is very little opposition to the bill and he expresses the hope that it will receive consideration early in the present session of Congress.

The essential features of the bill are given in the following summary:

The purpose of the bill is to "regulate radio communication," "radio communication" being construed as "communication without the aid of wire or other conduction connection."

The bill provides, in a provision similar to present laws, that all apparatus for radio communication must be licensed by the Secretary of Commerce, and that all such licenses may be revocable for good and sufficient reasons. No license will be required by a person or company occupied in the transmission and exchange of radiograms or signals between points in the same state, so long as the effect of this transmission or exchange shall not extend beyond the state in question.

The licenses must specify the ownership and location of the licensed station, and other particulars of identification, must give the estimated range and purpose of the station, its wave or wave lengths, state the power authorized for use by the station, and hours during which the station is licensed to operate. Every license will contain the proviso that in case of war or public emergency the President shall have the power to close the station for radio communication and to remove the radio apparatus, or authorize its control, reimbursing the owners.

The bill prohibits the use of radio apparatus for the reception with intent to divulge or publish the contents or meaning of any radiogram from any foreign country, or, other than distress calls, from any foreign ships, except under license from the Secretary of Commerce. Violation of the above rulings is to be punished by a fine of \$500 with confiscation of the apparatus.

In order to "prevent or minimize interference with radio communication, to further communication of distress and safety signals," and to "promote the uses of radio communication," the bill provides that the Secretary of Commerce shall have the power to classify stations and operators, assign wave lengths, limit of power, fix rates, and establish any further regulations to carry out the purpose of the bill. The regulations are to have the force of law. To assist the Secretary of Commerce, the bill would establish an advisory committee for radio communication, composed of seven members, one each designated by the Secretary of War, Navy, the Postmaster-General, and Secretary of Commerce, one by the Secretary of Commerce from Government technical departments, and two other radio experts not employed by the Government. The committee will advise the Secretary of Commerce in the administration of the laws, and treaties relating to radio communication, study of scientific problems involved and relation of radio development to governmental departments.

No further stations may be established, the bill provides, within fifteen nautical miles of Arlington, Virginia; Key West, Florida; San Juan, Porto Rico; North Head and Tatoosh Island, Washington; San Diego, Cal.; and of those Government stations that may be established in Alaska and the Canal Zone.

A fine of not more than \$500 for the first offense is to be imposed on whomever maliciously interferes with radio communication that is duly licensed for private or Governmental work. Any person receiving and divulging a radiogram to a person for whom the message was not intended is to be punished by a fine of \$500 for the first offense. Transmitting or publishing of fraudulent radiograms is also provided for through a fine of \$2,000 or five years imprisonment or both. Trial for such offenses is to take place in the district where the offense occurred.

It is expected that if this bill become a law that many of the present annoyances will be done away with. The bill seems to have much merit and deserves the support of every person interested in radio. It is up to you to do your part to have it passed.

Write your congressman.

Write your senator.

Tell your customers to do so.

Tell your friends to do so.

If you broadcast, tell your listeners to write.

Do it today.

With twelve features of superiority, yet within the reach of every radio user.

JEWETT SUPER - TWELVE SELF CONTAINED VACUUM TUBE RADIO RECEIVER

Meets the demand for a complete receiver, combining good range, extreme sensitiveness and selectivity, with moderate price and economical operation.

The Jewett Super-Twelve has a double circuit tuner, constructed with new Jewett coupler of extreme selectivity, designed by Professor J. H. Morecroft of Columbia University. The adjustments are unusually simple and easy, requiring no special technical knowledge to insure success.

Two steps of amplification are furnished which give an increase of signal strength equal to that obtained from three or four steps employing ordinary transformers. The high quality of the incoming speech or music is sustained through uniformly high amplification over the entire musical scale.

TWELVE DEFINITE POINTS OF SUPERIORITY

1. High quality signal reproduction.
2. Simplicity of adjustment.
3. Compactness.
4. Minimum high frequency resistance for a given induction.
5. Maximum amplification with minimum distortion.
6. Maximum sensitiveness.
7. Maximum selectivity.
8. Minimum noise.
9. Minimum distortion.
10. High quality design, workmanship, material and finish.
11. Highest efficiency at moderate cost.
12. Economical operation.

PRICE, \$75.00

In Kodak, Mahogany or Walnut Cabinet

JEWETT MANUFACTURING CORPORATION

Herbert F. L. Allen, *President*

NEWARK

NEW JERSEY

What the Manufacturers Are Doing

NEW FEDERAL SETS

Two new receivers are announced by the Federal Telephone & Telegraph Company, of Buffalo, N. Y. Receiver No. 57 has a carefully designed tuning system. Simple operation is also ob-



Federal No. 57 Receiver

tained through the use of radio frequency amplification and two stages of audio frequency amplification. Provision is made through a conveniently located switch for the adjustment to suit a wide variety of antennas. Crude adjustment is made by means of a large control knob, while minute adjustment is secured through the use of a very sensitive vernier condenser.

The DX No. 58 receiver is more selective than No. 57, due to the use of two-tuned circuits, provided with controls that permit of a greater variety of adjustments. This receiver can be used with a large variety of antennas and is especially adapted for the re-



Federal D. X. No. 58 Receiver

ception of signals. The entire unit is mounted on a polished panel which is assembled in a metal case, finished in dull black enamel. The receiver as a whole is a device of beauty of line and finish as well as one of effectiveness.

NEW AMRAD RECEIVER

The American Radio & Research Corporation, Medford Hillside, Mass., announce the 1923 model of their Amrad Crystal Receiver, which is enclosed in a solid mahogany cabinet with genuine insulating panels, front and rear. A simple knob is calculated to permit tuning of any wave length between 175 and 675 meters. With the addition of a loading coil the receptivity of the Amrad set can be increased to 3,000 meters, if desired, the makers say.

The new set permits of additions, unit by unit, to increase the efficiency of the reception, but in providing for this, the company has seen that the Amrad crystal receiver need not be discarded, remaining always as the vital part of any improved set.

NEW VALLEY CHARGER

A new type of radio and automobile battery charger which is similar in appearance to a watt-hourmeter, being enclosed in a moulded glass cover exposing all working parts to view, has



Valley Charger

been placed on the market by the Valley Electric Company, 3157 South Kingshighway Boulevard, St. Louis, Mo.

This appliance is attractive in appearance and is suitable for installation in a room in the home. It is known as the Valley type A and B charger and is designed to charge a 6-volt radio A battery or any make automobile battery at a 5-ampere rate without the use of lamps or complicated connections. It will also charge a 22½-volt and higher voltage B radio batteries.

This new model charger plugs in on the home lamp socket just like the or-

dinary electric light bulb. Connection to the battery is made by means of clamps which are furnished with the instrument, and produces a quick tapering charge at trifling cost.

MAMMOTH RADAK CABINET

Interest was shown by visitors at the Chicago and Boston radio shows in the giant model of the Clapp-Eastham R. Z. Radak receiving apparatus.

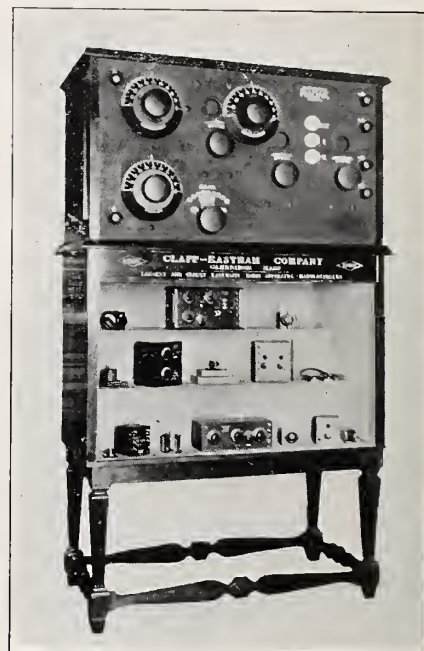

Mammoth Radak Cabinet

This will also be on display at the forthcoming New York show. This novel display has its utility feature, for a desk is provided for the use of the exhibitor, by means of a hinged back which lets down. The apparatus on the shelves in the illustration is nicely displayed by the gray broadcloth lining of the case and the concealed lights.

LONG DISTANCE PARTS

The McConnell Cable & Specialty Company, of Chicago, is featuring a list of long distance radio parts, which include variometers, variocouplers, dials and variable condensers. The company is also a specialist in magnet wire, carrying a full stock of plain enameled, single cotton enameled, single cotton and double cotton wire. The McConnell list includes almost every part requisite to the construction of a radio set.

MELCO ACHIEVEMENTS

The Mortimer Radio Corp., manufacturers of Melco radio apparatus and parts, while comparatively new in the radio field, are fast becoming a factor in the industry. Their Melco receiving sets are moderately priced, but of the highest quality.

Benjamin H. Price, president of the Mortimer Radio Corporation, due to his connection with the Save Electric Corporation, the large independent incandescent lamp manufacturers in this country, has in a comparatively short time succeeded in standardizing and putting into production the Melco products. The reception range of their set, which is non-regenerative, is very large, as is attested by owners of receiving sets, scattered throughout the country. With it Chicago hears Atlanta; Cleveland hears Schenectady; St. Louis hears New York, and Akron hears Davenport.

A large measure of publicity has been given the Melco radio receiving sets by the Cleveland Plain Dealer in its campaign for increased circulation. Full page advertisements are being run in a series of Ohio newspapers, with the result that the Melco sets are becoming very widely known throughout the Middle West.

WAVOLA UNITS

The Fairmount Electric & Manufacturing Company, of West Philadelphia, in their Bulletin No. 500, describe their Wavola sectional receiving units, built in twelve distinct types. These include a tuner unit; a detector; a radio amplifier, an audio amplifier, a detector and audio amplifier, a radio and detector unit, two stages of audio, two stages of radio, radio, detector and audio, detector and two stages of radio, two stages of radio and detector, and three stages of radio.

All of these units are constructed on the sectional book-case plan. The Fairmount Company also produces a complete line of accessories under the trade-name Maxum.

NIFTY EBY BLOTTER

The H. H. Eby Company, of Philadelphia, binding post experts and specialists, are distributing to dealers for further dissemination among radio enthusiasts, a neat little blotter in the shape of an Eby binding post. The design is original in conception and indicates the progressiveness of this firm. The Eby company have from the first shown great originality in their marketing plans. Another of their selling schemes is a mahogany stand delivered to dealers at cost which places the whole Eby line before the radio public.



Make it
the **GREATER** Radio
Christmas

FOR our dealers' information, we reproduce herewith the forceful and attractive illustration which appears in all Magnavox Advertising (more than seven millions of circulation) during the busy and profitable Christmas season.

Sooner or later every radio user wants a Magnavox—and every Magnavox owner has full confidence in the dealer who recommended the "Reproducer Supreme".

- R-2 Magnavox Radio** with 18-inch horn: this instrument is intended for those who wish the utmost in amplifying power; for large audiences, dance halls, etc. . . \$85.00
- R-3 Magnavox Radio** with 14-inch horn: the ideal instrument for use in homes, offices, amateur stations, etc. \$45.00
- Model C Magnavox Power Amplifier** insures getting the largest possible power input for your Magnavox Radio.
 - 2 stage AC-2-C . . \$80.00
 - 3 stage AC-3-C . . 110.00

Our publication *THE MAGNAVOX* contains valuable information on building a profitable Radio Business. Ask for it.

The Magnavox Co., Oakland, California
New York: 370 Seventh Avenue

MAGNAVOX
Radio
The Reproducer Supreme

ZELLAC

ECONOMICAL FINISHES

FOR

Radio Equipment

Zeller Lacquers and Enamels constitute the most economical finishes on the market today for radio equipment of all kinds. They are easily applied either by dipping, brushing or spraying and completely dry in normal room temperatures within 15 minutes.

Zellac is made in all colors and can be applied to all materials. Beside the standard natural wood finishes, our Hard Rubber Black has become popular among manufacturers for finishing instrument bases as well as cabinets while our White is used exclusively by many organizations for the graduations on dials and knobs, as well as for panel work. A thin coat of our material, which has a high dielectric strength, applied to coil windings, holds them permanently in place without causing the usual undesirable effects.

Distortion and metallic ring largely removed from loud speaking horns and phone diaphragms where our special material is applied. Write today for more information.

ZELLER LACQUER MFG. CO., Inc.

342 Madison Ave., New York

National Radio Week Post Card



The Postal Card Above, Beautifully Printed in Three Colors, Has Been Designed by H. Gernsbach of *Radio News* to Boost National Radio Week. These Cards May Be Obtained from the National Radio Week Committee or *Radio News* at Cost

R. T. A. to Meet

First Meeting to Be Held in New York December 26

The first meeting of the Radio Trade Association will be held at New York December 26th, the association having accepted the offer of the American Radio Exposition Company to meet in quarters that will be furnished by that association.

In addition to the organization meeting and hearing reports of committees, a number of prominent radio trade men will address the meeting, making short talks on subjects of general interest.

Plans of the association include a sweeping invitation to other organizations of the radio trade to attend this meeting and hear the speakers.

Full details of the programme will be published in *THE RADIO DEALER WEEKLY* at an early date.

Officers of the Radio Trade Association are: Henry M. Shaw, president; Hugh H. Eby, treasurer; L. A. Nixon, secretary; W. B. Curtis, first vice-president; R. P. Clarkson, third vice-president; Raymond F. Yates, fourth vice-president; Chauncey F. Carter, fifth vice-president; W. L. Sayer, sixth vice-president.

The Board of Directors consists of Bert B. Barsook, Powel Crosley, J. H. Smith, Oklahoma Radio Co., Bert B. Barsook, Powel Crosley, F. H. Pruden, F. Clifford Estey, F. D. Pitts, Harold M. Schwab, M. B. Sleeper, W. M. Kunkel, C. H. Love, A. H. Redden and Mortimer Salzman.

A WONDERFUL XMAS PRESENT



The Little Gem
(cut half size)

The dealer will at once appreciate the potential sales possibilities of this wonderfully efficient and beautiful little crystal receiving set. Has a large receiving radius. Test it yourself. You can then recommend it with the same confidence that we do. Stand and all other metal parts of solid brass and nickel plated.

PRICE, \$6.50 LIST

Manufactured by

United Specialties Co., Inc.

57-59 Spring St., Newark, N. J.

THIS IS A RADIO CHRISTMAS!

Panel Is Important

Necessity of Having It Built in a Scientific Way

"More thought should be given to the quality of the materials used in radio sets," was the statement made recently in an interview with George J. Levy, of Poster & Co. "When we speak of radio today the uppermost thought is of the type of instrument, its receptive powers and the hook-up," he explained. "But in addition, thought should be given to the quality of the materials used in making the



George J. Levy

set, for, regardless of the intent, it will not receive properly unless the parts are honestly made of worthy materials.

"This brings me to the consideration of the panel. Bakelite is the most universally used in its construction, due to the known qualities of dialectic strength, the fact that it will not warp under heat and will not be affected by acids or alkalis. Our company uses bakelite exclusively in panel construction.

"We have been specializing in the supply of bakelite for panels and parts, and are equipped to cut panels to any size, drill and engrave them according to specifications, sand the panels and complete them for mounting."

Mr. Levy also commented on the present outlook in the radio industry.

"Judging from the business we are doing at present," he said, "the radio business is progressing nicely and upon a sound basis, with more conservative ideas than were current last fall."

The SUPERTONE RADIO LOUDSPEAKER

*The Violin Maker's Science
in a Radio Loudspeaker!*

It has the approval of the
new intelligent radio buyer!

We have employed the science of that master craftsman, the violin maker, and designed a Radio Loudspeaker that for perfect reproduction of sound, cannot be excelled.

It renders the original tone always—whether it be the human voice or the music of an instrument. It completely eliminates all suggestion of harshness—all screeching, metallic and unnatural distortion that is so common among loudspeakers.

Supertone is the Amplifier the Radio World has been waiting for. It enables you to meet the demand of the customer who is neither able nor willing to buy an expensive "outfit"—yet demands an exact, dependable amplifying instrument.

It is the most practical loudspeaker to be had. And at the low retail price it is certain to bring you wide sales and rapid profits.

*Send us your
sample stock
order today*

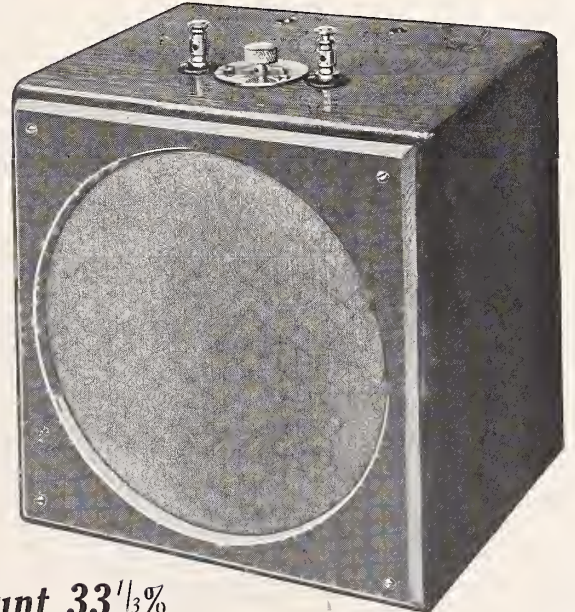

Retail Price

\$15

Dealer's Discount 33¹/₃%

Further discount to quantity buyers

*The Supertone Loudspeaker operates directly from the set,
therefore no extra battery is required*

No Power — No Horn — Therefore no distortion!

TRIANGLE PHONO-PARTS CO.

18 W. 20th Street

New York



NATIONAL SEAMLESS TUBING

In Large Diameters

For Vario-couplers, Vario-meters, Tuning Coils and wherever you use large diameter fibre tubing, National Seamless Tubing is less expensive and infinitely superior.

National Seamless Tubing is a specially developed, laminated tubing that retains its form and will not warp, swell or shrink. Exact in both diameters and easily worked.

Can be furnished in dark gray fibre or black fibre. Any quantities, diameters from 3" to 4½" I. D. Any wall from 3/32 up.

Give us your specifications. We'll send samples and prices.

National Fibre for Panels

Hard Black Panel Stock of good dielectric strength. Gives satisfaction for condenser tops and bottoms, rheostat bases, washers bushings, etc. Let us quote on the stock itself, or on completed parts machined to order.

Peerless Insulation

The standard thin weight fibre insulation or "fish paper."

National Fibre & Insulation Co.

Box 455 Wilmington, Delaware
New York, Chicago, Philadelphia, Detroit, San Francisco, Cleveland, Omaha, Pittsburgh, Boston, Rochester, Birmingham, St. Louis, Baltimore, London, England
In Canada, National Fibre Co. of Canada, Ltd., Toronto

Book Reviews

By

BERNARD JEROME FARRELL

The Editors of the RADIO DEALER will be glad to review new publications in this field as they may be issued. Address them attention BOOK REVIEW EDITORS, THE RADIO DEALER, 1133 Broadway, New York City.

IDEAS FOR THE RADIO EXPERIMENTER'S LABORATORY. By M. B. Sleeper. Published by the Norman W. Henley Publishing Company, New York City.

In this little volume, Mr. Sleeper has compressed his experience of many years in showing the amateur how to build bigger and better sets.

The accomplished and experienced amateur as well as those of an experimental turn of mind, will find much information on experiments and tests which are of great value to them, while the novice will discover a wealth of information which will assist him in the designing, constructing and testing of his set. A special feature is a complete table of inductance capacity and frequency, corresponding to wave lengths of from 100 to 39,000 meters.

Comprehensive data is given on such necessary laboratory instruments as the oscillator, wavemeter, direction finder, radio compass, V. T. characteristic measuring set, and detailed advice is given on the winding of the various kinds of standard inductance coils.

Much valuable information is contained in the chapter on rules and regulations on fire protection, which meets the requirements of the National Board of Fire Underwriters.

ACCOMPLISHMENTS OF THE SOCIETY FOR ELECTRICAL DEVELOPMENT, Being a Report for the Year Ending May 9, 1922. Published by the Society.

This is a comprehensive report of the work done by the Society for Electrical Development during the past year. Much headway in educating the public to "Do It Electrically" has been made; many points of contact, by means of which practically every group of present and prospective customers has been reached, have been established. Booklets, pictures, films and radio have been utilized to tell the story. The report is attractively made up and is enlivened by many illustrations which augment the text.

Attention Radio Mfg'r's and Jobbers Serco Radio Products

These prices
are net

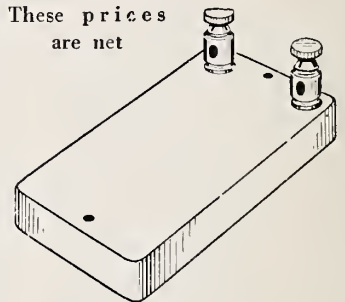

Serco Fixed Condensers,
moulded, 42 cents

Serco Fixed Condensers,
moulded, 54 cents

Serco Crystal Detector, 75 cents



Serco Amplifying Trans-
former, 10 to 1 ratio, \$1.75

We are Manufacturers
of
Serco Radio Products

Write for Trade Discounts

Scheib Elec. Radio Co.
6243 Station Street
Pittsburgh, Pa.

IMPROVED CONDENSERS

The New York Coil Company, 338 Pearl Street, New York City, are offering a variable condenser with several new features calculated to make this instrument among the most efficient and satisfactory of its kind.

Instead of using fibre or molded material for the outside frame with the possibility of such materials warping and throwing the plates out of alignment, they use heavy, nicked-steel plates with suitable insulation to support the rotating element. The plates are all made of very heavy aluminum, mounted on a $\frac{1}{4}$ -inch brass shaft and spaced with large diameter washers which are kept to uniform thickness, having a variation of less than .0001 of an inch.

A feature of importance is the adjustable pivot bearing employed, which insures the absence of shake or looseness in the bearings, at the same time introducing sufficient friction so that the instrument stays set in any position, dispensing entirely with counter weights or their equivalent, and also insures absolutely perfect electrical contact with the rotating element.

The New York variable condensers are made in three sizes, 11, 23 and 43 plates.

NEW RADIO MATERIAL

Fibroc, a product developed primarily for use in the electrical industry, is being used in the manufacture of insulated parts in radio. The Fibroc Insulation Company, Valparaiso, Ind., are adapting Fibroc to more and more radio uses.

This material is not subject to climatic changes, is insoluble in solvents such as weak acids or alcohol, will withstand the action of ozone in high voltage apparatus, being superior to hard rubber in this respect and will withstand boiling water indefinitely. As the regular grades of Fibroc are all of organic materials, they will char, but not melt or support combustion. Fibroc is manufactured in the form of sheets, rods and tubing.

IT IS NON-INDUCTIVE

In the advertisement of Durham & Company, radio engineers of 1936 Market Street, Philadelphia, Pa., that appeared in our November issue it was stated through a typographical error that the Durham variable high resistance (adjustable grid leak) is "non-conductive" instead of non-inductive as was the intention. The ohm range of model No. 101 should also have read as from 100,000 to 5,000,000.

ATWATER KENT

RADIO RECEIVING SET

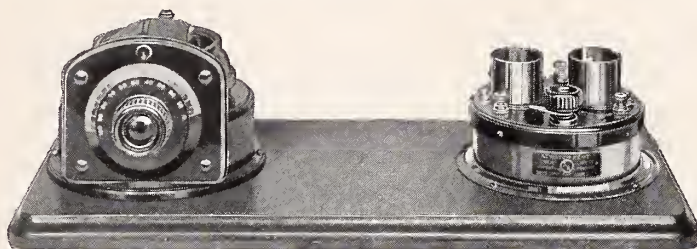

THE two instruments shown above comprise an excellent and complete receiving set. The Coupled Circuit Tuner and Detector Amplifier on the mahogany mounting board present a beautiful appearance. Complete outfit as above, unwired, \$32.00.

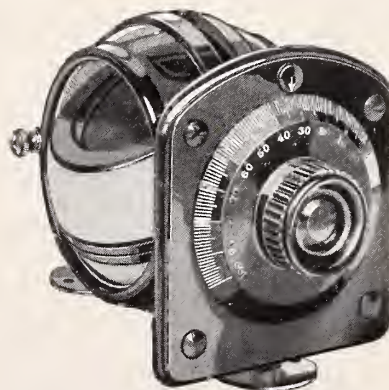

The Mounted Variometer carries through the standard quality of Atwater Kent products. For an open set it supplies a finished instrument unsurpassed in both appearance and performance.

Mounted Variometer, \$10.00

ATWATER KENT MANUFACTURING COMPANY
4941 STENTON AVE. Radio Dept PHILADELPHIA, PA.

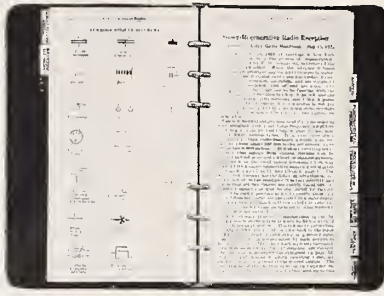

Lefax Radio Handbook

How to Sell Apparatus Quickest

Manufacturers, you can sell your apparatus, if it's first class, through Lefax Radio Handbook, the one book on Radio that never grows old. Here is the opportunity of giving your trade one of the best pieces of advertising co-operation. It is in loose leaf form and every buyer gets additional facts on Radio as soon as they are learned. These facts are printed and classified on Lefax pages ready to slip into the book. This service goes with the Lefax Radio Handbook.

Owners of this fine work ask all kinds of questions. They ask about apparatus—whether it's good, where to get it, how much it costs. We tell them with Apparatus Sheets to be made part of the Lefax Radio Handbook. Only good apparatus is listed. If yours is that kind, we recommend that you tell fans about it on our Apparatus Sheets.

Lefax Radio Handbook was written by Dr. J. H. Dellinger and L. E. Whittemore, Chief and Alternate Chief, U. S. Bureau of Standards, Radio Laboratory, Washington. Lefax Apparatus Sheets go direct to those interested in and users of apparatus. Mailings to 20,000 owners now available to you if you act quickly and your apparatus can qualify.

Within six months, 40,000 mailings will be available. Write today for full particulars and a Lefax Radio Handbook. If you want to create a demand for your apparatus, this is the time, this is the way. Lefax Radio Handbook is considered as first authority by every owner of it. Get the particulars. Write for them today.

LEFAX, Inc.

9th and Sansom Streets
PHILADELPHIA, PENNA.

JERSEY HEARD DENVER

Broadcasting taking place in Denver, Col., was heard in Ridgewood, N. J., recently when radio enthusiasts at the Ridgewood Talking Machine Company picked up radio waves which had traveled some 2,000 miles.

The instrument that picked up the travel-weary waves was a super-sensitive receiver, made by the Wireless Phone Corporation, of Paterson, N. J. In conjunction a three-stage amplifier and a Magnavox were used.

Several witnesses, including Robert Muns, radio engineer, of the Wireless Phone Corporation, can testify to the distinctness with which the Denver program was heard. They could not catch the call letters on account of local interference at the time the call was announced, but every one distinctly heard the name "Denver, Colorado." Previous to their signing off, two musical selections were heard loud enough on two stages to fill the room.

JOLLEY LOUD SPEAKER

Designed especially for amplified loud speaking for home, auditorium, aboard ship, or wherever loud speaking in conjunction with radio receiving is required, the Jolley loud speaker is now offered to the radio market by the Jolley Radio Co., of New York.

The horn is made of special alloy brass produced especially for the Jolley loud speaker. The joints are all silver soldered and appear seamless. It is finished in heavy nickel plate, highly polished.

The speaker is of the self contained magnetic field construction, no external energy being required other than an increase in "B" battery voltage operating on 80 to 125 volts for ordinary circuits and up to 250 volts for Armstrong superregenerative circuits.

KING QUALITY STANDARDS

Years of experience in the making of small parts on a large production scale have been of great advantage to the King Sewing Machine Company, of Buffalo, N. Y., who are now in the radio field. Skill in design, quality of material and accuracy of construction are the dominant notes of this concern, which has a reputation in other fields to live up to.

The radio apparatus division of the King company is at present engaged in the manufacture of King Quality dials, made in black or white; switch levers, with a mirror finish; binding posts of genuine bakelite, and tube sockets of moulded bakelite and tube and terminal binding posts of brass.

Standard Phone Plugs

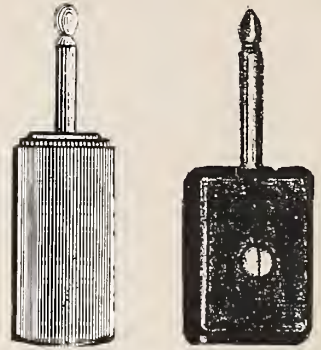

Price One Hundred or a thousand \$40.00 per hundred Net. Price One Hundred or a thousand \$22.00 per hundred Net.

Sample dozen postpaid \$5.00 Sample dozen postpaid \$3.00

The above plugs can be used with telephone cords having pin tips, spade tips or plain wire ends. NO SOLDERING NECESSARY.

ALL SAMPLES SENT C. O. D. NONE FREE.

S. S. NOVELTY CO.
255 Bowery, New York, N. Y.

POSTER'S Perfect PANELS

XX Bakelite - Dielecto Radio Panels

Manufacturers and dealers: immediate delivery—any quantity—cut to size.

Engraving and Drilling

Sharp white lettering, clean accurate work, quantity production at surprisingly low cost.

Write Today for Sample and Prices

POSTER & CO. INC.
552 SEVENTH AVE., NEW YORK
PHONE BRYANT 2-572

THIS IS A RADIO CHRISTMAS!

DISTANT STATIONS BROUGHT IN FOR LONG WAVE RECEPTION

USE AMCO ADJUSTABLE, 1, 2 AND 3 COIL MOUNTINGS

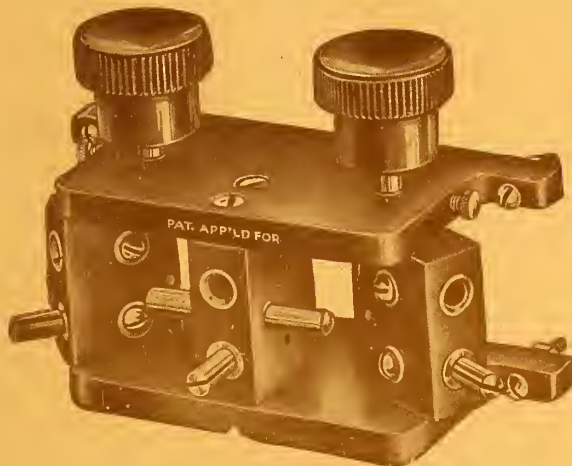

Licensed Under DeForest U. S. Patent, No. 1,365,170

Adjustable locking device, a patented feature, holds the coil firmly in place. Readily mounted on front of panel in any position. Constructed of the highest grade insulating material; polished and attractively finished. All metal parts heavily nickel plated.

NOT A MOULDED AFFAIR

ASTORLOID MFG. CO., INC.

Tel. Williamsburg 5104

416 MARCY AVE.

BROOKLYN, N. Y.

Triple Coil Mounting

List \$4.00

Two Coil Mounting

List \$3.00

Single Coil Mounting

List \$0.50

25,000 UNBREAKABLE DIALS

To close out below manufacturer's cost

These dials have a high polish and fine attractive finish. Fastened to large molded knob with brass bushing.

3" Dials \$0.20 net

3 1/2" Dials 0.25 "

SEND FOR SAMPLES



In Our New Factory

— ready for business —

The ACE DRY BATTERY is back. We had our fire which wiped out the factory but now we are in a better and larger factory—better equipped—better prepared to handle orders.

Send in your order for
ACE WIRELESS BATTERIES

There's a reason for their silent operation. For instance, the locknut terminals prevent vibration. The sealing compound will not bulge.

They are more powerful—longer lasting.

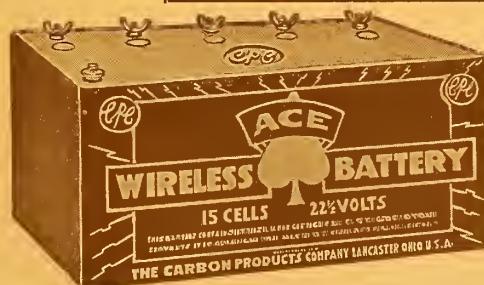

The Ace Radio Book

Give your customers an interesting and instructive book on radio. It cost them nothing. It costs you nothing. You are supplied with these books to give away with each Ace Wireless Battery.

The contents aim to sell other radio equipment for you as well.

**ACE
WIRELESS
BATTERIES**

THE CARBON PRODUCTS CO., LANCASTER, OHIO

Another THRADIO Triumph

A Rheostat built upon lines that makes impossible loose resistance strip
ACCURATE—RUGGED—DEPENDABLE

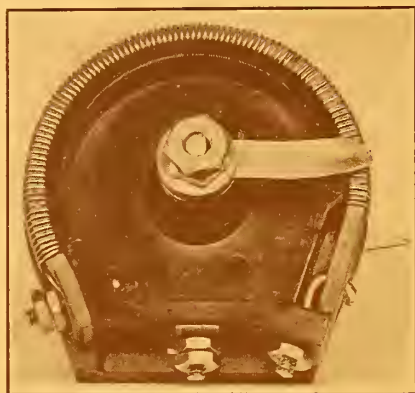

Note the manner in which STRIP is secured and held taut against flange of BASE keeping each turn of RESISTANCE WIRE accurately spaced.

THRADIO

SOCKETS

CONDENSERS

HEAD SETS

THRESHER RADIO CORP.

476-484 EIGHTEENTH AVE.

NEWARK, N. J.

NATIONAL RADIO WEEK

has been set for the Christmas week

December 23 to 30

The National Radio Week idea is gaining favor and the week will be observed in every city of any importance. Every dealer is urged NOW to start planning stunts for this week to push RADIO more strongly into the public eye.

National Radio Week! National Radio Xmas! More Business for All!

NATIONAL RADIO WEEK COMMITTEE,

J. ANDREW WHITE, Chairman,
 326 Broadway, New York City.

This is a **RADIO** *Christmas!*

THIS IS A RADIO CHRISTMAS!

PARAGON GROUNDS

Satisfying the need of the average radio enthusiast for an effective ground, the National Electric Specialty Co., of Toledo, Ohio, have evolved the Paragon line of grounds.

The Paragon ground is made of one continuous piece of pure copper from base to point of connection with leading-in wire above the surface of the earth. Copper is used because it has high conductivity and resists earth corrosion. The Paragon ground insures protection from lightning and high tension crossed wires. The National Electric Specialty Co. also make a line of lightning arresters which may be adapted for use in radio.

INTRODUCES NEW PART

The Feri Radio Mfg. Co., 1167 Bedford Avenue, Brooklyn, N. Y., has introduced a new type of variometer for which many advantages are claimed.

The strong outer winding, which is extremely light in weight, rotates about a stationary ball thus dispensing with the necessity for supporting blocks and simplifying this type of instrument. Friction contacts are replaced by pig-tail and stop arrangement. Only two small holes in the panel are required for mounting the Feri variometer. Territory is still open for distributors in the marketing of this new product.

SIMPLE, BUT COMPLETE

The G-W detector made by Gelman & Weinert, 42 Walnut Street, Newark, N. J., is extremely simple, but complete to the last essential detail. Its principal features are the cone-shaped phosphor bronze contact spring and the friction ball and thrust device. The spring has a telescoping action which permits an increase or decrease of pressure without losing this adjustment. The friction device automatically takes up wear and holds the adjusting arm firmly in any position despite changes in temperatures or vibration.

GOOD SYNTHETIC CRYSTAL

Exceptionally desirable qualities are possessed by Rusonite, a synthetic multipoint detector crystal that has been developed by the Rusonite Products Corporation, 15 Park Row, New York, after extensive research. They express the opinion that this crystal surpasses natural crystals in sensitiveness. On a sample recently tested by THE RADIO DEALER, the claim made by the manufacturer that Rusonite eliminates detector troubles and gives increased clearness and volume was borne out by a careful test.

The Outfit Everybody Wants!



The Little Giant Receiving Outfit

Greater Simplicity—More Efficiency—Popular Price

The Little Giant Receiving Outfit is surprising dealers everywhere with its extraordinary sales. People, who never showed any interest in radio, are buying this greatly improved, high grade receiving outfit. It overcomes all the objections of difficult operation, unsightliness, inconvenience and great expense common to most types. Dealers are increasing business with this rapid seller. Things are brighter after they give the Little Giant a chance to prove its appeal to everybody.

The entire set is contained in a highly polished American Walnut Cabinet that you can hold easily in one hand. The only adjustment necessary (once the detector is fixed) is the pulling out of a small rod on the side until the sound is clear and loud. Designed on entirely new principles. Combined with supersensitive Metro Headphones, the Little Giant Outfit is surprisingly simple and efficient. Everything needed to install the Little Giant is packed in the neat, black leatherette box.

Little Giant Outfit Complete

With Metro Headphones, Insulators, Ground Wire, Ground Clamp and Complete Aerial.

In Black
Leatherette
Box \$ **15**
List

Write for circular and interesting proposition. Get your share of the profits in Little Giant Receiving Outfits.

METROPOLITAN RADIO CORPORATION

70-74 Goble St., :- - Newark, N. J.



To the Trade

WE are authorized distributors for the following nationally advertised quality lines:

Brandes
Bradleystat
De Forest Tel. & Tel.
Dubilier
Everready
Four Way Radio Plug
Frost Fones
General Apparatus
Homcharger
Improved Radio Jacks
Klosner
Marko
Marle Transformers
Radiocraft Regenerative
Receivers
Radio Improvement
Company

We are able to make prompt shipments on the above lines. We suggest you place your orders at once to avoid delay in the Christmas rush. We welcome your inquiry for details regarding our dealer co-operative merchandising policies.

TRIANGLE RADIO
SUPPLY CO., INC.
 112 East 23rd Street
 New York, N. Y.

How One Firm Builds Lasting Trade

Gives Dealer Co-operation of
Livest Sort

THE Radio Improvement Company, of New York, is giving dealers real co-operation in the merchandising of Improved radio jacks.

All inquiries received from national advertising are referred to the dealers in the territory in which they originate. Consumer prospects receive a very interesting letter explaining the advantages of the Improved radio products and giving the name of the nearest dealer handling Improved radio products.

All orders from consumers accompanied by money order or check are shipped to them direct and the Radio Improvement Company in turn forwards a check to the dealer, covering his discount in the transaction. This procedure makes it possible to place the product in the hands of the consumer at the earliest possible moment. The consumer is also advised that he or his friends may purchase Improved radio products in the future from...
(Dealer's name and address).

The Radio Improvement Company is doing extensive national advertising and is co-operating in many other ways with the dealer.



A very attractive beveled glass counter display with gold lettering (illustrated above) sets off the Improved radio jacks and battery switches to great advantage. For new dealers entering the radio field, the Radio Improvement Company has prepared a complete assortment of Improved radio products, packed in one attractive package. This assures the dealer a full line, without stocking too great a number of any one item until he has learned which are in greatest demand in the territory he serves.



Dealers

WHO are interested in securing a greater volume of business should get in touch with our Dealer Service Dept.

We are distributors for the following nationally advertised products:

Adams Morgan
Nathaniel Baldwin
Brandes
Dubilier
Driver-Harris
Everready
Fada
Frost Fones
Improved Radio Jacks
Marle Transformers
National
Paragon
Radio Cieve
Radio Improvement Company



Improved double-circuit
jack. Price \$1.00

Improved Anti-capacity Radio Jacks require no soldering. We are receiving daily shipments of Improved Radio Jacks, and will be pleased to receive your inquiry on this fast-moving item.

**FEDERAL RADIO &
ELECTRIC CO.**

41 Park Avenue
 Paterson, N. J.



THIS IS A RADIO CHRISTMAS!



Radio Improvement Co. Makes New Radio Jack

Joseph W. Jones, Well-Known Inventor, Is Designer

A new anti-capacity radio jack called the Improved radio jack, has been designed and developed by Joseph W. Jones, inventor and patentee of the disc phonograph record, Jones speedometer, Jones taximeter, Jones Motrola, Jones drill, and other well known mechanical and electrical devices of world-wide reputation.

The Improved radio jacks embody the binding post feature, thereby eliminating the exasperating and unsatisfactory soldering of wires to tips, with its inevitable short-circuits from solder and acid. Being one-half the length and lighter than an ordinary telephone jack, they insure quick and secure installation. By eliminating long parallel leads, induction is reduced to a minimum.

The Radio Improvement Co., maker of the Improved radio jack, has also recently added to its line a double-circuit, filament-control jack and a single-pole, double-throw switch that is being used by some of the leading manufacturers as a loading coil switch to throw from long wave to short wave reception. These additions to the line are all built to embody ease in assembly, compactness in design and elimination of induction.

Mr. Joseph W. Jones is developing other improvements for the radio field that are as revolutionary in departure and in design as the Improved radio jacks and battery switches, compared with the ordinary types.

Improved radio jacks are manufactured in a factory that has produced high grade precision instrument work for 20 years. This plant is equipped with the most up-to-date machinery and employs engineers of national reputation.

The use of modern merchandising methods, backed by effective national advertising and embodying full dealer co-operation, has created a nationwide market for Improved radio products.

Associated with the Radio Improvement Company are some of the best merchandising and advertising men in the country, who are continually working out new ideas to increase the sale of Improved radio products and to develop the radio business in general.

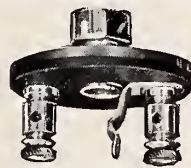

Open circuit
Price 70 cents



Closed circuit
Price 85 cents



Double circuit
Price \$1.00

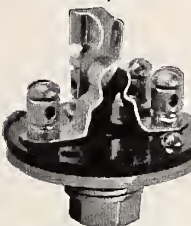

Single filament
control
Price \$1.00



Double filament
control Price \$1.25

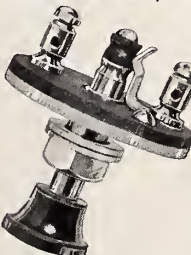

Single-throw A-
battery switch
Price \$1.00



Double-throw, single-
pole anti-capacity
switch Price \$1.25

IMPROVED Anti-capacity RADIO JACKS

The Highest Grade Wireless Equipment Made
Especially Designed for Radio

IMPROVED RADIO JACKS are distinctive in design and substantial in construction—radically different from all adaptations of the old telephone jack. They are universal—fit any plug, do away with soldering and resulting dangerous short circuits. Small and neatly finished, they save space and add to the appearance of any radio panel. Owing to the elimination of long parallel leads, induction is minimized.

You can save time, money and worry in assembling receiving sets by using Improved Radio Jacks—and, once installed, you can rely on them for consistent service and freedom from trouble.

DEALERS:

We are creating a nation-wide demand for Improved Radio Jacks. You can boost your sales by stocking them—NOW!

*Get in touch with your jobber,
or write us direct!*

Immediate Deliveries

RADIO IMPROVEMENT CO.
25 West 43rd Street NEW YORK CITY

See Our Exhibit at the Permanent Radio Fair



Mercury Radio Sets

A PROFITABLE line to handle, from the dealers' standpoint. A reasonably priced line to buy from the consumers' standpoint.

The low price is made possible by quantity manufacture in our large factory where every part is made, not merely assembled.

Write for details
and trade prices.

**MERCURY RADIO
PRODUCTS CO.**

LITTLE FALLS NEW JERSEY

FISCHER

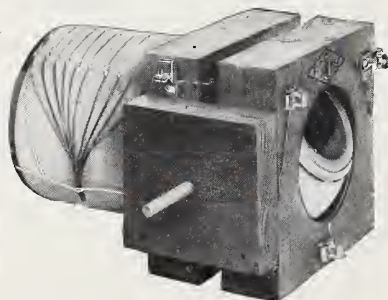

Vario-Wave Tuner

(Flat and Bank Wound)

Affords a guaranteed range of
200 to 3500 meters

Functions the same as a combination of Variometer, Variocoupler and Loading Coil. All three can be eliminated by **Price \$8.50** its use.

Territory open for Dealers

Write for proposition and catalogue

G. H. FISCHER & CO.

317 Cypress Hills Road
GLENDALE, L. I., N. Y.

TWO NEW UNITS

Patents are pending on the new Volta variometer and Variomo-coupler recently introduced by the Volta Engineering Company, Inc., Brooklyn, N. Y. The Volta variometer is built on a new principle, resulting in a compact and effective piece of radio equipment. Friction is reduced to a minimum, so that howling and mushing are largely done away with. Perfectly balanced construction allows an adjustment that stays, while the appearance and design of the variometer permits its use both on panel and table work. Special binding posts allow the use of either straight or spade tip connections.

No lever and contact adjustments are required to make fine tuning on the Volta Variomo-coupler. Taps and contact levers are done away with. The makers assert that the Volta Variomo-coupler's simplicity makes for proper primary tuning.

PLAN TO INCREASE SALES

Estimating that 60 per cent. of radio buyers build their own sets, the Sleeper Radio Corporation, 88 Park Place, New York, has concentrated on construction sets with which the amateur can satisfy his innate desire for building and creative effort.

The fascination of making things himself, which the average person is said to cherish, is further fostered by the Sleeper Corporation through a monthly magazine, *Radio & Model Engineering* and three books, recently published, on the "Design of Modern Radio Receiving Sets," all by M. B. Sleeper, president of the corporation, and a well-known radio expert. The combination of unassembled sets and a continuous inspiration to build a better and better set, improving here and there, as the Sleeper publications suggest, seems to be a winning one for increasing radio sales.

CERTIFIED RADIO PARTS

Two parts upon which the engineering skill of the Pioneer Radiophone Corp., Galesburg, Illinois, have concentrated are their vario-coupler and variometer. Each instrument is moulded of bakelite in a special brown and black mottled finish with a permanent polish. The rotors and stators are wound with double green silk wire of a large size to reduce internal resistance to a minimum. Secondary connections are positive, being constructed with the riding spring contact which are very accurately finished. The two instruments have been awarded certificates of merit from various publications.

SOCKET-RHEOSTAT

Registered U. S. Patent Office

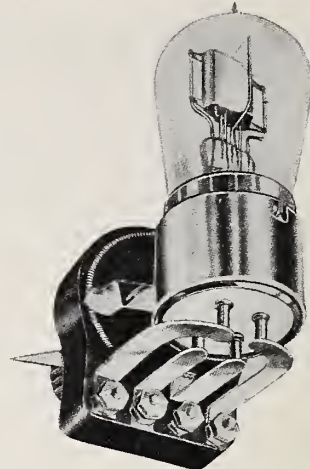

Type A-5 ohms, suitable for
detector bulb
Type B-2 ohms, suitable for **\$2.00**
power bulb

TWO IN ONE. A socket and rheostat
so combined as to form a single unit.

No more unnecessary leads between socket and rheostat. Just connect your leads to the four posts marked P F-F G and you are hooked up as far as the SOCKET-RHEOSTAT is concerned.

MANUFACTURED BY

Ajax Radio Corporation

Telephone: Bigelow 4097
538 SOUTH 10th STREET
NEWARK, N. J.

New Radio Inventions

Be sure to get the latest—



**Combined Variable
Grid Leak and
Micon-Condenser**

Price \$1.00

Unbroken range from zero to 5 megohms—all intermediate points. Fixed capacity .00025 M. F. Will improve your set wonderfully.

**Clarifies Your Signals
Lowers Filament Current
Increases Battery Life
Eliminates Hissing**

Write for Terms and Discounts

CHAS. FRESHMAN CO., Inc.
97 Beekman Street, New York

Home of Micon and Antenna

THIS IS A RADIO CHRISTMAS!

TUBE SET FOR NOVICE

With the idea of creating a vacuum tube set that would be satisfactory for the novice, to whom radio is an absolute mystery, the New York Coil Company, 338 Pearl Street, New York, have evolved their Entertain-A-Phone receiving set No. 2. The outfit, complete except for batteries, bulbs and telephone receivers, is contained in a hardwood case, 18 inches long by 6 inches high.

The knobs are large and molded, the vario-coupler is wound on bakelite tubing, the condenser is of the 23 plate type, the three tube sockets are black bakelite, and the two amplifying transformers are said to operate without noise or scratching.

Provision is made in front for connecting one, two or three phones. An extra bottom permits of the easy removal of the complete apparatus intact.

VERNIER VARIOMETER

The Fletcher Works recently placed on the market exclusively through their distributors, Durham & Company, a variometer which they claim has many advantages over the usual instrument. An unique feature about the winding was demonstrated at the recent radio show when one of the exhibitors removed the winding from the stator and stood upon it time and time again without being able to separate the wires or disintegrate the adhesive material used.

There are two rotating coils, one of sixty turns for the usual adjustment, and the other of eight turns for fine adjustment. The small coil is located concentrically within the larger coil and is so proportioned that a movement of thirty degrees on the small coil gives the effect of but one degree on the large coil. The wood used is mahogany, and the instrument is either furnished on a handsomely finished base, or with panel mounting.

SAVES VACUUM TUBES

An automatic filament current adjuster has been introduced to the trade by the Radiall Company, 99 Warren Street, New York, under the name of Amperite.

Claiming that the Amperite makes the operation of vacuum tubes absolutely fool proof, the makers say that the Amperite eliminates the necessity of rheostats in the filament circuits as the action is automatic and keeps the filament at the proper temperature thereby prolonging the life of tubes from two to three times and preventing burning out. As a result the Amperite eliminates the need for measuring instruments.

ESTABLISHED 1888



SENSORY CABINET UNITS

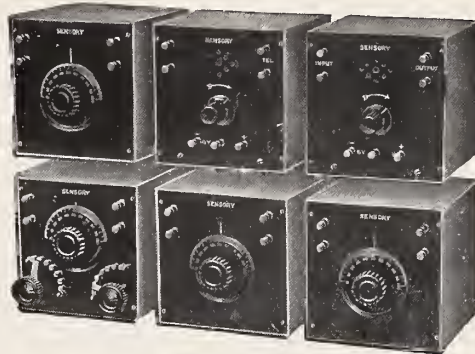

The most flexible method of adding to, or obtaining a variety of hook-ups, and giving an appearance equal to any single cabinet set. Each cabinet contains a "Sensory" element.

THE FULL LINE OF "SENSORY" ACCESSORIES IS SHOWN IN OUR NEW BULLETIN NO. 12
WRITE FOR IT TODAY



HEINEMANN ELECTRIC COMPANY

Manufacturers

Radio Division

Philadelphia, Pa.

SHELTONE LOUD SPEAKER

Reproducing the NATURAL TONE. No TINNY SOUND, NO DISTORTION, SWEET, MELLOW and DISTINCT. DIFFERENT from all LOUD SPEAKERS.



ANNOUNCING OUR LATEST ADDITION THE HAMPSON RADIO FREQUENCY TRANSFORMER

Specially constructed core—highest amplification. Bring in stations within 1,000 miles radius. Can be used with any standard hook-up with any available tubes. **Retail Price \$4.00**

Ready for Delivery Dec. 5th, 1922

STATES ELECTRIC COMPANY

20 Clinton St.

SOLE AGENTS

NEWARK, N. J.

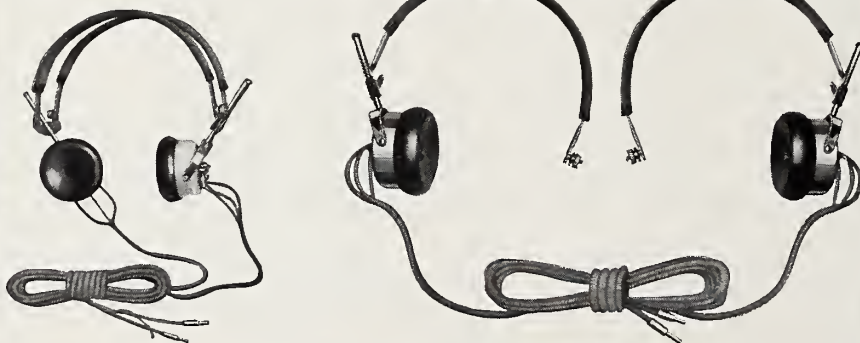

PATENTS

Premier Duplex

APLD. FOR

Premier Duplex Phones give real satisfaction. They increase the efficiency of receiving sets and add to the pleasure of listening in. The tone is clear, loud and pleasing. The caps feel good on your ears.

The best of materials, such as Tungsten Steel Magnets, Norway Iron Core, Commercially Pure Copper Wire Coils all carefully assembled and neatly finished make the Premier Duplex Phone one of the best.

The band splits into two parts, each having an overhead strip. It is very convenient for two persons to use. The adjustment is simple and effective. The cord permits of a five-foot separation between phones.

2000 Ohms \$6.50 Discount to Dealers 3000 Ohms \$8.00

PREMIER ACCESSORY & SPECIALTY CORP.

27 CONGRESS STREET

NEWARK, N. J.

Discount Sheet

Wholesale Radio Equipment Co.
Preferred Dealers List

Mortimer Salzman, who manages the Wholesale Radio Equipment Company of Newark, N. J., is sending out a letter to the trade, reading as follows:

"We are pleased to enclose herewith our Preferred Dealers' Discount Sheet, which we trust will serve to our mutual benefit.

"At the present time, due to the very chaotic conditions in the radio field, we have deemed it inadvisable to publish a catalogue, for it would soon be obsolete.

"In this discount sheet will be found items of standard manufacture, which are fully guaranteed. At the present writing there are additional items of interest being added to our lines which will enable us to take care of your entire requirements.

"We do an exclusively wholesale radio business, only catering to the radio dealer in the best possible way. We have no retail department nor any connection with one, thereby permitting the radio dealer to receive all the materials which we purchase.

"All merchandise is sold F. O. B. Newark, N. J., or points to which our trucks deliver.

"Our terms are 20 per cent, ten days, net thirty days, where satisfactory references are given."

The Preferred Dealers' Discount Sheet features these lines: Paragon, A. P., De Forest, Magnavox, Federal, Traco, Acme, Tuska, Murdock, Baldwin, Western Electric, Grewol, Kosner, Jefferson, Thordarsen and Bradleystat.

GENERAL RECEIVING SET

Dealers will find the radio supplies carried by the General Supply Company, Lincoln, Neb., composed of radio parts and sets made by reputable manufacturers with a nationwide reputation.

The General Supply Company, besides carrying the products of leading makers, feature their own General radio receivers, of which type GR-3 is their latest model. This is a three tube receiver consisting of one detector and two stages of audio frequency amplifications. The antenna condenser is equipped with vernier for fine adjustment, terminals are provided for a loud speaker, and battery connections are made at the rear. The whole set has been designed for convenience and approachability.

THIS IS A RADIO CHRISTMAS!

All Fans Not Boys

Average Radio Amateur Obeys Laws and Does Not Interfere

Interview with A. W. CHAMBERS

"All amateur radio operators are not small boys." That's the statement made to THE RADIO DEALER by A. W. Chambers, of the Birmingham Radio Company, Birmingham, Ala. Mr. Chambers is a dealer in radio equipment, has a Governmental license and is recognized by the air fans as "5 P.S."

The statement, above quoted, is made because of a criticism made anent amateur air operators in the last issue of THE RADIO DEALER. Mr. Chambers continues:

"In my opinion the criticism of the amateur operator must have been made by a writer with a grudge against the amateur operator. The amateur operator, according to this writer, is a small boy—whereas, in reality, the majority of amateur operators are men between the ages of 21 and 45 years old.

"The old, old question of amateur operators interfering with the broadcast listeners can usually be traced to the type of receiver which the listener is using, though of course the amateur is sometimes in fault.

"The writer of the article objected to indicates that amateur broadcasting stations are rapidly increasing, when in reality there is no such thing as an amateur broadcasting station, simply because our license does not permit it, though of course we can have radiophones but for direct communication only. As I have previously pointed out, the average amateur is above the boy age and is usually capable of handling the interference problem, if the receiver on the other end of the complaint has any selectivity whatever. The average radio amateur is usually law abiding.

"The reason I take the trouble to correct this article is that if the dealers generally do not know the truth about the amateur operator they will make enemies of the amateurs and will suffer accordingly."

(Mr. Chambers' point is well taken.
—Editor THE RADIO DEALER)

BEE RADIO SET

The Bee radio set has been placed on the market by F. W. Matthews, 167 Bloomfield avenue, Bloomfield, N. J. This set was developed by Mr. Matthews after a series of experiments made with the idea of designing a receiver that would sell at an extremely popular price and still afford simultaneous entertainment for more than one member of a family.

CONQUEROR

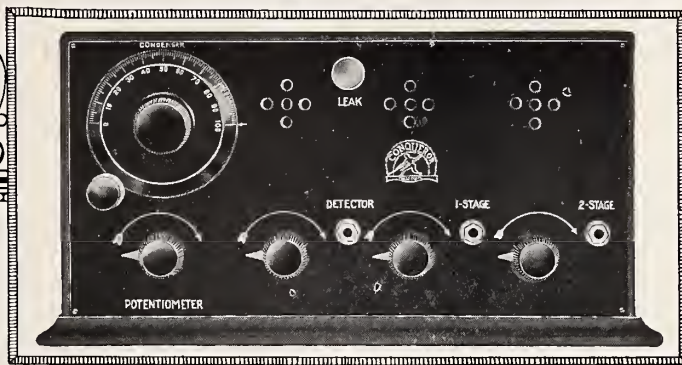

DO YOU BELIEVE
IN SANTA CLAUS?

Are you placing orders now in anticipation of the inevitable Christmas and winter boom in Radio Sales, or will you be obliged to say, "This is all we have?"

BUY NOW

CONQUEROR

Custom-Built, One-Knob Control
RECEIVING SETS

BECAUSE---

—They're the finest tuner, detector and 2 step amplifier sets made at any price—bar none.

—They're capable of an unprecedented degree of super-sharp tuning and render an undistorted tone as clear and voluminous as the finest talking machine made.

—They're so simple to operate and built of the finest units known to the science.

—They're the most beautiful looking sets you've ever seen—housed in a solid mahogany, piano finish case, sufficiently attractive to grace the most tastefully appointed home.

—There's an unconditional, bona-fide ONE YEAR GUARANTEE with every Conqueror Set we sell.

DEALERS AND JOBBERS

*Write right now, for specifications, price and discounts—
or demonstration.*

LEWIS & DE ROY RADIO CORP.

560 SEVENTH AVE
NEW YORK CITY

DESIGNERS AND
BUILDERS OF



CONQUEROR
RADIO SETS

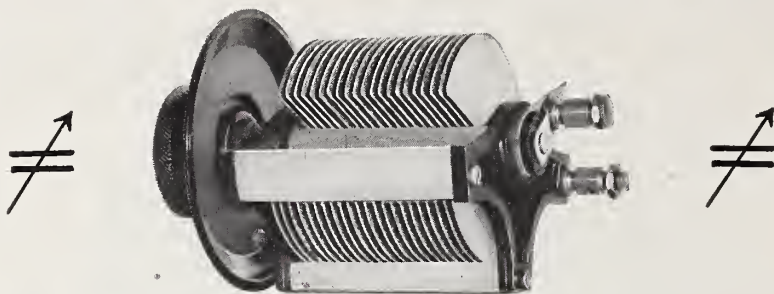

Radio Finds a Better Condenser

Bayley's 23-0005 and 43 Plate 0011 Variable Condenser is what Radio has found.

Its plates spaced close give it the finest tuning qualities.

It is a die-cast product, the stationary plates are cast solid, accurately and permanently spaced, on three upright supports, while the movable plates are cast on the centre revolving spindle. It is impossible for plates to loosen in service.

Solid rubber end pieces finished like black morocco leather make it beautiful. It is of good design and high grade workmanship. In an official test measures up to 0011 M.F.D. capacity and is uniform, it does not vary.

Each condenser has our guarantee, backed with a manufacturing record of more than forty years.

A sample order will convince you of its value.

And Make You, Certainly, A BAYLEY CONDENSER BOOSTER

We want business from houses that appreciate real value. It will give satisfaction and stay sold

Price, 23 Plates \$3.25 each. 43 Plates \$3.75 each

TO JOBBERS AND DEALERS A SPLENDID PROPOSITION

BAYLEY CONDENSER CO.

105-109 Vanderveer Street

Brooklyn, New York



CONDENSITE CELORON

Sets a New Standard in Radio Panels and Parts

Cut your panels from Condensite Celoron. It is the ideal panel material because it machines readily, engraves with clean cut characters and takes a high, natural polish or a rich, dull mat finish.

Give your customers Quality and they will give you orders

Condensite Celoron—approved by the Navy Department, Bureau of Engineering—offers a sales opportunity unequalled to the live wire dealer who is keen on building his business on a quality basis. Write us today for our Special Dealer's Proposition.

Diamond State Fibre Company
Bridgeport (near Philadelphia), Pa.

Branch Factory and Warehouse, Chicago

Offices in Principal Cities

In Canada: Diamond State Fibre Co., of Canada, Ltd., Toronto

Should Ford Broadcast from 400 Stations

Monopoly of Air by One Man Must Be Prevented

By BERNARD FREEDMAN

Henry Ford, according to newspaper reports, is planning to reach the American people, in a personal and direct manner, by the establishment of 400 radio broadcasting stations throughout the United States.

Whether this is mere press agent stuff, or whether Mr. Ford has correctly sized up the advertising possibilities in radio broadcasting and is about to take advantage of an opportunity, is not known.

Ford, despite his vaunted idealism, is practical and it may be that the maker of low-priced motor cars and tractors senses the fact that air advertising may—in days to come soon—cost less than newspapers, billboards and even hired praise agents. Air advertising certainly has its value today and will have greater value in later days when every home in the land has its radio receiving set.

Whether Ford can acquire Governmental permission to establish and operate 400 broadcasting stations is doubtful. No one person; no group of persons, no matter how righteous their aims nor how self-important their attitude, should be given what amounts to a rare concession. And the operation of 400 broadcasting stations by one person or one group makes for a monopoly.

It may be that Ford has no monopolistic designs; that his ideas are of the laughable peace-ship type. It may be that Ford really only aims to broadcast anti-Semitic stuff faked by Russian Jew-baiters. Mayhap Ford really only aims to help the three K folks.

The Ford idea, if its truly reported, develops the thought that a practical business man sees the future of radio; sees its possibilities and visions the future of radio better than do some of the so-called "big radio men" now sitting in the high councils of concerns that have made millions in the radio field already and are in a position to make more millions. Ford should not be permitted to create an air monopoly no matter how beneficent his designs. Ford has political ambitions—of course, but that shouldn't permit him to acquire any air concessions that may become monopolistic.

It is to be expected that the broadcasting stations, as well as the radio trade generally will oppose any such wholesale licensing of Ford broadcasting stations, as is talked about. Ford is not entitled to any special favors

THIS IS A RADIO CHRISTMAS!

from any branch of the Government—his great wealth notwithstanding.

The air must be made a monopoly. Ford isn't entitled to any concessions, any more than are the present broadcasters who have developed the radio industry. Ford has had no part in the development of radio, in any manner, and his desire to operate a broadcasting station from his home town is perfectly proper—if the neighbors don't cavil—but when he steps out with a declaration to operate 400 stations his motives may very properly be questioned.

THE RADIO DEALER doesn't believe Ford aims to operate 400 broadcasting stations, but this is a good time and place to state that the radio industry will not favor the establishment of an air monopoly for Ford or for anyone else.

BRU NO. 3 RECEIVER

The Bru No. 3 vacuum tube receiving set which is made by the Bruno Radio Corp., 152 West 14th Street, New York, has been designed to give the radio enthusiast a good outfit at reasonable cost. In this set the WD-11 tubes are used which operate on one dry cell. The cost, inconvenience and maintenance of storage batteries is therefore eliminated.

Another feature of this set is its flexibility. Although complete in itself the circuit can be readily altered so that it will operate in several ways. If the antenna is over 75 feet long for long distance reception, one can insert a variable condenser in the antenna circuit. If one cares to receive broadcasting stations other than those sending on wave lengths of between 150 to 600 meters, a honeycomb coil or other inductance can be inserted in the antenna circuit. Two binding posts are provided in the secondary circuit so that one may load the secondary circuit also, as the loading of the primary or antenna circuit is not as efficient.

ARMSTRONG CIRCUIT UNIT

The non-inductive high resistance requirements of the new Armstrong super-regenerative circuit have been met by the new resistance unit prepared by the Allen-Bradley Company, of Milwaukee, Wis. It is made in the form of a special resistance coating applied to a non-metallic base. There is absolutely no inductive action because there is no wire or metal in the resistance circuit. It can be simply installed with two screws that act as the terminal connectors. The resistance of each unit is calculated at 12,000 ohms.

An Important Message for Every Man Dealing in Radio Equipment

One of the most disagreeable things about the radio business so far as dealers are concerned is the ever occurring complaints from customers who can't get desired results from the equipment purchased.

Every dealer, in the past, has had this experience time and time again. Is it possible to do anything to overcome this situation?

It is! And the one message that we of the American Hard Rubber Company would register with all you many dealers this month is to tell you how to eliminate the majority of these customer kicks.

The positive operation of a present day radio set is not nearly as complicated a matter as driving a Ford car. And there are thousands driving Fords.

The trouble heretofore has been that during the rush of big radio retail sales, dealers stocking radio equipment for the first time have purchased quantities of radio junk from get-rich-quick manufacturers—frequently newer in the game than many of the dealers who purchased and sold what proved to be trash.

It is primarily this inferior equipment which has been the true cause of the many complaints dealers have received. A completed set will operate perfectly when well made. A set put together by the individual mechanically inclined will operate perfectly if all parts from cabinet and panels to dials or knobs which you sell are manufactured with intelligence.

Thus your troubles will be largely minimized if you will stock products which are made by the recognized manufacturers in the radio industry—the stable concerns—the concerns which use brains backed by years of experience in the construction of the equipment which they may offer you.

AMERICAN HARD RUBBER CO.

11 Mercer Street, New York

Manufacturers and Moulders of

R A D I O N

Dials, Knobs, Panels and Other Parts needing no apology from the responsible concerns offering them to their customers



← THE SIGN OF GOOD SERVICE AND
GUARANTEED SATISFACTION

IMMEDIATE DELIVERIES ON:

CLAPP-EASTHAM
BALDWIN PHONES
THORDARSON
NOVO BATTERIES
GREBE and MAGNAVOX

RADIO CORP. OF AMERICA
MURDOCK APPARATUS
DRAGON STORAGE BATTERIES
FADA APPARATUS
CHELTON APPARATUS

And All Other Standard Lines

EXCEPTIONAL DEALER'S DISCOUNTS—WRITE AT ONCE

WILMINGTON ELECTRICAL SPECIALTY CO., Inc.
912 ORANGE STREET Dept. A-10 WILMINGTON, DEL.

This Letter Was Unsolicited

We are distributors for the complete "RADAK" line, made by Clapp-Eastham.

A. H. LAWFORD
292 Main St., Bar Harbor, Me.
VIRGINIA RADIO CORP.
Dear Sirs:

Our books show that your company was the first to deliver their order although your letter was mailed last of four different companies which I ordered my initial stock from and also you were the greater distance from this town. Therefore you may expect the full amount of my business from now on.

Respectfully yours,
AUTHOR H. LAWFORD.

LARGE STOCK

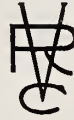

PROMPT SERVICE

VIRGINIA RADIO CORPORATION

Manufacturers—Jobbers
Charlottesville, Virginia

TUNING COILS

Double Ply—Dull and Bright Finish— $2 \times 3 \frac{1}{2}$, End Pieces Made of Composition Fibre.

REGULAR \$3.50 - NOW \$1.30

BERSHAW RADIO & MFG. CO.
82 Barelay St. Newark, N. J.

YOU SHOULD KNOW ABOUT OUR

 **AERWIN** 
PRODUCTS

THE MILLS RADIO & ELECTRIC CO.
INCORPORATED
1008 Springfield Ave. Irvington, N. J.

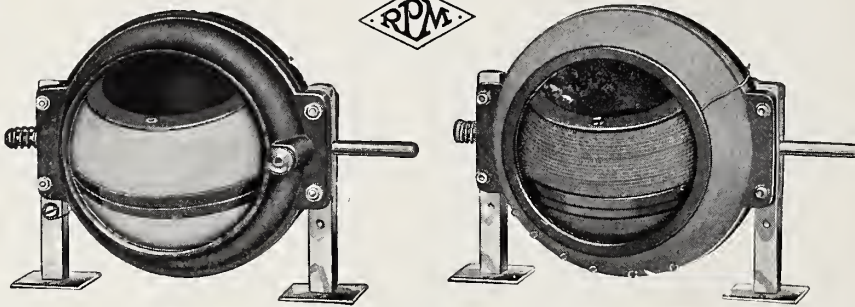

Variometer
Price, \$6.50

Variocoupler
Price, \$6.50

High Grade

RADIO APPARATUS

Twenty years in the electrical manufacturing field gives us the experience, organization and equipment to produce the highest grade of radio apparatus on the market.

Each unit is made complete in our own plant—from the moulding to the winding, assembling and final testing of the completed instrument.

The apparatus shown above is moulded from Redmanol, which is unaffected by water, oils, acids or other elements. It is a material which increases in resistance and strength with age. All joints and terminals are soldered, insuring perfect contact in all positions. These instruments are built to give unqualified service and satisfaction.

Write us for full information

Radio Products Mfg. Co.
667 W. Fourteenth St.
Chicago, Ill.

Radio Installment Plan

New York City Merchants Are Advertising to Sell on Deferred Payments

Radio sets on the installment plan have appeared in Eastern cities. In New York recently two different firms took quarter pages in prominent newspapers to inform the public that they were ready to sell radio sets on deferred payments. One of the advertisers offered a set for \$2.00 down and \$3.00 for the ensuing ten months. According to the advertisement, the specifications of this \$32 set are as follows:

One detector and tuner, complete; mahogany finished genuine bakelite engraved panel; calibrated dial from 0 to 180; 43 plate variable condenser bakelite spider-web coil, wound with high frequency Litzen wire. Cutler & Hammer rheostat; Dubilier front. 100 feet aerial wire; 2 insulators; 5 feet ground wire; 1 ground clamp; 20 feet lead-in wire; 1 variable $22 \frac{1}{2}$ volt "B" battery; 1-60 ampere an hour. "A" storage battery; 1 U. V. 200 radiotron; 1-3000 ohm double head set.

The company advertising this set claims that it will operate on wave lengths from 190 to 600 meters, over an approximate distance of 200 miles under normal conditions.

The second installment plan radio dealer advertised a set at \$69, for which "no storage battery is needed." The terms are \$39 down and six monthly payments of \$5 each. Another set is also offered at \$135, \$69 down and six monthly payments of \$11 each. These sets are said to include vacuum tubes.

REPLACES VARIOMETER

What is described as a receiving radiometer is being distributed by Ludwig Hommel & Co., national distributors of Pittsburgh, Pa. The device, for which patents are pending, is known as the Rogers receiving radiometer. It is said to have great tuning efficiency and sharpness because the dielectric material used in its construction is reduced to a minimum—no wood, parafine, shellac or varnish being employed.

The Rogers receiving radiometer takes up little space, much less than that required by the ordinary variometer, its dimensions being four inches in diameter by one inch in depth. The device can be used in any part of the circuit in which the ordinary ball type variometer is used.

THIS IS A RADIO CHRISTMAS!

RADIO APPARATUS TESTS

The New York Testing Laboratories, 80 Washington Street, New York City, of which L. R. Seidell is managing director, is giving special attention to the testing of all materials entering into the construction of radio apparatus and conducts investigations and development work on new apparatus.

THE RADIO DEALER is permitted to print through the courtesy of the New York Testing Laboratories the following report of a recent test that they made:

LEAKAGE TEST ON LIGHTNING ARRESTER

A 600-800 volt lightning arrester was submitted for tests required as follows:

1. Note the amount of leakage from a 600-volt line.
2. Give arrester five (5) flashovers of 5,000 volts and note the leakage from each flashover test.

RESULTS.

1. Actual voltage imposed was 610 volts, giving a leakage of .0039 amperes, or 3.9 milliamperes.
2. Five flashover tests at 5,000 volts and 60 cycles were made at intervals of five minutes with the following results:

Test No.	Leakage in Amperes
1	1.40
2	1.45
3	1.50
4	1.50
5	1.50

NOTE.

There was a small arc between graphite and carborundum in some sections of the resistor elements. This was not serious enough to cause disintegration of the graphite if the current was only applied momentarily.

DISCUSSION.

The first test shows the resistance to passage of current at 600 volts to be extremely good, as the milliamperage leak was very small.

The second series of tests also shows a great resistance to the flow of current at the higher voltage of 5,000.

The above tests show that this arrester can be connected from a 600-800-volt feeder direct to ground without danger of breakdown. Neither would there be arcing at this voltage which would cause disintegration of the carbon or carborundum.

VIRGINIA BULLETIN

The monthly bulletins of the Virginia Radio Corporation, Charlottesville, Va., are complete and interesting. The November, 1922, edition has been received and included everything that the complete distributor of radio can well be expected to handle.



The Profit Possibilities of
BESTONE
WIRELESS APPARATUS

Every Radio Dealer should investigate the unusual profit possibilities of BESTONE Wireless Apparatus for the following reasons:

- 1—BESTONE Receiving Sets embrace practically all popular types at prices ranging from \$22.50 to \$125.00.
- 2—BESTONE Receiving Sets are noted for attractive appearance, clarity of tone, volume and the elimination of distortion.
- 3—BESTONE Receiving Sets have demonstrated their long-range receiving capacity under practical conditions.
- 4—BESTONE Receiving Sets are backed by a leading manufacturing organization in the electrical field.

You are in time for Christmas Radio sales and profits.

Write for Illustrated Catalogue and Sales Proposition

HENRY HYMAN & CO., Inc.

Manufacturers

EXECUTIVE OFFICES
 476 Broadway, New York

BRANCH OFFICE
 212 W. Austin Ave., Chicago, Ill.

G-M

GUARANTEED RADIO APPARATUS

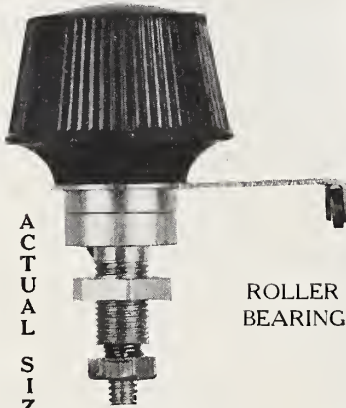

A Profitable Special

Roller bearing contact prevents cutting of points. Fada Type Knob. Adjustable Arm. List Price 50c.

WRITE FOR PRICES ON

Antenna Plugs
Antenna Wire
Honeycomb Coils
Insulators
Insulate Panels
Jacks
Planet Loud Speakers
Plugs
R. F. Transformers
Sockets
Socket Rheostats
Variable Condensers
Variocouplers
Variometers

NATIONAL DISTRIBUTORS
OF
QUALITY PRODUCTS

GENERAL MERCHANDISE CO.

142 Market St., Newark, N. J.
Manufacturers and Distributors

KEEPING OUR AD COLUMNS CLEAN

THE RADIO DEALER is making every effort to keep its columns free from the advertising of irresponsible dealers in radio equipment.

THE RADIO DEALER has already declined advertising contracts from a number of fakirs in the radio field.

THE RADIO DEALER will refuse to carry the advertising of mere stock-selling concerns, who are apparently radio manufacturers, but are obviously radio manufacturers as a side line to their stock-selling schemes. There are a number of such concerns.

TOM BROWN'S SET

The Specialty Service Co., of Fourth Avenue and Pacific Street, Brooklyn, N. Y., are distributors for the Lawsam Electric Company's radio products, which include Tom Brown's set, an attractive vacuum tube outfit, unassembled, in an appealing box.

This set, and with Tom Brown's own book of instructions, can be set up by anyone. The set contains the following: Cabinet, engraved panel, variable condenser, inductance coil units, tube-socket, rheostat; 3-inch dial for condenser, eight binding posts, receiver, cord and headband, grid leak and condenser combined, all wires bent and numbered and cut to size, also eight flat-head machine screws for mounting the various units on the panel, and four wood screws for mounting the panel on the box.

BUILD IT YOURSELF

A vacuum tube detector set complete in every detail except assembly is being put on the market by F. Jos. Lamb Company, of Detroit, Mich. This "Build It Yourself," set, as it is called, is designed to meet the demand of those radio enthusiasts who wish to make their own set. Included in the unassembled parts are polished bakelite panel, 6 x 9 inches in size, condenser, coil, detector tube socket assembly, rheostat and dial, binding posts, buss wires, and nuts and screws. All are packed together in a wood cabinet with a black finish. Instructions for building with a blue print showing wiring diagram go with each set. An attractive package is provided for shelf stock. The shipping weight is six pounds.

ADD-A-STEP

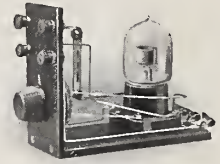

DETECTORS AND AMPLIFIERS

See them at the RADIO FAIR

ARROW RADIO CO.

Manufacturers of Quality Plus
Instruments

HACKENSACK

NEW JERSEY

Radio PLAN-O-PHONE



Loud Speaker \$3.50

The Plan-O-Phone is the most amazing value of any Radio Loud Speaker, on the market. Remarkable

A Big Seller

acoustics. Used with any 2 stage amplified receiving set. Fits any receiver. Made of statuary bronze—handsome, durable. Dealers: Write for special proposition.

PLANET RADIO CORPORATION

1223 S. Wabash Ave., Dept. F2, Chicago, Ill.



Na-ald De Luxe V.T. Socket

Contact strips of laminated Phosphor bronze press firmly against contact pins, regardless of variation in length. No open current trouble possible. Socket moulded from genuine Condensite. Practically unbreakable. Special protected slot, with exterior reinforcement. Unaffected by heat of bulbs or soldering iron. All excess metal eliminated, aiding reception. May be used for 5 Watt power tube. Highest quality throughout. Price 75c.

Special proposition to dealers and jobbers

ALDEN-NAPIER CO.

52 Willow St. Dept. H Springfield, Mass.

PATENTS

To the Man with an Idea

I offer a comprehensive, experienced, efficient service for his prompt, legal protection, and the development of his proposition.

Send sketch or model and description, for advice as to cost, search through prior United States patents, etc. Preliminary advice gladly furnished without charge.

My experience and familiarity with various arts frequently enable me to accurately advise clients as to probable patentability before they go to any expense.

Booklet of valuable information, and form for properly disclosing your idea, free on request. Write today.

RICHARD B. OWEN
Patent Lawyer

82 Owen Building, Washington, D. C.
2276-10 Woolworth Building, New York City

THIS IS A RADIO CHRISTMAS!

MOULDED EQUIPMENT

A moulded variometer has been put on the market by the Radio Instrument & Panel Co., of Chicago, Ill.

The stators are moulded in two halves with maximum diameter of 5 1/4 inches. The rotor is also moulded and highly polished, the maximum diameter being 4 inches. Large dimensions permit the use of low resistance wire. The rotor fits into the stator with minimum clearance. There is no possibility of shrinkage or warping in these moulded parts. All windings of green double silk wire. No shellac or paraffin is used in the wiring. Perfect contact is assured by a spring tension on the bearing. Base and panel mounting is provided for. The wave length is from 175 to 650 meters.

The Radio Instrument & Panel Co. also makes a full line of vario-couplers, condensers, variometers, and transformers.

CICO RADIO PLUG

Completely guaranteed, the Cico radio plug, type A, which is now being put on the market by the Consolidated Instrument Company of America, Inc., 41 East 42d Street, New York, offers an interesting example of the extreme simplicity to which radio parts may be reduced. An examination of this device reveals an extremely plain design, which augurs well for the strength and ease of performance of this instrument. The Cico plug fits all standard jacks, takes all types of tips, forked, straight or plain wire.

TUNING COMBINATION

Standardization in design of the F. R. S. universal combination has resulted in a set of tuning units which are interchangeable and thus may form three combinations outside of the usual uses of the three fundamental units, the variometer, the vario-coupler and a bank wound loading coil.

These units, which are of standardized construction, are more compact than most instruments and possess features of special merit. They are manufactured by the F. R. S. Radio Corporation, 407 East Fort Street, Detroit, Mich.

STERN CONNECTIONS

Stern & Company of Hartford, Conn., announce that they have recently renewed their selling agreement with the Colin B. Kennedy Company as exclusive sales agents in the New England states. They have also been appointed distributors in this territory for the Master Radio Corporation of Los Angeles, Cal.

Every QUEENS instrument carefully inspected before it leaves our factory

QUEENS Vario Coupler

The BEST THERE IS!

Not because we say so, but facts prove that Queens Vario-couplers are the best to be had regardless of price. They are designed and manufactured by men who have made radio their life work—beginning long before the days of broadcasting. This priceless experience, coupled with huge production have made such a low price possible. The real proof of the efficiency of Queens Vario-couplers is comparison. Compare them with any other vario-coupler on the market. Examine the fine workmanship and be convinced that what we say of the Queens' is so. None are so good at anywhere near the price of the Queens.



ITS COLLEAGUE,

the variometer, matches the coupler in quality as well as appearance and is an equally efficient instrument. When used together with the coupler, the utmost in clear and distinct reception of speech and code is obtained. Queens Vario-couplers and Variometers are perfectly adapted for use in the Armstrong regenerative and super-regenerative circuits.

If you sell Queens instruments, you will retain pleased customers and enjoy good profits. Attractive discounts to dealers and jobbers. Backed by national advertising, these instruments are big sellers. Write today and let us tell you more about ourselves and our instruments. Cash in on big profits with real efficient apparatus. Order your stock of Queens Vario-couplers and Variometers today.

QUEENS RADIO COMPANY, Inc.
12A Forest St. Winfield, L. I.

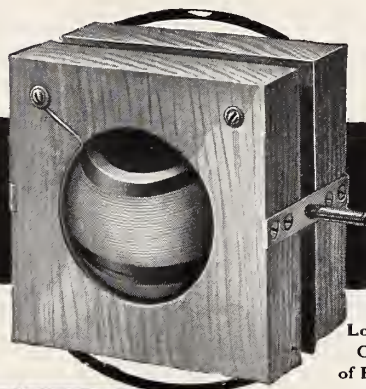

Look for our Green Tag of Perfection on every

QUEENS instrument

QUEENS Vario Meter

MANUFACTURERS —

Ugly sets don't sell—

The dials on most rheostats will not match the other dials on your panel—the rotation is too great. The dial on the PARKIN Dial-Type Rheostat (patented) will match the other dials on your panel—the scale is the same (100 divisions), the rotation is the same (180°), and this is but one of its many superior features. The resistance element is mounted in a recessed groove in the back of the dial outside the cabinet. This enables the tube socket to be mounted in the cabinet directly behind the PARKIN Rheostat, and gives a host of other important advantages that cannot be secured from any other rheostat. Retail price, \$1.50. See special manufacturers' offer below—

Mt. Tamalpais, California, in the shadow of whose lofty peak PARKIN Parts are made.



THE PARKIN DIAL-TYPE RHEOSTAT—

Send us 75 cents for one PARKIN Dial-Type Rheostat complete. Mount it on one of your sets and give it a thorough trial. If it does not improve both the appearance and operation of your set, return it to us and we will immediately refund the purchase price.

PARKIN MFG. CO., San Rafael, California



Stop that Snarling Symphony!

The screams and metallic screeches that so often ruin an evening's Radio enjoyment are not all due to "static." The trouble has finally been traced down to its source. And the remedy is simple, easy, almost instant!

A run-down or poorly functioning battery has been found out as the real cause behind "catfights." Unless your storage battery is working right, your Radio won't work right—*can't work right.*

Therefore, it has been proved necessary to make frequent and accurate battery hydrometer tests. This can be done best, most cheaply and satisfactorily with the *guaranteed*



This is the nationally advertised hydrometer, the one you've read about in "The Saturday Evening Post." It sells and sells and sells. It's a mighty satisfying item for Radio dealers to feature and push. Furthermore, the impetus of national advertising is making it sell and sell in larger quantities every day.

Ask about prices, the advertising campaign and window display material. It will interest you from a potential profit angle. Write us now—quickly.

HAFNER MANUFACTURING CO.
3130 Carroll Avenue Chicago, Illinois

75¢
Worth Twice
Its Price

RADIO CONCERTS CORACO

America's Greatest Radio Receiver
No Inside or Outside Connections
Room 1805
220 West 42nd St. New York City

RADIO CATALOG No. 54

Now ready
Send for it today

The A. C. Gilbert Company,
Dept. C., New Haven, Conn.

"All-American" Transformers Put You in Tune With Your Trade

By recommending "All-American" Amplifying Transformers (Audio and Radio Frequency), the dealer establishes his reputation as a man who knows Radio and whose judgment is sound and will stimulate his sales on every other Radio product.

Great little business builders, these. Note the workmanlike manner in which we have shielded the new type Audio Frequency Transformer.

Follow the example of leading manufacturers of Radio sets who have adopted "All-American" Transformers as standard equipment and tie to "All-American."

LIST PRICES—SUBJECT TO DISCOUNT

Type R-10—Radio Frequency—(150-550 Meter).....	\$4.50
Type R-12—Audio Frequency—(Ratio 3 to 1).....	4.50
Type R-13—Audio Frequency—(Ratio 10 to 1).....	4.75
Type R-21—Audio Frequency—(Ratio 5 to 1).....	4.75

Liberal Discount. Send for Bulletin 22

RAULAND MFG. CO.
35 So. Dearborn St., Chicago, Ill.

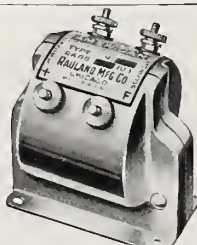

Audio Frequency Transformer



Radio Frequency Transformer

Philadelphia Pointers

By W. B. WILKINSON, JR.

GERACO PARTS

The General Radio Company, of Philadelphia, has recently placed on the market as an addition to their already rather complete line of Geraco products, an audio-frequency transformer of worth. The odd shape of the instrument allows it to fit into a small space. The terminals are well spaced and allow ample room to attach the wires.

The primary and secondary windings are of enameled copper wire carefully insulated from each other so as to admit the use of high plate voltages. The laminations of the magnetic circuit are of highest grade silicon steel securely held by aluminum castings. The winding terminals are entirely concealed and soldered to binding posts of a convenient size, clearly labeled with engraved letters on a polished rubber terminal board.

Another recent addition to the Geraco line is an entirely closed and sealed variometer, made of a special hard rubber compound. A vario-coupler of the same design follows in its footsteps, and enjoys with it the Geraco distinction.

MONARCH VARIOMETERS

The Monarch Radio Company has recently placed in the field a line of variometers and vario-couplers. The variometers are composed of solid mahogany rotors and stators, thoroughly seasoned and kiln-dried, making them warp-proof as well as ornamental. These variometers are equipped with adjustable spring bearings making interrupted contact an absolute impossibility. Another feature of the instrument is the use of patented brass clips, as an innovation over the old binding posts.

Variable condensers and vario-couplers are also manufactured by this concern, and all bear an absolute guarantee of satisfaction by the makers.

MP RECEIVERS

The Motor Parts Company, of North Broad Street, one of the first concerns to enter the Philadelphia radio field, are producing many types of high class radio frequency sets, of box-cabinet, suitcase, and phonograph cabinet types.

The MP type V, or radio Grand model, contains all the necessary equipment, including batteries, indoor loop, and loud speaker, in a modern, artistically designed phonograph cabinet. All MP types are constructed for

THIS IS A RADIO CHRISTMAS!

use with a loop aerial. The concern created a great amount of interest at the Radio Show in October when two men carried a complete set through the crowd giving perfect reception at all times.

EXIDE "B" BATTERY

The Electric Storage Battery Company are marketing a radio "B" battery of worth which has several unusual characteristics. The battery is composed of twelve glass tubes, each filled with a jelly-like electrolyte. The positive and negative plates are immersed in this electrolyte, insulated from each other by a rubber separator, and may be inspected at any time through the glass tubes. These plates are necessarily small, but the grids are cast as carefully in this battery as they are in the larger and more rugged automobile batteries which have been the product of this concern for years.

The battery is packed fully charged, and the only attention it requires is refilling when exhausted, and the occasional addition of a few drops of distilled water to keep the electrolyte moist.

PRAMCO DETECTOR

The Premier Radio Manufacturing Company, of Berks street, are manufacturing a crystal detector with two crystal cups. The advantage of this detector is that it allows the testing of two different minerals under the identical conditions of reception, as the adjustment may be changed instantaneously from one to the other. The Premier Company has been specializing since 1919 in smaller parts for radio sets, including binding posts, switch knobs, switch levers, nickel-plated screws, and in short, every part needed for mounting a crystal set.

HARMONY SETS

The Harmony Mfg. Company, of 1423 Blum street, Cincinnati, Ohio, have standardized on radio frequency receiving sets, each consisting of radio frequency amplification, detector and two stages of audio frequency amplification.

Four distinct models are described in a circular recently issued. Model one is for use with both loop and outside aerials, model 1-A for loop reception only. Model RV is a combination of Victrola and radio set, with many styles and finishes on the specially designed cabinets. Model VC can be built into a Victrola cabinet. All the models have cabinets made from American walnut and are polished with a wax or varnish finish.

ATTENTION! DEALERS



A Salesroom in
New York for a
Dollar a Day

Do Your Buying at

THE PERMANENT RADIO FAIR

HOTEL IMPERIAL - 32nd St. and Broadway

Buyers - Dealers - Radio Department Managers

Only Products of Representative Manufacturers are on display and demonstrations will be given of any of the exhibits.

Over 75 of the leading manufacturers now exhibited and space is being filled very rapidly—Call or Wire for Space.

M.P.M.
MILLION POINT MINERAL
The World's Greatest Radio Crystal

Nationally Advertised

A Supersensitive Crystal that greatly increases radius and improves audibility.

Concerts heard over six hundred miles with M. P. M. Crystal.

Write for Attractive Dealers' Proposition

M. P. M. SALES COMPANY

Dept. RD

247 So. Central

Los Angeles



DECEMBER SPECIALS

Standard Radio Jacks

Single Open - - .17
 Single Closed - .26
 Double - - - - .28

Rheostats - Tapered Knob
 Perfect Contact

24c

*Hundred Lots—C. O. D.
 Write for complete list
 of Christmas Specials.*

Harold M. Schwab, Inc.
 419 West 42nd Street
 New York City

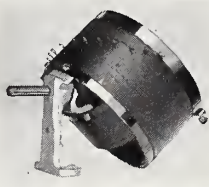

Shamrock
 180°
Vario Coupler
 Retail Price
\$4.50

Both Tubes Are Made of
BAKELITE
 Distributors, Jobber and Dealers Write for
 ATTRACTIVE DISCOUNTS
SHAMROCK RADIO CO.
 152 Sussex Ave., Dept. T, Newark, N. J.

Whirco Square Tinned Bus Wire

In 2 Feet Lengths or in Hundred to Thousand Pound Lots Quoted.

Shipments F. O. B. Mill

WHITE RADIO CO.
 123 East 23rd Street
 New York City

THE PARAMOUNT ENGRAVING MACHINE
 for Radio Panels

Greatest Production—Lowest in Price
PARAMOUNT MACHINE CO.
 207 Market Street Newark, N. J.

BUNTING'S CONDENSER

The Bunting Stamp Company of Pittsburgh, Pa., announces the perfecting of a variable condenser known as Bunting's variable condenser, ranging from .00009 mfd. to .0025 mfd. It is designed to provide a means for tuning out stations not desired at a minimum cost.

The principle of the condenser is one fixed copper disc insulated by a thin disc of clear mica. The movable disc is controlled by a threaded stem and nut and requires three complete turns to move the plate or disc three-sixteenths of an inch. The movable plate is held rigid by springs to guide its motion perpendicularly and true.

AIRVIA RADIO

The Fischer Radio Company, of Philadelphia, are producing a line of radio products under the trade name of Airvia which have met with success. Among the many features of their line are the Fischer triple-O-five condensers, furnished either with dial attached or fully mounted in a shielded case.

The features of this condenser are a soldered pig-tail spring connection to the rotary plates, and the absolute straight line curve showing an even change of capacity throughout. Single and multi-tube sockets, rheostats, audio-frequency transformers, and a two-stage amplifier unit, are also included in the Airvia line.

LISTS RADIO SPECIALTIES

A catalogue listing many radio specialties of tried value has recently been issued by the Aldine Radio & Manufacturing Co., of Chicago, Ill. The last pages of the publication are full of plans showing various hook-ups with Aldine equipment.

Among the specialties listed in the Mic-O-Phone listener-in, a device which permits the use of six receiving head sets with one phone. It is made of aluminum, highly polished. Another specialty is a compact little crystal set with aluminum body. The Aldine company are agents for Dictograph radio products.

PENN HEADSET

The Penn Headset Company, of Philadelphia, have placed on the market a laboratory-built headset which is comparable to the best on the market. A feature of the instrument is that it is extremely light, weighing but twelve ounces, and the ear caps have been especially designed for comfort. The head-band is covered with genuine leather, and is self-adjusted. The company is aiming to produce quality rather than quantity.



CRYSTAL RECTIFIER
 MULTIPOINT (Patent Pending)

A synthetic CRYSTAL DETECTOR sensitive over its entire surface

Eliminates all detector troubles.
 50% increase in clearness and volume.
 Endorsed by Radio experts and press.
 Awarded certificates of excellency.
 Sets a new standard of efficiency.

List price mounted **50c**
 Every package sealed

Dealers and Distributors quoted
 Attractive Discounts

RUSONITE PRODUCTS CORP.

15 Park Row, N. Y. Room 2004

THORNTON

AUDIO FREQUENCY
 AMPLIFYING TRANSFORMERS

Supreme Test Transformer

These transformers are supplied in either mounted or unmounted types.

Special attention paid to the manufacturer of receiving sets.

THORNTON TRANSFORMER CO., Inc.
 30 Church Street, New York City

Ask Our Service Bureau



"Essex" 150-600 meter
 180° variocoupler with
 3" molded dial.
 Price \$1.25 each
 Essex square turned
 bus wire 2 foot lengths
 \$1.00 hundred feet
ESSEX MANUFACTURING CO.
 117 Mulberry St.,
 Newark, N. J.

PATENTS

ELECTRICAL MECHANICAL
 RADIO

SEND SKETCH AND DESCRIPTION
 FOR OPINION

EMIL ALEXANDER KERN
 328 SOUTH SEVENTH STREET
 NEWARK, N. J.

Buy Apparatus

From a Reliable Manufacturer

FREED-EISEMANN RADIO CORP.
 255 Fourth Ave., New York City

American Radio & Electric Co.

1133 Broadway New York City

WRITE FOR OUR CATALOG
 JUST OFF THE PRESS

M-R FLEXIBLE VARNISHED TUBING
 THE GENUINE

"SPAGHETTI"

TWO STYLES—BEST GRADES MADE—ALL
 SIZES—ALL COLORS

Varnishes, Waxes, Compounds, Papers, etc.

MITCHELL-RAND MFG. CO.
 14 VESEY STREET NEW YORK, N. Y.

Dealers Should Push Advertised Goods

(Continued from page 34)

his goods in some unavoidable way get into the hands of these professional cut-rate dealers, he should investigate how they came into their hands and should immediately refuse to sell to the guilty parties again. All his dealers should be compelled to maintain the price he sets on his apparatus, with the exception of an occasional sale, and in these cases the lower prices should not be very much, depending on the price of the article.

It is understood, of course, that in setting his price originally the manufacturer has carefully considered the quality of the article and its competition, together with liberal discounts to the dealer. In this way he himself will have started a concrete foundation to eliminate cut-prices, and at the same time protect his dealers.

The manufacturer should keep his dealers constantly informed of his advertising schedule, advising the dealer of the media used and, where possible, furnish reprints of the advertisements themselves before they appear for publication, so the dealer may give them display either in his store or on his windows.

The manufacturer should be most careful that his advertisements do not contain false statements about his products. He should not bluff in his copy, but always adhere to facts. In this way only can he truthfully expect the dealer to push his goods. The manufacturer additionally should not overlook to assist his dealer with other advertising material, such as window displays, store hangers, counter cards, pamphlets, etc.

Where possible, the manufacturer's salesman should assist the dealer in making his window display and lend a hand or a suggestion, and wherever the opportunity presents itself place a store hanger here or there or paste a reprint of an ad on the dealer's window. In short, the manufacturer's salesman should have his eye constantly ready to assist the dealer in every way possible, even stepping a little out of his way occasionally to make a sale for his dealer. He should bear in mind that every sale the dealer makes is money in his pocket also.

With proper co-operation of the manufacturer and the dealer the road of tough sales resistance will be greatly smoothed and the dealer and the manufacturer will be closer related and both will be happy and radio given a lift.

Milliken Radio Towers

These towers were the pioneers in the development of the wireless—and have kept pace with progress. Now used at principal stations under the most exacting service. Of galvanized steel, self-supporting, standard types and heights.

AGENTS WANTED

We have an attractive proposition for agents—full information upon request.

Send for Complete Catalog

MILLIKEN BROTHERS MFG. CO., INC.
Woolworth Building
New York, N. Y.

STATION WVP

STATION WBZ

STATION 2XJ

It Pays to Sell "United" Radio Products

They are scientifically correct in proportion and design. They are made from the best materials in a careful, workmanlike way. And, like a famous cigarette,

"They Satisfy"

Buyers swear by them, not at them. Every user becomes a booster. And that means a lot in the freemasonry of radio.

United Variable Condensers with Vernier Scale Attachment, Made of Hard Aluminum with Bakelite ends. The only Vernier with a stop.

46 plate	\$6.50	Complete like
26 plate	5.50	

United Variable Condensers (Plain)

43 plate	\$4.50	5 plate	\$2.75
23 plate	4.00	3 plate	2.25
11 plate	3.50	Without dial or knob	



"United" Transformers

Audio-frequency, amplifying, magnetically shielded. A beautiful piece of workmanship. Gives loud, clear signals without howl or distortion.

Best Value on the Market \$4.50

"United" Products

have been adopted as standard equipment by leaders in the radio industries. Their endorsement and continued patronage carry more weight than all the advertisements that were ever written.

Send for circular.

UNITED MFG. & DISTRIBUTING CO.
536 Lake Shore Drive -.- Chicago, Ill.



Pat. Appd. For

DIAMANT
VARIABLE CONDENSERS
AND CRYSTAL DETECTORS
 Electrically and Mechanically Guaranteed
 Diamant Tool & Mfg. Co., Inc.
 93 Runyon Street Newark, N. J.

COTOCO
 MYERS DUBILIER BALDWIN
 RADIUM LOOPS—HOWARD, ERLA, BRANDES
 DEALERS: Write for discounts
 Hudson-Ross, 123 W. Madison St., Chicago

VIKING RADIO COMPANY
 WE MANUFACTURE:
 VIKING VERNIER CONDENSER
 VIKING VARIO-COUPLER (800 M.)
 WE DISTRIBUTE:
 CHAS. FRESHMAN CO. Products
 ALDEN-NAPIER CO. Products
 IDEAL VARIABLE CONDENSERS
 26-D Cortlandt St. New York City

RADI-UN
LOOP AERIALS
 Dealers: Write for Discounts
 HUDSON-ROSS
 123 W. Madison St. Chicago

FOR SALE: Manufacturer operating to capacity on other lines, will sell high class tools, parts and complete condensers and detectors. Write UNITED SERVICE ADVERTISING, 222 Market St., Newark, N. J.

Gould
 Radio "A" and "B" Batteries
 Write for Dealer Plan
 Gould Storage Battery Co.
 30 East 42d St., New York City

Fine Cuts for Illustrating
CENTRAL ELECTROTYPE
FOUNDRY COMPANY
 Electrotyping and Engravings
 9 Campbell Street Newark, N. J.
 Telephone: Mulberry 1698

MYERS TUBES
 Dealers: Write for Discounts
 HUDSON-ROSS
 123 W. Madison St. Chicago

FREE Radio Catalog



Our big stock of standard makes of radio sets, parts and supplies, fully illustrated. Play safe—buy standard equipment from a reliable house. We ship from stock.
 Send \$9.00 for sample high grade crystal detector outfit with variometer in large case. Sells for \$18.00.
JULIUS ANDRAE & SONS CO.
 In Business Since 1860
 114 Michigan St. Milwaukee, Wis.

Vital Points in the Radio Business

(Continued from page 35)

ment, and a general technical knowledge of its operation. It is true that some results can be obtained with practically no knowledge, but take a comparison with the sports of fishing and also photography. Successful fishing requires considerable experience which anyone can obtain. To those who attain it, it is a constant source of enjoyment.

The use of radio equipment, especially for long distance work, can be very well compared to fishing in the air. One cannot see what is to be caught, but it is known that there is a good deal to catch, and the fascination of radio work with these conditions, is as great as fishing, if not more so, on account of the number of people who can enjoy the benefits of one equipment.

The benefits of radio to the electrical trade are more far-reaching than is usually considered. There is no art which can possibly give to the public a greater insight into science than the study of that unseen force, radio.

Hitherto public acquaintance with electricity has been solely that it accomplishes in their homes certain benefits and functions such as lighting and heating, in an improved manner. There has been nothing in these which brought about an inquisitive state of mind on the part of the public in regard to the electricity. Radio, however, cannot help but do so. With the better knowledge and keener minds that result the future of electricity will be immensely assisted.

AUTOVOIX AMPLIFIER

The Autovoix, an amplifier produced by the Autovoix Company of Baltimore, Md., is a new loud speaker of the metal horn type for which its manufacturers claim many advantages over similar types now on the market.

It is built on the new lever principle and carries a large magnetic field in which the armature is suspended. It does not require a storage battery in its operation, nor does it require adjustment or attention after being installed.

The Autovoix is a power-operated instrument, and is said to require a minimum amount of current for a given amount of volume—the volume being in proportion to the input power. The range has been highly developed and it is said to render the lowest and highest notes in their true tones and to produce volume in its true value.

Have Outlet For
SURPLUS STOCKS
 Radio Supplies
 Price and Goods Must Be Right
 P. D. Jackson, 1441 So. State, Chicago

RADION HARD RUBBER PANELS
 Cut to Any Size
DISCS, WASHERS, BUSHINGS, ETC.
 Made to Order
 New York Hard Rubber Turning Co.
 212 Centre Street, N. Y. C.

 **RHEOSTATS**
 and Other
STANDARD PARTS
 FOR TUBE and CRYSTAL SETS
 Dealers: Write for Price List and Proposition.
 The Radiola Wireless Corp.
 208 W. 17th St. New York City

PATENT
 your Ideas. Protect your rights by U. S. and Foreign Patents and Trade-Marks. Moderate rates. CALL, WRITE or send us your invention.
 May one of our representatives call on you?
FREE CONSULTATION
 Phone: Vanderbilt 7212.

ASK MANUFACTURERS PATENT CO. FOR 520 FIFTH AVE. NEW YORK

KRAMER RADIO COMPANY
 4713 Sheridan Road, CHICAGO, ILL.
 MIDWEST DISTRIBUTORS
 Of Quality Radio Products
 Write Us for Catalog and Discounts

JOY-KELSEY CORPORATION
 Manufacturers
RADIO EQUIPMENT
 4021 West Kinzie St. Chicago Ill.

WHY BE SATISFIED
 With Single Surface Crystals
CONTAINA SETTING
 (Patent Pending)
 Makes Maximum Sensitive Area Available
 Awarded Evening Mail Certificate of Excellence
CURTIS G. CULIN
 366 Broadway New York City

"EDGCO" RADIO PRODUCTS
 Radio Highest grade Radio equipment and supplies at prices to astonish you.
 Bargains Leading advertised brands in every line.
 Write for Price List Today
 The EDW. J. GOETZ CO., 608 Race St., Cincinnati, O.

EVEREADY
RADIO "A" BATTERY
 Immediate Delivery from Stock
 - Manhattan
 Storage Battery Co., Inc.
 511 West 50th Street
 New York City

THIS IS A RADIO CHRISTMAS!

Test Specifications for Radio Receivers

(Continued from page 36)

or copper tubing, supports being provided inside the tube for spacing of the conductors relative to themselves and to the shield tubing. The success with which the shielding of the system against extraneous voltage has been accomplished can quite easily be observed by the rotation of the receiver coupling coil to a position in which the signal is a minimum, and if proper care has been taken, a position can be found in which the signal completely disappears. If this is not the fact, examination of the shielding system must be made and further care taken in the proper shielding of the entire device until the position of "o" signal is possible.

The calibration of the coupling coils for mutual inductance against their position relative to one another must then be made and a determination of the resistance of the receiver coupling coils must be made at the several frequencies at which measurement is to be made. With this given data, it is then possible to calculate the voltage induced in the receiver coupling coil for any position of that coil relative to the generator coupling coil and for any current in the coupling coil, and with the resistance of the coupling coil known, it is then possible to insert sufficient resistance in the phantom antenna circuit to make the total resistance that of the standard novice antenna.

The measurements may be made with any convenient value of the voltage induced in the antenna circuit, and all measurements made with this same voltage would then be comparable; or if a greater precision is required, several voltages may be used corresponding to weak and loud signals and the change of the receiver characteristics noted with change in signal strength. The values which have been used at the Bureau of Standards will be made available very shortly and these can be used in these tests as will be desirable. On these tests the manipulation for measurement consists merely in putting the generator into operation in measuring the current in the generator coupling coil, and from this and the calibration of the coupling system calculated in the voltage induced in the receiver coupling coil. This then is our in-put voltage.

The receiver is then tuned as carefully as possible to resonance with the in-put voltage, this condition being noted by maximum signals in the telephones. The telephones are then

DELICATE SOLDERING

Both the manufacturers' and amateurs' problem on all fine work is readily solved by the instrument constructed for this particular purpose.

THE POST SOLDERING IRON

Platinum Heating Unit—Interchangeable Tip—Universal Current



One Half Actual Size

LISTS AT \$6.00

Dealers' and Jobbers' discounts on request

Awarded Certificate of Excellency, N. Y. Evening Mail Radio Institute

POST ELECTRIC COMPANY, (Office 505) 39 E. 42nd St., New York

Standard Special Crystals



The Crystal in the Little Red Box

Every Standard Special Crystal is packed in a red tin box which is stamped with the words "STANDARD SPECIAL CRYSTAL." This is your assurance that the crystal you buy has been actually tested on the Radio waves. Every Standard Special Crystal is specially treated and will therefore give better and longer service than the ordinary kind. Every one is absolutely guaranteed.

STANDARD CRYSTAL CO.

274-A Halsey St.

NEWARK, N. J.

Canadian Agents: Sterling Specialties

213 Somerset Building, Winnipeg, Man., Canada

Western Representative: Engineering Sales Company, 220 North State St., Chicago, Ill.



Retail Price—\$4.50

Approved by Santa Claus



KNOCK-DOWN RADIO RECEIVING SET

Contains all high grade parts of WINCO manufacture.

Neatly packed in an attractive hinged cover box. Makes a wonderful display. All parts firmly attached to box and will not loosen in shipping. Complete blue printed diagram for assembly included.

We are manufacturers of high grade Radio equipment and supplies, also metal stampings, tools and screw machine products.

Can make immediate delivery on double slide tuning coils which retail at \$3.00 each and complete receiving sets which retail at \$8.00 each.

Liberal Discounts to Distributors and Jobbers

(Established 1871)

CHARLES WINKLER, INC., 178-182 Emmett St., Newark, N.J.



Galena Crystal, Mounted.....35c
Galena Crystal, Unmounted.....25c
IMMEDIATE DELIVERY



Manufacturers, Jobbers, Dealers
write for quantity prices

GALENA CRYSTAL MFG. CO.
2893 Fulton St. Brooklyn, N. Y.

NEW SUPER SENSITIVE RECEIVER

See Page 863 November Issue
RADIO NEWS

We understand you are having a great many calls from customers for *SPIDER WEB COILS* for this set. This hook-up is a wonder and you can sell the necessary parts for same.

We are prepared to furnish the two *SPIDER WEB INDUCTANCES* COMPLETE WITH MOUNTING at \$3.75, list less 40%.

Orange Research Laboratories
41 N. 16th St., East Orange, N. J.

AGENTS

Our established quality rewards your effort with liberal commissions ever on large orders. "Triple-test" multimount crystals and "Triple-tone" special gold alloy cat-whiskers are today the best sellers to jobbers and retailers. High priced, but unequalled in quality and sales helps. Repeat orders insured. State territory you want.

FOOTE MINERAL CO., Inc.
107 N. 19th St., Philadelphia, Pa.
Established Forty-seven Years

IMMEDIATE DELIVERY

CABINETS—		PANELS—	
Imitation any or	Mahog- Flemish	Genuine	Formica,
Oak Finish		3/16" thick	
6 x 7 x 10		6 x 10 1/2	
6 x 7 x 13 1/2		6 x 14	
6 x 7 x 20 1/2		6 x 21	

Other Sizes to Order

COMPLETE RECEIVING SETS

Jobbers and Dealers
Get Our Discounts

THE MIHO COMPANY

8 East Third St. Cincinnati, Ohio

COMPOSITION

LIST PRICE

DIALS 50¢ DIALS

Adjustable Switchlevers
Knobs

NEW YORK RADIO-DIAL CO.

316 Holden Bldg., Detroit, Mich.

alternately connected to the receiver and to the potentiometer, the voltage being applied by the potentiometer having varied until signals in either position of the switch are equal. The value of the telephone voltage under this condition is then noted. The ratio of this latter voltage to the in-put voltage is then the sensibility of the receiver.

Selectivity Determination

It has been found advisable to define selectivity arbitrarily as follows: If the receiver is set up as described above and is excited by a voltage in the antenna circuit with a resultant signal in the telephones, and if then the generator is detuned from the receiver, or the receiver detuned from the generator, the magnitude of the voltage induced by the generator being maintained constant and the value of the telephone signal voltage on the resonant and non-resonant wave lengths or frequencies having been observed, the selectivity may be defined as

$$\sqrt{\frac{Er + Eo}{Er} \cdot \frac{\lambda r}{\lambda r + \lambda o}}$$

where Er is the telephone voltage when the receiver and generator are of the same frequency or wave length; where Eo is the telephone voltage when the receiver and generator are not of the same wave length and frequency; where λr is the wave length at which both receiver and generator are resonant, and where λo is the wave length at which the receiver and generator are not resonant.

This arbitrary definition has been found advisable since it results in a value for selectivity having the dimensions of the reciprocal of the power factor, and therefore allows the formulation of the equivalent ideal single circuit receiver, such an ideal receiver being one in which the detector and indicator are loss-free and its power factor is the reciprocal of the selectivity of the receiver under test.

The manipulation in the selectivity determination is identical with that described above, with the exception that two measurements of telephone voltage are made, one at resonance between the receiver and the generator, and one out of resonance between the receiver and generator, the wave length of the generator or receiver being noted for these two conditions. The selectivity is then given by the substitution of these values of tele-



The Radio Set you were waiting for. Crystal Detector and two-stage amplifier with loud speaker, consisting of horn and Baldwin phone; list price, \$75.00. Long distance stations were received on this set. Everything in radio supplies. The U. S. Eagle crystals positively the best on the market.

Write for Prices

U. S. Radio Co. of Penna., Inc.
Pittsburgh, Pa.

The Comet Battery Co.

Manufacturers

Radio "B" Batteries

Cleveland, Ohio

Chaslyn "Sink or Swim" Ball Battery Testers Are Whirlwind Sellers
This clever little \$1.00 set catches the fancy and appeals to the good sense of everyone who hears about it.

Three balls of different colors and specific gravities tell the condition of the electrolyte instantly by the manner in which they sink or swim.

Depth Tester shows amount of acid over the plates. Air-controlled filling stopper makes adding distilled water easy.

Special Offer. We will send TWO complete sets to any dealer writing on his stationery for \$1.00. This is below wholesale price. Only one sale of this kind to any dealer.
THE CHASLYN COMPANY
4323 Kenmore Ave., Chicago



We Specialize in

Brass Rod and Tubing
Sheet Copper, Aerial Wire
and Binding Posts

McKenna Brass and Mfg. Co.

First Ave. and Ross St., Pittsburgh, Pa.

*Phone, Court 637

RADIO MAILING LISTS

10,975 Radio Dealers, covering U. S. by States. Per M.	\$7.50
1,320 Radio Manufacturers, covering U. S. by States. Per list.	12.50
1,325 Radio Supply Jobbers, covering U. S. by States. Per list.	12.50
260 Radio Stations. Per list.	4.00
257 Mfrs. who make and assemble complete Radio Sets. Per list.	4.00
25,000 Radio Amateurs and Managers of Radio Stations. Per M.	7.50
20 Radio Manufacturers in Canada. Per list	1.50
87 Radio Supply Jobbers in Canada. Per list	2.50
131 Retail Radio Dealers in Canada. Per list	3.00
125 Mfrs. and Jobbers and Retail Dealers. England. Per list.	4.00

Ready to send on receipt of Remittance.
TRADE CIRCULAR ADDRESSING CO.
166 W. ADAMS STREET, CHICAGO, ILL.

phone voltage and wave length in the above expression.

Determination of Distortion

It was agreed that for the present we must content ourselves with the determination of the distortion which results from the use of audio frequency amplifiers since there is no method available for the quantitative determination of distortion which may take place in the radio frequency circuits of receiving equipment. It was suggested that the most feasible means for determining the degree in which distortion takes place is the determination of the voltage amplification of the amplifier over a wide range in the audio frequencies, the in-put and out-put impedances being maintained approximately those met with in practice.

The method suggested for this consists of the application of a known voltage of known frequency to the grid of the in-put tube of the amplifier and the determination of the resultant output voltage at the telephones, the potentiometer method described above being used for the determination of both these voltages. With the voltage amplification determined over the range of frequencies between 100 and 2000 cycles, a plot of voltage amplification against frequency is then made and a simple calculation from this plot gives the degree of distortion. Such plots will undoubtedly indicate peaks at which the amplification is a maximum or will at least show a reasonably wide variation of amplification with frequency, and it is felt that if the ratio of maximum amplification to the mean amplification throughout the range in which the measurements are made is a reasonable measure of the distortion which will result from the amplifier.

Heat Resistance and Vibration Tests

It was deemed necessary to provide a test for heat resistance for the purpose of revealing the use of low grade moulding compounds, and to prevent the sets used in warm climates from being injured by heat. It was decided that every set should be subjected to 150 degrees Fahrenheit for two hours.

It was further decided that every set should be subjected to a Navy type vibration table. The time when different parts of the set broke down should be noted.

PRICES OBTAINED

Retailers and jobbers who are interested in receiving prices from manufacturers are invited to address THE RADIO DEALER SERVICE BUREAU, 1133 Broadway, New York City, which makes no charge for its services.

LATEST and MOST POPULAR

Radio Books

- Radio Hook-Ups, by M. B. Sleeper.....\$.75
An indispensable book to the radio amateur who designs or builds his own receiving apparatus.
- Radio Design Data, by M. B. Sleeper..... .75
A book giving tables and data for designing receiving and transmitting apparatus.
- Construction of New Type Trans-Atlantic Receiving Set, by M. B. Sleeper..... .75
Tells how to listen to the high-power telegraph stations of foreign countries.
- Construction of Radiophone and Telegraph Receivers for Beginners, by M. B. Sleeper75
Tells in detail the building of radio apparatus.
- How to Make Commercial Type Radio Apparatus, by M. B. Sleeper..... .75
Describes in detail many commercial types of transmitting spark and vacuum tube sets, both telephone and telegraph and receiving equipment of all kinds.
- Wireless Telegraphy and Telephony Simply Explained, by A. P. Morgan..... 1.50
A book the Radio experimenter cannot afford to be without.
- Experimental Wireless Stations, by P. E. Edelman..... 3.00
A book describing all modern improvements.
- A B C of Vacuum Tubes Used in Radio Reception, by E. H. Lewis..... 1.00
A book explaining in detail all about vacuum tubes.
- Ideas for the Radio Experimenter's Laboratory, by M. B. Sleeper..... .75
This is a book the wireless experimenter, amateur, or layman cannot afford to be without.
- Radio Experimenter's Hand Book, by M. B. Sleeper..... 1.00
It tells in clear concise language the principles underlying radio theory, and then goes into the operation of wireless sets, showing simple hook-ups and explaining the theory on which they work.

FREE! Catalogue of Wireless, Automobile and Other Books Sent Free on Request

The Norman W. Henley Publishing Co.

2 West 45th Street, New York

Liberal Discount to Supply Houses. Write for full particulars and dealer's proposition

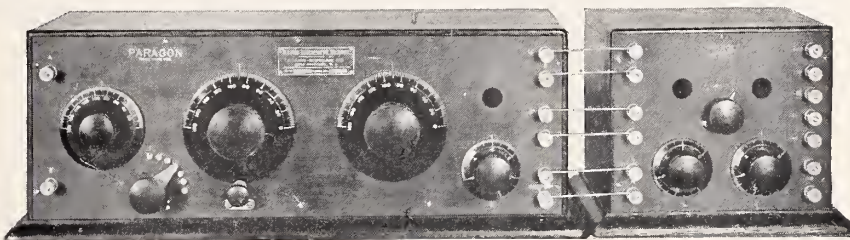

R-D-5 Tuner \$75 PARAGON A-2 Two-step Amplifier \$50

Wave length 510 meters. Same circuit as in R-A-10-1000 meters with the same finish and workmanship. Very selective. Get your order in now. Best service and discounts.

E. M. WILSON & CO., 11 Lafayette St., NEWARK, N. J.

Ask Cur Service Bureau

For CORRECT RADIO MAILING LISTS Use THE POCKET LIST

Of Radio Manufacturers, Jobbers and Dealers in the United States and Canada. Issued quarterly—January, April, July and October. October, 1922, issue corrected to September 15th, 1922. Classified under three different headings—Manufacturers, Jobbers and Dealers—and alphabetically arranged by states, cities, towns and names of firms. Containing over 15,000 names and addresses.

We have been exceptionally careful to see to it that every manufacturer, jobber and dealer is listed and, under the PROPER CLASSIFICATION. Most mailing list concerns charge more than \$100 for a list of this kind, and, as a rule, those supplied are far from being correct. Compare this list with any other and you will find it to be the very best obtainable anywhere at any price.

October number ready for distribution September 25th. Price \$5.00 per copy or \$10.00 per year (four issues, including monthly supplements which keep the list absolutely correct and up to date at all times). October edition limited, send in your order with remittance today.

1021 Carrington Street F. D. PICKENS JANESVILLE, WISCONSIN

"COPPERWELD"
TRADE MARK REG. U. S. PAT. OFF.

ANTENNA WIRE
 50% stronger than either
 solid or stranded copper

ELIMINATES SAGGING
Adopted by Largest Radio Manufacturers
 100, 150, 200 ft. per Carton

**LEAD-IN and
 GROUND WIRE**
 has the Underwriters' O. K.
 Rubber Insulated—Brown Braid
 25, 50, 100 ft. per Carton

BUY IT IN CARTONS
 with construction directions

COPPER CLAD STEEL COMPANY
 New York Chicago
 Braddock P. O., Rankin, Pa.

XMAS PRESENTS
 FOR BOYS AND GIRLS

CRYSTAL SET
 "The Little Wonder" **\$1.75**
 Unassembled - Net

Catches distinctly everything broad-
 casted within 30 miles. We also
 manufacture the "Little Wonder"
 assembled set to retail at \$4.00.

**GUARANTEED
 TESTED CRYSTALS**
 Galena 7½c Radiosite 8½c

SEND FOR FREE CATALOG
 It lists all our radio parts and
 supplies.

Holloway Elec. Supply Co., Inc.
 238 Third Ave. New York City

Radio Cabinets

Made to your specifications in any
 quantity, style, wood, or finish. Sub-
 mit specifications for quotation.

Standard models, all common sizes,
 in Mahogany, Walnut, and Quarter-
 sawed Oak. Descriptive material
 and prices on application.

Better Cabinets
 for
 Manufacturers and the Trade at Large

MARVIN B. FALLGATTER
 Waupaca Wisconsin

**Make It a Radio Christ-
 mas This Year**

(Continued from page 38)

Each ribbon leading from the set was attached to its appropriate explanation on the card. The man who designed the window was careful to make his statements in the simplest language he could muster and avoided as far as he could any technical words. Thus the ribbon leading from the variable condenser said: "This makes the sound waves steady and of equal strength and is called a variable condenser." The last line on the card read: "Radio is fascinating and simple."

So many other window displays suggest themselves that one wonders why some men who call themselves radio dealers feel inclined to resort to a mere piling up of parts in their windows. This confuses the average buyer and a sale is lost. Other themes, such as "Your boy wants a radio set," "Can you start a radio club," "A concert every night in your home," "Radio radiates cheer," and "Do you know how simple radio is?" are suitable for exposition in your best window. You may even stir newspaper comment, and free publicity, by having your window express the spirit of the season. A radio display with idea of showing that "Peace hath her victories no less renowned than War" would be a tribute both to radio and quality of your window settings. It would be sure to get a notice in your town paper.

The day after Christmas is just as much a part of the season's business as the day before, and the active dealer should take part in the profits from those who have delayed buying gifts or have received a present in cash. The boy who is looking where to spend his cash present will step into your store if you have a window display arranged with the idea, "Now you can get that radio set."

The father who is in a mellow mood during the holiday period will translate that mellowness into action, when he learns how fine it would be for the family to have a radio set. Sales at any season arise from the use of imagination in merchandising. It is particularly effective when used during the period generally referred to as the Christmas season.

Of course it is realized that everywhere with the possible exception of the larger cities, the radio dealer will not fail to make use of daily and weekly newspaper advertising, for this is a method of attracting attention to the merchandise he has to sell

DEALERS!

If the Holiday Sales have depleted your stock—reorder now for mid-winter sales. Prompt deliveries are absolutely guaranteed—and our discounts are the most liberal.

We Are Jobbers For
 Grebe Receiving Sets
 Federal, Fada and
 Radio Shop Products
 Murdock Products
 Baldwin Phones

Write For Our Special Proposition "Z"

THE RADIO SHOP
 —OF NEWARK—
 76 SPRINGFIELD AVENUE
 NEWARK, N. J.



T-B-H PHONES
SPEAK FOR THEMSELVES
 Pure Natural Tones, Light Weight
 Ornamental Appearance
 A Sturdy Reliable Head Set That Will Sell
 and Stay Sold
 Let us send a sample set for your inspection
 List \$7.00
 Substantial Discounts to Jobbers and Dealers
 T. B. H. CORPORATION, Dansville, N. Y., U. S. A.

"SAMCO"
RADIO PRODUCTS
 of QUALITY

**VARIABLE
 CONDENSERS**

			List Price
11	Plate .00025	M. F. Capacity	\$2.25
23	" .0005	" " "	2.85
43	" .001	" " "	3.60
63	" .0015	" " "	5.50

List

RHEOSTATS 6 Ohms	\$1.00
POTENTIOMETERS, 300 Ohms	1.75
INDUCTANCE SWITCHES	.50
VERNIER DIAL ATTACHMENTS	.50

**We Have a Special Proposition to
 DEALERS and DISTRIBUTORS**
 Samples sent Postpaid upon receipt of price
STANDARD APPLIANCE MFG. CORP.
 428 East 71st St., New York City

and permits him to bring his message directly before those he cannot reach in any other manner. It gives the dealer the opportunity of driving home certain facts that must be impressed on the ordinary prospective buyer of radio equipment before he will make a purchase, such as the safety, simplicity and ease of installation and operation of a radio set. It also permits the dealer to explain that technical knowledge is not essential and that a set that will give much pleasure and enjoyment can be bought for a modest price. This publicity accompanied by the thought that "This is a radio Christmas" cannot help but make the season a profitable one for the dealer who makes a real effort to instil the spirit of radio and Christmas into the minds of his prospective customers.

How to Determine Manufacturing Costs

(Continued from page 39)

The other insists that depreciation is of two kinds, one caused by the friction of turning wheels when the article is being manufactured, and the other goes on all the time. The latter form of depreciation is caused by heat and cold, damp weather and dry; hit by accident from outside sources; neglect to keep in repair, or oiled; unintelligent labor; and because this is going on all the time, and because it is impossible to separate the degree of one from the other, the capital invested should suffer and not the manufacturing costs. Accountants are inclined to accept this view, and to consider depreciation as much a cost of financing the business as some other items that will be mentioned when that subject is taken up.

Then comes Commercial Expenses, which consist of the classes of expenses mentioned above. First, there are the expenses of receiving and shipping; as expressage to customers, parcel postage, packing materials, labor of shipping clerks, and cost of upkeep of horses, trucks and automobiles.

Selling Expenses consist of salesmen's salaries and traveling expenses, advertising, commissions paid to salesmen, etc.

Administrative Expenses consist of salaries of office clerks, typists and bookkeepers, stationery, postage, telephone and all expenses required to administer the business from the executive end.

Cost of Financing the Business consists of all expenses incurred to protect capital, or due to lack of sufficient capital.

QUALITY and RESULTS

Remember last winter when anything that looked like radio apparatus had a ready sale? Remember how much of it only "looked like" radio? Remember how many "comebacks" you had on this inferior material and apparatus? Remember how many good customers you lost through sale of unsatisfactory goods? Wouldn't you be interested in handling a line which will sell itself, and produce no "business worries?"



Audio Frequency
Price \$6.50



Radio Frequency
Price \$7.50

The quality, operation, and appearance of the J. T. Boone Mfg. Co.'s Radio and Audio Frequency Transformers is setting a new standard. The Radio Frequency type is a real "range producer," while the Audio type assures powerful, distortionless amplification which reproduces the broadcast programs in a thoroughly enjoyable manner.



Boone Receiving Sets give unquestionable results. These sets are sold complete in every detail ready for immediate use. The backbone of all J. T. Boone Mfg. Co.'s products is Quality and Results.

J. T. BOONE MFG. COMPANY
3469 E. Jefferson Ave. Detroit, Michigan

A SUPERIOR AUDIO FREQUENCY TRANSFORMER

USED AND RECOMMENDED by LEADING REPUTABLE MANUFACTURERS of RADIO APPARATUS

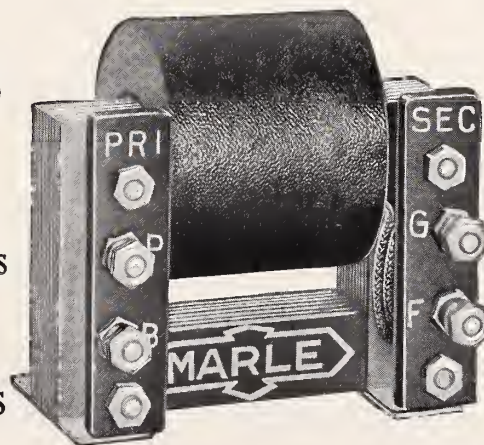

LIST 3.75 MOUNTED
Write for Information and Discounts
Jobbing Concessions Restricted

Manufactured by

MARLE ENGINEERING CO., ORANGE, N. J.

Special Prices Quoted On Unmounted Type To Manufacturers

Free Will help YOU increase sales



This catalog will show you how to secure the names of your best prospective customers, those you want to reach most. Counts and prices are given on thousands of different Lists, covering business concerns, professions and individuals, such as Noodle Manufacturers, Druggists, Coal Mines, Farmers, etc. Personalized sales letters and descriptive literature mailed to live prospects will increase your sales by creating direct orders or inquiries.

99% Guaranteed Mailing Lists backed by our 5¢ refund

Insure your getting up-to-date information, for our Lists must be compiled from the latest sources to avoid heavy losses through the guarantee.

Send for FREE Reference Book today
A postcard will bring this valuable sales help.
ROSS-GOULD CO., N.10th, St. Louis.

Ross-Gould Mailing Lists St. Louis

RADIO CABINETS



We manufacture a complete line of radio cabinets, of mahogany, walnut, oak, and white wood, in all sizes, and in any finish. Best of construction. Dirt, dust and moisture proof. Quick deliveries—quantity production prices. Send us your specifications, or a sample of your cabinets, and get our prices. We also make indoor loop aerials.

Cabinet Work Since 1900

E. ESHOO CABINET WORKS
635 Herkimer St. Telephone
Brooklyn, N. Y. Lafayette 2324

DEALERS REAL DISCOUNTS

Master Baldwins	Brandes
Coto Coil	Dubilier
Howard	Erla
Radi-un Loops	Signal
Atwater-Kent	Pacent

MYERS TUBES
CUNNINGHAM'S RADIOTRONS

HUDSON-ROSS
123 W. Madison St. Chicago

Maclite Vario-Coupler
Price \$5.00

Is, in the opinion of experts, the most efficient on the market.

All Other Maclite Parts are equally efficient, including the Maclite Variometer, Double Slide Tuner, Variable Condensers and Crystal Detectors. The Maclite Single Tube set at \$25.00 is the best buy we have ever seen. Let us tell you more about this set, also all other Maclite parts.

Dealers and Jobbers Write for Discounts

MACLITE RADIO CO.
701 Maclite Bldg., Clarendon St.
Boston, Mass.

The reader will notice the groups of expenses mentioned above are those representing the operating functions of the business and to classify the expenses in this way is to show properly the costs of each function. The importance of proper bookkeeping, followed by periodical audits, is also clearly seen, for to charge an expense to a group to which it does not belong is to make false operating costs, and since the executive is guided by a comparison of these figures from month to month, an incorrect entry becomes dangerous to the business.

Let me, in order to provide a concrete example, and illustrate the workings of what I have said above, assume that the costs of each of the above groups have been determined as follows for the period of one year:

Labor	\$125,000.00	
Material	125,000.00	
Manufacturing Overhead	10,000.00	
Commercial Expenses:		
Selling	\$20,000.00	
Receiving and Shipping	20,000.00	
Administrative	20,000.00	
Cost of Financing..	20,000.00	80,000.00

Total Costs\$340,000.00

First, let us assume that we have manufactured only one article, the material costing \$125,000, and the labor \$125,000, and in order to manufacture that item we incurred the above mentioned costs. Notice that the costs show up as follows:

Materials	\$125,000	50%
Labor	125,000	50%
Total materials and labor	\$250,000	100%
Manufact'g overhead..	10,000	4% of materials and labor
Total prime costs...	\$260,000	
Commercial expenses	80,000	30.77% of prime costs

Total costs of manufacturing\$340,000

Applying our findings for the past year to the calculation of the small article, we determine the cost of:

Material	\$1.10
Labor10
Total Material and Labor.....	\$2.20

Then, according to the scheme outlined above, we should next add 4% of the material and labor, or \$.008. Adding this to the 20% already arrived at, we get a prime cost of \$.208. Continuing, we then add 30.77% of \$.208, which amounts to \$.064, to \$.208, and get a total cost of \$.272 for the article.

In this manner we arrive at one very vital point: You now know that it costs you \$.272 to manufacture that article; now fix your selling price. You are the sole judge of how much to add to this sum for profit, but your good judgment must show you that you cannot sell for less without losing money.

GANAERITE Detector Crystals

Twenty years of practical mineralogy gave us the material to produce the highest quality crystal.

We are now undertaking the largest single order for mounted crystals in the market.

We individually test and guarantee to replace or refund on any unsatisfactory Ganaerite crystal.

The Harris Laboratory
26 Cortlandt St., New York City

Do You Know

We are the recognized authorities on wireless securities. Our Information and Analytical Departments are unexcelled. Let us know what company you are interested in and we will furnish without obligation, detailed information and opinion respecting its merits

FRANK T. STANTON & CO.
Specialists in Wireless Securities Since 1915
35 Broad St. New York
Phone: Broad 1670-3641-5819

PATENTS

on radio inventions apply to

OTTO K. ZWINGENBERGER
38 Park Row, New York
Cortlandt 3207

Ask Our Service Bureau

PATENTS

PROTECT YOUR INVENTION TODAY

Write for 1922 illustrated book free Radio-Electrical, chemical and mechanical experts; over 20 years' experience.

A. M. WILSON, Inc. (Radio 3 ARH)
309-20 Victor Building, Washington, D. C.
(Successors to business established 1891 by A. M. Wilson)

VERNITROL CONDENSERS

The heart of the radio set, the variable condenser, has received intensive study at the Malone-Lemmon Laboratories, whose offices are located in the Canadian Pacific Building, 342 Madison Avenue, New York. As a result the Vernitrol has been developed.

The Vernitrol condenser is constructed with two groups of plates so arranged that they are perfectly counter-balanced. This is said to prohibit the slightest tendency to turn under vibration, and the makers claim that it maintains the condenser setting. In the Vernitrol the vernier plate comes under separate control, which permits even the novice to tune to the crest of each wave. A novel end-shield construction in the Vernitrol is designed to reduce losses to a minimum. The new condenser is made in two sizes, one for use with loop aerials and for all ordinary broadcasting. This has a capacity of .0005 mfd. The .001 mfd. size is for all other purposes.

STOCKING RADIO

At a meeting of electrical dealers, held under the auspices of the Commonwealth Edison Company of Chicago, discussion was had as to the amount of money to be invested in opening a new electrical store.

One portion of their report refers to radio and on this they conservatively report, as follows:

"In the case of radio, it is difficult to decide what shall be done in the way of stock. This end of the business, he feels, is hardly developed enough to be steady, but certainly requires some consideration. He sets aside \$550.00 for the purchase of parts and equipment, along with one good set and expects to do as much business as possible on a back-order basis. The money placed in radio, because of the public interest in the subject, is generally well spent from an advertising standpoint."

R.P.M. USES REDMANDOL

The R.P.M. units made by the Radio Products Manufacturing Company, 667 West 14th Street, New York, are all made in their own plant from the moulding of the Redmandol parts to the winding, assembling and final testing of their completed variometers and vario-couplers, the latter being provided with sixteen taps, giving great range of wave lengths.

Redmandol, a phenol condensation product is used for insulation because of its resistance to extreme heat, high dielectric qualities, mechanical strength, acid resistance, accuracy of dimensions and attractive finish.

LET'S MAKE THIS A REAL RADIO CHRISTMAS

The Holiday season is going to mean increased Radio sales. THE EBY SILENT SALESMAN (illustrated below) will assist you in making quicker sales, as the prospective customer can wait on himself.



Price to Jobbers, Dealers and Manufacturers, \$1.00 Each

Full information as to specifications and prices of posts printed on the back. Cut shows our complete line, and our large stock means immediate deliveries. Invest in two of these attractive boards. They will pay for themselves the first week.

THE H. H. EBby MANUFACTURING CO., PHILADELPHIA, PA.



Amplify Your Radio Sales with Bradleystat



Retail Price
\$1.85

The Bradleystat is a guaranteed, graphite disc rheostat. Beware of carbon grain imitations. It is the result of 20 years' experience in designing graphite disc rheostats for precision control. Send for complete Bradleystat sales plan.

PERFECT FILAMENT CONTROL

Every radio set user, now depending upon a wire rheostat for detector control, is an immediate customer for the Bradleystat.

Thousands of dollars are being spent in advertising the Bradlestat in all leading radio publications. Dealers, everywhere, are profiting by the poor performance of wire rheostats and the good work of the Bradleystat.

Get the Bradleystat demonstrator, free, with your first order. It will amplify your radio sales beyond your expectations. The Bradleystat is a fast seller. Act, to-day.

Allen-Bradley Co.

Electric Controlling Apparatus
487 Clinton Street - Milwaukee, Wis.
Member of National Radio Chamber of Commerce

Clip this coupon—Mail it, to-day—Don't delay

ALLEN-BRADLEY CO., 487 Clinton St., Milwaukee, Wis.
Please send me your sales plan, giving prices and discounts, so that I may get my share of Bradleystat profits this year.

.....
.....

ROCCO PRODUCTS

SOCKETS

Base 1/4" solid sheet
Celeron - Condensite,
Brass tube, nickel
plated and polished.
Phosphor bronze con-
tacts, nickel plated—all
other parts brass nickel
plated.



LIST PRICES

Single As	Double As	Triple As
Above \$1.00	Above 2.00	Above 3.00
Fibre Base \$0.75	Fibre Base 1.50	Fibre Base 2.25

JACKS

Sterling silver contact points, nickel silver springs, Bakelite insula-
tion, all other parts brass nickel plated.

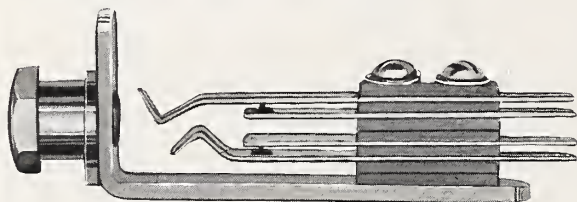

LIST PRICES

Single open \$0.55
Single Closed \$0.65
Double \$0.85

Exclusive Territory Open to Jobbers and Dealers
WRITE FOR DISCOUNT

GEO. ROCCO

500 Fifth Avenue

New York City

Telephone: Longacre 8328

Efficiency From the Amplifier Tube

(Continued from page 43)

this article are at the center of the list. Strictly speaking, they are not true voltage amplifiers, for they are low enough impedance to work as power amplifiers under certain circuit conditions. But they do make good voltage amplifiers and are much more stable and efficient when used as such, i.e., in the intermediate stages of the amplifier from detector to last or power stage.

A number of technical articles have been written on the theory of operation of vacuum tubes and as our space is limited we shall summarize the particular points we are now interested in, as follows:

All tubes are put in operation by lighting the filament and putting a relatively high voltage of D.C. on the plate circuit. Then by operating the grid with small values of alternating voltage, the plate circuit will operate correspondingly. The voltage component of this plate circuit alternating energy may then be applied to the grid of another tube by means of a transformer, choke coil (impedance), or resistance (according to whether the first tube is low, medium or high impedance). This second tube will likewise operate its plate circuit, except through a somewhat longer range than the first, and consequently act as an intensifier or amplifier.

It may now be appreciated that the higher the voltage applied to the grid of a tube the greater will be its plate circuit response. Since voltage, not amperage, is desired, and since the grid circuit is practically an open circuit, but an infinitesimal value of amperage is necessary. Accordingly, we must use tubes and supplementary apparatus which give us the highest possible voltage output when operated. Voltage amplifier (high impedance) tubes and transformers, choke coils or resistances, which have the same impedance as (or slightly higher than) the tube in whose plate circuit they are used will do this. We have seen from the above table that the voltage amplifiers are all relatively high impedance and therefore require for maximum efficiency, high impedance primary transformers, high impedance choke coils and high resistances for coupling devices.

The transformer is satisfactory up to about 30,000 ohms (impedance), which is about as high as it is possible to wind one efficiently. All the tubes listed below the WD-11 on our table may be used efficiently with transformers, provided they approximately

ASK OUR SERVICE BUREAU

"EURACO" MICA GRID CONDENSERS AND LEAKS

Price 60 cents
(Designed to fit Standard Grid Leak Base)

GRID LEAK
VALUES:

.5-1.0-1.5
2.0-2.5-3.0
Megohms

Price, 60 Cents



COMPACT,
INTER-
CHANGEABLE,
HANDY,
MOST
EFFICIENT

"Euraco" Condensers are composed of Copper Sheet and Best Grade India Ruby Mica, and are entirely Hand Made.

Manufactured in following capacities:

.00025 Mfd	—Correct for Myers Radio-Audion RAC-3
.0001 "	—For Special or Experimental Circuits
.00025 "	—Correct for Super-Hetrodyne & UV 201
.0005 "	—Correct for Radiotron UV 200

Condenser—Leak Mountings

Bakelite Base with Single Mounting\$.40
Bakelite Base with Double Mounting60
Bakelite Base with Triple Mounting80

SHIP OWNERS RADIO SERVICE, Inc., DISTRIBUTORS

80 Washington St., New York

Interesting Proposition to Dealers

(Mfd. By EUROPEAN RADIO CO., 1342 East 22d St., Brooklyn, N. Y.)

THIS IS A RADIO CHRISTMAS!

match the tube's impedance. The D.C. resistance of transformer primaries is but a rough approximation to the impedance, which is usually about 8 to 10 times the D.C. resistance. (A laboratory A.C. bridge is necessary for accurate measurements and manufacturers ought to therefore state the impedance on the carton). If a transformer is wound with resistance wire it can have the required D.C. resistance and yet have very low impedance, being therefore practically worthless.

Resistance or impedance (choke coil) coupling can be made high or low and is therefore much more efficient for high impedance tubes to match, which transformers cannot be wound. Resistance coupling can be made to give distortionless amplification and while not as efficient (loud) as transformer coupling for tubes in the moderate impedance class, is very desirable for high quality reproduction. The VT-1 is high enough impedance to work well with either transformer, resistance or impedance coupling and was used very satisfactorily in each capacity in government equipment during the war.

The UV-201 is not well adapted to resistance or impedance coupling, but is very efficient with moderate impedance transformers, such as the UV-712. When we come to the WD-11 we find this listed slightly above the transformer range, so that it is about equally efficient with resistance or high impedance transformer coupling. And since the former gives higher quality it is to be preferred. For this tube a resistance (preferably non-inductive) of approximately 50,000 ohms is very satisfactory with a mica or good paper grid condenser of .02 mfd. capacity, and if more than one stage is used the condensers should increase in capacity with each succeeding stage (.02-1-5-1.0) a grid leak of 1 to 3 megohms should be used from grid to negative filament to stabilize the system. When resistance coupling is used the "B" battery may safely be increased about 50% with improved results.

The above discussion is given for the express purpose of educating the dealer so that he can give his customer reliable information and suggestions on what to buy. The sooner a dealer learns to talk intelligently to his client and obtain his confidence, the sooner the dealer will gain steady customers. Radio is progressive. It is sufficiently experimental to keep the average man interested to progress with it. Give your customer help, give him service, and get his confidence—he'll come back to you the next time.

RADIO DEALERS



We Are Manufacturers of
F. M. C.

Audio Amplifying Transformers
Radio Frequency
Mica Condensers
Sensitive Crystals

Dealers and Jobbers Write Us for Proposition
IMMEDIATE DELIVERY

Ford Mica Co., Inc.

14 Christopher St.

New York

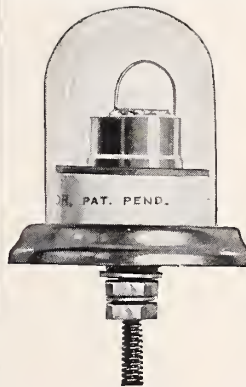

(Actual Size)

GREWOL, the DETECTOR
With a National Reputation **\$2.00**

ENTIRELY different—infin-
itely superior. Sells al-
most on sight. Makes
good and makes sales. Attract-
ively packed in individual car-
tons. Never stays long on any
shelf.

Lasting
Adjustment
Always Set
and Ready
Glass Enclosed

Write for Proposition TODAY!!

RANDEL WIRELESS CO.

Sole United States Distributors
9 CENTRAL AVE. NEWARK, N. J.

RADIO PANELS

And other insulation for Wireless Work

BAKELITE-DILECTO

Grade XX Black was used by the Government during the war for this purpose. It is the

Standard of the World

THE CONTINENTAL FIBRE COMPANY

NEWARK, DEL.

New York, 233 Broadway
Pittsburgh, 301 Fifth Ave.
Los Angeles, 411 S. Main St.
Seattle, Wash., 1927 First Ave., South

Chicago, 332 S. Michigan Ave.
San Francisco, 75 Fremont St.
Rochester, N. Y., 85 Plymouth Ave.,
South

Warren
Radio
Loop
Un-
Covered

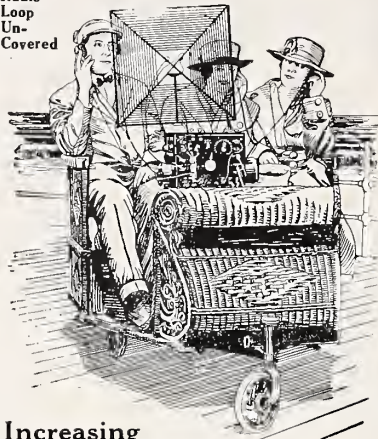

Increasing Demand for the WARREN RADIO LOOP

How Many Are You Selling?

LOOPS are rapidly replacing the old outside aerial—especially for the more sensitive tube sets. Most of them are Warren Radio Loops. Extremely powerful, extra well made, exclusive advantages. They leave nothing to be desired. Their advantages are being told every month to thousands of radio fans through generous national advertising. Your customers read this advertising. You can sell quantities of Warren Loops. One or two will demonstrate their profitableness. Order TODAY.

- Type A-737 (300-700 meters), 6 inches square—non-directional \$10
- Type A-7236 (175-1000 meters), 6 inches square—non-directional..... 12
- Type B-2337 (300-700 meters), 18 inches square—directional..... 20
- Type BL-2520 (200-18,000 meters), with honeycomb coil, 18 inches square—directional 25

Send for Bulletin P-102

V-DE-CO RADIO MFG. CO.
ASBURY PARK, N. J.
Dept. D

Praco Panel Service

We offer to the amateur and dealer

REAL PANEL SERVICE.

Our panels are cut to your order. Only genuine Condensite and Formica used.

- 1/8" per square in. 2c
- 3/16" per square in. 2 1/2c
- 1/4" per square in. 3c

We also carry a complete line of radio essentials. Dealers will find it profitable to have our latest price list and discount sheet.

PITTSBURGH RADIO AND APPLIANCE CO., Inc.
"Pittsburgh's Radio Shop"
Desk D
112 Diamond St., Pittsburgh, Pa.

Retail Radio Salesmen and Raspberries.

(Continued from page 46)

nical questions, for they will only gum up the works and make it harder for the new flock of customers the following day. What the average novice wants is a set that will receive and he wants to know what to buy and how to put it together, but when it comes to the technical stuff, forget it. The public don't want it and if they do they will either buy a book on the subject or else take a night course in a radio school. When they do that you won't have to worry about it anyhow.

The idea of trying to make a great mystery out of the radio business is all wrong and won't sell merchandise, which is what we are all in business for.

My idle dream is to see a radio set come out on the market with only one dial, no wires, batteries or binding posts. When that is done, there will be room to sell twenty million sets without batting an eyelid and our troubles with the customer will be over, but in the mean time let's help the customer all we can and quit surrounding the radio business with such an air of mystery. It may work with the novice at first, but after the first few weeks of experimenting and he finds he has purchased a whole lot of merchandise which he knows nothing about, didn't want and doesn't know what to do with, all I have to say is that some of it will probably be put to use to repair his flivver, make an ice cream freezer or simply left for the junk man—and another embryo "radio bug" is lost.

MELCO TYPE 400 UNIT

The Melco type 400 tuning and detector unit is made by the Mortimer Radio Corporation and distributed through the Save Sales Company, of 261 Broadway, New York.

The face plate of this new unit is of Radion, while the rest of the cabinet has a satin mahogany finish. The Melco is designed to operate in conjunction with a 150-meter antenna, at wave lengths from 150 to 600 meters. A specially designed vario-coupler, with rotor or secondary wound with Litz wire, permits selectivity, which, with the increasing number of broadcasting stations, is an important detail. This vario-coupler, the manufacturers state, will completely tune one station out and another in. The vario-coupler permits of acute adjustment.

"Vac-Shields" Sell Themselves

Trade
"VAC-SHIELD"
Mark



Patent Pend.
Price, \$1.00

"VAC-SHIELDS" Make Reception Worth While

Your customers will want them. You can sell them. See our Ad in Radio News for December.

BE PREPARED

Trial Order One Dozen
Vac-Shields By Mail \$8.00.
Order today.

ORANGE RESEARCH LABORATORIES

41 North 16th St., East Orange, N. J.



CRYSTALS **GALENA SILICON**

CRYSTAL DETECTORS List \$2.00

CRYSTAL RECEIVERS List \$9.00

RADIO APPARATUS CO.
6600 Hamilton Ave. Pittsburgh, Pa.

Twenty Receiving Sets to One a Year Ago

(Continued from page 46)

ning programs of the broad-casting stations is undoubtedly several million, and the audience reached by a single station may be 20,000 or more. The manufacture and sale of receiving sets and accessories has grown to be a great industry.

We may well ask whether the radio phone is a plaything which has caught the public's passing fancy or a real utility which is destined to become a permanent factor in our daily life. The answer to this question seems naturally dependent upon what radio is capable of supplying. If it be limited to music and entertainment, its permanency will undoubtedly depend upon quality, and inventive genius will be called upon to perfect the product so that those who listen-in will invariably receive perfect renderings—whether it be a symphony, opera, concert, church choir, or dance music. But the radio phone has other possibilities which should guarantee its permanence quite aside from its role as an entertainer.

About one-third of the population of the United States lives in rural districts and depends on the telegraph, telephone and post office, for information. A large part of this population is interested in the daily news as it happens; in the shipments of farm products to the large centers and the price at which they are sold. The radio phone is a new publicity agent capable of rendering a public service by disseminating news and information instantly throughout wide areas. A quarter of the population of the United States is within the area reached by WGY, and under favorable conditions the broadcasting from this General Electric station at Schenectady, N. Y., might extend much farther.

If radio has everyone "by the ears," it may also be credited with a considerable list of beneficent contributions to the world's prosperity and happiness. It distributes music and entertainment to thousands of homes; it shortens the tedious hours of the sick and injured in hospitals; it supplies daily market and weather reports to the great farming population; and it furnishes communications from ship to ship and from ship to shore. It is already an established method for the transmission of messages and the broadcasting of information and entertainment.

Radio will undoubtedly exert a powerful influence on press, pulpit, schools and theaters, but it will not

TOM BROWN'S RADIO SET

Manufactured by Lawsam

A complete knock down tube set, cabinet drilled, wires cut and shaped, everything ready to put together, in a handsome "take-me-with-you-looking" box. **\$21.75**
LIST

Buy now for the holidays

Write or wire for discount on radio's "best seller"

Also a complete line of parts

SPECIALTY SERVICE COMPANY

Cor. 4th Ave. and Pacific St.

Brooklyn, N. Y.

TRESCO RADIO

Licensed under Armstrong U. S. Patent 1,113,149

The alert dealer is looking for a receiving set which will establish him as a leader in his community—a set that will stay sold and require practically no service.

Tresco Regenerative Universal Receiving Set has been on the market for seven years and has proved a success in thousands of homes. Simple of operation—nothing to get out of order—unusual long distance receiving—it is no wonder that it was the sensation of the Chicago Radio Show.

Good reliable merchandise, backed by strong national advertising, makes Tresco an asset of no uncertain value to the dealer.

Write for discounts.



NOVO "B" Batteries



for Radio Outfits

NOISELESS—DEPENDABLE—GUARANTEED

All Sizes—Plain and Variable

22½, 45 and 105 Volts

Send for Catalogue and Discounts

NOVO MANUFACTURING CO.

424 W. 33rd St.
NEW YORK

531 So. Dearborn St.
CHICAGO



Radiphono Adapter - \$3.00

Add quality of tone and volume to your radio concerts

Designed for Edison, Victrola, Brunswick and other makes of phonographs. With this adapter you can eliminate distorted and metallic sounds and improve your receiving. This is a real adapter built along proper lines of a reproducing musical instrument. It gives better results than self-contained, expensive amplifying loud speakers.

Jobbers Communicate Dealers Ask Your Jobber

Manufactured by

Industrial Sales Engineering Co.

671 BROAD ST., NEWARK, N. J.

VOLIA
PRODUCTS

VARIOMO-COUPLER.....\$3.85 List
No taps, the only coupler with sharp primary tuning.

VARIOMETER.....\$3.25 List
Low distributed capacity, high range.

CRYSTAL SET.....\$8.50 List
Sharp tuning, triple range.

VACUUM TUBE SET.....\$29.00 List
Two circuit tuner, employing Vario-Coupler. Only one tuning adjustment.

Write for Trade Discounts

VOLTA ENGINEERING CO.

Tackawanna and Womrath Sts.
Frankford, Phila., Pa.

MANUFACTURERS OF

Receiving Sets Complete
Unites Mounted and Unmounted
Send for Description and Prices

RADIO OUTFITTING CORP.

Mfg. High Grade Radio Apparatus
410-412 East 34th St. New York, N. Y.

"MICROSTAT"

A Vernier Throughout its Range

\$1.50

LOUIS A. STAFF COMPANY

1755 Broadway New York

supplant them. It will make the best available to all, and public taste will become more critical. Higher standards will be demanded. There will be a beneficial evolution in which the inferior and mediocre will be eliminated. These results seem reasonable in what might be called the natural development of radio, but no one will place limitations on the ultimate possibilities, because radio has already proved that fact is far stranger than fiction.

The subject is admittedly one of international and world-wide importance. Wave lengths are being assigned for various classes of communication. There are wave lengths for market and weather reports, and for music and general broadcasting. Undoubtedly we will have additional assignments for local news, for advertising, for educational programs, church services, theatrical production and various additional kinds of broadcasting as they develop.

No great stretch of the imagination is required to suggest an international broadcasting station from which announcements of great international or universal importance might be made on a designated wave length. What effect this might have on the old dream of a general and mutual understanding of all peoples and the adoption of a universal language, is a fertile field for the mental speculator. While fancy plays with these alluring thoughts, it is hoped that the power to speak so that thousands, or even millions, may hear, will give rise to a desire to say something worth while and to say it well. Radio broadcasting carries with it responsibility.

Senator Guglielmo Marconi, who has contributed so much to the history of radio, when he last visited Schenectady spoke to the American people at the broadcasting station. His generous appreciation of the progress made in this country and his firm faith in the future of radio are expressed in the following quotation from his address:

"Today I have had the privilege of visiting the works of the General Electric Company and have been truly amazed at the progress made by this great organization since the time of my last visit to Schenectady during the war five years ago. Speaking to persons interested in radio, I can truly say that the practical application and study of all branches of this new method of communication is being vigorously investigated by the engineers and scientists of the company."



**Why Ray-O-Vac
"B" Batteries
Are Never Noisy**

The active materials in each cell are moulded into a solid core under heavy pressure. Each cell is thoroughly insulated by a heavy, acid-proof, rubbery jacket and held absolutely rigid. Cells connected by flexible copper leads, hand soldered, insure perfect connections in spite of jars and bumps. Patent spring clip terminal makes perfect contact. Holds the smallest wire without cutting or shearing.

These features, found only in Ray-O-Vac Batteries, eliminate receiving noises due to batteries. "Real value for our money" is the shopping cry of radio fans; and it will pay you to stock Ray-O-Vac B Batteries, already the choice of thousands of experienced users. Bulletin 225 is worth having. Send for it.

French Battery & Carbon Co.

Madison, Wisconsin

Chicago Dallas Atlanta New York
Denver Minneapolis Kansas City



French RAY-O-VAC
"B" Batteries

Ask Our Service Bureau

LOUD SPEAKER FOR ANY CRYSTAL SET



By using the
**STEINMETZ
AMPLIFIER \$8.50
NO STORAGE
BATTERY REQUIRED**
Amplifying unit uses a Westinghouse Tube which requires only a single dry cell in place of the storage battery. Tube and batteries for this unit \$7.95. For a two stage amplifier use two of these units. Amplifying unit sold knocked down for \$5.95.
SUPERIOR CRYSTAL SET, \$4.75.
STEINMETZ PHONES are of exceptional merit.

2,000 Ohms \$5.00, 3,000 Ohms \$6.50, single phones \$1.75. Equal to any ten or twelve dollar phones made.

Catalogue 5c at your dealers or
STEINMETZ WIRELESS MFG. CO.,
5706 Penn Ave., Pittsburgh, Pa.

Importing Agents May Register Trade-Marks

(Continued from page 42)

import the genuine product provided they are able to obtain it from other sources than the actual producer. Thus, where B in the United States has the exclusive agency here for the trade-marked products of A, located in France, there is nothing to prevent F, also in the United States, from purchasing and importing these products from E in Germany, who may have purchased them in turn from A or from D, a middleman in France, who purchased them from A.

To partially cure this situation, there has been inserted in the tariff act now in force a section which makes it unlawful to import foreign trade-marked merchandise where the trade-mark is owned and registered in the Patent Office here by an American citizen, firm or corporation, provided a record of such registration is on file in the Treasury Department, unless the consent of the registrant to the importation is obtained. Any merchandise imported in violation of this section becomes subject to seizure and forfeiture and persons dealing therein may be required to export or destroy the merchandise or remove or obliterate the trade-mark and be liable for triple damages and profits.

Those interested in the importation of foreign trade-marked merchandise or even in the handling of same should take steps to ascertain if the trade-mark is registered and if so to see that consent for importation is obtained. Exclusive agents for such merchandise would do well to acquire the rights to the trade-mark for this country, and to register the same in the Patent office and in the Treasury Department so as to protect such rights.

While this section will not materially help the exclusive agent who does not, as a part of his exclusive agency, acquire the right to the trade-mark in this country, it provides facilities for protecting exclusive importations not heretofore available.

RED SEAL CONTEST

The Manhattan Electrical Supply Co., Inc., 17 Park Place, New York, with branches in Chicago, St. Louis and San Francisco, has instituted a novel contest among radio enthusiasts and other users of batteries.

The contestants are required to give a second reason why the Red Seal dry battery, made by the Manhattan people, is best, the first reason being "because it is the all-purpose battery." Fifty-two prizes are offered.

STOP-LOOK-WRITE

DEALERS, JOBBERS AND MANUFACTURERS

Before placing orders, write us first and get samples and our big discount sheet.

Condensers	43-Plate.....	List \$3.50	Turney Head Sets.....	List \$6.50
"	23- "	2.75	Dials 3"75
"	11- "	2.25	Variometers	3.50
"	7- "	2.00	Variocouplers	3.50
"	3- "	1.50		

SPIRO BROTHERS, Manufacturers and Distributors
519 Real Estate Trust Building Philadelphia, Pa.

PRAMCO DUO - TECTOR

A Pramco Duo - Tector will outsell any \$1.00 Crystal Detector on the market.

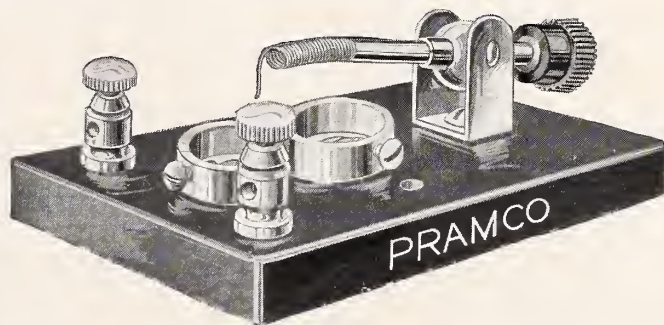

The two-cup arrangement allows a quick change from one crystal to another with very little interruption. It offers an opportunity to determine the relative value of different minerals under the same conditions.

All Metal Parts Standard Pramco Hand Polished and Plated

List \$1.00

LIBERAL DEALER AND JOBBER DISCOUNT

PREMIER RADIO MFG. CO.

1900 No. 6th St., Phila., Pa.

Ask Our Service Bureau

Trade-Marks Secure Trade Registrations Secure Trade-Marks
I Secure Registrations

CHAUNCEY P. CARTER

Radio Trade-Mark Specialist

4907 Potomac Avenue, N. W. Washington, D. C.

Correspondents in all countries

THE B-T VERNIER HAS NO EQUAL—CARRIED BY JOBBERS

FROM NEWFOUNDLAND TO SINGAPORE

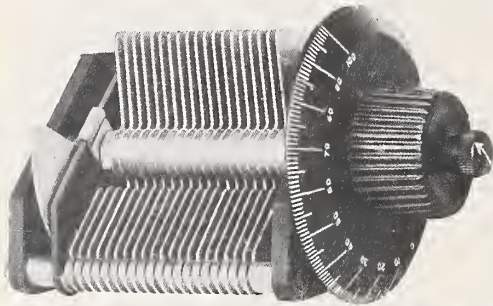

.00025, 11 pl. \$4.50
 .0005, 21 pl. 5.00
 .001, 41 pl. 6.00
 With 3-Inch SOLID DIAL.

DEALERS: Write us for name of nearest jobber.

BREMER-TULLY RADIO CO.
 Canal and Harrison Sts., CHICAGO

Western Office: 171 Second Street, SAN FRANCISCO
 Hawaiian Representatives: HAWAIIAN ELECTRIC CO., HONOLULU

ELECTRICAL TESTING

Of all materials entering into Radio Construction. Meters and apparatus calibrated and repaired.

**CHEMICAL ANALYSES
 STRENGTH TESTS**

Investigation or Development of New Apparatus and Materials. Routine Tests at Special Rates.

NEW YORK TESTING LABORATORIES

80 Washington Street

Bowling Green 7016



*Completely Assembled
 or Ready-To-Build.*

*Send for Circular of
 Capacities and Prices.*

**MARSHALL VARIABLE
 CONDENSERS**

Order Now For Christmas Business

NEW HAVEN RADIO CO., Mfrs., Chapel & Hamilton Sts., New Haven, Conn.

**A BIG HIT
 WITH THE RADIO TRADE**

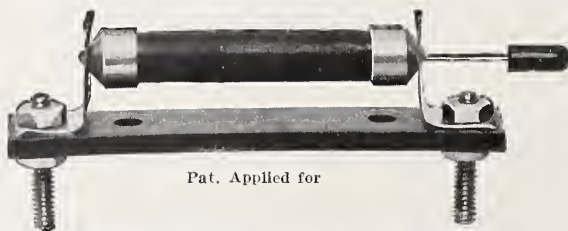

Pat. Applied for

The Durham Variable High Resistance (Adjustable Grid Leak)
 JUST VARY THE PLUNGER TO VARY THE RESISTANCE

Type 100—1000 to 100,000 Ohms Range
 Type 101—100,000 to 5 Megohms "

Price \$.75 Base \$.40

DURHAM & COMPANY, Inc. Radio Engineers
 1936 Market Street, Philadelphia, Pa.

TIMMONS TALKER

A new loud speaker with adjustable amplification, and differing widely in design from any of the previously existing types on the market, has been offered the radio trade recently by J. S. Timmons, of Philadelphia.

The Timmons Talker, as it has been named, is a square cabinet with a screen covering its face. In the center of this screen is a knob which controls the volume of sound produced by the amplifier. The amplifier is attached to the instrument simply by a pair of phone cords, and can be installed and regulated by a child. The instrument is contained in a handsome solid mahogany case. No batteries are necessary.

IN BUSINESS TO PLEASE

J. H. Leech, who operates the Wickley Service Station at Henry, Ill., is in the radio business with the slogan, "Satisfaction." He stocks Amrad sets and parts and the Magnavox loud speakers.

STATEMENT OF THE OWNERSHIP, MANAGEMENT, CIRCULATION, ETC., REQUIRED BY THE ACT OF CONGRESS OF AUGUST 24, 1912.

Of the Radio Dealer, published monthly at New York, N. Y., for October 1, 1922.

State of New York } ss.:
 County of New York }

Before me, a Notary Public in and for the State and County aforesaid, personally appeared Harry M. Konwiser, who, having been duly sworn according to law, deposes and says that he is the Publisher of the Radio Dealer, and that the following is, to the best of his knowledge and belief, a true statement of the ownership, management, etc., of the aforesaid publication for the date shown in the above caption, required by the Act of August 24, 1912, embodied in section 443, Postal Laws and Regulations.

1. That the names and addresses of the publisher, editor, managing editor and business managers are:

Publisher, Harry M. Konwiser, 1133 Broadway, New York City. Editor, Bernard J. Farrell, 1133 Broadway, New York City. Managing Editor, none. Business manager, Laurence A. Nixon, 1133 Broadway, New York City.

2. That the owners are: Radio Dealer Co., 1133 Broadway, New York City; Harry M. Konwiser, 1133 Broadway, New York City; Laurence A. Nixon, 1133 Broadway, New York City.

3. That the known bondholders, mortgagees, and other security holders owning or holding 1 per cent. or more of total amount of bonds, mortgages, or other securities are: None.

4. That the two paragraphs next above giving the names of the owners, stockholders, and security holders, if any, contain not only the list of stockholders and security holders as they appear upon the books of the company, but also, in cases where the stockholder or security holder appears upon the books of the company as trustee or in any other fiduciary relation, the name of the person or corporation for whom such trustee is acting, is given; also that the said two paragraphs contain statements embracing affiant's full knowledge and belief as to the circumstances and conditions under which stockholders and security holders who do not appear upon the books of the company as trustees, hold stock and securities in a capacity other than that of a bona fide owner; and this affiant has no reason to believe that any other person, association or corporation has any interest direct or indirect in the said stock, bonds, or other securities than as so stated by him.

5. That the average number of copies of each publication sold or distributed, through the mails or otherwise, to paid subscribers during the six months preceding the date shown is: Not required.

HARRY M. KONWISER, Publisher.
 Sworn and subscribed before me this 25th day of September, 1922.

(Seal) M. J. KLEIN.
 (My Commission expires March 30, 1924)

THIS IS A RADIO CHRISTMAS!

Manufacturer Analyzes Trade Conditions

(Continued from page 45)

Manufacturer is concerned. Such a condition of affairs is to be expected in sparsely populated territories such as Arizona, Wyoming and Idaho and also in sections where the broadcasting is inferior as in Arkansas and Louisiana.

However, the showing made by Georgia, with its high-powered broadcasting station at Atlanta, is rather discouraging. In fact none of the Southern states appear to be particularly enthusiastic about radio. It is possible that this may be due to poor business conditions and low purchasing power in that section of the country.

Judging from the New York state inquiries, it would appear that this state has passed through a period of decreasing interest during the last month but that it is once more on the up-grade with indications of extremely satisfactory radio business. Illinois also experienced a decline in interest during the same time but showed even a greater revival. In like manner Pennsylvania showed a slump with a rapid rise in interest in the last week. It should be noted that the slump in inquiries was followed by a falling off in orders from these sections, while renewal of heavy inquiries was accompanied by substantial orders.

Falling off of inquiries seem to indicate a declining interest in Iowa, Kansas, Wisconsin, New Jersey, Ken-

THE GENUINE AND GUARANTEED "ALL WAVE" COUPLER

TRADE-MARK
FLAT AND BANKWOUND

WAVE LENGTH—150 to 3000 Meters

ELIMINATES all Variometers, Variocouplers and Loading Coils
PREPARES for the higher wave lengths that have been and will be allotted. **BUILDS** a set that cannot become obsolete.

THOUSANDS of satisfied users
BEWARE OF IMITATIONS—Look for the Trademark "All Wave" on the Rotor and the six efficient hookups in the box

UNUSUAL RESULTS ATTAINED—Individual users of the "ALL WAVE" Coupler have written us that in Rhode Island it is nothing unusual to bring in stations as far south as Havana, Cuba, while in Mobile, Alabama, Newark, N. J., is brought in daily.

PRICE \$9.00

Guaranteed with an Absolute Money-Back Guarantee

Write for Literature and Display Signs



Patents granted and pending

CAPITOL PHONO-LIER CORPORATION, 56 Lafayette St., N. Y.

JEWELL VARIO COUPLER

Sell More Popular Price Couplers

Positive Connections
Positive Results

ROTORS SET LOW IN STATORS

WE MAKE OTHER STYLES TO 3000 METERS

DEALERS—JOBBER—AGENTS
PLEASE WRITE FOR DISCOUNTS

MANUFACTURED BY



\$1.25 List

400 meters, 3" rotor, tested stator, 21 s. c. wire, 1/4" aluminum shaft, 14 taps, pigtails.



\$2.50 List

600 meters, 3 1/4" rotor, composition stator, 24 d. c. wire, 1/4" brass shaft, pigtails, 14 taps, brass uprights.

JEWELL RADIO SALES CO. 90 West St., New York

Ask Our Service Bureau

MUSIO New Radio Discovery

\$12.50

Retail



Perfection Clarity

Range Beauty

Improved, Perfected Crystal Detector
Sensation of Radio World.

Includes complete antenna equipment
Immediate Deliveries

Microphones \$5.00. Every set guaranteed an \$8.00 value

DISTRIBUTORS

American Electro Phone Company, Inc.
NEW YORK

512 Fifth Avenue

Longacre 3552

We handle a complete line of first class radio sets and accessories



35c. each. 3 for \$1.00

Na-ald GENUINE CONDENSITE DIAL

The Dial that Runs True

Numerals engraved on bevel and knob so shaped that fingers do not hide them. Thin edge with clear graduation to make accurate reading easy. Concealed set screw in metal insert. Will not warp or chip. Finish and enamel permanent. Low price with this quality possible only through quantity production.

Special dealer and jobber proposition. An opportunity.

ALDEN-NAPIER CO.

52 Willow St. Dept. J Springfield, Mass.

SURPLUS RADIO STOCKS
SLOW MOVING
CONVERTED INTO

QUICK—IMMEDIATE—CASH

Small lots just as desirable as large quantities. Radio Market conditions justify turning of overstocks into Cash and thereby releasing tied up Capital for new and profitable use. Don't wait until everybody else considers unloading at the same time. **ACT NOW**

WRITE—WIRE—PHONE—OR CALL. State in detail, the items, quantity of each and lowest price acceptable.

THE R - C OUTLET

EXECUTIVE OFFICES

30 E. 23rd STREET NEW YORK CITY

Phones { Ashland 1109
Gramercy 1586-1587

MANUFACTURERS

OF RELIABLE RADIO EQUIPMENT WHO DESIRE HIGH-CLASS REPRESENTATION THRU-OUT TEXAS AND THE SOUTHWEST ARE INVITED TO SUBMIT SAMPLES AND FULL PARTICULARS IN FIRST LETTER.

UNLESS YOU HAVE CONFIDENCE IN YOUR PRODUCT AND ARE WILLING TO SUBMIT IT FOR SEVERE LABORATORY TESTS, DON'T WASTE YOUR TIME AND OURS.

MONARCH RADIO LABORATORIES

1513 1/2 Main St. Dallas, Texas



Dealers All Over the Country Handle Our **STANDARD RADIO GOODS**

OUR TRADE PRICES AFFORD GOOD MARGIN

Write for catalogue and price list

WIENER WIRELESS SPECIALTY COMPANY

21 ACADEMY ST. NEWARK NEW JERSEY

tucky, Oklahoma, California and District of Columbia. In Iowa, Kansas, Wisconsin and New Jersey it is probable that the next few weeks will show the same revival of interest which has already been indicated in New York, Illinois and Pennsylvania. The poor results shown in California may be due in this particular case to the presence of local competition and the distance of this manufacturer from the market.

Minnesota shows extremely healthy signs each week bringing in more and more inquiries. However, orders from this section have not as yet come up to expectations and this would tend to show that the manufacturer was not being properly represented in this territory by his jobbers. Indiana, Missouri and Massachusetts show some improvement.

From the total inquiries it can be seen that the interest in radio throughout the country has passed through a period of slight decline between October 30 and November 11 followed in the next week by a sudden upward jump. It is most likely that there will now be a steadily increasing interest indicated not only by the inquiries but by heavily increasing orders.

It should be remembered that the inquiries shown during the period of the above chart have not been affected by the Christmas demand. Hence when this demand is added to the present increasing normal demand there is every reason to believe that a heavy radio business will be in evidence.

This does not mean that a boom will be experienced such as the radio industry passed through in the early spring but that there will be a disappearance of hand-to-mouth ordering on the part of the jobbers and that the radio industry will be placed on a firmer basis with greater confidence in the future on the part of the manufacturer, jobber and dealer.

KEEPING A DAY AHEAD
of the headlines of tomorrow's newspapers!
That's what radio enthusiasts everywhere want to do! They're not completely satisfied with the regular broadcasted programs! They want to get the most out of radio!

Live Dealers are extending sales by stocking the **FINCH RADIO RELAY** which automatically receives any desired code message and makes a permanent record of it on a paper tape with unerring accuracy.

Write for Proposition RD12

FINCH RADIO MFG. CO.
303 FIFTH AVE., N.Y. CITY.

SUPERIOR PRODUCTS

The Rolls Royce of Radio

Starting Announcement in January Radio Dealer
SUPERIOR PRODUCTS MFG. CORP.
1080 Springfield Ave., Newark, N. J.

Continental Elec. Co.

119 East 129 St., N. Y.

COMPLETE LINE OF PARTS

Write for Catalog

NULOID

Scientific Chemical Compound for Radio Parts and Panels

NULOID CORPORATION

119 Chambers St. New York

"Better Than The Best"

AERIAL-A

The Radio Tube Set That Made Good in a Night

W.E. Supply & Service Corp. 18 Murray St., N.Y., U.S.A.

GREGG & COMPANY

ENGINEERS

Radio Department

165 Broadway New York
St. Louis, Mo. Washington, D. C.
Newark, N. J. Los Angeles, Cal.
Mexico City, Mexico

QUALITY-PLUS

INSTRUMENTS



Types 711; 711A

THE **HOME Radiophone Receiver**

Single Tube Set

Type 711, Wave length 150-2600 meters \$35

Type 711A, Wave length 150-800 meters \$28

Awarded Certificate of Excellence

Dealers! Jobbers! Distributors!
See Our Exhibit at the Radio Fair
Hotel Imperial, New York City

ARROW RADIO CO.

Manufacturers of Quality Plus Instruments

Hackensack New Jersey

MULTI-TERMINAL PLUG

A telephone plug that can accommodate six pairs of receivers is being featured by the Howard Radio Company, of Chicago. This new multi-terminal plug permits of nine connections by means of which any number of headsets up to six can be hooked up. The device is simple in appearance and operation. Operation is obtained by inserting the tips of the head phones in holes in the plug provided for the purpose.

Standard 2,000 and 3,000 ohm receivers are recommended for use with the Multi-Terminal telephone plug. The list price is \$2.00. The Howard Radio Company are also makers of rheostats, potentiometers, inductance switches, binding posts, grid condensers and leaks, and other products.

DARBY LEAVES MYDAR

The Mydar Radio Company has announced the resignation of W. Lee Darby as vice-president and manager of their mid-western sales department on November 15th. Mr. Darby has disposed of his entire interests in the Mydar company and is no longer connected with it.

"ETHEROLA"

**AERIAL
EQUALIZER TUBES
AND
GROUND
SEPARATOR TUBES**

Replaces Long Wire Aerials and Water Pipe or Other Grounds.

USED INDOOR OR OUTDOOR

**TO DEALERS
JOBBERs**

Demonstrate a Set and Get the Biz. Selling Rapidly Wherever Shown.

Assist you greatly in sale of high grade Receiving Sets

**GET YOUR TERRITORY
QUICK**

Write us now. Results guaranteed

**THE ETHEROLA
CORPORATION**

6216 Broad Street
PITTSBURGH, PENNA.

SALESMEN that have been or are calling on electric and radio trade. See Mr. Rice, 6311 N. St., Chicago.



In lots of 100,
\$3.50 each. In
smaller lots,
\$4.00 each.

Retail prices
optional, so that
special sales
may be held.

A superior receiving set with a vocal and musical range of from 38 to 45 miles—code range, 150 to 200 miles

MAHOGANY CASE, BAKELITE PANELS, NICKEL FIXTURES
8½" COIL AND TWO-SLIDE TUNER

STANDARD PRODUCTS CO.

93 WILSEY STREET

NEWARK, N. J.

Dealers who want strictly high class quality
Radio Sets and Equipment,
we can serve you.

Distributors: General Radio Corp., King Quality,
Dubilier Condenser and Radio Corporation,
De Witt - La France Co. *All Guaranteed Lines.*

INVINCIBLE PRODUCTS CO., Inc.

159 N. State St.

Phone: Dearborn 2638

Chicago, Ill.

Recommended for Reliability

RADIO STORES CORP.
VARIABLE CONDENSERS—
PLUGS—RESISTANCE UNITS, ETC.
222 West 34th Street, New York

Wang That's STATIC.
Take it Out with our
VERNIER CONDENSERS
Bang That's another Station
coming in. DITTO
ELECTRIC PRODUCTS CO.
11 Pemberton Sq. Boston, Mass.

Binding Posts—Contact Points

Knock-down Detector Sets

**VARIABLE
CONDENSERS**

with patented adjustable tension

JOHN A. COZZONE & CO.

61 Arlington Street

Newark, N. J.



Publicity and Its Effect on Market for Radio Securities

By FRANK R. STANTON
Radio Stock Specialist

Never before has an industry been denied the opportunity to be financed by public participation as radio. With the overnight popularity of radio, chambers of commerce issued circulars, letters, etc., and in addressing communities, warned against placing money in radio concerns. Newspapers took up the cry and followed along. The statements made and articles issued had a bad effect on all attempted legitimate financing.

True, there were unscrupulous stock promoters offering stock, but the desire to protect investors, while a very commendable move, created considerable skepticism towards the industry. The result was that the legitimate promotion and the already established concerns, found themselves unable to raise capital, which was diverted into other channels.

During this stage, the radio boom reached its highest point. Many manufacturers were unable to participate because of those conditions. Additional funds were required to increase facilities and purchase materials then selling at high prices. Also in distributing the goods, they had to give the trade from 30 to 90 days credit, which involved enormous sums of money. Those who were fortunate

enough to have obtained sufficient capital, took advantage of conditions while the average small concern was compelled to assume a waiting attitude.

The same condition prevails today. There are many legitimate companies that require capital for expansion of facilities, but are unable to interest the public.

QUOTATIONS

Stock	Bid.	Asked.
All American Cables.....	\$118	\$120
Amer. Tel. & Cable.....	61½	63½
Amer. Marconi Stamped....	5c.	20c.
Amer. Marconi Unstamped..	6	8
Amer. Tel. & Tel.	123	124
Baldwin Radio Corp.	5	8
Canadian Marconi	2¼	3
De Forest Radio	8	11
English Marconi com.	11½	14½
English Marconi pfd.	11	14
Federal Tel. Co. (Calif.)...	6¾	7¼
Federal Tel. & Tel. (N. Y.)	9	13
General Electric	173	174
Internat. Tel. & Tel.	57	63
Mackay Co. com.	102½	103½
Manhattan Elec. Supply....	52	53
Marconi Int. Marine.....	7	9
N. Y. Tel. 6½% pfd.	110	111
Radio Corporation com.	4	4½

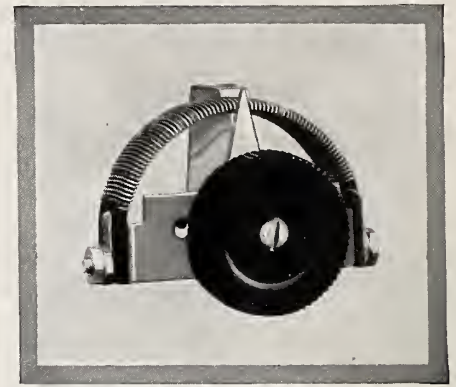

A BETTER RHEOSTAT

A nicer looking, smoother working and better made rheostat than you have ever seen before.

Furnished with or without vernier this instrument will improve the operation of any radio equipment.

The many valuable features coupled with national advertising make this an instrument every dealer and jobber should stock—liberal discounts give ample margin of profit and low list means quick turnover. Order now.

List Prices
123A Plain..... 80c
Type 123B Vernier..... \$1.40

THE WILCOX LABORATORIES
LANSING MICHIGAN

Radio Corporation pfd.	3	3½
Reynolds Spring	12	15
Spanish Marconi	1½	3
Western Union	110	111
Westinghouse E. & M.	58	59

Detailed information on any of the above stocks will be furnished free upon request.

R-C CABINETS

R-C Line—Bass—Mahogany Finish—
Hinged Top

Panel Size	Net Trade Price
7 x 10.....	\$1.25
7 x 14.....	1.50
7 x 18.....	1.65
7 x 21.....	1.75

Radio Cabinets of every description, size and style.
Removable Base Cabinets. Also new feature cabinets not requiring drilling or screws for attaching panels.
Solid Mahogany, Hand Rubbed and Piano Finish

THE R-C MILLS, Not Inc.

Executive Offices:
30 E. 23 St., New York City

SEABOARD

SPECIAL VALUES OF

23 Plate Variable Condensers.
Radion top and bottom plates.

Wholesale prices.	
In quantities of 100.....	\$1.25 each
200.....	1.15 "
500.....	1.10 "

Packed in handsome individual labelled boxes.

Jobbers and Distributors

Write for Our Proposition

SEABOARD RADIO CORPORATION
266 GRAND STREET, NEW YORK CITY
Phone Orehard 9156

"If a man can write a better book, preach a better sermon, or make a better mouse trap than his neighbor, though he build his house in the woods, the world will make a beaten path to his door."—EMERSON.

We have organized a better service to the retailer, "CSE" Service,—and the trade is making a path to our door. Why not join in and let us help you to larger radio business.

"CSE" Service is controlled by men of many years' experience in radio merchandising whose experience is at your service without additional cost.

To the trade in the Central States, we can offer the most comprehensive service—Engineering—Sales—Merchandising—of any organization. It will pay you to get in line with "CSE."

Central States Engineering Company

224 No. Halsted Street

Chicago, Illinois

LIST OF ADVERTISERS

(Advertisements Indexed by Products will be found on Pages 96 and 97 of this issue.)

A		F		McKenna Brass & Mfg. Co... 78	Rocco, George 84
Adams-Morgan Co..... 9		Fallgatter, Marvin B..... 80		Mercury Radio Products Co. 62	Ross-Gould Co..... 82
Aerex Radiophone Corp..... 64		Federal Institute of Radio Telegraphy 25		Metropolitan Radio Corp..... 59	Royal Electric Laboratories.. 11
Ajax Radio Corp..... 62		Federal Radio & Electric Co. 60		Mica Insulator Co..... 28	Rusonite Products Corp..... 74
Alden-Napier Co.....76, 91		Federal Telephone & Teleg. Co. 4		Mibo Co., The..... 78	
Allied Engineering Institute.. 23		Finch Radio Mfg. Co..... 92		Milliken Bros. Mfg. Co., Inc. 75	S
Allen-Bradley Co..... 83		Fischer & Co., G. H..... 62		Mills, R. C., The.....91, 94	Save Sales Co..... 32
American Electro Phone Co.. 91		Foote Mineral Co..... 78		Mills Radio & Electric Co.... 68	Scheib Elec. Radio Co..... 54
American Hard Rubber Co.. 67		Ford Mica Co., Inc..... 85		Mitchell-Rand Mfg. Co..... 74	Schwab, Harold M., Inc..... 74
American Radio Exposition Co. 3		Freed-Eisemann Radio Corp.. 74		Monach Radio Laboratories.. 92	Seaboard Radio Corporation.. 94
American Radio & Elec. Co. 74		French Battery & Carbon Co. 88		M. P. M. Sales Co..... 73	Shamrock Radio Co..... 74
Andrae & Sons Co., Julius... 76		Freshman Co., Inc., Chas... 62		Mu-Rad Laboratories, Inc.... 19	Signal Radio & Elec. Corp.. 12
Arrow Radio Co.....70, 92		Frost, Herbert H..... 10		Mydar Radio Corp., The..... 14	Specialty Service Co..... 87
Astorloid Mfg. Co., Inc..... 57					Spiro Brothers 89
Atlantic - Pacific Radio Supp- lies Co.....Inside Back Cover		G		N	S. S. Novelty Co..... 56
Atwater Kent Mfg. Co..... 55.		Galena Crystal Mfg. Co..... 78		National Fibre & Insulation Co. 54	Staff Co., Louis A..... 88
Automatic Electrical Devices Co. 8		General Merchandise Co..... 70		New Haven Radio Co..... 90	Standard Appliance Mfg. Corp. 86
		Gilbert Co., The A. C..... 72		New York Coil Co..... 5	Standard Crystal Co..... 77
B		Goetz Co., The Edw. J..... 76		New York Hard Rubber Turn- ing Co..... 76	Standard Products Co..... 93
Bayley Condenser Co..... 66		Gould Storage Battery Co.... 76		New York Itadio Dial Co.... 78	Stanton Co., Frank T..... 82
Bershaw Radio Mfg. Co..... 68		Gregg & Co..... 92		New York Testing Labora- tories 90	States Electric Co..... 64
Boone Mfg. Co., J. T..... 81				Novo Manufacturing Co..... 87	Steinmetz Wireless Mfg. Co.. 88
Bremer-Tully Radio Co..... 90		H		Nuloid Corporation 92	Superior Products Mfg. Corp. 92
Briggs & Stratton Co..... 15		Hafner Manufacturing Co.... 72			
Bristol Co., The..... 10		Harris Laboratory, The..... 82		O	Tait-Knob-And Dial Co..... 28
		Heinemann Electric Co..... 63		Orange Research Lab.....78, 86	T. B. H. Corporation 80
		Henley Publishing Co., The Norman W..... 78		Oranola Radio Corp..... 13	Thornton Transformer Co.... 74
		Holloway Elec. Supply Co., Inc. 80		Owen, Richard B..... 70	Thresher Radio Corp..... 58
		Hudson-Ross76, 82			Trade Circular Addressing Co. 78
		Hommell, Ludwig 29		P	Triangle Phono-Parts Co.... 53
		Hyman & Co., Inc., Henry... 69		Paramount Machine Co..... 74	Tresco Radio 87
				Parkin Mfg. Co..... 71	Triangle Radio Supply Co.... 60
		I		Pathé Phonograph & Radio Corp. 8	True-Tone Radio Mfg. Co.... 98
		Inter-Ocean Radio Corp..... 17		Permanent Radio Fair..... 73	
		Invincible Products Co., Inc., The 93		Pickens, F. D..... 79	U
		Industrial Sales Engineering Co. 88		Pittsburgh Radio & Appliance Co., Inc..... 86	United Mfg. & Distributing Co. 75
				Planet Radio Corp..... 70	U. S. Radio Co. of Penna., Inc. 73
		J		Post Electric Co..... 77	United Service Advertising.. 76
		Jackson, P. D..... 76		Poster & Co..... 56	United Specialties Co., Inc... 52
		Jewell Radio Sales Co..... 91		Premier Accessory & Specialty Corp. 64	Universal Stamping & Mfg. Co. 98
		Jewett Mfg. Corp..... 49		Premier Radio Mfg. Co..... 89	
		Joy-Kelsey Corp..... 76		Pruden, Frederick H..... 26	V
					V-De-Co Radio Mfg. Co..... 86
		K		Q	Victor Radio Corp..... 30
		Kern, Emil Alexander..... 74		Queens Radio Co., Inc..... 71	Viking Radio Co..... 76
		King Sewing Machine Co.... 22			Virginia Radio Corp..... 68
		Kramer Radio Co..... 76			Volta Engineering Co..... 88
				R	
		L		Radio Apparatus Co..... 86	W
		Lafax, Inc..... 56		Radio Distributing Co., Back Cover	W. E. Supply and Service.. Corp. 92
		Lewis & DeRoy Radio Corp.. 65		Radio Improvement Co..... 61	White Radio Co..... 74
				Radio Instrument Co..... 16	Wholesale Radio Equip. Co., Front Cover
		M		Radio Mica Products Co., Inside Front Cover	Wiener Wireless Specialty Co. 92
		Maclite Radio Co..... 82		Radio Outfitting Corporation. 88	Wilcox Laboratories 94
		Magna Instrument Co..... 7		Radio Products Mfg. Co..... 68	Wilmington Electrical Specialty Co., Inc..... 67
		Magnovox Co..... 51		Radiola Wireless Corp..... 76	Wilson, Inc., A. M..... 82
		Manhattan Storage Battery Co. 76		Radio Shop of Newark, The. 80	Wilson & Co., E. M..... 79
		Manufacturers Patent Co.... 76		Radio Stores Corp..... 93	Winkler, Inc., Chas..... 77
		Marle Engineering Co..... 81		Randel Wireless Co..... 85	
		Matthews, F. W..... 16		Rauland Mfg. Co..... 72	Z
				R-C Mills, The..... 94	Zeller Lacquer Mfg. Co., Inc.. 52
				R-C Outlet, The..... 91	Zwingenberger, Otto K..... 82

Where to Buy

A Handy Guide For the Convenience of Our Readers

"A" BATTERIES		COMPLETE LINE		Kramer Radio Co.....	76
Manhattan Storage Battery Co., Inc.	76	American Radio & Electric Co.....	74	New York Coil Co.....	5
AERIAL EQUALIZER TUBES		Adams-Morgan Co.....	9	Pittsburgh Radio & Appliance Co..	86
The Etherola Corp.....	93	Clapp Eastham Co.....	86	Pruden, Frederick H., Inc.....	26
AGENTS WANTED		Freed-Eisemann Radio Corp.....	74	Radio Distributing Co.....	Back Cover
Foote Mineral Co.....	78	Henry Hyman Co.....	69	Radio Shop of Newark, The.....	80
AMPLIFIERS		Gilbert Co., A. C.....	72	Specialty Service Co.....	87
Arrow Radio Co.....	70	Victor Radio Corp.....	30	Schwab, Harold M.....	74
Magnavox Co.....	51	COMPOSITION		Triangle Radio Supply Co.....	60
Save Sales Co.....	32	Diamond State Fibre Co.....	66	Virginia Radio Corp.....	68
Steinmetz Wireless Mfg. Co.....	88	Nuloid Corp.....	92	Weiner Wireless Specialty Co.....	92
AMPLIFIER UNITS		CONDENSERS		Wilmington Electrical Specialty Co., Inc.	67
Atwater Kent Mfg. Co.....	55	Bayley Condenser Co.....	66	Wholesale Radio Equipment Co.....	Front Cover
ANTENNA WIRE		European Radio Co.....	84	ELECTRICAL TESTING	
Copper Clad Steel Co.....	80	New Haven Radio Co.....	90	New York Testing Laboratories.....	90
APPARATUS FOR SALE		Scheib Elec. Radio Co.....	54	ELECTROTYPERS	
United Service Advertising.....	76	Thresher Radio Corp.....	58	Central Electrotpe Foundry Co.....	76
BATTERY CHARGERS		COUPLERS		ENGRAVING	
The Automatic Elec. Devices Co....	8	Capitol Phonolier Corp.....	91	Paramount Machine Co.....	74
"B" BATTERIES		CRYSTALS		EXPOSITIONS	
Gould Storage Battery Co.....	76	Galena Crystal Mfg. Co.....	78	American Radio Exposition Co.....	3
Novo Mfg. Co.....	87	Harris Laboratory.....	82	Permanent Radio Fair.....	73
BATTERIES		Radio Apparatus Co.....	86	FINISH	
Carbon Products Co.....	57	Rusonite Products Corp.....	74	Zeller Laquer Mfg. Co., Inc.....	52
Comet Battery Co.....	78	Standard Crystal Co.....	77	GRID LEAKS	
French Battery & Carbon Co.....	88	CRYSTAL DETECTORS		Durham & Co.....	90
BATTERY TESTERS		Continental Electric Co.....	92	Freshman Co., Inc., Chas.....	62
Chaslyn Co.....	78	Diamant Tool & Mfg. Co., Inc.....	76	HEAD SETS	
BESTONE PRODUCTS		M. P. M. Sales Co.....	73	Briggs & Stratton Co.....	15
Henry Hyman & Co., Inc.....	69	Premier Radio Mfg. Co.....	89	Dictograph Products Corp.....	4
BINDING POSTS		Randel Wireless Co.....	85	Mills Radio & Electric Co.....	68
The H. H. Eby Mfg. Co.....	83	CRYSTAL SETTING		Pruden, Fred. H.....	26
King Sewing Machine Co.....	22	Culin, Curtis C.....	76	Royal Electrical Laboratories.....	11
McKenna Brass & Mfg. Co.....	78	CRYSTAL SETS		Superior Products Mfg. Co.....	92
BOOKS		Diamant Tool & Mfg. Co., Inc., Co..	76	HYDROMETERS	
Allied Engineering Institute.....	23	DIALS		Hafner Mfg. Co.....	72
Norman W. Henley Pub. Co.....	79	Alden-Napier Co.....	91	INFORMATION	
Lafax, Inc.....	56	New York Radio Dial Co.....	78	Service Bureau	18
CABINETS		DISTRIBUTORS		JACKS	
E. Eshoo Cabinet Works.....	82	American Electro Phone Co., Inc....	91	Radio Improvement Co.....	61
Marvin B. Fallgatter.....	80	Andrac & Sons Co., Julius.....	76	KNOBS & DIALS	
Miho Co., The.....	78	Arrow Radio Co.....	70, 92	King Sewing Machine Co.....	22
R-C Mills, The.....	94	Central States Engineering Co.....	94	Tait Knob & Dial Co.....	28
CABINET SETS		Electric Service Supplies Co.....	6	LIGHTNING ARRESTERS	
Heinemann Electric Co.....	63	Federal Radio & Electric Co.....	60	Electric Service Supplies Co.....	6
Oranola Radio Corporation.....	13	Frost, Herbert H.....	10	LOOP AERIALS	
COIL MOUNTINGS		General Merchandise Co.....	70	Eagle Radio Co.....	98
Astorloid Mfg. Co.....	57	Goetz Co., The Edw. J.....	76	Hudson-Ross	76
Crown Radio Mfg. Corp.....	12	Hudson-Ross	67	V-De-Co.	86
		Hommell, Ludwig.....	29		
		Invincible Products Co.....	93		
		Jackson, P. D.....	76		

SEE ALPHABETICAL INDEX OF ADVERTISERS ON PAGE 95

THIS IS A RADIO CHRISTMAS!

Where to Buy

A Handy Guide for the Convenience of Our Readers

LOUD SPEAKERS		RECEIVING SETS		TESTING LABORATORIES		
Bristol Co., The.....	10	Atlantic-Pacific Radio Supplies Co.	Inside Back Cover	Gregg & Co.....	92	
Dictograph Products Corp.....	4	Arrow Radio Co.....	92	N. Y. Testing Laboratories.....	90	
Inter-Ocean Radio Corp.....	17	Aerex Radiophone Co.....	64	TOWERS		
Magnavox Co., The.....	51	Caragol-Clarke Co., Inc.....	22	Milliken Bros. Mfg. Co., Inc.....	75	
Pathé Phonograph & Radio Corp.....	8	Coraco Co., The.....	72	TRADE MARKS		
Planet Radio Corp.....	70	Eagle Radio Co.....	98	Carter, Chauncey P.....	89	
Triangle Phono-Parts Co.....	53	E-D Mfg. Co., The.....	21	TRANSFORMERS		
States Electric Co.....	64	Federal Tel. & Teleg. Co.....	4	Boone Mfg. Co., J. T.....	78	
MAILING LISTS		Holloway Elec. Supply Co., Inc.....	80	Fed'l Institute of Radio Telegraphy.....	25	
Pickens, F. D.....	79	Jewett Mfg. Co.....	49	Ford Mica Co.....	85	
Ross-Gould Co.....	82	Joy-Kelsey Corp.....	76	Marle Engineering Co.....	81	
Trade Circular Addressing Co.....	78	Lewis & DeRoy Radio Corp.....	65	Radio Instrument Co.....	16	
MERCHANDISE WANTED		Matthews, F. W.....	16	Rauland Mfg. Co.....	72	
R-C Outlet, The.....	91	Mercury Radio Products Co.....	62	Thornton Transformer Co.....	74	
MICA		Metropolitan Radio Corp.....	59	United Mfg. & Distributing Co.....	75	
Mica Insulator Co.....	28	Mu-Rad Laboratories, Inc.....	19	TUBES		
MICA DIAPHRAGMS		Oranola Radio Corp.....	13	Hudson-Ross	76	
Radio Mica Products Co.....	Inside Front Cover	Radio Outfitting Corp.....	88	TUNING COILS		
PANELS		Save-Sales Corp.....	32	Bershaw Radio & Mfg. Co.....	68	
American Hard Rubber Co.....	67	Seaboard Radio Corp.....	94	UNIT TYPE SETS		
Continental Fibre Co., The.....	85	Signal Radio & Elec. Corp.....	12	Magna Instrument Co.....	7	
National Fibre & Insulation Co.....	54	Standard Products Co.....	93	V. T. SETS		
New York Hard Rubber Turning Co.	76	Tresco Radio.....	87	Queens Radio Co., Inc.....	71	
Pittsburgh Radio & Appliance Co...	86	United Specialties Co., Inc.....	52	VACUUM TUBE SOCKETS		
Poster & Co.....	55	U. S. Radio Co. of Penna., Inc.....	78	Alden-Napier Co.....	70	
PATENTS		Victor Radio Corp.....	30	VACUUM TUBE ADAPTER		
Kern, Emil Alexander.....	74	W. E. Supply & Service Corp.....	92	The Mydar Radio Co., Inc.....	14	
Owen, Richard B.....	70	Wilson & Co., E. M.....	79	VARIABLE CONDENSERS		
Manufacturers Patent Co.....	76	Winkler, Inc., Chas.....	77	Bayley Condenser Co.....	66	
Wilson, Inc., A. M.....	82	RHEOSTATS		Cozzone & Co., George A.....	93	
Zwingenberger, Otto K.....	82	Allen-Bradley Co.....	83	Radio Stores Corporation.....	93	
PHONES		Parkin Mfg. Co.....	71	Spiro Bros.....	89	
Hudson-Ross	82	Radiola Wireless Corp.....	76	Standard Appliance Mfg. Corp.....	80	
Mills Radio & Elec. Co.....	68	Staff Co., Louis A.....	88	Universal Stamping & Mfg. Co.....	98	
Premier Accessory & Specialty Corp.	64	Thresher Radio Corp.....	58	VARIO-COUPERS		
T-B-H Corporation.....	80	Wilcox Laboratories, The.....	94	Essex Mfg. Co.....	74	
True-Tone Radio Mfg. Co.....	98	SHIELDS		Jewell Radio Sales Co.....	91	
PLUGS		Orange Research Lab.....	86	Maclite Radio Co.....	82	
S. S. Novelty Co.....	56	SOCKET RHEOSTAT		Queens Radio Co., Inc.....	71	
RADIPHONO ADAPTER		Ajax Radio Corp.....	62	Shamrock Radio Co.....	74	
Industrial Sales Engineering Co.....	88	SOCKETS		Viking Radio Co.....	76	
RADIO EQUIPMENT WANTED		Rocco, George.....	84	VARIO WAVE TUNER		
Monarch Radio Laboratories.....	92	SOLDERING IRON		Fischer & Co., G. H.....	62	
RADIO RELAYS		Post Electric Co.....	77	VARIOMETERS		
Finch Radio Mfg. Co.....	92	SPAGHETTI TUBING		Eisemann Magneto Corp.....	24	
RADIO TOWERS		Mica Insulator Co.....	28	Radio Products Mfg. Co.....	68	
Milliken Bros. Mfg. Co., Inc.....	75	Mitchell-Rand Mfg. Co.....	74	Volta Engineering Co.....	88	
STOCK BROKERS		SPIDER-WEB COILS		VERNIER CONDENSERS		
STANTON & CO., FRANK T.....		82	Orange Research Laboratories.....	78	Bremer-Tully Radio Co.....	90
WIRE		STANTON & CO., FRANK T.....		82	Electric Products Co.....	93
WHITE RADIO CO.....		74	WIRE		WHITE RADIO CO.....	
WHITE RADIO CO.....		74	WHITE RADIO CO.....		WHITE RADIO CO.....	

SEE ALPHABETICAL INDEX OF ADVERTISERS ON PAGE 95

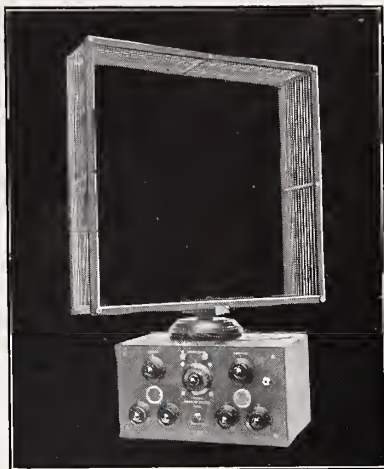

The PORTABLOOP RECEIVER

With a Baldwin Phone and a horn, loud enough volume is received for the home. No other amplifier is necessary

Mr. Dealer

WHY bother with outdoor aeri-als when the Portabloop Receiver can be demon-strated in the home with-out any loss of time?

Write for Discounts

We can make rush ship-ments.



210 Central Avenue

*Quick, Profitable
Turn-Over*

TRUE-TONE PHONES



"True-Tone"
SUPERSENSITIVE
3000 Ohms

Embody every factor of scientific Design. Perfection in Performance and Appearance.

\$5.00
LIST
3000
Ohms

Worth More, Yet, Cost Less. Backed By a Real Guarantee of Quality.
Maximum Wire Turns. Super-strength Tungsten Magnets. Noiseless Tinsel Cords. Mercerized finish. Web covered Comfort Head Band. Cups and Caps of lustrous Black Composition.

*"True Tone"
National Advertising
is behind You*

Clear and Loud

JOBBERS [*Write or wire—NOW—for
"True-Tone" Discounts
They are liberal*] **DEALERS**

TRUE TONE RADIO MFG. CO.
186 North La Salle Ave., CHICAGO, ILL.

Ask Our Service Bureau

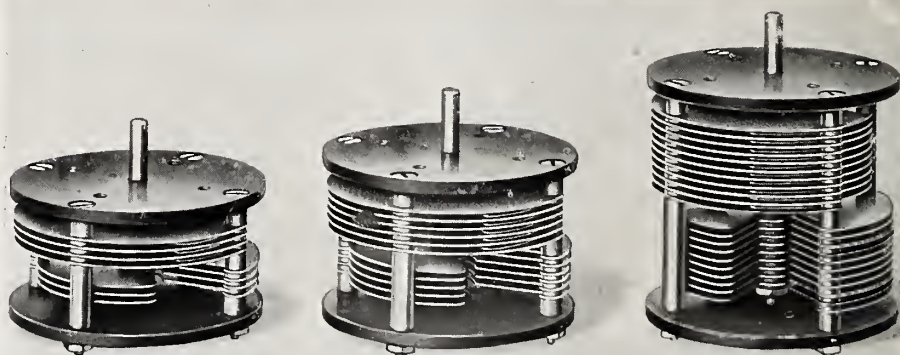

"Universal" Balanced Variable Condenser

All important mechanical and electrical features are embodied in the construction of the "Universal" Balanced Variable Condenser. The instrument is readily mounted on the back of panels and balanced. The "Universal" Balanced Variable Condenser is made in three sizes, as follows:

14 plates	—	.0003 M.F.	List Price, \$3.00
22 "	—	.0005 M.F.	" " 4.00
42 "	—	.001 M.F.	" " 5.00

Special discounts, according to quantity.

All condensers are guaranteed as to workmanship and material and tested before leaving factory.

Universal Stamping & Mfg. Co.
1925 South Western Ave., Chicago, Ill.

THIS IS A RADIO CHRISTMAS!

— for cottage or skyscraper!

This will be
A RADIO
CHRISTMAS

Christmas shoppers are going to buy radio apparatus this year, heaps of it, because A-P advertising has heralded the passing of barriers that have stood between radio and the masses. They know that from the *A-P quality line* they can now select sets so supremely simple anyone can operate them, so compact they are adapted for use in any location from the tiniest cottage to the tallest skyscraper, so efficient that broadcasted programs may be received from stations both far and near with perfect ease and clearness. For instance—

The Oard Phantom Receptor

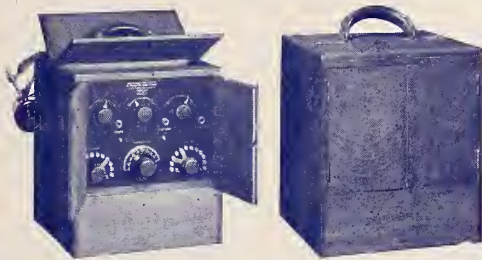

An A-P set so simple, compact, and complete within itself it can be used successfully in any location by any person who desires to receive radio programs or communications. It requires neither aerial nor ground connection. Efficient over both short and long distances. Highly selective.

Type AR-2 Receiver Detector and two-stage Amplifier

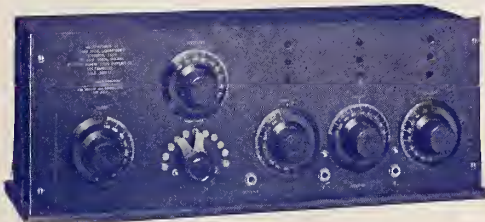

A beautiful regenerative set complete in a single cabinet. Combines ease of operation with marked sensitiveness and selectivity in action. Wave length, 175 to 2,000 meters.

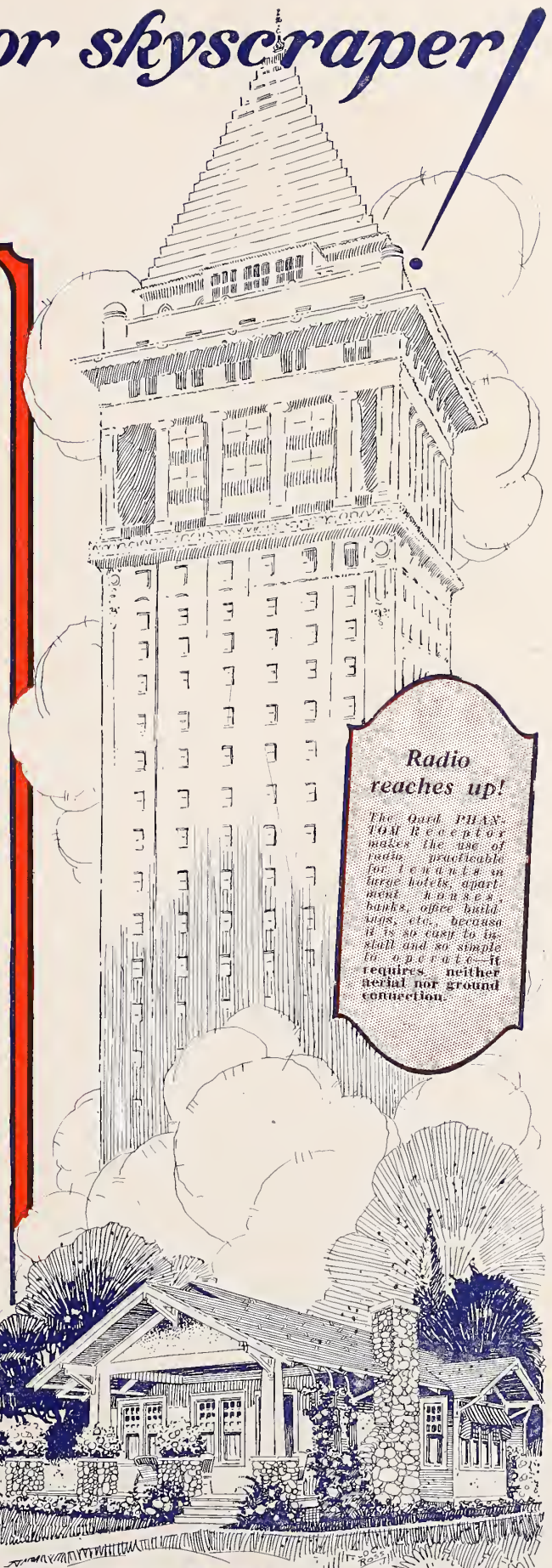

Radio reaches up!

The Oard PHANTOM Receptor makes the use of radio practicable for reception in large hotels, apartment houses, banks, office buildings, etc., because it is so easy to install and so simple to operate—it requires neither aerial nor ground connection.

If you want your share of this profitable Christmas business, don't wait to write, but wire Department "D" now for full particulars.

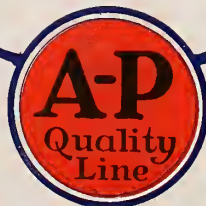

Atlantic-Pacific Radio Supplies Co.
646 Mission St. — San Francisco, Cal.

*"When You Think of Radio—
Think of Radisco"*

∴ ∴ ∴

Radisco means Service

Radisco has served thousands of radio dealers all over the country for several years.

∴ ∴ ∴

Special facilities enable Radisco to give good service and prices to radio dealers.

∴ ∴ ∴

This will be a radio Christmas for you if you are farsighted enough to order and get your stocks now.

∴ ∴ ∴

Remember—Radisco's ample stocks of Acme, Murdock, Radio Corporation, Clapp-Eastham, Brandes and many others are yet at your disposal.

∴ ∴ ∴

Get your stocks now—and cash in on the Holiday business.

Radio Distributing Company
8 West Park St., Newark, N. J.

A. H. CORWIN, General Manager

RADISCO

The RADIO DEALER

Vol. 2 No. 4 **JANUARY, 1923** One Dollar The Year

Published monthly at 1133 Broadway, New York, N. Y., by The Radio Dealer Company. Entered as Second Class Matter, at the Post Office at New York, N. Y., under the Act of March 3, 1879

Start the
New Year Right!
with

Standard Nationally Advertised Radio Merchandise

PROFIT by last year's experience. Make nationally advertised merchandise the keynote of your new merchandising policies. Branded goods need no pushing. The public demands them. They know their value—they are willing to pay for them. Branded goods involve no risk. They are certain sellers—they mean rapid turnover. The Wholesale Radio Equipment Company offer the latest lines of branded goods—it offers the best of service and absolute protection. Let us tell you more about our services. Drop us a card.



**Become an Authorized DeForest Dealer. Write for Contract.
Limited Number in Each Territory.**

A New Profit-Winner Burke Socket Adapter

The only adapter permitting the use of the 1½-volt W-D-11 tube in any standard open base socket **without raising the tube** or changing connections. As easy to insert in the socket as is the tube itself. Change from 6-volt to 1½-volt tube, or vice-versa, in a moment. Made of the finest materials, and fully guaranteed.

Packed Individually;
100 to a Case.

LIST PRICE, \$1.00
Write for Discounts.

Products of 22 or More Radio Manu-
facturers of National Importance

*Write TODAY for Attractive Discounts
on Complete Line.*

DISTRIBUTORS FOR

Acme
American Trans-
former
All Wave Coup-
lers
Baldwin
Bradleystat
Brandes
Chelsea
De Forest
Dubilier
Electrad
Eveready
Federal
Homcharger
Jefferson
Klosner
Magnavox
Murdock
Paragon
Radio Service
Laboratories
Thordarsen
Tuska
Western Electric

**WHOLESALE
ONLY**

Wholesale Radio Equipment Co.

24 WILLIAM STREET, NEWARK, N. J.

*List Price of
Red Seal Radio Sparkers*

No. 221-R 2 cell—\$1.00
No. 262-R 6 cell— 3.10
No. 282-R 8 cell— 4.00



It's New!

The Red Seal Radio Sparker

*A special Radio Dry
Battery for operating
the small WD-11
Vacuum Tubes*

THE makers of Red Seal Dry Batteries announce a special battery to operate the 1½ volt radio vacuum tubes.

At a nominal cost for adapters, 6 volt tube sets can be quickly and easily changed over to use dry battery tubes.

Radio Sparkers operating receiving sets equipped with these tubes are a great advancement in convenience and saving over the earlier type operated by a storage battery.

Radio Sparkers are light in weight and easy to handle. They are dry and clean with no injurious acid to spill. They will not scratch nor mar the finest table top.

Red Seal Radio Sparkers require no care or servicing—a great advantage to those living on farms or at points distant from battery charging stations.

The cost per hour of service rendered by a Red Seal Radio Sparker is much less than the cost per hour of service rendered by a storage battery, taking into consideration initial and recharging costs.

The individual special radio cells in Radio Sparkers are connected in parallel, and the actual operating life of the cells is increased from 2¾ to 2½ times the operating life of a single dry cell.

Red Seal Radio Sparkers are made in three different sizes to operate sets using from 1 to 4 WD-11 Vacuum Tubes. Complete wiring diagrams with instructions appear on the labels of each battery.

Everyone wants the convenience of this new method of operating tube receiving sets; therefore, Red Seal Radio Sparkers will be amongst the fastest selling merchandise in your radio stock.

Sparkers have to be renewed. This adds to the sales volume and the quick turnover increases your profit.

The radio season is at its height. Phone, wire, or write your jobber *today* for an assortment of Radio Sparkers. Every day's delay means lost sales.

M

MANHATTAN

ELECTRICAL SUPPLY Co. INC.

Makers of the famous Red Seal Dry Batteries and Manhattan Radio Telephone Sets

New York

Chicago

St. Louis

San Francisco

This shows how Celoron Radio Panels are wrapped, marked and numbered.



This shows reverse side of wrapping with full instructions for working and finishing Celoron Radio Panels

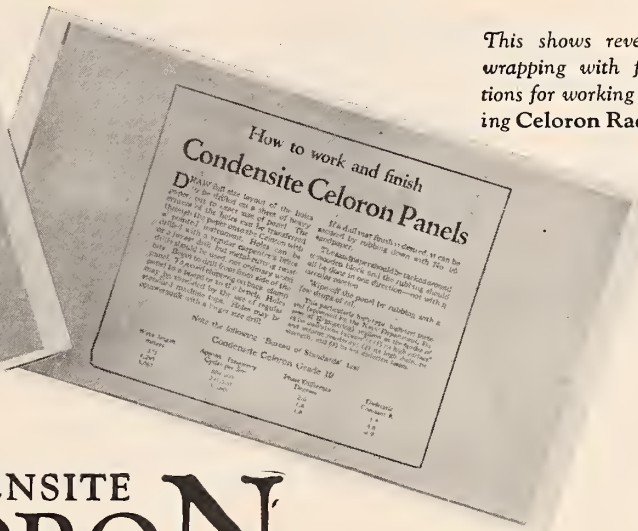

CONDENSITE CELORON

STANDARD SIZE RADIO PANELS

Panel No.	Size	Net Weight per Panel	List Price per Panel	Panel No.	Size	Net Weight per Panel	List Price per Panel
1	6 x 7 x 1-8	.2625 lbs.	\$.71	5	9 x 14 x 3-16	1.18 lbs.	\$2.71
2	7 x 9 x 1-8	.394 lbs.	1.00	6	7 x 21 x 3-16	1.38 lbs.	3.31
3	7 x 12 x 1-8	.525 lbs.	1.26	7	12 x 14 x 3-16	1.575 lbs.	3.39
4	7 x 18 x 3-16	1.18 lbs.	2.83	*8	7 x 46 x 3-16	3. lbs.	7.20

* This strip for cutting special sizes. Not wrapped in Glassine.
 * These prices are the list price to the Retail Trade and not the price to the consumer.

SUGGESTED STOCK ORDERS FOR RETAILERS

For your convenience we have made up two assortments of these panels after a very careful study of Dealer requirements, and can ship them immediately on receipt of your order.

ASSORTMENT No. 1

Quantity	Panel No.	Size	List Price	Total
20	1	6 x 7 x 1-8	\$.71	\$14.20
12	2	7 x 9 x 1-8	1.00	12.00
30	3	7 x 12 x 1-8	1.26	37.80
8	4	7 x 18 x 3-16	2.83	22.64
5	5	9 x 14 x 3-16	2.71	13.55
4	6	7 x 21 x 3-16	3.31	13.24
3	7	12 x 14 x 3-16	3.39	10.17
				\$123.60

ASSORTMENT No. 2

Quantity	Panel No.	Size	List Price	Total
10	1	6 x 7 x 1-8	\$.71	\$ 7.10
6	2	7 x 9 x 1-8	1.00	6.00
15	3	7 x 12 x 1-8	1.26	18.90
4	4	7 x 18 x 3-16	2.83	11.32
3	5	9 x 14 x 3-16	2.71	8.13
2	6	7 x 21 x 3-16	3.31	6.62
2	7	12 x 14 x 3-16	3.39	6.78
				\$64.85

These Prices subject to your regular Dealers Discount if billed thru your Jobber

Condensite Celoron is a particularly high type, high test material (approved by the Navy Dept. Bureau of Engineering and the U. S. Signal Corp) qualifies as the leader of radio insulations because of [1] its high surface and volume resistivity; [2] its high dielectric strength; and [3] its low dielectric losses.

We are now making it possible for you to sell Radio panels without the usual delay and extra cost of having panels cut to the order of your customers. These Radio panels are trimmed and wrapped in glassine to protect the surface, and are all ready to work and finish. The envelope is plainly marked to show number and size and has full instructions for working and finishing on the back.

Start your customer with a panel. Show him how to make his template and drill his board, and then sell him all the other parts to make a complete Radio set.



Diamond State Fibre Company

BRIDGEPORT (near Philadelphia) PENNSYLVANIA

BRANCH FACTORIES AND WAREHOUSES

BOSTON CHICAGO SAN FRANCISCO

Offices in Principal Cities

In Canada: Diamond State Fibre Company of Canada, Ltd., Toronto.

KING QUALITY
"Universal" Adapter, R-10 designed to fit all tubes and valves.

KING QUALITY
Rheostat, R-630 Resistance valve 6.5 ohms. Special Brass Panel Bushing insures smooth operation. Genuine Bakelite Base and Knob.

KING QUALITY
Vernier Rheostat, R-631 provides micrometer adjustment resistance. Superior construction assures perfect control.

KING QUALITY
ALL THE NAME IMPLIES
RADIO APPARATUS

QUALITY—so outstanding in appearance, in design, in workmanship, in servicability—that none dare deny its superiority.

Such a line as KING QUALITY any dealer may be proud to display and offer his customers as the Best on the market.

Increased sales and profits are the result of tying up with the KING QUALITY line. Write today to

RADIO APPARATUS DIVISION
King Sewing Machine Co., Buffalo, N. Y.
We maintain our own Bakelite Plant

THE - ONLY - KNOB - AND - DIAL - WITHOUT - A - SET - SCREW



The unsightly and troublesome SET-SCREW is at last eliminated. No more loosening of dials, splitting the head of the set-screw, or stripping of threads, perhaps ruining the dials.

To mount the TAIT KNOB AND DIAL simply hold the dial with one hand and screw on the knob with the other; a few seconds does it. No tools are necessary; when fastened it is self centering and self aligning. Numerals at correct angle for the best visibility.

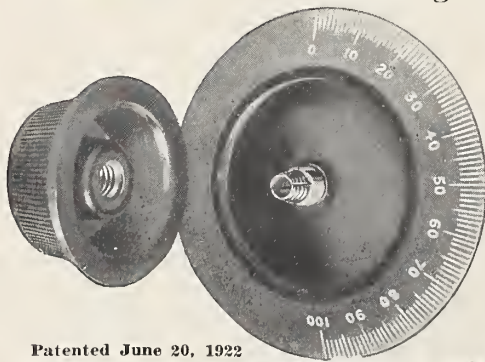

This beautifully patterned KNOB AND DIAL is made of the best grade of BAKELITE.

MANUFACTURERS—It will greatly beautify your receiving sets, also reduce your labor costs in assembly.

JOBBERS—This product is merchandized to the trade strictly through you. It sells on sight and is revolutionary in its field.

Patented June 20, 1922
Also Licensed Under Grebe Design Patent No. 57900

Dealers—write us and we will notify you of nearest jobber

List
Price
4 in.—\$1.50
3 in.—\$1.00

TAIT - KNOB - AND - DIAL - CO., Inc.

MANUFACTURERS

659 BERGEN AVENUE

NEW YORK

DON'T WASTE MONEY, TIME AND PATIENCE ON CHEAP IMPROPERLY DESIGNED RADIO PARTS.

Insist on getting NEW YORK COIL COMPANY'S Products, which insures entire satisfaction. Honestly priced, scientifically constructed and engineered to deliver the maximum results.

Each of the following articles are "thoroughbreds."

- | | | | | |
|------------------------|---|---|---|--------|
| STANDARD VARIOCOUPLER, | - | - | - | \$4.00 |
| STANDARD VARIOMETER, | - | - | - | 4.00 |

These items are large, full size *proven* products, the value of which is seen at a glance.

New York Coil Company's Variable Condensers have set a standard by which all others are judged. Plates are of extra heavy aluminum, accurately spaced. The frame work of the supporting elements is such that permanency results. Adjustable bearings with provision to take up wear and means for always insuring positive contact is provided.

Our 180 degree Variocoupler contains 50 turns No. 20 wire on primary, and 40 turns No. 22 wire on secondary, Bakelite tubing and pigtail connections. The best made and most efficient Coupler in existence\$4.50

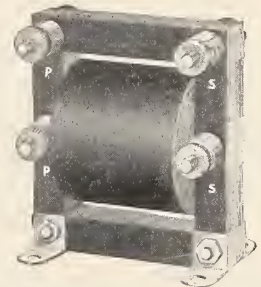
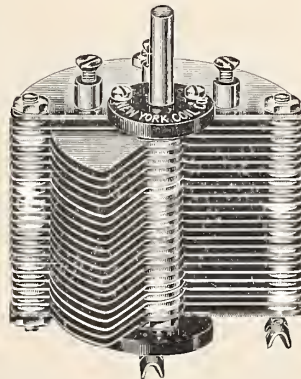

LIST PRICES:

- | | | | | | |
|-----------------|---|---|---|---|--------|
| 3 Plate Vernier | - | - | - | - | \$1.25 |
| 11 " | - | - | - | - | 1.50 |
| 23 " | - | - | - | - | 2.00 |
| 43 " | - | - | - | - | 3.00 |

AUDIO FREQUENCY TRANSFORMERS—Choice of leading manufacturers and radio engineers. Guaranteed to give high magnification, less distortion and better all round efficiency. No howling. Price \$4.00.



NEW YORK ENTERTAIN-A-PHONE RECEIVING SET No. 2—Complete with detector and two stages of amplification, all in one cabinet. Contains a non-regenerative two circuit hook-up with two stages audio amplification. Results are simply a revelation. It must be operated and heard to be appreciated. Workmanship and design and material of exceptional character throughout. Of unusual interest to the jobber. Price \$50.00, fully guaranteed.

NEW YORK COIL COMPANY, Inc.

338 Pearl Street

New York City, N. Y.

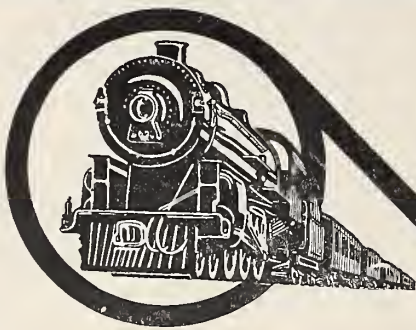

The Set That Grows

makes good on the

BROADWAY LIMITED

The unequalled success of the recent tryout of a stock E-D set on the world famous Broadway Limited has startled the radio world. Everyone is talking about it and wants such a set. This set, with its loop antenna confined in a steel car traveling at high speed, astonished and delighted its audience with its uniform clarity of tone and broadness of range, even under feedwires of 11,000 volts A. C.

This set is built in unit-panels so as to obtain uniform flexibility and efficiency. Each unit is individually shielded and is uniform in appearance. The amateur, by purchasing basic E-D panels is able to start with the same high-grade equipment used in the completed set, and because of this, from the very beginning can obtain more selectivity in tuning and broadness of range than found in other low priced sets.

Naturally, this has created a broad public demand for E-D equipment. It is fast becoming both a history and profit making line for dealers. The set is built by practical engineers in a plant that has a 25-year-old reputation.

We cordially invite you to write for all the intimate details of this uniquely successful set.

The E. D. Manufacturing Company

3303 Arch Street
PHILADELPHIA

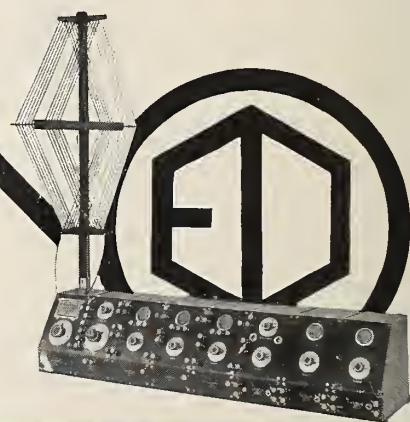

Cozzone Vernier Condenser

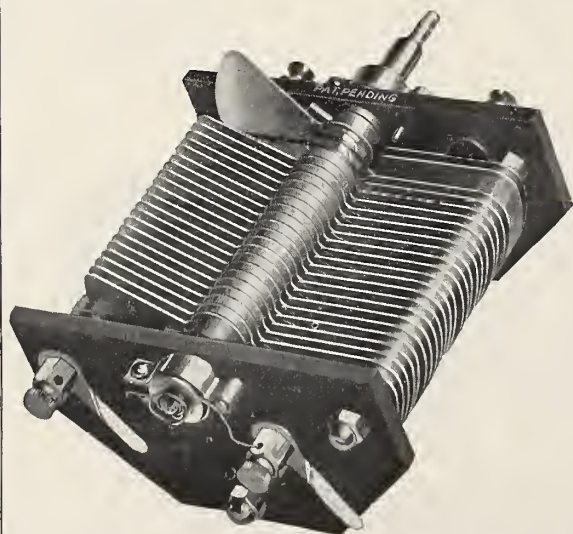

The following features are embodied in the COZZONE CONDENSERS

1. Patented adjustable brake band, which by a slight turn of the screw gives the required tension desired.
2. Backs made of best genuine insulating material, which are guaranteed not to warp or get out of shape, thus giving a long life to the condenser.
3. Furnished with both binding posts and connector which allows for a soldered or plain connection in the post.
4. Soldered pig-tail connection to rotary plates, thereby eliminating any possibilities of dust accumulating at connecting points.
5. All parts made of brass and highly nickel plated, making an ideal finished product.
6. Steel template for locating rotary shaft, and three tightening screw holes on instrument.

Sold on a money back guarantee

JOHN A. COZZONE & CO.
61 Arlington St. Newark, N. J.

Retail price furnished complete with 2 dials

43 Plate \$7.50
23 Plate 6.50



*—if you can afford to pay more—you will still prefer **CROSLEY** efficiency*

From the most humble home to the elaborate drawing room, Crosley Instruments are preferred. Regardless of the many higher priced instruments on the market, the man who knows—even if he can afford to pay more—will choose Crosley.

There is no secret in this. Crosley Instruments are the acme of efficiency and simplicity and their construction is based on sound, fundamental principles. Numerous tests by disinterested parties all over the country will bear us out in this statement.

If you are a prospective purchaser demand that your dealer demonstrate Crosley Apparatus.

He should be able to furnish you with Crosley Apparatus. If not, send us his name and order direct.

If you are a Jobber or Dealer and do not already handle Crosley Instruments, you will be wise to satisfy the demand that our national advertising has created.

CROSLEY
BETTER · COST LESS
RADIO

Complete sets from \$25 up, all kinds of parts and experimental units

Write for Catalog

Crosley Manufacturing Company
 132 Alfred St., Cincinnati, Ohio

CROSLEY RECEIVER MODEL X, a four tube outfit, the same as shown in the above scene. It consists of tuner, one stage of Tuned Radio Frequency Amplification (the feature that has made this set so popular), Detector and two stages of Audio Frequency Amplification in a beautiful mahogany cabinet. It will bring in distant stations loud and clear. With this set, listeners in Florida have heard Winnipeg, San Francisco and Honolulu. Price, without phones, batteries or tubes **\$55.00**

Winnipeg

THE PATHÉ LOUD SPEAKER

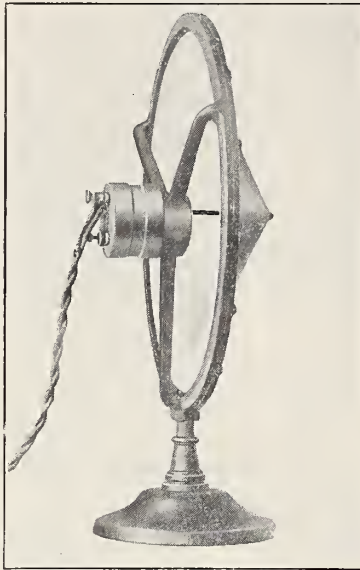

THE PATHÉ LOUD SPEAKER REPRODUCES EXACTLY THE SOUNDS SENT OUT BY THE BROADCASTING STATIONS. IT IS THE ONLY LOUD SPEAKER THAT CAN DO THIS.

List Price
\$24.00 Nickel Finish
\$22.00 Japan Finish

The Sound Wave Corporation has been consolidated with the Pathé Freres Phonograph Company and the new firm is known as

THE PATHÉ PHONOGRAPH AND RADIO CORPORATION
10-34 GRAND AVENUE, :: :: BROOKLYN, N. Y.

There Is Only ONE Homcharger

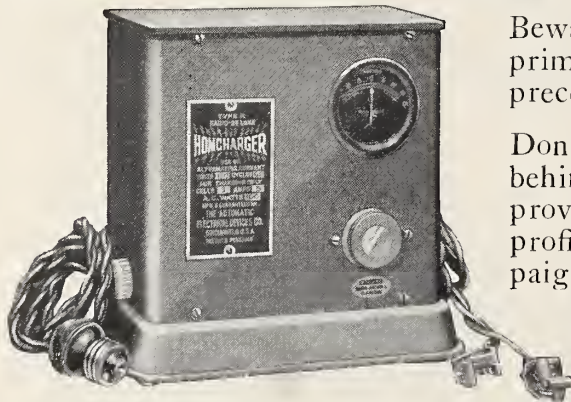

Beware of low priced, inefficient, imitations, designed primarily to "cash in" on the HOMCHARGER'S unprecedented popularity.

Don't be misled by long discounts, and low prices. Get behind a battery charger of established prestige and proven performance—one that will net you a generous profit—one that is backed by a REAL advertising campaign and dealer co-operation "to the limit."

THE
HOMCHARGER

is such a product—over 60,000 now in use—the most attractive merchandising proposition in the entire radio field. The only rectifier on the market embodying these NECESSARY features:

1—SELF-POLARIZING 2—HIGH CHARGING RATE 3—APPROVED BY UNDERWRITERS

Retail price \$18.50—complete with Ammeter, etc. See your jobber or write us direct for our proposition in detail.

DEALERS: Increase your profits and completely satisfy your customer by selling a HOMCHARGER with every Radio Set

The Automatic Electrical Devices Company

144 West Third Street

Cincinnati, Ohio

LARGEST MANUFACTURERS OF VIBRATING RECTIFIERS IN THE WORLD



From
Ben Franklin's Kite
to **Modern Radio**

IN the time of Franklin, the greatest minds of the day were groping toward some slight knowledge of electrical forces—to-day a child can operate the most intricate and marvellous electrical discovery of the age; namely, the radio receiver and amplifier.

Tell the Story, Dealers!

Radio brings music and knowledge of world events into the homes of the owners; entertainment and education, a means of keeping the family together in the home; ever new, Radio never stales and appeals equally to music lover, sports fan, children, adults, everybody.

Tell your customers these things for these are the reasons why they should buy Radio. Price?—there is a set for every purpose. Sell Radio.

Wire Collect Trial Order. Write for our new Illustrated Catalogue No. 222-D

LUDWIG HOMMEL & CO

530-534 FERNANDO ST.



PITTSBURGH, PENNA

THE AUDIOPHONE LOUD SPEAKER METHOD OF RECEIVING Makes You Forget It is Radio-Phone



AUDIOPHONE SR.
Horn 15 Inches Dia.
Price \$40.00



AUDIOPHONE JR.
Horn 11 Inches Dia.
Price \$22.50



ONE STAGE POWER AMPLIFIER
Price \$25.00

SO LIKE THE ORIGINAL VOICE AND ORCHESTRAL INSTRUMENTS

the tone is big in volume, rich, round and free from mechanical distortion.

The result of over six years' work on "Sound Reproduction" in the laboratories of The Bristol Company, a world known engineering firm, the Audiophone is not a temporary piece of equipment, but a permanent contribution to the Radio Field.

NO AUXILIARY BATTERIES are required for magnetizing.

About one watt is necessary to give the Audiophone full volume.

Most amplifiers are two stage and designed to give good response in head phones, but there is not sufficient power to operate loud speaker, except for small audiences. For this reason it is desirable to provide another stage of power amplification and Bristol's One Stage Power Amplifier is available which will give volume enough to be easily heard in a room seating 500 persons and over, when added to one or two stage amplifier.

Our representatives are located in all parts of the country. We can come to you with demonstration. Shall we send bulletins?

THE BRISTOL COMPANY WATERBURY, CONN.

ANNOUNCING

The New Moon Receiving Set "Satterlee Antennaless" Model C-1

This new set, Model C-1, invented by Dr. Francis Le Roy Satterlee, has made some remarkable records receiving on a loud speaker. Stations as far as Pittsburg, Chicago, Schenectady, etc., have been received on Long Island without any aerial whatsoever. A switch, mounted on the panel, allows an aerial to be used where one desires the reception of more distant stations.

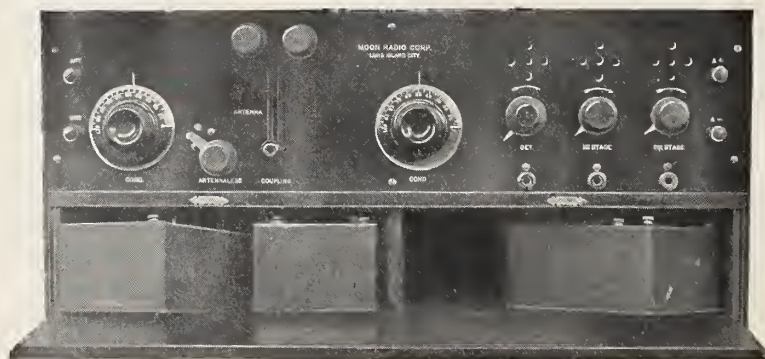

SHOWING MODEL C-1 WITH COMPARTMENT FOR
"B" BATTERIES. PRICE \$127.50

Two variable condensers are used for very sharp and selective tuning and a vernier rheostat on the detector tube. Model C-1 consists of a detector and two stages of audio frequency amplification, mounted in a highly polished solid mahogany cabinet with compartments for "B" batteries, eliminating a lot of unsightly wiring, as all "B" battery connections are made in the cabinet. Nothing but the highest grade material and workmanship are used in the manufacturing of these sets. **Dealers and Jobbers write for discounts.**

THE MOON RADIO CORP.

Manufacturers of
Ultra-fine Receiving Sets

12 Diagonal Street, Long Island City, N. Y.

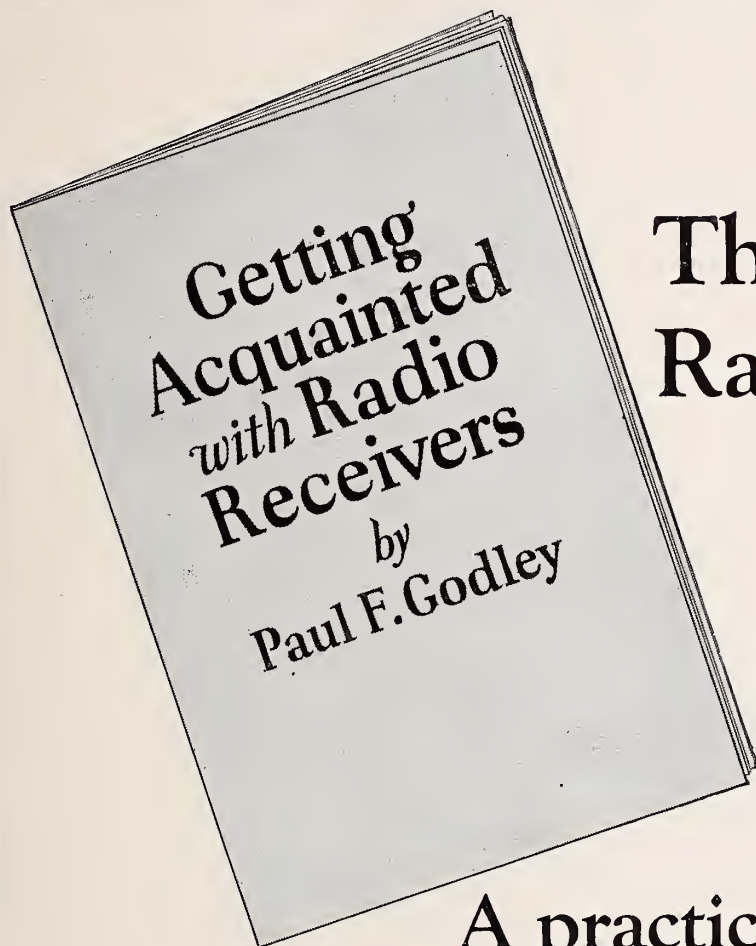

This Booklet on Radio Receivers Free to Dealers

A practical help in giving
the service that means more sales

PAUL F. GODLEY has written a booklet on radio receivers that every dealer who wants to give good service should send for at once. In simple, non-technical language it describes radio receivers, their functions, installation, operation and maintenance.

Everything is clearly explained with illustrations, circuit diagrams, plans for antennae, lay-out of apparatus, etc. It gives a *complete* and *correct* answer for every question a purchaser of a receiver is likely to ask.

Among the points covered are the following:

The Functions of a Radio Receiver

- Tuning Regenerative Receivers
- Why the "Tuner" Tunes
- What the Vacuum Tube Does
- The Vacuum Tube as an Amplifier

Installation

- Types of Antennae
- Ground Connections
- Lightning Protection

- Locating the Receiver
- "A" Battery and Its Care
- "B" Battery and Its Selection
- Loud Speakers

Operation

- Adjusting the Vacuum Tubes
- Testing the Circuits
- Adapting the Receiver to the Antenna
- Wave Length Calibration

Maintenance and Tests for Faults

The Adams-Morgan Company believes that this booklet will prove of such great practical value to enterprising radio dealers who *want* to give service that it has arranged for a special edition to be supplied *free* to the trade. So long as this edition lasts a complimentary copy will be sent to any radio dealer on request. To the general public the price will be 25 cents a copy. As the special edition is for dealers only and limited in number, we suggest that you write promptly on your business letterhead.

ADAMS-MORGAN COMPANY, 12 Alvin Avenue, Upper Montclair, N. J.

TRIUMPH COMBINATION COUPLER-METER



The "Triumph" Combination Coupler Meter fills the urgent need for a simple and efficient instrument to serve the purpose of both Coupler and Meter. We have solved the Problem. Our Coupler Meter is simple and efficient. There are no taps, no soldering and no complications. List Price, \$6.50 with Dial.



We are headquarters for Phone, Grid and Grid Leak Condensers. Price and quality are right. Free sample upon request.



"TRIUMPH" A1 V. T. Receiving Set
List Price \$30.00
Embodies the Triumph Coupler-Meter
So simple that a child can operate it
Best Value in the Radio Market To-day

The "Two-in-One" Instrument

Write Us To-Day for Samples and Full Particulars

SIGNAL RADIO & ELECTRIC CORP. 64 UNIVERSITY PL. NEW YORK CITY

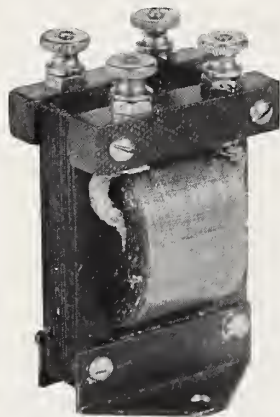

F. M. C. Audio Frequency Transformers

are now being sold to Jobbers, Dealers and Manufacturers under a guarantee to give satisfaction. To customers this company will gladly send a set of transformers to any reliable house for test purpose with the understanding that same can be returned if not found satisfactory. Our prices are right. Thousands have been sold on repeat orders. Dealers can have their name on transformers if desired. Don't hesitate. Order a set. Try them out and the volume without distortion will surprise and satisfy anyone. We stand back of these transformers. So Dealers can always be sure of satisfied customers.

The following is a test report made by a well known New York radio engineer:

Ratio 5 to 1			
Primary Resistances	900	OHMS	
" Impedance	53000	"	at 500 Cycles
" Leakage Impedance	1080	"	" 500 "
" Reactance	520	"	" 500 "
Secondary Resistance	6150	"	
Using this transformer for one step amplification with UV 201 tube 40 volts on the plate, the amplification on mean voice frequencies is:			
Audibility or telephone current increase	11.2	Times	
Energy increase	126	"	

FORD MICA Co., INC.

14 CHRISTOPHER STREET

NEW YORK

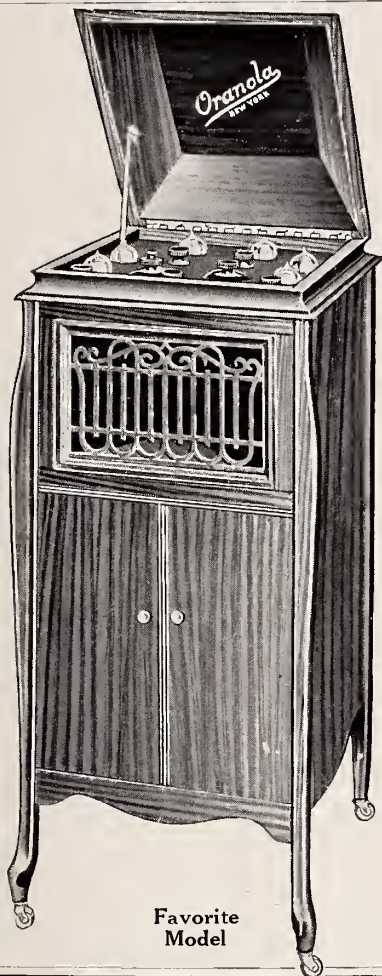

Favorite Model

Reg. U. S. Pat. Office

THE Oranola

PATENTS-PENDING

NO AERIAL USED

LOOP ANTENNA self-contained in artistic piano-finished cabinet eliminates any wiring by purchaser.

RADIO ENGINEERS universally agree that radio and audio frequency transformation of energy received is best for receiving broadcasting.

That is why we use the radio and audio frequency amplification.

NO EXPENSE has been spared to make our product the best in every detail. Having passed through the experimental stage, we are prepared to stand behind each instrument with our unqualified guarantee.

Distributors Propositions open. Desirable Territory.

OUR KEYNOTE is simplicity of operation. No knowledge of electricity or wireless is required.

SEVERAL MODELS with or without talking machine combination, listing up to \$450. Descriptive circulars and discounts on application. WIRE OR WRITE for exclusive territory proposition. DEMONSTRATIONS at our office during broadcasting periods.

DISTRIBUTORS

NATIONAL RADIO PRODUCTS CO.
New York City

MONARCH RADIO LABORATORIES
Dallas, Texas

ORANOLA RADIO CORPORATION
228 SEVENTH AVENUE NEW YORK CITY

New! Better! BESTONE RADIO PRODUCTS



Are you satisfied with mere "noise" and distorted "sounds" from your Receiving Set? It's all in the QUALITY of the apparatus used.

Bestone Wireless Apparatus are noted for scientific accuracy, clarity of tone and unusual volume. The Bestone products illustrated are without equal in design, construction and actual RESULTS.

We manufacture a wide range of Crystal and Vacuum Tube Receiving Sets as well as a complete line of radio parts.

Attractive Proposition to Jobbers and Dealers

Send for Illustrated Catalog "R"

HENRY HYMAN & CO., INC.

Manufacturers

Executive Offices:

476 Broadway, New York

Branch:

212 W. Austin Ave., Chicago

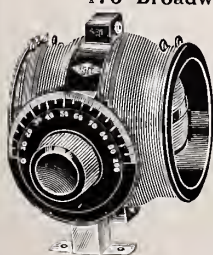

Bestone Condensite Vario-Coupler

No. 712

The most improved vario-coupler on the market. Unequaled for appearance and results. Is constructed of genuine mahogany, mahogany-colored condensite, colored. By its unique design the primary and secondary coils take the same general outline within each other, placing them in very close proximity. Primary divided into 16 taps enables very close tuning. Equipped with 3-inch Bakelite dial. Price.....\$7.50

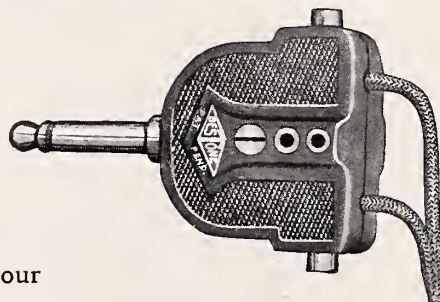

Bestone "Spring Grip" Telephone Plug

No. 727

New design—new construction—new features. The Plug that requires no disassembling. Just press the buttons—the cord tips cannot loosen. No more fussing or musing with tools. You do not have to take the Plug apart for any reason whatever. Saves time, temper and assures better results. Provides connection for three Head Phones. Price.....\$1.25

Bestone Amplifying Transformer

No. 715

Without doubt this apparatus is the foremost type of its kind. Assures clarity and volume of tone as well as undistorted reception. This Bestone product is characterized by superiority of design, excellence of materials and scientific construction. Spaghetti tubing insulates all internal wiring. Is fully enclosed in handsome aluminum case. Price.....\$5.00

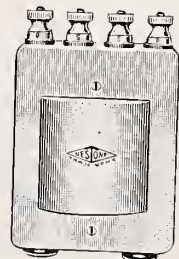

Every Dealer Can Profit From January Demand

As we approach the biggest buying season of the year retailers are asking how much they should buy—Our advice is

Buy Often—As You Need It

At Quantity Discounts

Our stocks are ample and shipments prompt. Our specials give our dealers something new to feature every week. Leaders you can advertise in the daily papers that will bring crowds to your store.

Write For Weekly Special List

HAROLD M. SCHWAB, Inc.

419 West 42nd Street

New York City

EMPIRE OILED TUBING

sometimes called spaghetti

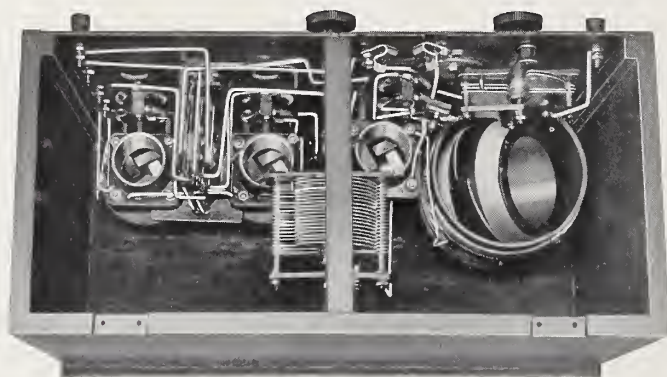

Real Radio sets of today, the kind that sell fast and last long, are insulated with Empire Oiled Tubing.

The illustration shows a receiver and two stage amplifier in which the wires are fully protected with tubing. The superior flexibility, durability, smoothness, high dielectric strength and insulating value of Empire Oiled Tubing sells the set and keeps it sold.

Made in black and white, yellow and other colors, in all sizes, 30 and 36 inch lengths.

Send today for Empire Oiled Tubing samples and quotations on 500, 1,000, 5,000, 10,000, 20,000 foot lots. Get acquainted with our other time tested radio insulation products

MICA INSULATOR COMPANY

68 Church Street, New York. 542 So. Dearborn Street, Chicago. Works: Schenectady, N. Y.
Agencies—The Monroe Brass & Wire Co., Cincinnati; G. Arthur Morrell, Cleveland; Electrical Specialty Co., San Francisco and Los Angeles

Here They Are At Last!

Two Non-Technical Books Answering Every Question of the Radio Fan

THE RADIO TELEPHONE HANDBOOK

By H. G. CISIN, M. E.

A Book of Authentic Information About Radio. It explains—

- The Operating Principles of Radio*
- How Crystal Detectors Work*
- How the Vacuum Tube Works*
- The Principles of Regeneration*
- How Amplification May Be Obtained*
- How to Check Up the Condition of the Storage Battery*
- Causes and Remedies for Weak Signals and Local Noises in Connection with Vacuum Tube Sets*
- When an Indoor Aerial Can Be Used*
- What the Loop Aerial Is*
- What Batteries, If Any, Are Necessary*
- When Shielding Is Necessary*

and many other important branches of Radio. It defines in language which the novice can understand.

- | | | |
|-----------------------------|------------------------|----------------------|
| Aerial | Ball-Type Variometer | Coil Receiver |
| Alternating Current | Bakelite | Compass |
| Alternation | Bellini-Tosi Direction | Condenser |
| Alternator | Ptrider | Connection Block |
| Ampere | Blocking Condenser | Counterpoise |
| Amplifier | Bridging Condenser | Coupling |
| Ammeter | Broadcasting | Coupling Condenser |
| Anode | Buzzing | Coupling Transformer |
| Antenna | By-Pass Condenser | Crystal Detector |
| Antenna Coil | "C" Battery | Cycle |
| Atmospheric Disturbance | C.W. | Detector |
| Audibility | Capacity | Diaphragm |
| Audio Frequency Transformer | Carborundum | Di-Electric |
| Audion | Cascade Amplification | Direct Current |
| Autodyne Receiver | Cathode | Discharge |
| Auto-Transformer | Cat-Whisker | Dummy Aerial |
| "B" Battery | Change-Over Switch | Dynamotor |
| | Charging Rectifier | Dynation |
| | Choke-Coil | Earth Connection |

AND NUMEROUS OTHERS

Mr. Hall of Ludwig Hommel & Co., Pittsburgh, Pa., says "We have given The Radio Telephone Handbook careful study and we believe that it is a very good publication. It should meet with very popular demands among those interested in radio."

PRACTICAL ELECTRICAL ENGINEERING

By H. G. CISIN, M. E.

The easiest book to understand which has ever been written on electrical engineering.

No higher mathematics—no symbols—no Greek letters—no algebra.

It tells in simple language the basic principles of direct current electrical engineering.

Among the many well-known concerns that have ordered PRACTICAL ELECTRICAL ENGINEERING are the following:

- | | |
|--|---|
| The American Tobacco Co., Baltimore | Maryland Casualty Co., Baltimore, Md. |
| The Wahl Co., Chicago, Ill. | Delaware County Tel. Co., Manchester, Ia. |
| National Blank Book Co., Holyoke, Mass. | Gates Rubber Co., Denver, Colo. |
| Coes Wrench Co., Worcester, Mass. | Willard Storage Battery Co., Cleveland |
| Elgin National Watch Co., Elgin, Ill. | Graham Glass Co., Evansville, Ind. |
| American Car and Foundry Co., N. Y. | Ludwig Baumann & Co., New York |
| Pittsburgh Plate Glass Co., Ford City, Pa. | Denver & Salt Lake R. R., Denver, Colo. |
| Hammermill Paper Co., Erie, Pa. | Kentucky Wagon Mfg. Co., Louisville, Ky. |
| Hanna Paper Corp., New York | W. F. Hall Printing Co., Chicago, Ill. |
| National Cloak & Suit Co., New York | Humble Oil & Refining Co., Houston, Tex. |
| Morse Dry Dock & Repair Co., Brooklyn | Ashtabula Dock Co., Ashtabula, Ohio |
| Ward Baking Co., Brooklyn, N.Y. | Florence Thread Co., Florence, N. J. |
| Bohn Refrigerator Co., St. Paul, Minn. | Cottage Planing Mill Co., Everett, Pa. |
| Ward Baking Co., New York | National Electric Water Heater Co., N. Y. |
| Thos. G. Plant Co., Boston, Mass. | General Realty Co., Philadelphia, Pa. |
| Dominion Textile Co., Ltd., Montreal | Ohio State University, Columbus, Ohio |
| Western Clock Co., La Salle, Ill. | Loews Theater, New York |
| Hotel Astor, New York | 14th Street Theater, New York |
| J. M. Horton Ice Cream Co., New York | Shuberts' Crescent Theater, Brooklyn |
| Westinghouse Building, Pittsburgh, Pa. | Keith's Jefferson Theater, New York |
| United Piece Dye Works, Lodi, N.J. | Grove Park Inn, Asheville, N. C. |
| Jamestown Worsted Mills, Jamestown, N. Y. | Elton Hotel, Waterbury, Conn. |
| R. J. Reynolds Tobacco Co., Lexington, Ky. | |

AND NUMEROUS OTHERS

A WONDERFUL COMBINATION

PRACTICAL ELECTRICAL ENGINEERING, \$2.00

(Bound in cloth—324 pages—71 Illustrations)

THE RADIO TELEPHONE HANDBOOK, \$1.00

(Bound in Flexible Buckeye—90 pages—Illustrated)

COMBINATION OFFER

\$2.50 FOR BOTH!

FILL THIS OUT, TEAR OFF AND MAIL.

ALLIED ENGINEERING INSTITUTE
1400 Broadway, N. Y. City

Gentlemen:
Send
..... Practical Elec. Eng.
..... The Radio Telephone Handbook
Find Enclosed \$.....

Name.....
Address.....
City.....
State.....



CORRECT SHIELDING

THE ideal method of shielding is to be found in the use of a metal panel.

Naturally all units mounted on metal panels must, of necessity, be completely self-insulated. Eisemann Variometers, Variocouplers and Condensers embody this feature.

Jobbers and Dealers find Eisemann Radio Parts readily saleable by reason of their advanced design, together with electrical characteristics of the highest order.

Eisemann Products are distributed through the Jobbing Trade. Write for descriptive literature.

EISEMANN MAGNETO CORPORATION

William N. Shaw, *President*

BROOKLYN, N. Y.

DETROIT

CHICAGO



Bestone Tube Set, including 2200 ohm head set. Equal in results to many higher priced sets. Guaranteed mechanically and scientifically perfect.
List\$27.00

Quick Service

ON

Standard Apparatus



List \$8.00



Bestone Variocoupler—Moisture repellent, dielectric and is wound with double silk covered wire. Assures maximum selectivity.

- 712 with 3-inch dial, 150-600 meters. List \$8.00.
- 714 with 3-inch dial, 150-580 meters. List \$7.00.

DOMINANCE

is assured the dealer who, at a time when the market is flooded with inferior goods, is equipped with standard, trade-marked radio parts.

"Pruden" Superior Products are popular because they are well advertised and are the best that can be procured.

Discriminating dealers will find our goods make lasting customers and that they are exceptionally fast sellers.

Attractive discounts and prompt delivery throughout the country.

Sole distributors for Dictograph Head Sets and Loud Speakers for New Jersey.

Frederick H. Pruden

991 F Lerner Bldg. Journal Sq.



Jersey City New Jersey

Only in 1 Hole Panel

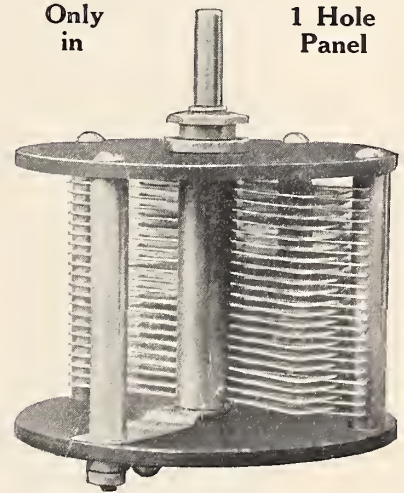

Variable Condenser requires only 1/2" hole in panel. Plates soldered in a slotted tubing (not spaced with washers) insuring perfect alignment.

- 5 Plate .000125 mfd. List.....\$3.00
- 11 Plate .00025 mfd. List..... 3.00
- 23 Plate .0005 mfd. List..... 3.50
- 43 Plate .001 mfd. List..... 4.50

Vernier condenser requires only 3/8" hole in panel. List.....\$1.50



Bestone Potentiometer — A correctly designed potentiometer with 2-inch molded dial. 300 ohms resistance. List \$1.50.
Bestone Rheostat. With 2-inch dial assures accurate control of filament current. List \$1.10.



"DICTOGRAPH" LOUD SPEAKER
The last word in simplicity and efficiency.
List \$20.00, including a five-foot cord.

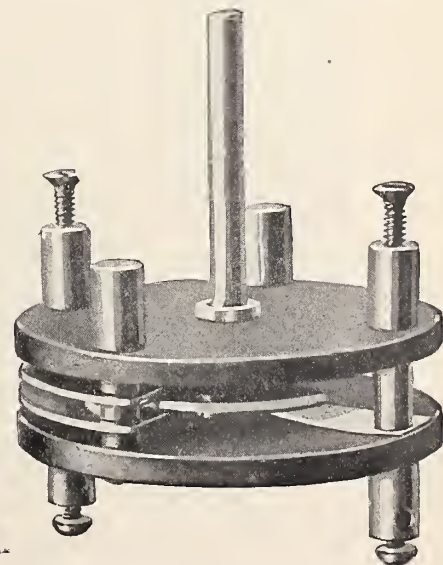

Vernier Condenser, the best of its kind. Capacity .000246 Mfd.
List without dial.....\$1.50
List with dial.....\$1.75

COMSCO PRODUCTS

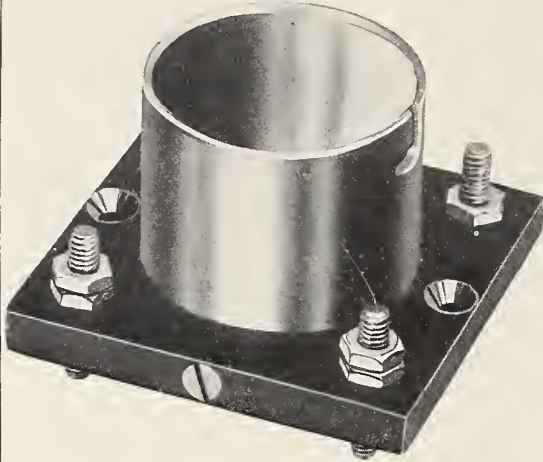

VT SOCKET

Base 1/4" solid sheet Celeron-Condensite. Brass tube heavily nickel plated and polished. Phosphor bronze contacts, nickel plated—all other parts brass, nickel plated.

LIST PRICES			
Single	\$1.00	As above but fibre base	
Double	2.00	Single	\$0.75
Triple	3.00	Double	1.50
		Triple	2.25

WD-11 SOCKET

Two-inch square, highly polished Radion base supported by insulated legs.

Binding posts non-removable. Phosphor bronze contacts.

List Price, \$0.70

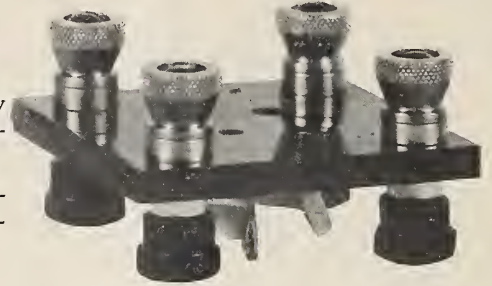

JACK

Sterling silver contact points. Condensite insulation. Tube brass nickel plated.

LIST PRICES	
Single open	\$0.55
Single closed	0.65
Double	0.85
Single Filament control	0.90
Double Filament control	1.10

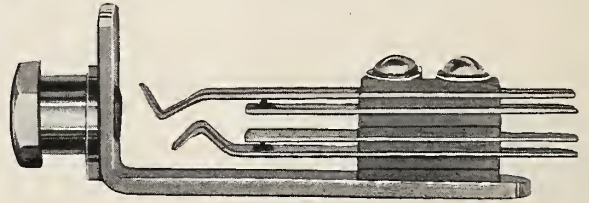

COMMERCIAL SCREW MACHINE PRODUCTS CO.

427-435 East 102nd St.

Tel. Lenox 0256

New York City

SPECIALISTS IN ACCOUNTING FOR THE RADIO INDUSTRY

BETTMAN & SEIDMAN

276 FIFTH AVENUE
NEW YORK

ANNOUNCE A CHANGE IN THE FIRM NAME TO

HENRY L. SEIDMAN & COMPANY

Certified Public Accountants

AND THE ADMISSION TO PARTNERSHIP OF

MR. BENJAMIN BARNETT, C.P.A.

NEW YORK, DECEMBER 31, 1922

TELEPHONE LEXINGTON 3033

Radio Trade Pictures

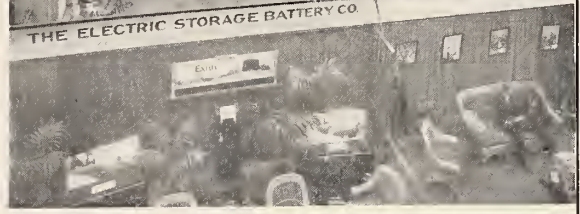
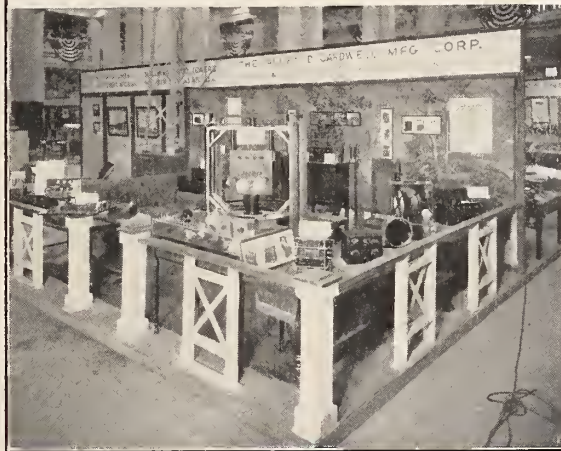
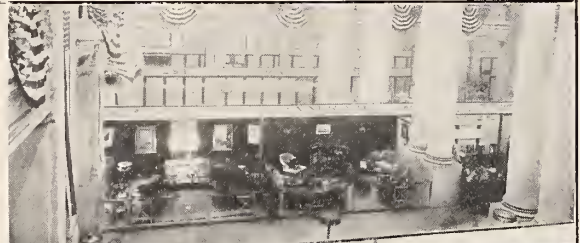
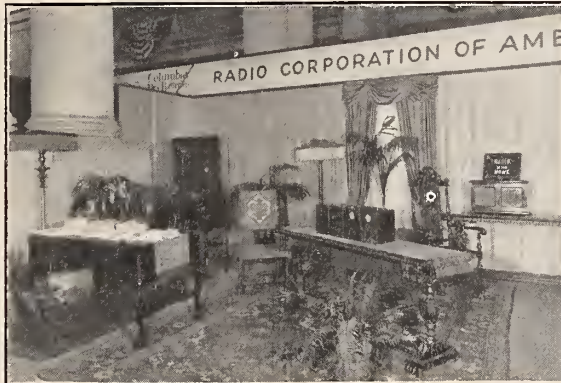

Some of the Attractive Booths at the Radio Exposition



PLEASING WINDOW DISPLAY

The New Window Display and Sales Proposition of the Radio Mica Products Company Is Designed First, to Attract Attention, and Then to Interest the Radio "Fan" in Mica Diaphragms



K. M. SMITH

Recently Appointed General Battery Sales Manager of the Manhattan Electrical Supply Company, and Formerly of the Gould Storage Battery Company

Let Our Free Service Bureau Help You Supply Your Needs

Tell us your needs and we'll put you in touch with reputable firms to the end that you will receive information on the latest and best equipment. A post card will do or use the coupon below.

- | | | | | |
|---------------------------------|---------------------------------------|---------------------------------|----------------------------------|---------------------------------|
| A | 62 Condensers, mica | I | 182 Patent wire | 238 Switches |
| 1 "A" Batteries | 63 Condensers, loading | 126 Indicators | 183 Patent wire terminals | 239 Switch levers |
| 2 Aerials | 64 Connection blocks | 127 Inductances, C. W. | 184 Plans | 240 Switch points |
| 3 Aerial wire | 77 Contract work | 128 Insulators | 185 Phonograph attachments | 241 Symbols |
| 4 Aerial protectors | 65 Control panels | 129 Insulation | 186 Plate condensers | T |
| 5 Aerial switches | 66 Condenser parts | 130 Invention developments | 187 Porcelain | 246 Tapes |
| 6 Aerial insulators | 67 Copper wire | J | 188 Porcelain cleats | 247 Telephone cord |
| 7 Aerials, loop | 68 Cords | 131 Jacks | 189 Porcelain insulators | 248 Telephone plugs |
| 8 Air condensers | 69 Cord tips | K | 190 Porcelain mountings | 249 Telephone receivers |
| 9 Adapters | 70 Crystals | 132 Knock down units | 191 Porcelain tubes | 250 Telegraph keys |
| 10 Amplifiers | 71 Crystal detector units | L | 192 Porcelain V. T. receptacles | 251 Telegraph teachers |
| 11 Amplifying units | 72 Crystal receiving sets | 136 Lead-in wire | 193 Porcelain V. T. sockets | 252 Testing instruments |
| 12 Aluminum wire | 73 C. W. Transmitter sets | 137 Lead-in switches | 194 Precision instruments | 253 Testing clips |
| 13 Ammeters | 74 C. W. Filament heated transformers | 138 Lead-in bushings | 195 Polarity indicators | 254 Terminals |
| 14 Amplifying tubes | 75 C. W. Inductances | 139 Lead-in insulators | 196 Plate connectors | 255 Thermometers |
| 15 Amplifying horns | 76 C. W. Power transformers | 140 Levers, Switch | 197 Paste solder | 256 Tools |
| 16 Amplifying transformers | D | 141 Lightning arrestors | 198 Phosphor-bronze wire sheets | 257 Trade marks |
| 17 Antennae, cage | 81 Detectors | 142 Lightning switches | Q | 258 Transformers |
| 20 Antenna light wire plugs | 82 Detector panels | 143 Loading coils | 307 Quenching spark gaps | 259 Transmitters |
| 18 Audio frequency transformers | 83 Detector tubes | 144 Loading inductance | R | 260 Transmitting sets |
| 19 Automatic transmitters | 84 Detector minerals | 145 Loose couplers | 308 Radio books | 261 Towers |
| B | 85 Detector units | 146 Loud speakers | 309 Radio schools | 262 Three coil mounting |
| 21 "B" Batteries | 86 Dictionary, Radio | 147 Locked lever switches | 310 Radio publications | 263 Tin foil |
| 22 Batteries, "A" | 87 Dials | 148 Lock nuts | 199 Radio frequency transformers | 264 Taping coils |
| 23 Batteries, dry | 88 Dial switches | 149 Loop aerials | 200 Reactor, plate circuit | 265 Tubes, amplifier |
| 24 Batteries, storage | 89 Drawings | 150 Lugs | 201 Reactor, filter | 266 Tubes, detector |
| 25 Battery chemicals | 90 Diagrams | M | 202 Receiving sets | 267 Tubing, flexible |
| 26 Battery chargers | E | 313 Mailing lists | 203 Receiving head sets | 268 Tube sockets |
| 27 Battery testing instruments | 91 End mountings (tubes) | 314 Metals | 204 Receiving transformers | 269 Tubes |
| 28 Battery switches | 92 Engraving | 151 Magnetic modulator | 205 Receptors | 270 Tuner and detector cabinets |
| 29 Battery rheostats | 93 Electrotypes | 152 Modulation transformers | 206 Receiver magnets | 271 Two stage cabinets |
| 30 Battery clips | F | 153 Machine screws | 207 Rectifiers | 272 Two stage amplifier unit |
| 31 Battery handles | 95 Fibre spools | 154 Magnet wire | 208 Rectifying tubes | U |
| 32 Battery potentiometers | 96 Fan switches | 155 Magazines, Radio | 209 Regenerative sets | 276 Unit type receiving sets |
| 33 Binding posts | 97 Filter reactors | 156 Mica | 210 Rheostats | 277 Unassembled sets |
| 34 Books | 98 Fixed condensers | 157 Mica diaphragms | 211 Rheostat wire | V |
| 39 Boxes | 99 Fire extinguishers | 158 Mica condensers | 212 Rods | 281 Vacuum tubes |
| 35 Brass parts | 100 Filament rheostat | 159 Mica diaphragm transformers | 213 Rotary lever switches | 282 Vacuum tube sockets |
| 36 Bushings | 101 Filter coils | 160 Microphone transformers | 214 Rotary spark gaps | 283 Variable condensers |
| 37 Bulbs | 102 Flashlights | 161 Milliammeters | 215 Rotary variable condensers | 284 Variometers |
| 38 Buzzers | 103 Fuse terminals | 162 Milli-voltmeters | 216 Rubber parts | 285 Vario couplers |
| O | G | 163 Motors | 217 Rotors | 286 Variable grid leak |
| 41 Cabinets | 106 Gaps, Spark | 164 Motor generators | S | 287 Vernier adjusters |
| 42 Cam switches | 107 Generators | 165 Mounting coils | 221 Safety switches | 288 Vibrators |
| 43 Carbon potentiometers | 105 Glass | 166 Minerals | 222 Safety fuses | 289 Vocalouds |
| 44 Change-over switches | 108 Grid condensers | 167 Mountings | 223 Sliders and rods | 290 Voltmeters |
| 45 Charging rectifiers | 109 Grid leaks | N | 224 Sockets | 291 Vulcanized fibre sheets |
| 46 Choke coils | 110 Grid leaks, variable | 171 Name plates | 225 Soft metal | 292 V. T. receiving sets |
| 47 Cat whiskers | 111 Grid coils | 172 Nickel parts | 226 Shielded dials | 293 Variogrid leak |
| 48 Cap nuts | 112 Ground clamps | 173 Nuts | 227 Short wave sets | 294 V. T. detector units |
| 49 Carbon walls | 113 Ground wires | O | 228 Solder | 295 V. T. control units |
| 50 Cardboard tubes | 114 Ground switches | 176 One stage amplifier | 229 Solder, bar | 296 V. T. receptacle |
| 51 Chopper, rotary | H | 177 Oscillation transformers | 312 Soldering irons (electric) | W |
| 52 Clamps | 116 Headsets and bands | P | 230 Spark transformers | 297 Washers |
| 53 Clips | 117 Honeycomb coils | 178 Panels | 231 Spark coil selectors | 298 Watch case receivers |
| 54 Coils | 118 Honeycomb mountings | 179 Panel plugs | 232 Spaghetti tubing | 299 Wattmeters |
| 55 Coil mountings | 119 Honeycomb plugs | 180 Panel controls | 233 Special apparatus | 300 Wavemeters |
| 56 Coil plugs | 120 Hook switches | 181 Paper tubes | 234 Spark gaps | 301 Wave tuner |
| 57 Coils, spark | 121 Horns | 311 Patent registration | 235 Spring clips | 302 Wire |
| 58 Condensers | 122 Hydrometers | | 236 Storage batteries | 303 Wire, aerial |
| 59 Condensers, fixed | | | 237 Sectional receiving sets | 304 Wire phosphor bronze |
| 60 Condensers, variable | | | | 305 Wire, copper clad |
| 61 Condensers, air | | | | 306 Wire, magnet |

Note the number of the item you want to buy—then check the corresponding number in the coupon below and mail to us.

-----TEAR OFF HERE-----

1	2	3	4	5	6	7	8	9	10	11	12	13	14	15	16	17	18	19	20	21
22	23	24	25	26	27	28	29	30	31	32	33	34	35	36	37	38	39	40	41	42
43	44	45	46	47	48	49	50	51	52	53	54	55	56	57	58	59	60	61	62	63
64	65	66	67	68	69	70	71	72	73	74	75	76	77	78	79	80	81	82	83	84
85	86	87	88	89	90	91	92	93	94	95	96	97	98	99	100	101	102	103	104	105
106	107	108	109	110	111	112	113	114	115	116	117	118	119	120	121	122	123	124	125	126
127	128	129	130	131	132	133	134	135	136	137	138	139	140	141	142	143	144	145	146	147
148	149	150	151	152	153	154	155	156	157	158	159	160	161	162	163	164	165	166	167	168
169	170	171	172	173	174	175	176	177	178	179	180	181	182	183	184	185	186	187	188	189
190	191	192	193	194	195	196	197	198	199	200	201	202	203	204	205	206	207	208	209	210
211	212	213	214	215	216	217	218	219	220	221	222	223	224	225	226	227	228	229	230	231
232	233	234	235	236	237	238	239	240	241	242	243	244	245	246	247	248	249	250	251	252
253	254	255	256	257	258	259	260	261	262	263	264	265	266	267	268	269	270	271	272	273
274	275	276	277	278	279	280	281	282	283	284	285	286	287	288	289	290	291	292	293	294
295	296	297	298	299	300	301	302	303	304	305	306	307	308	309	310	311	312	313	314	315

Service Bureau The Radio Dealer,
1133 Broadway, New York City.

We are interested in buying radio equipment and have circled the numbers on this coupon of the items we are ready to buy now. Please have manufacturers of these lines quote us dealers' prices.

Name.....

Address.....

..... 1923
—Retailers
—Jobbers
—Manufacturers



Head Phones
2000 Ohm---\$6⁰⁰
3000 Ohm---\$7⁵⁰



Vernier Rheostat \$1²⁵



Plain Rheostat 85¢

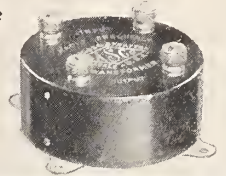

Radio Frequency Transformer \$5⁰⁰

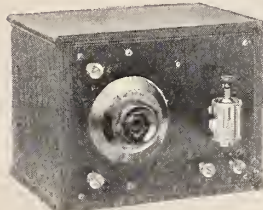

Complete Crystal Set \$12⁰⁰

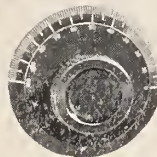

Dial 50¢

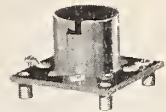

Tube Socket 50¢



Variable Air Condenser
11 to 43 Plate \$3⁴⁵ to \$4²⁵

Better Made, Lower Priced, Easier Sold

WHEN you can conscientiously and confidently sell a line of Radio equipment knowing that it is all and even more than it's represented to be—equipment that not only looks good but is good; when you can make a satisfied, stay-sold repeat-order customer of every buyer, your success is practically assured.

Your ultimate success then begins with judicious buying—the right line. And here it is—the Basco (Briggs & Stratton Company) Line—better made, lower priced, easier sold. Every unit embodies the accumulated experience of twelve years of electrical manufacturing—is built right to bring results—priced right to bring quick sales.

Besides articles shown and listed here, we also make switches, contact points, stop posts, binding posts and bezels.

Write for free catalog and details of our attractive dealer and jobber proposition

BASCO Radio Frequency Transformer. Efficient over wave band of 200 to 600 meters. Employs non-capacity winding—double silk covered wire—no enamel. Maximum transfer of energy. Windings encased in fibre. Mountings and binding posts silver plated. List Price, \$5.00.

BASCO Radio Receivers. Super-sensitive—natural voice pitch—no scratching. Light weight aluminum case—solid horseshoe type magnet—no laminations. Diaphragm set to thousandths-of-an-inch accuracy from magnet poles. Clean cut, rugged design. Comfortable on ears. 2000 and 3000 ohms. List \$6.00 to \$7.50, respectively.

BASCO Vernier and Plain Rheostats. Vernier adjusts to 1/150 of an ohm. None better for detector. Smooth, positive contact always. One hole only for panel installation. Coils rigidly inset in heat-resisting fibre—no shifting possible. Metal parts heavily nicked. List price—Vernier Rheostat \$1.25. Plain Rheostat, \$0.85.

BASCO Crystal Detector Set. Complete for instant hook-up to aerial, ground and phones. No batteries. Simple and sturdy. One dial to adjust. Sensitive tested crystal enclosed in glass. Simple cat whisker adjustment. Maximum crystal-set range. Metal parts solid brass. Bakelite composition panel. Mahogany finished cabinet, 8" x 6 1/2" x 6". List Price, \$12.00.

BASCO 11 to 43 Plate Air Condensers. Sturdy—compact. Heavy plates, accurately spaced—no chance of touching. Two screw holes for easy mounting. Without dial. List prices:

43 Plate.....\$4.25	17 Plate.....\$3.60
23 Plate.....3.75	11 Plate.....3.45

BASCO Tube Socket. Black oxidized tube holder. Bakelite base. Strong—good looking. Sure-contact springs. Nickled binding posts. An exceptional buy at 50c.

BASCO Moulded Composition Dial. Graduated 180° and 100 divisions. 3 inches diameter, 1 1/2 inch knob. High lustre black—white inlaid figures. Accurately trued brass bushing for 1/4 inch shaft. List Price, 50c.

Briggs & Stratton Co.
Milwaukee  Wisconsin
PRODUCT

First In The Field

The Radio Dealer (monthly edition) leads the field of Radio publications *because it has the circulation.*

The following analysis is of PAID Circulation, note printer's statement of press run.

Circulation By States THE RADIO DEALER

Alabama..... 21	East Orange.... 10
Arizona..... 11	Elizabeth..... 17
Arkansas..... 5	Jersey City.... 44
California..... 286	Newark..... 191
Los Angeles.... 34	Paterson..... 19
Oakland..... 13	Trenton..... 27
San Francisco.. 67	New Mexico..... 2
Colorado..... 28	New York..... 1094
Denver..... 14	N. Y. City... 710
Connecticut..... 185	Brooklyn.... 144
Bridgeport.... 12	Buffalo..... 28
Hartford..... 17	North Carolina... 27
New Haven.... 12	North Dakota... 5
Waterbury.... 12	Ohio..... 236
Delaware..... 11	Cleveland... 34
Wash., D. C..... 34	Cincinnati... 18
Florida..... 25	Columbus.... 13
Georgia..... 42	Toledo..... 22
Idaho..... 13	Oklahoma..... 15
Illinois..... 537	Oregon..... 11
Chicago..... 337	Pennsylvania.... 240
Indiana..... 87	Pittsburgh... 84
Indianapolis.. 18	Philadelphia.. 68
Iowa..... 35	Rhode Island.... 14
Kansas..... 33	Providence... 12
Kentucky..... 5	South Carolina... 9
Louisiana..... 23	South Dakota.... 2
Maine..... 12	Tennessee..... 14
Maryland..... 10	Texas..... 75
Massachusetts... 224	Dallas..... 43
Boston..... 88	Utah..... 13
Michigan..... 183	Vermont..... 12
Detroit..... 109	Virginia..... 20
Minnesota..... 41	Washington..... 37
Mississippi..... 14	West Virginia... 19
Missouri..... 195	Wisconsin..... 106
Montana..... 18	Milwaukee... 63
Nebraska..... 24	Wyoming..... 2
New Hampshire... 10	Canada..... 41
New Jersey..... 662	Foreign..... 185
Atlantic City.. 19	
Camden..... 18	

Tot. Pd. Circ't'n. .4958

The Williams Printing Company

Complete Manufacture of Publications

Eleventh Avenue, 36th to 37th Streets

New York City

October 2, 1922.

The Radio Dealer
1133 Broadway,
New York City.

Attention Mr. L. A. Nixon

Dear Sir:

I, Roy L. Atwood, Manager of The Williams Printing Company, hereby testify that we have printed and bound Eight Thousand (8000) copies of the current issue of the "Radio Dealer".

Very truly yours,

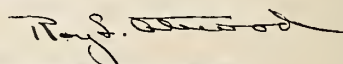

for THE WILLIAMS PRINTING COMPANY.

State of New York)
) Ss;
County of New York)

: On this second day of October 1922, before me came Roy L. Atwood to me known to be the person who subscribed the foregoing instrument and acknowledged that he executed the same freely and for the purposes therein set forth.

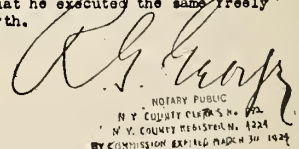

NOTARY PUBLIC
N. Y. COUNTY CLERK'S OFFICE
N. Y. COUNTY REGISTER, 1922
BY COMMISSION EXPIRES MARCH 31, 1923

First In The Field

THE RADIO DEALER

1133 Broadway, New York, N.Y.

35 South Dearborn St., Chicago, Ill.

THE RADIO DEALER

The Radio Trade Journal

For The Radio Retailer

CONTENTS JANUARY, 1923

SPECIAL ARTICLES

American Radio Exposition Successful Show.....	By R. C. Hull	27
Development of Melco Supreme Receiver.....	By J. McKerchar	35
How Denver's Little Store Became Big.....	By L. N. Allen	29
January Is the Inventory Month.....	By Henry L. Seidman	28
London Is Trying to Regain Position in Radio Stocks.....	By Frank T. Stanton	89
Lyon & Healy Store Is Complete Radio Depot.....		86
Mr. Gilbert Throws Light on Vacuum Tube Situation.....	By Thomas Herrin	28
Mountain Jobbers Develop Trade Service.....	By Jack L. Hursch	34
1923 Should Be Big Year for Radio Business.....	By Amplifier Al	25
Philadelphia Has Formed Radio Trade Association.....	By William B. Wilkinson, Jr.	31
Pointers for Radio Dealer Aiming to Increase Sales.....	By Albert Edwin Sonn, R.E.	34
Post Office Choked with Work Demanding Attention.....	By Chamcey P. Carter	36
Power Amplification for Loud Speakers.....	By S. G. Sears	31
President Henry M. Shaw Is Trade Authority.....	By H. E. Bennett	26
Radio Corp. Brings Action on Tube Apparatus Patents.....	By Johnson Forbes	30
Radio Trade Pictures.....		19
Radio Trade Association Meeting.....	By Laurence A. Nixon	26
The "Man in the Moon" Is a Regular Fellow.....	By Harry M. Konwiser	36
What Radio Owes to the Amateur.....	By N. B. Zimmerman	30
What Service Means.....	By Edward J. Connelly	50

DEPARTMENTS

Book Reviews.....	By Bernard J. Farrell	70
Editorials.....		32, 33
Service Bureau.....		20
What the Manufacturers Are Doing.....		33

THE RADIO DEALER, THE RADIO TRADE JOURNAL, published monthly on the first, at 1133 Broadway, New York, N. Y., by THE RADIO DEALER COMPANY, in the interest of dealers in Radio Supplies. HARRY M. KONWISER, Publisher; LAURENCE A. NIXON, Managing Editor; HERBERT M. WILLIAMS, Editor; A. L. KONWISER, B. S., ALBERT E. SONN, R. E., Technical Editors; N. B. ZIMMERMAN, BERNARD FREDMAN and EUGENE J. SCANLON, Associates; C. HOPPE, Circulation Manager; M. JAY KLEIN, Research Manager; E. B. STERN, Manager Service Bureau.

REPRESENTATIVES IN THE TRADE: ELMER W. MOORE, JOHN R. HALL, H. E. BENNETT, WM. B. WILKINSON, JR., J. MAURICE CASPER, H. L. KRENZ, M. A. CLARK, C. L. GEESEY, C. C. MUNIER, J. L. PECK, M. P. MCNEELEY, W. H. OKE, C. B. CABINISS, R. C. HULL, BERNARD J. FARRELL.

PUBLICATION OFFICE
1133 Broadway, New York, N. Y.
Telephone Watkins 8926-8927

SOUTHERN STATES
610 Barome Street,
New Orleans, La.

CANADIAN OFFICE
23 Lily Street, Winnipeg, Manitoba

PITTSBURGH
Suite 570, Union Arcade, Pittsburgh, Penna.
PACIFIC COAST
Suite 511, 456 S. Spring St., Los Angeles, Calif
Telephone Los Angeles 12050
512 Pacific Building, San Francisco, Calif.
Telephone Sutter 954

BRITISH OFFICE:
Walter Dandie Company, Ltd.
173-175 Great Portland Street
London, W. 1, England

CENTRAL STATES
35 South Dearborn Street, Chicago, Ill.
Telephone Dearborn 4053

NEW JERSEY
845 Broad Street, Newark, N. J.
Telephone Market 4659

CLEVELAND
1389 West 87th Street,
Cleveland, Ohio

Advertising Rates and detailed statement of circulation and other information for advertisers furnished on application. Advertising forms close the 15th of the month prior to date of issue.

Circulation restricted to manufacturers, jobbers and retailers in wireless equipment. Subscription in the United States, one dollar the year, payable invariably in advance. Subscription in foreign countries, two dollars the year, payable invariably in advance.



The "Melco Supreme" Radio Frequency Amplifying Receiver can be used with indoor or outdoor aerial, loop or lighting plug. It is a new departure in radio, non-reflex, non-regenerative, tuned radio-frequency. Amplification of this instrument is extremely high per stage, without loss of tone quality. IT DOES NOT DISTORT THE WAVE NOR INTERFERE WITH OTHER MEMBERS OF THE RADIO AUDIENCE.

This new system permits of single tuning adjustments that result in a high degree of selectivity and long distance reception.

PRICE \$125.00

For quality merchandise, price cannot be equalled

Save Sales Company

Sales Engineers

City Hall Building New York City
(Broadway and Warren Street)

MELCO

SUPREME

WRITE NOW FOR LITERATURE, ATTRACTIVE DISCOUNTS AND DISTRIBUTORS' PROPOSITION

The Radio Dealer

THE RADIO TRADE JOURNAL

Edited and Published at

1133 Broadway, New York, N. Y.

FOR THE RADIO RETAILER

VOL. 2. NO. 4

JANUARY, 1923

ONE DOLLAR THE YEAR

1923 Should Be Big Year For Radio Business

Responsible Manufacturer and Dealer Will Find Public Ready to Purchase Reliable Apparatus in Larger Numbers

By AMPLIFIER AL

LOOKING forward to 1923 the radio trade seems to have come to the conclusion that business will run smoother and that sales in the aggregate will increase.

Recently talking with a manufacturer who refused to be quoted the following points were made:

With the inefficient retailer vanished, radio retailing will naturally fall into strong hands, and the firms who give real service to the consumer and listener-in will find their sales satisfactory.

With better and better sets being produced the man who has considered radio reception as something for people who like to "fiddle with things" will join the throng at the dealers' counters.

With less and less distressed stocks on hand, prices will be stabilized and reliable manufacturers will be able to produce quality apparatus that will retail at fair prices.

With the fading away of the cut price store dealing in inferior merchandise, the buyer will purchase much more willingly, having his confidence restored in radio apparatus.

With the failure of inefficient manufacturers, those remaining will establish cost systems and otherwise make their plants more efficient, bringing about established prices and greatly aiding in restoring public and trade confidence.

The American public is not going to forget radio. The business of listening-in is rapidly passing from a fad to an every day occurrence and we may expect to see the radio business climb and climb to an even higher place in the industry of the country. The steady improvement of the calibre of business men in the industry points to better conditions, and also speaks volumes for the

industry as having convinced skeptical business men that it is a permanent industry.

A recent survey of the country conducted by THE RADIO DEALER organization pointed out that business in general was better, not only because of holiday demand, but because the *GENERAL PUBLIC WAS SIMPLY BUYING RADIO BECAUSE THEY LIKED IT THEMSELVES.*

Knowing these facts it remains for the trade to speed the day when radio is recognized everywhere as a business that is permanent and that carries no more risk than any other business.

Manufacturers can avoid troubles in their own plants by realizing the necessity for *selling* their merchandise. The manufacturer who makes inferior goods is lost already, but there is yet hope for the maker of quality equipment who is still waiting for the world to continue to travel the "beaten path to his door." These manufacturers are developing sales ideas, sales plans and policies—and it is in their development that we base our optimism.

Distributors can avoid troubles by checking closely the inefficient retailer, but helping the reliable dealer who is striving to advance the industry and to gain friends for radio. They can help by carrying good stocks, but not by speculating or over buying.

Retailers can aid by pushing the sale of radio equipment just as they push the sale of any other commodity. By advertising locally and by selling only goods of known quality they will bring repeat orders to their stores.

Everyone can help, and apparently everyone is helping. 1923 will be a big year for the wise radio man who watches the signs of the times.

Radio Trade Association Meeting

Large Gathering Enthusiastic at Interesting Addresses of Dr. Lee De Forest and Others Prominent in Industry

By LAURENCE A. NIXON

In line with the policy of the Radio Trade Association to present informative lectures to the radio trade, no business was conducted at the meeting held at Grand Central Palace, New York City, December 26. More than five hundred radio business men were in attendance while seven interesting speeches were heard.

Henry L. Seidman was the first speaker of the afternoon, following President Henry M. Shaw who reviewed conditions in the industry as well as outlining some of the work projected by the association.

Mr. Seidman held up a warning hand to dealers, jobbers and manufacturers who are not figuring their costs. His remarks in full will appear in the next issue of THE RADIO DEALER.

Dr. Lee De Forest, the famous inventor, was the next speaker. He said in part:

"I sincerely welcome this opportunity to meet with you. First, because it gives me a chance to shake hands once more with the men whose efforts made possible the presentation of radio to the great radio public of today and the still greater radio public of the immediate future. Again, because in this exposition we have an opportunity of witnessing the success attending these early efforts. Finally, because through your secretary, Mr. Nixon, I have been requested to speak to you upon one phase of radio development in which I have long held a particular interest; namely, radio in the country districts.

"First of all, let us not forget as Daniel Webster has well pointed out, that the farmers are the founders of civilization. Webster may have had his constituents in mind when he made the remark; nevertheless, agriculture is still the largest single industry in America, and nearly one-half of our people live under rural conditions. In other words, farmers and those who live in the rural districts generally, viewed from the point of view of any one class, are still the greatest buying public of these United States.

"Since my early boyhood days were spent first in the Middle West, and later on in the South, away from the great centers of industry, art and education, naturally, later on in life, when I first began to see the possibility of communication by radio, one of the first things that came to my mind was the important part that radio would play in country life.

"In these days of such rapid advancement by science and industry, those of us who live in the city are more or less apt to think of the country in the terms of a quarter of a century ago, when the country dwellers were without good means of com-

munication and transportation, without those things which we are pleased to call city comforts and conveniences. However, the country of today and of the immediate future is an entirely different land than that of our forefathers, and no one instrument of art and industry will do more to complete the evolution of country life, and especially of home life in the country than the radio receiving sets which you gentlemen are now offering to the people in these heretofore isolated districts.

"By means of this very wonderful instrument you are in a position to afford untold pleasure and progress to those who prefer, in some small degree, the open canopy of blue to the smoky cloud of industrial city life.

"This special contribution that radio can make to the development of life at home and especially life at home in the country is, to my mind, the great selling argument not only to the farm and to the village dweller, but also to the suburban resident and those who enjoy the benefits and pleasures of owning country estates for use either in winter or summer or the year 'round.

"Our agricultural leaders have long sought for some instrument that would keep the interest of the country boy or the country girl centered in the home. What better

instrument at hand than the radio receiving set, now, more than ever, when the Government itself, as well as our great universities and colleges and musical centers are working out a program for the distribution of the highest form of entertainment and instruction.

"Only a few days ago my attention was directed to a Sunday newspaper page pointing out the possibility of the enormous saving of money—some two million dollars, if I am not mistaken—which might be effected through the use of radio in conducting the educational classes in a Middle Western city, at home, mind you, instead of at an expenditure of two million dollars in the construction of new buildings. This idea may appear a little fantastic to those who are not acquainted with the full possibilities of radio development, nevertheless in the field of school, college and public lectures, the idea is by no means an impractical one, and here again the benefits will naturally be extended into the very territory we have in view, namely, in the country districts.

"In the year 1907 I first gave expression publicly to my feeling on the benefits that radio will bring to the country districts. In that year I said:

"In rural districts scores of individual
(Continued on page 77)

President Henry M. Shaw Is Recognized Trade Authority

By H. E. BENNETT



Henry M. Shaw

When Henry M. Shaw, president of the Radio Trade Association, presided at a meeting composed of men prominent in the radio industry in Grand Central Palace, New York City, during National Radio Week, many at the gathering recognized him as Shaw of Irvington, N. J.

It was in the electrical manufacturing business that Mr. Shaw made his reputation. Few men in active business to-day have such a long history identified almost throughout with electricity. Mr. Shaw's career in the electrical field began in 1886 with the manufacturing of wooden ceiling rosettes and branch cutouts for electric wiring. To-day Mr. Shaw is at the head of the Shaw Insulator Company, of 5 Kirk Place, Newark, N. J., where moulded radio parts are made of condensite.

(Continued on page 80)

American Radio Exposition Successful Show

New York Radio Show Pleases Exhibitors and Attracts the Public in Large Numbers—Record Made for Radio Shows

By ROBERT C. HULL

The American Radio Exposition Company, promoters of the American Radio Exposition held at Grand Central Palace, December 21 to 30, are to be congratulated on their successful show, which pleased exhibitors and public alike.

While the number of exhibitors was not large, not as large as it will be when this organization again stages a show, representative manufacturers were present in sufficient numbers to please the public and present a truthful and satisfactory picture of the radio industry.

To those who have attended former radio shows, held in New York and other parts of the country the exposition came as a distinct surprise and an enjoyable one at that. Not only were some of the greatest evils of former shows corrected, but the arrangement and display of the booths were above the average. Over half the booths gave evidence of considerable study and care in their arrangement, while a number were truly works of art fit to grace any exposition. To those who have attended expositions of other industries in this famous exposition place the radio show suffered

by comparison, but reflected rather the lack of age of the industry than anything else. The prediction is freely made that next year's show will have twice the number of exhibitors with three times the number of carefully arranged display booths.

One of the surprises of the show was the intense interest taken by the public in the apparatus displayed. The booths, which were larger than the usual exposition booths were crowded with people busily engaged in inspecting the apparatus and securing prices and addresses of dealers from whom it could be purchased.

While attendance figures are not available at this writing (December 28) it is believed that the crowds will exceed in number that of any former show held in any section of the country by several hundred per cent.

A greater amount of advertising done during the show brought the public in larger numbers, while special programs broadcasted from the exposition added to the public interest. The programs were of exceptional interest and reflected credit on the exposition and its program director.

A complete list of exhibitors follows:

Western Electric Company, Inc.
Radio Corporation of America.
General Insulate Company.
Pacent Electric Company.
National Carbon Company.
DeForest Radio Telephone & Telegraph Company.
Sleeper Radio Corp.
C. Brandes, Inc.
Sound Wave Corp.
Hutchison Radio Company.
Manufacturers Patent Company.
Novo Manufacturing Company.
Henry Hyman & Company.
Holtzer-Cabot Electric Company.
Clapp-Eastham Company.
Stromberg-Carlson Tel. Manufacturing Company.
National Airphone Corp.
Dubilier Condenser & Radio Corp.
Executive Radio Council, 2nd District.
National Radio Chamber of Commerce.
American Radio & Research Corp.
American Radio Relay League.
Coto-Coil Company.
Western Electrical Instrument Company.
Signal Electric Company.
Scholes Radio & Manufacturing Company.
Malone-Lemmon Laboratories.
A. H. Grebe & Co., Inc.
Electric Storage Battery Company.
Burgess Battery Company.

(Continued on page 74)

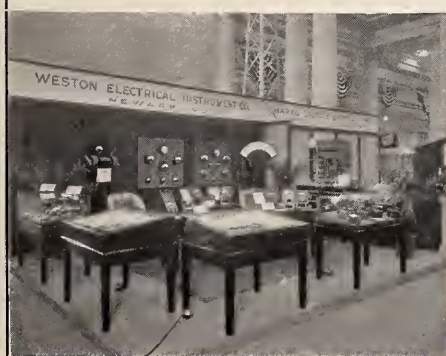

A Few of the Exhibits at the Radio Exposition

January Is the Inventory Month

True Condition of Radio Merchant's Business Can Only Be Obtained Through Accurate Stock-Taking and Summaries of Transactions

By HENRY L. SEIDMAN
Certified Public Accountant

The close of the year brings with it a realization that books must be closed, statements of income and profit and loss prepared, and balance sheets compiled. These statements are the summaries of the business transactions entered into during the year and disclose the elements of profit and loss and the condition of affairs on the last day of the year. They are the foundations for the business policies of the next year and prepare the way, when intelligently interpreted, for more economic and efficient management.

Before such statements can be prepared it becomes necessary to compile a list of all the merchandise on hand together with its cost or market value. This is commonly called "taking stock" or "taking inventory." Without such an inventory it is practically impossible to determine the state of affairs and the importance of determining accurately the value of the merchandise on hand cannot be too strongly emphasized.

That profits cannot be accurately determined is too well known to dwell upon much. In addition, it is a strong factor when it becomes necessary to determine the gross profit made on sales, and the percentages to be used in the future when estimating the cost of the merchandise sold. It gives a business man an idea of how much insurance he should carry at all times, and in the event of a fire an insurance company would be prone to place greater credence in a set of books which disclose the inventory at its proper value each year.

The banker and credit-man have emphasized again and again the importance of keeping the assets of a business in "liquid" form, so that they can be readily converted in cash. The danger of too great an inventory of merchandise on hand is manifest. If a sudden slump in business comes and when sales are few, the merchandise on the shelves represent a "frozen" asset, and debts cannot be readily paid. Should there come a sudden slump in prices besides, as happened in the textile, leather and

Your Inventory

Do not neglect to take it promptly. Without it you cannot accurately determine how much money you are really making or losing.

Too many merchants have hopelessly fooled themselves into failure thinking they knew the true condition of their business.

Make your inventory carefully, give conservative values to your stock and remember that merchandise yields no profit until sold.

Watch and study the inventory. It is the signal that tells of danger ahead.

metal industries only two years ago, the danger of bankruptcy is apparent.

A great deal of merchandise on hand represents an investment the funds of which are tied up so that it brings the breaking point into sight, it produces no interest or other income and becomes less valuable because of its depreciation.

An inventory must, therefore, be taken at least once a year, and where

it is practicable, it should be taken more often. In other words, watch your buying closely.

The question always arises; "How shall it be priced, at its cost, or at the price it can be bought for in the market?"

This has always been a topic for discussion, and the arguments on both sides are interesting and important. To price it at cost answers the question only partly; for, after all, if the inventory is taken for the purpose of determining the value of the business, are we not understating the value of the asset when we price it at cost when it can be sold in the trade to other dealers at higher prices?

And we are not overstating the value of an asset when we price it at a cost which is greater than the market value?

The result of following either of these courses is interesting. If we price our merchandise at market value when the cost is less, the profit and loss account includes a profit which has not been earned, and should dividends be declared, they

(Continued on page 60)

Mr. Gilbert Throws Light on Vacuum Tube Situation

By THOMAS HERRIN

Radio dealers, as well as radio fans, are interested in the tube situation. Considerable "inside information" is being handed out, in the trade, on this important matter and to get the correct slant upon the tube situation THE RADIO DEALER asked Charles Gilbert, president of the De Forest Radio Telephone and Telegraph Company for information and he responded as follows:

About two months ago our company decided that upon the expiration of the Fleming valve patent (November 7, 1922) we would again reenter that field and once again manufacture the

audion bulbs which Dr. Lee De Forest invented in 1906.

"It was only about November 15, last, that we finally decided on the design of the 6-volt tube, but for the time we have been unable to take up the design or production of a 1½ volt coated filament tube. Our machinery for the production of tubes, is now being installed."

The specifications of the 6-volt tubes are as follows:

Filament 5 to 6 volts; .05 ampere. Plate voltage 40 to 60. Filament of tungsten thorium. Horizontal plate

(Continued on page 28)

How Denver's Little Store Became Big

Dr. Reynolds, Starting in a Small Way, Won Confidence of Trade and Developed Radio Center that Handles Only Standard Lines

By L. N. ALLEN

One of the large radio stores in the country is that of the Reynolds Radio Company, Inc., which is situated at 1534 Glenarm street, Denver, Colo. The business was established in

radio enthusiasts. Today the store is one of the prominent ones in the country, with stock under one roof worth more than \$70,000—all of standard makes.

growth in disposing of radio equipment.

Dr. W. D. Reynolds, head of the technical department, is exceptionally well equipped from a technical stand-



The Salesroom Looking Toward the Street

Dr. Wm. D. Reynolds in KLZ

The Store Front

View Toward Rear of Salesroom

Minneapolis in 1914 and in 1921 was incorporated at Denver with Dr. William D. Reynolds as president, Dr. George W. Reynolds, vice-president; William D. Reynolds, Sr., secretary-treasurer; and Jack L. Hursch, general manager.

As a pioneer in the Colorado radio field, Dr. Reynolds started a very small store in Colorado Springs and later moved to Denver, where at 613 19th street he conducted a very small establishment and carried a stock valued at less than \$1,500. Gradually he won the confidence of

The store, which is 50 feet wide and 125 feet deep, is located on one of the central downtown streets of Colorado's chief city. Fine display windows, mahogany shelving and fixtures, excellent lighting arrangements and merchandise attractively displayed in pleasing show cases, make the store an unusual one.

After going through a period of depression that ended in August when policies were changed and a selling organization was formed and organized on a thoroughly up-to-date basis, the business has enjoyed a substantial

point to select the best apparatus for resale purposes.

The company operates two stations, KLZ and 9ZAF. KLZ is one of the largest broadcasting stations in the West and puts many interesting features on its programs. The so-called "canned music" is avoided. The consistent policy in the past has been to entertain and please the public.

"This broadcasting station," says Manager Jack Hursch, "is operated entirely for the benefit of the radio public and is at the service of all pub-

(Continued on page 60)

What Radio Owes to the Amateur

R. H. McMann in Interview Tells of the First Broadcasting of Music and of the Value of Early Amateur Experiments

By N. B. ZIMMERMAN

How the radio amateur succeeded in inoculating the country with the radio bug, and how the radio dealer can assist in the further spread of the radio fever was outlined in a recent interview by R. H. McMann, of the Continental Radio & Electric Corporation. Mr. McMann is one of the first amateurs in this country to broadcast music.

Mr. McMann is enthusiastic about what the radio amateur has done for radio in the past. "There would be no broadcasting today if it hadn't been for the amateur," he said in the course of a rapid survey of radio's history. "The amateur has been experimenting ever since the days when Marconi first transmitted his epoch-making message. And ever since that day a great deal of the remarkable development which radio has experienced has been due to the efforts of men who have been considered as amateurs and want to be considered as such. As amateurs pursuing the hobby that interests them more than anything else, they have constantly strived to go 'one better' and the results have been advantageous for the mechanical perfecting of radio."

Mr. McMann traced the amazing interest in radio, which startled the United States in 1921, to the influence of the radio amateurs. During the War, radio amateurs served in the Army and Navy in the Signal Corps and as operators on the ships mobilized.

"A great many other recruits to these divisions of our war activity," he explained, "came in contact with the radio amateurs and were fired by their enthusiasm for radio. From that day on the development of radio was marked by leaps and bounds."

The part that the radio enthusiast played in broadcasting was the foundation for the public broadcasting of today, represented as it is by 560 efficient broadcasting stations, according to Mr. McMann.

"The first real broadcasting," he said, "was done, as far as I know, by an amateur, Frank King, a charter member of the Radio Club of America, who in 1915, from his own home in West 107th Street, New York City, transmitted a violin selec-

tion to the fleet, stationed at that time in the Hudson River.

"Mr. Conrad of the Westinghouse Company also broadcasted from the station located in his own home. This was the first public broadcasting in the West. Then two or three amateurs in the East, among them E. V. Amy, Joseph Stantley, G. E. Burghard and myself, did some broadcasting of our own, with the help of popular phonograph records. It was no unusual occurrence then for people within a radius of 60 to 70 miles to call up by asking us would we please play this selection or could we broadcast that?"

The one big event, according to Mr. McMann, which demonstrated to the manufacturers of the allied industries that the public was interested in radio and wanted it made more accessible for home use, was the radio show which the Executive Radio Council of the Second District held in the Hotel Pennsylvania, New York, in the early part of 1921.

"But it was not until the Dempsey-Carpentier fight in July that the demand for radio on the part of the public became insistent. It was through the co-operation of radio clubs on the eastern seaboard that the broadcasting of this event, which was the centre of interest of two continents, was possible. From then on

the trend of radio toward a larger public interest was assured."

Such is the debt that the industry owes to the radio amateur. How can it benefit by his further co-operation and cater to his wants?

Mr. McMann has a carefully-reasoned answer for this, based on the psychology of the amateur who is "bugs" on radio.

"The radio man who enters the field today, although he is concerned chiefly with the reception of broadcasting, is not unlike the amateur of old, and reasons with the same philosophy. Broadcasting has only increased the bounds of experimentation, and whether the amateur is an old or new recruit to radio, he is at heart the same old 'bug.' The old amateur used to buy parts or a set, go home and experiment. In perhaps a week or so he would come back, satisfied that he knew all about radio, and argue with the dealer as a result of this strong faith within him.

"Today amateurs differ only in number, and perhaps the new recruits have more money. Whereas the pioneer experimenter bought only a crystal set, our new enthusiast buys an expensive set. But that does not mean that he will remain satisfied. If there is nothing else to egg him on, there is the 'distance bug' to irri-

(Continued on page 72)

Radio Corp. Brings Action on Tube Apparatus Patents

By JOHNSON FORBES

The Radio Corporation of America has instituted a patent action that has promise of being of far reaching importance. The defendants are A. H. Grebe & Co. and the J. H. Bunnell Company. Incidental actions against other concerns have been filed. The complaint alleges infringements of five specific patents concerning the vacuum tube.

Two suits are brought against each of the two above named defendants. The first is an action in equity on De

Forest patents numbers 841,387 and 879,532. The second action in equity is based on the Langmuir patent number 1,282,439, the Lowenstein patent number 1,231,764 and the Mathes patent number 1,426,754.

In the trade the opinion is expressed that these suits are the beginning of a long legal contest which has been anticipated since broadcasting grew to large proportions. What effect this litigation will have on the

(Continued on page 73)

Power Amplification for Loud Speakers

Types of Loudspeakers Are Described and Suggestions Given that Should Assist Salesmen in Demonstrating This Apparatus

By S. G. SEARS

Of Sterling Phonic Laboratories

To the average household or office receiving set the loudspeaker has become practically a necessity as is likewise the power amplifier since the two go, or at least should go, hand in hand. There seems to be a very poor understanding of the principle of operation of both devices among those who have taken radio seriously within the last year, and for this reason it is felt that more should be told about them than that they require power tubes and high voltage.

The dealer is probably the one who needs more definite information about them than anyone else, as he must depend on a good demonstration to help put over his sales. The time has passed when he can sell a customer a fine set "because it's all the rage." He has now to demonstrate it to be more entertaining and more enlightening than anything the prospective customer has at present.

The latter is becoming more critical all the time. He comments on "da-dee-da" interference and "canary birds" and scratchy noises and such. He knows distortion when he hears it, "and can't stand it so loud." Nine times out of ten these objections can be remedied by the proper arrangement and adjustment of the component parts of the set.

Most dealers can now give headphone demonstrations to perfection, but they unnecessarily murder the loud-speaking show—where the real money is. So a short discussion on power amplifiers and loudspeakers should not be wasted. If a little time is taken to try out suggestions that come to the reader throughout this paper, he will be well repaid. If the reader has not read the first two articles of this series, it will pay to obtain them and do so before reading this one. Also he should get the table of tube characteristics in the last issue for reference throughout this discussion.

The usual series of units in a good tube set is, first, detector—which converts the incoming signal energy into audible energy by rectifying; second, first stage of amplification—which intensifies the detector output somewhat and converts it to high voltage and low current, which operates the succeeding tube more efficiently; then the

second stage of amplification which increases the signal voltage still further; and the last or power stage which converts the high voltage output of the second stage amplifier into low volt-

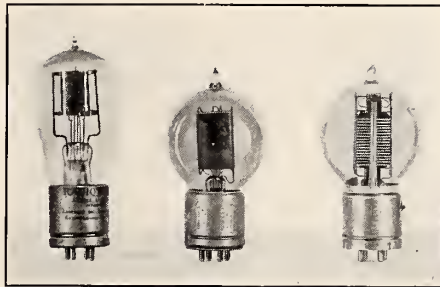

UV-202

VT-2

216-A

age and high current, which operates a loudspeaker more efficiently.

Now since each bulb in the series acts as a relay and must generate from its own plate, current or "B" battery supply, an intensified likeness of the signal impressed on its grid, the plate voltage all along the line should increase proportionately to accommodate the greater signal. That is, the detector on say 20 volts should feed into the first stage with 45 volts, this in turn to the next with about 90 volts,

and the power stage with about 130 volts. With this arrangement no tube in the series would be overloaded unless they all were and all signals would be clear, provided, of course, other things were equal. If 5 stages are used the voltage should be still further increased.

In order to connect this up with loudspeakers it will be necessary to say a few words about them as to their efficiency and capacity. There are four general classes of them, each with a maximum capacity for sound beyond which it will start to distort or rattle and each with peculiarities all its own. If we take them up in order, we shall consider first the bi-polar, iron diaphragm type such as the usual type of headphone. These can be wound to any reasonable impedance and will operate directly in the plate circuit of the tube as do headphones. The "B" battery D. C. passing through the winding serves to intensify the magnetic field of the permanent magnet usually employed in such (provided it flows in the right direction) and increases its efficiency somewhat. This type will operate satisfactorily up to about one watt input. Here a roughly

(Continued on page 64)

Philadelphia Has Formed Radio Trade Association

By WILLIAM B. WILKINSON, JR.

The radio merchants of Philadelphia, after holding several preliminary meetings during the last few months, have slowly evolved an association of responsible distributors, jobbers, and dealers, named "The Radio Trade Association of Philadelphia." The organization of this association was effected on November 13, when officers were elected and constitution and by-laws adopted.

The objects of the organization, as set forth in the constitution, are: "to

promote the welfare of its members and to distribute among them the fullest information obtainable in regard to all matters affecting the radio business; to aid in bringing about more friendly relations among those engaged in the radio business; to assist in standardizing and marketing high-grade radio merchandise; to inaugurate and maintain publicity campaigns; to improve the quality of radio goods marketed by American manufacturers and the service rendered by

(Continued on page 68)

From the Editorial Viewpoint

The New Year and Radio

Nineteen Hundred and Twenty-two was radio's best year. What will 1923 bring forth?

The year just passed has developed radio as an industry—but not to the extent hoped for by many of radio's real friends.

This weakness is not due to the lack of interest on the part of the present radio enthusiasts but is due, in great measure, to the obvious fact that the recognized trade leaders in this field have held aloof from the rank and file.

No criticism is being directed at any group of manufacturers or jobbers or retailers for their lack of proper foresight. If they lack the spirit of trade service, the final loss will be theirs.

There is ample opportunity to recover the lost ground—mainly because the great American buying public has not been oversold on radio.

Trade surveys indicate there are not over one million real radio sets in operation. Considering the fact there is, so it is recorded, more than twenty million homes in the United States, the future possibilities from this one source are interesting.

When radio broadcasting is properly developed every public institution, every railroad station, every hotel and most restaurants, and every factory and business place, will have a radio set.

The commercial angle for radio has its possibilities. Even today air space is being sold on certain broadcasting programs, at certain rates per hour. This is a premature perversion of public interest.

There was really no public demand for radio during the past year. There is none now and there never will be, for the simple reason that the public has no imagination.

The public really never "demands" anything. It takes what is offered and, if the result is pleasing, indicates thankfulness in praise that is usually fulsome.

Once in a while some genius sees something that the public would like if it knew of its existence, gives it to the public—and makes his fortune. Then the spokesmen for the generally mute populace do declare: "There was a demand for that thing and the man who saw the demand profited."

Deems Taylor, dramatic editor of the *New York World*, speaking on "demand," indeed cites a lesson for radio folks. Says Mr. Taylor:

"There was no public demand for Balieff's Chauve Souris in this country, for the public had never heard of the Chauve Souris before it appeared. There was no public demand for Ford cars until Ford invented them, and there was no public demand for the *Saturday Evening Post* until George Horace Lorimer made one.

"The public has certain vague wants, of course, which

are in latent form the thing we call demand. It is the business of the shrewd business man or editor to find out what these are and minister to them. Ford had the sense to see that the public would like to ride around in a vehicle that went by itself and didn't cost much. Lorimer saw that it took all kinds of people to make a world and that any magazine that offered something to everybody for a nickel a week would probably sell rather extensively."

Most of the business men in the radio industry are agreed that the American public will take radio if it can get it. Not all of these men are agreed as to the methods to be employed to reach the public to fill the "demand."

Why is this?

Is it because a few of the so-called big fellows are still believers in the divine right theory, insofar as they and the radio business is concerned?

Believers in the theory of divine right, as applied to the radio industry, have already suffered losses, totaling in the millions—because of defective apparatus. Their good-will loss is not a matter of bookkeeping.

There isn't anything the matter with the radio industry that common sense cannot cure and the one way to aid in the development of a real industry is by the several trade organizations, working together to the one end, the development of radio as an art and as an industry.

Better broadcasting will develop from co-operation; better business will come and proper methods can be applied to create real "demand" on the part of the public.

Radio, in all its wonders, is a blind thing to the average American. The story of radio must be told again and again and told properly. The picture must be placed before the buyer for his approval before the trade can expect quick sales.

Some of our larger radio organizations have not prospered, in the past year, to the extent hoped for by them. Poor business management must be blamed—nothing else. They enjoyed their opportunity and found themselves lacking. They must step aside and make room for others.

Big concerns are not necessarily infallible in sales promotions. Mere size doesn't beget ability—in the radio industry.

Nineteen Hundred and Twenty-two developed a new crop of business men—radio manufacturers, jobbers and retailers. At this writing they total around eight thousand.

There are not over five thousand retailers and jobbers in this industry.

These retail radio business men, it might be estimated, did a total retail trade of around fifty million dollars. The jobbers did a volume of about half of this and the manufacturers did the balance, direct to retail trade.

Obviously one hundred million dollars has changed hands during 1922 because of the advent of radio.

Figures are not available for radio, other than the knowledge of the number of radio retailers, jobbers and manu-

facturers. (These figures are as THE RADIO DEALER shows them to be.)

In the development of radio, as an art, the past year has brought forward real sets and real parts. It is no longer possible to produce apparatus of inferior quality, with the expectations of a ready market.

The radio retailers are becoming educated. Even the former electrical retailers admit they're learning!

Radio refinements developed during the past year rather than new things of basic value. The tube set situation will be cleared up this coming year, it is hoped, to the end that certain new offerings may be presented to the buying public.

Nineteen Hundred and Twenty-three can be expected to be a banner year for radio, because of the activities of a number of radio concerns who are producing real wares. The volume will be evident, during the year, and certain territories can figure their 1923 sales, now, on their knowledge of broadcasting conditions for their sections.

Good broadcasting programs, coupled with real selling development, will make 1923 the big year it should be in radio, for real merchants.

Referring to broadcasting, THE RADIO DEALER does not believe that a monopoly should be made possible for the air, no matter how obviously philanthropic the intent. There is now a tendency towards air monopoly. The time isn't right for any such monopoly and if it is maintained and enlarged the trade will suffer because the general public *will not purchase radio equipment if they are led to believe broadcasted programs are theirs through the monopolistic achievement of any certain group and that these programs are given as charity with each radio set purchased.*

Radio has a big year in sight and if proper steps are taken; if disinterested advice is followed the record at the end of the year will bear out the present prediction.

The Church and Radio

Radio has joined hands with the church.

Not only does radio bring the church into the home, but it brings church services into other churches.

The story is told of a church out West that lost its pastor. No substitute clergyman was available and it looked as if there would be no services on the Sabbath. A radio enthusiast saved the day. He rigged up a receiving set with a loud speaker. When the congregation assembled on Sunday morning it was surprised to see a mechanical device on the rostrum instead of a clergyman.

Soon the contraption on the rostrum prayed, sang, talked and preached. The sermon was said to be a good one. It was probably better than the little congregation was in the habit of hearing, for it was a poor church and had but little money.

No one knows what unexpected influences may be exerted by radio on church affairs. It may make possible the elimination of a certain number of clergymen. It may develop a new class—ecclesiastical orators—who will spe-

cialize in broadcasting and will leave the pastoral work to be done by others.

Such a condition is within the range of possibility. Doubtless it would result in better sermons; perhaps not better churches. It might also help the argument, "Why go to church when I can stay home and hear better sermons than in church?"

A recent survey shows that the broadcasting in this country of Sunday church and religious services covers 65.2 the area of the United States—surely enough for most people.

Some large churches are now broadcasting their own services to those who stay at home. Others will doubtless do this soon. Churches that aim to serve as "community centers" have receiving sets for the benefit of the church clubs and organizations seeking sociability and pleasure in the church-house.

Regardless of the effect that the church has on radio, it is not improbable that radio will have a greater effect on the church. Whatever the result, it is plain that this cooperation cannot help but increase the demand for radio equipment, which is the interesting point to the radio dealer.

Standardization of Radio Products

The Bureau of Standards in the past has done much creditable work in the direction of standardizing parts used in manufacturing. This has been a decided help in increasing factory production, in assuring quality and in eliminating many near duplications of parts. In the aircraft line alone, it has done away with many thousands of unnecessary sizes of gadgets and has given assurance of strengths of materials.

In a similar way, the Society of Automotive Engineers has done a like service for the automobile industry, and has made possible in no small way, the present comparatively low prices of motor cars and trucks.

A call for a meeting to be held in New York City this month to consider the formulation of radio standards has been made by the Bureau of Standards. The object is a worthy one, and if it receives the proper cooperation from the industry, should prove of benefit not only to the manufacturers, but also to the dealers and their customers.

Lesson Left by John Wanamaker

With the passing of John Wanamaker, the prince of retail merchants, and incidentally a radio merchant of no small magnitude, a lesson is brought home. Mr. Wanamaker from the smallest of beginnings developed a business of huge proportions. Strict industry, combined with the merchandising of reliable goods made success, which in no small part was augmented by the liberal advertising.

Mr. Wanamaker at no time lost the faith he had in advertising which he gained years ago when he was engaged in the publishing business. In a large measure he credited his success to telling the public what he had to offer.

Mountain Jobbers Develop Trade Service

Wholesalers Operate Technical and Commercial School and Co-operate to Bring Better Business to Every Radio Business Man

By JACK L. HURSCH

Manager, The Reynolds Radio Company, Denver, Colo.

For the promotion of better radio in the Western territory there has been arranged what might be termed the Radio Jobbers' Association of the Rocky Mountain District. This association will be known as the Radio Service Bureau. The organizing membership consisted of representatives of Hendrie & Bolthoff Supply Company, Mine and Smelter Supply Company, Reynolds Radio Company, Rocky Mountain Radio Company and Winner Radio Company.

These are the largest jobbers in the inter-mountain district, at this time, and at their organization luncheon meeting it was decided to call the business group, the Radio Service Bureau. Jack I. Hursch, general manager of the Reynolds Radio Company of Denver, was elected president. Baxter Lanus, of the Rocky Mountain Radio Company, was elected vice-president; Orville Sibbald, of the Broadcaster Company, was made secretary, and J. Vreeland, of the Winner Radio Company, was chosen treasurer.

So that's that. And now, to the objects of our co-operative movement:

Through the means of this Bureau, we have brought about a much healthier condition, first recognizing that co-operation and harmony are the first assets to good business. The members of the association have gotten together and have assisted each other in depleting over-stock which any individual organization carried, thus creating a healthier condition.

We are also carrying on and developing publicity in the newspapers and magazines headed "The Radio Service Bureau." Under this heading articles for the betterment of radio, to assist the radio amateur and the radio prospect for radio equipment are printed. The articles appear at proper intervals and are already bringing results. Further, jobbers and dealers have gotten together through The Service Bureau and have arranged to take full page newspaper advertising, thus placing before the public radio on a sturdier advertising basis.

The Bureau also arranged during November, a course of instructions, held in Denver at the DN₄ Station for the radio dealers. Post cards were

gotten out by each jobber to his dealers in his territory, asking them to fill in the return card, advising if they would have a representative to attend the course of instructions in radio, both from a technical standpoint as well as from a selling standpoint. These lectures enjoyed a large attendance (close to forty men), which was extremely pleasing to the Service Bureau. Intense interest was shown by the dealers to become acquainted with the merchandise which they are selling to the radio trade. Its effect was quite stimulating.

The school was conducted by the best radio technical men in Denver, namely: Dr. W. D. Reynolds, president of The Reynolds Radio Company; Captain Winner, of The Winner Radio Company; Mr. Peterson, of The Rocky Mountain Radio Company; Mr. Bartlett, of the Hendrie & Bolthoff Supply Company; and the writer.

Many standard radio equipments and standard radio sets were on dis-

play at the school, thus affording dealers the opportunity to acquaint themselves with the construction and operation of each individual standard set. Technical subjects were discussed and analyzed. The selling of radio was exploited and the possibilities developed were extremely satisfactory.

After the course of instructions, dealers were entertained by the jobbers, each individual organization throwing its doors wide open, giving the dealers opportunity to come into the organization, see every piece of radio equipment, see its operation and development.

In this territory, which is sparsely settled, the radio dealer has a great many disagreeable conditions to overcome in order to get satisfactory results in selling radio equipment, the dealer sometimes having to travel anywhere from 100 to 500 miles to make a demonstration of complete radio equipment, thus being unable to prepare himself for emergencies at the

(Continued on page 73)

Pointers for Radio Dealer Aiming to Increase Sales

By ALBERT EDWIN SONN, R. E.

Technical Editor, Newark, N. J., Sunday Call

Albert Edwin Sonn, who is the technical editor of the "Sunday Call," Newark, N. J., radio department, is a keen student of radio—as an art and as an industry—and is well qualified to discuss trade problems. Mr. Sonn is an early radio fan, of the vintage of 1905, when he operated a transmitting apparatus and helped create the code system applied to stations by the Government.

"Mr. Radio Dealer, what kind of service are you giving to your customers?"

It is not the purpose of this article to go into details of how the radio dealer should run his business, but to point out the little deficiencies in the dealer's attitude toward the buying public. These little points have come to the attention of the various radio circles during the fall radio season, and throw some light upon the failure of some radio supply stores to benefit from the great demand for apparatus at this season of the year.

How many dealers give their customer the benefit of a tuning talk, or an explanation of a good hook-up, or

(Continued on page 54)

Development of Melco Supreme Receiver

Lester L. Jones, the Engineer Inventor, Is Credited with Devising This Radio Amplifying Receiver After Careful Research and Investigation

By J. McKERCHAR

The Melco Radio amplifying receiver marks a distinct advance in the reception of broadcast radio telephones, according to the manufac-



Lester L. Jones

turers, with a real improvement in tone quality.

The Melco type 400 is a non-regenerative coupled circuit receiver with a two-stage audio-frequency amplifier. This outfit has a range of over 1,000 miles on an outdoor antenna, and is selective to tuning clearly and sharply between broadcasting stations. Type 400 did not satisfy the inventors as to meeting the requirements of those who could not have an outdoor antenna, so the manufacturers, the Mortimer Radio Corp., retained a consulting engineer who has a national reputation as an inventor and possesses broad experience in radio reception, Lester L. Jones, inventor of the Antenella, the Radio-bat B and the Telos variometer, to advise them in their quest for something better, to design apparatus embodying the best engineering principles, and if possible, to combine his inventions so as to permit commercial pro-

duction of a receiver that would be a real improvement.

Mr. Jones' conclusions as reported to the Mortimer Corporation were interesting. He reported:

1. The regenerative type receiver is already causing so much mutual interference among the now relatively dense radio audience, so much variation of signal intensity and so much loss of tone quality, that it hardly behooves any of us to increase their number. By itself, the regenerative type receiver does not give sufficient volume on indoor antennae for a loud speaker, and, as usually supplemented by two stage audio-frequency amplifiers, it loses tone quality.

2. The super-regenerative type set causes much more mutual interference among the radio audience than the regenerative type.

3. The superaudible frequency amplifier type set requires too many tubes for general use and has other disadvantages.

4. The reflex type of set is sensitive, economical of tubes, but depends on audio-frequency amplification. With its attendant loss of tone quality for a large part of its volume and with the vacuum tubes now commonly used, it suffers a very rapidly increasing distortion as the signals become loud, until complete loss of intelligibility results when its full sensitivity is utilized for loud speaker reception of nearby broadcasting stations.

5. The radio amplifying receiver (non-reflex, non-regenerative, tuned radio frequency amplification) gives high amplification per stage, no loss of tone quality, no interference to other members of the radio audience and no distortion of the passing radio waves that supply all of us our radio music, lectures and stories. In addition, this system permits of single tuning adjustments that result in a high degree of selectivity. All this, provided certain technical obstacles well known to engineers and experimenters are removed in a commercially practical way, make this type most desirable.

These technical obstacles are largely related to the "feed back" reaction through the vacuum tube, which causes radio and audio oscillations to be generated in the receiver long before one can tune in a signal of satisfactory volume.

Acting on the report of Mr. Jones, the Melco Supreme radio amplifying receiver was designed. It has four tubes, two for tuned radio-frequency

amplification, one for a detector and one for a one stage audio-frequency amplifier, included mainly for assistance in tuning-in distant stations.



Benjamin H. Price

The three tuning elements are a Telos variometer for tuning outdoor or indoor antenna or the loop, and two Telos tuning amplifier transformer variometers. This gives a system of three independent elements for tuning and amplifying over a wave length range of 175 to 500 meters.

The selectivity of this system should be sufficient for all needs and may be said to lean more towards being too great than too little. To assist the user when first handling the set, charts that aid in tuning study are packed with the set. Tuning is further simplified by setting of the two right-hand dials, which are always at very nearly the same degree. This increased ability to select between broadcasting stations is believed to be well worth the effort of making the necessary adjustment.

The elimination of internal oscillations is accom-

(Continued on page 58)



The Melco Supreme Amplifying Receiver

"The Man in the Moon" Is a Regular Fellow

Famous Bill McNeary, Radio Editor, Has Right to Proud Title of Real Friend to Radio Art and Radio Industry

By HARRY M. KONWISER

Before William F. B. McNeary became radio editor of the Newark, N. J., *Sunday Call*, he served Uncle Sam in Secret Service in Poland, Esthonia, Latvia, Czecho-Slovakia for a four-year period.

The *Sunday Call* began its radio department on October 9, 1921, and from the very first issue, featuring the wireless department, became a recognized force for good in the radio world. No newspaper has done more to interest people in radio and no paper has pursued a busier policy of service to its readers.

The service rendered by this paper is large, at least sixty inquiries being received and answered each day. This service labor is handled by Albert Edwin Sonn, who as a boy—in 1905—was one of the first "radio bugs" in the land. With other "bugs" Sonn developed a code call and this is now employed by the Government.

William McNeary, who is generally called "Bill," was a boyhood chum of Sonn's and together they have ascended to radio's heights. Their every activity has been a forward, uplifting one—an unselfish devotion to radio development. He enjoys a great measure of fame as a radio editor, with records showing the printing of sixty inches of advertising in the first radio department, going to 1,930 inches in April, 1922, and now running around 1,100 inches. It is generally agreed no other newspaper can show this volume.

Obviously McNeary is the right man in the right spot. The great favor enjoyed by radio throughout New Jersey is due to the *Sunday Call*. This statement is made with proper consideration.

Apart from the stellar work done on the *Call*, mention must be made of his broadcasting activities—for Bill is "The Man in the Moon." As radio broadcasting features come and go, "The Man in the Moon" is the most popular feature that has been broadcast—serving a unique public, the children.

McNeary is almost thirty-one years of age and radio folks who learn this fact wonder at his rare ability to chat to children, in the manner in which he does. His voice is sympathetic, "carrying a tremendous amount of



William F. B. McNeary,
"The Man in the Moon"

sympathy," as Charles James Fox (Br'er Fox) puts it.

The big idea around "the Man in the Moon" stories is not only that they are pleasing to children, but carry a moral lesson administered in a unique manner. A session with "The Man in the Moon"—for any child—makes for a better child, because of the lessons inculcated in this series.

Bill McNeary is the pioneer in

broadcasting to children and the fact that over twelve thousand children have written "The Man in the Moon" speaks for the wondrous popularity of this broadcasting feature. "The Man in the Moon" stories are broadcasted Tuesdays and Fridays at 6:30 p. m. from W.O.R. A supplemental feature, employed last month, was "Santa Claus." "Hercules" is another offshoot of the McNeary stunt.

Under the direction of McNeary, the *Sunday Call* was the first newspaper to broadcast, and the same paper leads in having first broadcasted a World's Series, big football games, and election returns. This paper has been helpful to the industry—building up and maintaining consumer interest to an unusual extent.

There isn't much more to say in a story of this sort about Bill McNeary because Bill isn't the sort of chap who lends himself to an interview. He is modest.

He has the "voice with a smile" and thousands who have listened-in to enjoy themselves have learned to love the McNeary voice.

Bill has one hobby—it would seem—and that is radio, and his philosophy of radio develops hard, continuous work. He doesn't dream; he acts.

Bill McNeary has a real claim on the friendship of every radio man, woman or child—whether the interest is in radio art or radio industry.

Patent Office Choked with Work Demanding Attention

By CHAUNCEY P. CARTER
Trade-Mark Specialist

The annual report of the Commissioner of Patents to the Secretary of the Interior covering the fiscal year ended June 30 last has just come off the press. It shows an unprecedented situation in the patent office.

One hundred and thirteen thousand five hundred and ninety-seven applications for patents, designs, trademarks and label and print copyright

registrations were filed during the year, or about 7,000 more than in the previous year, which was also a record year.

Notwithstanding the increases in salaries and staff granted by Congress last February, revolutionary changes in methods of doing business in the office, and economies of various sorts, (Continued on page 69)

Herman Lubinsky

Pioneer and Instructor Developed the Radio Shop of Newark

Within the last year or so radio has made gigantic strides forward until it has reached its present popular position in public and family life of today. This sudden leap in prominence has caused the public to think of it as a discovery of recent years. But to a close observer its steps have been slow but positive, and its present height has



Herman Lubinsky

come only after years of experimenting. Perhaps the greatest contributor to radio progress was the early pioneer who ventured beyond the realm of telegraphy into the new field called radio. One of these early experimenters was a boy by the name of Herman Lubinsky in the small town of Branford, Conn. Being of a mechanical turn of mind, his early training was in the electrical field. He began experimenting at an early age with what little apparatus he could obtain.

Then came what was thought a great invention, the coherer detector. Mr. Lubinsky began experimenting with this. In 1904 he adopted radio as a career, and at the outbreak of the war he immediately offered his service and was accepted to teach radio to army men in the New Haven High School. Later he became instructor at the Essex County Vocational School and an instructor of electrical theory and practice at the Essex County Vocational school for Boys.

While at these institutions, he contributed articles on electrical theory
(Continued on page 56)



PALS AGAIN

Never a dull evening in the home

MORE and more is the radio consumer buying his receiving set and other apparatus merely because he needs them as preliminary to the volume and clearness he can get from Magnavox Radio the Reproducer Supreme.

The sales helps we supply to our dealers link them up directly to the most interesting National Advertising Campaign in the industry.

- R-2 Magnavox Radio with 18-inch horn:** this instrument is intended for those who wish the utmost in amplifying power; for large audiences, dance halls, etc. . . \$85.00
- R-3 Magnavox Radio with 14-inch horn:** the ideal instrument for use in homes, offices, amateur stations, etc. \$45.00
- Model C Magnavox Power Amplifier** insures getting the largest possible power input for your Magnavox Radio.
 - 2 stage AC-2-C . . \$80.00
 - 3 stage AC-3-C . . 110.00

What we are doing to help Radio Dealers is carefully explained in our publication "The Magnavox" — send for free copy.

The Magnavox Co., Oakland, California
New York: 370 Seventh Avenue

MAGNAVOX

Radio

The Reproducer Supreme



What the Manufacturers Are Doing

Betts Special Receiver

An interesting receiving outfit is being brought out by Betts & Betts Corporation, 630 West Forty-third street, New York City, known in the electrical trade for the past twenty years. It consists of three units, including a highly specialized short-wave tuner, a visible detector and two-



stage amplifier and an unusually good loud speaker.

It is claimed that the tuner, being designed particularly for the usual broadcast wave-lengths of from 350 to 500 meters, is remarkably efficient and selective within this range. This being the popular demand there should be a large sale for such an instrument.

It is extremely compact, measuring only 5 x 10 inches, and goes nicely with their detector-amplifier. This latter is a neat and compact unit with the tubes in full view, embodying an ingenious inside arrangement with short connections and simple controls. The Betts loud speaker is unusually sensitive and embodies a type of horn which delivers pure, clear tones without metallic twang.

Every detail of material, workmanship and finish in this outfit is fine, and the whole is compact, simple to operate and unusually efficient, making a very high-grade receiver at a moderate price.

Neat Loop Aerial

The DuoSpiral loop aerial, made by the Radio Units, Inc., Maywood, Ill., and distributed by the Hudson-Ross Co., 123 West Madison Avenue, Chicago, is adapted for use where an or-

dinary outside aerial is not practical or desirable. In addition, it is a quality article, whose design and material, the makers claim, is calculated to insure excellent reception.

The DuoSpiral measures 24 inches by 24, and contains 96 feet of green silk-covered wire. The horizontal arms are forced out by springs, which keep the wire ever taut, thus eliminat-

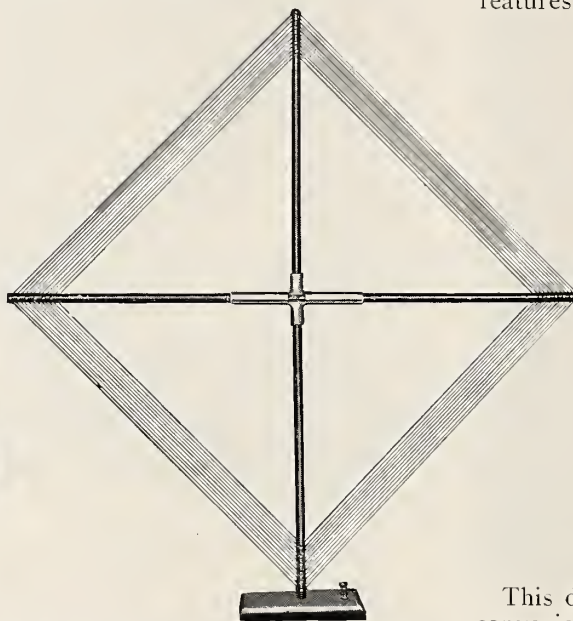

ing any possibility of lost efficiency through lax wires, and also insuring the neat appearance of the device.

Dictograph Helps Dealers

What one manufacturer is doing to assist the radio dealer to make his window displays more effective is illustrated in the accompanying cut. This shows the newest window display cut-outs and cards which the Dictograph Products Corporation, 220 West 42nd Street, New York, is supplying free of charge to all dealers handling the Dictograph products.



Parkin Dial-Type Rheostat

With a dial to match dials on the variable condenser and vario-coupler of any set, the Parkin dial-type rheostat is an innovation bound to meet with the approval of the radio enthusiast who is careful about the appearance of his radio set. This rheostat, made by the Parkin Manufacturing Co., San Rafael, Cal., has other features to recommend it.

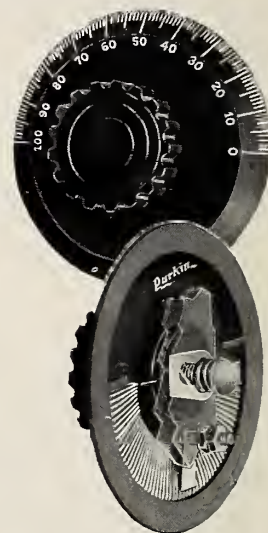

This dial-type rheostat is made for convenience. It is designed to eliminate one part in the assembling of a cabinet set, to do away with heating and to provide more cabinet space. The resistance element as used in this Parkin instrument makes this possible. It is placed in a recessed groove in the back of a three-inch molded bakelite dial, outside the cabinet. The resistance unit used is, as the illustration shows, a flat semi-circular core, wound radially with non-corrosive resistance wire. Adjacent turns are slightly spaced, allowing single-turn adjustment. The resistance is of five ohms with a carrying capacity of one and one-half amperes.

Efficient Condensers

Tests made recently at the Dunham Laboratory, Yale University, confirmed the faith that the Liberty Tool and Machine Company, of Derby, Conn., has in its Liberty Variable Condenser. The principal feature of this radio unit is the double bearing assuring rigid construction. Adjustments can be quickly made at either end and maintained with lock nuts.

Rotor Control of Hammarlund

The patented device that controls the vernier of the Hammarlund vernier variable condenser is only one of the features of this carefully designed instrument. This device moves the rotor plates by as little as one-fiftieth of a degree on the condenser scale,

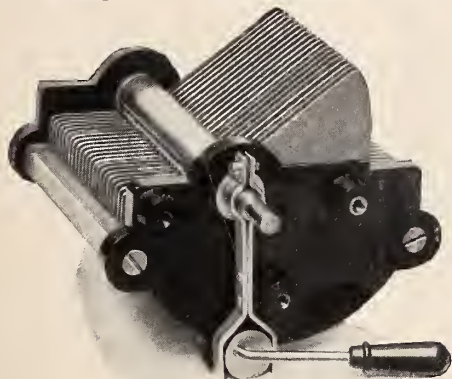

and is arranged to eliminate all interference due to body capacity.

Construction of the Hammarlund condenser is rugged throughout, the capacities remaining constant at given settings. Nickel-plated brass plates, 1/32" thick, are pressed into grooves accurately spaced and milled into heavy brass shafts. The inaccuracies of the washer type are thus obviated. The shafts run in bronze bearings moulded in genuine bakelite tops and bottoms. All metal parts are nickel-plated. The plates are Bureau of Standards straight-line wave length type suitable for wave-meter work.

Shielded Transformers

Known as specialists in radio transformers since the beginning of radio's great expansion, the Rauland Manufacturing Co., 35 South Dearborn Street, Chicago, is now on the market with a full line of its specialty, the All-American audio and radio frequency transformers.

The type illustrated here is the All-American audio frequency amplifying transformer. As the cut indicates, it is completely shielded in a black japanned case. The shielding makes it possible to mount the transformers extremely close to one another without inductive disturbances, howling, or distortion. The new 5-1 ratio transformer has an amplification constant approximately equal to that of the 10-1 transformer, but can be used in as high as three stages without distortion.

All the Rauland transformers are highly finished, presenting an extremely neat and attractive appearance for counter sale.

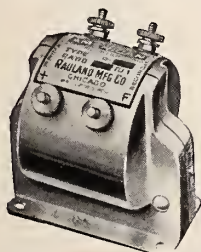

ATWATER KENT RADIO RECEIVING SETS

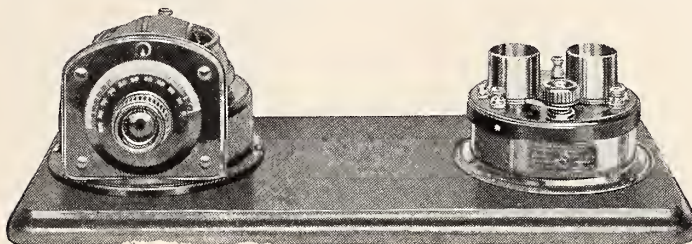

The two instruments shown above comprise an excellent and complete receiving set. The Coupled Circuit Tuner and Detector 1-Stage Amplifier on the mahogany mounting board, present a beautiful appearance.

Complete Outfit, as above, wired . . . \$32.00



The above set, consisting of Coupled Circuit Tuner and Detector 2-Stage Amplifier, is an ideal set for either phone or loud speaker use. Note that this set includes two stages of audio frequency amplification.

Complete Outfit, as above, wired . . . \$35.50

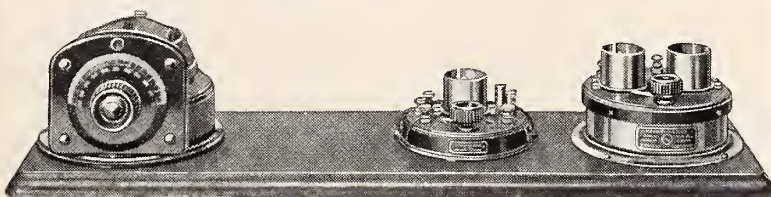

The Coupled Circuit Tuner and Detector Unit only, comprise a complete receiving set. Later, if desired, the 2-Stage Amplifier can be added for two stages of audio frequency amplification as shown above.

Complete Outfit, as above, wired . . . \$37.50
Complete Outfit, as above (without Amplifier), wired, 23.50

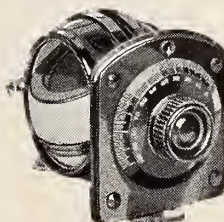

The Mounted Variometer carries through the standard quality of ATWATER KENT products. For an open set it supplies a finished instrument unsurpassed in appearance and performance.

Mounted Variometer . . . \$10.00

An Excellent Merchandising Proposition

ATWATER KENT MANUFACTURING COMPANY
4941 STENTON AVENUE Radio Dept. PHILADELPHIA, PA.



NATIONAL SEAMLESS TUBING

In Large Diameters

For Vario-couplers, Vario-meters, Tuning Coils and wherever you use large diameter fibre tubing, National Seamless Tubing is less expensive and infinitely superior.

National Seamless Tubing is a specially developed, laminated tubing that retains its form and will not warp, swell or shrink. Exact in both diameters and easily worked.

Can be furnished in dark gray fibre or black fibre. Any quantities, diameters from 3" to 4½" I. D. Any wall from 3/32 up.

Give us your specifications. We'll send samples and prices.

National Fibre for Panels

Hard Black Panel Stock of good dielectric strength. Gives satisfaction for condenser tops and bottoms, rheostat bases, washers bushings, etc. Let us quote on the stock itself, or on completed parts machined to order.

Peerless Insulation

The standard thin weight fibre insulation or "fish paper."

National Fibre & Insulation Co.

Box 451-A Wilmington, Delaware
New York, Chicago, Philadelphia, Detroit,
San Francisco, Cleveland, Omaha, Pitts-
burgh, Boston, Rochester, Birmingham,
St. Louis, Baltimore, London, England
In Canada, National Fibre Co. of Canada,
Ltd., Toronto

Loud Speaker Cabinet

Designed by Earl C. Hanson, the well-known technical expert of the Globe Phone Manufacturing Co., of Reading, Mass., the Globe cabinet loud speaker is a departure in point of construction from any other loud speaker or horn on the market. It most

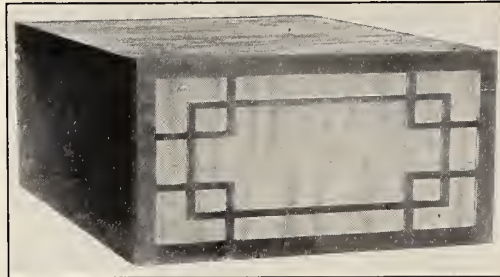

nearly resembles the reproducing box of a cabinet phonograph, and the principles underlying the tone-box construction of the phonograph have been adapted in the Globe cabinet loud speaker to radio use.

The cabinet is mahogany with highly polished finish, has scroll work front, is silk lined, with measurements 14½-x19x7¾ inches, weight 12 lbs., and has external binding posts. No extra power from batteries is required, and the loud speaker connects to the set same as head phones.

The Globe Phone Manufacturing Company also make the Standard and Junior model headsets, crystal detector sets, antenna attachment plugs and the Vactophone, invented by Mr. Hanson for use by the deaf.

Improved Radio Parts

New devices for radio service are being offered by the Radio Improvement Company, 25 West 43rd Street, New York City, in the shape of their improved brand of anti-capacity radio jacks for open, closed and double circuits, improved lamp sockets, battery switches and telephone plugs.

The jacks introduced by this company are said to be the first anti-



Double Anti-capacity Jack

capacity jacks designed specially for radio use. These jacks are neat in appearance, as the illustration of the double circuit jack printed herewith discloses, and are highly finished with contact springs of German silver and with silver contact points. They re-

quire no soldering, are easily mounted on the panel and fit any standard telephone plug.

The improved battery switch, also illustrated, serves as the simplest means of connecting or disconnecting the battery. A specially attractive feature is a red button which adds to the

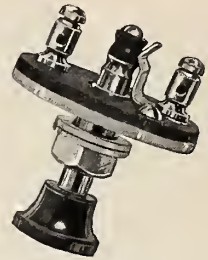

Improved Battery Switch

appearance of the receiving set.

These products were designed by Joseph W. Jones, who has been identified for many years with the production of high class electrical and scientific instruments and other products of wide reputation.

Selco Head Phones

One of the features of the Selco head phones, made by the Spies Electric Works, of 564 West Van Buren Street, Chicago, Ill., is the tempered clock-spring steel head bands, which are nickel-plated and soil and rust-proof.



Another unique feature is the tension adjustment for regulating the pressure of the receivers against the ears. By arrangement of careful design, pressure on the ears can be increased or decreased at will, merely by varying the distance between the two head band strips. The position of the receivers is not disturbed and the pressure adjustment can be made without removing the head phones.

Other specifications of the Selco head phones are Swedish iron cores, tungsten steel magnets, rust-proof diaphragms, nickel-silver clamps and phosphor-bronze forks. The weight of the head phones is twelve ounces.

CROWN Moulded Bakelite Variometer and Vario-Coupler

VARIOMETER

Embodied in this variometer are many unusual refinements and constructional innovations. Mechanically the instrument is without a peer. Double bearings on both front and rear shafts insure permanent rigidity and guarantee true spinning of the rotor. Genuine red bakelite forms of deep cross section render the instrument well nigh unbreakable. The heavy brass legs are so designed as to be integral with the entire unit and yet not interfere with the mounting of the device on a panel. Extreme accuracy throughout marks the construction. Through the utilization of the most approved principles of electrical design a degree of efficiency, seldom approached, has been attained. The carefully computed space between the inductances grants an astonishing sharpness of tuning. Connection to the rotor is made through flexible leads, so designed as to preclude any possibility of short circuits or broken connections. The assembled instrument is possessed of superlative beauty. Burnished brass, and specially buffed bakelite forms contribute towards making the instrument a desirable and fitting unit in the finest set.

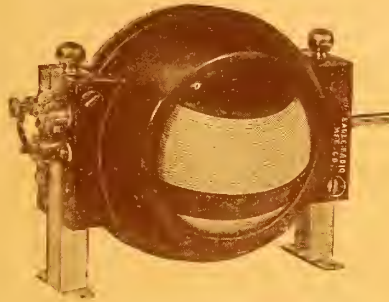

Wave Length Range—150-600 Meters

VARIO-COUPLER

The Crown Variocoupler was evolved to fill the demand for an instrument of high electrical precision. Through the employment of theoretical principles in a practical manner unusual sharpness of tuning is obtained, and the elimination of interference is made possible.

The high inductance value insures a maximum of signal intensity. Primary and secondary inductances are in the form of two concentric spheres separated one-half inch. The primary is internally wound in a bakelite form. The secondary winding is borne on a bakelite rotor. Fourteen taps on the primary, so arranged as to permit the use of any desired number of turns, are brought to a bakelite panel mounted on the rear of the instrument. This method of construction obviates any difficulty in connecting up the instrument in the set. Substantial red bakelite forms are used throughout the construction. Sturdy brass fittings provide for extreme rigidity. Flexible leads to the rotor guarantee a positive connection at all times. The greatest possible care has been taken to produce an instrument of both beauty and efficiency.

Variometer List Price \$8.50

Vario-Coupler List Price \$9.00

CROWN Triple Coil Calibrated Mounting

There is nothing more fascinating than the reception of Radio messages from high power stations located thousands of miles away. These stations use wave lengths between 1,000 and 25,000 meters. This is far above the receiving range of the average receiver designed for amateur broadcast reception.



This "Crown" Mounting has the following special features:

1. Made of Thermoplas, a high grade insulating material; it possesses the advantage over rubber of resisting heat to a far greater degree. It has high dielectric and mechanical strengths, is non-hygroscopic, is unaffected by atmospheric agents and will not deteriorate with age.
2. Special Locking Device to keep the coil in place, thus preventing it from being thrown out of adjustment.
3. Special Adjustable Bearing feature.
4. Special constructed Bushing, preventing wear on top and bottom plates.

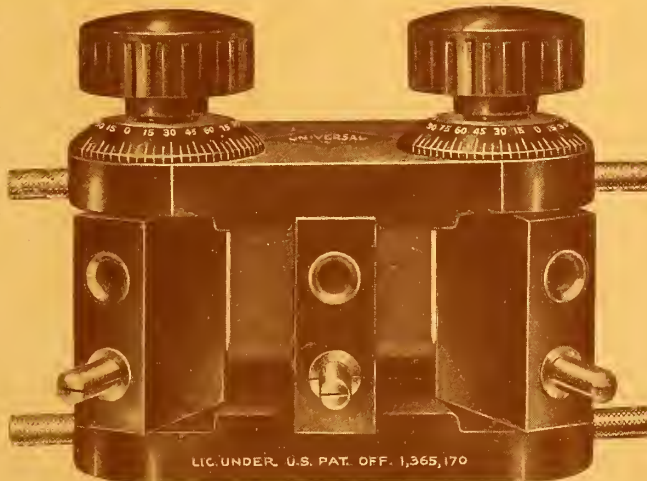

Licensed under DeForest U. S. Patent, No. 1,365,170

5. Special constructed Calibrated Dial, showing the stations tuned.
6. Positive Connections on rear of blocks.
7. Complete with Flexible Leads.
8. All Metal Parts of brass and highly nickel plated. Its high polish and fine finish give it a very attractive appearance.
9. The simplest Mounting to install on your set.

List Price

Triple Coil Mounting . . . \$5.00
 Single Coil Mounting50
 Telephone Plugs 1.00
 Telephone Jacks . . 65c, 80c, 95c
 Dials 2", 3", 3 1/2" . .35c, 50c, 75c

DISTRIBUTORS WANTED. WRITE FOR OUR PROPOSITION AT ONCE.

CROWN RADIO MFG. CORPORATION

78 FIFTH AVENUE

NEW YORK



DOUBLE Your Radio Sales in 1923

You can double your radio sales in 1923 if you give heed to the big selling plan back of ACE WIRELESS BATTERIES. We are going to have some real selling helps for you—not only to increase the sale of ACE batteries, but provided to sell *more* of any and all radio supplies.

The ACE RADIO BOOK is one of these ideas which, put to work, will sell and re-sell your merchandise. You give away free one of these interesting books to each customer buying an ACE WIRELESS BATTERY.

Get your supply of books with

GIVE AWAY ACE RADIO BOOKS

Everyone owning a radio set or contemplating one, wants one of these books. Besides they'll want the ACE Battery because you can guarantee results.

Ace Wireless BATTERIES

The battery is recognized as the leader in its field. It is silent in operation, because it is constructed along specific lines to eliminate noise. It will not bulge at the top from escaping gases. It is a higher voltage battery—each cell being higher in voltage than other makes.

Get in on this profit maker.

**THE CARBON PRODUCTS COMPANY
LANCASTER OHIO**

CUT OUT THIS COUPON
 THE CARBON PRODUCTS CO. Lancaster, Ohio
 Please send full information regarding free Radio Books and descriptive matter on ACE batteries.
 Books and descriptive matter on ACE batteries.
 Name
 Address

AT LAST!

The MICAPHONE

KODE-KILLER

THE FIRST PRACTICAL
WAVE TRAP



Eliminates code or any interfering station. Works on any set with any circuit. Just connect it in the ground lead. Every radio fan wants one. Sells on sight.

LISTS AT
\$7⁵⁰

THE SENSATION OF THE
NEW YORK SHOW

Liberal Discounts
to
Dealers and Jobbers

Orders Filled in Order of Receipt

WRITE OR WIRE TODAY

RADIO MICA PRODUCTS CO.
156 East 43rd St.

New York City

See our advertisement inside back cover

Red Seal Radio Sparker

One of the greatest successes in recent radio history has been the introduction of the WD-11, or dry-cell, vacuum tube. The simplicity of its operation, and the fact that it does not require an expensive battery, are in a measure responsible for the fact that within the last seven weeks 150,000 of these tubes have been sold in the United States alone, according to one estimate.

The position of the dry-cell tubes, in the light of this tremendous demand, seems assured, and further



perfections of this tube may be anticipated. Indeed, the Manhattan Electrical Supply Company, Inc., of New York, has already looked forward to an ever increasing use of the WD-11, and has recently perfected a dry-cell battery known as the Red Seal radio sparker, which is calculated to make the WD-11 tube even more convenient, economical and altogether desirable.

One who is acquainted with the excellence of the Red Seal battery, and other products, might look for equal excellence of workmanship and design in the Red Seal radio sparker—nor would he be disappointed. The careful design, the neat appearance of this battery are selling points of great appeal. But what is more important, the sparker has several inherent advantages which are expected to make it a fast-selling part of up-to-date radio apparatus.

Radio sparkers are light in weight and easy to handle. Unlike the storage battery, they are dry and clean, with no injurious acid to spill. They are easy to move, and in moving them there is no chance of scratching floors or table tops.

The cost of upkeep of a radio set is considerably heightened by the need of recharging the storage battery from time to time. But these new dry cell batteries do away with the necessity of lugging the storage battery to the nearest service station, if no device for charging the battery at home is



This seal is accepted by the discriminating purchaser everywhere as an unconditional guaranty of excellence of design, material, workmanship, and performance.

ON JANUARY 20th, 1923

we will commence deliveries to
AUTHORIZED DISTRIBUTORS
of the

ACCURATUNE **MICROMETER DIAL** PATENT PENDING

in which a positive, yet delicate micrometer adjustment is incorporated within the dial itself, resulting in

ABSOLUTE TUNING PRECISION
ABSENCE OF CLAP-TRAP AND
UNCERTAIN VERNIER ATTACHMENTS
EXCEPTIONALLY ATTRACTIVE APPEARANCE

Simultaneously we will offer a Rheostat Dial and a Fixt-Post Inductance Switch to match—an unusual combination to attract the discriminating trade.

Distributorship franchises on these truly extraordinary articles are now being allotted.

We also take pleasure in announcing

GREATLY INCREASED PRODUCTION
of the
BURKE ADAPTER FOR WD-11 TUBES

The adapter which is outselling all others because
"IT DOES NOT RAISE THE TUBE"



845 BROAD STREET

NEWARK, N. J.

G-M

GUARANTEED RADIO APPARATUS



VARIOCOUPLER

Reinforced taps, Cellulac tubes, full 180° rotation

List Price, \$4.00

WRITE FOR PRICES ON

Antenna Plugs
Antenna Wire
Honeycomb Coils
Insulators
Insulite Panels
Jacks
Planet Loud Speakers
Plugs
R. F. Transformers
Sockets
Socket Rheostats
Variable Condensers
Variocouplers
Variometers

NATIONAL DISTRIBUTORS
OF
QUALITY PRODUCTS

GENERAL MERCHANDISE CO.

142 Market St., Newark, N. J.

Manufacturers and Distributors

available. Once a radio sparker is exhausted, it is replaced at a low cost.

This feature has several important possibilities for the radio dealer. The fact that there is a radio battery that works without recharging and is easily replaced is especially appealing to the farmer in outlying districts. It also appeals to the average person who realizes that the cost per hour service rendered by a Red Seal radio sparker is much less than the cost per hour of service rendered by a storage battery, taking into consideration initial and recharging costs. It is also evident that since sparkers have to be renewed the dealer, by handling these attractive radio accessories, is adding to the volume of his sales and to the quick turn-over of his profits.

Red Seal radio sparkers are made in three types, to operate sets using from one to four WD-11 vacuum tubes. Complete wiring diagrams with instructions appear on the labels of each battery. The individual special radio cells in radio sparkers are connected in parallel, and the makers say that the actual operating life of the cells is increased from $2 \frac{1}{3}$ to $2 \frac{1}{2}$ times the operating life of a single dry cell.

Such is the device introduced by one of the aggressive manufacturers in radio the Manhattan Electrical Supply Company, Inc., 17 Park Place, New York, to increase the usefulness and attractiveness of radio.

New Wilcox Tube Socket

An entirely new design has been conceived by the Wilcox Laboratories of Lansing, Mich., in their new tube socket. Among the chief features of this new device is that it will fit any standard four-prong tube.

As the illustration discloses, it is easy to mount either on a base or panel, legs being provided for the former and mounting brackets, not illustrated, for the latter. It is easy to connect, as wires may be attached to connection posts at top or bottom. The insulation is of bakelite-dilecto. The Wilcox tube socket is small, being only two inches square.

Radio Buyers' Guide

The Radio Buyers' Guide is the name of an attractive folder catalog that has been issued by the Beckley-Ralston Company, 1801-1815 South Michigan Avenue, Chicago. It lists the various lines of radio equipment handled by this company. Most of the nationally-known radio sets and equipment are listed, with cuts. Many specialties of merit are included and list prices are given.

The Loop's the Thing

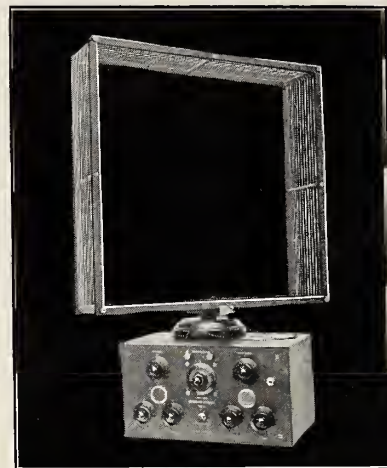

When You Hear

The

PORTABLOOP RECEIVER

You Have Heard
Radio at its Best

An Agency is a
Valuable
Franchise

Also

PORTABLOOP PORTABLOOP TUNER



210 Central Avenue

New Mazda Parts

The Mazda Radio Manufacturing Company, of 3405 Perkins Avenue, Cleveland, Ohio, claim to be one of the few manufacturers to offer anything new in the radio line this year. So far they have announced several innovations including a vernier tuning condenser and a rheostat with several novel features especially adapted for a regenerative set.

The Mazda Radio Manufacturing Company's Senior condenser will enable one to obtain the finest and

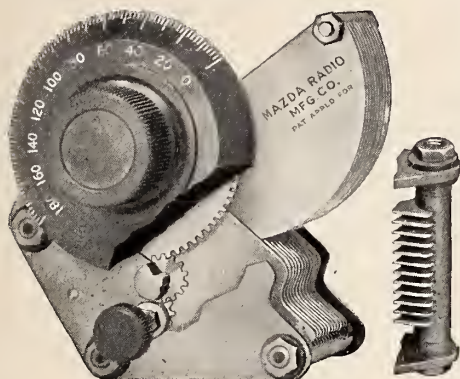

Mazda Senior Condenser

closest tuning in a radio receiving circuit. As is well known, most circuits tune sharp when a maximum of inductance and a minimum of condenser capacity is used. Any given signal can also be picked up at different taps on the primary control by varying the condenser. The same action can take place on the secondary by varying the coupling and condenser. For the reception of continuous wave signals and radio-telephone concerts from distant stations, a very selective tuning control is needed, which in an ordinary condenser often demands the use of an auxiliary condenser.

This Senior condenser, however, contains two built-in verniers; either being independent of the other. The shape and mounting of the plates is such that a considerable movement of the dial is required to make an appreciable change in capacity at the beginning and at the end of the scale, while in the center range of movement a very great increase or decrease takes place for the same movement of the dial.

The company's rheostat is of the resistance pile type, similar in principle and application to the resistance in world-wide use in delicate electrical measurement instruments. It is so designed that the total useful range of movement is six to eight turns. Two turns from the time the filament begins to glow will bring it to near its critical temperature, and

**STANDARD
RADIO
HORNS**

**Are
Fundamentally
Right**

**That's Why
They Sell**

ALSO MAKING

**7-inch Bell, 19 inches
High**

Rubberoid finish only. Will take all makes of receivers. No air pocket. Designed to give proper amplification. Heavy material to avoid blast.

No. 17, price \$7.50

**5-inch Bell, 14 inches
High**

Rubberoid finish only. Will take all makes of receivers. Specially designed for Radio purposes. Heavy brass. No vibration.

No. 15, price \$5.00

The line of Standard horns is now complete. The dealer who stocks Standards is thus able to supply correctly made horns for any Radio need—at popular prices.

We can furnish a single high-grade loud phone with cord—to fit any of these horns—to make a complete loud speaker.

Price, \$7.50 Extra

**STANDARD
METAL MFG.
CO.**

237 CHESTNUT ST.,
NEWARK, N. J.



14 Inch Bell, 24 Inches High

Rubberoid finish only. Will take all makes of receivers. No air pocket. For use where extra large horns are desired. Heavy material. No vibration.

No. 114, price \$12.00



11 Inch Bell, 14 Inches High

Here's a new design in Radio Horns—will take all makes of receivers. Surprisingly clear reproduction. Grained Mahogany or Black Rubberoid Enamel finish.

Gem, price \$7.50



Ray-O-Vac "B" Batteries Give Dealers A Big Advantage

Radio business has settled down to the solid basis of genuine value of merchandise and the repeat orders of satisfied customers. The mad rush for any sort of equipment with "Radio" printed on it, is over.

French Ray-O-Vacs give you an advantage over every other battery on the market, because thousands of radio fans have convinced themselves by actual experience, that there is no other radio battery as good as Ray-O-Vac.

That is because French battery experts, early in the development of Radio Telephony, overcame the battery faults which cause receiving noises. Ray-O-Vacs are not only noiseless, but they provide very uniform current, steady, strong and of unusually long life.

Full particulars given in Bulletin 225—a real piece of information for live radio dealers. Send for it.

French Battery & Carbon Co. Madison, Wisconsin

Chicago Dallas Atlanta New York
Denver Minneapolis Kansas City



French RAY-O-VAC "B" Batteries

ADD-A-STEP

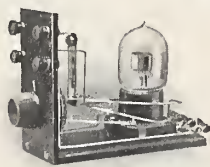

DETECTORS AND AMPLIFIERS

Awarded Mail's Certificate of Excellence
See them at the RADIO FAIR

ARROW RADIO CO.

Manufacturers of Quality Plus Instruments

HACKENSACK NEW JERSEY

in the remaining turns, the control range, by voltage, is approximately $1\frac{3}{4}$ volts, thus allowing delicate single knob control, over the critical range of the tube.

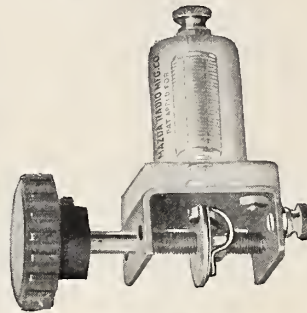

Mazda Rheostat

To insure flat contact surfaces, hence no losses, their rheostats are assembled with alternate bronze discs and graphite washers. The resistance pile is carried in a porcelain container. The maximum pressure possible on the pile is that exerted by a spring so that the most careless handling cannot crush them.

Telmaco Products

A neat and complete catalog, attractively bound in a colored cover, has been recently issued by the Telephone Maintenance Company, of 20 South Wells Street, Chicago. They are the makers of the Telmaco line of radio apparatus.

Besides the Telmaco vacuum tube receiver units, the Telephone Maintenance Company also make the Telmacophone, a new type of horn speaker, batteries, vario-couplers, and patented variometers. The company also are distributors in their territory for Westinghouse, General Electric, Clapp-Eastham, Remler, Chas. Freshman, Herbert Frost, Western Electric, Jewel and other brands known from coast to coast. The list is indicative of the quality of goods handled by this company. The line is complete from "A" batteries to vernier condensers, and includes microphones and molded parts.

Real Pocket Set

David M. Sarnoff, vice-president of the Radio Corporation of America, at a recent meeting of the New York Electrical Society, predicted that a new development in radio would come soon which he described as the "wrist-watch wireless set or radiolet."

"Such a set could be carried easily on the person," said Mr. Sarnoff, "and signals could be received from stations twelve or fifteen miles distant. Thus a man would receive in his vest pocket market reports, weather reports and details of championship games."

Warren Radio Loop Un-Covered



Large Quantities of Warren Radio Loops Being Sold Everywhere

How Many Are You Selling?

No mystery about the big profits in Warren Radio Loops. The Armstrong Circuit, regenerative sets and the increasing interference of stations, makes the loop aerial an absolute necessity. The Warren Loop is supplying this demand because it is best fitted for the job. National advertising is sending fans into the stores to ask for it. Be fair to yourself—try a small order.

A Type for Every Purpose

- Type A-737 (300-700 meters), 6 inches square—non-directional \$10
- Type A-7236 (175-1000 meters), 6 inches square—non-directional..... 12
- Type B-2537 (300-700 meters), 18 inches square—directional..... 20
- Type BL-2520 (200-18,000 meters), with honeycomb coil, 18 inches square—directional 25

Send for Bulletin P-102

V-DE-CO RADIO MFG. CO.
ASBURY PARK, N. J.
Dept. D

GANAERITE Detector Crystals

Twenty years of practical mineralogy gave us the material to produce the highest quality crystal.

We are now undertaking the largest single order for mounted crystals in the market.

We test and *guarantee* to replace or refund on any unsatisfactory Ganaerite crystal.

The Harris Laboratory
26 Cortlandt St., New York City

Pacent Convenience Device

To make easier the use of two pairs of phone cords on a single pair of binding posts, the Pacent Electric Company, Inc., of 22 Park Place, New York, have introduced their new Pacent Duojack.

This device is designed to readily convert an ordinary receiving set equipped only with binding posts into a plug and jack set. At the same time it provides for plugging in two pairs

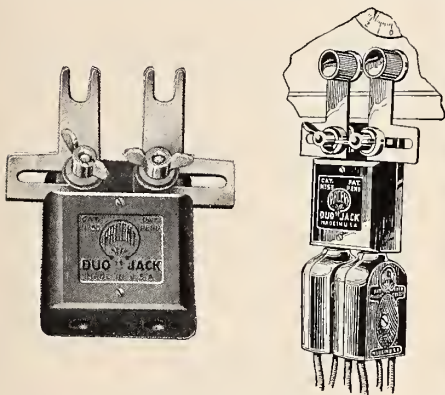

of phones or a pair of phones and a loud speaker.

The adjustable connectors on the Duojack make it easy to fit it to practically any pair of posts regardless of their spacing. When it is connected, it is properly rigid for plugging in. The two jacks are neatly enclosed in a moulded unit of heat resisting thermoplas, and resemble in appearance the ordinary wall plug. The makers of the Duojack are also manufacturers of similar devices such as the Pacent Multi-Jack, the Universal plug, and twin adapter.

Miraco Tube Units

Tube units that can be added to step by step are the specialty of the Midwest Radio Company, of 3423 Drury Avenue, Cincinnati, Ohio. The basic unit is the Miraco vacuum tube radio receiver, which was designed with efficiency, low cost and simplicity of operation in mind.

The wave length range of this basic unit is from 150-600 meters, and the makers claim an effective receiving range of from 50 to 100 miles for this outfit. Used in conjunction with the Miraco radio frequency amplifier unit, the Miraco receiver, the volume and receiving range in miles are increased many times.

The Midwest Radio Company also makes the Miraco radio frequency broadcast receiver which amplifies before it detects, and also the Miraco two-step audio frequency amplifier.



"ROYALFONE" King of All

A phone for every set

Our adjustable headband feature makes the "Royalfone" most comfortable.

The "Royalfone" is super-sensitive as very little current is required for its operation.

Our greatest selling asset is "Try one and you will buy one."

We guarantee every "Royalfone," and our guarantee holds good.



13000 turns—1500 ohms—\$5.00
16000 turns—2200 ohms—\$7.50

We Invite Correspondence

ROYAL ELECTRICAL LABORATORIES

MANUFACTURERS OF
Electrical and Radio Equipment
NEWARK N.-J.

Royalfone

Ask Our Service Bureau

ELECTRICAL TESTING

Of all materials entering into Radio Construction. Meters and apparatus calibrated and repaired.

CHEMICAL ANALYSES
STRENGTH TESTS

Investigation or Development of New Apparatus and Materials. Routine Tests at Special Rates.

NEW YORK TESTING LABORATORIES

80 Washington Street, New York City

Bowling Green 7016

SOCKET-RHEOSTAT

Registered U. S. Patent Office

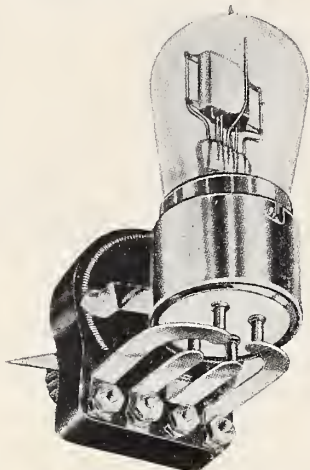

Type A-5 ohms, suitable for detector bulb
 Type B-2 ohms, suitable for power bulb
\$2.00
TWO IN ONE. A socket and rheostat so combined as to form a single unit. No more unnecessary leads between socket and rheostat. Just connect your leads to the four posts marked P-F-G and you are hooked up as far as the SOCKET-RHEOSTAT is concerned.

MANUFACTURED BY

Ajax Radio Corporation

Telephone: Bigelow 4097
 538 SOUTH 10th STREET
 NEWARK, N. J.

Resist-O-Meter

The Scholes Radio & Manufacturing Corp., 32-36 West 18th Street, New York City, recently brought out a new rheostat that embodies a number of points that will interest the radio trade. It is the invention of F. A. Rojas and its principles were evolved in the electroplating industry where a steady current is necessary.

The accompanying illustrations show the rheostat in two positions, one for bench mounting and the other

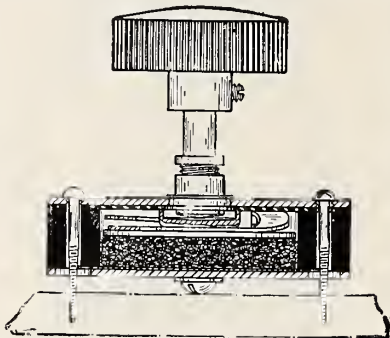

for panel mounting. By means of adjustable mounting attachments it can be attached to any panel even if the drilling is slightly out of line with the original intention.

An effective display cartoon has been devised for the apparatus, making an attractive appearance on the shelves of dealers handling the new product, which is marketed under the trade name of the Resist-O-Meter.

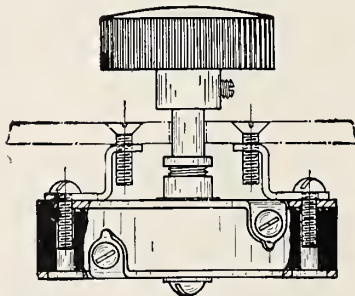

A recent statement of the company in regard to this product says:

The Resist-O-Meter is constructed upon the principles of a new discovery in contact-electricity which makes possible the claims of this device. There are on the market two distinct systems of rheostat, the sliding contact and the compression type. The sliding contact is deficient for radio work, first, because the wire of the coil resistor is subject to oxidization; and second, because it is noisy.

In so far as the compression type of rheostat is concerned, two main objections concur to render these instruments deficient, First, their resistance at full compression and second, their microphonic noise at low compression. A high resistance at full compression is a prohibitive condition, because aside from being wasteful of electrical energy, the magnitude of this resistance may be such that the voltage of the standard A battery may not suffice to impress



Mercury Radio Sets

A PROFITABLE line to handle, from the dealer's standpoint. A reasonably priced line to buy from the consumer's standpoint.

The low price is made possible by quantity manufacture in our large factory where every part is **MADE**, not merely **ASSEMBLED**.

Write for details and trade prices.

MERCURY RADIO PRODUCTS CO.

LITTLE FALLS NEW JERSEY

POSTER'S Perfect PANELS

XX Bakelite-Dilecto Radio Panels

Manufacturers and dealers: immediate delivery—any quantity—cut to size.

Engraving and Drilling

Sharp white lettering, clean accurate work, quantity production at surprisingly low cost.

Write Today for Sample and Prices

POSTER & CO. INC.
 552 SEVENTH AVE., NEW YORK
 PHONE BRYANT 2-572

FISCHER

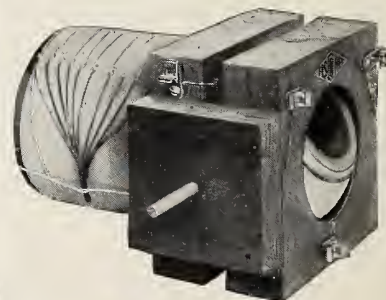

Vario-Wave Tuner
(Flat and Bank Wound)

Affords a guaranteed range of 200 to 3500 meters

Functions the same as a combination of Variometer, Variocoupler and Loading Coil. All three can be eliminated by **Price \$8.50** its use.

Territory open for Dealers

Write for proposition and catalogue

G. H. FISCHER & CO.

317 Cypress Hills Road
 GLENDALE, L. I., N. Y.

the adequate filament current for the efficient working of the two. The microphonic effect is also a prohibitive feature because of its annoying interference with clear hearing.

The Resist-O-Meter claims first, an extremely low resistance at full compression. This is saving of electrical energy; second, a gradual and firm increase or decrease of its resistance without noise and fluctuation between the low and the high limits of its ohmage capacity; third, high thermal capacity will dissipate 10 watts without undue heating; fourth, high efficiency of temperature coefficient; fifth, compactness; and sixth, freedom from deteriorating elements.

Officials of the Scholes company are W. H. Scholes, president; C. W. Preston, sales manager; C. F. Smith, vice-president and designing engineer; and W. H. Smith, treasurer.

The Brandes Girl

Radio manufacturers are paying increasing attention to radio dealer helps in a more effective display of their products.

An entirely new method of displaying headphones was brought out re-



cently in the bronze statuette furnished by C. Brandes, Inc., 237 Lafayette street, New York, to their jobbers and dealers.

It consists of a bronze bust bearing the Brandes name and featuring their trademark Matched Tone, which may be put on the counter and upon which an actual set of headphones is placed by the dealer. This form of merchandising is exceptionally practical as the statuette is in itself very attractive as shown in the accompanying illustration; making a neat appearance upon the counter and displaying the headphones to good advantage for both Brandes and the dealer.

Since the announcement of this statuette, the demand has been heavy, and it is considered a most satisfactory as well as desirable form of display by dealers who have exhibited the Brandes girl.



Don't lose money searching for your Radio Market

Bradleystat Advertising brings Radio Business to You

The Bradleystat is the most widely advertised filament rheostat on the market, today.

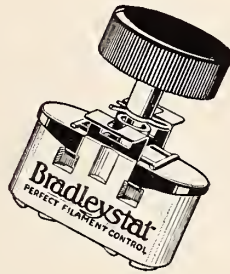

Retail Price \$1.35

The Bradleystat gives smooth, noiseless filament control. It increases your receiving range, gives quicker tuning and louder reception. No other rheostat has so many big selling points.

The Bradleystat has been acclaimed an overwhelming success by radio fans, everywhere. Thousands of radio enthusiasts, not satisfied with the old wire rheostats, are buying Bradleystats for their sets. You can get these sales, today, by putting in a small stock of Bradleystats and the new Bradleystat demonstrator for your counter. This demonstrator, painted in six oil colors, is given free to you with your first order. Act today, for your benefit, by mailing us the attached coupon.

Allen-Bradley Co.
Electric Controlling Apparatus

487 Clinton Street Milwaukee, Wis.
Manufacturers of Graphite Rheostats for 20 years

Send this request for our Radio Sales Plan!

ALLEN-BRADLEY CO., 487 Clinton St., Milwaukee, Wis.

We want to get immediate benefit from your powerful advertising campaign. Tell us how we can sell the Bradleystat and how you will help us merchandise it to the radio public.

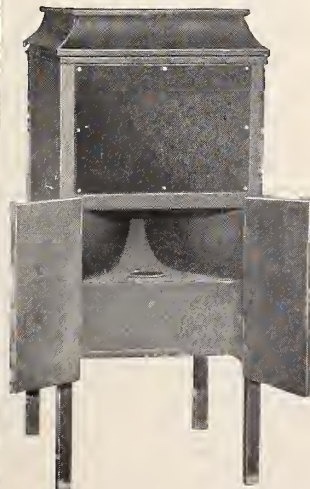

This Radio Cabinet

Especially suitable to completely and conveniently house radio sets. Size 43 inches high, 18 wide, 22 deep. Furnished in Mahogany or Oak—with or without horn, casters or Formica panel.

Write us your requirements and we will quote price.

CURTIS N. ANDREWS
BUFFALO, N. Y.

QUALITY-PLUS INSTRUMENTS



Types 711; 711A

THE HOME Radiophone Receiver

Single Tube Set

Type 711, Wave length 150-2600 meters \$35

Type 711A, Wave length 150-800 meters \$28

Awarded Certificate of Excellence

Dealers! Jobbers! Distributors!
See Our Exhibit at the Radio Fair
Hotel Imperial, New York City

ARROW RADIO CO.
Manufacturers of Quality Plus
Instruments

Hackensack New Jersey



Galena Crystal, Mounted.....35c
Galena Crystal, Unmounted.....25c
IMMEDIATE DELIVERY

*Manufacturers, Jobbers, Dealers
write for quantity prices*

GALENA CRYSTAL MFG. CO.
2893 Fulton St. Brooklyn, N. Y.

SURPLUS RADIO STOCKS

*SLOW MOVING
CONVERTED INTO*

QUICK—IMMEDIATE—CASH

Small lots just as desirable as large quantities. Radio Market conditions justify turning of over-stocks into Cash and thereby releasing tied up Capital for new and profitable use. Don't wait until everybody else considers unloading at the same time. ACT NOW.

WRITE—WIRE—PHONE—OR CALL State in detail, the items, quantity of each and lowest price acceptable.

THE R - C OUTLET

EXECUTIVE OFFICES

30 E. 23rd STREET NEW YORK CITY

Phones { Ashland 1109
Gramercy 1586-1587

Gould

Radio "A" and "B" Batteries

Write for Dealer Plan

Gould Storage Battery Co.
30 East 42d St., New York City

What Service Means

Supplying Standard Merchandise
Is Duty to Public

By EDWARD J. CONNELLY
Electric Service Engineering Co.

When early last spring the radio buyer was caught in the wild rush for standard material, the Electric Service Engineering Company decided that something had to be done and done quickly. A meeting of its officers promptly laid out a definite policy of where, how and what to buy. The three factors controlling this policy were quality, quantity and service.

An all-round radio technician was secured who could answer questions and draw hook-ups in a way that customers could understand them and without loading them up with a lot of technical information and materials that they did not want.

The task of securing the merchandise that the company sold was no small one. It took a lot of time, and it cost money, too, in order to make the right connections. It was a great relief to get this work finished, but it was worth the effort, for it put the company on record for demanding the best and in acquainting the trade with the fact that it could do what seemed impossible. The conditions in business to-day are different, although the organization of the distinctive personnel of qualified electrical specialists is continuing the same service and quality that they did in the busier months.

It is necessary that a period of depression follow over-busy days such as have passed. The public cannot be expected to be bunked much longer for it holds the whip hand and will stamp out those who are holding business back. Soon conditions will improve and a code of ethics will be established which all intelligent business men will live up to.

The company will continue to carry standard, tested materials only, and will strictly observe patent rights to protect the pioneer radio manufacturers who are entitled to reward for their efforts which have made the comforts and entertainment of radio possible.

Lyradion Five-Tube Set

The Lyradion Manufacturing Company of Mishawaka, Ind., has announced a new five-tube receiving set which is made entirely in their factories. This set includes a selector unit, two or three stages of radio frequency amplification and two stages of audio frequency amplification.

"COPPERWELD"

TRADE MARK REG. U.S. PAT. OFF.

ANTENNA WIRE

50% stronger than either
solid or stranded copper

ELIMINATES SAGGING

Adopted by Largest Radio Manufacturers
100, 150, 200 ft. per Carton

LEAD-IN and GROUND WIRE

has the Underwriters' O. K.
Rubber Insulated—Brown Braided
25, 50, 100 ft. per Carton

BUY IT IN CARTONS
with construction directions

COPPER CLAD STEEL COMPANY
New York Chicago
Braddock P. O., Rankin, Pa.

EVEREADY

RADIO "A" BATTERY

Immediate Delivery from Stock

Manhattan
Storage Battery Co., Inc.
511 West 50th Street
New York City

Praco Panel Service

We offer to the amateur and dealer

REAL PANEL SERVICE.

Our panels are cut to your order. Only genuine Condensite and Formica used.

1/8" per square in. 2c
3/16" per square in. 2 1/2c
1/4" per square in. 3c

We also carry a complete line of radio essentials. Dealers will find it profitable to have our latest price list and discount sheet.

PITTSBURGH RADIO
AND

APPLIANCE CO., Inc.
"Pittsburgh's Radio Shop"

Desk D
112 Diamond St., Pittsburgh, Pa.

Multiple Coil Idea

By bringing into the construction of a variometer the principles of the variable condenser, the Danziger-Jones, Inc., of 143 Prince Street, New York City, believe that they have increased the efficiency of the variometer as part of radio equipment. This firm has evolved this new variometer, which they call the Telos variometer, and claim, as the



result of the new principles embodied in it, high inductance, large inductive and wave length range, minimum external magnetic field and other advantages.

A system of having the rotor and stator each built up of a series of parallel equal coils which interleave somewhat after the manner of a variable condenser has been adopted. The coil units of the rotor and stator are of equal inductance. This multiple unit construction is also found in the very efficient coils used in the United States Navy radio equipment.

What to Look for in Tubing

Oiled Tubing, sometimes called spaghetti tubing, adds to the insulating safety of a receiving set as well as to its appearance. To work properly, such tubing must be smooth both inside and out. It must be flexible, of the right size, and uniform throughout. Spaghetti tubing should neither crack nor break. It must not be sticky nor "tacky," should possess both high insulating and electric qualities, be moisture-proof and it must not dry out.

The Mica Insulator Company, of 542 South Dearborn Street, Chicago, Ill., believe that in the Empire they have a brand of oiled tubing that answers all these requirements. Not only does it do better than common spaghetti, but the makers claim that it looks better and lasts longer, without costing more. They advise dealers desiring to handle a product without a "comeback" to communicate with them.

MuRad = Radio Amplification = Distance

TYPE MA-13 RECEIVER
HEARD WITH TWO FOOT LOOP

Regular Performance
of
Mu-Rad Receivers

The New
Star in
the Radio
World

A MU-RAD Radio Frequency Receiver with a small loop aerial is more sensitive, more selective, simpler to operate and more compact than any other type of receiving equipment.

Guaranteed for 1000 Mile Reception

A positive, written guarantee on each Mu-Rad Receiver of 1000 miles reception on a loop.

Their Performance Sells These Sets

The astounding advance in radio reception marked by these receivers starts real business wherever they are demonstrated. It is the set your customers will welcome, the set you can sell in large quantities.

*Too Good a Proposition to Wait—
WRITE TODAY*

Type MA-12
3 Stage R. F. and Detector
List \$128
Type MA-13
3 Stage R. F. Detector and 2 Stages A. F.
List \$160

Mu-Rad Laboratories, Inc.
800 Fifth Ave., Asbury Park, N. J.

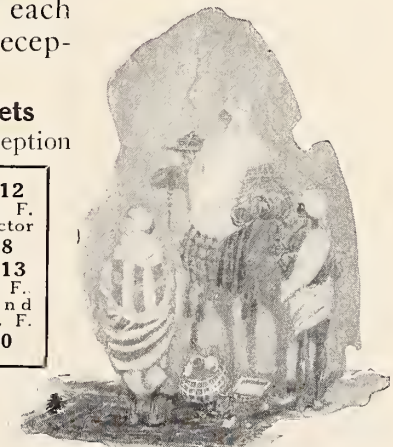

RADIO DEALERS

We are fully prepared to furnish you with Standard Radio Products at attractive discounts.

Prompt delivery and unlimited service

ELL-ESS RADIO EXCHANGE

<p style="text-align: center;">DISTRIBUTORS for</p> <p style="text-align: center;">Radio Receptor Co. Enco Electric Novelty Co. (B. Battery) Inter-Ocean Radio Corp. (Woodehorn) Jaynyxon Laboratories (Sellinite crystals)</p>	<p style="text-align: center;">ELL-ESS PRODUCTS</p> <p style="text-align: center;">At unusual Discounts</p> <p style="text-align: center;">Crystal Sets Variometers Vario Couplers K. O. Glass Crystal Detector</p>
---	---

Also other Standard Products
Write, call or phone

ELL-ESS RADIO EXCHANGE

Tel. Cortlandt 0405
57 Dey St., New York, N. Y.

NOVO
"B"
BATTERIES FOR RADIO
22½-45 & 105 VOLTS



**NOISELESS
DEPENDABLE
GUARANTEED**

ASK YOUR DEALER

NOVO MANUFACTURING CO.
424-438 W. 33rd ST.
NEW YORK

531 SO. DEARBORN ST., CHICAGO.



Discard your Storage Battery and use Dry Cells on your Tubes

"THE STEINMETZ ADAPTER"

Will enable you to do this by simply inserting it in your standard socket and using the Westinghouse Dry Cell Tube.

"Get Our Complete Catalogue"

STEINMETZ WIRELESS MFG. CO., INC.
5708 Penn Ave., Pittsburgh, Pa.

RADIO MAILING LISTS

12,400 Radio Dealers, covering U. S. by States, per M. \$7.50

1,614 Radio Manufacturers, covering U. S. by States, per list. 15.00

1,757 Radio Supply Jobbers, covering U. S. by States, per list. 15.00

260 Radio Stations, per list. 4.00

257 Manufacturers who make and assemble complete Radio Sets, per list. 4.00

25,000 Radio Amateurs and Managers of Radio Stations, per M. 7.50

Ask for price list covering Canada and England. Send remittance with order.

TRADE CIRCULAR ADDRESSING CO.
166 W. Adams Street Chicago



T-B-H PHONES
SPEAK FOR THEMSELVES
Pure Natural Tones, Light Weight Ornamental Appearance

A Sturdy Reliable Head Set That Will Sell and Stay Sold

Let us send a sample set for your inspection 2200 Ohms. List \$7.00

Substantial Discounts to Jobbers and Dealers

T. B. H. CORPORATION, Dansville, N. Y., U. S. A.

Crosley Crystal Set

Carrying the unit idea for crystal sets to its logical conclusion, the Crosley radio units, made by the Crosley Mfg. Co., of Cincinnati, Ohio, are complete and form a gradual opportunity for the amateur radio enthusiast to increase the scope of his outfit as his pocket-book and his knowledge of the science allow.

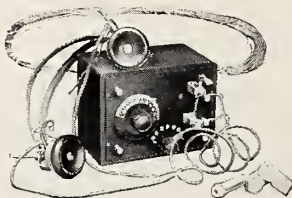

The first unit in the Crosley scheme is crystal receiver No. 1. This unit has a tapped inductance, crystal detector stand, and a variable condenser to permit sharp tuning. It is recommended by the makers for use on local broadcasting stations, under ordinary conditions for a distance up to 25 miles. It is designed to cover a range from 200 to 600 meters wave length.

The units that the Crosley company has provided to complete the assembly marking a high stage of development for a crystal set are the audio detector unit, the two-stage amplifier and the radio frequency tuned amplifier.

Will Sell Standard Goods

Beginning with the first of 1923, the Ship Owners Radio Service, Inc., of 80 Washington street, New York, and branches in large American cities, announce they will confine their sales to the following lines exclusively: Acme Apparatus Company; Allen-Bradley, Bradleystats; H. H. Eby Manufacturing Company, binding posts; Exide storage batteries; Euraco tubular grid leaks and condensers; Framingham products; Federal Telephone and Telegraph Company; Frost Radio; General Radio Company; Homcharger; Jewell instruments; Wm. J. Murdock Company; Eveready "B" batteries; Radio Corporation of America; and Rasla, radio frequency R. T. transformers.

In announcing this new policy, H. H. Barroll, sales manager of the company, said that "we believe that by concentrating our entire effort on well-known, standard lines such as these, we can serve our customers to the best advantage, because we will always have a complete stock of these lines, not only in New York, but at all branch offices."

RADIO CABINETS



We manufacture a complete line of radio cabinets, of mahogany, walnut, oak, and white wood, in all sizes, and in any finish. Best of construction. Dirt, dust and moisture proof. Quick deliveries—quantity production prices. Send us your specifications, or a sample of your cabinets, and get our prices. We also make indoor loop aerials.

Cabinet Work Since 1900

E. ESHOO CABINET WORKS
635 Herkimer St. Telephone
Brooklyn, N. Y. Lafayette 2324

KEEPING A DAY AHEAD

of the headlines of tomorrow's newspapers!

That's what radio enthusiasts everywhere want to do! They're not completely satisfied with the regular broadcasted programs! They want to get the most out of radio!

Live Dealers are extending sales by stocking the

FINCH RADIO RELAY

which automatically receives any desired code message and makes a permanent record of it on a paper tape with unerring accuracy.

Write for Proposition RD101





FINCH RADIO MFG. CO.
303 FIFTH AVE., N.Y. CITY.

"SAMCO" PRODUCTS

VARIABLE CONDENSERS

11 Plate	.00025 M. F. Capac.	List \$2.25
23	.0005	2.85
43	.001	3.60
63	.0015	5.50





Vernier Dial Attachments
List, \$50

Rheostats
60 ohms. List \$5.50

Potentiometers
300 ohms. List, \$1.50

Inductance Switches
List, \$50

WE HAVE A SPECIAL PROPOSITION TO DEALERS AND DISTRIBUTORS
STANDARD APPLIANCE MFG. CORP.
428 EAST 71st STREET, N. Y. CITY



Shamrock
180°
Vario Coupler
Retail Price \$4.50

Both Tubes Are Made of **BAKELITE**

Distributors, Jobber and Dealers Write for ATTRACTIVE DISCOUNTS

SHAMROCK RADIO CO.
152 Sussex Ave., Dept. T, Newark, N. J.

Supertone Loudspeaker

The Supertone loudspeaker which is being offered to the trade by the Triangle Phono-Parts Company of 18 West 20th Street, New York City, is unique in its qualities and construction.

This instrument which has no horn and requires no power is claimed to

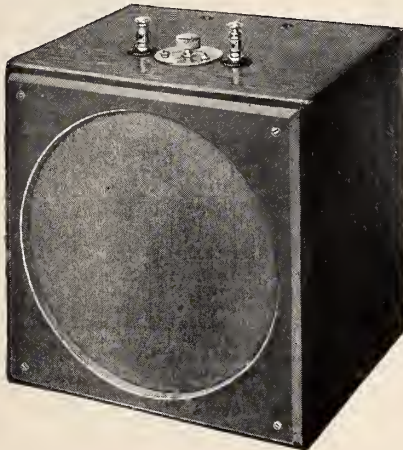

be the most truthful and exact radio sound amplifier that is made and eliminates all harshness. It screens all unnatural distortion that is so common among loud speakers. The Supertone enables the dealer to meet the demands of many customers who are unwilling to buy an expensive outfit, for it retails at \$15, and it will meet their demands for an exact dependable amplifying instrument that can be relied on at all times.

Radial Accurate Instruments

"Built with clock precision" is the motto behind the radio apparatus produced by the Radial Company, 99 Warren Street, New York, makers of the Langbein & Kaufman vario-coupler and variometer.

Neat and workmanlike in appearance, these instruments have the stamp of quality upon them. The shells and rotor are made of pure hard rubber, a material with a minimum dielectric constant. The coil wires are embedded in a solution, with a coating placed over the wires so that they will remain in place indefinitely. The solution has a very low specific inductive capacity and a high volume of resistance.

The vario-coupler is of the ball type which keeps the air gap at a uniform value and a fairly linear variation in coupling may be obtained from zero to 80 degrees from perpendicular.

The fine adjustment in workmanship permits the rotor to have a perfectly uniform motion which does not allow "tumbling or spinning." This even motion is one of the outstanding features of the instrument.

ESTABLISHED 1888

TRADE-MARK

SENSORY CABINET UNITS

HEINEMANN ELECTRIC COMPANY
Manufacturers
 Radio Division Philadelphia, Pa.

QUALITY and RESULTS

Remember last winter when anything that looked like radio apparatus had a ready sale? Remember how much of it only "looked like" radio? Remember how many "comebacks" you had on this inferior material and apparatus? Remember how many good customers you lost through sale of unsatisfactory goods? Wouldn't you be interested in handling a line which will sell itself, and produce no "business worries?"

Audio Frequency
Price \$6.50

Radio Frequency
Price \$7.50

The quality, operation, and appearance of the J. T. Boone Mfg. Co.'s Radio and Audio Frequency Transformers is setting a new standard. The Radio Frequency type is a real "range producer," while the Audio type assures powerful, distortionless amplification which reproduces the broadcast programs in a thoroughly enjoyable manner.

J. T. Boone Mfg. Co. gives unquestionable results. These sets are sold complete in every detail ready for immediate use. The backbone of all J. T. Boone Mfg. Co.'s products is Quality and Results.

J. T. BOONE MFG. COMPANY
 3469 E. Jefferson Ave. Detroit, Michigan

NOTICE!

We have an extremely profitable and timely proposition for live Jobbers, Distributors, and Buyers. Immediate action is necessary

WRITE AT ONCE

ARROW RADIO CO.

Hackensack .. New Jersey

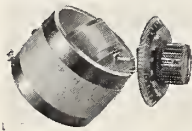

"Essex" 150-600 meter 180° vario-coupler with 3" molded dial.

Price. \$1.25 net

ESSEX BUS WIRE NO. 14
Square Tinned—Specially Prepared and Will Give Entire Satisfaction. \$1.00 Per Hundred Feet.

Send for Dealers' Quantity Prices

ESSEX MANUFACTURING CO.
117 Mulberry St., Newark, N. J.

Send for FREE story

Interesting, illustrated folder "How to get Greater Desk Efficiency" shows how to keep your desk cleared for action. Thousands of Kleradesks are giving entire satisfaction. Saves time locating, distributing or sorting papers. Takes less space than a tray. Sent FREE trial.

Kleradesk



Steel Sections

75¢ ea.

ROSS-Gould Co
538 N. 10th
ST. LOUIS

This Model \$6.25

Free Mailing Lists
Will help you increase sales
Send for FREE catalog showing details covering names of your best prospective customers. Counts and prices are given on thousands of different Mailing Lists.
99% Guaranteed 5¢ each by refund of
ROSS-Gould Co 538 N. 10th Street St. Louis

COMPOSITION LIST PRICE

DIALS 50¢ DIALS

Adjustable Switchlevers
Knobs

NEW YORK RADIO-DIAL CO.
316 Holden Bldg., Detroit, Mich.

Pointers for Dealer To Increase Sales

(Continued from page 34)

why certain sets are inefficient due to design?

How many take up five minutes time in going into detail, about the care of the batteries?

How often has a crowd gathered around the counter, some wanting binding posts while another may be ready to purchase a large set, and the dealer simply hurries to serve all within a few minutes and forgets that a little talk, which would benefit all concerned, would probably net a greater sale?

What about the fellow who comes into the store with a friend who has fallen victim to the radio fever, and has purchased an expensive set elsewhere?

Do you give him all your attention, hoping some day that another friend will probably seek your quarters and probably purchase a set or some parts? Do you tell him to go back where he bought his set, thereby making a bad impression with both, or do you spend five minutes with him explaining just how simple it is to tune the set?

What about the fellow who buys a vacuum tube? Everyone knows that there is no uniformity in vacuum tubes now on the market, and that if a customer brings back a tube that lights and does not operate, do you say that you will not take any tubes back?

That customer will surely never enter your store again. But this actually happens day after day at nearly every radio supply store. In this matter the customer should be given the benefit of the doubt just as in the larger department store where no questions are asked when an article is returned as defective.

A case recently came to light where a dealer lost a hundred and fifty dollar sale, because he refused to explain how to tune a set that was purchased elsewhere. The dealer did not know that a silent friend standing near the counter was ready with his money for the same set.

Do you draw diagrams for your customers? Or do you refer them to certain books, or just let them go on their way because you are busy with some one else who has been waiting?

If the dealer is not up on radio technique, there are newspapers in every city who have radio experts that give service to the public. There are numerous simple diagrams that can be printed, and distributed after each sale.

A customer buying a cheap radio set

A NIMBLE DOLLAR-SELLER!

The Chaslyn Sink-or-Swim Ball Hydrometer

Makes easy a task that otherwise bothers every battery-user—auto or radio. Three balls of different colors and densities show condition of electrolyte instantly, by the way they sink or swim.

Set also includes DEPTH TESTER and AIR-CONTROLLED RUBBER STOPPER for water bottle.

Retail price of Set \$1.00

Accredited dealers will be mailed TWO Initial Sets on receipt of a dollar.

THE CHASLYN COMPANY
4315 Kenmore Ave., Chicago



Maclite Vario-Coupler

Price \$5.00

Is, in the opinion of experts, the most efficient on the market.

All Other Maclite Parts are equally efficient, including the Maclite Variometer, Double Slide Tuner, Variable Condensers and Crystal Detectors. The Maclite Single Tube set at \$25.00 is the best buy we have ever seen. Let us tell you more about this set, also all other Maclite parts.

Dealers and Jobbers Write for Discounts

MACLITE RADIO CO.
701 Maclite Bldg., Claredon St.
Boston, Mass.

AGENTS

Our established quality rewards your effort with liberal commissions ever on large orders. "Triple-test" multimitom crystals and "Triple-tone" special gold alloy cat-whiskers are today the best sellers to jobbers and retailers. High priced, but unequalled in quality and sales help. Repeat orders insured. State territory you want.

FOOTE MINERAL CO., Inc.

107 N. 19th St., Philadelphia, Pa.

Established Forty-seven Years

IMMEDIATE DELIVERY

CABINETS—	PANELS—
Imitation Mahogany or Flemish	Genuine Formica,
Oak Finish	^{3/16"} thick
6 x 7 x 10	6 x 10 ^{1/2}
6 x 7 x 13 ^{1/2}	6 x 14
6 x 7 x 20 ^{1/2}	6 x 21

Other Sizes to Order

COMPLETE RECEIVING SETS

Jobbers and Dealers
Get Our Discounts

THE MIHO COMPANY

8 East Third St. Cincinnati, Ohio

FREE Radio Catalog



Our big stock of standard makes of radio sets, parts and supplies, fully illustrated. Play safe—buy standard equipment from a reliable house. We ship from stock.

Send \$9.00 for sample high grade crystal detector outfit with variometer in large case. Sells for \$18.00.

JULIUS ANDRAE & SONS CO.
In Business Since 1860
114 Michigan St. Milwaukee, Wis.



Are YOU Selling WESTON Voltmeters?

THERE are now about 700,000 vacuum tube sets in use in the United States! Everyone of these sets should have either a filament voltmeter or a filament ammeter to prolong the life of the tubes and aid quick, exact tuning. The Weston is the premier instrument in either case. And the cost is slight. It is scarcely more than that of a single tube—and the first cost is the only cost. Improve this profit making opportunity—and at the same time render your customers a valuable service.

Write for circular describing the complete group of Weston Radio Instruments. Prompt shipments made from stock.

Weston Electrical Instrument Co.

178 Weston Ave. Newark, N. J.
Electrical Indicating Instrument
Authorities Since 1888



"STANDARD" The World Over
**ELECTRICAL
INSTRUMENTS**

An Indicating
Instrument for
Every Individual
Need and Industrial
Purpose

Herman Lubinsky

(Continued from page 37)

and practice to various magazines and wrote a book on electricity, and its relation to radio.

At the close of the war he established the Standard Electric Company, thus becoming one of the early pioneer dealers of radio in Newark, N. J. His early start in this field gave him a position which enabled him, during the radio shortage of last year, to supply all customers without raising prices on scarce commodities.

His present business through honest practices and personal devotion has grown to a point where large quarters were necessary. He accordingly moved into 76 Springfield avenue, Newark, N. J., one of the most pretentious radio stores in the Newark district.

The Standard Electric Company, known to radio fans as the Radio Shop of Newark, N. J., are distributors of Acme apparatus, W. J. Murdock Products, Nathaniel Baldwin, Atwater-Kent, and Diamond Electric specialities. They are also sole distributors in New Jersey for the Grebe receiving set. A force of five men is maintained throughout the United States to take care of this business.

Radio Builder Set

A large proportion of the buying public is interested in a reasonably priced vacuum set. The Oranola Radio Corp., 228 Seventh Avenue, New York City, perfected a set along the most advanced lines to meet the needs of those who wish to assemble their own sets. The rheostat, socket and grid condenser and leak are already wired together as a single composite unit. This point is generally the one which causes trouble to purchasers when the various units are sold separately. Photographs and instruction leaflet will enable a youngster to assemble the set correctly, merely by using a screw driver.

The box containing the parts serves as a cabinet after assembly. Battery connections are provided on a bakelite strip at the rear. Genuine bakelite is used throughout and insulation is carefully watched in every part of the set. The circuit is a non-regenerative one, assuring undistorted wire and music. The set comprises a tapped inductance and variable condenser with necessary wires properly cut, bent and labelled, socket unit, rear connection strip, extra loud speaker or amplifier contact posts, etc. This outfit retails at \$20. Judging from the greatly increased volume of business during the last few weeks, this set is reported to be meeting with popularity as a holiday gift.

LITTLE GEM

PRICE
\$6.50

(Canada \$10.00)

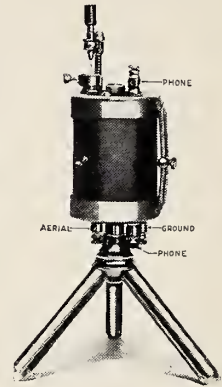

Simple, Clear, Efficient and
Beautiful

The LITTLE GEM presents a unique design combining compactness with efficiency. Unusually large receiving radius. Voice and musical tones come in with wonderful clearness and volume.

All metal parts are brass, nickel plated and polished. The instrument is beautiful in appearance, well made and practically indestructible. Nothing to get out of order or give trouble.

WHAT DISTRIBUTORS AND DEALERS SAY ABOUT THE LITTLE GEM:

"It will probably interest you to know that from our location at Columbus Circle, New York City, we are able to hear distinctly the broadcasting from WEAF, WJZ and WOR."

"We are enclosing an order for 100 more and trust you will be able to ship them before the 24th as specified. We also ask that you book us for 200 more." From a Troy, N. Y. distributor.

"Enter additional order for 100."—From Winnipeg, Canada.

"Last shipment of Little Gems all sold. Rush order enclosed. The Little Gem is proving to be a wonderful seller with us."—From a Tenn., dealer.

Attractive Proposition for
Jobbers and Dealers

United Specialties Co.
Incorporated
57-59 Spring St, Newark, N. J.

Crystal Set Amplifier

An amplifier for a crystal set is the latest and one of the most important developments offered by the Steinmetz Wireless Mfg. Company, of 5706 Penn Avenue, Pittsburgh, Pa. This innovation is intended to make the crystal set a more effective competitor of the vacuum set.

Only recently on the market, the Steinmetz amplifier is said to be suitable for any crystal set, coming in convenient units, so that one may add one, two, or three stages of amplification. These units use a peanut tube requiring only a single dry cell instead of the usual storage battery required by the more costly vacuum tube sets.

To insure against interruption in the operation of the crystal detector due to the fact of the cat whisker being dislodged from the sensitive crystal point, the makers have provided an ultra sensitive crystal which largely does away with this difficulty.

The combination of amplifier for a crystal set, coupled with the fact that no storage battery is necessary, is expected to add to the popularity of the crystal set.

Wave-Meter Design

The Bureau of Standards, Washington, has just issued a letter circular bearing the title, "Design of Portable Short-Wave Radio Wavemeter" in which is described the method by which one of these instruments may be made, together with constructive details. This instrument is intended primarily for use by the amateur who by the law is restricted when transmitting to use wave lengths not exceeding 200 meters, and it is important that he be able to adjust his transmitting set within the legal limits. The Bureau of Standards requests that as it has on hand only a very limited number of the mimeographed copies of this letter circular that copies cannot in general be distributed to the public.

North Ward Moves

The North Ward Radio Company of 72 Orange street, Newark, N. J., distributors for DeForest, Brandes, Magnavox, Burgess batteries, Saturn plugs and jacks and Marle transformers have moved to new quarters at 236 Halsey street, Newark, N. J. Their business has increased so largely that they have been forced to secure larger quarters, and in their new location they will be equipped to demonstrate fully their large line of radio equipment.

BETTS SPECIAL RECEIVER

Specially designed for receiving broadcasts at 300-400 meters —highly efficient and selective within this range.



A really fine receiving set sold at a moderate price. Made by a long established house, and offered only to the better class of trade on terms affording a white man's profit.

Write for terms.

BETTS & BETTS
CORPORATION

630 West 43rd St., New York

Betts Special Tuner,
type RC11 \$24.50

Betts Visible Detector-
amplifier, type D2A
without tubes \$38.50

Betts Loud Speaker
\$24.50
Three together \$81.50

M.P.M.
MILLION POINT MINERAL
The World's Greatest Radio Crystal

Nationally Advertised

Concerts heard over six hundred miles with
M. P. M. Crystal.

If all radio dealers would handle and push
M. P. M. Crystals, the interest and enthusi-
asm of the amateur would be increased a
hundred fold.

*Don't take our word. Send
for sample and test it.*

M.P.M. SALES COMPANY

Dept. RD

247 So. Central

Los Angeles

3 Y Q Transformers

High grade specialty built up to the highest quality and not down to a price.

Creates good will in customers.

RETAIL PRICE \$6.00

ORDER FROM YOUR
JOBBER

**"Amplification
without
Distortion"**

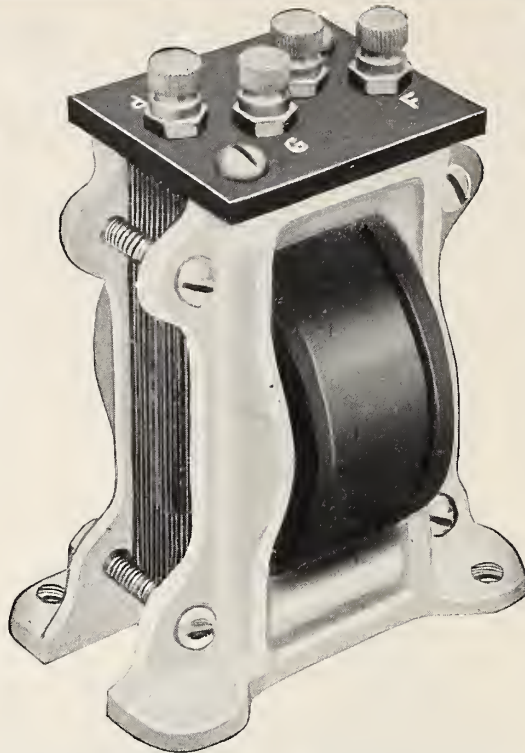

Federal Institute of Radio Telegraphy
Second and Federal Streets CAMDEN, N. J.

Development of Melco Receiver

(Continued from page 35)

plished by circuits embodied in the Telos amplifying transformer variometer, and by two adjustable units mounted on the panel. These units permit the use of any standard tube in the set. Instructions for the adjustments of these units for all the standard types of tubes now on the market are given with the set.

The set is suitable for use on loop, indoor or outdoor antenna or on lighting plugs. The reception of St. Louis in New York has been easily accomplished in a three-foot loop in recent tests. In point of distance it can receive, this set ranks with the best. In quality of tone reproduction is said to be far superior to most receivers and in a class by itself. It can be used with a power amplifier for outdoor demonstrations or for use in auditoriums, but the high tone quality suffers somewhat from the inherent defects of the audio-frequency amplifier.

The Melco Supreme Radio Amplifying Receiver is manufactured by the Mortimer Radio Corporation, New York City.

They Are Electragists Now

The tendency in shortening the names of occupations and in increasing their activities, as shown by the inventing of the word "realtor" to describe the "real estate man," has been followed by electrical contractors and dealers in the United States and Canada. They are now known as "electragists." What was formerly called the National Association of Electrical Contractors and Dealers is now the Association of Electragists, International, and its headquarters are at 15 West 37th Street, New York City.

Demonstration Before Sale

Payment for the crystal set after everything including an aerial has been set is the retail sales policy of the States Radio Corporation, 1416 Broadway, New York.

The company demonstrates the set first without obligation. Their salesmen make it work first in the home of the prospective purchaser. If the results are not satisfactory to him, the salesmen remove the set without any obligation.

The company's introductory set includes: States super crystal receiving set, single radio telephone receiver, 100 feet aerial wire, two insulators, clamp and wire for ground connections.

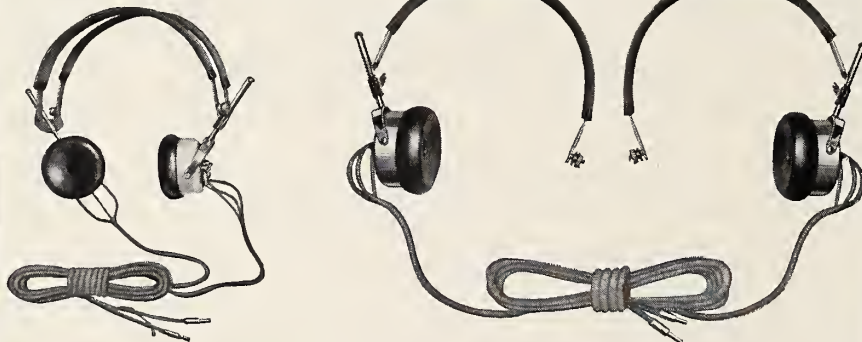

PATENTS

Premier Duplex

APLD. FOR

Premier Duplex Phones give real satisfaction. They increase the efficiency of receiving sets and add to the pleasure of listening in. The tone is clear, loud and pleasing. The caps feel good on your ears.

The best of materials, such as Tungsten Steel Magnets, Norway Iron Core, Commercially Pure Copper Wire Coils all carefully assembled and neatly finished make the Premier Duplex Phone one of the best.

The band splits into two parts, each having an overhead strip. It is very convenient for two persons to use. The adjustment is simple and effective. The cord permits of a five-foot separation between phones.

2000 Ohms \$6.50 Discount to Dealers 3000 Ohms \$8.00

PREMIER ACCESSORY & SPECIALTY CORP.

27 CONGRESS STREET

NEWARK, N. J.

Royalfone Activities

Continued increase in business has forced the Royal Electrical Laboratories to move into a new factory at 109-111 Tichenor street, Newark, N. J. The sales and advertising departments will still maintain their offices at 207 Market street, in charge of Harry L. Denburg.

The Royal Electrical Laboratories, besides making the nationally advertised Royalfone are also producing phones on contract for manufacturers of receiving sets for use as standard equipment with these sets. Their 1,500-ohm Royalfone has been found to be an ideal set for use with crystal detector sets. Due to their low resistance, greater audibility is secured when connected with this type of set. The Royalfone, 2200 ohms, is especially adapted for long range receiving, and is also suited for use in connection with loud speakers.

Charles Lehrfeld, radio engineer of the Royal Electrical Laboratories, promises that he will soon put out a phone that will have an adjustable diaphragm so that one can regulate the air gap between the poles and diaphragm and thus be able to take care of the change of potential. The person using this phone will not experience the sensation of the rough sounds that come through when change from detector to one or two stages of amplification is made. This phone is past the experimental stage and will in all probability be ready for sale within a few weeks.

As Royal Electrical Laboratories only sell to jobbers and preferred dealers they have established agencies both in the United States and Canada.

Chicago Show Opens Jan. 13

George S. Walker, president of the Western Radio Corp., at Denver, and president of the National Broadcasters' League, has instructed the secretary to issue a call for the first National Convention of Broadcasters to convene concurrent with the Second National Radio Exposition to be held in the First Regiment Armory, Chicago, January 13 to 20, 1923.

The dates for the exposition are at a time when dealers have passed through a busy holiday season and they will then be fired with enthusiasm over the future of radio. There are a number of sound proof rooms for loud speakers. None will be permitted on the main floor.

The management of the exposition is asking for help and suggestions in framing an educational program that will give the radio dealer some real information on merchandising.

WOODEHORN \$7.50 Loud Speaker

Complete special attachment to fit any loud speaking unit



Height
26 in.
Bell
10 in.

This non metallic loud speaker is revolutionizing the radio industry. It's the wood that makes the tone good. The clear bell-like tones of *WOODEHORN* give greater amplifications without distortion. It gives results equal to horns selling for \$50 and more. Investigate the fast selling *WOODEHORN* today. Low Price! Big profits!

Write Today for Sample Horn and Discounts

INTER-OCEAN RADIO CORP.

1140 Broadway

New York

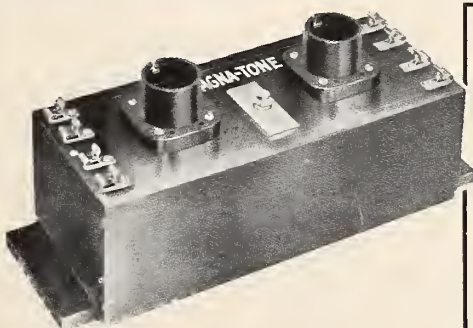

Lift the switch and this *MAGNA-TONE* Two stage Amplifier is in operation with filaments under fixed control. Circuit is automatically rearranged for one stage by lifting the first tube—at the left. Size, 13 x 5 x 5½ inches. Ebony finish.

JOBBERS AND DISTRIBUTORS—There's a big demand for this radio essential. Write at once for our special proposition.

List Price **\$24**

MAGNA INSTRUMENT COMPANY

340 West 42nd Street, New York City

MAGNA-TONE Vacuum Tube Receiver—a radio set without fussy adjustments. Only two adjustments necessary. Provided with Fahnestock terminals which insure positive connections throughout. Size, 13 x 5 x 5½ inches. Ebony finish.

DEALERS—Radio fans want simpler apparatus. Here it is. Discounts are generous. Big sales reported. Get in touch with your Jobber.

List Price **\$16**



Catalog on Request

"Better Than The Best"
AERIAL-A
 The Radio Tube Set That Made Good In a Night
 W.E. Supply & Service Corp. 18 Murray St. N.Y. U.S.A.

January is the Inventory Month

(Continued from page 28)

would be declared out of unearned profits which is against the law in New York and other states.

However, conservative business demands that inventories be priced at cost or market value, whichever is lower.

More business men look upon inventory-taking time with exasperation, to be mild; exasperated at the cost of it, the time lost, the slowing-up of business, and its general nuisance.

And yet the way out, the remedy, is simple. It consists of a simple system of perpetual inventory-keeping. The system fits in easily in all businesses where there is no manufacturing, but not so easily where there is. But it can be made to fit properly.

The radio dealer should have no trouble keeping such a system; it is easy to operate, costs very little or nothing for upkeep, and its advantages are multi-fold. It tells at a glance just how much of a given unit is on hand, where it was last bought, how much was paid for it, and how rapidly it is being sold. The dealer can watch his buying much more closely, and besides, keep track of where the material is going to.

Last, and certainly not the least important, an examination of your inventory will disclose to you at least some slow-moving merchandise, and a little ingenuity will show what good leaders you can arrange for your special sales which are to come.

Learn to watch your inventory and to use it, for it has proved itself one of the finest and surest danger-signals in a business. Where the signal is heeded it avoids much that may be lost, and prevents a sorry end.

How Denver's Little Store Became Big

(Continued from page 29)

lic speaking men for their lectures. A regular program as scheduled is maintained and a real, legitimate entertainment is provided. Nothing is permitted to be broadcasted in the line of advertising which may in turn be the means of a profit."

Recently the Reynolds company issued a good catalog of some sixty pages, illustrating their store and sales room and listing a number of broadcasting stations. All of the standard goods carried by the company are de-

PATENTS

PROTECT YOUR INVENTION TODAY
 Write for 1922 illustrated book free Radio-Electrical, chemical and mechanical experts; over 20 years' experience.
A. M. WILSON, Inc. (Radio 3 ARH)
 309-20 Victor Building, Washington, D. C.
 (Successors to business established 1891 by A. M. Wilson)

CONTAINA

The Adjustable Double Surface Crystal Setting Awarded Evening Mail Certificate of Excellence.
Minimum Cost *Maximum Service*
CURTIS G. CULIN
 366 Broadway New York City

KNOCK-DOWN RADIO RECEIVING SET

Neatly packed in an attractive hinged cover box. Makes a wonderful display. A child can assemble this set. Practical and instructive. Complete instructions for assembly included.
 RETAIL PRICE, \$4.50.
 Liberal Discounts to Jobbers. (Established 1871)
CHAS. WINKLER, INC., 178 Emmett St., Newark N. J.

RADION HARD RUBBER PANELS

Cut to Any Size
DISCS, WASHERS, BUSHINGS, ETC.
 Made to Order
New York Hard Rubber Turning Co.
 212 Centre Street, N. Y. C.

KRAMER RADIO COMPANY

4713 Sheridan Road, CHICAGO, ILL.
MIDWEST DISTRIBUTORS
 Of Quality Radio Products
 Write Us for Catalog and Discounts

PATENTS

on radio inventions apply to
OTTO K. ZWINGENBERGER
 38 Park Row, New York
 Cortlandt 3207

"EDGCO" RADIO PRODUCTS

Have You Our New Price List?
 Save money by our prices; save time by our prompt shipment. Successful dealers sell "EDGCO."
The EDW. J. GOETZ CO.
 608 Race St., Cincinnati, O.

M-R FLEXIBLE VARNISHED TUBING

THE GENUINE
"SPAGHETTI"
 TWO STYLES—BEST GRADES MADE—ALL SIZES—ALL COLORS
 Varnishes, Waxes, Compounds, Papers, etc.
MITCHELL-RAND MFG. CO.
 14 VESEY STREET NEW YORK, N. Y.

PATENT

your ideas. Protect your rights by U. S. and Foreign Patents and Trade-Marks. Moderate rates. CALL, WRITE or send us your invention.
 May one of our representatives call on you?
FREE CONSULTATION
 Phone: Vanderbilt 7212.

ASK MANUFACTURERS PATENT CO. FOR 520 FIFTH AVE. NEW YORK

MANUFACTURERS OF
 Receiving Sets Complete
 Unites Mounted and Unmounted
 Send for Description and Prices
RADIO OUTFITTING CORP.
 Mfg. High Grade Radio Apparatus
 410-412 East 34th St. New York, N. Y.

YOU SHOULD KNOW ABOUT OUR

THE MILLS RADIO & ELECTRIC CO.
 INCORPORATED
 1008 Springfield Ave. Irvington, N. J.

Fine Cuts for Illustrating
CENTRAL ELECTROTYPE FOUNDRY COMPANY
 Electrotyping and Engravings
 69-71-73 Warren St., near Plane
 Newark, N. J.
 Telephone: Mulberry 1698

Wang That's **STATIC**,
 Take it Out with our
VERNIER CONDENSERS
Bang That's another Station
 coming in. **DITTO**
ELECTRIC PRODUCTS CO.
 11 Pemberton Sq. Boston, Mass.

NULOID

Scientific Chemical Compound for
 Radio Parts and Panels
NULOID CORPORATION
 119 Chambers St. New York



RHEOSTATS
 and Other
STANDARD PARTS
 FOR TUBE and CRYSTAL SETS
 Dealers: Write for Price List and Proposition.
The Radiola Wireless Corp.
 208 W. 17th St. New York City

PATENTS

ELECTRICAL MECHANICAL
RADIO
 SEND SKETCH AND DESCRIPTION FOR OPINION
EMIL ALEXANDER KERN
 328 SOUTH SEVENTH STREET
 NEWARK, N. J.

Have Outlet For
SURPLUS STOCKS
Radio Supplies
 Price and Goods Must Be Right
P. D. Jackson, 1441 So. State, Chicago

scribed, from crystal sets to 50-100-watt transmitting outfits. Hook-ups are shown, as are other matters of radio interest. Ten thousand of these catalogs have been distributed throughout the country and it is the plan of the company to issue another edition of this guide to radio.

The organization has a definite selling plan to the dealer and is in position to give good service on standard equipment. The reputation and methods established by Dr. Reynolds in his selling organization are worthy of the attention of the trade.

Mr. Gilbert on Vacuum Tube Situation

(Continued from page 28)

grid and filament. Standard 4-prong base, heavily nickel-plated.

These tubes are all hard pumped in contra-distinction to the other tubes on the market and require an amount of current in the filament about one-half that required by these other tubes. They are small in size which makes breakage less likely, and also makes possible extremely short parallel lead wires.

"This, combined with the high resistance base," says Mr. Gilbert, "makes these tubes ideal for radio frequency amplification."

Mr. Gilbert kindly consented to throw some light upon the legal battles now being fought anent the production of tubes. He said:

"E. D. Myers of the Radio Audion Co. is not the inventor of the audion tube and his connection with the De Forest Company as an employe was a rather brief one during 1917. He was in our employ as general foreman of the vacuum tube department and had charge of the assembling and pumping of the same.

"Mr. Myers is at present an officer of the Radio Audion Company which has no connection with the De Forest Company except that it is manufacturing and selling vacuum tubes of a special type under an immunity agreement covering the grid patent."

The American Tel. & Tel. Company and the Radio Corporation of America are questioning this agreement, claiming same is violation of the license agreement the De Forest Company granted them in 1917. They claim that Mr. Gilbert's organization has no right to enter into such agreements with concerns desiring to manufacture three-element vacuum tubes. The matter of patent rights is now being threshed out in the courts.

On this subject the Radio Audion Company, through their exclusive distributors, the Radio Supply and Serv-

ATTENTION! DEALERS



A Salesroom in New York for a Dollar a Day

Do Your Buying at

THE PERMANENT RADIO FAIR

HOTEL IMPERIAL - 32nd St. and Broadway

Buyers - Dealers - Radio Department Managers

Only Products of Representative Manufacturers are on display and demonstrations will be given of any of the exhibits.

Over 75 of the leading manufacturers now exhibited and space is being filled very rapidly—Call or Wire for Space.

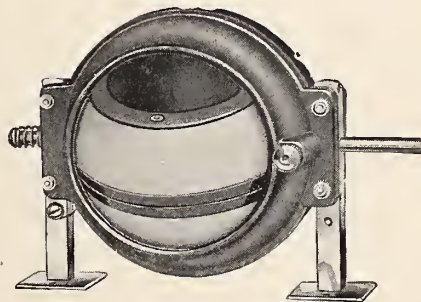

VARIOMETER

List Price \$6.50



The Finest Radio Apparatus

On the Market

The apparatus manufactured by the Radio Products Mfg. Co. is recognized as the very highest grade, designed to meet the most exacting requirements. Each unit is made complete in our own plant from the Redmanol moulding to the winding, assembling and final testing of the completed instrument.

Twenty years in the electrical manufacturing field gives us the wide experience, equipment and specialized organization necessary to produce the highest grade equipment to be had in this line.

Write us for full information.

Radio Products Manufacturing Co.

667 W. Fourteenth St.
CHICAGO, ILL.

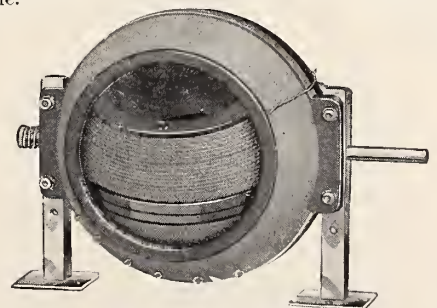

VARIOCOUPLER

List Price \$6.50

NEW FADA PRODUCTS



Fada Vernier Rheostat

Insures the most delicate filament control. One single knob for both main and vernier control.

No. 150-A Price \$1.25

Vernier Attachment Only

Can be applied to practically any make of rheostat, converting it into a vernier rheostat.

No. 151-A Price \$.50

Fada Potentiometer

Same base and construction as the regular FADA rheostats. Resistance strip accurately wound with special enamelled alloy wire.

No. 152-A (200 Ohms) Price \$1.00

No. 154-A (400 Ohms) Price \$1.00

WE ALSO DISTRIBUTE THE ENTIRE FADA LINE OF SETS AND PARTS

Immediate Deliveries at Present
DEALERS WRITE FOR DISCOUNTS

VIKING RADIO CO.

26-D Cortlandt St. New York City

PHONE PLUGS

Standard Type



35^c each

22^c each

in lots of 100 or more

The above plugs can be used with pin, spade, or plain wire ends.

No soldering necessary

S. S. NOVELTY CO.

255 Bowery, New York, N. Y.

ice Corporation, declare they will prosecute their million-dollar damage suit against the Radio Corporation of America, claiming losses suffered through the efforts of the Radio Corporation to interrupt their business.

The Radio Audion Company claims, in their legal papers, that the Radio Corporation put out a circular anent the Myers tube, declaring dealers are liable to prosecution for handling these tubes.

Pathé Loud Speakers

In the Pathé loud speaker, in contrast to other loud speakers, the sound waves are given directly from the diaphragm rather than in an indirect way by reflection from the sides of a metallic horn. This is said completely to eliminate the tinny sounds that are bound to come from many of the ordinary types.

Being experienced in the construction of tone arms, the Pathé corporation has introduced some of the principles found desirable in the designing of tone chambers in phonographs into the making of their loud speaker. The speaker is light in weight and is extremely compact. As for appearance, it can hardly be surpassed. To use the Pathé loud speaker it is only necessary to employ a receiver fitted with a two-stage amplifier and a 110-volt "B" battery. The two terminals on the speaker are wired to the telephone binding posts without the use of an auxiliary source of power. To get the most out of a Pathé loud speaker the use of a three-stage audio frequency amplifier with a plate battery of 90 to 135 volts is recommended. This apparatus is manufactured by the Pathé Phonograph & Radio Corporation, 10-34 Grand street, Brooklyn, N. Y.

Homcharger Cut-Out

One of the most effective cut-outs recently evolved by radio manufacturers is that used by the Automatic Electrical Devices Company of Cincinnati, Ohio, to bring their Homcharger before the attention of radio enthusiasts. It is in striking red and gold, a facsimile in size and outline of the regulation charger for home radio batteries. A real name plate affixed to the cut-out adds to the illusion which this piece of advertising carries out.

The cut-out graphically depicts the neatness, convenience and ornamental appearance of the Homcharger.

These cut-outs may be obtained by dealers handling Homchargers from the manufacturer or from Henry Paulson & Company, 37 South Wabash Avenue, Chicago.

\$3 makes your PHONOGRAPH the best loud speaker



Unscrew Head Phone Cap and Replace with Huguenot Sizes to fit all Standard Phones

Fits All Standard Phonograph Tone Arms. For Special Makes Use Bushing 50 Cents Extra

HUGUENOT

RADIO-PHONOGRAPH ATTACHMENT

No Metal Parts to Bend
No Leaks or Loose Connections
Quickly and Easily Attached
Made of Black Polished Hard Rubber

Double Phone Attachment—\$3.00
Single Phone Attachment—\$1.00

Mail orders filled promptly on receipt of remittance
Specify make of phonograph and head-phones.

McKENZIE ENGINEERING COMPANY
NEW ROCHELLE, N. Y.

Special discounts to the trade.

DISTANT STATIONS BROUGHT IN FOR LONG WAVE RECEPTION

USE AMCO ADJUSTABLE, 1, 2 AND 3 COIL MOUNTINGS

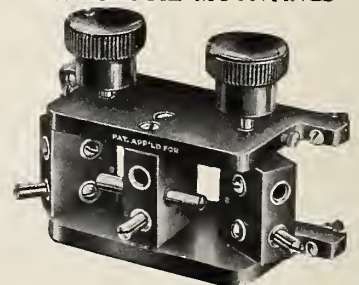

Licensed Under DeForest U. S. Patent, No. 1,365,170

Triple Coil Mounting List \$4.00

Two Coil Mounting List \$3.00

Single Coil Mounting List \$0.50

Adjustable locking device, a patented feature, holds the coil firmly in place. Readily mounted on front of panel in any position.

Constructed of the highest grade insulating material; polished and attractively finished.

All metal parts heavily nickel plated.

NOT A MOULDED AFFAIR

Astorloid Mfg. Co., Inc.

Tel. Williamsburg 5104

416 Marcy Ave. Brooklyn, N. Y.

Radio-A Recharger

Believing that the radio user would appreciate the elimination of the need for having radio batteries recharged at garages, and the attendant annoyance and expense, the King Electric Manufacturing Company, Inc., of 1681 Fillmore avenue, Buffalo, N. Y., are now offering their Radio-A Battery recharger, designed expressly for the recharging of radio filament batteries.

Ensuring an easy system of recharging at a small cost, the Radio-A is designed to provide for the successful operation of the modern radio set, dependent as it is upon a well-charged storage battery that keeps the vacuum tubes burning brightly and the signals working clearly.

A special feature of the Radio-A is the vibrator which when worn out can be replaced easily and quickly without tools. Being portable the recharger can be taken into the garage to add further utility by, recharging the battery of the car at a cost of about ten cents.

Uses for Radio Voltmeter

An instrument that combines in one unit the means for testing batteries, filaments and circuits of an entire radio system is provided to the radio public by the Pignolet Instrument Company, Inc., 11 Liberty Street, New York, in the Pignolet voltmeter.

The instrument, of the D'Arsonval type, is suspended on ground steel pivots fitted into sapphire bearings. Extremely accurate readings are provided for by an adjusting screw on the face of the cover which corrects the pointer for zero readings. The instrument is designed for use in connection with direct current. It is made in three styles, PRV, a portable instrument mounted on a base, FRV, flush type for switchboard mounting, back connected, and SRV, surface type, for switchboard mounting, back connected. A pamphlet, which may be had from the company for the asking, explains how the instrument may be applied to various testing uses in radio.

Magnus Enlarges Factory

The Magnus Electric Company, Inc., of 451 Greenwich Street, New York, announce that they are enlarging their factory floor space by 11,000 square feet to provide for additional output. This is the second increase in space within the year.

Specifications are being prepared for bids on new equipment and machinery for use in the electrical plug and radio accessory departments.

A representative line OF STAPLE MERCHANDISE

DeForest Equipment (New D. V. Tubes)
 Saturn Products, Perfect Jacks and Saturn Automatic Radio Plugs
 Rico Loud Speaker Phones—Brandes Phones
 Tungar Battery Charger, Extra Attachment for Storage "B" Batteries
 Dayton Fan and Motor Co. Variometers and Variocouplers
 Woodehorn Loud Speaker—Magnavox

NORTH WARD RADIO CO.

Phone Mitchell 1463

236 Halsey Street

Newark, N. J.

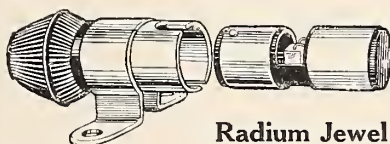

Radium Jewel Detector

Far above the ordinary crystal detector. Extremely sensitive. Easily adjusted. Makes reception much sharper and clearer. No battery or other accessories needed. The very latest development. The only device of its kind for sale.

- Combination \$1.00 list.
- Detector Bulb 60c
- Bulb Holder 40c

Write for Very Attractive Discounts

STAR MANUFACTURING CO. 868 BERGEN STREET NEWARK, N. J.

Their Novelty Sells and Sells Their Efficiency Brings Repeats

No shelf stuff: sells on sight, nothing like it. All guaranteed. A small trial order will show you real money. Send it today.

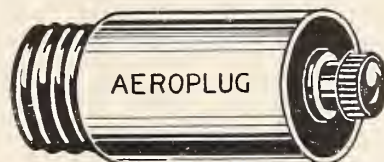

AEROPLUG—the Socket Aerial
 Just by screwing the plug into any lamp socket, makes house lighting circuit a powerful aerial Uses no current. No danger. Nothing to get out of order. Requires no attention. Lasts indefinitely. LIST \$1.50

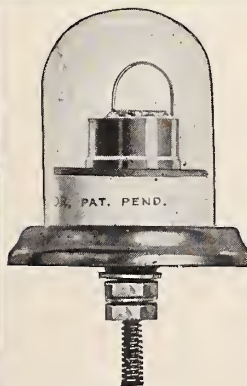

(Actual Size)

GREWOL, the DETECTOR

With a National Reputation \$2.00

ENTIRELY different—infinately superior. Sells almost on sight. Makes good and makes sales. Attractively packed in individual cartons. Never stays long on any shelf.

Lasting Adjustment
 Always Set and Ready
 Glass Enclosed

Write for Proposition TODAY!!

RANDEL WIRELESS CO.

Sole United States Distributors
 9 CENTRAL AVE. NEWARK, N. J.

DEALERS!

If the Holiday Sales have depleted your stock—reorder now for mid-winter sales. Prompt deliveries are absolutely guaranteed—and our discounts are the most liberal.

We Are Jobbers For
Grebe Receiving Sets
Federal, Fada and
Radio Shop Products
Murdock Products
Baldwin Phones

Write For Our Special Proposition "Z"

THE RADIO SHOP

—OF NEWARK—

76 SPRINGFIELD AVENUE
 NEWARK, N. J.

"The Little Wonder"

FOR BOYS AND GIRLS

CRYSTAL SETS

Unassembled - Net **\$1.75**

Catches distinctly everything broadcast within 30 miles. We also manufacture the "Little Wonder" assembled set to retail at \$4.00.

**GUARANTEED
 TESTED CRYSTALS**

Galena 7½c Radiosite 8½c
 Dealers and Jobbers Write for Free
 Catalog

It lists all our radio parts and supplies.

Holloway Elec. Supply Co., Inc.
 238 Third Ave. New York City

Radio Cabinets

Made to your specifications in any quantity, style, wood, or finish. Submit specifications for quotation.

Standard models, all common sizes, in Mahogany, Walnut, and Quarter-sawed Oak. Descriptive material and prices on application.

Better Cabinets

for

Manufacturers and the Trade at Large

MARVIN B. FALLGATTER

Waupaca

Wisconsin

Power Amplifiers for Loud Speaking

(Continued from page 31)

comparative table between input electrical energy (watts) to, and output sound energy from an average loud-speaker, will be helpful.

Watts Input	Relative Sound Output
¼	— Audible
½	— 3 or 4 feet from horn.
¾	— Around an average room.
1	— Fairly loud.
2	— Moderate phonograph intensity.
4	— Around a large hall.
6	— 2 or 3 blocks outdoors.
10	— About ½ mile.
20	— <i>Smell of insulation burning.</i>

This shows then that the bi-polar type of loud-speaking unit will operate satisfactorily up to the intensity of a soft (not plastic, but quiet) phonograph record and is therefore quite pleasant in an average room. If we want to let a number of persons in a large room hear well, a unit that will stand 2 or 3 times this wattage without distorting must be used. This would be one of the lever-arm type now in general use. This type is usually connected directly in the plate circuit as is the first mentioned and can likewise be wound to any reasonable impedance. The lever-arm type all have a maximum capacity of approximately 3 watts and are very good for ordinary inside work.

The next is the floating armature or Baldwin type which can be made to stand 10 (or even 20) watts if properly constructed. The Baldwin units, however, will not work clearly above approximately 2 watts and may be permanently spoiled if forced much above that value. This type should be used with a transformer since any D. C. from the plate circuit serves only to polarize the armature and therefore distort the diaphragm which in turn affects the output quality. This type gives the best results and highest quality when wound to about 2,000 ohms impedance and used with a step down transformer with a ratio of 3 or 4 to 1. They will give quite satisfactory results, however, without a transformer if wound to high impedance and used in the plate circuit of a voltage amplifier tube on not over 90 volts "B" battery.

The last of this group is the moving coil type unit which is well known on the American market. This must be used with a transformer as sufficient winding can not be put on the diaphragm without making it too heavy. The transformer is always supplied and is wound to fit moderate to low impedance tubes. The capacity can

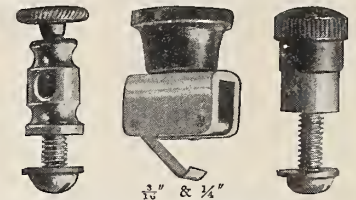

CRYSTALS **GALENA SILICON**
CRYSTAL DETECTORS List \$2.00
CRYSTAL RECEIVERS List \$9.00
RADIO APPARATUS CO.
 6600 Hamilton Ave. Pittsburgh, Pa.

Do You Know

We are the recognized authorities on wireless securities. Our Information and Analytical Departments are unexcelled. Let us know what company you are interested in and we will furnish without obligation, detailed information and opinion respecting its merits

FRANK T. STANTON & CO.

Specialists in Wireless Securities
 Since 1915

35 Broad St. New York

Phone: Broad 1670-3641-5819

THORNTON

**AUDIO FREQUENCY
 AMPLIFYING TRANSFORMERS**

Supreme Test Transformer

These transformers are supplied in either mounted or unmounted types. *Special attention paid to the manufacturer of receiving sets.*

**THORNTON
 TRANSFORMER CO., Inc.**
 30 Church Street, New York City

REAL DISCOUNTS

TO DEALERS

Master Baldwins	Dubilier
Coto Coil	Erla
Howard	Pacent
Atwater Kent	Brandes
Carter	Geraco
Radium Loops	United
Myers—Radiotrons—Cunninghams	

W.D. 11's

OUR NEW DISCOUNT SHEET IS
 READY

HUDSON - ROSS

123 W. Madison St. Chicago

DIAMANT

**VARIABLE CONDENSERS
 AND CRYSTAL DETECTORS**

Electrically and Mechanically Guaranteed

Diamant Tool & Mfg. Co., Inc.
 93 Runyon Street Newark, N. J.

be as high as 20 watts but at this input a seamless horn must be used as one with seams might be blown open. In fact very few single loudspeakers of any type have ever been operated satisfactorily at this value.

All loudspeakers have approximately the same efficiency of transformation from electrical to sound energy and the loudness of the sound from any is dependent principally on the signal energy supplied to it—the more wattage from the last tube, the more sound from the horn.

The two most important things to be done when volume is desired is to get enough signal voltage onto the grid of the power tube and then see that the tube has enough "B" battery energy supplied to it for the signal to work on. That is, if we want to operate a speaker to say 4 watts capacity we must have a power tube capable of handling high enough "B" battery voltage to allow the tube to deliver at least 4 watts and also have sufficient signal voltage available from the last stage of voltage amplification to operate the power tube 4 watts worth.

With an average antenna two stages of voltage amplification before the power stage should do this on broadcasting within 50 miles, while 3 stages may be necessary if the sending station is further away or antenna conditions are very unfavorable. Any more tubes in the circuit than necessary simply adds to the extraneous noise mixed with the music or speech and puts added drain on the batteries.

There have been observed, and only recently, too, demonstration sets in several stores with as many as eight tubes working and delivering about 3 watts of the most nerve-racking stuff imaginable. Customers come up to these places, *try* to listen a minute or so, look at the \$500.00 layout of apparatus, and walk out saying, "If that's all he can get with that much equipment, I think I'll wait till radio is perfected." That does not do radio justice nor does it sell apparatus. It simply kills the game—that's all.

What is the remedy? Simply this: Make your demonstration do the work with a minimum of apparatus. Make it *look* simple. Make it talk or sing or recite, not yell or screech or blaa-blaa. Reduce tube noises to a minimum by using the right tubes in the right place and by adjusting them to operate most efficiently. Don't put too many "B" batteries on the set—that's worse than too few. Don't let the amplifier screech at exceedingly high frequency. Ground the filament circuit. Learn to use "C" batteries if you set up your own amplifier. They make all

Etherphonette

The last word in RADIO

HERE is the most unique "listening in" outfit in the field of Radio. In the Etherphonette the receiving instrument is built right into the head phone. No extra equipment is needed. Simply connect to single wire aerial (40 to 75 feet long) inside or outside the home or to lamp socket antenna plug, and ground to radiator, gas or water pipe. Then "tune in."

One shell of the Etherphonette contains a 1500 ohm phone—the other an efficient tuner and concealed crystal detector. Catwhisker, crystal and tuning controlled by outside adjustment knobs. A special eight-foot cord with five foot split ends, and clips for aerial and ground connections, completes the set. Entire Etherphonette is no larger and no heavier than ordinary head phone. Retail at \$12.50.

Unusual Sales Possibilities

The unique construction of the Etherphonette and its low retail price offer you an unusual opportunity to materially increase your sales and your profits. Write today for particulars of our dealers' proposition, together with catalog of our complete line of Etherphone Receiving Sets ranging in price from \$3.50 to \$75.00.

RADIO APPARATUS CO.

Manufacturers of

"Etherphone" Radio Equipment

40 W. Montcalm St., Detroit, Mich.

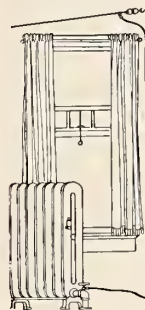

Retail Price \$12.50

Receiving Set and Head Phone Combined!

Remember that the Etherphonette is not a toy, but a practical, scientifically built, radio receiving set. Receives any broadcasting station, sending on 200 to 450 meters, within 15 to 20 miles.

SATURN



PRODUCTS

The Saturn "Automatic"



RADIO PLUG

The Saturn "PERFECT" Jack



No screwdriver required. Not necessary to dissemble.

To make connection, just insert terminal tips, and contact is made. The more you pull, the better the contact. To take terminal out, just press the release lug and the tips fall out.

The Plug you have been looking for
Every Plug sealed and fully guaranteed
List Price \$1.50

This jack is an improvement on any other Jack on the market. The crowfoot offset allows easy soldering. The Bracket is made of Brass, Nickel Plated; rounded corners. The Blades are of Spring German Silver. The Contact Points are Genuine Silver. The Nipples are shoulder type and are furnished with two washers, Nickel Plated and Polished.

- No. 1. Single Circuit Open . . . \$0.65
- No. 2. Single Circuit Closed . . . 0.75
- No. 3. Double Circuit Closed . . . 0.90
- No. 4. Single Filament Control . . . 1.00
- No. 5. Double Filament Control . . . 1.25

THE SATURN MFG. & SALES CO., Inc.

48 Beekman Street

Dept. D.

New York, N. Y.

Hammarlund Vernier Variable Condenser

For Super-Accurate Tuning

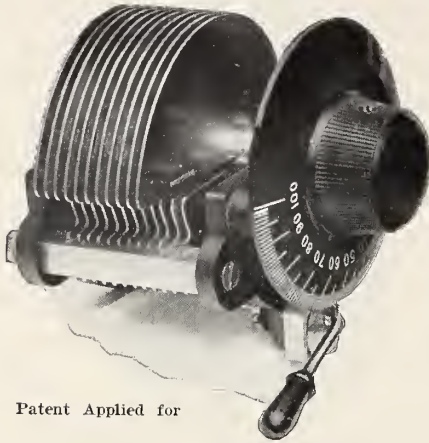

Patent Applied for

The Radio News Laboratories rate this condenser 96% perfect, the highest rating given any condenser. Tested and approved by the Tribune Institute.

.001 Mfd. \$7.00

.0005 Mfd. \$6.00

3½-in. Bakelite Dial, \$1.00

Write for descriptive circular

HAMMARLUND MFG. CO., Inc.

144-146 West 18th Street
New York

"MICROSTAT"

A Vernier Throughout its Range

\$1.50

LOUIS A. STAFF COMPANY

1755 Broadway New York

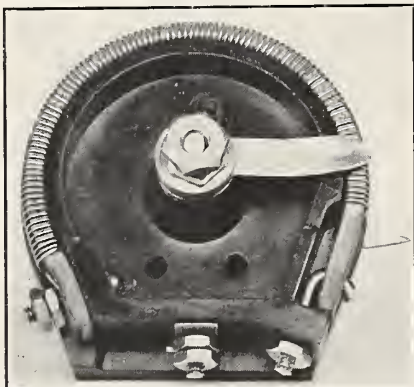

THRADIO RHEOSTAT

Plain and Vernier

Built on Absolutely New
Principles

HEAD SETS—SOCKETS
CONDENSERS—TRANSFORMERS
THRASHER RADIO CORP.

476-484—18th Avenue
Newark, N. J.

the difference in the world on amplifier tubes. Do all you can to eliminate spark interference even if you must resort to a loop and an extra stage of voltage amplification. It pays, especially if your customer brings his wife along.

The good broadcasting stations are away ahead of the receiving equipment as far as quality of tone is concerned. They are sending energy from their antennae that is practically a perfect copy of the artists' work, and we believe that if it were being reproduced with absolutely no distortion in every dealers' place, they would have no good radio material on their shelves for the next two or three years. It can be done because we've done it, so why not try it yourself?

Now to get back to the "how" of it again.

In the illustration, you will recognize the three available power tubes on the open market. They are the Radiotron U. V. 202, the VT-2, and the 216-A. The first is Radio Corporation and the last two, Western Electric. Referring to our table in the December issue of THE RADIO DEALER, we see that they are rated respectively at 6, 5½, and 3½ watts maximum output. Then, by our other table above, they will all deliver enough energy to a loudspeaker to cover a large hall, and, of course, can be reduced to any intensity below that.

However, if the filaments are not heated to operating temperature, or the plate voltage is not up to that given in the table, the full output cannot be obtained from them, no matter how many stages of amplification precedes the power tube. If we only have 300 volts on the U. V. 202 it will only deliver a maximum of about 3 watts to the speaker. But since that is enough for ordinary demonstration work, they give good results at that value. Likewise, the VT-2 on about 250 volts, will deliver about three watts, which is quite satisfactory.

In the case of the Western Electric 10-A loud-speaking set, the last stage employs two 216-A bulbs (each with a maximum output of 3½ watts at 160 volts) in a push-pull circuit. This arrangement not only gives much better quality, but also a little more output, so that it delivers about 4 watts on 150 volts.

The Magnavox power amplifier will deliver a maximum of about 5 watts on 375 volts with a U. V. 202 in the last stage. It should be remembered that the higher the plate voltage the higher the drain on the "B" batteries and consequently the shorter their life. It is well, therefore, not to use any more plate voltage than necessary to

RUSONITE

CRYSTAL RECTIFIER

MULTIPOINT (Patent Pending)

A SYNTHETIC CRYSTAL DETECTOR
Sensitive Over Entire Surface

GUARANTEED

Unequalled Clearness: Unequalled Volume: Unequalled Distance. The Standard Crystal Endorsed by Experts, Press and Trade

Manufacturers are increasing efficiency by equipping their Crystal sets with Rusonite Crystals.

List Price 50c.

RUSONITE CATWHISKER

(Patent Pending)

14 Karat Gold—Supersensitive

List Price 25c

Attractive Discounts to the Trade

RUSONITE PRODUCTS CORP.
Dept. D., 15 Park Row, New York, N. Y.

Recommended for Reliability

RADIO STORES CORP.
VARIABLE CONDENSERS—
PLUGS-RESISTANCE UNITS, ETC.
222 West 34th Street, New York

You'd walk a mile for a
RADION Panel if you
knew how much better
results you'd get.

**THE PARAMOUNT
ENGRAVING MACHINE**
for Radio Panels

Greatest Production—Lowest in Price

PARAMOUNT MACHINE CO.
207 Market Street Newark, N. J.

RADIO CATALOG No. 54
Now ready
Send for it today

The A. C. Gilbert Company,
Dept. C., New Haven, Conn.



"VICTOR JUNIOR"

Our Latest Model
Write for Catalog

Victor Radio Corp.
795 East 125th St.
New York City

Hit it anywhere!



Every point a sensitive one. The most sensitive detector substance on the world market. Unaffected by handling or moisture, and will render efficient service indefinitely. **GUARANTEED.** Display posters supplied to the Trade. Being advertised nationally. List 50 cents per crystal. **DEALERS write immediately.**

Owners and nationally Distributors

Gibbons-Dustin Radio Mfg. Co.
518 W. 9th St. Los Angeles, Cal.

give the intensity desired, with high quality.

As we suggested in the previous article on voltage amplifiers, the U. V. 201 can be used as a power tube with good results, except that it has a maximum output capacity of only 2½ watts. It is therefore suitable for use where but moderate intensity is needed and since the filament requires only 1 ampere at about 5 volts against 2¼ amperes at about 7 volts for the U. V. 202, it is much more economical. The "B" battery drain is also smaller with the former.

The amplification constant of the U. V. 202, VT-2, U. V. 201, 216-A, and VT-1 is approximately seven, and therefore the tube that fits the circuit in which it is used best, will amplify the best.

Power tubes do not amplify any more than other tubes unless they fit the apparatus characteristics better, and since they require more "A" and "B" supply than the voltage amplifiers, they should, for efficiency, be used only in the last stage to operate the loudspeaker. We are not overlooking the fact that the Western Electric 7-A amplifier (of the 10-A set) employs a 216-A tube in the next to the last stage. If the circuit is analyzed, however, it will be seen that this tube acts as a voltage amplifier operating into the push-pull stage. This is done, primarily, for merchandising efficiency.

It is true that power tubes do give as good or sometimes better amplification in some of the commercial audio frequency amplifying units than ordinary tubes. This may be due to either of two things, namely, the amplifier tubes used not being up to standard, or, the audio transformers employed in the set not being high enough primary impedance to match the amplifier tubes properly. This condition should not obtain in a well designed amplifying unit. At any rate it is poor policy to operate a power tube into an audio amplifying transformer primary because the much higher plate current (milliamps) is liable to burn out the winding any time.

It will be noticed that our table in last issue rates the WD-11 at only ¾ watt maximum output. This means that it will operate an ordinary loudspeaker to cover an average room very nicely, and if the loud-speaking unit is high enough impedance to match the tube well (i. e. is about 40,000 ohms impedance) very satisfactory loud-speaking results, for the home, can be had. But this is the limit of intensity that can be forced from the WD-11, no matter how many stages of amplification precedes it. If the tube is overloaded with signal, added distor-

STOP-LOOK-WRITE

DEALERS, JOBBERS AND MANUFACTURERS

Before placing orders, write us first and get samples and our big discount sheet.

Condensers 43-Plate.....	List \$3.50	Turney Head Sets.....	List \$6.50
" 23- "	2.75	Dials 3"75
" 11- "	2.25	Variometers	3.50
" 7- "	2.00	Variocouplers	3.50
" 3- "	1.50		

SPIRO BROTHERS, Manufacturers and Distributors
519 Real Estate Trust Building Philadelphia, Pa.

Standard Special Crystals



The Crystal in the Little Red Box

Every Standard Special Crystal is packed in a red tin box which is stamped with the words "STANDARD SPECIAL CRYSTAL." This is your assurance that the crystal you buy has been actually tested on the Radio waves. Every Standard Special Crystal is specially treated and will therefore give better and longer service than the ordinary kind. Every one is absolutely guaranteed.

STANDARD CRYSTAL CO.

274 S. Halsey St. NEWARK, N. J.

Canadian Agents: Sterling Specialties
213 Somerset Building, Winnipeg, Man., Canada

Western Representative: Engineering Sales Company, 220 North State St., Chicago, Ill.

"CSE" SERVICE

has grown considerably—hence its removal to new quarters was necessary, so note carefully our new address—also the

"CSE Buyers Handbook of Radio"

is ready. Your request for it on your business letterhead will bring you 60 pages (Loose-Leaf) of the most interesting Radio Reading known. Incidentally its use by you will save you many dollars. Better ask for it now.

CENTRAL STATES ENGINEERING CO.

9 South Clinton Street

Chicago, Illinois

Ask Our Service Bureau

THE B-T VERNIER HAS NO EQUAL—CARRIED BY JOBBERS

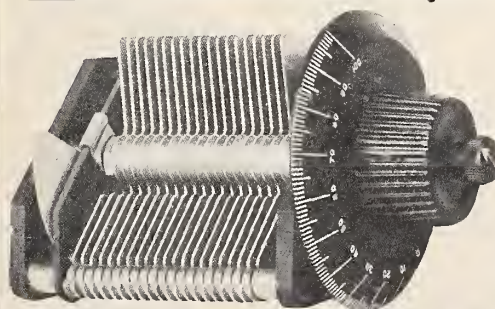

FROM NEWFOUNDLAND TO SINGAPORE

.00025, 11 pl.....	\$4.50
.0005, 21 pl.....	5.00
.001, 41 pl.....	6.00

With 3-Inch SOLID DIAL.

DEALERS: Write us for name of nearest jobber.

BREMER-TULLY RADIO CO.
Canal and Harrison Sts., CHICAGO

Western Office: 171 Second Street, SAN FRANCISCO
Hawaiian Representatives: HAWAIIAN ELECTRIC CO., HONOLULU

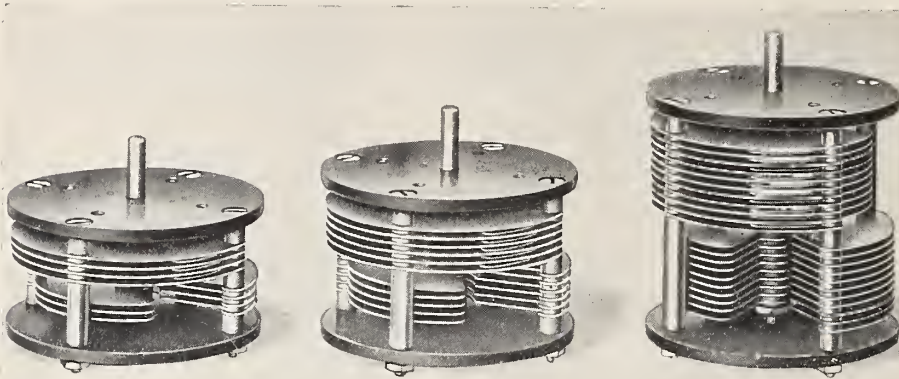

"Universal" Balanced Variable Condenser

All important mechanical and electrical features are embodied in the construction of the "Universal" Balanced Variable Condenser. The instrument is readily mounted on the back of panels and balanced. The "Universal" Balanced Variable Condenser is made in three sizes, as follows:

14 plates	—	.0003 M.F.	List Price, \$3.00
22 "	—	.0005 M.F.	" " 4.00
42 "	—	.001 M.F.	" " 5.00

Special discounts, according to quantity.

All condensers are guaranteed as to workmanship and material and tested before leaving factory.

Universal Stamping & Mfg. Co.
1925 South Western Ave., Chicago, Ill.

tion will be the only result. It will therefore never supplant the larger tubes for loud-speaking purposes, at least until a much more efficient loud-speaker than any now available is devised.

It is very encouraging to see, here and there, a dealer demonstrating radio in all its glory. One who believes "it can be done" and is putting forth every effort to make it go, and go big. There is no question that it is going, but it must be kept going *big*, and it must be kept the great thing that it is—"the wonder of the electric age."

Philadelphia Forms Trade Association

(Continued from page 31)

the various branches of the radio industry."

The qualifications of members as laid down by the constitution of the association give a clue to the aim and value of the organization: "Any individual, firm or corporation in the counties of Philadelphia and Camden (New Jersey), regularly engaged in merchandising radio supplies from an established location and carrying a comprehensive line of radio material suitably displayed, shall be eligible to membership. . . . Such firms shall have been engaged in this business for at least sixty days prior to the date of application for membership."

M. A. Wiegant, of Gimbel Brothers, has been elected president of the association. The other officers are: First vice-president, William R. Work, of W. R. Work Company; second vice-president, Earl Sager, of Central Lock & Electric Company; secretary, J. E. McCusker, of Philadelphia Radio Company; treasurer, W. L. Sayre, of Sayre-Level Radio Company; chairman executive committee, W. L. Eckhardt, General Radio Corp. The members of the executive committee chosen were: W. F. Coryell, the Sport Centre; G. H. Nagel, Nagel-Middleton Electric Co.; W. H. Fithian, Strawbridge & Clothier; F. R. Elliott, Elliott-Lewis Electric Co.; and J. L. Hill, Federal Institute of Radio Telegraphy, of Camden.

While no definite steps have as yet been taken by the organization in the active carrying out of its policies, the machinery has been set in motion, and a publicity campaign is being planned to seek to stimulate general consumer interest in radio in the Quaker City. Meetings are called regularly at the Manufacturers' Club, and a tentative fee of ten dollars per year has been suggested for members.

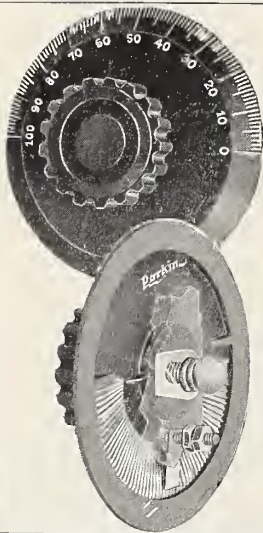

Parkin
Dial Type
Rheostat

SELLS QUICK
— b e c a u s e

"The Peak of Perfection"

—it will improve both the appearance and operation of any set. Will match the other dials on any panel, something no other rheostat will do. Resistance element recessed in the back of the dial *outside the cabinet*, which gives more cabinet space, prevents resistance over-heating, and assures constant signal strength—other exclusive talking points for the PARKIN dealer. Retail price \$1.50. Send 75 cents for dealer's sample, and if you are not convinced you can make it one of the fastest selling items in stock, we will gladly refund the 75 cents.

PARKIN MFG. CO.—San Rafael—California

"IN GOOD COMPANY"

When you join our family circle of All-American Distributors you'll be in good company.

"ALL AMERICAN"

Audio and Radio Frequency Amplifying Transformers

will be found in every city, town and village in the store that has won leadership by its intelligence in choosing its lines.

Radio Frequency Transformer

Type R 10 operates on 150 to 550 meter wave lengths, amplifying signals many-fold; widening the range of any radio set and largely eliminating static and other disturbances. Last price, \$4.50.

Audio Frequency Transformers

Amplifying the detected signals so that they come clear and strong through any good Loudspeaker. Also adapted to headphone receiving. Made in three Types:

No. R-12, Ratio 3 to 1.....	\$4.50
No. R-13, Ratio 10 to 1.....	4.75
No. R-21, Ratio 5 to 1.....	4.75

Send for Bulletin 22, writing us fully and frankly about your ability to represent us properly; so that we may quote you dealer discounts and invite you to join the All-American family circle.

RAULAND MFG. Co.
35 So. Dearborn St., Chicago, Ill.

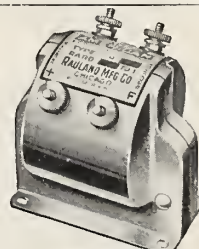

Audio Frequency Transformer



Radio Frequency Transformer

Patent Office

Choked with Work

(Continued from page 36)

at the close of the fiscal year all divisions are behind with their work, and eight of them are more than one year behind. Applications to the number of 75,916 (sufficient to occupy the whole force for a year) now await official examination.

Where trade-mark applications should be examined and accepted or refused within thirty days, it is frequently eight or nine months before they are reached at the present time. Grant of registration within a year of filing is the exception rather than the rule. This cannot be remedied without at least twelve additional trade-mark examiners.

The patent office is one of the few self-supporting offices of the government, showing an annual surplus of about \$150,000 and an accumulated surplus of over \$8,000,000. This represents money paid by inventors and trade-mark owners over and above the cost of the service rendered them, and it would seem that common justice should demand congressional authorization of some part of this sufficient to warrant a staff and salaries sufficient to give reasonably prompt consideration to the claims of inventors and trade-mark owners who pay the prescribed fees.

Besides taking care of current work, there is urgent need for many undertakings necessary to properly classify and index registered trade-marks, patents issued, etc. Congress should make a liberal appropriation for this sort of thing if the condition of our patent office is to keep pace with the demands of industry and commerce. At present Congress is considering appropriations for the patent office for the fiscal year which commences next July and those in the radio industry who are interested in seeing the issuance of patents and the registration of trade-marks and copyrights facilitated should lose no time in urging their representatives in Congress to provide liberal funds for the patent office. In a new industry, such as radio, it seems imperative that the many applications received should secure prompt attention.

To Discuss Radio

At the annual convention of the Wisconsin State Association of Electrologists, which will be held at Hotel Pfister, Milwaukee, on January 24 to 28, a paper entitled, "Can the electrical contractor-dealer properly function as a radio merchant" will be one of the interesting features.

"THE BEST IN RADIO" ATTENTION! FORWARD! MARCH

**THE
BEST
IN
RADIO"**

**JOIN
THE
R.
T.
A.**

Let's go for a Better and Bigger
RADIO INDUSTRY

By Selling only
STANDARD ADVERTISED

Radio Apparatus of Merit

Let us put you on our mailing list for our Monthly Price
Bulletin

AT YOUR SERVICE

VIRGINIA RADIO CORPORATION

Distributors
Charlottesville, Virginia

RADIO PANELS

And other insulation for Wireless Work

BAKELITE-DILECTO

Grade XX Black was used by the Government during the war for this purpose. It is the

Standard of the World

THE CONTINENTAL FIBRE COMPANY

NEWARK, DEL.

New York, 233 Broadway
Pittsburgh, 301 Fifth Ave.
Los Angeles, 411 S. Main St.
Seattle, Wash., 1927 First Ave., South

Chicago, 332 S. Michigan Ave.
San Francisco, 75 Fremont St.
Rochester, N. Y., 85 Plymouth Ave., South



← THE SIGN OF GOOD SERVICE AND
GUARANTEED SATISFACTION

IMMEDIATE DELIVERIES ON:

- | | |
|--------------------|--------------------------|
| CLAPP-EASTHAM | RADIO CORP. OF AMERICA |
| BALDWIN PHONES | MURDOCK APPARATUS |
| THORDARSON | DRAGON STORAGE BATTERIES |
| NOVO BATTERIES | FADA APPARATUS |
| GREBE and MAGNAVOX | CHELTON APPARATUS |

And All Other Standard Lines

EXCEPTIONAL DEALER'S DISCOUNTS—WRITE AT ONCE

WILMINGTON ELECTRICAL SPECIALTY CO., Inc.
912 ORANGE STREET Dept. A-10 WILMINGTON, DEL.

May Change Hook-Ups at Will

The Davis A-1 receiver, made by the Davis Radio Company, of Keyport, N. J., met with an enthusiastic reception at the American Radio Exposition at Grand Central Palace, New York.

This is a new idea in receivers. In conception it is like a telephone switchboard. The operator inserts wires



into single pole jacks in any combination, securing the hook-up desired. All the tuning instruments terminate in single-pole jacks on the face of the panel with the symbols and names of the instruments engraved at their respective terminals.

This unique cabinet is not only convenient in principle for the change of hook-up, but, as the accompanying illustration shows, the lower portion of the panel is inclined at an angle most convenient for operation. High-grade apparatus is employed for the operation of this latest receiver, which includes a variable condenser, variable coupler, two variometers, detector and two stages of audio frequency amplification. There is also a concealed loud-speaking horn which contains no metal, giving the best of tonal reproductions.

Low-Price Vario-Coupler

A low-price vario-coupler carrying a guarantee is on the new list of the Jewell Radio Sales Company, 90 West Street, New York. This Jewell vario-coupler is made in two sizes, No. 202 being adapted for use up to 400 meters, and No. 307 for use up to 600 meters. Each carries a non-warp rotor, 14 taps, screw adjustment and pigtailed. The stator of No. 202 is specially treated, that of No. 307 is of composition.

Book Reviews

By

BERNARD JEROME FARRELL

The Editors of the RADIO DEALER will be glad to review new publications in this field as they may be issued. Address them attention BOOK REVIEW EDITORS, THE RADIO DEALER, 1133 Broadway, New York City.

IDEAS FOR THE RADIO EXPERIMENTER'S LABORATORY. By M. B. Sleeper, 134 pages. Published by the Norman W. Henley Publishing Company, New York.

This book contains valuable information for the serious fan who wishes to have in his possession a wealth of data and information that help him to build better and more efficient radio receivers. This is a how-to-do-it and a how-to-make-it volume from cover to cover.

A great deal of information and data are given on the construction of inductance coils for various wave lengths and tables are included which make the winding of coils for any particular purpose very easy for the novice. The construction of various testing and laboratory instruments is also given.

A chapter is given over to the various methods of hooking up tickler coils. This will be of great value to the radio workers who wish to get the very best results with their home-made regenerative outfits.

The final chapter contains the rules and regulations for fire protection drafted by the National Fire Protection Association for the use of wireless amateurs in the United States.

PRACTICAL RADIO. By Henry Smith Williams, M.D., LL.D. Cloth. 427 pages. Funk & Wagnalls Company, publishers, New York.

It is an unusually interesting, chatty and informative book on radio. Beginning with a few introductory remarks on the surprising speed with which the small boy has picked up the technique and vocabulary of radio, the author proceeds to describe the construction of the cheapest workable crystal set. Gradually he proceeds toward the vacuum tube set and the construction of a super-regenerative outfit.

The way is made easy for the beginner who reads this book as his first treatise on radio by numerous photographs and diagrams.

Pictures in large numbers have been used to supplement the text and these have been chosen not for their interest alone but for their informative value,

AEREX King of the Air

COMBINATION RECEIVING SET
CRYSTAL-DETECTOR-TWO STEP

Aerex Radiophone Corporation
342 MADISON AVENUE, New York City

SUPERIOR PRODUCTS

The Rolls Royce of Radio

Startling Announcement in
February Radio Dealer

SUPERIOR PRODUCTS MFG. CORP.
1080 Springfield Ave., Newark, N. J.

**FRANKLIN
SOCKET**



**FOR W-D-11
DRY CELL TUBE**

Holds tube firmly
Makes perfect contact

Price \$0.50

We also make an adaptor that fits standard sockets. Price, \$1.00.

Dealers write for discounts

FRANKLIN RADIO MFG. CO.
711 Penn Ave. Wilkesburg, Pa.

A good article is always imitated!

Sell only the genuine

FRESHMAN

**Variable Grid Leak and
Micon Condenser
Combined**



Price only \$1.00

3 Points to Remember

1. It is hermetically sealed in a mould to prevent moisture from affecting the grid resistance.
2. It has an unbroken range from zero to 5 megohms, allowing proper adjustment for maximum efficiency of detector.
3. It contains a tested Micon Condenser of .00025 M.F.

Wire or write for Terms and Discounts
Manufactured by

CHAS. FRESHMAN CO., Inc.
97 Beekman St., New York City

and any one who follows sequentially the circuit diagram, or practical hook-ups, and studies the text therewith, will gradually develop, without other instruction, into an adept in utilizing radio as a practical art.

The distinctive feature of this new book on radio is the fact that it is not cut and dried. It is away from the beaten path and is written by a man who knows how to popularize any science.

The author, Henry Smith Williams, M.D., LL.D., is also author of "The Wonders of Science in Modern Life" in ten volumes, "Miracles of Science" and other works, has long been known for his capacity for interpreting even obscure scientific phenomena in terms that are comprehensive to the average reader. He makes the story of radio a fascinating, even a romantic, narrative. Under his guidance radio apparatus becomes in its simple forms a fascinating plaything for boys and girls, and in its more elaborate development a no less fascinating instrument of precision in the hands of the adult.

RADIO RECEPTION by Harry J. Marx and Adrian Van Muffling. 241 pages. Published by G. P. Putnam's Sons, New York.

This volume covers the entire field of reception. The preliminary pages deal with the elements of electricity and magnetism related in words that can be easily understood by the "newest" amateur. The reader is brought through the various subjects relative to reception in a sequence that holds the interest and in a manner that impresses the important facts on the memory.

The book covers the subjects of wave and wave action, the merits of the crystal detector and its limits, progressing into the vacuum tube detector, explaining the operation of this generally puzzling part in a manner that leaves the reader with a sense of how simple it is after all. Receivers, loud speakers, tuning apparatus, amplifying circuits antennae, ground, batteries and miscellaneous apparatus are explained in detail. The operation of the various sets is clearly explained.

THE RADIO AMATEUR'S HANDBOOK. By A. Frederick Collins. 404 pages. Published by Thomas Y. Crowell Company, New York.

A revised edition of this work by one of the radio pioneers is just off the press. Written for the amateur, as are many of the author's works, it contains plain explanations of the various subjects considered and is unusually fully illustrated.

DELICATE SOLDERING

Both the manufacturers' and amateurs' problem on all fine work is readily solved by the instrument constructed for this particular purpose.

THE POST SOLDERING IRON

Platinum Heating Unit—Interchangeable Tip—Universal Current

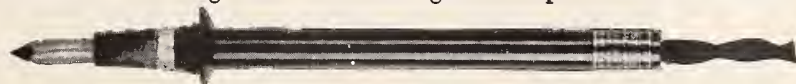

One Half Actual Size

LISTS AT \$6.00

Dealers' and Jobbers' discounts on request

Awarded Certificate of Excellency, N. Y. Evening Mail Radio Institute

POST ELECTRIC COMPANY, (Office 505) 30 E. 42nd St., New York

The Only Quality 3000 Ohm Phones listing for \$5



TRUE-TONE Perfection is Guaranteed — Performance and Appearance

Worth More

Costs Less

Embodying Every Factor of Highest Quality

High sensitivity attained by maximum wire turns. Super-strength magnets of Tungsten steel. Noiseless Tinsel Cords. Cord connections concealed within phones, eliminating losses from effect of body contacts.

\$5.00
LIST
3000 Ohms

Comfort Head Band, webbed-covered; all metal parts highly nickered. Cups and caps lustrous black moulded. Caps designed to comfortably fit ears. A handsome head set.

Write or Wire for Name of TRUE-TONE Jobber in Your Territory

TRUE-TONE RADIO MFG. CO.

186 No. La Salle Ave.

CHICAGO, ILLINOIS

"EURACO" MICA GRID CONDENSERS AND LEAKS

Price 60 cents
(Designed to fit Standard Grid Leak Base)

GRID LEAK VALUES:

0.5—.75—1.0
1.5—2.0—2.5
Megohms

Price, 60 Cents



COMPACT, INTER-CHANGEABLE, HANDY, MOST EFFICIENT

"Euraco" Condensers are composed of Copper Sheet and Best Grade India Ruby Mica, and are entirely Hand Made.

Manufactured in following capacities:

.000025 Mfd—Correct for Myers Radio-Audion RAC-3
.0001 " —For Special or Experimental Circuits
.00025 " —Correct for Super-Hetrodyne & UV 201
.0005 " —Correct for Radiotron UV 200

Condenser—Leak Mountings

Bakelite Base with Single Mounting\$.40
Bakelite Base with Double Mounting60
Bakelite Base with Triple Mounting80

SHIP OWNERS RADIO SERVICE, Inc., DISTRIBUTORS

80 Washington St., New York

Interesting Proposition to Dealers

(Mfd. By EUROPEAN RADIO CO., 1342 East 22d St., Brooklyn, N. Y.)

Milliken Radio Towers

Dealers in wireless equipment can increase their sales and prestige by selling these towers. Now being used for all classes of service in different parts of the country. Galvanized steel, self-supporting, standard types.

We have an attractive proposition for agents; full information upon request.

Send for Illustrated Catalog

**MILLIKEN BROTHERS
MFG. CO., INC.**
Woolworth Building
New York, N. Y.

Agents Wanted



STATION WVP



STATION WBZ



STATION 2 XJ

What Radio Owes To the Amateur

(Continued from page 30)

tate his desire, and the prospect of getting Bahia, Brazil, or Nome, Alaska, keeps him going.

"Any amateur worthy of the name thinks a few days after he has first delved into the subject that he knows all about it and that he is the living radio prodigy. It will take all the patience and tact of the dealer's salesman to satisfy, not merely to sell, him. It is a difficult problem, but it is worthy of more than one attempt at solution. The man who can reassure the amateur about his knowledge of radio, even to the point of flattery, and at the same time impart information that will be of real help, without making his superior knowledge obtrusive, that man is going to be the successful radio dealer.

"The house that caters to the new novice," Mr. McCann said in concluding, "in the way that we used to cater to the old amateur, is bound to be successful. But he must go one step farther. Advise the prospective purchaser to buy a complete receiving instrument first in preference to parts. These parts may be made by capable or incapable concerns, but they are not necessarily designed to work together. The novice must first experience the delight of a working outfit, and incidentally acquire the fundamentals of radio. It is only after this knowledge that he can experiment and experiment satisfactorily. It is only after this primary information that he will be fired with the ambition and desire to experiment and enlarge both his radio vision and his radio needs."

Fuse Protects Tubes

A fuse that is designed to prevent burning out of vacuum tubes is the latest addition to radio equipment of the Radio Equipment Company, 630 Washington, Boston, Mass.

This device, known as the Radeco safety fuse, for which patents are pending, fits the terminals of any standard sockets. It is applied directly at the point where the current enters the tube, making it impossible for an overload or short circuit to burn out the tube. The Radeco safety fuse is easily attached to the filament terminals, all that is required being that the terminals be cleaned thoroughly, so that the fuse can be slipped on without any effort. The Radio Equipment Company claims that the device affords a positive protection for the most delicate part of a radio outfit.

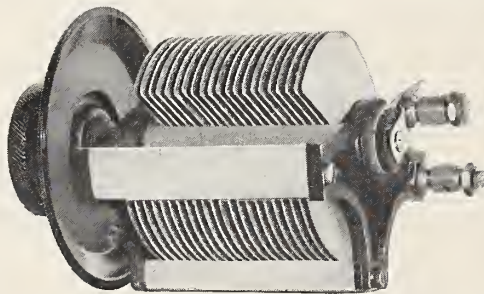

Radio Finds a Better Condenser

Bayley's 23-0005 and 43 Plate 0011 Variable Condenser is what Radio has found.

Its plates spaced close give it the finest tuning qualities.

It is a die-cast product, the stationary plates are cast solid, accurately and permanently spaced, on three upright supports, while the movable plates are cast on the centre revolving spindle. It is impossible for plates to loosen in service.

Solid rubber end pieces finished like black morocco leather make it beautiful. It is of good design and high grade workmanship. In an official test measures up to 0011 M.F.D. capacity and is uniform, it does not vary.

Each condenser has our guarantee, backed with a manufacturing record of more than forty years.

A sample order will convince you of its value.

And Make You. Certainly, A BAYLEY CONDENSER BOOSTER

We want business from houses that appreciate real value. It will give satisfaction and stay sold

Price, 23 Plates \$3.25 each. 43 Plates \$3.75 each

TO JOBBERS AND DEALERS A SPLENDID PROPOSITION

BAYLEY CONDENSER CO.

105-109 Vanderveer Street

Brooklyn, New York

Radio Corp. Brings Action on Patents

(Continued from page 30)

manufacturers of vacuum tube radio apparatus is not yet apparent.

It is said that should the Radio Corporation be successful with this suit, it will be in position to prevent others from producing vacuum tube radio equipment, including those who are operating under Armstrong patent licenses.

A corporation of the Armstrong license holders has been formed which will co-operate with the Grebe company in defense of the action. It is expected that the cases will be tried early this year, and the decision will be awaited with interest by manufacturers, dealers and the entire radio fraternity.

In response to a request from a representative of THE RADIO DEALER for a statement regarding the cases, I. J. Adams, the patent expert of the Radio Corporation of America, said that no statement for publication would be made at this time. Willis H. Taylor, Jr., of Pennie, Davis, Marvin and Edmonds, counsel for the defendants, also declined to make any announcement.

Mountain Jobbers Develop Service

(Continued from page 34)

time of the demonstration. However, it was voted by the dealers that the course was very beneficial and its results would undoubtedly be extremely valuable. It is possible that, at the suggestion of these dealers, there will be another such course very soon.

The Bureau anticipates holding a convention at some later date in the city of Denver for the benefit of the radio dealers and prospective radio dealers throughout the territory. It is anticipated that a retail association will be formed on similar lines and that further developing of radio from the dealers' standpoint be worked out to better satisfaction, with the endeavor on every radio dealer's and jobber's part to be for better radio.

Radio Equipment of Train

Equipped with a Zenith receiving set and a two-stage amplifier in a handsome cabinet having panels of Mahoganyite Radion, the Louisville & Nashville de luxe flier entertains its passengers with radio. Among the stations that have already been picked up are Louisville, Atlanta, Baltimore and New Orleans.

HELP! HELP! HELP! HELP!

This is the cry of the busy Radio salesman during rush hours

The EBY SILENT SALESMAN (illustrated below) will assist the man behind the counter as it enables the customer to wait on himself—and quickly.



Price to Jobbers,
Dealers and Manu-
facturers, \$1.00 Each

Full information as to specifications and prices of posts printed on the back.
THE H. H. EBY MANUFACTURING CO., PHILADELPHIA, PA.

Trade-Marks Secure Trade Registrations Secure Trade-Marks

I Secure Registrations

CHAUNCEY P. CARTER

Radio Trade-Mark Specialist

4907 Potomac Avenue, N. W. Washington, D. C.

Correspondents in all countries

DRY CELL TUBE SOCKET BIG SELLER

The WD-11 Tube has converted numerous "Crystal" fans to the use of a Detector Tube. The 1/2 volt tube requires a special socket. Hence the

BIG DEMAND

for this Genuine Bakelite Socket having springs of phosphor bronze. The special contact arrangement is a feature of the

BRUNO 5 SOCKET

Dealers and Jobbers Write

Carlson Dunn Co., 26 No. Desplaines St., Chicago, Ill.
H. T. Wrecks, 1308 Majestic Bldg., Detroit, Mich.
S. H. Stone, 609 Chamber of Commerce Bldg., Pittsburgh, Pa.
A. L. Handel, 2751 Detroit Ave., Toledo, Ohio

BRUNO RADIO CORPORATION

152 West 14th Street

New York, N. Y.



List \$0.75

Radio Exposition Big Success

(Continued from page 27)

Crosley Manufacturing Company.
 Experimenter's Information Service.
 Copper-Clad Steel Company.
 Jewett Manufacturing Company.
 Musio Radio Company.
 Formica Insulating Company.
 Marko Storage Battery Company.
 Eismann Magneto Company.
 Capitol Phonolier Company.
 Stanley & Patterson.
 S. D. Tuska Company.
 Experimenter Publishing Company.
 Radio Industries Company.
 A. D. Cardwell Company.
 Fiber Products Company.
 Willard Storage Battery Company.
 Davis Radio Company.
 Post Electric Company.
 Boissonnault Company.
 Radio Mica Products Company.
 Radio Digest.
 Electric Specialty Company.
 Feri Radio Manufacturing Company.
 Tait Knob & Dial Company.

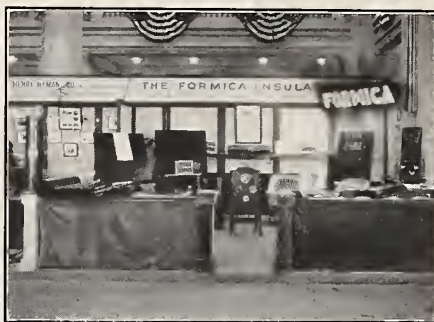

Formica Booth at the American Radio Exposition

Bel-Canto.
 Ackerman Brothers.
 Electrical Record.
 Radio Guild.
 Lefax, Inc.
 Milliken Brothers, Manufacturing Company.
 American Bell-Radio.
 National Radio Products.
 Brilliantone Radio Products.
 Engravers & Printers Machinery Company.

Consolidated Radio Call Book Company, Inc.
 States Radio Company.
 Moon Radio Manufacturing Company.
 Pathe Phonograph & Radio Co.
 Associated Manufacturers of Electrical Supplies.
 Radio Topics.
 The Evening Mail.
 Radio Directory & Publishing Company.
 Gould Storage Battery Company.
 Henley Publishing Company.
 S. Newman & Company.
 Crocker-Wheeler Company.
 Alden-Napier Company.
 Inter-Ocean Radio Corporation.
 Milliken Bros. Mfg. Company.
 Triangle Phone Parts Company.
 Royal Electrical Laboratories.
 Railroad Accessories Corporation.
 Harris Laboratory.
 The Bristol Company.
 Rasla Sales Corporation.
 Ranco Electrical Products, Inc.
 Radio Directory & Pub. Company.
 Popular Radio.
 Betts & Betts Corporation.
 Radio Detector Company.
 The Radiall Company.

F. M. C. Transformer Test

The F. M. C. audio transformer, made by the Ford Mica Company, Inc., 14 Christopher street, New York, has a five-to-one ratio. The following test report shows the efficiency of this instrument, while its appearance vouches for a well-designed and neat piece of equipment:

Primary resistance, 900 ohms; primary impedance, 53,000 ohms at 500 cycles; primary leakage impedance, 1,080 ohms at 500 cycles; primary leakage reactance, 520 ohms at 500 cycles.

Secondary resistance, 6,150 ohms.

Using this transformer for one-step amplification with UV-201 tube, 40 volts on the plate, the amplification on mean voice frequencies is: audibility or telephone current increase, 11.2 times; energy increase, 126 times.

Dubilier Makes Du-Tec

Du-Tec is a synthetic material manufactured to take the place of crystals for purposes of rectification in radio circuits. Du-Tec is made by a secret process and it is free from all the objectionable characteristics of the natural crystal.

It is highly sensitive and uniformly so; it is sensitive all over, and the usual tedious process of searching for a sensitive spot need not be resorted to when Du-Tec is used. This synthetic rectifier does not change nor is its sensitivity altered over long periods of use. For best results it should be used with a very fine catwhisker and light contact. It comes mounted in a cup ready for insertion in place of the ordinary crystal detector. It is manufactured by the Dubilier Condenser & Radio Corporation, 48 West Fourth street, New York City.



Stop that Snarling Symphony!

The screams and metallic screeches that so often ruin an evening's Radio enjoyment are not all due to "static." The trouble has finally been traced down to its source. And the remedy is simple, easy, almost instant!

A run-down or poorly functioning battery has been found out as the real cause behind "catfights." Unless your storage battery is working right, your Radio won't work right—*can't work right.*

Therefore, it has been proved necessary to make frequent and accurate battery hydrometer tests. This can be done best, most cheaply and satisfactorily with the *guaranteed*

HAFNER
HYDROMETER
"First Aid To Your Battery"

This is the nationally advertised hydrometer, the one you've read about in "The Saturday Evening Post." It sells and sells and sells. It's a mighty satisfying item for Radio dealers to feature and push. Furthermore, the impetus of national advertising is making it sell and sell in larger quantities every day.

Ask about prices, the advertising campaign and window display material. It will interest you from a potential profit angle. Write us now—quickly.

HAFNER MANUFACTURING CO.
 3130 Carroll Avenue Chicago, Illinois

75c
 Worth Twice
 Its Price

Dealers Price List

CHAS. FRESHMAN CO.

INCORPORATED

97 BEEKMAN STREET

NEW YORK CITY

January, 1923

Telephone BEEKMAN 0829

"Antenella"	FRESHMAN Variable Grid Leak and Condenser Combined	"Micon"
-------------	--	---------

ANTENELLA IS DEvised FOR TAKING RADIO WAVES FROM POWER OR ELECTRIC LIGHT WIRES.



ANTENELLA

LIST PRICE

\$2.00

Dealer's Discount 33 1/3 %.

AN EXCEPTIONALLY NEAT PLUG, WELL DESIGNED AND CONSTRUCTED.
 FORMS PERFECT RECEIVING AERIAL
 RECEIVES IN ANY ROOM OF THE HOUSE
 ELIMINATES MOST STATIC
 NO OUTSIDE WIRES NECESSARY
 PLUGS INTO ANY LIGHT SOCKET
 USES NO CURRENT
 GIVES SHARPER TUNING THAN OUTSIDE ANTENNA
 SAVES COST OF LIGHTNING ARRESTER

FRESHMAN

Variable Grid Leak and Condenser Combined

INCREASES SIGNAL STRENGTH
 LOWERS FILAMENT CURRENT
 INCREASES BATTERY LIFE
 ELIMINATES HISSING

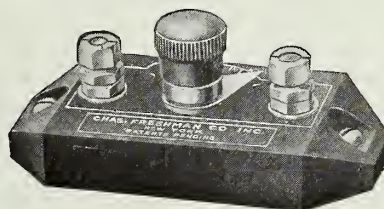

LIST PRICE

\$1.00

Dealer's Discount 33 1/3 %.

Takes the place of a grid condenser, mounting and a grid leak, and in addition permits an adjustment of the correct amount of resistance.

ZERO to 5,000,000 OHMS

The condenser is the proper capacity for grid leaks .00025.
 This is the only grid leak on the market that gives you a straight line resistance curve.

This leak will maintain its value permanently.

Variable Grid Leak—without Condenser—List Price 75c. Dealer's Discount 33 1/3 %

Price List Continued

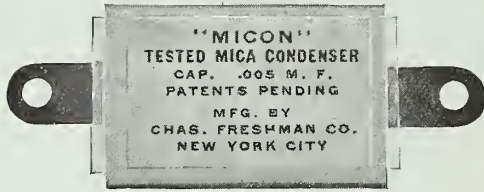

“Micon”

NOISELESS

Tested Mica Condenser

Constant Fixed Capacity

The design of MICON is such that constant equal pressure is exerted on the condenser plates over the entire area. This is the only condenser that does this and therefore the only condenser that avoids noises, which are due to variable pressure on the plates. The metal case protects the plates and reduces hysteresis losses to a minimum. Only the best grade PURE INDIA RUBY MICA is used.

LIST PRICE

SIZE	EACH
.0001	\$.35
.00015	.35
.00025	.35
.00035	.35
.0005	.35
.0008	.40
.001	.40
.002	.40
.0025	.50
.005	.75
.006	1.00
.01	1.50

MICON condensers tested at 2,000 volts, 500-cycle A. C. Current will usually stand 5,000 volts, 60-cycle A. C.

Dealer's Discount 33 1/3%.

The “MICON” Midgets

are noiseless Tested Mica Condensers but will not stand as high a voltage as the standard sizes.

.0001	\$.25	.0005	\$.25
.00015	.25	.000025	.30
.00025	.25	.00005	.30

Dealer's Discount 33 1/3%.

Manufactured only by

CHAS. FRESHMAN COMPANY
INCORPORATED

97 BEEKMAN STREET, NEW YORK

*Discount of 33 1/3% applies where total order amounts to \$15.00 or over, figured at list prices.
We pay parcel post or express charges on all shipments.
Literature and display cards furnished without charge on request.
Prices and Discounts subject to change without notice.*

Radio Trade Association Meeting

(Continued from page 26)

radio telephone services can be maintained between widely separated farms, ranches, cross-road stores, etc. It will very soon be possible to distribute grand opera music from transmitters placed on the stage of the Metropolitan Opera House. Church music, sermons, lectures, etc., can be spread abroad by the radio telephone.

"This particular prophecy, spoken and written in the spring of 1907, at the time when it was my privilege to put on the market the first radio telephone instrument manufactured by the De Forest Company, is somewhat vividly recalled to my mind this afternoon by a letter which came to me hardly a week ago from one who, incidentally, is interested in a demonstration center for out-of-door life. This letter bears the imprint of the National Headquarters of the Inkowa Camp, a splendid organization headed by Miss Grace Parker and Miss Maude Wetmore for the purpose of interesting young women in some of the finer things of life, namely, outdoor life. The letter came to me after I had made an address before the New York City organization on the subject of radio communication. From this letter, I wish to read just these few lines. Miss Parker says:

"I feel that I must tell you of a unique experience which I had yesterday. I spent the week-end at Greenwood Lake, and yesterday morning in a little humble cottage there, where I went to see some of the village people, I listened to the entire wonderful St. Thomas Church service through a radio set. I cannot conceive of anything more wonderful than to make possible to the thousands of shut-ins, as well as to hundreds of thousands of others, the great things which are going on in the world, and to bring these great things into their own humble surroundings. The women in this family yesterday listened to the same service as that heard by the heretofore privileged group sitting within St. Thomas Church on Fifth Avenue. It is a marvelous achievement!"

"What greater inspiration do we need for the New Year and for the New Year's business than to sell this variety of happiness to these people in the country districts, who, perhaps more than any one class, are entitled to the news of the world, the best of music, literature and education—in short, to all those finer things which go to make life on this earth so well worth while."

Dr. De Forest was followed by Major J. Andrew White of the *Wireless Press*. Major White touched on the multiplicity of broadcasting stations, emphasizing the need for legislation. While he was appealing to his audience for co-operation with the Associated Radio Publishers who are striving to have the White Bill considered by Congress, a telegram came from Washington announcing that the bill had been referred to committee.

Every one in the trade is urged to submit their claims for amendments to the White Bill at once, so that the action of the committee may be speeded. Public hearings on the bill will be held before the Committee on Merchant Marine and Fisheries on January 2.

Major White also commented on

the large contributions sent to famous churches that broadcast their services, mentioning thousand dollar bonds, etc., that were sent to St. Thomas' in New York as an example.

Closing his remarks the Major urged closer co-operation between the trade in movements for the advancement of the industry.

"The Radio Jobber" was the subject chosen by George L. Patterson, of the firm of Stanley & Patterson of New York. Mr. Patterson had hurried back from a holiday trip in Maine and came directly to the convention hall. He pointed out the necessity of service on the part of the retailer as offering the best opportunity for selling more radio by retailers. The jobber's duty, according to Mr. Patterson, is to aid the retailer who gives service by giving still more service to the dealer.

The subject of price cutting came in for some pointed remarks by Mr. Patterson who showed how easy it is for a manufacturer to prevent his goods being sold repeatedly by retailers at prices that legitimate firms who give service cannot make. He closed his remarks by again expressing his faith in the future of radio as a business for business men.

H. H. Eby, treasurer of the association, was scheduled for an address but was unable to attend due to illness. The following telegram from Mr. Eby was read by the secretary:

"Illness prevents my being with you today in person, but not in spirit. Please convey to the officers, speakers and members of the association my sincere regrets for my inability to be with you.

"The official program was received this morning and from the eminent speakers who will take part in this our first official meeting, I am positive that much will be done for the good of radio.

"My proposed message will be sent you shortly to do with as you wish, but the summary of it is as follows:

"Radio is here to stay. Conditions outside of New York are much more promising than in the Metropolitan District. There is a tremendous demand for quality merchandise. There are too many manufacturers, jobbers and dealers in the trade.

"Manufacturers, jobbers and dealers should bind themselves together through an association such as we have just formed to keep worthless merchandise off the market and to coordinate our ideas for the public good.

"Sincerely trusting that much good seed will be sown today I assure you it is with profound regret that I cannot be with you."

Another telegram received from Mr. Eby during the meeting, read as follows:

"Please express to the members of the Radio Trade Association my sincere appreciation of their confidence in electing me treasurer of this association. I shall do my utmost to further the interests of this association and to deserve their confidence in me.

"I hope that at our next annual meeting, we can report a membership of at least five hundred."

A. C. Corwin, of the Radio Distributing Company of Newark, spoke on "Radio in New Jersey." Mr. Corwin outlined the development in the industry in what has often been termed "the cradle of the radio business," pointing out that at one time over three-fourths of the radio business was located in the state of New Jersey. He also spoke against the use of loud speakers as a street demonstration of radio, because, he said, it gave the average citizen a false idea of the quality or reproduction made by radio instruments. "Don't force the man who wants to buy passed your store because of the horrible noises coming from the speaker." In speaking of the function of the radio jobber, Mr. Corwin advised his hearers to "pick out the jobber in your district to serve you. If he doesn't, pick some jobber who will."

Paul Godley, the well-known radio expert of the Adams-Morgan Company, was the last speaker addressing the meeting on the future of the equipment now on the market. "There are two camps among American radio manufacturers," he said, "one believing that it is impossible to sell radio sets to the American public that are operated by more than one control, the other that the proper set to sell is one that is best in the long run, one that is more efficient but yet slightly more complicated. I may say," he added "that I am of the latter camp." Mr. Godley also pointed out that he believed that the present type of good sets will not be superseded by any radical improvements for at least two years.

At the close of the meeting the Western Electric Company presented to the trade in attendance a motion picture showing the action of a vacuum tube used in radio. This number was of considerable interest to the members and held the audience until the last.

The Radio Trade Association, according to recent announcements made to the membership, is planning considerable in the way of future meetings of similar character.

By-Laws of the Radio Trade Association

Due to the great interest in the activities of the Radio Trade Association THE RADIO DEALER presents the report of the committee on by-laws of the association:

ARTICLE I.

NAME

SECTION 1. This organization shall be known as the RADIO TRADE ASSOCIATION.

ARTICLE II.

OBJECTS

SECTION 1. To establish and disseminate ethical principles of fair dealing and prac-

tices for the common good of the radio industry and the public saved thereby.

SECTION 2. To educate its members with regard to better business methods through the exchange of ideas on accounting, salesmanship, etc.

SECTION 3. To establish standards for radio equipment in co-operation with other bodies working for the same end, and to aid in defining the various factors in the trade with a view towards bettering trade conditions.

SECTION 4. To work for the betterment and stabilization of broadcasting facilities and other conditions affecting the radio business.

SECTION 5. To impress upon the public the manifold benefits to be obtained by enlarging and popularizing radio communication and the advantages of educating the youth in radio practice and operation as well as the observance of Federal and State radio laws.

SECTION 6. To co-operate with and be of assistance to similar and allied associations, always taking an active and united

interest in the advancement of the radio art.

ARTICLE III.

MEMBERSHIP

SECTION 1. Any firm or individual engaged in or concerned with the manufacture, sale or distribution of radio supplies and equipment shall be eligible for membership.

SECTION 2. Members shall be elected by a majority vote of the Board of Directors, but no person shall be elected whose application has not been approved by the Membership Committee.

SECTION 3. Voting shall be done by firms. Each firm shall be entitled to one vote but any member representative of the firm shall be entitled to cast that vote.

ARTICLE IV.

OFFICERS AND THEIR DUTIES

SECTION 1. The officers of this association and their duties shall be as follows:

- (a) President, who shall preside at meetings of the association, and at meetings of the Board of Directors and Executive Committee, etc.
- (b) Treasurer, who shall receive and bank all funds of the Association as collected by the Secretary, duly reporting on same at the request of the President or Board of Directors.
- (c) Secretary, who shall handle the correspondence of the Association, receive and receipt for moneys for dues from the membership, duly turning over same to the Treasurer and otherwise act at the instruction of the President and Board of Directors of the Association.
- (d) First Vice-President, who shall head the Committee on Shows and Expositions and duly pass on any advertising propositions presented to any member, also acting in the stead of the President in his absence from any meeting.
- (e) Second Vice-President, who shall head the Committee for Co-operation between the Association and Amateur Bodies having as their purpose the advancement of the science of radio.
- (f) Third Vice-President, who shall head the Committee on Standards for Radio Equipment, which also will have in charge any laboratory work that may be attempted by the Association at any time.
- (g) Fourth Vice-President, who shall head the Committee on National Publicity.

- (h) Fifth Vice-President, who shall head the Legal Committee of the Association.
- (i) Sixth Vice-President, who shall head the Membership Committee of the Association.
- (j) Fifteen members of the Board of Directors who shall be elected by the membership in the following manner.

1. director from the membership at large.

2. directors from each of the following sections of the membership (to be elected by the members in the territory that the directors represent): Pacific Coast, The South, Central States, East of New York City, New York City, East Central Section, New Jersey.

SECTION 2. Officers shall be elected by a majority vote of the membership at large, except as provided in the case of the members of the Board of Directors who are elected to represent certain sections, and shall serve until September 1st of each year, or until their duly elected successors are installed.

SECTION 3. In the event of the resignation, death or removal of any officer prior to the expiration of his term of office the President shall be empowered to appoint his successor to serve the unexpired term of the officer removed, deceased or resigned.

SECTION 4. Balloting for officers shall be in the first week in August of each year. The Board of Directors shall appoint a Nominations Committee, which shall confer in July of each year and prepare lists of nominations for the various officers. A Teller shall be appointed and the Secretary shall mail to every member in good standing at his last known address ballots with the names of the nominees for every office printed thereon together with sufficient blank spaces for other names to be written in by the members voting. These ballots shall be mailed to reach the members as nearly to the first day of the first week of the month of August of each year as possible. The ballots shall be marked and signed and returned to the official Teller so that the post-mark on the envelope containing the ballot be not later than the last day of the first week of the month of August. After allowing a reasonable time for receipt of these ballots the Teller shall announce the results of the voting to the Secretary who shall in turn advise the membership and officially notify the new officers of their election.

Acknowledgement of acceptance of office shall constitute installation of the officer elected.

ARTICLE V.

MEMBERSHIP FEES AND DUES

SECTION 1. On and after February 1, 1923, an admission fee of five dollars (\$5.00) shall be required of all new members, which fee shall be collected by the Secretary on application for membership and shall be deposited in a bank selected by the Treasurer and held subject to withdrawal at the will of the Finance Committee and expended for such purposes as are ordered by the Committee acting under the guidance of the Board of Directors.

SECTION 2. Annual dues of one dollar (\$1.00) per member shall be collected by the Secretary each year covering the fiscal year ending with March 31st of each year, and shall be delivered to the Treasurer as collected for deposit and expenditure as specified for the admission fees.

SECTION 3. If the dues of any member are not paid within thirty days from the

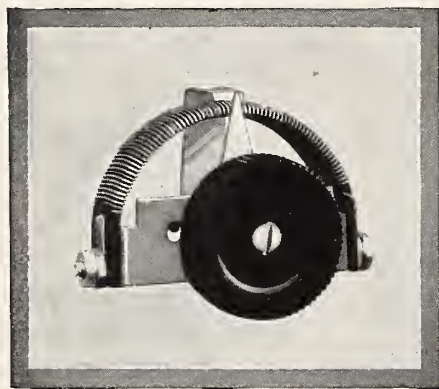

A BETTER RHEOSTAT

A nicer looking, smoother working and better made rheostat than you have ever seen before.

Furnished with or without vernier this instrument will improve the operation of any radio equipment.

The many valuable features coupled with national advertising make this an instrument every dealer and jobber should stock—liberal discounts give ample margin of profit and low list means quick turnover. Order now.

	List Prices
123A Plain.....	80c
Type 123B Vernier.....	\$1.40

THE WILCOX LABORATORIES
LANSING MICHIGAN

Dealers who want strictly high class quality
Radio Sets and Equipment,
we can serve you.

Distributors: General Radio Corp., King Quality,
Dubilier Condenser and Radio Corporation,
De Witt - La France Co. *All Guaranteed Lines.*

INVINCIBLE PRODUCTS CO., Inc.

159 N. State St.

Phone: Dearborn 2638

Chicago, Ill.

date they become due he shall be notified by the Secretary that he is in arrears and if such dues are not paid within thirty days from the date of such notice the Board of Directors has authority to suspend the member.

ARTICLE VI.

COMMITTEES AND THEIR DUTIES

SECTION 1. There shall be the following standing committees: Shows and Advertising Stunts; Co-Operation Between Amateur Bodies; Standards; National Publicity; Legal Matters; Membership; and Finance.

- (a) The heads of these committees shall be the Vice-Presidents elected to these offices except that the President shall be head of the Finance Committee.
- (b) The chairman of each of the above committees shall appoint two, three, four, or five members to serve on his committee.

SECTION 2. There shall be the following special standing committees: Policy of the Association; Export and Meetings:

- (a) The Secretary shall be the head of the Committee on Meetings which shall endeavor to promote meetings in every section where the membership desires it and to secure competent speakers to address these meetings. Members on this committee may be appointed by its chairman to serve for the full year, or for one or two special meetings.
- (b) The membership of the Committee on Policy and the Export Committee shall be appointed by the President, and the President shall be ex-officio chairman of both of these committees.

ARTICLE VII.

MEETINGS

SECTION 1. All business of the Association shall be conducted by mail.

- (a) Any member wishing to secure the attention of the Association on any subject of importance may address the President, presenting his motion together with his argument for the passing of the motion.
- (b) It shall be the duty of the Secretary to notify every member, at intervals of not over one month, of all motions proposed and invite interested members to forward their arguments for and against the motions.
- (c) It shall be the duty of the Secretary to cause to be delivered to every member copies of each motion together with the arguments for and against, together with a ballot form so that every member can register his will in regard to the motion.
- (d) It shall be the duty of the Secretary to collect these ballots and announce the result to the membership at large not later than three weeks after the mailing of the ballots.

SECTION 2. The Committee on Meetings shall endeavor to secure meeting places and speakers for public meetings of the Association open to everyone in the radio trade where educational addresses and talks of interest to the trade shall be delivered.

- (a) It shall be understood that no business shall be transacted at these meetings and that attendance is not commanded of any member.

ARTICLE VIII.

AMENDMENTS

SECTION 1. These by-laws may be amended by a two thirds vote of the members voting of the Association, after the ballots have been duly prepared and mailed out in the manner described in Article VII., Section 1.

The above regulations are submitted to the membership of the Association for approval and revision. Members wishing to amend them prior to their adoption should address the Secretary stating their amendments together with the arguments for same so that they may be submitted to the membership for ballot at an early date.



\$5.00

STATES ELECTRIC CO.

20 CLINTON ST. NEWARK, N. J.

GREGG & COMPANY

ENGINEERS

Radio Department

165 Broadway New York

St. Louis, Mo. Washington, D. C.

Newark, N. J. Los Angeles, Cal.

 Mexico City, Mexico

Radio PLAN-O-PHONE



Loud Speaker \$3.50

The Plan-O-Phone is the most amazing value of any Radio Loud Speaker, on the market. Remarkable acoustics. Used with any 2 stage amplified receiving set. Fits any receiver. Made of statuary bronze—handsome, durable. Dealers: Write for special proposition.

PLANET RADIO CORPORATION

1223 S. Wabash Ave., Dept. F2, Chicago, Ill.

Whirco Square Tinned Bus Wire

In 2 Feet Lengths or in Hundred to Thousand Pound Lots Quoted.

Shipments F. O. B. Mill

WHITE RADIO CO.

123 East 23rd Street

New York City

American Radio & Electric Co.

1133 Broadway New York City

WRITE FOR OUR CATALOG

JUST OFF THE PRESS

USE THIS COUPON TO JOIN

THE RADIO TRADE ASSOCIATION

THE RADIO TRADE ASSOCIATION,

1133 Broadway,

New York City.

Please count us in as charter members of

THE RADIO TRADE ASSOCIATION

and send us all bulletins regarding same as they are issued.

We are jobbers . . . , retailers . . . , manufacturers . . . of radio equipment.

Name

Town

State

Date

President Henry M. Shaw is Recognized Trade Authority

(Continued from page 26)

It is typical of the man that he should be at the forefront of development of the latest angle of electricity, radio. He has never lagged behind. He has been in the electrical business almost since it existed, and to-day he is actively in touch with electricity's brightest star. Mr. Shaw made his first radio part in 1908. Indeed, he was the pioneer in lighting switches, making the first radio switch at that time.

As a consequence of being a pioneer, Mr. Shaw views the present litigations with something akin to amusement. He recalls the many patent fights in the early days of electricity when it was being exploited for light and power and when the term "alternating current" was so much Greek for the average "electrician" and beyond his comprehension.

Radio to-day is being confronted with almost the identical problems regarding patents, monopolies, credits and what Mr. Shaw terms as "get-rich-quick parasites" so that he can bring his experience to bear upon a solution of all these problems. A mere recital of the part Mr. Shaw has played in electrical manufacturing is to outline the history of electrical expansion since 1886.

With the advent of the trolley car, Mr. Shaw set to work to improve it mechanically. His contribution to the best mode of urban transportation in 1892 were overhead trolley insulator fittings from shellac compounds known to the electrical trade as Shawlac.

In 1893 he produced the swing ball and Shaw lightning arresters for electric lighting and street railways. The continued expansion of American cities and the consequent spread of trolley systems interested him, and by 1900 Mr. Shaw was financing, constructing and operating electric street railways. The telephone at the opening of the Twentieth Century was also becoming an important branch of electrical development, with the result that in that year he was also busy constructing rural telephone lines.

By 1904 Mr. Shaw was beginning to specialize in certain electrical devices, and the Edward Longstreth medal, awarded him in that year by the Franklin Institute of Philadelphia for his high-resistance lightning arresters induced him to devote his efforts to the manufacture and design

of electrical specialties. In 1905 he was making and installing soldered rail bonds and third rail insulators, besides developing lightning arresters for high tension currents.

In 1908 his first piece of wireless apparatus appeared, and along with it the first lightning arrester for wireless.

What next attracted his attention was the introduction and perfection of synthetic compounds for use in moulding electrical parts. Mr. Shaw is one of the pioneer moulders of bakelite and other patented gums of a synthetic nature. This was in 1910. By 1914 his company had come to specialize in moulded insulation. The war, however, made other demands.

At the beginning of the recent war he was called upon by the British and American governments to design the four-prong vacuum tube brass shell known as the "Shaw Base" used by the General Electric Company and the Moorhead Laboratories, and became interested in assisting Moorhead in the manufacturing of vacuum tubes for the Marconi company.

In March, 1920, he was elected president of the Moorhead Laboratories and in September, 1921, he organized and became president of the Atlantic-Pacific Radio Supplies Company. Mr. Shaw resigned both offices in May, 1922, on account of ill health, due to overwork and demands made upon his time by the rapid expansion in the radio field at that time.

Mr. Shaw is concentrating all his interests at the present time in the Shaw Insulator Company, which only recently moved into its new factory at 148-152 Coit Street, Irvington, New Jersey. Here moulded parts are made to order of condensite, Shawlac and other compounds. The company is also actively engaged in the design and manufacture of lighting protective equipment, licensed under patents held by Mr. Shaw as early as 1893 and as recent as 1908.

Mr. Shaw fits into the position of president of the Radio Trade Association by virtue of his electrical experience and his pioneering spirit, a spirit so necessary in a business which has all the future before it.

Musiophones at \$5

In the advertisement of the American Electro Phone Company, Inc., of 512 Fifth Avenue, New York City, in the December issue of THE RADIO DEALER, through a typographical error it was stated that the company is offering microphones, whereas the advertiser desired to call the attention of the radio trade to its offering of musio-phones that are guaranteed to be an eight dollar value for five dollars.

Works with Loop

To offset the inconvenience of an outside aerial and the annoyance of sound distortion, the F. Joseph Lamb Company, of 1938 Franklin Street, Detroit, Mich., have evolved the radio frequency receiver, type RFA-1, which is designed to operate on an indoor loop, making use of the highly directional properties of the loop. It minimizes interference and gives a high degree of selectivity. Radio frequency amplification permits the working of a rectifier tube at a much higher efficiency, and also gives a much purer tone, as it is not sensitive to audio frequency noises.

Among the specifications for this set are: Three rheostats, one controlling the radio frequency tubes, another the detector tube and the third the two audio frequency amplifier tubes.

The whole instrument presents a very beautiful appearance, the front panel being Gorton machine engraved, showing all controls.

Bruno Radio Plans Expansion

The Bruno Radio Corporation, of 152 West 14th Street, New York City, are negotiating for the expansion of their present factory and office. The corporation is specializing in the manufacture of a receiving set especially adapted to the use of the WD-11 tube.

Besides the Bruno receiving set, the corporation has recently perfected a two-stage amplifier, using but one control. Among the special parts necessary for the use of the dry cell tube which the Bruno corporation manufactures is a special socket.

The socket is made of bakelite, the metal contacts being of original design, insuring perfect contact. The Bruno Radio Corporation are rushing the manufacture of several other special parts suitable for use with the WD-11 tube, which will appear on the market in the near future.

New G-W Product

The latest addition to the G-W line, manufactured by Gehman & Weinert, 42 Walnut Street, Newark, N. J., is a new insulator. What should especially recommend this insulator is the fact that, before adding it to the line composed of the popular G-W slider, two-slide tuning-coil and detector, it was submitted to far more strenuous mechanical and electrical tests than would seem necessary. The manufacturers made certain that it would measure up to the G-W reputation for quality. The special composition of which this G-W insulator is made is waterproof, and is said to resist heat and stand heavy strains.

Standard Goods at Coen Sales

Ralph Coen, who has been operating regular auction sales for the radio trade, has established a reputation for square dealing and the many radio business men who attend the Coen sales, held at New York, recognize the fact that the Coen sales are honestly conducted and sales are made in proper manner.

Mr. Coen's activities, in this branch of the radio industry, are helpful because, in these sales, are offered many standard wares which are sold to legitimate dealers. If there was no such outlet as the Coen sales these wares would be offered at "less than factory" prices to the damage of the industry.

Properly conducted sales, it is generally admitted, help to stabilize an industry and in doing this pioneer work Mr. Coen has the moral support of many folks in the trade.

Attendance at the Coen sales develop the knowledge that standard apparatus can be sold, at this time readily. Apparently the New York market is not over-flooded with staples. Every article offered at the Coen sales is guaranteed and therefore so-called "junk" is not offered.

Converts Crystal Set

For converting a crystal set into a more efficient tube set the Add-A-Step detector has been designed by the Arrow Radio Company, 138 Central Avenue, Hackensack, N. J.

This detector has a bakelite panel and a smooth running rheostat controlling the filament current. An "off" position on the rheostat eliminates a switch. The grid-leak and the grid condenser are of the proper capacity for the modern tube, for which a moulded condensite socket is provided. The springs have large round-end contact surfaces. The wiring is of the approved bus-bar type and all connections are soldered. The in-put and out-put terminals of hard rubber are mounted on opposite sides so that additional steps may be added at any time.

Dodge Tone Amplifier

Ackerman Bros., Inc., 301 West Fourth street, New York City, are distributors of the Dodge tone amplifier, a new radio loud speaker which is made of wood pulp. The amplifier was designed by one of the foremost acoustical specialists. The instrument, beautifully encased and attractively finished, is entirely free from metallic sounds, and it is claimed to be free from distortion of voice or music.

Every Dealer
Every Jobber
Every Manufacturer

in

The Radio Trade

Should be a member of

The Radio Trade Association

Full details may be obtained at headquarters

The Radio Trade Association
1133 Broadway **New York City**

Officers and Directors are:

Henry M. Shaw, Shaw Insulator Company, Newark, N. J., president.

Hugh H. Eby, H. H. Eby Company, Philadelphia, Penna., treasurer.

Laurence A. Nixon, The Radio Dealer, New York City, secretary.

W. B. Curtis, Curtis Sales Company, Newark, N. J., first vice-president.

Laurence I. Mott, San Francisco, Calif., second vice-president.

R. P. Clarkson, Radio Mica Products Company, New York City, third vice-president.

Raymond Francis Yates, Permanent Radio Fair, New York City, fourth vice-president.

Chauncey P. Carter, trade mark attorney, Washington, D. C., fifth vice-president.

W. L. Sayre, Sayre Level Company, Philadelphia, Pa., sixth vice-president.

The Board of Directors is composed of the following:

Paul F. Johnson, Altadena Radio Laboratory, Pasadena, Calif.

Arthur Halloran, publisher, Radio, San Francisco, Calif.

J. H. Smith, Virginia Radio Company, Charlottesville, Va.

Wm. A. Debold, Oklahoma City Radio Company, Oklahoma City, Okla.

Bert B. Barsook, jobber, Chicago, Ill.

Powell Crosley, Jr., Crosley Manufacturing Company, Cincinnati, Ohio.

F. Clifford Estes, The Clapp-Eastham Co., Cambridge, Mass.

F. D. Pitts, F. D. Pitts Company, Boston, Mass.

Harold M. Schwab, Harold M. Schwab, Inc., New York City.

M. B. Sleeper, Jr., Sleeper Radio Corp., New York City.

W. M. Kunkel, Pittsburgh Radio & Appliance Company, Pittsburgh, Pa.

C. H. Love, L. F. Grammes & Sons, Allentown, Pa.

F. H. Pruden, F. H. Pruden Co., Jersey City, N. J.

A. H. Redden, A. H. Redden Co., Irvington, N. J.

Mortimer Salzman, Wholesale Radio Equipment Co., Newark, N. J.

Insulating Materials Tests

The Bureau of Standards has published a paper giving the results of extensive research on the laminated phenol-methylene type of insulating materials. This publication, Technologic Paper No. 216, "Properties of Electrical Insulating Materials of the Laminated Phenol-Methylene Type," by J. H. Dellinger and J. L. Preston, is now obtainable from the Superintendent of Documents, Government Printing Office, Washington, D. C., at 30 cents.

The manufacture of these electrical insulating materials is an industry that has become commercially important within the last 20 years.

This paper is concerned only with materials of the laminated type, which are made up by building up to some desired thickness sheets of paper, fiber, or fabric which has been previously impregnated or coated with phenol (synthetic) varnish and then subjecting the stack to comparatively great pressure in a heated hydraulic press.

All the materials of this type on the market have been investigated; that is, Condensite Celoron, Bakelite Dilecto, Formica, and Bakelite Micarta. The properties or effects which have been measured for this type of material include radio frequency, phase difference, or power loss, dielectric constant, flash-over voltage, direct-current volume resistivity and surface resistivity, moisture absorption, thermal expansivity, and other properties.

The data of these properties have been arranged in such a manner as to be conveniently available for reference either by a person desiring detailed information or by a person interested only in a general way.

Leco Vario-Coupler

Especially suited to panel mounting is the Leco vario-coupler type VCI, made by the Lew Brothers Company, of 605 North Walnut Street, Champaign, Ill.

Illustrating the careful planning inherent in the design of this instrument is the fact that the primary coil is wound on a formica tube and the secondary coil is wound on a hard wood rotor. The instrument is suited for a wave length of 200 to 500 meters.

The makers claim for this instrument a radio part of general utility, neat appearance and all-around efficiency, and of unique value at the nominal price at which it can be sold at retail.

Radio Fair Boosts Industry

The Permanent Radio Fair which is located at the Hotel Imperial, Broadway and 32nd Street, New York City, has proved a success and a rendezvous for radio fans as well as radio buyers, who are interested in the centralized exhibits of the representative manufacturers. Radio engineers are in attendance and gladly demonstrate any of the products that are on exhibit. Every effort is made for the distribution of the literature of manufacturers to interested buyers. Arrangements have also been made so that buyers can place orders at the Fair. Additional space is available for manufacturers who desire to exhibit.

Atlantic Jr. Sets

Sharwell Radio Supply Co., 1136 Raritan avenue, New Brunswick, N. J., manufacturers of Sharadio products, are now the exclusive wholesale distributors of Atlantic, Jr. sets for New Jersey. The Atlantic, Jr. is a crystal receiving set complete with aerial and headset. This receiving set was designed by the best of engineering talent and every part of it is thoroughly inspected and tested before leaving the factory.

The manufacturers guarantee that the Atlantic, Jr. is not surpassed in performance by any other crystal receiver on the market.

Socket for Dry Cell Tube

Designed for WD-11 tubes working on a single dry cell battery, the Na-Ald socket recently introduced by the Alden-Napier Company, 52 Willow Street, Springfield, Mass., is an instrument for this exclusive purpose. It is moulded from Condensite, and the makers claim that it is unbreakable and unaffected by heat. In keeping with the ideas of advanced electrical engineers, the contact in this socket slides, wipes and presses firmly at all times. The contact strips are of phosphor bronze.

Catalog of Wiener Wireless

The Wiener Wireless Specialty Company, 21 Academy street, Newark, N. J., have issued a revised list of the lines carried for the trade. The list includes Nerco phones, variable condensers, vario-couplers, variometers, crystal sets, dials, sockets, switch levers, switch points, rheostats, bakelite binding posts, composition binding posts, lightning switches, detector cups, knobs, rotors, coils, tuning coils, condensers, porcelain cleats, insulators, slider rods and sliders.

Radio Club of Illinois

Within a period of one year the Radio Club of Illinois has sprung from field of endeavor to the saddle of recognized supremacy among the radio clubs of the United States. Its club house at 16 East Ontario street, Chicago, Ill., is the scene of continued activity and social interest. Visitors in great numbers have availed themselves of the hospitable invitation to visiting radioists to make the club their headquarters.

Herbert H. Frost is chairman of the trade relation committee and a code of rules will soon be enforced that will improve the general conduct of business.

Lawrence H. Schmitt, from the Ninth District, supervisor of radio, was the first president, and upon the conclusion of his term was succeeded by Alfred Thomas, Jr., at present prominently connected with the Radio Corporation of America.

Prof. Frank D. Pearne, instructor of radio at Lane Technical High School, and contributor to radio columns of the Chicago *Herald-Examiner* and other newspapers, is chairman of the board of directors and has led a successful fight against the imposition of a tax on aeriels by the city of Chicago. John P. Tansey is the secretary since its organization and the source of activity, which has placed the Radio Club in the front row of Chicago civic organizations.

Other officers are: Frank Comerford is counsel for the club. Paul G. Niehoff, prominent Chicago manufacturer; A. H. Koprach, an engineer of reputation, and Herman J. Pomy are vice-presidents. J. Elliott Jenkins, once with Thomas Donnelly of Station D.W.A.P., is treasurer.

Universal Loud Speaker

The Universal loud speaker has been developed by the Roller-Smith Company of 233 Broadway, New York City, with the idea of stressing the musical possibilities of radio, so that full and natural tones might be reproduced rather than the shrill and strident notes frequently associated with radio. The makers feel that they have succeeded in their aim by the design of this product and by the construction of a tone chamber specially suited to the two special receiver mechanisms employed. These are matched to within one-half a musical note. The Universal loud speaker is a symmetrical horn with a crystalline finish. Each instrument is complete, ready for installation, with five feet of green cord with pin terminals which can be attached to any standard plug if desired.

Cozzone's Condensers

The precision condenser now being made by John A. Cozzone & Company, Inc., 61 Arlington Street, Newark, N. J., is the result of a demand in the industry for instruments of quality and reliability.

Some of the features of this precision condenser are:

1. Patented adjustable brake band, which by a slight turn of the screw gives the desired tension.
2. Genuine bakelite backs, which

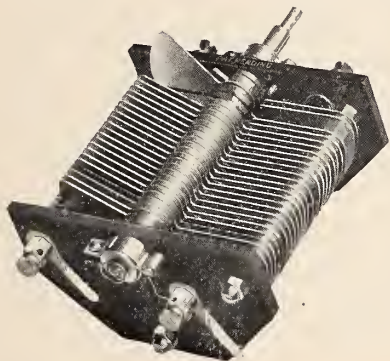

are guaranteed not to warp or get out of shape.

3. Furnished with both binding posts and connectors, which allows for a soldered or plain connection in the post.

4. All parts made of brass and highly nickel plated.

5. Direct wire connections from condensers to connecting plates.

6. Steel template for locating main spindle hole, and three tightening screw holes on instrument.

These condensers are made in both the plain and vernier type.

John A. Cozzone started in business in March, 1915, making small, accurate screw machine products. The company, which he formed, began manufacturing a complete line of binding posts, contact points, knock-down detectors, etc., when radio struck its present stride. Throughout this period the company has adhered to the standard adopted in the beginning.

Radio Frequency

Radio Frequency is an attractive booklet published by the Rasla Sales Corporation, 10 East 43d Street, New York City, which treats of "radio frequency for the engineer and layman." Dealing in the introductory chapter with the question of distance versus quality, it goes on with the outline of radio-frequency transformers and radio-frequency amplifiers. The pamphlet has some very clear and useful hook-ups, for securing desirable results.

Describes Use of Loop

A circular that tells much in a small space has been issued by the Egel Radio Company, 210 Central Avenue, Newark N. J., which describes the uses and mode of operation of the Portabloop.

It also shows several hook-ups of this efficient loop aerial with different types of receiving sets.

The descriptive matter is unusually clear and informing, so that the novice may easily understand an aerial loop. The chief points brought out are that with a Portabloop used in conjunction with a variable condenser, for tuning, no other tuner is necessary; that the Portabloop should be turned in the general direction of the station from which the signals are coming, and that it is of greatest utility when used in conjunction with a tube set.

Big Battery Installation

A 2,000-volt, 20-ampere hour storage battery has been installed in a new broadcasting station KFDB, which has been opened by the Mercantile Trust Company, of California, on Telegraph Hill, San Francisco. To eliminate the disturbing noise due to the commutator hum of the generator, 333 Philco radio "A" batteries made by the Philadelphia Storage Battery Company, were installed. The generator is used for recharging these batteries in series.

Free

Will help YOU increase sales

This catalog will show you how to secure the names of your best prospective customers. Those you want to reach most. Counts and prices are given on thousands of different Lists, covering business concerns, professions and individuals, such as Noodle Manufacturers, Druggists, Coal Mines, Farmers, etc. Personalized sales letters and descriptive literature mailed to live prospects will increase your sales by creating direct orders or inquiries.

99% Guaranteed Mailing Lists backed by our 5¢ refund

Insure your getting up-to-date information, for our Lists must be compiled from latest sources to avoid heavy losses through the guarantee.

Send for FREE Reference Book today
A postcard will bring this valuable sales help.

ROSS-GOULD CO., N. 10th, St. Louis.

Ross-Gould
Mailing Lists St. Louis

CONQUEROR

Custom-built, One-knob Control
RECEIVING SETS

LEWIS & DeROY RADIO CORP.
560 Seventh Ave. New York

Radak

Reg. U. S. Pat. Off.

RELIABLE RADIO EQUIPMENT
made by America's oldest and largest manufacturers of radio equipment exclusively. Sold by the best electrical and radio dealers.

CLAPP - EASTHAM CO.
133 Main Street Cambridge, Mass.

INTERESTED IN RADIO PATENTS?

Radio Business men and Manufacturers who are interested in the patents issued by the U. S. Patent office may find this information each week in

THE RADIO DEALER WEEKLY

Address

Two dollars the year. Sample free on request

THE RADIO DEALER WEEKLY, 1133 Broadway, New York, N. Y.

JEWELL VARIO COUPLER

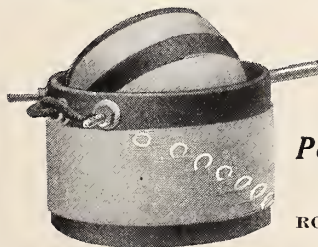

\$1.25 List

400 meters, 3/4" rotor, tested stator, 21 s. c. wire, 1/4" aluminum shaft, 14 taps, pigtails.

Sell More Popular Price Couplers

Positive Connections Positive Results

ROTORS SET LOW IN STATORS

WE MAKE OTHER STYLES TO 3000 METERS

DEALERS—JOBBERS—AGENTS PLEASE WRITE FOR DISCOUNTS

MANUFACTURED BY



\$2.50 List

600 meters, 3/4" rotor, composition stator, 24 d. c. wire, 1/4" brass shaft, pigtails, 14 taps, brass uprights.

JEWELL RADIO SALES CO. 90 West St., New York

THE DRY SET THAT SELLS

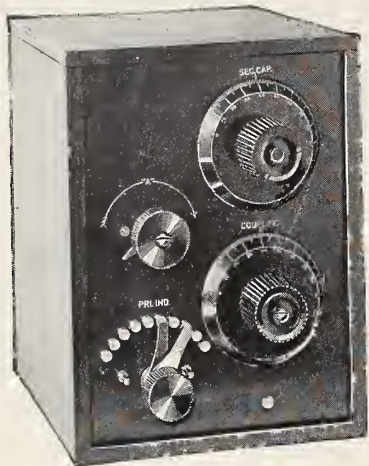

Q. T. DRY CELL SET

\$8.50

NET TO THE DEALER

Can be sold at \$25.00 with phones, tube and batteries at a good profit.

SPECIFICATIONS—

Mahogany-stained cabinet, engraved Radion panel, Ajax socket-rheostat, 21 plate variable condenser, 8 tap vario-coupler, no external binding posts, busbar wiring.

Write for Full Information

The Q. T. Light Co.
East Orange N. J.

Harris Crystals

Specialists in radio crystals, the Harris Laboratory, 26 Cortlandt Street, New York, have developed several grades and kinds of crystals suitable for individual styles of sets.

The feature of the Harris line are their Ganaerite crystals. This is a guaranteed highly-sensitive crystal, made from a special, crystalline form of pyrites that has been obtained from but one source and sold for several years for use in large stations. It is now quite generally distributed throughout the United States and Canada. Careful selection is made by individual test of each crystal, and the company assures 60-75% of the surface sensitive.

The company have also developed their own brand of galena crystal; culina crystal, a guaranteed, 100 per cent. sensitive surface crystal made from a special grade of silver galena; and silicon crystals, which are made up by the company on order in limited quantities.

Bureau of Standards Tests

The Bureau of Standards of the Department of Commerce, has prepared a pamphlet, Letter Circular No. 73, entitled "Fees for Testing Radio Apparatus," for the information of those who desire to have tests performed. The Bureau limits its tests of radio materials to tests for the government, tests of instruments, which in turn are to be used as standards, tests of importance to the Bureau for research, tests in which the Bureau is to act as referee, and a few other special tests in which special reason is shown why these tests are to be undertaken by the Bureau. Before an article is submitted for the test it must be preceded by a written request for test, and if it can not be undertaken the applicant is furnished, if possible, with the name and address of one or more laboratories who may make the test if requested.

The request should enumerate the articles, giving serial numbers or other identification marks, if any; should state the nature of the test desired and the conditions under which the apparatus is used, and state his reasons for believing that the test should be made by the Bureau of Standards. There is a limited number of copies of this fee schedule available at the Bureau to persons who have actual use for it.

New Loud Speaker

The Spirola Concert is one of the feature products handled by the Invincible Products Company, Inc., of 159 North State Street, Chicago, Ill. It is a self-contained loud speaker and in design is distinct from every loud speaker now on the market.

Although only eight inches high, the peculiar construction of the tone chamber permits of a horn of about two feet in length, thus insuring sufficient volume, but also eliminating distortion and metallic sounds. The paper-thin diaphragm of the Spirola Concert is the only moving part in the unit, so that there are no intrusive vibrations to spoil the reception. The loud speaker is especially adapted for use with two stages of amplification, although the makers claim that with one stage broadcasting within a radius of twenty-five miles can be heard.

The Spirola Concert comes in two finishes, mahogany and dark oak with a bronzed throat. The Invincible Products Company also handles other featured lines, including the Geraco variometer and vario-coupler, Music Master Loud Speaker, Invincible Superadio set, and Geraco aerial inductors.

Keeps Track of Radio

What the loose-leaf encyclopedia is to reference books, so is the Lefax Radio Handbook, made by Lefax, Inc., Ninth and Sansom streets, Philadelphia, to other books attempting to give the reader the requisite information for a thorough understanding of radio. The inherent advantage of the loose-leaf system is timeliness, and by the system which Lefax has adopted, the purchaser learns of new developments in radio as soon as they have been collated. At regular intervals the Lefax company sends him additional pages in loose-leaf form, all pages being numbered and properly classified. The text matter, moreover, is extremely valuable, being written by Dr. Dellinger and Mr. Whittemore, of the U. S. Bureau of Standards. Both these men are of necessity in touch with every phase of radio and with the information at their control are enabled to broadcast the new twists in radio first through the Lefax Radio Handbook.

Adapts Phonograph

Turning any cabinet phonograph into a loud speaker is the purpose of the Radiophono adapter, made by the Industrial Sales Engineering Co., of 671 Broad Street, Newark, N. J.

The Radiophono adapter is designed to give clear musical tones with volume. It is also fashioned so that all metallic and distorted sounds may be eliminated. The device is of moulded composition, fitting any of the well-known makes of cabinet phonographs. It is attached to the tone arm. In the adapter any telephone receiver can be placed, and is held firmly by the adjustable threaded cap which prevents any vibration and in which the receiver is completely encased.

The saving resulting from utilizing the phonograph cabinet as a loud speaker should be a great selling point for this device.

Comsco's New Socket

The Commercial Screw Machine Company of 427 East 102 Street, New York City manufacturers of Comsco products have added a new WD-II socket to their line. A special feature of the socket is that the binding posts are so designed that it is impossible to remove the caps thus preventing the annoying dropping of the cap when one is connecting a wire to the posts.

Other products of the Comsco line are a V. T. socket and various types of jacks. The products are of excellent workmanship and list at a popular price.

Instrument for Fine Tuning

Sharp tuning so that interference may be eliminated is one of the features provided for in the Crown vario-coupler, made by Crown Radio Manufacturing Corporation, 78 Fifth Avenue, New York.

The high inductance value insures a maximum of signal intensity. Primary and secondary inductances are in the form of two concentric spheres separated one-half inch. The primary is internally wound in a bakelite form. The secondary winding is borne on a bakelite rotor. Fourteen taps on the primary, so arranged as to permit the use of any desired number of turns, are brought to a bakelite panel mounted on the rear of the instrument. This method of construction obviates any difficulty in connecting up the instrument in the set.

Substantial bakelite forms are used throughout the construction of the Crown vario-coupler. The heavy brass legs are so designed as to be integral with the entire unit and yet not interfere with the mounting of the device on a panel. This insures the rigidity of construction.

Connection to the rotor is made through flexible leads, so designed as to preclude any possibility of short circuits or broken connections. From the above description it appears that the Crown vario-coupler is the result of a careful planning and painstaking design.

Navy Transmitter

A detailed description of the U. S. Navy one kilowatt radio transmitter, sold by the United Supply & Machinery Company, Land Title Building, Philadelphia, is contained in a striking booklet recently issued by that concern.

These transmitters were built in accordance with specifications issued by the U. S. Navy Bureau of Steam Engineering. They were constructed under constant government supervision and inspection in the Kilbourne & Clark plant and are instruments of performance and service.

Talking Movie

The pallophotophone is a recent invention by C. A. Hoxie, of the General Electric Company, by which the voice and musical instruments, or any sound, may be registered by light waves on a moving picture film, which in turn reproduces the sounds when it is run through a reproducing instrument. It has been hoped that not only would the invention be of use in radio, but that it would eventually bring

about the development of a talking-movie which would be practicable.

The machine records vibrations of the voice on the edge of a strip of film, where, when it is developed, it can be traced in delicate markings, like those of a seismograph. The light wave which traces the tiny marks comes from a mirror about the size of a pin-head, which is actuated by a diaphragm influenced by sound waves. When the film is used for reproduction this process is, in a way, reversed by means which the General Electric Company has not permitted to become known. The resulting effect is striking.

Cyclone "B" Batteries

A complete line of Radio "B" batteries are manufactured by the Standard Electric Novelty Company, 324 Lafayette street, New York city, as a result of experience in manufacturing radio batteries for the United States and Allied governments during the late war.

Each of the various types is made in two styles, plain and variable. The company also furnishes special types of the amperage, voltage and variations that may be desired. Types 9285A and 9285 are made in two size

thirty large cells and thirty medium cells with fifteen variations each. Each battery is thoroughly tested and examined before leaving the factory.

Speaking for a Loud Speaker

A very effective means of bringing to the attention of radio dealers throughout the country the advantages of the Timmons Talker, a loud speaking device, has been adopted by the maker, J. S. Timmons, 339 East Tulpehocken street, Philadelphia, Pa.

This consists of a folded tab which is part of all letterheads leaving the Timmons office. The tab is not attached, but is part of the same sheet as the letter, being merely folded over, with the inscription Timmons Talker in red to excite the curiosity of the recipient of the letter so that he will turn over the tab and read about the Timmons Talker.

The Timmons Talker is an amplifier, not merely a headset with horn amplification. The amplification may be controlled to any degree desired, from a volume sufficient for a living room to that filling a large auditorium. No batteries are necessary. The Timmons Talker is built in a solid mahogany case and being of cabinet shape, adds to the appearance of the receiving set.



Complete with Special Attachment for use in Connection with any Phone.

"WOODEHORN"

LOUD SPEAKER

\$7.50

List Price

MOST STARTLING LOUD SPEAKER
AT A
MOST AMAZING PRICE

"WOODEHORN" suggests without much effort the character of the Loud Speaker—"it's the wood that makes the tone good."

If you would have the tones of a rare violin then do not hesitate to try a "WOODEHORN" Loud Speaker.

"WOODEHORN" was the hit of the American Radio Exposition, New York. Hear "WOODEHORN" before you stock loud speakers.

Manufactured by

INTER-OCEAN RADIO CORPORATION

1140 BROADWAY, N. Y. C.

Liberal Discounts
To Recognized
Distributors and
Dealers.



**Na-ald
De Luxe
V.T. Socket**

Contact strips of laminated Phosphor bronze press firmly against contact pins, regardless of variation in length. No open current trouble possible. Socket moulded from genuine Condensite. Practically unbreakable. Special protected slot, with exterior reinforcement. Unaffected by heat of bulbs or soldering iron. All excess metal eliminated, aiding reception. May be used for 5 Watt power tube. Highest quality throughout. Price 75c.

Special proposition to dealers and jobbers

ALDEN-NAPIER CO.
52 Willow St. Dept. H Springfield, Mass.

PATENTS

To the Man with an Idea

I offer a comprehensive, experienced, efficient service for his prompt, legal protection, and the development of his proposition. Send sketch or model and description, for advice as to cost, search through prior United States patents, etc. Preliminary advice gladly furnished without charge. My experience and familiarity with various arts frequently enable me to accurately advise clients as to probable patentability before they go to any expense. Booklet of valuable information, and form for properly disclosing your idea, free on request. Write today.

RICHARD B. OWEN
Patent Lawyer
82 Owen Building, Washington, D. C.
2276-10 Woolworth Building, New York City

Ask Our Service Bureau

Great **SELECTIVITY** and **EXCEPTIONAL LONG RANGE** are some of the **CHARACTERISTICS** of the **FEDERAL**
DX TYPE NO. 58 R. F. RECEIVER
Write for Bulletin 119-W
Federal Telephone and Telegraph Co.
BUFFALO, N. Y.



WALCON

Radio Frequency Transformer

THE BEST YOU CAN BUY

A Transformer that Guarantees Results
Particularly suited for W. D. 11 Tubes.

List Price \$4.00

Manufactured by
THE RADIO CENTER

2 West Broadway New York
Dealers and Jobbers write for our attractive sales proposition backed by National Advertising.

**Lyon & Healy Store Is
Complete Radio Depot**

The radio store of Lyon & Healy, one of the most complete in the city of Chicago, is located on the ground floor of the Lyon & Healy building next to

it by radio by merely stepping from the radio store into the concert hall.

The Radiopera cabinet outfit shown herewith is one now offered to the



Lyon & Healy Store



Radiopera Cabinet

the Jackson Boulevard entrance. A good photograph of the interior of the store has been reproduced in the accompanying illustration. This store was designed to fit the peculiar needs of radio customers and for the proper display of goods. The counter displays themselves are worthy of special note. They present in an attractive but compact form a complete array of accessories and parts.

A very attractive feature of the new store is the fact that it has special demonstration rooms where customers may, in private, test out their contemplated purchase. The radio store listens in on daily concerts held in the Lyon & Healy concert hall. As a result one may compare the voice of the singer with the reproduction of

trade by Lyon & Healy. This is a complete radio installation enclosed in an especially designed brown mahogany cabinet. The outfit contains a Westinghouse R C. receiver, Western Electric loud speaker, Willard rubber incased 'A' battery, Tungar battery charger, and Burgess "B" battery, complete with antenna, etc.

A disappearing door permits free passage of the sound waves of the horn of the loud speaker. Panel doors both in front and in back give easy access to all parts of the radio apparatus to facilitate the adjustment of wire connections. The outfit is an economical one to operate. It is compact and a very handsome article of furniture.

Phonograph Attachment

The Gilbert H. Downey Co., 7 South 17th Street, Philadelphia, Pa., have ready for distribution their new E-C (Easy Change) phonograph attachment for the Victor and Columbia phonographs.

This attachment is complete with special loud speaking unit with cord and aluminum case which fastens on to the tone arm of the phonograph after the reproducer is removed. There are no set-screws to injure the unit.

A phonograph with the "E-C" attachment makes a very satisfactory loud-speaker for the home at a very low cost.

Combines Two Parts

An improvement in radio likely to meet with success is a combination variable grid-leak and Micon condenser.

The grid leak consists of a piece of fibre specially treated upon which a bronze spring is rotated to vary the resistance in an unbroken range, from practically zero to five megohms. The condenser is a tested Micon condenser of .00025 mfd. The whole is combined and sealed in a neat moulded body with nicked binding posts, and a pointer and dial to set the grid-leak resistance.

The variable grid-leak and condenser can be used in the parts of the circuit to eliminate noise and distortion. It has a distinct advantage when placed across phones instead of usual phone condensers.

This device is manufactured by the Chas. Freshman Company, Inc., of 97 Beekman Street, New York City. The accuracy and construction will be in line with the tested Micon condenser.

Simplex Panel Units

The Simplex Radio Company, of 1013-5 Ridge Avenue, Philadelphia, Pa., are manufacturers of radio telephone and telegraph apparatus of quality that is distributed through the Electric Service Supplies Company, with offices in New York, Philadelphia and Chicago. The Simplex panel units are said to be a real joy to the radio enthusiast as these perfected instruments eliminate much of the uncertainty of success in receiving broadcasting.

The units consist of Simplex panel-mounted variometers, vario-couplers, variable condensers, tube detectors and tube amplifiers. With these units an exceptionally attractive set can easily be made up and a variety of hook-ups tried. As Simplex units can be bought separately, an elaborate set may be built up by adding units when desired.

Sell Radio Books

The Norman W. Henley Publishing Company, 2 West Forty-fifth Street, New York City, one of the foremost publishers of radio books, are interesting dealers in stocking standard works that their customers will be interested in. This book feature has been found to be a profitable one for the radio dealer, especially when the long discounts that the Henley company is offering to those who buy an assorted quantity order is considered. M. B. Sleeper, E. H. Lewis, P. E. Edelman and A. P. Morgan are the authors who wrote the ten Henley radio books.

With twelve features of superiority, yet within the reach of every radio user.

JEWETT SUPER - TWELVE SELF CONTAINED VACUUM TUBE RADIO RECEIVER

Meets the demand for a complete receiver, combining good range, extreme sensitiveness and selectivity, with moderate price and economical operation.

The Jewett Super-Twelve has a double circuit tuner, constructed with new Jewett coupler of extreme selectivity, designed by Professor J. H. Morecroft of Columbia University. The adjustments are unusually simple and easy, requiring no special technical knowledge to insure success.

Two steps of amplification are furnished which give an increase of signal strength equal to that obtained from three or four steps employing ordinary transformers. The high quality of the incoming speech or music is sustained through uniformly high amplification over the entire musical scale.

TWELVE DEFINITE POINTS OF SUPERIORITY

1. High quality signal reproduction.
2. Simplicity of adjustment.
3. Compactness.
4. Minimum high frequency resistance for a given induction.
5. Maximum amplification with minimum distortion.
6. Maximum sensitiveness.
7. Maximum selectivity.
8. Minimum noise.
9. Minimum distortion.
10. High quality design, workmanship, material and finish.
11. Highest efficiency at moderate cost.
12. Economical operation.

PRICE, \$75.00

In Kodak, Mahogany or Walnut Cabinet

JEWETT MANUFACTURING CORPORATION

Herbert F. L. Allen, *President*

NEWARK

NEW JERSEY

LIST OF ADVERTISERS

(Advertisements Indexed by Products will be found on Pages 90 and 91 of this issue.)

A		Fiber Products Co..... 92	Mitchell-Rand Mfg. Co..... 60	Ross-Gould Co.54, 83	
Adams-Morgan Co. 11	Finch Radio Mfg. Co..... 52	Moon Radio Corp..... 10	Royal Electric Laboratories. 47	Rusonite Products Corp..... 66	
Aerex Radiophone Corp..... 70	Fischer & Co., G. H..... 48	M. P. M. Sales Co..... 57	S		
Ajax Radio Corp..... 48	Franklin Radio Mfg. Co..... 70	Mu-Rad Laboratories, Inc.... 51	Saturn Mfg. & Sales Co., Inc. 65	Save Sales Co..... 24	
Alden-Napier Co. 86	Foote Mineral Co..... 54	Mydar Radio Corp., The.... 43	Schwab, Harold M., Inc.... 14	Seaboard Radio Corporation. 89	
Allied Engineering Institute. 15	Ford Mica Co., Inc..... 12	N			
Allen-Bradley Co. 49	French Battery & Carbon Co. 46	National Fibre & Insulation Co. 40	Seidman & Co., Henry L.... 18	Shamrock Radio Co..... 52	
American Hard Rubber Co.. 66	Freshman Co., Inc., Chas.... 70	New York Coil Co..... 5	Signal Radio & Elec. Corp.. 12	Spiro Brothers 67	
American Radio & Elec. Co.. 79	G				
Amplex Instrument Labs.... 92	Galena Crystal Mfg. Co..... 50	New York Hard Rubber Turn- ing Co. 60	S. S. Novelty Co..... 62	Staff Co., Louis A..... 66	
Andrae & Sons Co., Julius... 54	General Merchandise Co.... 44	New York Radio Dial Co.... 54	Standard Appliance Mfg. Co. 52	Standard Crystal Co..... 67	
Andrews, Curtis N..... 49	Gibbons Dustin Radio Mfg. Co. 66	New York Testing Labora- tories 47	Standard Metal Mfg. Co.... 45	Stanton Co., Frank T..... 64	
Arrow Radio Co.....46, 50, 54	Gilbert Co., The A. C..... 63	North Ward Radio Co..... 63	Star Mfg. Co..... 63	States Electric Co..... 79	
Astorloid Mfg. Co., Inc..... 62	Goetz Co., The Edw. J..... 60	Novo Manufacturing Co.... 52	Steinmetz Wireless Mfg. Co.. 52	Superior Products Mfg. Corp. 70	
Atwater Kent Mfg. Co..... 39	Gould Storage Battery Co... 50	Nuloid Corporation 60	O		
Automatic Electrical Devices Co. 8	Gregg & Co..... 79	P			
B		H			
Bayley Condenser Co..... 72	Hafner Manufacturing Co... 74	Oranola Radio Corp..... 13	T		
Betts & Betts..... 57	Hammarlund Mfg. Co., Inc.. 66	Owen, Richard B..... 86	Tait-Knob-And Dial Co..... 4	T. B. H. Corporation..... 52	
Boone Mfg. Co., J. T..... 53	Harris Laboratory, The.... 46	Q			
Bremer-Tully Radio Co..... 67	Heinemann Electric Co..... 53	Q. T. Light Co..... 84	T. F. Radiophone Co..... 89	Thornton Transformer Co... 64	
Briggs & Stratton Co..... 21	Holloway Elec. Supply Co., Inc. 64	R			
Bristol Co., The 10	Hudson-Ross 64	Radio Apparatus Co. (Detroit) 65	Thresher Radio Corp..... 66	Trade Circular Addressing Co. 52	
Bruno Radio Corp..... 73	Hommell, Ludwig 9	Radio Apparatus Co. (Pitts- burgh) 64	True-Tone Radio Mfg. Co.... 71	U	
C		Hyman & Co., Inc., Henry... 13	Post Electric Co..... 71	United Mfg. & Distributing Co. 55	
Carbon Products Co., The... 42	I				
Carter, Chauncey P..... 73	Inter-Ocean Radio Corp...59, 85	Planet Radio Corp..... 79	United Specialties Co., Inc... 56	Universal Stamping & Mfg. Co. 68	
Central Electrotype Foundry. 60	Invincible Products Co., Inc., The 78	Post & Co..... 48	V		
Central States Eng. Co..... 67	J				
Chaslyn Co. 54	Jackson, P. D... 60	Premier Accessory & Specialty Corp. 58	V-De-Co Radio Mfg. Co.... 46	Victor Radio Corp..... 66	
Clapp-Eastham Co..... 83	Jewell Radio Sales Co..... 83	Pruden, Frederick H..... 17	Viking Radio Co..... 62	Virginia Radio Corp..... 69	
Commercial Screw Machine Co. 18	Jewett Mfg. Corp..... 87	K			
Continental Fibre Co., The.. 69	L				
Copper Clad Steel Co., The.. 50	Kern, Emil Alexander..... 60	Lewis & DeRoy Radio Corp. 83, 89	W		
Cozzone & Co., John A..... 6	King Sewing Machine Co.... 4	M			
Crosley Mfg. Co..... 7	Kramer Radio Co..... 60	Magna Instrument Co..... 59	W. E. Supply and Service Corp. 60	Weston Elect. Instrument Co. 56	
Crown Radio Mfg. Corp..... 41	K				
Culin, Curtis C..... 60	Magnovox Co. 37	Manhattan Electric Supply Co. Inside Front Cover	White Radio Co..... 79	Wholesale Radio Equip. Co., Front Cover	
D		Manhattan Storage Battery Co. 50	Radio Mica Products Co., 42, Inside Back Cover	Wilcox Laboratories 78	
Diamant Tool & Mfg. Co., Inc. 64	L				
E		Manufacturers Patent Co.... 60	Radio Outfitting Corporation. 60	Wilmington Electrical Spe- cially Co., Inc..... 69	
Eagle Radio Co..... 44	Marle Engineering Co..... 55	Radio Products Mfg. Co.... 61	Radio Shop of Newark, The. 64	Wilson, Inc., A. M..... 60	
Eby Mfg. Co., The H. H..... 73	McKenzie Engineering Co... 62	Radio Stores Corp..... 66	Radio Trade Association... 81	Winkler, Inc., Chas..... 60	
E-D Mfg. Co., The..... 6	Mercury Radio Products Co.. 48	Radiola Wireless Corp..... 60	Randel Wireless Co..... 63	Z	
Eisemann Magneto Corp.... 16	Mica Insulator Co..... 14	Radio Mica Products Co., 42, Inside Back Cover	Rauland Mfg. Co..... 68	Zwingenberger, Otto K..... 60	
Electric Service Supplies Co. 89	Miho Co., The..... 54	Radio Mica Products Co., 42, Inside Back Cover	R-C Outlet, The..... 50		
Electric Products Co..... 60	Milliken Bros. Mfg. Co., Inc. 72	Radio Mica Products Co., 42, Inside Back Cover			
Ell-Ess Radio Exchange.... 51		Radio Mica Products Co., 42, Inside Back Cover			
Eshoo Cabinet Works, E.... 52		Radio Mica Products Co., 42, Inside Back Cover			
Essex Mfg. Co..... 54		Radio Mica Products Co., 42, Inside Back Cover			
European Radio Co..... 71		Radio Mica Products Co., 42, Inside Back Cover			
F					
Fallgatter, Marvin B..... 64					
Federal Tel. & Tel. Co..... 86					

London Is Trying to Regain Position in Radio Stocks

By FRANK T. STANTON
Radio Stock Specialist

Guglielmo Marconi was unable to get financial backing in Italy and surrounding countries for his wireless invention. His mother, who was of Irish extraction, used her influence and he was finally financed in England, where the Marconi Wireless Telegraph Company, Ltd., was formed. London then became the radio center of the world and until very recently maintained this position. The activities of the Radio Corporation of America which bought out the American Marconi Company, have placed New York on top for the past few years.

With the advance of sterling and the improved financial condition of England, London is again attempting to regain its former supreme position in radio and has been a big buyer of shares in the principal companies in the field. To illustrate this point, it is interesting to note that the Marconi Wireless Telegraph Company recently authorized 1,500,000 pounds of 6½% Convertible 10-year first debenture stock and within one hour after the books were open, the issue was over-subscribed more than ten times. The demand for radio stocks continues unabated.

Broadcasting in England is being conducted in a very efficient and economical manner. The six largest companies have combined into one unit, for the purpose of centralizing broadcasting. In order to receive the programs, etc., one has to obtain a license from the government which costs \$5. Of this, \$2.50 goes to the broadcasting company and the remainder to the government. Broadcasting reports from Newark, N. J., have already been heard in London, which served to create increased enthusiasm in radio. Practically every person owning a set is trying to hear Newark. It should not be long before both countries will be able to distinctly hear one another's broadcasting efforts.

Mr. Kellaway, postmaster-general of England, who supervises all radio, telephone, postal and other activities, has become associated with the Marconi Wireless Telegraph Company, Ltd. An exodus of high public officials into the radio companies is expected.

In the local markets, Radio Corporation of America stock issues have

maintained a very firm tone and should do considerably better. General and Westinghouse Electric have been strong and active. Both report unusually large earnings. This is the time of the year when the radio stocks show their greatest activity.

Following are the quotations for the principal radio stocks:

	Bid	Asked
All American Cables.....	\$118	\$120
Am. Tel. & Cable.....	63	65
American Marconi Unstamped.	5	7
American Marconi Stamped...	5c	20c
American Tel. & Tel.....	124¾	125¼
Canadian Marconi.....	2¾	3¼
De Forest Radio Tel. & Tel..	7	10
English Marconi, common....	11	14
English Marconi, preferred....	10½	13½
Federal Tel. & Tel. N. Y.....	9	12
Federal Telegraph Co. Calif....	6¼	7½
General Electric, com.....	180½	181
General Electric, New 6%.....	11	12
International Tel. & Tel.....	55	60
Mackay Company, com.....	113	114
Manhattan Elec. Supply.....	50	52
Marconi Int. Marine.....	6	8
Pacific Tel. & Tel.....	93	94
Radio Corporation, com.....	3¼	3¾
Radio Corporation, pfd.....	2¾	3
Reynolds Spring.....	26	30
Spanish Marconi.....	1	3
United Fruit.....	156	157
Western Union.....	112½	113
Westinghouse E. & M.....	159½	160½

(Quotations as of December 15, 1922, furnished by Frank T. Stanton & Company, 35 Broad Street, New York City. Specialists in wireless securities.)

Woodehorn a Success

Myron Studner, general manager of the Inter-Ocean Radio Corp., of 1140 Broadway, New York, has introduced a radio horn of distinction both in the quality of the tone produced and in the moderateness of price.

This horn is called the Woodehorn and its name reveals its most unusual feature. The entire bell and throat are made of wood, which more than any

other material now on the market, is resonant and full of ample tones and vibrant sounds, according to Mr. Studner. A wooden bell insures less distortion and scratchy sounds than any other method of sound amplification, while the shape of the Woodehorn is scientific in principle and graceful in design.

The Woodehorn is neat in appearance and convenient in size. The height of the instrument is 26 inches, and the diameter of the bell is ten inches. It is not surprising, in view of all the features and advantages of the Woodehorn that it has been a success ever since its recent introduction, so that now it is one of the fastest selling horns in the market.

SEABOARD

SPECIAL VALUES OF
23 Plate Variable Condensers.
Radio top and bottom plates.

Wholesale prices.
In quantities of 100.....\$1.25 each
200.....1.15 "
500.....1.10 "

Packed in handsome individual labelled boxes.
Jobbers and Distributors
Write for Our Proposition

SEABOARD RADIO CORPORATION
266 GRAND STREET, NEW YORK CITY
Phone Orchard 9156

CONQUEROR

CUSTOM-BUILT **\$115.00**
ONE KNOB CONTROL

RADIO
RECEIVING SET

WRITE FOR OUR DISCOUNT ARRANGEMENT

LEWIS & DeROY RADIO CORP.
560 Seventh Ave., New York City

Dealers and Jobbers ask for our
MERCHANDISING PLAN

TITAN-O-TONE RADIO PARTS AND SETS

Manufactured by
T-F RADIOPHONE CO.
667 Coney Island Ave. Brooklyn, N. Y.

Ask Our Service Bureau

SIMPLEX PANEL UNITS

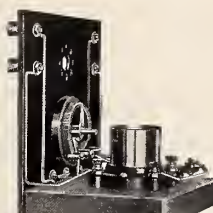

No. 47490
Simplex Detector Panel
Side View

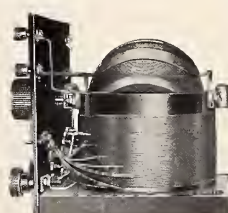

No. 47499
Simplex Vario-Coupler
Showing Side View of
Panel Mounting

Simplex Panel Units permit trying out many different hook-ups and thus determining the best for a certain locality without having to disassemble a complete outfit. This is a decided advantage, but of no less interest is the fact that the beginner can first purchase one Vario-Coupler Panel and one Detector Panel and have a good receiving set at minimum cost with the advantage of later adding additional units to obtain greater sensitiveness and selectivity. Thus a Simplex outfit is unquestionably one of the most attractive and efficient receiving sets now offered to the public.

A very attractive line for Jobbers and Dealers. Simplex Material is high grade in every respect. Write for new circular today.

ELECTRIC SERVICE SUPPLIES CO.

17th and Cambria Streets, Philadelphia, Pa.
Manufacturers of Lightning Arresters for 30 years. Distributors for SIMPLEX RADIO CO.

Where to Buy

A Handy Guide For the Convenience of Our Readers

"A" BATTERIES		CABINETS		DETECTORS	
Manhattan Storage Battery Co., Inc.	50	Andrew, Curtis N.	49	Star Mfg. Co.	63
ACCOUNTANTS		E. Eshoo Cabinet Works	52	Mydar Radio Co.	43
Henry L. Seidman & Co.	18	Marvin B. Fallgatter	64	New York Radio Dial Co.	54
AMPLIFIER UNITS		Miho Co., The	54	Tait Knob & Dial Co.	4
Arrow Radio Co.	46	COIL MOUNTINGS		DISTRIBUTORS	
Magna Instrument Co.	59	Astorloid Mfg. Co.	62	Andrae & Sons Co., Julius	54
ANTENNA WIRE		Crown Radio Mfg. Corp.	41	Central States Engineering Co.	67
Copper Clad Steel Co.	50	COMPLETE LINE		Ell-Ess Radio Exchange	51
BATTERY CHARGERS		American Radio & Electric Co.	79	Goetz Co., The Edw. J.	60
The Automatic Elec. Devices Co.	8	Adams-Morgan Co.	11	Hudson-Ross	64
BATTERY TESTERS		Briggs & Stratton Co.	21	Hommell, Ludwig	9
Hafner Mfg. Co.	74	Clapp-Eastham Co.	83	Invincible Products Co.	78
"B" BATTERIES		Gilbert Co., A. C.	66	Kramer Radio Co.	60
French Battery & Carbon Co.	46	New York Coil Co.	5	North Ward Radio Co.	63
Gould Storage Battery Co.	50	Pruden, Frederick H., Inc.	17	Radio Distributing Co.	Back Cover
Novo Mfg. Co.	52	Signal Radio & Elec. Corp.	12	Radio Shop of Newark, The	64
BATTERIES		COMPOSITION		Radio Stores Corporation	66
Carbon Products Co.	42	Nuloid Corp.	60	Schwab, Harold M.	14
Manhattan Electric Supply Co.	Inside Front Cover	CONDENSERS		Virginia Radio Corp.	69
BATTERY TESTERS		Bayley Condenser Co.	67	Wilmington Electrical Specialty Co., Inc.	69
Chaslyn Co.	54	European Radio Co.	71	Wholesale Radio Equipment Co.	Front Cover
BESTONE PRODUCTS		Freshman Co., Charles	70	ELECTROTYPERS	
Henry Hyman & Co., Inc.	13	Spiro Bros.	67	Central Electrotype Foundry Co.	60
BINDING POSTS		CRYSTALS		ENGRAVING	
The H. H. Eby Mfg. Co.	73	Foote Mineral Co.	54	Paramount Machine Co.	66
King Sewing Machine Co.	22	Galena Crystal Mfg. Co.	50	EXPOSITIONS	
McKenna Brass & Mfg. Co.	78	Gibbons-Dustin Radio Mfg. Co.	66	Permanent Radio Fair	61
BUS WIRE		Harris Laboratory	46	HEAD SETS	
White Radio Co.	79	M. P. M. Sales Co.	57	Premier Accessory & Specialty Co.	58
BOOKS		Radio Apparatus Co. (Pittsburgh)	64	Royal Electric Laboratories	47
Allied Engineering Institute	15	Rusonite Products Corp.	66	True Tone Radio Mfg. Co.	71
Central States Engineering Co.	67	Standard Crystal Co.	67	INSULATION	
CABINET SETS		CRYSTAL DETECTORS		National Fibre & Insulation Co.	40
Heinemann Electric Co.	53	Culin, Curtis C.	60	Saturn Mfg. & Sales Co., Inc.	65
Oranola Radio Corporation	13	M. P. M. Sales Co.	57	JOBBER'S WANTED	
AMPLIFIER UNITS		Randel Wireless Co.	63	Arrow Radio Co.	54
ACCOUNTANTS		CRYSTAL RECEIVERS		KODE KILLER	
ANTENNA WIRE		Holloway Elec. Supply Co., Inc.	64	Radio Mica Products Co.	42
BATTERY CHARGERS		CRYSTAL SETTING		LOOP AERIALS	
BATTERY TESTERS		Culin, Curtis C.	60	Eagle Radio Co.	44
"B" BATTERIES		CUSTOM BUILT SETS		V-De-Co.	46
BATTERIES		Lewis & De Roy	89		

SEE ALPHABETICAL INDEX OF ADVERTISERS ON PAGE 88

Where to Buy

A Handy Guide for the Convenience of Our Readers

LOUD SPEAKERS

Bristol Co., The.....	10
Inter-Ocean Radio Corp.....	59, 85
Fiber Products Co.....	92
Magnavox Co., The.....	37
Pathe Phonograph & Radio Corp..	8
Planet Radio Corp.....	79
Standard Metal Mfg. Co.....	45
States Electric Co.....	79

MAILING LISTS

Ross-Gould Co.	54, 83
Trade Circular Addressing Co.....	52

MERCHANDISE WANTED

Jackson, P. D.	60
R.-C. Outlet, The.....	50

MICA

Mica Insulator Co.....	14
------------------------	----

MICA DIAPHRAGMS

Radio Mica Products Co.....	
Inside Back Cover	

PANEL UNITS

Electric Service Supplies Co.....	89
-----------------------------------	----

PANELS

American Hard Rubber Co.....	66
Continental Fibre Co., The.....	69
New York Hard Rubber Turning Co.	60
Pittsburgh Radio & Appliance Co..	50
Poster & Co.....	48

PATENTS

Kern, Emil Alexander.....	60
Manufacturers Patent Co.....	60
Owen, Richard B.....	86
Wilson, Inc., A. M.....	60
Zwingenberger, Otto K.....	60

PHONES

T-B-H Corporation	52
True-Tone Radio Mfg. Co.....	98

PHONOGRAPH ATTACHMENTS

McKenzie Engineering Co.....	62
------------------------------	----

PHONE PLUGS

S. S. Novelty Co.....	62
-----------------------	----

RADIO RELAYS

Finch Radio Mfg. Co.....	52
--------------------------	----

RADIO TOWERS

Milliken Bros. Mfg. Co., Inc.....	72
-----------------------------------	----

RECEIVING SETS

Aerex Radiophone Corp.....	70
Arrow Radio Co.....	50
Atwater Kent Mfg. Co.....	39
Betts & Betts.....	57
Crosley Mfg. Co.....	7
E-D Mfg. Co., The.....	6
Federal Tel. & Tel. Co.....	86
Jewett Mfg. Co.....	87
Lewis & DeRoy.....	83
Mercury Radio Products Co.....	48
Moon Radio Corp.....	10
Mu-Rad Laboratories, Inc.....	51
Q. T. Light Co.....	84
Radio Apparatus Co. (Detroit)....	65
Radio Outfitting Corp.....	60
Save Sales Co.....	24
Superior Products Mfg. Co.....	70
T. F. Radiophone Co.....	89
United Specialties Co., Inc.....	56
Victor Radio Corp.....	66
W. E. Supply & Service Corp.....	60
Winkler, Inc., Chas.....	60

RHEOSTATS

Allen-Bradley Co.	49
King Sewing Machine Co.....	4
Parkin Mfg. Co.....	68
Radiola Wireless Corp.....	60
Staff Co., Louis A.....	66
Thresher Radio Corp.....	66
Wilcox Laboratories, The.....	78

SOCKET ADAPTER

Steinmetz Wireless Mfg. Co.....	52
---------------------------------	----

SOCKET RHEOSTAT

Ajax Radio Corp.....	48
----------------------	----

SOCKETS

Alden-Napier Co.	86
Bruno Radio Corp.....	73
Commercial Screw Machine Co....	18
Franklin Radio Mfg. Co.....	70

SOLDERING IRON

Post Electric Co.....	71
-----------------------	----

SPAGHETTI TUBING

Mica Insulator Co.....	14
Mitchell-Rand Mfg. Co.....	60

STOCK BROKERS

Stanton & Co., Frank T.....	64
-----------------------------	----

TESTING LABORATORIES

Gregg & Co.....	79
N. Y. Testing Laboratories.....	47

TOWERS

Milliken Bros. Mfg. Co., Inc.....	72
-----------------------------------	----

TRADE MARKS

Carter, Chauncey P.....	73
-------------------------	----

TRADE ASSOCIATIONS

Radio Trade Association.....	81
------------------------------	----

TRANSFORMERS

Amplex Instrument Labs.....	92
Boone Mfg. Co., J. T.....	53
Ford Mica Co.....	12
Marle Engineering Co.....	55
Radio Center	86
Rauland Mfg. Co.....	68
Thornton Transformer Co.....	64

VARIABLE CONDENSERS

Bayley Condenser Co.....	72
Diamant Tools & Mfg. Co.....	64
Seaboard Radio Corp.....	89
Standard Appliance Mfg. Corp.....	52
United Mfg. & Dist. Co.....	55
Universal Stamping & Mfg. Co.....	68

VARIO-COUPERS

Essex Mfg. Co.....	54
General Merchandise Co.....	44
Jewell Radio Sales Co.....	83
Shamrock Radio Co.....	52

VARIOMETERS

Eisemann Magneto Corp.....	16
Radio Products Mfg. Co.....	61

VARIO WAVE TUNER

Fischer & Co., G. H.....	48
--------------------------	----

VERNIER CONDENSERS

Bremer-Tully Radio Co.....	67
Cozzone, John & Co.....	6
Electric Products Co.....	60
Hammarlund Mfg. Co., Inc.....	66

VERNIER RHEOSTATS

Viking Radio Co.....	62
----------------------	----

VOLTMETERS

Weston Elect. Instrument Co.....	56
----------------------------------	----

SEE ALPHABETICAL INDEX OF ADVERTISERS ON PAGE 88

The FIBER HORN



Eventually Replaces all other Radio Horns

BECAUSE—It is a scientific development which produces only true mellow tones. The shape of the horns gives the fullest amplification without blast, countervibration or other distortion. The volume of sound is accordingly larger and far more clear than ordinarily.

INDESTRUCTIBLE—Will not crack, chip or dent.

SEAMLESS—No unsightly glued joints or rivets to loosen.

FINISH—Black crystalline.

TWO SIZES—No. 1, 10" Bell, 23" High.
No. 2, 14" Bell, 28" High.

MANUFACTURERS of the leading loud speakers use our horns. They put a loud speaker at its very best. Quality of workmanship and material is evident in every detail.

Write Today for Price List and Full Particulars

FIBER PRODUCTS CO.

Bloomfield Avenue and No. 10th Street

Branch Brook 4978

NEWARK, N. J.



MANUFACTURERS:
HORNS BUILT
ACCORDING TO
YOUR OWN
DESIGN

W-D-12 AMPLIFIER TRANSFORMER

Especially Designed for Use with W-D-11 Tubes

W-D-11 Tubes require specially constructed transformers for the best results.

W-D-12 Transformer makes the volt and a half tube "speak up" like a 6-volt tube.

**MAXIMUM AMPLIFICATION
NO DISTORTION**

Used and recommended by leading manufacturers
Just what the fan wants

List Price, \$5.00

Write for our special introductory offer

AMPLEX INSTRUMENT LABORATORIES

57 Dey Street, New York

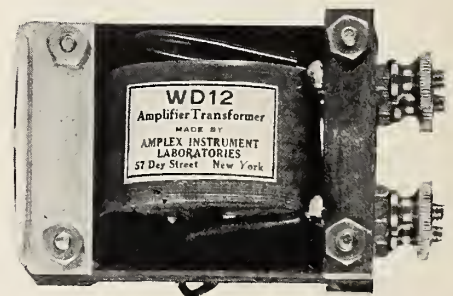

The heart of all radio

**THE RECEIVER
DIAPHRAGM**



Why do all good phonographs use mica diaphragms ?

Because mica is the only material
known which reproduces sound with
true tone and without distortion

Mica Diaphragms are even more essential in radio head-sets

DEALERS: Send for free samples

We make only mica diaphragms to replace the old style metal discs in any standard head phones and loud speakers

IMMEDIATE DELIVERIES

Radio Mica Products Company

156 East 43rd Street, New York City

SOLE MANUFACTURERS

Distributors
Exclusive territory
now open



Appreciation

We wish to express to you our appreciation of the business entrusted to us during the past year.

It is our firm belief that a business can not last long unless it benefits the customers who make money for it as much as it benefits the proprietors who make money by it.

The new year finds us better equipped and more efficient than the year before and we assure you that our best efforts will be extended to give every radio dealer the kind of service he may justly expect.

RADIO DISTRIBUTING COMPANY
8 West Park Street Newark, N. J.
A. H. CORWIN, General Manager

RADISCO

The RADIO DEALER

Vol. 2 No. 5 FEBRUARY, 1923 One Dollar The Year

Published monthly at 1133 Broadway, New York, N. Y., by The Radio Dealer Company. Entered as Second Class Matter, at the Post Office at New York, N. Y., under the Act of March 3, 1879

The AUDIOPHONE Jr.
Loud Speaker



BRISTOL'S ONE STAGE
POWER AMPLIFIER



The AUDIOPHONE Sr.
Loud Speaker

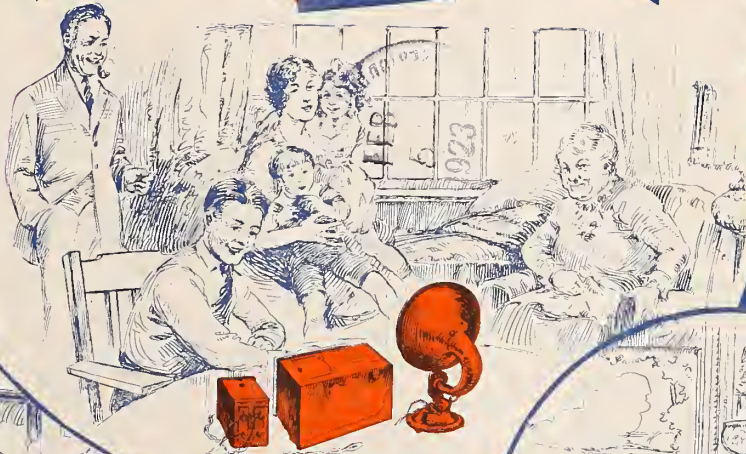

AT HOME

ALL
LISTEN IN

BRISTOL'S AUDIOPHONE LOUD SPEAKER

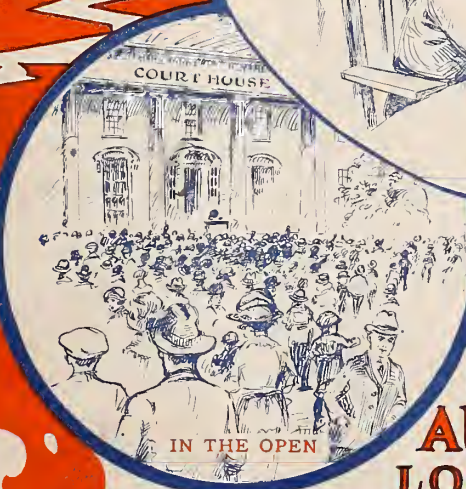

IN THE OPEN



AT THEATER

Wonderful results in Radio-Phone Receiving are secured by the complete Loud Speaker combination unit, including Bristol AUDIOPHONE Loud Speaker and Bristol One Stage Power Amplifier. The AUDIOPHONE gives a large volume of tone sufficient to be heard by everyone in a room seating several hundred persons. The quality is round and full, entirely free from mechanical distortion, and faithfully reproduces the original broadcasting. No Auxiliary Batteries are required to operate.

Constructed on a new principle of Audio Frequency, the Bristol One Stage Power Amplifier uses a circuit which does not require a C battery to maintain the grid

negative. So designed and constructed that no distortion of tone quality can be detected.

This equipment is designed and manufactured by The Bristol Company, an established engineering firm for over 30 years; and internationally known for their Recording Electrical Instruments and other power plant instruments of precision.

AUDIOPHONE, SR., Loud Speaker.....List \$40.00
AUDIOPHONE, JR., Loud Speaker.....List 22.50
Bristol ONE STAGE POWER AMPLIFIER.....List 25.00

Write for Bulletins and Trade Discounts

THE BRISTOL COMPANY

WATERBURY, CONN.



NEW!

The RED SEAL Radio Sparker

for operating WD-11 Tubes

A Special Dry Battery that lasts nearly 3 times longer

THE introduction of the Red Seal Radio Sparker a month ago proved a sensation, both in the trade and to the public.

The Radio Sparker is a special battery designed for operating the WD-11 dry battery tube. It is composed of special cells intended for radio work. Radio Sparkers will give longer service and better satisfaction operating WD-11 vacuum tubes than a single dry cell. For instance, a two-cell Radio Sparker operating one WD-11 tube will last, not twice as long, but nearly three times as long as a single cell.

The Red Seal Radio Sparker is a light weight, complete unit. The internal connections between cells are soldered thus increasing their efficiency.

The Radio Sparker is distinguished by a new label of striking design and brilliant color. The reverse side of this label contains simple diagrams and instructions showing the proper method of connecting Radio Sparkers to receiving sets.

Everyone wants to use this new convenient method of operating tube receiving sets. Phone, write or wire your jobber for an assortment of Red Seal Radio Sparkers now. Every day's delay means lost sales.

The New Manhattan Genuine Bakelite Variocoupler, Variometer and Dials

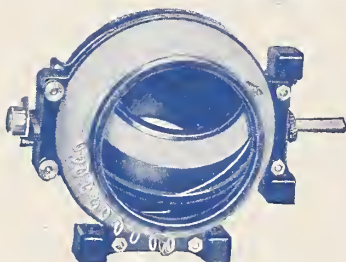

Manhattan Variocoupler

The primary winding is provided with 12 taps—giving complete control up to a wave length of 700 meters. (List price \$6.50.)

"pigtales," making connection with the rotating member. This insures positive contact and quiet operation. Sufficient friction is provided to permit easy turning of the rotor and just sufficient binding to have it stay put in the position desired. A strong stop limits its movement to 180 degrees.

The stator of both the Variocoupler and Variometer is provided with a 1/4-inch collar, permitting the attachment of a standard 3-inch bakelite tube for constructing the

BOTH the Variocoupler and the Variometer are made of moulded, genuine reddish brown bakelite and have that fine attention to detail so much sought after by the critical buyer.

The amount of metal used in the instrument has been reduced to a minimum to keep the electrical losses as low as possible. Variocouplers and variometers are frequently mounted on "shielded" panels. Realizing this fact, we have provided a bakelite mounting block permitting the use of the variocoupler and variometer on a metal panel, thus eliminating all insulation difficulties. These are two distinctive features of Manhattan Variocouplers and Variometers.

Both instruments are provided with heavy braided

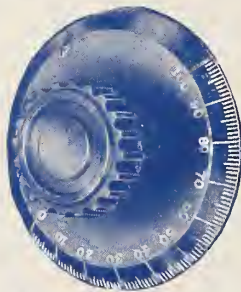

Manhattan Bakelite Dial

familiar "long wave" coupler. The demand for these new Manhattan instruments is piling up fast. Your order should be sent your jobber at once to avoid delay.



Manhattan Variometer

As commonly connected in a receiving set has a wave length of 140 to 420 meters. (List price \$6.50.)

MANHATTAN BAKELITE DIALS

The Manhattan line of genuine non-warping bakelite dials will appeal to those who desire precision and quality. The brass bushings for the shaft are accurately centered and insure perfect alignment. The engraving on the dials is extremely fine and clear. Manhattan Bakelite dials are made in 2", 3" 4" diameters for both 3/16" and 1/4" shafts and list at 60c, 75c and \$1.25 respectively.

M

MANHATTAN

ELECTRICAL SUPPLY Co. INC.

Makers of the famous Red Seal Dry Batteries, Radio Sparkers and Manhattan Radio Products

New York

Chicago

St. Louis

San Francisco

CONDENSITE CELORON

STANDARD RADIO PANEL



Put your panel troubles behind you

DO you cut your radio panels yourself? Or do you have them cut to your order?

In either case you are wasting time and energy and testing the patience of your customers. Save the delay, extra cost and trouble of having radio panels cut according to many different needs by selling Celoron Radio Panels cut in standard sizes, ready for immediate sale.

Each panel is a separate article, wrapped in glassine paper to protect the surface. On every one are size, number, and full instructions for working and finishing. You carry an article that is easily merchandised, has quick turnover, and admits of substantial profit.

Stock these Celoron panels before the height of the radio season passes. Let your customers know you carry them. When they buy, show them how to make their templates and drill their boards. Then sell them the other parts for a complete set.

Celoron is a leader among radio

insulations. It is easily worked, machine drilled and tapped and will engrave evenly without feathering. It has high insulation resistance, high dielectric strength, and low dielectric losses. These qualities have gained for it the approval of the U. S. Navy Department Bureau of Engineering and the U. S. Signal Corps.

You can obtain these panels in the following sizes, which have been selected because they meet practically every need of the radio set-builder.

- | | |
|------------------|-------------------|
| 1.—6 x 7 x 1/8 | 5.—9 x 14 x 3/16 |
| 2.—7 x 9 x 1/8 | 6.—7 x 21 x 3/16 |
| 3.—7 x 12 x 1/8 | 7.—12 x 14 x 3/16 |
| 4.—7 x 18 x 3/16 | 8.—7 x 46 x 3/16* |

* This strip for cutting special sizes. Not wrapped in glassine.

For your convenience we have made up two assortments of panels after a careful study of dealer requirements, and can ship them through your jobber immediately.

Put your radio panel troubles behind you. Send in your order today, designating by number the sizes you want. We will also be glad to send you on request, dealer helps in the shape of display cards and window strips for your store.

Diamond State Fibre Company

BRIDGEPORT (near Philadelphia) PENNSYLVANIA

BRANCH FACTORIES AND WAREHOUSES

BOSTON CHICAGO SAN FRANCISCO

Offices in Principal Cities

In Canada: Diamond State Fibre Company of Canada, Limited
245 Carlaw Avenue, Toronto

ATWATER KENT

Radio Receiving Sets and Parts

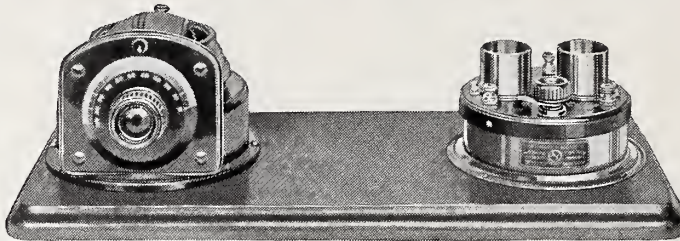

Complete Receiving Set—Coupled Circuit Tuner and Detector 1-stage Amplifier
A similar set is furnished with Detector 2-stage Amplifier

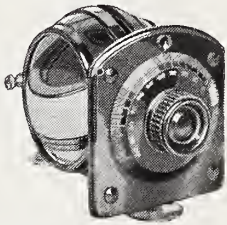

Mounted Variometer

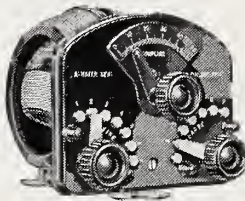

Mounted Variocoupler

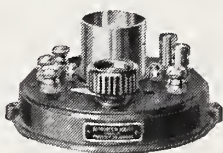

Detector Unit

ATWATER KENT products sell on appearance; they stay sold on quality of performance.

This is the reason for the popularity of ATWATER KENT Radio Equipment.

Look over the illustrations. They show a portion of the line, which includes complete sets, as well as parts from which the radio fan may build his own receiver.

There are various sets all mounted on mahogany bases and wired ready to attach to antenna and battery. No bothering with hook-up.

Use a set as YOUR demonstrator

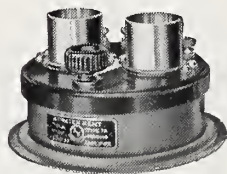

Detector 1-stage Amplifier
A similar unit is furnished in a 2-stage Amplifier



Detector 2-stage Amplifier



Standard Tube Socket



1/2-Volt Tube Socket

ATWATER KENT MANUFACTURING COMPANY, PHILADELPHIA, PA.

Radio Department

4941 STENTON AVE.

Write for Literature

ATWATER KENT

Radio Receiving Sets and Parts

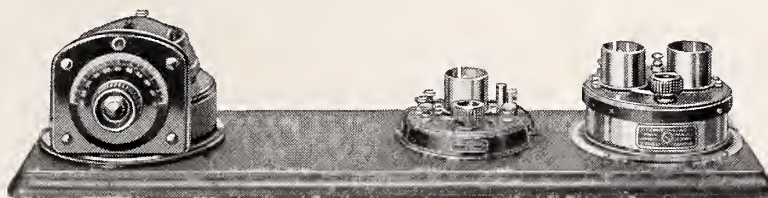

Complete Receiving Set—Coupled Circuit Tuner, Detector Unit and 2-stage Amplifier
This Set is also furnished without Amplifier

THESE sets are attractive enough in appearance to be installed in the most "exclusive" home or club; moderate enough in price to be within reach of anyone; and excellent enough in operating qualities to satisfy the most particular.

For the fan who wants to experiment with varying hook-ups there are parts which will meet every requirement.

ATWATER KENT Radio Sets and Units sell readily and are a very profitable line.

They're always SEEN in the show windows

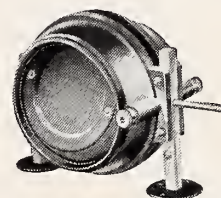

Unmounted Variometer

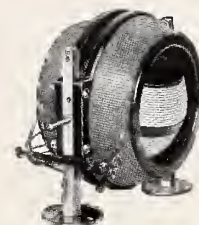

Unmounted Variocoupler



Condensite Dials
in 50 or 100 pt. graduations
for $\frac{3}{16}$ " or $\frac{1}{4}$ " shafts



Type L Transformer A.F.

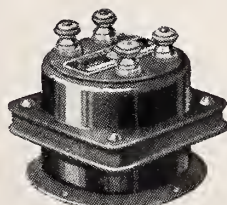

Transformer A.F.

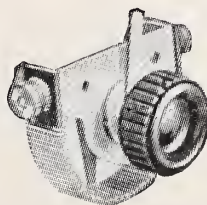

Panel Rheostat

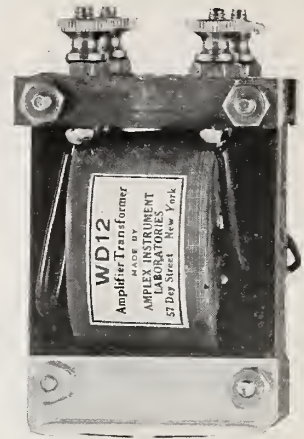

Table Rheostat

ATWATER KENT MANUFACTURING COMPANY, PHILADELPHIA, PA.
Radio Department 4941 STENTON AVE. Write for literature

“WD 12”

The Only AMPLIFIER TRANSFORMER Especially Designed for Use With WD 11 TUBES



Over 200,000 WD 11 tubes sold within the past two months and “WD 12” the ONLY transformer especially designed for their use

“WD 12” makes the volt and one-half set “Speak Up” like a 6 volt set

List Price, \$5.00

Endorsed by engineers and thousands of fans. Used and recommended by leading manufacturers
Send for our special introductory offer

AMPLEX INSTRUMENT LABORATORIES, 57 Dey St., New York, N.Y

Self Deception Is The Worst Deception

Are you fooling yourself?

Do you know that you can make a better product at less cost?

Do you know how your product ranks by comparison with American standards of simplicity, efficiency and cost?

Do you know that the facts regarding your product can be impartially and authoritatively determined?

GREGG and COMPANY, through their Radio Testing Laboratory, which has no connection with any manufacturing enterprise, can enable you to answer these questions to your satisfaction.

GREGG and COMPANY

165 Broadway

New York

Newark, N. J. Washington, D. C. St. Louis, Mo. Los Angeles, Cal. Mexico City, Mexico

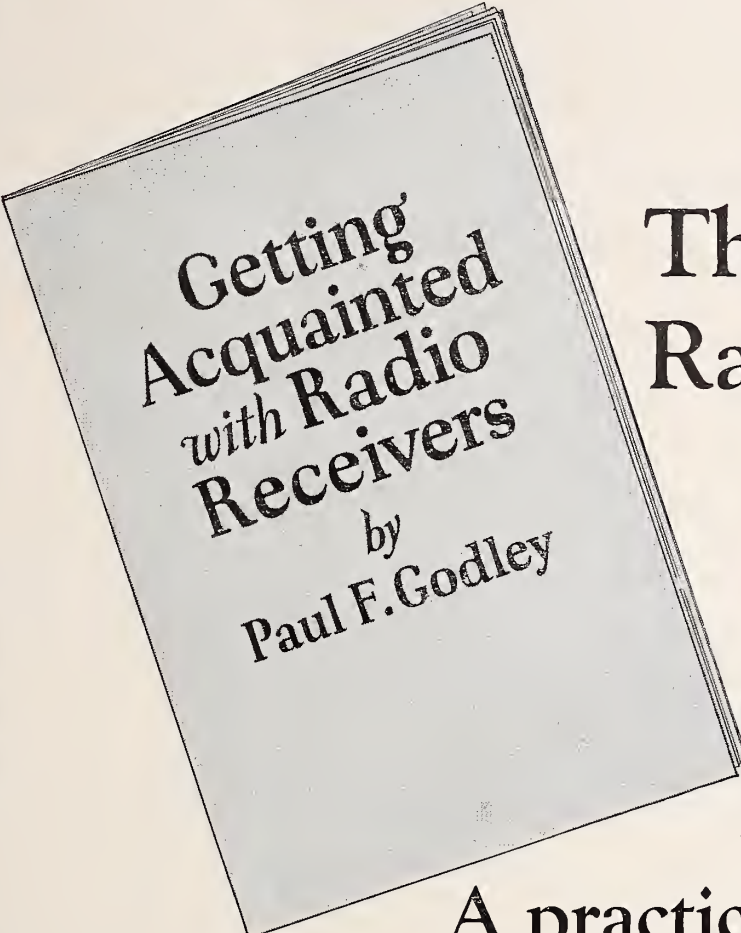

Getting
Acquainted
with Radio
Receivers
by
Paul F. Godley

This Booklet on Radio Receivers Free to Dealers

A practical help in giving
the service that means more sales

PAUL F. GODLEY has written a booklet on radio receivers that every dealer who wants to give good service should send for at once. In simple, non-technical language it describes radio receivers, their functions, installation, operation and maintenance.

Everything is clearly explained with illustrations, circuit diagrams, plans for antennae, lay-out of apparatus, etc. It gives a *complete* and *correct* answer for every question a purchaser of a receiver is likely to ask.

Among the points covered are the following:

The Functions of a Radio Receiver

- Tuning Regenerative Receivers
- Why the "Tuner" Tunes
- What the Vacuum Tube Does
- The Vacuum Tube as an Amplifier

Installation

- Types of Antennae
- Ground Connections
- Lightning Protection

- Locating the Receiver
- "A" Battery and Its Care
- "B" Battery and Its Selection
- Loud Speakers

Operation

- Adjusting the Vacuum Tubes
- Testing the Circuits
- Adapting the Receiver to the Antenna
- Wave Length Calibration

Maintenance and Tests for Faults

The Adams-Morgan Company believes that this booklet will prove of such great practical value to enterprising radio dealers who *want* to give service that it has arranged for a special edition to be supplied *free* to the trade. So long as this edition lasts a complimentary copy will be sent to any radio dealer on request. To the general public the price will be 25 cents a copy. As the special edition is for dealers only and limited in number, we suggest that you write promptly on your business letterhead.

ADAMS-MORGAN COMPANY, 12 Alvin Avenue, Upper Montclair, N. J.

FEBRUARY SPECIAL

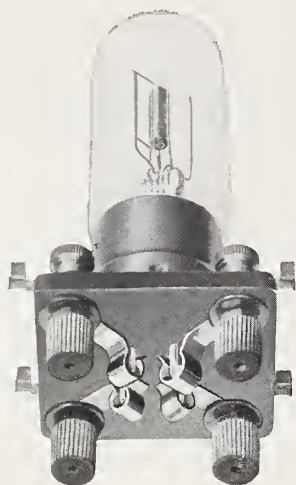

Every Dealer Can Profit By Selling the
Horton W D 11 Socket

The Only Socket With The
Bull Dog Grip Double Contact

Guaranteed Efficient

Sold To The Trade In Lots Of 50 Or More At

35 cents net

Retail Price, One Dollar

HAROLD M. SCHWAB, Inc.
419 West 42nd Street New York

"Headquarters For Radio Bargains"

*Write for
Weekly
Special List*

BRU PRODUCTS ELIMINATE STORAGE BATTERIES

BRU No. 6

Two Stage Amplifier
operates with *ANY*
detector unit—Crystal
or Tube. Very compact
List - - \$30.00

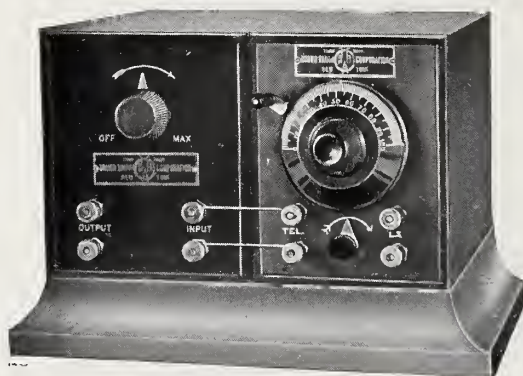

BRU No. 8

Tuner and Detector
permits sharp tuning.
Normal wave length,
200 to 550 meters:
List - - \$25.00

BRU No. 10
DETECTOR AND
TWO STAGE AMPLIFIER WITH
SUB-BASE.

List, \$65.00

The most compact receiving set
made. All batteries necessary are
concealed in sub-base.

Only two controls.
Will operate
good Loud Speaker
without distortion.

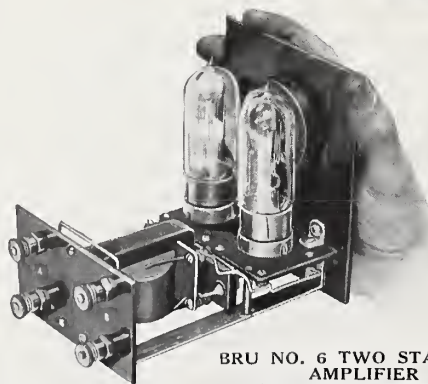

BRU NO. 6 TWO STAGE
AMPLIFIER
(cabinet not shown)

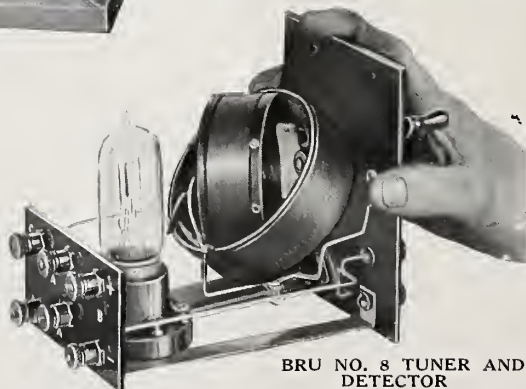

BRU NO. 8 TUNER AND
DETECTOR
(cabinet not shown)

BRUNO RADIO CORPORATION, 152 W. 14th St., New York, N. Y.

Wide Range Proves Crosley Efficiency

Sebring ~
Florida
Hears
Honolulu ~
Hawaii

HONOLULU

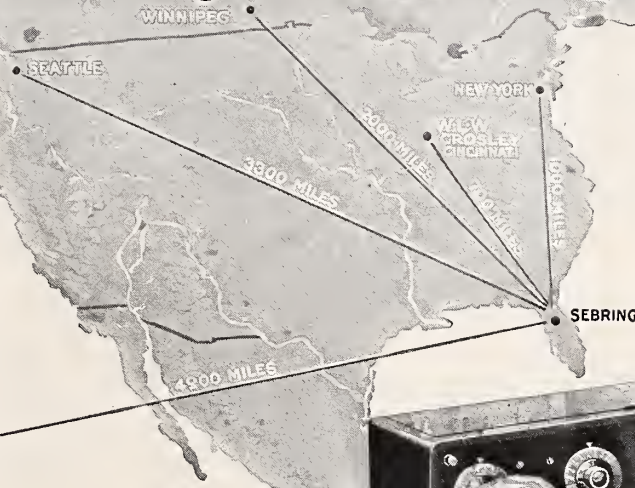

Every day there comes to us unsolicited new evidence of the remarkable results achieved with various models of Crosley Radio Receiving Sets.

Sebring, Fla., using a Model X Crosley Receiver — price only \$55 for this four-tube set — “Clearly hears three selections and two announcements from KDYX at Honolulu, 4,900 miles away.”

Centerburg, Ohio, receives 1,920 miles from Los Angeles, Calif.; 950 miles from Fort Worth, Tex.; 1,200 miles from Havana, Cuba; and 750 miles from South Dartmouth, Mass. A Crosley Model VI, a two-tube set that costs but \$28, was used.

With a Crosley Harko Senior, \$20 — a man from Rock Valley, Iowa, had these very satisfactory results: “I have tested out the Harko Senior and am ready to agree that you made no overstatements. We have heard Winnipeg, Canada; Dallas, Tex.; and many other points.”

Wide-awake radio dealers everywhere are making large profits handling the Crosley line.

They know that every Crosley Model does everything claimed for it — and more besides. They have found by experience that they are building a clientele of satisfied customers by pushing Crosley instruments.

From our smallest complete receiving outfit at \$25, including other sets incorporating Crosley radio frequency tuned amplification at \$28, \$48, \$55, and up to our beautiful Console Model XXV, price \$150, Crosley instruments offer the highest efficiency at the lowest cost.

We also manufacture a complete line of parts for those who wish to make their own outfit. Among these are Variable Condensers, Knobs and Dials, V-T Sockets, Variometers, Vario-Couplers, Rheostats and the well-known Crosley Radio Frequency Amplifying Tuner.

Write for Complete Catalog

CROSLEY
Better — Cost Less
RADIO RECEIVERS

CROSLEY MANUFACTURING COMPANY
232 ALFRED STREET CINCINNATI, OHIO

The Three Most Popular Receivers on the Market

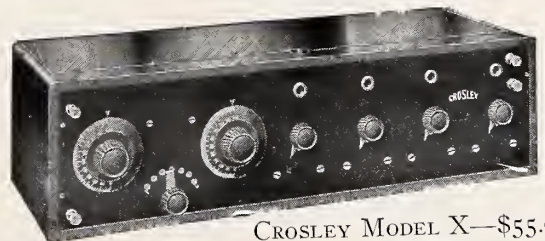

CROSLEY MODEL X—\$55.00

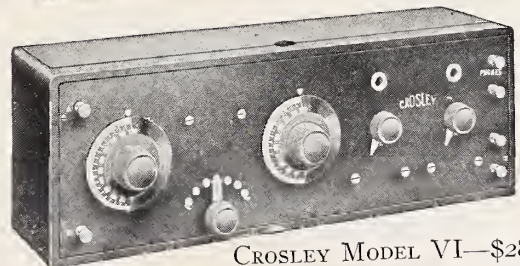

CROSLEY MODEL VI—\$28.00

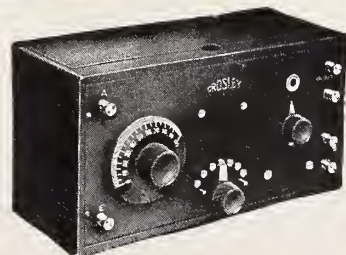

The Crosley Harko Senior, a one-tube non-regenerative receiver, of which thousands have been sold — retail price, \$14, \$15 and \$16. Similar instruments, but using Armstrong Regenerative Circuit, manufactured under license under Armstrong Patent No. 1,113,149, dated October 6, 1914, can be obtained from the manufacturers, The Precision Equipment Co., Powel Cresley, Jr., Pres., Cincinnati, Ohio. Write them direct.



KING QUALITY SWITCH LEVER

With perfect mechanical and electrical features. Mirror finish. Bakelite knob with polished knurl that glows like a diamond. 3 sizes: 1 in., 1 1/4 in., 1 1/2 in.



KING QUALITY
ALL THE NAME IMPLIES
RADIO APPARATUS

R-74 R-73 R-75 R-70
R-72 R-71
R-790 R-791 R-792 R-793 R-794 R-795 R-796 R-797 R-798 R-810

AN attractive dealer "help" —counter "help" play showing King Quality Binding Posts and Contact Points. Furnish on request — write for details.



KING QUALITY VACUUM TUBE SOCKET

Base of black or mahogany finished genuine moulded Bakelite with mirror finish; tube and terminal binding posts of brass nickel plated and highly polished.



KING QUALITY "UNIVERSAL" ADAPTER.
R-10 designed to fit all tubes and valves.

NOT our claim of quality alone, but the opinions of some of the largest radio jobbers in the country are responsible for the widespread acceptance of the King Quality Line as the "best on the market." King Quality Radio parts look good, they sell better, but finally they prove Best in operation.

Have YOU stocked this fast-selling quality line? Write for catalog and prices—or send for samples to convince yourself.

RADIO APPARATUS DIVISION
King Sewing Machine Co. Buffalo, N. Y.
Lower in Price—Highest in Quality

Every Dealer

Every Manufacturer

Every Jobber

in

THE RADIO TRADE

Should be a member of

The Radio Trade Association

Full details may be obtained at headquarters

The Radio Trade Association

1133 Broadway, New York City

Officers and Directors are:

Henry M. Shaw, Shaw Insulator Company, Newark, N. J., president.

Hugh H. Eby, H. H. Eby Company, Philadelphia, Penna., treasurer.

Laurence A. Nixon, The Radio Dealer, New York City, secretary.

W. B. Curtis, Curtis Sales Company, Newark, N. J., first vice-president.

Laurence I. Mott, San Francisco, Calif., second vice-president.

R. P. Clarkson, Radio Mica Products Company, New York City, third vice-president.

Raymond Francis Yates, Permanent Radio Fair, New York City, fourth vice-president.

Chauncey P. Carter, trade mark attorney, Washington, D. C., fifth vice-president.

W. L. Sayre, Sayre Level Company, Philadelphia, Pa., sixth vice-president.

The Board of Directors is composed of the following:

Paul F. Johnson, Altadena Radio Laboratory, Pasadena, Calif.

Arthur Halloran, publisher, Radio, San Francisco, Calif.

J. H. Smith, Virginia Radio Company, Charlottesville, Va.

Wm. A. Debold, Oklahoma City Radio Company, Oklahoma City, Okla.

Bert B. Barsook, jobber, Chicago, Ill.

Powell Crosley, Jr., Crosley Manufacturing Company, Cincinnati, Ohio.

F. Clifford Estes, The Clapp-Eastham Co., Cambridge, Mass.

F. D. Pitts, F. D. Pitts Company, Boston, Mass.

Harold M. Schwab, Harold M. Schwab, Inc., New York City.

M. B. Sleeper, Jr., Sleeper Radio Corp., New York City.

W. M. Kunkel, Pittsburgh Radio & Appliance Company, Pittsburgh, Pa.

C. H. Love, L. F. Grammes & Sons, Allentown, Pa.

F. H. Pruden, F. H. Pruden Co., Jersey City, N. J.

Mortimer Salzman, Wholesale Radio Equipment Co., Newark, N. J.



THE RADIO DEALER—A MERCHANT

THE business of the Dealer in Radio parts is to sell merchandise. He should not be called upon to act as a consulting engineer to buyers of Radio parts who are building their own sets.

Every responsible Dealer is quite willing to advise his customers in the selection of units which will give satisfaction. His function should end there. "Giving service" does not mean that his time should be consumed in going into the details of lay-out and wiring.

Dealers have learned that radio parts of unquestioned merit do not give satisfaction unless properly applied. The correct physical location of units, in their relation one to the other and proper wiring are essential in order that good results may be obtained. The numerous requests to exchange parts, which every Dealer receives, emphasizes this fact.

We believe the parts and panels, which we are now offering, solve many of the Dealer's problems.

All parts are of advanced design. There is no tap switch to be mounted, as an internal switch is provided in the variocoupler. Binding posts, properly located, are placed on each unit. The necessity for complicated wiring and cross-leads is eliminated.

Aluminum panels in four stock sizes make unnecessary all drilling of holes and use of shielding. Proper spacing of units is assured. Uniform size openings in panels permit mounting of all parts interchangeably.

DESCRIPTIVE FOLDERS ON REQUEST

EISEMANN MAGNETO CORPORATION

WILLIAM N. SHAW, *President*

DETROIT

BROOKLYN

CHICAGO

First In The Field

The Radio Dealer (monthly edition) leads the field of Radio publications *because it has the circulation.*

The following analysis is of PAID Circulation, note printer's statement of press run.

Circulation By States THE RADIO DEALER

Alabama.....	21	East Orange.....	10
Arizona.....	11	Elizabeth.....	17
Arkansas.....	5	Jersey City.....	44
California.....	286	Newark.....	191
Los Angeles.....	34	Paterson.....	19
Oakland.....	13	Trenton.....	27
San Francisco.....	67	New Mexico.....	2
Colorado.....	28	New York.....	1094
Denver.....	14	N. Y. City.....	710
Connecticut.....	185	Brooklyn.....	144
Bridgeport.....	12	Buffalo.....	28
Hartford.....	17	North Carolina.....	27
New Haven.....	12	North Dakota.....	5
Waterbury.....	12	Ohio.....	236
Delaware.....	11	Cleveland.....	34
Wash., D. C.....	34	Cincinnati.....	18
Florida.....	25	Columbus.....	13
Georgia.....	42	Toledo.....	22
Idaho.....	13	Oklahoma.....	15
Illinois.....	537	Oregon.....	11
Chicago.....	337	Pennsylvania.....	240
Indiana.....	87	Pittsburgh.....	84
Indianapolis.....	18	Philadelphia.....	68
Iowa.....	35	Rhode Island.....	14
Kansas.....	33	Providence.....	12
Kentucky.....	5	South Carolina.....	9
Louisiana.....	23	South Dakota.....	2
Maine.....	12	Tennessee.....	14
Maryland.....	10	Texas.....	75
Massachusetts.....	224	Dallas.....	43
Boston.....	88	Utah.....	13
Michigan.....	183	Vermont.....	12
Detroit.....	109	Virginia.....	20
Minnesota.....	41	Washington.....	37
Mississippi.....	14	West Virginia.....	19
Missouri.....	195	Wisconsin.....	106
Montana.....	18	Milwaukee.....	63
Nebraska.....	24	Wyoming.....	2
New Hampshire.....	10	Canada.....	41
New Jersey.....	662	Foreign.....	185
Atlantic City.....	19		
Camden.....	18		

Tot. Pd. Circ't'n. 4958

The Williams Printing Company

Complete Manufacture of Publications

Eleventh Avenue, 36th to 37th Streets

New York City

October 2, 1922.

The Radio Dealer
1133 Broadway,
New York City.

Attention Mr. L. A. Nixon

Dear Sir:

I, Roy L. Atwood, Manager of The Williams Printing Company, hereby testify that we have printed and bound Eight Thousand (8000) copies of the current issue of the "Radio Dealer".

Very truly yours,

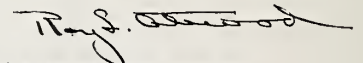

for THE WILLIAMS PRINTING COMPANY.

State of New York))
) Ss;
County of New York)

On this second day of October 1922, before me came Roy L. Atwood to me known to be the person who subscribed the foregoing instrument and acknowledged that he executed the same freely and for the purposes therein set forth.

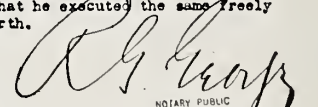

NOTARY PUBLIC
N. Y. COUNTY CLERK'S No. 122
N. Y. COUNTY REGISTER No. 1224
BY COMMISSION EXPIRES MARCH 30, 1923

First In The Field

THE RADIO DEALER

1133 Broadway, New York, N.Y.

35 South Dearborn St., Chicago, Ill.

LIST OF ADVERTISERS

(Advertisers Indexed by Products will be found on Pages 16 and 17 of this issue.)

A		Federal Tel. & Tel. Co..... 47	M. P. M. Sales Co..... 48	Spiro Brothers 67
Adams-Morgan Co. 7	Fiber Products Co..... 38	Mu-Rad Laboratories, Inc... 41	S. S. Novelty Co..... 40	Standard Appliance Mfg. Co.. 66
Ajax Radio Corp..... 56	Fischer & Co., G. H..... 66	Mydar Radio Corp., The..... 53	Standard Crystal Co. 67	Standard Metal Mfg. Co..... 39
Allen-Bradley Co. 69	Ford Mica Co., Inc..... 48		Standard Mineral Co..... 68	Stanton Co., Frank T..... 44
American Hard Rubber Co.. 46	French Battery & Carbon Co. 60	N		
Amplex Instrument Labs.... 6	Freshman Co., Inc., Chas.... 61	National Vulcanized Fibre Co. 16	Star Mfg. Co..... 41	States Electric Co..... 44
Andrae & Sons Co., Julius... 46		New York Coil Co..... 5	Steinmetz Wireless Mfg. Co... 42	Strauss & Blum, Inc..... 62
Aremco Mfg. Co..... 70	G		Stuckeman Bros., Inc..... 42	Superior Products Mfg. Co... 68
Arrow Radio Co..... 60, 64	General Merchandise Co..... 20	New York Hard Rubber Turn- ing Co. 64		
Astorloid Mfg. Co., Inc..... 60	Gibbons Dustin Radio Mfg. Co. 70	New York Radio Dial Co..... 44		
Atlantic & Pacific Radio Co.. 56	Goetz Co., The Edw. J..... 56	New York Testing Labora- tories 67		
Atwater Kent Mfg. Co..... 4, 5	Gould Storage Battery Co... 56	North Ward Radio Co..... 65		
Automatic Electrical Devices Co. 43	Gregg & Co..... 6	Novo Manufacturing Co..... 66		
		Nuloid Corporation 46		
B		T		
Bathgate, Walter E..... 66	H		T. B. H. Corporation..... 50	
Bayley Condenser Co..... 61	Hafner Manufacturing Co... 64	O		
Bel-Canto Corp..... 57	Hammarlund Mfg. Co., Inc... 66	Orange Research Lab..... 69	T. F. Radiophone Co..... 62	
Betts & Betts..... 43	Harris Laboratory, The..... 62	Oranola Radio Corp..... 56	Thornton Transformer Co.... 62	
Box M 21..... 54	Heinemann Electric Co. 45		Thresher Radio Corp..... 64	
Bremer-Tulley Radio Co..... 70	Holloway Elec. Supply Co., Inc. 56	P		
Briggs & Stratton Co..... 18	Hudson-Ross 62, 64	Paramount Machine Co..... 70	Trade Circular Addressing Co. 44	True-Tone Radio Mfg. Co.... 27
Bristol Co., The..... Front Cover	Hyman & Co., Inc., Henry... 52	Permanent Radio Fair..... 49		
Bruno Radio Corp..... 8		Pittsburgh Radio & Appliance Co., Inc. 42		
C		Q		
Carbon Products Co., The.... 38	I		Plaret Radio Corp. 79	
Central States Eng. Co..... 70	Inter-Ocean Radio Corp..... 45	Post Electric Co..... 65		
Chaslyn Co. 46		Poster & Co..... 42		
Clapp-Eastham Co. 64	J			
Commercial Screw Machine Co. 66	Jackson, P. D..... 66	Q. T. Light Co..... 54		
Continental Fibre Co., The.. 51	Jewett Corp Co..... 35			
Copper Clad Steel Co., The.. 42		R		
Cozzone & Co., John A..... 70	K			
Crosley Mfg. Co. 9	Kern, Emil Alexander 64	Radio Apparatus Co. (Pitts- burgh) 44	V-De-Co Radio Mfg. Co.... 40	Victor Radio Corp..... 46
Crown Radio Mfg. Corp..... 37	King Sewing Machine Co.... 10	Radio Center 57	Viking Radio Co..... 66	Virginia Radio Corp..... 50
Culin, Curtis C..... 66	Kramer Radio Co..... 46	Radio Courses, Inc..... 40		
		Radio Distributing Co., Back Cover		
D		L		
Diamant Tool & Mfg. Co., Inc. 56	LaFrance Import & Sales Co., Inc. 52	Radio Mica Products Co.... 37	Wald Elec. Co..... 64	W. B. L. Radio Co..... 62
Diamond State Fibre Co.... 3	Lewis & LeRoy Radio Corp... 66	Radio Outfitting Corporation. 64	W. E. Supply & Service Co... 46	Western Rubber Mold & Batty. Co. 50
		Radio Products Mfg. Co..... 59		
E		M		
Eagle Radio Co. 36	Manhattan Electric Supply Co. Inside Front Cover	Radio Shop of Newark, The. 62	Weston Elect. Instrument Co. 17	Westphal Mfg. Co..... 65
Eby Mfg. Co., The H. H..... 67	Manufacturers Patent Co.... 64	Radio Stores Corp..... 64	White Radio Co..... 79	Wilcox Laboratories 42
Egyptian Lacquer Mfg. Co.... 58	Marle Engineering Co..... 59	Radiola Wireless Corp..... 46	Wilmington Electric Specialty Co., Inc. 57	
Eisemann Magneto Corp.... 11	Mercury Radio Products Co... 40	Rauland Mfg. Co..... 52	Wilson, Inc., A. M..... 46	Winkler, Inc., Chas..... 64
Electric Service Supplies Co. 63	Mica Insulator Co. Inside Back Cover	R-C Outlet, The 64		
Electric Products Co..... 56	Milliken Bros. Mfg. Co., Inc. 49	Ross-Gould Co. 56		
Ell-Ess Radio Exchange.... 66	Mills Radio & Elec. Co..... 46	Royal Electric Laboratories. 66		
Eshoo Cabinet Works, E..... 44	Mitchell-Rand Mfg. Co..... 66	Rusonite Products Corp..... 70		
Essex Mfg. Co..... 64	Moon Radio Corp..... 55			
European Radio Co..... 44, 46		S		
		Saturn Mfg. & Sales Co., Inc. 54		
F		Save Sales Co..... 63		
Fallgatter, Marvin B..... 46		Schwab, Harold M., Inc..... 8		
		Shamrock Radio Co..... 51		
		Short Cut Radio Co..... 20		
		Signal Radio & Elec. Corp., Inside Back Cover		
			Z	
			Zwingenberger, Otto K..... 64	

Let Our Free Service Bureau Help You Supply Your Needs

Tell us your needs and we'll put you in touch with reputable firms to the end that you will receive information on the latest and best equipment. A post card will do or use the coupon below.

- | | | | | |
|---------------------------------|---------------------------------------|---------------------------------|----------------------------------|---------------------------------|
| A | 62 Condensers, mica | I | 182 Patent wire | 238 Switches |
| 1 "A" Batteries | 63 Condensers, loading | 126 Indicators | 183 Patent wire terminals | 239 Switch levers |
| 2 Aerials | 64 Connection blocks | 127 Inductances, C. W. | 184 Plans | 240 Switch points |
| 3 Aerial wire | 77 Contract work | 128 Insulators | 185 Phonograph attachments | 241 Symbols |
| 4 Aerial protectors | 65 Control panels | 129 Insulation | 186 Plate condensers | T |
| 5 Aerial switches | 66 Condenser parts | 130 Invention developments | 187 Porcelain | 246 Tapes |
| 6 Aerial insulators | 67 Copper wire | | 188 Porcelain cleats | 247 Telephone cord |
| 7 Aerials, loop | 68 Cords | J | 189 Porcelain insulators | 248 Telephone plugs |
| 8 Air condensers | 69 Cord tips | 131 Jacks | 190 Porcelain mountings | 249 Telephone receivers |
| 9 Adapters | 70 Crystals | | 191 Porcelain tubes | 250 Telegraph keys |
| 10 Amplifiers | 71 Crystal detector units | K | 192 Porcelain V. T. receptacles | 251 Telegraph teachers |
| 11 Amplifying units | 72 Crystal receiving sets | 132 Knock down units | 193 Porcelain V. T. sockets | 252 Testing instruments |
| 12 Aluminum wire | 73 C. W. Transmitter sets | | 194 Precision instruments | 253 Testing clips |
| 13 Ammeters | 74 C. W. Filament heated transformers | L | 195 Polarity indicators | 254 Terminals |
| 14 Amplifying tubes | 75 C. W. Inductances | 136 Lead-in wire | 196 Plate connectors | 255 Thermometers |
| 15 Amplifying horns | 76 C. W. Power transformers | 137 Lead-in switches | 197 Paste solder | 256 Tools |
| 16 Amplifying transformers | | 138 Lead-in bushings | 198 Phosphor-bronze wire sheets | 257 Trade marks |
| 17 Antennae, cage | D | 139 Lead-in insulators | | 258 Transformers |
| 20 Antenna light wire plugs | 81 Detectors | 140 Levers, Switch | Q | 259 Transmitters |
| 18 Audio frequency transformers | 82 Detector panels | 141 Lightning arrestors | 307 Quenching spark gaps | 260 Transmitting sets |
| 19 Automatic transmitters | 83 Detector tubes | 142 Lightning switches | R | 261 Towers |
| B | 84 Detector minerals | 143 Loading coils | 308 Radio books | 262 Three coil mounting |
| 21 "B" Batteries | 85 Detector units | 144 Loading inductance | 309 Radio schools | 263 Tin foil |
| 22 Batteries, "A" | 86 Dictionary, Radio | 145 Loose couplers | 310 Radio publications | 264 Tuning coils |
| 23 Batteries, dry | 87 Dials | 146 Loud speakers | 199 Radio frequency transformers | 265 Tubes, amplifier |
| 24 Batteries, storage | 88 Dial switches | 147 Locked lever switches | 200 Reactor, plate circuit | 266 Tubes, detector |
| 25 Battery chemicals | 89 Dry batteries | 148 Lock nuts | 201 Reactor, filter | 267 Tubing, flexible |
| 26 Battery chargers | 90 Drawings | 149 Loop aerials | 202 Receiving sets | 268 Tube sockets |
| 27 Battery testing instruments | 90 Diagrams | 150 Lugs | 203 Receiving head sets | 269 Tubes |
| 28 Battery switches | E | M | 204 Receiving transformers | 270 Tuner and detector cabinets |
| 29 Battery rheostats | 91 End mountings | 313 Mailing lists | 205 Receptors | 271 Two stage cabinets |
| 30 Battery clips | 92 Engraving | 314 Metals | 206 Receiver magnets | 272 Two stage amplifier unit |
| 31 Battery handles | 93 Electrotypes | 151 Magnetic modulator | 207 Rectifiers | U |
| 32 Battery potentiometers | F | 152 Modulation transformer | 208 Rectifying tubes | 276 Unit type receiving sets |
| 33 Binding posts | 95 Fibre spools | 153 Machine screws | 209 Regenerative sets | 277 Unassembled sets |
| 34 Books | 96 Fan switches | 154 Magnet wire | 210 Rheostats | V |
| 35 Brass parts | 97 Filter reactors | 155 Magazines, Radio | 211 Rheostat wire | 281 Vacuum tubes |
| 36 Bushings | 98 Fixed condensers | 156 Mica | 212 Rods | 282 Vacuum tube sockets |
| 37 Bulbs | 99 Fire extinguishers | 157 Mica diaphragms | 213 Rotary lever switches | 283 Variometer condensers |
| 38 Buzzers | 100 Filament rheostat | 158 Mica condensers | 214 Rotary spark gaps | 284 Variometers |
| O | 101 Filter coils | 159 Mica diaphragm transformers | 215 Rotary variable condensers | 285 Vario couplers |
| 41 Cabinets | 102 Flashlights | 160 Microphone transformers | 216 Rubber parts | 286 Variable grid leak |
| 42 Cam switches | 103 Fuse terminals | 161 Milliammeters | 217 Rotors | 287 Vernier adjusters |
| 43 Carbon potentiometers | G | 162 Milli-voltmeters | S | 288 Vibrators |
| 44 Change-over switches | 106 Gaps, Spark | 163 Motors | 221 Safety switches | 289 Vocalouds |
| 45 Charging rectifiers | 107 Generators | 164 Motor generators | 222 Safety fuses | 290 Voltmeters |
| 46 Choke coils | 105 Glass | 165 Mounting coils | 223 Sliders and rods | 291 Vulcanized fibre sheets |
| 47 Cat whiskers | 108 Grid condensers | 166 Minerals | 224 Sockets | 292 V. T. receiving sets |
| 48 Cap nuts | 109 Grid leaks | 167 Mountings | 225 Soft metal | 293 Variogrid leak |
| 49 Carbon walls | 110 Grid leaks, variable | 171 Name plates | 226 Shielded dials | 294 V. T. detector units |
| 50 Cardboard tubes | 111 Grid coils | 172 Nickel parts | 227 Short wave sets | 295 V. T. control units |
| 78 Charts | 112 Ground clamps | 173 Nuts | 228 Solder | 296 V. T. receptacle |
| 51 Chopper, rotary | 113 Ground wires | O | 229 Solder, bar | W |
| 52 Clamps | 114 Ground switches | 176 One stage amplifier units | 312 Soldering irons (electric) | 297 Washers |
| 53 Clips | H | 177 Oscillation transformers | 230 Spark transformers | 298 Watch case receivers |
| 54 Coils | 116 Headsets and bands | | 231 Spark coil selectors | 299 Wattmeters |
| 55 Coil mountings | 117 Honeycomb coils | P | 232 Spaghetti tubing | 300 Wavemeters |
| 56 Coil plugs | 118 Honeycomb mountings | 178 Panels | 233 Special apparatus | 301 Wave tuner |
| 57 Coils, spark | | 179 Panel plugs | 234 Spark gaps | 302 Wire |
| 58 Condensers | 119 Honeycomb plugs | 180 Panel controls | 235 Spring clips | 303 Wire, aerial |
| 59 Condensers, fixed | 120 Hook switches | 181 Paper tubes | 236 Storage batteries | 304 Wire phosphor bronze |
| 60 Condensers, variable | 121 Horns | 311 Patent registration | 237 Sectional receiving sets | 305 Wire, copper clad |
| 61 Condensers, air | 122 Hydrometers | | | 306 Wire, magnet |

Note the number of the item you want to buy—then check the corresponding number in the coupon below and mail to us.

-----TEAR OFF HERE-----

1	2	3	4	5	6	7	8	9	10	11	12	13	14	15	16	17	18	19	20	21
22	23	24	25	26	27	28	29	30	31	32	33	34	35	36	37	38	39	40	41	42
43	44	45	46	47	48	49	50	51	52	53	54	55	56	57	58	59	60	61	62	63
64	65	66	67	68	69	70	71	72	73	74	75	76	77	78	79	80	81	82	83	84
85	86	87	88	89	90	91	92	93	94	95	96	97	98	99	100	101	102	103	104	105
106	107	108	109	110	111	112	113	114	115	116	117	118	119	120	121	122	123	124	125	126
127	128	129	130	131	132	133	134	135	136	137	138	139	140	141	142	143	144	145	146	147
148	149	150	151	152	153	154	155	156	157	158	159	160	161	162	163	164	165	166	167	168
169	170	171	172	173	174	175	176	177	178	179	180	181	182	183	184	185	186	187	188	189
190	191	192	193	194	195	196	197	198	199	200	201	202	203	204	205	206	207	208	209	210
211	212	213	214	215	216	217	218	219	220	221	222	223	224	225	226	227	228	229	230	231
232	233	234	235	236	237	238	239	240	241	242	243	244	245	246	247	248	249	250	251	252
253	254	255	256	257	258	259	260	261	262	263	264	265	266	267	268	269	270	271	272	273
274	275	276	277	278	279	280	281	282	283	284	285	286	287	288	289	290	291	292	293	294
295	296	297	298	299	300	301	302	303	304	305	306	307	308	309	310	311	312	313	314	315

Service Bureau The Radio Dealer,
1133 Broadway, New York City.

We are interested in buying radio equipment and have circled the numbers on this coupon of the items we are ready to buy now. Please have manufacturers of these lines quote us dealers' prices.

Name.....

Address.....

..... 1923
We are
—Retailers
—Jobbers

Radio Trade Pictures



This photograph was taken at a meeting of the district managers and sales department of C. Brandes, Inc., that was recently held in New York City. The following offices of the organization were represented: Boston, Chicago, Minneapolis, San Francisco, Pittsburgh, Huntington, Atlanta and Washington. At the meeting, the general opinion expressed was that business is rapidly stabilizing, and will broaden on a firmer foundation. Increased business is looked for in 1923 over 1922.

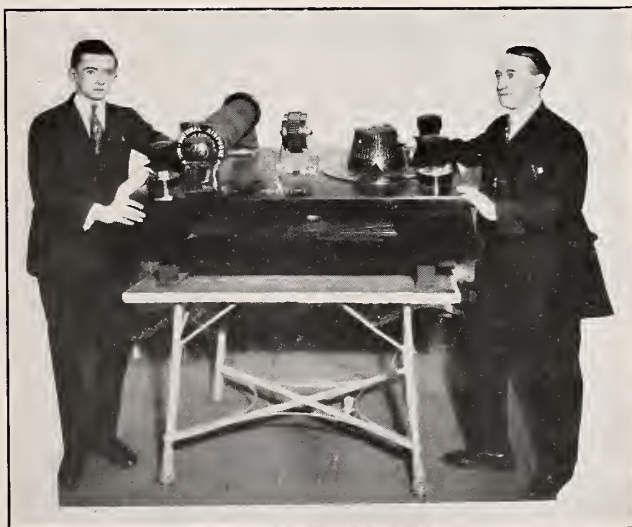

This is the monster National Airphone, Model G, that was recently exhibited. It is over five feet long, and weighs over 200 pounds. It is probably the largest crystal set that was ever manufactured. It was made by the National Airphone Corp., 16-22 Hudson Street, New York.



The giant Rico headset was one of the exhibits at the New York Radio Show. The cord is 50 feet long, the receiver weighed over 150 pounds, and all parts were of proportionate size. It is said that this big headset actually worked. This apparatus was made by the Radio Industries Corp., 131 Duane Street, New York.

ANNOUNCING
the consolidation

of the

**National Fibre &
Insulation Co.**

the

Keystone Fibre Co.

and the

**American
Vulcanized Fibre Co.**

In order that we
may unify our efforts
to better serve our
customers and
through them the
public—we have con-
solidated and in the
future will be known

as the

**National
Vulcanized
Fibre Co.**

of Wilmington, Delaware



Where to Buy

A Handy Guide For The Convenience of Our Readers

AMPLIFIER UNITS		CRYSTAL DETECTORS	
Magna Instrument Co.....	59	Culin, Curtis C.....	66
Steinmetz Wireless Mfg. Co..	42	European Radio Co.....	46
		M. P. M. Sales Co.....	48
AMPLIFIERS		CRYSTAL RECEIVERS	
Standard Metal Mfg. Co.....	39	Holloway Elec. Supply Co.,	
Arrow Radio Co.....	60	Inc.	56
AMPLIFYING TRANSFORMERS		CUSTOM BUILT SETS	
Rauland Mfg. Co.....	52	Lewis & De Roy.....	66
ANTENNA WIRE		DETECTOR-AMPLIFIER TUBES	
Copper Clad Steel Co.....	42	La France Import & Sales Co.,	
BATTERY CHARGERS		Inc.	52
The Automatic Elec. Devices		DETECTOR STANDS	
Co.	43	Box M 21	54
BATTERY TESTERS		DIALS	
Chaslyn Co.....	46	N. Y. Radio Dial Co.....	44
Hafner Mfg. Co.....	64	DISTRIBUTORS	
Western Rubber Mold & Batty.		Andrae & Sons Co., Julius...	46
Co.	50	Ell-Ess Radio Exchange.....	66
" B " BATTERIES		Goetz Co., The Edw. J.....	56
French Battery & Carbon Co..	60	Hudson-Ross	62
Gould Storage Battery Co....	56	Kramer Radio Co.....	46
Novo Mfg. Co.....	66	North Ward Radio Co.....	65
BATTERIES		Radio Distributing Co., Back Cover	
Carbon Products Co.....	38	Radio Shop of Newark, The..	62
Manhattan Electric Supply Co.		Radio Stores Corporation.....	64
Inside Front Cover		Schwab, Harold M.....	8
BESTONE PRODUCTS		Virginia Radio Corp.....	50
Henry Hyman & Co., Inc....	52	Wilmington Electrical Spe-	
BINDING POSTS		cialty Co., Inc.....	57
The H. H. Eby Mfg. Co.....	67	DRY CELL SETS	
BOOKS		Q. T. Light Co.....	54
Central States Engineering		ENGRAVING	
Co.	70	Paramount Machine Co.....	70
CABINETS		EXPOSITIONS	
E. Esho Cabinet Works.....	44	Permanent Radio Fair.....	49
Marvin B. Fallgatter.....	46	HEAD SETS	
COIL MOUNTINGS		Royal Electric Laboratories...	66
Astorloid Mfg. Co.....	60	Superior Products Mfg. Co....	68
Crown Radio Mfg. Co.....	37	Thresher Radio Corp.....	64
COMPLETE LINE		True Tone Radio Mfg. Co....	51
Adams-Morgan Co.....	7	HORNS	
Atwater-Kent Mfg. Co.....	4, 5	Fiber Products Co.....	38
Briggs & Stratton Co.....	18	INDOOR AERIALS	
Hudson-Ross	64	Short Cut Radio Corp.....	20
Mills Radio & Elec. Co.....	46	INSULATION	
Signal Radio & Elec. Corp....		National Vulcanized Fibre Co.	16
Inside Back Cover		Diamond State Fibre Co.....	3
COMPOSITION		JACKS	
Nuloid Corp.	46	Saturn Mfg. & Sales Co., Inc..	54
CONDENSERS		Union Radio Co.....	60
Freshman Co., Charles	61	LIGHTNING ARRESTERS	
Spiro Bros.	67	Electric Service Supplies Co..	63
CRYSTALS		LOOP AERIALS	
Gibbons-Dustin Radio Mfg. Co.	70	Eagle Radio Co.....	36
Harris Laboratory	62	V-De-Co	40
M. P. M. Sales Co.....	48	LOOSE COUPLER SETS	
Radio Apparatus Co. (Pitts-		T-F. Radiophone Co.....	62
burgh)	44		
Rusonite Products Corp.....	70		
Standard Crystal Co.....	67		
Standard Mineral Co.....	68		

Alphabetical Index to Advertisers on Page 13

Where to Buy

A Handy Guide For The Convenience of Our Readers

LOUD SPEAKERS		SHIELDS	
Atlantic & Pacific Radio Co.	56	Orange Research Lab.	69
Bel-Canto Corp.	57	SOCKET AERIAL	
Bristol Co., The	Front Cover	Star Mfg. Co.	41
Inter-Ocean Radio Corp.	45	SOCKET RHEOSTAT	
Magnavox Co.	33	Ajax Radio Corp.	56
States Electric Co.	44	SOCKETS	
LACQUER		Bruno Radio Corp.	8
Egyptian Lacquer Mfg. Co.	58	Commercial Screw Machine Co.	66
MAILING LISTS		SOLDERING IRONS	
Ross-Gould Co.	56	Post Electric Co.	65
Trade Circular Addressing Co.	44	Strauss & Blum, Inc.	62
MERCHANDISE WANTED		SPAGHETTI TUBING	
Jackson, P. D.	66	Mica Insulator Co.	Inside Back Cover
R. C. Outlet, The	64	Mitchell-Rand Mfg. Co.	66
MICA		Westphal Mfg. Co.	65
Mica Insulator Co.	Inside Back Cover	STOCK BROKERS	
MICA CONDENSERS		Stanton & Co., Frank T.	44
European Radio Co.	44	SWITCH LEVERS	
MICA DIAPHRAGMS		King Sewing Machine Co.	10
Radio Mica Products Co.	37	TESTING LABORATORIES	
MICROMETER DIALS		Gregg & Co.	6
Myder Radio Co.	53	N. Y. Testing Laboratories.	67
PANELS		TOWERS	
American Hard Rubber Co.	46	Milliken Bros. Mfg. Co., Inc.	49
Bremer-Tully Radio Co.	70	TRANSFORMERS	
Continental Fibre Co., The	51	Amplex Instrument Labs.	6
Eisemann Magneto Corp.	11	Federal Institute of Radio Tel.	47
New York Hard Rubber Turning Co.	64	Ford Mica Co.	48
Pittsburgh Radio & Appliance Co.	42	Marle Engineering Co.	59
Poster & Co.	42	Radio Center	57
PAPER CONDENSERS		Radio Courses, Inc.	40
Walter E. Bathgate	66	Superior Products Mfg. Co.	68
PATENTS		Thornton Transformer Co.	62
Kern, Emil Alexander	64	UNIT TYPE SETS	
Manufacturers Patent Co.	64	Heinemann Elec. Co.	45
Wilson, Inc., A. M.	46	VARIABLE CONDENSERS	
Zwingerberger, Otto K.	64	Bayley Condenser Co.	61
PHONE PLUGS		Diamant Tools & Mfg. Co.	56
S. S. Novelty Co.	40	Standard Appliance Mfg. Corp.	66
PHONES		Stuckeman Bros., Inc.	42
T-B-H Corporation	50	United Mfg. & Dist. Co.	55
RADIO FREQUENCY SETS		VARIO-COUPERS	
Mu-Rad Laboratories	41	Essex Mfg. Co.	64
RECEIVING SETS		G. H. Fischer & Co.	66
Arrow Radio Co.	64	General Merchandise Co.	20
Atwater Kent Mfg. Co.	4, 5	Maclite Storage Battery Co.	44
Betts & Betts	43	Shamrock Radio Co.	41
Clapp-Eastham Co.	64	VARIOMETERS	
Crosley Mfg. Co.	9	Aremco Mfg. Co.	70
Jewett Mfg. Co.	35	Atwater-Kent Mfg. Co.	4, 5
Mercury Radio Products Co.	40	Radio Products Mfg. Co.	59
Magna Instrument Co.	47	VERNIER CONDENSERS	
Moon Radio Corp.	55	Cozzone, John & Co.	70
Oranola Radio Corp.	56	Electric Products Co.	56
Radio Outfitting Corp.	64	VERNIER RHEOSTATS	
Save Sales Co.	63	Viking Radio Co.	66
United Specialties Co., Inc.	58	VOLTMETERS	
Victor Radio Corp.	46	Weston Elect. Instrument Co.	17
W. B. L. Radio Co.	62	RECEIVING SETS	
W. E. Supply & Service Corp.	46	Allen-Bradley Co.	69
Winkler, Inc., Chas.	64	Radiola Wireless Corp.	46
RHEOSTATS		Wald Electric Co.	64
Allen-Bradley Co.	69	Wilcox Laboratories, The	42
Radiola Wireless Corp.	46	ALPHABETICAL INDEX TO ADVERTISERS ON PAGE 13	
Wald Electric Co.	64		
Wilcox Laboratories, The	42		

Alphabetical Index to Advertisers on page 13



Make Two Profits Instead of One



THE Weston Voltmeter is advertised regularly in all the leading Radio Magazines. Regardless of the kind of tubes or Voltage used—a Weston Ammeter should be on every tube set to prevent premature tube burnouts, unnecessary depletion of battery or cells—to make tuning and duplication of results possible more quickly.

Render YOUR tube customers a real service by drawing the Weston Voltmeter to their attention—and make a profit, not only on tubes, but a liberal voltmeter profit as well.

Write for descriptive circular covering this and other important Radio instruments

Weston Electrical Instrument Co.

178 Weston Ave. Newark, N. J.
Makers of Electrical Indicating Instruments Since 1888

WESTON

"THE SUN NEVER SETS ON THE WESTON"

"STANDARD" The World Over

ELECTRICAL INSTRUMENTS

An Indicating Instrument for Every Individual. Need and Industrial Purpose



\$ **6.00**
2000 Ohm
\$7.50 3000 Ohm

Their Deep, Natural-Voiced Pitch Is Rapidly Selling Thousands

ACTUALLY — thousands are being snapped up on the strength of their pleasing voice tone and keen sensitiveness. The same hair-line refinement of design which for over eleven years has been so sharply pronounced in hundreds of Basco electrical units, here again shows itself in these skillfully constructed

We also make
the Basco Radio Frequency
Transformer, Vernier and
Plain Rheostat, Variable Air
Condensers, Tube Socket,
Dials and a Complete Crystal
Outfit.



Put up in attractive
orange and black
cartons

RADIO Head Phones "Hear" More and Cost Less

They are built **right**, pitched **right** and priced **right**. Close examination is convincing proof. They embody every high priced quality — perfect balance, clear, scratchless reproduction. Coils encased in aluminum shell — light weight, easy on the head. Employ solid horseshoe magnet — no laminations. Bus-bar connections, no loose hair-like wires.

Light, extra sensitive diaphragm, set to thousandths-of-an-inch accuracy from magnet poles. Clean cut, rugged design throughout. Compare them with any other head set — irrespective of price — then you'll be convinced they're what you want. Ask your dealer to show you Basco Head Phones. If he hasn't them, write us direct

Jobbers and Dealers! Write for our exceptional discount proposition and name of our nearest factory representative.

Briggs & Stratton Co.
Milwaukee **PRODUCT** Wisconsin

THE RADIO DEALER

The Radio Trade Journal

For The Radio Retailer

CONTENTS FEBRUARY, 1923

SPECIAL ARTICLES

Advertise the Stellar Broadcasting Programs.....	By R. C. Hull	23
Costs of Conducting a Radio Business.....	By Henry L. Seidman	26
Cut Prices to Consumers Menace to Rural Dealers.....	By H. S. Webster	32
Development of Wire for Radio Antennas.....	By L. N. Allen	30
Economic Sales Factors in Radio Industry.....	By Alexander Eisemann	27
Insulation Facts the Dealer Should Know.....	By O. B. Carson	31
Jones Helps the Dealer.....	By H. G. Cisin	62
New York Stater Has a Novel Way of Selling Radio Sets.....	By Harvey Gordon	25
Psychological Elements in Salesmanship.....	By Edward H. Lerchen	24
Radio Trade Is Subject to Natural Laws.....	By Bernard Freedman	25
Receiver Interferences.....	By W. B. Schulte	52
Reception Noises Are Not Caused by "B" Batteries.....	By Bernard J. Farrell	36
Retailers Should Test Their Head Phones.....	By Thomas H. Mullen	23
Selling Apparatus with Cut-Out Sections.....	By Herbert E. Metcalf	32
Standardization Will Advance Industry.....	By Amplifier Al	21
Standardization of Radio Panels.....	By J. F. McKerchar	22
Thomas A. Edison Announces New WD-11 Dry Cell Battery.....	By William Coleman	68
Trade Marks Should Receive Federal and State Protection.....	By Chauncey P. Carter	30

DEPARTMENTS

Book Reviews.....	By Bernard J. Farrell	55
Editorials.....		28, 29
Radio Trade Pictures.....		15
Service Bureau.....		14
What the Manufacturers Are Doing.....		34

THE RADIO DEALER, THE RADIO TRADE JOURNAL, published monthly on the first, at 1133 Broadway, New York, N. Y., by THE RADIO DEALER COMPANY, in the interest of dealers in Radio Supplies. HARRY M. KONWISER, Publisher; LAURENCE A. NIXON, Managing Editor; HERBERT M. WILLIAMS, Editor; A. L. KONWISER, B. S., ALBERT B. SONN, R. E., Technical Editors; N. B. ZIMMERMAN, BERNARD FREEDMAN and EUGENE J. SCANLON, Associates; C. HOPPE, Circulation Manager; M. JAY KLEIN, Research Manager; B. B. STERN, Manager Service Bureau.

REPRESENTATIVES IN THE TRADE: ELMER W. MOORE, JOHN R. HALL, H. E. BENNETT, WM. B. WILKINSON, JR., J. MAURICE CASPER, H. L. KRENZ, M. A. CLARK, C. L. GEESEY, C. C. MNIER, J. L. PECK, M. P. MCNEELEY, W. H. OKE, C. B. CABINTSS, R. C. HULL, BERNARD J. FARRELL.

PUBLICATION OFFICE
1133 Broadway, New York, N. Y.
Telephone Watkins 8926-8927

SOUTHERN STATES
610 Barome Street,
New Orleans, La.

CANADIAN OFFICE
23 Lily Street, Winnipeg, Manitoba

PITTSBURGH
Suite 570, Union Arcade, Pittsburgh, Penna.
PACIFIC COAST
Suite 511, 456 S. Spring St., Los Angeles, Calif.
Telephone Los Angeles 12050
512 Pacific Building, San Francisco, Calif.
Telephone Sutter 954

BRITISH OFFICE:
Walter Dandie Company, Ltd.
173-175 Great Portland Street
London, W. I., England

CENTRAL STATES
35 South Dearborn Street, Chicago, Ill.
Telephone Dearborn 4053

NEW JERSEY
845 Broad Street, Newark, N. J.
Telephone Market 4659

CLEVELAND
1389 West 87th Street,
Cleveland, Ohio

Advertising Rates and detailed statement of circulation and other information for advertisers furnished on application. Advertising forms close the 15th of the month prior to date of issue.

Circulation restricted to manufacturers, jobbers and retailers in wireless equipment. Subscription in the United States, one dollar the year, payable invariably in advance. Subscription in foreign countries, two dollars the year, payable invariably in advance.

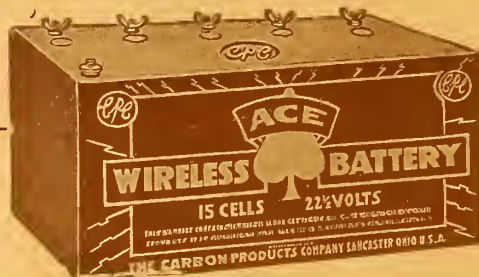

To Those Who Haven't Made The Most of Radio Opportunities

Radio merchandising's success depends largely on separating the riff raff articles that have flooded the market from the products which sell on merit.

We have produced a better battery for radio receiving, not only because of our 30 years' experience, but because our research work began before the pell-mell radio epidemic swamped the country.

Added to this we have worked out a successful plan of selling these batteries. This is not manufacturer's theory, but real, honest-to-goodness "back of the counter" merchandising.

Ask for the complete story. It's worth the time to investigate.

Ace No. 6 Cell

An ideal battery of special characteristics that make it valuable for WD-11 Westinghouse sets.

THE CARBON PRODUCTS COMPANY

Lancaster, Ohio

Ace Radio Books

Give away these useful books free to your customers.

ACE BATTERY

for Radio Success

EVENTUALLY! The FIBER HORN Replaces All Others

Because: It is scientifically developed to produce only true, mellow tones.

Indestructible: So constructed that it will not crack, chip or dent.

Seamless: No unsightly glued joints or rivets to loosen or come apart.

Finish: Attractively finished in black crystalline; enhances appearance of set.

Sizes: No. 1, 10" Bell, 23" high.

No. 2, 14" Bell, 28" high.

Dealers: Write for Attractive Proposition

FIBER PRODUCTS CO.

No. 10th St. and
Bloomfield Avenue
Newark, N. J.



Manufacturers:

Horns built
according
to your own
designs.

The Radio Dealer

THE RADIO TRADE JOURNAL

Edited and Published at

1133 Broadway, New York, N. Y.

FOR THE RADIO RETAILER

VOL. 2. NO. 5

FEBRUARY, 1923

ONE DOLLAR THE YEAR

Standardization Will Advance Industry

Selection of Committee to Formulate Plans for Eliminating Waste and Duplication an Important Step

By AMPLIFIER AL

Standardization is in the air!

The biggest advance in radio will be made when apparatus, nomenclature sizes, designs, capacities and materials will be put on a uniform basis in the industry. Realizing this truth, the Bureau of Standards called a meeting recently in New York at which prominent radio engineers, and representatives of the Bureau of Standards, the Army and Navy attended. Leading trade associations and firms in the industry were also represented, and the meeting lasted through one day.

The result of this meeting was the appointment of a permanent committee to conduct the work of standardization. This body is under the joint sponsorship of the American Institute of Electrical Engineers and the Institute of Radio Engineers.

The radio industry may look with confidence toward the work which this committee will do. They may rest assured that the men who form this committee will do their part. What is required of *every man in the industry*, however, be he dealer, jobber, manufacturer or engineer, is co-operation.

Co-operation is a word that is so commonly used that it seemingly calls forth little response. Co-operation in the work of standardization may imply a certain amount of self-sacrifice. But when the alternatives before the industry are a chaotic array of parts, materials, and capacities, and, on the other hand, an orderly development, with waste, duplication and disorganization reduced to the minimum, it is plain to see which alternative the men who have the true interests of radio at heart will choose.

No one will deny that standardization will benefit the industry and what benefits the industry will reflect itself on the individual radio man.

It is significant proof of the paramount necessity for standardization that many manufacturers have already taken steps to standardize their respective branches of the business. The meeting on January 12 was inspired by the manufacturers which shows the public spirited interest with which one has come to consider the radio men. The industry that can offer to the people the widespread benefits of broadcasting as a free public service will do even more to enable radio to take its logical place in the life of the community.

The Badge of the Radio Trade



Members of the Radio Trade Association can now display the insignia of their organization on letterheads, circulars and the like. The Secretary of the Association is now ready to distribute cuts similar to those illustrated here to members at cost. Cost price in this case is the nominal sum of thirty-five cents. The design may be had in other sizes as well, at varying prices.

The design of the cut is neat and simple and carries with it wherever it may appear the assurance that its user is an alert, public-spirited and conscientious member of the radio trade. Requisitions for cuts and applications for membership in the Radio Trade Association should be addressed to the Secretary, Radio Trade Association, 1133 Broadway, New York.



Standardization of Radio Panels

Prominent Manufacturer Is Now Supplying Trade with Panels Cut to Standard Sizes Which Reduce Waste and Facilitate Sales

By J. F. McKERCHAR

The question of the standardization of radio parts is arousing more interest at present than ever before in the history of the radio industry. This means that radio men are at last awake to the vital importance for concerted action to eliminate duplication and waste.

No one is more alive to the need for standardization than L. T. McCloskey, general sales manager of the Diamond State Fibre Company of Bridgeport, Pa. Mr. McCloskey is the man who is responsible for one instance of standardization; perhaps the first in the radio industry. The fibre panels put out by the company he represents are now in definite sizes, which it is likely that the whole industry will adopt.

"Up to the present, standardization," said Mr. McCloskey in a recent interview, "has been more or less a subject for discussion rather than an object for any definite action. Radio interests have been too busy, perhaps, satisfying the demands made upon them by the public even to consider the subject of standardization.

"But if one regards the condition of the industry at the present time," he went on to say, "he cannot help but feel how much of the confusion that exists could be eliminated if there were some order established in the manufacture of radio products. Whether standardization will come late or soon depends entirely upon the initiative and willingness of radio men. One feature of the question must be pointed out and that is that certain radio parts will be standardized before others.

"I am thinking particularly of radio panels. I am proud to say that the branch of the radio manufacturing business which manufactures panels is showing the way for the rest of the industry."

Mr. McCloskey then told of the Condensite Celeron panels manufactured by the Diamond State Fibre Company. Celeron is the black, shiny, lustrous insulating material on which instruments and controls in high grade transmitting and receiving sets are mounted.

Up to the present this product has been supplied in sheet form to radio manufacturers and to jobbers and

dealers who cut it to order for amateurs and set constructors. To handle this business properly, many dealers found it necessary to install special saws. Those who were not equipped to do their own cutting and who were inclined to put in expensive equipment had to send the work out. The dealer was frequently forced to make his customer wait a day or more for the size of panel desired. Some dealers because of this fact have refused to handle panels at all.

All this is now in the process of being changed. Manufacturers, jobbers and dealers have realized the deplorable waste and uncertainty of cutting panels to the single order and in as many sizes as there are divisions on a yard-stick. To handle this panel business, they are beginning to realize, some standardization is necessary. To meet this situation, some time ago several of the representative dealers decided to carry a few sizes of cut panels in stock. This was a step toward efficiency, but their efforts were not organized and, consequently, the standardized idea was not applied.

This was a case of the spirit being willing but the flesh weak, so the Diamond State Fibre Company stepped in to do what it could to help things along.

"We surveyed the entire country first," Mr. McCloskey explained, "and worked out a plan of standardizing and merchandising panels. I am glad to say that the plan was received with favor by radio dealers the country over."

This survey proved that the bulk of the set builders' requirements could be satisfied with a few carefully worked out sizes designed for the popular sets and circuits which are commonly used. This was found to be correct. As a result, Celeron is now sold in the following standard sizes:

Panel Number	Size	Net Weight per Panel
1	6x 7x1-8	.2625
2	7x 9x1-8	.394
3	7x12x1-8	.525
4	7x18x3-16	1.18
5	9x14x3-16	1.18
6	7x21x3-16	1.38
7	12x14x3-16	1.575
8	7x46x3-16	3.00

These sizes are designed to meet present-day needs. Perhaps future developments will show the necessity for additional sizes. If the demand is large enough, it will be a simple matter to supply them. Each panel is trimmed, neatly finished, enclosed in a glassine wrapper, marked and numbered, and full instructions go with each for working and finishing a panel.

Thus, the Diamond State Fibre Company has created a convenient packaged and trademarked article out of a commodity formerly obtained only in bulk. The advantages to both manufacturer and dealer are obvious. To the dealer, especially, substantial benefits accrue. Inconvenience of cutting is eliminated, handling and delivery facilitated, increased turnover, and profits attained and, what is most important, better service is offered to the customer.

"But standardization, to be a success, ultimately depends upon the consumer," Mr. McCloskey said. "Will the amateur appreciate and approve this innovation? Does he know what is being done? Our company is not only standardizing but merchandising as well. We are advertising the step that we have taken. It has received the backing and support of organizations, publications and radio departments of newspapers. All welcome it as an aid to the set builder.

"We are following up on the idea by educating the dealer in the program of sales enlargement. Standard layouts are prepared, templates and wiring diagrams presented which utilize the standard size panel best adapted to each set."

The sales value of such standardization cannot be over-estimated. The dealer is advised to start the purchaser off with the proper panel, then sell him the parts and equipment necessary to complete the set. If a question is raised as to size of panel, the dealer can dismiss it immediately by saying, "This panel has been especially designed and finished for this set."

There is no doubt that standardization is going to pay in the radio industry.

Retailers Should Test Their Head Phones

By Assuring Customers Every Instrument Works Perfectly, Dealers Will Satisfy Customers and Enhance Their Reputations

By THOMAS H. MULLEN

Mr. Retailer! How do you test a head-set?

Did you ever stop to realize the possible damage your stock may encounter on its way from the factory?

Perhaps a reason for your drop in sales is because some of your goods were not in perfect condition when they left the store. Most frequently the public places the blame on radio instead of on you. It must be the dealer's first aim to encourage the advancement of radio and thereby help build up his trade.

It is recognized that a dealer has a responsibility to his customers. In too many cases have dealers sold apparatus that would not work properly—sometimes would not work at all. This has injured the cause of radio by producing discouragement and dissatisfaction. It has also lost many a customer. Head phones are one of the things that must be good. Otherwise, the whole receiving set is apt to be condemned.

Any dealer can test his phones and then have confidence that they will give satisfaction. Felix Wyner, director of a radio firm in New York City, is testing all the phones that he sells. For this purpose he uses a home-made head-set tester, which, after extensive trial of more complicated and expensive apparatus, has convinced him that this simpler tester is the more efficient.

To be sure that nothing has gone wrong with a phone in handling and to make certain that both phones of a head-set are in perfect accord both in tone and intensity, he gives them a final test. Presumably an audio-oscillator would serve the purpose, but unfortunately that is an expensive and somewhat complicated arrangement. The ultimate aim is to have the phone give the best possible results from the radio set. To attach the head-set to the receiving set, therefore, as a last test, would seem the most practical method. This has been proven to be far from true, because with the varied sounds broadcasted, it is impossible for anybody but one with a highly trained ear, to detect the difference between a perfect phone and one which would ordinarily be rejected. Nothing but a very marked difference between the two pieces



Above—Phone Testing Outfit
Below—Testing Phones

could be detected in this manner.

The simple buzzer has proved to be a solution to the problem. The one here illustrated was photographed in Mr. Wyner's office. The apparatus consists of nothing but dry batteries,

a small buzzer, one telephone receiver and several small pieces of felt.

The batteries are joined together in series and are then bound to a flat board of convenient size. Several pieces of felt are laid on the board next to the batteries, one on top of the other and the buzzer is placed on top. A small block of wood is then nailed to the board immediately in front of it. Resting between this and the buzzer is an ordinary radio telephone receiver. The felt is placed beneath the buzzer in order to prevent vibration. Any other material that will have the same effect may be used.

The apparatus is then complete except for the wiring. So that no sound may be heard, it is wise to place it in a drawer at the farthest end of the room from the testing table. A four-wire cable is strung from the apparatus to this table and the two ends from the battery-buzzer circuit are attached to two of the four wires of the cable. This makes it possible to operate the buzzer from the testing table. The other two ends of the cable are joined to the phone of the apparatus, thus completing one end of the tester.

At the testing table, an ordinary switch is screwed down. To this are attached the two leads from the buzzer circuit. There are also fastened to the table two double-spring binding posts.

(Continued on page 39)

Advertise the Stellar Broadcasting Programs

By R. C. HULL

Radio is no longer a novelty and must be sold to the great mass of people *for their homes*.

Better broadcasting has developed this, bringing radio up from a business with young people who acclaimed radio for its novelty. Now that radio is something the public should want, the dealers in this field must make proper effort to acquire the business of the general public.

The current broadcasting programs

are the best selling points for the dealer and to sell radio apparatus successfully the dealer will tie up his selling campaign with the programs.

Do you know that the Chicago Opera, for instance, is being broadcasted regularly and that the City Symphony Orchestra of New York is having its concerts broadcasted?

Every music lover in the land ought to know these things and they can

(Continued on page 39)

Psychological Elements in Salesmanship

The Real Salesman Utilizes Them While the Order Taker Fails to Appreciate the Value of These Important Selling Helps

By EDWARD H. LERCHEN
Of Orange Research Laboratories

Study Your Customer

*Salesman or order-taker?
Which are you? Which do you
want to be?*

*The writer of this article cleverly
tells the difference between
them and supplies suggestive
pointers for the salesman's
guidance.*

*The psychological side of the
question is discussed and prin-
ciples for guidance are laid down
which should be helpful in effect-
ing sales.*

You have no doubt heard the old saying that "Salesmen are born not made." I for one doubt this statement very much. I believe any healthy, intelligent human being can become a real salesman if he can only learn the value of psychology in connection with the selling of merchandise.

We all know or should know, that a sale always first takes place in the buyer's mind before it reaches your order book and as psychology is that branch of science which deals with the mind you will therefore understand why psychology in connection with selling goods is so essential. There never was a successful salesman who was not a psychological salesman whether he was aware of the fact or not; he may not even know the meaning of the word psychology.

All men selling merchandise are not salesmen; some are order-takers, not salesmen. There is as much difference between an order-taker and a salesman as day is from night. Anyone can be an order-taker, but it takes a salesman to sell goods.

You, perhaps, wonder just what the particular difference is between an order-taker and a salesman. I will endeavor to explain in a very few words: An order-taker only sells a customer those goods which the customer wants; a salesman sells his customer that which he needs but which the customer thinks he doesn't need. Every time you make a sale on that basis you are a real psychological salesman.

You often hear of a man who boasts of having loaded so and so up with merchandise; that kind of a sale is not good salesmanship; it is not psychological salesmanship. When a salesman does that or can do it, it is simply because his mind and will are stronger than the buyer's while in his presence, but immediately the salesman departs that same buyer is figuring on how he can return most of the goods when they arrive—and selling goods that are sold only to be returned is not salesmanship. This condition exists because the merchandise was sold without the salesman creating in the buyer's mind the desire to possess these goods at the time the order was taken which would cause him to keep them after they were received.

An example of this is where a sales-

selling any goods to that man are nil, for that day at least.

It is all right for a salesman to be friendly and sociable with his customers but he should not become familiar with them. No truer words were ever uttered than that "familiarity breeds contempt." I once knew a salesman who boasted of his familiarity with a certain buyer and how this buyer was giving him all of his business, but the salesman was only "kidding" himself. I overheard this same buyer at a club one night remark how much he admired a certain young salesman who called on him and how businesslike he was, adding that he was giving this young man all of the business that he possibly could as he seemed to know his line so well and was all business. This certain young salesman happened to be selling a competitive line of goods to those which the fellow who had boasted of getting all of this buyer's orders, so you see you never can tell just where you stand. But, it might be well to remember that it is better to be all business than too familiar.

When selling goods to a buyer, always be positive in your answers when asked a question. Say, "yes" or "no" without hesitation in a straightforward manner. Don't say, "I guess so," "I think so," and above all never say "I don't know" because you should know. If you don't know, it is somebody's fault, either your own or the firm you are working for. You should, therefore, never try to sell any article until you are thoroughly familiar with it and the uses for which it is intended.

Your own confidence in knowing that you understand your line will inspire you with enthusiasm and you cannot sell merchandise unless you are enthusiastic about what you are selling. Learn to know your buyers likes and dislikes in general. Learn not only to think with him, but ahead of him.

Now remember, a salesman does not sell goods, but the goods sell themselves. This sounds somewhat revo-

(Continued on page 48)

man takes a large order for goods on the strength of the argument that John Smith & Co., and Brown & Co., are using same and find them O. K. That is a poor argument to use in selling as your buyer has a large amount of pride in his firm and also his ability to know the value of good merchandise and he does not like to have his judgment placed secondary to John Smith & Co. Furthermore, he is not interested in what Smith & Co. are using. He is only interested in something which will benefit his particular business and it is up to the salesman to give him the real possibilities of the article he is selling.

It is mighty poor policy to knock your competitor and his goods. Many a salesman does this, but it is wrong. It is much better to say, "Yes, I know them and they make a very fine line of merchandise." Then say no more but go on and explain the merits of your own particular line and forget about your competitor. The world loves a fighter, but also fair play, so play the game fair even with your competitors. It will pay you in the end.

As first impressions count for a great deal a salesman should always be neatly but not over-dressed and always a gentleman and not too much of a talker. Many a man has talked himself out of a sale. If you don't know when to stop talking study your buyer's face and actions, you will then find your cue. Don't talk until he starts to shift from one foot to the other. If he does this you may rest assured you have said enough and your chances of

Radio Trade Is Subject to Natural Laws

As in Other Lines Inefficiency and Dishonesty Will Ultimately Vanish to Leave Clear Field for Reputable Dealer

By BERNARD FREEDMAN

"What is the future of the radio industry?" is the question I have been asked time and time again by friends of mine. Indeed, so common is this question that I am sure that every man in the radio business today has at some time or other been confronted by the same query.

I put the question of radio's future to two men in the industry, Myron G. Studner and A. E. Pollock, of the Inter-Ocean Radio Corporation, New York. And they dictated the statement which follows:

"When most people ask 'What is the future of radio?' they really mean, 'How long is it going to last?' They think that it is a fad.

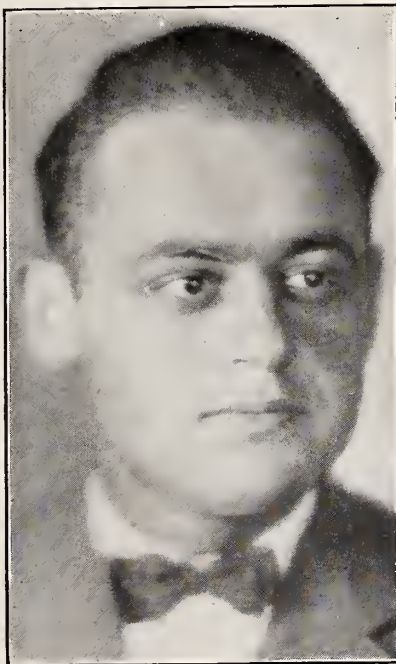

MYRON G. STUDNER
General Manager, Inter-Ocean Radio Corp.

"Of course radio is not a fad. The tremendous radio buying last Christmas and the steady buying since then amply prove this, for it means that once a customer becomes acquainted with radio he sticks to it. But the reason radio impresses so many people as being a fad is because of the sudden rush of men from every other field of business into this "royal gold field," the radio trade. Many people argued from this that the radio business could not be very stable or enduring for this reason.

"Fortunately the natural law of water reaching its own level is applicable to the radio industry. Applied to this business of ours it means that men expecting positions or engaging in a business for which they are not fitted soon reach the level for which they are fitted. In some cases this is oblivion.

"The process of elimination has been working slowly but surely, and the so-called radio men who have been either grossly inefficient or unbelievably corrupt are gradually finding out that the time has come to pay for these two cardinal sins of business. The men handling inferior merchandise made by men who did not know how to make any better instruments, have at last awakened to the sad truth that in order to keep a business intact you must deliver the type of merchandise that will be creditable to the business and satisfactory to the ultimate user.

"Radio instruments are so constructed that each part is dependent upon the other for working efficiency. A whole outfit may be put out of commission by a cheap coupling. An inefficient condenser leads to just as bad results as an inefficient amplifier. Con-



A. E. POLLOCK
Sales Manager, Inter-Ocean Radio Corp.

sequently it is apparent that in the industry the vigilance of every one concerned must be exercised if the
(Continued on page 43)

New York Stater Has a Novel Way of Selling Radio Sets

By HARVEY GORDON

In Binghamton, N. Y., there is a firm that appreciates the fact that radio requires ingenuity and salesmanship than most other lines to make it a success. The concern is the Radio Testing Station, of 25 Sturges Street. C. L. Reynolds, the manager, describes what they have done to introduce radio in rural districts.

"First," he says, "we select the community that is least interested in radio. We make arrangements with some amateur to erect a one-wire

aerial on the church, school or whatever building in this community that may be suitable. In most cases we have hand-bills printed, and hire men interested in radio to distribute them. We place an advertisement in a country newspaper, and also have a news item or two written at the same time and see that it is printed in the papers.

"After all these plans are formulated," he continues, "we install a loud-speaking receiving set which is
(Continued on page 42)

Costs of Conducting a Radio Business

Statement of Plain Facts That Should Guide Every Business Man Who Expects to Make Success in Radio

By HENRY L. SEIDMAN
Certified Public Accountant

Men in business have a way of shirking unpleasant discussions. We have found it to be especially true where their own frailties have been called to their attention. And yet, neither the future of radio as an industry nor the future of any other industry is at all assured unless that industry is capable of making money for those who are engaged in it.

Successful executives have long realized that knowing how to figure costs is essential to the success of every business and that it is not a theory advanced by professional accountants for the purpose of making work for themselves, although to the untrained man, the simplest schemes of cost accounting have long been veiled in deepest mystery.

We have wondered for a long time whether it is not such a mental attitude that accounts for the fact that, according to the statistics prepared by the Federal Government, more than half of the 250,000 business corporations in this country work year in and year out without a profit, and that not more than 5 per cent. of the entire 250,000 corporations have any sort of system by which they can record what it actually costs them to make their goods.

In our work we find that the small margin of profit existing in so many of our industries is due almost entirely to ignorance of what the merchandise actually costs. This ignorance causes the making of unprofitable selling prices which forces the business man who does know what his costs are to sell at the same prices in order to meet competition and the entire field becomes unprofitable.

Formerly the necessity for the determination of true costs was not as imperative as it is today. Margins between costs and selling prices were larger. Costs could be ignored except in a general way and a good return still be made on the investment; but today competition is so keen, and new firms are being organized so rapidly, especially in the radio field, that margins of profit in this line as well as in most lines of trade are much more narrowed than formerly, and the necessity for

Making a Profit

At the recent meeting of the Radio Trade Association, Henry L. Seidman, the well-known accountant, made an address in which he warned the members concerning the hazards of not knowing their business costs and in selling their merchandise under cost. Extracts from this address are reproduced herewith, so that the radio trade may avail itself of Mr. Seidman's helpful advice.

the most efficient management and closest analysis is felt as never before.

The beginning of every new industry seems to have been attended by unpleasant occurrences to say the least, and by unpleasant occurrences in the radio field, I mean to call your attention to the bankruptcies and the business interruptions that have taken place. We learned a great deal from these bankruptcies but the results are no different from what has gone before.

An examination of these bankruptcies revealed to us some rather astonishing facts. After we had assembled these facts and interpreted them, we found that 90 per cent. of the men who had failed did so, not because they were such terribly poor business men, but rather because they sold their merchandise for prices which were at cost or below. Those who sold at cost succeeded in avoiding bankruptcy a little longer than the others, but they went. In every case we found that the main reason for selling their merchandise below cost was that they didn't know what their cost of doing business was.

The general practice was to add to the net cost of the merchandise 50 per cent of its cost, and that, in turn became the selling price. The 50 per cent. was supposed to cover all of the overhead charges. If he was a manufacturer, it consisted of all costs of manufacturing such as repairs, depreciation, expenses in the factory gener-

ally; his selling expenses, such as advertising, salesmen's commissions, the traveling expenses of salesmen; his administrative expenses consisting of the salaries of his office force, stationery, printing, telephone and electric light; his cost of financing the business, such as interest on indebtedness, insurance, rent, the various classes of taxes that we have with us today, the cash discounts to customers and dozens of other things.

In no case was 50 per cent. the proper amount. Some cases were down as low as 10 per cent., and we had one flagrantly bad case where a man thought he was making money when he sold the merchandise for what it cost him, but he kept the cash discount of 5 per cent. as a profit.

We made an examination of approximately twenty of these bankruptcies and we found that the average percentage which should have been added to the cost of the merchandise was $83\frac{1}{3}$ per cent. If these men had sold their merchandise for what it cost them plus $83\frac{1}{3}$ per cent. of that cost they would have averted bankruptcy.

A further examination convinced us at that time that $83\frac{1}{3}$ per cent. of their costs was too high. It was too high because their methods and their practices in business were inefficient, so grossly inefficient as to make it so high. Since that time, we have found in our work with the business men in the field today that 50 per cent. is about the right figure.

It has come down from $83\frac{1}{3}$ per cent. because of the fact that the men who had good business training before they entered the radio field brought that business training with them and their past experience taught them where and how to economize to eliminate this economic waste that goes on day after day right under our very eyes, and which is so greatly ignored.

New methods have been introduced and improved machinery installed in the factories every day with a view of reducing costs either by the elimination of waste or the increasing of efficiency. It is impossible, however, to know whether the introduction of

(Continued on page 40)

Economic Sales Factors in Radio Industry

Selling Parts to Amateurs Does Not Produce Satisfaction to Users as Do Properly Designed Complete Sets

By ALEXANDER EISEMANN
Treasurer of Freed-Eisemann Radio Corp.

An analysis of the elements in the radio buying public would appear to divide the public into three classes.

1. The radio experimenter who builds his own set and who rushes eagerly to buy new devices which he thinks will improve its reception.

2. The section of the general public which is temperamentally inclined to purchase a new article before its use has become general. This element buys complete radio sets because it wants to have in radio or in any other field, the satisfaction of knowing that it belongs to a class of progressives always ready to try out a new article.

3. The vast majority of the public that buys only after it has been convinced that the new article is necessary, useful or desirable.

From present indications this third class is not yet awakened to the usefulness and desirability of having a radio receiving set at home and the line of least resistance for the manufacturer and the dealer is to supply whatever element the public is buying. Therefore, the business in parts and accessories done with the amateur who builds his own set, far exceeds in volume the business done with the average man-on-the-street who would never think of trying to construct his own set. The average man on the street, however, is to a certain extent, supplied by thousands of individuals who have become competitors to the ultimate manufacturers.

John Jones builds himself a radio set. He shows it to a dozen or more of his friends and while the home made set is frequently indifferent in its operation, nevertheless, the vanity of John Jones is flattered when his friends ask him whether he will build them a set like his. In every community there are hundreds of John Joneses whose friends pay for the parts and whose compensation for his labor is the satisfaction which his vanity receives in doing something for his friends which they could not do themselves. An investigation, however, discloses that this source of supply is one which seldom gives a good reputation to the radio art.

It stands to reason that these individuals who compete with dealers and



Alexander Eisemann

manufacturers, while they are doing the best they can, have caused the impression to be gained by a tremendous number of prospective radio buyers that, to quote the average phrase, "*It is very interesting but I will wait until something is developed which will be less noisy and more entertaining before I put it in my home.*" Thousands of prospective buyers are "*waiting for radio to be perfected.*" They do not know the degree of excellence to which the apparatus of the larger and more stable manufacturers has attained.

Among their circle of friends you may find one who has a well built and properly designed manufacturers' set to perhaps a dozen sets built by amateurs, of varying degrees of efficiency and audibility.

A friend of the writer who is president of one of the largest banks in Philadelphia, strolled into the office not long ago and remarked jokingly, "I want one of these things when I can understand what is being said, after it has been strained through that complicated looking noise maker." He had listened in on three or four sets built by friends of his sons and considered it an interesting toy for the chil-

dren and was amazed when he heard broadcasting on a properly designed set.

The dealers and the manufacturers have a different problem to overcome in this regard. Radio started with the amateur experimenter and hundreds of newspapers throughout the country are almost daily showing prospective radio buyers how to enter the experimenter class by showing them diagrams, etc., with complete instructions of how he can build his own set.

They do not show him how he could build his own phonograph, nor his own bicycle, nor his own automobile, but they do show him how he could build his own radio set. It would appear that, in spite of the fact that all of us are doing a more or less satisfactory business in radio parts, which we sell at satisfactory profits to these amateurs, nevertheless, the future of our industry is at stake if radio does not gain in popular esteem.

Many of our dealers are already pointing out to prospective customers that, while they can build their own radio sets and get fairly good reception, if built properly, nevertheless, these sets must be designed by a skilled radio engineer in order to get results that will please those who are interested in radio for *results* only, and for whom nothing is of any value except clear and undistorted reception.

Another economic factor in the radio business is that of the maintenance of the list price. I submit that there is but little reason for keeping the list price on an article when the manufacturer hasn't the means or the facilities for maintaining that list price. I do not refer to illegal combines. I merely regard the matter from a strictly commercial viewpoint. All manufacturers would like to see their list prices maintained, but it would appear to be a hopeless task with bankrupt stocks thrown on the market and with manufacturers' surplus sold at or below cost, to endeavor to maintain a list price on some competitive article.

It is ruinous for the manufacturer to buy up all his merchandise which is offered below the list price, and results show that even those who have

(Continued on page 44)

From the Editorial Viewpoint

Proof of the Pudding Still in the Eating

THE RADIO DEALER offers slight apology for talking about itself, but the truth of the matter is that if you don't say a word for yourself the other fellow is apt to take the same viewpoint and presto!—you have a lot of old ground to cover.

THE RADIO DEALER points with pride to its activity of almost one year and wants its newer friends to make mental note of the fact that this paper is the pioneer radio trade paper in the field; that this paper has never sold advertising, except for cash, and that this paper leads the field—in advertising printed and in circulation.

THE RADIO DEALER believes there is a logical reason for the fact that this paper is legitimately the leader in the field.

THE RADIO DEALER believes the radio trade has approved of our efforts to develop a better spirit of commercial endeavor in the radio trade.

THE RADIO DEALER believes that the trade approves of our 100 per cent. constructive attitude.

THE RADIO DEALER firmly expects to maintain its present policy of trade improvement and we reiterate our statements to the effect that the fakirs in the radio industry will *not* be permitted to purchase space in this paper.

THE RADIO DEALER holds no plea for the self-avowed believers in the divine-right theory—as applied to the radio industry.

THE RADIO DEALER welcomes the continued support of the honest tradesmen and those who believe in the future of radio

Trade-marks Are Pirated In Many Foreign Countries

According to the American Manufacturers' Export Association, firms doing business in foreign lands are the victims of unrestrained trade-mark pirates to an extent unknown to the average American concern making effort to do business in other countries.

During the past twelve months no less than 430 American trade-marks were pirated and of this total Cuba appropriated forty-seven trade-marks. France came next with forty, Japan adopted thirty-nine and Germany thirty-four. Other countries came in this order: Argentina, 33; Great Britain, 32; Uruguay, 25; Canada, 24; Australia, 21.

These figures must be of interest to manufacturers aiming to establish foreign business and the situation makes it almost imperative for American manufacturers to take proper steps to protect their brand names.

Manufacturers who expect foreign business should be willing to make some attempt to protect their business, and

the very best plan is to consult some reliable patent attorney.

The foreign countries have regulations for safeguarding foreign trade-marks and while some of these lands exact unfair taxes, the prospective exporter should learn just what he is to contend with by investigating before exporting.

Secretary Hoover Expected To Solve All Air Troubles

If the White Bill, now before Congress is enacted into law, Secretary Hoover will be given great powers and it is expected that this noteworthy business-like Cabinet official will correct some of the present broadcasting difficulties developed from the lack of sufficient legal supervision.

Secretary Hoover will probably suggest methods of avoiding air conflicts, now in evidence, and it may be that Secretary Hoover will suggest proper plans that will not only remove air conflicts, but will develop better air concerts for the millions of listeners-in.

The possibilities for better broadcasting arrangements are evident—to any intelligent bystander and the great mass of citizens really look forward to Mr. Hoover to straighten out the broadcasting stations conflicts—to the end that the public shall best be served.

There is no fear on the part of the radio industry that Herbert Hoover will mismanage the ether situation. The public has great faith in his ability to solve the world's latest problem and while this work may not be as well advertised—in the press—as have some of Mr. Hoover's other activities, the esteemed statesmen can feel assured that the radio enthusiasts can be expected to remember him and to praise him for work well done.

Electrical Men Are Attracted to Radio

Significant is the fact that the electrical men are beginning to evince a real interest in radio and its possibilities. They are putting their ears close to the ground, and at practically every convention of electragists, as they are now calling themselves, the question is discussed as to the part the electrical dealer will play in the radio development. This is generally from the interested viewpoint which resolves itself into the query of "How will radio aid the electrical man?"

The strongest argument in favor of having electrical men take up radio seriously has been advanced by George Patterson, of Stanley & Patterson, of New York. He asserts that the electrical business as at present constituted

is too limited to provide a steady and profitable income for the electrical man. There are not enough lines to insure a year-around business according to Mr. Patterson, so that the advent of radio may be compared to the discovery of a spring of water in the desert, from the electragist's point of view.

So far it seems that electrical men regard radio merely as a side-line. Those who have the most faith in radio regard it as quite capable of establishing a permanent and distinct form of retail trade—radio retailing. Radio as a side-line of the electrical store obviously can not experience the same development and prestige that radio, in the hands of men who devote all their energy and their time to it, will achieve.

The field is at present being developed for the exclusive radio trade. Radio advertising and radio organization are directed to the exclusive radio specialist, because he has the true interests of the radio industry at heart.

Summer Appeals Should Create Fans

Selling radio sets or equipment is like starting perpetual motion. The splendid results experienced by radio dealers the country over during the Christmas buying season are a cause for congratulation, for they will insure steady buying during the Winter and Spring months.

Once the potential customer has been bitten by the "radio bug," the desire for radio spreads, and expresses itself in the purchase of additional equipment, improved parts, the switching from one style of set to another, and above all, in the ceaseless attempt to listen in on greater and greater distances.

Radio dealers may confidently expect to profit from the introduction, this Christmas, of radio into many homes, where it was previously unknown. The effects of this will be felt all through the winter and spring months.

But what of the Summer? Is radio to experience a slump in 1923 similar to the one felt last June? Not if radio dealers are awake to their opportunities and responsibilities.

Looking ahead now to what may possibly happen next June seems like crossing a bridge before coming to the stream. But it may be said that without some pretty deep thinking and planning now, radio may possibly experience a slump this coming Summer.

Fortunately the fate of radio is largely in the hands of the radio dealer. The old alibi that "static" ruined any chance of Summer trade has been discounted since Perce B. Collison tore it to pieces in an article in *THE RADIO DEALER* of last June.

The big obstacle that the radio dealer must work against during the Summer is the desire of folks to be outdoors. Radio's great selling-point during the Winter is that it is "the center of the cozy fireside," "the magnet that draws the family circle together" or that "it brings the achievements of the world to your living room." These points are not so appealing during the Summer time. It is the duty of the radio dealer to induce the prospective purchaser to take radio out of doors with him.

The Storm Has Passed

The storm came last Summer with but little warning; with the force of a hurricane it swept destruction on right and left. In its wake many a business was wrecked.

But it left its lesson behind.

Those that builded on a firm foundation survived, but the many that went into radio without capital, experience or appreciation that honestly made goods are essential to success, did not endure.

It is well they did not.

When a garden is planted, many seeds are put into the ground that are destined not to survive. Some do not germinate; they are too weak. Others are killed by the hot sun or from lack of moisture; they lack strength. Still others, that appear strong and healthy, are plucked by the Gardener; they must needs be weeded out so that the plants may mature and bear fruit. So it was in the radio business.

More manufacturers and dealers started in than were needed by the industry. The slump came; some were killed, and conditions weeded out others until now a much more healthy situation exists than before.

The outlook is brightening rapidly; business is increasing, and reports from all over the country indicate better business and encouraging prospects. While recovery has been slow, from all appearances it is to be continuous, for now the radio is settling down to be a stable industry that is endeavoring to manufacture and sell products that are of merit and of value.

Fight Arguments Opposed to Radio

Enemies of radio, including politicians who fear radio's power to transmit the truth, and others hurt by radio, are not far to seek. It is in their interest to say that radio is a "fad," and to cast slurs on its efficiency and appeal.

There are many ways of combatting this vicious propaganda and the radio dealer should not be slow to take the measures in his power to prove to the public, if proof is necessary, of the desirability of radio.

It is to be regretted, however, that many dealers do not help radio by their selling methods. We have particularly in mind the system of placing a loud speaker above the entrance to the store and filling a whole street with loud, confused and indeterminate shrieks. The person, who is not acquainted with radio, will be repelled rather than attracted by this demonstration, thinking that no better results than this continued howling can be obtained.

It is true that the radio dealer using this device is taking advantage of out-door publicity, but there are two kinds of publicity, helpful and injurious. There can be no doubt as to which category the street loudspeaker belongs.

How much better is the private demonstration in a specially-constructed demonstration room, similar to the ones found in any up-to-date phonograph shop. Copy from the phonograph dealers? Why not? The successful business man is always learning from others.

Development of Wire for Radio Antennas

Story of Wire Drawing from the Earliest Crude Methods to the Molten Welded Process with Hot Rolling and Cold Drawing

By L. N. ALLEN

Early in the history of man, almost in prehistoric days, wire was made. The story of its development is most interesting and culminates in the production of a steel wire covered with copper which, when stretched from home to tree, catches something that cannot be seen that is transferred into human song and laughter.

The manufacture of metallic filaments or shreds, known as wire, dates back to the early ages of man. According to excellent authority, evidences of it can be traced to early Egypt. Gold wire is mentioned in connection with the decorations of the robes of Aaron, while metallic shreds have been discovered that date back to about 1700 B. C. Homer and Pliny in their early writings made reference to similar products. Metal heads, having imitation hair made of wire were recovered from the ruins of Herculaneum.

From these remote times up to the Fourteenth Century, wire was made by hammering out strips of metal, inasmuch as the modern process of drawing had not then been invented. The first advance in the process of wire manufacture was made when the die was introduced. This consisted of a flat block of metal, having a hole, slightly tapered, bored through it.

The die was securely fastened to one end of a table, or bench, as it was later called, in such a position that the hole was in a horizontal position and longitudinal to the bench; the smaller end of the tapered hole towards the far end of the table.

A round rod slightly larger than the smaller end of the die hole was previously hammered out from a small casting while still hot. It was sufficiently tapered at one end, so that when inserted in the die, a few inches protruded from the opposite side. When this rod became entirely cold, the tapered end was inserted in the die. The protruding end, gripped in a clamp securely fastened to a chain, was pulled from the far end of the table. The rod was drawn through the die and by this simple process became wire.

Smaller sizes were obtained by tapering the end of the wire, inserting it through a smaller die, and again

drawing it. The reduction in diameter elongated the wire. The length of wire obtained in this manner was limited to the length of the table.

This difficulty was later overcome by coiling the wire around a power driven drum instead of pulling it the length of the bench. This permitted the use of longer rods, therefore giving a greater length of wire. The introduction of the rolling mill, taking the place of the laborious hand hammering of rods, was a boon to the wire industry.

Present methods of rolling rods and the drawing of them into wire have increased the wire lengths from the few feet of the Fourteenth Century to the several miles of today.

Practically every metal known can now be drawn, due to the many refinements in the art of wire drawing. Larger sizes are drawn through steel or chilled iron dies, while very small sizes of wire are usually drawn through dies made from diamonds or hard semi-precious stones.

The hot rolled rods have but a small percentage of the tensile strength induced by subsequent cold drawing. This cold drawing hardens the metal while reducing its diameter. Hardening it gives strength. However, there is a point of hardness at which the metal becomes brittle and again loses its strength. Before this point of brittleness is reached, drawing must be stopped. Hard-drawn copper is weak when compared to steel, and aluminum

has less than half the strength of copper.

The two metals commonly used for wire are copper and steel. Both have serious limitations. Copper, used mostly for electrical purposes, being weak stretches and breaks, so cannot be used for long spans. Steel wire is strong but a very poor electrical conductor. It rusts rapidly even when protected by a galvanized coating.

The need of a high strength non-corroding electrical conductor was seen some forty years ago. Many attempts have been made to combine these metals with their ideal characteristics into a single wire. Wrapping steel wire with copper strip was tried with disastrous results, due to electrolytic action between the two metals. Plating was tried with similar results.

Finally after years of research the molten welding process was developed whereby a thick layer of highly heated copper is cast around a large steel billet, previously heated to a white heat. The two metals weld together and cannot be separated. This welded billet is hot rolled and cold-drawn into wire as previously described. This wire is known as Copperweld.

Aerials for radio stations is one of the uses to which Copperweld is particularly adapted. Its conductivity at radio frequencies is equal to that of pure copper and is much stronger, due to its high strength steel core. It is the recognized wire for commercial and amateur radio stations.

Trade-Marks Should Receive Federal and State Protection

By CHAUNCEY P. CARTER

The trade-mark committee of the American Bar Association has just completed a draft of a uniform state trade-mark law which will be submitted to the legislatures of the different states for enactment at an early date by the association's committee on the uniformity of state legislation.

This action of the national association of attorneys serves to emphasize to many and to bring to the attention

of others the fact that in addition to the Federal trade-mark registration law, there is in practically every state a state law providing for registration of trade-marks.

Trade-mark specialists are often asked, "What is the value of necessity of state trade-mark registrations?" and "Isn't my federal registration sufficient without the necessity

(Continued on page 45)

Insulation Facts the Dealer Should Know

Synopsis of Educational Talk Advocating the Use of Hard Rubber Products That Was Recently Broadcasted from WEA F

By O. B. CARSON

Of the American Hard Rubber Company

The tremendous interest of the general public in radio has developed an entirely natural thirst for information on every phase of radio construction and the materials used. Sometimes this takes a humorous turn—for instance. One puzzled radio fan asked his favorite New York newspaper if it was necessary to remove the mattress, blankets, and other bed coverings in order to use the bed spring as an antenna on a crystal set. The editor's answer is unknown.

But for the most part questions of a practical and serious nature are asked and the dealer is the logical man toward whom to turn for authoritative information. Familiarity with materials and why they are peculiarly adapted for certain purposes enables the dealer to generate good will through service to his customers and exercise a powerful sales advantage.

One of the substances which has established its peculiar adaptability for radio insulations is Radion. It consists essentially of a compound of rubber and sulphur into which other ingredients are incorporated and which when vulcanized or "cured" will produce a material best suited to the purpose for which it is to be used.

Other than Radion there are a great many hard rubber compounds. Some of them are more suitable than others for radio insulations. However, in general, hard rubber compounds possess in a high degree those characteristics most necessary for insulating materials employed in making radio panels and such molded parts as dials, knobs, sockets, insulators and the like.

It is a fact generally known that high frequency currents are difficult to control, and consequently radio receiving apparatus is best which is designed and made of materials which permit the smallest possible electrical losses.

Radio engineers have determined that there are four most important characteristics to be considered in panel or other insulating material. These are phase angle difference, dielectric constant, resistivity, both volume and surface, and the tendency to absorb moisture.

Phase difference is a property which expresses the heating of the material and at radio frequency largely determines the radio frequency voltages the material will stand without injury and power loss in insulating parts. It introduces resistance in the circuit and diminishes selectivity. The phase difference should be the lowest possible.

Dielectric constant is an important factor in the material used in making the condenser. It determines the amount of alternating current which flows when an alternating voltage is impressed on the condenser. It also helps in determining how much the condenser heats and the high frequency voltage at which the insulating material is injured.

Surface and volume resistivity determine the resistance to the passage of an electric current across the surface or through the insulation. The higher the resistivity the better the insulation.

Absorption of moisture has a most

important effect on many of the electrical properties of the material, especially on phase difference and resistivity. Insulating material should therefore absorb no moisture and have a high surface finish to produce the best results throughout all seasons and in climates where humidity is a serious factor.

Radio insulations commonly used may be divided into three classes: Special hard rubber compounds, phenolic compounds, which include also the laminated phenolic material sold under various names; and compositions of shellac, tar and similar materials.

Shellac and similar compounds are the cheapest and do not possess to a very high degree the essential characteristics cited in the preceding paragraphs.

In the laminated phenolic compounds the base consists of sheets of paper, fabric or fibre, and the binder is a phenol, or, as commonly known, a condensation product of carbolic acid. These materials possess characteristics for phase difference, dielectric constant, surface and volume resistivity to a much higher degree than the shellac compounds.

Now a hard rubber compound best suited for radio use, besides possessing these necessary electrical characteristics, must be non-porous, non-absorbent, permanent, easily, quickly and accurately moulded and machined with ordinary tools without danger of chipping. It must also be low in free sulphur content, and the sulphur must be fixed in the compound so that it will not come to the surface or "bloom," as it is called. Radion is a compound which has been developed particularly for radio panels and insulations, which meets the most important requirements.

Results of investigations by the Bureau of Standards show that Radion has a phase difference of one-fourth, a dielectric constant of one-half, and an absorption of moisture of one-fourteenth of these same characteristics for phenolic and laminated phenolic materials.

Experts have produced this mate-
(Continued on page 46)



O. B. Carson

Selling Radio Apparatus With Cut-Out Sections

By **HERBERT E. METCALF**

Sales Department, The Magnavox Company

If you were to visit the majority of the high-grade automotive agencies in the cities today, each of them would be sure to have somewhere in their shop or display room a recent model of their machine, which had been cut so as to show the action of the engine and various other moving parts.

More than likely when a prospective customer calls he or she is conducted to the sectionalized machine where the salesman with convincing evidence in front of him can show the customer just where the superior qualities of his merchandise lies. At almost any place where the public in general, or, as it might better be stated, prospective customers, congregate such as, for instance, automobile shows, such sectionalized models are greatly in demand.

Particularly will such demonstration machines be valuable for the demonstration of any unique principle, or one which is different from the ordinary run of machines and different from those with which the general public is familiar.

Radio is a new art, one in which the merchandising plans and methods are new, and yet there are many things which can be learned by a study of some of the older and better established industries such as the automotive field. Magnavox radio is a loud speaking reproducer, differing greatly from any other. At first it was difficult for the average customer, whether he be jobber, dealer or consumer, to visualize its action and inward construction.

Even though taken apart, exposing the various units, it is hard to see just what makes it go. So, by taking a lesson from the time-tried and successful custom of the automotive industry, all Magnavox radio salesmen who visit the jobbers and dealers have been equipped with a sectionalized electro-dynamic receiver.

This receiver is simply a standard radio reproducer which has had a section cut out of it exactly the same way as one cuts a section from a piece of pie. In this manner every moving part in the instrument is exposed to view. The field coil within the case is shown with its many turns wound with mathematical regularity. The entire magnetic field circuit can be seen and a customer can at once visualize just how the magnetic air gap

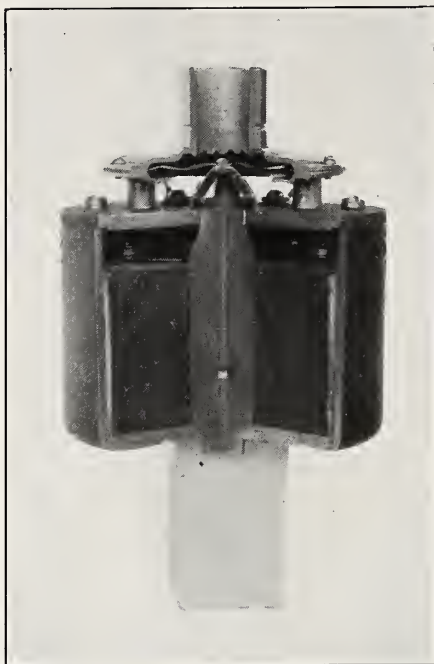

Cut-Out Section of Magnavox Sample

is energized. In this air gap rests the little coil which generates so much power. The fine wire wound on the little bakelite coil frame in a depression bit by a diamond tool, is easily visible and one can immediately see how the power and energy of this little coil is transmitted by means of a conical support to the diaphragm.

The corrugations of the diaphragm explain how the soft nickel-silver is made stiff enough to withstand the heavy push and pull of the coil and yet be soft and pliable enough to withstand crystallization from millions of tiny reversals of motion. The observer can see at once the peculiar shape of the sound box whereby the air displaced by this diaphragm is passed into the horn.

As this is brought directly to the customer's view there are no more questions asked as to what is actually inside of this instrument. They can see for themselves that the field coil fills the entire base, that it serves a most useful purpose, and that the can is not there just to make the instrument look larger than it really is.

The salesman who is equipped with an instrument of this sort has a powerful advantage when it comes to influencing the purchaser. He can demonstrate with standard equipment the performance of this machine, and then show the buyer just how his demonstration was superior because of the unique construction of the instrument. He can show him so that he will forever remember it by means of the sectionalized samples.

It always pays to take a tip from other industries, and the radio industry today is no exception. Numerous other opportunities to make use of the time-tried selling helps developed by other industries are constantly available. Let us keep our eyes open for them and use them for radio, for it is certain that the radio is now an industry of its own and before long will be having other industries looking to it for ideas in selling and merchandising problems.

Cut Prices to Consumers Menace to Rural Dealers

By **H. S. WEBSTER**

Radio Dealer, Lyndon Center, Vt.

The rural radio dealer is confronted with his own problems. In the country districts some dealers cover territory extending over three counties, yet with a combined population of not more than a closely populated city block.

In order to cover this extended territory, the country dealer is confronted with large expense, as his prospects are widely scattered, and to reach them miles of poor roads must be traveled.

One of the latest problems with

which the rural dealer is forced to contend is that certain department stores and jobbers in the larger places are selling new and up-to-date apparatus and sets at what appear to be wholesale prices. Recently a gentleman in our territory purchased a complete set at one of these reduced price stores. He set the apparatus up himself, and naturally fails to get good results. The outfit was accordingly condemned as being no good.

Shortly after this the country dealer
(Continued on page 50)



This publication offers useful selling suggestions.

Building Business with the MAGNAVOX Radio

AS an alert and well posted dealer you have not failed to follow Magnavox National Advertising as it has appeared month after month in Saturday Evening Post, Literary Digest, Country Gentleman, American Magazine and other publications of character and influence.

On the right of this column we show the illustration used in the Magnavox advertisement for the current month.

From the beginning of Radio, the position of Magnavox products has been unusually favorable and secure.

A word of friendly advice to dealers is this—do not overlook the tremendous value to your business of using the splendid selling helps furnished all those who carry the Magnavox Radio and Power Amplifier in stock.

Magnavox selling helps popularize the entire "radio idea" wonderfully, and bring customers to your store for all radio supplies.

The whole story of our free dealer service is told in THE MAGNAVOX, illustrated above. Be sure your name is on our list to receive every copy as published, and be sure that your Magnavox stock is adequate. Write us today.

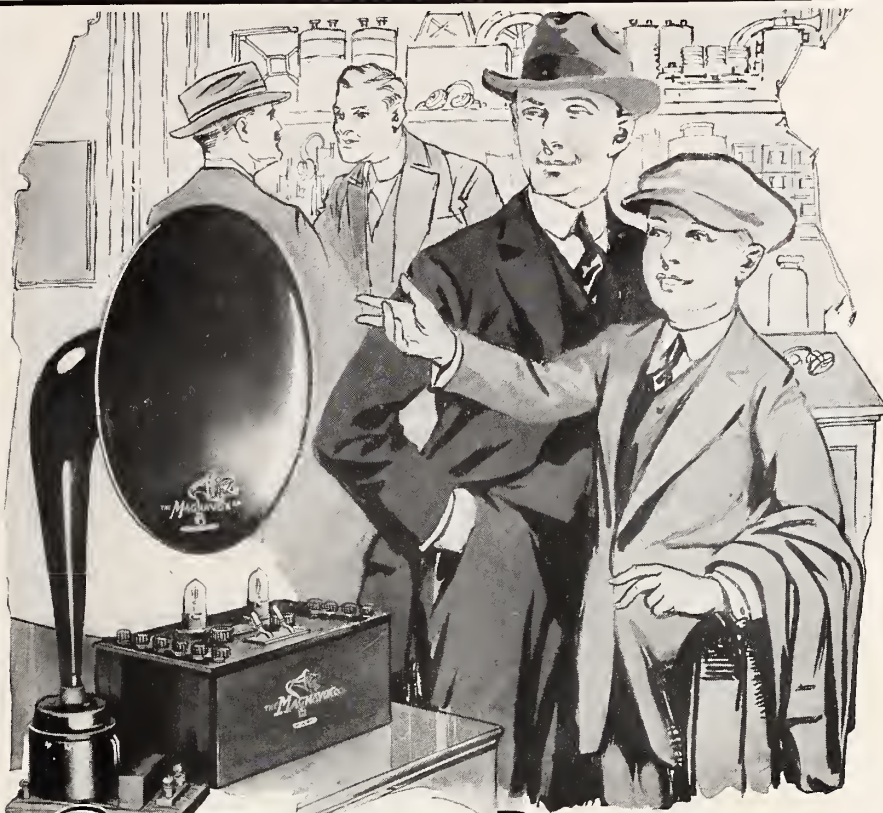

No Wireless Receiving set is complete without



WHEN your boy points to the Magnavox trade mark and says "Dad, that's the real reproducer," he sums up pretty much the whole story of Magnavox supremacy and radio enjoyment.

To enjoy all that radio offers, ask your dealer for a receiving set equipped with Magnavox Radio, the Reproducer Supreme and the Power Amplifier.

R-2 Magnavox Radio with 18-inch horn: for those who wish the utmost in amplifying power; for large audiences, dance halls, etc. . . \$85.00

Model C Magnavox Power Amplifier insures getting the largest possible power input and volume for your Magnavox Radio. 2 stage . \$80.00
3 stage . 110.00

R-3 Magnavox Radio with 14-inch horn: the ideal instrument for use in homes, offices, amateur stations, etc. \$45.00

Combination R-3 Reproducer and 2 stage Power Amplifier Price \$125.00

Magnavox Products can be had from good dealers everywhere. Our interesting new booklet (illustrated in three colors) will be sent on request.

The Magnavox Co., Oakland, California
New York: 370 Seventh Avenue

MAGNAVOX Radio The Reproducer Supreme



What the Manufacturers Are Doing

New Manhattan Instruments

Performance and appearance are the keynotes in the construction of the Manhattan bakelite vario-couplers and variometers. These instruments display in their careful finish and attention to detail the painstaking design

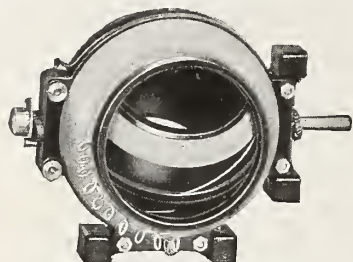

Manhattan Vario-Coupler

upon which their construction has been based.

The material used, for instance, is moulded bakelite, reddish brown in color and neat in appearance. The amount of metal used in the instrument has been reduced to a minimum to keep the electrical loss as low as possible. Bakelite is used as extensively as is practicable because its electrical qualities are well known and its strength insures a rigid construction.

Since both vario-couplers and variometers are frequently mounted on "shielded" panels, the Manhattan instruments are mounted on a bakelite block. By this simple device the vario-coupler or variometer can be used on a metal panel without the

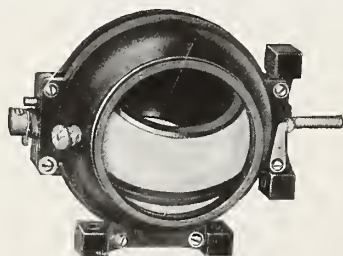

Manhattan Variometer

usual difficulties connected with insulation.

The makers of the Manhattan instruments claim additional features for their products. Both instruments are provided with heavy braided "pigtailed" making connection with the rotating member. This is said to insure positive contact and quiet operation.

Both instruments have a stator with a one-quarter inch collar, permitting the conversion into a long wave coupler by attaching a standard three inch bakelite tube.

The Manhattan vario-coupler has a primary winding with twelve taps with control of wave lengths up to 700 meters. The variometer has a wave length of 140 to 420 meters as connected in an ordinary hook-up.

These instruments are made by the Manhattan Electrical Supply Company, Inc., 17 Park Place, New York City.

Robbins Air Condensers

One of the pioneer makers in the condenser field, the Robbins Electric Co., 830 Liberty Ave., Pittsburgh, Pa., have now standardized on four capacities of variable air condensers which have 3, 11, 23 and 43 plates.

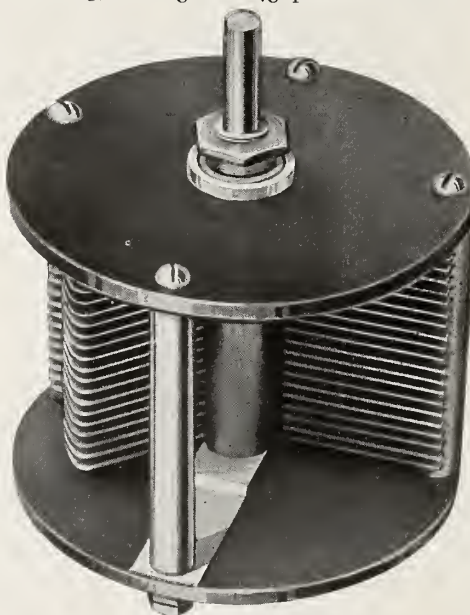

Robbins Condenser

Some of the advantages claimed for these Robbins condensers are: Single hole mounting, for if one hole is bored in the panel the mounting of the condensers is only the operation of a fraction of a minute. The single hole mounting is also said to eliminate twisting strain on stationary plates. There are no steel parts, the instruments being entirely constructed of aluminum, nickered brass, lead alloy and bakelite. The ends are of sheet bakelite, and full circle disks add to the rigidity of construction and protection of plates in all positions.

The plates are not of the washer type, but are anchored by lead alloy in slotted brass tubes, slotted with accuracy on milling machines. Spacing is thus held to the correct limit, and constant alignment is assured.

Readily Adjustable Grid Leak

The adjustable grid unit that has just been placed on the market by the Central Radio Laboratories of 303 Sixteenth street, Milwaukee, Wis., consists of an adjustable grid leak and a grid condenser, the latter being



Adjustable Grid Unit

mounted between the outer ends of the grid leak binding posts.

The high resistance of the leak can be gradually and smoothly changed to any desired value between one-half and four megohms merely by turning the operating knob. The point of maximum sensitiveness can be definitely and quickly ascertained.

Mounted on the bakelite base is a fabric strip, the ends of which are connected to the binding posts shown in the illustration. The fabric strip is impregnated with a high resistance compound of tested permanence. The current from the grid leaks along this strip, the amount being regulated by adjusting the area of contact of the strip with a curved phosphor-bronze spring that is held in place by a compression block. The compression block is operated by the screw attached to the operating knob. As the knob is turned to compress the spring, a larger area of the spring comes into contact with the fabric strip and the resistance between the binding posts is decreased. More current leaks across and the potential of the grid is decreased. Turning the knob in the other direction decreases the area of contact and cuts down the current leakage and permits a higher potential between the grid and the plate. The potential that provided the maximum signal strength is thus obtained with ease and certainty.

The entire unit, which is mounted through a single hole in the panel, takes up a space $2\frac{3}{4}$ inches long and $\frac{3}{4}$ of an inch wide.

Wide Range Condenser

According to the Bureau of Standards, an ideal condenser would have constant capacity under all circumstances, with zero resistance in the leads and the plates and no absorption in the dielectric. The Magnus Electric Company, Inc., 17 Desbrosses Street, New York City, are offering the Magnus Wide Range variable condenser as filling the specifications for



Magnus Wide Range Condenser

this ideal condenser as closely as possible.

The Magnus condenser differs from the general trend of instruments in that instead of using a large number of plates for high capacity, two heavy plates are used. By means of a differential screw, the two plates can be separated by infinitesimal degrees, the two plates being separated by one-hundredth of an inch through turning the dial once. The dial has 360 scale divisions so that turning it one division would mean separating the two plates by $1/36,000$ of an inch. Thus a very high capacity is obtained.

The plates used are heavy die-castings instead of the familiar semi-circular sheets now on the market. This gives a very low resistance in the plates of the condenser. Circular plates are also superior from a mechanical point of view, the makers assert, since there is no chance of buckling or bending of such plates. Their permanence and rigidity and high electrical efficiency are thus secured.

Kester Wire Solder

The Kester Acid-Core wire solder is made of hollow wire of genuine tin and lead containing pockets which hold an acid fluid and is sold by many wholesalers, to the radio trade. Kester Solder is put up in one pound cartons, and on one, five and ten-pound spools. This solder is made by the Chicago Solder Co., 4201 Wrightwood Ave., Chicago.

With twelve features of superiority, yet within the reach of every radio user.

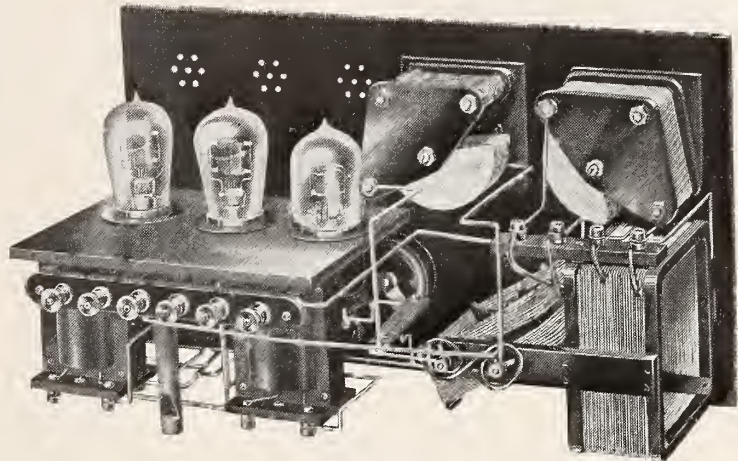

Rear View

JEWETT SUPER - TWELVE SELF CONTAINED VACUUM TUBE RADIO RECEIVER

Meets the demand for a complete receiver, combining good range, extreme sensitiveness and selectivity, with moderate price and economical operation.

The Jewett Super-Twelve has a double circuit tuner, constructed with new Jewett coupler of extreme selectivity, designed by Professor J. H. Morecroft of Columbia University. The adjustments are unusually simple and easy, requiring no special technical knowledge to insure success.

Two steps of amplification are furnished which give an increase of signal strength equal to that obtained from three or four steps employing ordinary transformers. The high quality of the incoming speech or music is sustained through uniformly high amplification over the entire musical scale.

Operated with W. D. 11 Tubes and Dry Cells or storage battery; also with indoor aerial or loop.

PRICE, \$75.00

In Kodak, Mahogany or Walnut Cabinet

JEWETT MANUFACTURING CORPORATION

Herbert F. L. Allen, *President*

NEWARK

NEW JERSEY

The Loop's the Thing

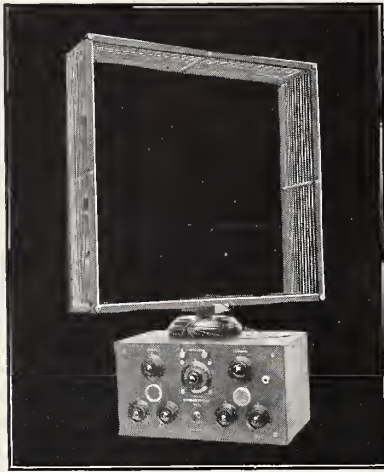

As the
Vacuum Tube
has Replaced
the Crystal
so the
PORTABLOOP
is Replacing
the Outside
Antenna

Stock up
Before the
Spring Rush
Makes a
Shortage



210 Central Avenue

Reception Noises Are Not Caused by "B" Batteries

By BERNARD J. FARRELL

Assertions that the "B" battery is the cause of noise in radio reception have been made and refuted since radio began to experience national popularity. The latest argument in defense of the "B" battery is contained in a statement recently issued by the National Carbon Company, Inc., of Long Island City, N. Y.

"The truth about the matter," this publication states, "is that there is no such thing as a noisy 'B' battery. What is more," it adds, "there never was one and there never will be one. It does not matter whether it is a dry 'B' battery or a storage 'B' battery. It simply cannot produce noise on its own account.

"Of course," it proceeds, "if there is a loose or faulty connection in the battery, the connection may cause noise; a poor contact will do that anywhere in a radio set. But there is nothing in the cells themselves which can produce noise.

"Noise in radio receiving sets," the statement continues, "is always the result of irregular fluctuation in 'B' battery current. Anything which can set up these irregular fluctuations becomes a source of noise. If we carefully analyze the average receiving set, we find literally dozens of places where noise may originate. Why, then, should we indiscriminately blame the 'B' battery?"

"It has been observed that the tendency for certain factors to produce noise is aggravated by sub-normal 'B' battery voltages. This is why batteries are believed to become noisy when nearly exhausted. Substituting a new battery for the old one will stop the noise, not because the old battery was noisy, but because this procedure restores the voltage to normal, under which conditions noises are less likely to occur."

The statement goes on to state that there are so many diverse causes of noise in radio reception that radio engineers are still at a loss to explain them all. And yet, it asserts, the local "radio expert" is willing to lay all the blame upon the "B" battery. Even today radio engineers are at work trying to eliminate noises from reception.

"This elimination will not be accomplished suddenly," the statement resumes. "It will come as the consequence of evolution. It takes years to

perfect any new device. The radio receiving set of today will doubtless pass through several stages before final perfection is reached." As an illustration, the evolution of the telephone to its present perfection is cited:

"It took many years of intensive study and development work before the telephone became a reliable instrument. And one of the big difficulties encountered in the early days was what telephone engineers thought to be noisy batteries. This was a real problem, and the best minds of the time unhesitatingly blamed the batteries for certain otherwise unexplainable noises. Yet time has proven that those troublesome noises did not originate in the batteries. As the telephone went through its natural period of evolution, the noises gradually ceased, and today, a noisy telephone battery is unheard of, although there are millions of dry cells in telephone use.

"The refinement of radio receiving sets will follow much the same lines as in the refinement of the telephone. One by one the things that now cause noise in a radio receiving set will be eliminated and eventually, we hope soon, all talk about noisy 'B' batteries will be as extinct as talk about noisy telephone batteries.

"Select your 'B' battery carefully. Any manufacturer's claim of noiselessness should be considered only with respect to the quality and permanency of the connections between the cells in the battery. Consideration should be given to the reputation of the manufacturer. Choose a 'B' battery made by a manufacturer of established reputation whose products are backed by extensive research laboratories."

Value of R. T. A. Membership

That membership in the Radio Trade Association is a valuable asset in business is shown by the fact that it appears to be the vogue for members to make the fact known that they connected with this organization. One of the first of the distributors to do this is R. R. Garrick, 126 North Redfield Street, Philadelphia, Pa., who carries at the foot of his new letterheads the line, "Member of the Radio Trade Association."

ALL PRODUCTS GUARANTEED



The MICAPHONE

Money Back Guarantee

Trade **KODE KILLER** Mark

- (1) Kills code—both amateur and commercial.
- (2) Separates interfering broadcast stations.
- (3) Gives sharper tuning.
- (4) Does NOT cut down signal strength.



Send \$5.75 for trial sample. Big discounts in quantities. **LISTS AT \$7.50**

Mica Diaphragms made for all phones

Scientific Construction Rubber Mounting

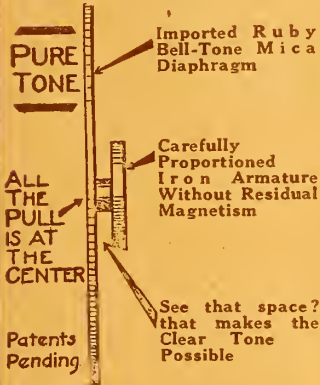

Send \$13.75 for trial dozen pair assorted sizes to fit all phones.

Mounted on attractive counter display easel. Complete with size list, circulars and window display easel.

They make all phones better.

2 Big Profits for You!

List \$2.00 Per Pair

RADIO MICA PRODUCTS CO.
156 EAST 43d STREET, NEW YORK

KNOWN FAVORABLY EVERYWHERE

CROWN Triple Coil Calibrated Mounting

There is nothing more fascinating than the reception of Radio messages from high power stations located thousands of miles away. These stations use wave lengths between 1,000 and 25,000 meters. This is far above the receiving range of the average receiver designed for amateur broadcast reception.



This "Crown" Mounting has the following special features:

1. Made of Thermoplax, a high grade insulating material; it possesses the advantage over rubber of resisting heat to a far greater degree. It has high dielectric and mechanical strengths, is non-hygroscopic, is unaffected by atmospheric agents and will not deteriorate with age.

2. Special Locking Device to keep the coil in place, thus preventing it from being thrown out of adjustment.

3. Special Adjustable Bearing feature.

4. Special constructed Bushing, preventing wear on top and bottom plates.

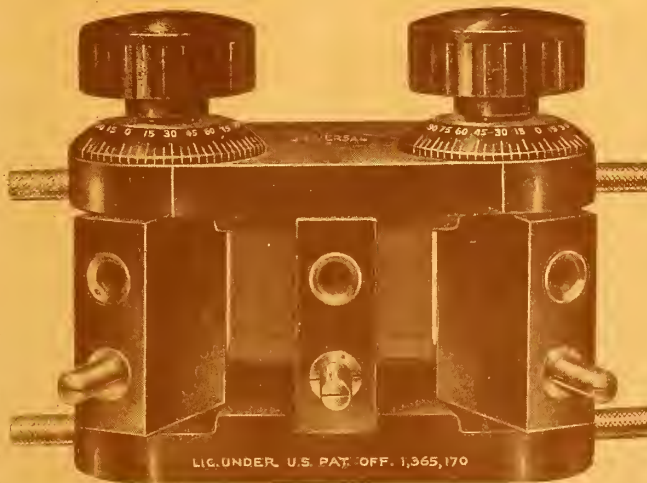

Licensed under DeForest U. S. Patent, No. 1,365,170

5. Special constructed Calibrated Dial, showing the stations tuned.

6. Positive Connections on rear of blocks.

7. Complete with Flexible Leads.

8. All Metal Parts of brass and highly nickel plated. Its high polish and fine finish give it a very attractive appearance.

9. The simplest Mounting to install on your set.

List Price

Triple Coil Mounting . . . \$5.00
Single Coil Mounting50
Telephone Plugs 1.00
Telephone Jacks . . . 65c, 80c, 95c
Dials 2", 3", 3 1/2" . . . 35c, 50c, 75c

DISTRIBUTORS WANTED. WRITE FOR OUR PROPOSITION AT ONCE.

CROWN RADIO MFG. CORPORATION

78 FIFTH AVENUE

NEW YORK

Good bye Aerials!

This ingenious cylinder (SHORT-CUT ANTENNA)—just perfected by radio engineers—takes the place of aerials, loops, plugs, etc.,—and makes the radio set PORTABLE!

Eliminates lightning dangers, landlords' objections, static interference—brings clearer signals and greater reception. Fits all standard sets—simply connect to aerial and ground terminals of set.

One New York department store sold dozens in a single day—what an opportunity for you!

To be nationally advertised—think of the demand. Sells for \$5—satisfaction guaranteed.

SHORT CUT RADIO CORPORATION

243 West 54th Street
New York

DEALERS!

Write for our attractive proposition on SHORT CUT ANTENNA.



Size
2 x 6½
inches

SHORT CUT RADIO CORPORATION
243 West 54th Street, New York
Send me at once full particulars on your
SHORT CUT ANTENNA.

NAME

ADDRESS

CITY STATE

G-M

GUARANTEED RADIO APPARATUS

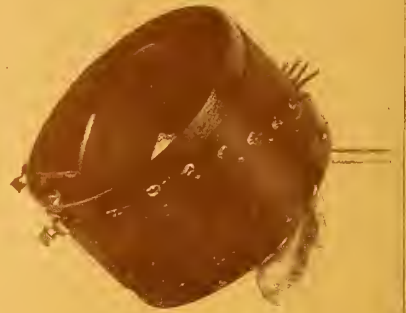

VARIOCOUPLER

Reinforced taps, Cellulac tubes, full 180° rotation

List Price, \$4.00

WRITE FOR PRICES ON

Antenna Plugs
Antenna Wire
Honeycomb Coils
Insulators
Insulite Panels
Jacks
Planet Loud Speakers
Plugs
R. F. Transformers
Sockets
Socket Rheostats
Variable Condensers
Variocouplers
Variometers

NATIONAL DISTRIBUTORS
OF
QUALITY PRODUCTS

GENERAL MERCHANDISE CO.

6 Academy St., Newark, N. J.

Manufacturers and Distributors

Phone Mitchell 2746

Dealers Should Test Their Head Phones

(Continued from page 23)

The two wires leading from the phone are attached to the two nearest springs of the binding posts. To the other two springs are joined the ends of a single telephone cord. Everything is now ready for the testing.

The person testing takes the master phone (one that is beyond reproach) in his right hand and with his thumb, presses the tips of the cord attached to the posts into their place in the phone. With his left hand he throws the switch. A loud steady "buzz" should be heard. He immediately replaces the master phone for one that is to be tested and in this manner a comparison is easily made.

If two phones do not have exactly the same tone, it does not necessarily mean that one of them is useless. However, it is imperative that two phones possessing different tone qualities be not put into the same head-set. Phones, to give the best results, must be "matched." After a short time, at operating the apparatus, even a novice will be able to hit an average point above which phones will be accepted and below which they should not be used.

Advertise the Stellar Broadcasting

(Continued from page 23)

only know this when the facts are presented in a proper manner.

Every dealer can capitalize on the wonderful programs now available in the air every day. Every person in the land ought to be told of the rare opportunity of listening in on real concerts in the most comfortable manner, in an easy chair at home.

All of us cannot attend the opera as often as we would like, but it can be done by radio at practically no cost.

The radio dealer naturally uses his windows to display radio apparatus—but why not go a step further? Send forth publicity on the programs.

Take any week's program and have a few signs printed, reading as follows:

Tonight Via Radio
at Your Home
The A B C Receiver
Brings You
Chicago Grand Opera

Many people do not know this great thing about radio—that it brings programs of real quality to the home for the asking.

STANDARD RADIO HORNS

Are Fundamentally Right

That's Why They Sell

ALSO MAKING

7-inch Bell, 19 inches High

Rubberoid finish only. Will take all makes of receivers. No air pocket. Designed to give proper amplification. Heavy material to avoid blast.

No. 17, price \$7.50

5-inch Bell, 14 inches High

Rubberoid finish only. Will take all makes of receivers. Specially designed for Radio purposes. Heavy brass. No vibration.

No. 15, price \$5.00

The line of Standard horns is now complete. The dealer who stocks Standards is thus able to supply correctly made horns for any Radio need—at popular prices.

We can furnish a single high-grade loud phone with cord—to fit any of these horns—to make a complete loud speaker.

Price, \$7.50 Extra

STANDARD METAL MFG. CO.

237 CHESTNUT ST.,
NEWARK, N. J.



14 Inch Bell, 24 Inches High

Rubberoid finish only. Will take all makes of receivers. No air pocket. For use where extra large horns are desired. Heavy material. No vibration.

No. 114, price \$12.00



11 Inch Bell, 14 Inches High

Here's a new design in Radio Horns—will take all makes of receivers. Surprisingly clear reproduction. Grained Mahogany or Black Rubberoid Enamel finish.

Gem, price \$7.50



Mercury Radio Sets

A PROFITABLE line to handle, from the dealer's standpoint. A reasonably priced line to buy from the consumer's standpoint.

The low price is made possible by quantity manufacture in our large factory where every part is **MADE**, not merely **ASSEMBLED**.

Write for details and trade prices.

MERCURY RADIO PRODUCTS CO.

LITTLE FALLS NEW JERSEY

PHONE PLUGS

Standard Type

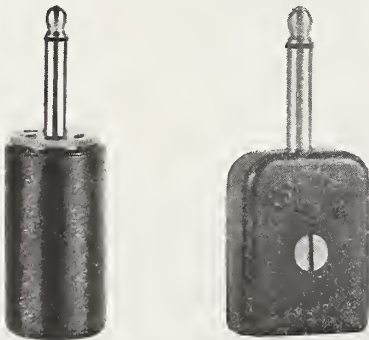

35^c each

22^c each

in lots of 100 or more

The above plugs can be used with pin, spade, or plain wire ends.

No soldering necessary

S. S. NOVELTY CO.

255 Bowery, New York, N. Y.

Costs of Conducting a Radio Business

(Continued from page 26)

these improvements will reduce costs unless the business man knows what his total costs are and exactly what items make up the total. Items of cost are frequently lost track of when the total only is considered, but if these items were properly segregated so as to show what they were, they could be materially reduced and in some instances eliminated altogether.

For instance, we had a case where a man figured the cost of his material to be \$10.00, and the cost of his labor \$5.00, and the cost of his overhead to be 50 per cent. of the sum of these two making his total cost at this point \$22.50. Then, he knew that he must allow customers a discount for cash of 5 per cent. on \$22.50, amounting to \$1.13, and this he added to \$22.50, making his selling price at least \$23.63. To this sum he added 10 per cent for profit, which brought the selling price up to \$26.00.

He did not stop to realize, however, that when the customer remitted the cash payment he deducted 5 per cent of \$26.00, amounting to \$1.30, from his check, and that, therefore, he was losing from his profit of 10 per cent., seventeen cents on each article he sold so that his profit instead of being \$2.36 was \$2.19.

The proper segregation of all the expenses of a business means that the business man can tell just how much it costs him to manufacture the article, how much it costs him to sell the article, how much it costs him to administer his business and how much it costs him to finance it. It can be plainly seen that the act of segregating these articles is in itself highly important, because it would never do to charge to, say, selling expenses, the salaries of a bookkeeper or stenographer whose sole function is administration.

Only a week ago, a jobber right here in New York City said to me one Saturday morning, "Seidman, did you see my advertisement in the newspaper today." I said, "Yes, how much did it cost you." "\$250.00," he told me. And then he added, "advertising is certainly a cheap way of selling merchandise, isn't it? Here! If I sell \$250.00 of merchandise today, I have the money to pay for my advertisement."

That man did not stop to realize that for every penny of expenses he had along such lines he had to add, in his particular instance, 66⅔ per cent. of the cost of the merchandise that he was selling before he could have re-

Warren
Radio
Loop
Un-
Covered



The Warren Radio Loop

Monopolizes Profits

Safe to stock and profitable to handle because it is the only loop with all its advantages on the market. Your customers can't buy anything at any price anywhere that will do the trick as well.

Loops are now a necessity in many places. Their advantages are recognized by all. The dealer that handles **Warren Radio Loops** is getting the bulk of the business.

Type A-737 (300-700 meters)	
6 inches square—non-directional	\$10.00
Type A-7236 (175-1000 meters)	
6 inches square—non-directional	12.00
Type B-2537 (300-700 meters)	
18 inches square—directional	20.00
Type BL-2520 (200-18,000 meters) with honeycomb coil,	
18 inches square—directional	25.00
Send for Bulletin P-102	

V-DE-CO RADIO MFG. CO.

ASBURY PARK, N. J.

Dept. D

"W. D. SPECIAL"

Transformer for use with W.D. 11 Tubes

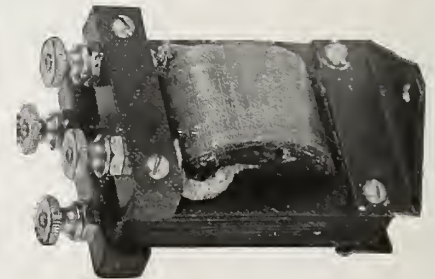

Get Your Share!

Meet the big demand with this specially wound transformer—for use with WD 11 and all other 1½ volt tubes.

Perfect Results—No Distortion—Full Volume. \$5.00 list—Extra Liberal Discounts to Dealers and Jobbers. Immediate Deliveries. Place full order or we will send one C. O. D.

WIRE, WRITE OR PHONE ORDER

Radio Courses, Inc.

552M Seventh Ave.

New York City

turned to him not only the cost of his merchandise but his \$250.00, as well as his other expenses for the day.

We have operated in practically every line of business in existence today, and during the past ten years we have gathered, for statistical purposes, the average sales of all the businesses, the cost of doing business, and the profits derived from them, and we have found that the average percentage of overhead that must be added to the cost of the merchandise before a concern can begin to make a profit amounts to, for manufacturers, 55 2/3 per cent. of the cost of the labor and the material alone, for jobbers 44 per cent. and for retailers 51 per cent.

Let me at this moment caution you very, very strongly, not to leave here with the impression that when you get back to your businesses that if you add these percentages to your costs of material, you will have arrived at a figure at which you can safely sell, and break even. You cannot do this; you must not do this, for we have found that averages of an industry as a whole may be entirely different from the percentage of some one individual business where we tried to apply them. The truth of this can be readily seen in the case of rent alone, where the average of factory rent for the industry amounts to \$250.00 per month, and your rent amounts to \$350.00 a month. Your percentage must necessarily be higher.

Gentlemen, your calculations must be somewhere around the figures mentioned. You cannot do business by adding 10 per cent. or 15 per cent. or 25 per cent. to the cost of the merchandise and make a profit from the selling price that results. If you are to stay in the manufacturing or jobbing of apparatus, you must know what the cost of doing business to your particular firm is.

Not only does accurate cost accounting give to the manufacturer complete information for establishing selling prices, but it also assists him in meeting new industrial conditions as they arise from time to time.

While statistics show that the peak in prices of basic commodities and labor was passed some time ago, yet the recent decline in prices has been checked to a large extent and the manufacturer is again confronted with demands for higher wages and better labor conditions, and these in the face of keen competition in marketing his product.

I spoke to you of averages a few minutes ago. Certain trades have established bureaus for the tabulation and distribution of trade statistics relating to business conditions and of

WABASH RAILWAY COMPANY
TRAFFIC DEPARTMENT
J. E. WATTS, PASSENGER TRAFFIC MANAGER
ST. LOUIS
November 30 1922

Mu-Rad Laboratories, Inc.
800 Fifth Avenue
Asbury Park, N. J.

Gentlemen:

It is a pleasure to report the result of the tests which were recently conducted on Wabash trains No. 2 and 5 with one of your Mu-Rad Radio Receivers.

The Mu-Rad Receiver with a 2' loop aerial was set up in all-steel club car placed in the middle of a train of fourteen cars which left St. Lo. for Kansas City at 11:00 P.M. on the night of November 28th. Some forty persons were present in the car and were very elated at hearing on the horn the signals from the St. Louis Post Dispatch broadcasting station and from the Kansas City Star. The signals were very clear and strong up to the time the broadcasting shut down.

On the morning of November 29th a second test was made on the train running from Kansas City to St. Louis, the Mu-Rad equipment of this test being set up in the observation car. On this return trip, three stations in Kansas City, one in Wichita, Kansas, and one in Jefferson City, Mo., two at Atlanta, Ga., and one in St. Louis, and the Schenectady, N.Y. station, were all picked up very clearly.

Persons who witnessed the tests considered the performance the most wonderful radio achievement they had ever seen expressing surprise at the clarity and strength of signals received on a small loop and particularly within an all steel car during daylight.

Yours very truly,
H. E. Watts
Passenger Traffic Manager.

*The New
Star in
the Radio
World*

What the Railroad said about the performance of the Mu-Rad Set on the Wabash Express

MU-RAD Radio Frequency Amplification

Triumphs
in Test on Express Train

*They copied all they could copy,
But they could not copy our mind;
We left them tearing and swearing
A thousand miles behind.*

—Kipling

THE entire radio world is agog at this latest supreme achievement—the reception of radio programs inside a steel car, with no outside aerial or ground, moving at express speed—the severest test ever given any receiving apparatus.

Such striking superiority is the finest guarantee of profits on Mu-Rad Apparatus. Your cash register is missing this money. Let us give you the details.

Type MA-12
3 Stages R. F. and
Detector
\$128

Type MA-13
3 Stages R. F., and
Detector and 2
Stages A. F. \$160

DEALERS: Write for interesting proposition.

Mu-Rad Laboratories, Inc.
800 Fifth Ave. Asbury Park, N. J.

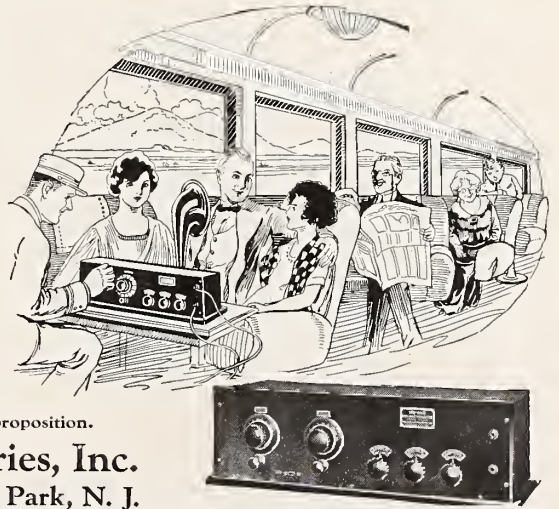

AEROPLUG—THE SOCKET AERIAL

A Fast Seller

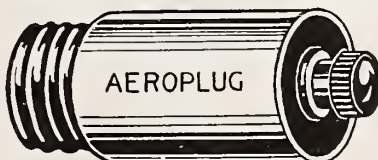

Screwing the plug into any lamp socket makes a wonderful aerial of the house lighting circuit. No current used. No danger. Nothing to get out of order. Lasts indefinitely.

Aeroplug sells on sight. All are guaranteed. A small trial order will prove its possibilities. Write NOW.

\$1.50

LIST

Used for Crystal Sets Only
When Close to Stations.

Write for Attractive Discounts

STAR MANUFACTURING CO. 868 BERGEN STREET
NEWARK, N. J.

A QUALITY CONDENSER

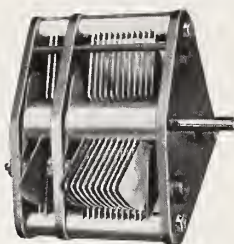

3 plate.....\$1.60
 11 " 2.30
 23 " 2.75
 43 " 3.25

With 3 plate Vernier "Built In"

11 plate.....\$3.80
 23 " 4.25
 43 " 5.00

Bakelite end plates, moulded posts with brass reinforcing rod running through each post. Adjustable spring tension. Accurate spacing and alignment.

SPECIAL Fiber end plate, "Old construction"
 3 plate.....\$1.25
 11 " 1.30
 23 plate.....\$2.00
 43 " 2.50

ADAPTERS

\$1.50 Polished and nickel plated, threaded to screw on your Receiver. Made for any combination of phone and phonograph. Specify desired combination.



STUCKEMAN BROS., Inc.
 18 Ruth St. Pittsburgh, Pa.

special value to the respective trades. When the executive studies the trend of business as evidenced by his own comparative statements and sees, perhaps, that his own business is falling off, he is also able to view his results in comparison with those of the trade as a whole.

If he knows that his own business has been maintained as to volume at a relatively higher ratio to normal than general business has been maintained in his line, he may have reasonable grounds for satisfaction in believing that he has continued to secure at least his share of the available orders, provided, however, that he has not sacrificed profits in obtaining the business; but if he finds that he has not maintained his relative proportion of business done, he has a compelling reason for searching inquiry in order to ascertain the cause of such a condition.

New York Stater's Novel Selling Plan

(Continued from page 25)

capable of producing sufficient volume. After our audience has gathered around, we give a short talk, starting from the advent of wireless to the broadcasting stage. We end this talk by tuning in different stations.

"After our concert is over, we request all those interested to stay for a short time, and all nearly always do. We then talk the cost of radio sets, and allow those interested to tune the demonstrating outfit, which in almost every case makes a sale. There is no charge whatever to those who are interested enough to come to these demonstrations, as we meet all the expenses incurred, such as advertising and erection of the aerial."

Mr. Reynolds calls this plan "stimulating trade." It might also be called "using one's brains."

Issue Guide and Catalog

A little guide and catalog of the products made by the Parkin Manufacturing Company, San Rafael, Cal., was recently issued, showing some of the radio novelties made by this firm.

Among the varied radio parts the firm has to offer are several recently patented devices, including the Parkin knob type rheostat, the Parkin .001 variable condenser and the Parkin dial-type rheostat. Other lines included in the catalog are Parkin bakelite knobs, switch levers, fixed condensers, switch contacts, tube sockets, and crystal detectors. All are made in the Parkin factory, within sight of Mount Tamalpais.

Praco Panel Service

We offer to the amateur and dealer

REAL PANEL SERVICE.

Our panels are cut to your order. Only genuine Condensite and Formica used.

1/8" per square in. 2c
 3/16" per square in. 2 1/2c
 1/4" per square in. 3c

We also carry a complete line of radio essentials. Dealers will find it profitable to have our latest price list and discount sheet.

PITTSBURGH RADIO AND APPLIANCE CO., Inc.

"Pittsburgh's Radio Shop"
 Desk D
 112 Diamond St., Pittsburgh, Pa.

"COPPERWELD"

TRADE MARK REG. U.S. PAT. OFF.

ANTENNA WIRE

50% stronger than either solid or stranded copper

ELIMINATES SAGGING

Adopted by Largest Radio Manufacturers
 100, 150, 200 ft. per Carton

LEAD-IN and GROUND WIRE

has the Underwriters' O. K. Rubber Insulated—Brown Braid
 25, 50, 100 ft. per Carton

BUY IT IN CARTONS

with construction directions

COPPER CLAD STEEL COMPANY

New York Chicago
 Braddock P. O., Rankin, Pa.

POSTER'S PERFECT PANELS

XX Bakelite—Dilecto Radio Panels
 Manufacturers and dealers: immediate delivery—any quantity—cut to size.

Engraving and Drilling

Sharp white lettering, clean accurate work, quantity production at surprisingly low cost. Write today for sample and prices.

POSTER & CO., INC.
 552 Seventh Ave., New York
 Phone: Penn. 5385

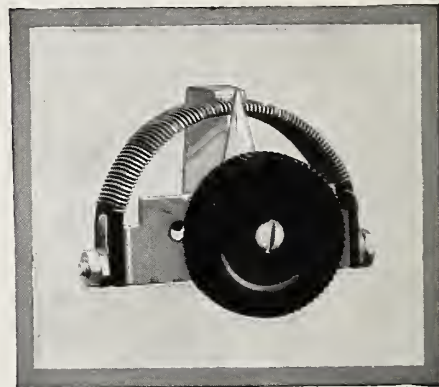

A BETTER RHEOSTAT

A nicer looking, smoother working and better made rheostat than you have ever seen before.

Furnished with or without vernier this instrument will improve the operation of any radio equipment.

The many valuable features coupled with national advertising make this an instrument every dealer and jobber should stock—liberal discounts give ample margin of profit and low list means quick turnover. Order now.

List Prices
 123A Plain..... 80c
 Type 123B Vernier.....\$1.40

THE WILCOX LABORATORIES
 LANSING MICHIGAN

LOUD SPEAKER FOR ANY CRYSTAL SET

The Steinmetz Amplifying unit selling for \$3.50 will enable you to hear any crystal set all over the room. No storage battery required. All Steinmetz equipment is thoroughly guaranteed.

STEINMETZ 3000
 Ohm Phones.....\$6.50
STEINMETZ 2000
 Ohm Phones..... 5.00
STEINMETZ 1000
 Ohm Phones..... 1.75
 Equal to any \$10.00 or \$12.00 Phones Made

"Superior" Crystal Set, \$4.75
 Complete catalogue 5c at your dealer or
STEINMETZ WIRELESS MFG. CO.
 5706 Penn Ave. Pittsburgh, Pa.

Radio Trade Subject To Natural Laws

(Continued from page 25)

best interests of radio are to be served.

There is nothing more abhorrent in the practice of genuine business than the desire of unscrupulous merchants to "put one over." It is cause for some rejoicing, therefore, that the natural law of any business is working to put these same merchants "out of the running." In the radio industry this class of outlawed merchants are in their own tempestuous haste to accumulate quick return, succeeding only in destroying themselves.

The house-cleaning era of the radio industry is almost over. There are signs everywhere, in the scope of our advertising, in the trend of our organization, and in the appreciation of the general public and the press, that radio is here and here to stay. The coming months cannot but reflect the growing importance of radio as far as the people of the United States are concerned.

The past experience of the radio industry is but an indication of what the future holds in store. In the past dishonesty in methods and manufacture proved unprofitable. The same will be true of the future. To acquire a permanent name in any business requires adherence to a single proposition: "Make the Best."

CSE Service

Service for the radio dealer, as outlined by the Central States Engineering Company, of 234 North Halsted street, Chicago, Ill., embodies three things: An intelligently conducted engineering bureau, a sales service worthy of consideration and an active service bureau for the use of the radio retailer. This is known as "CSE" service.

The Central States Engineering Committee Company's engineering bureau is under the direct supervision of a former Army Signal Corps engineer assisted by men of proven ability, who are ready to aid the dealer in matters of a technical nature. The sales service handles the lines for which the Central States Engineering Company are distributors. These include more than twenty-five standard makes including the R-W line. The CSE service bureau, among other things, distributes monthly trade letters, outlining conditions in various sections of the country, and broadcasting trade tips, etc. Listings in this trade letter for quick turnover of stock are made gratis, but a small charge is made when sale is completed.

BETTS SPECIAL RECEIVER

Specially designed for receiving broadcasts at 300-400 meters
—highly efficient and selective within this range.



A really fine receiving set sold at a moderate price. Made by a long established house, and offered only to the better class of trade on terms affording a white man's profit.

Write for terms.

BETTS & BETTS
CORPORATION

630 West 43rd St., New York

Betts Special Tuner,
type RC11 \$24.50

Betts Visible Detector-
amplifier, type D2A
without tubes \$38.50

Betts Loud Speaker \$24.50

Three together \$81.50

Sell a HOMCHARGER With Every Radio Set

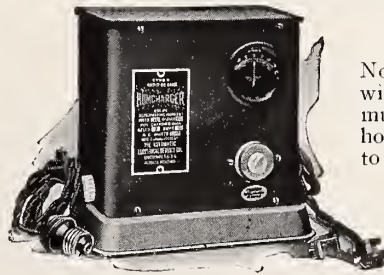

No Radio Set using batteries is complete without a HOMCHARGER. "A" Batteries must be charged *at least once a week* and the home is the only practical and economical place to do it.

**THE
HOMCHARGER**

is the most profitable rectifier for you to handle, leading all others in popularity and volume of sales—over 70,000 NOW in use.

It quickly, quietly and efficiently charges Radio "A" or "B" batteries without trouble, fussing, or muss AT HOME for a NICKEL.

IT'S MERCHANDISED

NONE but the HOMCHARGER combines ALL of these necessary features:

1. Nationally Advertised in 30 publications.
2. Dealer Helps and Dealer Cooperation to the limit.
3. It's SELF-POLARIZING.
4. Has a HIGH CHARGING RATE.
5. It's APPROVED BY UNDERWRITERS.

Retail price \$18.50—complete with ammeter, etc. See your jobber or write TODAY for our proposition in detail.

The Automatic Electrical Devices Co.

144 West Third St.

::

Cincinnati, Ohio

LARGEST MANUFACTURERS OF VIBRATING RECTIFIERS IN THE WORLD

"Euraco" Products

"Euraco" Mica Condensers are of the Cartridge Type, glass enclosed, and are composed of COPPER SHEET and BEST GRADE INDIA RUBY MICA—ENTIRELY HAND MADE.

Compact, Interchangeable, Most Efficient.

(.000025-.0001-.00025-.0005 Mfd. Capacities)

PRICE .60 PER UNIT

Bakelite Base with Single Mounting... .40
Bakelite Base with Double Mounting... .60
Bakelite Base with Triple Mounting... .80

Interesting Proposition for Dealers

Shipowners Radio Service, Inc., Distributors

80 Washington Street New York

Mfd. by European Radio Co.
1342 E. 22nd St.
Brooklyn, N. Y.



WITH ORIGINAL NATHANIEL BALDWIN

Type C PHONES

Headset, complete, \$17.00
Unit 11.00

Write for discounts

STATES ELECTRIC CO., Agents
469 BROAD STREET
NEWARK, N. J.

Maclite Vario-Coupler

Price \$5.00

Is, in the opinion of experts, the most efficient on the market.

All Other Maclite Parts are equally efficient, including the Maclite Variometer, Double Slide Tuner, Variable Condensers and Crystal Detectors. The Maclite Single Tube set at \$25.00 is the best buy we have ever seen. Let us tell you more about this set, also all other Maclite parts.

Dealers and Jobbers Write for Discounts

MACLITE RADIO CO.
701 Maclite Bldg., Claredon St.
Boston, Mass.

COMPOSITION LIST PRICE

DIALS 50¢ DIALS

Adjustable Switchlevers
Knobs

NEW YORK RADIO-DIAL CO.
316 Holden Bldg. Detroit, Mich.

Economic Sales Factors in Radio Business

(Continued from page 27)

made strenuous efforts to maintain the published retail price, have expended their efforts in vain. What then is the solution? It simply narrows down to the fact, in my opinion, that the dealers are beginning to realize that building up their good will on price basis alone instead of a quality and service basis will only result, in the long run, in an unsatisfactory and unprofitable situation.

In some sections the dealers have already come to the conclusion that it is necessary to add a fair margin of profit to their merchandise irrespective of whether or not some other dealer tries to capitalize the situation by selling some well-known article at cost. No one dealer can get all the business in his town, and the dealer is certainly entitled to a fair profit. He is beginning to realize that the advertisements offering standard merchandise at little or no profit merely to create public good will toward his store at the expense of his competitors, is a short-sighted policy which in the long run will not result in any benefit either to himself or his dealer competitors, who in self-defence, retaliate by more price cutting.

There are already on the horizon, signs of the awakening of the man-on-the-street to the fact that there is a vast difference between one radio set and another and particularly between the amateur built sets and the sets built by the manufacturers after long research and experiment

However, so long as the newspapers continue to create enthusiastic amateurs by showing them how to build their own sets, there will be an increasing business in the sale of parts. From our own standpoint, however, we would prefer to forego this profitable business if some way could be found to prevent the increase of the experimental amateur class, so that we could sell them complete sets behind which we and other manufacturers are glad to place their names and reputations.

By pointing out the situation to the man behind the counter and instructing them to convey the message to the buying public. I believe that the dealers will sell more complete sets and create in the public mind a much more favorable opinion toward radio in general, to say nothing of the prospective business from thousands who are waiting for an improvement in radio reception and whose procrastination is due to noises which they have heard emanating from a set built by some enthusiastic amateur.

RADIO CABINETS



We manufacture a complete line of radio cabinets, of mahogany, walnut, oak, and white wood, in all sizes, and in any finish. Best of construction. Dirt, dust and moisture proof. Quick deliveries—quantity production prices. Send us your specifications, or a sample of your cabinets, and get our prices. We also make indoor loop aeriols.

Cabinet Work Since 1900

E. ESHOO CABINET WORKS

635 Herkimer St.
Brooklyn, N. Y.

Telephone
Lafayette 2324

Do You Know

We are the recognized authorities on wireless securities. Our Information and Analytical Departments are unexcelled. Let us know what company you are interested in and we will furnish without obligation, detailed information and opinion respecting its merits.

FRANK T. STANTON & CO.

Specialists in Wireless Securities
Since 1915

35 Broad St. New York
Phone: Broad 1670-3641-5819

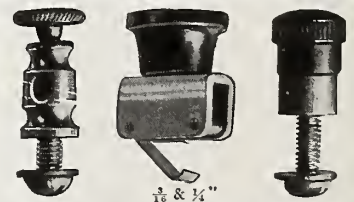

CRYSTALS GALENA SILICON

CRYSTAL DETECTORS List \$2.00

CRYSTAL RECEIVERS List \$9.00

RADIO APPARATUS CO.

6600 Hamilton Ave. Pittsburgh, Pa.

RADIO MAILING LISTS

- 12,400 Radio Dealers, covering U. S. by States, per M..... \$7.50
- 1,614 Radio Manufacturers, covering U. S. by States, per list..... 15.00
- 1,757 Radio Supply Jobbers, covering U. S. by States, per list.. 15.00
- 260 Radio Stations, per list..... 4.00
- 257 Manufacturers who make and assemble complete Radio Sets, per list..... 4.00
- 25,000 Radio Amateurs and Managers of Radio Stations, per M.... 7.50

Ask for price list covering Canada and England. Send remittance with order.

TRADE CIRCULAR ADDRESSING CO.
166 W. Adams Street Chicago

Federal and State Trade-Mark Protection

(Continued from page 30)

of any state registrations?" Such questions more often than not result from an ignorance of the meaning and effect of trade-mark registration in this country. Too many of our traders have the opinion that the registration of a trade-mark at Washington is like the grant of a patent and thereafter gives them the right to the exclusive use of the mark anywhere in the country. This is not so. Registration in the United States, whether under a state law or under the federal law, is merely evidence of the registrant's claim.

The federal government, being constitutionally limited to jurisdiction over commerce among the states, with the Indian tribes, and with foreign nations, cannot have anything to do with the use or ownership of a trade-mark within the confines of any one state. It is quite possible for John Smith to have the right to the exclusive use of a certain trade-mark in commerce among the states, with the Indian tribes, and with foreign nations, and for Richard Roe to have the right to the exclusive use of the same mark within the state of New York.

Such rights, however, are not granted either by the state of New York or by the federal government. They arise automatically out of the use of the trade-mark and accrue to the earliest user. One who is the owner of a trade-mark within the state of New York by reason of having been the first to make use of same within that state may have at hand at all times legal evidence of such ownership by registering his trade-mark under the New York state trade-mark law. So, one who is the owner of the right to the exclusive use of a given trade-mark in interstate commerce may have at hand at all times legal evidence of that fact by securing registration at Washington under the federal trade-mark law.

Now let us see of what value to the national advertiser is registration under a state law. Suppose this national advertiser is located in Connecticut and another merchant in Connecticut places on sale only in that state similar products bearing the national advertiser's mark.

Can the national advertiser sue him under the federal trade-mark law? No, because the infringement took place wholly within the state. Can he sue him under the Connecticut state trade-mark law? No, because he has not registered his mark under that law. If he had registered his mark



Complete with Special Attachment for use in Connection with any Phone.

"WOODEHORN"

LOUD SPEAKER

\$7.50

List Price

STANDS
26" High
10" Bell

**MOST STARTLING LOUD SPEAKER
AT A
MOST AMAZING PRICE**

"WOODEHORN" suggests without much effort the character of the Loud Speaker—"it's the wood that makes the tone good."

If you would have the tones of a rare violin then do not hesitate to try a "WOODEHORN" Loud Speaker.

"WOODEHORN" was the hit of the American Radio Exposition, New York. Hear "WOODEHORN" before you stock loud speakers.

Manufactured by

INTER-OCEAN RADIO CORPORATION

1140 BROADWAY, N. Y. C.

Liberal Discounts
To Recognized
Distributors and
Dealers.

ESTABLISHED 1888

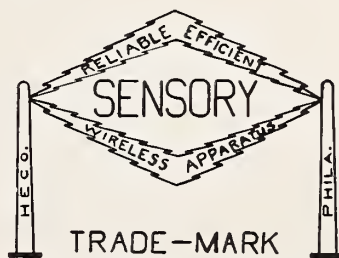

SENSORY CABINET UNITS



HEINEMANN ELECTRIC COMPANY

Manufacturers

Radio Division

Philadelphia, Pa.

"Euraco" Products

EURACO Mica Condensers, cartridge type, (.00025; .0001; .00025; .0005 mfd.).....	\$.60
" Single Mount (Bakelite base)40
" Double Mount (Bakelite base)60
" Triple Mount (Bakelite base)80
" Crystal Detector (Glass encl.)	1.40
" Crystal Detector (Open type)60
" Moulded Socket60
" Semi-metal Socket70
" Potentiometer (240 ohms) ..	1.30
" Rheostat (Bakelite base) ..	.85
" Rheostat (Cold Moulded base)70
" Switch lever complete....	.30
" Series-Parallel Switch45

Send for Descriptive Circular
Interesting Proposition for Dealers

EUROPEAN RADIO COMPANY
1342 East 22nd St., Brooklyn, N. Y.

Radio Cabinets

Made to your specifications in any quantity, style, wood, or finish. Submit specifications for quotation.

Standard models, all common sizes, in Mahogany, Walnut, and Quarter-sawed Oak. Descriptive material and prices on application.

Better Cabinets for

Manufacturers and the Trade at Large

MARVIN B. FALLGATTER
Waupaca Wisconsin

A Million Set Owners Need The Chaslyn 'Sink or Swim' Ball Battery Tester

And they buy on sight, because it's just what they have been wishing for. What's more, every buyer becomes a "bug" telling all his friends about it. Set consists of

1. BATTERY TESTER, with three balls of different colors and weights. The way they sink or swim shows condition of acid instantly.

2. Depth Gauge for determining depth of acid.

3. Air Controlled Bottle Stopper for adding distilled water. Price of Set \$1.00.

Special Offer to Dealers—Write on your business stationery: Enclose one dollar for TWO of the above sets. This is below wholesale price. Only two sets sold to each dealer at this price.

THE CHASLYN COMPANY
4315 Kenmore Ave., Dept 2
Chicago, Ill.



"VICTOR JUNIOR"
Our Latest Model
Write for Catalog
Victor Radio Corp.
795 East 125th St.
New York City

under the Connecticut law, he might have sued him under that law and had he won the suit the infringer could be fined five hundred dollars and be imprisoned for thirty days!

So we see that there is often considerable value to registrations under state trade-mark laws and the owners of all valuable trade-marks should not fail to register them under the law of their own state at least, in addition to securing registration under the federal law when this can be obtained.

Insulation Facts the Dealer Should Know

(Continued from page 31)

rial with beautiful satin-like finish and in various colors. These panels are made in three colors—black, brown, and mahogany. The last named is particularly beautiful, as it effectively represents the grain and color of highly polished mahogany.

As interest grows in radio reception from far distant stations, and the application of the theory of radio frequency becomes correspondingly more general, the importance of protecting all apparatus against slight leaks and losses, due to ineffective insulation, is more and more appreciated. This condition will gradually bring about the use of panels, dials, and other parts having smooth polished surfaces free from small pits and furrows, and having unusual freedom from inherent and surface moisture.

Nassau Loop-Tuner

To rid the radio fan of the bugbears of interference and static, against which the outdoor aerial is helpless, the Nassau Radio Company, Inc., of 60 Court Street, Brooklyn, N. Y., have introduced the Nassau loop-tuner.

This device is a loop aerial and something more. Mechanically it has the appearance of a loop aerial, strong and rugged in construction. But its distinctiveness lies in the fact that it is provided with a variable condenser installed in such a way as to overcome much of the body capacity effects.

The Nassau loop-tuner can be used with any vacuum tube set, but as its name implies, it is a tuner in itself, and with a detector and an amplifier will make a complete receiving outfit. Besides the advantages of the indoor aerial, such as elimination of unsightly outside apparatus, absence of lightning hazard and insurance inspection, this device is said to do away with static. It is easily portable and can be turned in any direction to cut out a station not desired and bring in the maximum signal from the desired station.

FREE Radio Catalog



Our big stock of standard makes of radio sets, parts and supplies, fully illustrated. Play safe—buy standard equipment from a reliable house. We ship from stock.

Send \$6.50 for genuine Westinghouse WD-11 "peanut" tube—no storage battery needed. 60 cents extra for signal socket. \$1.00 for Bradley adapter. Wonderful results.

JULIUS ANDRAE & SONS CO.
In business since 1860
114 Michigan St. Milwaukee, Wis.

15 STOCK SIZES RADION PANELS

Radio fans everywhere are scrapping their old panels and buying RADION panels. They know why it's better. Keep your customers. Have a RADION supply.

AMERICAN HARD RUBBER CO.
11 Mercer St. New York City

ATWATER KENT MIDWEST DISTRIBUTORS

Immediate Deliveries

KRAMER RADIO CO.
4713 Sheridan Road, Chicago, Ill.
Jobbers Standard Lines

"Better Than The Best"



The Radio Tube Set



That Made Good In a Night

W.E. Supply & Service Corp. 18 Murray St., N.Y., U.S.A.

YOU SHOULD KNOW ABOUT OUR



THE MILLS RADIO & ELECTRIC CO.
INCORPORATED
1008 Springfield Ave. Irvington, N. J.

NULOID

Scientific Chemical Compound for Radio Parts and Panels

NULOID CORPORATION

119 Chambers St. New York

PATENTS

PROTECT YOUR INVENTION TODAY

Write for 1922 illustrated book free Radio-Electrical, chemical and mechanical experts; over 20 years' experience.

A. M. WILSON, Inc. (Radio 3 ARH)
309-20 Victor Building, Washington, D. C.
(Successors to business established 1891 by A. M. Wilson)

You'd walk a mile for a
RADION Panel if you
knew how much better
results you'd get.



RHEOSTATS

and Other
STANDARD PARTS
FOR TUBE and CRYSTAL SETS
Dealers: Write for Price List and Proposition.

The Radiola Wireless Corp.
208 W. 17th St. New York City

Wave Lengths Searched

Scientists Make Investigations and Report on Radio Wave Lengths

Many matters of scientific interest were discussed at the recent meetings of the American Association for the Advancement of Science, held at Cambridge, Mass., and of particular interest to the radio industry was the scientific paper on wave-lengths.

This report was made by Dr. Ernest Fox Nichols, Director of Pure Science at the Nela Research Laboratory, and Dr. T. J. Tear. Dr. Nichols is a well-known scientist, formerly president of the Massachusetts Institute of Technology.

They made an almost unbroken search of wave lengths from the wireless waves, which have a length up to fifteen miles or more, down to the X-rays whose lengths are to be described in fractions of billionths of an inch and down to the still shorter gamma rays of radium.

Hitherto there have been gaps or blank spaces representing unidentified wave lengths between the ultra-violet rays and the X-rays, between the X-rays and the gamma rays and between the long wave length infra-red or heat rays and the electric waves used in radio.

The discovery reported by Dr. Nichols and Dr. Tear fills in the spectrum from the longest wireless waves to the ultra-violet, while other work has recently been reported recording almost the last of the missing wave lengths in the gaps between the ultra-violet and the gamma rays.

While it has been generally supposed that electric waves, light waves and heat waves differed only in wave lengths, this was definitely proved, it was announced by Drs. Nichols and Tear.

Small Rheostat Is Handy

Due to its small size, the filament rheostat made by the Radio Engineering Company, of New Rochelle, N. Y., adapts itself readily to the construction of receiving sets, detectors, amplifiers, and other apparatus employing the vacuum tube. The diameter of the rheostat is but two inches, and is so constructed as to be used on back or front of a panel.

The base of this filament rheostat, type R-101, is constructed of a composition said to possess great heat resisting properties. The resistance wire is wound on a fibre strip mounted so as to give maximum radiating surface and this permits considerable current carrying capacity without excessive heating.



Lift the switch and this MAGNA-TONE Two stage Amplifier is in operation with filaments under fixed control. Circuit is automatically rearranged for one stage by lifting the first tube—at the left. Size, 13 x 5 x 5½ inches. Ebony finish.

JOBBERS AND DISTRIBUTORS—There's a big demand for this radio essential. Write at once for our special proposition.

List Price **\$24**

MAGNA INSTRUMENT COMPANY

340 West 42nd Street, New York City

MAGNA-TONE Vacuum Tube Receiver—a radio set without fussy adjustments. Only two adjustments necessary. Provided with Fahnestock terminals which insure positive connections throughout. Size, 13 x 5 x 5½ inches. Ebony finish.

DEALERS—Radio fans want simpler apparatus. Here it is. Discounts are generous. Big sales reported. Get in touch with your Jobber.

List Price **\$16**



Catalog on Request

"Amplification without Distortion"

3 Y Q Transformers

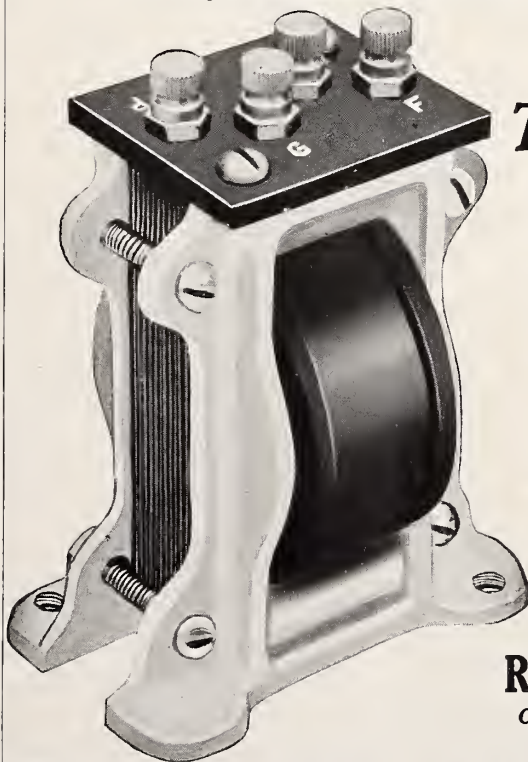

The reputation that the 3 Y Q has gained with jobbers, dealers and users is evidence that there is no other Transformer giving such reliable service in amplifying without distortion. The 3 Y Q is made right and priced right. It is a Transformer all jobbers and dealers can back to the limit.

The 3 Y Q Transformer is distributed through the regular jobbing and retail channels.

RETAIL PRICE \$6.00

ORDER FROM YOUR JOBBER

Federal Institute of Radio Telegraphy

Second and Federal Streets

CAMDEN, N. J.

RADIO DEALERS:

Are You In Position to Get the Benefit
of the National Advertising Campaign Now Running on

M. P. M.

Million Point Mineral

THE WORLD'S GREATEST RADIO CRYSTAL

Makes a Crystal Set 100% efficient.
Will not burn out or corrode.
Sensitive at practically every point.
Increases radius and audibility.
Concerts heard over 600 miles.

The introduction of M. P. M. is revolutionizing the business in crystal sets. Don't take our word. Send for sample and test it.

M. P. M. SALES COMPANY

Dept. RD

247 So. Central Ave., Los Angeles

Psychological Elements In Salesmanship

(Continued from page 24)

lutionary, but is a fact just the same. The only thing the salesman can do is to create the desire in the buyer's mind to possess the goods and then the goods must sell themselves. Therefore, if you do not create the proper desire in your buyer's mind to possess a certain article you can never hope to sell it to him simply by showing the merchandise.

Three things are required to sell goods, a salesman, a sample or a catalogue. Now the next statement will no doubt astonish you, especially if you who read this happen to be a salesman and not an order-taker.

Merchandise can be sold in large quantities without either the help of a salesman or samples. Millions of dollars worth of goods are sold annually by the large mail order houses throughout the United States with no selling medium except a catalogue and the necessary postage. How is it accomplished you ask. It could not be done, if it were not for that little element of psychology which enters into the transaction. If these catalogues only contained a picture of the article which they have to sell they would never sell any goods, but underneath each picture is a wonderful little short story describing the article, but only in a few simple words.

Why don't they tell all about the article in the catalogue? Here is just where psychological salesmanship comes in. If they were to describe each article fully, they would leave nothing open for the buyer's mind to dwell on. Curiosity once killed a cat, they say, and it is that same curiosity which causes the reader or buyer in this case to enclose a post office money order to Chicago, New York or elsewhere for a shirt, pair of shoes, stove, lawn mower or something else. It is that curiosity to see whether or not the goods when they arrive will be as pictured and described and woe be unto the publisher of that catalogue or the writer of the article describing it if the goods when they arrive are not as represented, for you may rest assured they have lost a customer for life.

But the writers of these descriptions are students of psychology and they have learned to underrate the article rather than overrate it and also they know how to create the desire for the purchaser to possess the goods even before they have seen them.

Here are some pointers for a salesman carrying samples which may help from a psychological standpoint:

RADIO DEALERS & JOBBERS

WE ARE MANUFACTURERS OF THE

F. M. C. AUDIO TRANSFORMERS



Try them with your W. D.
11 Tube Sets and note
the increase in your sales.

Stock them up and watch
them move.

LIST PRICE, \$5.00

For Test Reports and Discounts
Write to Dept. R. S.

FORD MICA CO., Inc.

14 CHRISTOPHER ST.
NEW YORK CITY

Never show your sample until you have told your story to the prospective purchaser and have created in his mind the desire to possess the article in question and in describing the article to him do not bring out all of the good points, rather underrate it. If you tell all about the article before you show your sample, you will leave nothing for you to talk about when you produce your sample.

Furthermore, if there are any good points about the articles which you have not touched upon your purchaser may notice the good points when you produce the sample which will naturally cause the article to appear even better to him than you had pictured.

Remember, your sample must be in first class condition when produced for inspection. First impressions always count and no matter how good your merchandise may be you could never hope to take an order or make a sale if you brought forth a soiled, or damaged sample no matter how much you had talked about the goods before you produced the sample and you do not want to be placed in the position of having to make apologies for the condition of your sample.

My advice to any young man who expects to become a salesman and not an order-taker is to spend a few evenings each week in some public library reading up all the good books on psychology he can get hold of and then apply himself accordingly. Also to make a study of human nature when and wherever possible, know and talk to every and all classes of people from the messenger boy on the street to the president of the biggest corporation you can find, and when you do, try to put yourself on the same level with that person you can never hope to learn anything. If you put yourself above the messenger boy, he won't tell you all he knows and he sometimes knows a great deal more than you give him credit for. At any rate always use common sense.

Grebe Regenerative Sets

Two receiving sets designed specially for amateur relay work are made by A. H. Grebe and Company, Richmond Hill, New York. These two types, CR-8 and CR-3 are made on the lines of the Armstrong regenerative tuned grid and plate circuit. The use of continuously variable inductances in the grid and plate circuits gives maximum selectivity and a high degree of regenerative amplification.

Each unit has been effectively shielded by grounded aluminum plates, thus eliminating annoying external capacity effects. Type CR-8 includes a vacuum-tube control unit while CR-3 is made without this feature.

BUYERS of RADIO

MERCHANDISE can see the exhibits of nearly one hundred leading representative manufacturers of Radio Products at the



RADIO FAIR

Don't miss the RADIO SENSATION of the world at the

PERMANENT RADIO FAIR, Inc.

HOTEL IMPERIAL—RED ROOM

Broadway and 32nd St.

New York

Milliken Radio Towers

These towers are suitable for broadcasting and receiving stations, large and small. Numerous installations are in service in all parts of the country. Towers are of galvanized steel, self-supporting, standard types. Economical.

AGENTS WANTED

We have an interesting proposition for local agencies. Send for full information. Illustrated Catalog mailed on request.

**MILLIKEN BROTHERS
MFG. CO., INC.**

**Woolworth Building
New York, N. Y.**



STATION WVP



STATION WBZ

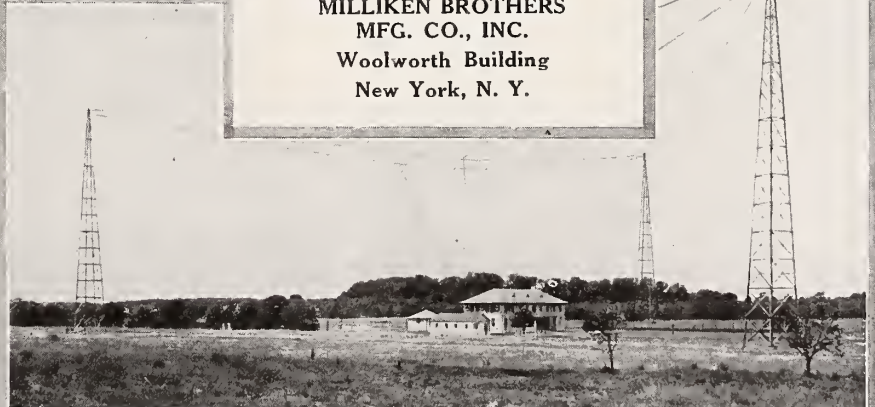

STATION 2 XJ

“THE BEST IN RADIO”

ATTENTION! FORWARD! MARCH

Let's go for a Better and Bigger
RADIO INDUSTRY

By Selling only
STANDARD ADVERTISED
Radio Apparatus of Merit

Let us put you on our mailing list for our Monthly Price
Bulletin

AT YOUR SERVICE
VIRGINIA RADIO CORPORATION

Distributors
Charlottesville, Virginia

**J
O
I
N

T
H
E

R.
T.
A.**

**Cut Prices Are Menace
to Rural Dealers**

(Continued from page 32)

called on a neighbor of this party who had purchased his set in the city. In reply to a question, the dealer mentioned a set that would give satisfactory results for the location, but was promptly informed that he knew that this set was a fake and would not work because his neighbor had one.

The dealer then volunteered to put this set in order for the neighbor so as to prove that it is good and reliable. This was quickly done and the prospective customer was thoroughly satisfied with the set until he was quoted the standard price. The would-be customer thought this too high, threw the dealer down and sent to the city for one at the cut price. When it arrived, he set it up just as the dealer had set up the neighbor's, and, of course, it worked satisfactorily.

But, where were the dealer's profits?

Should not the manufacturers cooperate with the rural dealers and relieve this condition? The dealer on the ground must develop this trade, and he cannot afford to do this under the existing conditions.

The country dealer must secure the profits to which he is entitled if he is going to continue in business and the manufacturer has no right to expect a dealer to sell products of a manufacturer who permits unfair competition by allowing other dealers to cut the retail prices. Manufacturers who permit price cutting do not deserve the support of reputable dealers. Some of the best makes of apparatus are being sold regardless of what price the dealer sells them. This is unjust.

In our section of the country, where we are at a considerable distance from broadcasting stations, the general demand is for high-class receiving sets, and these must be maintained in good order to obtain satisfactory results.

The rural dealers must be given support for developing radio reception on the farms and in the small villages, or the benefits of broadcasting will be practically restricted to the cities, where they are least needed.

In our part of the country, several dealers have been forced out of business by the competition of firms that have been selling to individuals at wholesale prices. This condition should not be permitted to exist. Of course, there should not be too many dealers in a given territory, but dealers are the only ones who will develop radio in the rural communities, and they should not be forced out of business by unfair competition. It is up to the radio manufacturers to protect



THE LABORATORY TECHNICIAN SAYS:

Audibility Plus
Matching Perfect
Volume Plus

T-B-H PHONES SPEAK FOR THEMSELVES
Pure Natural Tones—Light Weight Ornamental Appearance.

A Sturdy Reliable Head Set That Will Sell and Stay Sold.
17500 Turns (2200 Ohms)—\$7.00.

Substantial Discounts to Jobbers and Dealers.

THE TELEPHONE BOOK HOLDER CORPORATION
Dansville, New York, U. S. A.

District Agents and Warehouse:
Central States Engineering Company
Chicago, Illinois

WESTERN HOME BATTERY CHARGER

NOW \$6.85

Charges your Radio Storage Batteries from 110 volt alternating or direct current lighting socket, of any cycle.

Keep your Battery fully charged and receive the maximum range from your receiving set.

Charges Battery over night for a few cents—absolutely noiseless.

Has no delicate bulbs to break or burn out; no moving parts of any kind to get out of order; no adjustments to make, and will charge as many as six 6 volt batteries at one time if necessary.

Will also charge Automobile starting and lighting batteries. Shipped anywhere in the United States and Canada for \$6.85. Send 25% with order; balance C. O. D., or 2% may be deducted if full cash accompanies order.

“Note”:-We have a large quantity of high grade Radio Storage Batteries of all sizes, which we are selling at bargain prices.

Radio Dealers should send at once for our distributors proposition. Description of our line of Chargers and Radio Storage Batteries sent upon request.

WESTERN RUBBER MOLD & BATTERY CO.

321-323 N. Crawford Ave.

Chicago, Ill.

the rural dealers if they want to promote the radio development in the country.

In order to make it worth while for the rural dealers to push the expansion of radio, it is essential that the manufacturers—

1. Standardize retail prices.
2. Select reputable dealers.
3. Prevent wholesalers from selling to others than legitimate dealers.
4. Make prompt shipments to dealers.

The observance of the above conditions would have made the last Christmas season a profitable one for the radio dealers, instead of having it spoiled by those who sold at wholesale prices, without making any profit either for themselves or permitting the legitimate dealers to make any.

Hutchison Phono-Phane

A detector operating on a new principle has recently been placed on the market, under the name of Phono-Phane, by the Hutchison Radio Company, 342 Madison Avenue, New York City.

It has been found that the Phono-Phane is more sensitive than the aver-



Hutchison Phono-Phane

age crystal and it is not susceptible to either physical or electrical disturbances. They are adjusted at the factory and once adjusted they cannot be disturbed even with the most violent treatment.

They are also able to withstand heavy discharges of static and it has been found that these charges in no way effect the sensitivity of the device. It is only necessary to insert the Phono-Phane in the circuit in place of the crystal detector. The sensitive element is encased in a heavy fibre tube with nickel-plated brass ends. The retail price is \$3.50.

New Rasco Catalog

The eighth edition of the Rasco catalog, published by the Radio Specialty Company, 96 Park Place, New York, is just off the press and is more complete than ever. More than one hundred different radio parts are listed with illustrations. The present catalog also includes diagrams for seventy-five hook-ups.

\$ 5.00 List 3000 Ohms

"True-Tone"
SUPERSENSITIVE
3000 Ohms

\$ 5.00 List 3000 Ohms

Cord Connections concealed within phones, eliminating losses from effects of body contacts.

Cups and caps lustrous black moulded; caps designed to comfortably fit the ears.

Worth More—Cost Less

EMBODYING every factor of Scientific design. High sensitivity attained by maximum wire turns.

\$ 5.00 LIST 3000 Ohms

PERFORMANCE and Appearance—backed by a positive guarantee of Quality. Tungsten Magnets; noiseless Tinsel Cords.

Write or Wire for Name of TRUE-TONE Jobber in Your Territory

TRUE-TONE RADIO MFG. CO.
186 No. La Salle Ave. CHICAGO, ILLINOIS

A Wonderful Pair SHAMROCK

180°
Vario-Coupler and Variometer

All Tubes Are GENUINE BAKELITE
wound with green silk covered wire

Distributors, Jobbers and Dealers write for ATTRACTIVE PRICES

SHAMROCK MANUFACTURING CO.
314-322 Market St. Dept. T. Newark, N. J.

RADIO PANELS

And other insulation for Wireless Work

BAKELITE-DILECTO

Grade XX Black was used by the Government during the war for this purpose. It is the

Standard of the World

THE CONTINENTAL FIBRE COMPANY

NEWARK, DEL.

New York, 233 Broadway
Pittsburgh, 301 Fifth Ave.
Los Angeles, 411 S. Main St.
Seattle, Wash., 1927 First Ave., South

Chicago, 332 S. Michigan Ave.
San Francisco, 75 Fremont St.
Rochester, N. Y., 85 Plymouth Ave., South



Just Off the Press

the New

BESTONE RADIO CATALOG

A Compendium of Radio Information
Sent Free Upon Request.

The New, two-color Bestone Radio Catalog we have just issued is one of the most elegant catalogs yet produced.

This catalog is profusely illustrated with the latest types of Bestone radio equipment, and contains considerable technical information that will prove of exceptional value and interest to every radio Jobber, Dealer and Amateur.

Send for the Bestone Catalog—NOW

HENRY HYMAN & CO., INC.

Manufacturers

Executive Offices:
476 Broadway
New York City

Branch:
212 W. Austin Ave.
Chicago, Ill.

Receiver Interferences

Dealers Should Recognize Causes That Hinder Reception

By W. B. SCHULTE
Of the Burgess Battery Company

Dealers should bear in mind that atmospheric conditions affect radio reception and therefore influence their sales. They should keep informed on the atmospheric conditions and be prepared to explain them to their customers. The progressive dealer is a radio fan himself and will keep posted through his own experience. If he cannot do this, he should inquire frequently of his customers as to the conditions of the broadcast signals.

It is generally known that after a few days of good clear weather, when many receiving sets have been hearing distant broadcasting stations, there is an intense interest in radio and radio sales increase. When conditions are poor, many listeners become suspicious of their sets and make unwarranted complaints to their dealers.

Recently, in a Western city, there was an unexpected request for the recharging of storage batteries and an increased sale of "B" batteries. The night before, the broadcasts had been decidedly fading in and out, and every receiver thought that the trouble was in his instruments or that his batteries were low. The dealers who knew of the atmospheric conditions were able to explain the troubles and thus warded off complaints and established themselves with their customers as giving "radio service."

Another source of annoyance to receivers is interference from a broken city lighting circuit. Such interference usually is noticed as a sixty-cycle hum in the set. If the dealer has several complaints about such noises, he can feel quite sure that there is a nearby break in a power or lighting circuit. He should then locate it approximately by taking a number of sights with a loop antennae and after he has approximately located it, the power company will usually be glad to find it and repair their break.

Other sources of unexpected interference are receiving sets which radiate energy while their tubes are oscillating. Dealers should explain that an oscillating tube radiates energy and interferes with nearby stations, and all new customers should be warned against tuning their sets to cause this interference. The new purchaser should be taught to recognize the tones from his neighbor's set so he won't



WE PRESENT
2 in 1
DETECTOR-AMPLIFIER

NEW PRICE, \$4.50 EACH

A proposition that will appeal to business-getters and win approval from the cautious fellows is open to Jobbers and Dealers everywhere. Write for territory and discounts.

LA FRANCE IMPORT & SALES CO., Inc.
280 Madison Avenue, at 40th St., N. Y. C.

A SUPER TUBE
IN DESIGN AND
CONSTRUCTION

"ALL-AMERICAN" AMPLIFYING TRANSFORMERS

(Radio and Audio Frequency)

Are wonderful *Business-builders* for all who handle them. They so broaden the range and improve the tone-quality of radio-reception that every sale made to a set-owner stimulates numerous other sales.

Like an endless chain, the good news of *scientific amplification* spreads, in constantly-widening circles.

No advertisement ever written equals, in selling-force, the enthusiastic praise of users of All-American Transformers.

This is why

IT PAYS TO HANDLE THE
"ALL-AMERICAN" LINE

Send for Bulletin No. 22, prices and discounts.

RAULAND MFG. CO.
35 So. Dearborn St., Chicago, Ill.

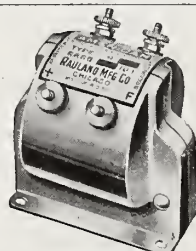

Audio Frequency
Transformer



Radio Frequency Transformer



think that it is coming from his own outfit.

Experimental stations or broadcasting stations when testing or tuning sometimes cause an interference which fortunately is not continuous, but if it is not modulated, it can not be always recognized. Broadcast receivers should be warned that such interference is possible, and that when they get a continuous hum or whistling more or less intermittent, they should bide their time until the station is through testing.

Live dealers will frankly warn their customers of these conditions and will keep in touch with them themselves, so that they can give the right information and avoid many complaints which might otherwise be charged against the receiving apparatus.

Oranola Six-Tube Cabinet

The Oranola Radio Corp., 228 Seventh Avenue, New York has produced an upright six tube cabinet set, which is proving a revelation to the radio public. It functions without either aerial or ground and gives very pure signals of great intensity. These are sold as straight radio or in combination with the talking machine feature. The price is lower than most three tube sets with loud speaker attachments. Three steps of radio frequency, and two of audio comprise the radio unit which causes a specially designed loud speaker to function. Distant stations are easily heard without aerial. On a Saturday night in the office of a corporation located in a still building in downtown New York, Chicago and Atlanta, Ga. signals could be heard at least sixty feet from the set.

Homcharger Instruction Book

The Automatic Electrical Devices Company, 120 West Third Street, Cincinnati, Ohio, manufacturers of the Homcharger, has recently issued a revised instruction book, which will prove valuable to any radio enthusiast.

This booklet, besides containing the simple directions for operating the Homcharger, contains a paragraph devoted entirely to storage battery maintenance. The information contained in this chapter will enable one to obtain the best service from his battery at minimum expense.

The novel feature of the book, however, is its incorporation of a complete list of all the radio broadcasting stations in the United States, Canada and Cuba. Copies may be secured by any one interested for 10 cents to cover cost of postage.



This seal is accepted by the discriminating purchaser everywhere as an unconditional guaranty of excellence of design, material, workmanship, and performance.

ON JANUARY 25th, 1923

we commenced deliveries to

AUTHORIZED DISTRIBUTORS

of the

ACCURATUNE

MICROMETER DIAL

PATENT PENDING

in which a positive, yet delicate micrometer adjustment is incorporated within the dial itself, resulting in

**ABSOLUTE TUNING PRECISION
ABSENCE OF CLAP-TRAP AND
UNCERTAIN VERNIER ATTACHMENTS
EXCEPTIONALLY ATTRACTIVE APPEARANCE**

Simultaneously we will offer a Rheostat Dial and a Fixt-Post Inductance Switch to match—an unusual combination to attract the discriminating trade.

Distributorship franchises on these truly extraordinary articles are now being allotted.

We also take pleasure in announcing

GREATLY INCREASED PRODUCTION

of the

BURKE ADAPTER FOR WD-11 TUBES

The adapter which is outselling all others because

“IT DOES NOT RAISE THE TUBE”



845 BROAD STREET

NEWARK, N. J.

Saturn ^{TRADE}  ^{MARK} Products



The Saturn Automatic Radio Plug

The Plug with the RED SEAL

**No Screwdriver required!
Not necessary to dissemble!**

To make connection just insert terminal tips, and contact is made. The more you pull, the better the contact. To take terminals out, just press the release lug and the tips fall out.

Every plug sealed and fully guaranteed. Sells for \$1.50

The Saturn "PERFECT" Jack



An improvement on all others. **Crowfoot offset:** Allows easy soldering.

Bracket, the mainstay of every jack, made of specially rolled Brass, with rounded edges. This insures uniformity, strength, appearance.

Blades: Spring temper German Silver, enforced where needed.

Contact Points: Genuine Sterling Silver.

Nipples: Shoulder type, with two 1/16" washers, insuring perfect fit to the panelboard.

All parts, except Blades, nickel-plated and highly polished.

- No. 1. Single Circuit, Open . . \$0.65
- No. 2. Single Circuit, Closed. 0.75
- No. 3. Double Circuit, Closed 0.90
- No. 4. Single Filament Control 1.00
- No. 5. Double Filament Control 1.25

The Saturn Mfg. & Sales Co., Inc.
Dept. D
48 Beekman Street
New York, N. Y.

Double Head Set

A head set that two can use as conveniently as one was recently put on the market by the Premier Accessory and Specialty Company, of 31 Congress Street, Newark, N. J. The device permits the double head-band to be split into two separate head-bands with one phone attached to each and with each having a padded friction clamp for height adjustment.

The padded clamp is also a desirable feature for it can be adjusted up or down with a slight pressure of thumb and forefinger without scratching the nickel plate, and without the use of the ordinary thumb nut or screw.

The phones themselves consist of a drawn aluminum shell, rust-proof diaphragm of special quality iron, enamelled copper wire coils, cores of Norway iron, varnished cambric insulation and magnets of tungsten steel. The cords used on the Premier Duplex are of equal length, and a distance of five feet is possible between the two halves when the set is split.

Specialists in Mineral

The Gibbons Dustin Radio Manufacturing Company, of 518 West Ninth street, Los Angeles, Cal., are making an intensive effort at present to make their Magnetite radio crystal better known. This company also makes the watch case head phones, and the radiotrola.

Magnetite radio crystal is said to be different from any other crystal used in a crystal detector in that the operator may place the cat's whisker anywhere upon its surface, every spot being sensitive. The makers claim that Magnetite radio crystals are unaffected by handling or moisture and that they will render efficient service indefinitely. Window and counter display posters featuring Magnetite crystals may be had from the Gibbons Dustin company who are ready to distribute them to all dealers handling their specialty.

California Leads Ohio

The *Crosley Radio Weekly*, published by the Crosley Manufacturing Company, Cincinnati, Ohio, is developing into a periodical full of information and news. Among the articles contained in a recent issue was one listing the number of broadcasting stations in each state and in Canada.

Being an Ohio concern, the Crosley Manufacturing Company takes a great deal of pride in the fact that Ohio is now second of all the states in the Union in the number of radio stations with 34, California being first with 66.

Nearly half of our orders for the DRY CELL SET THAT SELLS

are

REPEAT ORDERS

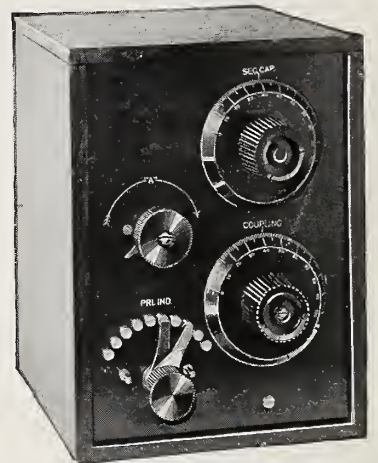

Q. T. DRY CELL SET

\$8.50

NET TO THE DEALER

Can be sold at \$25.00 with phones, tube and batteries at a good profit.

SPECIFICATIONS—

Mahogany-stained cabinet, engraved Radion panel, Ajax socket-rheostat, 21 plate variable condenser, 180° vario-coupler, no external binding posts, busbar wiring, all connections securely soldered.

Write for Full Information

The Q. T. Light Co.
East Orange N. J.



CLOSING OUT

Manufacturer will sell AT COST several hundred detector stands — Celon Base, Nickel-Plated Brass Parts.

\$18.00 per hundred

Box M21 RADIO DEALER

Book Reviews

By
BERNARD JEROME FARRELL

The Editors of the RADIO DEALER will be glad to review new publications in this field as they may be issued. Address them attention BOOK REVIEW EDITORS, THE RADIO DEALER, 1133 Broadway, New York City.

LETTERS OF A RADIO-ENGINEER TO HIS SON. By John Mills. Published by Harcourt, Brace & Company, New York. 265 pages.

A radio book with a sense of humor is the distinctive description that must be applied to the work of a member of the engineering department of the Western Electric Company. Mr. Mills has succeeded in simplifying the theory of radio as well as making it interesting.

This result he achieved first by his plan of presentation—a series of letters to his son, each progressively more informative and technical than the preceding. The book begins with an explanation of how a battery works and ends with amplification. And in every letter-chapter there is humor.

“Letters of a Radio-Engineer to His Son” is more than a current book on radio which becomes out-of-date almost as soon as printed, owing to the rapid advances in the science. This book will be of value almost indefinitely because it discusses and reveals the foundations of radio and these are everlasting.

ACOUSTICS AND THE TELEPHONE. By G. B. Crouse. Published by the Connecticut Instrument Company, Stamford, Conn.

This pamphlet deals with a new theory of sound based on the principle that all sound waves consist in alternate expansions and compressions of air.

From this theory the writer goes on to the development of sound reproducers showing how distortion arises, by means of an explanation of the difference between musical and unmusical sounds. How a non-metallic diaphragm in a radio phone filters noise and how it produces a restful effect is also explained.

Publish Hook-Up Book

A book of construction plans and hook-ups which is designed to appeal to the average radio enthusiast, who is always on the lookout for something that will enable him to increase his knowledge and radio efficiency, is now being issued by S. Newman &

If you want more business, handle the
NEW MOON RECEIVING SET
Model C-1—“Satterlee Antennaless”



Works without any aerial whatsoever. For short or long distance reception.

A LONGFELT WANT
THE NEW
NATURALTONE
LOUDSPEAKER

A loudspeaker with a clear non-metallic tone—at the right price—
\$27.50

DEALERS AND JOBBERS
write for discounts



MOON RADIO CORPORATION
12 Diagonal Street, Long Island City

“UNITED” RADIO PRODUCTS
Give a Quick Turnover

The retailer who gets them started enjoys the tremendous advantage of the word-of-mouth “advertising” by every user.

The uniformly satisfactory performance of

“UNITED”
AMPLIFYING TRANSFORMERS
and
VARIABLE CONDENSERS

has already given these instruments a national reputation that speeds up their sale everywhere. Dealers repeat because their customers boost.

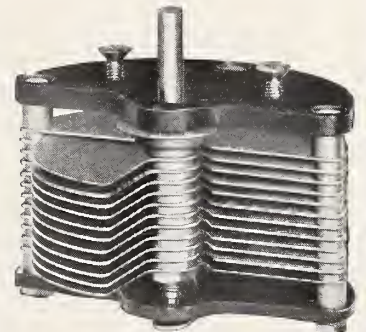

“UNITED” VARIABLE CONDENSERS

43 plate.....	\$4.50	5 plate.....	\$2.75
23 plate.....	4.00	3 plate.....	2.25
11 plate.....	3.50	without dial or knob	

“UNITED” TRANSFORMER

Audio-frequency, amplifying, magnetically shielded. A beautiful piece of workmanship. Gives loud, clear signals without howl or distortion.

Best Value on the Market, \$4.50.



Pat. Appd. For

“UNITED” PRODUCTS

have been adopted as standard equipment by leaders in the radio industries.

UNITED MFG. & DISTRIBUTING CO.
536 Lake Shore Drive Chicago, Ill.

ATLANTIC & PACIFIC RADIO COMPANY
 131 West 37 St (NEAR BWAY) New York

The Volume of the Atlantic and the Smoothness of the Pacific

A & P Loud Speaker

makes a theatre of your home. Every note will sing out as if the Broadcaster were right in your Speaker. Why listen to stuff that sounds like a tired phonograph record when the A & P LOUD SPEAKER gives faithful reproduction—with triple volume, clear and sweeter than very expensive speakers.

\$4.95

POSTAGE PREPAID
 MONEY BACK GUARANTEE
 Dealers and Jobbers write for Proposition.

Note: The A & P Loud Speaker owes its quality to the Special Alloy used and to the peculiar Acoustic Properties of its design.

WE CARRY A COMPLETE LINE OF STANDARD PARTS AT REDUCED RATES

"The Little Wonder"
 FOR BOYS AND GIRLS
CRYSTAL SETS

Unassembled - Net **\$1.75**

Catches distinctly everything broadcasted within 30 miles. We also manufacture the "Little Wonder" assembled set to retail at \$4.00.

GUARANTEED TESTED CRYSTALS

Galena 7½ Radiosite 8½
 Dealers and Jobbers Write for Free Catalog

It lists all our radio parts and supplies.

Holloway Elec. Supply Co., Inc.
 238 Third Ave. New York City

Free Mailing Lists
 Will help you increase sales
 Send for FREE catalog showing details covering names of your best prospective customers. Counts and prices are given on thousands of different Mailing Lists.

99% Guaranteed 5¢ each
 by refund of

ROSS-Gould Co St. Louis
 518 N 10th Street

Company, 47 Dey street, New York. The book, attractively printed, gives not only hook-ups for crystal sets, tube sets, audio-frequency and radio frequency arrangements, but also gives full particulars as to the capacity, design, and construction of each of the parts going into the respective hook-ups.

True-Tone Advises User

Efficient merchandising includes seizing every advantage to impress the quality of one's goods on the prospective purchaser as well as keeping him satisfied once these goods are purchased.

The True-Tone Radio Mfg. Co., of 186 North La Salle street, Chicago, Ill., have grasped these merchandising truths, as evidenced by the carton in which each True Tone head set is packed and sold. The cartons are sealed with a green slip on which are printed directions for use and a guarantee.

The guarantee assures the purchaser that the True-Tone phones, "if not tampered with, will be replaced with a new one within ten days from date of purchase, if defective in manufacture. This guarantee must be presented for replacement."

But to reduce any returns to the minimum, the green slip also gives some valuable advice to the purchaser on the care of head phones. "The True-Tone head set is designed according to advanced scientific principles; it is essentially a very delicate instrument. Handle it as such. Do not touch or remove any part of the inside of phones, as you may alter the adjustment and decrease efficiency. Lift phones only by the head band. Avoid jerking the cords."

Fiber for Horns

What should be the material for making the bell of a loud speaker, wood, metal or fiber? The Fiber Products Company, of Bloomfield Avenue and North Tenth Street, Newark, N. J., have the conviction that fiber will be the finally accepted medium for construction of amplifiers.

The Fiber horn, the product of the Fiber Products laboratory, is seamless, without unsightly glued joints or rivets to become loose, and it is practically indestructible, since it will not crack, chip or dent. As for the sounds produced by this instrument, the makers claim that it produces only mellow tones, without distortion or tinny effects. The firm is prepared to build horns for other manufacturers according to their own designs, the capacity and equipment of their factory being ample for such service.

SOCKET-RHEOSTAT
 Registered U. S. Patent Office

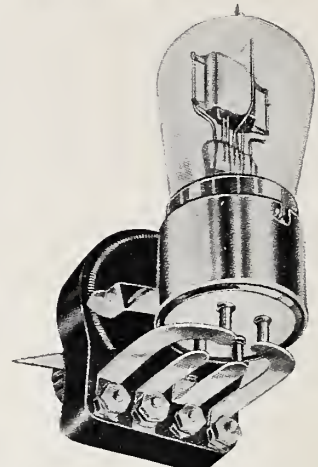

Type A-5 ohms, suitable for detector bulb
 Type B-2 ohms, suitable for power bulb **\$2.00**

TWO IN ONE. A socket and rheostat so combined as to form a single unit.

No more unnecessary leads between socket and rheostat. Just connect your leads to the four posts marked P F-F G and you are hooked up as far as the SOCKET-RHEOSTAT is concerned.

MANUFACTURED BY
Ajax Radio Corporation
 Telephone: Bigelow 4097
 538 SOUTH 10th STREET
 NEWARK, N. J.

Gould
 Radio "A" and "B" Batteries
 Write for Dealer Plan
 Gould Storage Battery Co.
 30 East 42d St., New York City

WE WILL MAIL ONE VERNIER CONDENSER
 for \$3.50 C.O.D.; Parcel Post Paid To any address outside of New Eng. To introduce our line

ELECTRIC PRODUCTS CO.
 11 Pemberton Sq. Boston

Complete Receiving Sets of Merit
 Write for descriptive circular
Oranola Radio Corp.
 228—7th Ave., N. Y. C.

Have You Our New Price List?
 Save money by our prices; save time by our prompt shipment. Successful dealers sell "EDGCO."

"EDGCO" RADIO PRODUCTS
 The EDW. J. GOETZ CO.
 608 Race St., Cincinnati, O.

DIAMANT
 VARIABLE CONDENSERS AND CRYSTAL DETECTORS
 Electrically and Mechanically Guaranteed
Diamant Tool & Mfg. Co., Inc.
 93 Runyon Street Newark, N. J.

Soldering Iron

By pressing a button located in the handle of the new Sabco two-heat electric soldering iron, the instrument is increased in wattage and temperature from twenty to thirty per cent. The user of a Sabco soldering iron is thus practically in the possession of two distinct irons of different heats, either



2-Heat Soldering Iron

of which may be used for the work for which it is best adapted.

This two-heat feature is a new development in soldering-iron construction and a patent is pending. In Model B-100, 90 watts is low heat, while by the pressure of the button 120 watts are consumed. Similar increases in wattage are possible on the two other models. These three models have tips specially designed for radio use and will appeal to the radio fan who uses an electric soldering iron.

Other features of the Sabco two-heat iron are: low wattage consumption as compared to other soldering instruments; neat appearance; simplicity of operation; and a guarantee for a period of one year against factory and material defects. The Strauss & Blum, Inc., of 254 W. 41st Street, New York City, manufacturers of the Sabco two-heat soldering iron, are backing their product with free distribution of folders and striking cut-outs.

Standard Metal Horns

The new problems in horn construction presented by radio have met with the serious consideration of the Standard Metal Manufacturing Company, of 237 Chestnut street, Newark, N. J., a company which has been making phonograph, telephone and automobile horns for twenty years.

As a result of their experimentation, they now offer several types of radio horns under the trade name of Standard. Four of these horns are finished in rubberoid only. No. 114 Standard will take all makes of receivers, and is designed for use where extra large horns are desired without vibration. No. 17, gracefully designed, is calculated to give proper amplification, while its heavy construction prevents blast. Made of heavy brass, Standard No. 15 does away with vibration. The New Gem taking all makes of receivers is said to give surprisingly clear reproduction. It is made with a grained mahogany or black rubberoid finish.

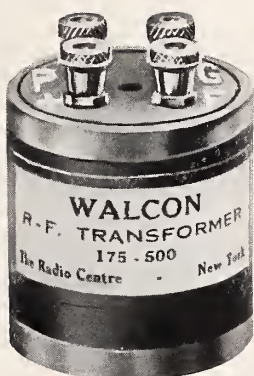

WALCON

Radio Frequency Transformer

THE BEST YOU CAN BUY

A Transformer that Guarantees Results Particularly suited for W. D. 11 Tubes.

List Price \$4.00

Manufactured by
THE RADIO CENTER

2 West Broadway New York
Dealers and Jobbers write for our attractive sales proposition backed by National Advertising.



Endorsed by PADEREWSKI

The Magic of the Living Voice

Clear, resonant, mellow-toned as an old violin, the BEL-CANTO AMPLIFIER gives in its original richness, the living voice of the artist, or the most delicate tones of an orchestra. Designed on the principle of the human throat, and built of reeds and metals that will not vibrate, it entirely eliminates all harshness and sound distortion, amplifying to unparalleled perfection.

Facsimile of congratulatory letter from the World's Most Famous Pianist

It was with great pleasure that I heard your Bel Canto loud speaker, the other day. The clarity and volume of tone transmitted, and particularly the absence of sound distortion make it a remarkable device.

While listening to different radio stations, some of them far away, I heard music and lectures with surprising distinctness, and the reproduction of Victor records sounded to me as if the performance were taking place in the same room.

You are indeed to be congratulated upon your ingenious invention.

Truly yours,

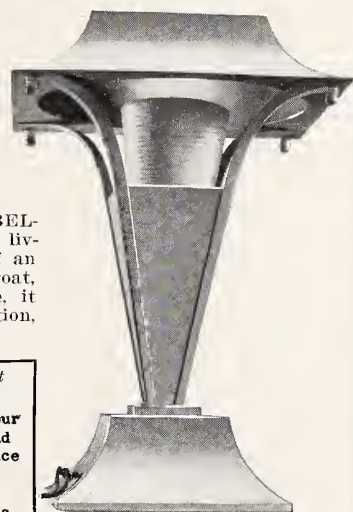

Patent Applied for

BEL-CANTO is adjusted for the following circuits: Regenerative two stages of amplification for stations within 50 miles. For long distance reception 5 tube radio and audio frequency circuit. Special extra sensitive phone unit, ample cord and plug. Price \$30.00 F.O.B. New York.

At your Dealer or Direct from Maker

BEL-CANTO CORPORATION

417 East 24th Street New York City



← THE SIGN OF GOOD SERVICE AND GUARANTEED SATISFACTION

IMMEDIATE DELIVERIES ON:

CLAPP-EASTHAM	RADIO CORP. OF AMERICA
BALDWIN PHONES	MURDOCK APPARATUS
THORDARSON	DRAGON STORAGE BATTERIES
NOVO BATTERIES	FADA APPARATUS
GREBE and MAGNAVOX	CHELTON APPARATUS

And All Other Standard Lines

EXCEPTIONAL DEALER'S DISCOUNTS—WRITE AT ONCE

WILMINGTON ELECTRICAL SPECIALTY CO., Inc.
912 ORANGE STREET Dept. A-10 WILMINGTON, DEL.



ELIMINATE COIL SUPPORTS BY THE USE OF RADIO-LAC

Radio-Lac is a liquid cement which can be applied to covered wire coils to hold them rigidly in shape without additional support.

Radio-Lac is moisture proof, non-conductive and is not affected by climatic changes. Its use will permit close coupling insuring greater efficiency of units and will lower cost of production of these various parts.

Radio-Lac is particularly adapted for use on winding Rotor or Stator of Variometers, Vario-couplers, etc. Samples and additional information furnished upon request.



**The Egyptian
Lacquer Mfg. Co.**
Dept. R.
5 East 40th Street
New York, N. Y.

Indoor Aerial Results

The Bruno Radio Company, 152 West 14th Street, New York City, were pleased to receive the following letter from a customer at New Brighton, N. Y. The cheery letter is reprinted here because we believe that our readers will be pleased to read it too:

"For a long time I have listened to what I had supposed were 'radio dreams' from different customers, to whom I had sold 'Bruno No. 3' receivers. These customers were always talking about what distance they were getting. I was absolutely content with the way my own Bruno was working both at home and in our store getting WJZ, WEAJ, WAAM, WRW, WHN on indoor aerials, the one in the store being 34 feet and the one at home 18½ feet across the parlor (one wire, no loop). But the whole business of distance finally got on my nerves last Saturday night, when three real radio bugs were discussing the marvels of the Bruno and what it had done for them. They didn't claim Europe but with the list of stations each one had, I don't see how any station in this good old country of ours was missing.

"Was on the verge of calling an ambulance because I surely thought they were completely 'gone.' So, just to find out for my own satisfaction I went to work last night at home on my little 18½ foot straight wire parlor aerial and this is what happened to me from 6:20 on:

"KDKA (Pittsburgh), WWJ (Detroit), WDAP (Chicago), WSB (Atlanta), and two other stations. I could not get call letters on, one saying 'Minnesota came in fine last night.' On the other I caught a piano solo. I could tune out WJZ for KDKA at will. Frankly I would not have believed it myself only I have my wife to verify all I claimed. Remember this is on an 18½ foot straight indoor aerial, one wire. As Coué says, 'Every day in every way, I'm getting better and better.'
J. A. VAN DAM."

Mr. Van Dam is a member of the firm of G. F. Van Dam & Son, 467 Richmond Terrace, New Brighton, N. Y.

All U. S. Via Radio

The day is not far distant when the President of the United States will address the people of the nation directly by radio, Otto B. Blackwell, transmission development engineer of the American Telephone and Telegraph Company, told members of the American Society of Civil Engineers at the

LITTLE GEM

**PRICE
\$6.50**

(Canada \$10.00)

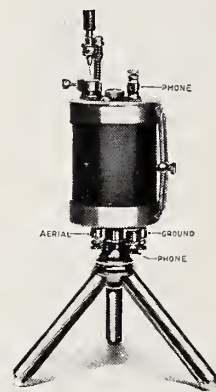

**Simple, Clear, Efficient and
Beautiful**

The LITTLE GEM presents a unique design combining compactness with efficiency. Unusually large receiving radius. Voice and musical tones come in with wonderful clearness and volume.

All metal parts are brass, nickel plated and polished. The instrument is beautiful in appearance, well made and practically indestructible. Nothing to get out of order or give trouble.

WHAT DISTRIBUTORS AND DEALERS SAY ABOUT THE LITTLE GEM:

"It will probably interest you to know that from our location at Columbus Circle, New York City, we are able to hear distinctly the broadcasting from WEAJ, WJZ and WOR."

"We are enclosing an order for 100 more and trust you will be able to ship them before the 24th as specified. We also ask that you book us for 200 more." From a Troy, N. Y. distributor.

"Enter additional order for 100."—From Winnipeg, Canada.

"Last shipment of Little Gems all sold. Rush order enclosed. The Little Gem is proving to be a wonderful seller with us."—From a Tenn. dealer.

*Attractive Proposition for
Jobbers and Dealers*

United Specialties Co.
Incorporated
57-59 Spring St., Newark, N. J.

seventieth annual meeting held at New York.

The A. T. and T. expert, who has conducted a research into radio development, explained to the engineers the field to which radio can be devoted.

"It is of inestimable service in the marine field, for talking with airships and guiding them, and for sparsely settled regions," Mr. Blackwell said.

Dubilier Micadon Type 610

The Dubilier Micadon, type 610, is of the usual Dubilier sturdy construction, with only the best grade of India mica used as a dielectric material. The condenser element itself is constructed under a patented and controlled process which assures permanency of capacity. The importance of this fea-



Dubilier Micadon

ture is usually overlooked by the radio novice.

Permanency of capacity means the elimination of many of the distorting noises that are audible in the average radio circuit. In the Dubilier product the conducting surface of tinfoil is held so closely to the surface of the dielectric (mica) that it is practically a part of it. As a final precaution against changes in capacity the entire condenser element is held tightly in a special clamping device.

The Micadon type 610 may be had in capacities ranging from .001 to .02. The molded composition case, which encloses the condenser element is provided with two composition covered binding posts and four small holes for holding-down screws. It is manufactured by the Dubilier Condenser & Radio Corp., 48 West 4th St., New York City.

Testrite Battery Testers

The increasing attention given to the condition of radio batteries indicates that the radio public is alive at last to the fact that the battery is the heart of the receiving set.

The makers of the Testrite hydrometer believe that the demand for battery testers will continue to grow at a rapid rate from now on, since radio fans are aware of the importance of

MARLE

AUDIO FREQUENCY

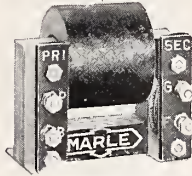

TYPE A4
RATIO 3 3/4 to 1
LIST PRICE \$3.75
TYPE A6
RATIO 5 to 1
LIST PRICE, \$4.25

RADIO FREQUENCY



TYPE R1
LIST PRICE, \$4.00

MODULATION



TYPE M1
LIST PRICE, \$5.00

TRANSFORMERS

SUPERIOR QUALITY TRANSFORMERS USED AND RECOMMENDED BY LEADING REPUTABLE MANUFACTURERS OF RADIO APPARATUS

MANUFACTURED BY

MARLE ENGINEERING CO., Orange, N. J.

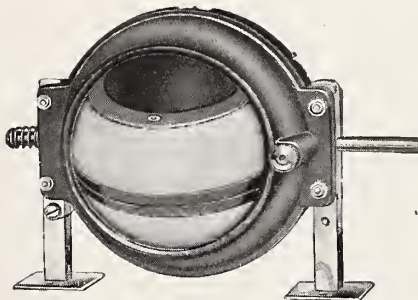

VARIOMETER
List Price \$6.50



The Finest Radio Apparatus

On the Market

The apparatus manufactured by the Radio Products Mfg. Co. is recognized as the very highest grade, designed to meet the most exacting requirements. Each unit is made complete in our own plant from the Redmanol moulding to the winding, assembling and final testing of the completed instrument.

Twenty years in the electrical manufacturing field gives us the wide experience, equipment and specialized organization necessary to produce the highest grade equipment to be had in this line.

Write us for full information.

Radio Products Manufacturing Co.

667 W. Fourteenth St.
CHICAGO, ILL.

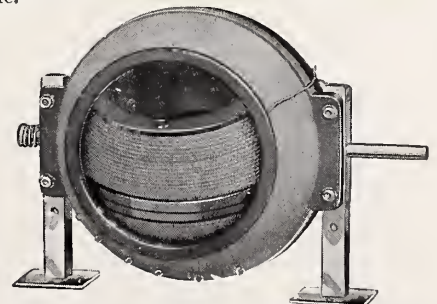

VARIOCOUPLER
List Price \$6.50

Mister Ray-O-Lite
Your Guide to Guaranteed
Batteries



Satisfied Customers,
Quick Turnover
On
RAY-O-VAC "B"
BATTERIES

Thousands of owners know that their radio sets operate better when equipped with Ray-O-Vac Batteries. Ray-O-Vacs are built from special cells, perfectly insulated and bound into one solid block by a rubbery, acid-proof insulating compound. This construction overcomes the receiving noises present when using ordinary "B" Batteries. The current is steady, strong and long-lived. Spring clip terminals insure perfect contacts. Radio fans have proved the facts for themselves and recommend Ray-O-Vacs to their friends. Dealers carrying stocks secure a quick turnover and build a solid list of satisfied customers. Send for Bulletin No. 225.

French Battery & Carbon Co.
Madison, Wisconsin
Chicago Dallas Atlanta New York
Denver Minneapolis Kansas City

RAY-O-VAC "B"
Batteries

ADD-A-STEP

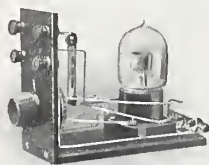

DETECTORS AND AMPLIFIERS
Awarded Mail's Certificate of Excellence
See them at the RADIO FAIR
ARROW RADIO CO.
Manufacturers of Quality Plus
Instruments
HACKENSACK NEW JERSEY

keeping the "A" and "B" batteries in condition. Testrite hydrometers are made in three styles, each of which are guaranteed to register the condition of the battery accurately. The Testrite Instrument Company recently moved into new quarters at 101 Fifth Ave., New York City.

Radio Golf a New Game

"Radio golf," is the new game invented by Frank Jones of Tuinucu, Cuba. The object of the game is to see which of the competitors can catch the greatest mileage of stations within a stated time. Each competitor keeps his own score card.

Higher score cards may have been turned in, but the card of Robert H. Anthony, of Needham, Mass., seems to have established the record at present. His best score is 3,576 miles per hour. This speed was maintained December 30 and 31 over a period of six hours and twenty minutes. Among the cities visited (by radio) were San Francisco and Long Beach, Cal.

The broadcasting of all cities heard totalling 45 in all, was received during 14 hours and 20 minutes operating time on the evenings of December 24, 25 and 30, and the early morning of December 31. The total number of miles covered during this time was 39,345, which establishes Mr. Anthony's claim to a radio golfer of high rank.

Mr. Anthony is New England manager for R. Thomas-Sons Co., manufacturers of electric porcelains. A standard Amrad radio frequency receiver 3,500, employing one stage of radio frequency, and two stages of audio frequency amplification was used. San Francisco was heard clearly through a loud speaking horn.

"B" Battery Construction

The complete line of Burgess "B" batteries, made by the Burgess Battery Company, Harris Trust Bldg., Chicago, Ill., have all been designed with a view to radio efficiency. Some of the features peculiar to each type are: Heavy moisture proof container; triple top seal, united with wax between the cells, completing a solid block construction; reinforcing webbing in the top seal; moisture proof insulating and reinforcing partitions between the cells; wax between cells which insulates and combines them into a solid unit; double moisture proof wrapper, an important factor contributing to "noiselessness"; and finally a one piece "jointless" zinc can for each cell battery which permits no leaks.

Burgess "B" batteries are made in styles with voltage ranging from 22.5 to 113. The weight of these batteries ranges from one pound to 28 pounds.

**UNION RADIO
PHONE TIP JACKS**
(Pat. Applied For)

25 cents A PAIR

These convenient Phone Tip Jacks replace the old fashioned binding post. They assure positive contact and quick operation at all times. Accommodate any standard round phone tip and several sizes of bare wire. Great for W D 11 connections and coil mountings. Ideal for experimental circuits. Packed in

1/12 1/2 and 1 Gross
Counter Display Cartons

We make a complete line of Variable Condensers, Rheostats, Tube Sockets, Condensite Dials, Tip Jacks, Receiving Sets and Two Step Amplifiers.

Write today for our liberal dealer proposition, samples and prices.

Catalogue K on request.

UNION RADIO CORPORATION
200-MT. PLEASANT AVENUE, NEWARK, N.J.
NEW YORK OFFICE 116-WEST 32ND STREET.
lllll

**DISTANT STATIONS
BROUGHT IN
FOR LONG WAVE
RECEPTION**

USE AMCO ADJUSTABLE, 1, 2
AND 3 COIL MOUNTINGS



Licensed Under DeForest U. S. Patent,
No. 1,365,170

Triple Coil Mounting List \$4.00
Double Coil Mounting List \$3.50
Single Coil Mounting List \$0.50

Adjustable locking device, a patented feature, holds the coil firmly in place. Readily mounted on front of panel in any position.

Constructed of the highest grade insulating material; polished and attractively finished.

All metal parts heavily nickel plated
NOT A MOULDED AFFAIR

Astorloid Mfg. Co., Inc.
Tel. Williamsburg 5104
416 Marcy Ave. Brooklyn, N. Y.

Moon Naturaltone Speaker

Experiments are being endlessly conducted these days to discover what gives the human voice its rounded, vibrant tones, and how these may be reproduced in a loud speaker. Engineers of the Moon Radio Corporation, manufacturers of the Moon Naturaltone



Moon Naturaltone Speaker

Loud Speaker, claim to have made the biggest advance in recent times in horn construction by modeling the horn of the Naturaltone loud speaker after the shape of the human mouth.

The horn itself is made of wood pulp composition, in keeping with the idea that the nearer one approaches nature the more likely one is to obtain natural effects. From time immemorial wood in various forms has been used to make musical instruments with resonance and timbre, from the marimba of the Peruvian Indians to the sweetest instrument of all—the violin that Stradivarius made.

The Naturaltone loud speaker is set in a mahogany finished cabinet, which is designed to make an attractive addition to any receiving set. The Moon Radio Corporation, also makers of the Satterlee antennaless receiving set have offices at 12 Diagonal Street, Long Island City, N. Y.

Transformer of Unique Design

The audio-frequency amplifying transformer put out by the Radio Supply Company, of Hornell, N. Y., comes as a distinct relief to the dealer and to the radio enthusiast. It is of unusual design in that it is unusually simple and neat in appearance. This transformer is said to produce volume of sound without distortion, and the makers say that three stages of amplification may be used with practical results.

The Radio Supply Company also make a loud speaker unit and a radio headset that are attractive both in price and design. Each instrument manufactured by the company carries with it a money-back guarantee.

FRESHMAN PRODUCTS—ACCURATE AND DEPENDABLE



“MICON”
Tested Mica
Condensers

Size	Price
.00025	\$.035
.0005	.35
.001	.40
.002	.40
.0025	.50
.005	.75
.006	1.00
.01	1.50



Variable Resistance Leak

With .00025 Mfd.
Micon Condenser
Combined

\$1.00

Without
Condenser

75c

Unbroken range—Zero to 5 Megohms, Clarifies signals, lowers filament current, increases battery life, eliminates hissing.



Assure absolute noiselessness—clarity of tone—accuracy—constant fixed capacity.

.006 Micons with Variable Resistance Leaks, especially adapted for Flewelling Circuit.

ANTENELLA

No antenna or aerial needed. Eliminates all the inconveniences in radio, operates from any light socket. Price only—

\$2.00

CHAS. FRESHMAN COMPANY, Inc.

97 Beekman Street, New York City

Dealers: Discount 33 1/3% on all orders \$15.00 and over. We pay parcel post, express or freight charges. Literature and display cards free on request.

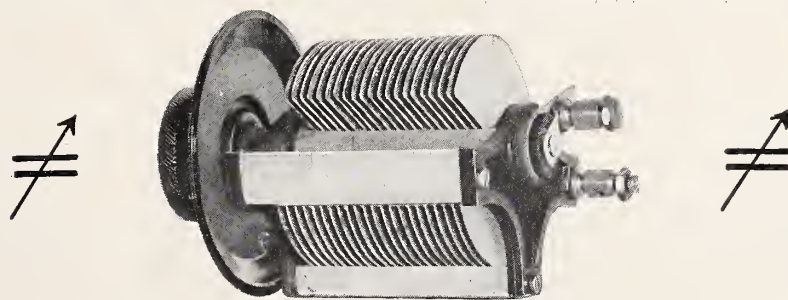

Radio Finds a Better Condenser

Bayley's 23-0005 and 43 Plate 0011 Variable Condenser is what Radio has found.

Its plates spaced close give it the finest tuning qualities.

It is a die-cast product, the stationary plates are cast solid, accurately and permanently spaced, on three upright supports, while the movable plates are cast on the centre revolving spindle. It is impossible for plates to loosen in service.

Solid rubber end pieces finished like black morocco leather make it beautiful. It is of good design and high grade workmanship. In an official test measures up to 0011 M.F.D. capacity and is uniform, it does not vary.

Each condenser has our guarantee, backed with a manufacturing record of more than forty years.

A sample order will convince you of its value.

And Make You. Certainly, A BAYLEY CONDENSER BOOSTER

We want business from houses that appreciate real value. It will give satisfaction and stay sold

Price, 23 Plates \$3.25 each. 43 Plates \$3.75 each

TO JOBBERS AND DEALERS A SPLENDID PROPOSITION

BAYLEY CONDENSER CO.

105-109 Vanderveer Street

Brooklyn, New York

The
SABCO



2
HEAT
PAT. PENDING

**ELECTRIC
SOLDERING
IRON #** **6.00**

MODEL
B-100
LIST PRICE

DISCOUNTS & CATALOG
SHOWING COMPLETE LINE
ON REQUEST

MFD. BY
STRAUSS & BLUM, INC.
256 1/2 West 41 St.
New York.

Leading Attraction at Recent
New York Radio Show
COMPLETE UNASSEMBLED
TITAN-O-TONE
LOOSE COUPLER RECEIVING SET
Including two wired coils
List Price \$4.00
Attractive Dealers Display Board
LIBERAL DISCOUNT
Manufactured by the
T-F RADIOPHONE CO.
667 Coney Island Ave. Brooklyn, N. Y.

FLEWELLING

All Parts necessary

Dealers: Write for Discounts.

HUDSON-ROSS
123 W. Madison St. Chicago

THORNTON

AUDIO FREQUENCY
AMPLIFYING TRANSFORMERS

Supreme Test Transformer

These transformers are supplied in either mounted or unmounted types. Special attention paid to the manufacturer of receiving sets.

THORNTON
TRANSFORMER CO., Inc.
30 Church Street, New York City

Jones Helps the Dealer

Shows Him How to Utilize His Window as a Salesman

By H. G. CISIN

Jones, the jobber's salesman, walked into Boyd's radio store the other day with a cardboard package under his arm.

"I want you to see this new window display," he said.

"Sure, I'll look at it," said Mr. Boyd, "but that's as far as I'll go. You fellows don't seem to realize that I get tons of that stuff in every mail. Just look back here." He led Jones to a closet filled with cardboard displays, counter cards, posters, circulars, etc. "Enough stuff there to fill the store to the exclusion of my entire radio stock," he said.

"No doubt about that," said Jones, and proceeded to open up the window display. "But say, Mr. Boyd, did you ever stop to consider that you could put a lot of that so-called stuff to work for you selling goods and making money? Now just take this display, for instance. It doesn't take much imagination to realize that it must have cost the manufacturers quite a sum of money. It was made by experts for just one purpose—to speed up the sale of Dictograph head sets and loud speakers. A fine chance it would have of doing that if placed in your back room. Get that loud speaker out of the carton and put it on this center platform, and take those two Dictograph head sets from that collection in your showcase. You see, the head sets fit one on each side panel of the display."

"The display does set them off," agreed Boyd, "but I'm not entirely sold on the idea."

Just then a customer interrupted. "That's the Dictograph loud speaker, isn't it?" he asked. "I saw it advertised. Would you mind hooking it up a moment?"

Boyd connected the loud speaker to a two-stage receiving set and tuned in WJZ. "Oh, boy, that's some speaker," said the customer, "I'll take it along with me." At this point Jones edged into the conversation. "How about distant stations?" he queried. "do you like to get them?" "I'll say I do," said the customer, "I'd stay up all night to get Havana or Frisco."

"In that case," said Jones, "you'd better take along a Dictograph head set with the speaker. You'll also find that it will simplify tuning in the loud speaker, no matter what station you are trying to get. Here's the way to use it: Just plug in the head set, tune

GANAERITE Detector Crystals

Twenty years of practical mineralogy gave us the material to produce the highest quality crystal.

We are now undertaking the largest single order for mounted crystals in the market.

We test and *guarantee* to replace or refund on any unsatisfactory Ganaerite crystal.

The Harris Laboratory
26 Cortlandt St., New York City



TYPE 209 DETECTOR | TYPE 309 AMPLIFIER
LIST \$18.00 | LIST \$30.00
RADIO RECEIVING SETS FOR 1 1/2 OR 6 VOLT
TUBES
IMMEDIATE DELIVERY
Distributors, Jobber and Dealers Write for
ATTRACTIVE DISCOUNTS
W. B. L. RADIO CO.
22 Norfolk St. Newark, N. J.

DEALERS!

If the Holiday Sales have depleted your stock—reorder now for mid-winter sales. Prompt deliveries are absolutely guaranteed—and our discounts are the most liberal.

We Are Jobbers For
Grebe Receiving Sets
Federal, Fada and
Radio Shop Products
Murdock Products
Baldwin Phones

Write For Our Special Proposition "Z"

THE RADIO SHOP
—OF NEWARK—
76 SPRINGFIELD AVENUE
NEWARK, N. J.

in your station to the maximum volume and then plug in the loud speaker. That's the idea. After listening-in on that head set, I guess you don't have to be told the other reasons why you should own it. I listen-in every night. After enjoying the loud speaker for a while, I plug in the head set and try for distance. I've heard stations from Canada to Cuba and from the Atlantic to the Pacific, and what's more that phone can't be beat for clearness and musical tones."

"Wrap up a head set with the speaker," said the customer. As the man left the store Boyd turned to Jones and said: "Say, old man, I wish I could afford to hire a salesman like you."

"You can," said Jones; "that display is the best little salesman you ever saw, and what's more it doesn't cost you a cent in salary."

"Right you are," said Boyd. "I'm going to put it to work at once in the center of the front window."

Hydrometers for All

Bringing the battery tester within the reach of every radio fan, the Stadeker Manufacturing Company, 123 South Jefferson Street, Chicago, Ill., is now offering the Stadco Jumbo hydrometer at a reasonable price.

This hydrometer is distinguished by several features besides good appearance. The Jumbo has an extra large bulb which protects the glass barrel from breakage. It also provides large capacity when used as a battery filler. The prongs on the float prevent sticking to the sides of the barrel. Projections on the nozzle prevent rolling.

Only high grade materials are used in the construction of this instrument. The glass used in moulding the barrel is of extra strength and free from defects. High grade rubber is used in the bulb and nozzle. The Stadco Jumbo hydrometer comes in an attractive two-color telescope box. The Stadeker Manufacturing Company also makes a standard instrument at a lower price than the Jumbo.

Sells Known Brands

R. R. Garrick, of West Philadelphia, Pa., is a distributor who believes in handling only nationally-known and nationally-advertised radio accessories, among which are the "K-N" helix antenna, made by Walter S. Krenz; the Pramco Unit crystal set, made by the Premier Radio Mfg. Co., of Philadelphia; the Ajax socket-rheostat, made by the Ajax Radio Corp., and the S. & S. variometer, made by the Sunday & Scholtz Co.



The "Melco Supreme" Radio Frequency Amplifying Receiver can be used with indoor or outdoor aerial, loop or lighting plug. It is a new departure in radio, non-reflex, non-regenerative, tuned radio-frequency. Amplification of this instrument is extremely high per stage, without loss of tone quality. **IT DOES NOT DISTORT THE WAVE NOR INTERFERE WITH OTHER MEMBERS OF THE RADIO AUDIENCE.**

This new system permits of single tuning adjustments that result in a high degree of selectivity and long distance reception.

PRICE \$125.00

**A complete line of high grade parts are also available
For quality merchandise, price cannot be equalled**

SAVE SALES COMPANY

Sales Engineers

City Hall Building

New York City

(Broadway and Warren Street)

MELCO

Write Now for Literature, Attractive Discounts and Distributor's Proposition

KEYSTONE Lightning Arresters

Listed as standard by Underwriters' Laboratories (362 A-4)



Type B. Retail Price, \$2.00

Keystone Radio Arresters last indefinitely because they have no vacuum to lose nor fuses to blow. They are enclosed in heavy porcelain, sealed and tested. Installed outdoors where an arrester belongs. Take the place of a lightning switch.

Buy them from your Jobber or direct.

For sale by Jobbers everywhere.

SIMPLEX PANEL UNITS

Write for catalog on these Simplex products.

Simplex Variometers, mounted or unmounted.

Simplex Vario-Couplers, mounted or unmounted.

Simplex Condenser Panels

Simplex Detector Panels

Simplex Amplifier Panels

Simplex Type RF Receivers



ELECTRIC SERVICE SUPPLIES CO.

Manufacturers of Lightning Arresters for 30 years.

17th and Cambria Sts., Phila.

Distributors for SIMPLEX RADIO CO.



Essex 150-500 meter
180° Vario-Coupler—
Green Wire with 3"
molded dial.
Price \$1.25 net
Special Essex WDI
Audio Transformer de-
signed for dry cell
tubes. Price \$2.55.

ESSEX BUS WIRE NO. 14
Square Tinned—Specially Pre-
pared and Will Give Entire
Satisfaction. \$1.00 Per Hundred
Feet.

Send for Dealers' Quantity Prices

ESSEX MANUFACTURING CO.
117 Mulberry St., Newark, N. J.

REINARTZ

All Parts necessary

DEALERS: Write for discounts

HUDSON-ROSS
123 W. Madison St. Chicago



Head Sets, V.T. Sockets, Rheostats and
Condensors

THRESHER RADIO & MACHINE CORP.
476-482 Eighteenth Ave.
Newark, N. J.

KNOCK-DOWN RADIO RECEIVING SET



Neatly packed in an attract-
ive hinged cover box. Makes
a wonderful display. A
child can assemble this set.
Practical and instructive.
Complete instructions for as-
sembly included.
RETAIL PRICE, \$4.50.
Liberal Discounts to Jobbers.
(Established 1871)

CHAS. WINKLER, INC., 178 Emmett St., Newark N. J.

Radak

Reg. U. S. Pat. Off.

RELIABLE RADIO EQUIPMENT
made by America's oldest and largest manufacturers
of radio equipment exclusively. Sold by the best
electrical and radio dealers.

CLAPP-EASTHAM CO.
133 Main Street Cambridge, Mass.

RADION HARD RUBBER PANELS
Cut to Any Size
DISCS, WASHERS, BUSHINGS, ETC.
Made to Order
New York Hard Rubber Turning Co.
212 Centre Street, N. Y. C.

Recommended for Reliability

RADIO STORES CORP.
VARIABLE CONDENSERS—
PLUGS-RESISTANCE UNITS, ETC.
222 West 34th Street, New York

Hydrometer Is Well Known

Nationally advertised in such publi-
cations as the *Saturday Evening Post*
the Hafner hydrometer, one of the
specialties of the Hafner Manufac-
turing Company, 3128 Carroll Street,
Chicago, Ill., is one of the best known
brands of radio equipment.

The Hafner hydrometer is a heavy
one-diameter barrel designed for easy
reading and hard wear. A correct
reading is always easy for the float
can not be held against the barrel by
capillary attraction. Glass beads on
the float keep it floating freely. Rub-
ber connections are of soft, acid-proof
stock, protecting the hydrometer from
breakage and preventing loss of suc-
tion and leakage of acid.

Besides being one of the lowest-
priced hydrometers on the market the
Hafner hydrometer is backed by na-
tional advertising and dealers' helps,
such as eye-compelling window cards
and folders which may be slipped into
every radio purchase.

Amplifier for Speaker

A one-stage amplifier for use with
a loud speaker has been introduced by
the Bristol Company, of Waterbury,
Conn. This device is used in connec-
tion with a detector and one or two
stages of amplification.

The instrument known as the Bris-
tol power amplifier, is neat in appear-
ance, resembling a unit of a high grade
set. It is constructed on a principle
that uses a circuit which eliminates the
need for a "C" battery to maintain
the grid negative. High voltage may
be used on the Bristol power amplifier,
being limited only by the capacity of
the tube.

The Bristol Company especially
recommends its use with the Bristol
line of audiophones, a list of loud
speakers upon which the company is
at present placing stress.

Sales Helps for Tubes

Free electros and mats for the ex-
ploitation of Cunningham tubes is one
method adopted by the Audiotron
Manufacturing Company, 35 Mont-
gomery Street, San Francisco, Cal.,
to increase sales.

These electros and mats are designed
for use with the dealer's name in
newspapers. There are six different
styles for the use of the dealer and
each graphically calls the attention
of the reader to the Cunningham tube
and its advantages.

The Audiotron Manufacturing
Company is also distributing attrac-
tive folders to dealers for store ad-
vertising. Dealers are asked to state
on their business stationery the num-
ber of folders and electros they can use.

NOTICE!

We have an extremely
profitable and timely
proposition for live
Jobbers, Distributors,
and Buyers. Immedi-
ate action is necessary

WRITE AT ONCE

ARROW RADIO CO.

Hackensack New Jersey

PATENTS

on radio inventions apply to
OTTO K. ZWINGENBERGER
38 Park Row, New York
Cortlandt 3207

PATENTS

ELECTRICAL MECHANICAL
RADIO

SEND SKETCH AND DESCRIPTION
FOR OPINION

EMIL ALEXANDER KERN
328 SOUTH SEVENTH STREET
NEWARK, N. J.

PATENT

your ideas. Protect your rights by U. S. and Foreign
Patents and Trade-Marks. Moderate rates. CALL,
WRITE or send us your invention.

Free booklet and inven-
tion recording blank.

FREE
CONSULTATION
Phone: Vanderbilt 7212.

FREE MANUFACTURERS
PATENT CO., INC.
BOOK 1520 FIFTH AVE.
NEW YORK

HAFNER FOR HYDROMETERS

Guaranteed instruments to sell for 75c your
a good profit margin for dealers. Ask your
jobber or write us direct.

HAFNER MANUFACTURING CO.
3130 Carroll Ave., Chicago, Ill.

"Have a Hafner Handy"

Vario-coupler

180 Degrees—Bakelite tubing, green
silk wire.

Write for prices and discounts.

WALD ELECTRIC CO.
101 Varick St. New York City

We will furnish immediate Cash for
Radio Stocks or Material

In making offerings state full details as to
quantity and lowest price acceptable.

THE R-C OUTLET, 30 E. 23 St., N. Y. C.
A National Clearing House for the Mutual
Benefit of the Industry

MANUFACTURERS OF

Receiving Sets Complete

Unites Mounted and Unmounted

Send for Description and Prices

RADIO OUTFITTING CORP.

Mfg. High Grade Radio Apparatus
410-412 East 34th St. New York, N. Y.

International Phones

With a total weight of cord and phones of eleven ounces, the International K-17 phones, made by the International Radio Telephone Apparatus Company, of 395 Broadway, New York City, form one of the lightest head-sets on the market.

The makers claim that every detail which would add to the acoustic qualities has been carefully studied and weighed in its relation to the object to be attained. The diaphragm is of standard ferrotype metal, and is so supported in the cap as to allow for correct reproduction of music, without the transposition of certain high pitched notes common to many telephones. The pole pieces are of Swedish iron, laminated to reduce eddy currents. The permanent magnets are of tungsten steel, quadruple laminated and lacquered. A six-foot mercerized cord is provided with pin tips to connect to the receiving apparatus with concealed terminals at the telephone ends. Each phone has a resistance of 1,500 ohms. The phones are put up in two styles, one with mercerized cord and the other in a velvet lined case, with a silk cord.

Fenstermaker Switches

A line of radio switches, and screws that are attractive in appearance and efficient in operation is now being put on the market by C. B. Fenstermaker, 43 Green Street, Lancaster, Pa., under the trade name of Mars.

The feature of the Mars line is a ball-bearing switch, S-3, for which patents have been applied. Other parts in the Mars output are contacts, switch stops, bushings, binding posts, washers, nuts and screws. The Fenstermaker company is now merchandising these products by means of attractive showcards on which the products are displayed in dozen lots. The company is also equipped to manufacture special brass turned and stamped parts from samples or blue prints.

Long Distance Essentials

Three instruments designed to secure fine control for the radio fan are made by F. A. D. Andrea, of 1581 Jerome Avenue, New York City. They are the FADA potentiometer, vernier rheostat and vernier attachment.

The FADA potentiometer and vernier rheostat are said to insure an extremely delicate control of receiver circuit and tube filament currents. The FADA vernier attachment can be quickly applied to practically any make of rheostat having three-sixteenths of inch shaft, for purposes of converting it into a vernier rheostat.

DELICATE SOLDERING

Both the manufacturers' and amateurs' problem on all fine work is readily solved by the instrument constructed for this particular purpose.

THE POST SOLDERING IRON

Platinum Heating Unit—Interchangeable Tips—Universal Current
(Large and Small)

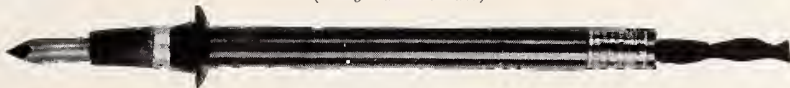

One Half Actual Size

LISTS AT \$6.00

Dealers' and Jobbers' discounts on request

Awarded Certificate of Excellency, N. Y. Evening Mail Radio Institute

POST ELECTRIC COMPANY, (Office 509) 30 E. 42nd St., New York

Westphal's
FLEXIBLE
Spaghetti

WESTPHAL'S SPAGHETTI

Black or Yellow

Grade "A" Grade "B"

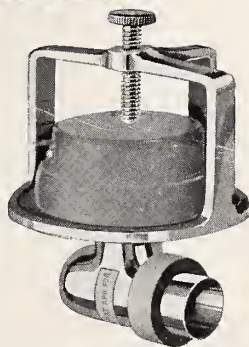

10,000 feet lots, per ft. . . . 3 cts.	10,000 feet lots, per ft. . . 1 1/4 cts.
5,000 feet lots, per ft. . . 3 1/4 cts.	5,000 feet lots, per ft. . . 1 1/2 cts.
1,000 feet lots, per ft. . . 3 1/2 cts.	1,000 feet lots, per ft. . . 1 3/4 cts.
500 feet lots, per ft. . . 3 3/4 cts.	500 feet lots, per ft. . . 2 cts.
Less than 500 ft., per ft. 4 1/4 cts.	Less than 500 ft., per ft. 2 1/2 cts.

Write for Samples

The WESTPHAL ADAPTER fits all phonographs and headphones. Constructed in one unit and does not require bushings. Resonance chamber with single phone produces tones and volume not found in other adapters.

Write for our attractive discounts.
Samples sent postpaid \$1.85.

Westphal Manufacturing Laboratory

224 So. Michigan Ave.

Chicago, Ill.

A representative line OF STAPLE MERCHANDISE

DeForest Equipment (New D. V. Tubes)

Saturn Products, Perfect Jacks and Saturn Automatic Radio
Plugs

Rico Loud Speaker Phones—Brandes Phones

Tungar Battery Charger, Extra Attachment for Storage
"B" Batteries

Dayton Fan and Motor Co. Variometers and Variocouplers
Woodehorn Loud Speaker—Magnavox

NORTH WARD RADIO CO.

Phone Mitchell 1463

236 Halsey Street

Newark, N. J.

General Insulate Products

The General Insulate Company, 1008 to 1024 Atlantic avenue, Brooklyn, N. Y., reports that the year that has just closed has shown a volume of sales of more than double that of the previous year and that 1922 was the second largest in volume of sales in the history of the company, since its establishment nearly twenty years ago.

This company is known as moulders of insulate, black shellac composition and of Hi-Heet, a phenol composition parts for the radio and electrical trades. It has recently introduced a new product called Star Insulate, a material that is said to have great mechanical and dielectric strength, combined with resiliency. It can be moulded into almost any shape, thick or thin and in any color, either opaque or translucent.

Radio Trade Mailing Lists

For the radio manufacturer and retailer desiring mailing lists reaching certain distinct classes of potential buyers, the lists compiled by the Trade Circular Addressing Company, 166 West Adams Street, Chicago, can be secured.

This company is at present making a specialty of radio lists and have compiled twelve distinct radio rosters containing some 40,000 names. There are separate lists containing the names of radio dealers, radio manufacturers, radio supply jobbers, all by states, radio stations makers of complete sets. The list of chief interest to the radio retailer is one containing the names of 25,000 radio amateurs and managers of radio stations. The company guarantees the lists with a money-back policy.

Loud Speakers Aid Rehearsals

Directing rehearsals in New York's largest theater and in one of the largest in the world is not an easy task, but Samuel L. Rothafel, directing the productions at the Capitol Theater, New York, has found the Western Electric Company's public address system of great help.

Sitting at the back of the immense theater, Mr. Rothafel can now talk into a microphone in ordinary tones and can be heard in the projection room, on the stage, by the men in charge of the lighting system and by the conductor of the orchestra. He can move ten feet away and give directions and still the sensitive microphone will pick up his words and transmit them to the persons interested. The system involves the use of loud speaking projectors in various parts of the auditorium, and a vacuum tube amplifier.

DAY-BY-DAY—IN-EVERY-WAY

EBY SERVICE

is getting
BETTER
and
BETTER
and
BETTER



Commander



Ensign



Sergeant "SS" Corporal

Notwithstanding the tremendous demands being made upon us from all parts of the country, for our popular line of quality products, we are maintaining a 24-hour service. Anticipate your requirements and be assured of a supply of EBY posts.

THE H. H. EBY MANUFACTURING CO., PHILADELPHIA, PA.

ELECTRICAL TESTING

Of all materials entering into Radio Construction. Meters and apparatus calibrated and repaired.

CHEMICAL ANALYSES
STRENGTH TESTS

Investigation or Development of New Apparatus and Materials. Routine Tests at Special Rates.

NEW YORK TESTING LABORATORIES
80 Washington Street, New York City
Bowling Green 7016

STANDARD SPECIAL CRYSTALS

Are you selling Standard Special Crystals? They are recognized as the most efficient crystals on the market, and are sold in every country where wireless is being used. Every Standard Special Crystal is specially treated and tested on a radio wave, and is absolutely guaranteed. They will last longer and give better service than the ordinary kind.



The Guaranteed Crystal

STANDARD CRYSTAL CO.
274 S. Halsey St.
NEWARK, N. J.

Canadian Agents: Sterling Specialties
213 Somerset Building, Winnipeg, Man., Canada

Western Representative: Engineering Sales Company, 220 North State St., Chicago, Ill.

STOP-LOOK-WRITE

DEALERS, JOBBERS AND MANUFACTURERS

Before placing orders, write us first and get samples and our big discount sheet.

	List		List
Condensers 43-Plate.....	\$3.50	Turney Head Sets.....	\$6.50
“ 23- “	2.75	Dials 3”75
“ 11- “	2.25	Variometers	3.50
“ 7- “	2.00	Variocouplers	3.50
“ 3- “	1.50		

SPIRO BROTHERS, Manufacturers and Distributors
519 Real Estate Trust Building
Philadelphia, Pa.

Thomas A. Edison Announces New WD-11 Dry Cell Battery

By WILLIAM COLEMAN

That the importance of the dry cell battery operating vacuum tubes is being recognized is evidenced by the action of manufacturers who are now introducing improved batteries for

this purpose. Proof that the dry cell tube is one of the most important innovations in radio in years is furnished by the announcement that Thomas A. Edison has recently brought to per-

fection a battery for exclusive use with the WD-11 tubes.

That such an eminent inventor should devote his time to this problem is not surprising, since the advent of the WD-11 tube has made possible the successful operation of radio sets

CRYSTALS Unconditionally GUARANTEED



Standard Brand Special Radiocite

Crystals are unconditionally guaranteed to give satisfaction—we tie no strings to our offer, they must be right.

Packed in Neat Containers
Samples and Prices Upon Request

STANDARD MINERAL COMPANY

216 Market St.

Newark, N. J.



Thomas A. Edison

without the trouble and annoyance of the storage battery. The great number of these tubes sold is an indication of a desire on the part of the radio buying public to discard the storage battery and presages to a certain extent the universal popularity which is certain to be accorded the low voltage tube set.

In rural districts the use of this



Edison Radio Primary Battery

type tube is almost compulsory. Where no available means of charging is to be had, or where storage batteries must be laboriously carted to and from charging stations for recharging, the WD-11 tube comes into its own.

The dry cell, which has heretofore been used in the operation of these tubes, has, however, to be replaced fre-

“SUPERIOR PRODUCTS”

The Rolls-Royce of Radio



Headsets

Loud Speaker Phones

Variometers

Variocouplers

Variable Condensers

Tait Dials

Electrical efficiency plus handsome appearance.

Ratio $4\frac{1}{2}$ to 1. Primary reactance 30,000 ohms. Secondary, random wound and untuned gives a flat top amplifying characteristic from 150 to 2,000 cycles. Exceptionally tight coupling. Moisture proof. Uniform operation under all conditions. Will not burn out. A quality product used and recommended by successful manufacturers of radio sets. Another “Superior Product” which reflects credit upon the radio industry.

SUPERIOR PRODUCTS MANUFACTURING CORPORATION

1078-80 Springfield Avenue, Irvington, N. J.

quently. This fact has led Thomas A. Edison to make available for radio use a battery having voltage characteristics similar to the dry cell but with an extraordinarily long life. This new battery known as the Edison radio primary battery has a life of 250 amperes hours and means are provided for repeating this life indefinitely and at slight cost by renewing the elements and solution.

The battery will operate one, two or three tubes. When operating one tube the life of each renewal is 1,000 hours, or approximately the life of the tube itself. A battery which lasts as long as the tube requires no attention during that time and which may then be renewed, repeating this performance indefinitely, is certain to enjoy a large and wide demand.

The cell used in the new battery is not new in itself. It has been used for over twenty-five years in the operation of telephone and telegraph circuits, fire alarm systems, railway signal operation and other fields, in which absolute dependability, long life and un-failing service are prime essentials.

The renewal feature is interesting to the dealer, as it insures further and continued business to him in the form of renewal sales. Each battery sold means further business in renewals.

The Edison radio primary battery is made by Thomas A. Edison, Inc., Primary Battery Division, Bloomfield, N. J., and the makers state that they are now about ready to begin the active marketing of the unit and are making connection with jobbers in all parts of the country.

Radio Stocks

By FRANK T. STANTON

Conditions governing radio securities were never more favorable than at present. The leading concerns in the field were never in a stronger physical or financial condition than today.

Following are quotations for the principal radio stocks:

Stock.	Bid.	Asked.
All American Cables	\$119	\$120
Amer. Tel. & Cable	60	61
American Tel. & Tel.	123½	124
Am. Marconi Stamped	5c	20c
Am. Marconi Unstamped	\$7	\$9
Canadian Marconi	2½	3¼
De Forest Radio	8	11
English Marconi, com.	11	14
English Marconi, pfd.	10½	13½
Federal Tel. Co. Cal.	7	8
Federal Tel. & Tel.	11	12
General Electric, com.	181	182
Gen. Elec. 6% new stk.	11½	12
Inter. Tel. & Tel.	58	60
Mackay Co., com.	104	105
Mackay Co., pfd.	68	70
Man. Elec. Supply	53	54
Marconi Int. Marine	9	11
Radio Corp., com.	3½	3¾
Radio Corp., pfd.	3½	3¾
Spanish Marconi	1	3
Western Union	110	111
Westinghouse E & M.	59	60

YOUR CUSTOMERS

are asking us for Vac-Shields: We want you to sell them.

The invention eliminates linking up the magnetic fields between vacuum tubes, does away with inter-stage electro-static coupling, overcomes stray capacity effects that are always troublesome, which make it so difficult to tune in distant stations.

Trial Order—One Dozen, by mail, postpaid, \$8.00, sent C.O.D. Order today. See our ads in Wireless Age, Radio Broadcast, Radio World, etc.

ORANGE RESEARCH LABORATORIES

East Orange, N. J.

HIGH GRADE SALESMEN WANTED

TRADE
"VAC-SHIELD"
MARK



PATENT-PEND

Price \$1.00

Stop-Look-Read!

DETROIT ELECTRIC CO.
ESTABLISHED 1883
PHONE MAIN 7830
113 E. JEFFERSON AVE.
DETROIT, MICH.
RADIO SUPPLIES

Allen-Bradley Co.,
1918 Ford Building, Detroit, Mich

Gentlemen:—With reference to the Bradleystats, we wish to say that we have sold a great number of them. We have watched the Bradleystat with particular interest because we were one of the first to have a supply.

We have sold them to manufacturers who positively refuse to use any other rheostat. One of the talking points has been the length of time which the Allen-Bradley Company have manufactured rheostats. This has proved of enormous worth from a selling standpoint and we assure you that we are more than pleased with the results obtained.

We have not had any returned for any cause, and assure you that we will stock them continually.

Respectfully yours,
DETROIT ELECTRIC COMPANY



Retail Price

\$1.85

Get your quota of Bradleystat sales by sending this coupon NOW!

Allen-Bradley Co., 487 Clinton St., Milwaukee, Wis.

We are interested in your sales plan for the Bradleystat. Please send prices and discounts.

CONDENSITE CELORON

Is recognized as the highest type of insulation for

RADIO PANELS

We are authorized distributors and can fill any order for standard panels or special sizes, plain or shielded.

Write for information.

BREMER-TULLY MANUFACTURING COMPANY

Canal and Harrison Sts.

Chicago

"CSE" SERVICE

has grown considerably—hence its removal to new quarters was necessary, so note carefully our new address—also the

"CSE Buyers Handbook of Radio"

is ready. Your request for it on your business letterhead will bring you 60 pages (Loose-Leaf) of the most interesting Radio Reading known. Incidentally its use by you will save you many dollars. Better ask for it now.

CENTRAL STATES ENGINEERING CO.

9 South Clinton Street

Chicago, Illinois

RUSONITE

CRYSTAL RECTIFIER
MULTIPOINT (Patent Pending)

A SYNTHETIC CRYSTAL DETECTOR
Sensitive Over Entire Surface

GUARANTEED

Unequaled Clearness; Unequaled Volume; Unequaled Distance. The Standard Crystal Endorsed by Experts, Press and Trade

Manufacturers are increasing efficiency by equipping their Crystal sets with Rusonite Crystals.

List Price 50c.

RUSONITE CATWHISKER

(Patent Pending)

14 Karat Gold—Supersensitive

List Price 25c

Attractive Discounts to the Trade

RUSONITE PRODUCTS CORP.

Dept. D., 15 Park Row, New York, N. Y.

THE PARAMOUNT ENGRAVING MACHINE

for Radio Panels

Greatest Production—Lowest in Price

PARAMOUNT MACHINE CO.

207 Market Street Newark, N. J.

JOHN A. COZZONE & CO.

61 Arlington Street, Newark, N. J.

VERNIER CONDENSERS

Hit it anywhere!

Magnetite Radio Crystal

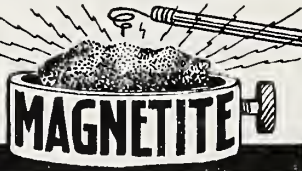

The most sensitive Crystal Detector on the WORLD market. Unaffected by handling or moisture and will render efficient service indefinitely—GUARANTEED—Display posters supplied to the Trade. Being advertised nationally—List 50 cents per Crystal.

JOBBER AND DEALERS WRITE IMMEDIATELY

GIBBONS-DUSTIN RADIO MFG. CO

Owners and National Distributors

518 West 9th St.

Los Angeles, Calif., U. S. A.

FINAL PERFECTION AND DOWN TO A PRICE "KING" SR., VARIOMETER

Qualifications:
All capacity loss eliminated by elimination of hardware

New attachment method of wires eliminates wires loosening.

Pigtail connection

Fahnestock Clips
for
Hook Up Connections

Size **\$1.60 Each**
4 3/4 x 4 3/4 x 3 Price to the Trade

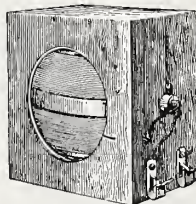

Advantages to Consumer.

A Price Within the Reach of All.

Rough usage and unprofessional handling cannot harm this variometer.

A guarantee slip packed with each variometer makes the manufacturers responsible direct to consumer.

Beautiful Natural Oak Finish.

The biggest sensational value of 1923. Smaller type "King Jr." Costs Less

THE AREMCOE MANUFACTURING COMPANY

Sales Office: 30 E. 23rd St.

Gramercy 1586

New York City

Beautiful Loud Speaker

Resembling in appearance the finest cabinet phonograph, the Whiteland radio loud speaker, made by the Whiteland Manufacturing Corp., of Washington Avenue, Long Island City, N. Y., has been put on the market to satisfy the demand for beautiful as well as efficient radio apparatus.

The Whiteland loud speaker is made in two styles. Model A is for direct connection to the receiving set and Model B is used with a magnetic amplifier operated from a local battery.

Both models have an adjustable series of wooden strips reflecting the sound waves and thus controlling the volume of sound. This device is similar to those used in the sound boxes on the most efficient phonographs.

Kellogg-White Bill in House

The House of Representatives at Washington failed to pass upon the report on the Kellogg-White Bill, designed to regulate broadcasting, when it came before the house in committee on Tuesday, January 23rd.

This report on the bill, which was drawn up by the Committee on Merchant Marine and Fisheries, indicated that the Kellogg-White Bill was merely an amplification of the regulatory powers granted to the Government by the existing act, passed in 1912.

The Kellogg-White Bill, during the debate in the House of Representatives was attacked by two Democrats, Marvin Jones and Blanton of Texas, who argued that the bill would place too much control in the hands of the Secretary of Commerce. They admitted that they were generally opposed to the extension of federal control.

Representative Wallace N. White, Jr., of Maine, who drew up the bill, defended it on the grounds of expediency, stating that there were at present only 191 wave lengths, and 122 of these were used by 279 government stations, leaving but 69 wave lengths for use by private stations. When the presence in the United States of between one and a half to two and a half million private radio sets is considered, he argued, the need for some regulation resulting in organized and non-interfering broadcasting was obvious.

"TRIUMPH" COMBINATION COUPLER-METER

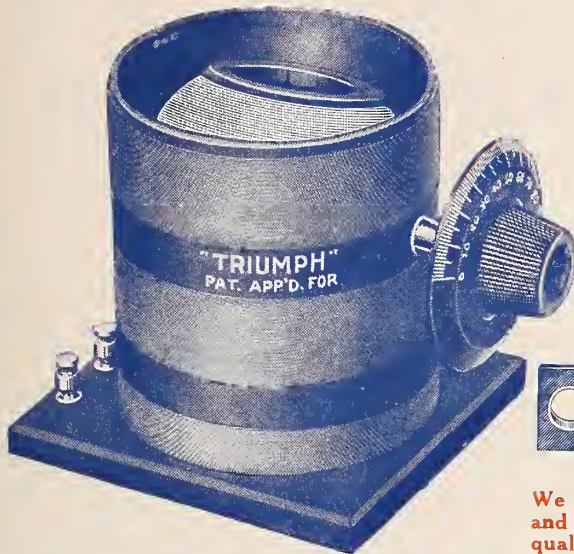

The "Two-in-One"
Instrument



We are headquarters for Phone, Grid and Grid Leak Condensers. Price and quality are right. Free sample upon request.

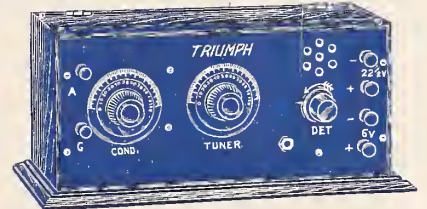

"TRIUMPH" A1 V. T. Receiving Set
List Price \$30.00
Embodies the Triumph Coupler-Meter
So simple that a child can operate it
Triumph 2 Stage Unit \$35
Best Value in the Radio Market To-day

Samples will be sent on memorandum to any rated concern upon request

SIGNAL RADIO & ELECTRIC CORP. 64 UNIVERSITY PL. NEW YORK CITY

EMPIRE OILED TUBING *sometimes called spaghetti*

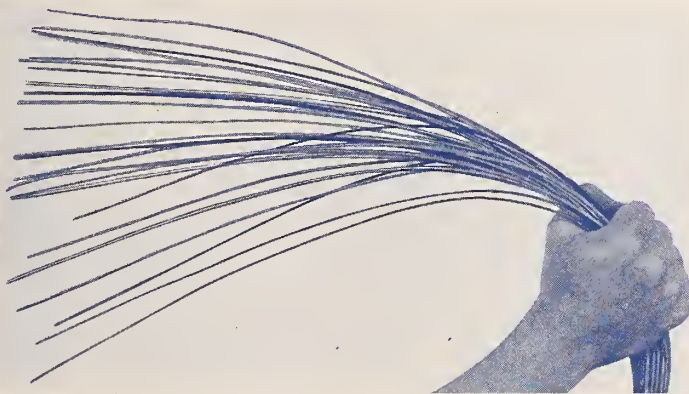

EMPIRE PERFECT INSULATOR
Empire Tubing builds solid business for Radio Dealers. It brings both amateur and professional back for more, because the purchaser and his friends like its superior flexibility, durability, smoothness, high dielectric strength and insulating value. Empire Tubing is a standard product among engineers throughout the electrical industry. Made in black and white, yellow and other colors, in all radio sizes, 36 inch lengths.

Send today for Empire Tubing samples and quotations on 500, 1,000, 5,000, 10,000, 20,000 foot lots. Get acquainted with our other time tested radio insulation products

MICA INSULATOR COMPANY

68 Church Street, New York. 542 So. Dearborn Street, Chicago. Works: Schenectady, N. Y.
Agencies—The Monroe Brass & Wire Co., Cincinnati; G. Arthur Morrell, Cleveland; Electrical Specialty Co., San Francisco and Los Angeles

2022-F

“ I do the very best I know how, the best I can, and I will keep doing so until the end.”—Lincoln



WHETHER rendering service to a nation or to an individual, the fundamental principles are alike. In simple words of one syllable, Abe Lincoln has aptly expressed the thought of SERVICE.

However hard we have labored to achieve our reputation for service, we are working harder than ever to hold and enhance it.

And our reward for good service, plus right prices, plus quality merchandise is a dealer confidence that we are proud to acknowledge.

We carry ample stocks of
ACME
BRANDES
MURDOCK
CLAPP-EASTHAM
WESTERN ELECTRIC
RADIO CORPORATION
and many
other makes

RADIO DISTRIBUTING COMPANY
8 West Park Street Newark, N. J.
A. H. CORWIN, General Manager

RADISCO

The RADIO DEALER

Vol. 2 No. 6

MARCH, 1923

One Dollar The Year

Published monthly at 1133 Broadway, New York, N. Y., by The Radio Dealer Company. Entered as Second Class Matter, at the Post Office at New York, N. Y., under the Act of March 3, 1879

RADISCO *means service*

“Service” unquestionably is a very much overworked word. It is the common thing nowadays to rave a good deal about it. Most firms do not even know the definition of the word while others know very well what it means but only think they give it.

There are many institutions, however, really rendering a service. They do all that the customer expects them to do—and a whole lot more. Such is the Radio Distributing Company.

Service is a hard thing to give. It cannot be copyrighted and is the most difficult thing in the world to imitate.

We carry ample
stocks of

ACME
BRANDES
MURDOCK
CLAPP-EASTHAM
WESTERN ELECTRIC
RADIO CORPORATION

and many
other makes

RADIO DISTRIBUTING COMPANY
8 West Park Street Newark, N. J.
A. H. CORWIN, General Manager

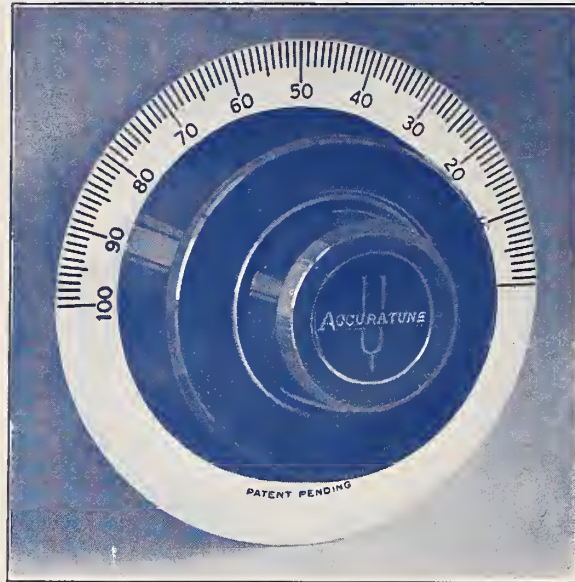

ACCURATUNE MICROMETER DIAL

PATENT PENDING

Entirely self-contained, absolutely automatic in action, and above all "fool-proof"—

Its unique micrometer mechanism provides for an accuracy of adjustment eight to ten times as great as is obtainable with any other so-called "vernier" device or attachment, resulting in—

ABSOLUTE TUNING PRECISION

Quite as appealing in its rich, distinctive appearance and evident quality as in its mechanical perfection, the Accuratune Micrometer Dial—

SELLS ITSELF AT SIGHT

Order immediately through your regular channels one of our attractive mounted display samples, (the cost is nominal). Place it on your counter—let the interest it arouses determine your stock order.



"THE SEAL OF MERIT"



845 BROAD STREET, NEWARK, N. J.



Why he did not buy

THE customer wanted a radio panel immediately. But the dealer could not deliver it because he had to have it cut from sheet stock. The customer did not want to wait, and walked out. How many sales like that do you lose?

You can keep radio panel sales in your store by stocking Celoron Radio Panels. They come in standard sizes selected to meet the requirements of practically every set-builder. Each panel is already cut, trimmed, and wrapped in glassine paper. Each is a separate package, easily stocked and merchandised.

The customer asks for a certain size. You select a Celoron panel and pass it across the counter. This instantaneous service is something your customers will appreciate. They will be more likely to

come to you for the other articles they need to complete their sets.

Celoron has high insulating resistance, high dielectric strength, and low dielectric losses. It is easily worked, machined, drilled and tapped, and will engrave evenly without feathering.

After thorough investigation of dealer requirements and those of the set-builder these sizes have been selected:

- 1. — 6 x 7 x $\frac{1}{8}$
- 2. — 7 x 9 x $\frac{1}{8}$
- 3. — 7 x 12 x $\frac{1}{8}$
- 4. — 7 x 18 x $\frac{1}{8}$
- 5. — 9 x 14 x 3-16
- 6. — 7 x 21 x 3-16
- 7. — 12 x 14 x 3-16
- 8. — 7 x 46 x 3-16

*This strip for cutting special sizes. Not wrapped in glassine.

Let us have your order today, specifying by number the sizes you want.

Diamond State Fibre Company

BRIDGEPORT (near Philadelphia) PENNSYLVANIA

BRANCH FACTORIES AND WAREHOUSES

BOSTON CHICAGO SAN FRANCISCO

Offices in Principal Cities

In Canada: Diamond State Fibre Company of Canada, Limited, 245 Carlaw Avenue, Toronto

CONDENSITE CELORON STANDARD RADIO PANEL

ATWATER KENT

Radio Receiving Sets and Parts

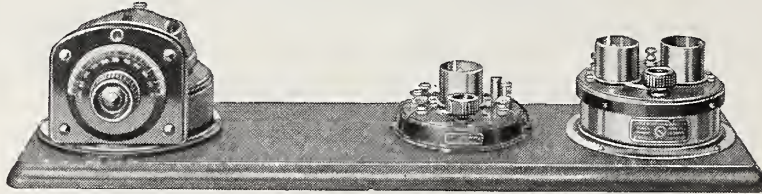

Complete Set consisting of Coupled Circuit Tuner, Detector Unit and 2-stage Amplifier. Other sets shown in circular.

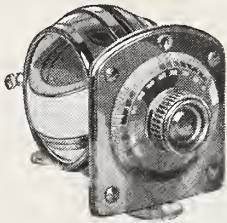

Mounted Variometer

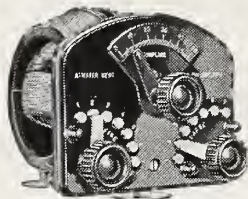

Mounted Variocoupler

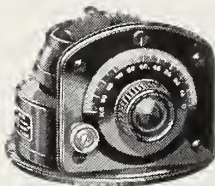

Type 11 Tuner

ATWATER KENT Receiving Sets and Parts are built with the most particular care. From the moulding of the condensite forms and winding of the various coils, through the assembling and finishing of the units to the final mounting and wiring, every step is subjected to the most rigid inspection. It must be "just so." This is the reason why ATWATER KENT radio equipment has that "different" look that makes it instantly noticeable in any surrounding.

Atwater Kent products sell on appearance.

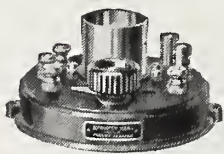

Standard Tube Detector Unit



1 1/2-Volt Tube Detector Unit



1-stage Amplifier

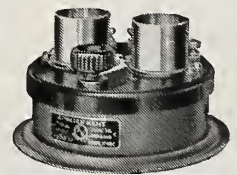

Detector 1-stage Amplifier
A similar unit is furnished in a 2-stage Amplifier

ATWATER KENT MANUFACTURING COMPANY, PHILADELPHIA, U. S. A.

Radio Department

4941 STENTON AVE.

Correspondence Solicited

ATWATER KENT

Radio Receiving Sets and Parts

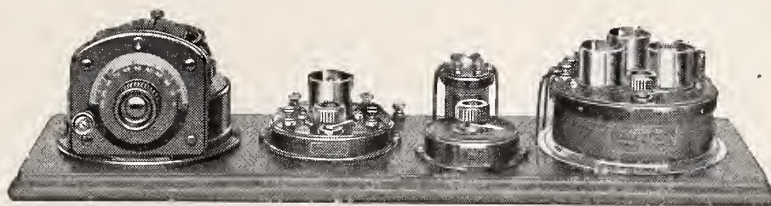

Complete Set consisting of Type 11 Tuner, one stage of Radio Frequency Amplification, and Detector 2-stage Audio Frequency Amplifier.

BUT appearance is not the only feature that is watched. Even though the factory is pushed to its utmost capacity by the extraordinary demand for ATWATER KENT sets and parts, every unit is carefully tested to make certain that its performance is right. By this means, the radio fan is sure of getting a part or set that is not only strikingly handsome in appearance, but works perfectly, and gives the utmost satisfaction.

They stay sold on quality of performance.



R. F. Transformer



2 to 1 A.F. Transformer Type L



Standard Vac. Tube Unit

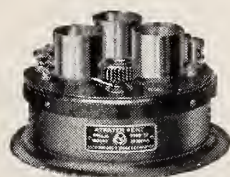

Detector 2-stage Amplifier



Table Potentiometer

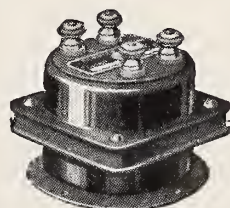

9 to 1 A.F. Transformer

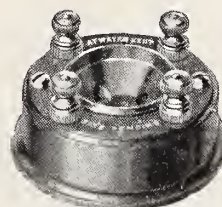

1 1/2-Volt Tube Socket

ATWATER KENT MANUFACTURING COMPANY, PHILADELPHIA, U. S. A.
 Radio Department 4941 STENTON AVE. Correspondence Solicited



Sell Him a VOLT- METER!

Why?



BECAUSE he NEEDS it. He MUST know his exact voltage to tune satisfactorily—to duplicate results quickly—to obtain full life and service from his tubes.

Because YOU will be rendering him a genuine SERVICE that will be appreciated—when you show him the real value of a Weston Voltmeter.

The FUTURE of Radio will be built on service. Are YOU going to build YOUR business on this basis—and at the same time take advantage of this wonderful profit-making opportunity? Every tube user is a prospect. Start talking Weston Voltmeters today.

Write for Booklet J, illustrating and describing Weston indicating instruments for Radio use. Prompt shipments made from stock.

Weston Electrical Instrument Co.

178 Weston Ave. Newark, N. J.

Electrical Indicating Instrument
Authorities Since 1880

THE RADIO DEALER

The Radio Trade Journal

For The Radio Retailer

CONTENTS MARCH, 1923

SPECIAL ARTICLES

Bright Future for the Dealer Assured.....	By A. H. Corwin	18
Confidence and Self-Respect Essential to Radio Salesmen.....	By Walter French	47
Dangers of Monopoly in Germany.....	By H. Jaeger	32
Dealers Disclose Unfair Tactics of Mail Order Competition, By W. L. Harrison and R. A. Wheeler		21
Do Cut Prices Make Radio More Popular?.....	By Harold M. Schwab	20
Hook-Ups as an Aid to Sales Promotion.....	By Sigmund Newman	17
Letters Get Trade.....	By Bernard Freedman	52
Making Your Store the Radio Centre.....	By R. D. Ridley	24
Present Trade Marks Do Not Protect.....	By Chauncey P. Carter	16
Schools Help Sales.....	By William Coleman	69
Tuner in Tube.....	By Martin Gridley	50
Two Kinds of Stores.....	By Jarrold Thomlinson	55
Three Contests Indicate Dealer Interest.....	By L. N. Allen	19
The First Year.....	By the Publisher	39
Your Store Is Your Best Advertisement.....	By N. B. Zimmerman	15
Why Buy From The Jobber.....	By A. E. Pollock	17

DEPARTMENTS

Book Review.....	By B. J. Farrell	58
Editorial		22-23
Radio Pictures of the Month.....		34
Radio Stock Markets.....	By Frank P. Stanton	54
Service Bureau.....		Back Cover
What the Manufacturers Are Doing.....		26

THE RADIO DEALER, THE RADIO TRADE JOURNAL, published monthly on the first, at 1133 Broadway, New York, N. Y., by THE RADIO DEALER COMPANY, in the interest of dealers in Radio Supplies. HARRY M. KONWISER, Publisher; LAURENCE A. NIXON, Managing Editor; N. B. ZIMMERMAN, Editor; A. L. KONWISER, B. S., ALBERT E. SONN, R. E., Technical Editors; BERNARD FREEDMAN and EUGENE J. SCANLON, Associates; C. HOPPE, Circulation Manager; M. JAY KLEIN, Research Manager; F. A. NEARY, Manager Service Bureau.

REPRESENTATIVES IN THE TRADE: ELMER W. MOORE, H. E. BENNETT, WM. B. WILKINSON, JR., J. MAURICE CASPER, H. L. KRENZ, M. A. CLARK, C. L. GEESSEY, C. C. MINIER, J. L. PEOK, M. P. MCNEELEY, W. H. OKE, BERNARD J. FARRELL, C. C. GREEN.

PUBLICATION OFFICE: 1133 Broadway, New York, N. Y. Telephone Watkins 8926-8927
 CENTRAL STATES: 35 South Dearborn Street, Chicago, Ill. Telephone Dearborn 4053
 NEW JERSEY: 845 Broad Street, Newark, N. J. Telephone Market 4659
 PACIFIC COAST: Suite 511, 456 S. Spring Street, Los Angeles, Calif. Telephone Los Angeles 12050
 512 Pacific Building, San Francisco, Calif. Telephone Sutter 954
 PITTSBURGH: Suite 570, Union Arcade, Pittsburgh, Penna.
 SOUTHERN STATES: 610 Barome Street, New Orleans, La.
 PHILADELPHIA: 3723 Spruce Street. Telephone Preston 1851-W
 CLEVELAND: 1389 West 87th Street, Cleveland Ohio
 BRITISH OFFICE: Walter Dandie Company, Ltd., 173-175 Great Portland Street
 London, W. I., England

SOUTH AMERICA: Casilla Coireo 280, Buenos Aires, Argentine. Wm. Schneider, Representative
 CANADIAN OFFICE: 23 Lily Street, Winnipeg, Manitoba

Advertising Rates and detailed statement of circulation and other information for advertisers furnished on application.

Advertising forms close the 15th of the month prior to date of issue.

Circulation restricted to manufacturers, jobbers and retailers in wireless equipment. Subscription in the United States, one dollar the year, payable invariably in advance. Subscription in foreign countries, two dollars the year, payable invariably in advance.

Also publishers of THE RADIO DEALER WEEKLY—for Manufacturers.

Smith & Brown, Inc.
Radio Supplies

217 MAIN ST.

MADISON, OHIO

Dear Mr. Evans:

Dullness will fly out of your window on the night that your first radio programme flies in.

Millions of other folks are nightly plucking a whole evening's entertainment out of the very air they breathe - why not you?

Think what it would mean to you to sit in your easy chair, "listening in" to grand opera, to symphony concerts, to splendid programmes of vocal music - enjoying the latest jazz hits - getting the daily scores and play-by-play reports of the big athletic contests - obtaining the daily market reports, weather forecasts, and interesting news from everywhere - refreshing yourself with lectures and sermons by renowned lecturers and preachers - enjoying yourself and improving your mind in a thousand-and-one other ways.

We carry a very complete line of radio parts and apparatus. At reasonable cost, we will make it easy for you to fill your home with days and nights of magic delight, broadcasted from stations far and near.

We will gladly bring a receiving set out to your home some evening and let you see and hear for yourself.

Sincerely yours,

SMITH & BROWN, Inc.

This set of
sales-building
letters free to
radio dealers

A series that will get results from any good prospect list

YOU know the value of a good prospect list.

You also appreciate the need of getting action from it.

Is anything better for the purpose than a good circular letter—one which puts your particular message up in the right way to your particular kind of prospects?

The six letters, included in this free set, are exactly that kind—just the thing to send out to the many persons in your territory, who are on the verge of becoming radio enthusiasts, but who need a little push to send them over.

Each letter emphasizes that your store is the place to go to for dependable radio apparatus, reliable service and timely advice.

The whole series is written in a live, humanly-interesting manner, and is sure to get results.

The Adams-Morgan Company, manufacturers of Paragon Radio Products, believes that enterprising dealers would be glad to have a set of such thoroughly practical letters on hand at this time when the Radio season and Radio enthusiasm are at their height—the very time when a good prospect list should be systematically circularized in a live and distinctive way.

Accordingly, we have arranged to have a limited number of the sets made up to be supplied *free* to dealers, whether or not they handle Paragon Radio Products.

If you would like to get a set before the supply is exhausted, we suggest that you write us promptly on your business letterhead.

ADAMS-MORGAN COMPANY, 12 Alvin Avenue, Upper Montclair, N. J.

Important Announcement

To protect our customers against inferior imitations the name of your old friend RADION (panels and parts) now is made safe by the registered trade mark RESISTON. This name stamped on panels or parts means the best in radio insulating materials.

**RESISTON
RADION**
Panels and Parts

RESISTON RADION is a superior grade of hard rubber developed exclusively for Radio use.

RESISTON RADION is mechanically better than ordinary panel insulations, because it will not warp under normal conditions; it is easily worked with simple tools, cuts and drills clean without chipping, is easily engraved.

RESISTON RADION has a beautiful satin-like polish comparable to the finest finish ever put on hard woods.

RESISTON RADION excels all other insulations in the four most important characteristics required for Radio use, viz: (1) low phase angle difference, (2) low dielectric constant, (3) high resistivity, and (4) non-absorbent qualities. Tests by disinterested organizations including the New York Electrical Testing Laboratories establish these claims beyond question.

RESISTON RADION costs no more, in most cases LESS than phenolic, laminated phenolic or other insulation materials usually offered for panels.

RESISTON RADION is made in two colors, black and mahogany. The latter resembles fine old mahogany in appearance.

RESISTON RADION is made in 18 stock sizes of panels, hence it can be used with minimum waste. Each panel packed in envelope to protect beautiful finish. Stock sizes are as follows:

6x 7 inches	7x21 inches
6x10½ "	7x28 "
6x14 "	7x48 "
6x21 "	9x14 "
7x 9 "	10x12 "
7x10 "	12x14 "
7x12 "	12x21 "
7x14 "	14x18 "
7x18 "	20x24 "

Also made into dials, knobs, sockets, antennae insulators, etc.

RESISTON RADION is economically moulded to any specifications at our factories.

Inquiries from those interested in the best insulating material are solicited.

American Hard Rubber Company
11 Mercer St., New York

"The Supreme Insulation"

List of Advertisers

(Advertisers Indexed by Products will be found on Pages 12 and 13 of this issue)

A	
Adams-Morgan Co.	7
Aerovox Wireless Corp.	58
Ajax Radio Corp.	40
Allen-Bradley Co.	41
American Hard Rubber Co.	8
Amplex Instrument Labs.	13
Aremco Mfg. Co.	57
Arrow Radio Co.	42
Astorloid Mfg. Co., Inc.	42
Atwater Kent Mfg. Co.	4, 5
Automatic Electrical Devices Co.	32-33
B	
Bathgate, Walter E.	58
Betts & Betts.	51
L. S. Braeh Mfg. Co.	64
Bremer-Tulley Radio Co.	50
Briggs & Stratton Co.	14
Bristol Co., The.	31
Brooklyn Metal Stamping Co.	51
Bruno Radio Corp.	60
C	
Carbon Products Co., The.	28
Chauncey P. Carter.	61
Chaslyn Co.	68
Clapp-Eastham Co.	44
Commercial Screw Machine Co.	64
Continental Fibre Co., The.	53
Copper Clad Steel Co., The.	48
Cozzone & Co., John A.	50
Crosley Mfg. Co.	19
Crown Radio Mfg. Corp.	28
D	
Darling Radio Co.	54a
Diamant Tool & Mfg. Co., Inc.	44
Dictograph Prod. Corp.	49
Diamond State Fibre Co.	3
E	
Eagle Radio Co.	36
Eagle Radio Mfg. Co.	59
Eby Mfg. Co., The H. H.	41
Eastern Radio Mfg. Co.	58
Edison, Inc., Thos. A.	38
Eisemann Magneto Corp., Inside back cover	
Electric Service Supplies Co.	46
Electric Products Co.	44
Ell-Ess Radio Exchange.	42
Eshoo Cabinet Works, E.	48
Essex Mfg. Co.	54
European Radio Co.	57
F	
Fallgatter, Marvin B.	46
Federal Tel. & Tel. Co.	68
Fiber Products Co.	55
Fischer & Co., G. H.	40
Ford Mica Co., Inc.	49
Four Way Co.	65
Franklin Radio Mfg. Co.	50
French Battery & Carbon Co.	64
Freshman Co., Inc., Chas.	43
G	
General Merchandise Co.	52
Gibbons-Dustin Radio Mfg. Co.	55
Globe Radio Equip. Co.	66
Goetz Co., The Edw. J.	44
Gould Storage Battery Co.	44
Gregg & Co.	44
H	
Hafner Manufacturing Co.	44
Harris Laboratory, The.	58
Heinemann Electric Co.	69
Holloway Elec. Supply Co., Inc.	52
Hudson-Ross.	64-66-68
Hyman & Co., Inc., Henry.	58
I	
Inter-Ocean Radio Corp.	66
J	
Jackson, P. D.	44
Jaynxon Lab.	50
K	
King Sewing Machine Co.	72
Kramer Radio Co.	44
L	
Lewis & LeRoy Radio Corp.	44
M	
Maelite Storage Battery Co.	68
Magna Instrument Co.	63
Magnavox Co., The.	25
Manufacturers Patent Co.	44
Marle Engineering Co.	32
Metro Electrical Co.	59
Mica Insulator Co.	14
Mills Radio & Elec. Co.	64
Mitchell-Rand Mfg. Co.	44
Moon Radio Corp.	68
M. P. M. Sales Co.	69
Multiple Elec. Products Co.	67
Mu-Rad Laboratories, Inc.	35
Mydar Radio Corp., The. Second cover, 71	
N	
National Vulcanized Fibre Co.	12
Newman & Co., S.	27
New York Hard Rubber Turning Co.	52
New York Radio Dial Co.	68
New York Testing Laboratories.	57
Novo Manufacturing Co.	52
O	
Oranola Radio Corp.	56
P	
Paramount Machine Co.	44
Parkin Mfg. Co.	47
Permanent Radio Fair.	45
Pittsburgh Radio & Appliance Co., Inc.	48
Post Electric Co.	57
Poster & Co.	56
Precision Equipment Co.	11
Pruden, Frederick H.	44
Q	
Q. T. Light Co.	56
Queens Radio Co., Inc.	42
R	
Radio Apparatus Co. (Pittsburgh)	48
Radio Accessories Co.	39
Radio Center.	61
Radio Courses, Inc.	42
Radio Detector Co.	54
Radio Distributing Co. Front cover	
Radio Mica Products Co.	65
Radio Outfitting Corporation.	44
Radio Products Mfg. Co.	63
Radio Shop of Newark, The.	68
Radio Stores Corp.	72
Radio Trade Association.	71
Rauland Mfg. Co.	53
Ross-Gould Co.	68
Royal Electric Laboratories.	56
Rusonite Products Corp.	62
S	
Samson Elec. Co.	43
Saturn Mfg. & Sales Co., Inc.	30
Save Sales Co.	39
Service Bureau. Back cover	
Schwab, Harold M., Inc.	31
Shamrock Radio Co.	57
Shaw, H., Insulator Co.	38
Shelton Mfg. Co.	37-42-50-58-64
Signal Radio & Elec. Corp.	50
Simple A Radio Co.	54-B
Spee-Dee Specialty Co.	36
S. S. Novelty Co.	40
Standard Appliance Mfg. Co.	44
Standard Metal Mfg. Co.	29
Standard Mineral Co.	27
Standard Wireless Panel Co.	35
Stanton Co., Frank T.	48
Steinmetz Wireless Mfg. Co.	68
Strauss & Blum, Inc.	56
Stuckeman Bros., Inc.	52
Superior Products Mfg. Co.	50
T	
T. B. H. Corporation.	60
Testrite Instrument Co.	50
T. F. Radiophone Co.	52
Thornton Transformer Co.	52
Thresher Radio Corp.	9
Trade Circular Addressing Co.	68
Triangle Electro Trading Co.	61
True-tone Radio Mfg. Co.	67
U	
Union Radio Corp.	40
United Mfg. & Distributing Co.	45
United Specialties Co., Inc.	58
V	
Viking Radio Co.	50
Virginia Radio Corp.	61
W	
Wald Elec. Co.	58
W. B. L. Radio Co.	48
Werner & Patch.	60
W. E. Supply & Service Co.	44
Weston Elect. Instrument Co.	6
Westphal Mfg. Co.	62
Wilcox Laboratories.	48
Winkler, Inc., Chas.	44

"A Man Is Known By The Company He Keeps"

The Dealer's Standing With His Customers Depends Upon the Quality of His Merchandise.

The Buyer of Radio Parts Has Learned to Discriminate in His Selection of Dependable Materials.

A Satisfied Customer is a Booster.

THRADIO Products Designed and Built Upon Correct Electrical and Mechanical Principles Guarantee Highest Results and Dependability.

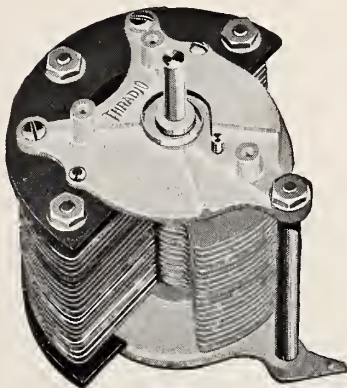

Pat. Pend.

VARIABLE CONDENSER. Plain.

Arranged for panel mounting. Stationary plate assembly carried by Bakelite Washers placed out of field. Positive contact. Strut insures perfect alignment of end Bearings and Plates.

11, 23, 43 Plates.



HEADSETS
 HEAD BANDS
 V. T. SOCKETS
 RADIO FREQ. TRANSFORMERS
 AUDIO FREQ. TRANSFORMERS
 RHEOSTATS, PLAIN
 RHEOSTATS, VERNIER
 VAR. CONDENSERS, PLAIN
 VAR. CONDENSERS, VERNIER
 GRID CONDENSERS
 DETECTOR UNITS

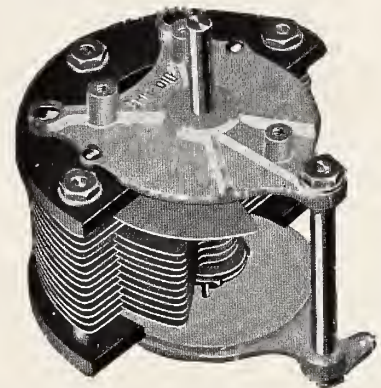

Pat. Pend.

VARIABLE CONDENSER. Vernier.

Only CONDENSER having both ROTOR PLATES and VERNIER. Controlled by ONE KNOB. Stationary plate assembly same as Plain type.

12, 24, 44 Plates.



GRID CONDENSER and TERMINAL.
 Adjusted for UV-200, UV-201, WD-11 Tubes.

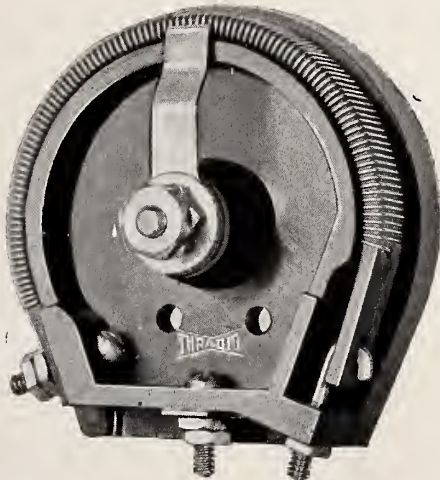

Pat. Pend.

FILAMENT RHEOSTAT. Plain.

Bakelite Base. Untreated Fiber Strip anchored at only one end and adjustable to hold firmly against flange of base. No corroded or shorted Resistance. Rugged construction.

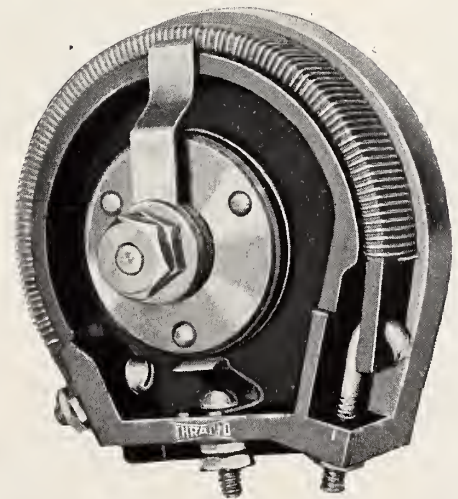

Pat. Pend.

FILAMENT RHEOSTAT. Vernier.

Low Resistance Unit in series gives accurate and positive regulation.

SPECIAL DISCOUNTS
 TO
 DEALERS
 DISTRIBUTORS
 MANUFACTURERS

THRESHER RADIO & MACHINE CORPORATION

476-484 Eighteenth Avenue, Newark, N. J.

For Radio Frequency Sets

Constantly Making New Distance Records

Here's a Complete Assortment



Crosley Model VI

This set consists of one stage of Tuned Radio Frequency Amplification and Audion Detector. It is normally for use with head phones but is especially recommended to be used with any type of loud speaker. Additional amplification is unnecessary if head phones and horn are used in receiving local stations. With the Crosley Receiver Model VI distant broadcasting stations are brought in loud and clear. It also eliminates static to a large extent.

Mounted on formica panel, Adam brown mahogany finished cabinet without tubes, batteries or phones

Price \$30.00

Crosley Model VIII

A new set offering exceptional value. Contains one stage of tuned radio frequency amplification, detector and one stage of audio frequency amplification. Also offered as a portable instrument, using 1 1/2-volt tube. Price, without batteries, tubes and phones, **Regular Model VIII, \$48, Model VIII Portable, \$60.00.**



Crosley Model X

The most complete receiving set on the market. A 4-tube set consisting of one detector, one stage of tuned radio frequency and two stages of audio frequency amplification. In placing this receiver on the market, we are offering you a unit whose range, volume and selectivity is remarkable. Nothing can compare with it at twice the price. Developed in the Crosley laboratories, this unit is absolutely the last word in long range Radio Receiving Apparatus. Used with head phones and loud speaker, it will bring in distant stations all over the house. Price, without phones, batteries or tubes.....\$55.00



Crosley Receivers

From our smallest complete receiving outfit at **\$25**, including other sets incorporating Crosley radio frequency tuned amplification at **\$28, \$48, \$55**, and up to our beautiful Console Model XXV, price **\$150**, Crosley instruments offer the highest efficiency at the lowest cost.

CROSLEY
Better — Cost Less
RADIO RECEIVERS

Write for Catalog

Crosley Parts

We also manufacture a complete line of parts for those who wish to make their own outfit. Among these are Variable Condensers, Knobs and Dials, V-T Sockets, Variometers, Vario-Couplers, Rheostats and the well-known Crosley Radio Frequency Amplifying Tuner.

CROSLEY MANUFACTURING CO.
332 ALFRED ST., CINCINNATI, OHIO

CROSLEY ACE

Regenerative Receivers

\$20.00
and
up

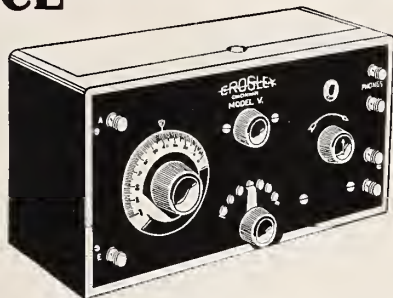

Crosley Model V Regenerative Receiver

Remarkable records are being achieved by owners of the Crosley Model V regenerative radio receiver, which is the greatest result-producing one-tube set being manufactured today. With a range of from 150 to 600 meters, this little wonder brings in amateur, broadcasting and commercial stations. Concerts broadcast more than 1000 miles away are heard by those who own the Model V. The cabinets are arranged to permit use of the one and one-half volt tubes, with which they operate very efficiently. Use of these tubes eliminates necessity of buying more expensive "A" batteries. The name "Crosley" is used by permission of the Crosley Manufacturing Company. Made in two models. Both have Adam brown mahogany finished cabinets and beautifully engraved panels. The Crosley two-step amplifier matches this unit perfectly.

- Model V-C..... \$20.00
 - Model V-D..... \$19.00
- Model V-D has overhanging lid, otherwise it is the same as Model V-C.

ANNOUNCEMENT

Powel Crosley, Jr., President of the Crosley Manufacturing Company, has acquired controlling interest of the capital stock of The Precision Equipment Company, of Cincinnati, licensed to manufacture regenerative apparatus under Armstrong Patents. Crosley management, production and sales methods already have enabled us to offer even better apparatus at lower prices.

ACE TRU Regenerative Radio Receiver

No powerful station in the United States is too far away to be copied by owners of the Tru radio receiver. The cabinet of the Tru is beautifully finished, the panel is of genuine formica and all the parts are the most efficient obtainable. Without amplification, the Tru will bring in distant stations loud and distinct. In comparison with any of the highest quality instruments available, the Tru receptor will equal, if not surpass, the performance of any of them. If the owner desires to operate a loud speaker, an amplifier must be added, and we recommend the AV-2, illustrated below.

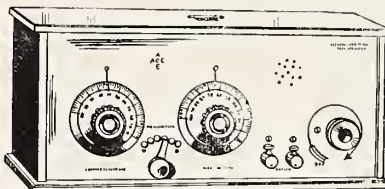

Price of the Tru Receptor (formerly \$65) now..... \$35.00

ACE AV-2 Two-Step Amplifier

The AV-2 Two-Step Amplifier designed to be added to the Tru radio receiver, with which it matches perfectly, may be used in conjunction with any audion receiver. Ace type transformers and sockets are used in the AV-2. The cabinet is beautifully finished. The panel is of genuine formica. There is a switch permitting use either of one or two stages of amplification, and also special binding posts for the use of head phones in conjunction with a loud speaker. Experiments have shown that the amplification constant is approximately twenty times that of the incoming signal on the first stage and 400 times on the second.

Price of the AV-2 (formerly \$65) now..... \$35.00

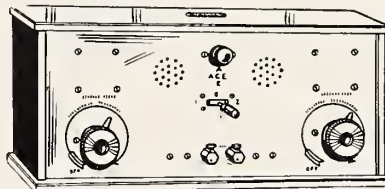

Ace Transformer

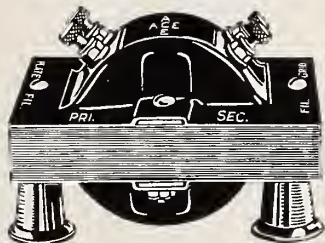

Enormous amplification has been attained and foreign noises have been eliminated through use of the Ace transformer. A generous core of high-grade transformer iron supports rugged primary and secondary windings. The core, in turn, is supported by two nickel-plated cones, which permit of base or panel mounting. Plainly marked terminals through insulation bushings in the shell provide convenient connections in the circuit.

Price \$5.00

Ace Condenser

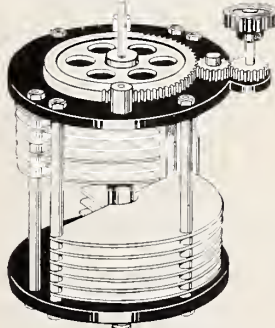

Capacity .0005 Mfd.
Exclusive features of this condenser are too numerous to dwell upon. These, however, include balanced non-warping plates, carefully adjusted, and a fine positive gear vernier, with a five to one ratio.

Price with Vernier..... \$7.50
Without Vernier..... 5.00

Ace Tube Socket

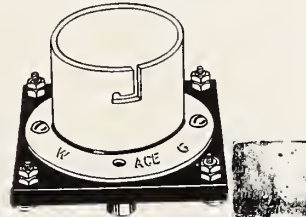

A real good socket, built to stand long and hard service. There is no moulded base to melt when the soldering iron is applied. Instead this is of real sheet formica, one-quarter inch thick. Substantial metal die casting—pure phosphor bronze springs. This socket has been designed to prevent short circuiting and burning out of the expensive vacuum tubes. Prong contacts are carefully adjusted. One and one-half volt tubes may be used in these after adapters are inserted. We recommend the adapters made by the Crosley Manufacturing Company.

Price \$1.00

Licensed under Armstrong U. S. Patent No. 1,113,149, October 6, 1914. For use by radio amateurs in radio amateur stations, to radio experimenters and scientific schools and universities, for use in experimental and scientific schools or university radio stations. The Crosley Manufacturing Company has discontinued the sale of regenerative radio receivers, but Crosley dealers will be able to supply you with those made by the Precision Equipment Company.

WRITE FOR CATALOG OF COMPLETE SETS

THE PRECISION EQUIPMENT COMPANY

POWEL CROSLEY, JR., President

332 GILBERT AVE.

CINCINNATI, OHIO

An unusual Equipment for an unusual Service

The National Vulcanized Fibre Company is the result of the consolidation of three large and well-known fibre manufactories. Each of these three organizations has contributed unusual equipment and facilities for the manufacture of Vul-Cot Fibre and Vul-Cot fibre products.

Three-fold Service

The present organization offers to manufacturers unprecedented fibre service—a service with three-fold equipment for speedy production, three-fold facilities for quick deliveries and a three-fold reputation.

Make it of Vul-cot Fibre

The guaranteed purity of Vul-Cot Fibre—its strength, toughness and work-ability has made it a part of the products of a host of well-known manufacturers. If there is a place for fibre in your product—either in a very minor or very important position—this unusual experience in the manufacture of all sorts of fibre articles and parts, this unusual service is at your command.

Just a reminder

The three organizations that have combined to form the National Vulcanized Fibre Company with headquarters in Wilmington, Delaware, are the National Fibre and Insulation Co., the Keystone Fibre Co., and the American Vulcanized Fibre Co.



Where to Buy

A Handy Guide For The Convenience of Our Readers

AMPLIFIER UNITS	
Magna Instrument Co.....	63
Steinmetz Wireless Mfg. Co...	63
AMPLIFIERS	
Standard Metal Mfg. Co.....	29
Multiple Elec. Products Co....	67
AMPLIFYING TRANSFORMERS	
Rauland Mfg. Co.....	53
ANTENNA WIRE	
Copper Clad Steel Co.....	48
AUDIO TRANSFORMERS	
Ferd Mica Co.....	49
BATTERY CHARGERS	
The Automatic Elec. Devices Co.	32-33
BATTERY TESTERS	
Chaslyn Co.	68
Hafner Mfg. Co.....	44
"B" BATTERIES	
Edison, Thomas A., Inc.....	38
French Battery & Carbon Co.	64
Gould Storage Battery Co....	44
Novo Mfg. Co.....	52
BATTERIES	
Carbon Products Co.....	28
BESTONE PRODUCTS	
Henry Hyman & Co., Inc.....	58
BINDING POSTS	
The H. H. Eby Mfg. Co.....	41
BUSS WIRE	
Essex Mfg. Co.....	54
CABINETS	
E. Eshoo Cabinet Works.....	48
Marvin B. Fallgatter.....	46
CHARTS	
S. Newman & Co.....	27
COIL MOUNTINGS	
Astorloid Mfg. Co.....	42
Crown Radio Mfg. Co.....	28
COMPLETE LINE	
Adams-Morgan Co.....	7
Atwater Kent Mfg. Co.....	4, 5
Electric Service Supplies Co...	46
King Sewing Machine Co.....	72
Mills Radio & Elec. Co.....	64
CONDENSERS	
Freshman Co., Charles.....	43
Signal Radio & Elec. Corp....	50
CRYSTALS	
Gibbons-Dustin Radio Mfg. Co.	55
Harris Laboratory	53
Jaynxon Lab.	50
M. P. M. Sales Co.....	69
Radio Apparatus Co. (Pitts-	
burgh)	48
Rusonite Products Corp.....	52
Standard Mineral Co.....	27
CRYSTAL DETECTORS	
European Radio Co.....	57
CRYSTAL RECEIVERS	
Holloway Elec. Supply Co., Inc.	52
CUSTOM BUILT SETS	
Lewis & De Roy.....	44
DETECTORS	
Radio Detector Co.....	54
DIALS	
N. Y. Radio Dial Co.....	68
DIALS (MICROMETER)	
Mydar Radio Co.....	Second cover
DISTRIBUTORS	
Ell-Ess Radio Exchange.....	42
Goetz Co., The Edw. J.....	44
Hudson-Ross	66
Kramer Radio Co.....	44
Pruden, Frederick H.....	44
Radio Distributing Co. Front cover	
Radio Shop of Newark, The.....	68
Radio Stores Corporation.....	54, 72
Schwab, Harold M., Inc.....	31
Virginia Radio Corp.....	61
DRY CELL SETS	
Q. T. Light Co.....	56
DRY CELL TUBE SOCKETS	
Bruno Radio Corp.....	60
ENGRAVING	
Paramount Machine Co.....	44
EXPOSITIONS	
Permanent Radio Fair.....	46
FLEWELLING PARTS	
Hudson-Ross	64
GENERAL LINE	
Federal Telephone & Telegraph Co.	62
HEAD SETS	
Royal Electric Laboratories...	56
Tresher Radio Corp.....	9
Triangle Electro Trading Co....	64
True Tone Radio Mfg. Co.....	67
HONEYCOMB COILS	
General Merchandise Co.....	52
HORNS	
Fiber Products Co.....	55
HYDROMETERS	
Testrite Instrument Co.....	50
INDOOR AERIALS	
Short Cut Radio Corp.....	9
INSULATION	
National Vulcanized Fibre Co.	12
Diamond State Fibre Co.....	3
JACKS	
Saturn Mfg. & Sales Co., Inc...	30
Union Radio Co.....	40
LIGHTNING ARRESTERS	
Brach, L. S., Mfg. Co.....	54
Electric Service Supplies Co...	47
Radio Accessories Co.....	39
LOOP AERIALS	
Eagle Radio Co.....	36
LOOSE COUPLER SETS	
TF. Radiophone Co.....	62
LOUD SPEAKERS	
Bristol Co., The.....	31
Inter-Ocean Radio Corp.....	66
Magnavox Co.....	25
Shelton Mfg. Co....64-42-50-37-58	
MAILING LISTS	
Ross-Gould Co.	68
Trade Circular Addressing Co.	68
MERCHANDISE WANTED	
Jackson, P. D.....	44
MICA	
Mica Insulator Co.....	14

Where to Buy

A Handy Guide For The Convenience of Our Readers

MICA CONDENSERS
 European Radio Co..... 57

MICA DIAPHRAGMS
 Radio Mica Products Co..... 65

MICROMETER DIALS
 Mydar Radio Co. Inside front cover

MOLDED INSULATION
 Shaw Insulator Co..... 38

OFFICE EFFICIENCY HELPS
 Ecs-Gould 68

PANELS
 American Hard Rubber Co.... 8
 Continental Fibre Co., The.... 52
 Eisemann Magneto Corp.,
 Inside back cover
 New York Hard Rubber Turn-
 ing Co. 52
 Pittsburgh Radio & Appliance
 Co. 48
 Poster & Co..... 56
 Standard Wireless Panel Co... 35

PAPER CONDENSERS
 Walter E. Bathgate..... 58

PARTS
 Darling Radio Co..... 54a

PATENTS
 Manufacturers Patent Co..... 44
 Omen, Robt. E..... 50

PHONES
 Briggs & Stratton Co..... 14
 Dictograph Products Corp.... 49
 T-B-H Corporation 69

PHONE PLUGS
 S. S. Novelty Co..... 40

PHONE TIPS
 Union Radio Corp..... 40

RADIO FREQUENCY SETS
 Mu-Rad Laboratories 35

RADIO TRADE-MARKS
 Carter, Chauncey P..... 61

RECEIVING SETS
 Adams-Morgan 7
 Arrow Radio Co..... 42
 Atwater Kent Mfg. Co..... 4, 5
 Betts & Betts..... 51
 Clapp-Eastham Co. 44
 Crosley Mfg. Co..... 8, 9
 Magna Instrument Co..... 63
 Metro Elec. Co..... 59
 Moon Radio Corp..... 68
 Oranola Radio Corp..... 57
 Radio Outfitting Corp..... 44
 Save Sales Co..... 39
 Simple A Radio Co..... 54-B
 United Specialties Co., Inc.... 58
 Victor Radio Corp..... 41
 W. B. L. Radio Co..... 63
 W. E. Supply & Service Corp. 44
 Winkler, Inc., Chas..... 44

REINARTZ SET PARTS
 Hudson-Ross 68

RHEOSTATS
 Aerovox Wireless Corp..... 58
 Allen-Bradley Co. 41
 Darling Radio Co..... 54a
 Parkin Mfg. Co..... 47
 Radio Stores Corp..... 72
 Superior Products Mfg. Co.... 50
 Wald Electric Co..... 64
 Wilcox Laboratories, The.... 48

SOCKETS
 Bruno Radio Co.rp..... 60
 Commercial Screw Machine Co. 64
 Franklin Radio Co., Inc..... 50
 Spee-Dee Specialty Co..... 36

SOCKET RHEOSTAT
 Ajax Radio Corp..... 40

SOLDERING IRONS
 Post Electric Co..... 57
 Strauss & Blum, Inc..... 56

SPAGHETTI TUBING
 Mica Insulator Co..... 14
 Mitchell-Rand Mfg. Co..... 44
 Westphal Mfg. Co..... 62

STOCK BROKERS
 Stanton & Co., Frank T..... 48

SWITCH LEVERS
 King Sewing Machine Co..... 72

SWITCH PLUGS
 Four Way Co..... 65

TESTING LABORATORIES
 Gregg & Co..... 44
 N. Y. Testing Laboratories.... 57

TRADE ASSOCIATIONS
 Radio Trade Association..... 71

TRANSFORMERS
 Amplex Instrument Labs.... 13
 Brooklyn Metal Stamping Co. 51
 Ford Mica Co..... 49
 Marle Engineering Co..... 32
 Radio Center 61
 Radio Courses, Inc..... 42
 Samson Elec. Co..... 43
 Superior Products Mfg. Co.... 50
 Thornton Transformer Co.... 52

TUBES
 Werner & Patch..... 60

UNIT TYPE SETS
 Heinemann Elec. Co..... 69

VARIABLE CONDENSERS
 Diamant Tool & Mfg. Co..... 44
 Standard Appliance Mfg. Corp. 44
 Stuckeman Bros., Inc..... 52
 United Mfg. & Dist. Co..... 45

VARIO-COUPLERS
 Eastern Radio Mfg. Co..... 58
 G. H. Fischer & Co..... 40
 Globe Radio Equip. Co..... 66
 MacLite Storage Battery Co.. 68
 Queens Radio Co..... 14
 Shamrock Radio Co..... 57
 Wald Elec. Co..... 58

VARIOMETERS
 Aremeo Mfg. Co..... 57
 Atwater Kent Mfg. Co..... 4, 5
 Eagle Radio Co..... 59
 Radio Products Mfg. Co..... 63

VARIO WAVE TUNER
 Fischer, G. H., & Co..... 40

VERNIER CONDENSERS
 Bremer-Tulley Radio Co.... 50
 Cozzone, John, & Co..... 50
 Electric Products Co..... 44

VERNIER RHEOSTATS
 Viking Radio Co..... 50

VOLTMETERS
 Weston Elect. Instrument Co.. 6

WAVE TRAPS
 Mydar Radio Co..... 71

Alphabetical Index to Advertisers on page 8

AMPLEX WD12

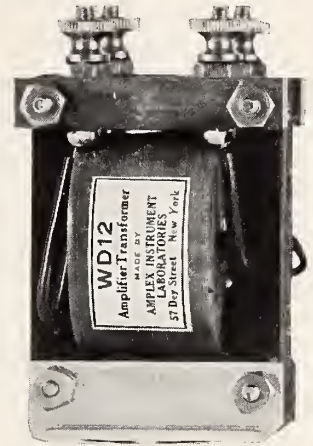

**THE
ONLY**

Amplifying Transformer especially designed for use with 1 1/2 volt tubes.

Made by ex-Government Engineers.

Proven to give greater volume with less distortion than any other transformer made.

Leading manufacturers use them.

Engineers and thousands of fans recommend them.

AMPLEX WD 12 Transformers fill the greatest demand for transformers ever created.

Are you getting Your share of the business?

Xtra liberal discounts to live dealers and jobbers.

List Price \$5.00

**AMPLEX INSTRUMENT
LABORATORIES**

57 Dey St., New York, N. Y.

New York  Tribune
First to Last—the Truth News Editorials Advertisements

JANUARY 7, 1923

**Well Known 'Spaghetti' Is
 An Insurance Against 'Shorts'**

Mica Insulator Company's Tubing—
 Most of us take an interest in the final appearance of our home-concocted sets and all of us in their proper performance. Tubing of the oiled, or blackfish paper type, will contribute to both. Where there is a multiplicity of short leads to a tapped inductance, or beneath the base panel when underwiring is used this type of tubing is first class insurance against intermittent "shorts" that so often surround the set with an air of mystery. A slight vibration in such a case will bring forth a roar of protest from the phones or perhaps complete silence for an interval. The tubing comes in several sizes, with various degrees of flexibility to suit any of the ordinary connections. Manufactured by Mica Insulator Company, New York City.

Jack Binns

**New York Tribune Certifies
 Empire Oiled Tubing**

We are glad to announce that our Style "B" Empire Oiled Tubing and Black Fish Paper Tubes have been tested in the Tribune Laboratories and approved, and we have been awarded the Tribune Institute Certificate.

This new proof of a quality product supplements many years of use throughout the electrical industry.

Send today for Empire Tubing samples and quotations on 500, 1,000, 5,000, 10,000, 20,000 foot lots. Get acquainted with our other time tested radio insulation products.

MICA INSULATOR COMPANY

68 Church Street, New York

542 So. Dearborn Street, Chicago Works: Schenectady, N. Y.

Agencies—The Monroe Brass & Wire Co., Cincinnati; G. Arthur Morrell Cleveland; Los Angeles Electrical Specialty Co., San Francisco

2026-E

Designed! Not Just "Made"

The market is over-run with head phones. Some are "made to sell"—others "designed" to perform a *service*—a service measured in terms of sensitiveness, tone quality, clarity—phone efficiency.

Such is the Basco Radio Head Phone—built first for service. *Designed*—not just "made." One year on the market—and a phenomenal sales record. Why? Examine one.

They are tuned to a deep natural-voiced pitch—and keenly sensitive. Perfectly balanced—clear scratchless reproduction. Coils encased in aluminum shell—light

weight—easy on the head. Employ solid horseshoe magnet—no laminations. The diaphragm is extra light—set to thousandths-of-an-inch accuracy from magnet poles.



\$ 6 2000 Ohm

\$7.50 3000 Ohm

Jobbers and Dealers! Write for our exceptional discount proposition on our complete line of parts and name of our nearest representative.

RADIO Head Phones
 "Hear" More and Cost Less

Compare their construction with the highest priced phones on the market. You will find Basco Head Phones are clean cut and ruggedly designed throughout. See them before you buy.

12 Years
 in
 Business

Briggs & Stratton Co.
 Milwaukee PRODUCT Wisconsin

Mfrs. of
 Famous
 Basco Line

The Radio Dealer

THE RADIO TRADE JOURNAL

Edited and Published at

1133 Broadway, New York, N. Y.

FOR THE RADIO RETAILER

VOL. 2. NO. 6

MARCH, 1923

ONE DOLLAR THE YEAR

Your Store Is Your Best Advertisement

Effective Arrangement of Radio Shops From Window to Counter Displays Mean Thought

By N. B. ZIMMERMAN

As the retail radio trade becomes more established, dealers are beginning to realize that, as in any other branch of the retail game, to stock up a store is not sufficient to establish a successful business.

Much has been said in the past about the value of daily and weekly newspaper advertising, the distribution of circulars through the mails and the free publicity of established radio departments in the newspapers. But in such discussions, the retail store itself is usually neglected.

The importance of the store itself cannot, however, be over-estimated. Here at least the sales are made, and here it is, moreover, that many potential buying prospects are converted into actual buyers, first through the window displays and second through counter displays and demonstrations in the store.

It is conceivable, for instance, that an attractive campaign in the newspapers should bring interested prospects to the radio store. But on

seeing a heterogeneous pile of radio parts heaped up in the window displays, it is also conceivable that these potential customers should be turned back without getting any further than the door.

It is therefore obvious that the building of window displays should demand careful thought on the part of the radio dealer. That he is thinking of the importance of such displays is evidenced by the fact that in a recent window display contest conducted by the Manhattan Electrical Supply Company of New York City, dealers the country over took part, putting up special windows. The contest was keen and the winning

window display, reproduced in this issue of THE RADIO DEALER, represents the pick of hundreds of entries.

The problem of window displays resolves itself into the question of how the dealer wants the public to regard his store. There is only one kind of radio store, it is true. The radio store is a retail business that handles



Window display of Louis D. Rubin Electrical Co., 345 King Street, Charleston, S. C., that won first prize in contest conducted by Manhattan Electrical Supply Co.

(Continued on page 60)

Present Trade-Marks Do Not Protect Products

Expert Shows How Consumer is Not Assured of Quality of "Imported" Goods Made Here

By CHAUNCEY P. CARTER

The protection and lack of protection embodied by a trade-mark registered in the United States is being brought out more clearly every day by the decisions of the American courts. These decisions, forming the basis of future laws on the subject, are proving of great importance to those in the radio industry, and will prove of greater importance as the importation of radio apparatus becomes more general.

Not long ago, the United States Circuit Court of Appeals for the Second Circuit created quite a flurry in the import specialty trade by holding that the purchaser of the right to the exclusive use in the United States of a foreign trade-mark for a certain article could not prevent another firm in the United States from importing supplies of that article packed and so trade-marked by the original foreign owner of the trade-mark. This decision of the Circuit Court in the case of *A. Bourjois & Co., Inc., v. Anna Katzel*, which was rendered in June, 1921, reversed an earlier decision of the District Court, and was based on the fact that the public was not deceived since it got the same powder from the defendant as it did from the plaintiff, except that the plaintiff imported its powder in bulk and packed the same in this country whereas the powder imported by the defendant was packed by the manufacturer of the powder in France. One of the learned justices of the Circuit Court filed a very interesting dissenting opinion in which he took the position that "a trade-mark is primarily a protection to the owner's business" and only secondarily an agency for "protecting the public from imitations." Probably on the basis of this dissenting opinion, counsel for *A. Bourjois & Co., Inc.*, filed a petition for a rehearing of the case and asked that the question be certified to the Supreme Court in view of its importance as affecting the "many businesses with their accompanying trade-marks of German citizens bought during the European war

by citizens of this country from the custodian of alien property." This petition was dismissed in language that made clear the position of the Circuit Court, viz.: that inasmuch as *Bourjois & Co.* had continued to obtain their supply of powder from the original source, it made no difference that they had purchased the right to the exclusive use of the mark in the United States since the mark still distinguished powder from the original source, namely the French proprietors of the mark and business, and as long as it was used only on such powder, the public could not be confused or deceived and there could be no infringement.

It was at once seen that under this decision the purchasers of the rights in this country in foreign trade-marked articles were not safe from indirect competition here with the people from whom they purchased such rights. Two courses were open to the losers by this decision, namely to apply to the Supreme Court for a writ of certiorari or to apply to Congress for legislation to adjust the situation. As a matter of fact, both of these courses were adopted and strange to relate both were successful. On September 21 last, the President approved the Tariff Act of 1922, Section 526 of which prohibits the importation of merchandise bearing a trade-mark registered by a citizen of the United States in the Patent Office and in the Customs Offices here without the consent of such registrant. Merchandise imported in violation of this provision is subject to seizure and forfeiture under the Customs laws and any person dealing in such merchandise may be enjoined and required to destroy or export the same or to remove or obliterate the trade-mark and is liable for triple damages and profits.

The writ of certiorari was issued by the Supreme Court as applied for and on January 29, 1923, that Court handed down its opinion in the case which reverses the decree of the Circuit Court cited above. The decision

of the court of last resort holds that inasmuch as "the French manufacturers could not have come to the United States and have used their old marks in competition with the plaintiff," no one else should be allowed to do so. Of the trade-mark, the Court said "It stakes the reputation of the plaintiff upon the character of the goods," implying that one who is willing to stake his reputation on the quality of goods identified by a certain trade-mark should not be called on to stand sponsor for goods bearing that trade-mark over which he can exercise no control. It might be for instance, that the *Bourjois Company* exercised special care to see that the powder which they placed on the market would reach the consumer in good condition and that packages would be full weight, etc., and this care might have had a great deal to do with the popularity of the article here. Under the circumstances, it would hardly be fair to let someone else get powder from the same source and put it on the market under the same mark but without exercising any care to see that the packages were full weight or that the powder would reach the consumer in good condition. In other words, the trade-mark had come to mean more than the origin of the article in a certain factory in France; it signified in addition that such powder has been selected, imported, packed and marketed by the plaintiff and that said plaintiff stood responsible for its quality, for the statements, if any, on the label, the methods of distribution in this country and a hundred and one other particulars any or all of which might be of great benefit to the ultimate purchaser who in purchasing additional quantities of such powder under the same trade-mark would naturally expect the benefits of the same care that had been bestowed upon packages previously bought under that mark.

The decision is a good one, being
(Continued on page 53)

Hook-Ups As An Aid to Sales Promotion

Research of Trade Has Proven That the Distribution of Hook-Ups Has Greatly Increased the Sale of Parts

By SIGMUND NEWMAN
Of S. Newman and Company

After a dull summer, which caused the pessimist to say that the radio boom of last spring would never be seen again, the radio business is again doing well. However, its characteristics have changed. While this time last year most sales were of complete outfits, this year the bulk of the business is composed mainly of parts and accessories. Comparatively few expensive sets are being sold. Loudspeakers, power amplifiers and the like, which the amateurs and radio fans cannot make themselves, of course, find a ready market. It is indeed a very interesting experiment to visit the various radio stores and listen to conversations between salesmen and buyers. One notes that even the most inexperienced fans want to build their own and are looking for all the information available; magazines and books are perused for the latest developments.

Great publicity has been given lately to several forms of "new" circuits, some of them being merely old hook-ups disguised under another name. Wonderful results are claimed for these circuits and undoubtedly they bring in distant stations when properly built and operated. The radio fan of today wants to try them out and will spend a good deal of money buying parts to experiment to learn more about the art.

We know of some wealthy radio fans who bought complete outfits last year, with which they played for a while and then, after being bothered with code, static and other interference, they inquired as to how to get rid of these nuisances, how to cut out the amateur stations and anything and everything that disturbed the broadcasting. After getting information from one source or another, they started to "improve" their sets by adding variable condensers, wave-traps, etc. Today, the complete outfits are cobwebbed in a corner and home-made sets have taken their place.



SIGMUND NEWMAN

Another great craze that has come is distance. Everybody wants to hear distant stations even if the programs are not as good as those of the local stations; most of the fans are happy

if they can hear the announcer give his call letters and the location of the station. To hear distance, tubes are added, radio frequency amplifiers constructed, special tuners wound and a lot of other improvements made in order to bring in DX. All these fans and amateurs have found that the real fun of radio is getting good results by building proper apparatus. The reasons why they build their own are two-fold. First, they can build any particular set or combination of outfits that they desire and second the cost of such receivers and amplifiers is much lower than a ready-made set since they only have to buy the parts and they do not count their time. Moreover, the home-made set can be transformed at will into a different type by the addition of a few parts. The circuit may be changed and the tuning quality as well as the results usually improved. By doing this, most fans, who last year had little practical experience with tools, began

(Continued on page 58)

Why Buy from the Jobber of Radio Goods?

By A. E. POLLOCK
Of the Inter-Ocean Radio Corp.

This is a question of vital interest and must be answered and settled before the Radio business shall become the staple industry that destiny has decreed it shall be.

Experience has taught, that no manufacturer can successfully market a product no matter how good until the problem of distribution has been solved; or in other words, until a definite means of quickly supplying the demand of the ultimate consumer has

been created. The very magnitude of this country makes it impossible to eliminate the jobber in the distribution of merchandise; what does any manufacturer in New York know about a small dealer in the average small town, in let us say, Idaho; what position is he in to judge his credit standing satisfactorily? The local jobber of a community stands in the same relation to

(Continued on page 66)

Bright Future for the Dealer Is Assured

Though Still in Its Infancy, Great Popularity Such as Automobile and Movies Achieved Will Come to Radio

By A. H. CORWIN

Treasurer, Radio Distributing Co.

Many questions, some foolish, some otherwise, have been put to me by radio dealers and radio enthusiasts in reference to the future of radio. In the main, the two questions of greatest interest to the trade have been: "Is radio a fad, destined to die out?" and "When will radio reach the saturation point?"

Every reader knows that radio is not new. Yet prior to 1921 it was practically unknown to the man on the street. It was in that year that the "radio craze" began to sweep the country, spreading with the rapidity of a prairie fire until North, East, South and West were talking radio, dreaming radio, constructing radio and listening to radio.

It is needless to speak of the results of this sudden boom. On every hand there sprang up radio manufacturers and radio dealers, all eager to reap a quick harvest of profits. Radio machines made their appearance in veritable droves. Every one seemed to have a "new" style set or some new part that he had invented. Their visions of sudden riches dimmed the rough road of competitive merchandising and distributing costs that must be overcome for permanent success.

And then came the reaction! Inevitable as night follows day! The market became flooded with radio parts and outfits, many of which were absolutely worthless. There is nothing that can so quickly kill enthusiasm as a worthless article. People unable to differentiate between the good and the bad reverted to the rule of "safety first" and stopped buying!

Sales dropped off—the radio industry suffered—yet some lasting good resulted. The worthless stuff went begging, but there were no buyers in sight. The radio industry went through the same experiences that every young industry invariably is forced to experience. Mushroom growth is not conducive to a firm foundation.

There has been a constant struggle for "the survival of the fittest." There has been a heavy mortality of machines taken on the market. Many more will fall by the wayside.

And the survivors will be those that

have stood the test, that have passed through the consuming fire of the experimental stage and have so improved their products as to give an all-satisfying service to the user, manufacturers who have a definite and far-seeing policy of advertising nationally, thereby creating new sales for radio outfits.

The wise retailer will select machines of outstanding merit and individuality, and begin to build for permanent trade. If he expects to stay in business he will link up with his manufacturer and distributor, use their their window display trims and do local advertising.

Radio is here to stay. It is no longer a fad. It has taken its place as a means of entertainment and education alongside of the talking machine and the moving picture.

Think of what radio has accomplished for people who live on farms and in rural communities. And remember that the major portion of the American population lives in towns of less than 5,000 inhabitants! Think of the growing generation—how their imaginations are fired and their ambitions spurred by listening to the living, breathing voices of men who are the nation's leaders in business, in statesmanship, in religion and education. Think of young America thrilling to the report of a world's baseball series, spellbound by the roars of the crowd and with ears alert to hear the crack of the bat.

Think of the people of the Middle West listening to concerts by the City Symphony Orchestra of New York or grand operas, or Vincent Lopez's Pennsylvania Hotel Band, or artists whom even in their rosier dreams they never hoped to hear. The radio is instilling a greater culture and a love for the music of the masters of old into the hearts of countless Americans. It is an educational, refining and entertaining influence that is difficult to overestimate. Can such a thing be a fad? Never!

Radio has proven its worth in times of peace—how about in times of war? Picture a radio set with a loud speaker in every public school, courthouse, city hall and other public building through-

out this land. Suppose war has been declared; people are eagerly awaiting news from the nation's head, wondering what the next move will bring. The morning papers announce that this evening the President will broadcast a message to the nation. Picture this in your mind, and answer this question: "Will people flock to the public places where radios are installed, or will they calmly wait to read the message in the next morning's newspapers?" To folks who know human nature there can be but one answer: Those who haven't a radio set of their own will come from miles around to listen to the voice of the President.

No longer will the roll of drums and the blare of bugles need to rouse the nation to arms. A single voice, spoken at Washington, but heard throughout the length and breadth of the land, a voice vibrant with emotion, staunch with courage and ringing with authority will summon the nation to action, will weld a hundred million people into a solidarity such as the world has never before known. The radio of today will be the Paul Revere of 1775!

Few have cause to criticize the programs or the methods of broadcasting of the leading stations of the country. Yet everybody knows that broadcasting is still in its infancy. The years to come will bring improved changes in the manner of transmitting and in the quality of the program. We are still in the embryonic stage of development. We are where the automobile was twenty years ago or the moving picture was fifteen years ago.

Remember the old Nickeldrome, where for the munificent sum of five cents we could be thrilled for an entire evening? Remember the blood curdling scenes of Wild West; the Injuns and cowboys; the sleepy youngster thumping a hollow sounding piano with more vigor than skill; and the audible sigh of satisfaction and relief as the handsome hero rescued his maiden fair from the cruel designs of the villain? What a far cry from the photographic splendor and realism of today! The radio, too, is bound to improve with the passing of time—both in quality of the machines and

(Continued on page 40)

Three Contests Indicate Interest in Radio

Huge Number of Entries in Manhattan Electrical Company Contest Delays Announcement of Winners

By L. N. ALLEN

Dealers, jobbers' salesmen, and people interested in electricity in general, have eagerly awaited the results of the three competitions conducted by the Manhattan Electrical Supply Company, Inc., of 17 Park Place, New York. The enormous number of entries caused a delay of almost a month in awarding the prizes of the three contests, which were run off simultaneously.

The contest for the dealers in radio and electrical equipment was in the form of a window-display competition, in which dealers from all over the country took an enthusiastic part. Retailers in every State in the Union fixed up their windows into attractive displays calculated to create a favorable impression toward radio and Manhattan Electrical radio specialties. The winner of the first prize in this contest was the Louis D. Rubin Electrical

Company, of 345 King Street, Charleston, S. C. A photograph of this prize-winning window arrangement is reproduced on page 15 of THE RADIO DEALER. George A. Myers & Co., Inc., 61 Washington Street, Paterson, N. J., were winners of the second prize in this dealers' competition, while two firms were tied for third prize, the companies be-
(Continued on page 62)

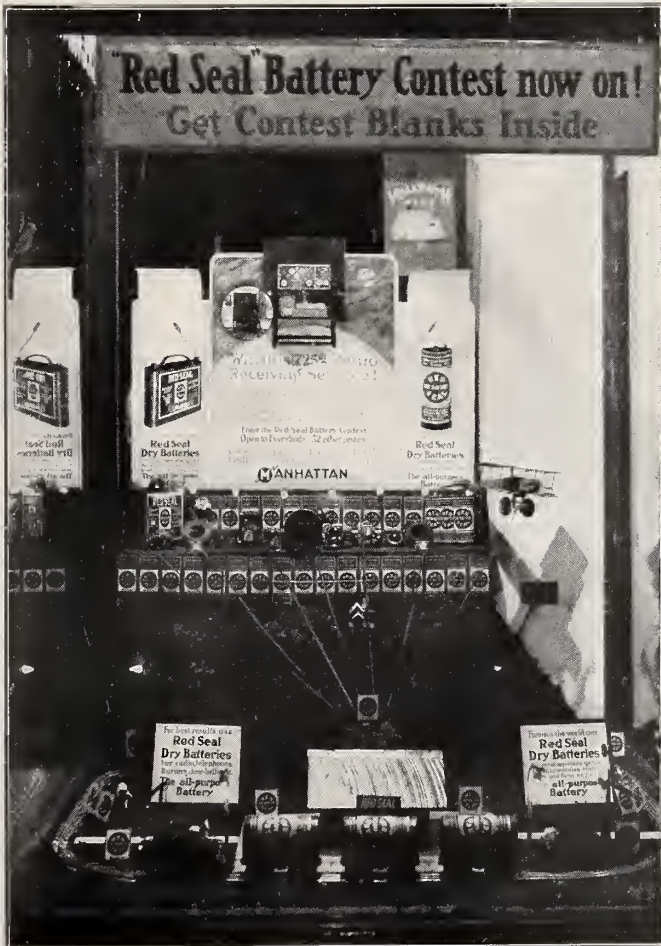

This window display won a tie for third prize for the Busch Hardware Company, 5745 West Division Street, Chicago, Ill.



Second Prize in the Manhattan Electrical Supply Company's Dealers' Window Contest. It was arranged by George A. Myers & Co., Inc., 61 Washington St., Paterson, N. J.



Tied for third prize, this fine window arrangement attracted much attention to the H. L. Miller Co., Pasadena, Calif.

Do Cut Prices Make Radio More Popular?

Owner of Chain Radio Stores Maintains that Low Prices Make Radio More Attractive for Those Whom It Interests

By HAROLD M. SCHWAB

President, Harold M. Schwab, Inc.

During these days of heated discussion on price-cutting, discounts, slashing and so called "gypping" of radio supplies, it might be interesting to consider where the radio industry would be today without the dealer who practices these so-called evils.

Let us suppose that the price-cutter does not exist and that all radio merchandise is sold over the retail counter at full list price. In other words, let us suppose that a switch lever sells for 75 cents, a rheostat for \$1.50 and a composition socket for \$1. If all other supplies were based on these same prices, the American boy with a keen desire to build a radio set and listen to the wonderful broadcasting schedules, would of necessity be forced to ask Dad for no less than a fifty dollar bill in order to purchase the required supplies. This would mean that radio would be only within the reach of those who can afford Steinway pianos, Tiffany pearls and Rolls Royce motors. Take on the other hand the scheme advertisement of the cut rate radio dealer building a complete set, including tubes, batteries, cabinet and so forth "Radio for assembling installation for the remarkably low price of \$25." This price immediately brings radio within the grasp of the average American citizen and by so doing increases its popularity by more than one thousand per cent. In my opinion, radio is now an industry which is fast gaining a normal basis. The cut rates which have been worrying many of us are fast disappearing because of the fact that high manufacturing costs have been reduced and cut rates are no longer cut rates, but are merely fair and reasonable prices for the merchandise produced.

The retail stores which are now controlled by Harold M. Schwab, Inc., have been built up and are thriving on cut rate prices. By this I do not mean to imply that everything sold over the counter is sold at

prices which are inconsistent with the quality and workmanship of the product in question. Certain supplies which we handle are sold at very highest prices, because of the fact that their very appearance and their efficiency warrant the price asked for them. On the other hand, composition dials, which not many months ago listed at one dollar, are today sold for a quarter or less, because that is all they are worth. It has always been our policy at all times in our retail stores to make not only the merchandise we sell, but our stores and clerks as well, as attractive as possible to our customers. Our service is recognized in New York City as being of a standard excelled by none. This service includes not only advice on how to build sets, hook-ups, and the best instruments to use for efficiency, but also in loaning tools and other implements used in putting the set together to our patrons. Two of our stores contain complete work shops for our customers who may take off their coats, roll up their sleeves and go to work drilling their panels, soldering connections and testing their sets. This service is in the hands of an expert radiotrician who is competent to answer the most technical questions and to assist in all details pertaining to the building of the radio set of any type. That this service has been appreciated by our customers has been proven to us in more ways than one. It is a common occurrence for a man to walk into our store and inform us that his friend Mr. So and So, "the fellow that had so much trouble with the radio frequency set" sent him in for advice. In this event, we advise him to the best of our ability, telling him what parts he needs and what parts work most efficiently together.

In this connection, I might state that our men on the road continually write to inform us of the sales resistance they meet through buyers not familiar with radio, purchasing mer-

chandise for appearance alone, without considering quality. Every article sold by us through its jobbing department or in its retail stores has been thoroughly tested for efficiency as well as construction and for this reason we are able to sell our retail customers parts which work together in harmony. As an example of what would make up an inefficient set, let us consider a vario-coupler containing sixty turns on the rotor with twenty-five turns on the stator hooked up with two variometers, one with eighty turns on the rotor and the same number on the stator and the other with twenty turns on rotor and stator. Such a set as this was recently brought us for repair. Naturally the results obtained from it were negligible and it required an excessive amount of argument being used on the customer to convince him of the fact that such a set was not balanced and could, therefore, not possibly work efficiently. All radio dealers should bear in mind the fact that while it may be possible to make a sale of such parts as above mentioned to a customer once, there is not much chance of this man coming back or sending his friends back for a second dose of such treatment.

We have always found that by explaining to a customer our reason for suggesting this or that accessory for his set, we would not only make the sale, but would create his good will, which is so essential to every retail store. Another system of gaining customers has been employed with considerable success in our stores by giving a sales slip with each purchase, on the bottom of which is printed the following:

"We hereby guarantee the goods bought on this slip to be perfect and to give satisfaction. Should they be unsatisfactory, return this slip with goods within five days for refund if

(Continued on page 44)

Dealers in Smaller Communities Disclose Unfair Tactics of Competition from Cities

Dealer-Distributor Asserts Every- body Gets Discount Sheets

An Interview With
W. L. HARRISON
Lindsborg, Kansas

"Are jobbers and wholesalers to continue to mail discounts to every Tom, Dick and Harry in the country, whoever he may be?" is the question that W. L. Harrison, a dealer-distributor of Lindsborg, Kansas, asks. Mr. Harrison is head of the Central Kansas Radio Supply Company, and vice-president of the Kansas Radio League.

"Everyone from a school-boy to a grown-up," Mr. Harrison asserted in a recent interview with a representative of THE RADIO DEALER, "has some discount-sheet or other in his possession, whether or not he knows the difference between a variometer and a vario-coupler. Not only is it true, at least in the state of Kansas, that discount-sheets are everywhere, but it is also apparent that those least entitled to them are the ones that display them most proudly to their friends. The whole system is pernicious.

"This distribution of discount-rates to those not entitled to them is more general than we dealers are likely to imagine," Mr. Harrison went on to say. "The condition seems to result from a confusion of ideas as to what the manufacturer and jobber owe to the dealer, and what obligations they assume when they get a dealer to invest money in their products.

"I say that there is a confusion of ideas as to this responsibility. If there were not, who is it then that is furnishing radio fans with dealers' discount-sheets?"

"It is decidedly unfair that the average member of the buying public, who hasn't a cent invested in radio, should be given the identical privileges and discounts of the dealer in radio goods. The dealer, who must rely on a profitable re-sale of these goods for his living, is put at a disadvantage amounting to unfair competition by the promiscuous distribution of discount-rates among persons who are not in the radio business and never were. The dealer cannot sell at the price at which these favored individuals can buy because the dealer must include overhead expenses, interest on money invested and operating expenses in his selling price.

Mr. Harrison wished it to be made clear that he was not particularly attacking the mail order houses. "The mail order business," he said, "is a perfectly legitimate one and is nice clean competition compared with the illegitimate possessor of discount-sheets with whom the dealer must contend." The Kansas radio dealer said that he had in mind one St. Louis firm which mails a catalog and a discount sheet to anyone that writes for a catalog of prices.

"The success of radio," Mr. Harrison went on to say, "depends upon the brawn and brain effort that the dealer puts forth. He cannot exist without the co-operative ef-

(Continued on page 35)

Rural Dealer Complains of Discounts to Consumer

By R. A. WHEELER
President, Mining Equip. & Supply Co.
Wilkes-Barre, Pa.

The writer has just finished reading the article in THE RADIO DEALER for February entitled "Cut Prices to Consumers Menace to Rural Dealers," written by H. S. Webster. Mr. Webster has hit a sore spot with all retail dealers whether functioning in rural or urban communities.

The writer personally spent considerable time in an attempt to arouse an interest in radio in the rural districts of Northeastern Pennsylvania, and was continually confronted with catalogs and widely distributed price lists of supposedly legitimate jobbers and distributors, where offers were made to consumers at discounts on a par with or better than we, as dealers, get.

One experience the writer had was a parallel to an incident quoted by Mr. Webster. A rural radio fan had purchased a very reputable set from a jobber in this state, from whom we too had purchased, and at the same cost as ours. He had not been successful in securing desired results. His set, however, was left in good working condition, and if any of his neighbors have since purchased they, too, have bought from the jobber.

Another instance was similar. A call was made on the owner of a set with a view to selling him a loud speaker. He had a loud speaker—one of the most widely advertised on the market. He expressed surprise at the discount which had been granted him. It was the same as our company received from the same house for a dozen of the same instruments.

Where are we and other dealers going to sell if our jobbers sell to customers of ours? What is this discount game?

The manufacturers, jobbers and distributors are retarding the proper distribution of radio materials by handling the business in this manner. It is creating a wrong impression on prospective buyers. One fan will buy—from a jobber or an honest and hard working dealer if the dealer meets the jobbers' price, while nine postpone buying until all prices are stabilized and uniform, on the basis of jobbers' prices to consumers. If the jobbers' prices to consumers are normal selling prices the manufacturers ought to sell direct to the dealer, so he can realize a little profit for his labors.

Our little part in the big radio game ahead is insignificant. It is probably needless to say, too, that we have blacklisted jobbers who are playing the double-faced game. If all dealers would do that, and reputable manufacturers would refuse to fill orders from the same jobbers they would soon be eliminated and the business stabilized, so that the margin of profit due each branch would be forthcoming.

From the Editorial Viewpoint

Radio Set Essential In Every Home In Land

New Yorkers who have radio sets will soon be enabled to listen in at meetings of the Board of Estimate and other municipal affairs. So will other radio set owners.

This is due to the fact that New York City, ever progressive in its municipal activities, is about to operate a broadcasting station to be located on city property at Elmhurst, but to be operated from New York City.

New York activities interest the entire world and this new manner of keeping in touch with municipal affairs alone will make for increased installation of high-grade radio sets in many homes.

Every business man, every respectable voter, is interested in the doings of the municipal managers, the elected servants of the people. Unfortunately all citizens cannot attend all public meetings. So the radio solves the problem. You sit at home and hear what your City Fathers are doing for you.

The United States Board of Education is now broadcasting regular special events and many cities are preparing to install radio broadcasting stations to be used in emergencies.

Obviously, the day is dawning when every business office, every shop, every public place—like hotels, clubs and restaurants, will be compelled to install a radio receiving set. Like the news ticker and the newspaper it is a thing here—for the public's use.

Broadcasting, to paraphrase the much abused Coueism, is getting better day by day in every radio broadcasting center, and the recent additions of interesting concerts and public events has taken radio out of the schoolboy amusement class and made a radio set an absolute necessity in every home, for education and for pleasure.

Good-Will Really Not Property of Monopolists

Monopoly is not the basis of great merchandising success. The best business success is developed from good-will.

Some of the business adventurers in the radio industry—new to business ideas—already must have observed this fact. To business men who entered the radio industry the value of good-will as against hopeful monopoly was apparent from the start.

These men, it is understandable, are opposed to the the-

ory of divine-right ownership propounded by some of the very early business houses in the radio industry.

Good-will means "bringing the customer back." That is one of the things some of the first commercially-minded radio enthusiasts overlooked. That is why they're joining the down-and-outs of the radio field. That is why some of the early business men are less important today than they were a few years back—when the radio industry was the commercial prize of a few so-called radio experts.

The real business men in the radio field today are spending money to create good-will. They know that good-will means giving service and giving value received for money. Good-will means public opinion. Without that no business can *succeed*—no matter how important its patents may seem to the non-thinking business executive.

Good-will business builders recognize the public. The public, after all, is the real judge, the one to place the laurel wreath of business success on the business adventurer's bank-roll.

There is no uncertainty about good-will. You cannot purchase it with mere money; you cannot achieve it by self praise; you cannot acquire it by wishing for it; you cannot control it by large representations.

To acquire good-will you must make good to your public and if that public is the radio industry you have a plain course—if you're a manufacturer—and that course, the line of least resistance, is to produce standardized apparatus at prices that are based upon production costs and you are expected to extend service to your jobber and retailer.

Divine Right Folks Have No Business Observation

It may interest the several radio manufacturing concerns who, in days not far distant, elected to assume a divine-right theory anent the selling of radio apparatus, that there are in New York City about two hundred and fifty radio retailers.

This 250 total means stores selling radio equipment, exclusively (90 per cent of these stores were not in business two years back).

Brooklyn and other sections of New York City have not over fifty exclusive radio stores.

These figures confound some of the divine-right folks, the folks who declare—by insidious whispers—that the radio retailing *must* go to certain persons and yet it is known these divine-right folks make every effort to sell their wares to the new crop of radio retailers developed recently.

In addition to the three hundred radio retailers in greater New York City there are radio departments in most of the big department stores, and the red-front chain systems sell radio parts. Some phonograph dealers sell sets, as

do a few piano shops and quite a few electrical stores sell radio parts.

But, a careful survey of the New York City retail radio business, made by THE RADIO DEALER, indicates beyond a question of doubt that at least fifty per cent. of the radio business of the New York territory is being done by the three hundred exclusive radio retail stores of Greater New York.

This survey was made during the past two weeks.

A resume of the entire circulation of THE RADIO DEALER indicates that the radio industry—retail and wholesale—is in the hands of radio dealers to the extent of 39 per cent. throughout the country.

The percentages of the radio industry are as follows:

	Per Cent
Exclusively radio3883 $\frac{2}{3}$
Electrical2666 $\frac{2}{3}$
Hardware0650
Battery stations and garages having battery stations...	.0466 $\frac{2}{3}$
Department stores and dry goods companies0383 $\frac{2}{3}$
Phonograph0366 $\frac{2}{3}$
Lighting fixtures0166 $\frac{2}{3}$
Automotive parts and automobiles, no mention of battery service0333 $\frac{2}{3}$
Scientific instrument dealers and laboratories0216 $\frac{2}{3}$
Foreign and American buyers for export.....	.0216 $\frac{2}{3}$
Novelty shops0150
Music stores0116 $\frac{2}{3}$
Sporting goods shops0100
Drug stores0066 $\frac{2}{3}$
Telephone & Telegraph Co.0050
Toy shops0033 $\frac{2}{3}$
Tool shops; Butcher supply houses; Carpenters, Plumbers, Photographers supplies; Washing machine dealers, gasoline dealers, and jewelers0133 $\frac{2}{3}$
or0016 $\frac{2}{3}$
	each

These figures ought to be of interest to every advertiser in the radio industry.

Build Good Sets Today And Your Future Is Certain

An old Arabian tale goes like this:

“A King saw a man planting date seeds. The King said: ‘My good man, it takes a date seed a long time to grow. You will not have fruit from your date seeds.’

“The man replied: ‘Our grandfathers planted date seeds and we eat the fruit from the trees. I plant for my grandchildren.’

“The King thought the answer such a good one that he gave the man five shekels.

“Then the man said: ‘See, I have fruit from my seeds already!’”

Some of our radio apparatus manufacturers might learn a lesson from the tale above narrated.

A Year Full of Constructive Radio Progress

In the past twelve months the radio has seen tremendous progress made, in organization, in the improvement of broadcasting programs and above all in radio apparatus.

The big step was made when radio manufacturers came to the conclusion that radio was to be for the people, and not for a clique. The result was that those interested in the true destiny of radio set about to make it more accessible to the people.

Books were written on the “how” of radio, some good, some bad; newspapers began to conduct radio columns; dealers sprang up to bring radio before the eyes of the public; and above all, radio instruments were made more and more simple. Such is the history of one radio year.

There is still room for improvement. Many a crystal set now on the market is simple in operation, but the average citizen would never guess this from glancing at the instrument. Some of these sets look almost as complicated as a linotype machine or a duplex printing press; or grandmother’s recipe for making mince pie.

The reassuring fact, however, is that any new apparatus that comes on the radio market these days is likely to show some effort on the part of the manufacturer to eliminate unnecessary parts, to make the apparatus look neat and workmanlike and to make it appear simple. The up-to-date manufacturer of radio parts realizes that many potential customers are deterred from radio by the thought that it is too difficult for them, a prejudice probably entertained by the sight of intricate monstrosities in the neighborhood radio store. Simplified apparatus will do much to make radio even more popular in the year of progress that lies before us.

Radio Is Ploughing Its Own Field

One indication that radio is sufficient unto itself to provide a system of exclusive radio stores the country over, is to be found in the forms of service provided by the radio dealer. Such innovations as tool-shops, which the radio retailer is fitting up for his customers, so that they may build, repair or change the hook-ups of their sets, are unknown to other forms of retail trade. The real radio dealer has sufficient to offer to warrant the exclusive patronage of his district in this one field—radio.

The firm and settled foundation of the retail radio trade, whose signs are everywhere evident, shows that the retailer has grasped the essential differences of his business and the possibilities which these differences offer for the development of trade. This means that the radio dealer is stronger now than ever to cope with the problems of seasonal changes and other fluctuations in demand. It also means that radio is ploughing its own field.

Make Your Store the Center of Your District

Expert Suggests that Attraction of Radio Offers Great Opportunity to Rural Dealer for Increasing Sales

By R. D. RIDLEY

The radio dealer in the small town has a great opportunity for making his store the radio center of his community and eventually the radio buying center of the same district. Indeed, by making the radio activities of his district revolve around his well-supplied store he is doing the most effective work in his power to reduce the attraction of the mail order house.

Let us admit from the start that the mail order house is the greatest rival of the rural radio dealer or any other retailer in a small community.

Among the attractive things about a mail order house that induce the prospective purchaser to do his shopping by mail is what is known as "prestige." The mail order house happens to be in a large city, therefore, the goods it handles must be the latest, of course. Besides, if a dress or parlor table comes from the City, it has about it an indefinable glamor which in other circumstances is called hallucination.

Then again, there is the element of fashion. The large cities are naturally supposed to be in touch with styles sooner than the rural communities. This may have been true years ago, before the days of the Rural Free Delivery and decent railway schedules. But not today.

And yet millions of dollars come pouring into the coffers of mail order houses from communities that have stores offering service and goods that are just as good. What is the rural dealer to do?

The rural dealer must give his community more than the mail order house. In the radio line, the rural radio dealer has a golden opportunity to keep the local trade strictly local. For he has service and the personal element to offer, which the most efficient mail order concern cannot supply.

The rural radio dealer can with ease become not only the centre of radio activity in his community but the centre of a great deal of the total amusement in his territory. And at little cost.

If it should become known that concerts may be heard every afternoon and evening at the store of J. Jones, radio dealer, the potential buyers of your community must become interested sooner or later. If it should become known that on Saturdays, when everybody more or less, is "off work," that your store is the auditorium where folks can hear people in New York, Pittsburgh, Los Angeles, Detroit, Fort Worth, or Toronto, or other places, it stands to reason that a great many people will make a beaten pathway to your door.

How can you make this known? By word of mouth, by prominent signs in your town and by newspaper advertising. Weekly newspaper advertising is cheap and, if properly done, is effective. In return for advertising in his columns, your newspaper proprietor will be only too glad to publish radio news of interest that you may furnish, or broadcasting programs a week in advance.

Once you have the crowds coming to listen, you can also have them coming to buy. You can make your retail radio store a radio service station.

The radio amateur, like his brother, the automobilist, has need for the service station. He is always wanting new parts, new accessories, new ideas, new hints. The logical place to obtain these is at the local radio dealer's. The thought of writing to the mail order house for advice does not enter his mind. Why, then, should he buy from the mail order house, if the parts he can get from the rural dealer are just as good and are sold at a price just as reasonable? The average American citizen is fair-minded, and if things are made clear to him, he will act accordingly. If he accepts your service, he cannot help but feel that he should also accept the obligation in turn of buying from you.

Making your radio store a service station means always being ready with advice as regards hook-ups and the like, when this advice is sought. It means having a sufficient stock of

standard radio goods always on hand. It also means being able to supply a part out of stock at twenty-four hours' notice. It may also mean having a small tool shop at the disposal of amateurs for the construction, repair and alteration of receiving sets. This extra service has been successfully adopted by a large eastern retailer. If it pays in the face of high rents for space in a large city, it should surely pay in a small town where the extra room entailed in the establishment of such a tool shop is not so expensive.

The rural retailer has just the same opportunity as the dealer in the larger cities to establish firm connections with the potential buying clientele through personal contacts. The popular dealer anywhere can successfully compete with the mail order houses. And the dealer may become popular through service.

The radio dealer in rural communities has the opportunity of making his store the centre of much of the community's activities, because of broadcasting. He can enlarge the scope of his work and the chances for trade by giving radio concerts in the school buildings or the town hall. He can develop prospects for further business by giving private demonstrations in the homes of his district. Starting first with the most prominent citizens, he can get them lined up for radio sets. Then the lesser lights in the community will follow.

There are many ways in which the radio dealer of the smaller communities can bring radio before the people both in summer and in winter—skating parties with music supplied by radio, dancing on the green with an orchestra a thousand miles away supplying the music—by radio! The opportunities for radio exploitation are limited only by one's imagination.

The dealer in the country should create the demand. Once this is done, he should see that he is the one to satisfy the demand, for it rightfully belongs to him.

Stimulate Business with Magnavox Products

EVERY business built up on price considerations alone, is subject to disastrous competition from every other business in the same line so built.

The present need in Radio—as declared by far sighted merchants—is *confidence*; the one factor responsible for building really large and permanent retail stores.

Increase your Radio business with Magnavox Products—their value, worth and price are firmly established by continuous National Advertising; everywhere the name Magnavox has come to mean technical excellence, superior workmanship, and absolute dependability in daily use.

Moreover, Magnavox "selling helps" present the entire Radio proposition so attractively to the consumer, that their use by the merchant is a direct stimulus to business in all classes of Radio Supplies carried by him.

The advertisement shown on the right will be read by nearly seven millions of people this month—many of them your customers and those you want for customers. Such advertising can be made worth many dollars to you if you avail yourself of our selling assistance.



This publication offers useful selling suggestions.

Write us today for free copy of this publication THE MAGNAVOX, which explains our valuable "dealer service."



This Combination Completes any RADIO RECEIVING SET

Whether placed in the average living room or large dance hall, Magnavox Radio floods the desired area with clear, resonant music or speech—its volume perfectly controlled from the Magnavox Power Amplifier constructed specially for it.

Combination R-3 Reproducer and 2 stage Power Amplifier (as illustrated).

R-3 Magnavox Reproducer with 14-inch curvex horn: ideal for homes, offices, etc.

R-2 Magnavox Reproducer with 18-inch horn: the utmost in amplifying power, for store demonstration, large audiences, dance halls, etc.

Model C Magnavox Power Amplifier insures getting the largest possible power input for your Magnavox Reproducer . . . 2 and 3 stage etc.

Magnavox Products can be had of good dealers everywhere

The Magnavox Co., Oakland, California

New York: 370 Seventh Avenue

Write for booklet illustrating and describing the

MAGNAVOX Radio

What the Manufacturers Are Doing

New Amrad Radio Frequency Receivers

Three types of Radio Frequency Receivers of new design are now being offered the retail trade by the American Radio and Research Corporation (Amrad, Medford Hillside, Mass.)



Amrad Radio Frequency Receiver 3500. Rated receiving range, 1,000 miles and up. Wave length range, 200 to 500 meters

These are said to be Long Distance Receivers, capable of receiving 1,000 miles or more.

All three designs incorporate radio frequency amplification, the newest form of amplification, known to exist for a long time, but only recently made practical for general use.

Simplicity of operation was the main goal in the design of these sets with the result, it is said, that tuning is from 30 to 50% quicker and easier than is possible with regeneration, and that both tone volume and purity have been improved.

All sets are encased in solid mahogany cabinets.

Receiver 3500 consists of Broadcast Tuner 3475 and Detector 2-Stage Amplifier 2634, assembled

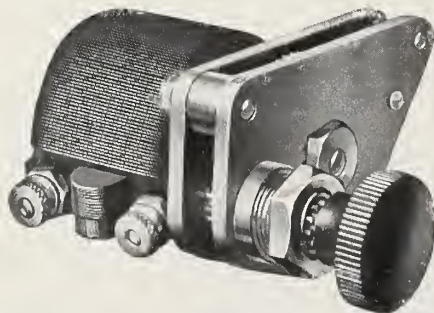

Close-up of Amrad Vernier Potentiometer incorporated in both Radio Frequency Receivers, illustrated above

together as a unit by means of polished aluminum strips. Overall dimensions are 15" x 10 $\frac{1}{4}$ " x 7 $\frac{1}{4}$ ". The Broadcast Tuner is the double circuit type providing a range of wave length of 200 to 500 meters, which may be raised to 3,000 meters by the addition of adjustable loading coils.

This equipment is particularly suitable for installation in the homes of city residents, as the design affords a high degree of selectivity which enables the operator to separate more readily the broadcasting of conflicting stations. That is to say, its adjustment is "sharp," so that incoming broadcasts on very slightly different wave lengths may be tuned in or eliminated as desired. Users, it is said, are able to tune out local broadcasting and hear distant stations — something greatly desired by the radio enthusiasts.

Amrad Receiver 3380 is similar in appearance, but is

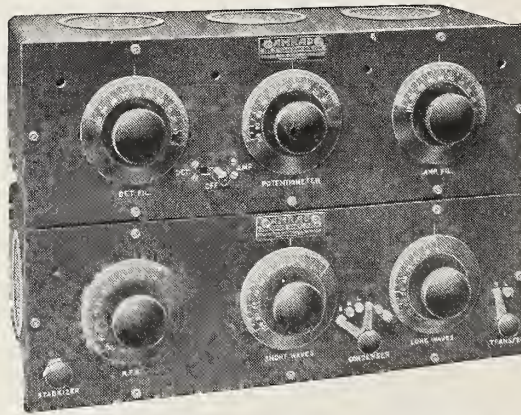

Amrad Radio Frequency Receiver 3380. Rated receiving range, 1,000 miles and up. Wave length range, 180 to 3,400 meters

more particularly adapted to rural conditions where broadcasting stations are not close by the user, and where reception of stations issuing information of special interest to rural residents on the longer wave lengths is more likely to be desired. Its range is 180 to 3400 meters. It is a single circuit type of receiver, and therefore easier to tune than Receiver 3500, although this difference is considerably mitigated by the fact that in the receiver described above, tuning is normally limited to 200 and 500 meters, whereas in Receiver 3380, much wider range of wave length is provided.

A very exact regulation of tone intensity and purity is provided by the Vernier potentiometer, incorporated in both sets. This potentiometer is a new wrinkle controlled by a knob geared to the potentiometer shaft in a ratio of 1 to 4.6, thus insuring extreme fineness in adjustment.

Receiver 3590 is somewhat smaller than the above sets, overall dimensions measuring 10" x 10" x 7 $\frac{1}{4}$ ". Receiving range is about the same — 1,000 miles and up. It is a single circuit type of receiver, consisting of Crystal Receiver 2575, VT 1-stage Amplifier 2766 and Radio-Audio Amplifier 3570, thus combining two stages of audio with one stage of Radio Amplification. This receiver has a wave length range of 175 to 675 meters, which may be stepped up by adding an adjustable load coil. The cam switch enables the operator to use either straight audio amplification, or both audio and radio amplification.

In all three receivers, the famous Amrad basketball variometer with its patented "wavy-weave" windings, is incorporated as also the well-known Amrad Ampliformers and Radio-formers.

Makers Evolve Dealer Aids

There has been great activity recently among radio manufacturers all over the country to provide merchandising helps to dealers handling their products. Among these aids are sets of circular letters, upon which the dealer can place his imprint, attractive display cut outs, miniature models of receiving sets, and monthly or weekly periodicals full of suggestions for increasing radio sales.

New Moon Receiving Set

A new receiving set, the invention of Dr. Franklin Leroy Satterlee, and known as the Model C-1, has been offered to the trade by the Moon Radio Corp., 12 Diagonal Street, Long

(Continued on page 29)

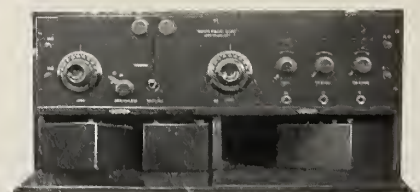

Model C-1.—Satterlee Moon Set

*Just
off the
Press*

THE
**RADIO
CONSTRUCTOR**

*List
25
Cents*

VOL. 1-No. 2

This Book contains, in picture drawings, the most popular hook-ups as determined by a recent research of the trade. They are thoroughly explained in accompanying text.

The popular FLEWELLING, REINARTZ and REFLEX circuits are among those clearly described.

Number one of this volume sold fast; number two should move like lightning.
The Price is right; the Book is right; your Profit is right.

**Sell Them The Book and They
Will Come Back for the Parts**

Dealers Write For Sample Copy and Discounts

S. Newman & Co. Publishers 74 Dey St., New York, N. Y.



STANDARD BRAND

BETTER GRADE CRYSTALS

UNCONDITIONALLY GUARANTEED

Manufactured
by

STANDARD MINERAL CO.

216 MARKET ST.

NEWARK, N. J.

Coming!

An Announcement of Business Interest



Get ready for something of interest to every merchant selling radio supplies. We cannot divulge the significance of this announcement at the present time, but in order to learn about it before the next issue of the RADIO DEALER appears you can secure first hand information by sending in your name NOW.

In the meantime don't forget the exceptional possibilities selling

ACE WIRELESS BATTERIES

The battery that has made dealers and radio "bugs" the best of friends.

THE CARBON PRODUCTS CO.

Lancaster, Ohio

Manufacturers of
Ace Dry Cells, Victor Telephone Cells, Ace Hot
Spark Batteries, Ace Wireless Batteries, Ace Flash-
lights and Batteries, Ace Carbon Brushes and Car-
bon Specialties.



Use coupon for
advance informa-
tion

The Carbon Products Co.
Lancaster, Ohio

We want to know the good news. Write
Name
Street
City
State

Crown Products for Radio Perfection

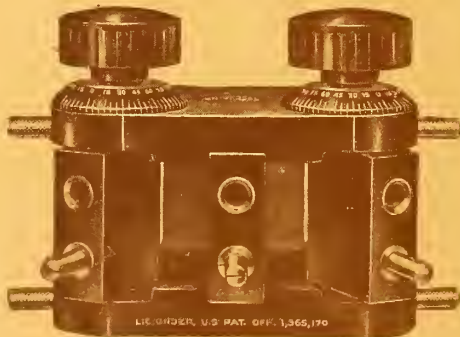

Licensed under De Forest Patents

List Price, \$5.00

CROWN COIL MOUNTINGS especially adapted for FLEWELLING CIRCUIT

Used by manufacturers as standard equipment on sets.
For long and short wave reception.
A few of its many special features:

1. Special Locking Device to keep the coil in place, thus preventing it from being thrown out of adjustment.
2. Special Adjustable Bearing feature.
3. Special constructed Calibrated Dial, showing the stations tuned.
4. Positive Connections on rear of blocks.
5. Complete with Flexible Leads.

CROWN "WD 11"

The Transformer Designed Especially for use with "WD 11" Tubes

The reputation gained by the Crown "WD 11" with jobbers, dealers and users is evidence that there is no other transformer giving such reliable service in amplifying without distortion. The Crown "WD 11" is mechanically perfect, ruggedly constructed and priced right. It is a transformer all jobbers and dealers can back to the limit.

Audio Frequency.....\$5.00

Radio Frequency.....\$4.00

We also manufacture

23 PLATE VERNIER CONDENSERS.....\$5.50
43 PLATE VERNIER CONDENSERS..... 6.50

BAKELITE MOULDED VARIOMETER..... \$8.00
BAKELITE MOULDED VARIOCOUPLER..... 9.00

LIBERAL DISCOUNTS TO DEALERS



CROWN RADIO MANUFACTURING CORPORATION

78 FIFTH AVENUE

NEW YORK CITY

What the Manufacturers are Doing

(Continued from page 26)

Island City, N. Y. It is said that this set has made gratifying long distance receptions on a loud speaker without the use of an aerial.

A switch mounted on the panel allows an aerial to be used when it is desired to get the more distant stations. Two variable condensers are used for very sharp and selective tuning, and a vernier rheostat is placed on the detector tube.

This set has a detector and two stages of audio frequency amplification are provided. It is mounted on a highly polished solid mahogany cabinet with compartments for "B" batteries, thus eliminating a lot of wiring as all "B" battery connections are made in the cabinet. It is stated by the manufacturers that nothing but the highest grade of materials and the best workmanship are put into these cabinets.

Murdock Makes Speaker

The latest addition to the Murdock line of radio goods, manufactured by the William J. Murdock Company, Chelsea, Mass., is the Murdock Radio Loudspeaker.

This simple instrument, which is retailed at a reasonable price, is built

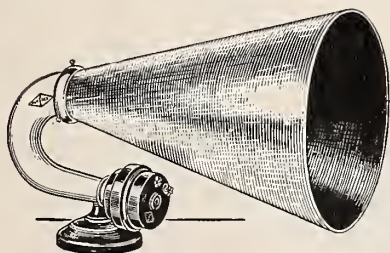

The New Murdock Speaker

on a new Murdock Loudspeaker phone unit. Wires or cord may be connected on the back of the phone unit, which is adjustable.

To adjust the phone unit, all that is necessary is to turn the phone cap, the unit being held in the other hand. When receiving local broadcasting programs, the loudspeaker may be operated from a tube set with amplification.

The phone unit is also sold separately.

Do You Need "A" Batteries, Bus Wire, Condensers, Detectors or anything else in the radio field?

ASK OUR SERVICE BUREAU.

STANDARD RADIO HORNS

Are Fundamentally Right

That's Why They Sell

ALSO MAKING

7-inch Bell, 19 inches High

Rubberoid finish only. Will take all makes of receivers. No air pocket. Designed to give proper amplification. Heavy material to avoid blast.

No. 17, price \$7.50

5-inch Bell, 14 inches High

Rubberoid finish only. Will take all makes of receivers. Specially designed for Radio purposes. Heavy brass. No vibration.

No. 15, price \$5.00

The line of Standard horns is now complete. The dealer who stocks Standards is thus able to supply correctly made horns for any Radio need—at popular prices.

We can furnish a single high-grade loud phone with cord—to fit any of these horns—to make a complete loud speaker.

Price, \$7.50 Extra

STANDARD METAL MFG. CO.

237 CHESTNUT ST., NEWARK, N. J.



14 Inch Bell, 24 Inches High

Rubberoid finish only. Will take all makes of receivers. No air pocket. For use where extra large horns are desired. Heavy material. No vibration.

No. 114, price \$12.00



11 Inch Bell, 14 Inches High

Here's a new design in Radio Horns—will take all makes of receivers. Surprisingly clear reproduction. Grained Mahogany or Black Rubberoid Enamel finish.

Gem, price \$7.50

PRICES REDUCED ON

Saturn  Products

HAVING had more than the anticipated success in the sale of our goods, we are pleased to inform the trade that the correspondingly larger output caused lower production cost, and consequently we are now in a position to lower our list prices.

THIS reduction is for the United States only and will be effective after February 28th.

The New Prices Are:



The Saturn
Automatic
Radio Plug

The Plug with
the RED SEAL

\$1.25

The Saturn "PERFECT" Jack



- No. 1. Single Circuit, Open.. \$0.50
- No. 2. Single Circuit, Closed. 0.55
- No. 3. Double Circuit, Closed 0.70
- No. 4. Single Filament Control 0.75
- No. 5. Double Filament Control 0.80

Now the best at the price
of common goods

The Saturn Mfg. & Sales Co., Inc.
Dept. D
48 Beekman Street
New York, N. Y.

What the Manufacturers Are Doing

Bristol Audiophone, Jr.

No separate storage battery is needed for the new loudspeaker, the Bristol Audiophone, Jr., which the Bristol Company, of Waterbury, Conn., recently placed on the market. In order to make this instrument suitable for all types of radio amplifier circuits, a transformer is mounted in the base. When connected to a third stage of amplification operating on 100 volts or over, the volume of sound is great enough to be easily heard in a room seating five hundred people. For smaller rooms, such as in private houses, good results are obtained from the Audiophone when connected with a two stage amplifier.

There is but one moving element in the entire loudspeaker, this being the armature, which is directly connected to the diaphragm by a multiplying lever. One end of the armature rocks on one pole piece of a strong permanent magnet, while the other end is in the field of the other pole piece of the magnet with a small air gap. The device is protected by two patents.

The whole instrument is of a com-

pact and artistic design, finished in bronze. The bell of the horn, eleven inches in diameter, is similar to the one on the Senior Audiophone, also made by the Bristol Company. The design of the bell is calculated to eliminate distortion.

Radiola Co. Changes Name

By an amicable settlement the Radiola Wireless Corporation, 204 West 17th Street, has relinquished the use of the trade name "Radiola" in favor of the Radio Corporation of America. The company will henceforth be known as the Aerovox Wireless Corporation. The line of radio products manufactured by this company will be called the "Aerovox" line.

Variadon—New Condenser

The Dubilier Variadon, a new form of condenser, is said to make possible the crowding of a very large capacity into a very small space. In place of air, mica is used as a dielectric, since the dielectric constant of this substance is very high, but one movable plate is necessary. By placing the plate close to the conducting surfaces, a condenser of .001 mfd. capacity is obtained, a capacity equal to the high-grade 43-plate condenser.

The Variadon is enclosed in a moulded case of high-grade material. By a slight adjustment it can be used on front or back of the panel. It is said to allow very sharp tuning without the need of a vernier. The Variadon is made by the Dubilier Condenser and Radio Corp., of 48 West Fourth St., New York City.



The Bristol Audiophone, Jr.



The Dubilier Variadon

THE AUDIOPHONE LOUD SPEAKER METHOD OF RECEIVING

Makes You Forget It is Radio-Phone

SO LIKE THE ORIGINAL VOICE AND ORCHESTRAL INSTRUMENTS

the tone is big in volume, rich, round and free from mechanical distortion.

The result of over six years' work on "Sound Reproduction" in the laboratories of The Bristol Company, a world known engineering firm, the Audiophone is not a temporary piece of equipment, but a permanent contribution to the Radio Field.

NO AUXILIARY BATTERIES are required for magnetizing.

About one watt is necessary to give the Audiophone full volume.

Most amplifiers are two stage and designed to give good response in head phones, but there is not sufficient power to operate loud speaker, except for small audiences. For this reason it is desirable to provide another stage of power amplification and Bristol's One Stage Power Amplifier is available which will give volume enough to be easily heard in a room seating 500 persons and over, when added to one or two stage amplifier.

Our representatives are located in all parts of the country. We can come to you with demonstration. Shall we send bulletins?



AUDIOPHONE SP.
Horn 15 Inches Dia.
Price \$40.00



AUDIOPHONE JR.
Horn 11 Inches Dia.
Price \$22.50



ONE STAGE POWER AMPLIFIER
Price \$25.00

THE BRISTOL COMPANY WATERBURY, CONN.



MARCH SPECIALS FOR THE LIVE RADIO DEALER

W. D. 11 SOCKETS

Bakelite Base, Bull Dog Grip Contacts, List \$1.00 **35c**

3 1/4" DIAL, TAPERED KNOB

1/2" heavy Brass Bushing, Individually boxed, List 75c. **22c**

SWITCH LEVER, TAPERED KNOB

Adjustable switch arm from 1 to 1 1/2 inches, List 40c. **12c**

3 PLATE VERNIER CONDENSER

Accurate spacing, Heavy Plates, List \$1.50 **65c**

VERNIER DIAL CONTROL

Makes vernier out of any condenser, etc. List 75c. **23c**

TUBULAR GRID LEAK

1/2 to 5 Megohms. Fits any standard Base. List 65c. **20c**

GRID LEAK BASE

For standard size leaks. High polished base. List 60c. **22 1/2c**

VARIABLE GRID LEAK

Very accurate values 1/2 to 3 1/2 Megohms, **33c**

ABOVE SPECIALS FOR MONTH OF MARCH ONLY

All prices NET CASH, F.O.B. New York in lots of 50 and more

IS YOUR NAME ON OUR MAILING LIST?

HAROLD M. SCHWAB, Inc.

419 WEST 42nd STREET

NEW YORK, N. Y.

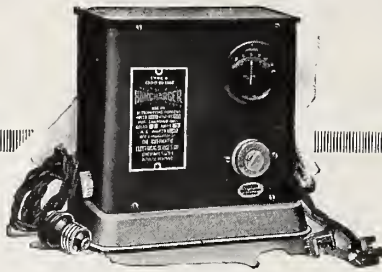

There Is Only ONE Homcharger

Beware of low priced, inefficient imitations, designed primarily to "cash in" on the HOMCHARGER'S unprecedented popularity.

Don't be misled by long discounts, and low prices. Get behind a battery charger of established prestige and proven performance—one that will net you a generous profit—one that is backed by a REAL advertising campaign and dealer co-operation "to the limit."

THE HOMCHARGER

is such a product—over 90,000 now in use—the most attractive merchandising proposition in the entire radio field. The only rectifier on the market embodying these NECESSARY features:

- 1—SELF-POLARIZING
- 2—HIGH CHARGING RATE
- 3—APPROVED BY UNDERWRITERS

*Retail Price \$18.50
complete with Ammeter, etc.*

See your jobber or write us direct for our proposition in detail.

DEALERS: Increase your profits and completely satisfy your customers by selling a HOMCHARGER with every Radio Set.

THE AUTOMATIC ELECTRICAL DEVICES CO.
144 West Third Street, Cincinnati, Ohio

LARGEST MANUFACTURERS OF VIBRATING RECTIFIERS IN THE WORLD

MARLE

AUDIO FREQUENCY

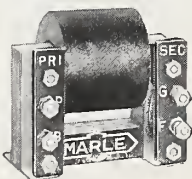

TYPE A4
RATIO 3 3/4 to 1
LIST PRICE \$3.75
BLACK TERMINAL
BOARD

RADIO FREQUENCY



TYPE R1
LIST PRICE, \$4.00

AUDIO FREQUENCY



TYPE A6
RATIO 5 to 1
LIST PRICE, \$4.25
RED TERMINAL
BOARD

TRANSFORMERS

SUPERIOR QUALITY TRANSFORMERS USED AND
RECOMMENDED BY LEADING REPUTABLE
MANUFACTURERS OF RADIO APPARATUS

MANUFACTURED BY

MARLE ENGINEERING CO., Orange, N. J.

Dangers of Monopoly Shown in Germany

Writer Demonstrates Disastrous Effect Upon Broadcasting

By H. JAEGER

Of Jaeger & Co., Berlin, Germany
(Translation by N. B. Zimmerman)

Competition is the source of all progress and all effort. A state whose future development is going to be branded by reconstruction has therefore every reason for encouraging rivalry to the best of its ability, and if that state is among the first, then this competition mobilizes productive activity and forces it to the highest achievements. Monopoly, however, means the end of all competition. It should step into an industry only when the need makes it absolutely necessary and entirely imperative.

The "splendid isolation" which has once already proved so disastrous to Germany now seems about to become an actuality in another sphere. Post and telegraph have for a long time been a monopoly of the German Government. It was a natural result that the control of wireless dispatches was commanded by this monopoly. In this respect other lands have done exactly this same thing. But the development of radio advanced. It succeeded in creating a wireless system which could broadcast speeches, songs and other kinds of music; yes, even whole operas. With this, new possibilities in radio development as well as in the industry presented themselves. These possibilities had to be employed to aid production according to the need of the day. Monopolization could only harm them.

Proceeding from this point of view, countries other than Germany perceived a division in radio activities. Radio telegraphy remained a state monopoly, divided among the organizations with a government concession. All the remaining activities of radio development were granted freely to all; in some countries in their entirety, in others with certain slight restrictions.

This was done in such a way that certain wave lengths were reserved for radio telegraphy and were not to be used by private sources. Other wave lengths are free. Their use is open to everybody.

The fruitful and stirring results of this were demonstrated immediately. If anyone opens a newspaper or periodical from countries other than Germany, where there are no restrictions upon the transmitting of speeches, music, sermons, etc., he im-

mediately finds evidences of a mighty advance in radio. This is patent in America. And the same condition is fast developing in Holland, where the newspapers and magazines carry pages of advertisements of radio manufacturers and dealers of apparatus of varied kinds for use in the home, hall or assembly place.

But in Germany! Mark the difference. No one is allowed to erect a sending station, be it ever so small. No one is allowed to operate a receiving set under penalty of being punished by the Government. While in other countries an unparalleled development of radio has taken place, a studio organization has been formed in Germany which, in co-operation with post office directors, will make a trial in ten cities to find out with what acclaim the broadcasting of speeches, etc., will be received by the people.

For one hour every evening an orchestra concert or speech is to be heard. Whoever wants to hear this will have to make an application to the post office, upon which he will receive a sealed set which will make reception possible.

The development of the radio in Germany will undoubtedly suffer if operated on the above plan, since only a small part of the people will have the time or the inclination to listen-in for just an hour to the speeches delivered under governmental limitations. Furthermore, even for the best broadcasting there will only be a small specified group under this plan. Others will want to hear something else.

Matches and alcoholic liquors can be monopolized by the state, but not artistic and the finer activities of life. These must be free and they must remain so. But it needs no further proof that through this state monopoly of wireless the technical development of radio is also checked. Through this governmental restriction competition between individual factories is obviously suppressed. Original production is restricted and advantage created for foreign electrical development. Furthermore, through this monopoly valuable avenues of experimentation and research are closed to German engineers and electrical craftsmen, as well as to mere amateur radio enthusiasts who have helped to develop radio in the United States, for example.

How the monopoly of broadcasting by a state affects the development of radio is indicated in the preceding article, written by an active German radio man. The conclusions drawn, after reading this statement, are that monopoly, whether it be a state monopoly, or that of a private corporation, harms broadcasting and injures radio. It should be understood that in the article the viewpoint of a German business man is expressed. THE RADIO DEALER assumes no responsibility other than for the translation.

A Big Stride forward

The Autostat A Super Rheostat

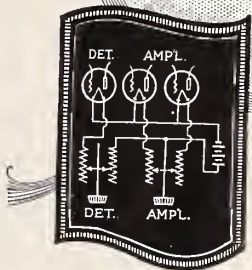

THE AUTOSTAT presents an entirely new principle in filament rheostat construction and radio takes another **BIG** step forward.

No longer is it necessary to turn a "hair's breadth" to tune in that *elusive* station, for with the AUTOSTAT you can give the knob a substantial turn and get a *superfine* adjustment. No other rheostat to date possesses the necessary "fineness" of adjustment to eliminate interference and "tube howls" **under all conditions**. But the AUTOSTAT, with its micrometer adjustment, will positively give these much-sought-for results.

How It Works

Two parallel mounted resistance tubes are connected in series by a "micrometer-operated" slider—the length of wire in circuit depending upon the location of this movable slider. **Forty turns** of the AUTOSTAT knob are required to complete the variation from minimum to maximum resistance—against one-half to three turns on others.

This exclusive patented construction means:

1. One full turn of AUTOSTAT knob produces finer tuning than a "hair's breadth" turn on any other.
2. Economical—only two AUTOSTATS required for a three-bulb set.
3. Greatly increased receiving range and clearness of signals.
4. A uniform change in resistance with each turn of the AUTOSTAT knob.
5. Indestructible wire-wound fireproof lava resistance element.
6. Unqualifiedly guaranteed.

Popularly priced, **\$1.35**

Dealers

The AUTOSTAT will be nationally advertised. And all HOMCHARGER dealers and jobbers know that when we say "advertising" we will dominate the field and convert their stocks of AUTOSTATS into cash **QUICKLY** and **PROFITABLY**.

AUTOSTATS come in neat individual boxes, which, in turn, are packed in "business-getting" display cartons—with plenty of live dealer helps, and discounts that net real profits.

Order a carton of AUTOSTATS from your HOMCHARGER jobber **TODAY**—be the first in your locality to "cash in" on what is destined to be radio's fastest-selling filament rheostat. If he can't supply you, write us direct.

Jobbers

Write or wire for radio's most attractive merchandising proposition.

THE AUTOMATIC ELECTRICAL DEVICES COMPANY

144 W. Third St., Cincinnati, Ohio: Builders of Precision Rheostats Since 1914



Radio Trade Pictures



Left—W. L. Harrison, of Lindsborg, Kansas, vice-president of the Kansas Radio League, who protests against unfair jobber competition on Page 21 of this issue

Right—R. A. Wheeler, President, Mining Equipment and Supply Company, Wilkes-Barre, Penna., who joins Mr. Harrison in his protest

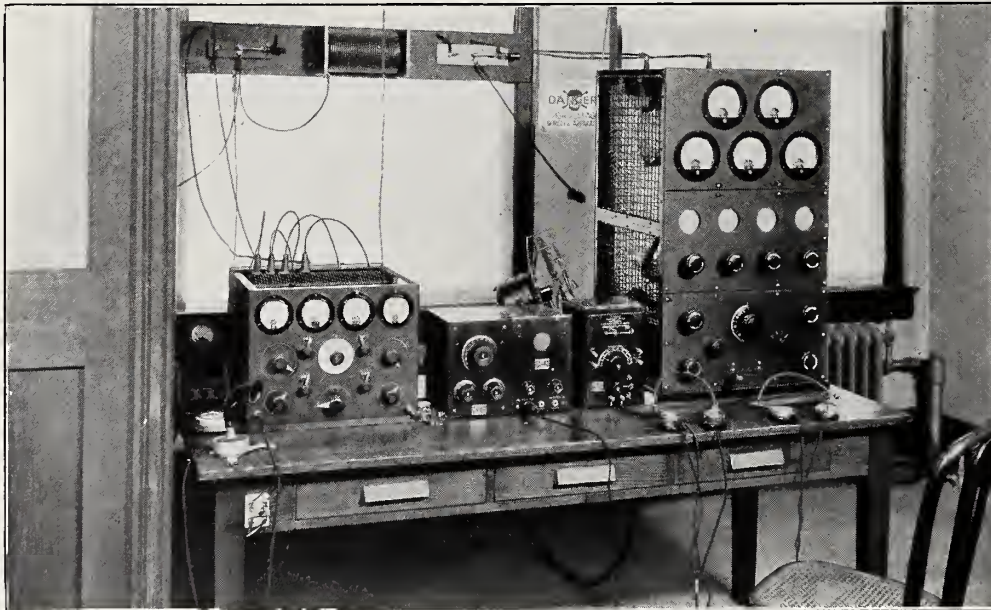

Station WHK, Cleveland, Ohio, operated by the Radiovox Company showing apparatus in transmission room
Article on Page 43



Two views in the factory where The Chicago Radio Laboratory manufactures Zenith Long Distance Equipment. Note the "progressive system" of manufacture



Everybody Gets Discounts

(Continued from page 21)

forts of the manufacturer and jobber. He must naturally look for protection from some source. If the manufacturer and jobber refuse to aid him, where can he turn?

"Last Winter when the art of radio was young, this dangerous policy of discounts to everybody was conducted on a very large scale. Today the situation is not much better.

"We in this country are not naturally pessimistic. We understand that protective rights must prevail. To put the radio industry on a sound basis we must have staunch co-operation and good will. The menace of the illegitimate discounteer is a reality, which the retailer, jobber and manufacturer have to face.

"Once the jobber or manufacturer realizes," Mr. Harrison stated in conclusion, "that the prosperity of the dealer means the prosperity of the radio industry and his own prosperity, this menace of indiscriminate discounts will be put to flight."

Garrick to Move April 1

R. R. Garrick, radio distributor of 126 North Redfield street, Philadelphia, Pa., announces that he will open new quarters in Beechwood, Delaware County, Pa., on April 1, to be known as the Garrick Radio Laboratories. Here the distribution of radio products will be continued and, in addition, the laboratories will be engaged in the manufacture of radio sets, as well as in research work.

The Garrick Radio Laboratories, as distributors, will represent the following concerns: Ajax Radio Corporation, Radio Engineering Co., Orange Research Laboratories and the Aerex Company. Further additions to the Garrick list will be announced at a later date.

Crosley Welcomes Visit

No visit to Cincinnati is complete without a tour of inspection of radio station WLW and the Crosley Manufacturing Company, says the *Crosley Weekly*. Everyone is cordially invited to see how this station, which has been heard from ocean to ocean and from Canada to Mexico, is operated. Visitors are welcome from eight until five daily and from eight until twelve on Saturday. You will see how the Crosley sets are made, tested and shipped to all parts of the world.

Heard with A MU-RAD Receiver

And A 2 Foot Loop Aerial



(The MA-13)



The New
Star in
the Radio
World

They copied all they could copy,
But they could not copy our mind;
We left them tearing and swearing
A thousand miles behind.

—Kipling.



From <u>NEW YORK</u>	From <u>DETROIT</u>	From <u>CLEVELAND</u>
Davenport 830 Miles	Fort Worth 1092 Miles	Fort Worth 1050 Miles
Kansas City 1040 Miles	Havana 1680 Miles	Denver 1200 Miles
Fort Worth 1285 Miles	Calgary 1667 Miles	Salt Lake City 1530 Miles
Havana 1567 Miles	Porto Rico 2036 Miles	Havana 1671 Miles
From <u>ST. LOUIS</u>	San Diego 2070 Miles	San Francisco 2180 Miles
Manitoba 900 Miles	Los Angeles 2070 Miles	From <u>CHICAGO</u>
Montreal 1000 Miles	San Francisco 2210 Miles	Havana 1621 Miles
San Francisco 1820 Miles		Los Angeles 1840 Miles
Honolulu 4278 Miles		San Francisco 1955 Miles

Why MU-RAD Excels

1. **Unequalled Sensitivity**—Exceeds the sensitivity of the average set many times. The above record demonstrates this.
2. **Fine Selectivity**—Permits differentiation of stations 1% off tune.
3. **Simple Operation**—All tuning can be done with one hand.
4. **1,000 Mile Reception**—Guarantee goes with every set.
5. **Distinctive Appearance**—Solid mahogany cabinet, Radion panel, highly polished.

Reasons for Selling MU-RAD Sets

Every one of these advantages makes it easier for you to sell MU-RAD apparatus.

The great distance records of MU-RAD sets are interesting your customers. MU-RAD advertising has already introduced these sets to the whole country.

Write for Our Interesting Proposition

MU-RAD Laboratories, Inc.

800 Fifth Avenue Asbury Park, N. J.

Two Types MU-RAD SETS	
Type MA-12 3-Stage R-F and De- tector	\$128
Type MA-13 3-Stage R-F. Detector & 2 Stages A.F.	\$160

PANELS

BAKELITE—DILECTO

Standard sizes — Special sizes — Sheet stock —
Machined and finished — Immediate delivery.

STANDARD WIRELESS PANEL CO.

49 MECHANIC ST., NEWARK, N. J.

Market 7308

THE PORTABLOOP'S THE THING

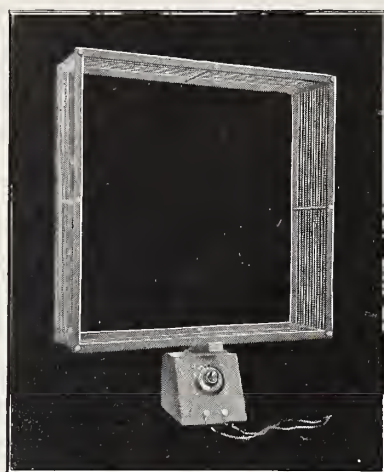

FORGET ABOUT STATIC
WITH THE

Eagle Portabloop and Radio Frequency

You Can Make
Radio Into a
Summer Sport

Be Prepared for the
Spring and Summer
Rush

Order Now



210 Central Avenue

Melco Radio Receiver

The Melco receiver, made by the Mortimer Radio Corp., of 114 Fulton St., New York, has two tuned circuits with variable magnetic coupling, similar to the commercial and naval receiving sets. It is designed to cover the amateur and broadcasting waves efficiently and with high selectivity on the average small outdoor antenna.

The radio waves are tuned in the antenna circuit by a tapped inductance having switches for broad and fine tuning. The resulting electric oscillations are magnetically transferred to a cylindrical coil wound with Litz and tuned by a variable condenser. This closed tuned circuit has extremely low damping and tunes quite sharply.

Both circuits tune from 165 to 600 meters and when loosely coupled give high selectivity and loudest signals. Coupling control is effected by rotation of the Litz wound coil in the magnetic field of the antenna load coil. The coupling variation is sharp and clear from zero to maximum. Placing the Litz coil at the ground end of the antenna coil has reduced the disturbing influences of capacitive coupling so that no low frequency noises are carried over from the antenna to the tuned secondary.

The radio oscillations are detected in the tuned secondary by an audion with condenser and resistance leak in the grid circuit. Stations within a 75-mile radius may be heard directly in the head phones with fair strength, the makers claim. More distant stations may be heard by amplifying the detector output in a Melco two stage audio frequency amplifier made for this set.

The Melco products are produced under the watchful guidance of Lester L. Jones, a radio engineer of many years' standing. The sales are handled by the Save Sales Co., 261 Broadway, New York City.

Issue Effective List

An effective little catalog is now issued by Henry Paulson & Co., 37 South Wabash Avenue, Chicago, Ill., which lists many standard and nationally advertised radio parts and equipment. A feature of the publication is that each brand of apparatus listed is illustrated, so that the appearance and quality of each instrument is quickly perceived.

MANUFACTURERS JOBBER and DISTRIBUTERS

SOCKETS (HERCULES PRODUCTS)

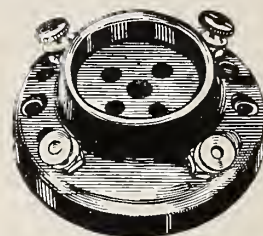

List Price, \$1.00

Discounts 50 to 80%

Moulded of highest heat resistance compound

Phosphor bronze springs that give perfect contact

All screws and nuts are brass nickel plated

Highly polished

RADIO PARTS

Dials, Detectors, Insulators, Telephone Plugs, Switch Levers, Rheostats, Rheostats with Dials, Potentiometers

Composition Initialed and Metal Binding Posts

Series Parallel and Vernier Control Switch Levers

ENCLOSED GLASS DETECTOR

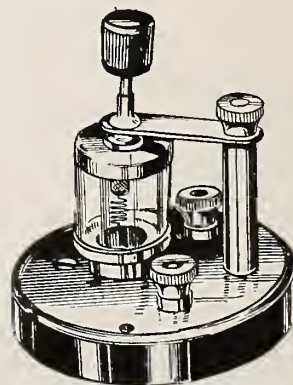

List Price, \$2.00

Discounts 50 to 80%

Catalog on Request

Speer Dee Specialty Co.
271 Canal St., New York, N. Y.

World's Greatest Headset
Original
Nathaniel Baldwin Type C
With
Sheltone Loud Speaker

This complete outfit positively makes a most wonderful Loud Speaker.

In actual tests by experts they all agree that its tone is mellow, natural and clear.

Headset can be used in regular way with headband or on Loud Speaker.

Regular Price

Baldwin Phone..... \$12.00

**Shelton e Loud
 Speaker 5.00**

Phones not sold without loud speakers.

Live dealers, here is the quick quality seller.

Order now. Immediate delivery

Thousands being sold
 Nationally advertised

Actual size 8½ inches high Beautifully Rubberized Finish



Special Price, complete outfit, \$16.00

Dealers Discount 40%

THE SHELSTONE COMPANY
 70 Halsey Street Newark, N. J.

THE PERFECT WD-11 BATTERY ONE THOUSAND HOURS OPERATION WITHOUT BATTERY ATTENTION

The Edison Radio Primary Battery supplies current for one, two or three WD-11 Tubes. When one tube is used the life is 1000 hours.

When the battery becomes exhausted it is renewed by simply replacing the elements and solution, and is then the same as new.



LIBERAL DISCOUNT TO THE TRADE

THOMAS A. EDISON, INCORPORATED

Primary Battery Division

Bloomfield, N. J.

CHICAGO
752 Peoples Gas Building

ST. LOUIS
2044 Railway Exchange Building

SAN FRANCISCO
1205 Hobart Bldg.

RADIO MANUFACTURERS Attention! For Efficiency—

SHAW

Moulded Insulation
PRODUCTS

Moulded insulation to fit your every need Exactly. For we manufacture it according to *your own* specifications and moulds. That's the SHAW way. Try it—"for efficiency." We neither retail nor wholesale. We manufacture only. Submit your specifications for a SHAW estimate.

SHAW INSULATOR COMPANY

Founded 1892

Henry M. Shaw, President

Frank H. Shaw, Vice President and Gen'l. Manager

150 COIT ST., IRVINGTON—NEWARK, N. J., U. S. A.

The First Year

A Record of Progress and Growth in the Radio Industry

With this issue THE RADIO DEALER closes its first year, having issued and regularly mailed twelve monthly editions of this paper.

THE RADIO DEALER is the first radio trade paper and has carried its constructive message to almost everyone in the radio industry.

THE RADIO DEALER points with pride to one thing particularly, and that is the establishment and maintenance of a one-price rule to all advertisers.

THE RADIO DEALER has held to the ideal of trade betterment and working toward that excellent ideal organized, for the trade, The Radio Trade Association.

THE RADIO DEALER has consistently declined to carry the advertisements of get-it-quick concerns and stock-promotion concerns. (There are such still in existence.)

THE RADIO DEALER has maintained a Service Bureau for the use of the trade and has consistently given public notice to every new thought in radio.

THE RADIO DEALER has refused to be subsidized, as certain persons know, and has consistently maintained that the radio industry is not a side-line proposition. To this viewpoint this paper has acquired the endorsement of numerous manufacturers.

THE RADIO DEALER has surveyed the entire land, from the radio standpoint of radio, and has published these reports for the benefit of the trade.

To our readers, THE RADIO DEALER extends its thanks.

THE PUBLISHER

RADIO STOCKS

(Quotations as of February 24, 1923, furnished by Frank T. Stanton & Company, 35 Broad St., New York City, Specialists in Wireless Securities.)

Stock.	Bid.	Asked.
American Marconi Stamped..	5c	15c
American Marconi Unstamped	\$5	\$7
American Tel. & Tel.....	123	123½
Canadian Marconi	2½	3½
De Forest	7	10
English Marconi com.....	11	15
English Marconi pfd.....	11½	15½
Federal Tel., Calif.....	5	6
General Electric	185½	186
Mackay Company com.....	115	116
Marconi Int. Marine	8	10
Radio Corporation com.....	3½	3½
Radio Corporation pfd.....	3½	3¾
Spanish Marconi	1	3
Western Union	117	117½
Westinghouse E. & M.....	64½	65

MELCO SUPREME

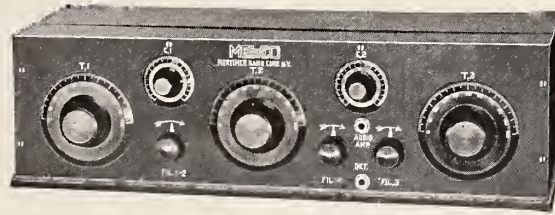

Sold by
Hundreds
of Live
Radio Dealers

Only
\$125

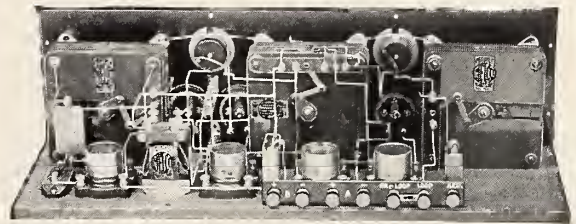

The "Melco Supreme" Radio Frequency Amplifying Receiver can be used with indoor or outdoor aerial, loop or lighting plug. Operation is simplicity itself. Covers all broadcasting ranges from 175 to 500 meters wave length. A new departure in radio, non-reflex, non-regenerative, tuned radio-frequency.

Amplification is extremely high per stage without the slightest loss of tone quality. Neither distorts the wave nor interferes with other receivers. Single tuning adjustments assure greatest degree of program selectivity and most satisfactory long distance receiving is permitted by this new system.

We also manufacture a complete line of standard parts, including sockets, condensers, audio and frequency transformers, variocouplers, inductance switches, rheostats, potentiometers, etc.

DEALERS: Wire or write to any of our offices below for Booklets 1001 and 1002, prices, discounts and full particulars about our proposition.

MORTIMER RADIO CORP.

114-116 FULTON STREET, NEW YORK

Huntington, W. Va.
1028 Fourth Ave.
Atlanta, Ga.
Flatiron Bldg

Philadelphia, Pa.
636 Victory Bldg.
San Francisco, Cal.
709 Mission St.

Pittsburgh, Pa.
704 Granite Bldg.
St. Louis, Mo.
13 South 4th St.

Los Angeles, Cal., 337 South Western Ave.

Exclusive Canadian Representative, Scott Bros., Ltd., 332 St. Catherine St. West, Montreal, Que.

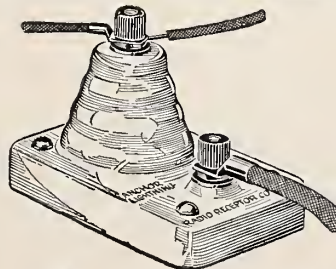

IT HAS STOOD THE TEST OF
TIME AND SURVIVED

R. R. ANCHOR

LIGHTNING PROTECTOR

List Price, \$1.50

For indoor or outdoor use National Board
Fire Underwriters

Attractive Proposition to Dealers and Jobbers

Radio Accessories Co.

59 Bank St.

New York



UNION RADIO PHONE TIP JACKS

(Pat. Applied For)

25 cents A PAIR

These convenient Phone Tip Jacks replace the old fashioned binding post. They assure positive contact and quick operation at all times. Accommodate any standard round phone tip and several sizes of bare wire. Great for W D II connections and coil mountings. Ideal for experimental circuits. Packed in

1/12 1/2 and 1 Cross
Counter Display Cartons

We make a complete line of Variable Condensers, Rheostats, Tube Sockets, Condensite Dials, Tip Jacks, Receiving Sets and Two Step Amplifiers.

Write today for our liberal dealer proposition, samples and prices.

Catalogue K on request.

UNION RADIO CORPORATION
200 MT PLEASANT AVENUE, NEWARK, N.J.
NEW YORK OFFICE 116 WEST 32ND STREET

SOCKET-RHEOSTAT

Registered U. S. Patent Office

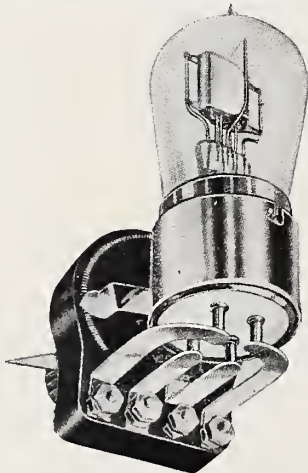

Type A-5 ohms, suitable for detector bulb **\$2.00**
Type B-2 ohms, suitable for power bulb

TWO IN ONE. A socket and rheostat so combined as to form a single unit. No more unnecessary leads between socket and rheostat. Just connect your leads to the four posts marked P-F-F-G and you are hooked up as far as the SOCKET-RHEOSTAT is concerned.

MANUFACTURED BY

Ajax Radio Corporation

Telephone: Bigelow 4097
538 SOUTH 10th STREET
NEWARK, N. J.

Bright Future for Dealer Assured

(Continued from page 18)

the standard of broadcasting. And greater improvement means that more and more people will be won to radio.

"When will we reach the saturation point?"

In the first place there is no saturation point for radio sets any more than there has been a saturation point for automobiles. Far more people own automobiles today than the number who owned horses and carriages a generation ago! There are only about one million real radio sets in use in America today, and there are at least twenty million homes!

Every owner of a crystal set or a small home-made set is a potential buyer of a bigger and better bulb set, just as every Ford owner invariably graduates to a better and more expensive car. Every customer who bought a cheap radio set to start with can be sold a better machine. He is a potential buyer—even though he be unconscious of it.

Make a list of these previous purchasers. The next time they come into your store show them the merits of a better machine. Create a real desire for ownership and then follow the business getting slogan of the automobile industry, "Ask 'Em to Buy!" Dealers have been taking only the "cream" of the business as it has been thrust upon them. They have failed to make any concerted effort to secure the "milk"—which is the bulk of the business after all.

There are enough radio shops in the country. What is needed are better radio shops. Your real competitors are the stores that sell talking machines, and you must compete with them by setting as high or higher a standard than they set. Our competitors are not the merchants in the same industry, selling an article similar to what we are selling. Your real competitors are those who are endeavoring to induce the buyers to spend their money for something you do not sell.

Under the old conception of competition dealers in the same line of business believed that they had to fight one another. Under the new conception we know that the competition to be feared is not that of other individuals in the same line of business as ourselves, but the competition of other industries.

The buying public has just so much money to spend each year, sometimes more, sometimes less; but even in periods of business depression the total available for purchases of things

PHONE PLUGS

Standard Type



35^c each

22^c each

in lots of 100 or more

The above plugs can be used with pin, spade, or plain wire ends.

No soldering necessary

S. S. NOVELTY CO.

255 Bowery, New York, N. Y.

Tel. Orchard 8932

FISCHER

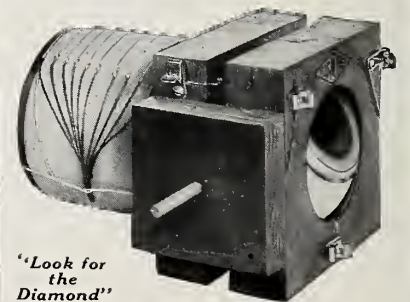

"Look for the Diamond"

Vario-Wave Tuner

(Flat and Bank Wound)

Affords a guaranteed range of 200 to 3500 meters

Functions the same as a combination of Variometer, Variocoupler and Loading Coil. All three can be eliminated by its use.

G. H. FISCHER & CO.

317 Cypress Hills Road

GLENDALE, L. I., N. Y.

other than the bare necessities of life is enormous. The prosperity of the individual members of an industry depends not on how much business they can pull away from one another, but on how much of this big sum spent by the purchasing public they can attract to their own industry.

Let us make our stores more attractive and our service better, and, to use a popular phrase of the day, "day by day, in every way, business will be getting better and better."

Amrad Has House Organ

The *Amrad Messenger* is the house organ and circular published by the American Radio and Research Corporation, Medford Hillside, Mass., "from time to time." This publication will devote itself to hints and information for the dealer. In the first issue the following bit of sound argument appeared:

"Many people are not buying radio today because they think revolutionary changes are coming in the equipment. To them radio is new — only a few months or a year old. They do not realize present apparatus is the result of seven years of development."

The *Amrad Messenger* will be looked forward to by radio dealers who are wise enough to enter their names on the subscription list.

Magnavox Issues Organ

The first issue of the *Magnavox*, published by the Magnavox Company Oakland, California, and 370 Seventh Avenue, New York City, is a decided pace-maker for all the issues of this magazine that are to follow.

From the interesting two-colored cover to the very back page, this publication, which has the same dimensions as the *Saturday Evening Post*, is an interesting and informative effort.

The keynote of the first issue is Magnavox National Advertising and the radio dealer's opportunity. This idea is carried out in every page. The next issue is to deal with newspaper advertising and dealer helps. Copies may be had by radio dealers on application to the Magnavox Company.

Among the features of the first issue is an article on the superior construction of the Magnavox loud speaker. There is also a short feature on the "fulfillment of three great prophecies." Every item in the publication is full of "human interest."

ATTENTION! RADIO DEALER

THE TREMENDOUS DEMAND FOR

EBY BINDING POSTS

IS GREATER TODAY THAN LAST SPRING



Commander



Ensign



Corporal



Sergeant

We anticipate a great volume of business during the coming Spring, and we request that you anticipate your orders through your nearest jobber at once.

There is an EBY jobber in or near your City, but if you are unable to procure our products, send us your order with your jobber's name and we will ship direct and bill you through him.

When placing orders with your jobber, don't fail to ask for a quantity of attractive EBY literature.

THE H. H. EBY MFG. CO., PHILADELPHIA, PA.



Bradleystat Window Trim Is Ready for You

THE NEW WINDOW TRIM is an attractive border for your windows. It is printed in orange and black and offers an unlimited variety of borders. Feature the Bradleystat for one week. The sales will surprise you.

THE NEW DEMONSTRATOR is a striking six-color oil poster for your window and also for your counter. It is a live Bradleystat salesman because it gives the customer a chance to try the Bradleystat on the demonstrator.

ACT NOW — USE THIS COUPON

Allen-Bradley Co.
487 Clinton St., Milwaukee, Wis.

Send me your window trim so that I can feature the Bradleystat in my radio window. Send me suggestions for novel window effects.

DISTANT STATIONS BROUGHT IN FOR LONG WAVE RECEPTION

USE AMCO ADJUSTABLE, 1, 2
AND 3 COIL MOUNTINGS

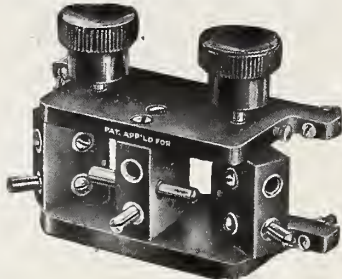

Licensed Under DeForest U. S. Patent,
No. 1,365,170

Triple Coil Mounting List \$5.00
Double Coil Mounting List \$3.50
Single Coil Mounting List \$0.50

Adjustable locking device, a patented
feature, holds the coil firmly in place.
Readily mounted on front of panel in
any position.

Constructed of the highest grade insulating
material; polished and attractively
finished.

All metal parts heavily nickel plated
NOT A MOULDED AFFAIR

Astorloid Mfg. Co., Inc.

Tel. Williamsburg 5104

416 Marcy Ave. Brooklyn, N. Y.

RADIO DEALERS

We are fully prepared to furnish you with Standard Radio Products at attractive discounts. Prompt deliveries and unlimited service.

ELL ESS PRODUCTS

At Unusual Discounts

Crystal Sets
K. D. Glass Crystal Detectors
Tubular Grid Leaks

ALL CAPACITIES

DISTRIBUTORS

FOR

Raven Radio, Inc.
Enco Electric Novelty Co.
Inter-Ocean Radio Corp.
Jaynixon Laboratories

Also Other Standard Products

WRITE, CALL OR PHONE

ELL ESS RADIO EXCHANGE

57 Day St. New York, N. Y.

Show in San Francisco

A radio and electrical exposition will be held from April 3 to 8, inclusive, in the Exposition Auditorium, San Francisco, under the auspices of the American Radio Exposition Company of New York. This company managed the American Radio Exposition which was held in New York at the Grand Central Palace during Christmas week.

The San Francisco show has been endorsed by the Pacific Radio Trade Association, the San Francisco Electrical Development League, the Electrical Contractors & Dealers Association of San Francisco and the California State Association of Electrical Contractors and Dealers.

There will be special broadcasting features, and contests and prizes for radio amateurs.

Free Report Cards Ready

The Continental Radio and Electric Corporation, 15 Warren Street, New York City, is now ready to distribute free to dealers report postal cards for further distribution among their customers.

The average amateur who receives a long distance station is anxious to inform the station of the feat. These report cards make it easy for him. Space is allowed on these postal report cards for the name of the station, time and date heard, the name and address of the amateur and details of the receiving equipment. Room is given at the bottom of the postal for the imprint of the dealer.

These postals are expected to appeal strongly to the amateur, because of their convenience; to the broadcasting stations, because they are always anxious to hear the extent of their clientele; and to the dealer because they provide a pleasant method of publicity and an effective method, too, for the amateur will appreciate the service and come back for more cards and incidentally more radio parts.

Urges Study

Retailers should devote more time to a study of fundamental trade conditions that they may be able to buy more wisely, keep more complete records and to take advantage of research agencies to inform themselves of general business conditions and market fluctuations.—Professor Wesley C. Mitchell, Department of Economics, Columbia University.

Ask Our Service Bureau



SHELSTONE

Loud Speaker

Without phones

\$5.00

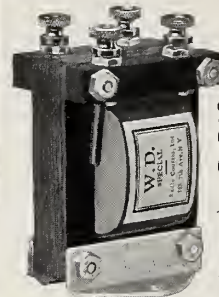

W. D. SPECIAL

Cash in on the big demand with this perfect amplifier transformer for use with W.D. 11 and all standard tubes.

Extra Liberal Discounts

List \$5—Dealer's Net \$2.75
Jobbers, write for your price

RADIO COURSES, Inc.

552 W Seventh Ave., N. Y. C.

PEN nsylvania 0574

ADD-A-STEP



DETECTORS AND AMPLIFIERS

LIST \$5.00 LIST \$9.50

Awarded Mail's Certificate of Excellence

See them at the RADIO FAIR

ARROW RADIO CO.

Manufacturers of Quality Plus
Instruments

HACKENSACK

NEW JERSEY

QUEENS Vario Coupler



\$5.00

BIG DEMAND—BIG PROFITS!

Wise dealers everywhere are cashing in on the huge demand for the nationally advertised QUEENS VARIOCOUPERS AND VARIOMETERS, because they realize that there are NONE BETTER MADE—THEY MAKE RADIO RECEPTION A PLEASURE—AND THEY BRING IN REAL PROFITS.

Order yours to-day—or send to us immediately for our attractive prices.

QUEENS RADIO COMPANY, INC.
12-A Forest St. Winfield, L. I.

Anchor Wins Approval

The idea is growing among radio users that some adequate protection should be made against lightning, no matter whether the underwriters or landlords require such protection, and that some adequate escape to the ground should be provided for the inevitable chance of a lightning flash. What is needed is a rugged device with plenty of current-carrying capacity, not a delicate or complicated device that the elements can easily destroy when used outdoors.

The Anchor lightning protector, made by the Radio Receptor Company of 59 Bank street, New York City, is said to answer all the requirements for a lightning protective device. It is designed to really hold the end of the antenna mechanically and electrically

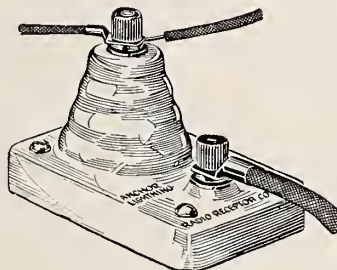

as securely as an anchor holds its cable.

The ground end does not require high insulation, so it is down on the base of the device, but the antenna terminal, a critical part of any protector, must be free from moisture or grounds. In the Anchor it is up in the air on a sort of pedestal, thus complying with the needs of an efficient device. Finally the makers claim that the Anchor maintains a free path to the ground at five hundred volts to satisfy national electric code standards.

Eastern Radio Moves

The Eastern Radio Manufacturing Company, formerly of 65 West Broadway, New York City, have moved to larger quarters at 55 Warren street, where they have installed machinery and equipment to manufacture all types of couplers. Among their principal products are a long wave-coupler and special couplers for the wavelengths that at present do general broadcasting. The products bid fair to hasten the standardization of couplers both as to construction and price.

Freshman Products—Accurate and Dependable



"MICON"
Tested Mica
Condensers

Size	Price
.00025	\$.35
.0005	.35
.001	.40
.002	.40
.0025	.50
.005	.75
.006	1.00
.01	1.50



Variable Resistance Leak

With .00025 Mfd.
Micon Condenser
Combined

\$1.00

Without
Condenser

75c

Unbroken range—Zero to 5 Megohms,
Clarifies signals, lowers filament current,
increases battery life, eliminates
hissing.



Assure absolute noiselessness—clarity of
tone—accuracy—constant fixed capacity.

.006 Micons and Variable Resistance Leaks, especially adapted for New Flewelling "SUPER" Circuit.

ANTENELLA

No antenna or aerial needed. Eliminates all the inconveniences in radio, operates from any light socket. Price only—

\$2.00

CHAS. FRESHMAN COMPANY, Inc.

106 Seventh Avenue, New York City
(Note New Address)

Dealers: Discount 33 1/3% on all orders \$15.00 and over. We pay parcel post, express charges. Literature and display cards free on request.

THE SAMSON ELECTRIC CO.

ANNOUNCES

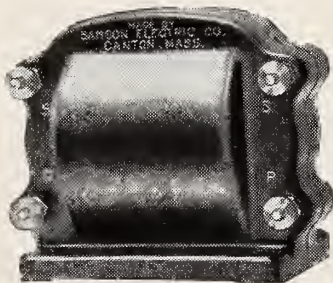

an advanced type of winding in use on their HW-A1 Transformer for audio frequency.

This winding is built up of disc shaped layers of coiled wire, and has no paper between layers.

This construction eliminates distributed capacity and permits a high ratio of turns, producing a signal 40% louder than the best of transformers using coils with paper between layers, and a tone as clear as if a detector alone were used.

Send for bulletin and trade prices

SAMSON ELECTRIC CO.

CANTON, MASS.

Manufacturers since 1882



Pruden Reliable Radio Specialties for Good Results
Dealers write today for our interesting proposition.
FREDERICK H. PRUDEN, Inc.
993 Bergen Ave., Jersey City, N. J.

MANUFACTURERS OF
Receiving Sets Complete
Unites Mounted and Unmounted
Send for Description and Prices
RADIO OUTFITTING CORP.
Mfg. High Grade Radio Apparatus
410-412 East 34th St. New York, N. Y.

DIAMANT
VARIABLE CONDENSERS
AND CRYSTAL DETECTORS
Electrically and Mechanically Guaranteed
Diamant Tool & Mfg. Co., Inc.
93 Runyon Street Newark, N. J.

WE WILL MAIL
ONE
VERNIER CONDENSER
for \$3.50 C.O.D.; Parcel Post Paid
To any address outside of New Eng.
To introduce our line
ELECTRIC PRODUCTS CO.
11 Pemberton Sq. Boston

M-R FLEXIBLE VARNISHED TUBING
THE GENUINE
"SPAGHETTI"
TWO STYLES—BEST GRADES MADE—ALL
SIZES—ALL COLORS
Varnishes, Waxes, Compounds, Papers, etc.
MITCHELL-RAND MFG. CO.
14 VESEY STREET NEW YORK, N. Y.

THE PARAMOUNT
ENGRAVING MACHINE
for Radio Panels
Greatest Production—Lowest in Price
PARAMOUNT MACHINE CO.
207 Market Street Newark, N. J.

Have Outlet For
SURPLUS STOCKS
Radio Supplies
Price and Goods Must Be Right
P. D. Jackson, 1441 So. State, Chicago

ATWATER KENT
MIDWEST DISTRIBUTORS
Immediate Deliveries
KRAMER RADIO CO.
4713 Sheridan Road, Chicago, Ill.
Jobbers Standard Lines

PATENT
your ideas. Protect your rights by U. S. and Foreign
Patents and Trade-Marks. Moderate rates. CALL
WRITE or send us your invention.
Free booklet and inven-
tion recording blank.
FREE
CONSULTATION
Phone: Vanderbilt 7212
FREE MANUFACTURERS
PATENT CO., INC.
800K 520 FIFTH AVE.
NEW YORK

"SAMCO" VARIABLE CONDENSERS

11 Plate .00025 M. F. Capac. List \$2.25
23 " .0005 " " " 2.85
43 " .001 " " " 4.50
63 " .0015 " " " 7.50
Substantial Discounts to Dealers
STANDARD APPLIANCE MFG. CORP.
428 EAST 71st STREET, N. Y. CITY

Do Cut Prices Help Radio Trade?

(Continued from page 20)

goods are in same condition as when bought.

"Save these coupons; \$10 worth of these coupons will be exchanged for one dollar's worth of Radio Supplies within three months of date hereon."

This sales slip accomplishes two purposes. In the first place it is evidence of the responsibility of the store in backing up to the last ditch the merchandise it sells. Further than this it tends to bring the customer back for other supplies, due to the fact that if he purchases ten dollars' worth within three months, he is entitled to one dollar's worth of merchandise without charge.

On the whole radio retailing, while not being the gold mine it was thought to be a year ago, it is now more or less on a sound basis. If the retailer will bear in mind the fact that he must give service in radio as well as sell merchandise, it will take him head and shoulders above his competitors in whatever locality he may be situated. The trouble so far with the radio industry has been the fact that so many knowing nothing about the game or its parts have entered the field blindly and are soon groping about in darkness trying to find the way out. Radio retailing must be handled not only by a man familiar with radio in a technical way in order to enable him to buy instruments which will work efficiently under normal conditions, but must also be in the care of a man capable of merchandising the articles once they are purchased. In fact, our success in supplying dealers throughout the country with efficient radio parts which they can market at prices which meet all competition in large cities, and small towns as well is largely due to the fact that our organization consists wholly of men, not only experienced in the technical side of the radio problem, but in the merchandising end as well. To come back to my first statements regarding price cutting, I would welcome correspondence on this subject from any source, inasmuch as it is one of great interest to me. It has caused considerable discussion in New York City among the retail dealers and I have as yet been unable to be convinced that my theory of putting radio into fifteen million homes at twenty-five dollars each will

Gould
Radio "A" and "B" Batteries
Write for Dealer Plan
Gould Storage Battery Co.
30 East 42d St., New York City

KNOCK-DOWN RADIO RECEIVING SET
Neatly packed in an attractive hinged cover box. Makes a wonderful display. A child can assemble this set. Practical and instructive. Complete instructions for assembly included.
RETAIL PRICE, \$4.50.
Liberal Discounts to Jobbers.
Established 1871.
CHAS. WINKLER, INC., 178 Emmett St., Newark N. J.



"Better Than The Best"
AERIAL-A
The Radio Tube Set That Made Good In a Night
W.E. Supply & Service Corp. 18 Murray St., N.Y., U.S.A.



CONQUEROR
CUSTOM-BUILT ONE KNOB CONTROL RADIO RECEIVING SET
\$115.00
WRITE FOR OUR DISCOUNT ARRANGEMENT
LEWIS & DeROY RADIO CORP.
560 Seventh Ave., New York City

Radak
Reg. U. S. Pat. Off.
RELIABLE RADIO EQUIPMENT
made by America's oldest and largest manufacturers of radio equipment exclusively. Sold by the best electrical and radio dealers.
CLAPP-EASTHAM CO.
133 Main Street Cambridge, Mass.

Have You Our New Price List?
"EDGCO" RADIO PRODUCTS
Save money by our prices; save time by our prompt shipment. Successful dealers sell "EDGCO."
The EDW. J. GOETZ CO.
608 Race St., Cincinnati, O.

CABINETS
Write for quotations
MARVIN B. FALLGATTER
Waupaca, Wisconsin

HAFNER FOR HYDROMETERS
Guaranteed instruments to sell for 75c with a good profit margin for dealers. Ask your jobber or write us direct.
HAFNER MANUFACTURING CO.
3130 Carroll Ave., Chicago, Ill.
"Have a Hafner Handy"

Ask Our Service Bureau
GREGG & COMPANY
ENGINEERS
Radio Department
165 Broadway New York
St. Louis, Mo. Washington, D. C.
Newark, N. J. Los Angeles, Cal.
Mexico City, Mexico

be better in the end than putting it into one million homes at one hundred dollars a piece. I do not doubt that this statement will bring forth emphatic denials from many sturdy and venerable distributors who still insist that the average dealer can exist on a discount of twenty-five per cent. It is my contention that the dealer deserves at least thirty-five per cent, if not forty per cent, or more on which to work. Now let the letters come and address them to me at 419 West Forty-second Street, New York City.

The Service Bureau of The Radio Dealer will be glad to help you find what you want to buy.

Books for Dealer Distribution

A radio handbook that the radio dealer may distribute at nominal cost is being distributed by the Archway Book Store, Seattle, Washington. This book, "How to Make Vacuum Tube Receiving Sets," was written in detail the process of constructing vacuum tube receiving sets; also includes Armstrong super regenerative hookup, with a chapter devoted to the aerial and its installation. The book contains diagrams that are easily followed. The sets constructed by L. D. Brigham, and describes in following the plans in this book are said to be capable of receiving long distance up to 2000 miles.

The publishers have printed a few lines informing the reader where he may buy the necessary parts to build the sets and have reserved space for the dealer's name and address.

Prefers Selling to the Small Retailer

A sales executive for a radio concern asserted recently that he had instructed his salesmen to make a 100 per cent. effort to sell to every small dealer and he declares if he had his way he would sell only to the small dealer.

"Give me the small dealer," he declares. "To begin with, he is not solicited by every radio manufacturer for business and because of this he is not likely to change lines overnight—like the big retailer.

"The small dealer seldom overbuys and is more amenable to reason when requests are firmly made for money and when losses come—they are sworn."

Wonder what's to be said contrarily to the above? Who will answer?

BUYERS of RADIO

MERCHANDISE can see the exhibits of nearly one hundred leading representative manufacturers of Radio Products at the



RADIO FAIR

Don't miss the RADIO SENSATION of the world at the

PERMANENT RADIO FAIR, Inc.
HOTEL IMPERIAL—RED ROOM

Broadway and 32nd St.

New York

COMING!

A NEW "UNITED"
VARIABLE CONDENSER
WITH IMPROVED VERNIER

Get your name on our free mailing list for Bulletin, which will be sent as soon as it leaves the printers.

Everybody about our great \$800,000 plant is "wild" about our new Vernier Variable Condenser. You will be too, when you see it perform. And so will your customers.

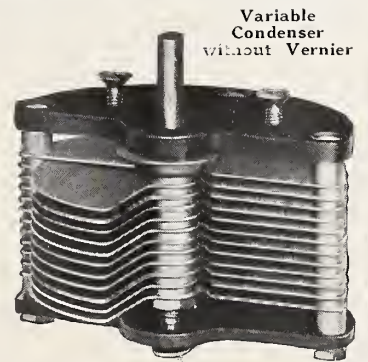

Variable Condenser without Vernier

IT PAYS TO HANDLE

"UNITED"

RADIO INSTRUMENTS

They "make good" everywhere, and all the time. Set owners have learned that

"United" Variable Condensers and Audio Transformers

give uniformly good results, stay on the job, have no cranky moods and offer the biggest dollar's-worth for every dollar of their cost.

"UNITED" CONDENSERS
43 plate. \$4.00 5 plate. \$2.50
23 plate. 3.50 3 plate. 2.25
11 plate. 3.00 without dial
or knob.

"UNITED" TRANSFORMER
Audio - Frequency, amplifies detected signals wonderfully. Magnetically shielded. Ratio 5 to 1. List Price... \$4.50

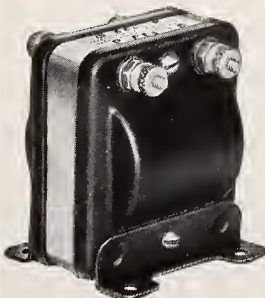

Pat. Appd. For

"UNITED" NATIONAL ADVERTISING

Tells the public to go to your store for United Instruments. Don't disappoint anybody. Send for circular and discounts.

UNITED MFG. & DISTRIBUTING CO.
536 Lake Shore Drive Chicago, Ill.

Confidence and Self Respect Essential to Radio Salesmen

By WALTER FRENCH

If there is one thing above all else that a man needs to be a successful salesman, according to men who by years of selling experience have been qualified to speak with authority, it is confidence. Primarily, the man must

have confidence in himself, but to no less an extent must he have confidence in his house and in the goods he sells. Without it he cannot hope to succeed.

"One of the troubles with the selling lads, in the radio field, today, is

that there are too many side-street and side-line men in the game."

That's the way a prominent radio salesman puts it—to THE RADIO DEALER and for obvious reasons, the name of the salesman is omitted but his thoughts run, about as follows:

Of course, the jobber's salesmen are quite, as a class, a bit of all right and so are some of the so-called exclusive radio salesmen—but a lot of radio is made in factories not exclusively sold by exclusive radio salesmen.

The side-line men are the sort of salesmen who, prior to the advent of radio as an industry, managed to eke out a living, in other lines, selling to small stores on side-streets, rather than to the department stores and to wholesale houses.

These men are drifters and when a new thing comes along you can gamble these lads will be on deck and right now, today—at this very moment—some of these chaps are sitting in the high spots in some of our exclusive radio concerns.

Some will stay but others will fall, for their climb was at the expense of the swift going-up radio industry and not because of any selling genius they controlled.

These side-street chaps are, in many instances, of the same type as side-line salesmen. Radio can benefit, of course, if the side-line salesmen will make an effort to grasp their subject, to know their line.

Did you ever call on a storekeeper or jobber only to be told "we never handled your line and we don't want to handle it"? Did you argue price and quality? Did you offer to wage your line would make more profit for the house than the present line? That last idea opened a nice account for me, not so long ago.

A certain desirable department store declined to carry our line, though salesman and general manager had made all proper effort. Then I came along and threw "the more profit" idea into the head of the radio department head and won out, for *not many department stores are showing any real profit in their radio departments.*

Talking about side-street salesmen I heard and saw one take abuse from a new radio buyer, the other day. This abuse was not deserved and should not have been taken, under any cir-

Lightning Storms Are Just Ahead

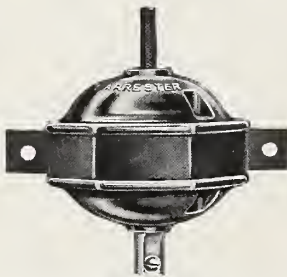

Type A, List Price \$2.00

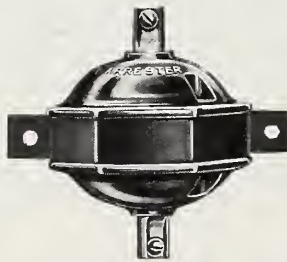

Type B, List Price \$2.00

Underwriters are more insistent that their regulations be fulfilled



Manufacturer of Lightning Arresters for 30 years

Order Your Stock of KEYSTONE RADIO LIGHTNING ARRESTERS

Each day the demand for Keystone Radio Arresters is increasing and you may expect it to reach unprecedented proportions. Thousands will not buy arresters until the lightning storms begin—but they will then want them in a hurry and the fellow who has stock on hand will surely reap a harvest. We do not want you to place orders for more than you can handle, but want you to order now so that we can ship them to you when the rush comes.

Production is already ten days behind orders so don't wait—get your order in to-day.

Keystone Arresters are listed as standard by the Underwriter's Laboratories.

ELECTRIC SERVICE SUPPLIES CO.

17th and Cambria Sts., Phila., Pa.
50 Church Street, New York, N. Y.
Monadnock Bldg., Chicago, Ill.

cumstances. The salesman, representing a big radio concern, took it and after an ineffectual attempt to get an order left.

And, mind you, he HAD something to sell. His house makes something every radio retailer requires!

Being next in line, the buyer started the same tactics with me but he didn't get far. I put it to him, in this manner:

"Mr. Blank, look here, I came here to sell you goods, not to take any language from you you wouldn't dare to use outside your office. Let's get this straight, whether I sell you or don't—the men who come in to sell you are not gutter-loafers and as for myself, I'll wager one hundred dollars I've got more money in the bank than you have and that I live better and I did all these things before you were in the radio business."

Of course, the buyer interposed, with an expression that I "had a lotta nerve."

Well, the short of it is that the buyer admitted he was on the wrong steer, same being due to his newness in the work and as we parted, friendly, I did get an order and so would have the man ahead of me if he had acted like a real salesman.

Have confidence in your line and in yourself. Base your self-confidence on self-respect. When you lose your self-respect you are through, as a salesman. When you lose confidence in your line you are through. Acquire and maintain self-respect that is important.

Condensers of Quality

The condensers made by Stuckeman Bros., Inc., of 18 Ruth Street, Mount Washington, Pittsburgh, Pa., are unique in that while they are of the moulded post type, a brass rod is moulded into the post at the time of pouring. Thus the rod becomes an integral part of the post, eliminating the possibility of breakage and insuring a rigid condenser.

The manufacturers also believe that their spring tension adjusting device will automatically follow up a greater amount of wear than other condensers. Aluminum is used in the condenser plates, and these as well as the whole assembled instrument are tested to determine if the rotor is properly centered and to discover possible warping before they leave the factory.

These Stuckeman condensers now made in four capacities, three of these capacities being made both in the regular and vernier type.

Most Radio Fans Prefer These Reliable **SIMPLEX** Variometers and Couplers



Simplex Variometer Unmounted.
Price\$5.00

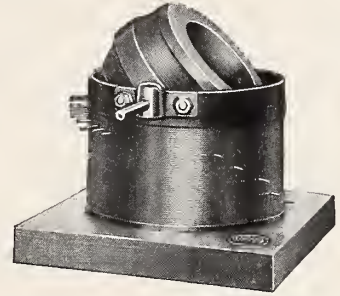

Simplex Vario-Coupler Unmounted.
Price\$5.00

For efficient and accurate tuning they are unsurpassed. They were designed for efficiency and not to meet a price. They are, in every sense, a quality product being sold at a popular price.

We can now make immediate delivery with demand steadily increasing. Place a trial order with us and thus get the opinion of your Radio Fans. Insist upon the original Simplex products.

Simplex Panel Units likewise offer you an excellent proposition. Write for Bulletin No. 187 and dealer discount sheet.

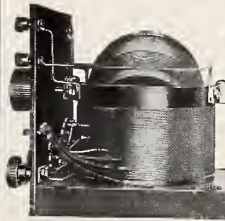

Simplex Vario-Coupler Panel

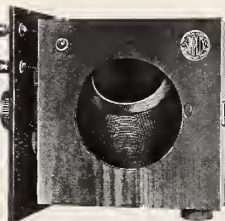

Simplex Variometer Panel

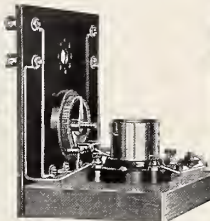

Simplex Detector Panel

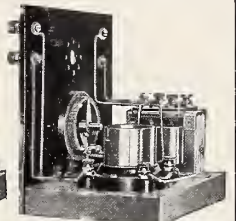

Simplex Amplifier Panel

Write for Catalog and Discounts

Electric Service Supplies Co.

Mfrs. of Lightning Arresters for 31 Years

PHILADELPHIA NEW YORK CHICAGO
17th and Cambria Streets 50 Church Street Monadnock Building

Distributors for Simplex Radio Company



FIXED CONDENSER

"The peak of perfection"

The Parkin FIXED CONDENSER is a substantial and efficient one-piece unit of the regulation type for use in receiving circuits. It is molded right into a solid, unbreakable Bakelite base, which will not discolor or soften with heat. The binding post screws also are soldered to the unit and molded into the base so they cannot become loose. The entire instrument is Parkin quality throughout. A good seller because every one sold brings orders for more. Order No. 53 retail price—

70c

Dealers and Jobbers write for sample

PARKIN MFG. CO.,
San Rafael, California



CRYSTALS **GALENA SILICON**

CRYSTAL DETECTORS List \$2.00

CRYSTAL RECEIVERS List \$9.00

RADIO APPARATUS CO.
6600 Hamilton Ave. Pittsburgh, Pa.

"COPPERWELD"
TRADE MARK REG. U.S. PAT. OFF.

ANTENNA WIRE

50% stronger than either solid or stranded copper

ELIMINATES SAGGING

Adopted by Largest Radio Manufacturers
100, 150, 200 ft. per Carton

LEAD-IN and GROUND WIRE
has the Underwriters' O. K.
Rubber Insulated—Brown Braid
25, 50, 100 ft. per Carton

BUY IT IN CARTONS
with construction directions

COPPER CLAD STEEL COMPANY
New York Chicago
Braddock P. O., Rankin, Pa.

Praco Panel Service

We offer to the amateur and dealer

REAL PANEL SERVICE.

Our panels are cut to your order. Only genuine Condensite and Formica used.

1/8" per square in. 2c
3/16" per square in. 2 1/2c
1/4" per square in. 3c

We also carry a complete line of radio essentials. Dealers will find it profitable to have our latest price list and discount sheet.

PITTSBURGH RADIO AND APPLIANCE CO., Inc.
"Pittsburgh's Radio Shop"
Desk D
112 Diamond St., Pittsburgh, Pa.

Helical Coil Avoids Noise

The greatest difficulty encountered in audio frequency amplification has been the capacitance effects in the transformers used. Distributed capacity in a transformer causes a current to flow in the secondary in such a direction as to oppose the current in the primary coil. The strength of the opposing current increases directly with the frequency. These capacitance effects result in "howling."

The helical coil winding in the Samson HW-A1 transformer, made by the Samson Electric Co., Canton, Mass., is designed to reduce distributed capacity to a minimum, at the same time bringing in sounds forty per cent. clearer and louder. This helical winding, both in the primary and secondary coil, is wound on automatic machines with an exact number of turns to each layer and with these layers perpendicular to the axis of the coil, rather than parallel to it, as is the general practice. There is no paper between the layers the avoidance of insulating paper between the strata of winding also doing much to eliminate capacity effects.

New G. E. Receiving Set

A new type radio receiving set with loud speaker which operates entirely by dry cells and which it is claimed has an equal or better reception range than the average two-stage set using storage batteries for the filament current has been perfected by the General Electric Company, Schenectady.

This set uses three of the new type G. E. tubes which consume but sixty milliamperes filament current per tube or six one hundredths of the current used by the present type UV-201 tube.

The "A" battery, which is the storage battery in ordinary receiving sets, consists of three dry cells such as used for door bells. The "B" battery consists of four, twenty-two and one-half volt units which supply ninety volts to the plate of the tubes. There is also a "C" battery, consisting of a small three-film flashlight dry battery supplying four and one-half volts to the amplifier grid.

INSTALL TESTING MACHINE

NEW YORK.—The New York Testing Laboratories, 80 Washington Street, have installed a new automatic 100,000 lb. Tinius Olsen testing machine, adding to their equipment for handling tensile, compression and transverse tests.

TO TEACH DEAF PUPILS

CINCINNATI, O.—The Cincinnati School Board is now using various forms of radio amplification in the instruction of deaf pupils.

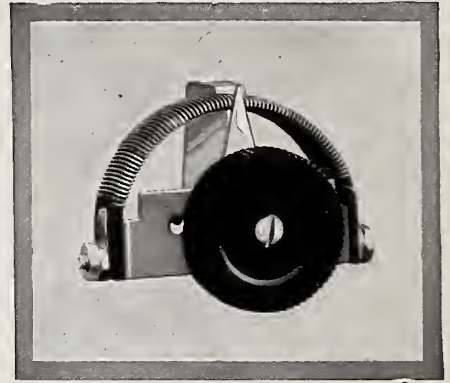

A BETTER RHEOSTAT

A nicer looking, smoother working and better made rheostat than you have ever seen before.

Furnished with or without vernier this instrument will improve the operation of any radio equipment.

The many valuable features coupled with national advertising make this an instrument every dealer and jobber should stock—liberal discounts give ample margin of profit and low list means quick turnover. Order now.

List Prices
123A Plain 80c
Type 123B Vernier \$1.40

THE WILCOX LABORATORIES
LANSING MICHIGAN

Do You Know

We are the recognized authorities on wireless securities. Our Information and Analytical Departments are unexcelled. Let us know what company you are interested in and we will furnish without obligation, detailed information and opinion respecting its merits.

FRANK T. STANTON & CO.

Specialists in Wireless Securities
Since 1915

35 Broad St. New York
Phone: Broad 1670-3641-5819

RADIO CABINETS

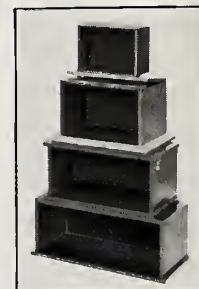

We manufacture a complete line of radio cabinets, of mahogany, walnut, oak, and white wood, in all sizes, and in any finish. Best of construction. Dirt, dust and moisture proof. Quick deliveries—quantity production prices. Send us your specifications, or a sample of your cabinets, and get our prices. We also make indoor loop aerials.

Cabinet Work Since 1900

E. ESHOO CABINET WORKS

635 Herkimer St.
Brooklyn, N. Y.

Telephone
Lafayette 2324

Thorophone S-5

As the millions of radio fans become more and more dependent upon radio for recreation and information, they are becoming insistent upon worth while results in loud speakers. The Thorophone high power type S-5 loud speaker combines a solenoid unit built in conjunction with a controlled mica diaphragm. The sound box is of the phonograph type with mica diaphragm giving a good tone.

The Winkler-Reichmann Company, 4801 South Morgan Street, Chicago, have developed in this loud speaker an instrument that it claims will handle long distance signals with clear articulation.

Standard Condensers

The features of construction of the Standard variable condensers, which are made by the Radio Parts & Manufacturing Company, 127 North Dearborn Street, Chicago, Ill., offer some excellent selling points.

Standard hard aluminum parts are permanently imbedded in solid brass posts, so that the instrument is not of the washer type. The minimum capacity is approximately one-thirtieth of the maximum, making fine tuning possible. The ends are of 3/16 of an inch bakelite, sufficiently large to protect the plates. The adjustment of the plates is stable, not being disturbed by jar or wrenching. The Standard variable condenser is made in three sizes, 41, 21 and 11 plates, with a microfarad capacity of .001, .0005 and .00025, respectively.

Kellogg Transformer

Makers for years of telephones and telephone equipment, the Kellogg Switchboard & Supply Co., Chicago, Ill., are also manufacturers and distributors of radio parts. Among the Kellogg leaders are the Kellogg transformers. They are built on ratios of from 1 to 3, 4, 5 and upward and are designed to overcome any defects of the transformers on the present market.

The primary and secondary bindings posts are easily accessible, being placed on top of the transformer, connections being held by nuts. These binding posts are plainly marked so that there can be no error in assembling. The highest grade of wire is used, and the instrument is enclosed in a black enameled metal case, giving it a neat and workmanlike appearance.

Let our Free Service Bureau help you supply your wants

RADIO DEALERS & JOBBERS

WE ARE MANUFACTURERS OF THE

F. M. C. AUDIO TRANSFORMERS

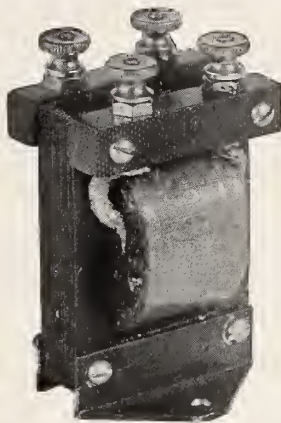

Try them in your W. D. 11 and other Tube Sets and note the increase in Volume

Stock them up and watch them move.

LIST PRICE, \$5.00

For Test Reports and Discounts
Write to Dept. R. S.

FORD MICA CO., Inc.
14 CHRISTOPHER ST.
NEW YORK CITY

DICTOGRAPH

A Good Name

Dictograph Radio Headset

The Best Headset in the World at *any price—and the choice of every expert and radio fan*

Dictograph Loud Speaker

A *real* Loud Speaker at a popular price

Sell your customers goods you KNOW they will be proud of

Order through your jobber or write direct for names of authorized distributors

Dictograph Products Corporation
220 West 42d St. New York City

Branches in All Principal Cities

FRANKLIN SOCKET



**FOR W-D-11
DRY CELL TUBE**

Holds tube firmly
Makes perfect contact
Price \$.50

We also make an adaptor that fits standard sockets, Price, \$1.00.

Dealers write for discounts

FRANKLIN RADIO MFG. CO.
711 Penn Ave. Wilksburg, Pa.

We are headquarters for Phone, Grid and Grid Leak Condensers. Variable Condensers. Rheostats.

WRITE FOR PRICES

Signal Radio & Elect. Corp.

64 University Place, New York City



SHELTONE

Loud Speaker

Without phones

\$5.00

VIKING RADIO CO.

26 D Cortlandt St. New York City

Distributors for

F. A. D. ANDREA CO.
ALDEN NAPIER CO.
CHAS. FRESHMAN CO.

Wholesale Only

Distributors and Jobbers Write for Discounts

PATENTS

To the Man with an Idea

I offer a comprehensive, experienced, efficient service for his prompt, legal protection, and the development of his proposition.

Send sketch or model and description, for advice as to cost, search through prior United States patents, etc. Preliminary advice gladly furnished without charge.

My experience and familiarity with various arts frequently enable me to accurately advise clients as to probable patentability before they go to any expense.

Booklet of valuable information, and form for properly disclosing your idea, free on request. Write today.

RICHARD B. OWEN
Patent Lawyer

82 Owen Building, Washington, D. C.
2276-10 Woolworth Building, New York City

Tuner in Tube

**Filkostat a Device to Make Finer
Tuning Possible**

By MARTIN GREELEY

Efforts are constantly being made to make the vacuum tube, the brain of the modern radio set, even more efficient.

In the Filkostat, a new filament control just perfected by S. R. Hipple, well known as an inventor of apparatus for the control of electric currents, there is at last presented an instrument which is distinctly designed to utilize the great tuning possibilities of the vacuum tube itself. Radio set builders, amateurs and manufacturers have been looking forward to the advent of such a device. They have realized that all rheostats, and other filament regulators, are not capable of adjusting the infinitesimal graduations.

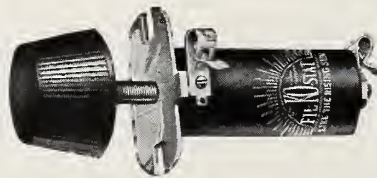

of filament so essential to perfect tuning.

The Filkostat permits more perfect regulation of filament heat. Since the heat emitted varies as the square of the current, fine current regulation becomes extremely necessary to accomplish. This governs the flow of electrons. Proper control of the electronic flow in the tube permits the very finest tuning conceivable. The fine adjustment of the Filkostat starts slightly before the tube begins to function. With other filament controls, what minute adjustment there is, starts when the filament is almost at maximum heat. Between 1,800 degrees—dull red glow—and 2,050 degrees—white heat—the Filkostat control is so fine that increases of temperature are in fractions of a degree, with corresponding variations of electronic flow from the filament to the plate, are obtainable.

The initial inrush of current prevents the crystallization of the filament which so many experts claim occurs when the current is fed too slowly at first as is done in other forms of filament controls. This means considerable increase in tube life. Furthermore the extreme degree of fineness in increase and decrease of electronic flow by infinitesimal variations, makes the Filkostat control even more desirable.

The perfection of design including ample internal contact is the cause of

JOHN A. COZZONE & CO.
[61 Arlington Street, Newark, N. J.
VERNIER CONDENSERS

SUPER CRYSTAL

JAYNIXON
GUARANTEED 50% LONG DISTANCE REFLECTION 50%
THE VACUUM TUBES ONLY KVV41

Reflex and R.F. Crystals

Every User a Booster

JAYNIXON LABORATORY
57 DEY ST. NEW YORK, N. Y.

BREMER-TULLY MFG. CO.

Dealers

Write us for information on
CONDENSITE CELORON PANELS
and other high grade material
532-536 South Canal Street Chicago

Superior Products Manufacturing Corporation
1078-80 Springfield Ave. Irvington, N. J.

Watch for our special announcement
in next issue of RADIO DEALER on
SOCKETS.

FOR RADIO BATTERIES TESTRITE Reg. U. S. Pat. Off. HYDROMETERS

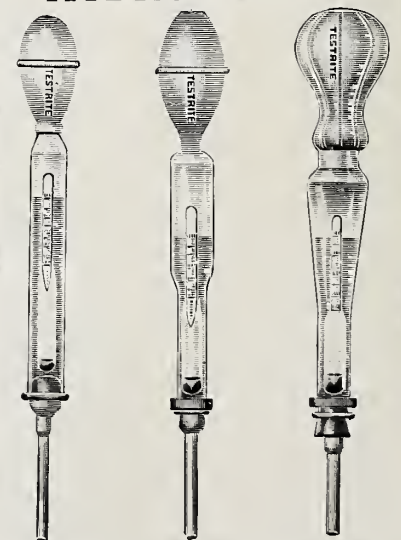

No. 100	LIST	No. 110	PRICES	No. 120
50c		75c		\$1.00

GUARANTEED ACCURATE
JOBBERS write for PRICES
Manufactured by
TESTRITE INSTRUMENT CO.
101 FIFTH AVENUE, NEW YORK CITY

this new instrument being non-microphonic, practically silent, and comparatively free from all noises.

Claims for the Filkostat have been substantiated by tests made on the Bureau of Standard's instruments

The Filkostat has a definite off. It is so designed that the filament extinguishes abruptly indicating that the A battery supply is completely disconnected. At full on the Filkostat resistance is practically zero. The Filkostat consists of a hollow cylinder containing the special resistance material placed between two large adjustable contacts controlled by turning the knob. The resistance element is so finely divided that no further division is possible. There are no disks to break or chip. The resistance remains constant at any position eliminating current variations once set.

The Filkostat is manufactured by the DX Instrument Company of Harrisburg, Pa. The entire international distribution is in the hands of Radio Stores Corporation of 218 West 34th street, New York City. An extensive advertising campaign to reach the dealer and consumer has been planned by the Arthur Rosenberg Co. Advertising Service of New York City.

R. T. A. Cuts Now Ready

During the past month, there has been more than a gratifying demand for the cuts to be used by members of the Radio Trade Association on their stationery, circulars, and the like. These cuts provide a means for members of this organization to display the insignia of their association.



Two sizes of cuts as here illustrated are now obtainable, the smaller one having been added as more suitable for imprinting on envelopes. Either size of the Radio Trade Association insignia may be obtained from the Secretary at the nominal sum of thirty-five cents each.

The design of both cuts is the same, and is neat and simple carrying with it, wherever it may appear, the assurance that its user is an alert, public-spirited and conscientious member of the radio trade. Requisitions for cuts and applications for membership in the Radio Trade Association should be addressed to the Secretary, Radio Trade Association, 1133 Broadway, New York.

Ask Our Service Bureau

"TRI-COIL"

THE TRANSFORMER WITH THE COMPENSATING COIL
RADIO FREQUENCY



Awarded certificate of excellence by N. Y. Tribune

List Price

\$1.50

Attractive Discounts to Dealers

PATENT APPLIED FOR
LATEST DEVELOPMENT IN COUPLING
A TRANSFORMER THAT GUARANTEES RESULTS

This transformer was successfully used in receiving music in a steel car in the steel subway tubes under the East river.

Manufactured By
RADIO APPARATUS DIVISION
BROOKLYN METAL STAMPING CO., Brooklyn, N. Y.
718-728 ATLANTIC AVENUE

BETTS SPECIAL RECEIVER

Specially designed for receiving broadcasts at 300-450 meters—highly efficient and selective within this range.



A really fine receiving set sold at a moderate price. Made by a long established house, and offered only to the better class of trade on terms affording a white man's profit.

Write for terms.

BETTS & BETTS
CORPORATION
630 West 43rd St., New York

- Betts Special Tuner, type RC11 \$24.50
- Betts Visible Detector-amplifier, type D2A without tubes \$38.50
- Betts Loud Speaker Type W-800, \$25.00
- Three together \$88.00

"The Little Wonder"

FOR BOYS AND GIRLS

CRYSTAL SETS

Unassembled - Net **\$1.75**

Catches distinctly everything broadcast within 30 miles. We also manufacture the "Little Wonder" assembled set to retail at \$4.00.

GUARANTEED TESTED CRYSTALS

Galena 7½c Radiosite 8½c
Dealers and Jobbers Write for Free Catalog

It lists all our radio parts and supplies.

Holloway Elec. Supply Co., Inc.
238 Third Ave. New York City



CRYSTAL RECTIFIER

MULTIPOINT (Patent Pending)

A SYNTHETIC CRYSTAL DETECTOR
Sensitive Over Entire Surface

GUARANTEED

Unequaled Clearness; Unequaled Volume; Unequaled Distance. The Standard Crystal Endorsed by Experts, Press and Trade

Manufacturers are increasing efficiency by equipping their Crystal sets with Rusonite Crystals.
List Price 50c.

RUSONITE CATWHISKER

(Patent Pending)

14 Karat Gold-Supersensitive
List Price 25c

Attractive Discounts to the Trade

RUSONITE PRODUCTS CORP.
Dept. D., 15 Park Row, New York, N. Y.

RADION HARD RUBBER PANELS

Cut to Any Size

DISCS, WASHERS, BUSHINGS, ETC.

Made to Order

New York Hard Rubber Turning Co.
212 Centre Street, N. Y. C.

A QUALITY CONDENSER

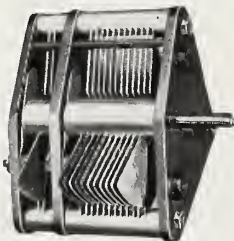

3 plate.....\$1.60
11 " 2.30
23 " 2.75
43 " 3.25

With 3 plate
Vernier
"Built In"

11 plate.....\$3.80
23 " 4.25
43 " 5.00
Dials - Bakelite,
Rubber60

Bakelite end plates, moulded posts with brass reinforcing rod running through each post. Adjustable spring tension. Accurate spacing and alignment.

SPECIAL Fiber end plate,
"Old construction"
3 plate.....\$1.25
23 plate.....\$2.00
43 " 2.50

ADAPTERS

\$1.50 Polished and nickel plated, threaded to screw on your Receiver. Made for any combination of phone and phonograph. Specify desired combination.

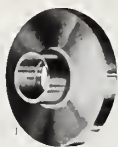

STUCKEMAN BROS., Inc.
18 Ruth St. Pittsburgh, Pa.

Letters Get Trade

Direct Letters Often Pay the Retailer

By Bernard Freedman

Until the average distribution of radio sets in the homes of your district is one hundred per cent, your district has not reached a saturation point. Radio has interests for everybody in your community, be he brainworker or laborer, school teacher or business man, adult or child.

To reach this mine of prospective purchasers you must advertise directly or indirectly. The following method of getting prospects interested (the direct letter) was used by the Virginia Radio Corporation, Charlottesville, Va., for one of its retail stores:

"Dear Sir:

"Every night is a happy one for each member of the family when you have a radio set.

"Did you ever sit in your own home at night and wish you could 'listen in' and hear great speeches and fine concerts going on in Chicago and New York City?

"Nothing would please your family and friends more than to be able to sit around a warm fire on a cold night and listen to the wonders of radio, some times coming from a thousand miles away—right out of the air—as if by magic. On Sunday nights you may hear a great sermon—in fact, the whole church service, including fine pipe organ and singing.

"We specialize in radio equipment only and would be pleased to show you the merits of our radio sets and how easily you can tune them. We make good every word we say for our sets."

ADVERTISING VALUE

More and more do institutions realize that a store's stability depends in a great measure on the character of its printed and spoken word.

In the same proportion that constructive advertising, based on truth and fact, helps its organization, so does careless advertising undermine not only the confidence in which the store is held by its patrons, but it creates something equally dangerous—a careless regard for truth and fair dealing among the personnel of the organization itself.

That is probably one of the most fatal conditions that can enter into store life.—Herman Neaderland, of A. I. Namm, of Brooklyn.

Ask Our Service Bureau

THORNTON AUDIO FREQUENCY AMPLIFYING TRANSFORMERS

Supreme Test Transformer

These transformers are supplied in either mounted or unmounted types. Special attention paid to the manufacturer of receiving sets.

**THORNTON
TRANSFORMER CO., Inc.**
30 Church Street, New York City

NOVO "B" BATTERIES

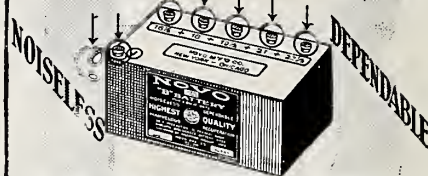

NOTE THE INSULATED BINDING POSTS AND 7/16" WIRE CONNECTOR

NOVO MFG. CO.
424 W. 33rd ST. NEW YORK
531 SO. DEARBORN ST. CHICAGO



GUARANTEED RADIO APPARATUS

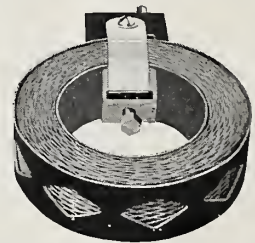

HONEYCOMB COILS at special prices

WRITE FOR PRICES ON
Antenna wire, Insulators, Bakelite Panels, Jacks, Plugs Variable Condensers, Variocouplers, etc.

**NATIONAL DISTRIBUTORS
OF
QUALITY PRODUCTS**

**GENERAL
MERCHANDISE CO.**

6 Academy St., Newark, N. J.

Present Trade Marks

(Continued from page 27)

eminently fair to both the trade-mark proprietor and the consuming public. And yet, one cannot help but wonder whither we are heading in this matter.

It seems quite conceivable that where a face powder or a dentifrice of foreign origin and of more or less definite formula or composition becomes popular in the United States owing largely to the happy nature of such formula or composition and goes by a certain name or trade-mark which does not in this country distinguish any other product, and where a domestic firm acquires the right and the knowledge necessary to sell or manufacture the said powder or dentifrice in this country that it should be permitted to designate its product by the original name or trade-mark so long as such product conformed to the original product. There should be some responsibility to the public, however, that the domestic product should conform to the original foreign product so long as it bore the original foreign name or trade-mark and this responsibility should be of a positive nature with the right to the use of the trade-name conditioned upon faithful performance in the manufacture and sale of the product.

In short, the time seems not far distant when Congress or the Courts or both will have to distinguish between marks that indicate solely origin and those that indicate also or solely a certain article of more or less constant composition, method of manufacture or other constant factors. Marks of the first class should not be permitted to be transferred for use on products of any but the original establishment and even then perhaps the change in ownership should be required to be noted on the goods in connection with the trade-mark for a limited length of time. Marks of the second class should be permitted to be transferred or licensed for use on goods of the same characteristics as the original product only and failure to maintain such characteristics should be punishable as a criminal offense and should involve a forfeiture.

Until a system of this sort is devised, we shall have an increasing number of trade-mark cases that seem quite irreconcilable with prior decisions, a resulting increase in appeals, and dissent among the judiciary.

CRYSTALS Unconditionally GUARANTEED



Standard Brand Special Radiocite

Crystals are unconditionally guaranteed to give satisfaction—we tie no strings to our offer, they must be right.

Packed in Neat Containers
Samples and Prices Upon Request

STANDARD MINERAL COMPANY

216 Market St.

Newark, N. J.

NATIONAL ADVERTISING IN RADIO AND POPULAR MAGAZINES

and their uniformly satisfactory performance, have created a positive and widespread demand for

“ ALL-AMERICAN ” AMPLIFYING TRANSFORMERS

(Radio and Audio Frequency)

Dealers handling this line have every advantage: Quick Sales; liberal discounts; effective cooperation—and the knowledge that they are giving their customers the best Transformers ever built.

Send for circular and Discounts



RAULAND MFG. Co.
35 So. Dearborn St., Chicago, Ill.

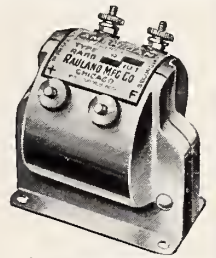

audio frequency Transformer



Radio Frequency Transformer

ASK OUR SERVICE BUREAU

RADIO PANELS

And other insulation for Wireless Work

BAKELITE-DILECTO

Grade XX Black was used by the Government during the war for this purpose. It is the

Standard of the World

THE CONTINENTAL FIBRE COMPANY

NEWARK, DEL.

New York, 233 Broadway
Pittsburgh, 301 Fifth Ave.
Los Angeles, 411 S. Main St.
Seattle, Wash., 1927 First Ave., South

Chicago, 332 S. Michigan Ave.
San Francisco, 75 Fremont St.
Rochester, N. Y., 85 Plymouth Ave., South

WHITE BILL DEFEATED IN U. S. SENATE

The White Bill, aimed to regulate broadcasting, placing radio broadcasting in charge of Secretary Hoover, passed recently by the House of Representatives, has been defeated in the Senate.

Senator Walter E. Edge, of New Jersey, in a statement to the publisher of the RADIO DEALER says the White bill was defeated because Senator Underwood, Democratic Senator from Alabama, raised the objection to rushing through legislation on such an important subject, at a time so close to adjournment.

Another Senator says that objection was made to the bill because it furthered a tendency to create monopolistic air conditions for certain "interests." The Senator asked that his name should not be used.

Many of the folks in the radio trade—in a commercial manner—declare they are pleased at the action of the Senate and declare that when a bill to regulate air matters is again offered, the Senators will be enabled to emasculate such measure in proper fashion—to conserve the interests of radio fan and business man.

New Radio Boom

Better Merchandise and Advertising Have Splendid Results

By FRANK T. STANTON

In a survey of the radio field, I find that the sales and distribution system of apparatus is the most efficiently operated since the great boom of last year. At that time the demand for equipment bordered on hysteria. Purchases were made without regard for the quality of equipment and practically every store of importance in the community handled radio apparatus, whether they were primarily in the drug, hardware, furniture or electrical business. Today, however, conditions have become more stabilized. People are discarding inferior equipment and have turned their attention to the better grade of apparatus manufactured by the well known and established concerns. Much of this is due to the national advertising campaigns by the prominent companies together with the co-operation of newspapers and trade journals. The consensus of opinion seems to be that we are having today a good sized boom in the radio industry, similar to the great activity of last year but in a more quiet way. Manufacturers now know what the public want and have shaped their policies to meet the new specifications. Likewise, qualified agents handle the sales and distributing end of the business—giving the people service plus high quality and low cost, a combination that is difficult to exceed.

Radio securities have done little in the stock market during the past few weeks, but conditions governing them were never more favorable than today. With the public again entering the market, considerable improvement may be expected.

Last year we had a radio boom, when an attempt was made to flood the public with doubtful promotions. Investors were warned to confine their purchases to the seasoned and established concerns in the field, with the result that the mushroom concerns of little merit were compelled to fall by the wayside. Subsequently, we had an industrial boom, then of oils and now we are in the midst of taxi-cab stock offerings. This should soon peter out when the radio stocks will again come into their own. Many of the successful independent radio concerns that are making money and face splendid prospects, should play a prominent part in this activity, which will be on a broader and more legitimate scale than that of last year.



Essex 150-600
meter 130°
Vario - Coupler—
Green Wire.
Price \$1.00 net

ESSEX SPECIAL AUDIO TRANSFORMER DESIGNED FOR USE WITH WD11 AND 201A TUBES.

PRICE, \$2.55 EACH, NET

ESSEX BUS WIRE NO. 14
Square Tinned—Specially
Prepared and Will Give
Entire Satisfaction. \$1.00
Per Hundred Feet.

ESSEX LIGHTNING
ARRESTERS
75c Each. List Price, \$1.50

Send for Dealers' Quantity
Prices



ESSEX MFG. CO.
117 Mulberry Street, Newark, N. J.

De Forest 

HEADQUARTERS
Complete Stock—All Sets,
Parts, Tubes, Accessories.

Write for your copy of the new De
Forest dealer authorization proposition.
It is worth money to you.

Reliability—Service—Co-operation

RADIO STORES CORPORATION
Distributors
224 West 34th St. New York City

PATENTS
ELECTRICAL MECHANICAL
RADIO

SEND SKETCH AND DESCRIPTION
FOR OPINION

EMIL ALEXANDER KERN
328 SOUTH SEVENTH STREET
NEWARK, N. J.



CLOSING OUT
Manufacturer will sell AT COST
several hundred detector stands —
Celon Base, Nickel-Plated Brass Parts.
\$18.00 per hundred
Box M21 RADIO DEALER

THEY'RE GOOD—GET ONE

"EVERY SPOT SENSITIVE"

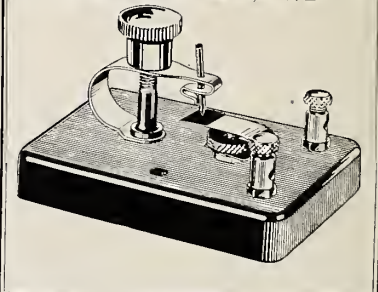

A CHEMICAL DETECTOR

Try the loud, clear velvet
tone Reinhold Radio De-
tector and forget your
catwhisker troubles. List
\$1.50.

Dealers and Jobbers
Write for Proposition

Radio Detector Co.
33 Clinton St.
Newark, N. J.

Announcing **MAZDA** Radio Parts

For the Progressive Retailer and Jobber
at Discounts of 50% and More

SENIOR VERNIER CONDENSER

Straight Line Plates
3 plate, 23 plate, 43 plate

VERNIER TUNING CONDENSERS

Finest Tuning with ease
3 plates only

JACKS

5 styles covering all demands
Soldering with a Match

**SPRING DOUBLE CONTACT
SOCKETS**

Gold plated contacts, metal shell
Moulded or set screw type

**FIXED CONDENSERS
(Variable)**

Varies Down From Capacity .00025-.0005.

JUNIOR VERNIER CONDENSER

Contains 2-built verniers
3 plate, 23 plate, 43 plate

RHEOSTAT

Graphite Filament Control
For Receiving or Transmission

SENIOR PLUG

Phone Tips, Spade Terminal or Wire
No Short Circuit

KNOBS AND DIALS

Handsomely Finished and Polished
Made for 1/4 inch and 3/16 inch shaft

BINDING POSTS

CRYSTAL CUPS

CONTACT POINTS

Mazda Parts are New, Original and Better

DARLING RADIO COMPANY

Phone: Audubon 5670

563 West 145th Street

∴

New York City

SELL THE RADIO SET IN SECTIONS

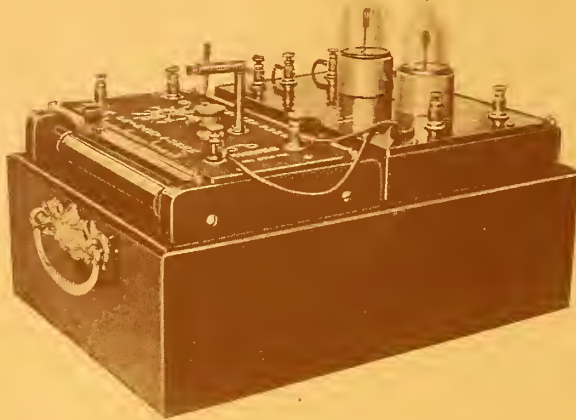

\$24 complete
(Without tubes or batteries)

Dealers can make more profit by selling to the masses
(more people can buy a Radio Set in sections than complete)

The Crystal Receiving Unit with two stages of amplification added has proven to be the clearest and most efficient for receiving broadcast concerts. This foolproof Crystal Receiving Unit (equipped with the Mul-Ti-Tec Crystal) used with a two stage amplifying unit allows the use of a loudspeaker.

Crystal Receiving Unit, Two Stage Amplifying Unit, and Batteries [both "A" (dry cells) and "B"] contained in beautiful mahogany chest.

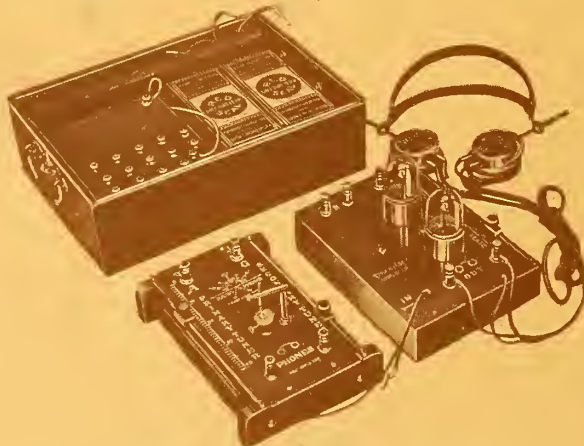

SIMPLE-X CRYSTAL RECEIVING UNIT.—The same efficient crystal receiving set that has enjoyed such wonderful success—Foolproof—equipped with Mul-Ti-Tec crystal and roller sliders to give smooth constant contact.

List Price.....\$6.00

SIMPLE-A TWO STAGE AMPLIFYING UNIT.—A high class unit easily attached to crystal receiving unit and thus allowing the use of a loudspeaker. Equipped with either W.D 11 or U.V. 201 sockets.

List Price.....\$16.00

MAHOGANY CHEST.—Designed especially to hold the Simple-X Crystal Receiving Unit and Simple-A Two-Stage Amplifying Unit together with batteries ("A" dry cells and "B"). Gives nice appearance from all sides.

List Price.....\$3.00

TWO UNITS WITH MAHOGANY CHEST.....\$24.00

*Distributors—There are still some exclusive territories open
Dealers—Write or wire for discounts*

SIMPLE-A RADIO CO.

82 Beaver St.

New York City

The Service Bureau Of the Radio Dealer

Performs a peculiar service for the radio industry in that it brings buyers and sellers together.

If you want anything in radio consult the Service Bureau, and it is a hundred to one shot that you will be brought in contact with the person who wants to sell it.

Service Is Free

Write your wants on a postcard or use the coupon below

.....
Manager, Service Bureau,
THE RADIO DEALER,
1133 Broadway, New York.

Kindly put me in touch with concerns that can supply me with

.....
.....
.....
.....

Signed

No.....

City.....

Date..... State.....

Check Here:
We are:

Manufacturers..... Jobbers.....

Dealers.....

Two Kinds of Stores?

Distinction Between Apparatus and Set Shops Discussed

By JARROLD TOMLINSON

What will the radio store of the future be, is a question that has more than passing interest for the radio dealer of today.

Many persons who have made a special study of the radio business since its earliest beginnings seem to see a gradual division of the business into stores that sell parts and stores that handle complete sets exclusively and compare the latter class to the present development of the phonograph shop.

But it seems to the writer that in trying to decide what present radio retailing is developing into, the average person is inclined to base his beliefs too much on comparisons with other lines of retail business. Radio is absolutely distinct from every other line of distribution. The distinction lies in this fact: A radio set is a progressive instrument. It is always being changed.

The process of acquiring a radio set, it may safely be said, will usually consist, first, in buying a small, cheap set and then gradually in advancing to a better and more expensive one. Behind all this incentive for better reception, there will always be the distance craze, as new continents and new distances come into the general range.

Since the radio equipment in the average household will always be changing, it stands to reason that the radio dealer will have to stock up on both complete sets, some in period cabinet designs, and a full line of apparatus.

Some there are who dispute the fact that there will be sufficient to warrant the establishment of exclusive radio stores. The answer to this is that the present tendency is toward exclusive stores. If there is sufficient business, in the larger cities at least, to warrant the establishment of exclusive shirt stores, glove stores, hosiery stores, etc., it stands to reason, also, that there is sufficient opportunity to create enough business to establish exclusive radio stores. Radio is vastly more important than anybody at present is prone to realize.

Bruno Increases Production

The Bruno Radio Corporation, of 152 West Fourteenth street, New York, have found it necessary to increase their production on the Bru WD-11 vacuum tube socket. This increase has been caused by the incessant demand for this popular socket.

FIBERTONE

Follow up your radio sales with the Fibertone horn. Every customer that walks into your store presents a sales possibility for you.

The universal demand is for fiber horns. Fibertone is more than a fiber horn—it is hand made and scientifically correct for radio amplification.

The unique method of manufacture which requires all hand work, builds a horn unequalled for true and mellow tone, eliminating blast, vibration tinny, and metallic sound.

Fibertone horns are seamless, and will not crack or chip. Handsomely finished in black crystalline. A very easy horn to sell. Quick turnover and a good profit.

Write for Dealer Proposition

Fiber Products Company

Bloomfield and N. 10th St.

NEWARK, N. J.

Every
Radio customer
is a prospect for
the dealer handling
FIBERTONE
horns

MANUFACTURERS
Horns built according
to your own designs

*Now
is the
time
to sell
horns*



\$10

Hit it anywhere!

Magnetite Radio Crystal



The most sensitive Crystal Detector on the WORLD market. Unaffected by handling or moisture and will render efficient service indefinitely—GUARANTEED—Display posters supplied to the Trade. Being advertised nationally—List 50 cents per Crystal.

JOBBERS AND DEALERS WRITE IMMEDIATELY

GIBBONS-DUSTIN RADIO MFG. CO
Owners and National Distributors

518 West 9th St.

Los Angeles, Calif., U. S. A.



A Phone
For Every Set

ROYALFONE
King of All
A Master Radio Phone

Try One and You'll Buy One

**Royal Electrical
Laboratories**
Manufacturers of
Electrical and Radio Equipment
NEWARK, N. J.
Royalfone

Guarantees Distance

The Volta Engineering Company, of Frankford, Pa., are having remarkable success with a long distance set which is guaranteed to reach stations within a radius of 2,500 to 3,000 miles. This novel guarantee is a proof of the faith the company has in their product. The set is a detector and three stage radio frequency amplifier, constructed entirely of parts made by the company itself.

Among the novel features of the set is the Volta Variomo-coupler which is the exclusive product of this company. Wave-lengths from 200 to 750 meters can be tuned in with the utmost accuracy by means of this simple, fool-proof combination of variometer and coupler. There is a special jack for the plugging in of a loop aerial, while all binding posts are nickel-plated and suitable for either pin or spade tips. These posts are an exclusive Volta product and add to the neatness of the set's external appearance.

There is no soldering of the wiring, all wires being scraped and bolted. The dials are of bakelite, with a panel of special Radion hard rubber. The set is enclosed in a solid mahogany cabinet. The wiring is not complicated, and the tubes are well spaced, doing away with inter-tube interference.

Recent tests at Philadelphia have brought in stations in Los Angeles; Reno, Nevada; Seattle, Washington; and Winnipeg, Canada.

Announce New Battery

Announcement is made that on March 1, the Carbon Products Company, of 11 Moore St., New York City, will begin distribution of their new Ace Radio A Battery, designed especially for operating WD-11 and the new UV-201 tubes.

These new dry-cell batteries, the makers add, are made from selected cells, connected in parallel to increase the life of the whole battery. This type of battery does not involve re-charging, a great advantage to those users who are far from a battery-charging station.

The Ace Radio A batteries are made in three sizes, 1½ volts, 2 volts and 4½ volts. They are said to be more convenient than storage batteries, since they are cleaner, containing no injurious acids to spill and no fumes to inhale. They are particularly adapted to radio use, as they are sufficiently light to be carried about with ease and can be placed anywhere, without damaging the finish of table tops, polished floors or other delicate surfaces.



The
SABCO

MODEL B 100
6.00
WEST OF MISS.
7.00

2 HEAT
PAT. PENDING

**ELECTRIC
SOLDERING
IRON**

AT YOUR DEALER - OR DIRECT FROM MAKER

**THE IRON WITH
TWO HEATS
FOR ACCURATE
RADIO WORK**

M'F'D BY
STRAUSS & BLUM, Inc.
256½ West 41 St.
NEW YORK CITY

DISTRIBUTORS WANTED

**Complete Receiving Sets
of Merit**

Write for descriptive circular
Orancla Radio Corp.
228—7th Ave., N. Y. C.

REINARTZ

All Parts necessary
Wholesale Only
DEALERS: Write for discounts

HUDSON-ROSS
123 W. Madison St. Chicago

Ask Our Service
Bureau

**POSTER'S
PERFECT
PANELS**

XX Bakelite—Dilecto Radio Panels
Manufacturers and dealers; immediate delivery—any quantity—cut to size.

Engraving and Drilling
Sharp white lettering, clean accurate work, quantity production at surprisingly low cost. Write today for sample and prices.

POSTER & COMPANY, INC.
552 Seventh Ave., New York
Phone: Penn. 5385

Have you investigated the
DRY CELL SET THAT SELLS
It will pay you to do so

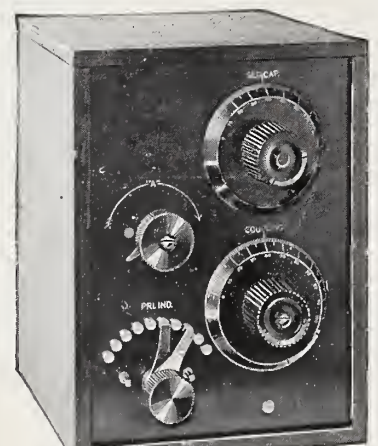

Q. T. DRY CELL SET

\$8.50
NET TO THE DEALER

Can be sold at \$25.00 with phones, tube and batteries at a good profit.

SPECIFICATIONS—
Mahogany-stained oak cabinet, engraved Radion panel, Ajax socket-rheostat, 23 plate variable condenser, 180° Bakelite variocoupler, no external binding posts, busbar wiring, all connections securely soldered.

Write for Full Information
THE Q. T. LIGHT CO.
East Orange Dept. D-2 N. J.

DX Transformers

How to make the reception of short wave lengths through the use of radio frequency amplification more efficient is the problem that the Radio Instrument Company, of Tenth and D Streets, N. W., Washington, D. C.,



set out to solve, and their DX radio frequency amplifying transformer and mounting is the result.

Type DX-1 is designed for reception of a range of 170-450 meters; type DX-S for 400-1,200 meters, and type DX-2 for 900-3,000 meters.

Radioceive Sets

A head set weighing only twelve ounces and designed for the comfort of the radio fan in many other ways is now being offered by the Radioceive Manufacturing Company, Jeliff Avenue, Newark, N. J. The head bands are made in a single piece of nickel-plated phosphor-bronze, which will not rust and is sanitary, being easily cleaned. There is nothing in the whole set to catch in the hair. The Radioceive head set is adjustable by moving the phones up or down in a slot and locks in any position. The ball joint feature makes the phones self-conforming to the ear.

The phones themselves are designed for service. The magnets and pole pieces, rigidly mounted, are made of magnet steel, carefully analyzed to insure permanent magnetism. The cord that goes with each set is six feet long and can be removed from the phones without opening the cases. Each Radioceive head set is packed in

BROADCAST IN CHINA—NEXT!

SHANGHAI.—The first radio broadcasting program ever given in China was staged last week by the American Radio Corporation, through the China Press. The Chinese Y. M. C. A., the principal hotels and ships at sea enjoyed the program, the dispatch states.

DELICATE SOLDERING

Both the manufacturers' and amateurs' problem on all fine work is readily solved by the instrument constructed for this particular purpose.

THE POST SOLDERING IRON

Platinum Heating Unit—Interchangeable Tips—Universal Current
(Large and Small)

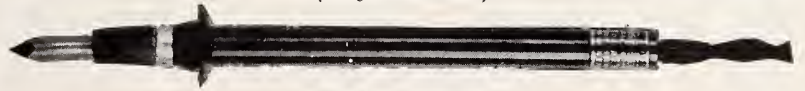

One Half Actual Size
LISTS AT \$6.00

Dealers' and Jobbers' discounts on request

Awarded Certificate of Excellency, N. Y. Evening Mail Radio Institute

POST ELECTRIC COMPANY, (Office 509) 30 E. 42nd St., New York

ELECTRICAL TESTING

Of all materials entering into Radio Construction. Meters and apparatus calibrated and repaired.

CHEMICAL ANALYSES STRENGTH TESTS

Investigation or Development of New Apparatus and Materials. Routine Tests at Special Rates.

NEW YORK TESTING LABORATORIES

80 Washington Street, New York City

Bowling Green 7016

FINAL PERFECTION AND DOWN TO A PRICE "KING" SR., VARIOMETER

Qualifications:
All capacity loss eliminated by elimination of hardware
New attachment method of wires eliminates wires loosening.
Pigtail connection
Fahnestock Clips for Hook Up Connections

Size \$1.60 Each
4 3/4 x 4 3/4 x 3 Price to the Trade

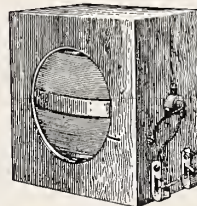

Advantages to Consumer.
A Price Within the Reach of All.
Rough usage and unprofessional handling cannot harm this variometer.
A guarantee slip packed with each variometer makes the manufacturers responsible direct to consumer.
Beautiful Natural Oak Finish.
The biggest sensational value of 1923. Smaller type "King Jr." Costs Less

THE AREMCOE MANUFACTURING COMPANY

Sales Office: 303 Fourth Avenue

Gramercy 1583

New York City

"EURACO" MICA GRID CONDENSERS AND LEAKS

Price 60 cents
(Designed to fit Standard Grid Leak Base)

GRID LEAK VALUES:

0.5—0.75—1.0
1.5—2.0—2.5
Megohms

Price, 60 Cents



COMPACT,
INTER-CHANGEABLE,
HANDY,
MOST EFFICIENT

"Euraco" Condensers are composed of Copper Sheet and Best Grade India Ruby Mica, and are entirely Hand Made.

Manufactured in following capacities:

.000025 Mfd—Correct for Myers Radio-Audion RAC-3
.0001 " —For Special or Experimental Circuits
.00025 " —Correct for Super-Hetrodyne & UV 201
.0005 " —Correct for Radiotron UV 200

Condenser—Leak Mountings

Bakelite Base with Single Mounting \$.40
Bakelite Base with Double Mounting80
Bakelite Base with Triple Mounting80

Interesting Dealers' Proposition

EUROPEAN RADIO COMPANY

1342 East 22nd St., Brooklyn, N. Y.

LITTLE GEM

Simple, Clear, Efficient and
Beautiful

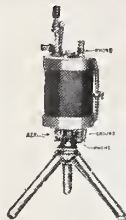

PRICE
\$6.50

Attractive Proposition for
Jobbers and Dealers

UNITED SPECIALTIES CO.
Incorporated
57-59 Spring St., Newark, N. J.

WHEN YOU NEED
INSULATORS—

MORSCAN RADIO CO.
202 Market St., Newark, N.J.



RHEOSTATS
and Other
STANDARD PARTS
FOR TUBE and CRYSTAL SETS
Dealers: Write for Price List
and Proposition.

The Aerovox Wireless Corp.
208 W. 17th St. New York City

Ask our Service Bureau



Assures
Quality

Henry Hyman & Co., Inc.

476 Broadway, New York City 212 W. Austin Ave. Chicago, Ill.

PAPER CONDENSERS

Manufacturers, Jobbers, Dealers

Will sell any standard size condensers in thousand lots only for

\$25.00 per 1,000

Standard sizes: .00025, .0005, .0005 & 1/2 Meg. G. L.

.001
Special sizes: .002, 35.00 per 1000; .005, .006—60.00
per 1000

WALTER E. BATHGATE
67 Elliott Street Passaic, N. J.



SHELSTONE

Loud Speaker

Without phones

\$5.00

Vario-coupler

180 Degrees—Bakelite tubing, green
silk wire.

Write for prices and discounts.

WALD ELECTRIC CO.

101 Varick St. New York City

Book Reviews

By

BERNARD JEROME FARRELL

RADIO FOR ALL. By H. Gernsback.

Published by J. B. Lippincott Company, Philadelphia. 292 pages.

Attractive both in content and make-up, this latest addition to the ranks of radio treatises is expected to be one of the most widely read of its kind. Its author, Mr. Gernsback, is editor of a well-known amateur radio journal, and wherever the name vacuum tube or rheostat is a household word his name is likely to be mentioned.

"Radio for All" is a complete summary of radio in its every manifestation, written as only a man thoroughly acquainted with the beginnings as well as the present state of radio could write it. And it is this knowledge of the present and past that enables the writer also to discuss the future of radio with a great deal of interest. The book is written clearly from beginning to end and Mr. Gernsback makes every difficulty clear through the use of verbal as well as pictorial illustrations. Beginning with a chapter on the historical side of radio, he proceeds to describe radio waves in a chapter on Wave Analogies. Gradually he goes deeper and deeper into the subject, first describing the process of transmitting, so that the reader may later understand reception more clearly.

There are chapters for every part of radio equipment and the final divisions deal with the construction of sets. The last chapter on the future of radio is illuminating, as is the frontispiece, which is an imaginative picture of what radio will perform in the future. There are numerous appendices, including those on radio abbreviations, wireless telegraphy codes, and the radio law of 1912. The book is decidedly worth-while.

Hook-Ups Aid

(Continued from page 17)

to acquire quite a knowledge of the construction of apparatus.

This assembling idea should be encouraged by dealers, as their profits depend greatly upon parts. By supplying information on the new circuits or even on standard hook-ups sales will be increased. In a great many cases, it has been observed that the dealer's salesmen are not willing to spend much time making diagrams and talk-

THE EASTERN 180°-Vario-Coupler

List
\$4.00



"EVERY FEATURE A COUPLER SHOULD HAVE"

Bakelite Tubing
Double Silk Covered Wire
Spring Adjustment
180 deg. Stops
Panel or Table Mounting
Fahnestock Connectors
Soldered Pigtail Leads
1/4" Solid Shaft—True Rotation
Single and Multiple Turn Taps
We manufacture a complete line of
Vario Couplers

Dealers write for discounts

EASTERN RADIO MFG. CO.

22 Warren Street New York, N. Y.

Keep up with
PATENTS

Read The Radio Dealer Weekly
1133 Broadway, New York, N. Y.

GANAERITE Detector Crystals

Twenty years of practical mineralogy gave us the material to produce the highest quality crystal.

We are now undertaking the largest single order for mounted crystals in the market.

We test and *guarantee* to replace or refund on any unsatisfactory Ganaerite crystal.

The Harris Laboratory

26 Cortlandt St., New York City

ing to fans and amateurs who seek information. Many boys or even middle-aged men are disappointed because of what they call "lack of service." In most stores only one or two salesmen are available and since they have to attend to several waiting customers, they cannot stop to give the information these customers desire, before purchasing apparatus. This means a loss of sales in all of these cases as it is well known that if given intelligent information, a man will buy the necessary parts to make an outfit, otherwise, the great majority will not attempt the job unless they know exactly what to do and how to use the parts which they have seen advertised and are willing to buy.

The majority have a very vague idea on how to proceed. After hearing so much said about such and such a tuner or circuit, they want to try it but do not know how to start to make it. If the dealer to whom they go can give them enough data on how to construct the set that they want, this would mean a fair sized sale for that dealer. We have seen on the market plans and books on how to construct outfits. Some of them only show the circuits, others give information but very few are complete in themselves and contain enough information to enable the layman to construct a receiving set. A great majority of radio fans do not know how to read a diagram nor understand the symbols, and are not interested in the plain diagrams as generally drawn by the experienced amateurs who know the game. It is commonly believed that the dealer should attach importance to any of these publications that will help make a sale since it will save their time and will make a few dollars extra profit which is a sure-fire proposition, as in 99 cases out of 100, the buyer will be willing to spend a small sum to buy the information he needs. Some of these publications give the list of parts necessary to construct the sets described in the book. This enables the customer to make a list of the parts that he needs, thereby providing another saving in time for the salesman. Recently there has been placed on the market, a book of plans in which all the sets are shown as actually built with the wires connecting each piece of apparatus represented where it should be and as it is, not in the form of a diagram which most cannot understand, but simply drawn. In addition

WHY METRO HEADPHONES ARE SUPERIOR



MAGNETS

Permanently Sensitive

THE magnets of Metro Phones are made of highest quality tungsten steel, put through a special heat treatment, magnetized and then carefully "aged" to a uniform magnetic strength. These magnets will not weaken or lose their magnetism.

Profitable Merchandise

Metro Products outsell ordinary radio merchandise on sheer merit, demonstrably better value and assurance of durability. Each one has exclusive points of advantage, points that mean big profits and more frequent turnover.

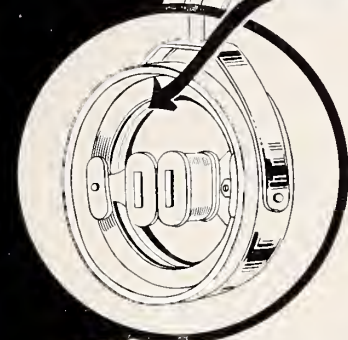

Little Giant Receiving Set
A surprisingly compact set. Cabinet highly polished American walnut finish. Simplest tuning device. Complete with Metro Headphones. LIST, \$14

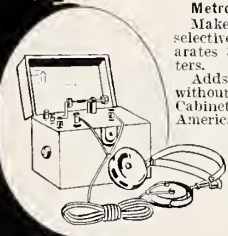

Metro Wave Selector
Makes any set highly selective. Completely separates 300 from 400 meters. Adds only one control without changing set. Cabinet, highly polished American Walnut finish. LIST, \$7.50

Metro Electrical Co., Inc.
Manufacturers of
Metropolitan Radio Products
71 Goble St. Newark, N. J.



List Price, \$8.00

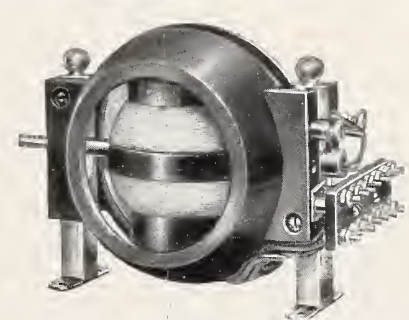

List Price, \$8.00

Our aim is to produce Radio Apparatus that will approach as near to perfection as present day manufacturing methods will allow. This applies not only to appearance, but also to materials and construction.

THE EAGLE VARIOMETER is made of genuine red moulded Bakelite, with special attention given to details and ease of attachment to the Receiving Set. All metal parts are of brass and all connections are securely soldered. Guaranteed range of 150-750 meters. Easily adapted for use with regenerative circuit when used in place of variocoupler.

THE EAGLE VARIOCOUPLER is also constructed of genuine red moulded Bakelite with brass fittings. All 14 taps are taken off and securely soldered to a small panel, thus allowing ready connection to switch points on main panel. An absolute range of 150-750 meters assured.

We believe that Eagle products are superior to any others on the present day market, and are sure that once you sell our products you will realize that quality merchandise is the most profitable.

THE MANUFACTURER'S UNQUALIFIED GUARANTEE BACKS UP EVERY SALE YOU MAKE

Liberal Discounts to Dealers

EAGLE RADIO MANUFACTURING CO.

858 Bedford Ave.



Brooklyn, N. Y.

DRY CELL TUBE SOCKET BIG SELLER

The WD-11 Tube has converted numerous "Crystal" fans to the use of a Detector Tube. The 1½ volt tube requires a special socket. Hence the

BIG DEMAND

for this Genuine Bakelite Socket having springs of phosphor bronze. The special contact arrangement is a feature of the

BRUNO 5 SOCKET

Dealers and Jobbers Write

Carlson Dunn Co., 26 No. Desplaines St., Chicago, Ill.
H. T. Wreaks, 1308 Majestic Bldg., Detroit, Mich.
S. H. Stone, 609 Chamber of Commerce Bldg., Pittsburgh, Pa.
A. L. Handal, 2751 Detroit Ave., Toledo, Ohio

BRUNO RADIO CORPORATION

152 West 14th Street New York, N. Y.



List \$0.75

Your Store Your Best Ad

(Continued from page 15)

complete radio sets and parts exclusively. But many radio stores display only parts in their windows, thus conveying to the general public a false impression of their goods and their policy. Every wise dealer caters to two classes, to those that make their own sets and those that want them complete.

The window that has a miscellaneous assortment of radio parts is certainly calculated to draw the trade of those already interested in radio. It will draw few others. It appears obvious then that such a policy unduly restricts the appeal of the dealer's windows. To devote all one's efforts to attract the custom of those already interested in radio is to neglect the larger field of potential buyers upon which the broad appeal of radio should ultimately rest.

The large mass of people today has heard of radio and is in a receptive mood concerning it. With the excellent broadcasting being done at present, and with the intrinsic interest that radio possesses, this receptive mood should easily be converted into radio sales. Most individuals can be carried over from the passive state concerning radio to active buying through the sight of actual sets and through hearing actual demonstrations.

The window displays of the radio dealer should be the means for bringing the potential customer into the stores. This can be done by simplicity in window arrangement, above all. For the one great thing the dealers, and indeed everyone in the radio industry must combat is the idea that the art of radio reception is a difficult one to master. Simplicity of the arrangement of complete sets in the windows, is worth driving for.

The arrangement of counter-displays deserves the same amount of thought as the window dressing. One of the questions that has to be solved is: In what part of the store are the radio demonstrations to be held?

Here the radio dealer can take a leaf out of the note-book of the five-ten or the department store. These stores almost invariably have their music departments at the back of the floor. The reason is that the music draws the customer toward the music, but in the process of advancing toward the department where music is being purveyed, the customer sees other merchandise. So, in the case of the radio store the customer conducted

THE LABORATORY TECHNICIAN SAYS:

Audibility Plus
Matching Perfect
Volume Plus

T-B-H PHONES SPEAK FOR THEMSELVES NO "FUZZ" OR "TINNY" TONE

Aluminum cases 6 ft. Cord weight 12 oz.
Type 6-A 17500 Turns (2200 ohms) Hard Rubber caps \$7.00
Junior 16000 Turns (2000 ohms) Composition caps 5.00

Substantial Discounts to Jobbers and Dealers.

THE TELEPHONE BOOK HOLDER CORPORATION Dansville, New York, U. S. A.

District Agents:
Central States Engineering Company
Chicago, Illinois



List \$5.00

ASK OUR SERVICE BUREAU

REAL DISCOUNTS TO DEALERS

on the following well-known and standard products

FROST
GENERAL RADIO
MASTER BALDWIN
REMLER
DAYTON

KING
ESTRU
GREWOL
UNITED
RADI-UN LOOPS

ALL TUBES IN STOCK

Our new catalog will be out March 5th. Write for copy

WERNES & PATCH
MASONIC TEMPLE

159 N. STATE ST., CHICAGO, ILL.

to the back of the store, sees on the way very attractive sets in mahogany and walnut. These are the first things that he sees and these make the strongest impression upon him as a consequence.

And in going out, the final impression that the customer carries away with him is of the things that he has seen last, these same well-made and attractive radio sets.

The most satisfactory arrangement of the interior of a store seems to be to display the complete sets and cabinets near the entrance with a gradual change into individual apparatus. This is logical for it is another way of showing the customer the set and then taking it apart and showing of what it consists.

The counters, moreover, should not be overloaded. Counters loaded with apparatus in a planless arrangement only confuse the customer, and thereby defeat their own object; creating the desire to possess and buy.

These are only some of the general principles of counter and window display. No one can attempt with profit to say how radio stores in general should solve these problems, for each store presents its own peculiar difficulties, arising from competition, locality, state of trade, prices and season.

It must be remembered, the dealer must convey through his windows the idea that he is giving quality at a reasonable price. Even the dealer who caters solely to the amateur class, which makes its own sets, gives an erroneous idea of his goods by displaying them indiscriminately in the windows. Varico-couplers piled on condensers, and aerial wire winding in and out of honey-comb coils subconsciously reflect on the store where they are thus displayed.

When apparatus is to be shown, the effort should be made to set off some particular part or emphasize the especially low price of another device.

GRANT RIGHTS IN BRAZIL

RIO DE JANEIRO.—A Brazilian new agency, the Sociedad Anonyma Agencia Americana, has been awarded a forty-five year concession for the erection and operation of Brazilian radio-telegraph and telephone stations.

PHILADELPHIA FIRM MOVES

PHILADELPHIA.—Spiro Brothers, distributors and wholesalers, have recently moved from their offices in the Real Estate Trust Building to larger quarters at 218 North 13th Street. This concern has recently contracted for the entire output of the factory of Sunday and Scholtz, of this city, manufacturers of a high grade line of variometers and variocouplers.



WALCON
R-F TRANSFORMER
175-500
The Radio Centre New York

WALCON

Radio Frequency Transformer

THE BEST YOU CAN BUY

A Transformer that Guarantees Results
Particularly suited for W. D. 11 Tubes.

List Price \$4.00

Manufactured by
THE RADIO CENTER
2 West Broadway New York

Dealers and Jobbers write for our attractive sales proposition backed by National Advertising.

Trade-Marks Secure Trade Registrations Secure Trade-Marks

I Secure Registrations

CHAUNCEY P. CARTER

Radio Trade-Mark Specialist

4907 Potomac Avenue, N. W. Washington, D. C.

Correspondents in all countries

RADIO

DEALERS! Try Our Service

If you want REAL Radio Service, write for The Radio Virginian. It's Free.

We specialize in RADAK Receiving Sets, Western Electric Loud Speakers and Eveready Batteries.



MEMBER
RTA
RADIO TRADE ASSOCIATION

VIRGINIA RADIO CORPORATION

Distributors

Charlottesville Virginia



Permanent Exhibit of Radio Parts at Atlantic City

Col. Mapes, managing director of the Permanent Radio Fair, New York City, announces an affiliation with the National Exhibitors, Inc., who maintain a permanent manufacturers exhibit at Atlantic City, N. J., at 1729 Board walk and also on Garden Pier.

The Atlantic City exposition will be open every day in the year and radio apparatus displayed there will be viewed by thousands of interested fans and would be fans from all over the country every week. The

exhibit in New York is drawing large numbers of buyers now, aided by the toy fair being held at the Hotel Imperial, where the Permanent Radio Fair is located.

Through the new affiliation, contracts for displays of radio apparatus signed for one exhibit will be effective for both places.

The Radio Fair plans considerable in the way of publicity and has some further interesting announcements to make at an early date, according to Colonel Mapes' statement.

3 Contests Go Big

(Continued from page 19)

ing the Busch Hardware Co., 5745 W. Division Street, Chicago, Ill., and H. L. Miller & Co., of Pasadena, Call. More than fifty dealers in other parts of the country won honorable mention for their efforts at window decoration.

The result of this contest, aside from the winning of awards, are far-reaching, for the competition has emphasized the importance of proper arrangement of windows as an advertisement of radio goods.

The prize letter contest for jobbers' salesmen, the second competition to be conducted under the auspices of the Manhattan Company, was also provocative of many entries, and the judges, after great deliberation and much study, awarded first prize to W. J. Teehey, a city salesman in the employ of the Richards & Conover Hardware Company, 433 South Benton Street, Kansas City, Mo. The second prize was granted to Charles A. Byers, salesman for Faeth Company, jobbers, of 1422 Appleton Street, Parsons, Kansas. Harry Goldstein, of the Lowe Motor Supply Co., 756 Garden Street, Hartford, Conn., won the third prize in this contest. The difficulty of selecting winners out of the shoals of praiseworthy efforts that this particular contest sponsored is evidenced by the fact that the judges saw fit to give honorable mention to thirty-three other contestants.

But the most popular contest of the three was for amateurs and indeed for anyone familiar with the qualities of Manhattan Red Seal batteries. Those who entered the competition had to finish the following sentence, giving a second reason for the superiority of these Manhattan batteries: "The Red Seal Dry Battery is best, (1) because it is the all-purpose Battery, and (2) because

"Thirty Years of experience are back of its seal," was the way Louis Peine, of 1506 Rosalie Avenue, Houston, Texas, put it and won the first prize, a beautiful cabinet type receiving set. Ralph E. Turner, of 34 Dwyer Circle, Medford, Mass., who won second prize, gave as the second reason for Red Seal superiority, the fact that "it retains Nature's Energy under Seal." "Red Seal outside means more energy inside," was the way the third prize winner put it. He is W. E. Long, of 408 West Fourth Street, Sterling, Ill.

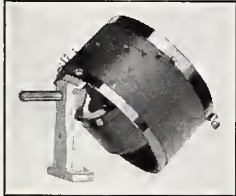

A Wonderful Pair
SHAMROCK
180°
Vario-Coupler
and
Variometer

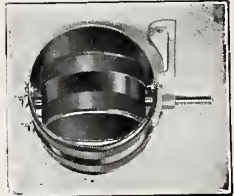

All Tubes Are GENUINE BAKELITE
wound with green silk covered wire

Distributors, Jobbers and Dealers write for
ATTRACTIVE PRICES

SHAMROCK MANUFACTURING CO.

314-322 Market St.

Dept. T.

Newark, N. J.

Westphal's
FLEXIBLE
Spaghetti

WESTPHAL'S SPAGHETTI

Black or Yellow
Grade "A"

(Samples Sent on Request)

10,000 feet lots, per ft.	3 cts.
5,000 feet lots, per ft.	3 1/4 cts.
1,000 feet lots, per ft.	3 1/2 cts.
500 feet lots, per ft.	3 3/4 cts.
Less than 500 feet, per ft.	4 1/4 cts.

Grade "B"

10,000 feet lots, per ft.	1 1/4 cts.
5,000 feet lots, per ft.	1 1/2 cts.
1,000 feet lots, per ft.	1 3/4 cts.
500 feet lots, per ft.	2 cts.
Less than 500 feet, per ft.	4 1/4 cts.



RADIO PHONOGRAPH ADAPTER

The WESTPHAL ADAPTER fits phonographs and headphones of all makes. Constructed in one unit and does not require bushings. Acoustical chamber with single phone produces volume and tone not obtained in

LOUD SPEAKERS.

List \$2.50—A Big Seller—Attractive Discounts

Westphal Manufacturing Laboratory

424 South Michigan Ave.

Chicago, Ill.

Fifty amateurs all over the country were given honorable mention and Manhattan headsets as consolation prizes.

The Manhattan Electrical Supply Co., Inc., were gratified both by the number of entrants in the various contests and by the quality of effort which these contests brought forth. The members of the company are in turn to be congratulated for launching these contests, which have done much to arouse public interest in things radio.

Freshman Moves

The growth in their business has compelled the Charles Freshman Company, Inc., formerly of 97 Beekman Street, to move to newer and larger quarters at 106 Seventh Avenue, New York City. Production of Antenellas, Micon condensers, variable resistance leaks and other radio specialties manufactured by this firm is now on an increased basis. These exclusive radio products are meeting with an insistent demand on the part of radio buyers, which was responsible for the move to larger and more modern quarters.

New Type of Variocoupler

The Pioneer Radiophone Corporation of Galesburg, Ill., are producing a radio variocoupler which is inside-wound, on the same principle as a variometer.

As will be seen by the illustration, the rotor is enclosed by a spherical stator, the shell of which is made of molded bakelite. Internal resistance is reduced to the minimum by the use of a large size of wire and by the close coupling which this type of construction permits.

The relative position of rotor and stator is maintained positively by a unique type of cone-bearing on the shaft, in connection with what is known as the "riding-spring" contact.

The same company also builds a variometer to match this variocoupler. Both instruments are exceedingly attractive—their Circassian walnut-finish bakelite shells contrasting with the bright green of the silk-covered wire of the stator and harmonizing with the nickled brass hardware. Both are perfectly balanced on wavelengths from 150 to 750 meters, and are stated to be producing remarkably fine, clear, long-range results.

**Ask Our
Service Bureau**



Lift the switch and this MAGNA-TONE Two stage Amplifier is in operation with filaments under fixed control. Circuit is automatically rearranged for one stage by lifting the first tube—at the left. Size, 13 x 5 x 5½ inches. Ebony finish.

JOBBER AND DISTRIBUTORS—There's a big demand for this radio essential. Write at once for our special proposition.

List Price **\$24**

MAGNA INSTRUMENT COMPANY

340 West 42nd Street, New York City

MAGNA-TONE Vacuum Tube Receiver—a radio set without fussy adjustments. Only two adjustments necessary. Provided with Fahnestock terminals which insure positive connections throughout. Size, 13 x 5 x 5½ inches. Ebony finish.

DEALERS—Radio fans want simpler apparatus. Here it is. Discounts are generous. Big sales reported. Get in touch with your Jobber.

List Price **\$16**



Catalog on Request

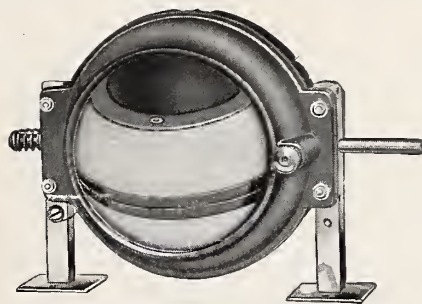

VARIOMETER

List Price \$6.50



The Finest Radio Apparatus

On the Market

The apparatus manufactured by the Radio Products Mfg. Co. is recognized as the very highest grade, designed to meet the most exacting requirements. Each unit is made complete in our own plant from the Redmanol moulding to the winding, assembling and final testing of the completed instrument.

Twenty years in the electrical manufacturing field gives us the wide experience, equipment and specialized organization necessary to produce the highest grade equipment to be had in this line.

Write us for full information.

Radio Products Manufacturing Co.

667 W. Fourteenth St.
CHICAGO, ILL.

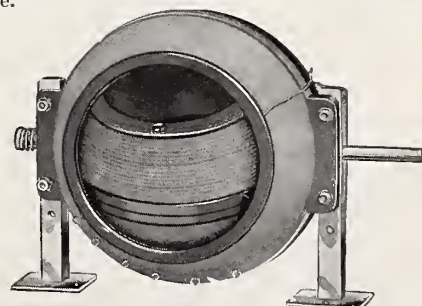

VARIOCOUPLER

List Price \$6.50

FLEWELLING
 All Parts necessary
 Wholesale Only
 Dealers: Write for Discounts.

HUDSON-ROSS
 123 W. Madison St. Chicago

SHELTONE
 SOUND SPEAKER

WITH ORIGINAL
 NATHANIEL BALDWIN
 Type C PHONES

Headset, complete, \$17.00
 Unit 11.00

Special Discounts to Dealers

The SHELTONE Co.
 70 Halsey Street

BERWICK SUPREME HEAD SET
 LIST, \$8.00

The Quality Product
 100% Guarantee or Money Back
 Write for Discounts

TRIANGLE ELECTRO TRADING CO.
 632 Broadway New York, N. Y.

Manufacturers will find our Service Bureau an aid. Ask us where to buy.

Dealers Should Never be
 "Just Out" of the

BRACH
 vacuum
 RADIO PROTECTOR

It Lasts for Years

Acknowledged by the most experienced engineers to be the best of all instruments for reducing static interference. Positively protects apparatus against lightning. In use for over 17 years.

Approved by the National Board of Underwriters.

Add to Your Line

SOLDERALL
 A Metal in Paste Form

Insure perfect reception. All you need is a tube of this paste solder and a match to heat it. Results guaranteed equal to bar solder.

Sold by Leading Jobbers

L. S. BRACH MFG. CO.
 NEWARK NEW JERSEY

Coast Representatives:
 Pacific States Electric Co., San Francisco, Los Angeles,
 Oakland, Seattle, Portland, Spokane.

Philco Radio Batteries

To put into the hands of the radio enthusiast "A" and "B" batteries that are as fresh as on the day they left the factory has been the aim of the Philadelphia Storage Battery Company, Ontario and C Streets, Philadelphia, Pa. It is claimed that the Philco Drynamic line of batteries reach the user in a state as "fresh as the day they were Philco born."

Drynamic is the name given to the system through which this result is obtained. A Philco Drynamic battery may stay indefinitely on the dealer's shelves, but it will not deteriorate because it does not begin to charge until Philco electrolyte is added. As soon as this electrolyte is added, the Philco battery gives a 50 per cent. rated capacity without any initial charging, and a full capacity or over after a few cycles.

This system applies both to Philco "A" and "B" batteries. Other features of these batteries are the Diamond-grid plates used in their construction and the slotted retainers. The Diamond-grid plates are designed for great internal strains, eliminating buckling and warping. The slotted retainers are said to do away with the sloughing off of the plates by the active material in the battery.

Announce Improved Process

Further improvement in the composition of Radion, the hard-rubber material used in the manufacture of radio panels, is announced by the American Hard Rubber Company, 11 Mercer Street, New York City.

This improved product will henceforth be known as Resiston-Radion, Resiston being the trade-mark adopted and registered by the American Hard Rubber Company for sheet or moulding material compounded for electrical insulating purposes, including radio apparatus.

Fishermen to Enjoy Radio

Christiania, Norway.—The entire Norwegian fishing fleet, numbering more than 14,000 vessels, is to be equipped with radio telephones as soon as the big broadcasting stations now planned are erected. Application for license to establish such stations at Christiania, Bergen and Trondhjem has been made by the Norwegian Wireless Society, the Norwegian Marconi Company and the Norse Telegram Bureau. Listening-in sets will be rented to subscribers, but they will remain under the control of the State Department of Telegraphs.



Ray-O-Vac "B" Batteries
 Sell other
 Radio Goods

Sell Ray-O-Vac "B" Batteries to your customers and the satisfaction they get will bring them back to you whenever they need other radio equipment.

Ray-O-Vacs do the work because they are built for radio service. The cells are specially adapted to overcome receiving noises. They are perfectly insulated and cemented into a single solid block with a firm, rubbery, acid-proof insulating compound.

They give a strong steady current, and build up instead of depreciate when not in use.

Spring clip terminals make perfect contact.

Your patrons get real value for their money in Ray-O-Vacs and they appreciate it. Use Ray-O-Vacs to build up sales on your entire line of radio goods. Send for Bulletin 225.



French Battery & Carbon Co.
 Madison, Wisconsin

Chicago Dallas Atlanta New York
 Denver Minneapolis Kansas City

RAY-O-VAC "B" Batteries

Ask Our Service Bureau

COMSCO PRODUCTS

W. D. II-SOCKET
 U. V. SOCKET Single, Double & Triple
 JACKS All sizes

Manufactured by
 Commercial Screw Machine Products Co.
 427-435 E. 102 St. New York, N. Y.
 Telephone: Lenox 0256

YOU SHOULD KNOW ABOUT OUR

AERWIN
 PRODUCTS

THE MILLS RADIO & ELECTRIC CO.
 INCORPORATED
 1008 Springfield Ave. Irvington, N. J.

To Eliminate Aerials

A device that eliminates the need for outside or loop aerials, antenna plugs and that makes the receiving set really portable, has recently been introduced by the Short Cut Radio Corporation, 243 West Fifty-fourth Street, New York City.

This device, known as the Short Cut Antenna, resembles a dry-cell battery in appearance. There are two terminals at one end of the instrument, one of which is connected with the ground terminal of the receiving set, the other with the aerial terminal. A third connection on the other end of the device is attached to the ground.

The makers claim that all that is necessary to add to the working array of a receiving set is this Short Cut Antenna, which measures two inches in diameter by six inches in length.

The Short Cut Antenna is expected to be in great demand in apartment houses, where the construction of an outdoor aerial is inconvenient or not allowed, and elsewhere where aerials may prove unsightly. The device should become especially attractive during the coming vacation months, enabling the automobilist to tune in with ease on broadcasting programs while on long or short jaunts. Vacation pleasures, such as camping, boating and motor boating, should be particularly enhanced by the use of a receiving set without the bother of building up an aerial.

Two Types of Sets

"Not a fad, but a social and business necessity," is the motto that has guided the Michigan Radio Corporation, Grand Rapids, Mich., in the construction of Michigan receiving sets and equipment.

Two of the outstanding types of sets evolved by this company are the "Junior" and "Senior" regenerative radio receivers. The Junior is designed for use with headphones, but a loud speaker can be employed with the Junior through the addition of the Michigan two-stage amplifier. The Michigan Senior includes a tuner, detector, and a two-stage amplifier, the latter being specially designed to bring in full volume without distortion.

A patented Michigan "split hair" vernier dial adjuster is an exclusive feature of Michigan sets. This device permits the turning of the dial by fractional distances, resulting in fine tuning. It is said to solve the interference problem to a great extent.

The Service Bureau of The Radio Dealer will help you supply your wants.

THIS IS THE SWITCH
that does the trick
Turn it 'till you hear it click

FOUR WAY COMPANY, SPRINGFIELD, MASS. U.S.A.

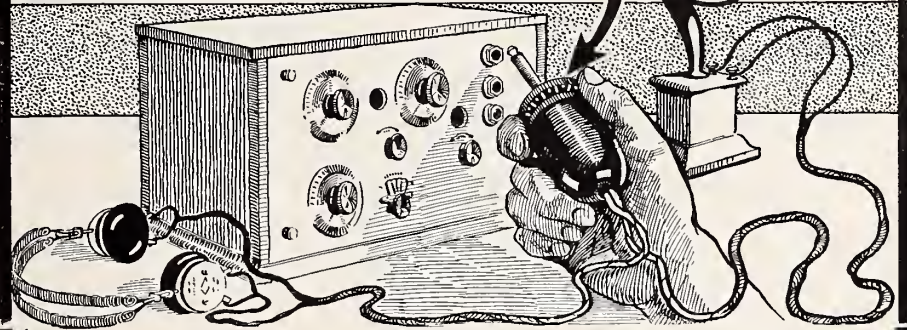

YOU must have a FOUR WAY Radio Switch Plug!
—the latest and greatest improvement in radio.

- Turn 1: Head Set
- Turn 2: Loud Speaker
- Turn 3: Both in Series
- Turn 4: Both in Parallel

A switch plug that makes it possible to tune in through head set and switch in loud speaker by turning dial. Two head sets can be readily attached, or one head set and loud speaker. Both can be used at the same time or either one alone.



FOUR WAY Company
Dept. D, Springfield, Mass.

\$1.50
Ask your dealer



ON AMPLIFIERS MICAPHONE MICA-DIAPHRAGMS

(Made for all Phones)

- Eliminate Distortion
- Prevent Rattling, Fluttering or Whipping
- Do Away With Blasting
- Lessen Tube Squealing
- Cut Out Battery Noises
- Soften Static and Give Pure, Sweet, True, Tone

Satisfaction or Money back

Retail \$2.00 per pair
To recognized dealers 40% discount in lots of 12 pair. Mounted on counter stand.

They cannot rust, cannot become bent, cannot get loose.

The rubber mounting makes them adjustable by simply turning the cap.

Thousands of pairs are now in use everywhere.

RADIO MICA PRODUCTS CO.

156 EAST 43d STREET, NEW YORK, N. Y.

RADIO DEALERS! RADIO DEALERS!

We are in a position to supply dealers with standard merchandise at best discounts

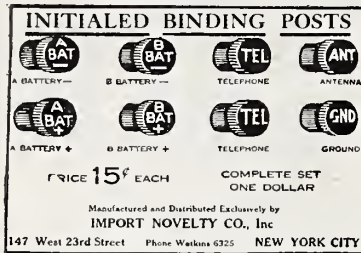

DISTRIBUTORS FOR
Scranton Button Products
Klosner Rheostats

We have for immediate delivery Spaghetti, Fada Type Switch Levers, Binding Posts, Jacks, Plugs, Framingham Rheostats. Rubber and Porcelain Insulators

IMPORT NOVELTY CO., INC.

Mfrs and Distributors
147 West 23rd St., N. Y. C.

FOR THE FLEWELLING CIRCUIT

THE ORIGINAL
GLOBE

VARIO COUPLER

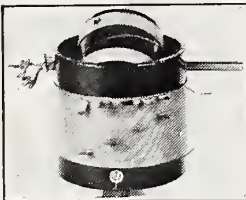

Replaces Honey Comb Coils and Mounting. Gives Wonderful Results Because It Embodies All the Specifications Recommended by E. T. Flewelling:

Rotor — Tubular, Bank Wound, 90 Turns, Loosely Coupled Stator—50 Turns

PRICE, \$3.00 LIST

DEALERS AND JOBBERS: Be the first to handle this wonderful instrument in your territory. Order now

GLOBE RADIO EQUIPMENT CO., 288 E. Burnside Ave., New York

We also make a variable Grid-Leak and Condenser specially adapted to this circuit List 25c.

“WOODEHORN”

LOUD SPEAKER

\$7.50

List Price

STANDS
26" High
10" Bell

Complete with Special Attachment for use in Connection with any Phone.

MOST STARTLING LOUD SPEAKER

AT A

MOST AMAZING PRICE

“WOODEHORN” suggests without much effort the character of the Loud Speaker—“it’s the wood that makes the tone good.”

If you would have the tones of a rare violin then do not hesitate to try a “WOODEHORN” Loud Speaker.

“WOODEHORN” was the hit of the American Radio Exposition, New York. Hear “WOODEHORN” before you stock loud speakers.

Manufacturers, we will build horns according to your specifications

INTER-OCEAN RADIO CORPORATION

Manufacturers

1140 BROADWAY, N. Y. C.

Liberal Discounts To Recognized Distributors and Dealers.

Why Buy from Jobbers?

(Continued from page 17)

the dealer as does the banker; where credits are not based altogether on cold statements of assets and liabilities but rather upon an intimate knowledge of the man. Would any dealer in Springfield, Illinois, negotiate a loan at a bank in New York? Certainly not; nor could he if he wanted to.

The purchase of merchandise is no different than making a bank loan, in fact, it is a loan of merchandise, which is money. Only the jobber who is constantly in actual personal touch can make these daily loans, so to speak, to the dealer, and with which assistance the dealer is able to make many more turnovers during the year than he would otherwise be able to.

The matter of quick delivery of merchandise is just as important to the dealer as other considerations, and shipping distances again enter into the matter to prohibit a direct dealing between the manufacturer and the dealer.

The idea that the dealer could purchase direct from the manufacturer and save the jobber's discount for himself, or in other words, purchase direct at jobber's discount is a fallacy. Were a manufacturer to eliminate jobbers he would practically speaking have to become a jobber himself. Opening thirty to forty offices and warehouses in every strategic distributing center, and hiring a staff of salesmen and managers. Unless the product was one involving vast production and distribution, such an enterprise would increase the cost of distribution—not lower it because the average jobber rarely makes more than 20% gross on his items of which he has many, and can exist only by virtue of the fact that he carries a large and varied line. A manufacturer could not do business on 20%, and pay all the expenses and commission incidental to distribution of just one product or line, and so once more

(Continued on page 70)

ATWATER-KENT

DISTRIBUTORS

Wholesale Only

Dealers: Write for Discount

HUDSON-ROSS
123 W. Madison St. Chicago

For Fine Tuning

Specially adapted to permit the tuning-in of far-off broadcasting stations without interference from local stations, the Bunting Condenser, made by the Bunting Stamp Company, Inc., 713 Liberty Avenue, Pittsburgh, Pa., is designed to appeal to the radio fan annoyed by intruding stations.

The Bunting patented condenser has undergone a series of improvements in the hands of capable engineers and the instrument now ranges from .00009 to .00175 mfd. capacity. It has a fine adjustment and an absence of body capacity, thus permitting easier tuning. For the elimination of local stations, while the operator is trying to listen-in on outside programs, the use of two Bunting condensers is recommended, one being inserted in the aerial circuit, the other across the secondary.

This arrangement brings the desired result, as the following letter from a Pittsburgh fan shows: "I am able to tune up in WGY, of Schenectady, New York, while WCAE, KDKA and WJAS, of Pittsburgh, are operating."



"True-Tone"
SUPERSENSITIVE
3000 Ohms

\$ 5.00
List
3000
Ohms

\$ 5.00
List
3000
Ohms

Cord Connections concealed within phones, eliminating losses from effects of body contacts.

Worth More—Cost Less

Cups and caps lustrous black moulded; caps designed to comfortably fit the ears.

EMBODYING every factor of Scientific design. High sensitivity attained by maximum wire turns.

\$ 5.00
LIST
3000
Ohms

PERFORMANCE and Appearance — backed by a positive guarantee of Quality. Tungsten Magnets; noiseless Tinsel Cords.

Write or Wire for Name of TRUE-TONE Jobber in Your Territory

TRUE-TONE RADIO MFG. CO.

186 No. La Salle Ave. CHICAGO, ILLINOIS

THIS IS STATION

M. E. P. C.

Station of { Atlas Amplitone Loud Speakers & Atlas Head Phones
Multiple Electric Products Company, Inc.

W. H. V. announcing.

We are pleased to inform our friends of our good fortune in securing the services of the nationally known radio engineer and foremost expert on acoustics, Mr. Benjamin F. Miessner, who will head our laboratory forces. Mr. Miessner's extensive experience in radio will insure continued perfection and improvement in our output.

We have considerably increased our output of our *Atlas Amplitone Loud Speakers* and *Atlas Head Phones* to meet the tremendous demand which both our loud speakers and head phones are enjoying.

The *Atlas Amplitone Loud Speaker* does away with the requirement of extra battery, extra tubes and otherwise expensive equipment that is essential in loud speakers with power amplification.

The *ATLAS AMPLITONE LOUD SPEAKER* is a leader of any loud speaker on the market to-day, irrespective of the price, design or principle. Here is a loud speaker that will delight the most exacting with its pure, exquisite tone, originating in the patented construction of a double composition diaphragm.



Musical and vocal sounds are reproduced with a mellow quality, giving broadcasted reproduction, life-like distinctness.

The Principle of the *ATLAS AMPLITONE* is made effective through a sensational new patented invention, supported by high grade materials with expert workmanship employed in its construction.

We offer you this loud speaker complete with well designed horn of pleasing finish, sound base, and horn attachment for \$25.00 F. O. B. our factory, Newark.

The *ATLAS AMPLITONE UNIT* without horn and base but with Graphonola attachment, converts any standard phonograph, except the Brunswick, to the highest grade of loud speaker.

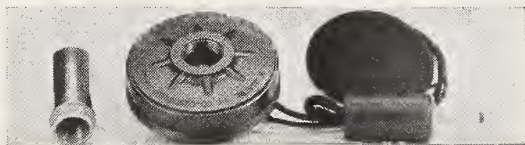

The *ATLAS AMPLITONE UNIT* enables you to economize both in expenditure and in the space occupied by your equipment, assuming that you already have a base and horn or you want to make from your phonograph an efficient loud speaker.

The *ATLAS AMPLITONE UNIT* we offer for \$12.50 each, F. O. B. our factory, Newark, and our Graphonola attachment will cost you \$1.00.

We offer our *ATLAS HEAD PHONES*, highest grade quality phone on the market to-day for \$9.00 each.

Jobbers and Dealers wire or write for proposition

Radio Division MULTIPLE ELECTRIC PRODUCTS CO., Inc.

4 ORANGE ST., NEWARK, N. J.

The Most Talked-About Radio Specialty of the Day

Dealers tell us that, of all the hundreds of items they sell, the clever little

"CHASLYN" Sink-or-Swim BALL BATTERY TESTER

gets the most free advertising. Every buyer becomes a "Chaslyn fan" spreading the good news far and wide, about the new, quick, clean, safe way of testing battery acid by the way these little "Chaslyn" balls sink or swim.

Set including Ball Hydrometer, Depth Gauge, and Rubber Bottle Stopper, retails at \$1.00. Dealers! Send a dollar for two sets, special introductory offer.

THE CHASLYN COMPANY
4315 Kenmore Ave., Dept. 2,
Chicago, Ill.



Superior Audio Transformer

The Superior Audio Transformer is the latest addition to the lines of radio products made by the Superior Products Manufacturing Company, 1080 Springfield Ave., Newark, N. J.

The instrument is designed to work on the straight line of the characteristic on either strong or weak signals. The ratio is 4½ to 1. Primary winding is random wound of high-grade enameled wire and is of a size sufficiently large to insure against burn-outs. The primary has a reactance of 30,000 ohms; the secondary is random wound and untuned. It gives a flat top amplifying characteristic from 150 to 2,000 cycles.

The core and bobbin is impregnated in a special insulating compound to insure uniform operation under all conditions. The complete transformer is then imbedded in a solid block



The Superior Transformer

of insulating compound, proof against moisture. The top and bottom panels are of machined black or mahogany radion, shell or triple nickel-plated brass tubing, hard rubber binding posts with nickel-plated washers.

This transformer is unique in that when a certain amount of energy is dissipated in the secondary, new energy is at once supplied from the source to compensate for this loss.

Another condition of particular importance in the reception of very loud signals is to operate the iron in the core on a portion of its characteristic which is perfectly straight. In other words, sufficient iron should be put in the core so that it never reaches saturation thereby causing enormous losses and distortion. In a like manner too much iron will cause the same type of distortion because only for certain loud tones will it reach its proper magnetizing point. These and other conditions are successfully met by Superior products.



TYPE 209 DETECTOR LIST \$18.00
TYPE 309 AMPLIFIER LIST \$25.00
RADIO RECEIVING SETS FOR 1½ OR 6 VOLT TUBES
IMMEDIATE DELIVERY
Distributors, Jobber and Dealers Write for ATTRACTIVE DISCOUNTS
W. B. L. RADIO CO.
22 Norfolk St. Newark, N. J.

COMPOSITION

LIST PRICE

DIALS 50¢ DIALS

Adjustable Switchlevers
Knobs

NEW YORK RADIO-DIAL CO.
316 Holden Bldg. Detroit, Mich.

Maclite Vario-Coupler

Price \$5.00

Is, in the opinion of experts, the most efficient on the market.

All Other Maclite Parts are equally efficient, including the Maclite Variometer, Double Slide Tuner, Variable Condensers and Crystal Detectors. The Maclite Single Tube set at \$25.00 is the best buy we have ever seen. Let us tell you more about this set, also all other Maclite parts.

Dealers and Jobbers Write for Discounts

MACLITE RADIO CO.

701 Maclite Bldg., Claredon St.
Boston, Mass.

LOUD SPEAKER FOR ANY CRYSTAL SET



The Steinmetz Amplifying unit selling for \$8.50 will enable you to hear any crystal set all over the room. No storage battery required. All Steinmetz equipment is thoroughly guaranteed.

STEINMETZ 3000
Ohm Phones....\$6.50
STEINMETZ 2000
Ohm Phones.... 5.00
STEINMETZ 1000
Ohm Phones.... 1.75
Equal to any \$10.00 or \$12.00 Phones Made

"Superior" Crystal Set, \$4.75

Complete catalogue 5c at your dealer or

STEINMETZ WIRELESS MFG. CO.
5706 Penn Ave. Pittsburgh, Pa.

We Have Been Appointed

SOLE DISTRIBUTOR
for the genuine

Nathaniel Baldwin
Phones

For The Entire State of
New Jersey

We solicit enquiries from Radio Dealers and Jobbers to whom we are offering Liberal Discounts.

RADIO SHOP OF NEWARK
76 Springfield Ave. Newark, N. J.

RADIO MAILING LISTS

12,400 Radio Dealers, covering U. S. by States, per M..... \$7.50
1,614 Radio Manufacturers, covering U. S. by States, per list..... 15.00
1,757 Radio Supply Jobbers, covering U. S. by States, per list... 15.00
260 Radio Stations, per list..... 4.00
257 Manufacturers who make and assemble complete Radio Sets, per list..... 4.00
25,000 Radio Amateurs and Managers of Radio Stations, per M.... 7.50

Ask for price list covering Canada and England. Send remittance with order.

TRADE CIRCULAR ADDRESSING CO.
166 W. Adams Street Chicago

Federal Standard

Head Sets

are Nationally Advertised and endorsed by experts.

Write for particulars regarding the full line of Federal Standard radio equipment.

Federal Telephone & Telegraph Company
Buffalo New York



MOON RADIO CORP.

Manufacturers of
ULTRA-FINE RECEIVING SETS

12 Diagonal St.
Long Island City
552 Seventh Ave.
New York

Ask Our Service Bureau

Send for FREE story

Interesting, illustrated folder "How to get Greater Desk Efficiency" shows how to keep your desk cleared for action. Thousands of Kleradesks are giving entire satisfaction. Saves time locating, distributing or sorting papers. Takes less space than a tray. Sent FREE trial.

Kleradesk



free Mailing Lists
Will help you increase sales
Send for FREE catalog showing details covering names of your best prospective customers. Counts and prices are given on thousands of different Mailing Lists.
99% Guaranteed 5¢ each
by refund of 5¢ each
Ross-Gould Co
538 N. 10th Street
St. Louis

Schools Help Sales

Live Dealer Ties Up with School Aids

By WILLIAM COLEMAN

The semi-annual radio exhibition of the pupils of a New York public school suggests a means of bringing radio before the public eye in other cities.

This successful event, the sixth of its kind to be held by the pupils of Public School No. 165, has been the means of displaying the work of the pupils during the past term in designing and constructing radio receiving sets. Among the types of sets displayed were pocket size crystal models, large cabinet size crystal sets, and vacuum tube regenerative receivers with amplifiers.

The mothers and fathers and relatives of these bright youngsters attended. Amazement was expressed at the quality of the reception of these instruments. Newspapers gave publicity to the exhibition.

In a smaller town than New York the papers would have given even more free advertising for radio as a result of such an exhibition.

Why not take advantage of such an opportunity as this? Get the manual training department of the schools in your city to give instruction in radio building. And if you are public-spirited enough, present prizes for the best sets made in different classes. The school board should be glad to cooperate and the newspapers will give you a lot of free publicity, because a school boy exhibition has always "news value."

If you want to add some punch, have a special prize for radio sets made by girls!

Midget Condenser

The Chelten Electric Company, of Philadelphia, have put on the market a new midget variable condenser of a radically novel type, and have been forced to tax their production capacity to meet the mammoth influx of orders on this specialty. The Chelten line includes a complete assortment of parts for use in radio sets.

Ask Our Service Bureau

ESTABLISHED 1888

TRADE-MARK

SENSORY CABINET UNITS

HEINEMANN ELECTRIC COMPANY
Manufacturers
 Radio Division Philadelphia, Pa.

RADIO DEALERS:

Are You In Position to Get the Benefit
of the National Advertising Campaign Now Running on

M. P. M.

Million Point Mineral

THE WORLD'S GREATEST RADIO CRYSTAL

Makes a Crystal Set 100% efficient.
Will not burn out or corrode.
Sensitive at practically every point.
Increases radius and audibility.
Concerts heard over 600 miles.

The introduction of M. P. M. is revolutionizing the business in crystal sets. Don't take our word. Send for sample and test it.

M. P. M. SALES COMPANY

Dept. RD

247 So. Central Ave., Los Angeles

Why Buy from Jobbers?

(Continued from page 66)

does the jobber appear to be low price insurance rather than the opposite.

American industrial and commercial institutions are British in origin; early American trade and industry were simply British trade and industry transplanted. What American business is today, is that transplanted British industry, modified, developed, elaborated by the enterprise, the daring and business intelligence of American business men. The origin of the American jobber was therefore in England. In England the jobbers developed during the years of 1660 and 1760. This was a golden age in British business prior to the marvelous development which resulted from the Industrial Revolution. There was a tremendous increase in production and trade, domestic and foreign; new ways to market were opened up and commercial areas broadened.

The so-called jobber or middleman is the merchant who stands between the producer and dealer. Considered for long as unproductive the middle man won for himself the recognition of doing a task worth while. As a matter of fact, he has performed a great social service. It is through his enterprise, his initiative, his daring and courage that English wares entered foreign markets and multiplied in the home markets. As itinerant peddler, as merchant prince, as specialized salesman, in established markets, the jobber reached the position of importance where the producer was already dependent upon it. In questions of finance, in taking risks, in finding new markets, it was the jobber who led the way. It was the duty of these intermediaries to bring buyer and seller together, to assist in fixing prices, to test the goods for possible defect, to select for the purchase the quality and quantity he had bought, and to see to its proper delivery. Supplies equalized in times and places and made less dependent upon accidents of weather, economic life acquired a speculative quality, the modern categories of business rose. Business was born. The modern commercial organization has by no means shaken off the power of the jobber (or middleman). They have continued largely because they performed a necessary service, and partly because of the inertia of business.

There can be no question, however,

Court Decision May Influence Radio Patent Suits Now On

(Facts explained by an attorney)

A decision of the Supreme Court of the United States, which was handed down recently, is worthy of note by all interested in the present situation in radio litigation.

The Radio Corporation of America has begun a large number of suits during the past year, of which seventeen or eighteen suits are now pending in various United States District Courts. As is well known, the Radio Corporation does not own the patents on which it sues, but claims its right to sue through a certain assignment of a so-called "right to exclude" the individuals sued. This form of assignment was recently brought in question in the case of Radio Corporation against Hohenstein, Liberty Appliance Corporation, et al., and in that case the District Court upheld it, for the reason that the Circuit Court

that the jobber would long since have practically disappeared if they were not really functioning economically.

A profound law governs the process of civilization. The law is that the civilized man tends to minimize the variable elements or the risks of his business, and is dependent more and more largely upon the use of clearly defined and intelligible means, the result of his own observation and of the widening experience of the race. Jobbers, like economic institutions, rise to meet a need. In general their services are most needed in a widely dispersed industry, with little local specialization in which the means of communication and transportation are poor and there is seasonal activity.

For in such conditions there are small lots at both ends of the process; commodities are collected by the jobber from many small sources and are distributed to many small dealers. Risk is his at all times, the financial burden of every filled storehouse to meet quickly ever changing local demands and conditions. He sells and buys upon his superior knowledge of demand and supply.

In general he must have a superior knowledge of the commodity of the supply and demand. He must have capital, he must have a storehouse. He is the buffer between production and consumption; he levels out the seasonal supply geographically and chronologically. The justification of the jobber is that by his activities, economies are realized and savings are made equal, at least to the returns which he receives.

of Appeals in Chicago has sustained the identical assignment in the Nye Tool Company case. From the decision in the Hohenstein case, an appeal was taken to the Circuit Court of Appeals in New York and this appeal is based chiefly upon the contention that the form of assignment in question is ineffective to give the Radio Corporation the right to sue on the De Forest patents, which were there in suit.

In the Hohenstein case, the Radio Corporation sued on two patents of Lee De Forest, numbers 841,387 and 879,532, both of which, it is set forth in the complaint, are owned by the American Telephone and Telegraph Company. The complaint further states that the American Telephone and Telegraph Company, without assigning the legal title to the patents themselves, conveyed to the Radio Corporation the right to exclude and to enjoin the defendant Hohenstein, individually, from practicing the inventions covered by said patents.

Charles J. Holland, of New York City, attorney for the defendants in the Hohenstein case, filed a brief in the Circuit Court of Appeals, the main contention of which is that the right to exclude individuals from the practice of the inventions in question and the right to enjoin them from such practice was an incident of the ownership of the patents themselves and inseparable therefrom. In other words, the patents themselves were the principal property and the right to injunction against infringers thereof was incidental to the ownership of the patent.

The form of assignment interpreted by the Supreme Court in the Nye Tool Company case, decided last week, was identical with that in the case of Radio Corporation against Hohenstein. This was admitted by the attorneys for the Radio Corporation when they recently appeared in the Circuit Court of Appeals in New York and secured an adjournment of the argument of the appeal in the Hohenstein case on the ground that the Nye Tool Company case was pending before the United States Supreme Court and that the same assignment was involved in both cases. In the light of this admission and of the contention raised by Hohenstein, the language used by Chief Justice Taft in deciding that the assignment of the Nye Tool Company case was ineffective and in dismissing the complaint in that case is very significant.

Judge Taft says: "The error in the position of the respondent and the court below is in a failure to distinguish between the property or title or interest in a patent capable of assignment and the chief incident of that property, title or interest, an incident which can only pass by assignment when attached to the right to make, use and vend. The Government is not granting common law right to make, use and vend, but it is granting the incident of exclusive ownership of that common law right, which cannot be enjoyed save with the common law right."

Following this reasoning Judge Taft decides as follows: "As the owner of the patent is not a party to this bill, the result is that on no ground can the bill of the plaintiff be sustained and that the motion to dismiss should have been granted."

Not a Makeshift - But a Finished Product



List \$7.50

ONE PIECE MOLDED CONDENSITE
CASE — CONDENSITE DIAL —
NICKELED BINDING POSTS

which you will be proud to show to your most discriminating customer and which he will carry from your store with the feeling of having received his money's worth—

ACCURATUNE WAVE-TRAP

A quality instrument, worthy of the name it bears, and one which will do anything any good wave-trap can do.

Don't let the public clamor tempt you into handling anything but a quality wave-trap. Order from your regular jobber. If he can't supply you, write or wire direct. The discounts are liberal.



845 Broad Street

Newark, N. J.

Every Dealer

Every Manufacturer

Every Jobber

in

THE RADIO TRADE

Should be a member of

The Radio Trade Association

Full details may be obtained at headquarters

The Radio Trade Association

1133 Broadway, New York City

Officers and Directors are:

Henry M. Shaw, Shaw Insulator Company, Newark, N. J., president.

Hugh H. Eby, H. H. Eby Company, Philadelphia, Penna., treasurer.

Laurence A. Nixon, The Radio Dealer, New York City, secretary.

W. B. Curtis, Curtis Sales Company, Newark, N. J., first vice-president.

Laurence I. Mott, San Francisco, Calif., second vice-president.

R. P. Clarkson, Radio Mica Products Company, New York City, third vice-president.

Raymond Francis Yates, Permanent Radio Fair, New York City, fourth vice-president.

Chauncey P. Carter, trade mark attorney, Washington, D. C., fifth vice-president.

W. L. Sayre, Sayre Level Company, Philadelphia, Pa., sixth vice-president.

The Board of Directors is composed of the following:

Paul F. Johnson, Altadena Radio Laboratory, Pasadena, Calif.

Arthur Halloran, publisher, Radio, San Francisco, Calif.

J. H. Smith, Virginia Radio Company, Charlottesville, Va.

Wm. A. Debold, Oklahoma City Radio Company, Oklahoma City, Okla.

Bert B. Barsook, jobber, Chicago, Ill.

Powell Crosley, Jr., Crosley Manufacturing Company, Cincinnati, Ohio.

F. Clifford Estes, The Clapp-Eastham Co., Cambridge, Mass.

F. D. Pitts, F. D. Pitts Company, Boston, Mass.

Harold M. Schwab, Harold M. Schwab, Inc., New York City.

M. B. Sleeper, Jr., Sleeper Radio Corp., New York City.

W. M. Kunkel, Pittsburgh Radio & Appliance Company, Pittsburgh, Pa.

C. H. Love, L. F. Grammes & Sons, Allentown, Pa.

F. H. Pruden, F. H. Pruden Co., Jersey City, N. J.

Mortimer Salzman, Wholesale Radio Equipment Co., Newark, N. J.

When they ask for "FIL-KO-STAT"

Be Ready!!!

It is distinctly designed to be a REAL filament control—not just a Rheostat.

Nation Wide Advertising will
Bring the Demand
Positive Proof that

Pat.
Applied for

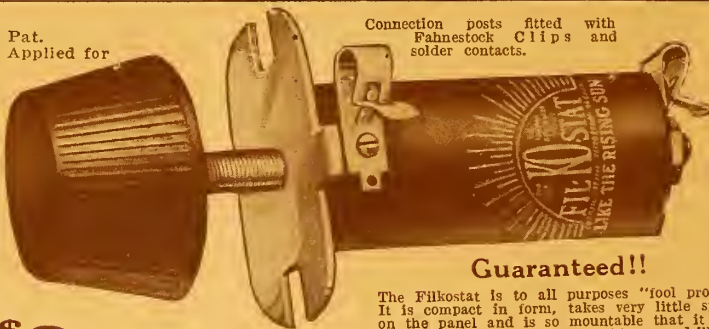

Connection posts fitted with Fahnestock Clips and solder contacts.

Guaranteed!!

The Filkostat is to all purposes "fool proof." It is compact in form, takes very little space on the panel and is so mountable that it can replace any other control without redrilling. The Filkostat is guaranteed by the makers to be unbreakable. If broken—within 1 year—it will be replaced.

\$2 RETAIL
LIBERAL DISCOUNTS

FIL-KO-STAT is the Best Filament Control—will Make Big Sales

Tests made on Bureau of Standards Instruments comparing the fine adjustment control of the FIL-KO-STAT with rheostats and other filament controls prove FIL-KO-STAT superiority beyond doubt. Our National Advertising features this test and we furnish dealers with copies of the graph proving that the FIL-KO-STAT permits infinite adjustments of filament Heat—infinitesimal control of electronic flow—fine tuning needed for DX—is ideal for WD11's—fine adjustment starts where tube begins to function. Other features include DEFINITE OFF—indicating "A" battery is disconnected—at FULL ON Resistance is practically zero—resistance element so finely divided further division impossible—no disks to break or chip—operation absolutely silent.

MANUFACTURED AND GUARANTEED BY
DX MANUFACTURING CO.
HARRISBURG, PA.

Backed by a tremendous Publicity Campaign and Intelligently Merchandised to give the Jobber and Dealer the greatest co-operation.

Don't Delay! When they Say "Fil-Ko-Stat" have them on display! Write at once for your proposition.

Sole International Distributors

RADIO STORES CORPORATION

Dept. Rd. 218-222 W. 34th St., New York

Full Page Consumer
Ads Appear in

RADIO NEWS
RADIO
WIRELESS AGE
RADIO WORLD
RADIO DIGEST
POPULAR RADIO
RADIO BROADCAST
Q. S. T. and other Publications



Write for a copy today.

This little book

Shows why the KING QUALITY line is in demand!

ALL THE NAME IMPLIES



KING QUALITY Rheostat. R-630
Resistance valve 6.5 ohms. Special Brass Panel Bushing insures smooth operation. Genuine Bakelite Base and Knob.



KING QUALITY "Universal" Adapter. R-10
designed to fit all tubes and valves.



KING QUALITY VACUUM TUBE SOCKET

Base of black or mahogany finished genuine moulded Bakelite with mirror finish; tube and terminal binding posts of brass, nickel plated and highly polished.



QUALITY sells King Quality Radio Apparatus on sight; service keeps it selling. That's why the King Quality line is a desirable one to handle; why leading jobbers and dealers throughout the country are finding it the most profitable quality line on the market.

It keeps moving in stock—it satisfies users and produces profits and turn-over for the dealer.

Our catalog will show you why there is no finer line of radio goods made anywhere in the world. Write for your copy.

RADIO APPARATUS DIVISION
King Sewing Machine Co., Buffalo, N. Y.

Lower in Price—
Highest in Quality

KING QUALITY
ALL THE NAME IMPLIES
RADIO APPARATUS

We maintain our own
Bakelite Plant

PROGRESS

NNATURALLY, at this early stage, the Art of Radio Communication is not standing still. It is undergoing a normal evolution.

The low-hung, straight line automobile of today is unlike its cart-like predecessor of twenty years ago, although the principle of locomotion remains the same.

So, too, the design of Radio apparatus advances. Insulated panels and live shafts are supplanted by metal panels and completely insulated instruments—the obvious thing to do, making unnecessary the use of a shield. Unsightly, protruding knobs are replaced by recessed dials and straight tuning bars, permitting fine adjusting without cramping the hand. The tap switch is removed entirely from the panel and becomes an integral part of the vario-coupler, being placed *inside* the rotor, thus eliminating all soldering of primary leads.

It is significant that all these improvements have been developed in the Eisemann laboratories.

Descriptive literature will be sent to dealers upon request

EISEMANN MAGNETO CORPORATION

William N. Shaw, *President*

BROOKLYN, N. Y.

DETROIT

CHICAGO



Let Our Free Service Bureau Help You Supply Your Needs

Tell us your needs and we'll put you in touch with reputable firms to the end that you will receive information on the latest and best equipment. A post card will do or use the coupon below.

- | | | | | |
|---------------------------------|---------------------------------------|---------------------------------|----------------------------------|---------------------------------|
| A | 62 Condensers, mica | I | 182 Patent wire | 238 Switches |
| 1 "A" Batteries | 63 Condensers, loading | 126 Indicators | 183 Patent wire terminals | 239 Switch levers |
| 2 Aerials | 64 Connection blocks | 127 Inductances, C. W. | 184 Plans | 240 Switch points |
| 3 Aerial wire | 77 Contract work | Transmitting | 185 Phonograph attachments | 241 Symbols |
| 4 Aerial protectors | 65 Control panels | 128 Insulators | 186 Plate coudeusers | T |
| 5 Aerial switches | 66 Condenser parts | 129 Insulation | 187 Porcelain | 246 Tapes |
| 6 Aerial insulators | 67 Copper wire | 130 Invention developments | 188 Porcelain cleats | 247 Telephone cord |
| 7 Aerials, loop | 68 Cords | J | 189 Porcelain insulators | 248 Telephone plugs |
| 8 Air condensers | 69 Cord tips | 131 Jacks | 190 Porcelain mountings | 249 Telephone receivers |
| 9 Adapters | 70 Crystals | K | 191 Porcelain tubes | 250 Telegraph keys |
| 10 Amplifiers | 71 Crystal detector units | 132 Knock down units | 192 Porcelain V. T. receptacles | 251 Telegraph teachers |
| 11 Amplifying units | 72 Crystal receiving sets | L | 193 Porcelain V. T. sockets | 252 Testing instruments |
| 12 Aluminum wire | 73 C. W. Transmitter sets | 126 Lead-in wire | 194 Precision instruments | 253 Testing clips |
| 13 Ammeters | 74 C. W. Filament heated transformers | 127 Lead-in switches | 195 Polarity indicators | 254 Terminals |
| 14 Amplifying tubes | 75 C. W. Inductances | 128 Lead-in bushings | 196 Plate connectors | 255 Thermometers |
| 15 Amplifying horns | 76 C. W. Power transformers | 129 Lead-in insulators | 197 Paste solder | 256 Tools |
| 16 Amplifying transformers | D | 130 Levers, Switch | 198 Phosphor-bronze wire sheets | 257 Trade marks |
| 17 Antennae, cage | 81 Detectors | 141 Lightning arrestors | Q | 258 Transformers |
| 20 Antenna light wire plugs | 82 Detector panels | 142 Lightning switches | 307 Quenching spark gaps | 259 Transmitters |
| 18 Audio frequency transformers | 83 Detector tubes | 143 Loading coils | B | 260 Transmitting sets |
| 19 Automatic transmitters | 84 Detector minerals | 144 Loading inductance | 308 Radio books | 261 Towers |
| B | 85 Detector units | 145 Loose couplers | 309 Radio schools | 262 Three coil mounting |
| 21 "B" Batteries | 86 Dictionary, Radio | 146 Loud speakers | 310 Radio publications | 263 Tin foil |
| 22 Batteries, "A" | 87 Dials | 147 Locked lever switches | 199 Radio frequency transformers | 264 Tuning coils |
| 23 Batteries, dry | 88 Dial switches | 148 Lock nuts | 200 Reactor, plate circuit | 265 Tubes, amplifier |
| 24 Batteries, storage | 89 Dry batteries | 149 Loop aerials | 201 Reactor, filter | 266 Tubes, detector |
| 25 Battery chemicals | 90 Diagrams | 150 Lugs | 202 Receiving sets | 267 Tubing, flexible |
| 26 Battery chargers | E | M | 203 Receiving head sets | 268 Tube sockets |
| 27 Battery testing instruments | 91 End mountings (tubes) | 313 Mailing lists | 204 Receiving transformers | 269 Tubes |
| 28 Battery switches | 92 Engraving | 314 Metals | 205 Receptors | 270 Tuner and detector cabinets |
| 29 Battery rheostats | 93 Electrotypes | 151 Magnetic modulator | 206 Receiver magnets | 271 Two stage cabinets |
| 30 Battery clips | F | 152 Modulation transformers | 207 Rectifiers | 272 Two stage amplifier unit |
| 31 Battery handles | 95 Fibre spools | 153 Machine screws | 208 Rectifying tubes | U |
| 32 Battery potentiometers | 96 Fan switches | 154 Magnet wire | 209 Regenerative sets | 276 Unit type receiving sets |
| 33 Binding posts | 97 Filter reactors | 155 Magazines, Radio | 210 Rheostats | 277 Unassembled sets |
| 34 Books | 98 Fixed condensers | 156 Mica | 211 Rheostat wire | V |
| 35 Boxes | 99 Fire extinguishers | 157 Mica diaphragms | 212 Rods | 281 Vacuum tubes |
| 36 Brass parts | 100 Filament rheostat | 158 Mica condensers | 213 Rotary lever switches | 282 Vacuum tube sockets |
| 37 Bushings | 101 Filter coils | 159 Mica diaphragm transformers | 214 Rotary spark gaps | 283 Variable condensers |
| 38 Buzzers | 102 Flashlights | 160 Microphone transformers | 215 Rotary variable condensers | 284 Variometers |
| C | 103 Fuse terminals | 161 Milliammeters | 216 Rubber parts | 285 Variable grid leak |
| 41 Cabluets | G | 162 Milli-voltmeters | 217 Rotors | 287 Vernier adjusters |
| 42 Cam switches | 106 Gaps, Spark | 163 Motors | S | 288 Vibrators |
| 43 Carbon potentiometers | 107 Generators | 164 Motor generators | 221 Safety switches | 289 Vocuouds |
| 44 Change-over switches | 108 Glass | 165 Mounting coils | 222 Safety fuses | 290 Voltmeters |
| 45 Charging rectifiers | 109 Grid condensers | 166 Minerals | 223 Slders and rods | 291 Vulcanized sheet |
| 46 Choke coils | 110 Grid leaks | 167 Mountings | 224 Sockets | 292 V. T. receiving sets |
| 47 Cat whiskers | 111 Grid coils | N | 225 Soft metal | 293 Variogrid leak |
| 48 Cap nuts | 112 Ground clamps | 171 Name plates | 226 Shielded dials | 294 V. T. detector units |
| 49 Carbon walls | 113 Ground wires | 172 Nickel parts | 227 Short wave sets | 295 V. T. control units |
| 50 Cardboard tubes | 114 Ground switches | 173 Nuts | 228 Solder | 296 V. T. receptacle |
| 51 Chopper, rotary | H | O | 229 Solder, bar | W |
| 52 Clamps | 116 Headsets and bands | 176 One stage amplifier units | 312 Soldering irons (electric) | 297 Washers |
| 53 Clips | 117 Honeycomb coils | 177 Oscillation transformers | 230 Spark transformers | 298 Watch case receivers |
| 54 Coils | 118 Honeycomb mountings | P | 231 Spark coil selectors | 299 Wattmeters |
| 55 Coil mountings | 119 Honeycomb plugs | 178 Panels | 232 Spaghetti tubing | 300 Wavemeters |
| 56 Coil plugs | 120 Hook switches | 179 Panel plugs | 233 Special apparatus | 301 Wave tuner |
| 57 Coils, spark | 121 Horns | 180 Panel controls | 234 Spark gaps | 302 Wire |
| 58 Condensers | 122 Hydrometers | 181 Paper tubes | 235 Spring clips | 303 Wire, aerial |
| 59 Condensers, fixed | | 311 Patent registration | 236 Storage batteries | 304 Wire phosphor bronze |
| 60 Condensers, variable | | | 237 Sectional receiving sets | 305 Wire, copper clad |
| 61 Condensers, air | | | | 306 Wire, magnet |

Note the number of the item you want to buy—then check the corresponding number in the coupon below and mail to us.

---TEAR OFF HERE---

1	2	3	4	5	6	7	8	9	10	11	12	13	14	15	16	17	18	19	20	21
22	23	24	25	26	27	28	29	30	31	32	33	34	35	36	37	38	39	40	41	42
43	44	45	46	47	48	49	50	51	52	53	54	55	56	57	58	59	60	61	62	63
64	65	66	67	68	69	70	71	72	73	74	75	76	77	78	79	80	81	82	83	84
85	86	87	88	89	90	91	92	93	94	95	96	97	98	99	100	101	102	103	104	105
106	107	108	109	110	111	112	113	114	115	116	117	118	119	120	121	122	123	124	125	126
127	128	129	130	131	132	133	134	135	136	137	138	139	140	141	142	143	144	145	146	147
148	149	150	151	152	153	154	155	156	157	158	159	160	161	162	163	164	165	166	167	168
169	170	171	172	173	174	175	176	177	178	179	180	181	182	183	184	185	186	187	188	189
190	191	192	193	194	195	196	197	198	199	200	201	202	203	204	205	206	207	208	209	210
211	212	213	214	215	216	217	218	219	220	221	222	223	224	225	226	227	228	229	230	231
232	233	234	235	236	237	238	239	240	241	242	243	244	245	246	247	248	249	250	251	252
253	254	255	256	257	258	259	260	261	262	263	264	265	266	267	268	269	270	271	272	273
274	275	276	277	278	279	280	281	282	283	284	285	286	287	288	289	290	291	292	293	294
295	296	297	298	299	300	301	302	303	304	305	306	307	308	309	310	311	312	313	314	315

Service Bureau The Radio Dealer,
1133 Broadway, New York City.

We are interested in buying radio equipment and have circled the numbers on this coupon of the items we are ready to buy now. Please have manufacturers of these lines quote us dealers' prices.

Name.....

Address.....

..... We are
---Retailers
---Jobbers

