

集古十種

第三

708
M282a

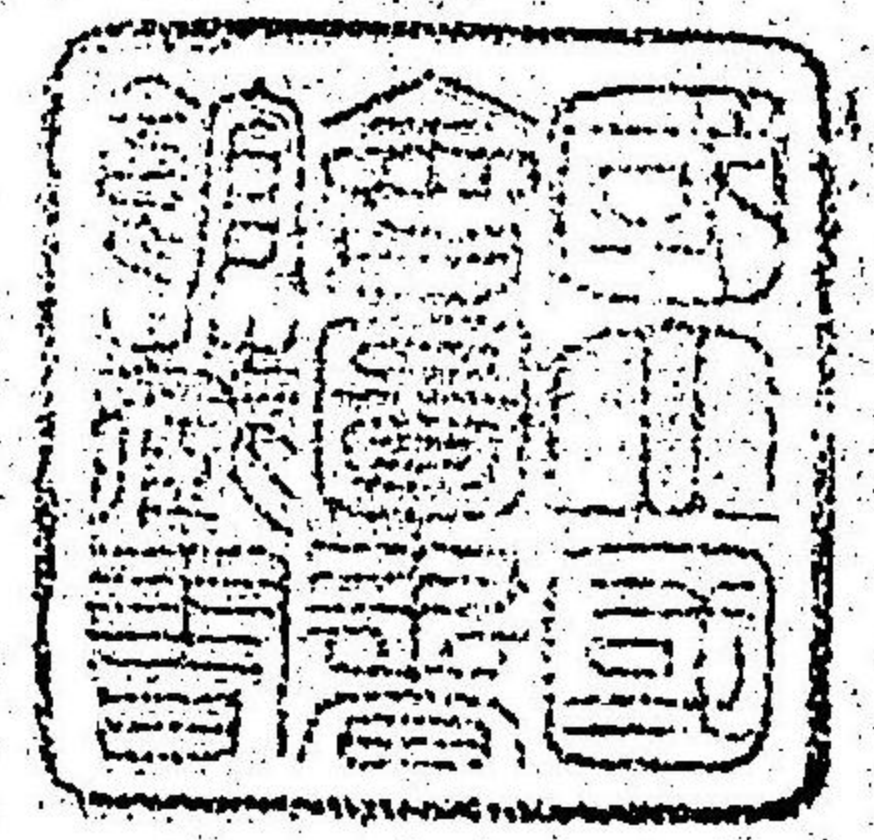

213517

集古十種第三目錄

源義經朝臣甲冑圖山城國鞍馬寺藏	一
鏡井鏡櫃圖同藏	一三
祇園會淨明山木偶人所著甲冑圖 <small>京六角通烏丸坊圖藏 傳云楠正成卿之物</small>	二二
膝鏡圖松浦家藏、足利義教公所賜	二六
腹當圖同藏、同上	二七
武田信玄前立物圖或家藏	二八
腹卷圖陸奥國石川郡石川村八幡社藏	二八
兵器類 甲冑 二	
赤威甲冑圖武藏國多摩郡御嶽權現社藏	三二
紫裾濃甲冑圖同藏	四八
鏡圖山城國鞍馬寺藏	六一
兵器類 甲冑 三	
甲冑圖南都春日神庫所藏、西人岩井某所藏模本	七三
大塔宮母衣圖大和國三輪社藏	九六

集古十種第三目錄

鏡直垂圖毛利家藏、足利義輝公所賜	九六
京極氏信鏡直垂圖藏未詳	九九
義經朝臣甲冑圖南都春日日本談話屋藏	一〇〇
喉輪圖出雲國日御崎社藏	一三三

兵器類 甲冑 四

新田義宗朝臣袖圖橫瀨家藏	一一五
義經朝臣籠手圖南都興福寺觀音坊藏	一一八
袖圖出羽國平鹿郡沼館村八幡社	一二二
實盛冑袖圖 <small>加賀國江沼郡須輪間村 多太社藏、損失不全</small>	一二五
河野通信袖圖伊豫國三島社藏	一三三
鍬形圖 <small>信濃國高井郡保科村 清水寺入將權現社藏</small>	一三六
景清甲冑并唐櫃圖尾張國馬島明眼院藏	一三七
兵器類 甲冑 五	
甲冑圖南都春日神庫所藏	一五四
兵器類 甲冑 六	
甲冑圖南都春日日本談話屋藏	一八四

楠正成卿胄大袖圖大和國信長山本寺藏……………一九五
 大塔宮咽輪圖同藏……………一九八
 半首圖或家藏……………一九九
 甲冑圖南都春日神庫所藏、函人岩井某所藏摸本……………二〇〇
 鏡圖陸奥國棚倉郡々古和氣神社藏……………二〇七

類 兵器 甲 冑 七

甲冑圖出雲國日御崎神社藏……………二二六
 新田義重朝臣冑圖由良家藏……………二五六
 新羅三郎義光甲冑圖安藝國嚴島神社藏……………二六〇

類 兵器 甲 冑 八

佐々木盛綱甲冑圖備前國豐原庄上寺八幡宮藏……………二七四
 腹卷及袖圖大和國藤原山法貴寺寶相院藏……………二九七
 腹卷及喉輪圖大和國吉野山吉水院藏……………三〇六
 楠家腹卷及喉輪圖河內國觀心寺藏……………三一

類 兵器 甲 冑 九

冑圖中村彌大夫藏……………三二六

武田家楯無甲冑圖甲斐國菅田天神社藏……………三一九
 楠正成卿胸丸及大袖圖家藏……………三三五
 鞆圖家藏……………三四八

類 兵器 甲 冑 十

義家朝臣甲冑圖安藝國嚴島神社藏……………三五〇
 甲冑圖那須家藏……………三六九

類 兵器 甲 冑 十一

小松内府重盛公甲冑圖安藝國嚴島神社藏……………三八三
 小櫻威甲冑圖同藏……………四〇一

類 兵器 甲 冑 十二

大内義隆卿甲冑圖嚴島神社藏……………四一八
 大森盛長甲冑圖大坂商家大森三郎兵衛藏……………四四一
 足利家母衣圖新庄家藏……………四五六

兵器類

甲 冑

集古十種兵器類

凡例

凡甲冑弓矢旌旗刀劍係兵器者皆載此集
 凡題曰某藏甲冑者所謂腹卷胸丸之類在其中不須枚舉覽者就圖求之可也
 凡邦制甲冑分目或依函工之方言或出後人之附會如笠印付環又為高勝環天空又為息出又為天穴之類固不一定也且甲冑
 摹本善者至少此集歷數年而成隨得隨載而注之故前後體例有未歸一者然其意自晰今不必改也
 甲冑分目之說近世稱故實者多附會難盡從也此集一仍俗稱其衆說之折衷取舍付諸集古十種考
 凡稱古製而間有新製或稱某鑑而有非當時製今且從傳稱而登錄不敢妄改說詳于集古十種考刀劍鞍鏡之屬亦倣此
 凡寺廟寶器多就其屬所俟伯官員而訂焉如嚴嶋於廣嶋俟三島於松山俟是也其或訂正之不權者蓋其所使之人掌古之學
 莽或繪畫之手不精耳今且從之收入其疎脫者後日幸得善本即追改
 凡刀劍間有似蠻製者現傳為本祠寶器今謹收載不敢以私見斥棄
 凡旌旗方幅難容皆縮寫以收至其題字則寫元文而附未令知筆意之委曲但縮字猶可辨體勢者則不別出
 四天王寺所藏古旌旗今所存者其題字耳若夫全幅長短則不可得而知又雖或後世所書今不敢省
 凡此集隨得收入是以世次年代皆不能以序
 凡文字脫誤畫圖紕謬俟覽者考訂而改焉

山城國鞍馬寺藏義經朝臣甲冑圖

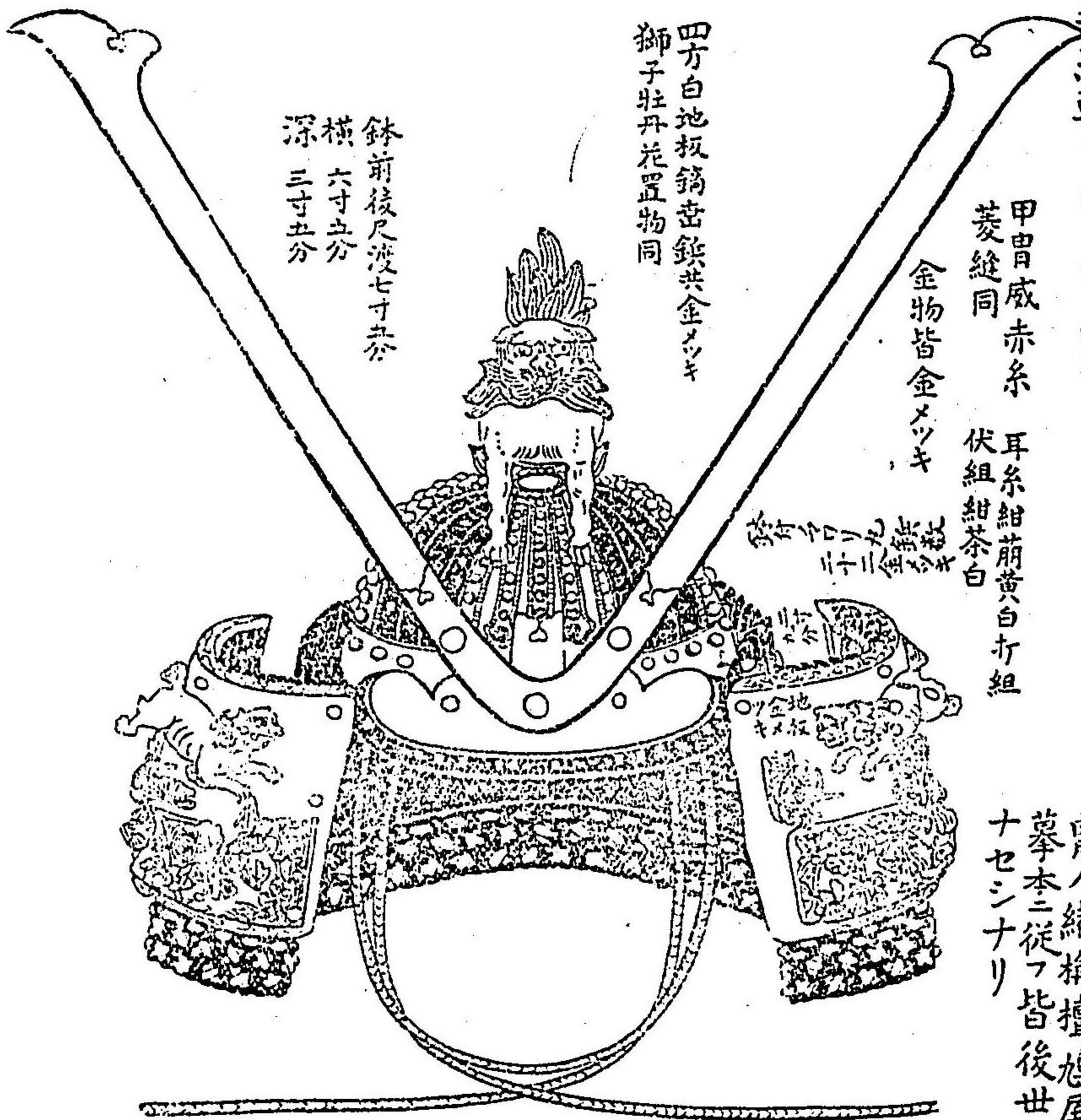

甲冑威赤系

耳系紺朋黃白打組

菱縫同

伏組紺茶白

金物皆金メッキ

由月ノ緒梅檀鳩尾ノ緒
 摹本ニ從フ皆後世漫ニ
 ナセシナリ

四方白地板鎬齒共金メッキ
 獅子牡丹花置物同

鉢前後尺渡七寸六分
 横六寸五分
 深三寸五分

威赤系打

鉢付鉄ノクノリテ高三分半

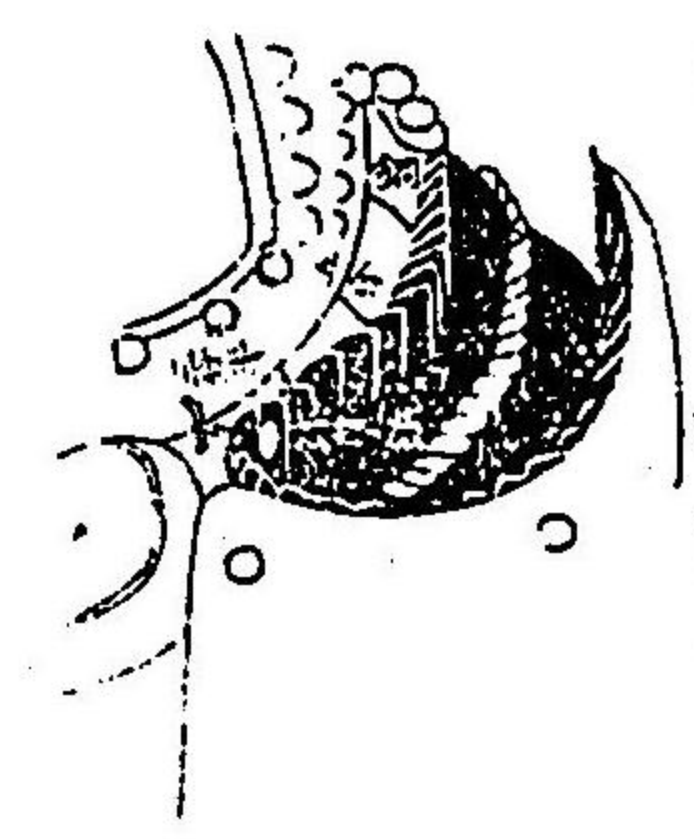

吹返反之図
左右不一様
右

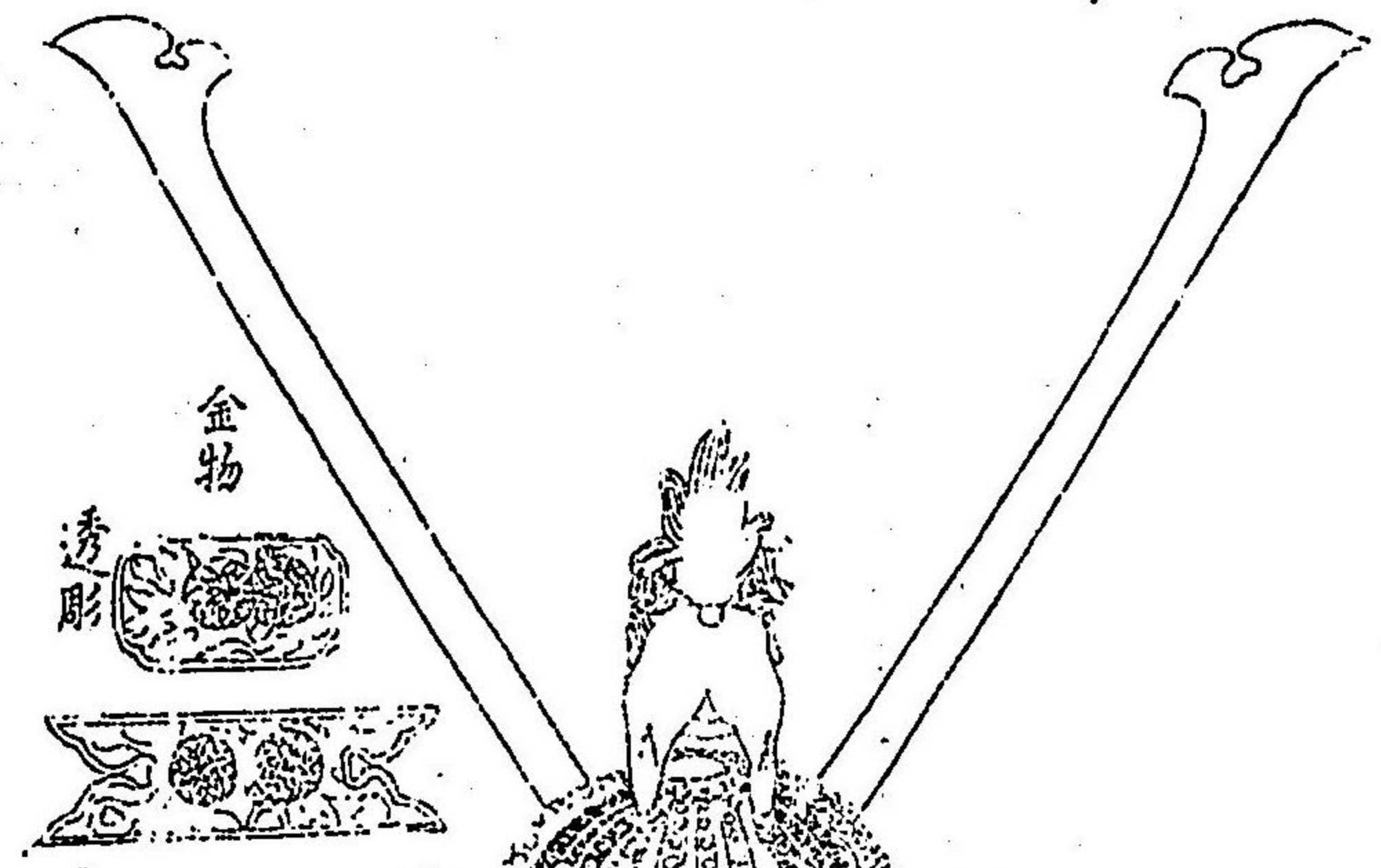
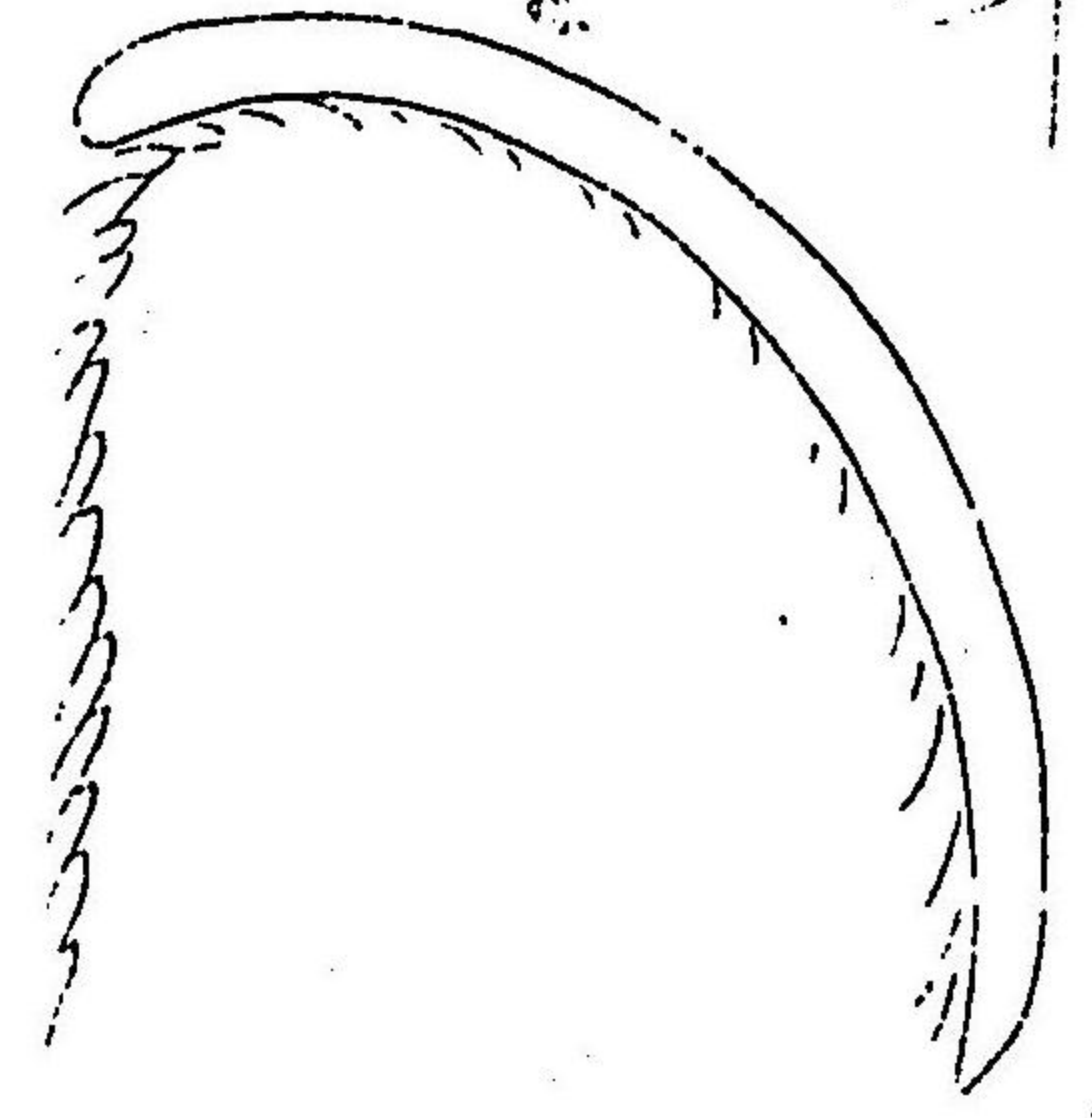
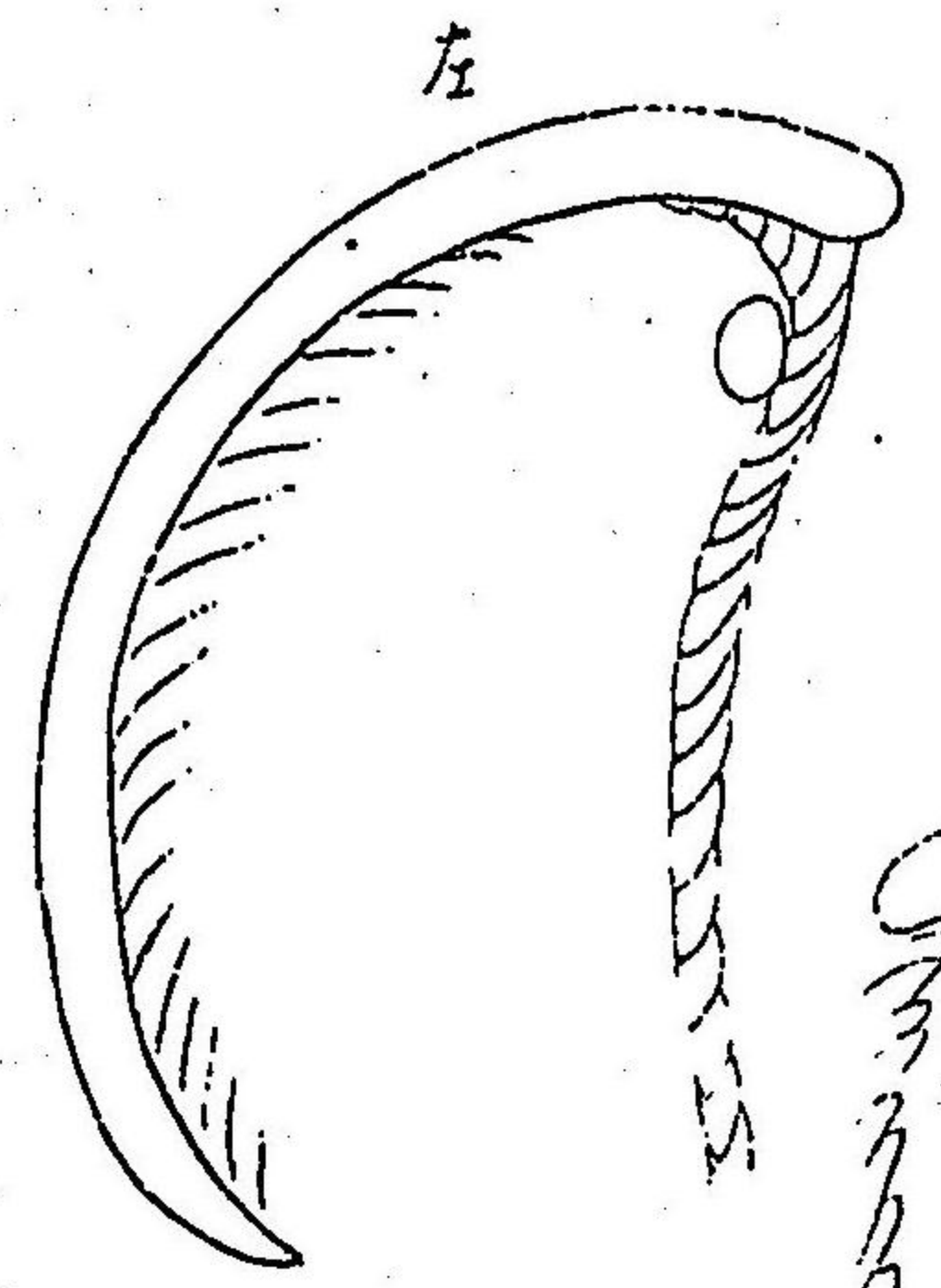

金物

透彫

獅子金ノツキ
胴之内空

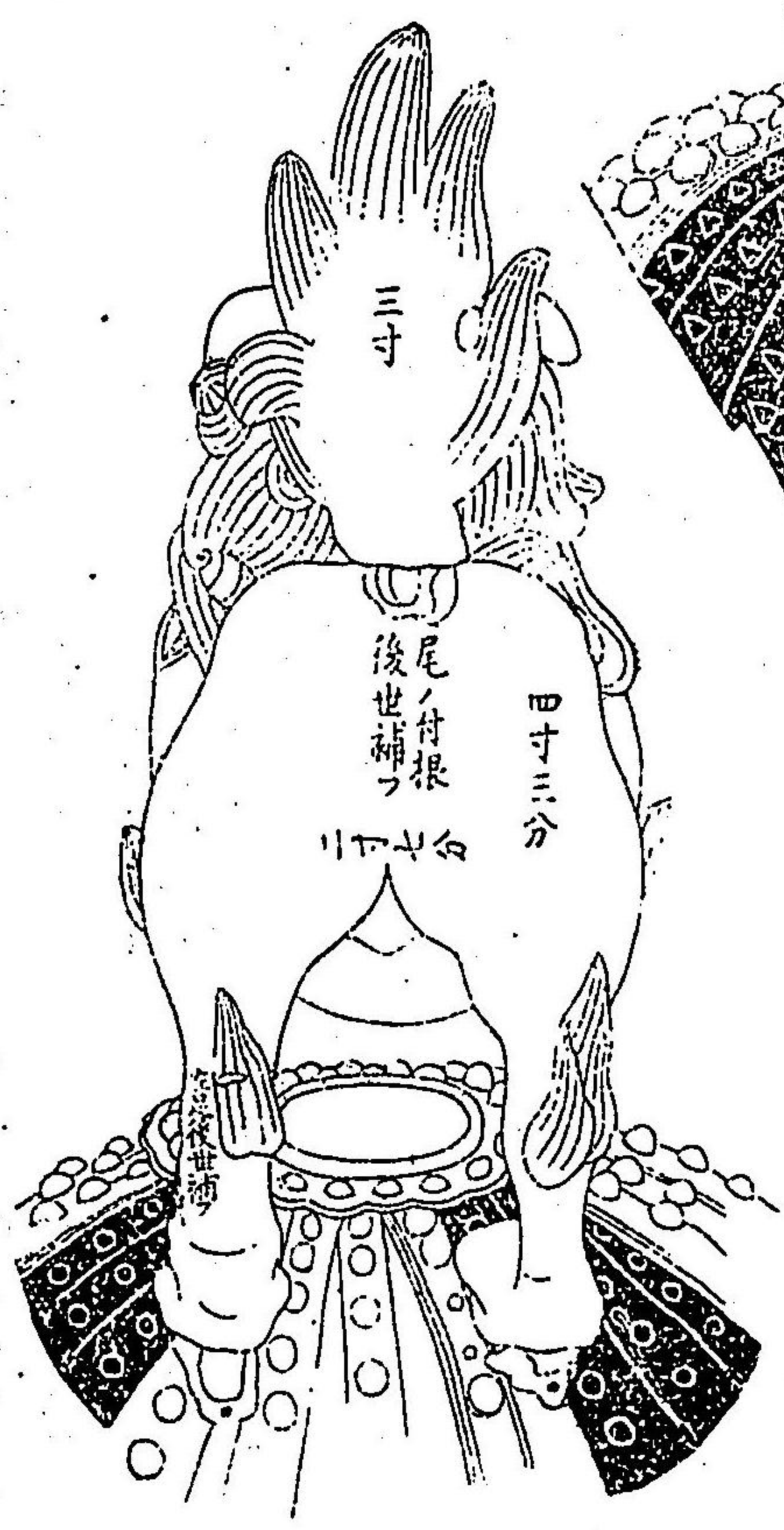
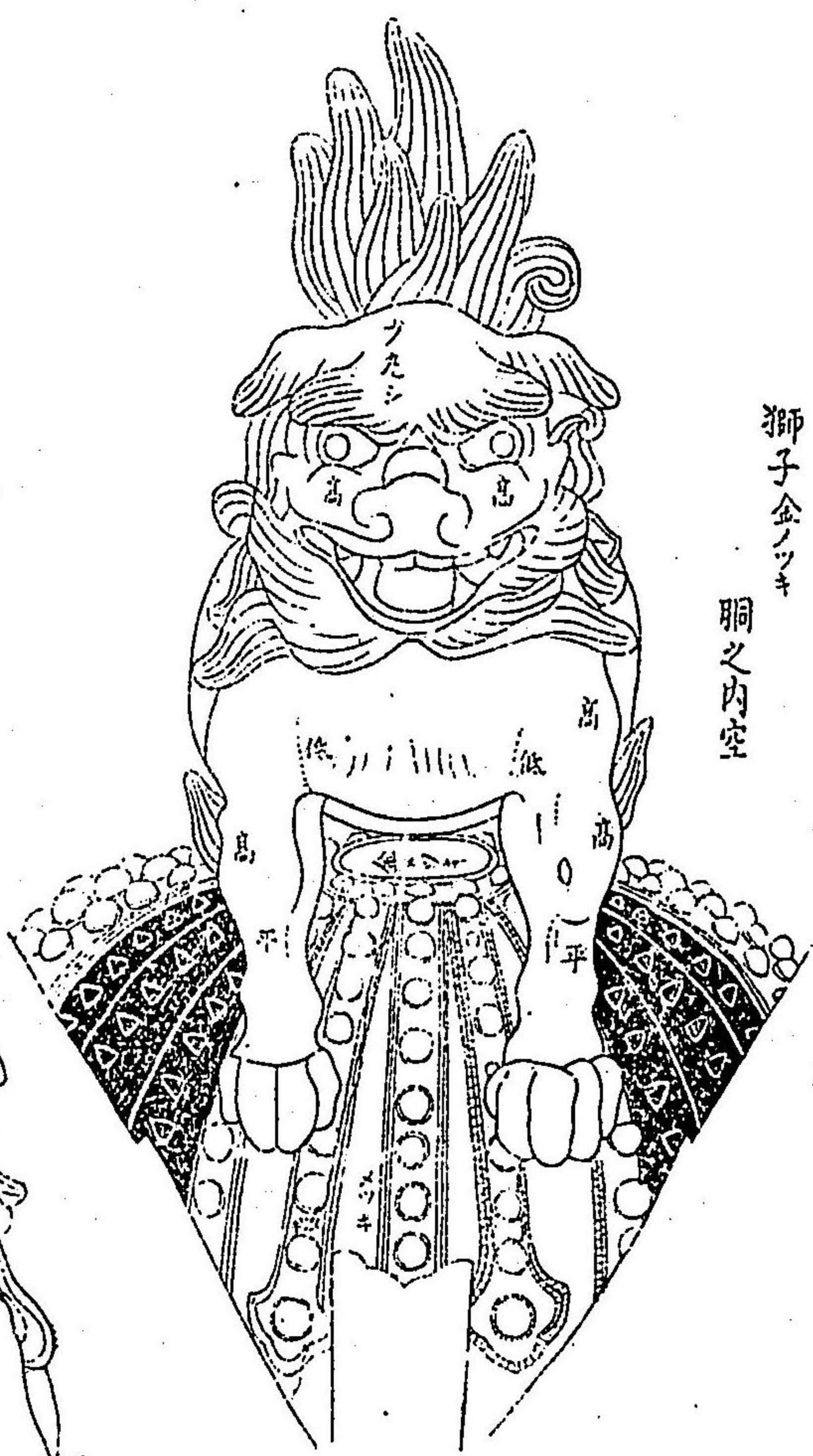

三寸
尾ノ付根
後世補フ
四寸三分

尾先ヨリ鼻端ヲテ八寸二分
尾先ヨリ足先マテ六寸三分
頭ヨリ前足ノ先マテ五寸

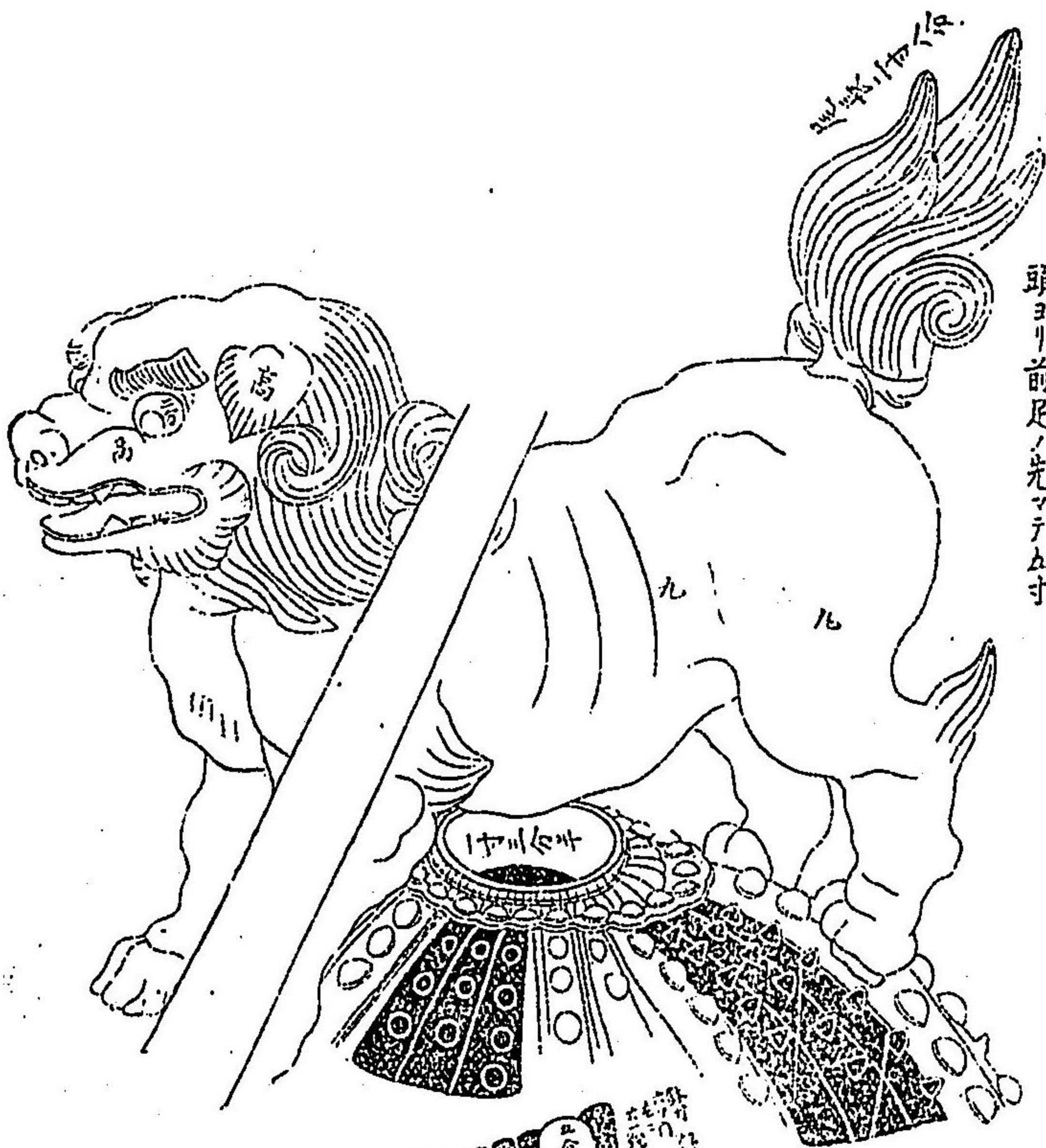

左吹返

獅子腹肉置高八分
同 頭肉置高九分半
同 後足高一寸二分半
牡丹花置上高四分或三分
或四分余
葉置上高一寸二分
獅子鼻端ヨリ左足ノ先マテ
四寸八分

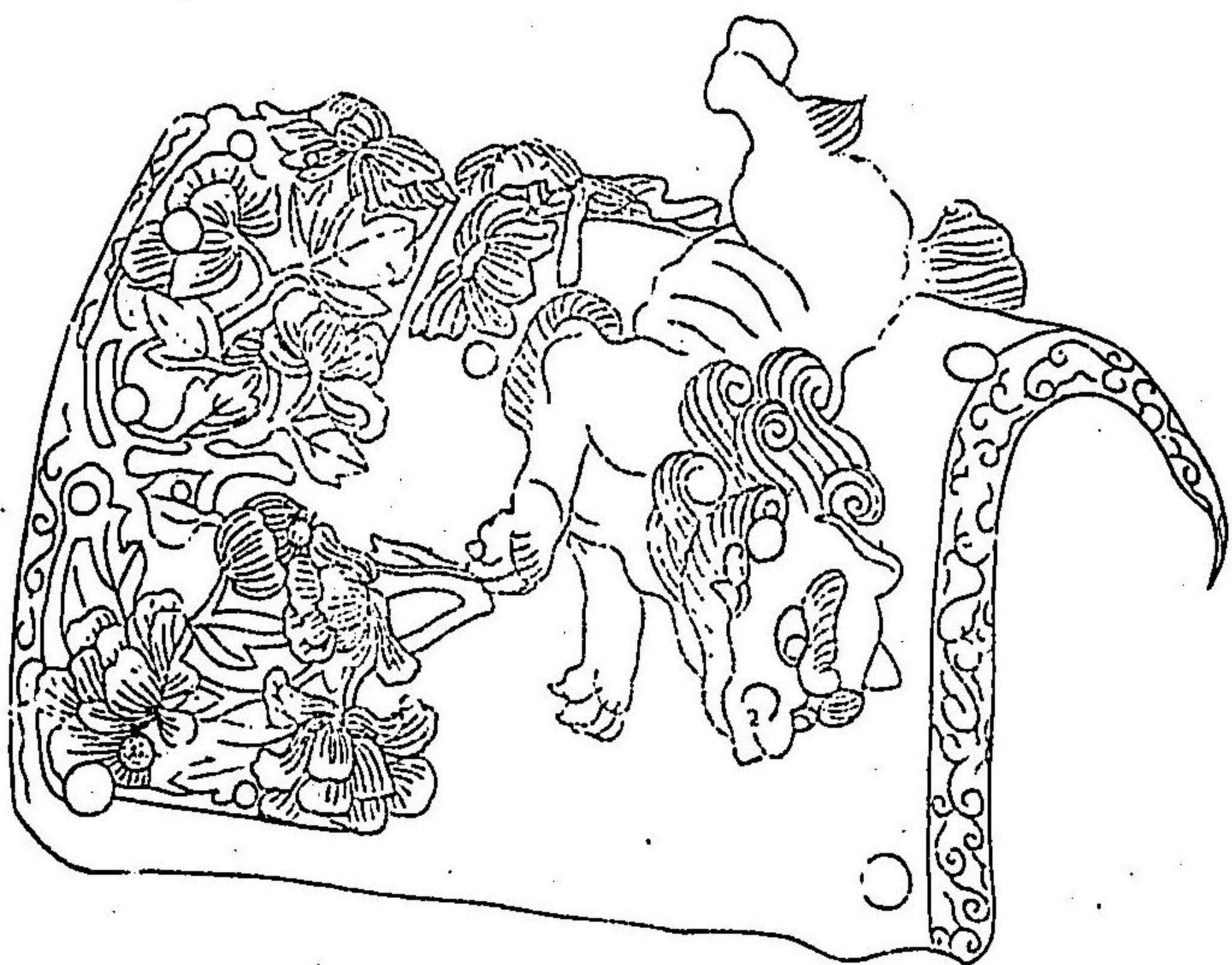
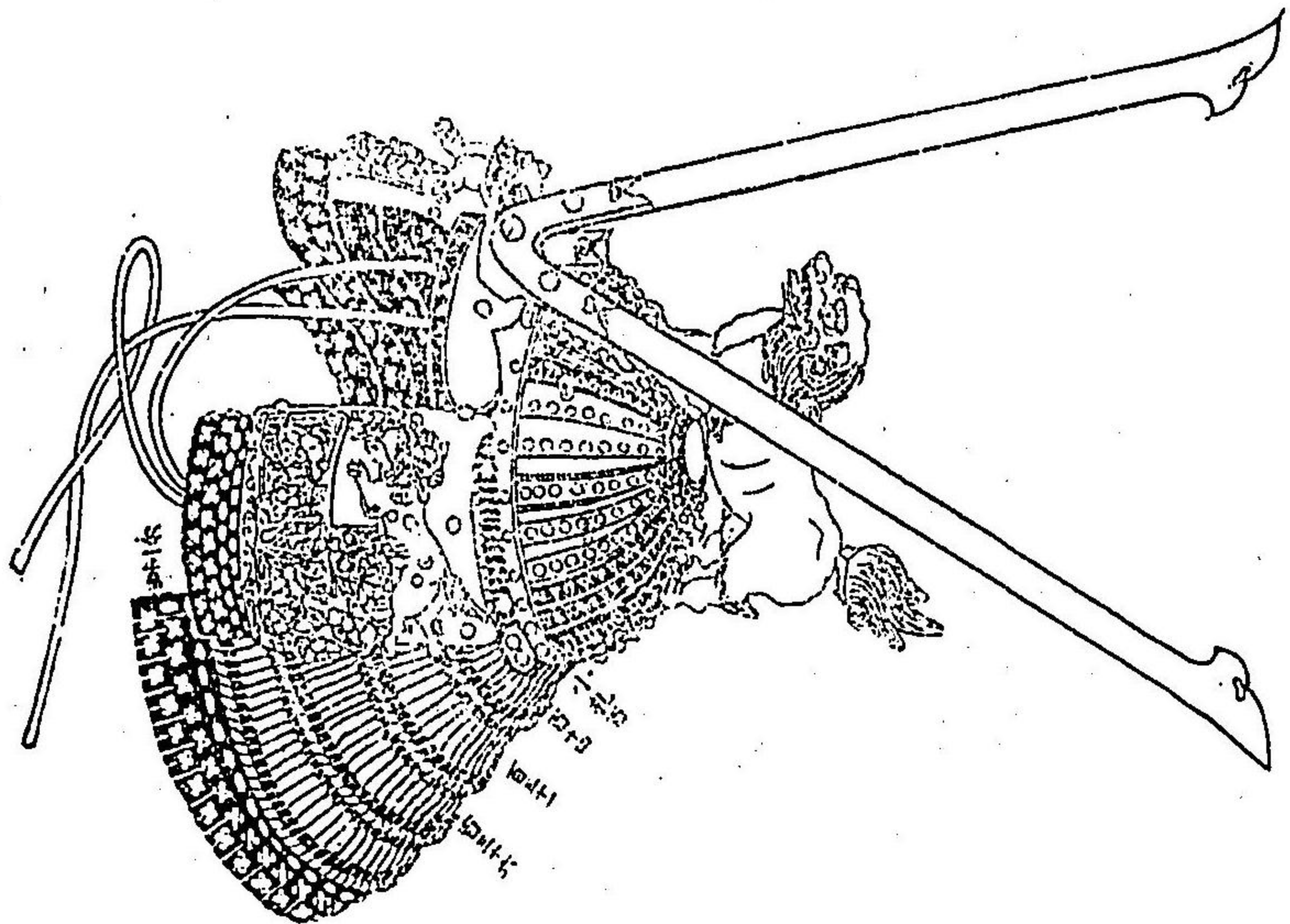
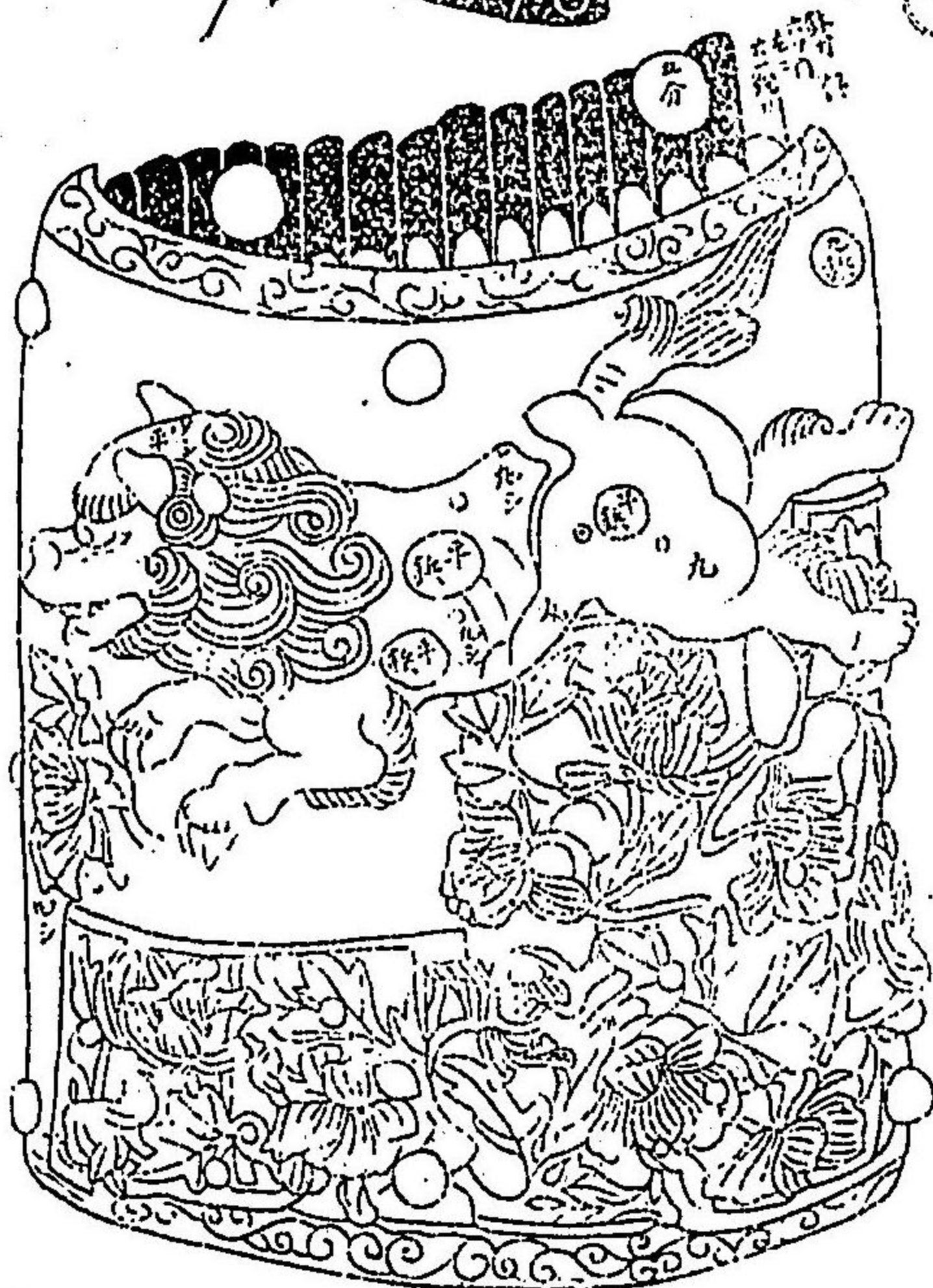

吹返及獅子牡丹

序張布如圖
一箇ニサシテ
内ニ又ニ一箇ヲ
張有之至キ
厚キ布ニテ
如キ

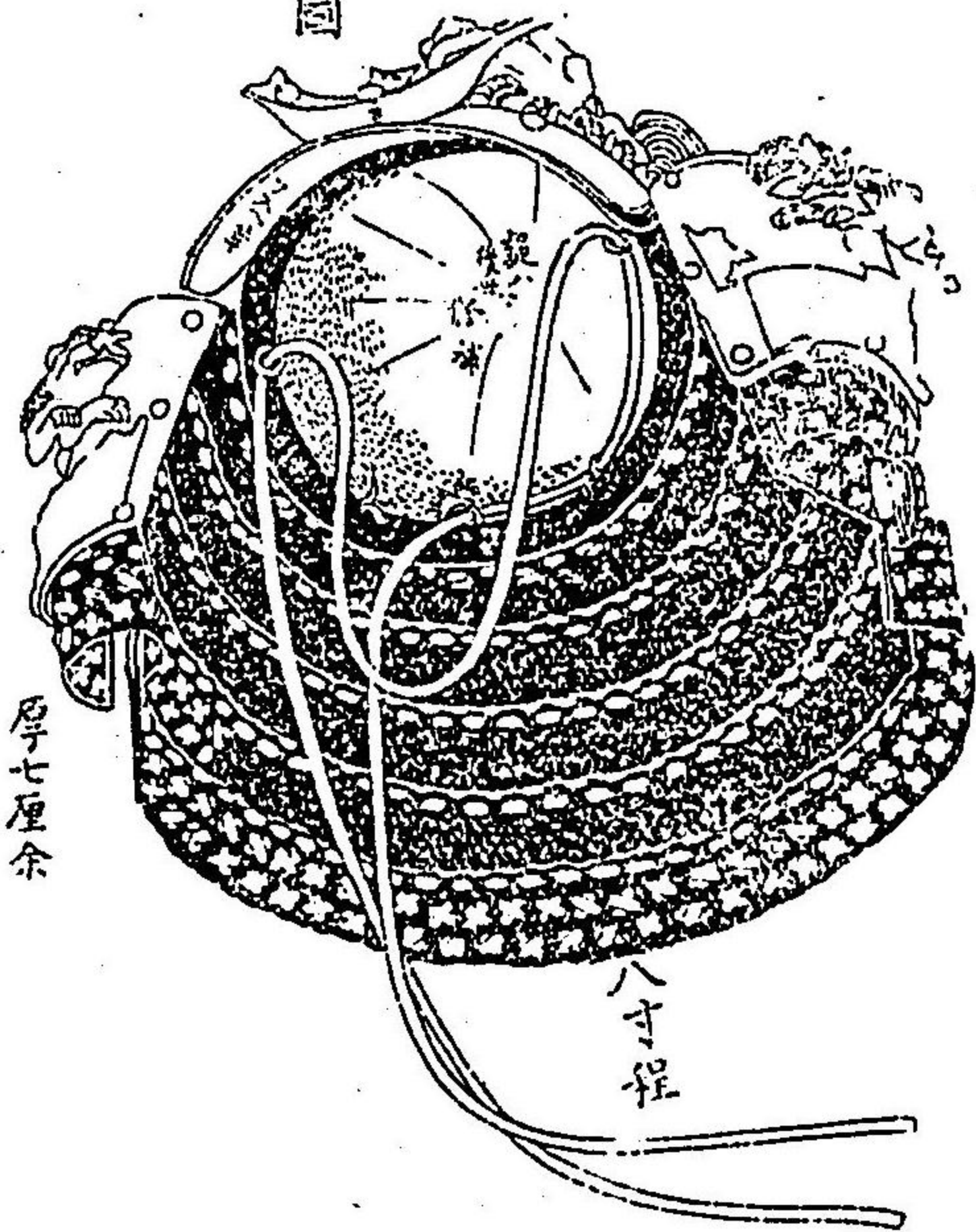

厚七厘余

八寸程

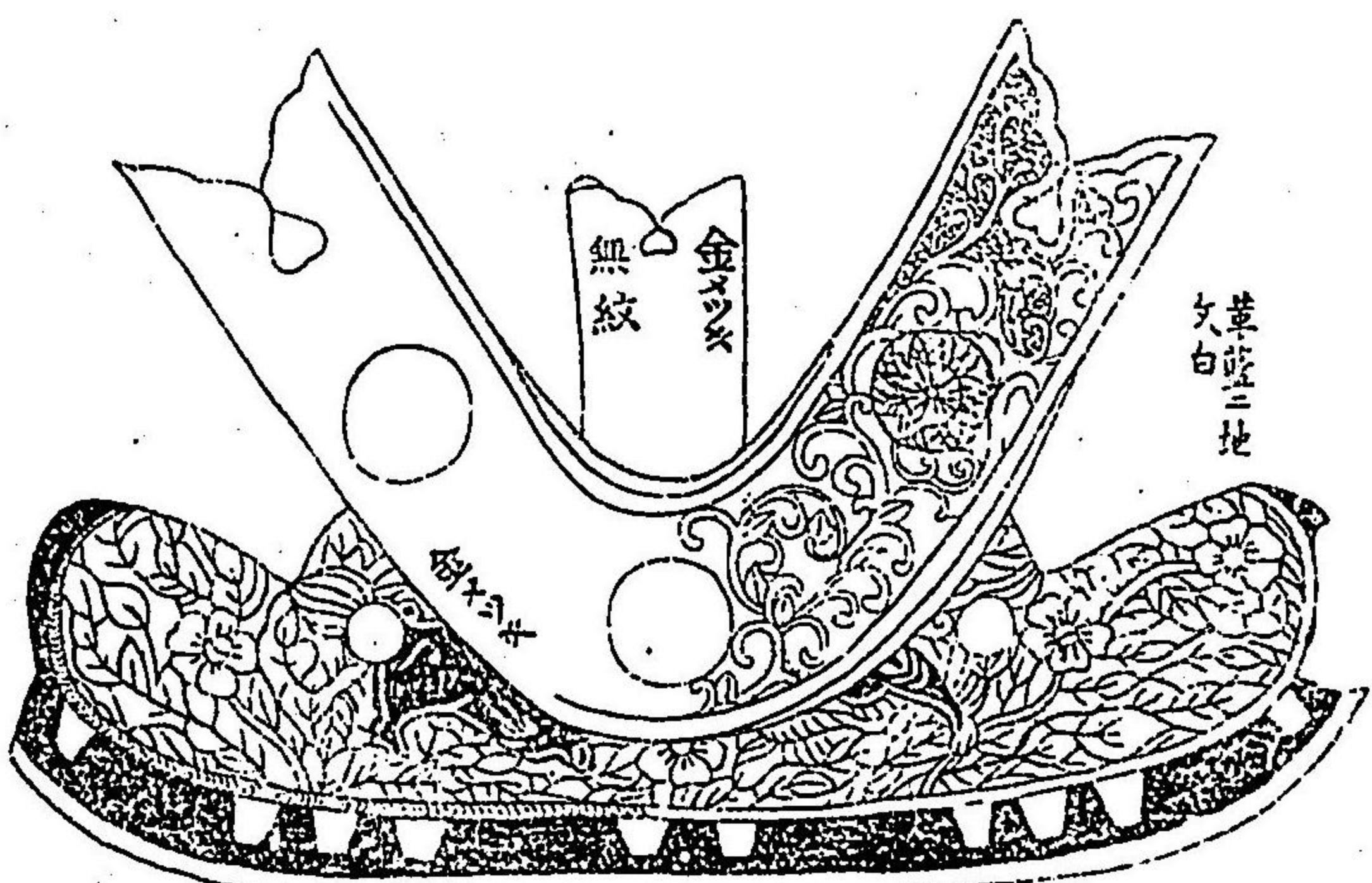

華盛ニ地
女白

金ニ
無紋

小緑丸形
後世ニ補

厚
一分

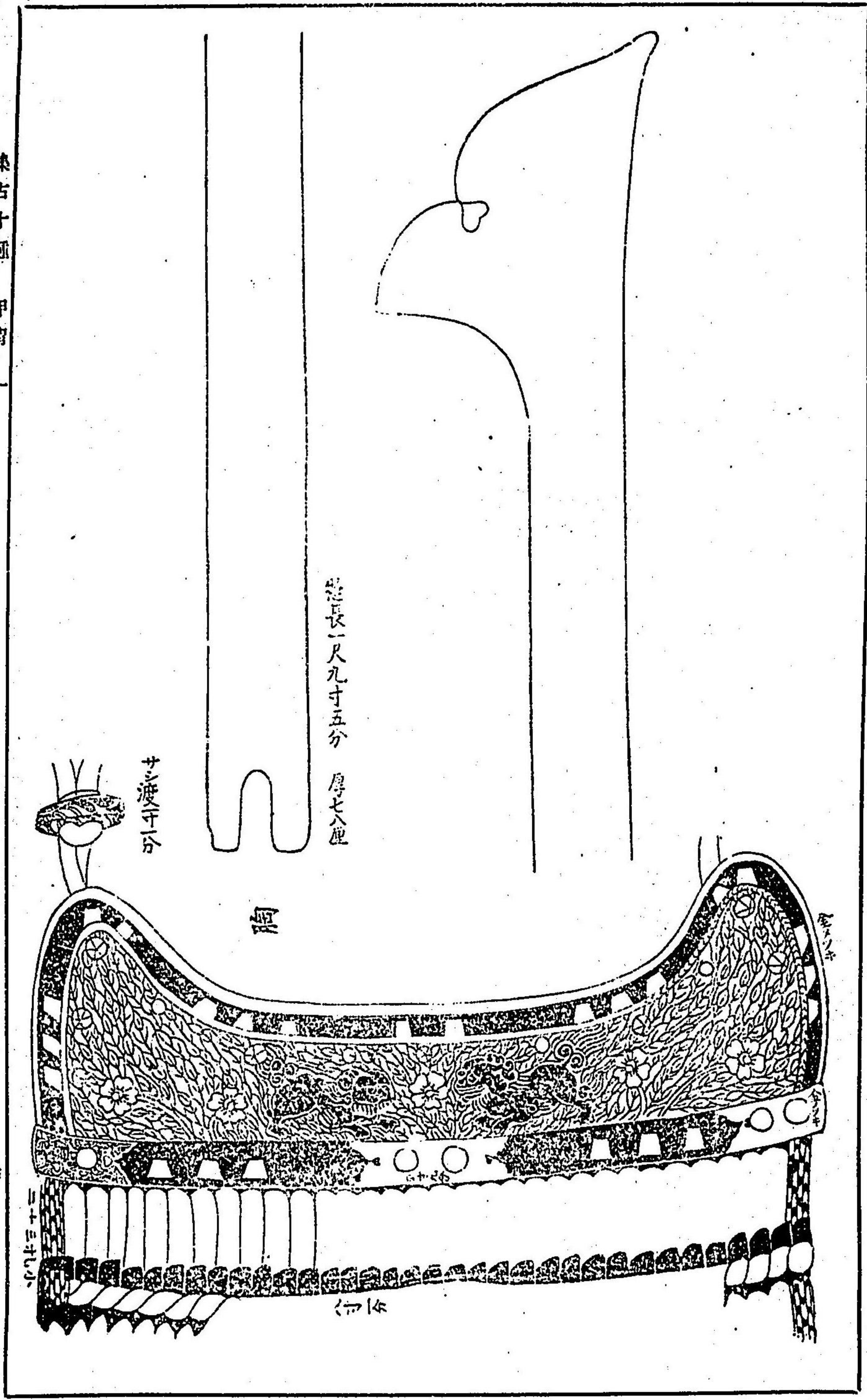

總長一尺九寸五分 厚七厘

サシ渡寸分

細

細

全圖

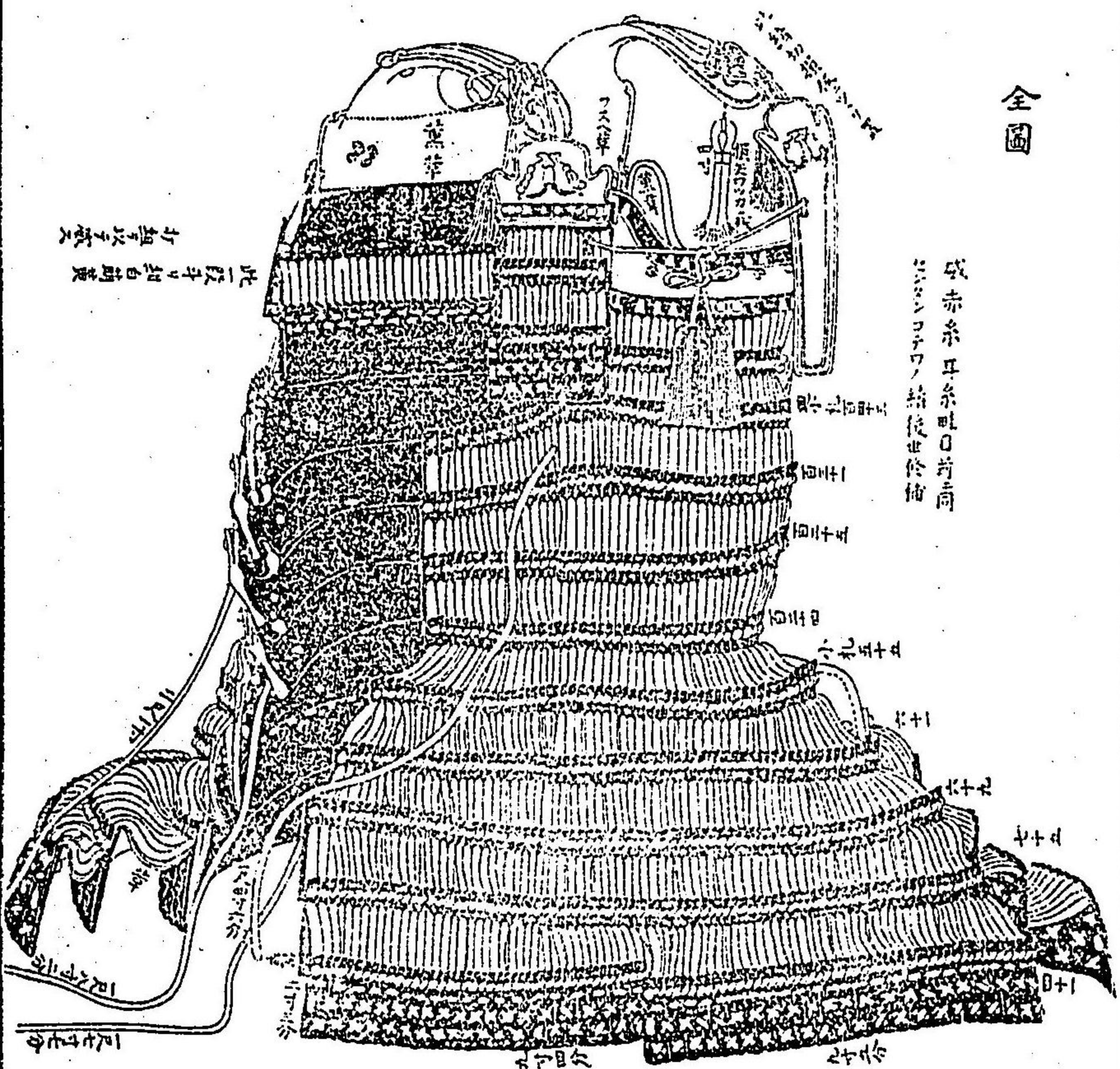

成赤糸耳系吐口前高
結後世俗備

此段字細白筋裏
打綴字樣大

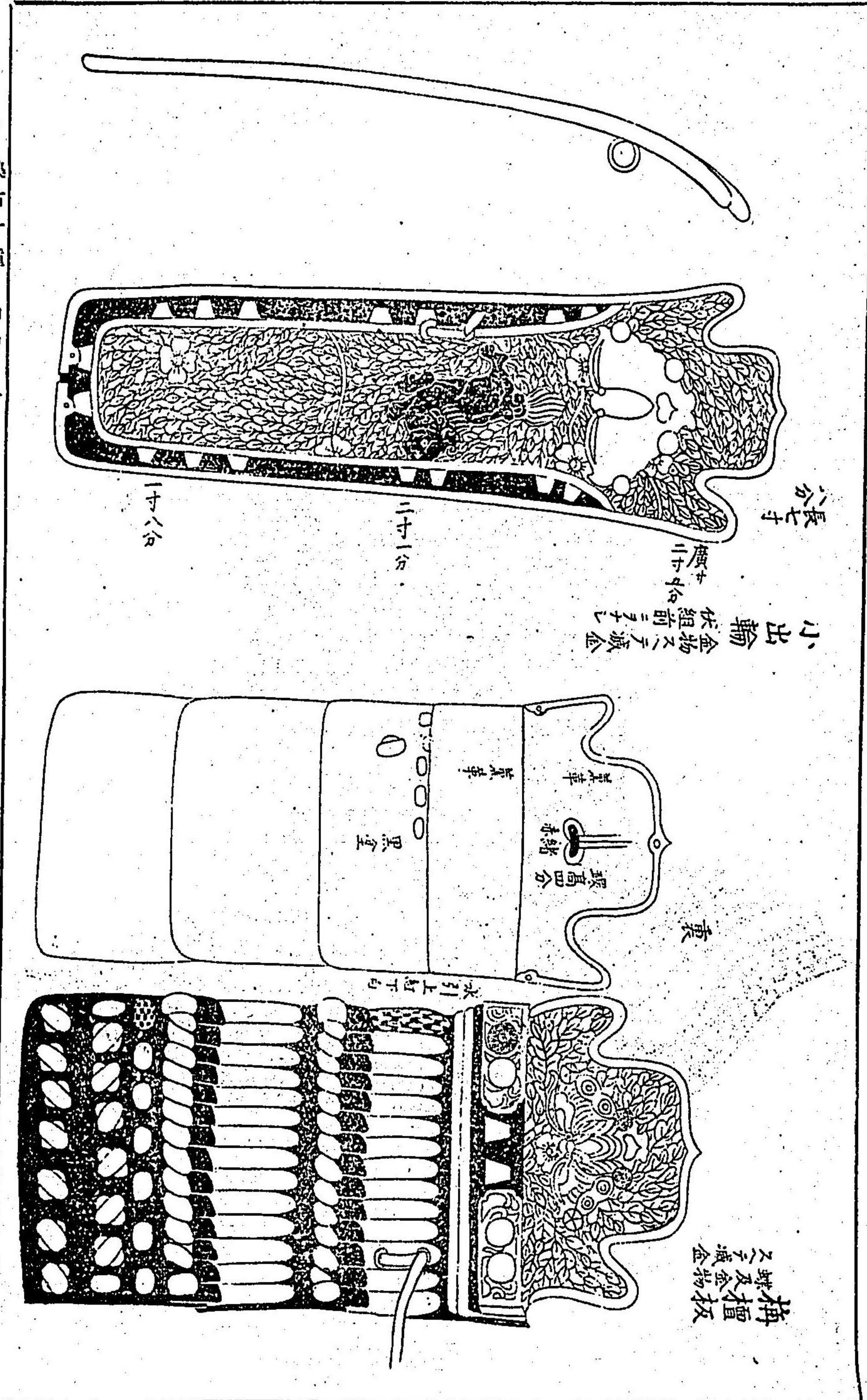

小出輪 金物之天藏金
伏組前ニナシ

長七寸

二寸一分

一寸八分

梅摺板
之天藏金物

表引上紐下可

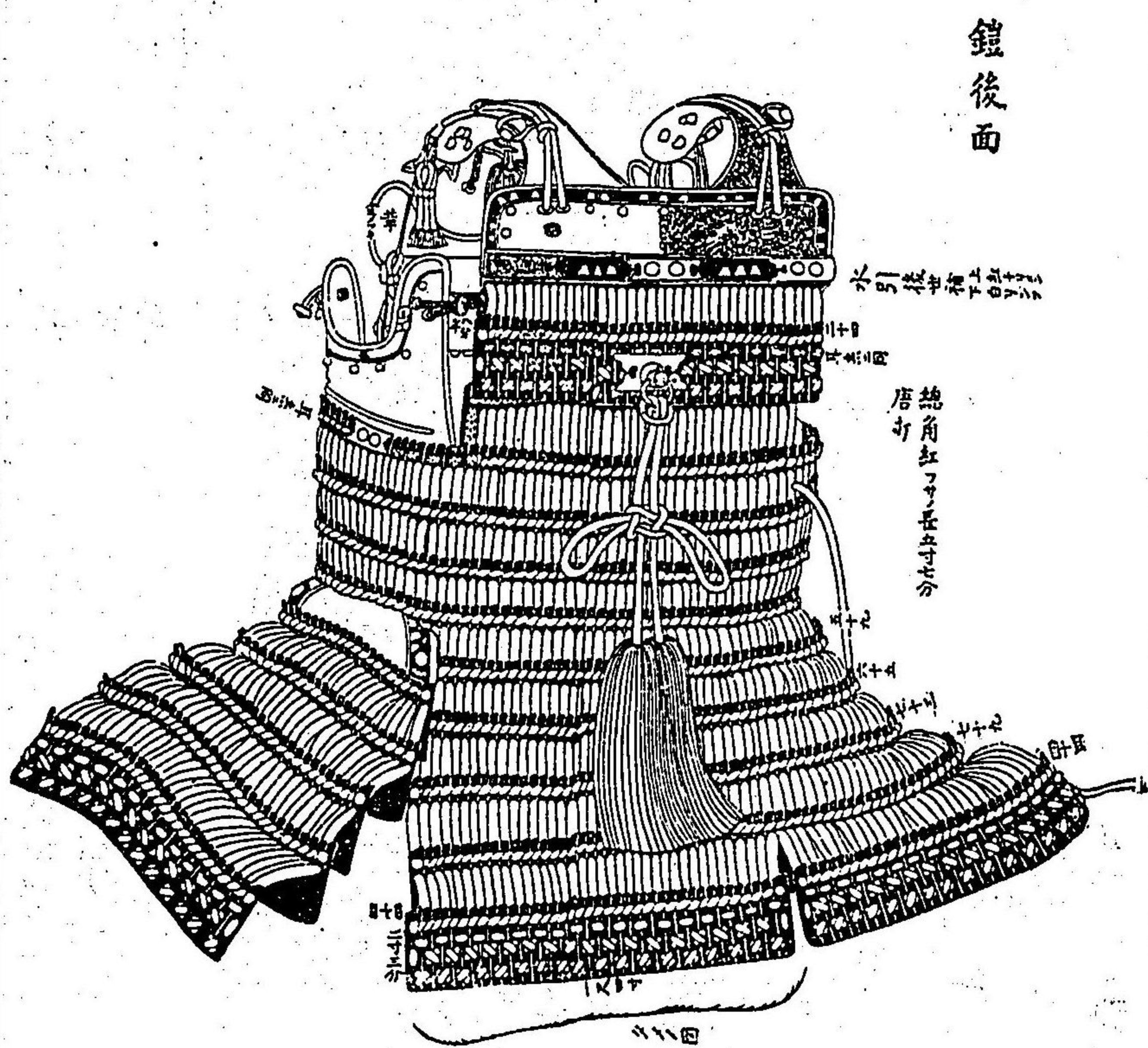

鏡後面

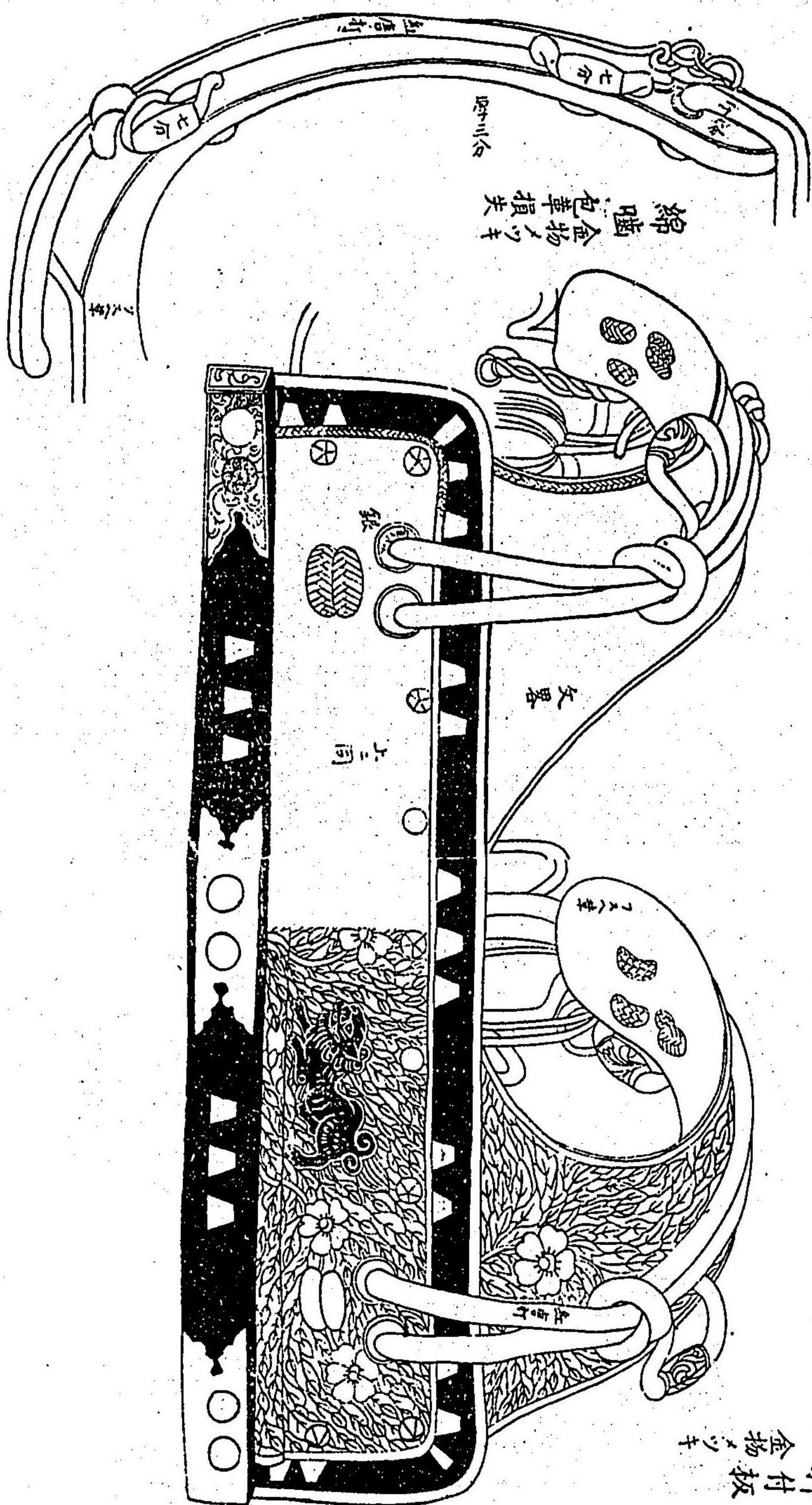

押付板
金物ノキ

射向

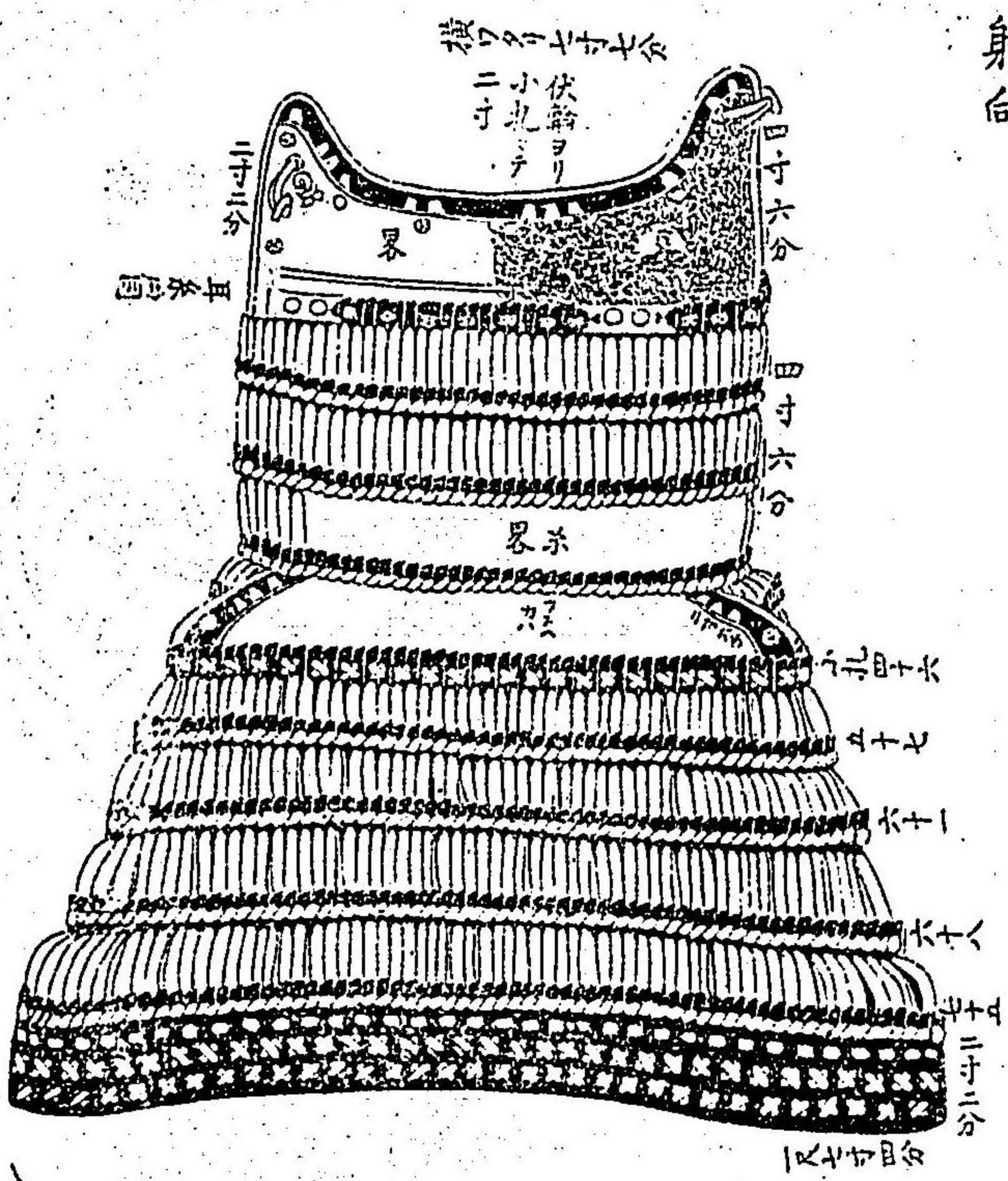

脇立損失

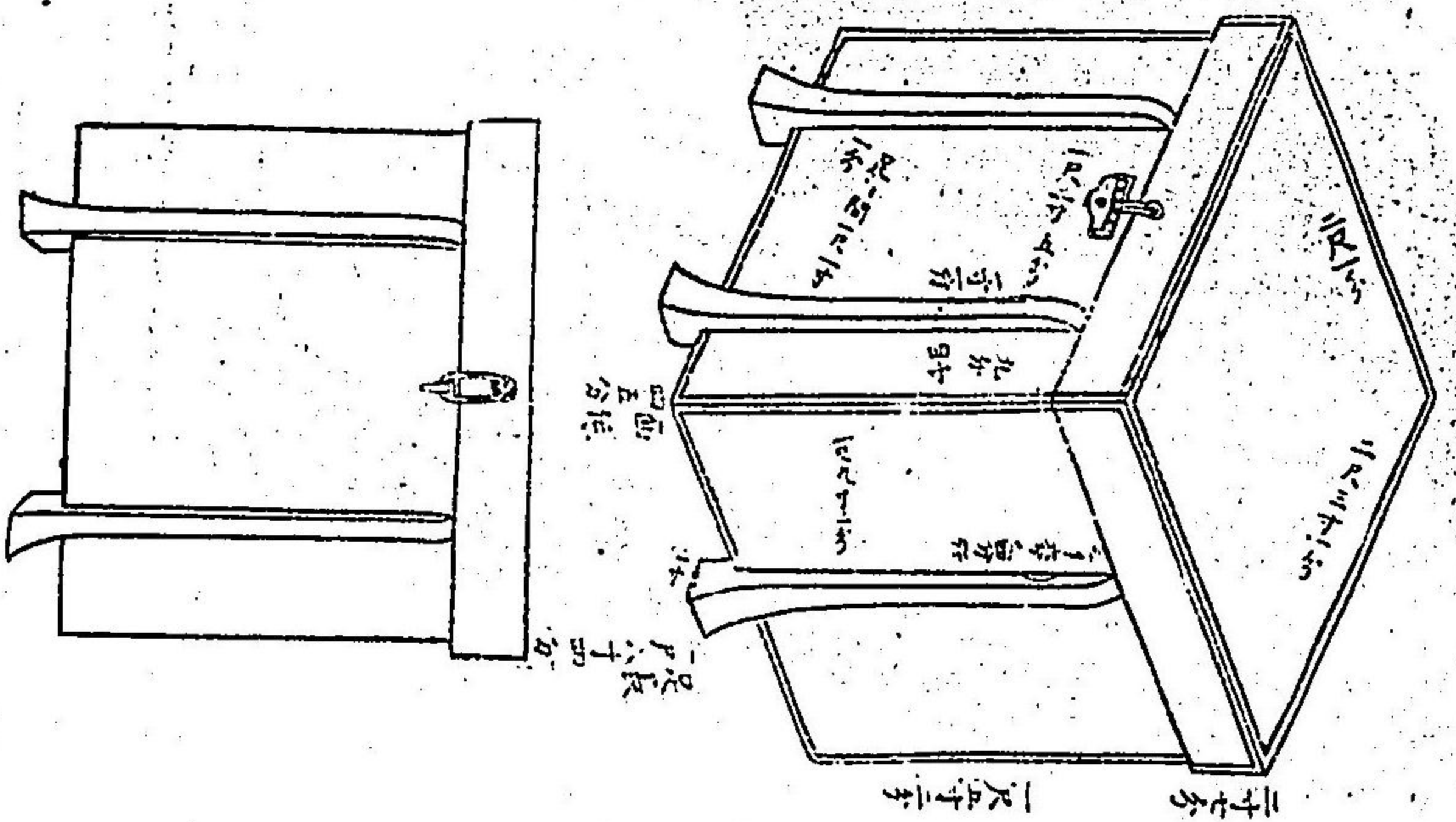
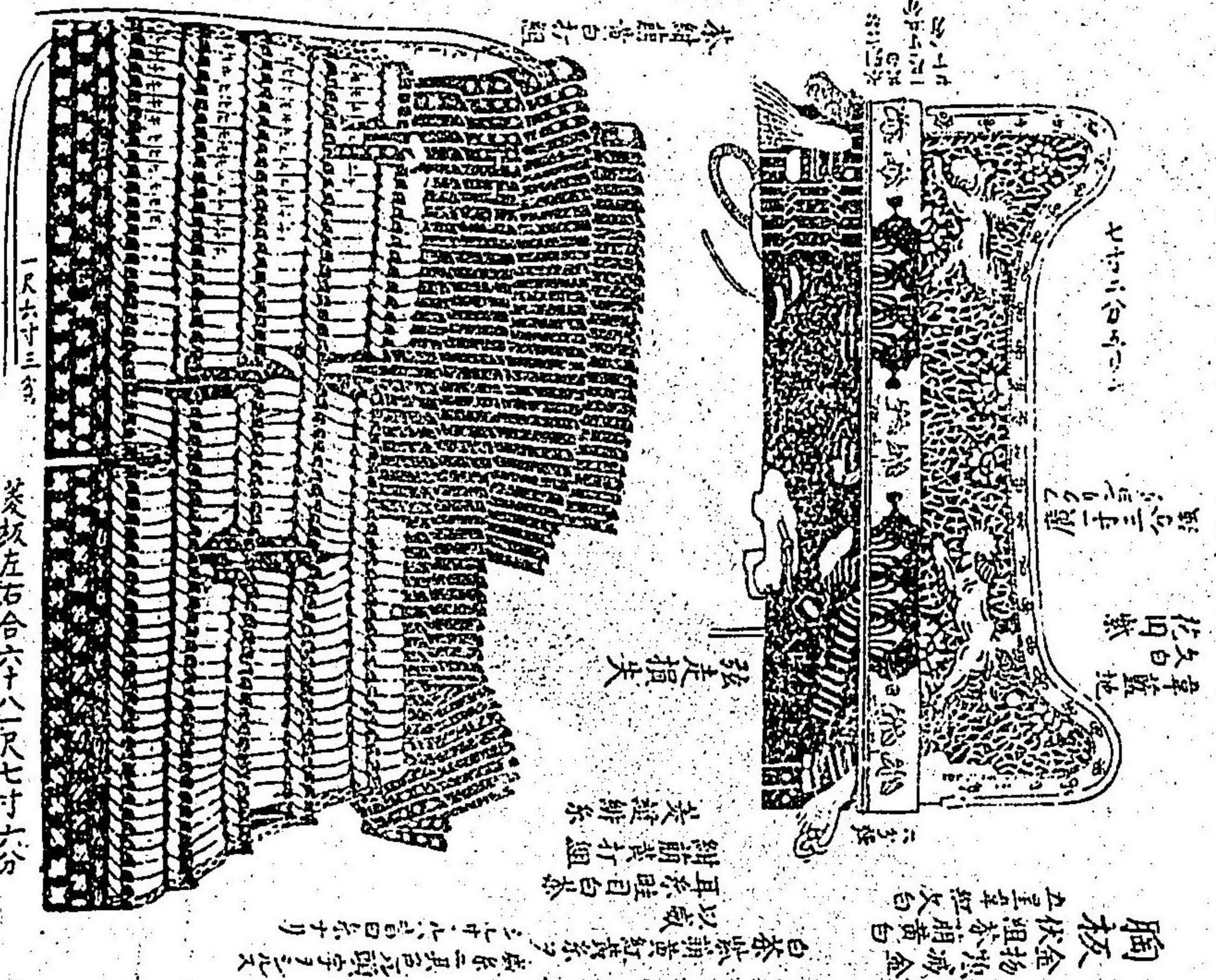
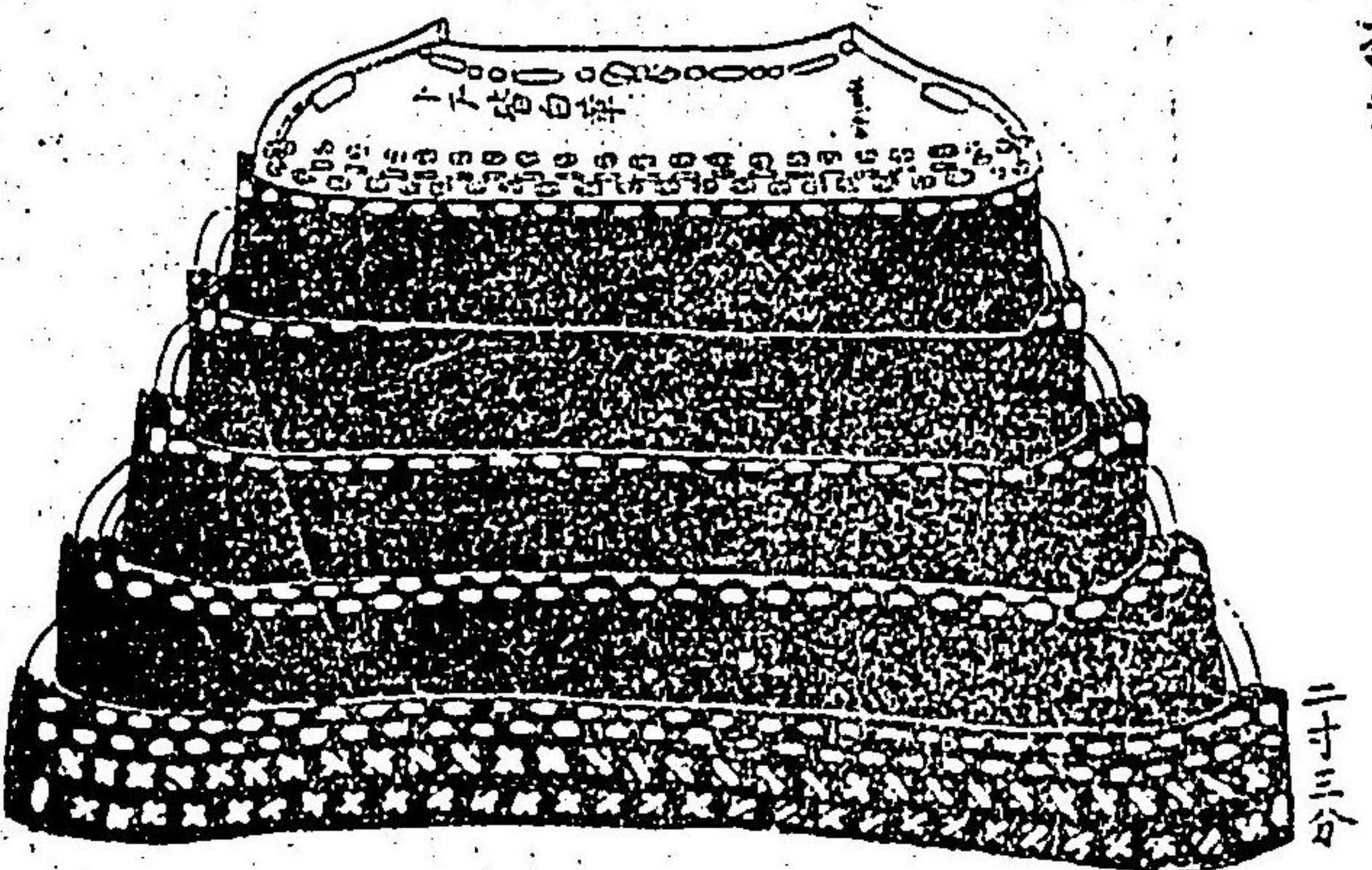

同藏盤子櫃圖 此櫃中二領共納内外櫛本地古色漆アリノ如 内一領第二卷出

草摺反リ

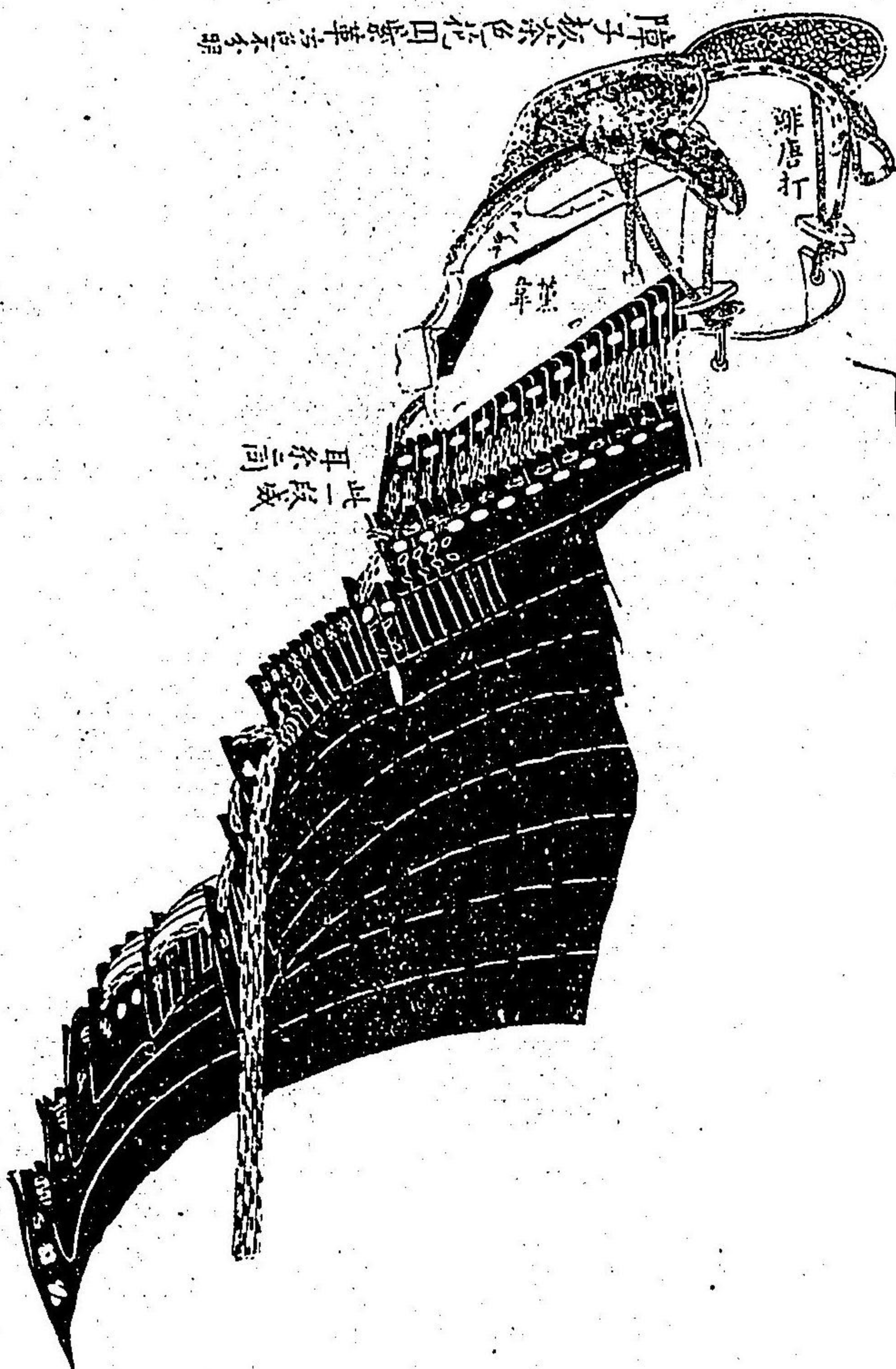

金物章伏組胸板三向

辨唐打

草葉

此一段成
甲終同

甲子終終色花田家傳為本朝

引敷反

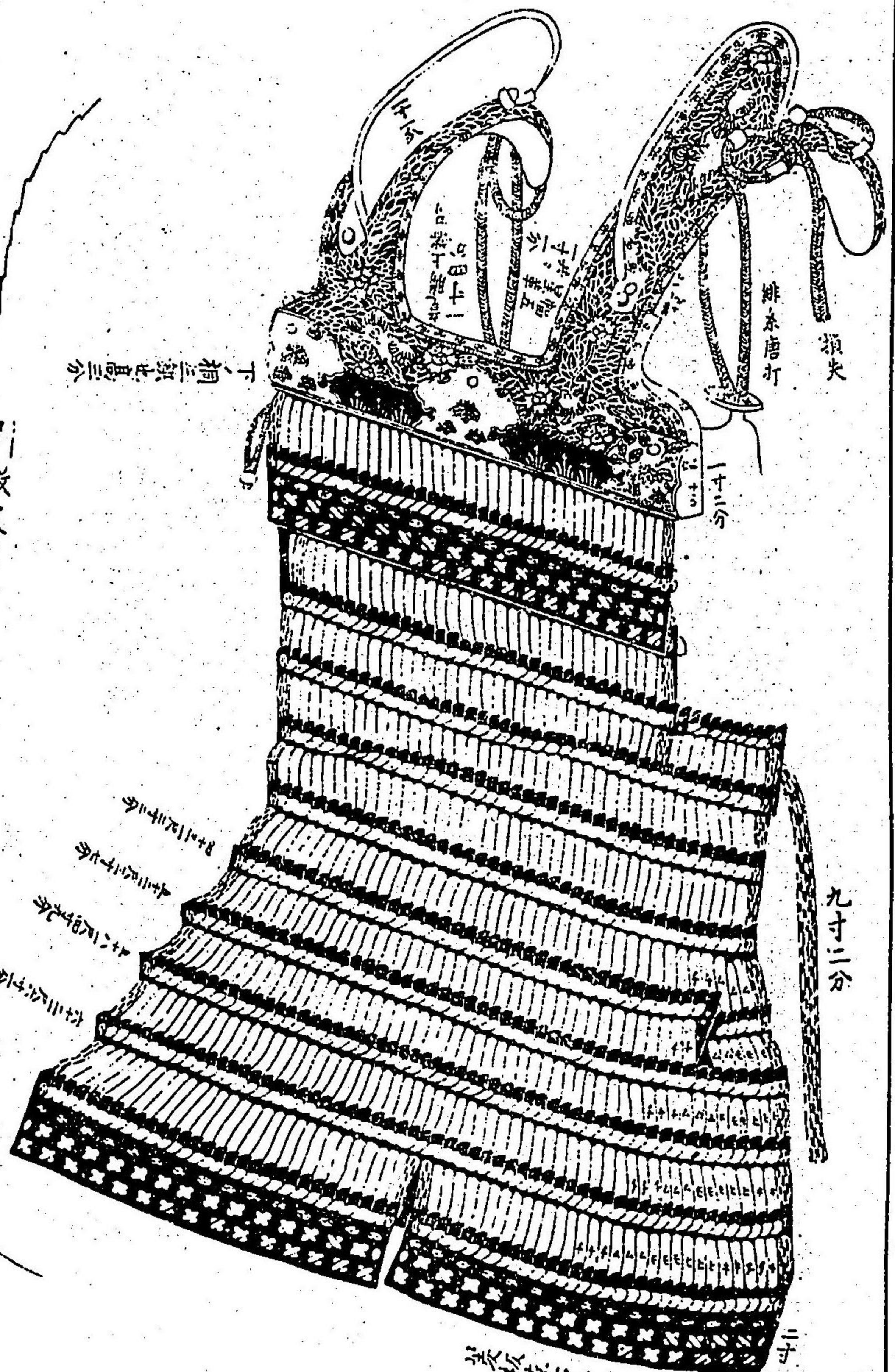

九寸二分

寸

辨本唐打

穎尖

一十二分

下欄三類七最三

茶茶左右合六十八尺寸五分

小出輪
金物章伏組
前同

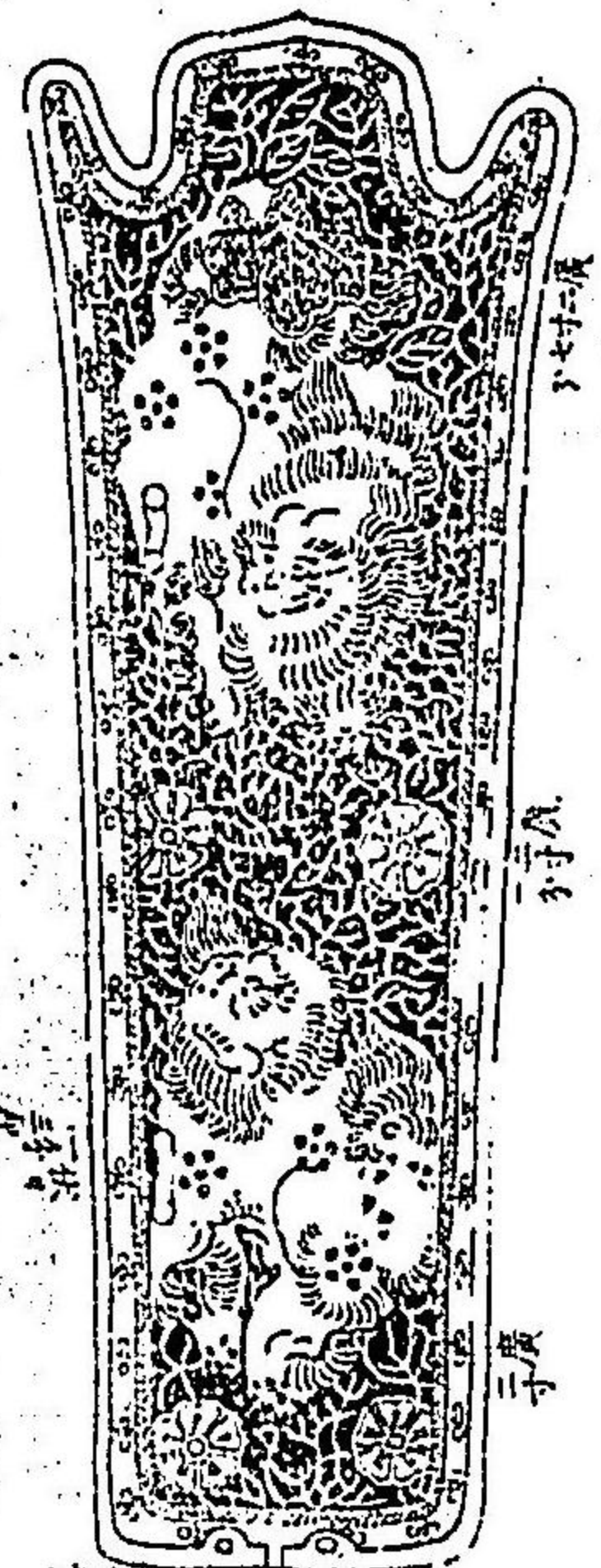

同模



裏

章障子板裏同



柃檀板 長 七寸三分 金物滅金
小礼長二寸一分

威皆白

廣四寸

寬勝損失

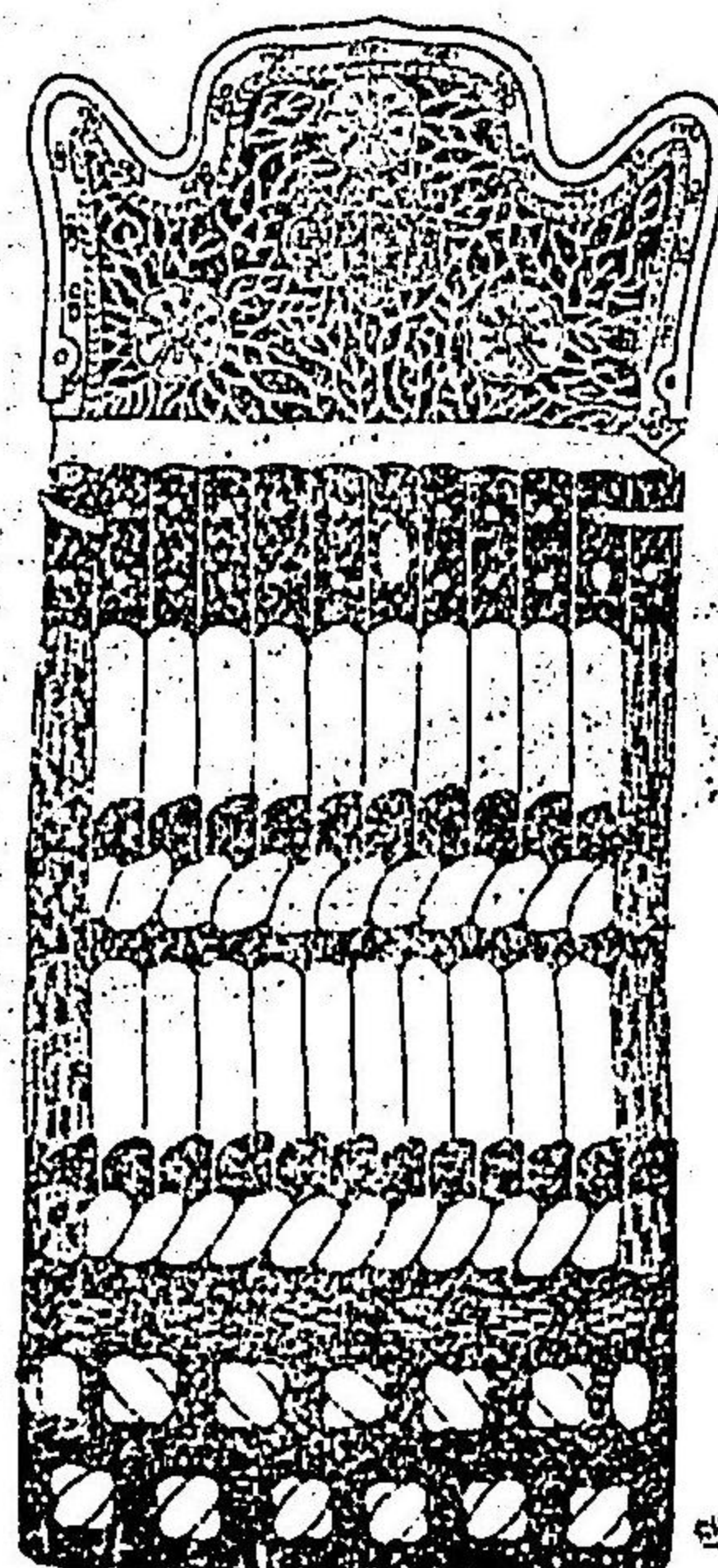

章伏組且系胸板同

長川中|金計

裏章障子板
裏章二同

長二寸一分

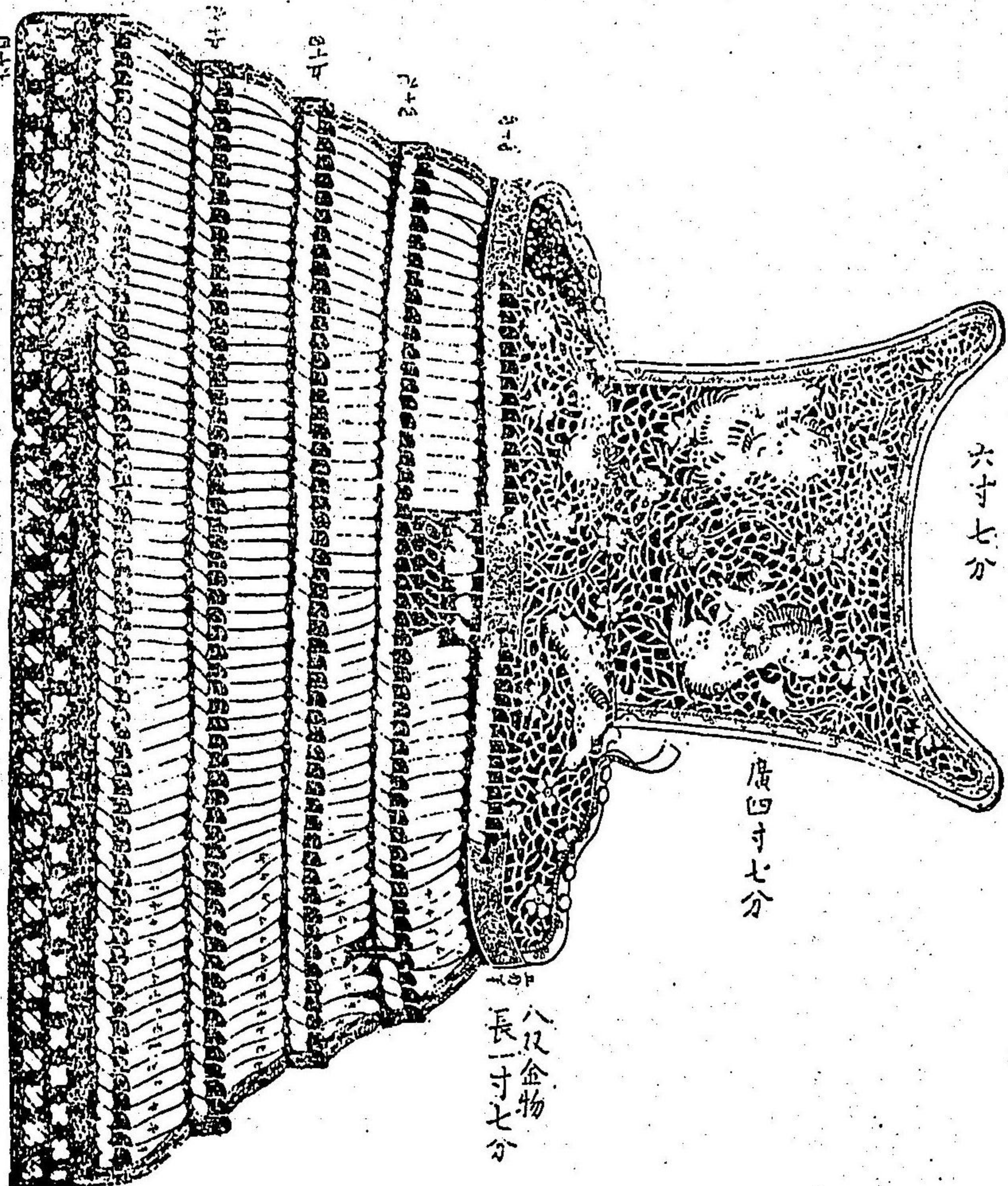
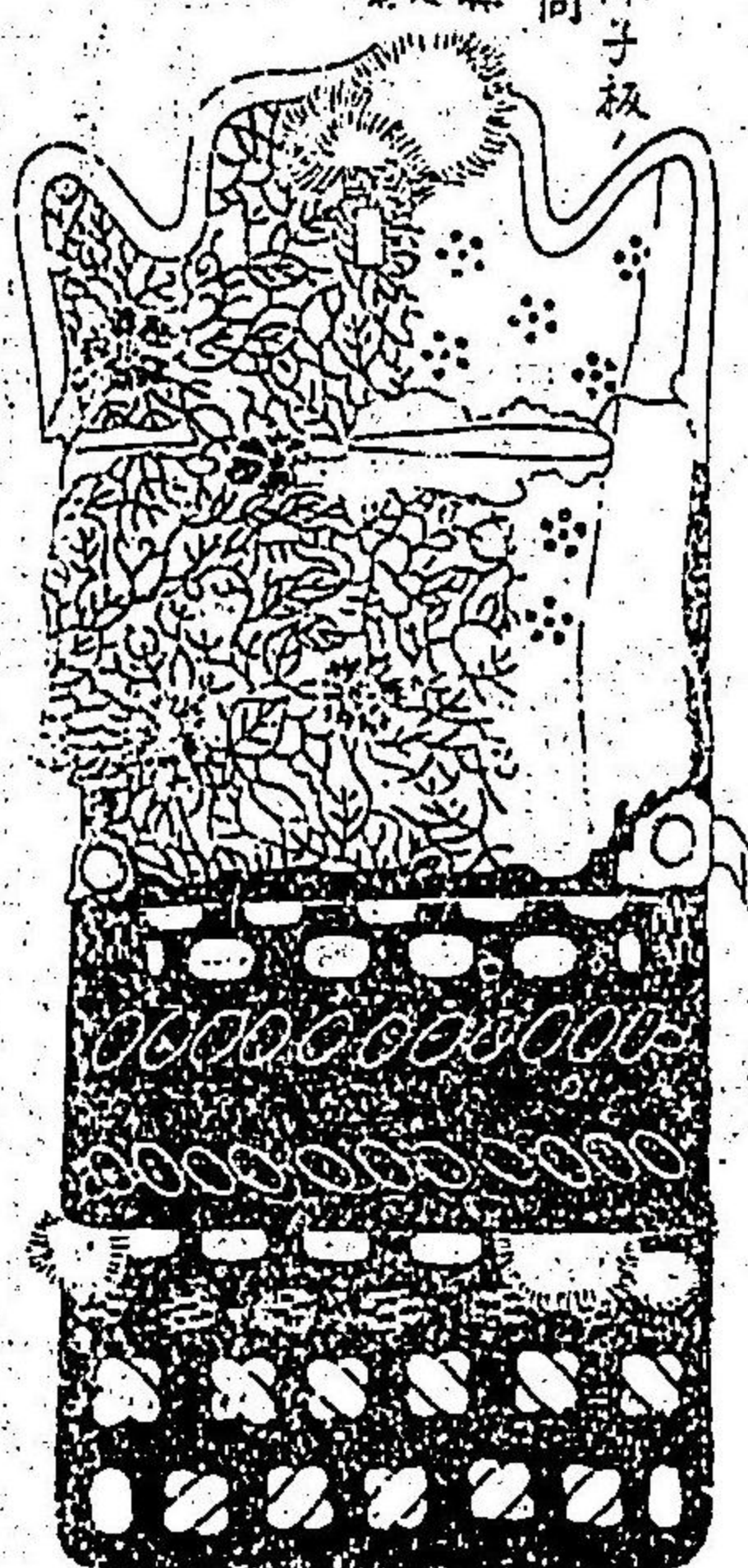

六寸七分

廣四寸七分

八尺金物
長一丈七分

脇指 裝身伏組金物身系新同

菱縫排

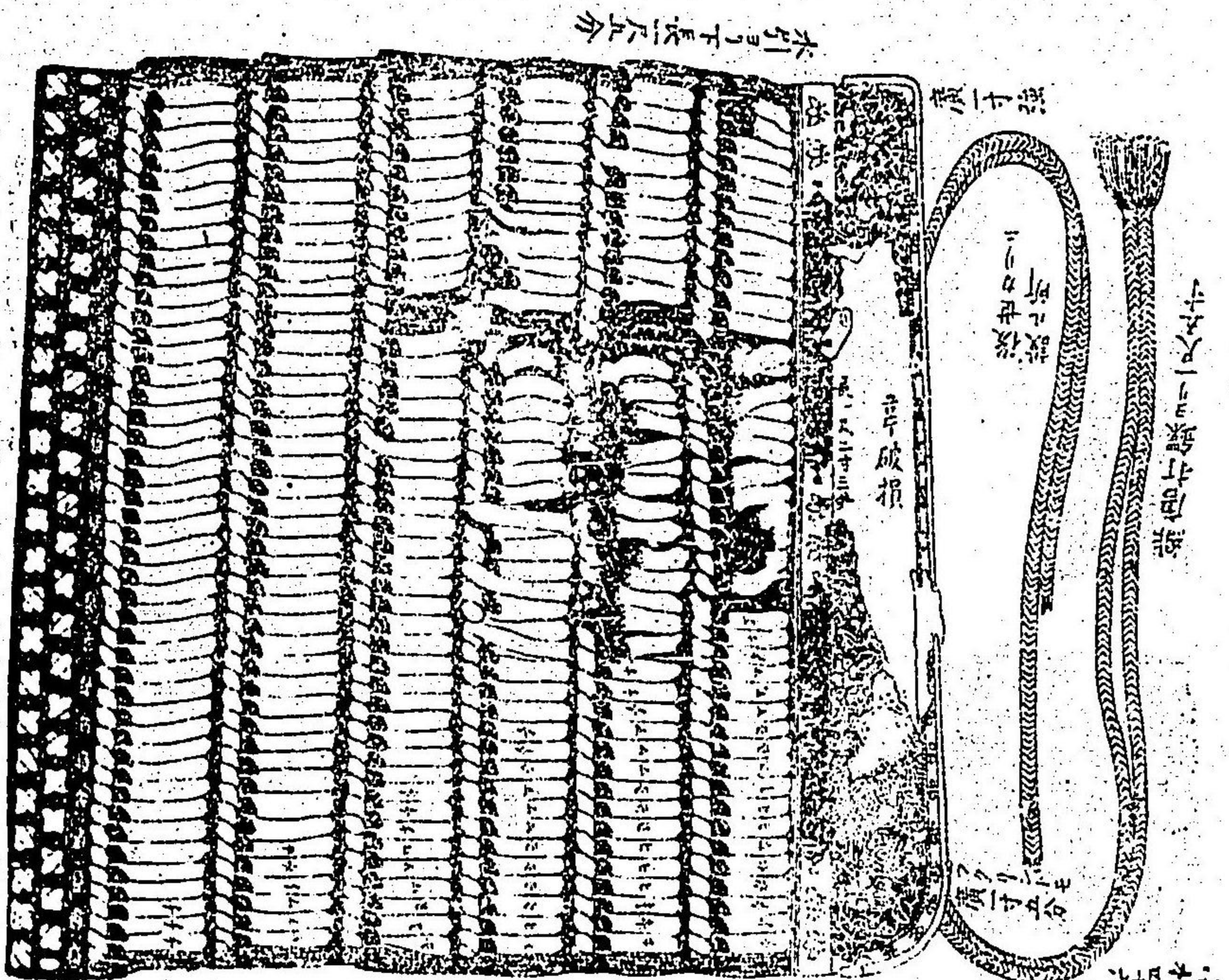
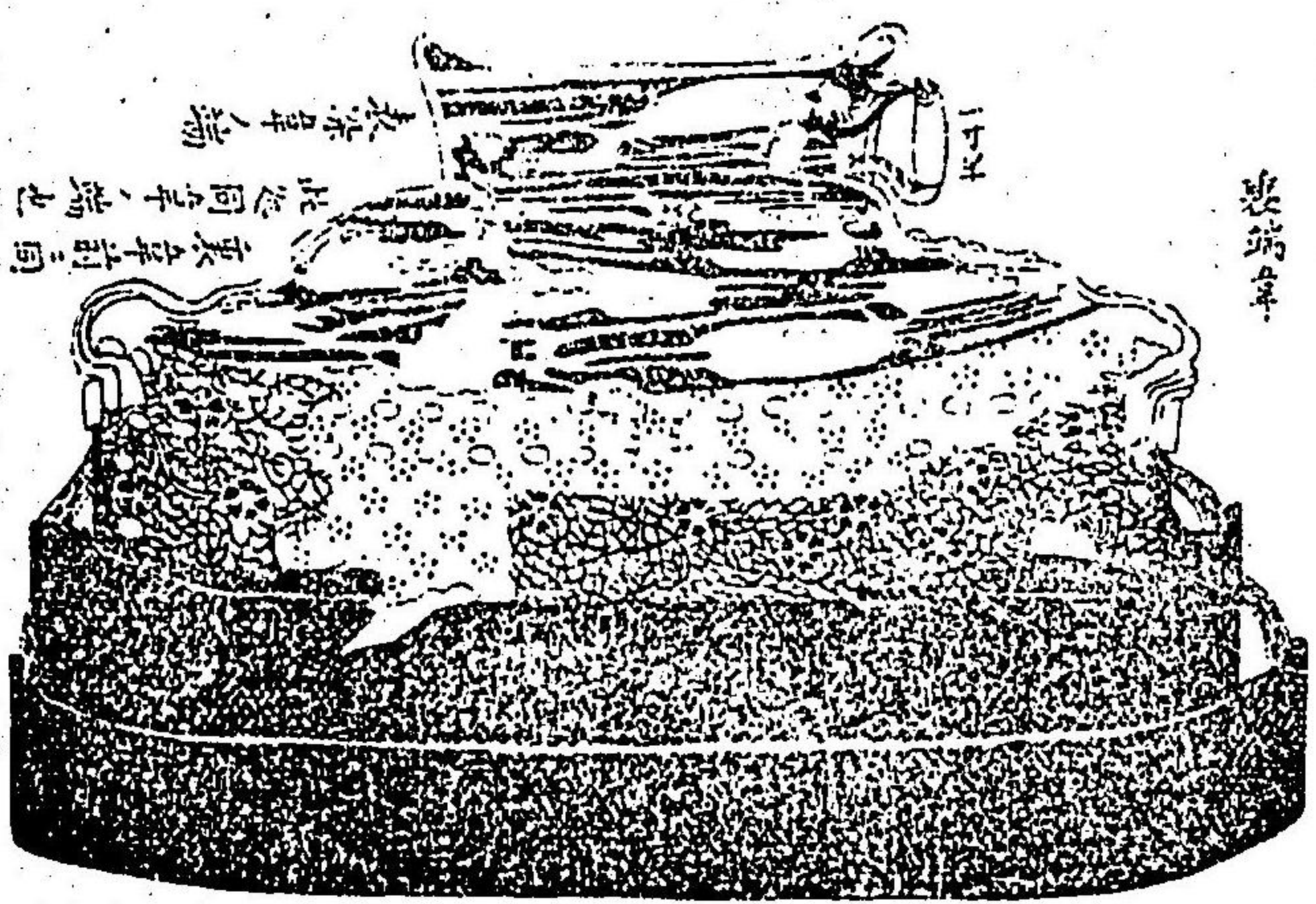
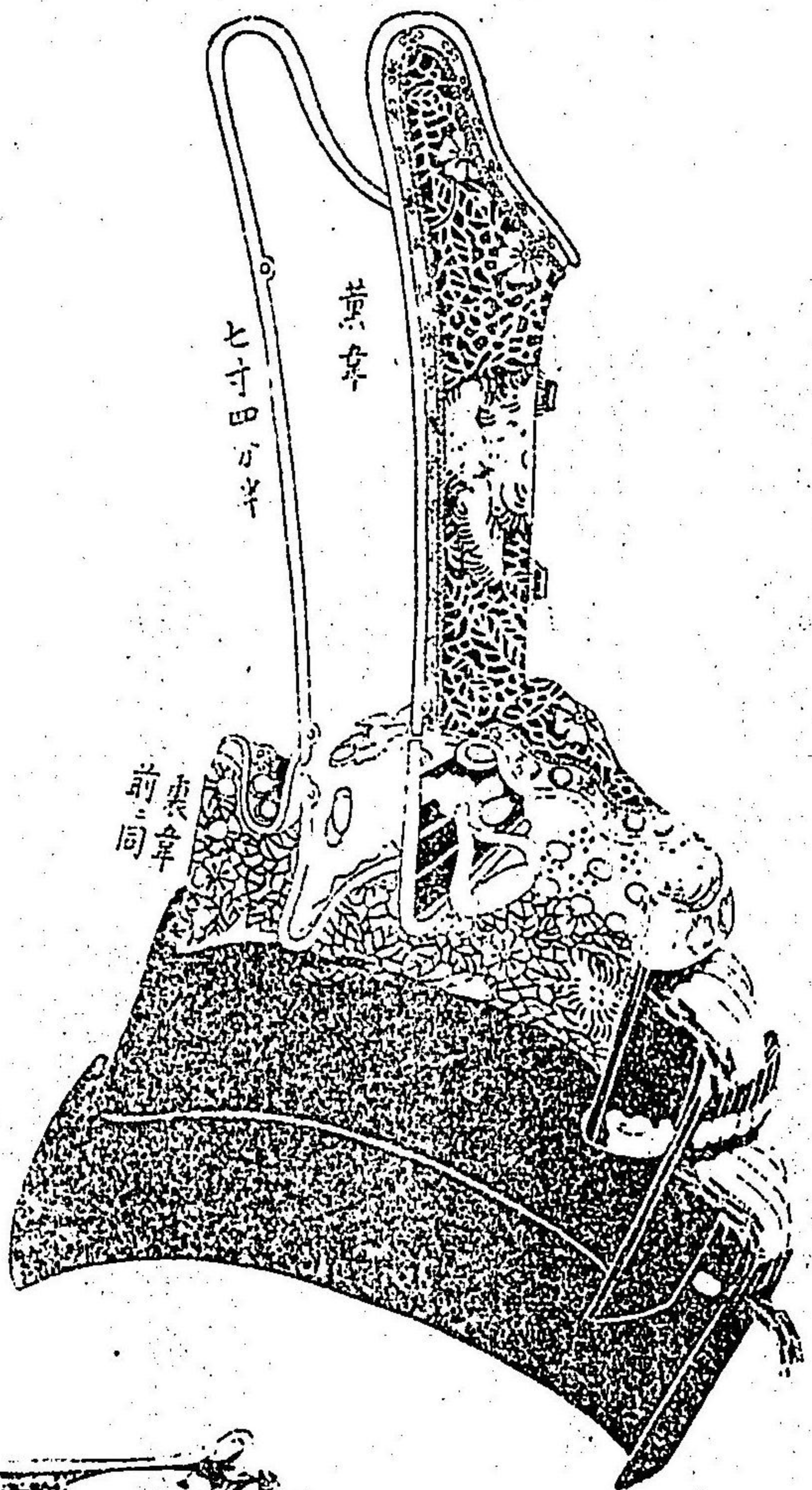

礼四十六
八双金物 堅立分接立分水引二款共白
右袖
前裏章外
同

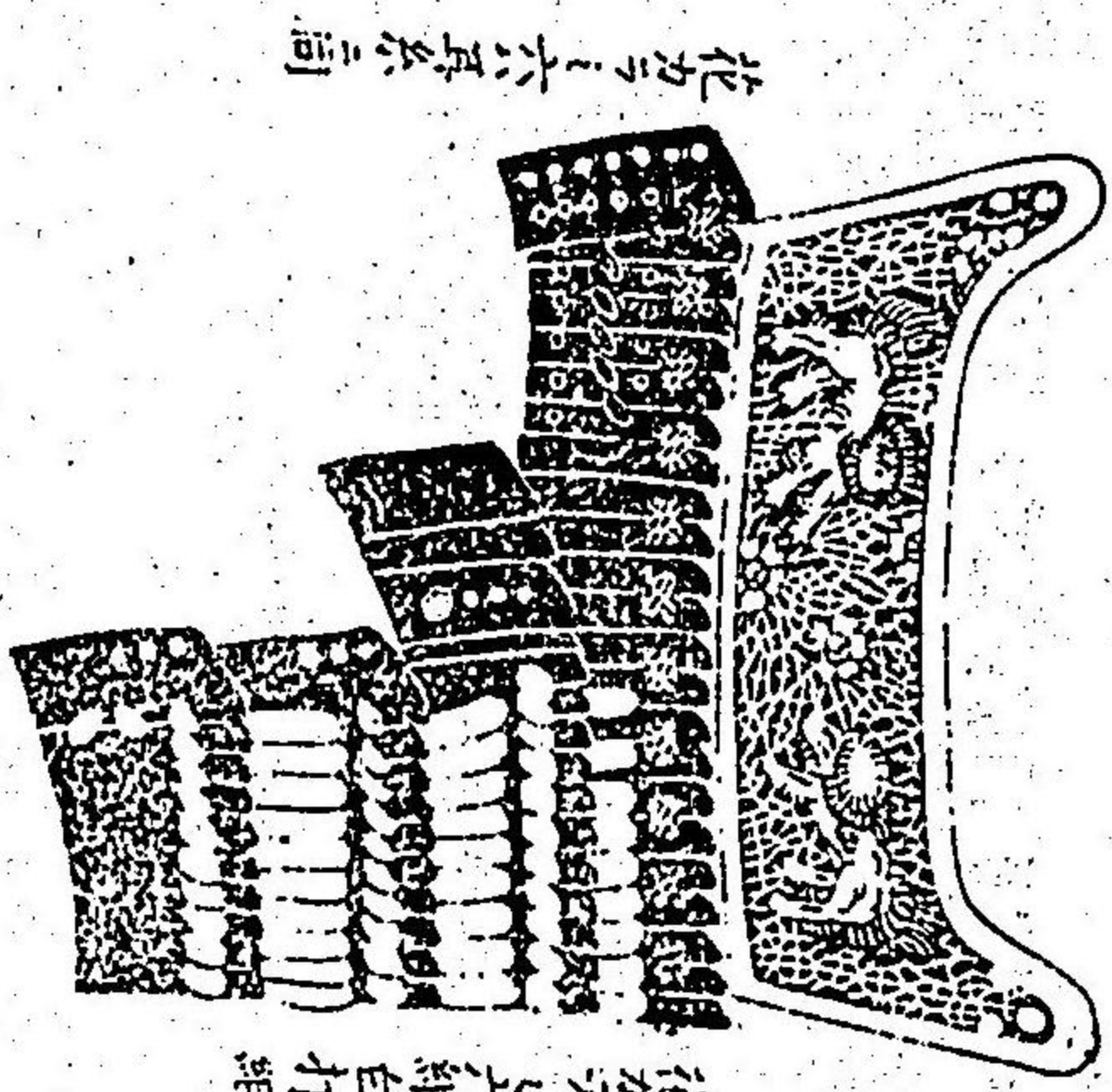

花乃六打組

射向金物其外共前同

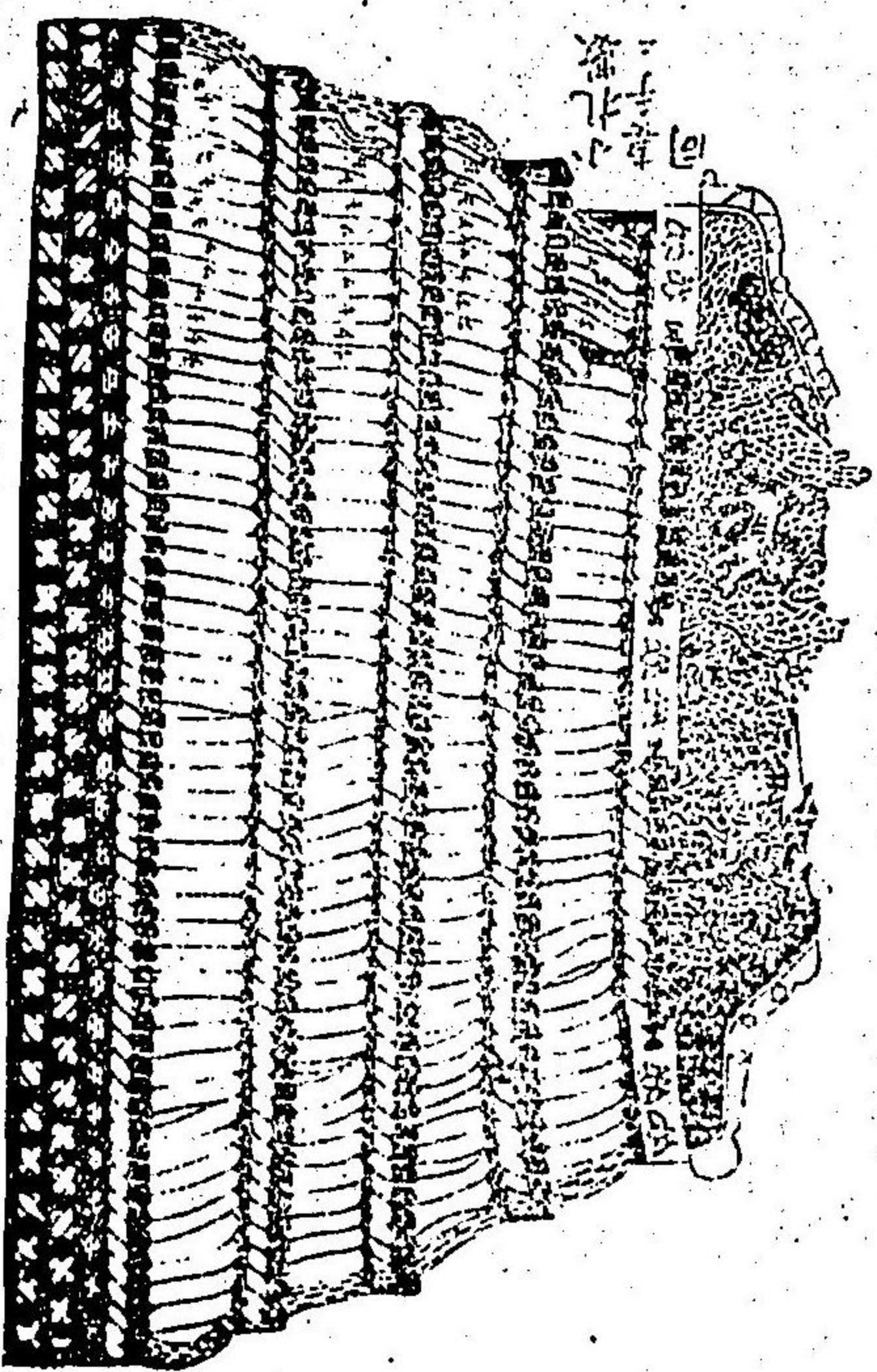

胴後

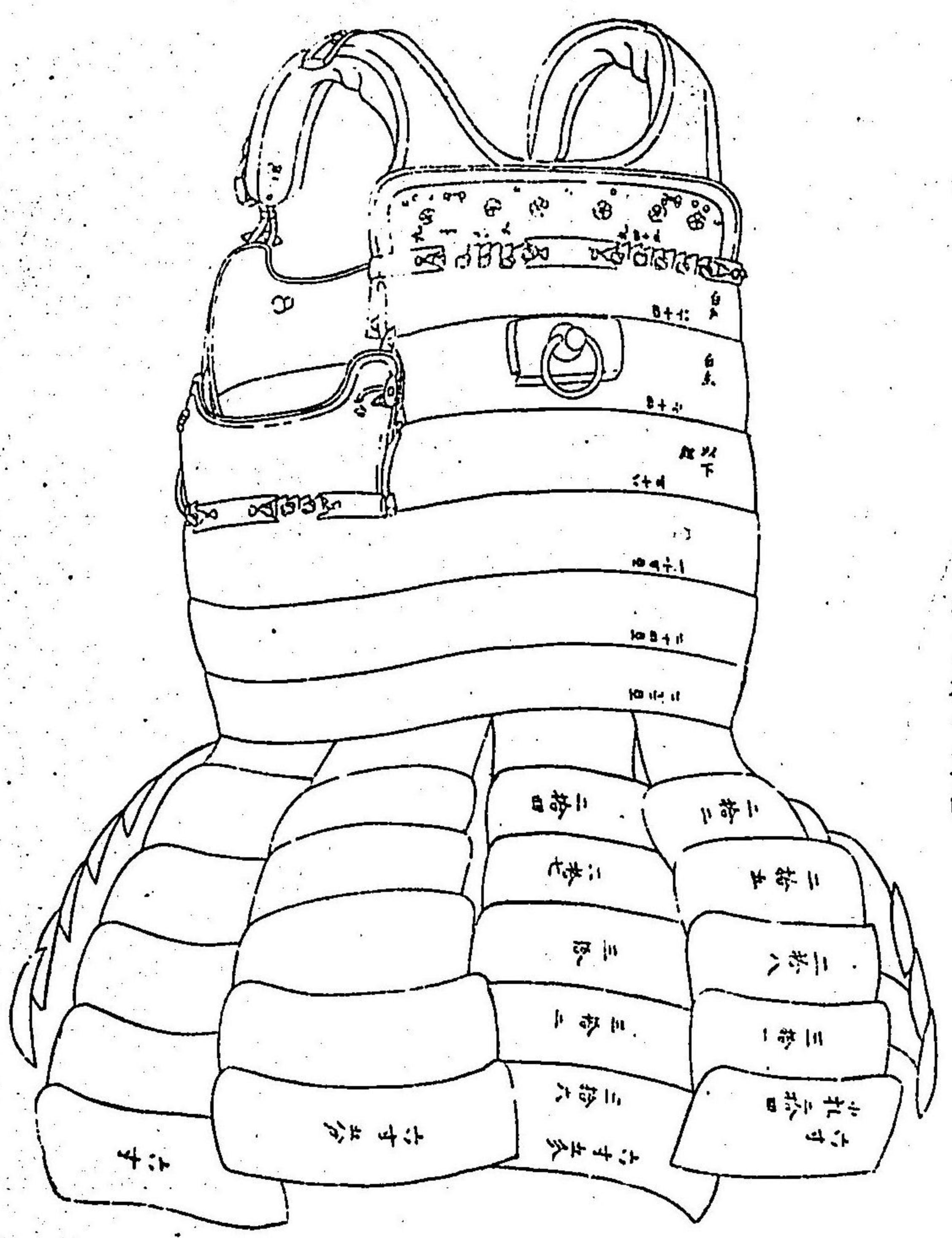

草摺裏柑子草包

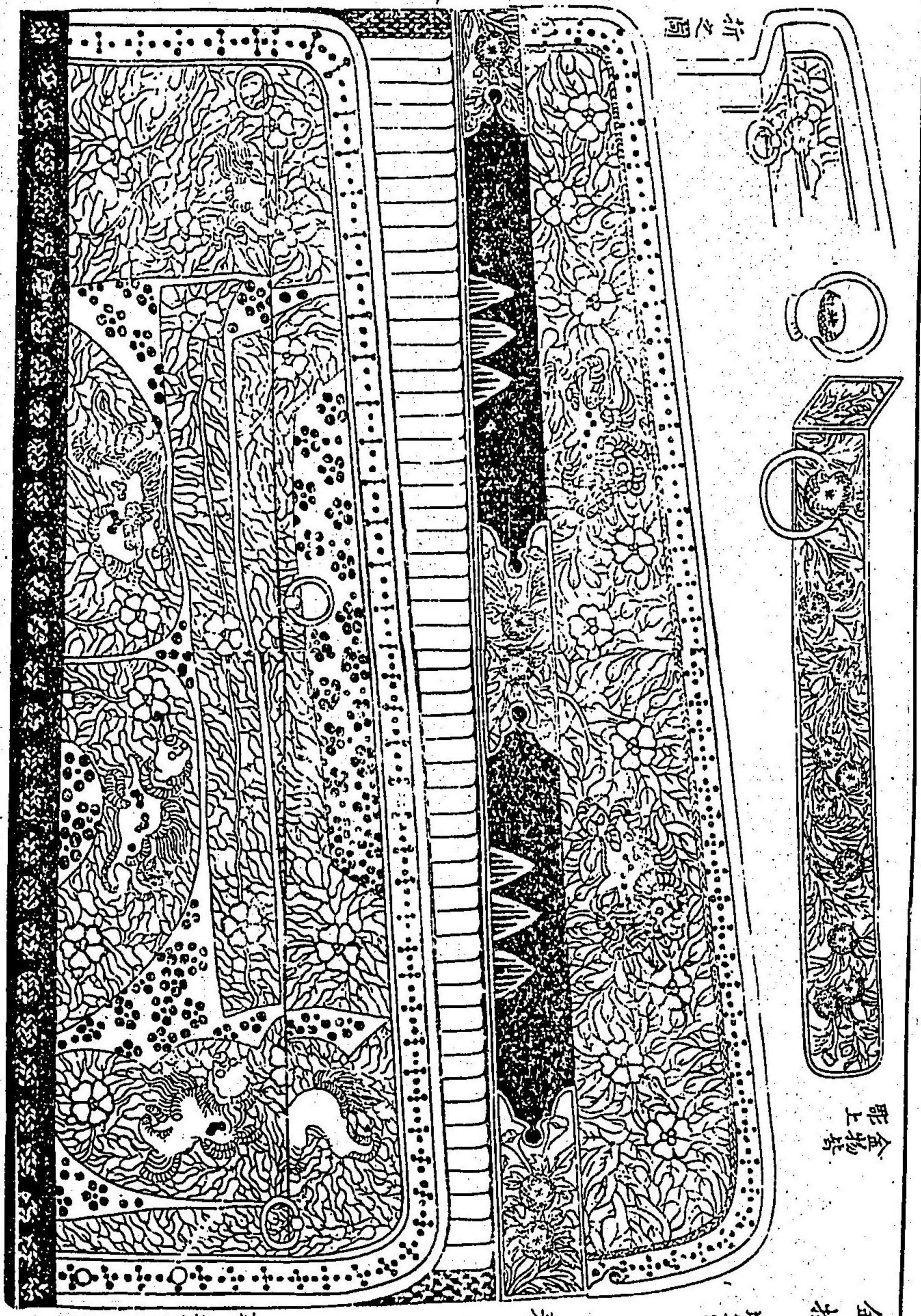

金冠物板
皇赤草菅司
上平草摺
地名

表
東地草菅大

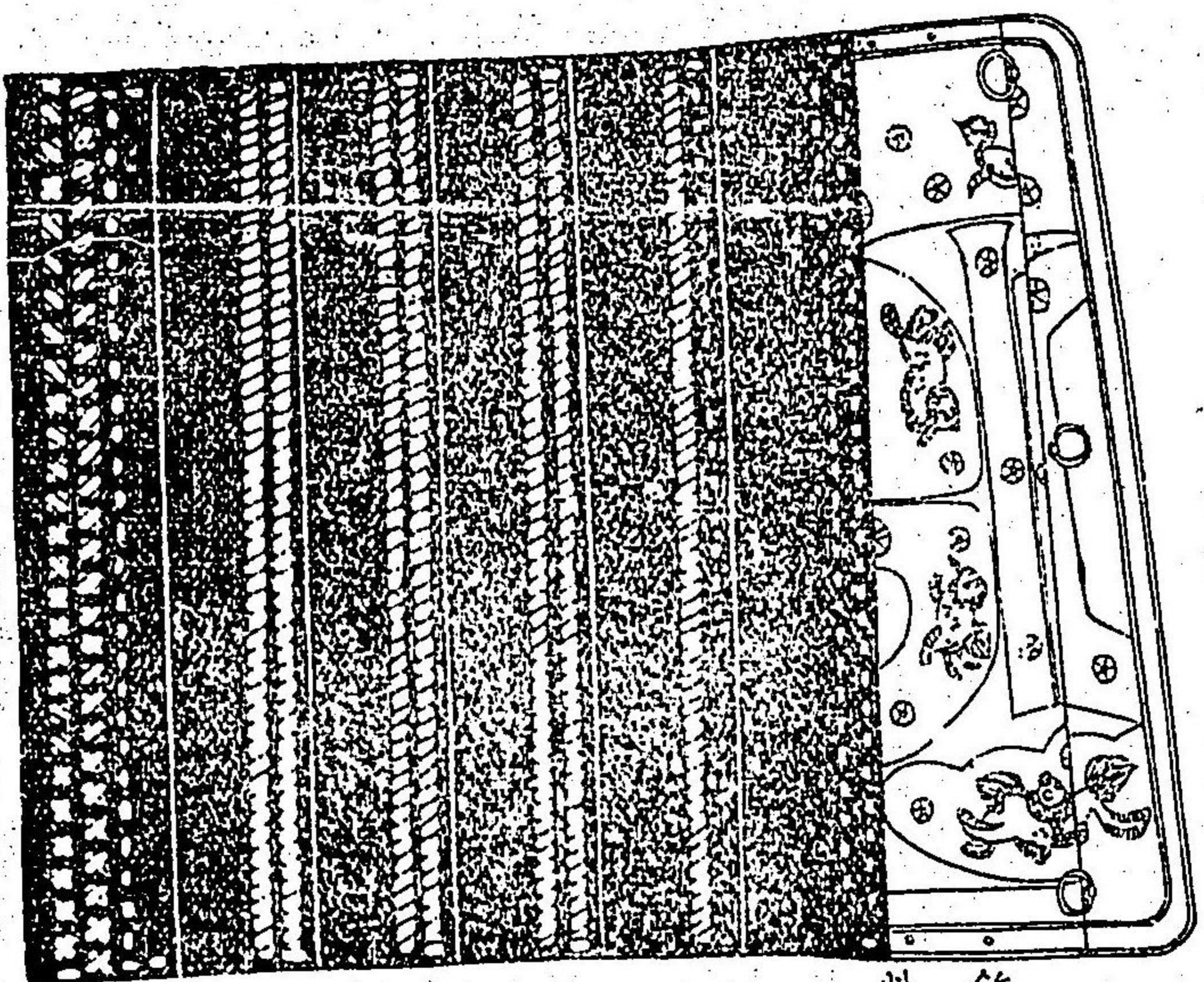

裏圖

二
打
組
或
東

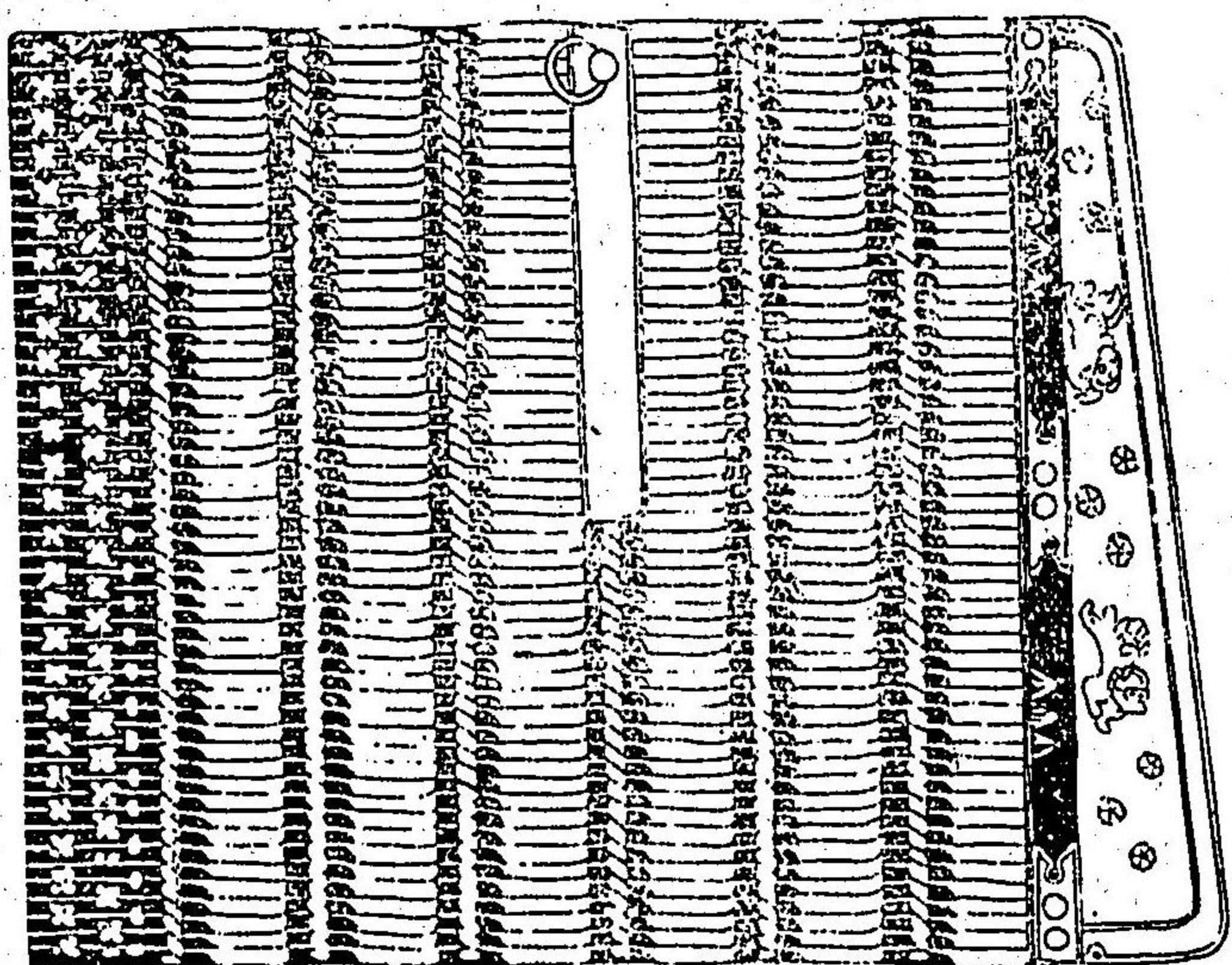

表圖

袖
金助耳表
伏組同上

赤引
白
上段白糸以下紺糸小孔五十四

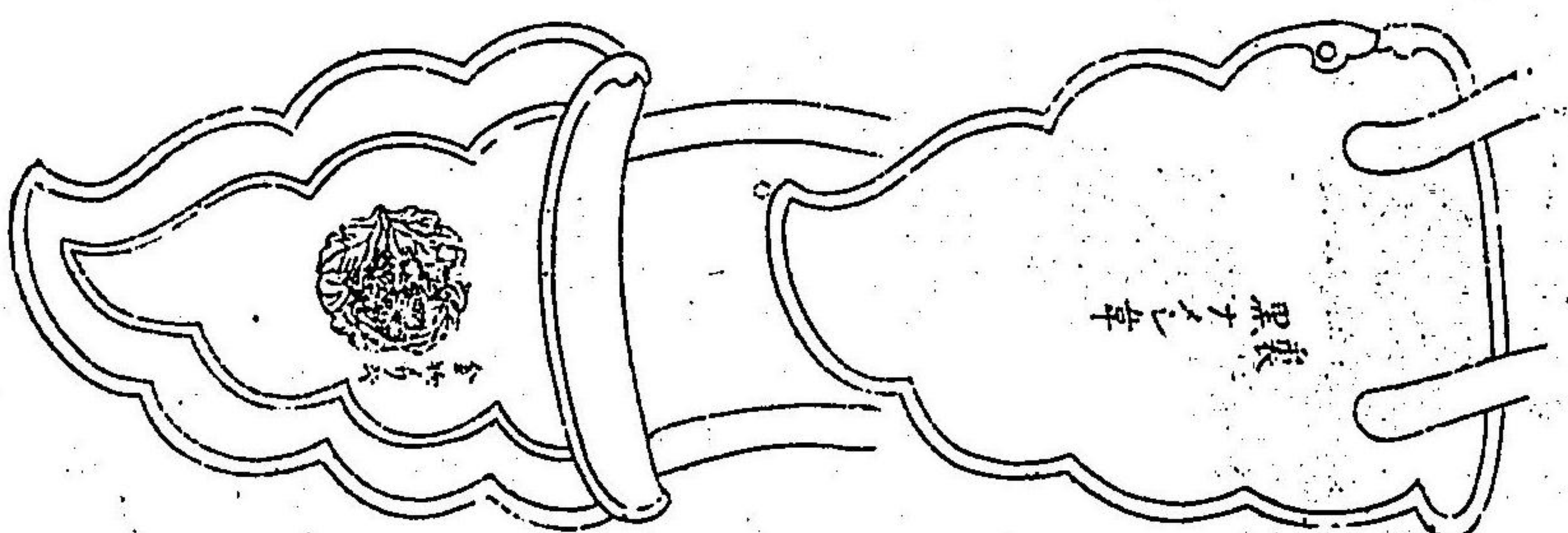

裏
黒糸之半

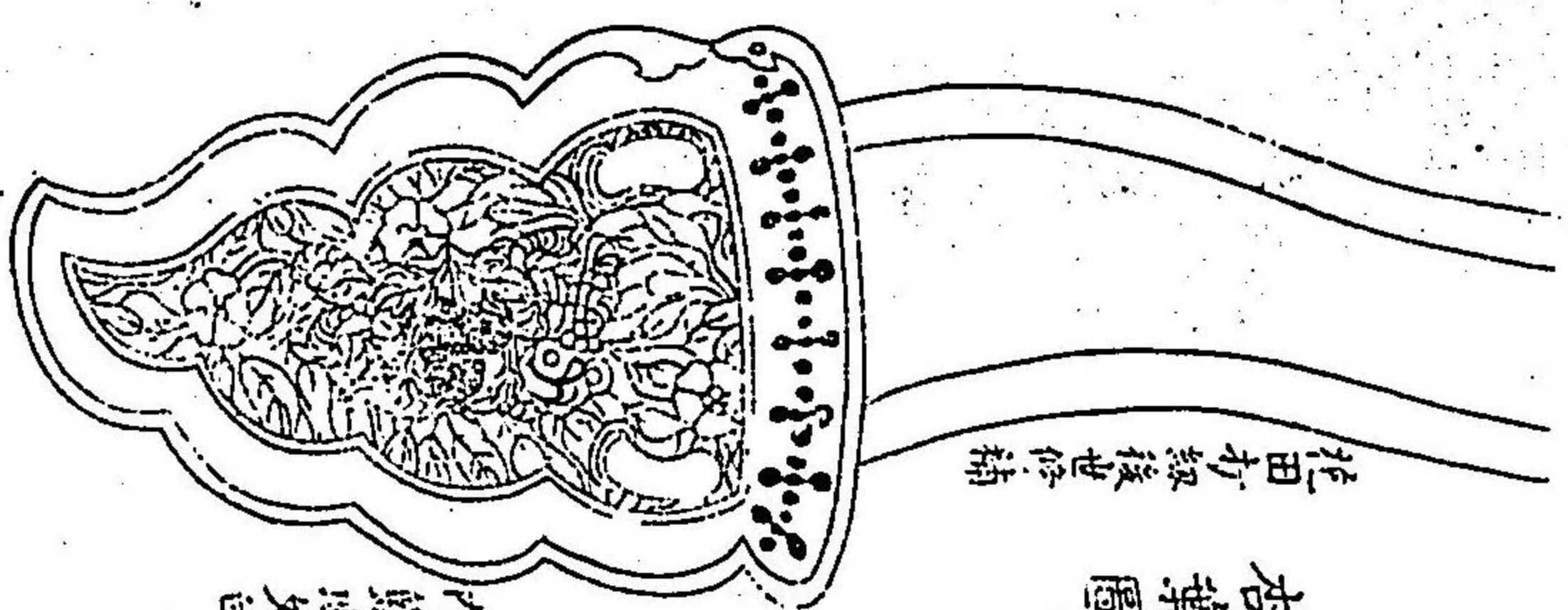

杏葉圖

花田打紐後世修補

紫立星弁
内盤地文白

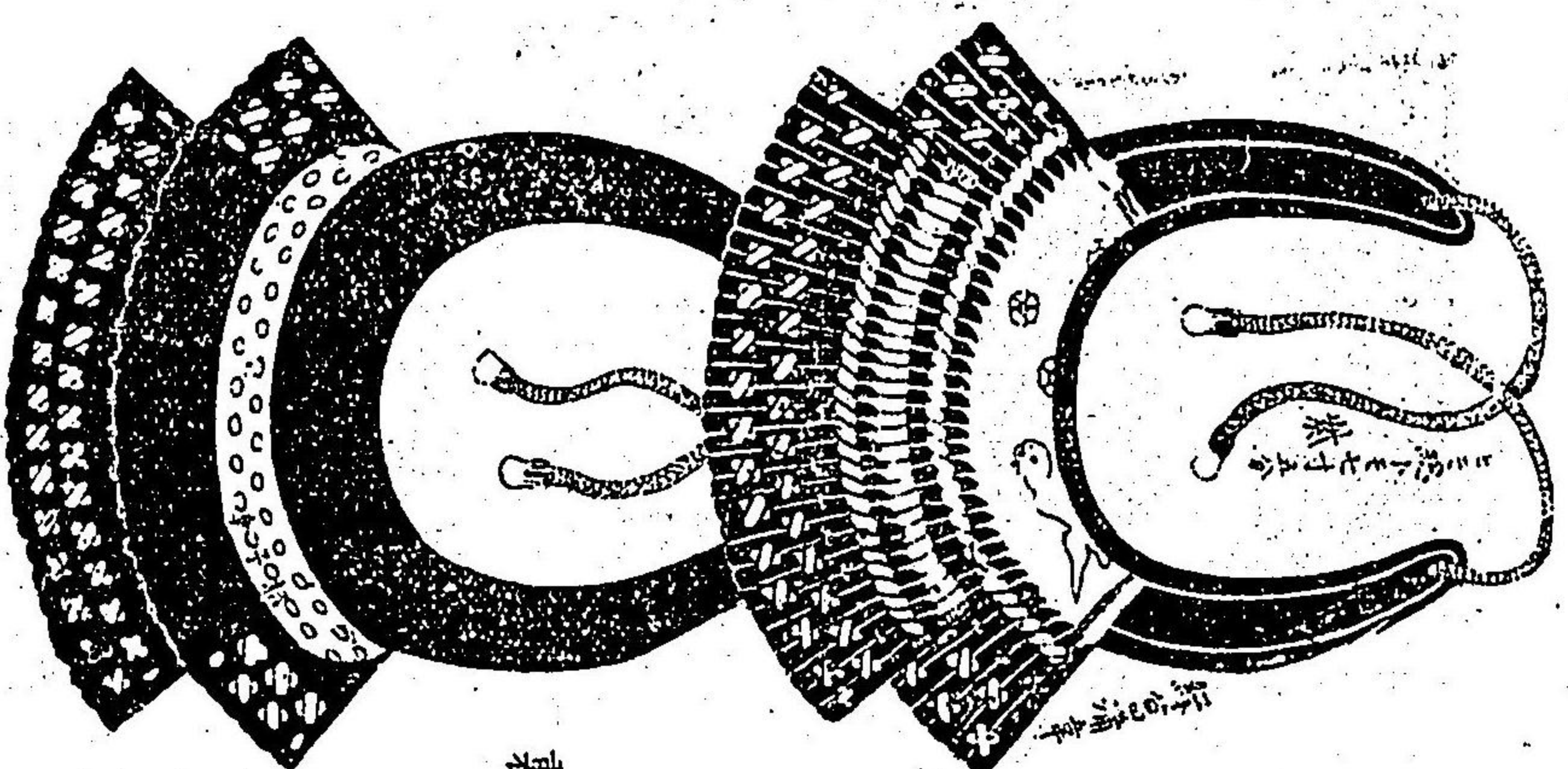

喉輪

耳糸同上或辨糸

裏

後

錦

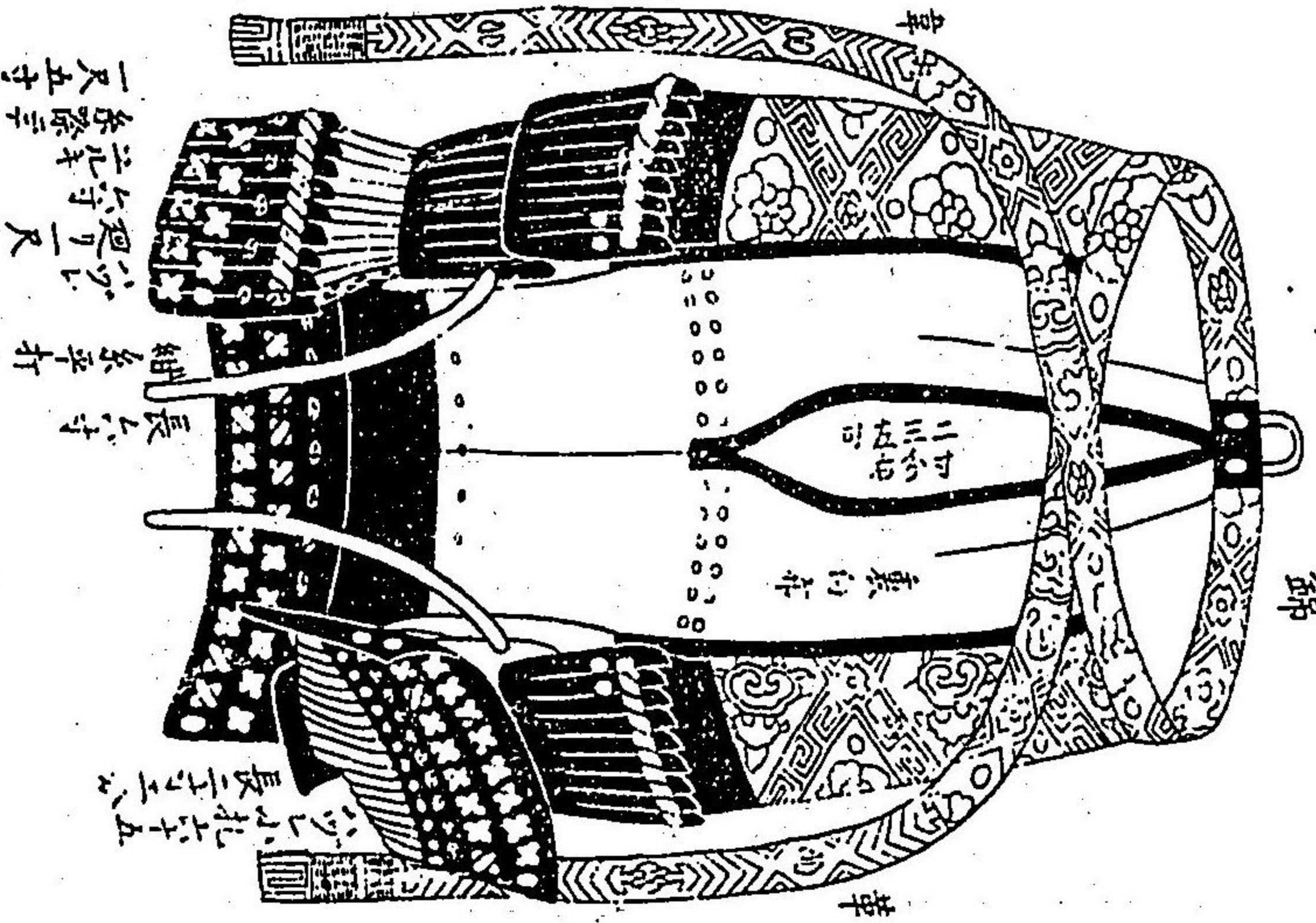

前

錦

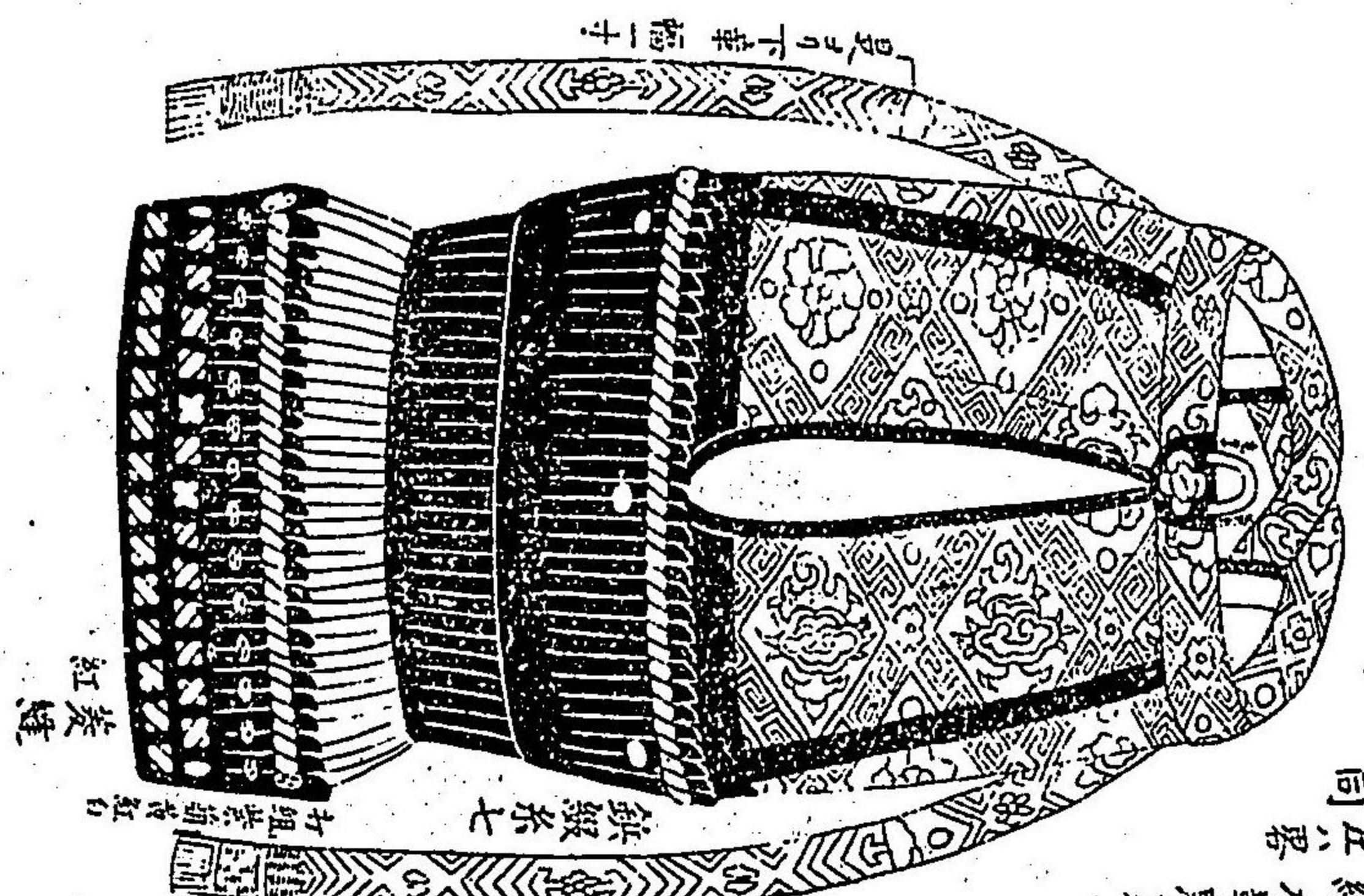

松浦家藏膝鎧圖
足利義教公所賜
北黑威毛紺刀鞆第六、
膝鎧右ノ面左、界
无割左右共同
上板八寸四分、一分廻リ上、二尺三分下、三寸三分
次板七寸七分、一分廻リ上、一尺七寸八分下、一尺六寸
八分下散、一尺八寸二分上、一尺六寸九分下、一分三分

一十六

同藏腹當圖 同

小孔雀包威系紅

金拵管金ノ寸キ

打細白威黒朝黃

胸板クミヨリ赤板ノ一尺八寸

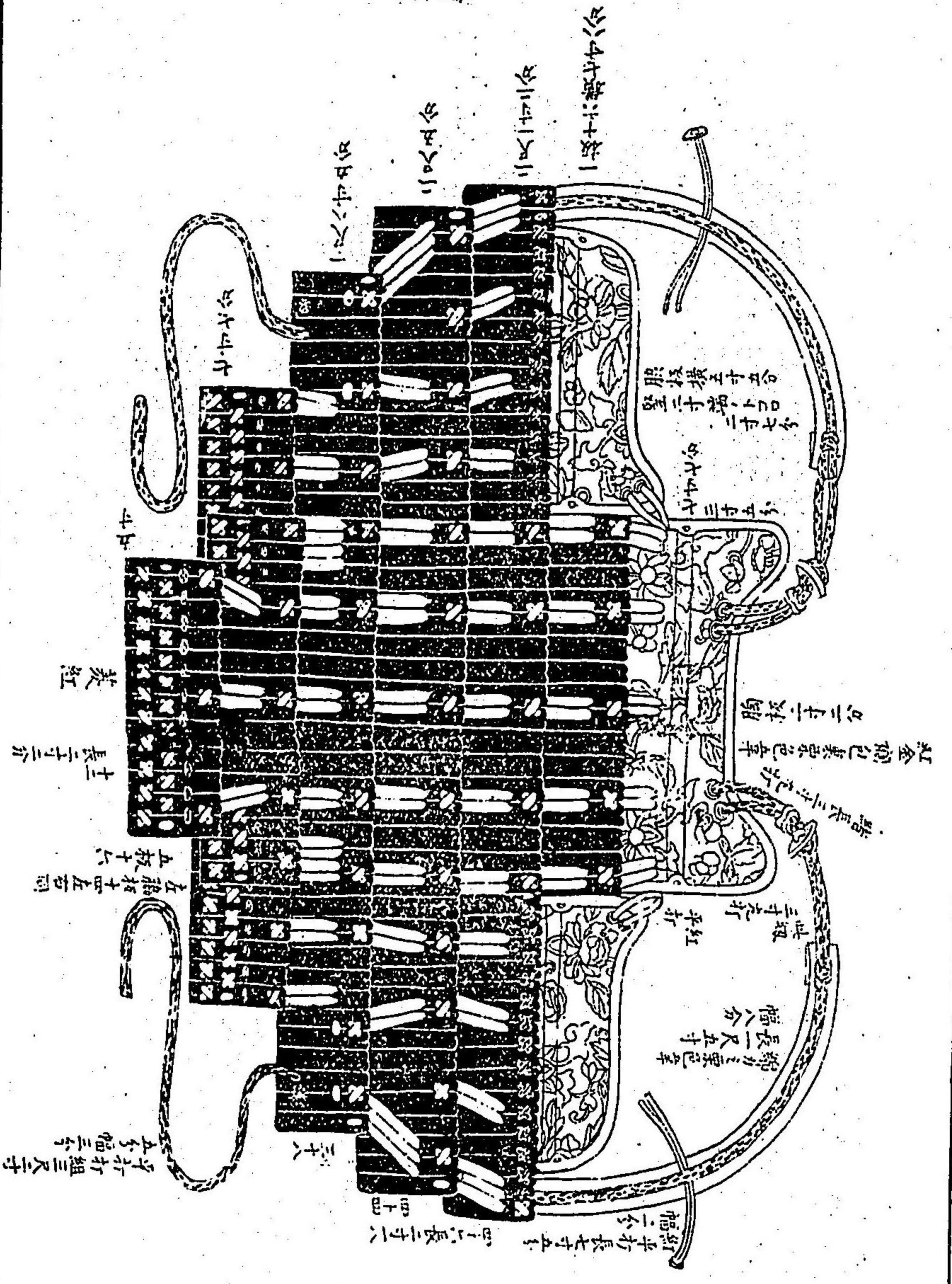

一十二

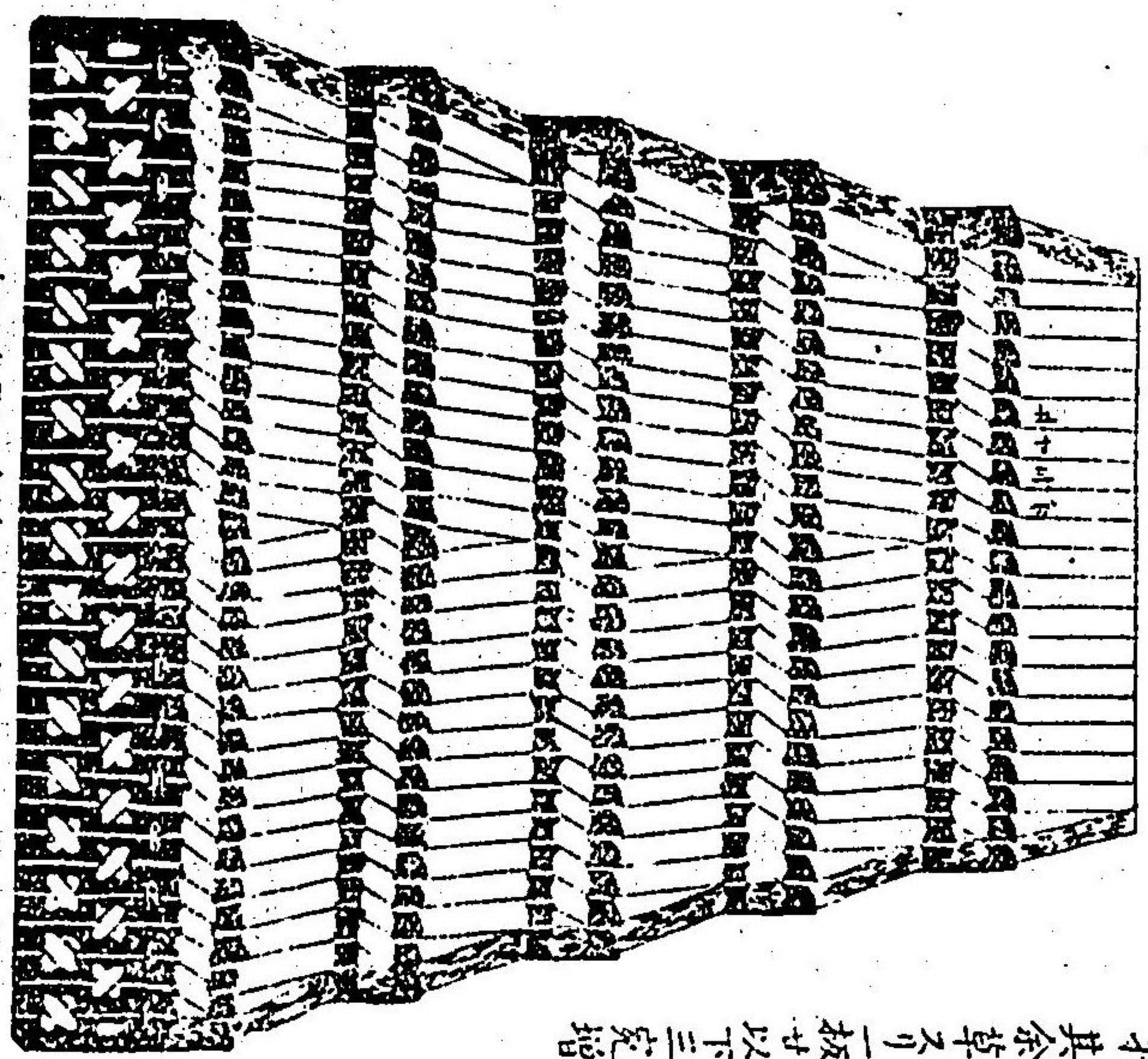

草摺 前二板廿二板廿五三板廿八四板卅一五板卅四
其余草摺不于一板廿以下三定增

前草摺延長七寸八分
其余七寸四分
尺寸



胸板
上端八寸
下七寸分

中央二寸九分

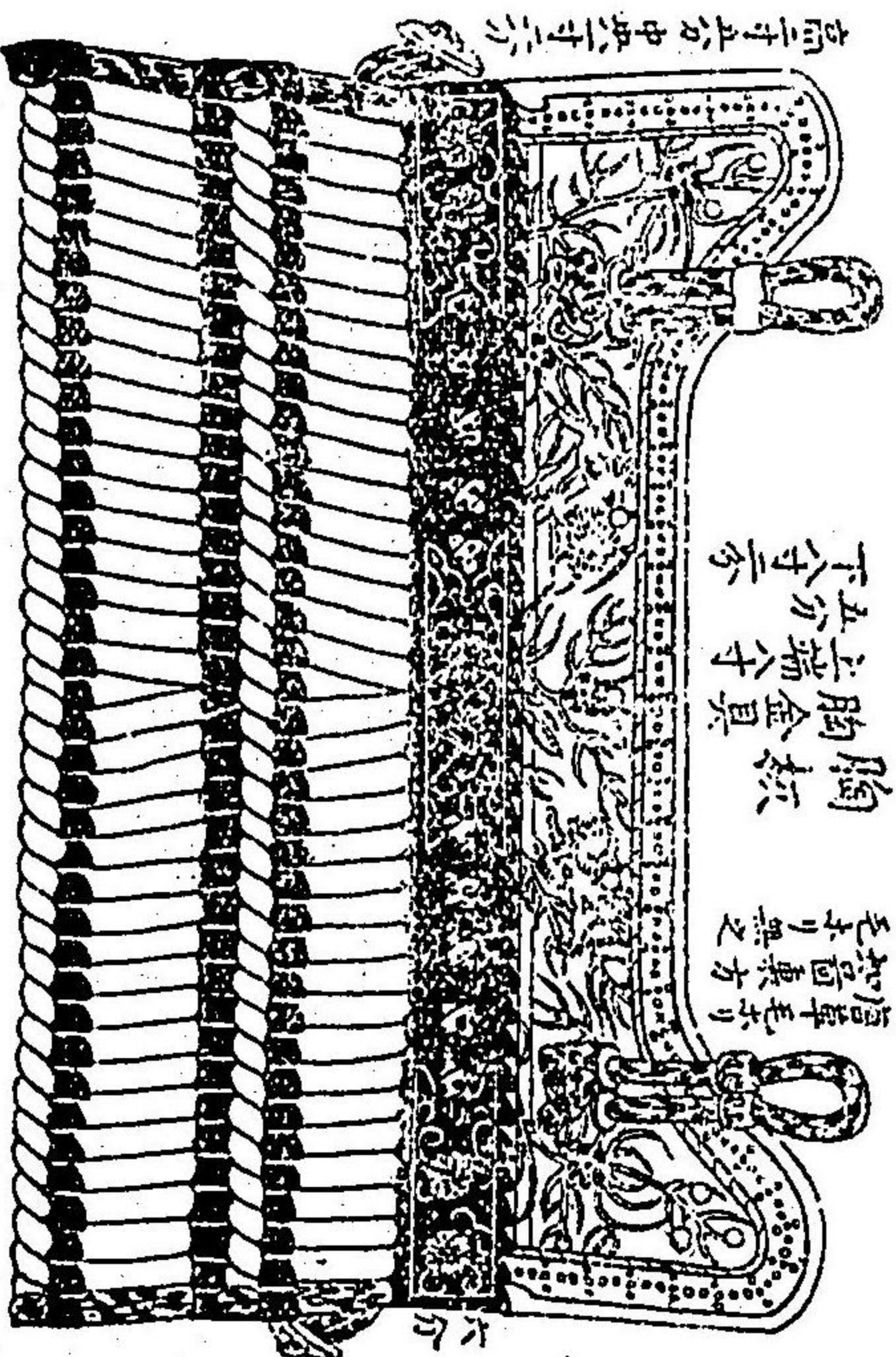

胸板
上端八寸
下七寸分

高四寸方
毛寸無之

高寸方中央寸方

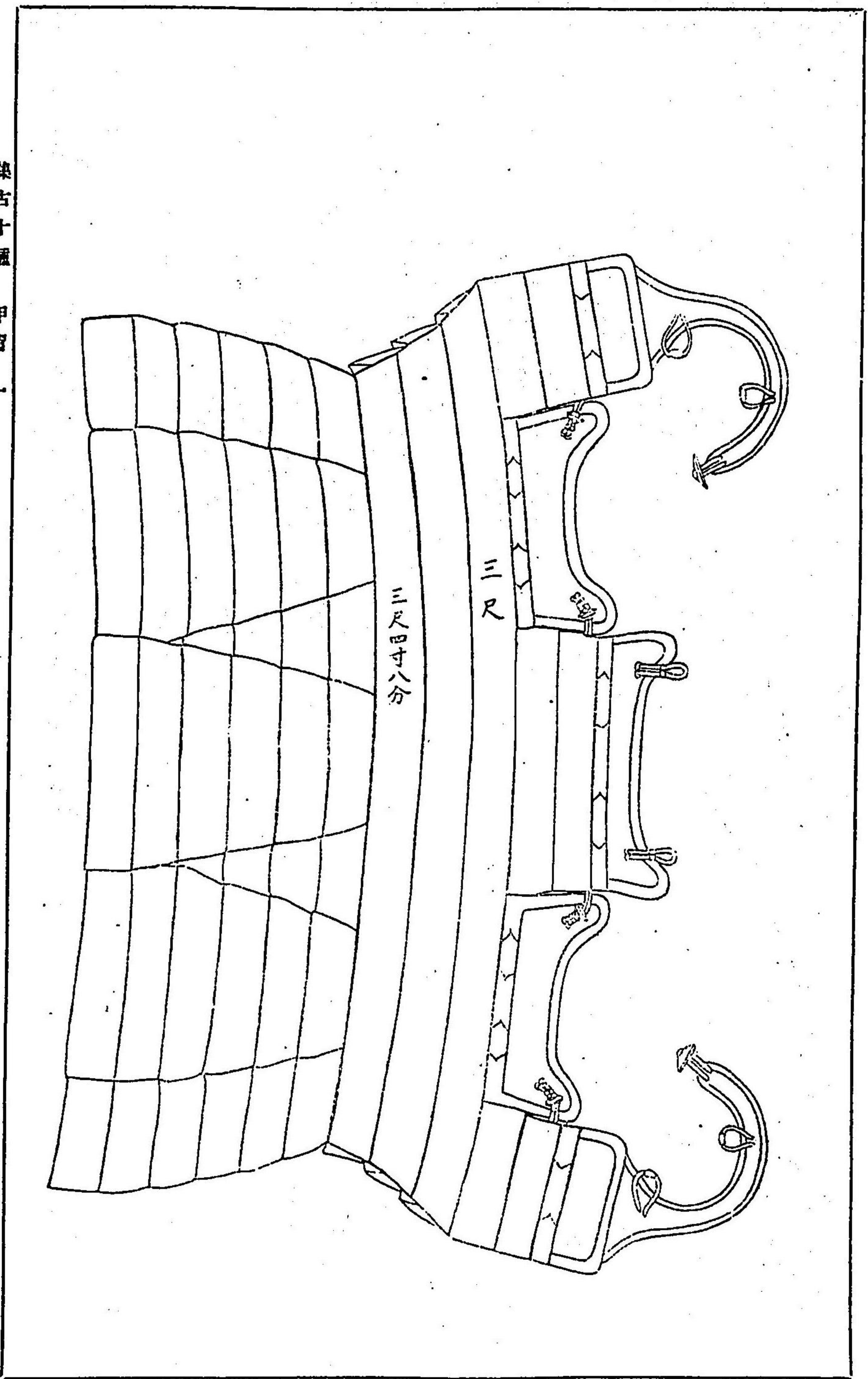

三尺四寸八分

三尺

武藏國多摩郡御嶽權現社藏赤威甲冑圖

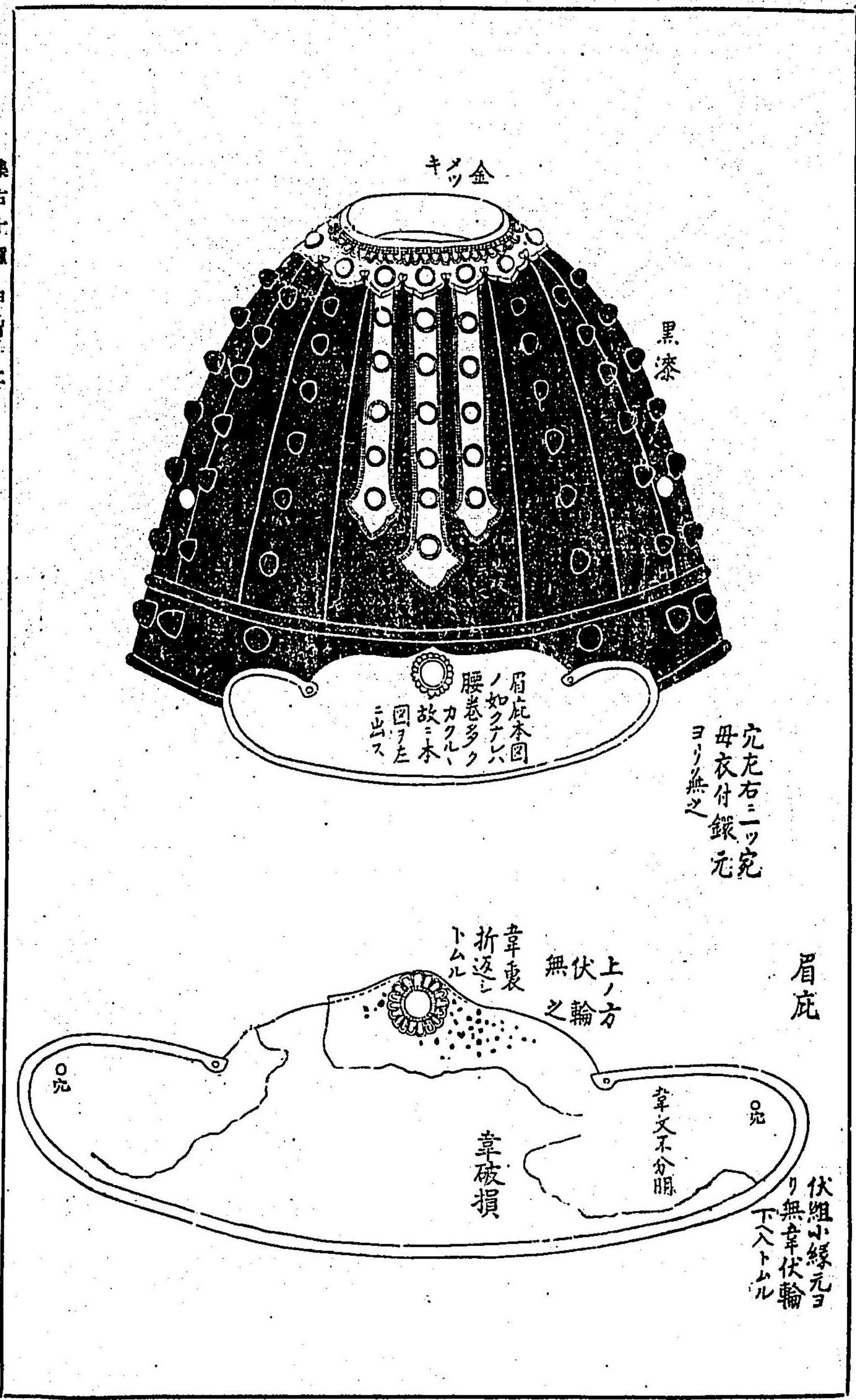
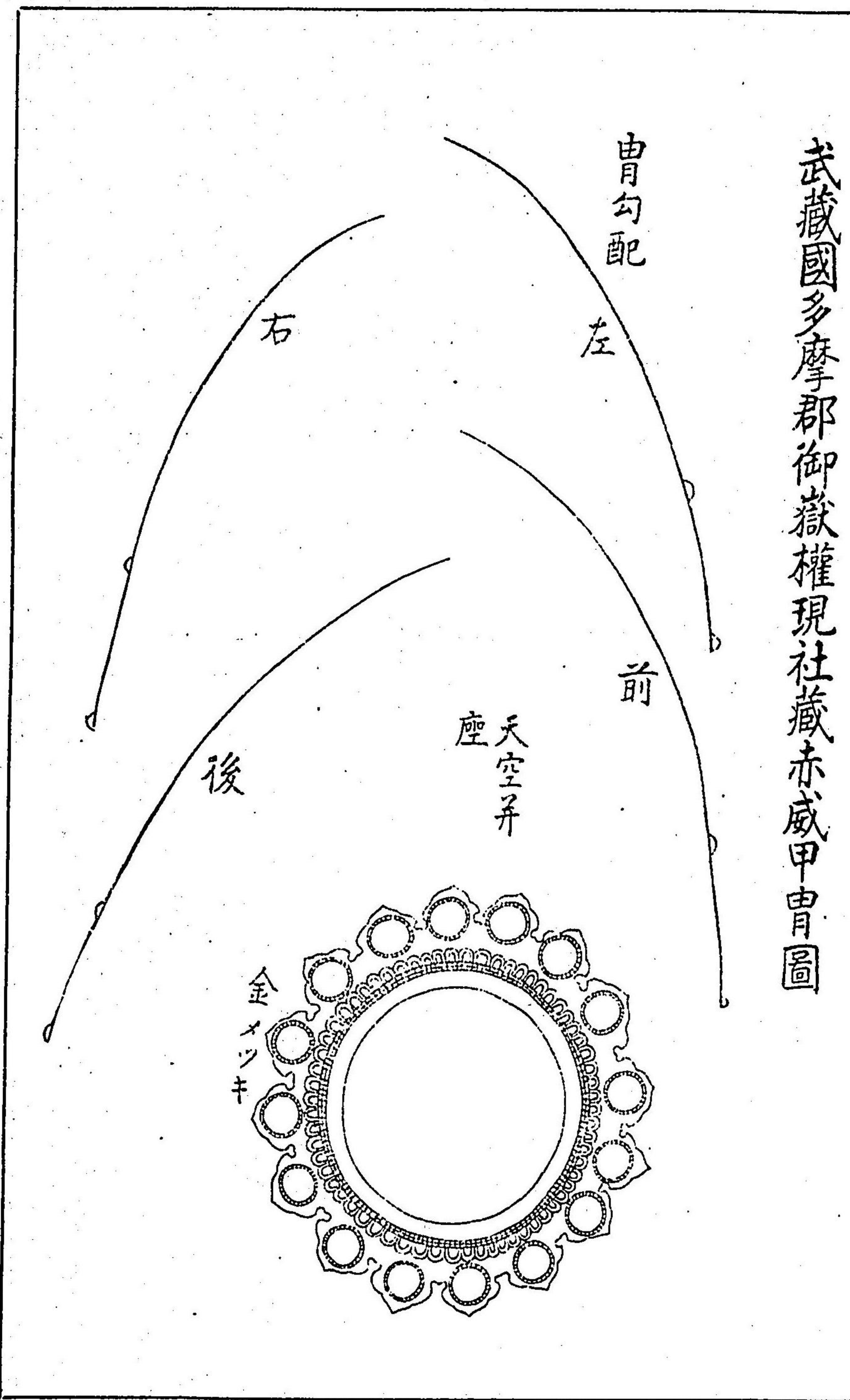

眉庇反恰好如圖

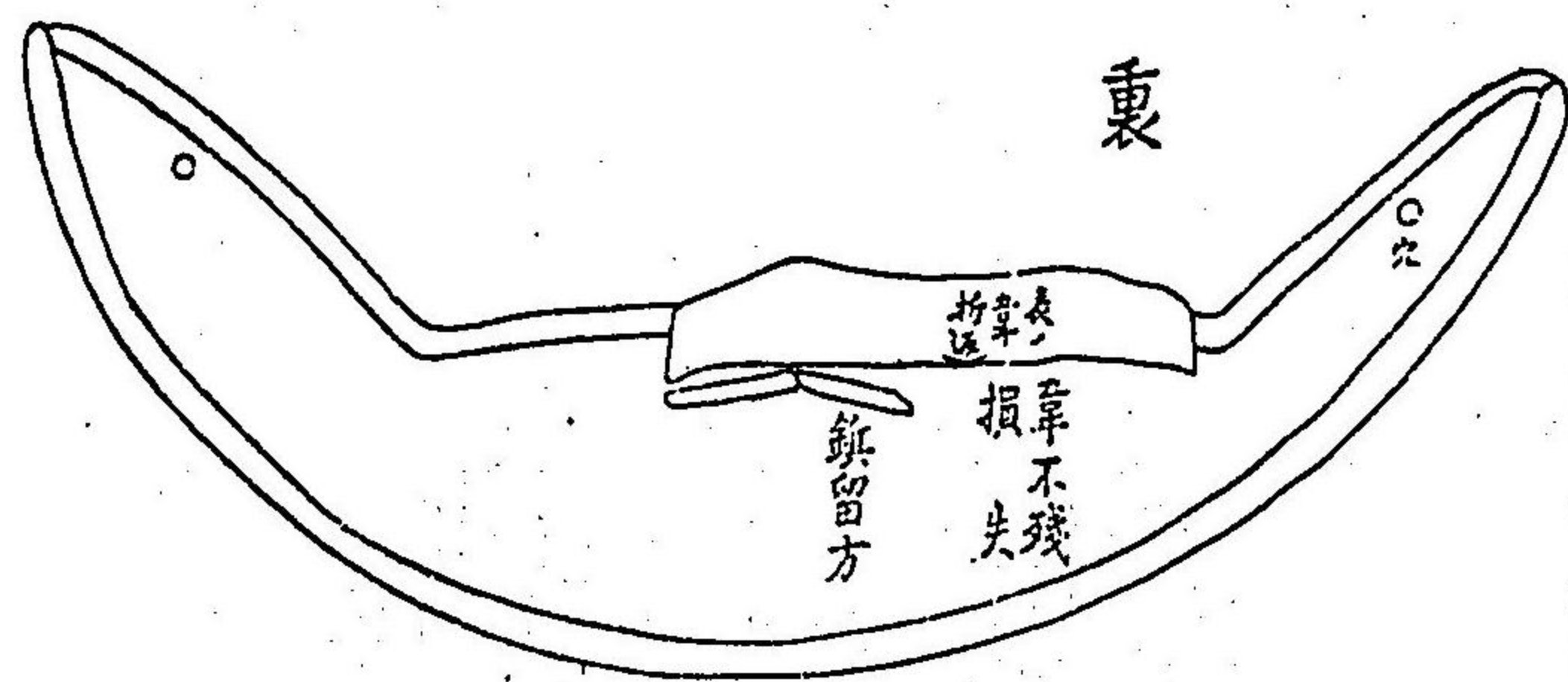

深三寸七分

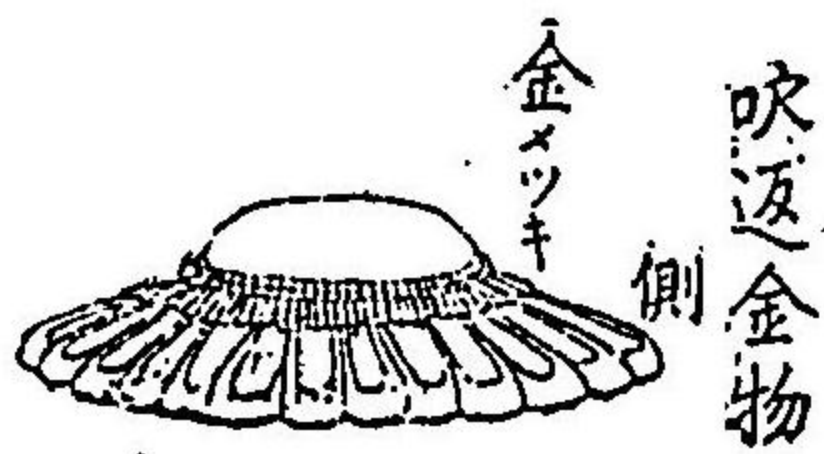
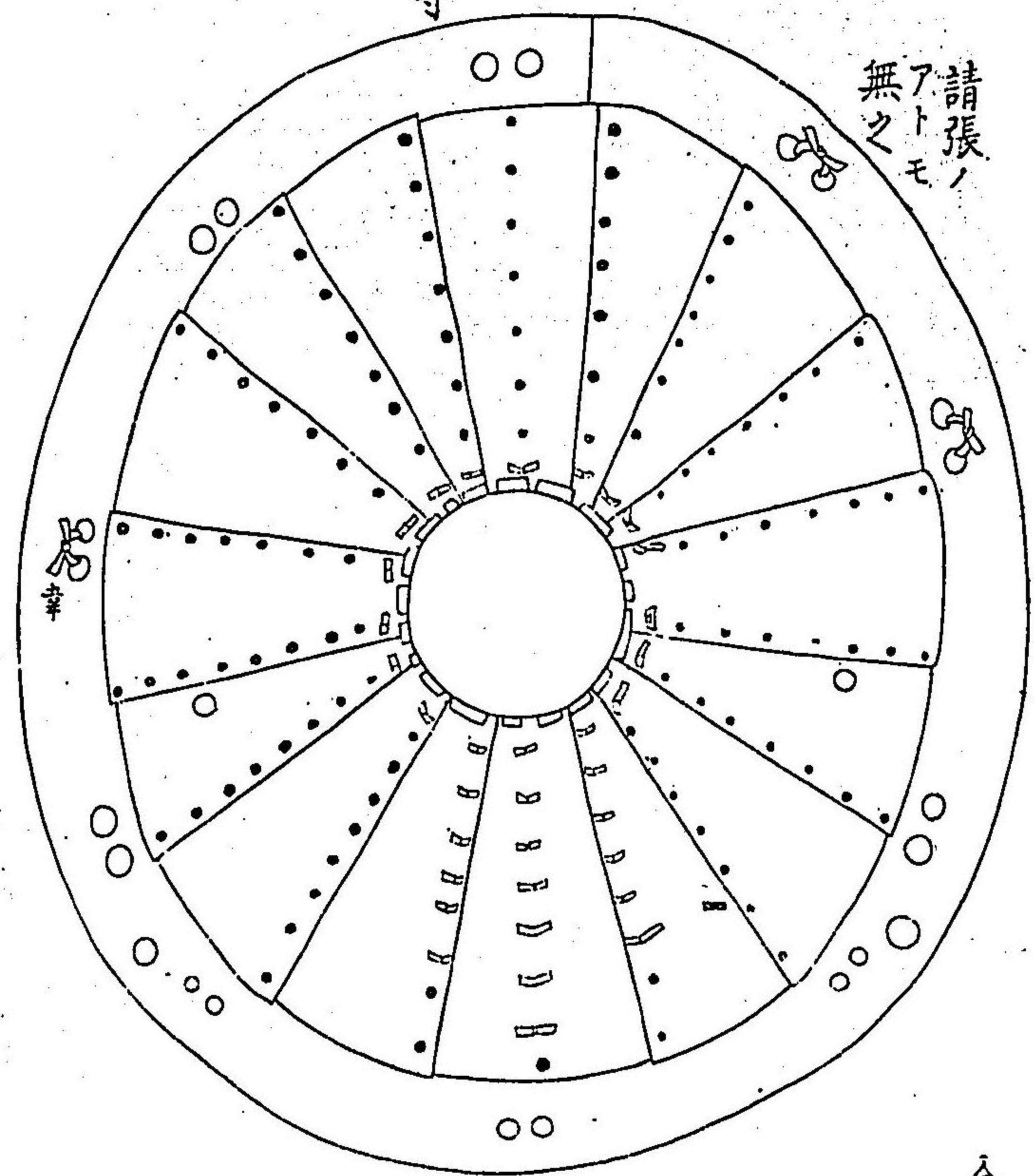

吹返左

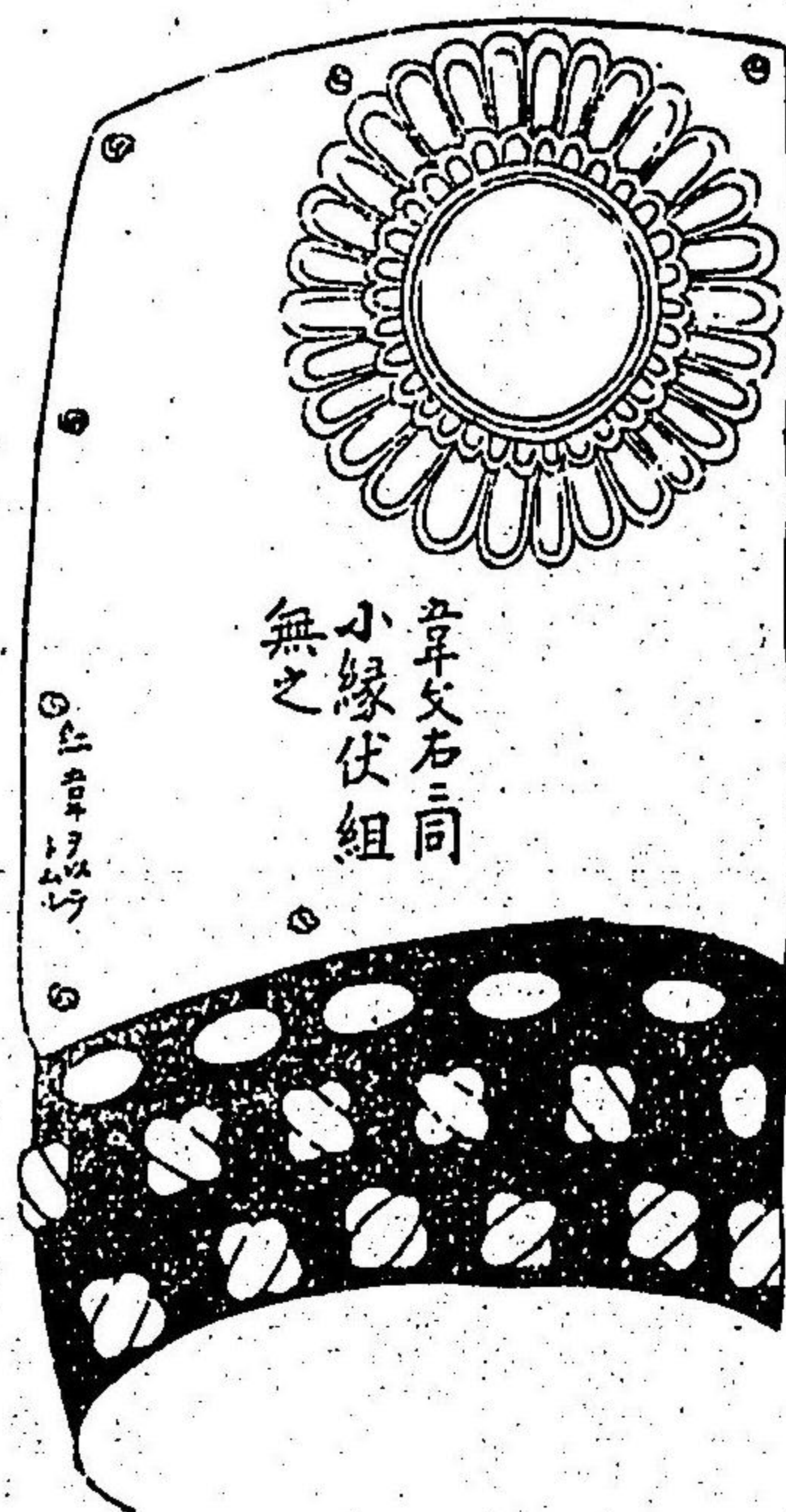

同右

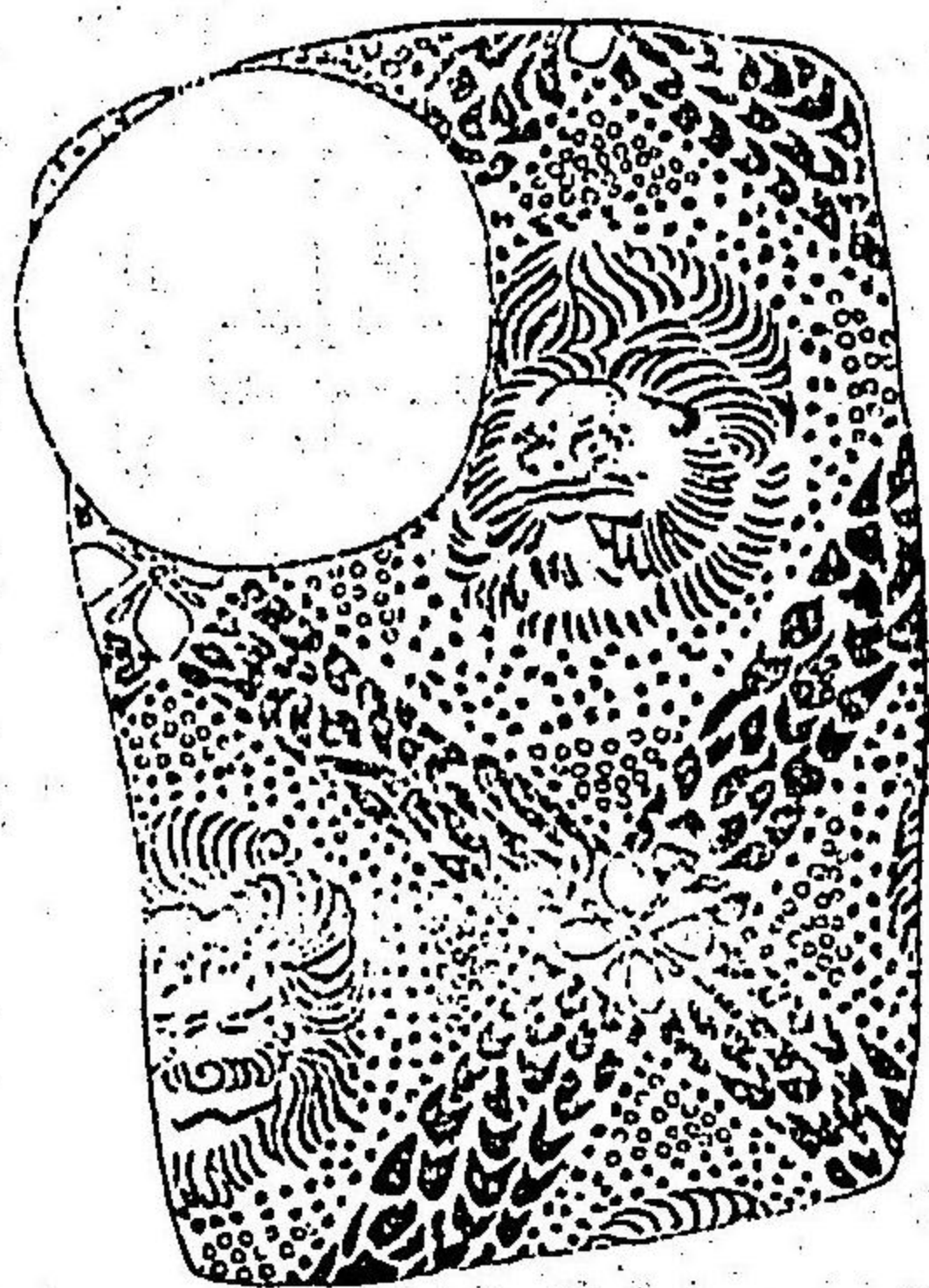

藍文地白圓紫サシ入双鉤ヲ以テワカソ後比皆如此

此編損シ多其大畧ヲ圖ス

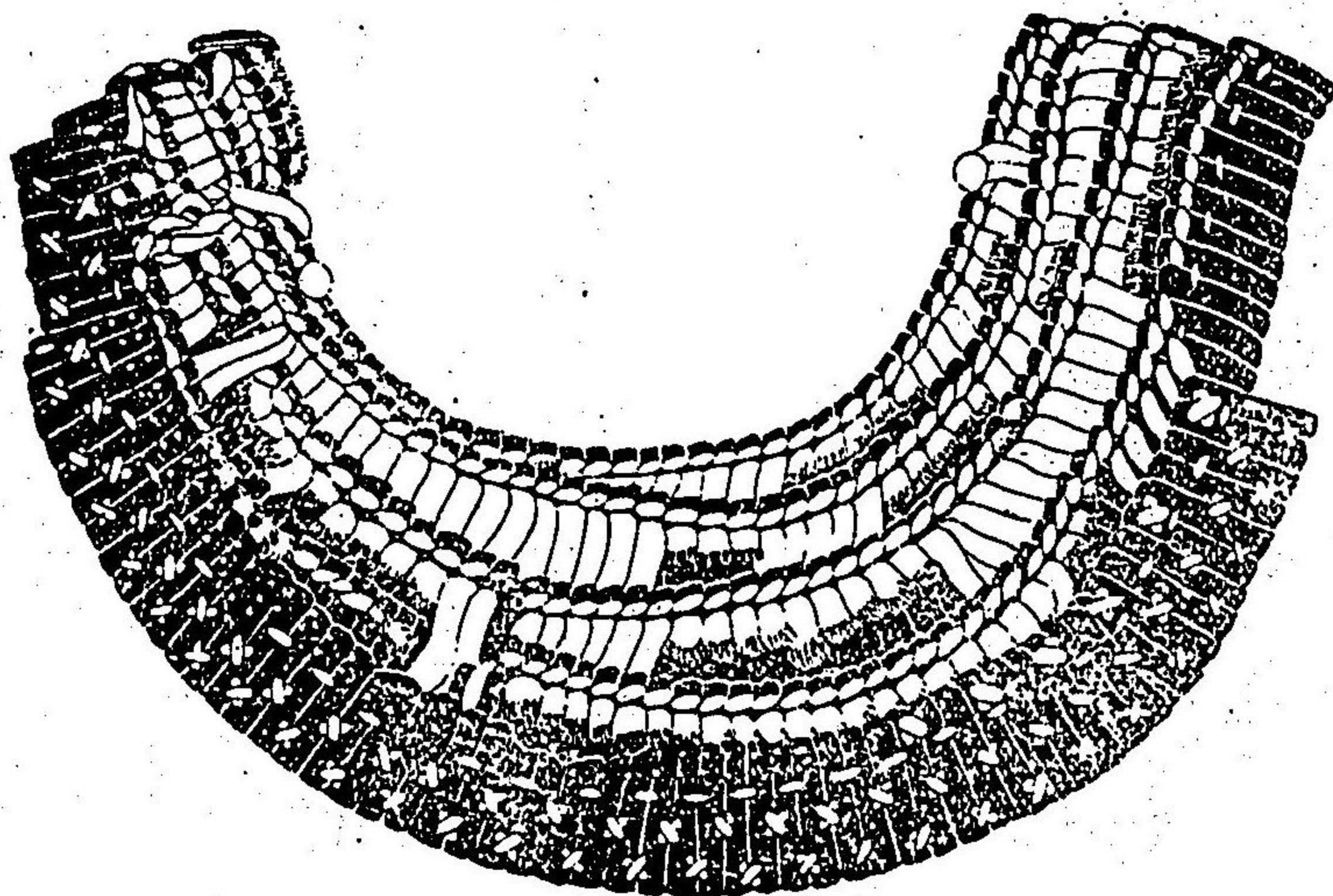

袖全圖 小孔皆革

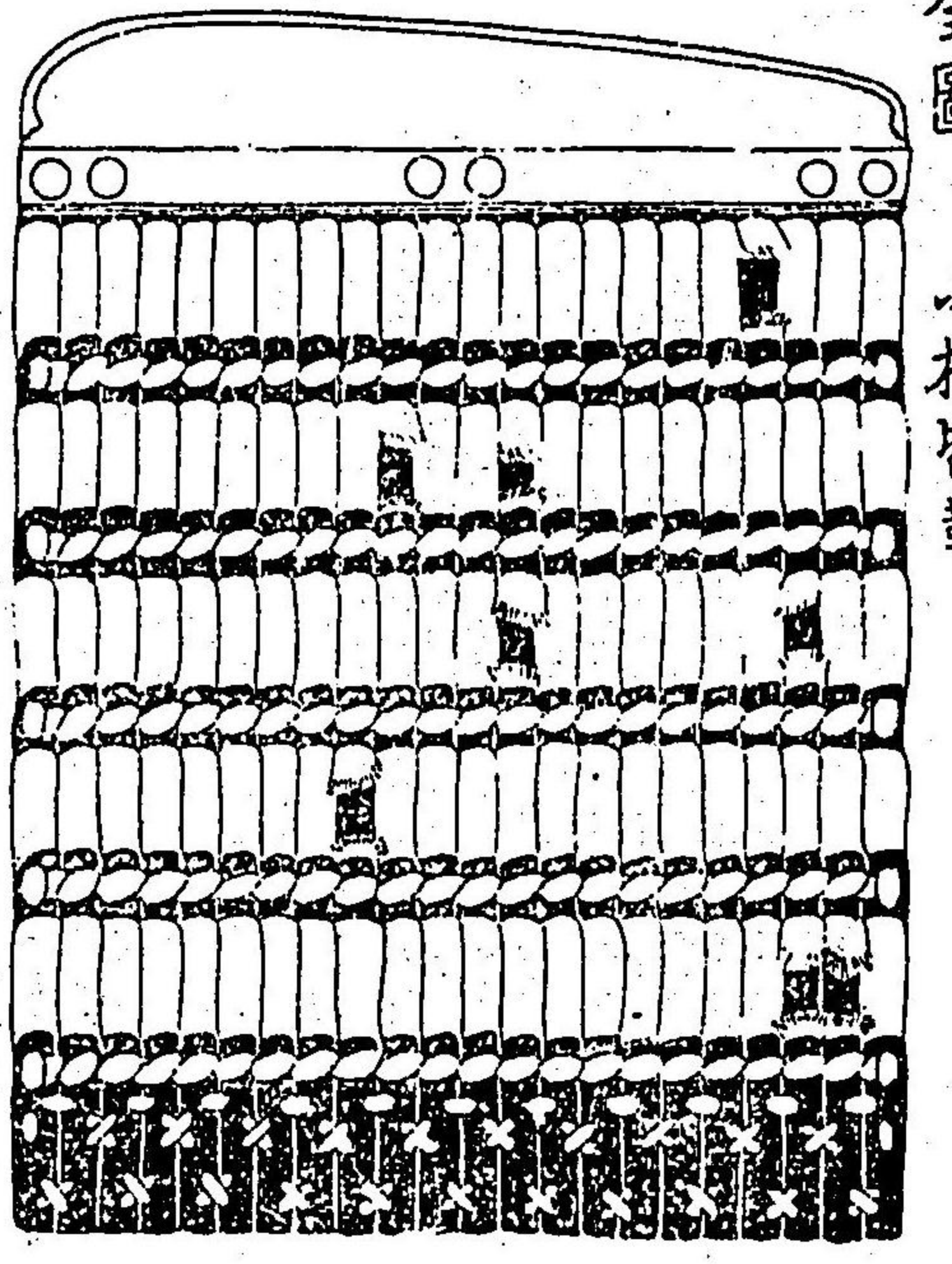

小孔ノ圖

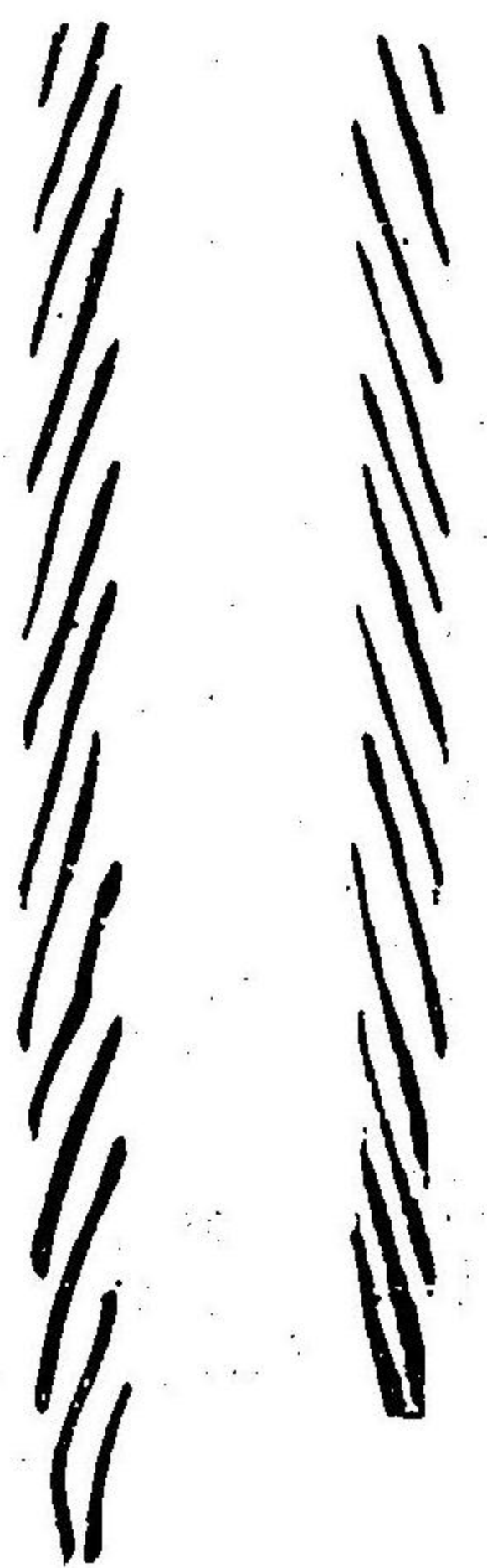

袖 伏組 損失 小縁 赤章 文不 分明

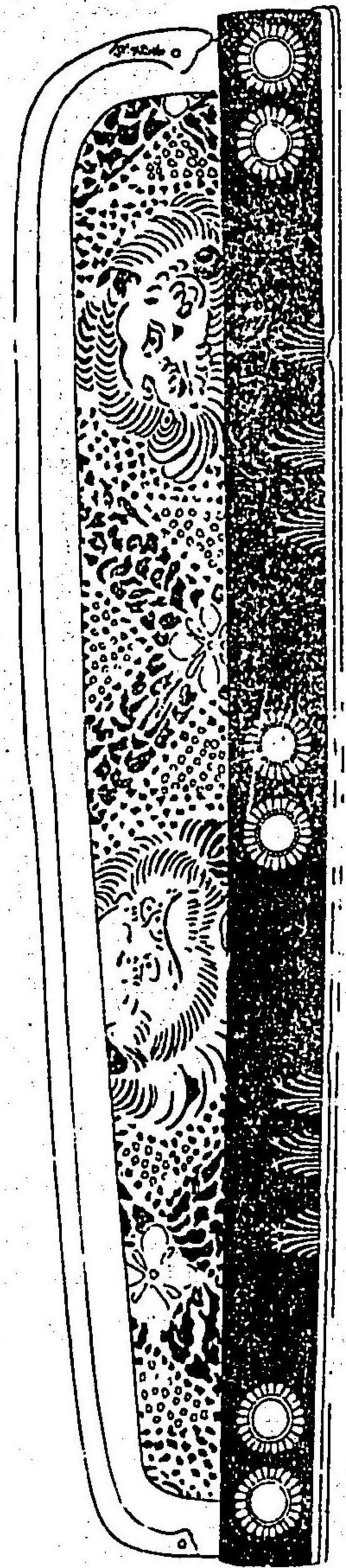

環伏輪 金ノツキ 袖裏

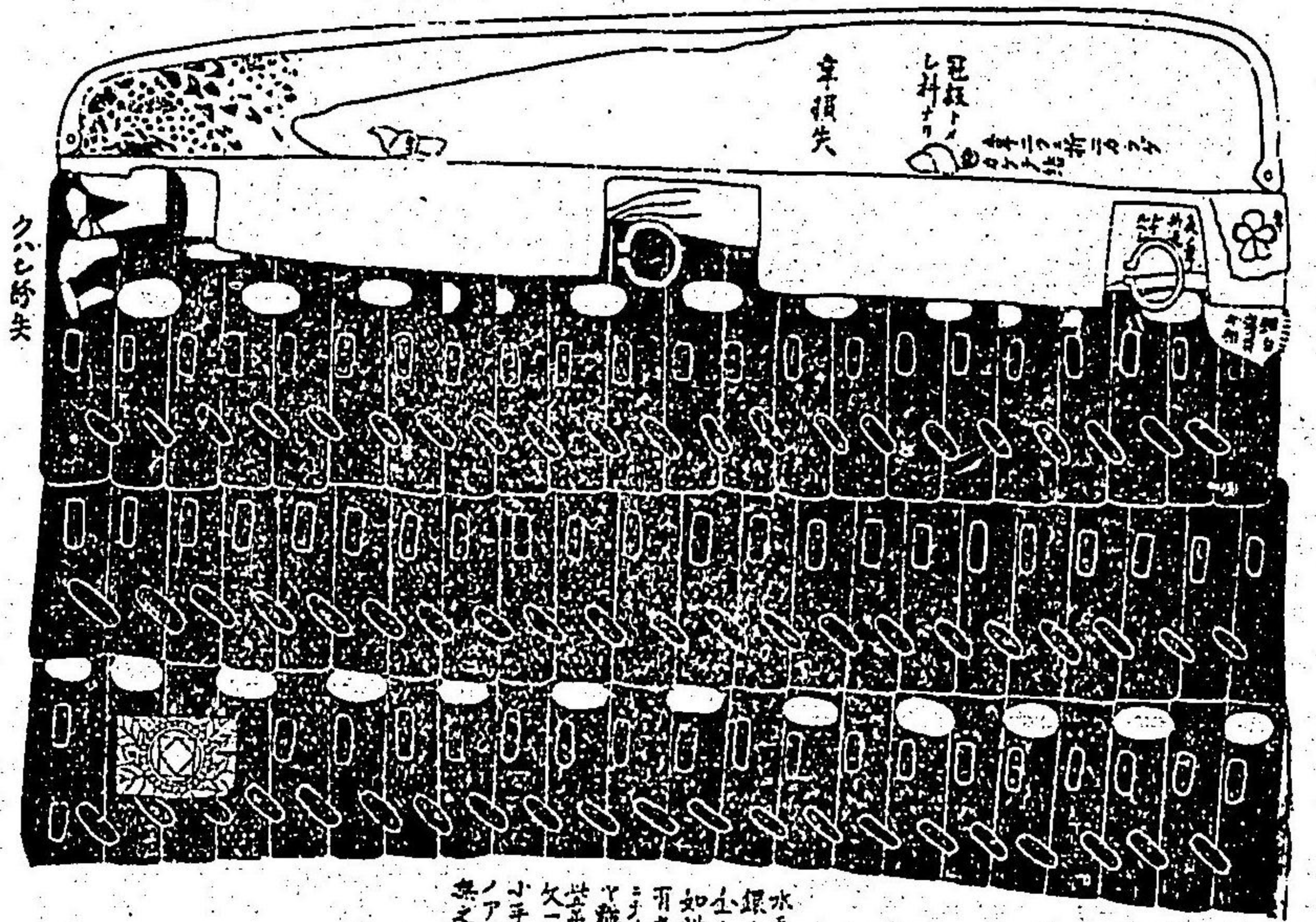

水春 銀ノ下 如以 有之 漆 子付 之 漆 久一 好 小手 相 無之

環伏小孔共

袖并、裏左、右、内、外、損、少、キ、ノ、コ、ノ、圖、ス、シ、リ、カ、キ、ノ、打、方、如、此、等、常、カ、ハ、リ

金表ノ裏下

裏色赤ノ下、此、并、也、紅、子、付、ト、シ、テ、知、此、也、ル

鳩尾板

集古十種 甲冑 二



小塚去草

伏細紺白今色地野○○ミ下ノ無ク

三十八

側面

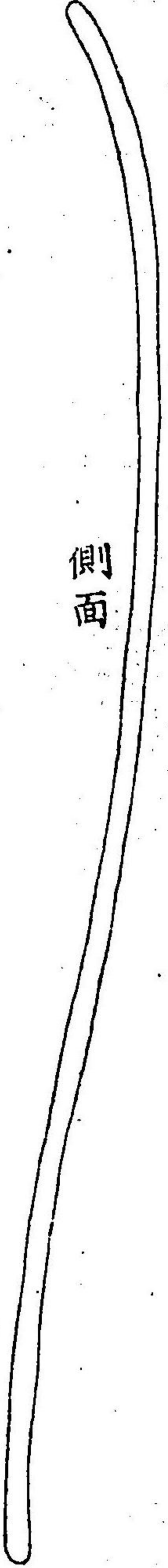

側面

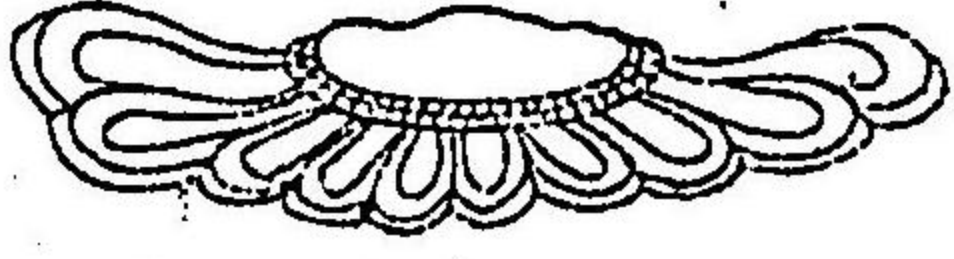

伏輪合七目



反リノ圓

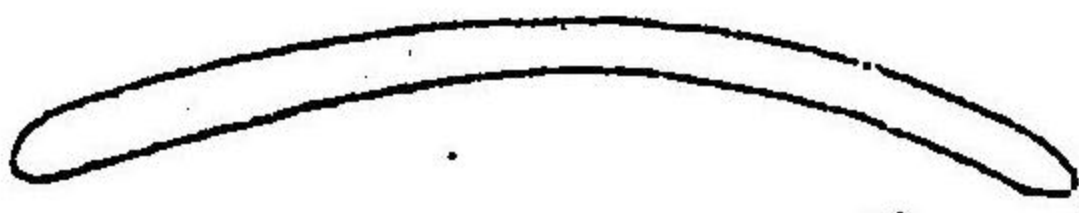

集古十種 甲冑 二

三十九

表板檀栴

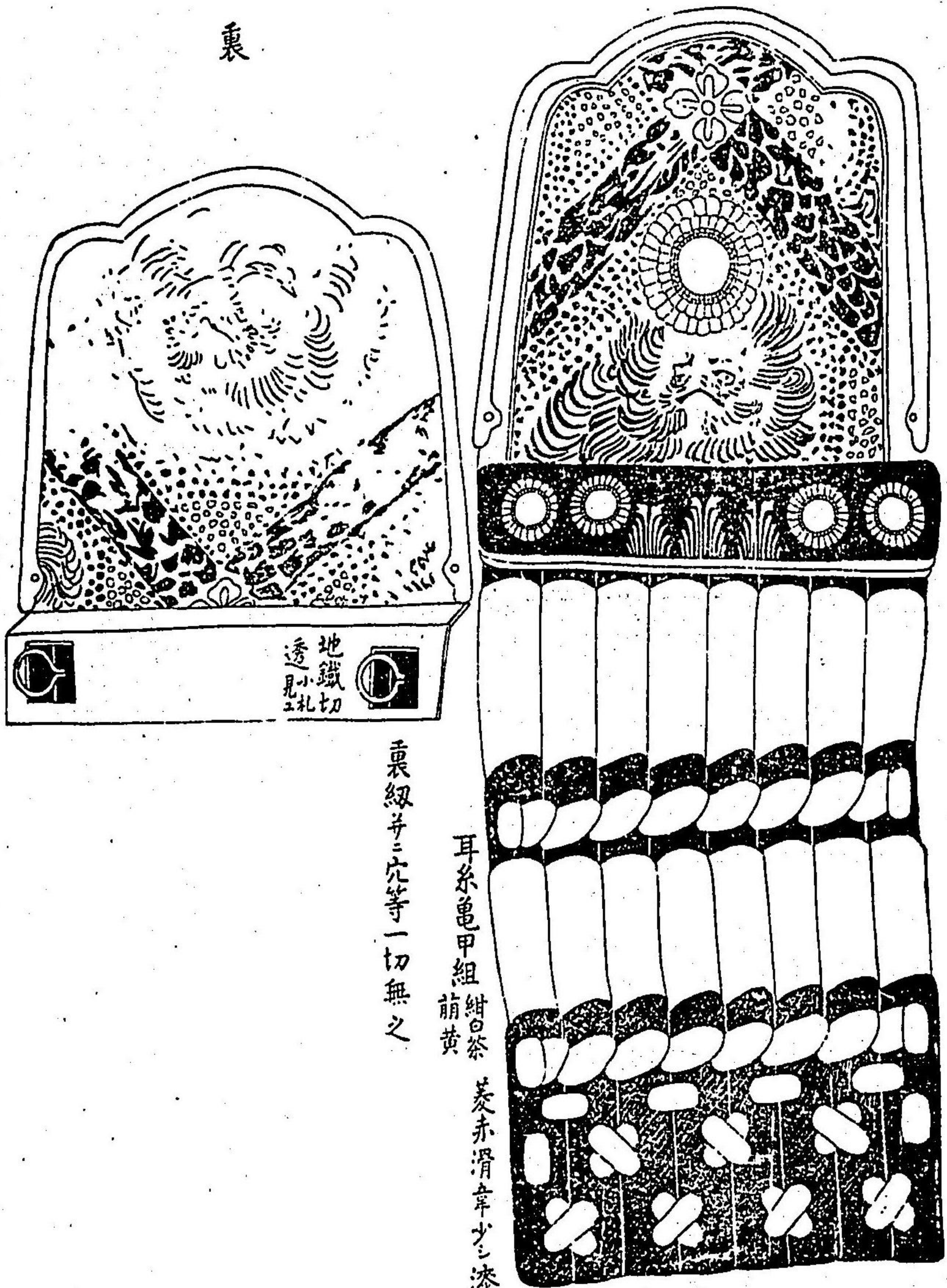

耳糸亀甲組 紺白茶 萌黄

菱赤滑草少シ漆カクル

裏紐并穴等一切無之

地鉄切透小孔

裏

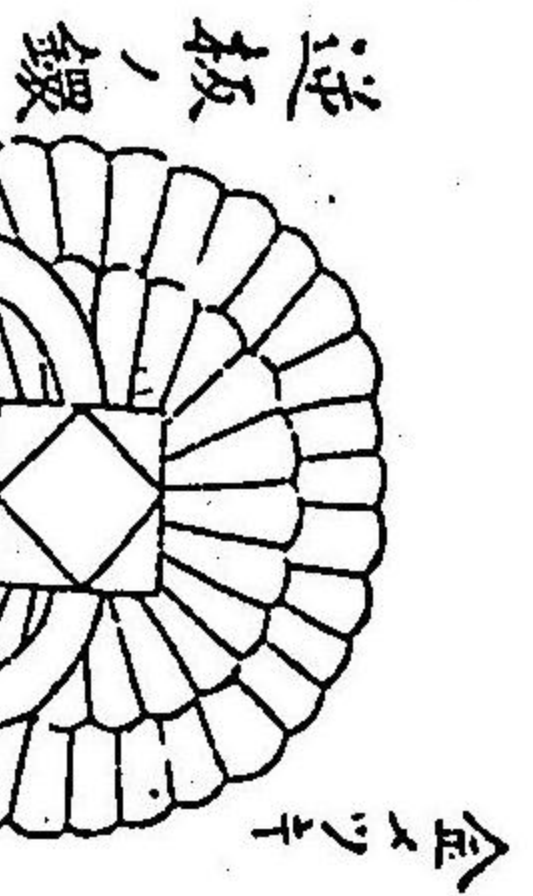

金メッキ

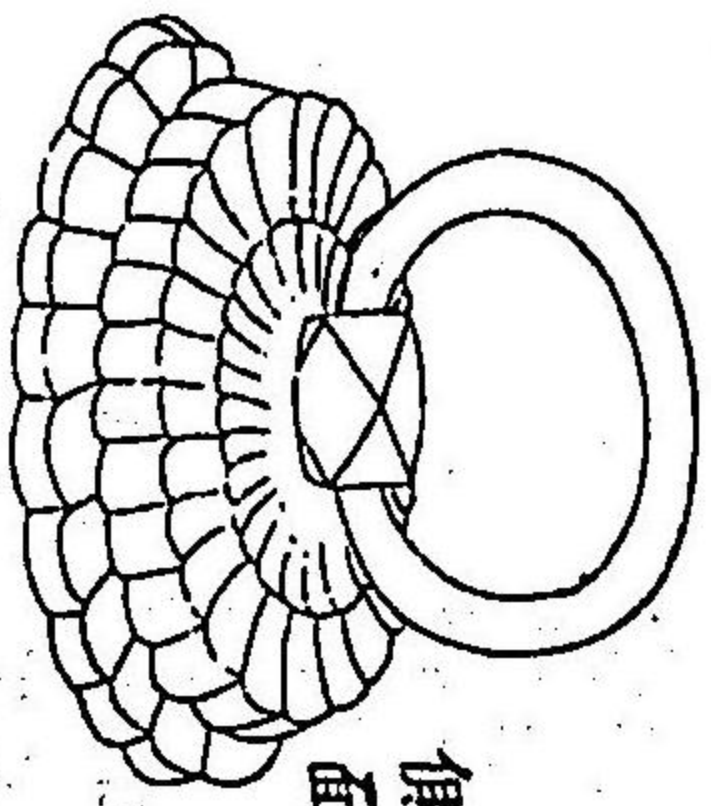

側面

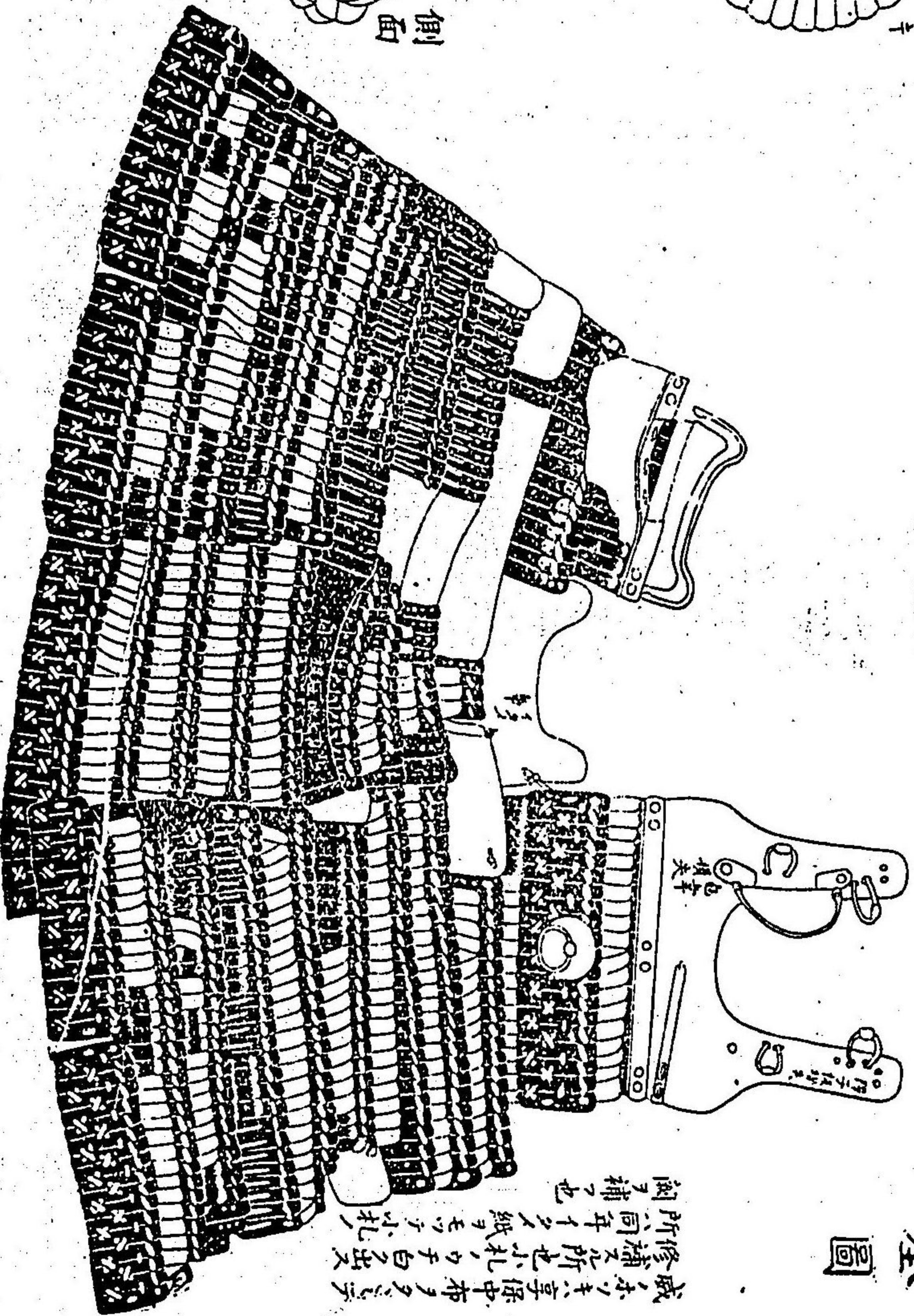
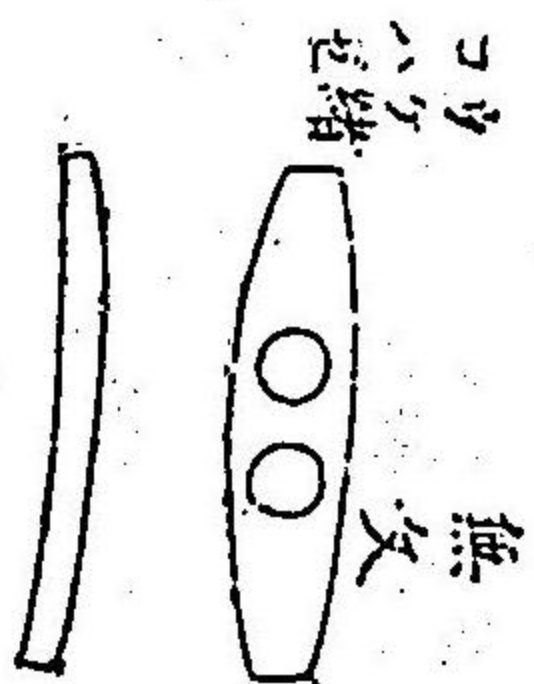

全圖

威ノホノミ字係中布ヲタテテ
修補ニ化所也小札ノウチ白出
所同年イノ紙ヲモツテ小札
闕ヲ補了也

小札十四七寸

胸板

此金物サレ渡シ五寸七分
狭障ノシニイル所ノ木
折ルハ合スレハ七寸

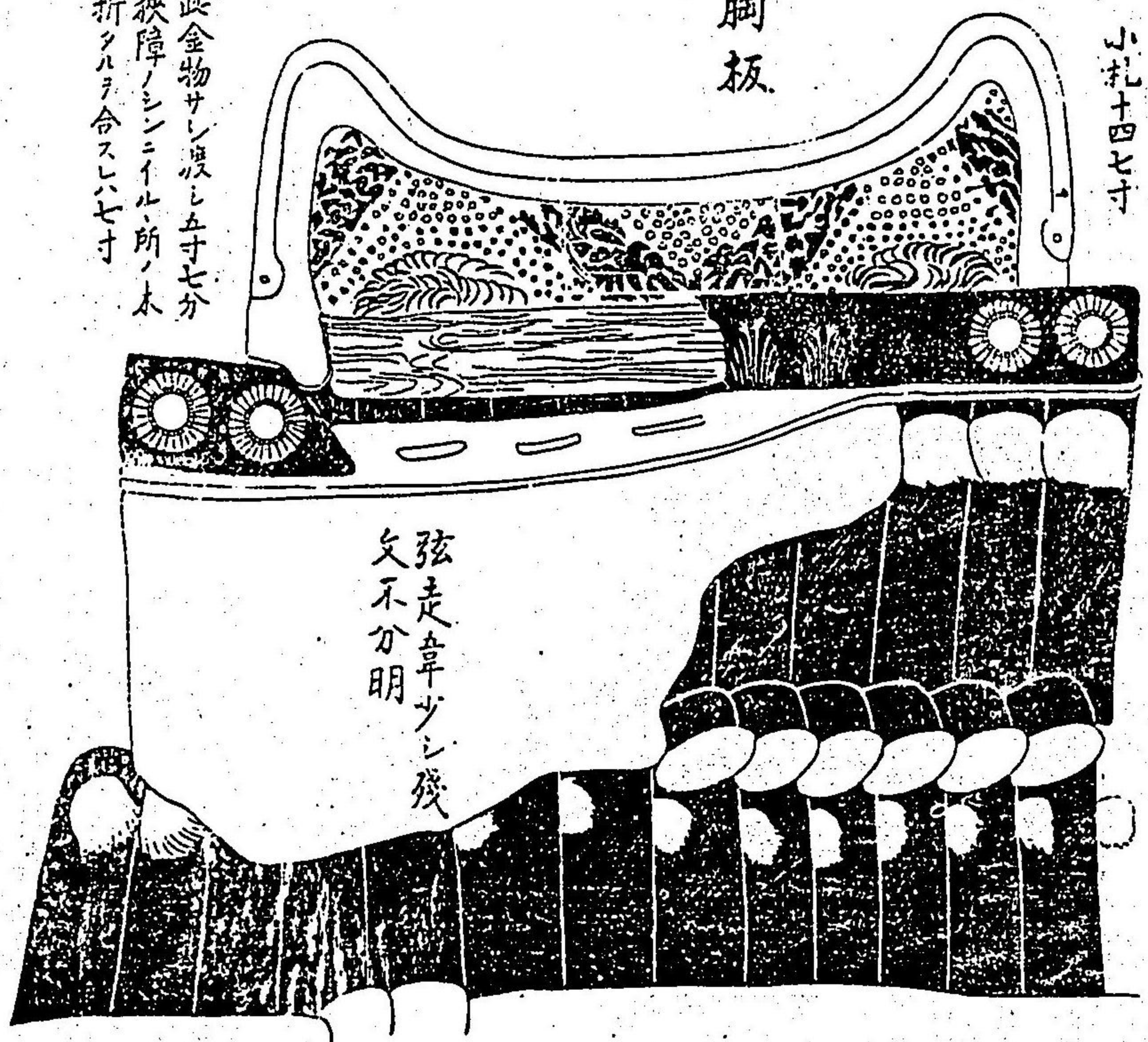

弦走章少シ残
欠不分明

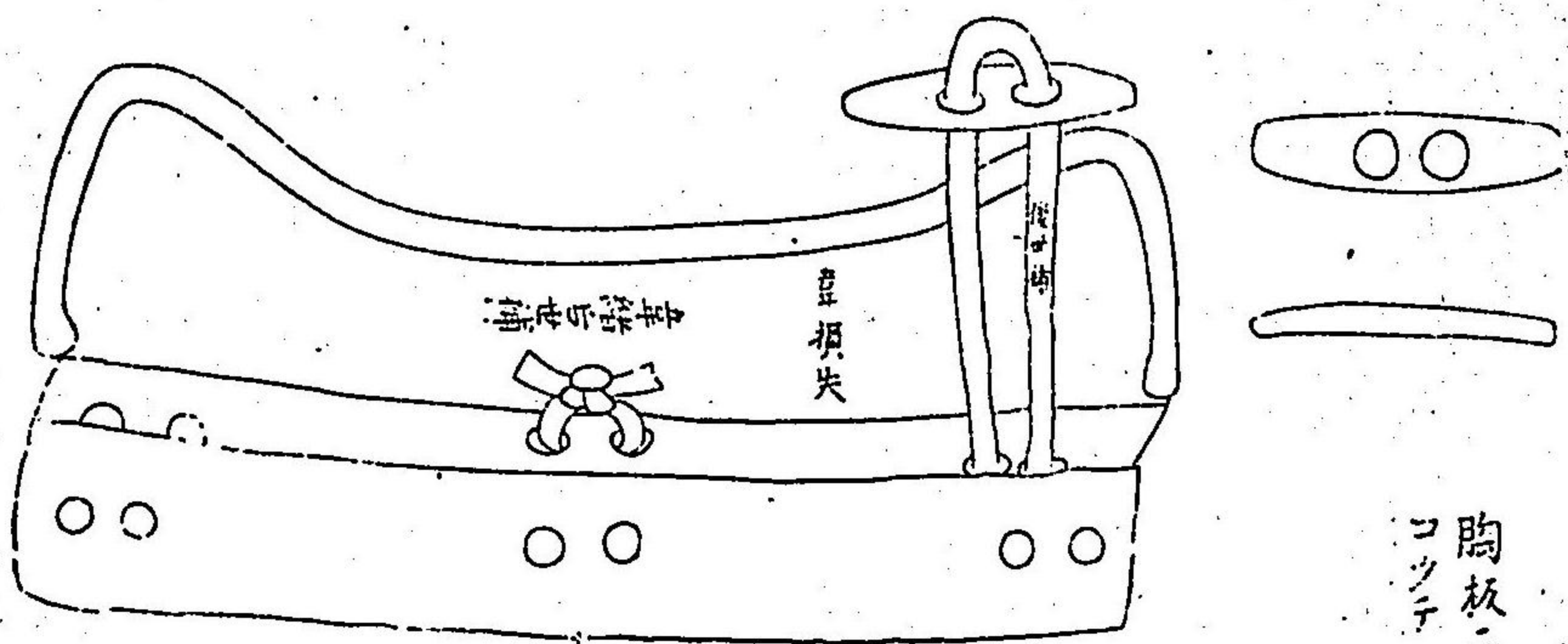

皇損失

無印印

胸板二枚目
コツテ

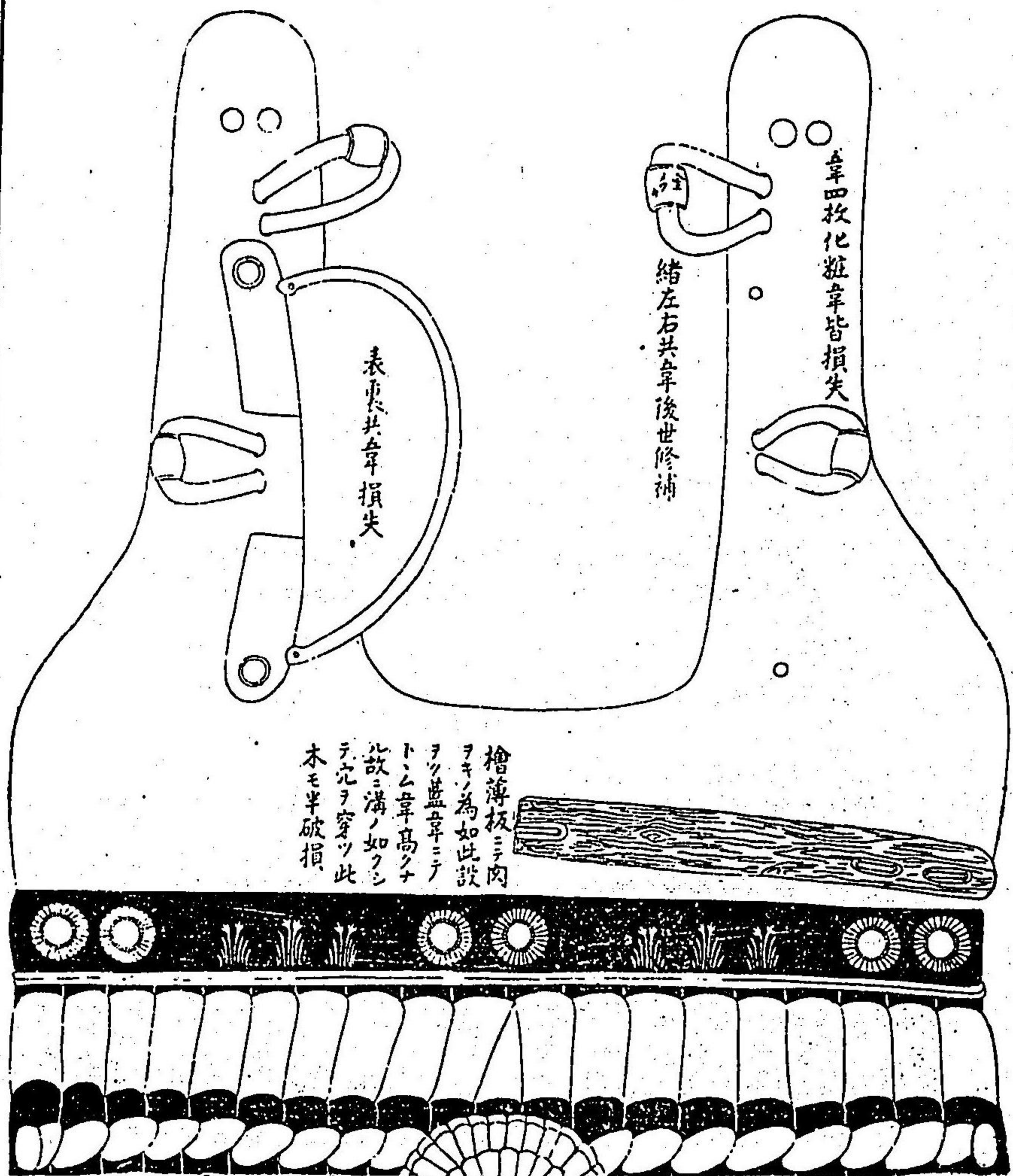

表亦共章損失

章四枚化粧章皆損失

結左右共章後世修補

檜薄板ニ肉
ヲキク為如此設
ヲツ藍母ニテ
トム章高クナ
レ故ニ溝ノ如クシ
テ穴ヲ穿ツ此
木モ半破損

脇楯全圖

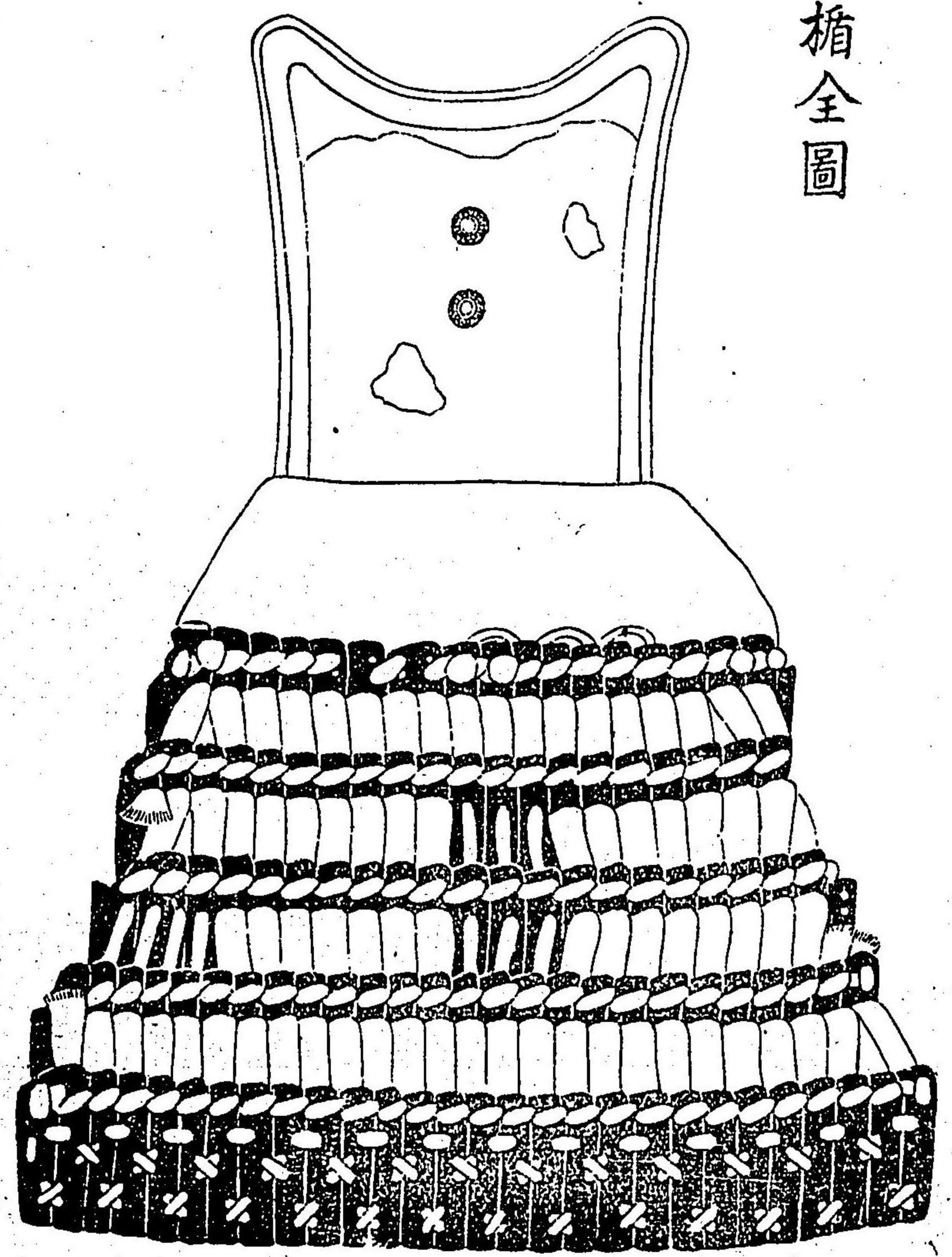

脇楯

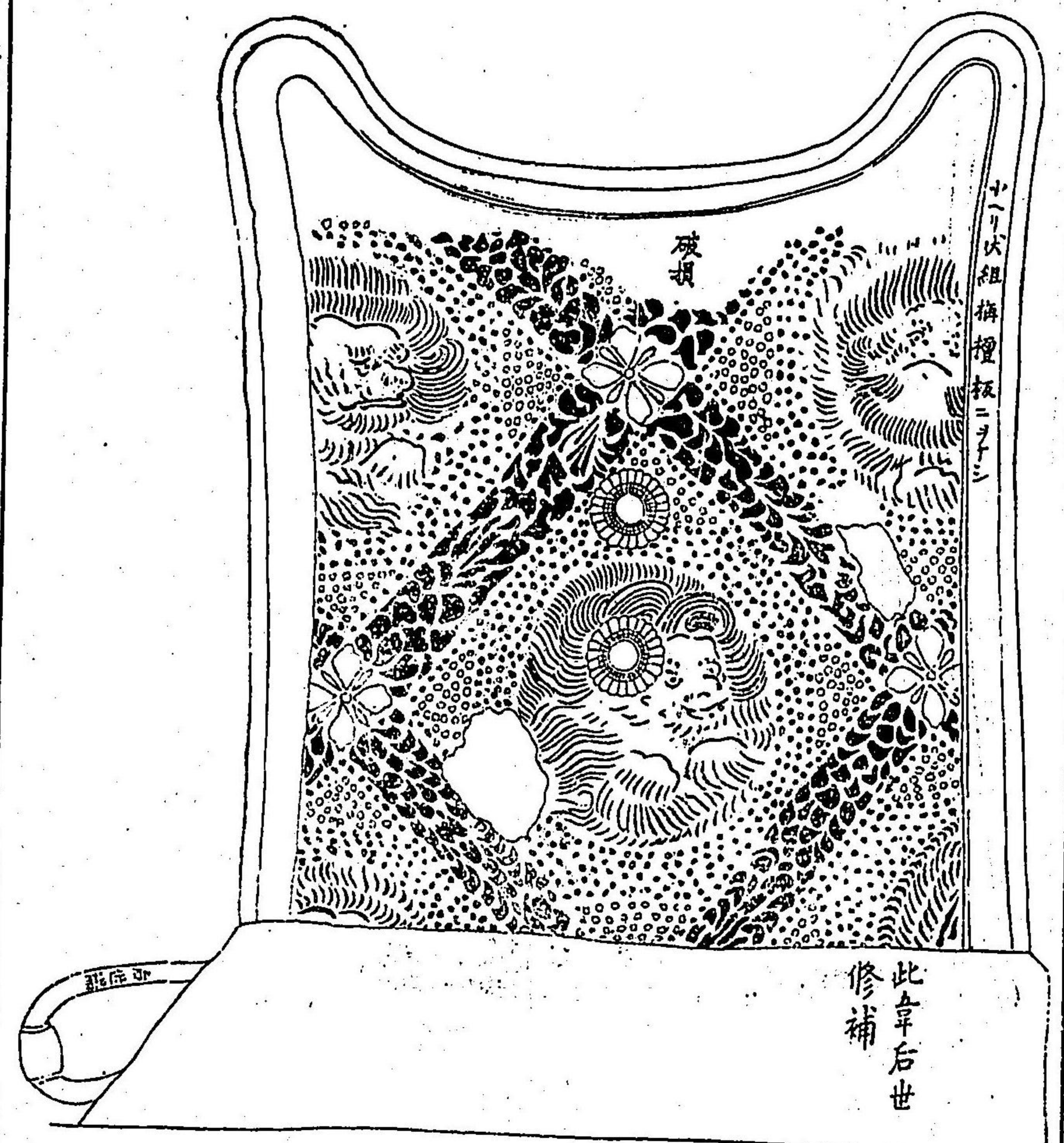

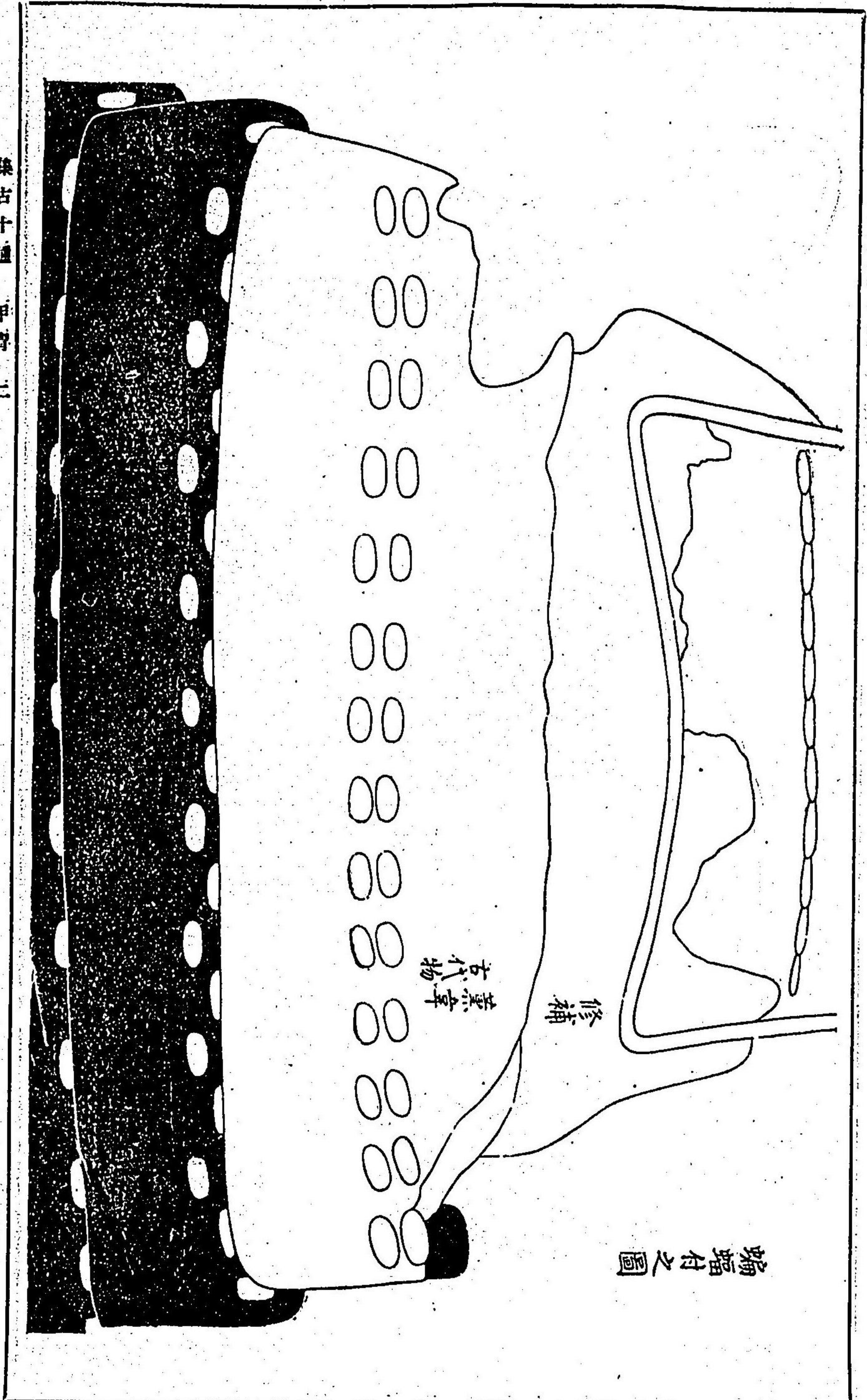
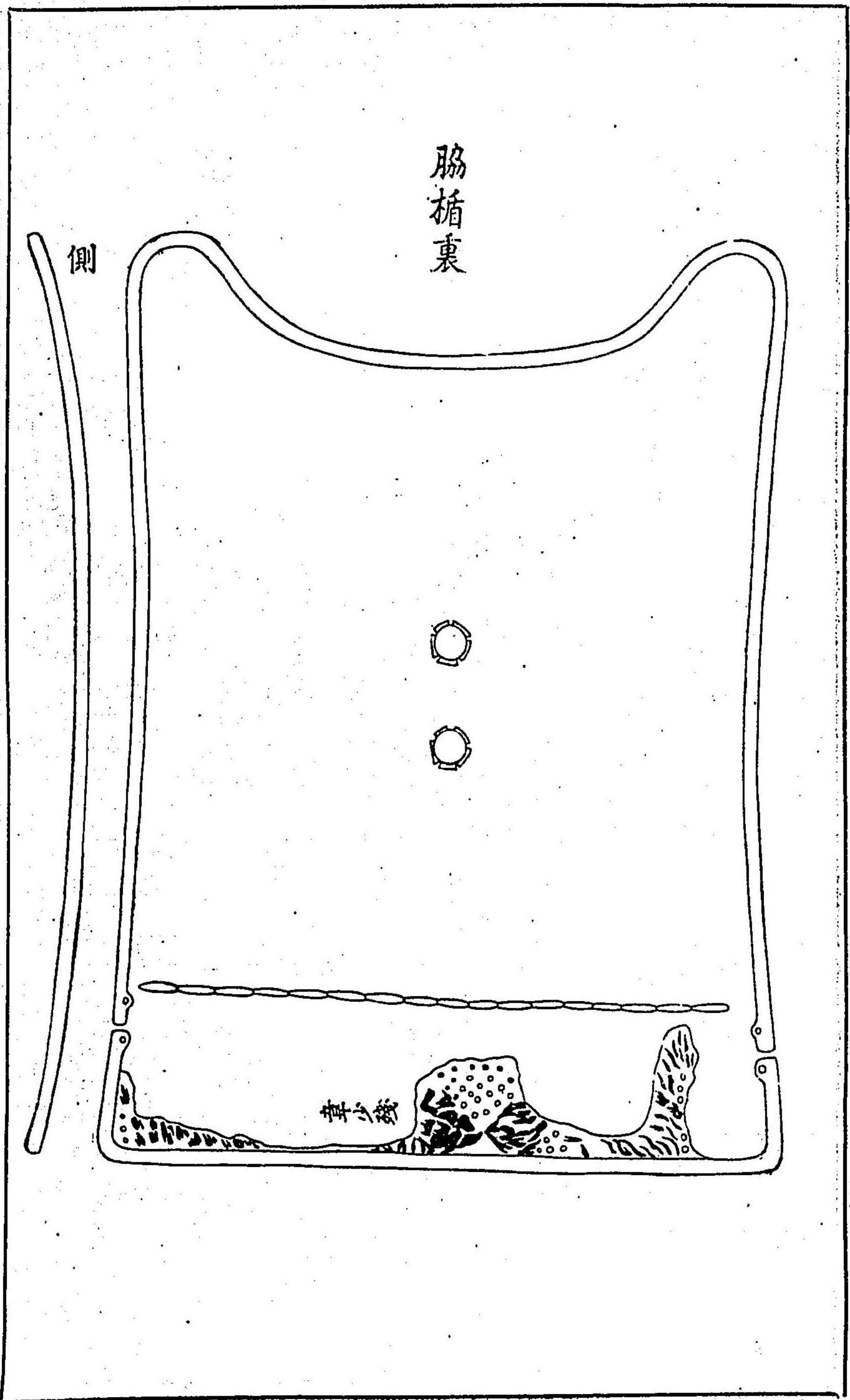

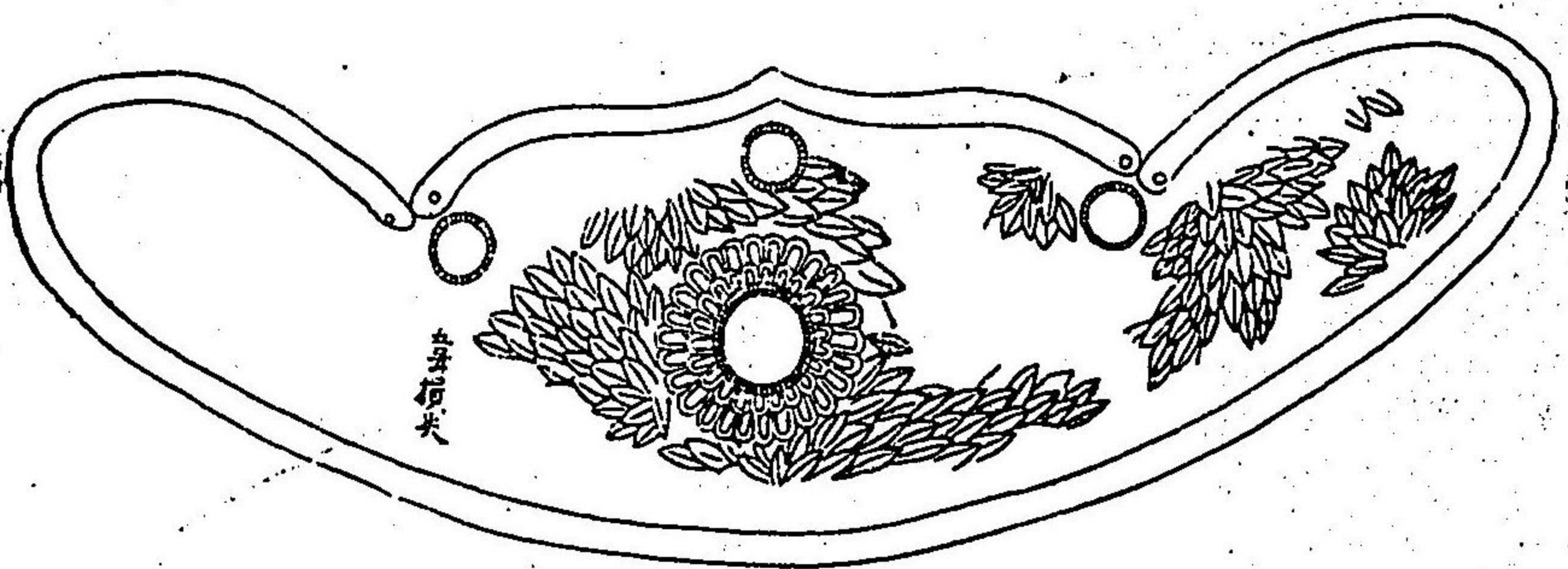

伏組損失
小緑之赤
文不分明
草藍地
文白

眉廂

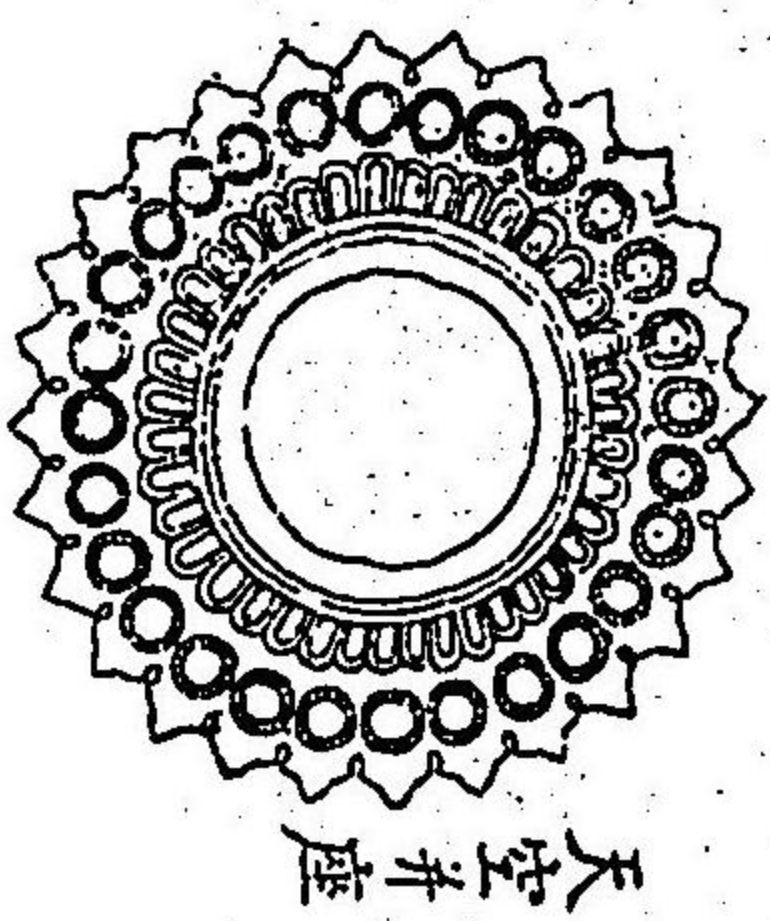

天空弁座

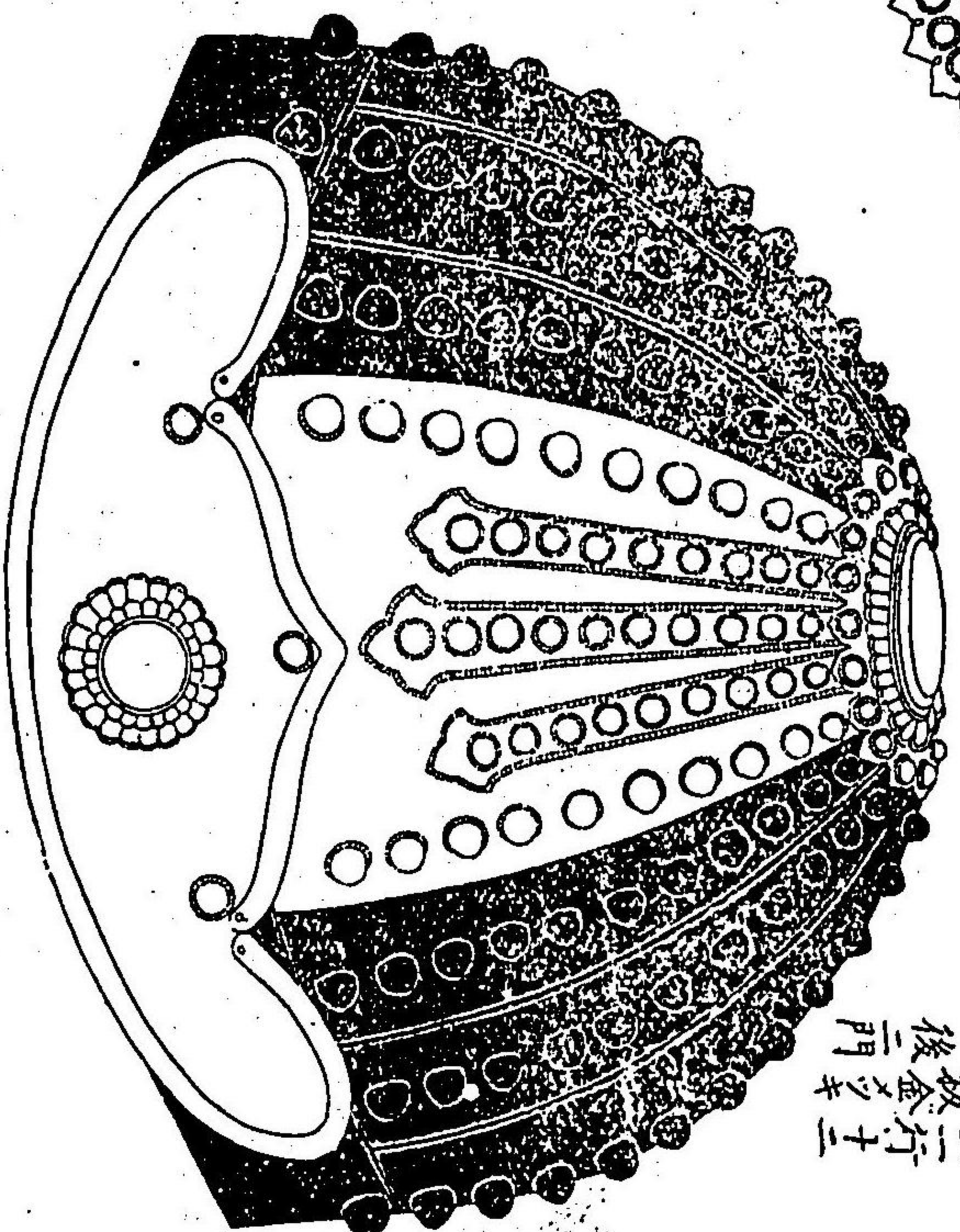

三十間星二行十二
方白地板金多キ
前五間 後二門
黒漆

金物金成金

同藏紫裾濃甲冑圖

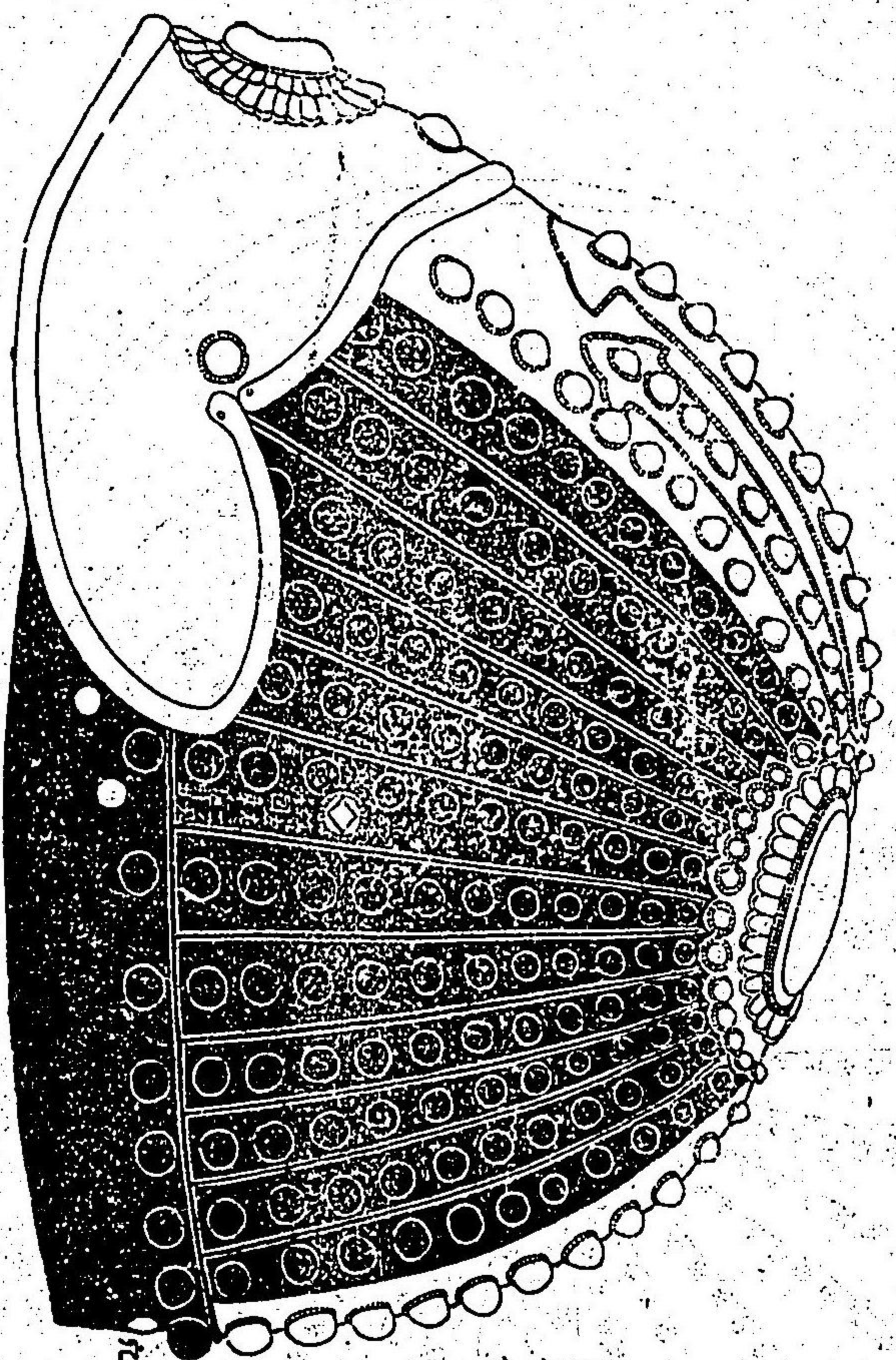

後鑄 並無之
地板銀前同

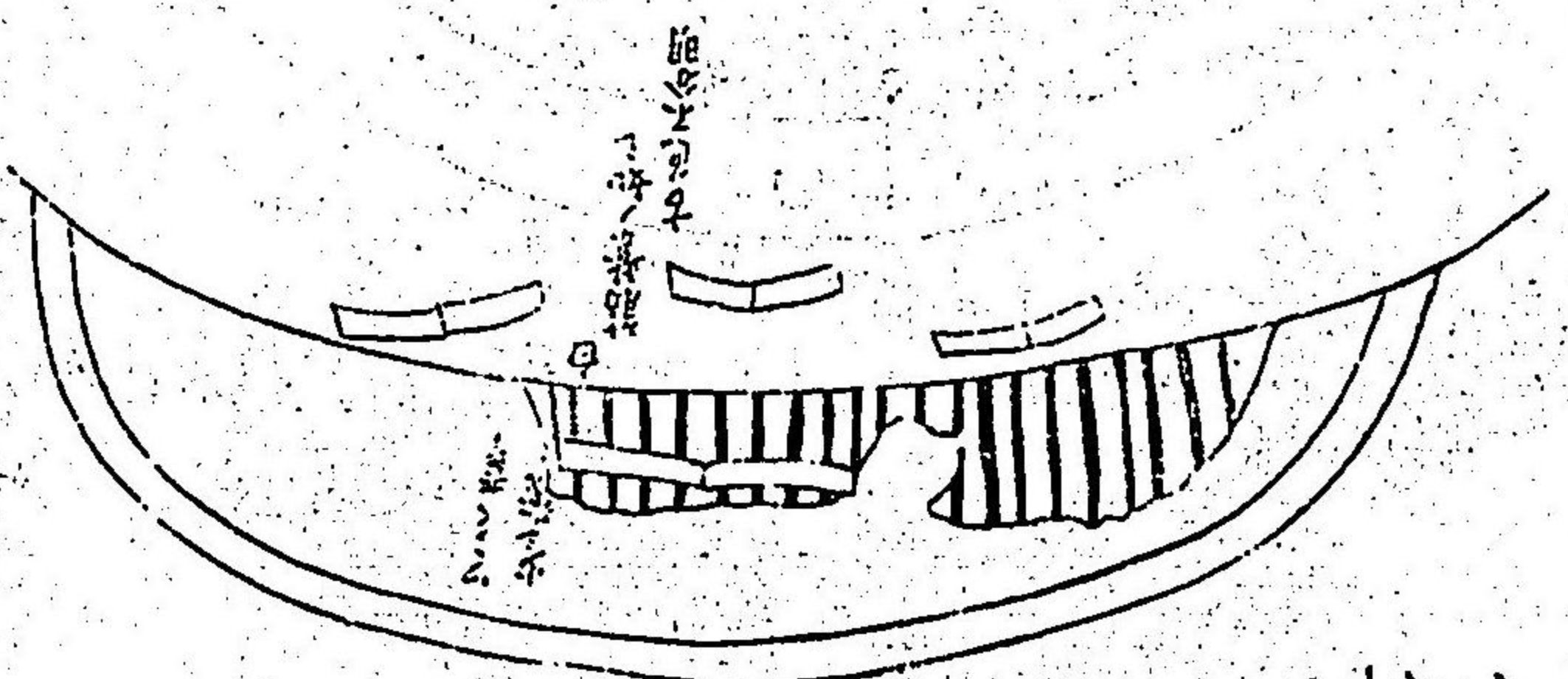

眉廂裏

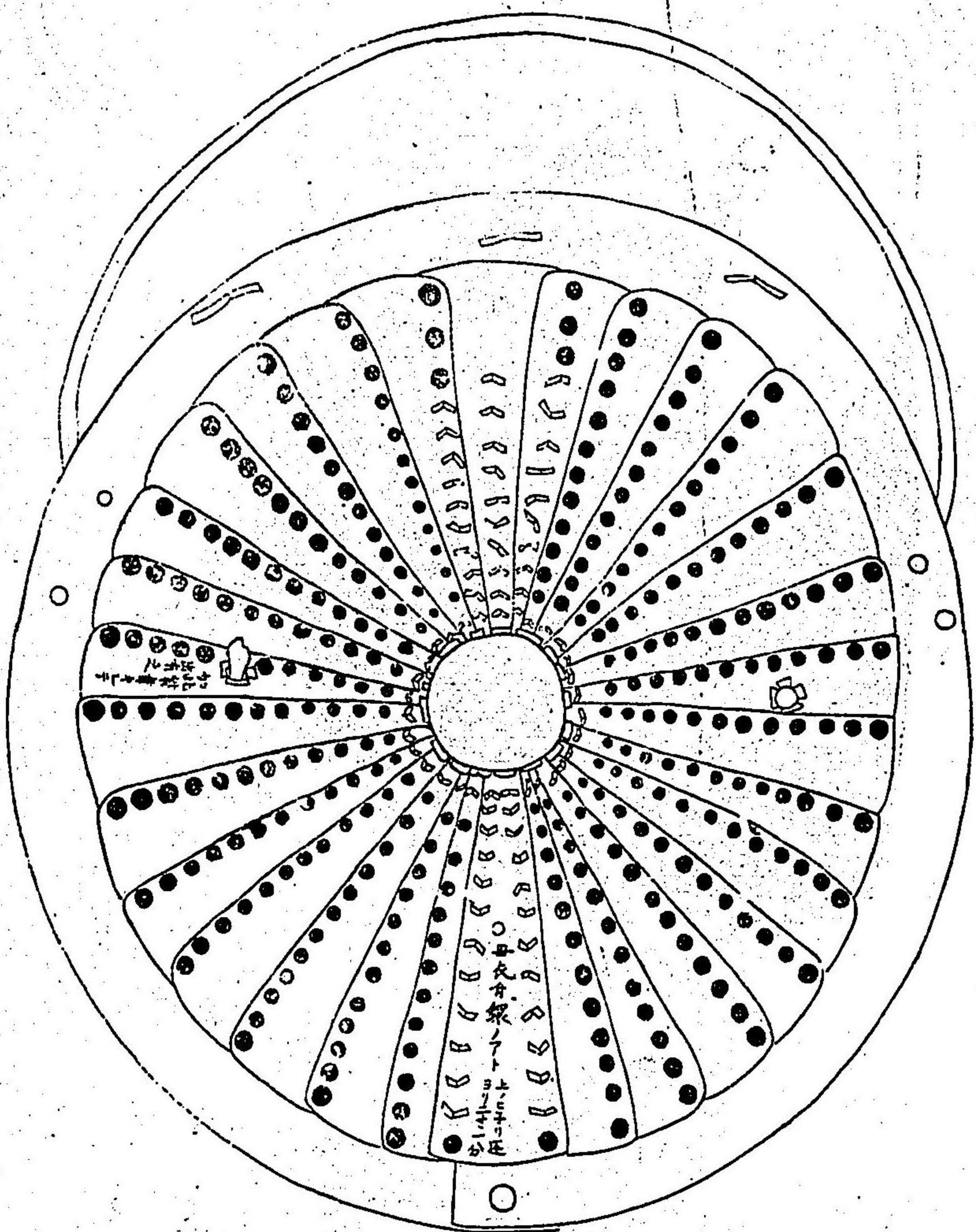

鉢裏
請張アリモ無

深四寸内腰表寸

前後勾配

左右勾配

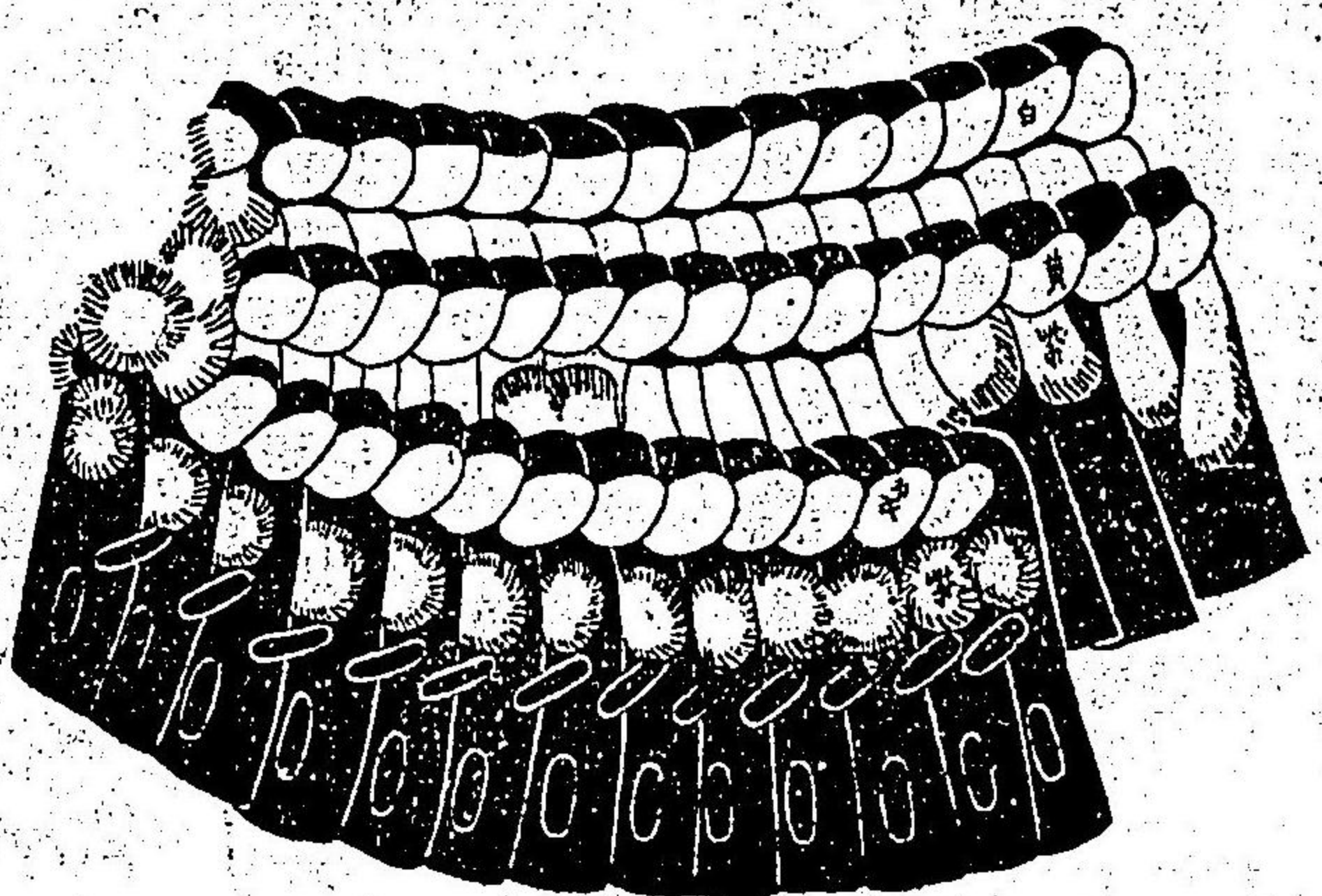
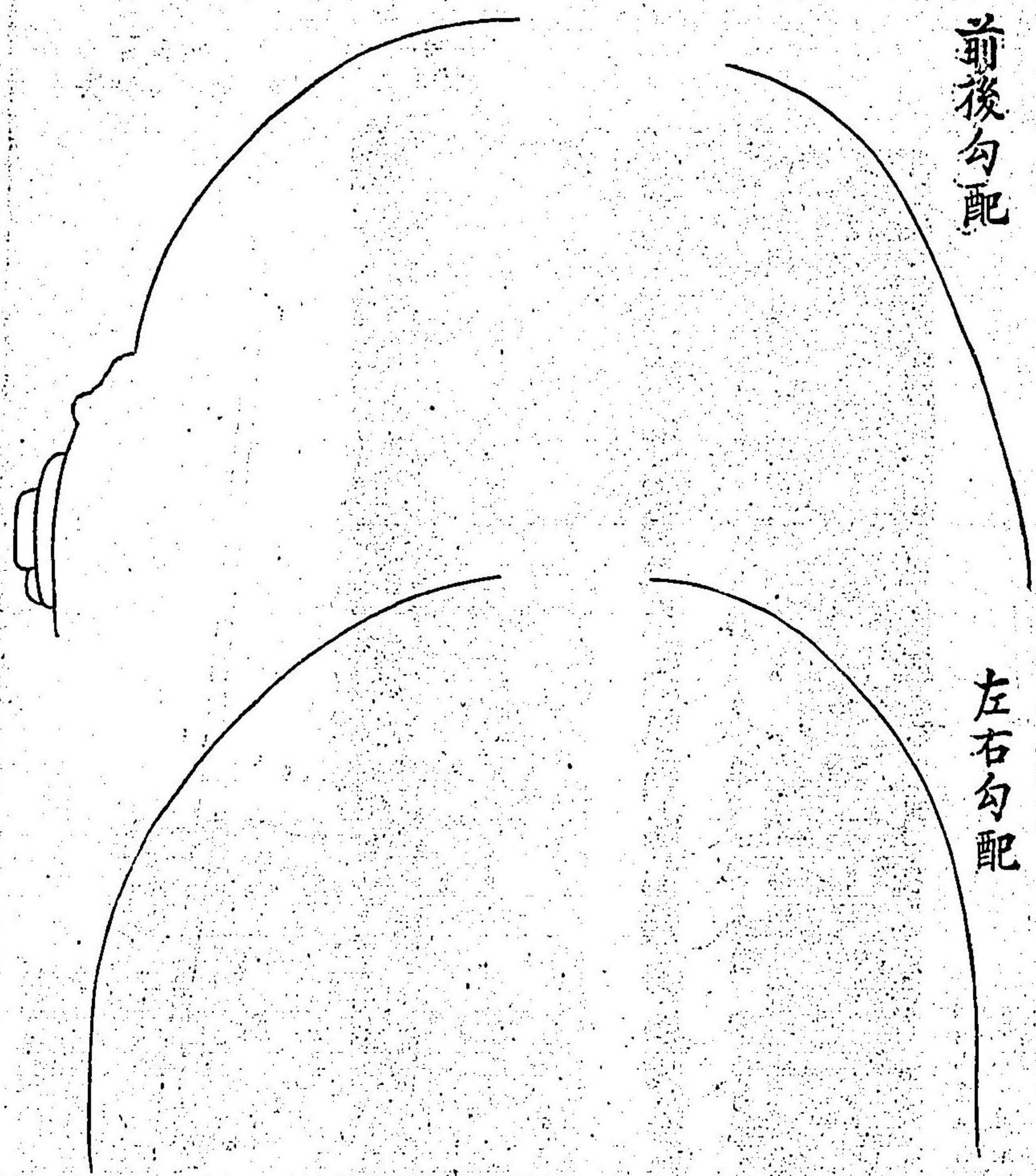

鞆如此不連續モノ不少
連續セルモノツアリ
タメノ様モシレカタキニ
ヨツテ少シクコニ図

水蒸縮，銀，類
一切無之
了毛無之
八五金物

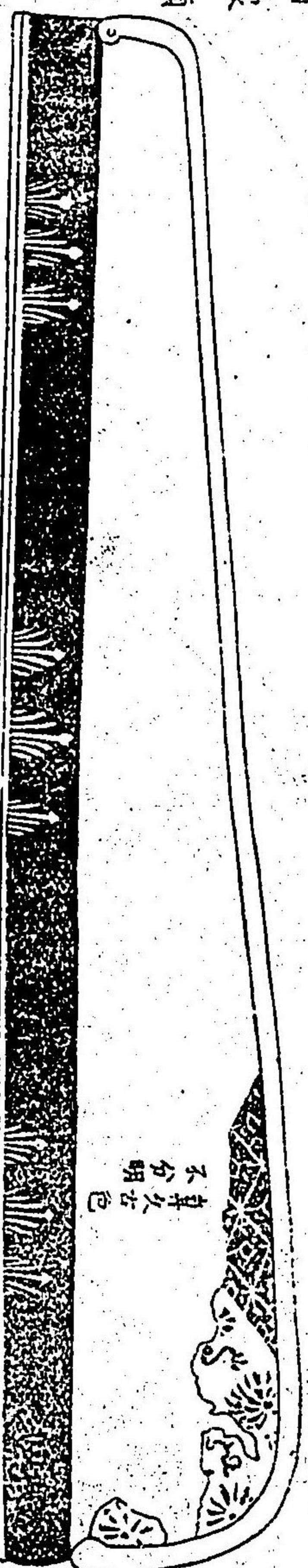

袖冠板菱板

草少，殘之其餘皆剝落

水引赤丹
白了也

真久古色
不分明

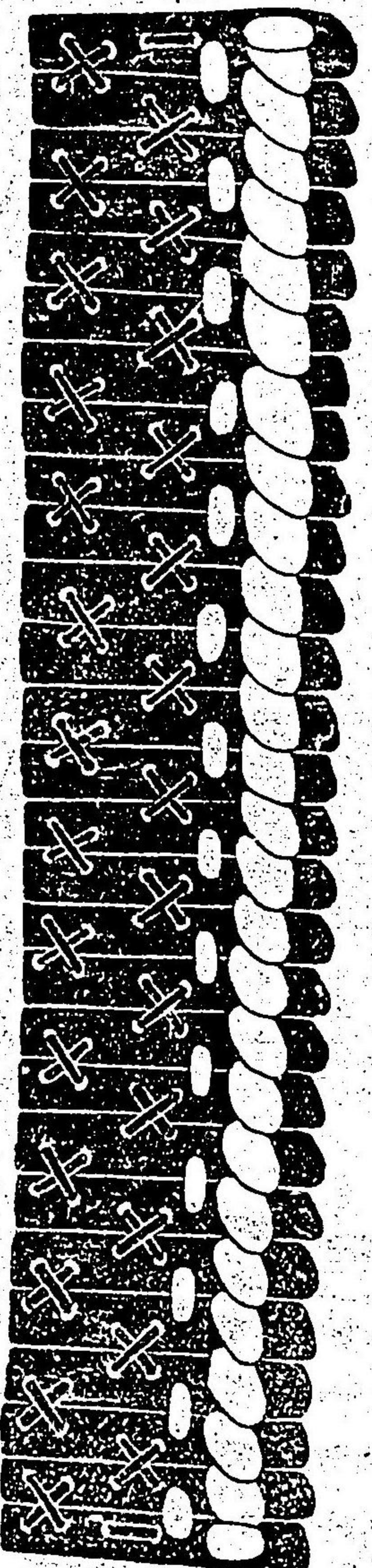

菱縫草漆，穴字，有之，然有之，別有之，菱縫草漆，穴字，有之，然有之，別有之

袖裏篋手摺了毛無之

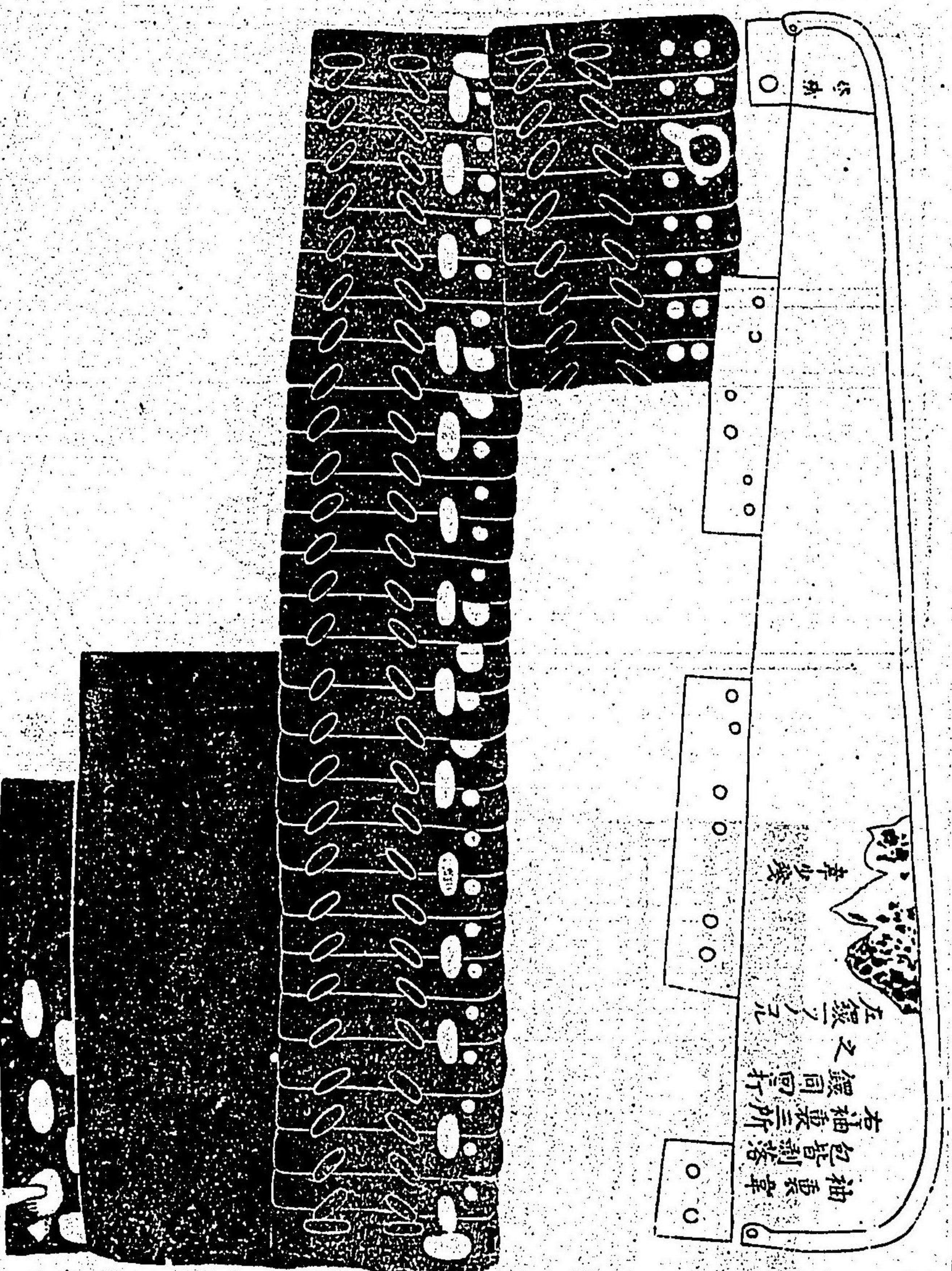

袖裏草
包皆剝落
右袖裏三所
之銀同打
左銀了之

草少殘

四段目威糸，
端紫草上，
之實者有之

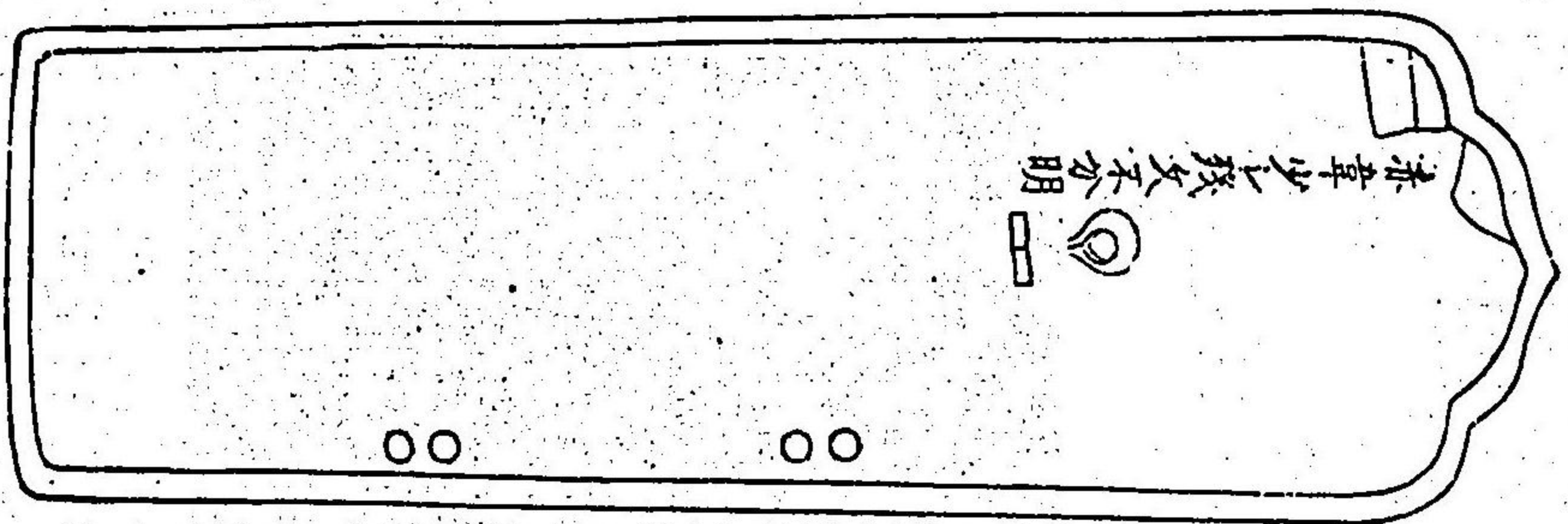

裏



袖尾板

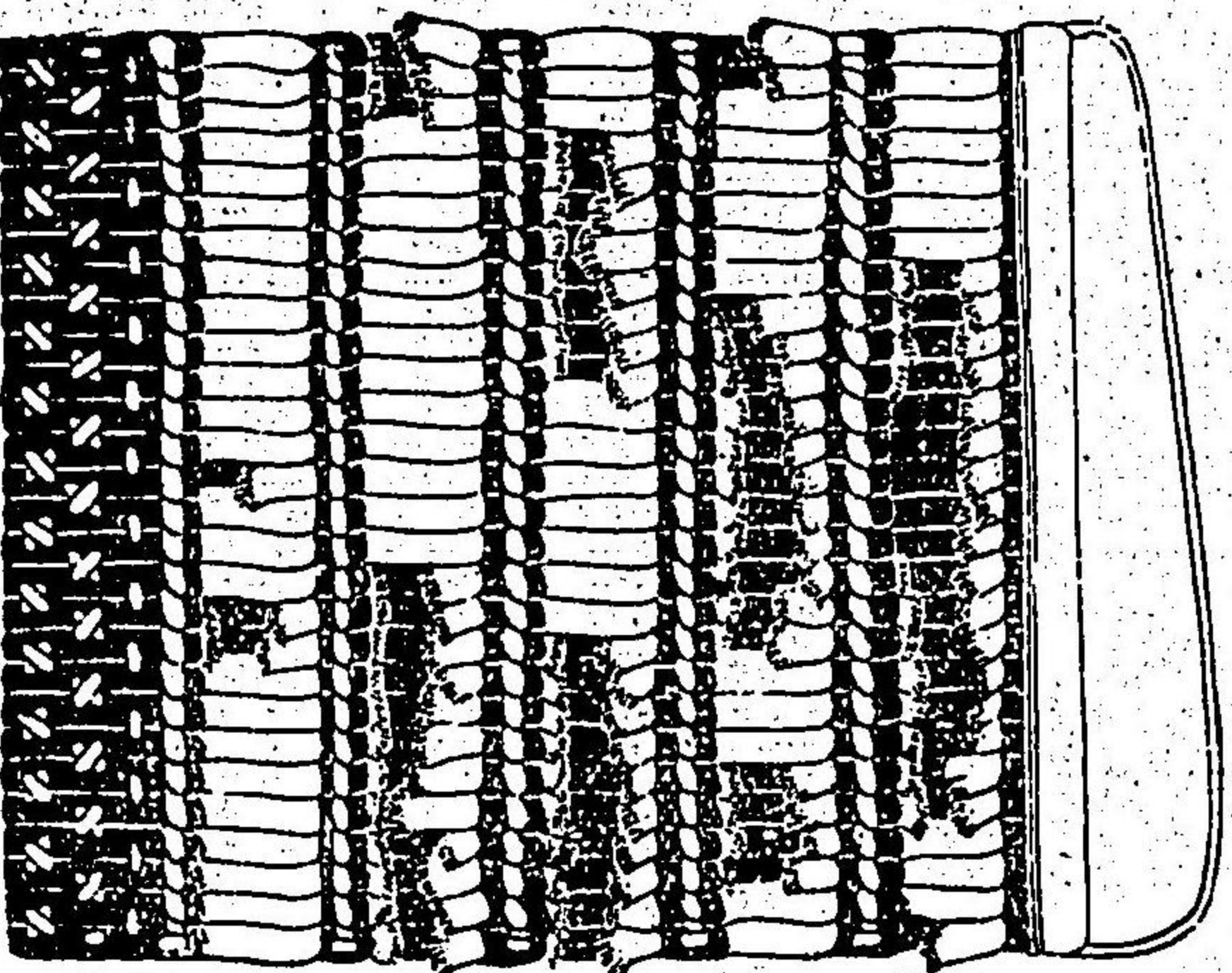

袖全圖

上四段華紋二枚下二段華

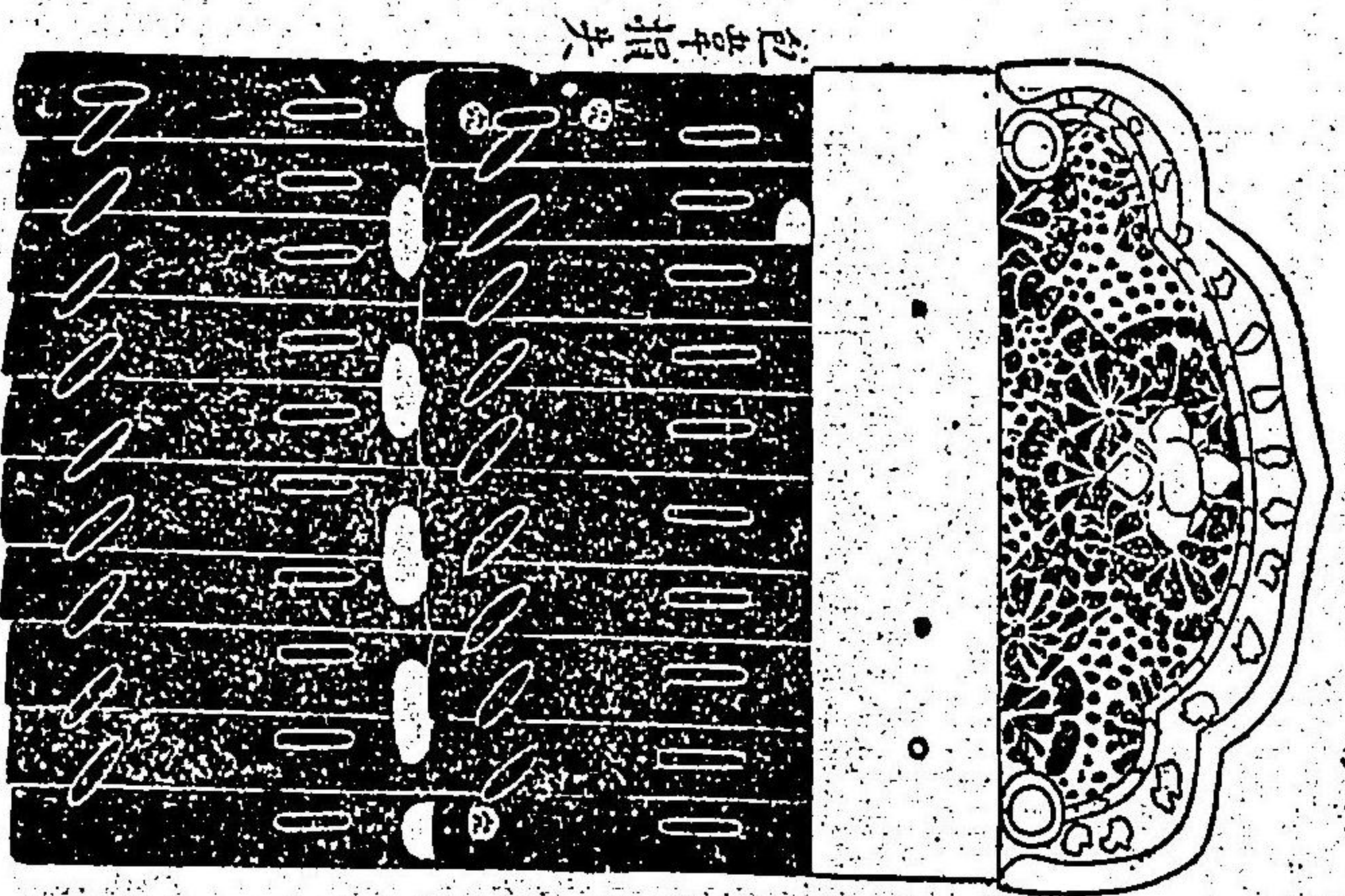

表通之丸少
ヨリノ西ニ様
竹釘ヲ入テ
トム丸尤後世修
補

裏

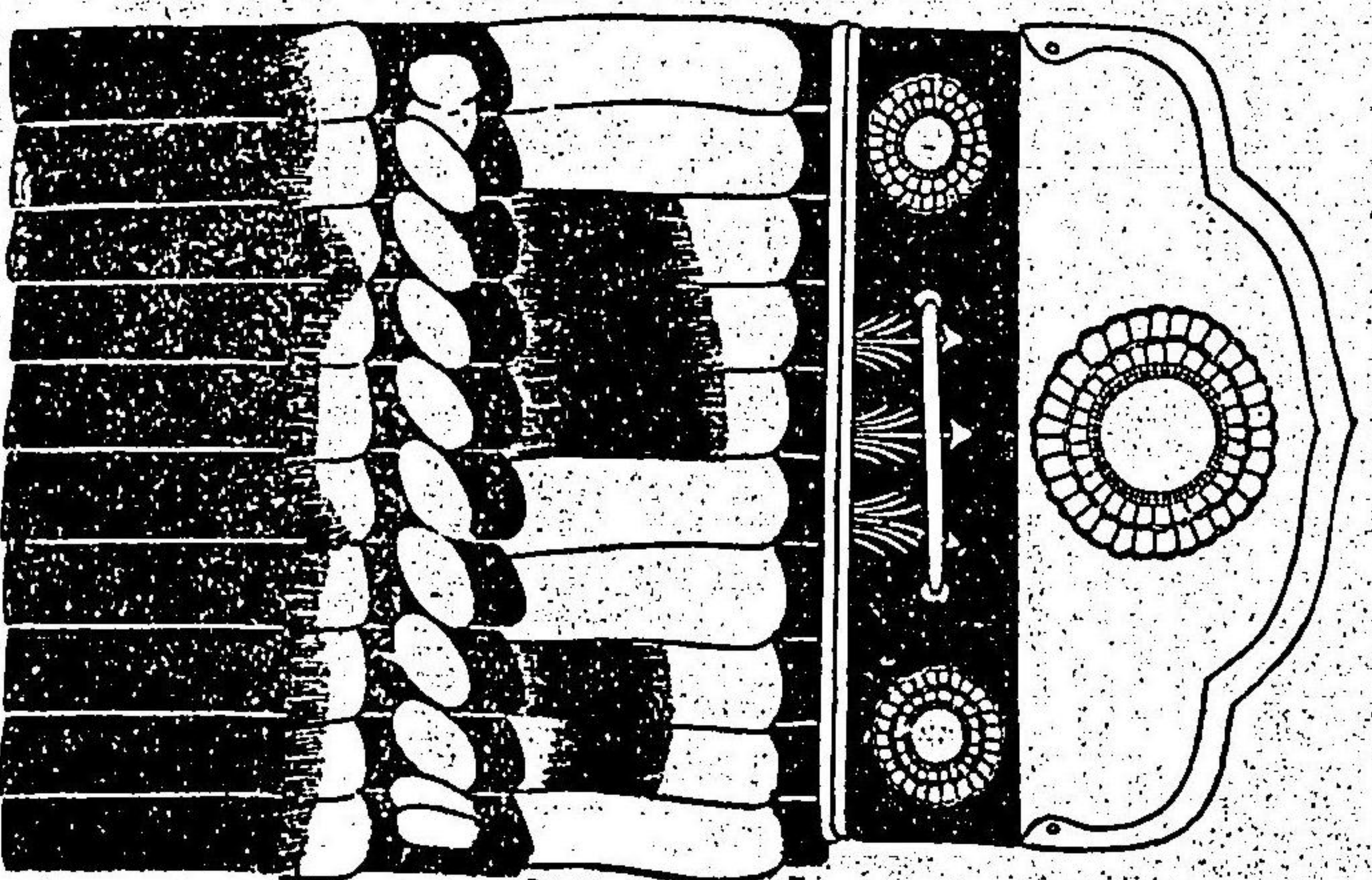

構櫃板

扶障板如图カヨリ以テ板ニシテトム
年然穴ニ元ヨリ有之サレトモ無之
上二段薄其下濃

菱板無

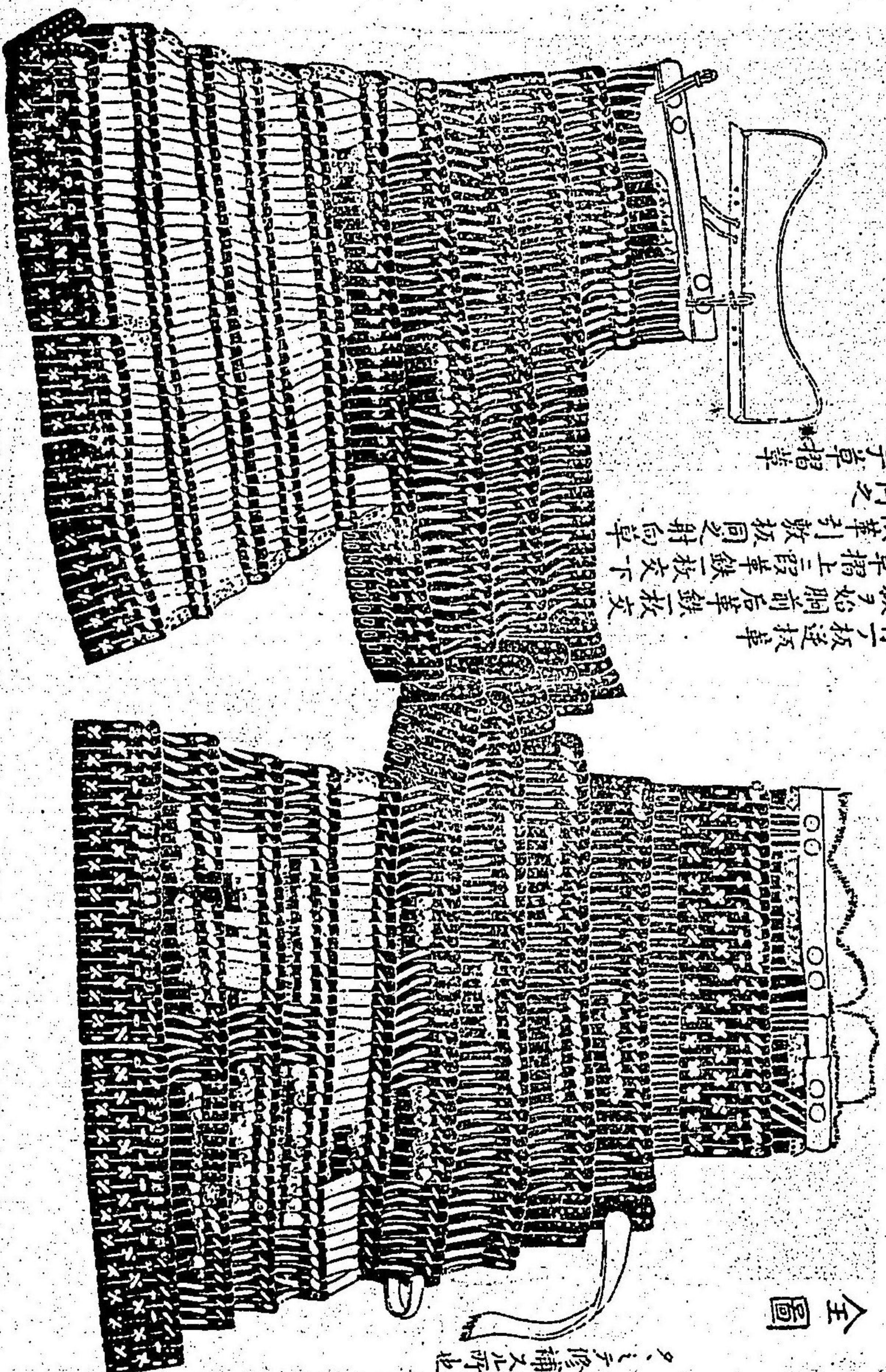

全圖

威古字公字保中布
久之手修補不止也

押付了板逆板
胸板了始胸前居草鐵板交
前草摺上段草鐵板交下
三段草引數板同之射向草
摺同之
委子草摺草

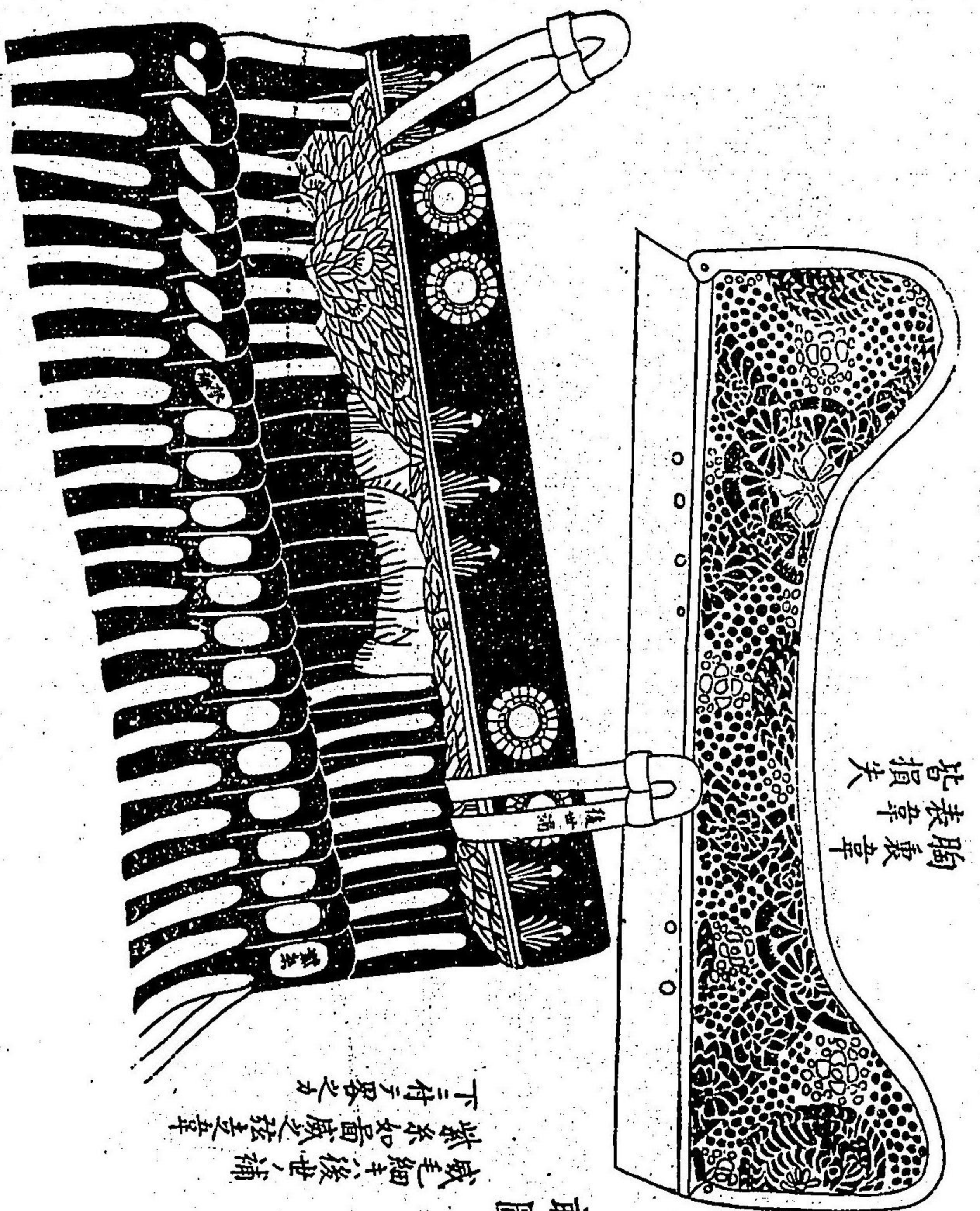

胸裏草
表草
皆損失

前圖

威毛細手後世補
鐵亦如面威之強草
下三付之草之



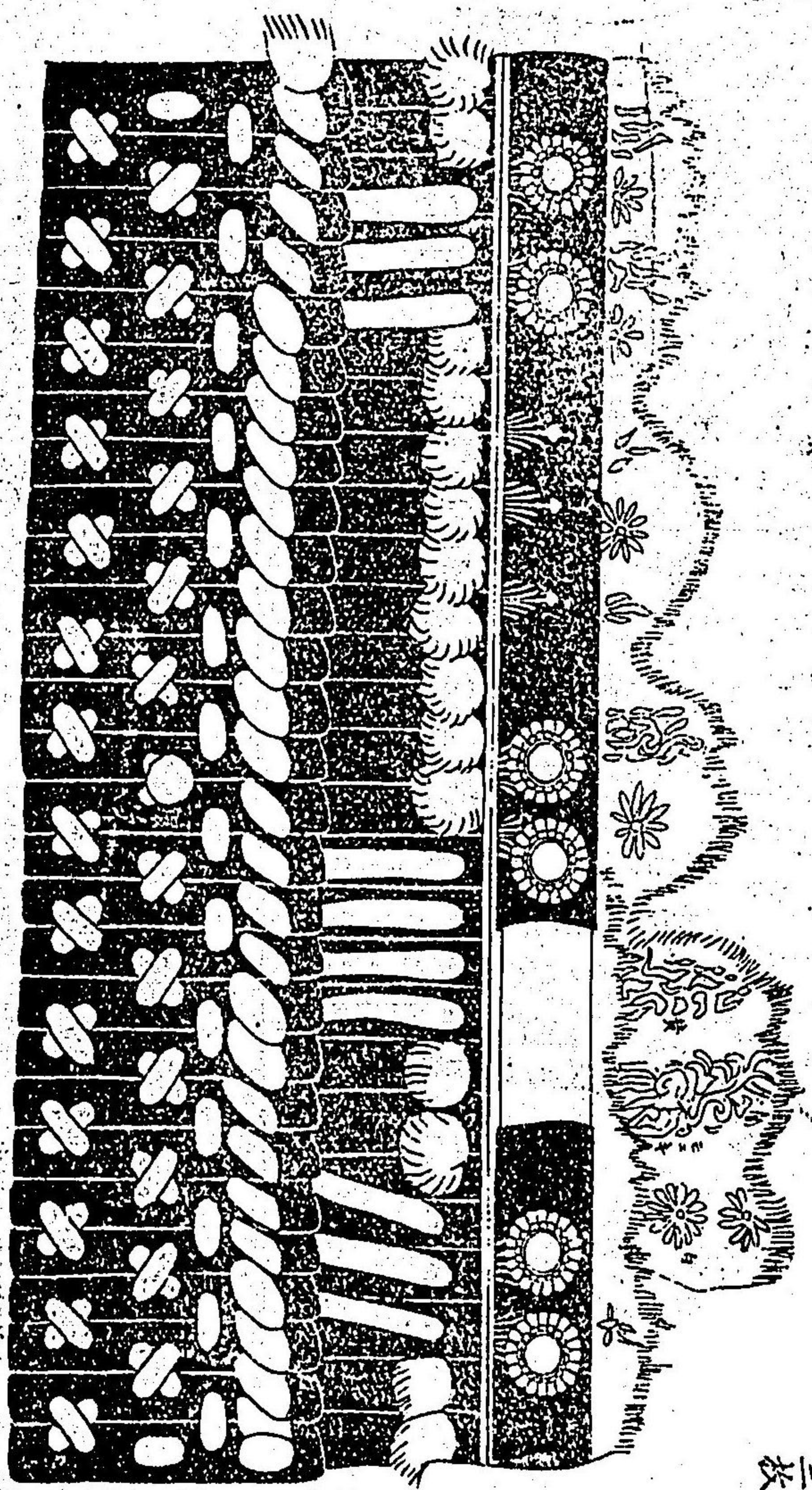

後圖
 茶地下手綿
 以此錦三重
 厚為三枚
 逆板睡目紺白淺黃 炭赤草

脇楯壺板



草少葵
 後世修補

脇楯全圖

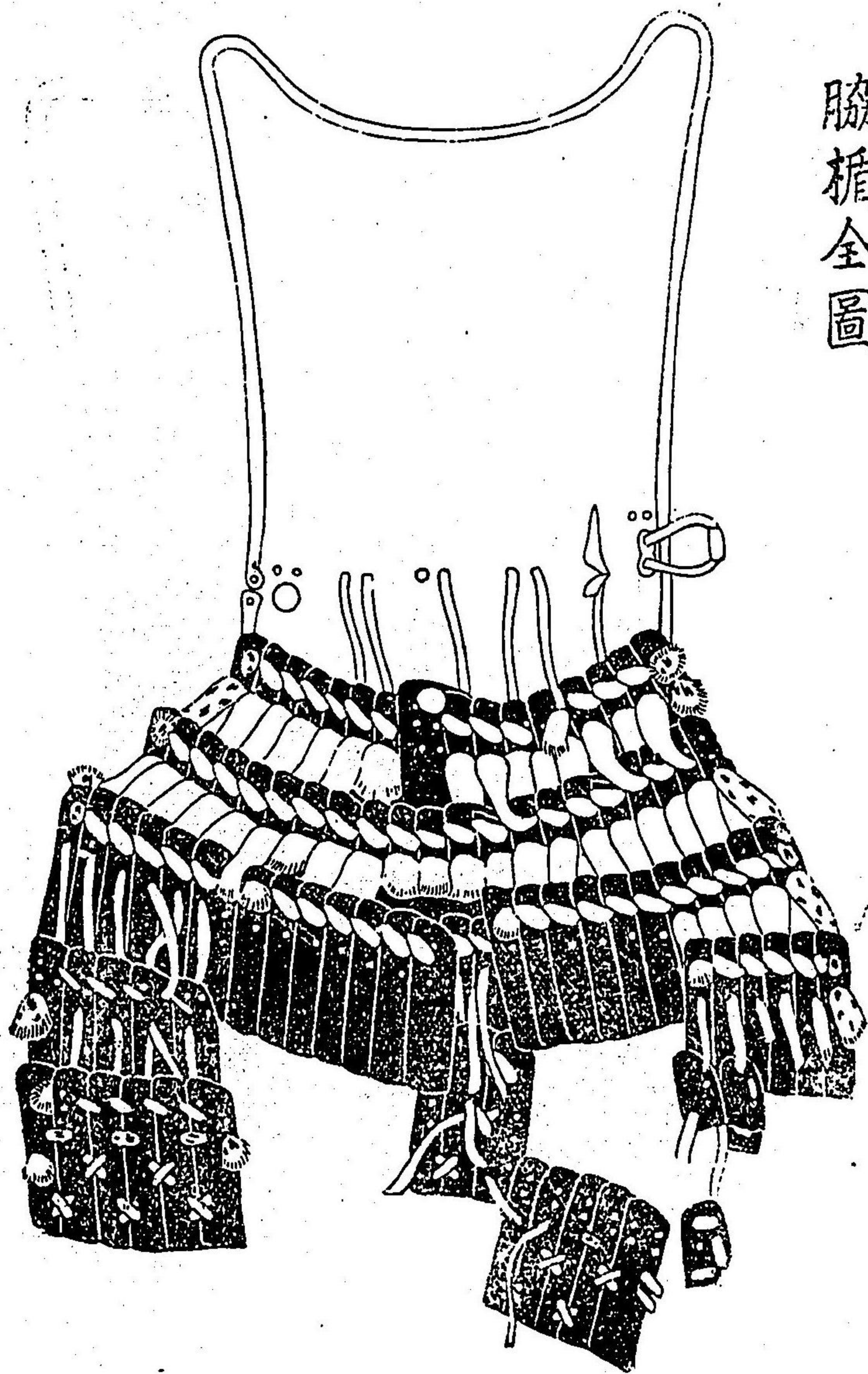

山城國鞍馬寺 藏鎧圖

威糸白紫モエキ黒カハチヤ
耳糸紫モエキ黒白打組
伏組白紫モエキ
金物金メツキ
以頭字註文
後板袖等
黒茶黄ノ
色糸アリ
下皆同

前

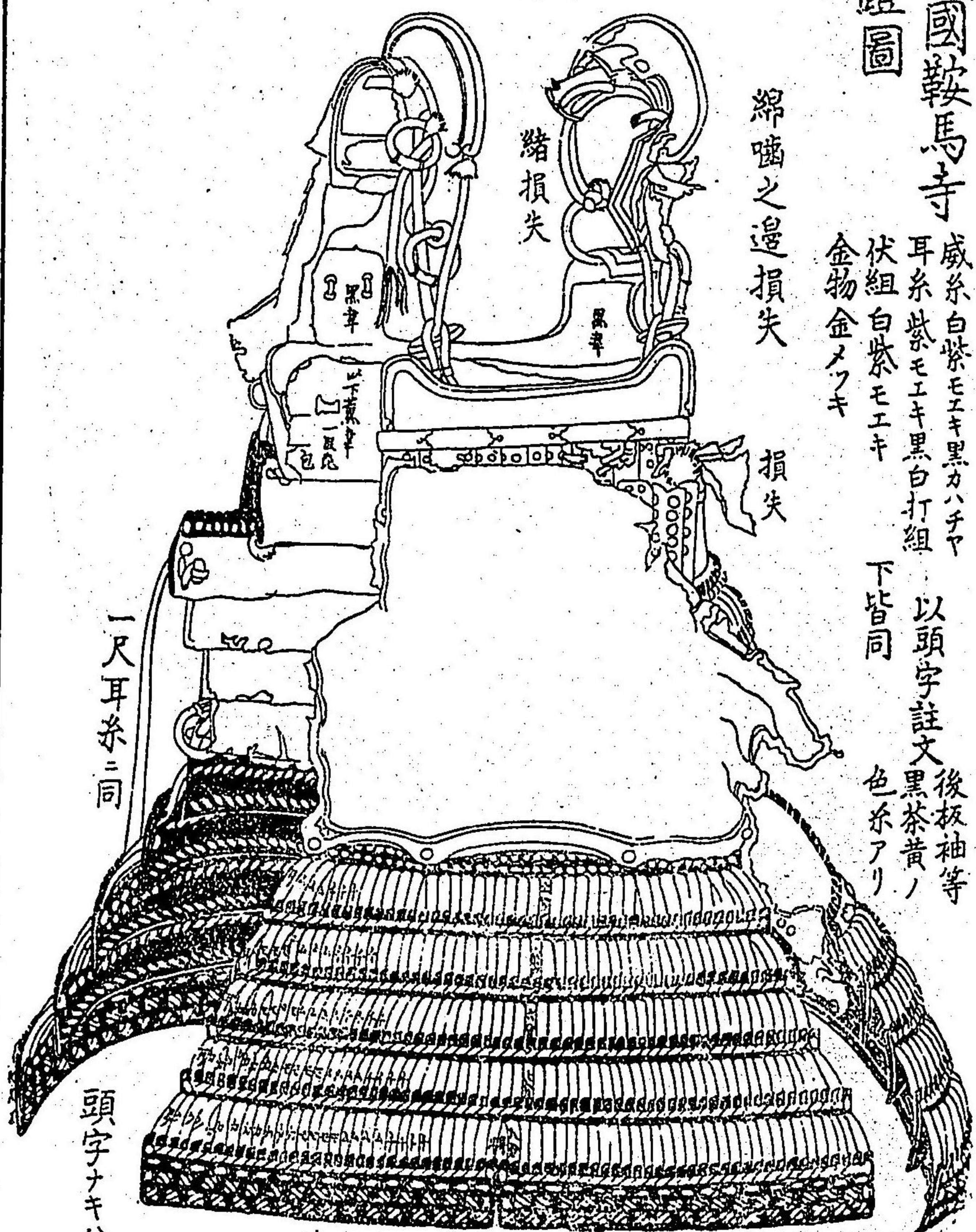

綿嚙之邊損失

損失

緒損失

一尺耳糸ニ同

頭字ナキ八白糸

菱緋

前
小札
如數板

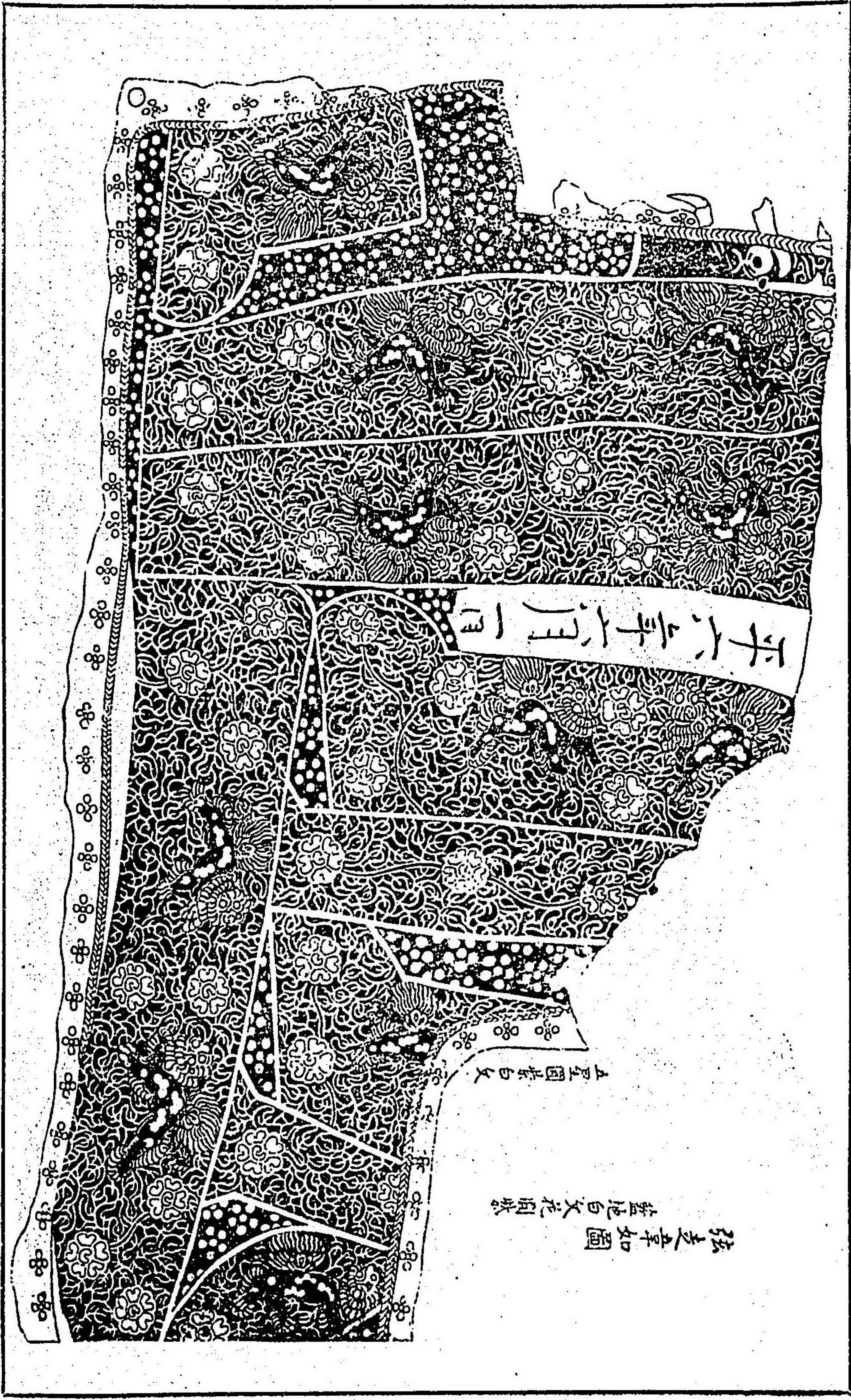

弦之章如圖
藍地白花團狀

五聖圖紫白文

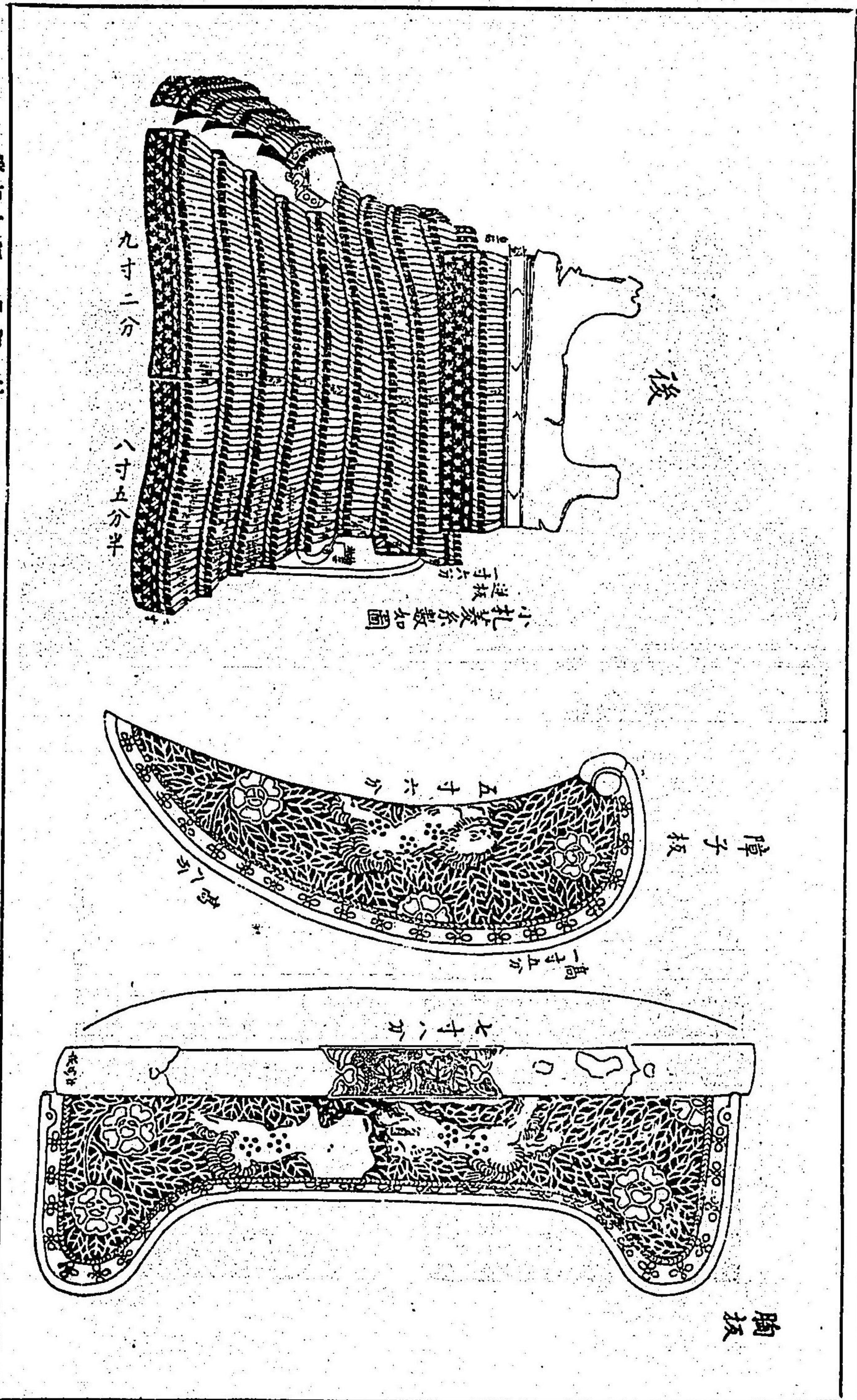

胸板

障子板

後

小扎裝糸數如圖

七寸八分

五寸六分

九寸二分

八寸五分半

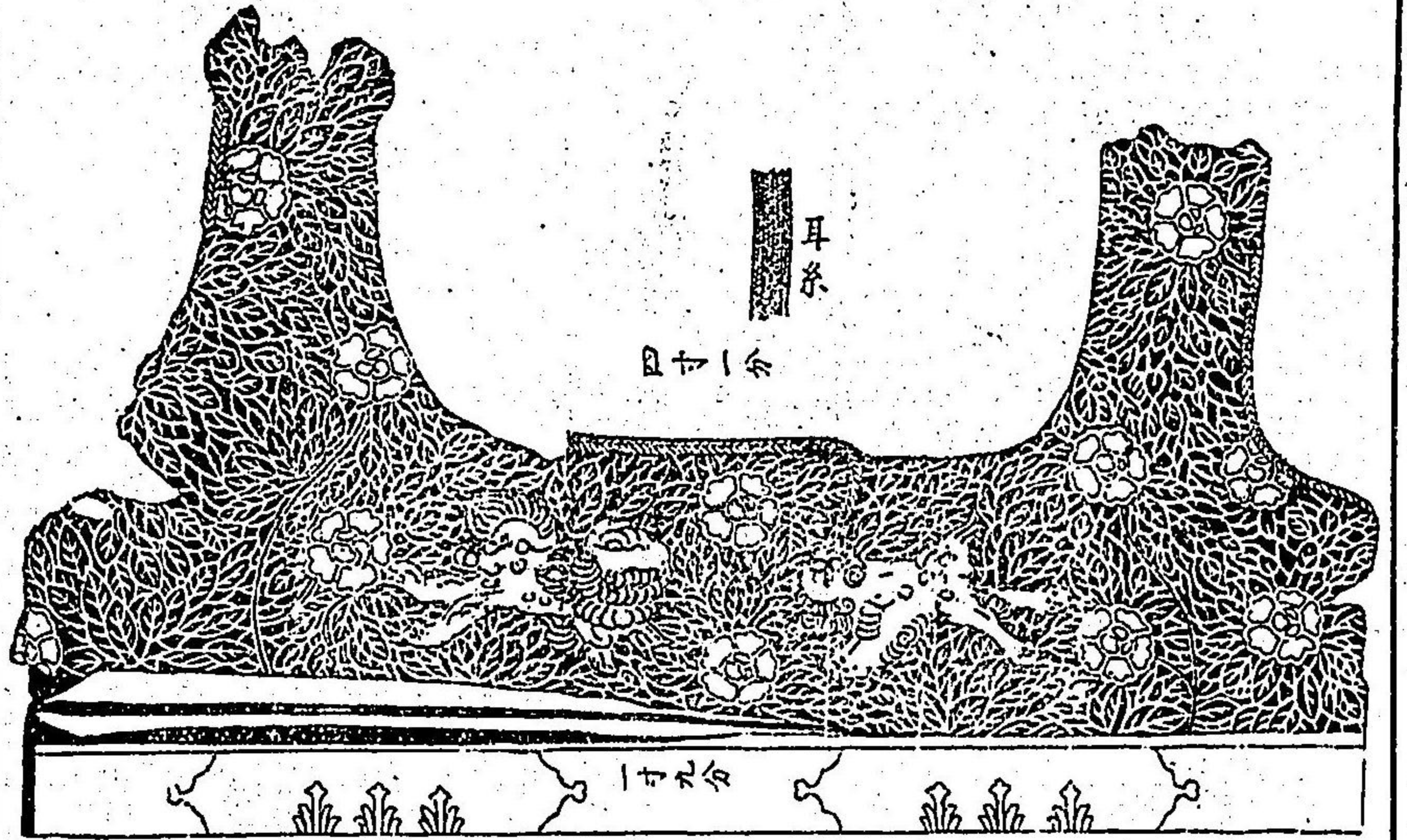

耳糸

四寸一分

一寸二分

九寸七分

袖
小札糸敷
如图

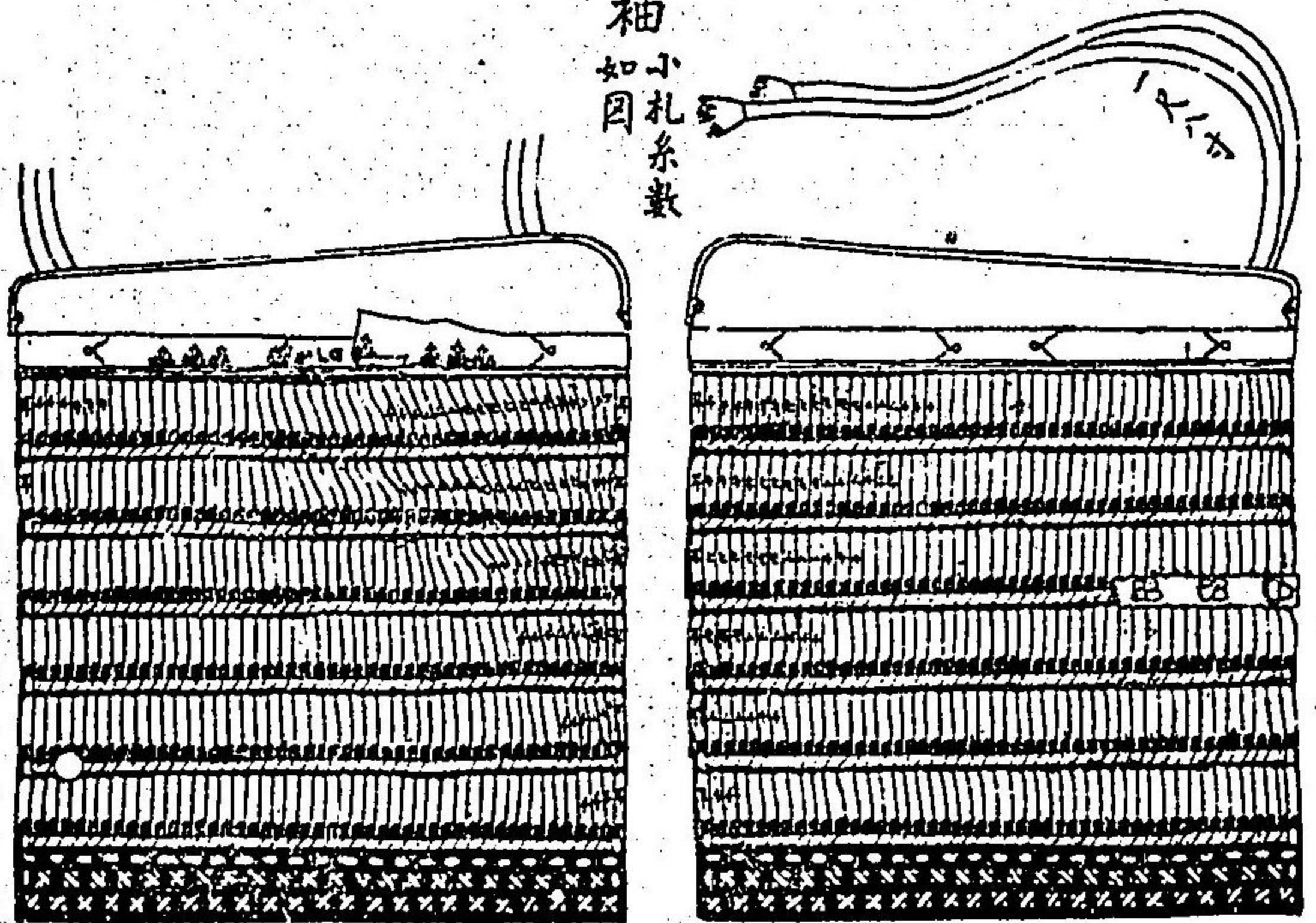

一尺八寸

水引白二筋

鎌高三分半
スカーン

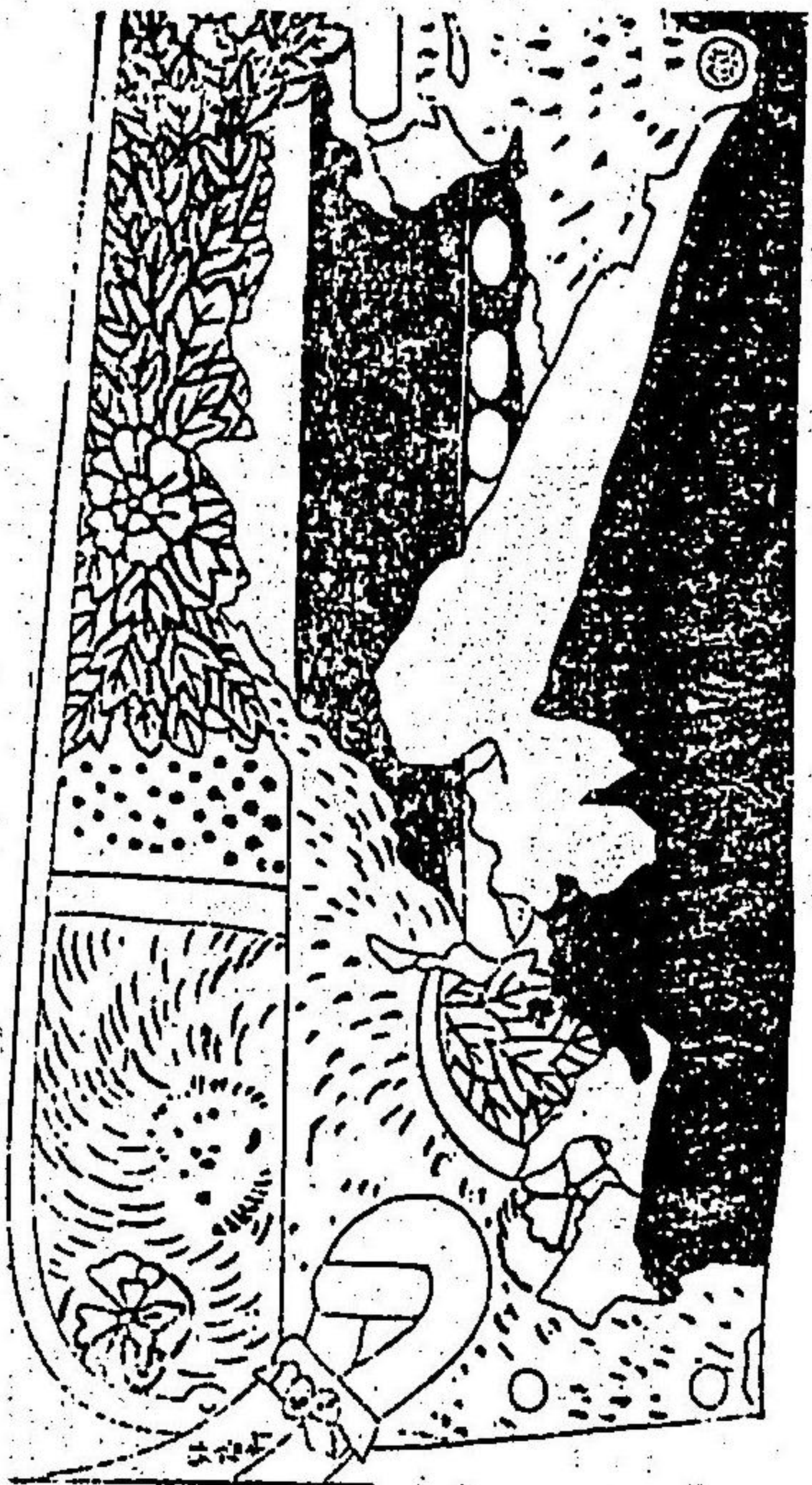
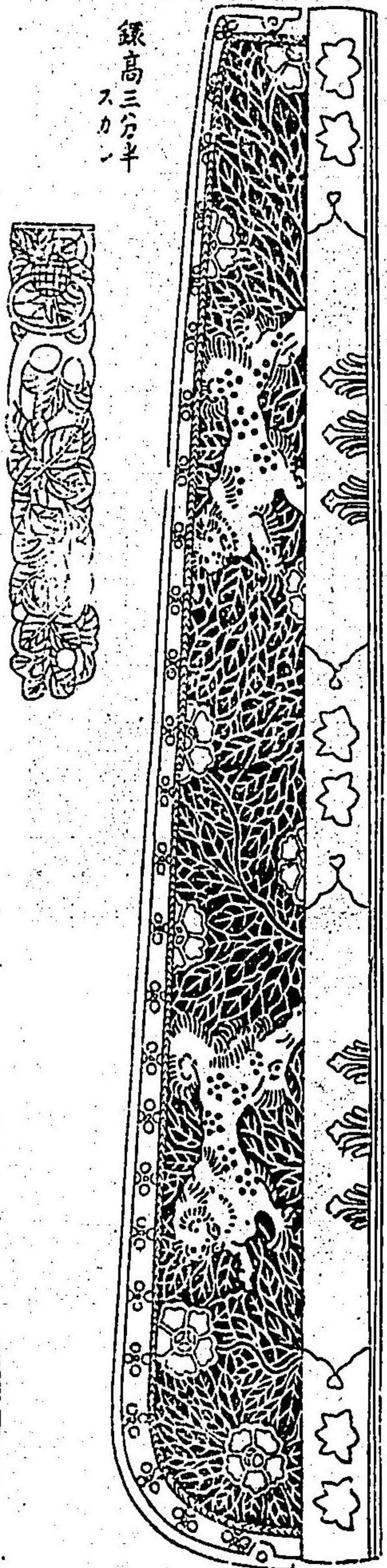

明子不色章

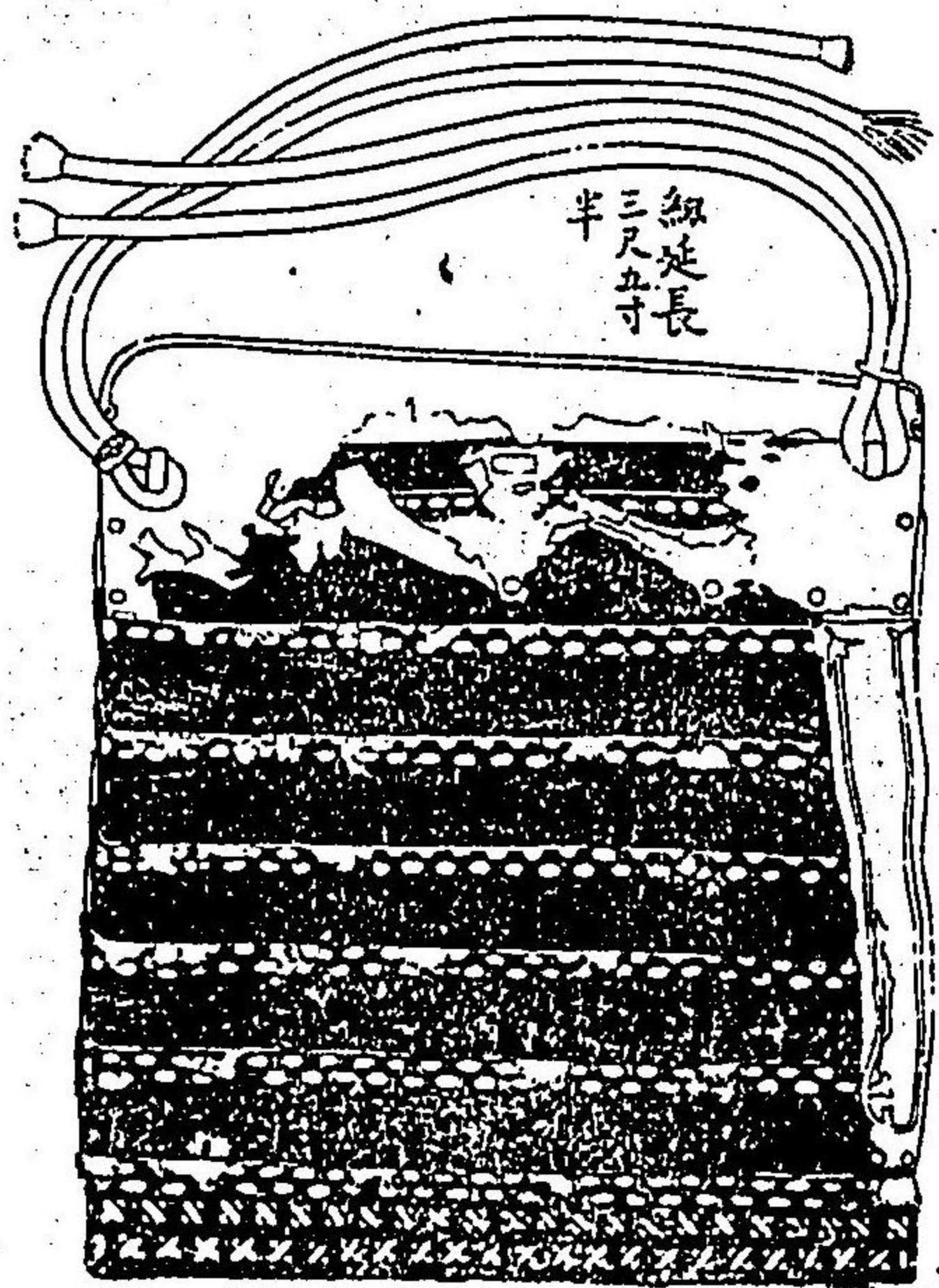

紐延長
三尺五寸
半

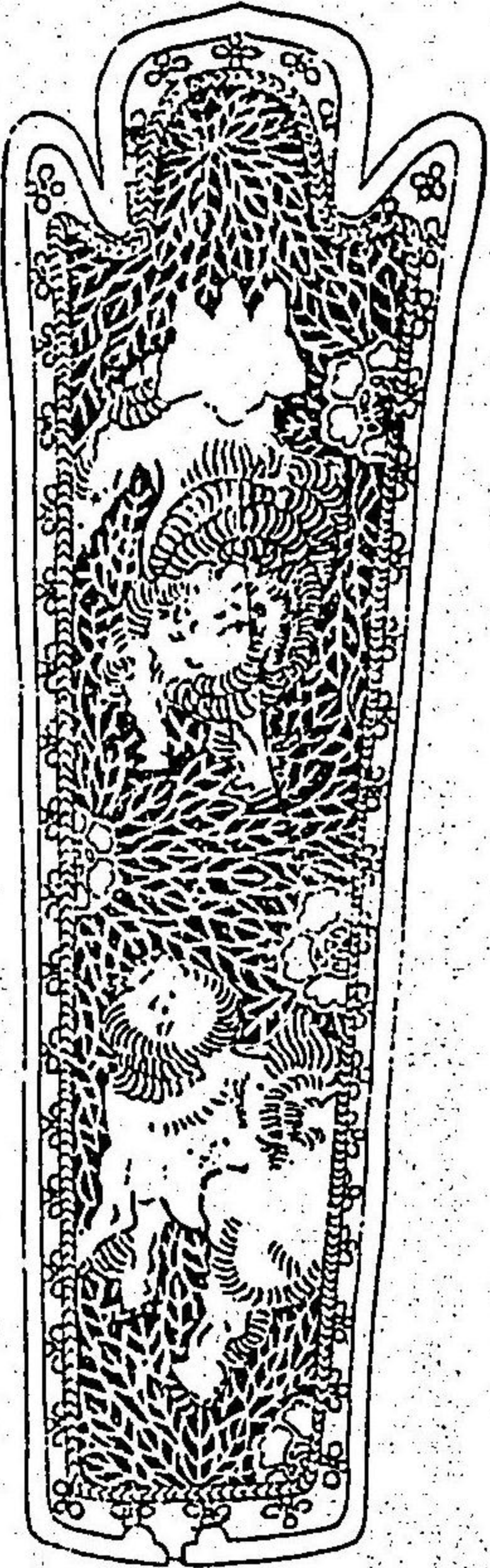

小出輪

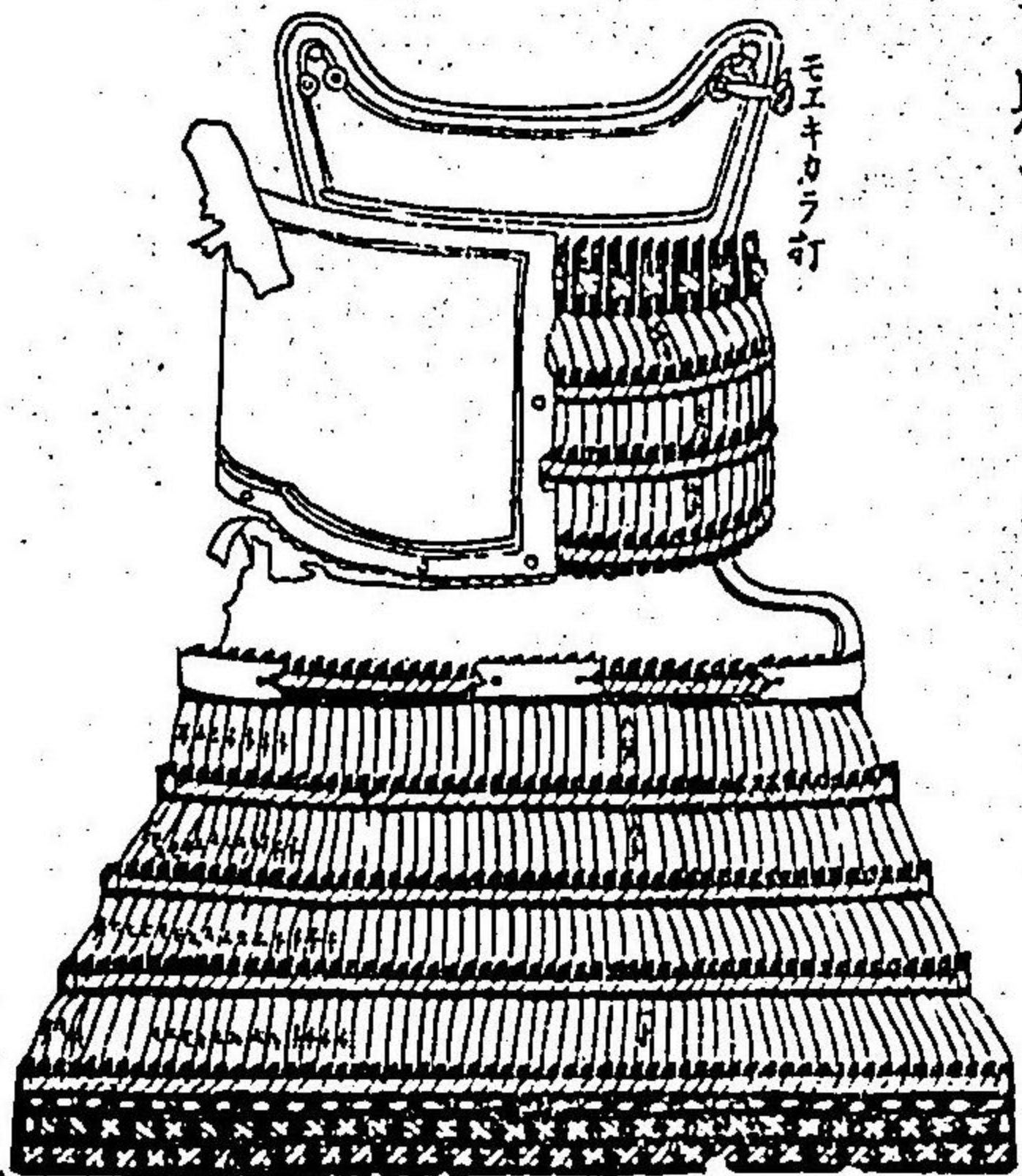

射向

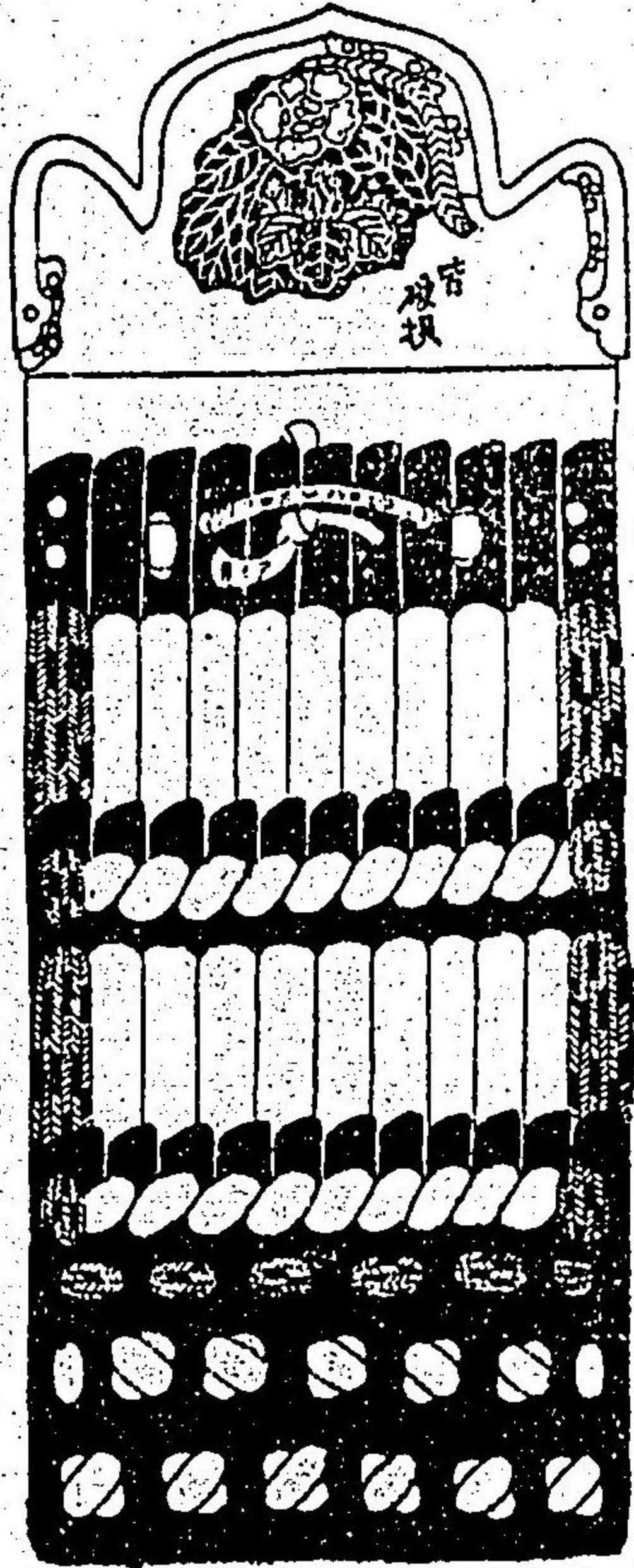

梅檀板

威白糸

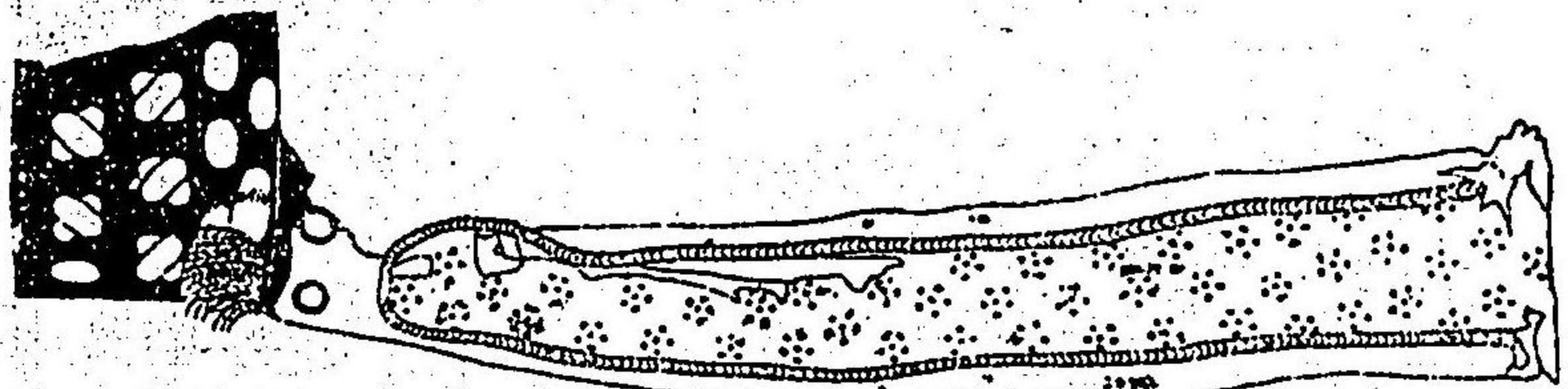
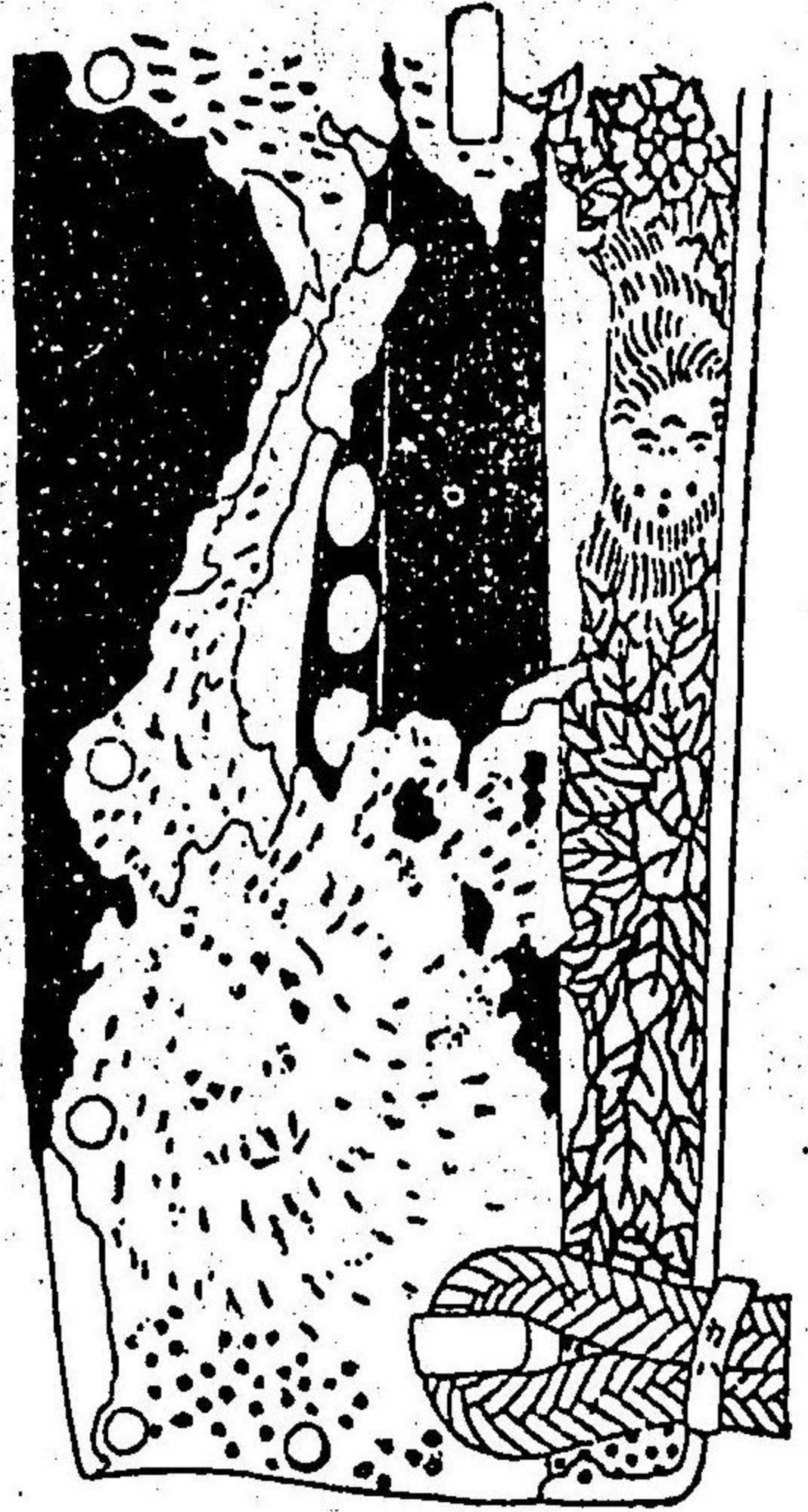

射向

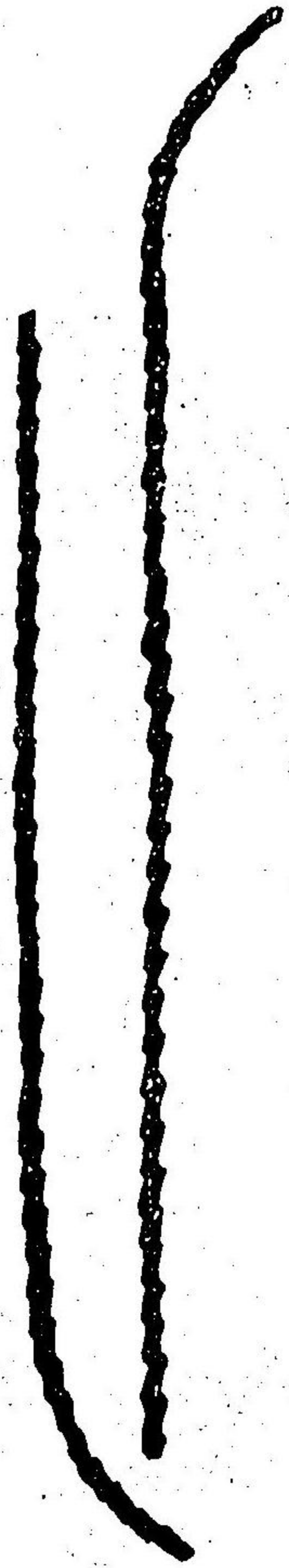

服立

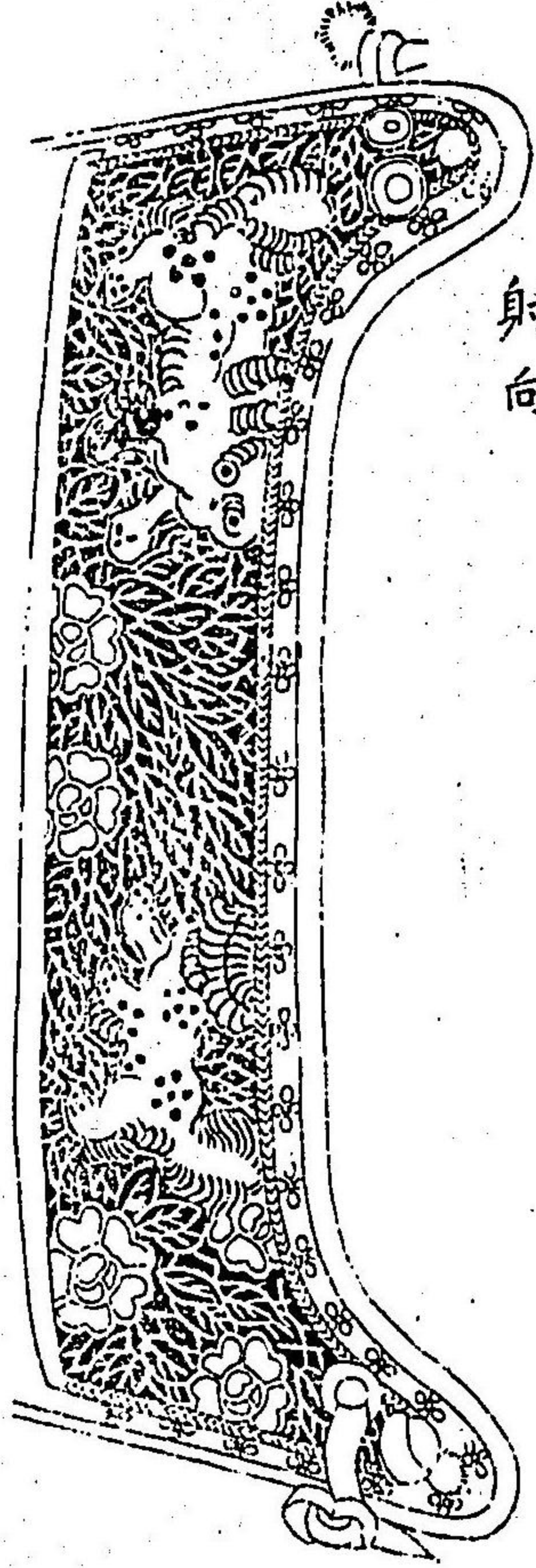
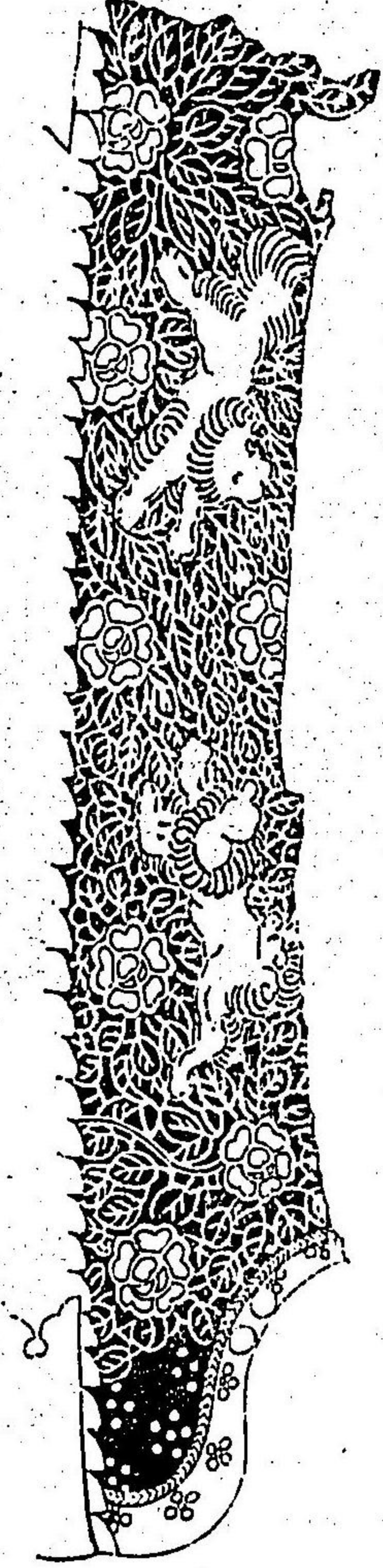

射向

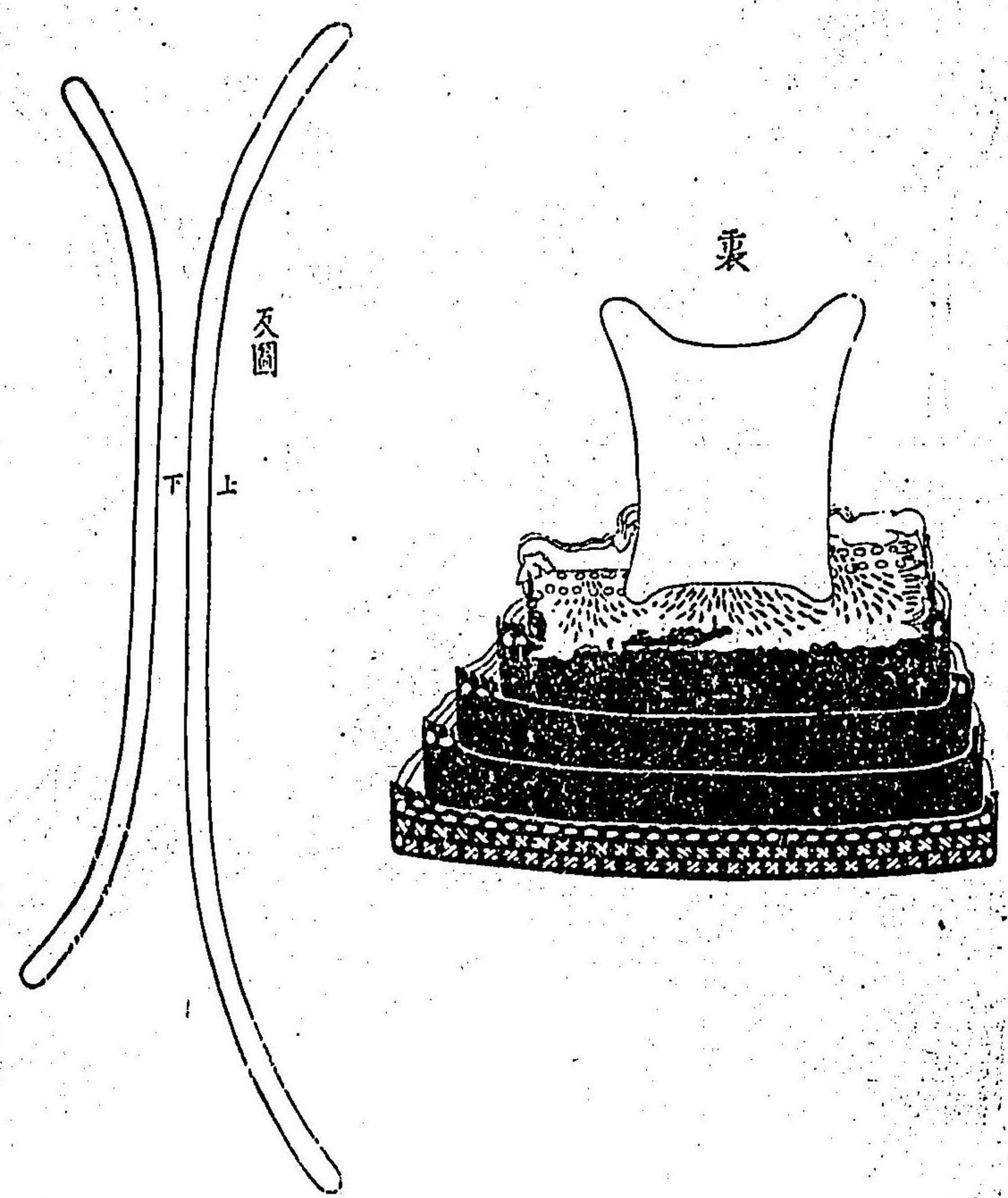
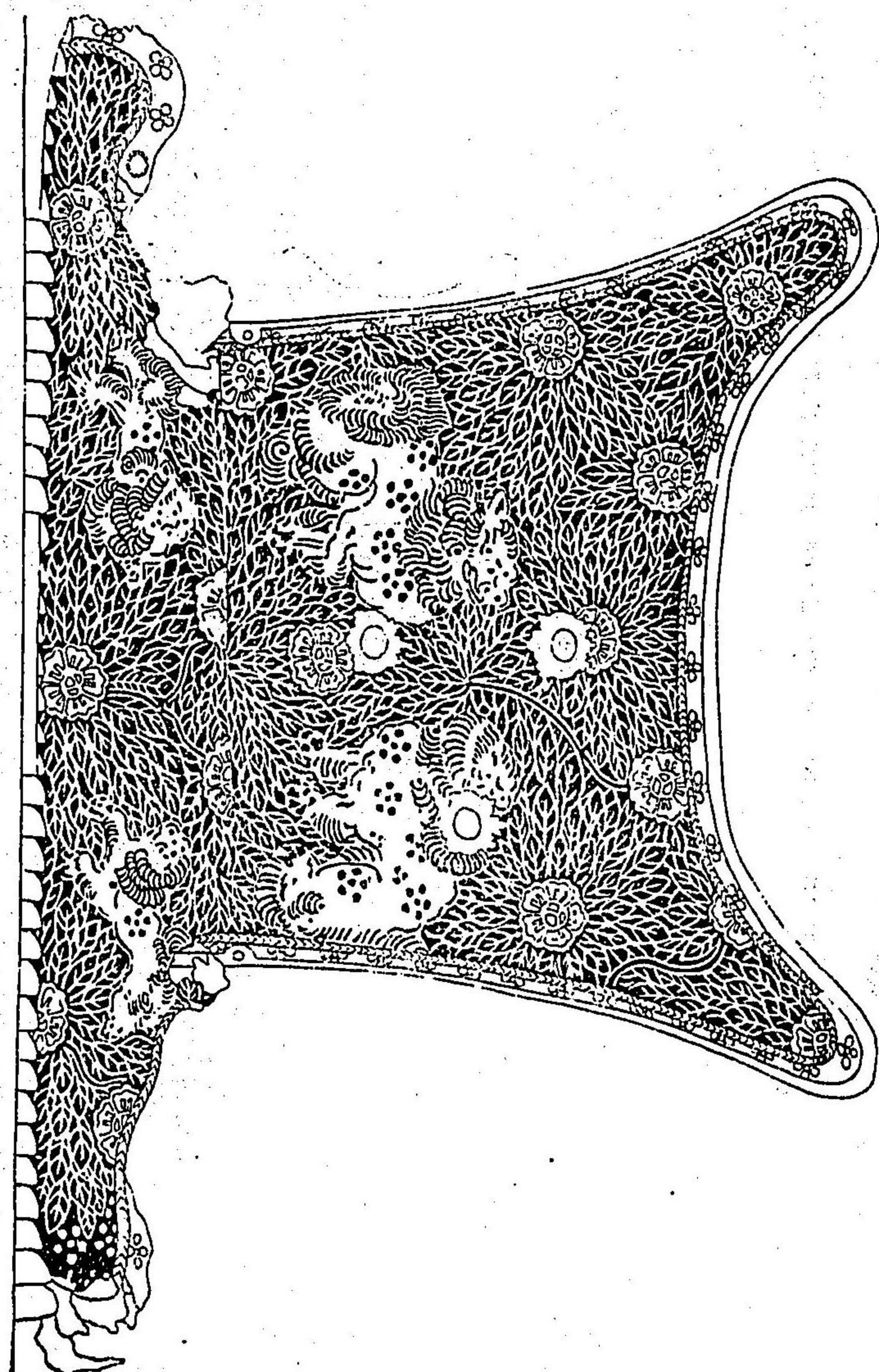

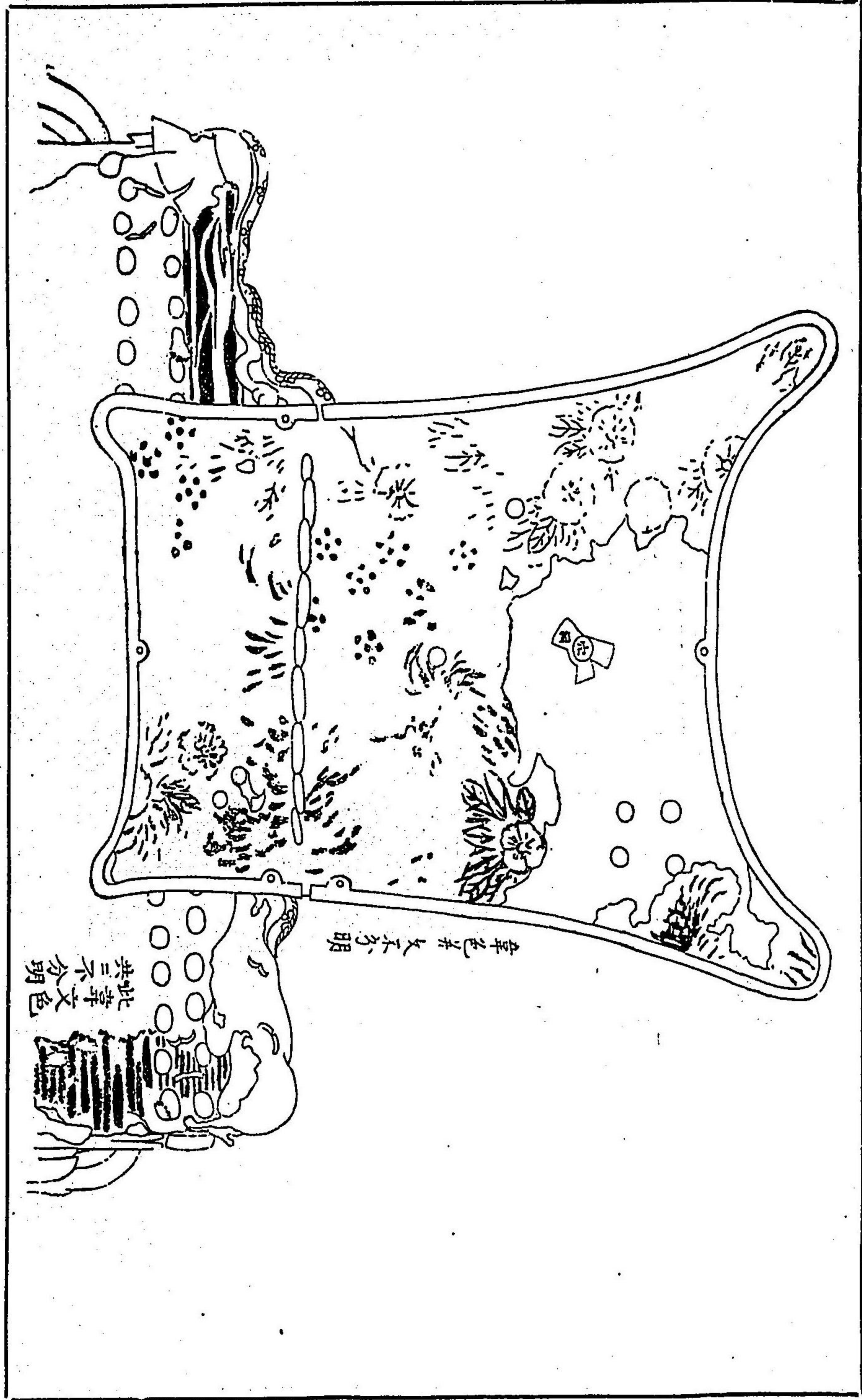

甲冑色并 文不分明

此等文色 共三不分明

南都春日神庫所藏甲冑圖 函人岩井某所藏摸本

冑全圖



金物金減金多シ 圖中一々不註之

鉢付鉾 スキ無之

冑八方白

十六間黒塗屋冑

前シノタト三筋其餘

皆二筋

甲冑威糸カバ色 或曰鶉色威疑緋 色経年色ヲ衰ス ルモノカ

耳糸睦目シリシメ 白紺紫崩黄打組

由側面

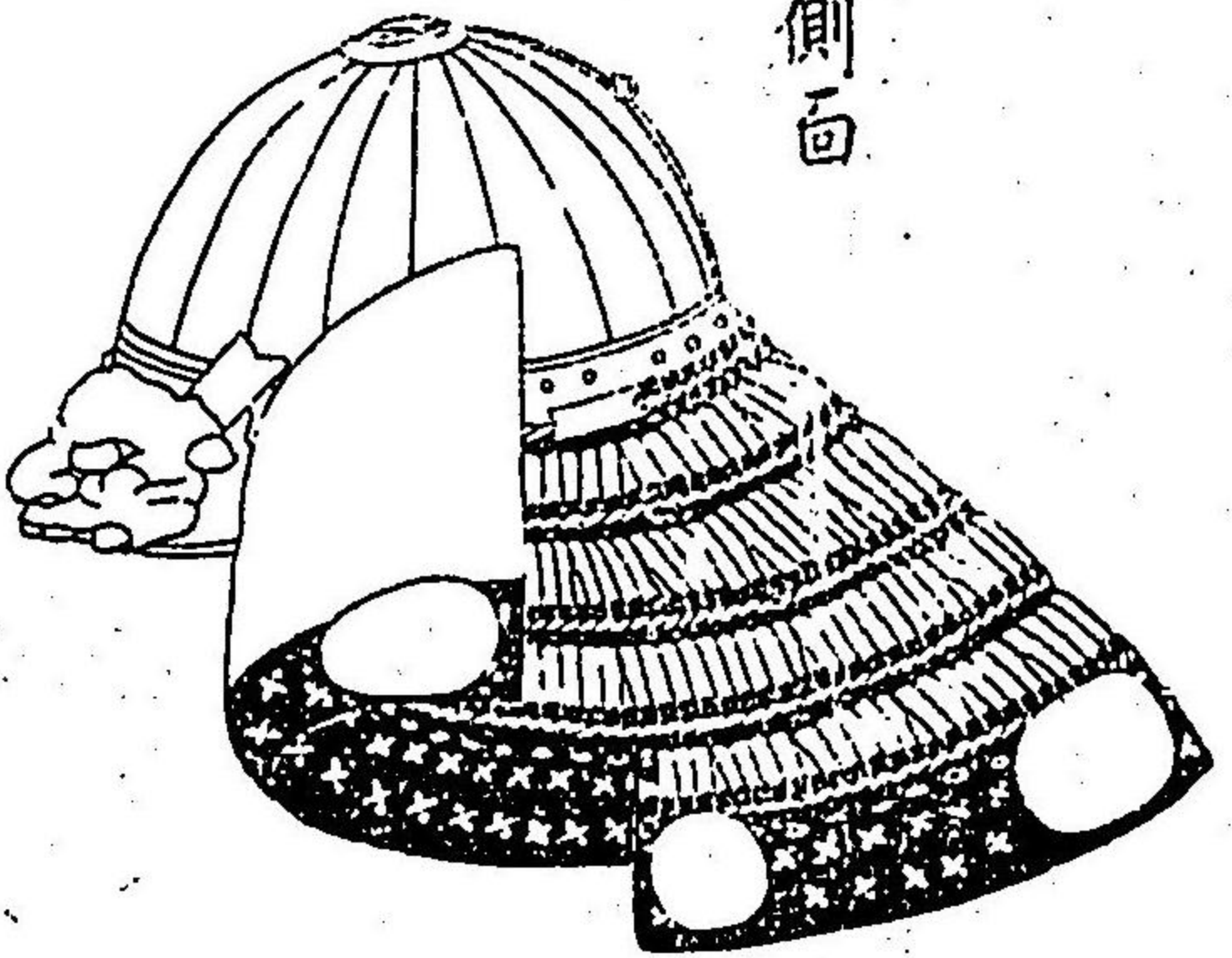

天空并前鎬垂
左右後制同
鎬垂二本宛

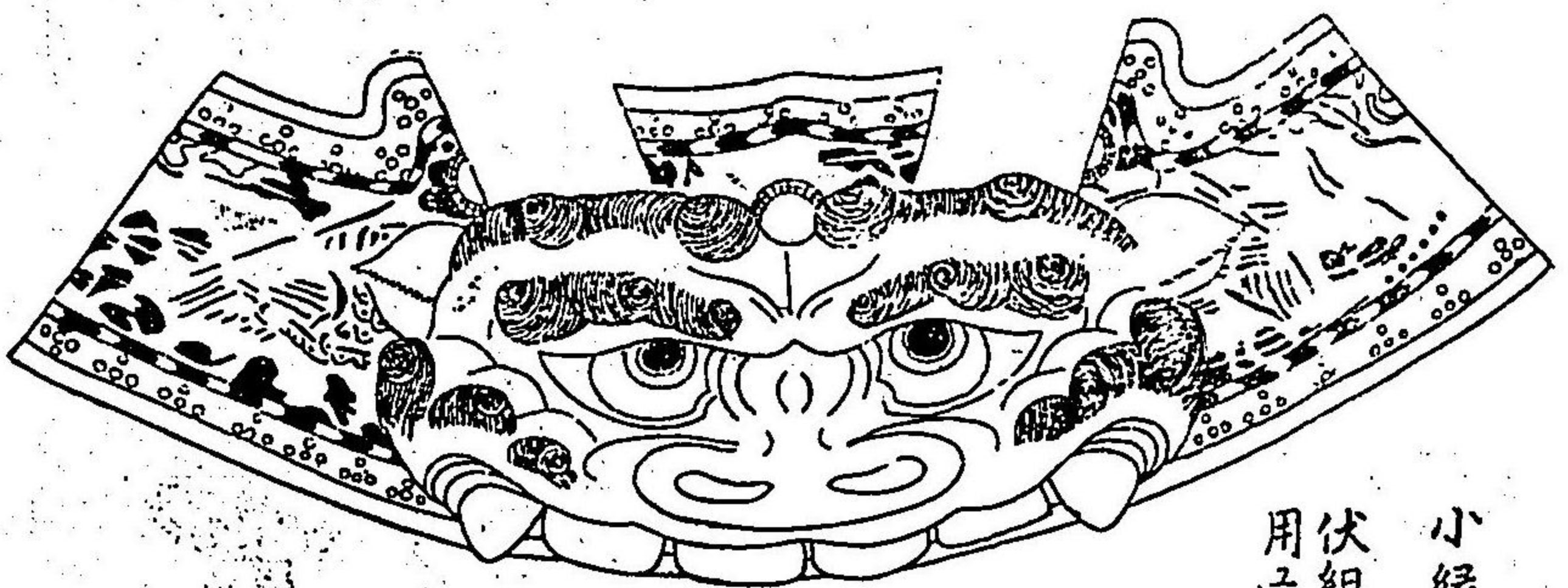
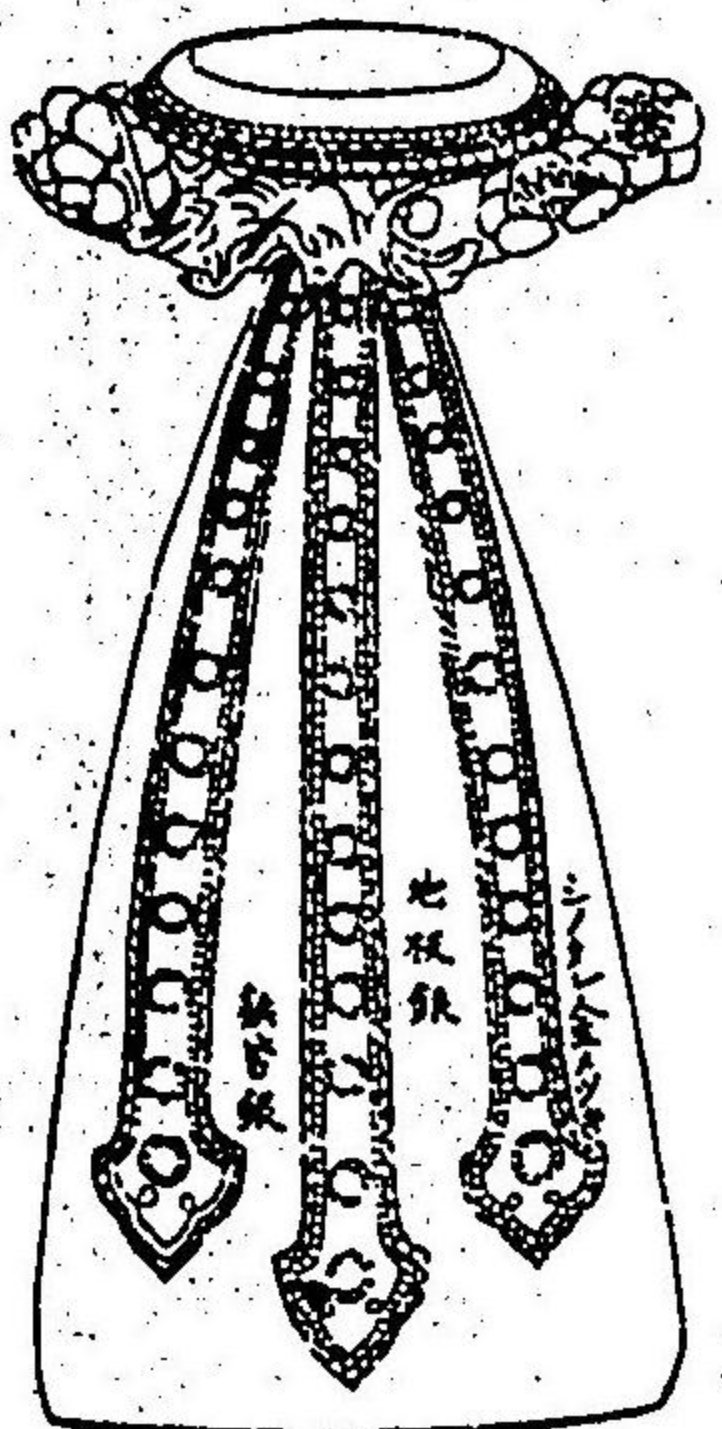

小縁草五呈赤草
裏表同
伏組白紺紫甲冑裏
用之所白紺茶

シカミ彫上金メウキ
玉眼牙歯銀

鍬形馬羽毛彫

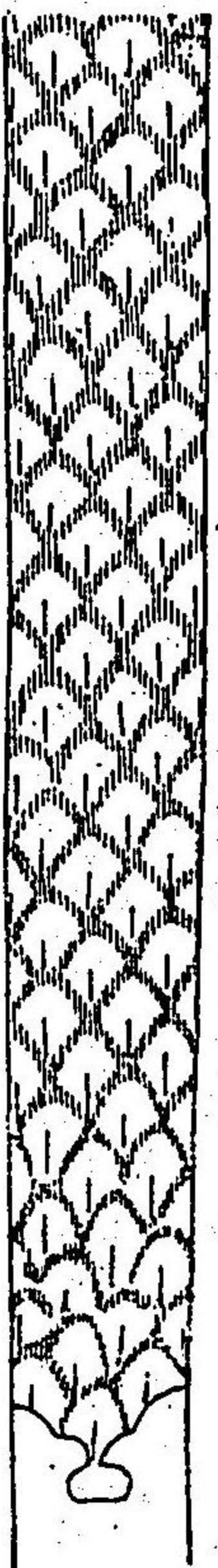
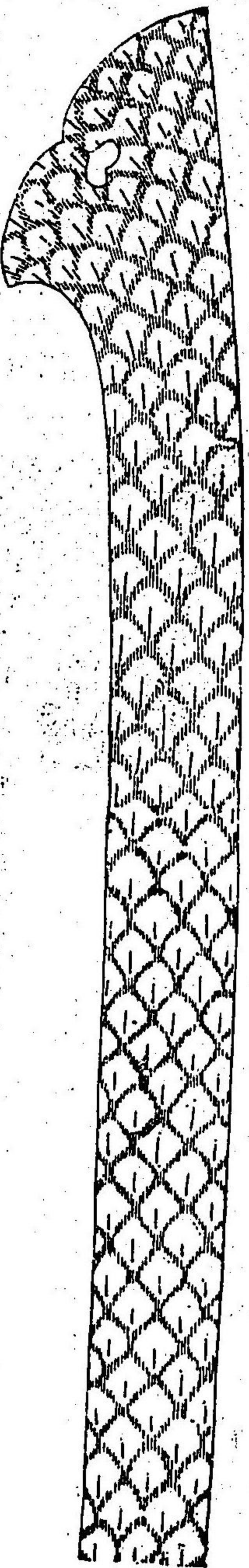

鞆裾金物左端



銀地板ノ上
梅カキホリ
金メウキ
裾袖草摺等
同
裾金メウキ

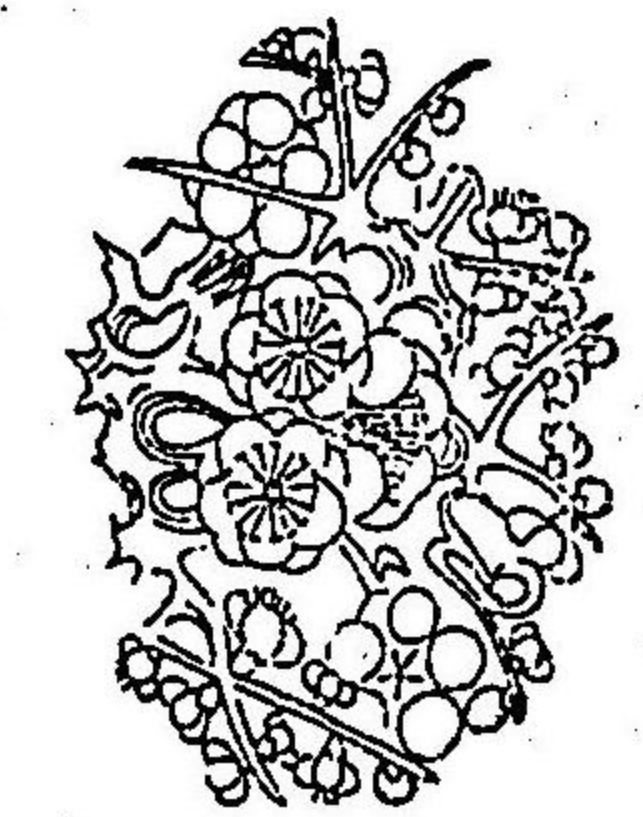

後中央

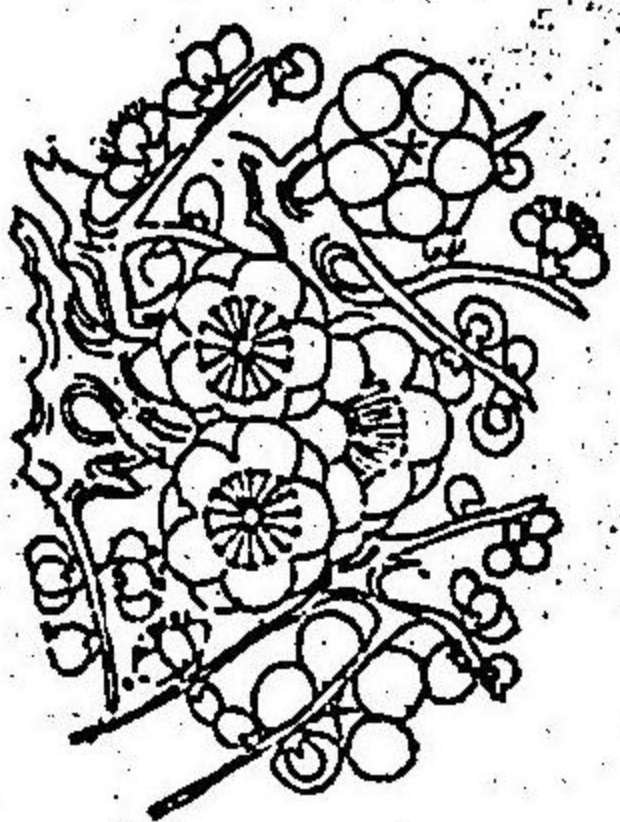
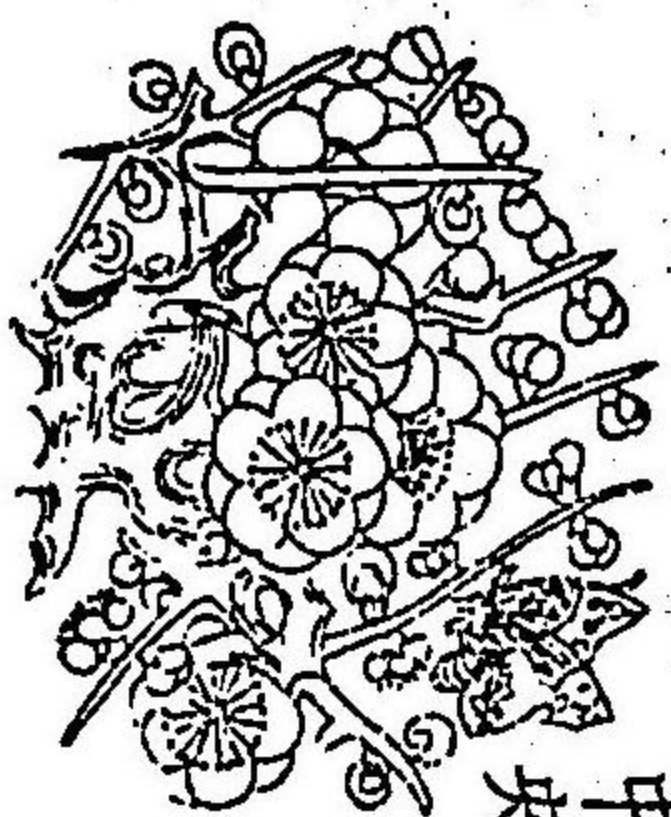

右端

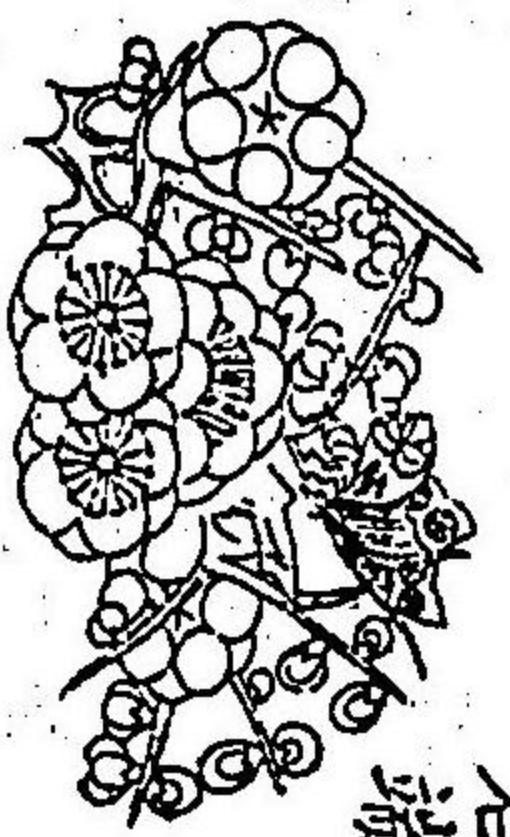

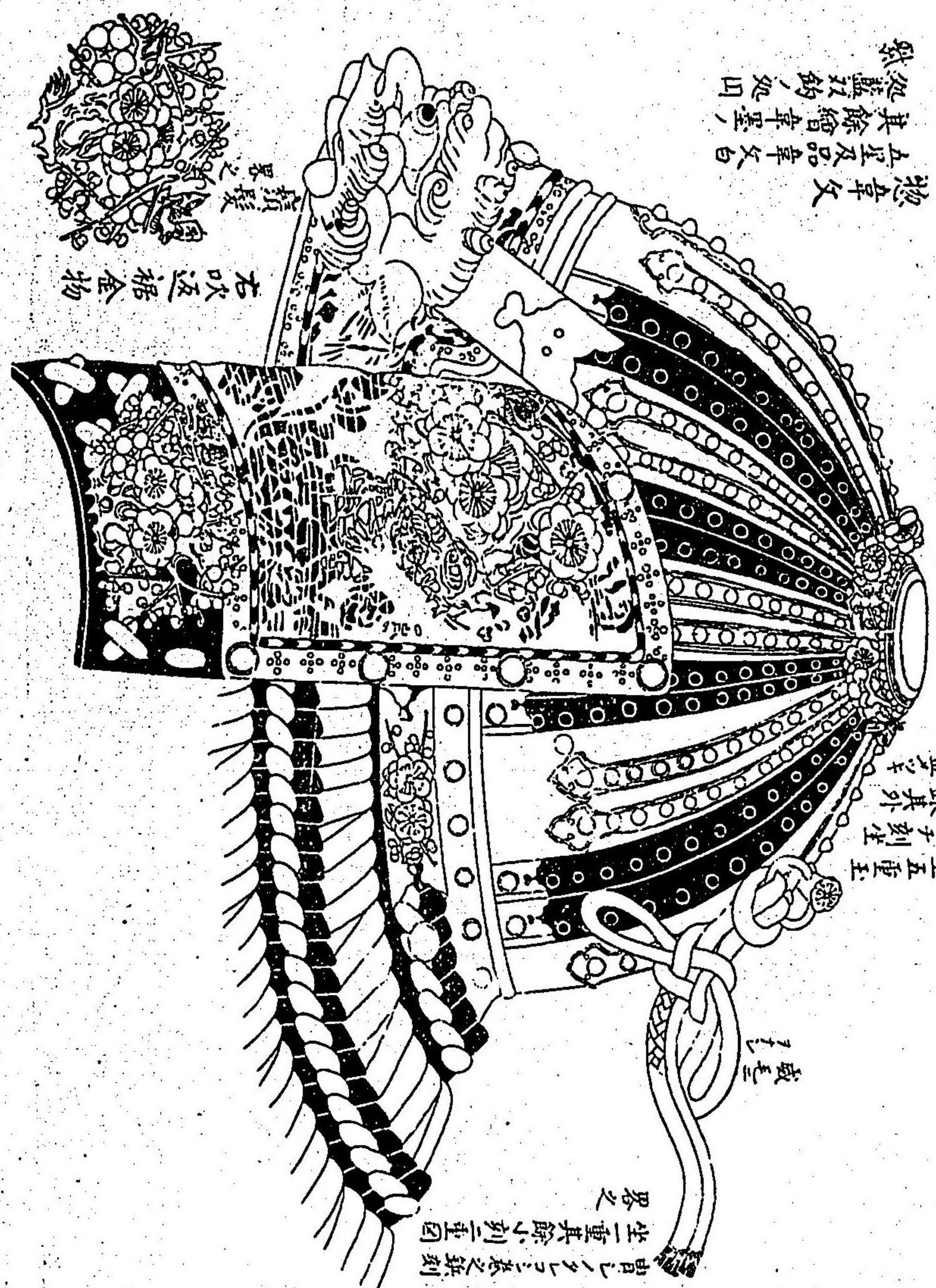

左吹返
雷文
公文

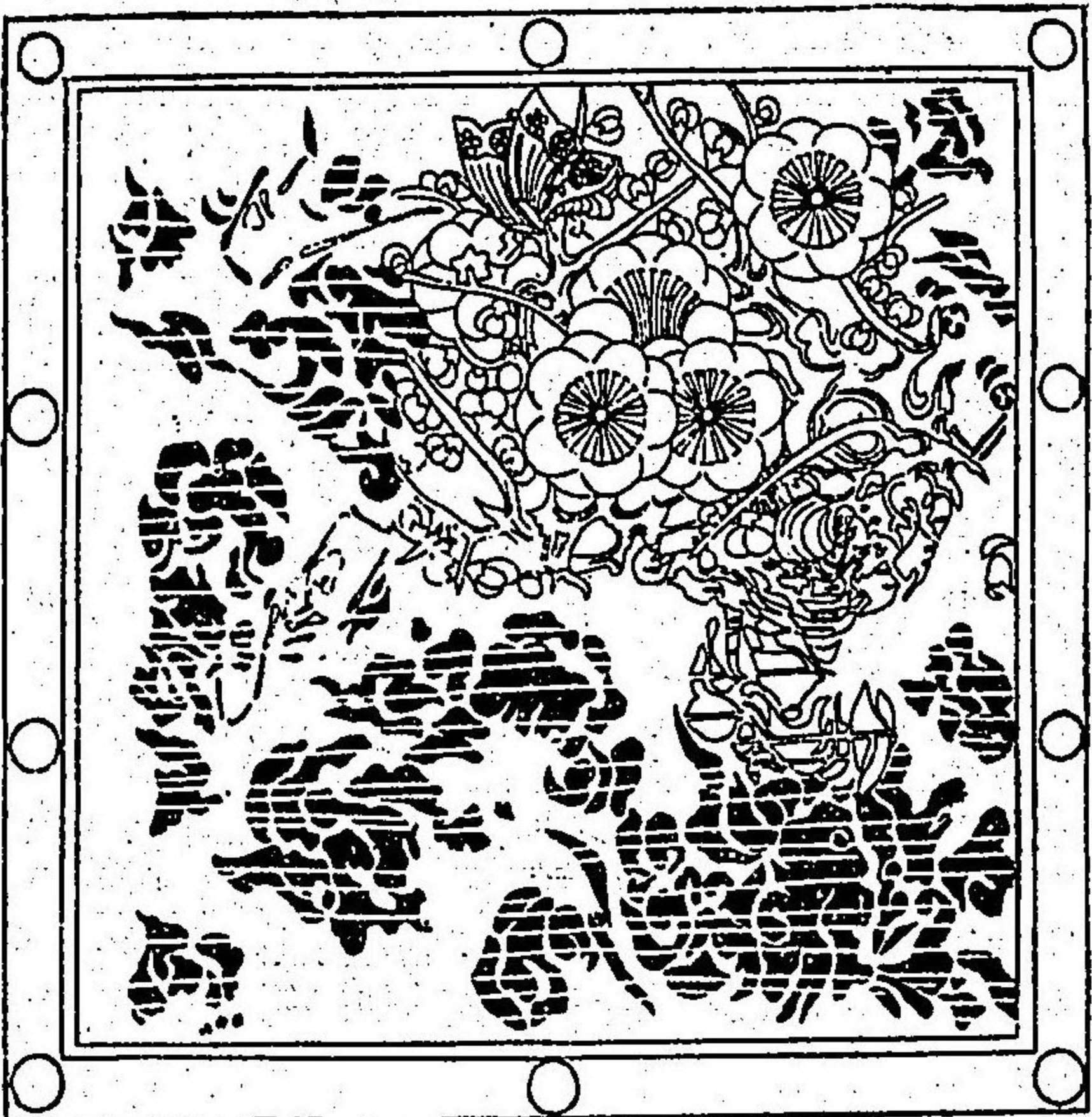

右吹返
津文風伯

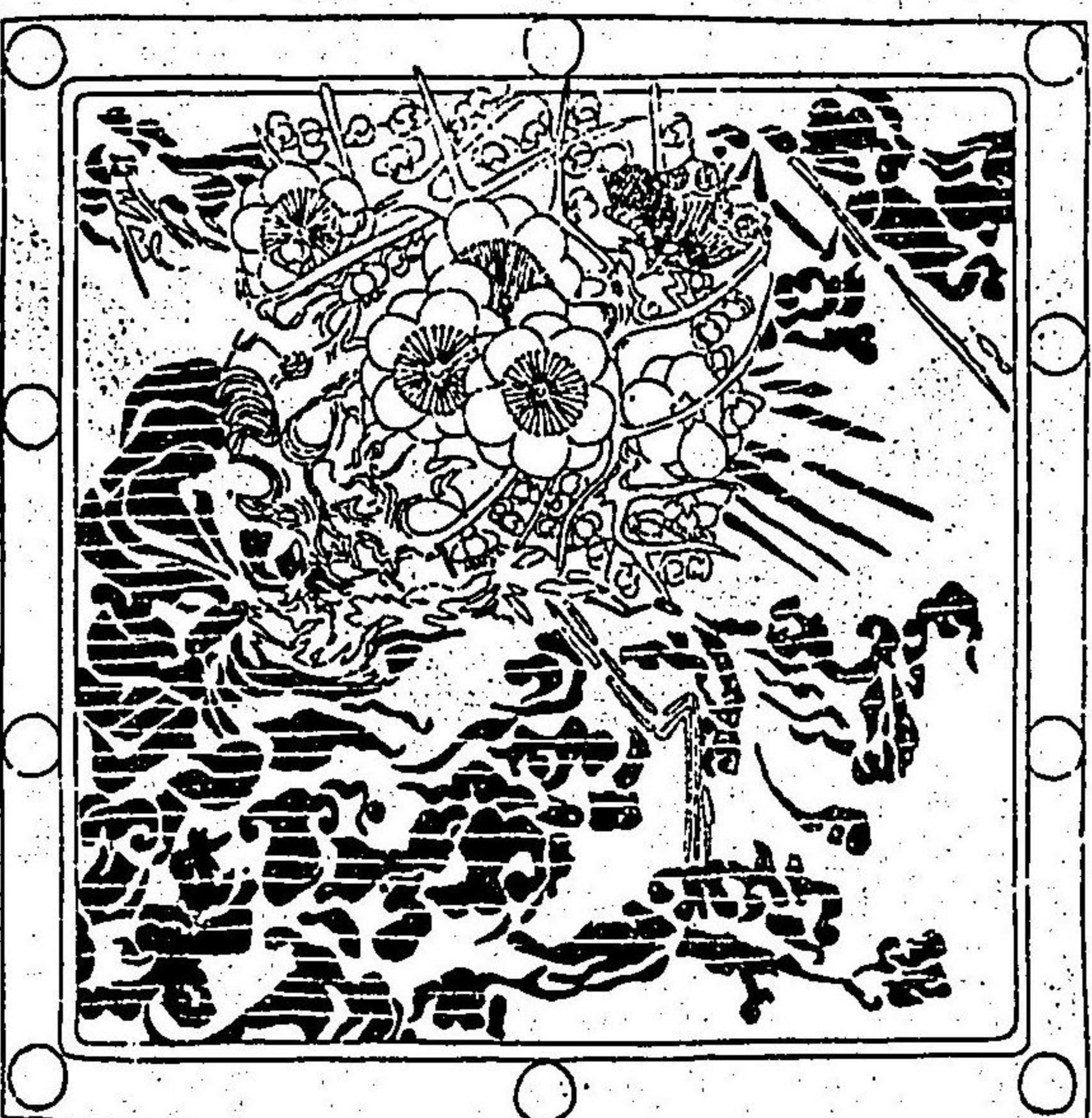

鉢裏

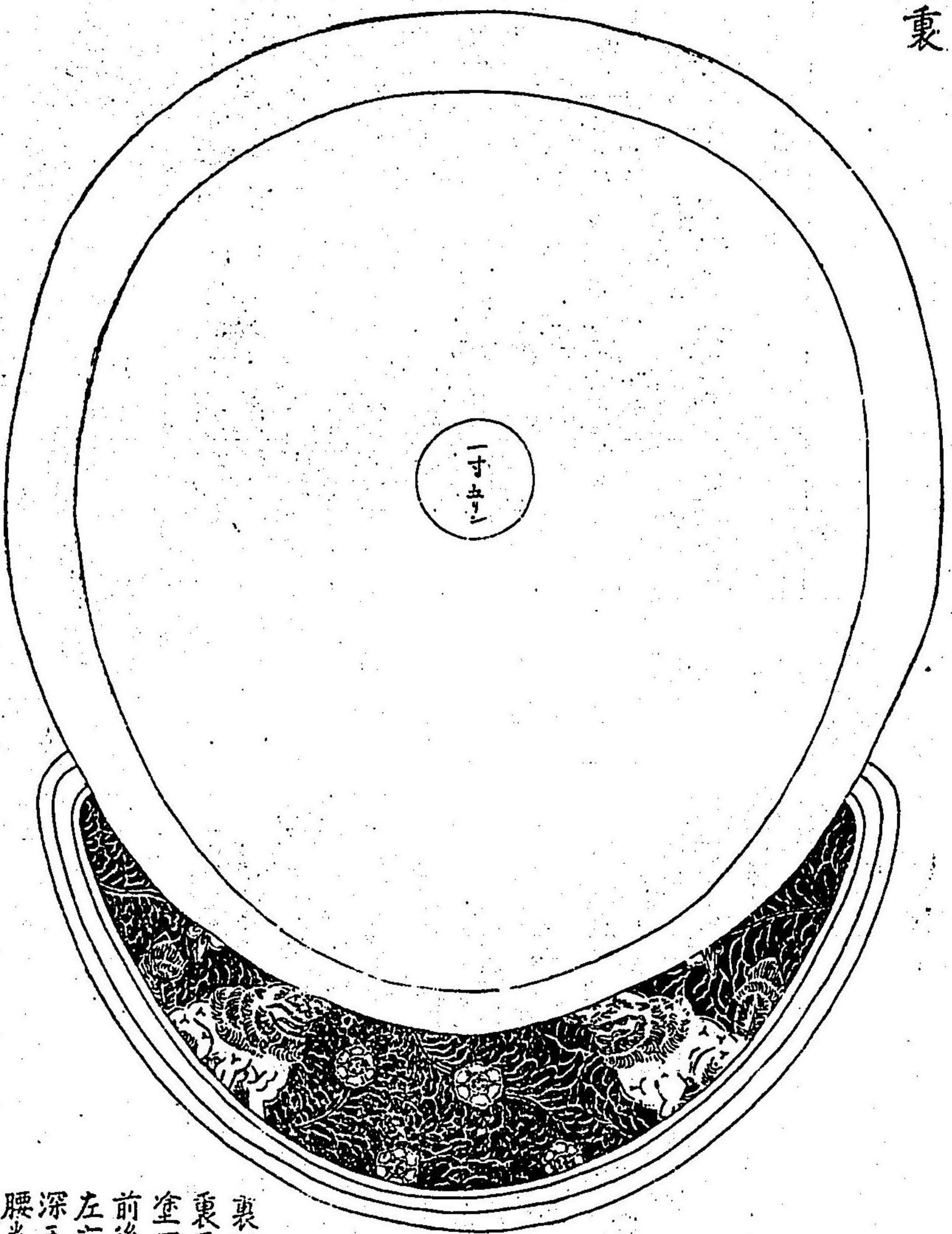

裏張無之
裏三十二間錯留
塗四天緒忍緒根緒無之
前後七寸二分
左右六寸六分
深三寸
腰卷廣八分

右袖裏

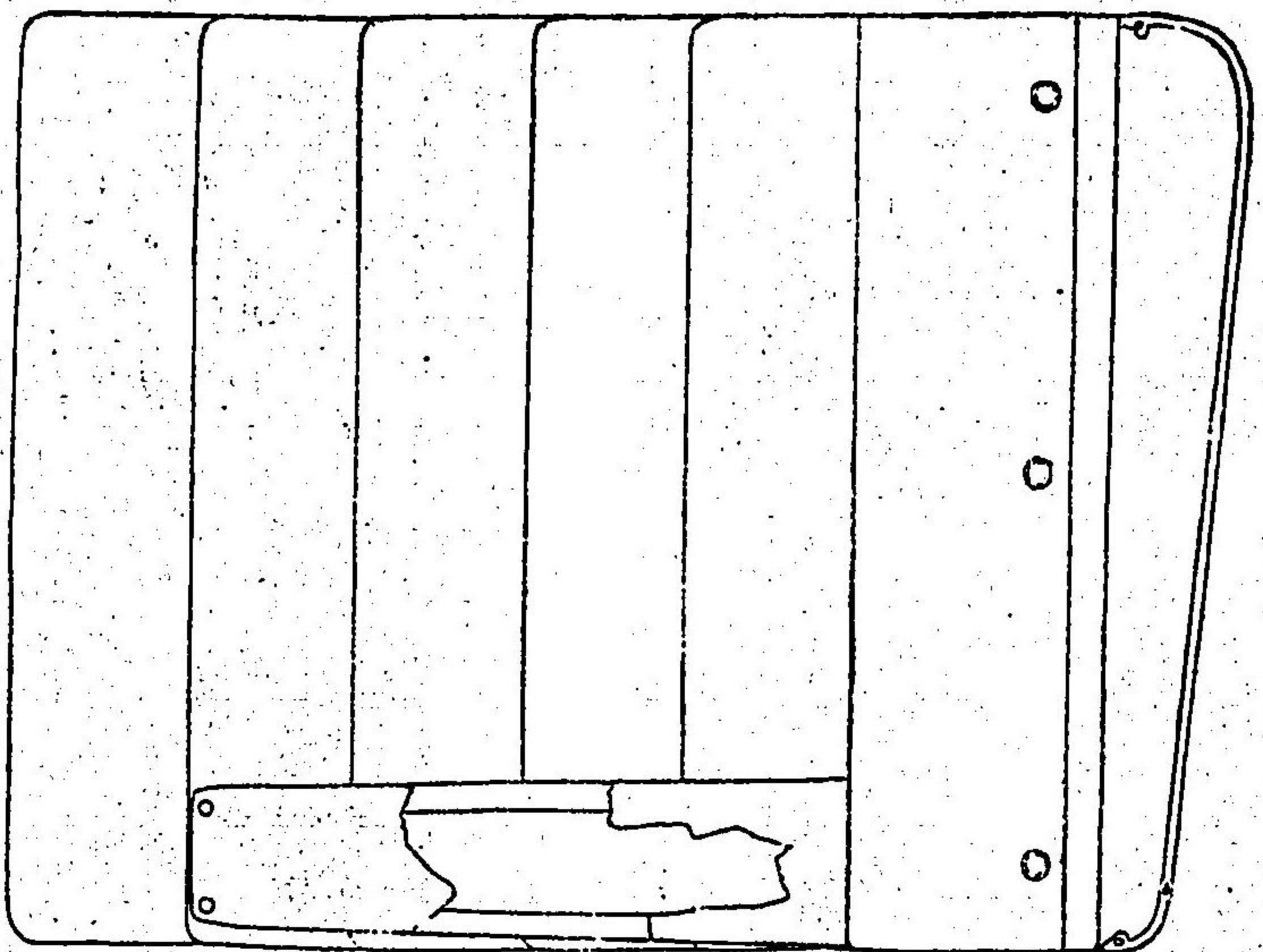

左袖全圖 六段威毛其外
同水吞緒珍尖

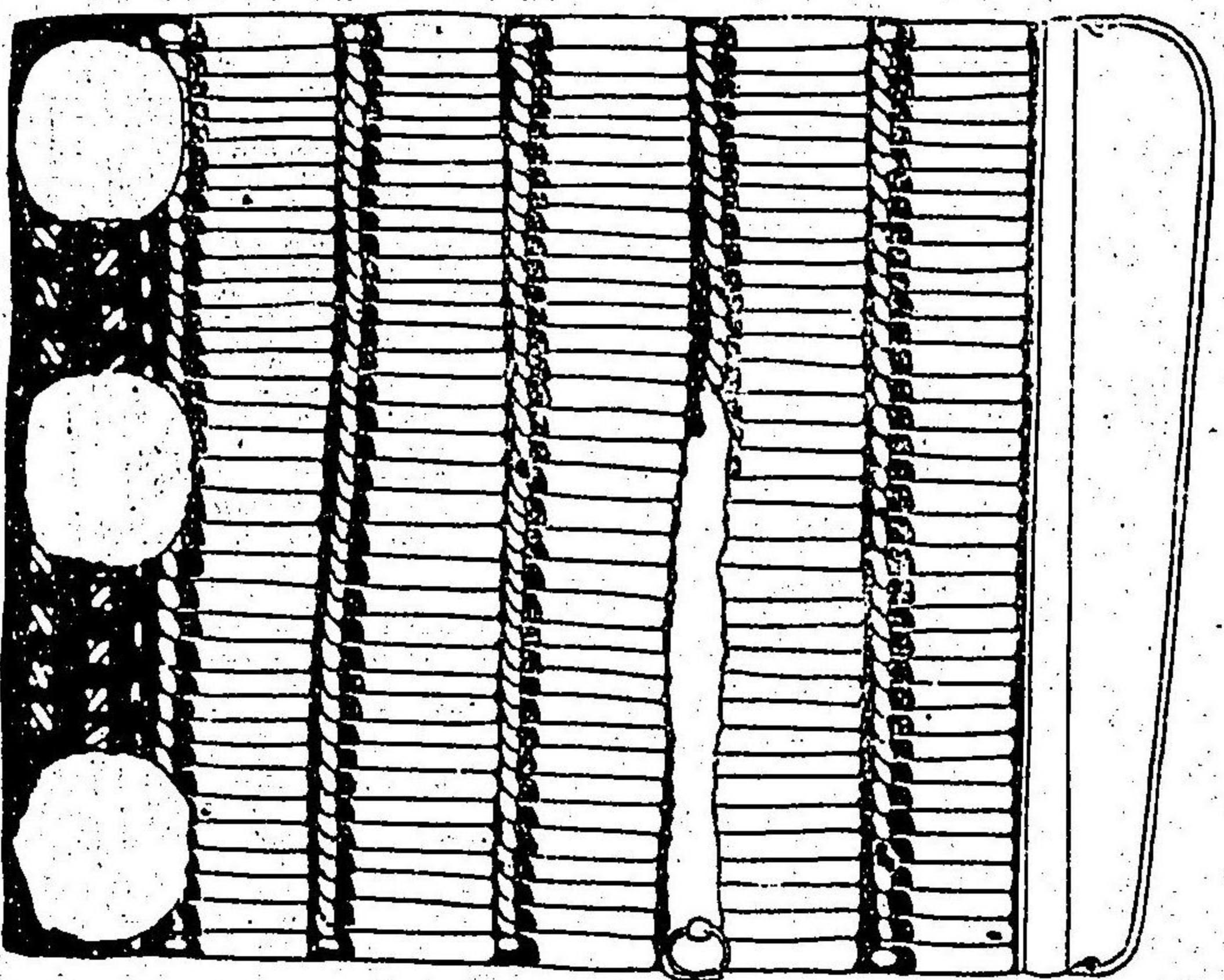

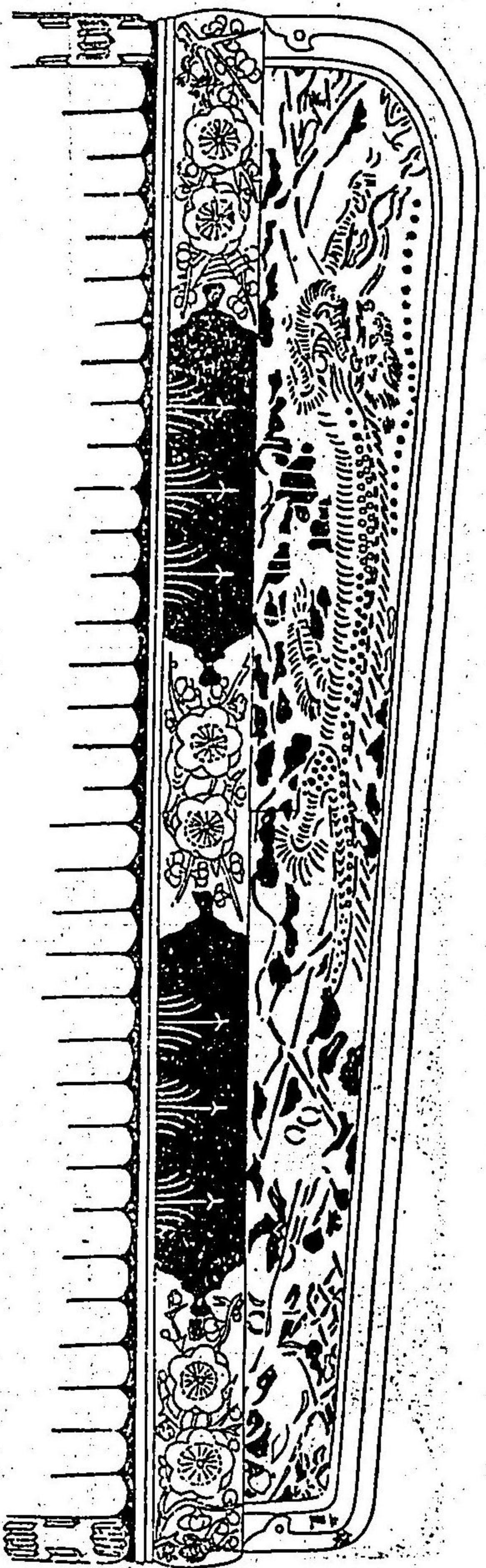

冠板

狹障金物銀梅ナリアケ金メッキ
水引紅白ナ

左袖金物

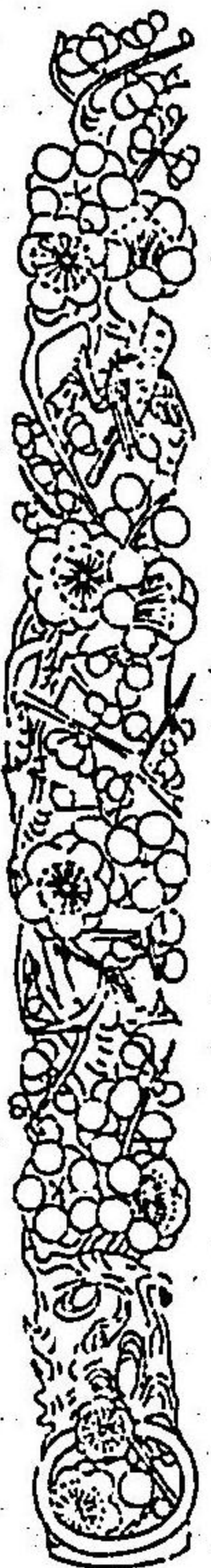

右

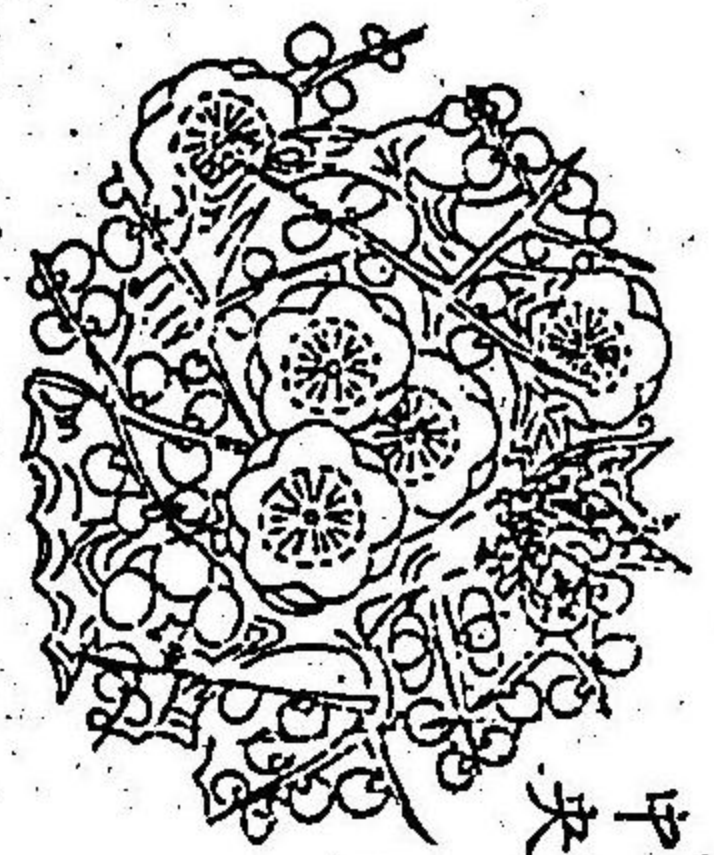

中央

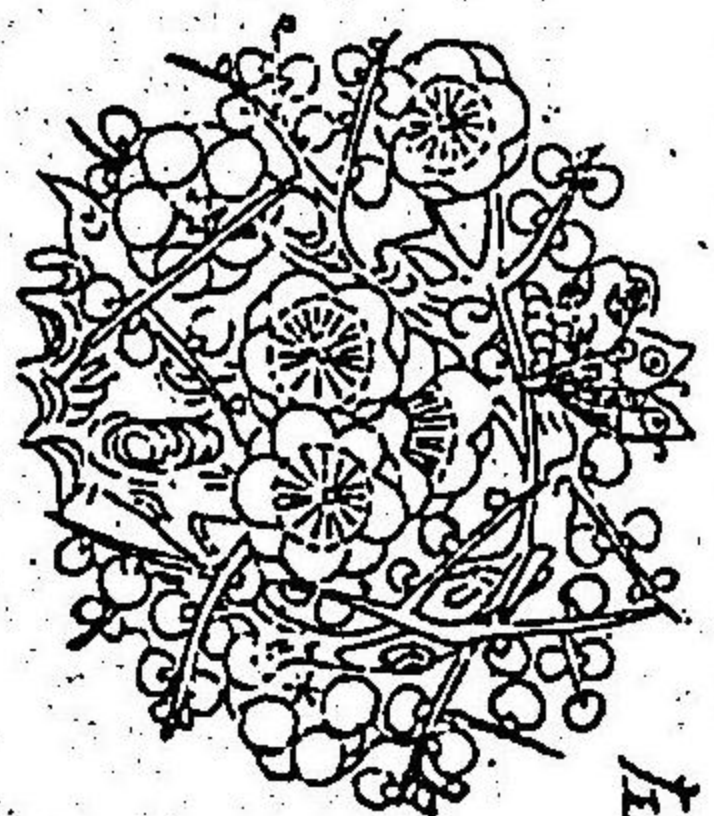

左



左袖震

菟手摺無之

折目 藍地枝葉白獅子藍及鈎之所紅

右袖金物

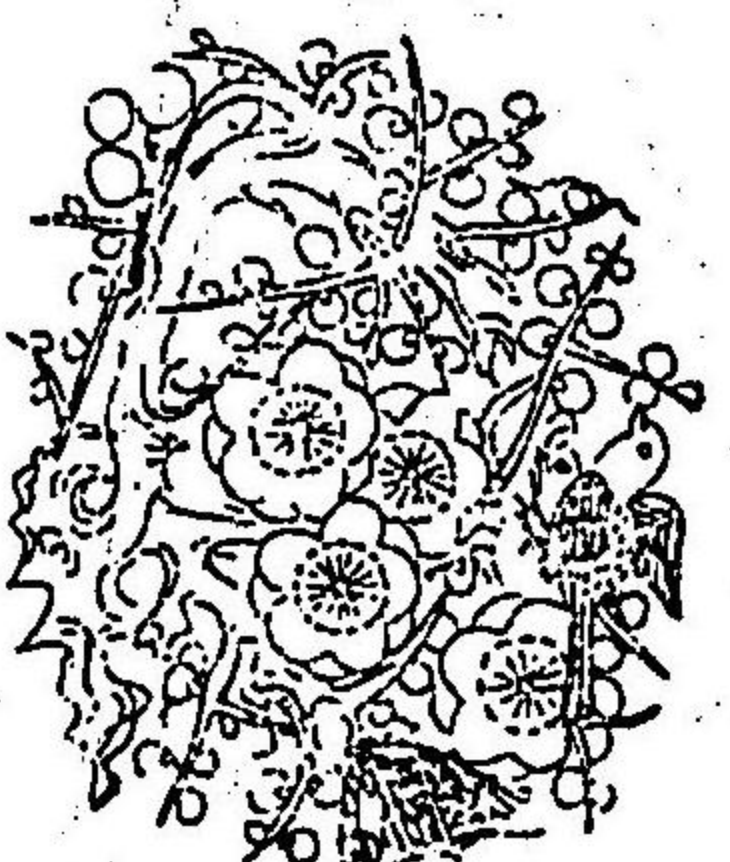
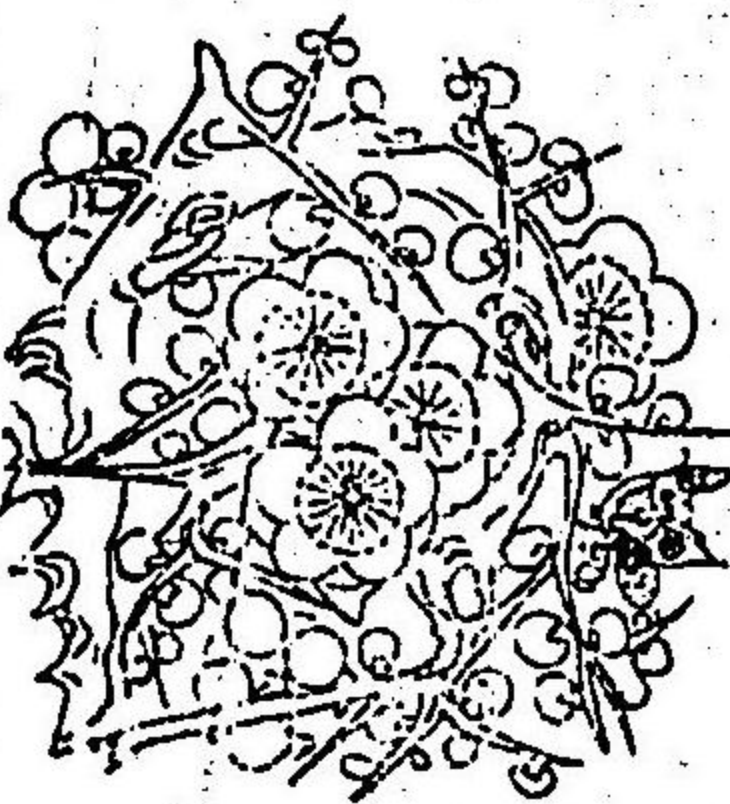
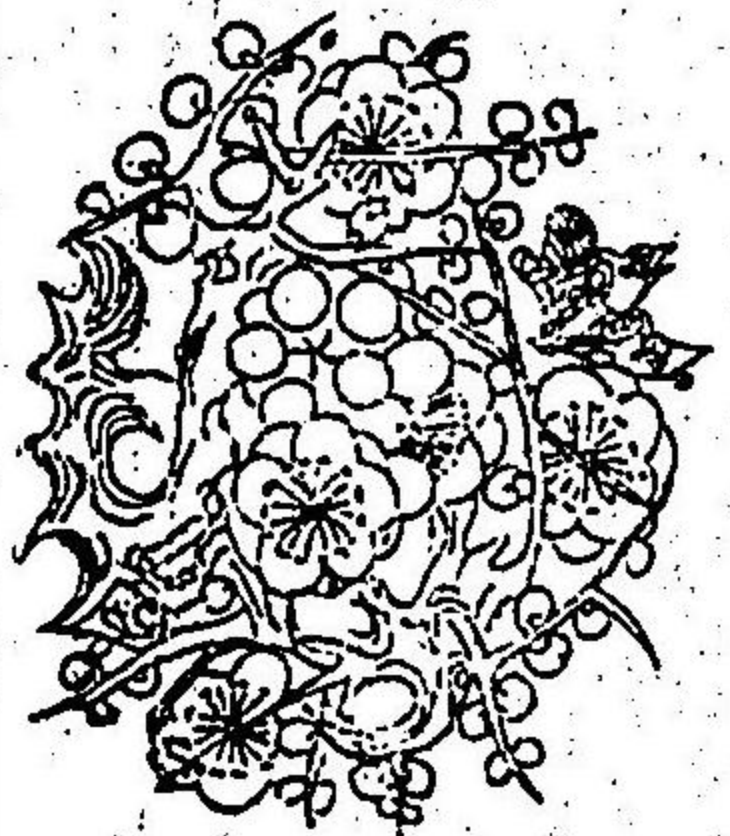



右袖 裏

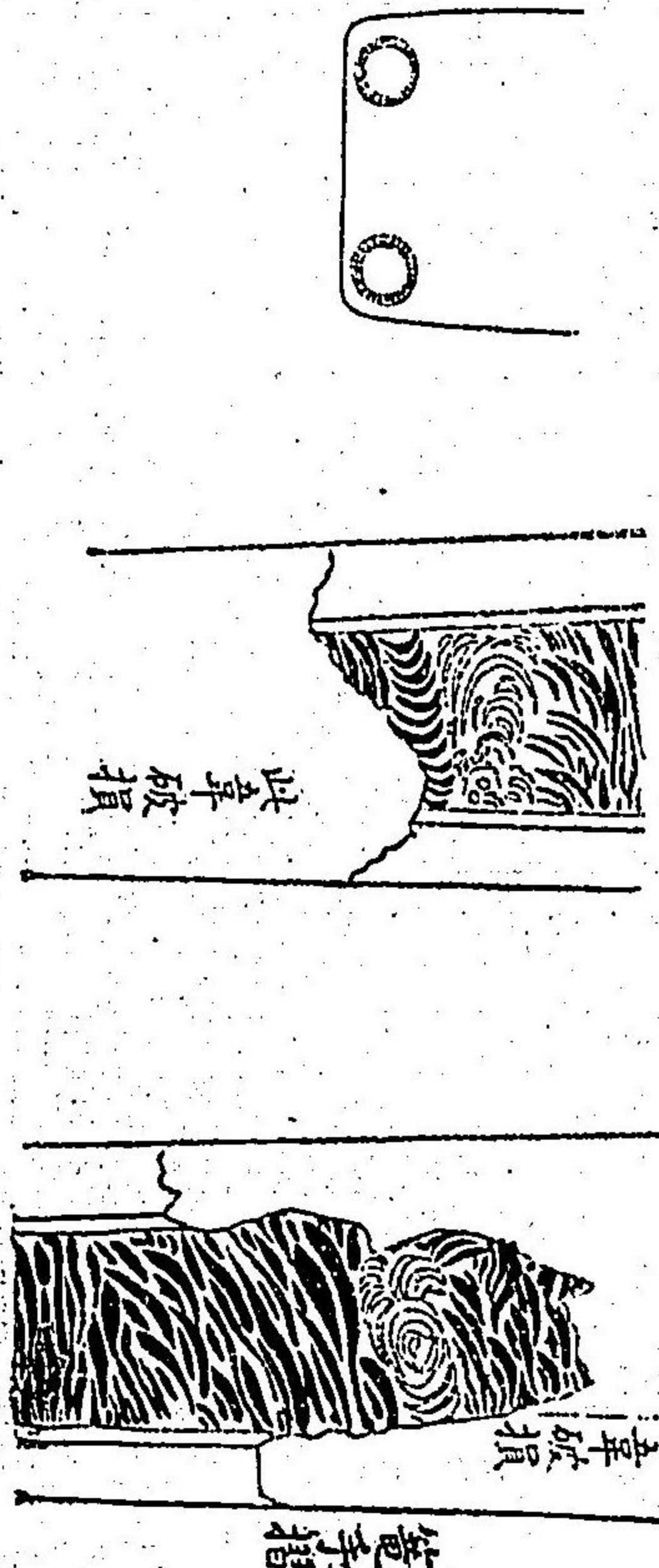

此年破損

此年破損

尾子摺

鳩尾板

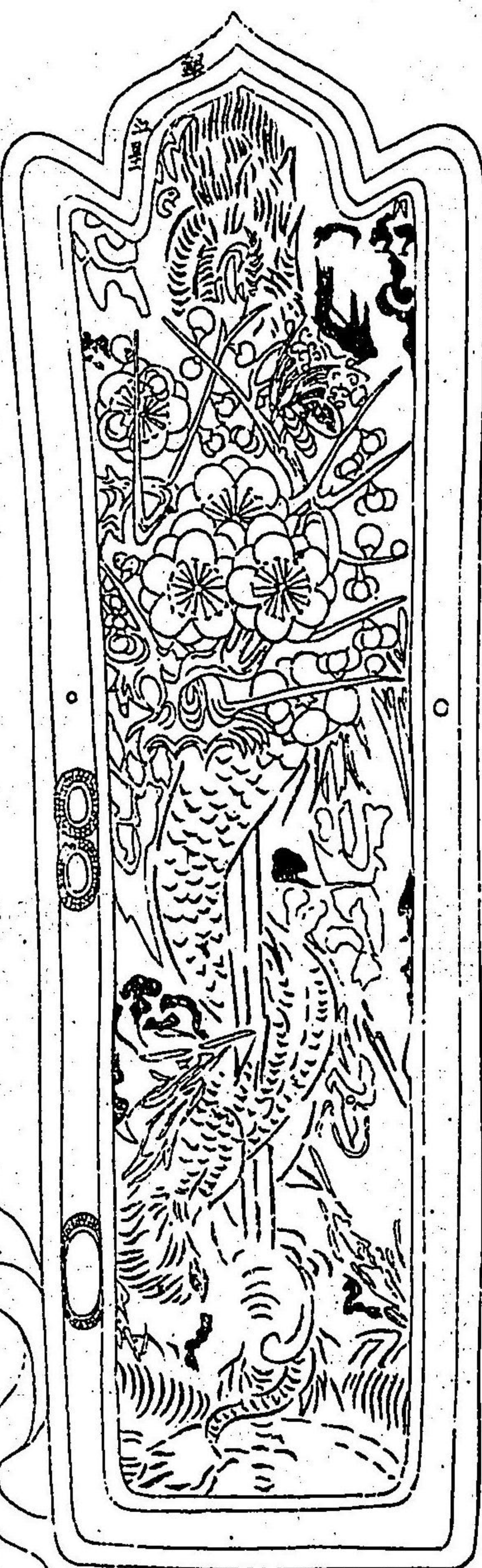

裏

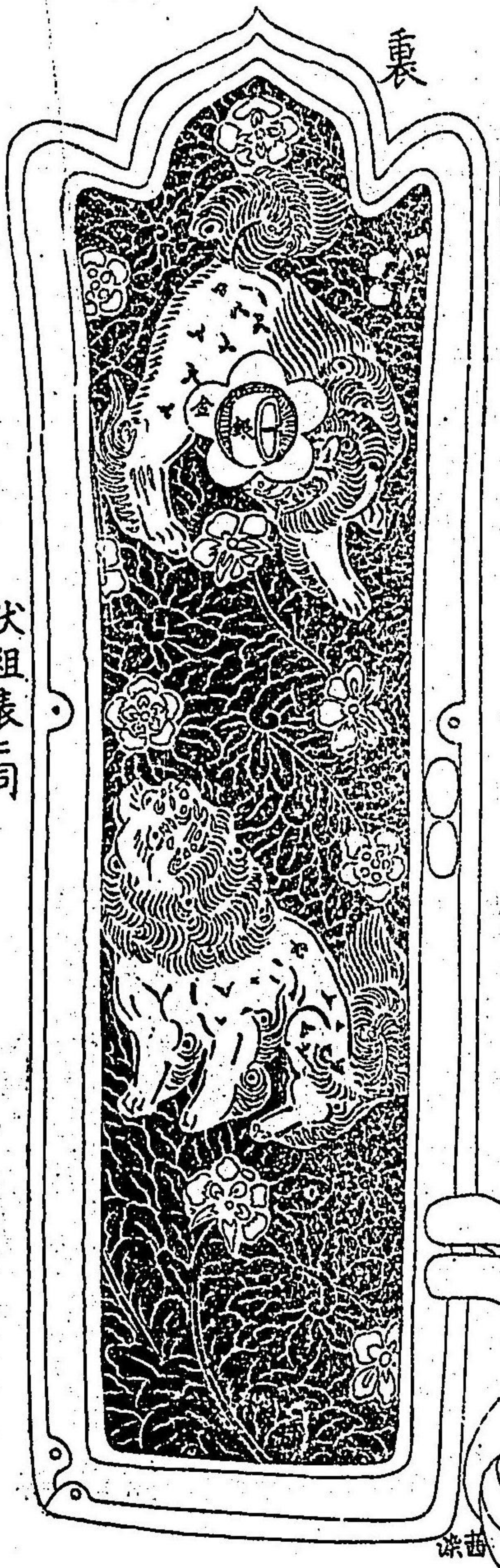

伏組表 同

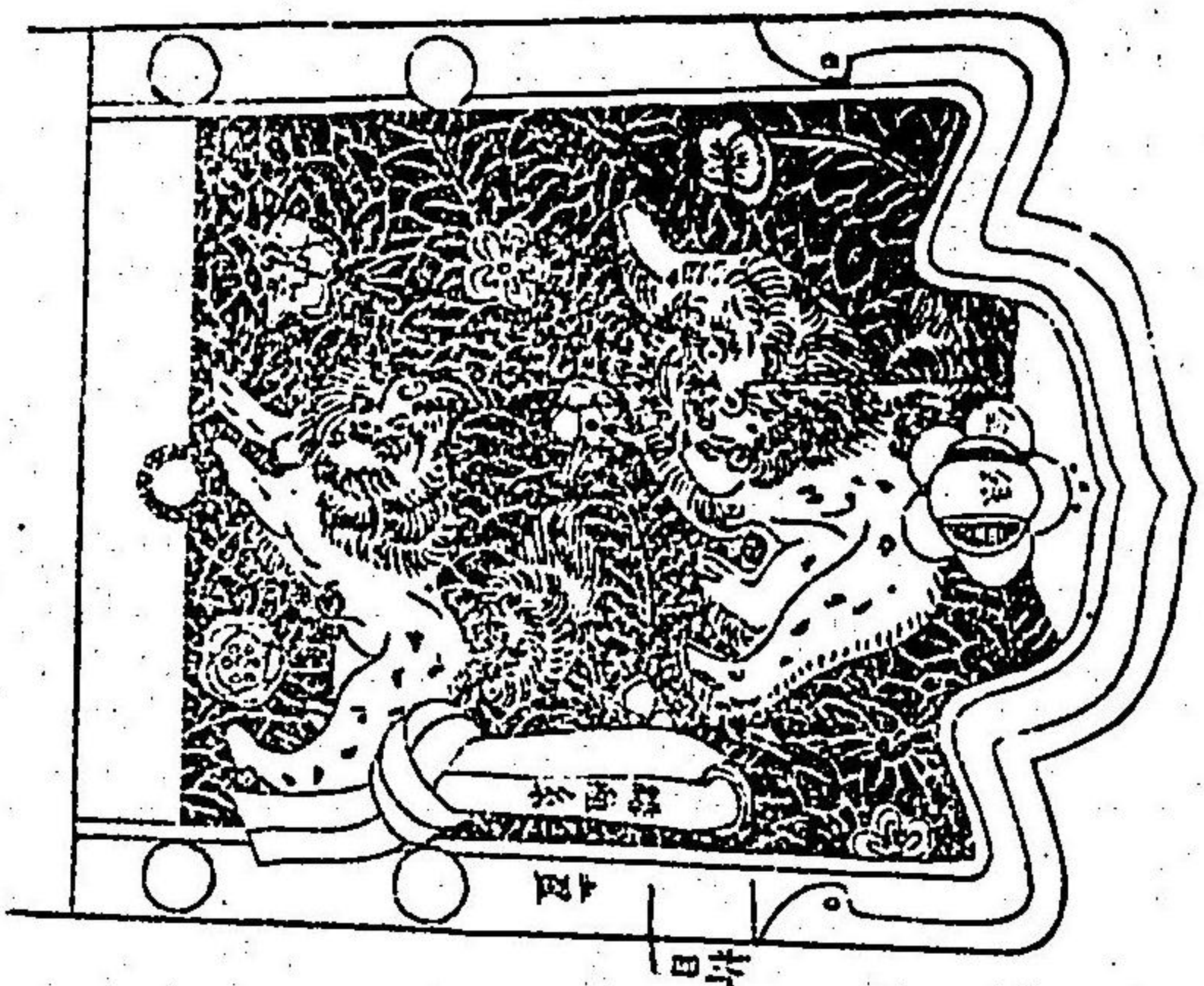

東

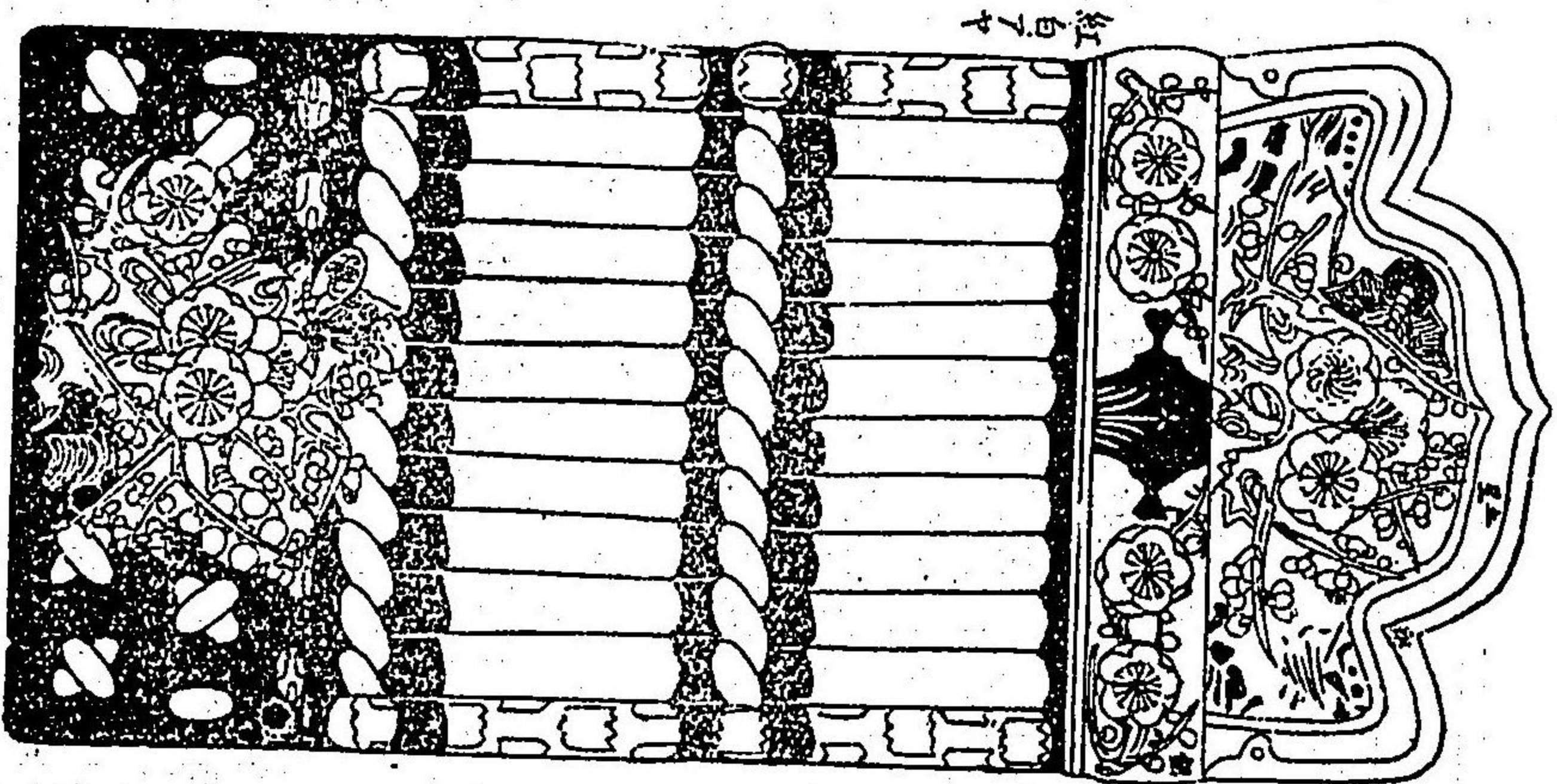

梅摺板

梅摺物金

紅白丁字

胴全圖

裏包無之

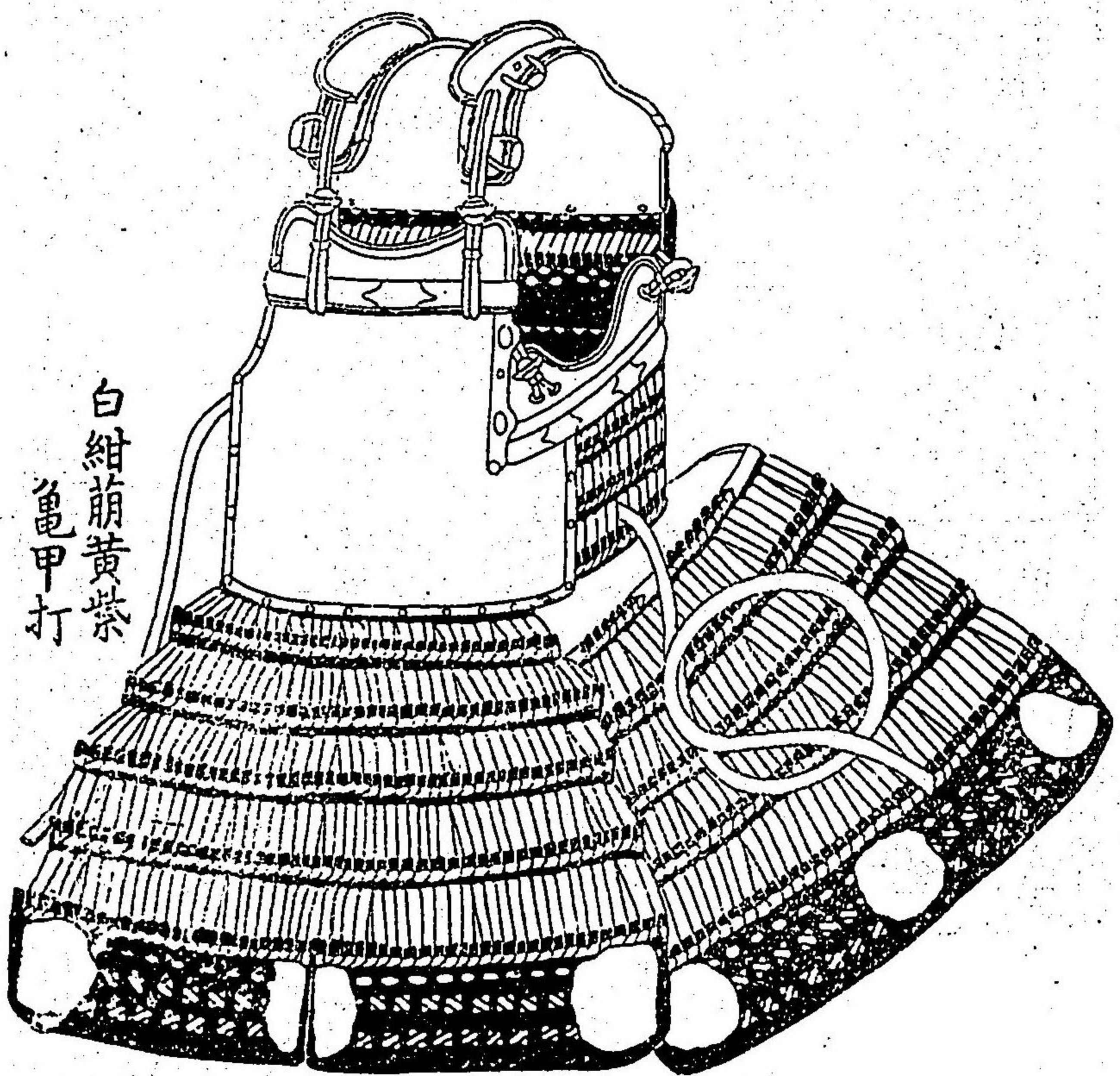

白紺蒔黃紫
龜甲打

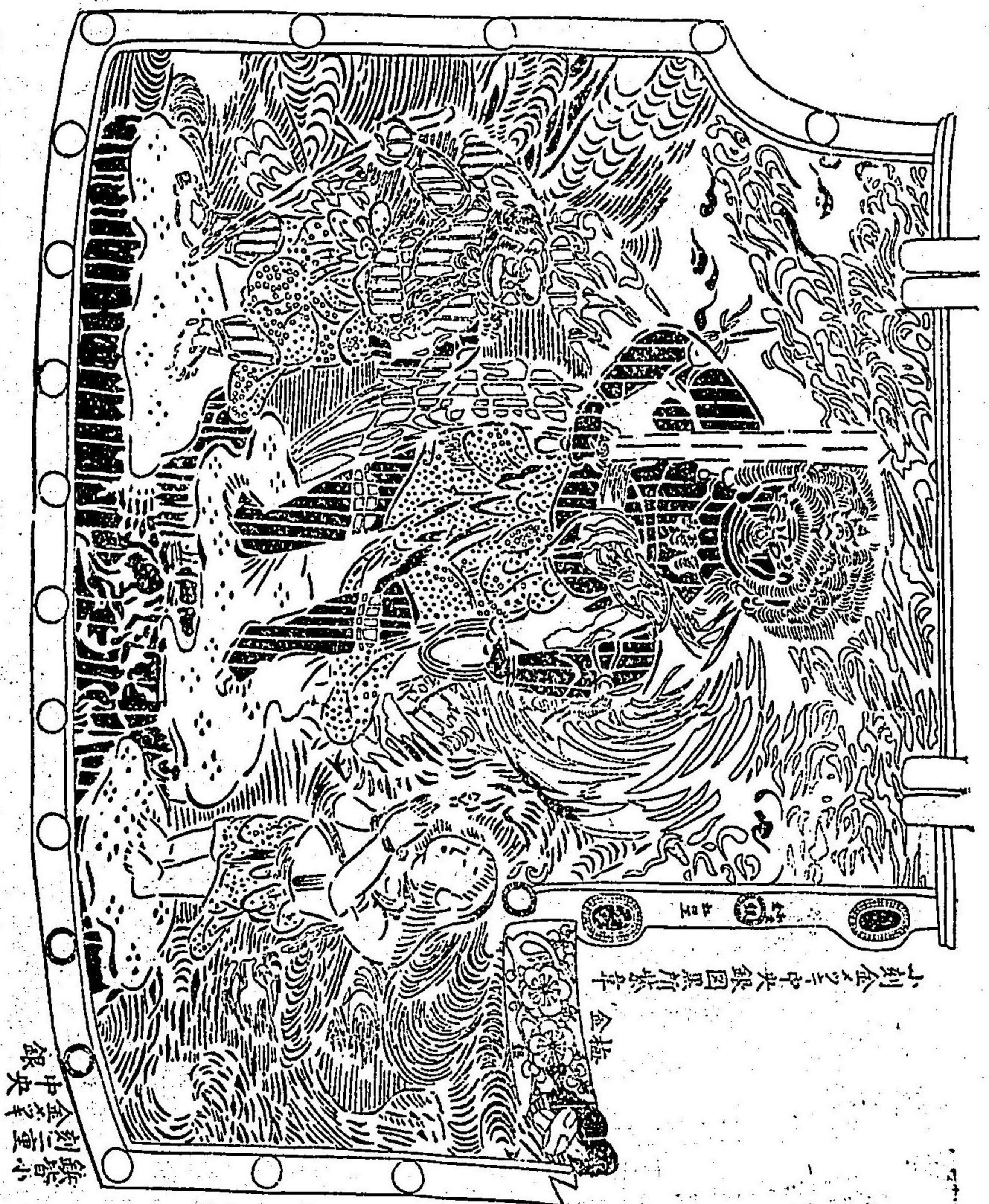

弦走亭

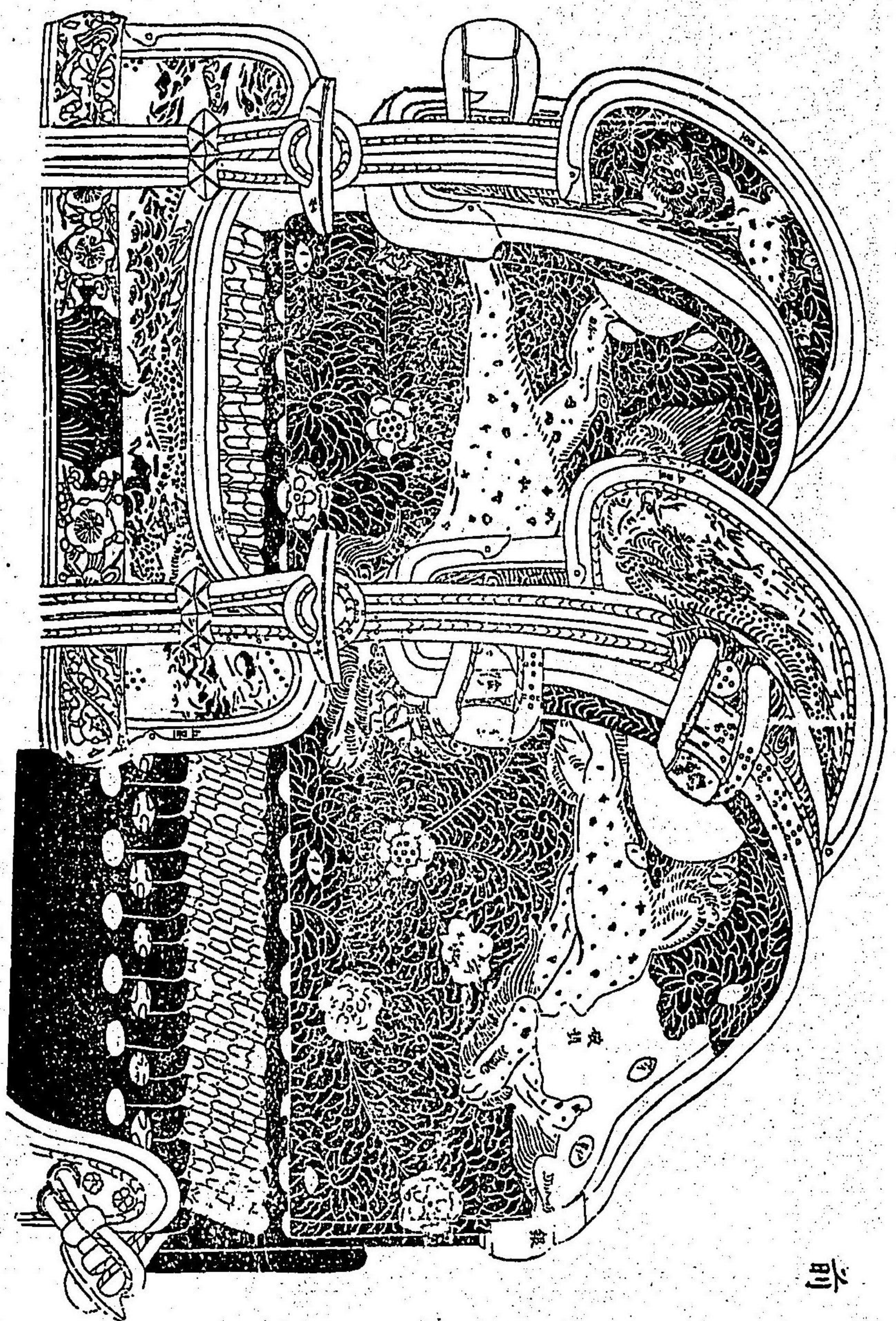

前

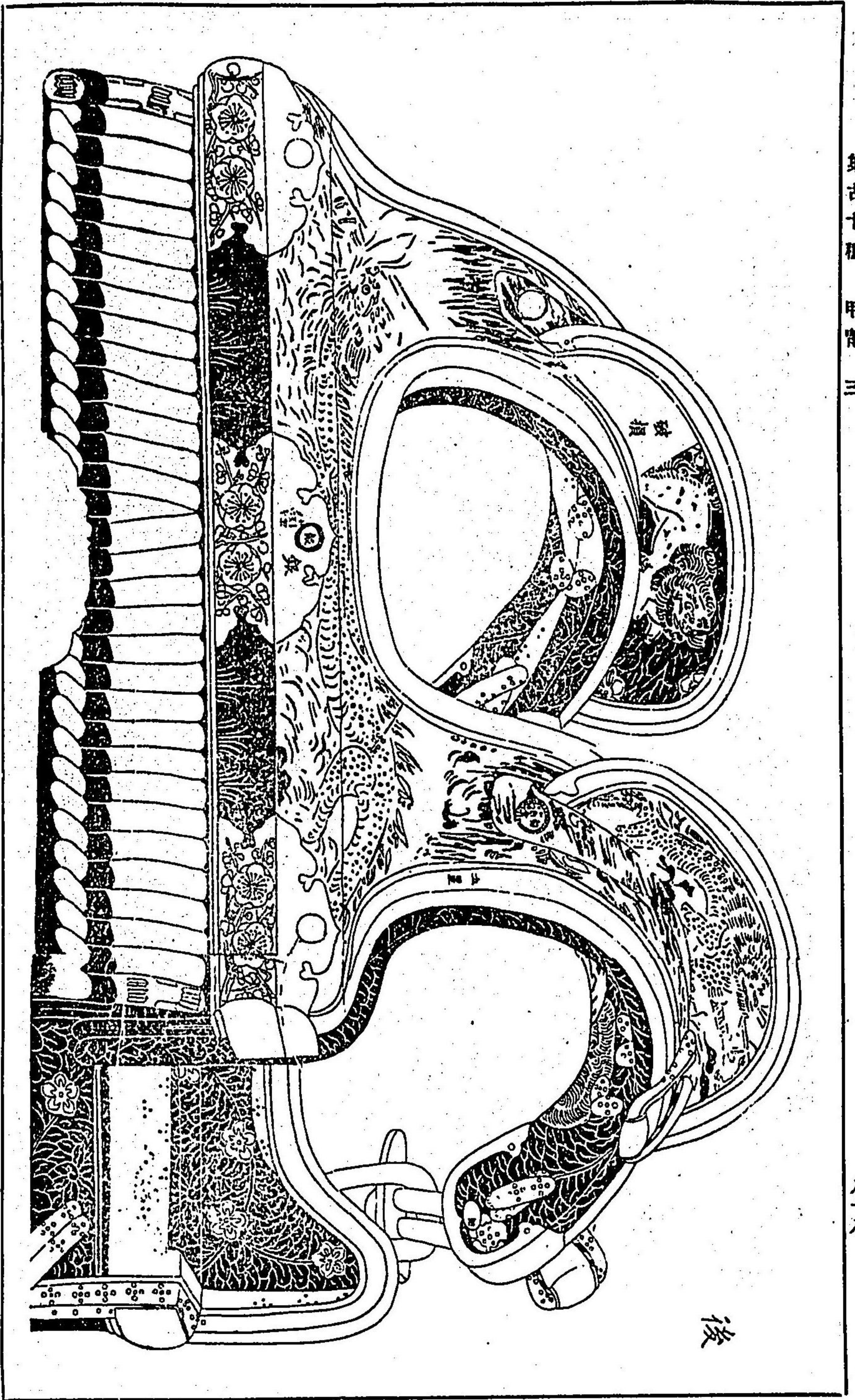

前板桐金物

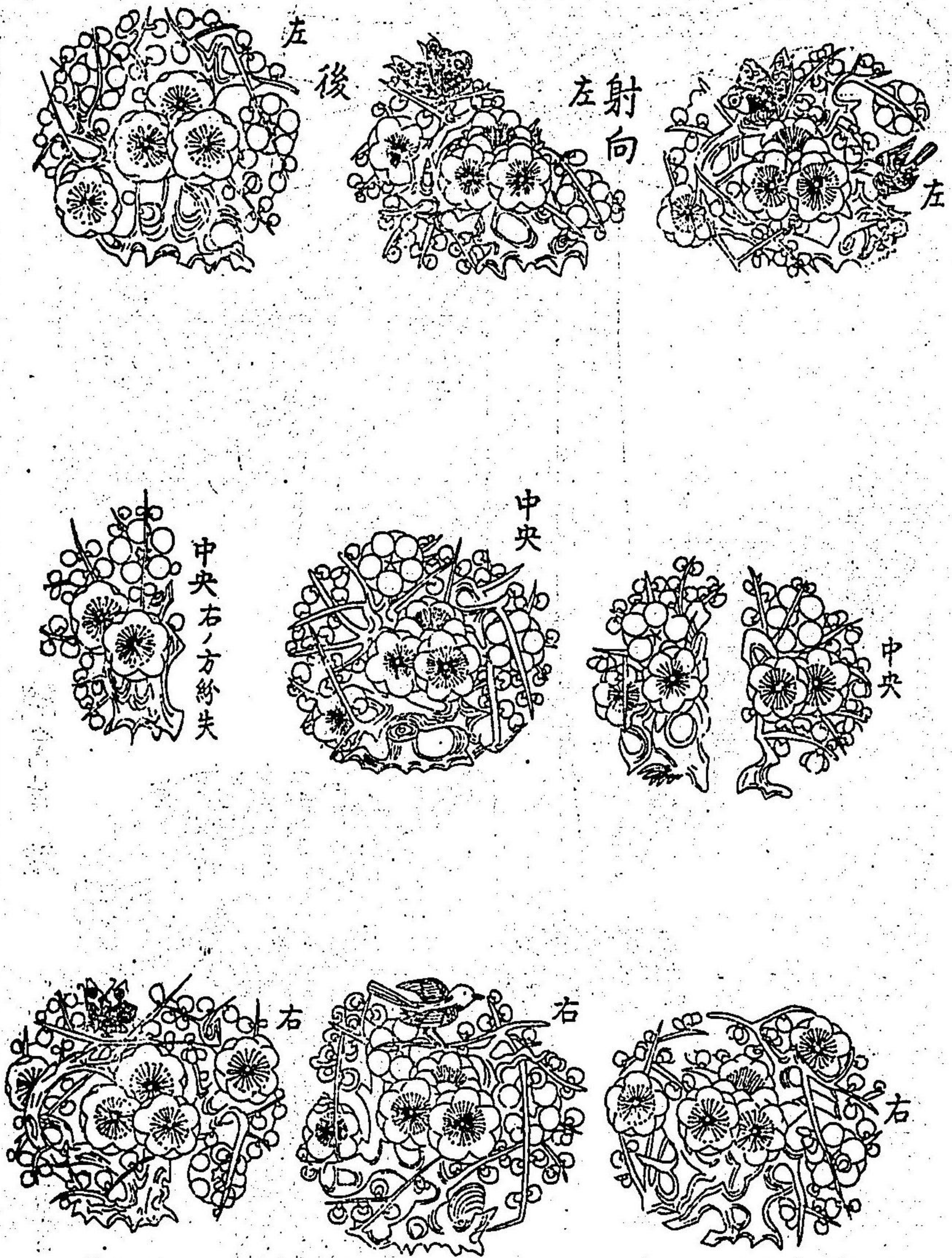

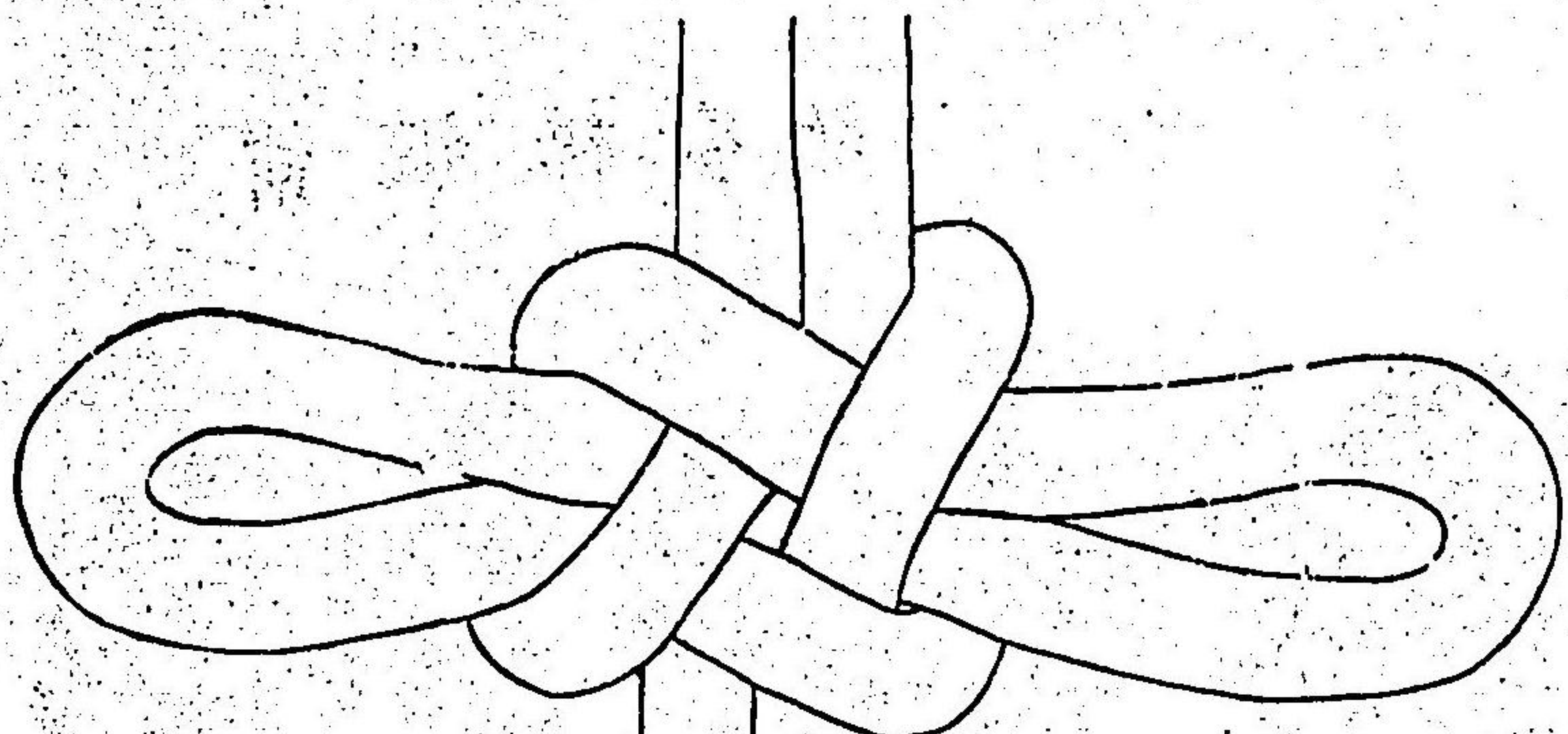

苗唐組



總角付之銀

小刻四重下ヨリ三重目
刻ナシ銀メツキ其餘金メツキ

射向

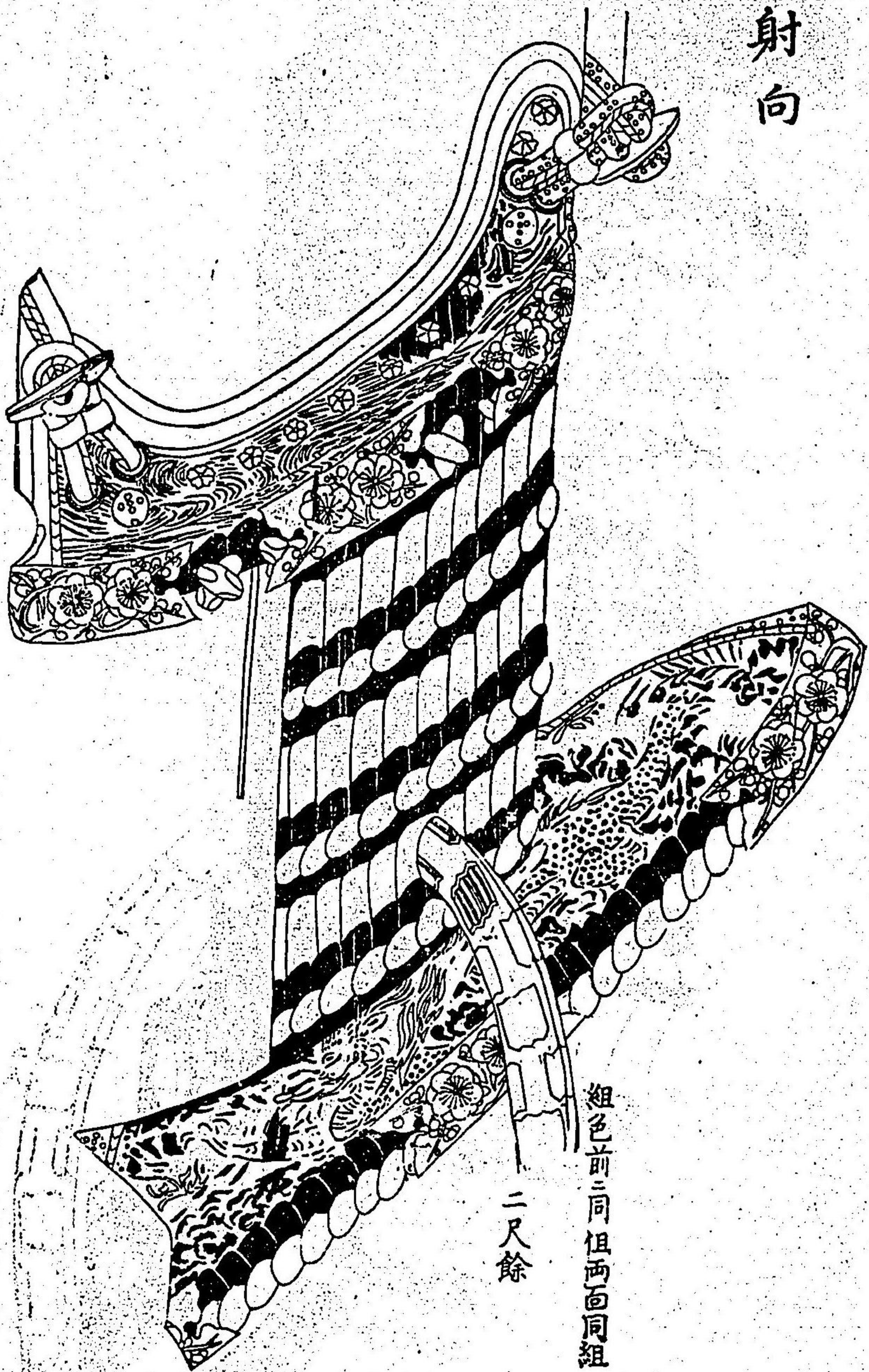

二尺餘

組色前ニ同但西面同組

妻手圖

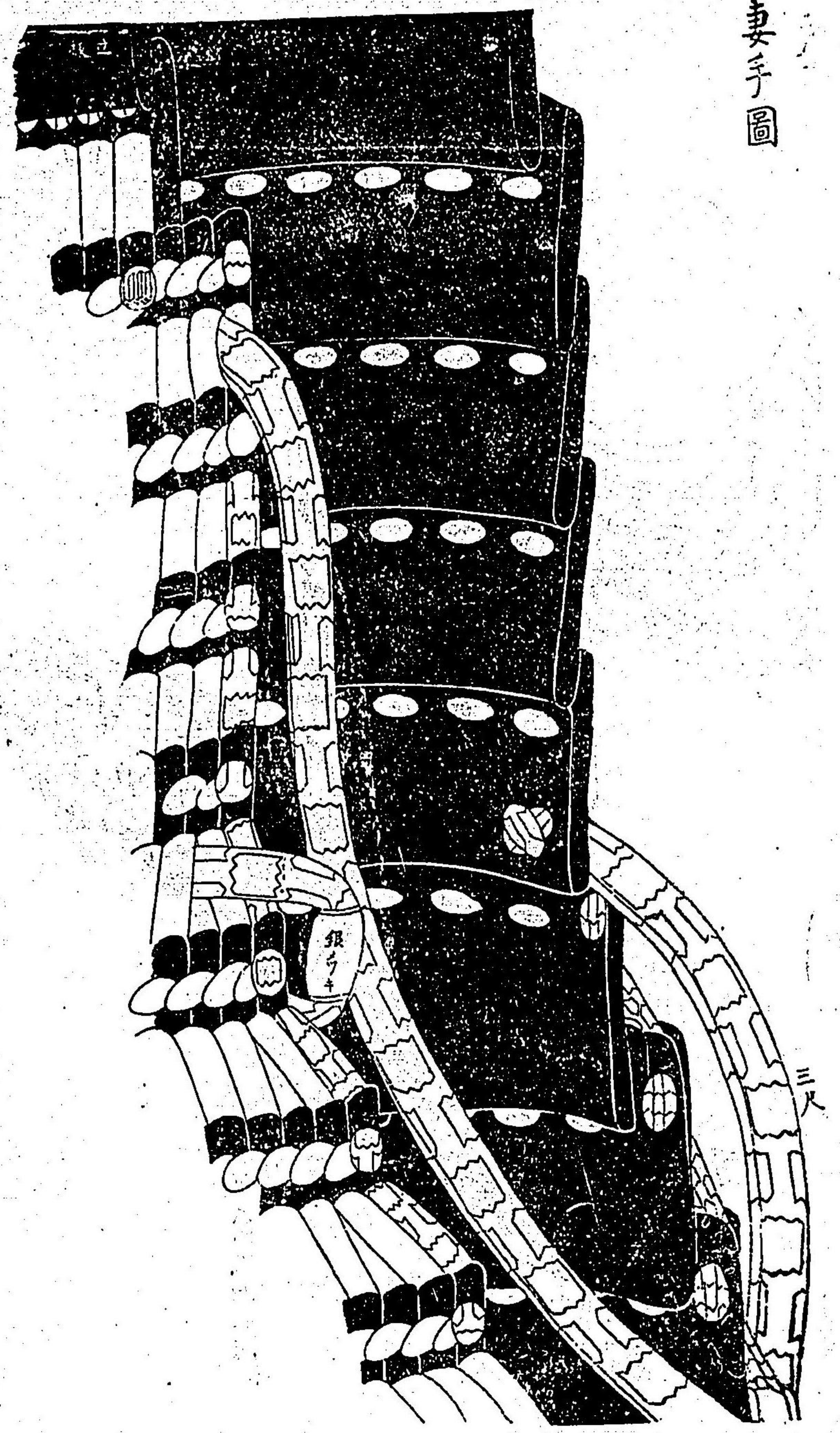

三人

脇楯全圖

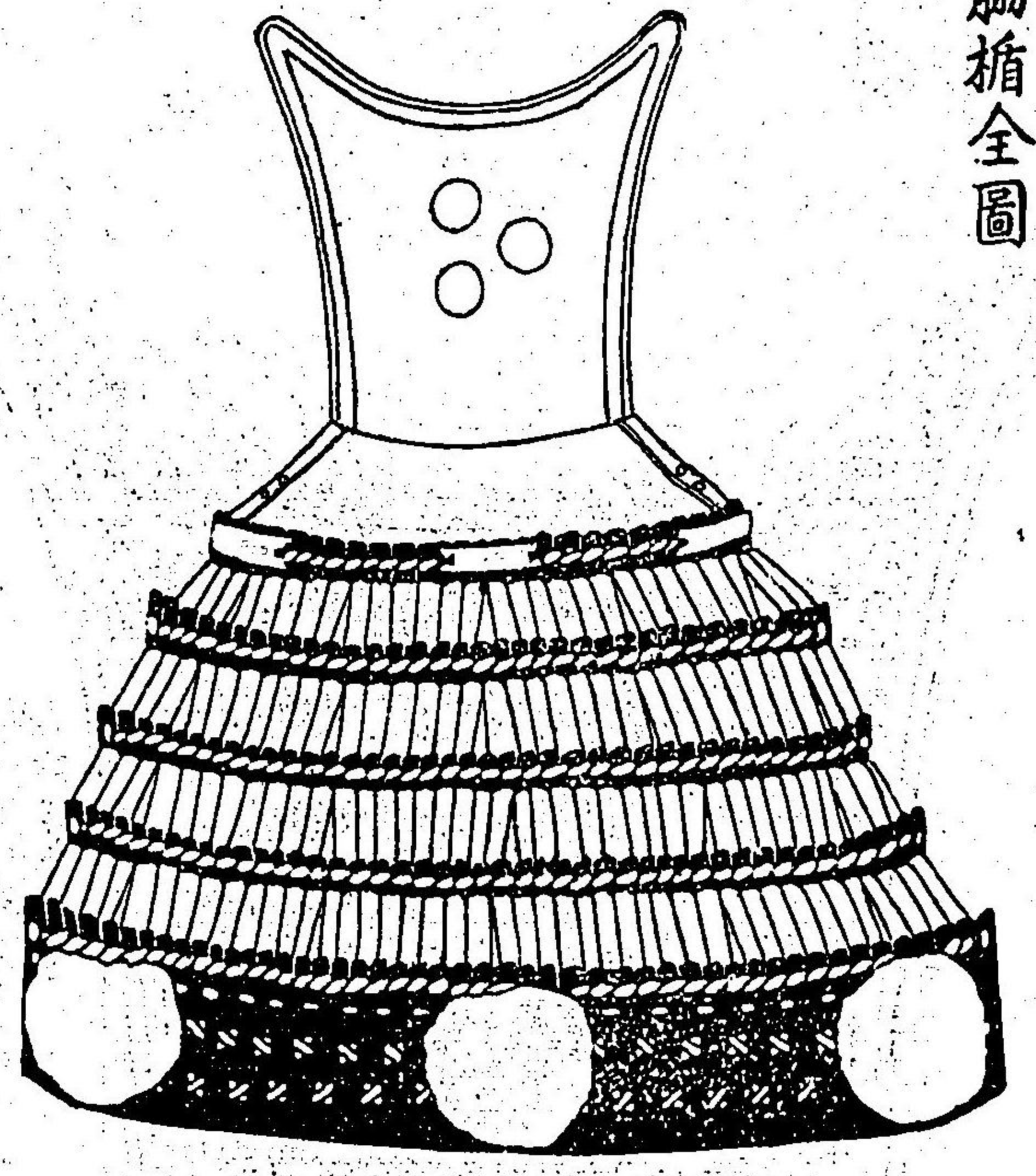

妻手裾金物

左

中央

右

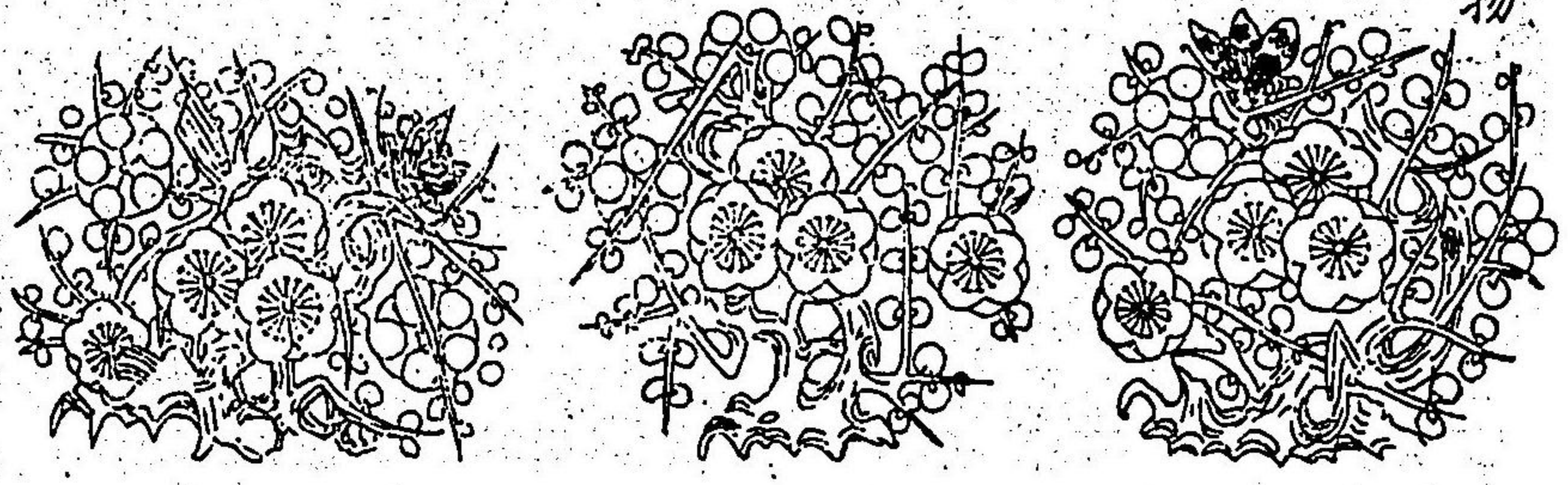

表

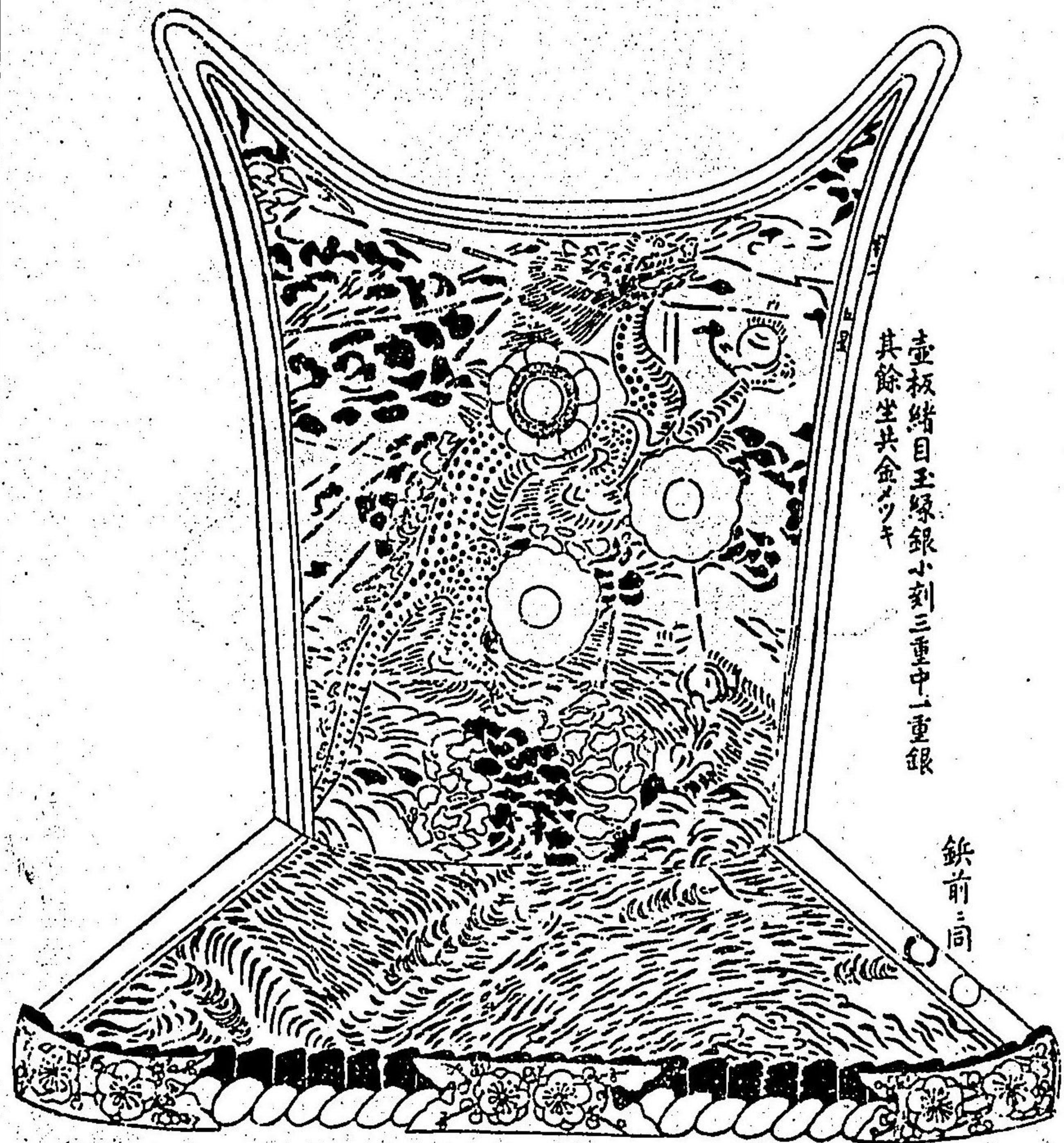

裏

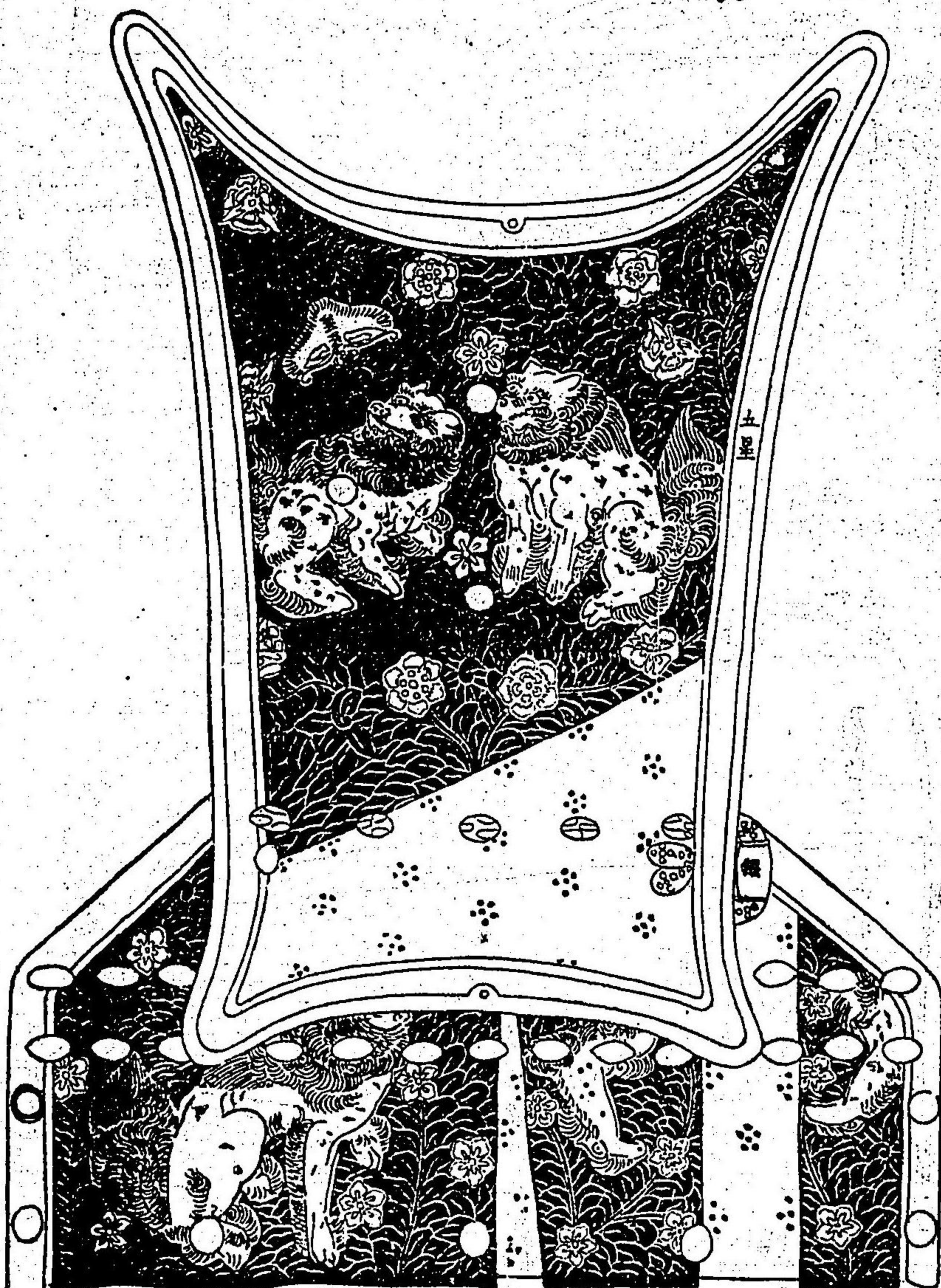

錦文

地赤 桐白黃紫雲形崩黃



京極氏信鑑直掛圖 織未詳

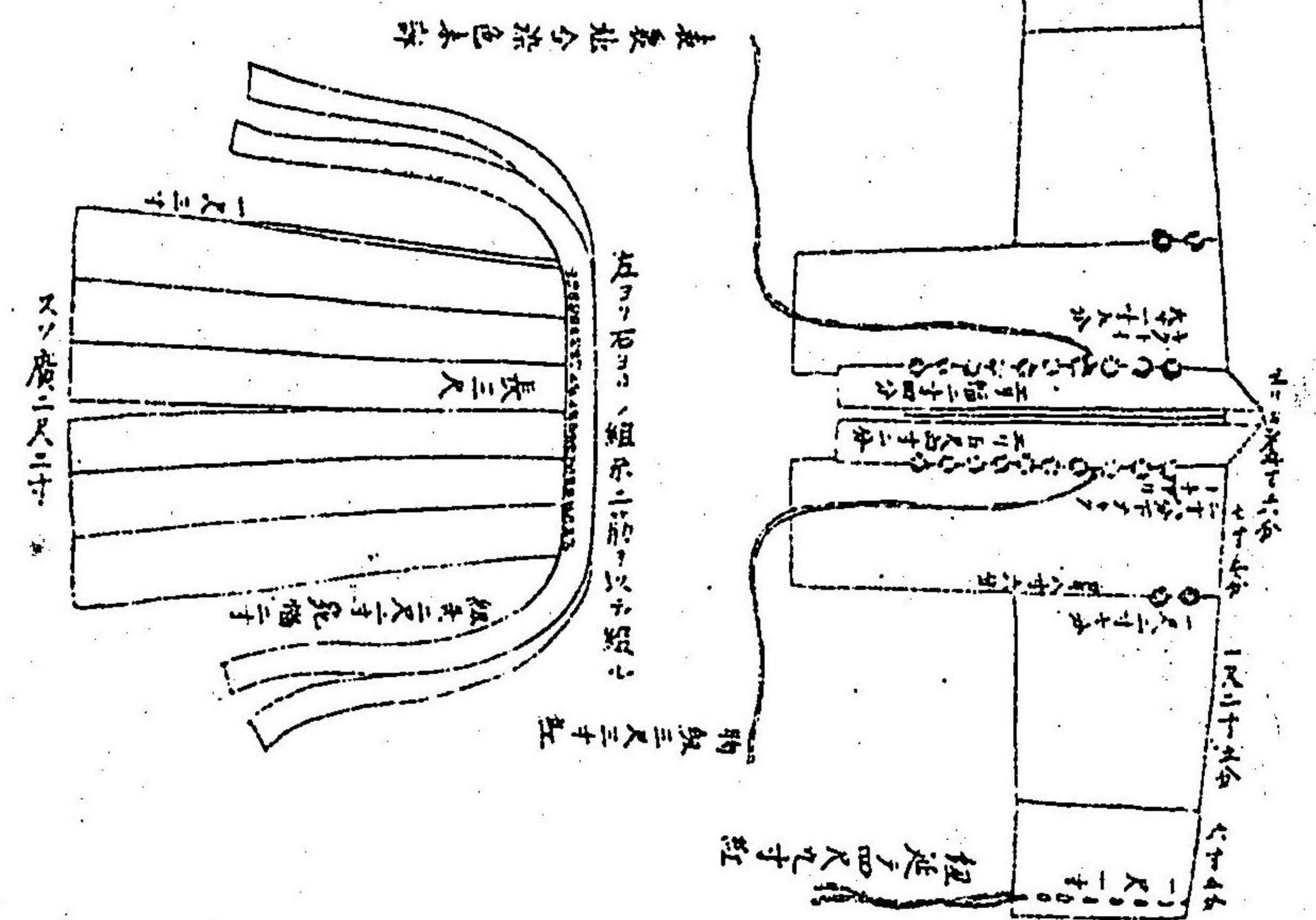
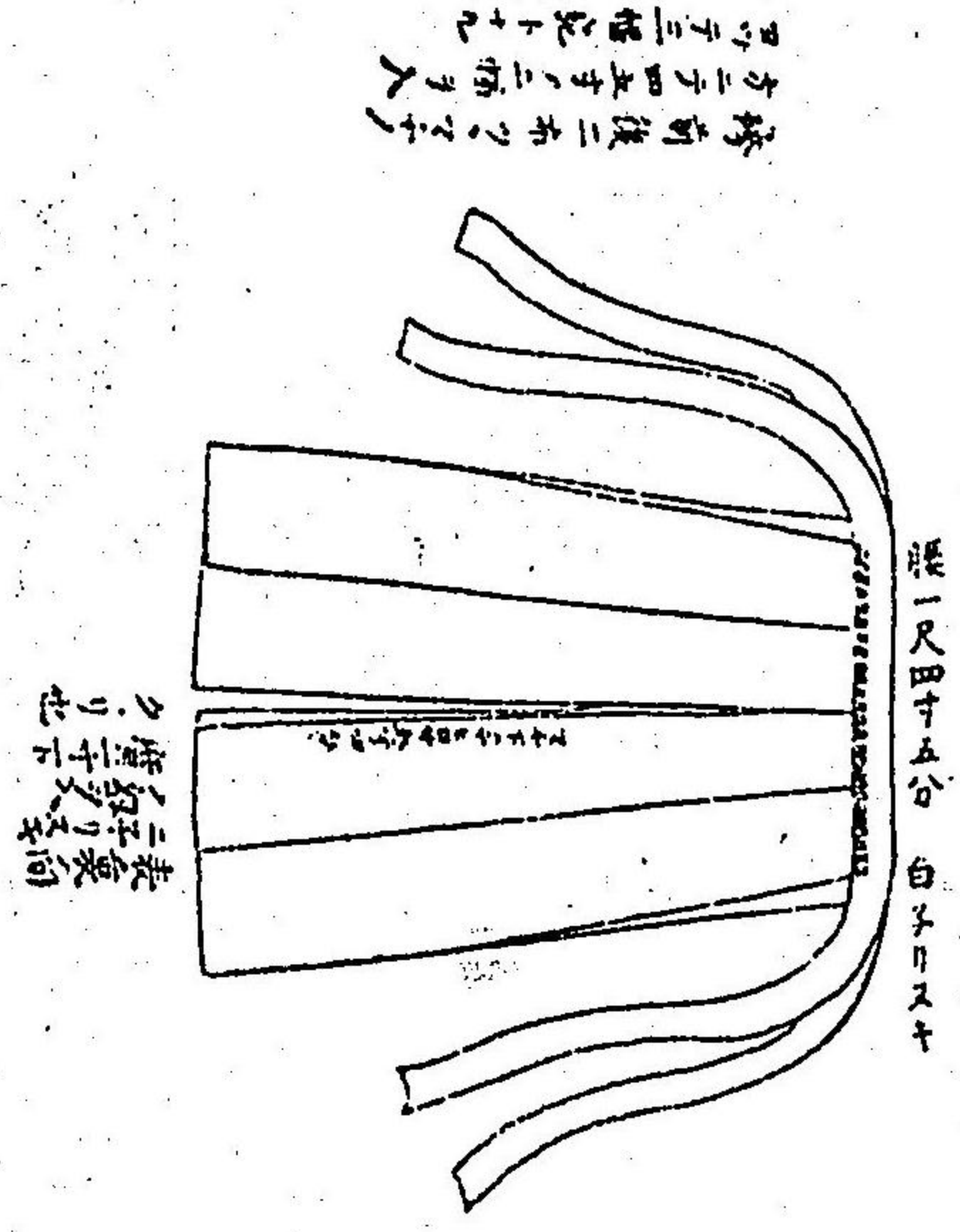
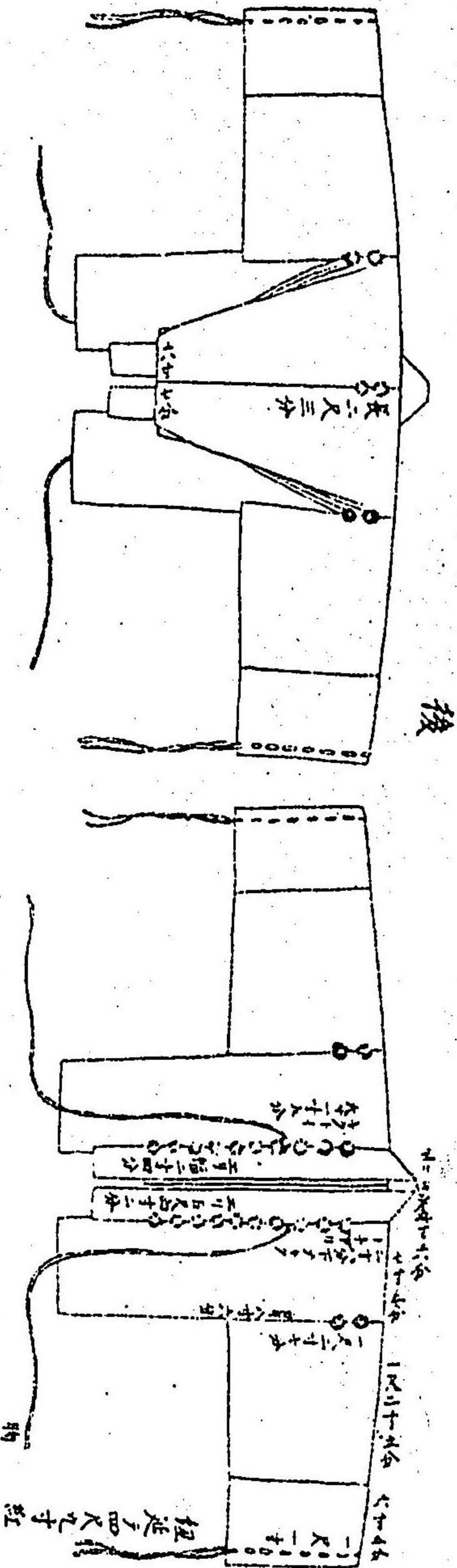

南都春日本談議屋藏義經朝臣
甲冑圖

甲冑
金物皆金減金 一々
不註之
伏組白紺茶
耳赤紫萌黃
白龜甲
睦目同色
小石打

冑全圖

黑漆二十八間四方白
星十六星廻六間宛合廿八間
但審視之全縣
三十六間三間宛四方白也
星九十七點一黙天空坐ノ
中ニカクル
前後七寸一分左右六寸八分
深三寸五分

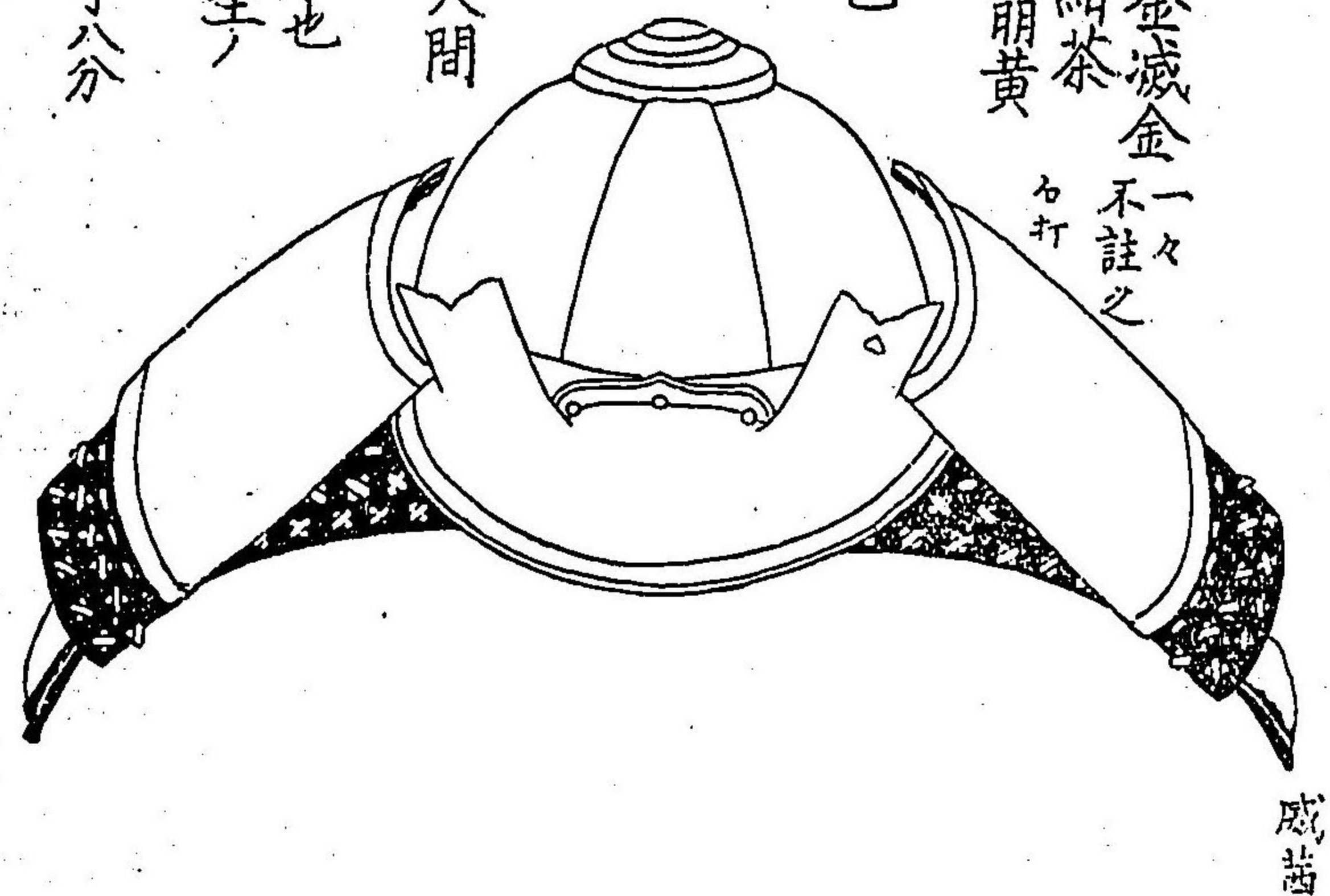

威蓋

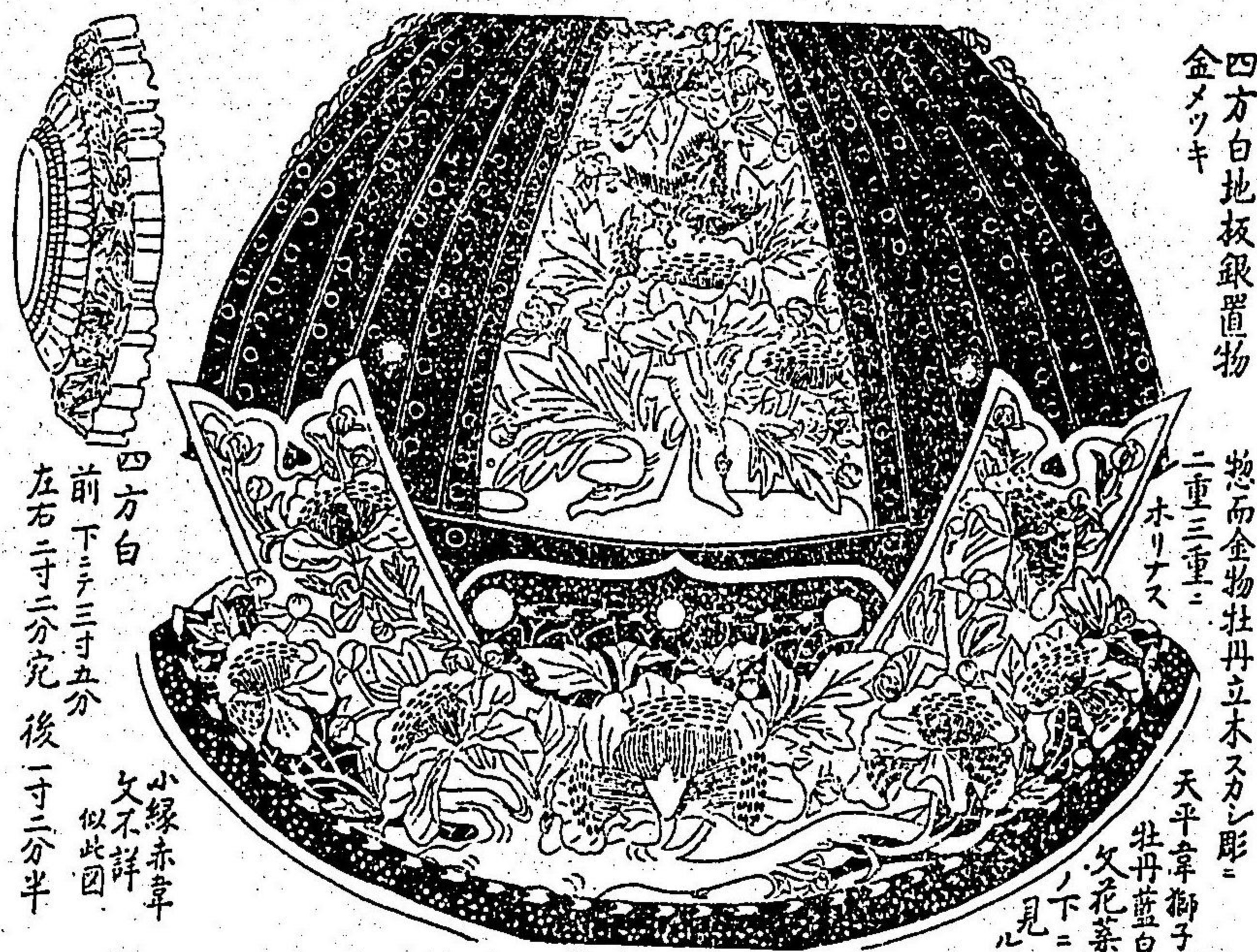

四方白地板銀置物
金メッキ

惣而金物牡丹立木スカシ彫ニ
二重三重ニ
ホリナス
天平章獅子
牡丹藍白
文花菜
見

四方白
前下ニテ三寸五分
左右ニ寸二分宛 後一寸二分半
小緑赤章
文不詳
似此圖

側面全圖

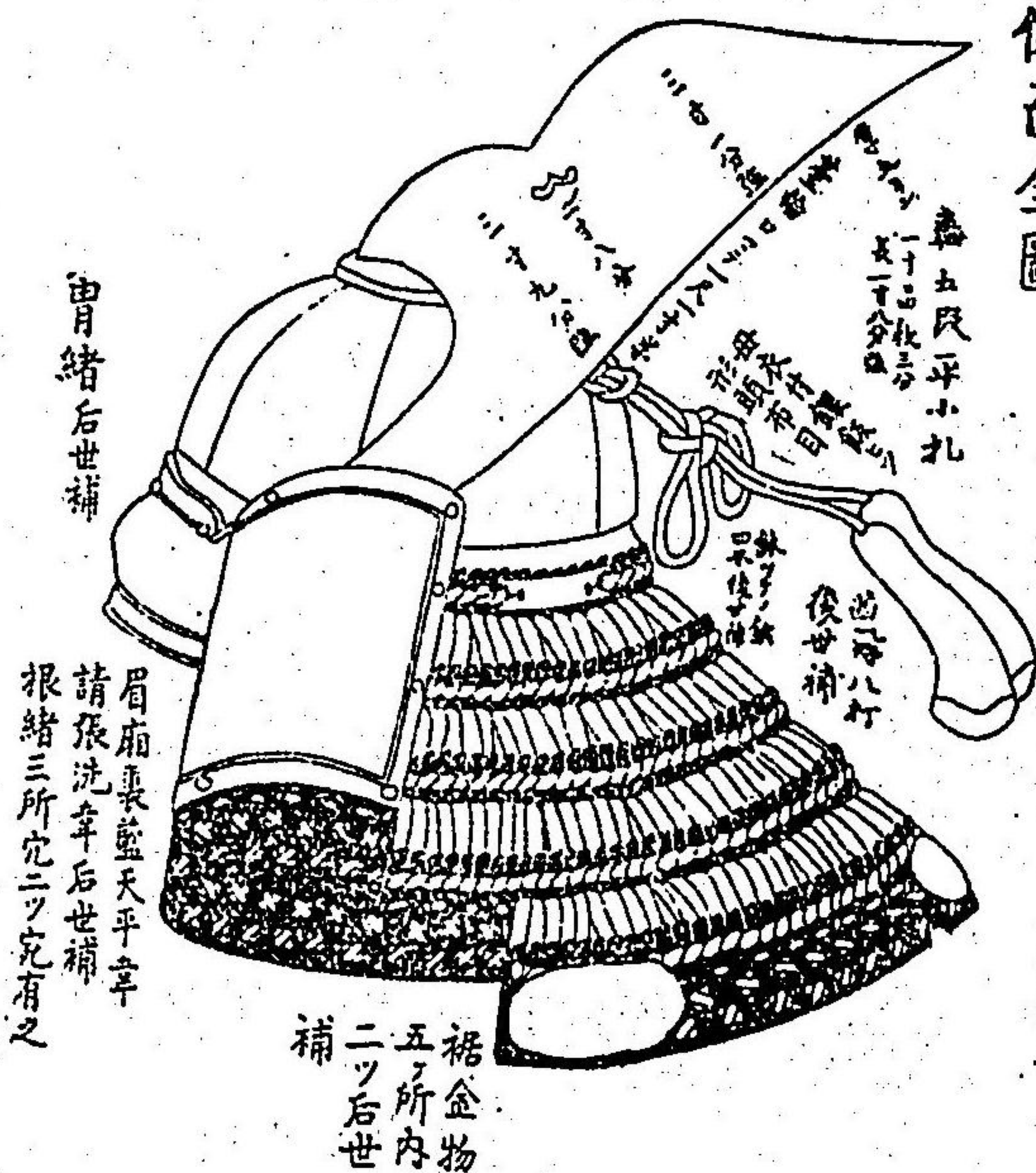

惣而稱後世補者寛文十年之修補也

眉前裏藍天平章
請張洗車后世補
根緒三所宛ニツ宛有之
補
裾金物
五所内
二ツ后世
補

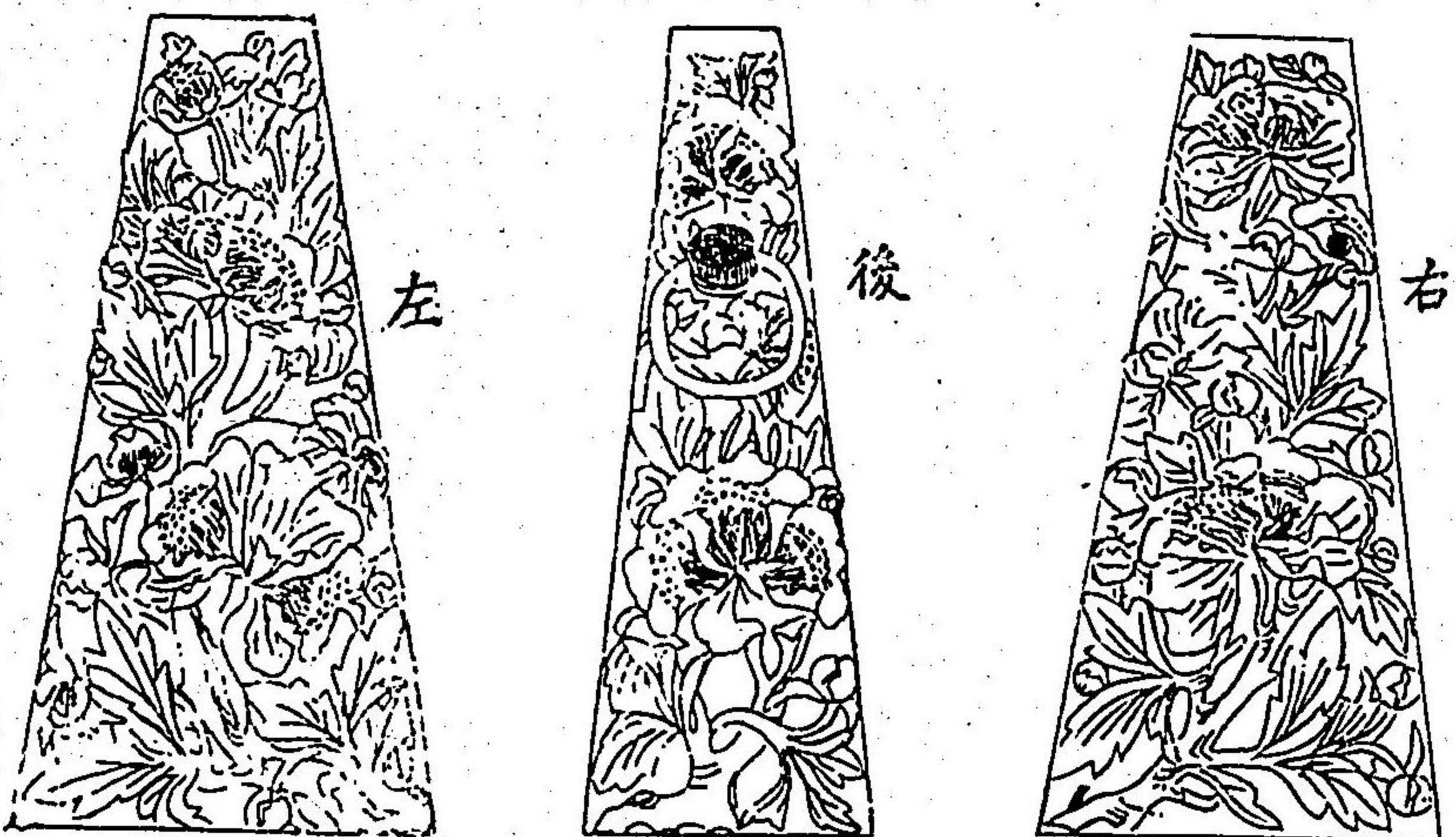

左吹返金物 繪草之上
ツクル

右同

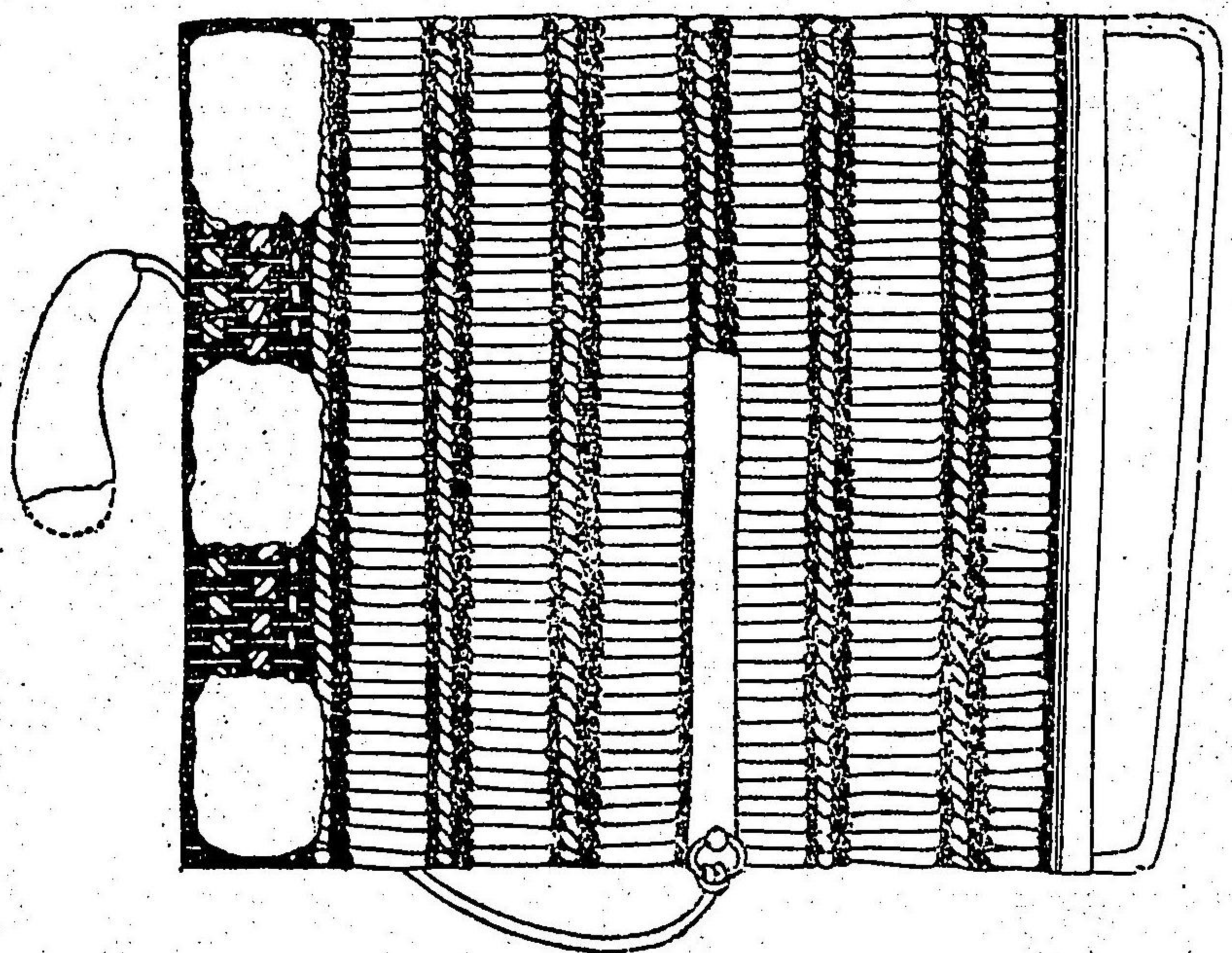

袖全圖

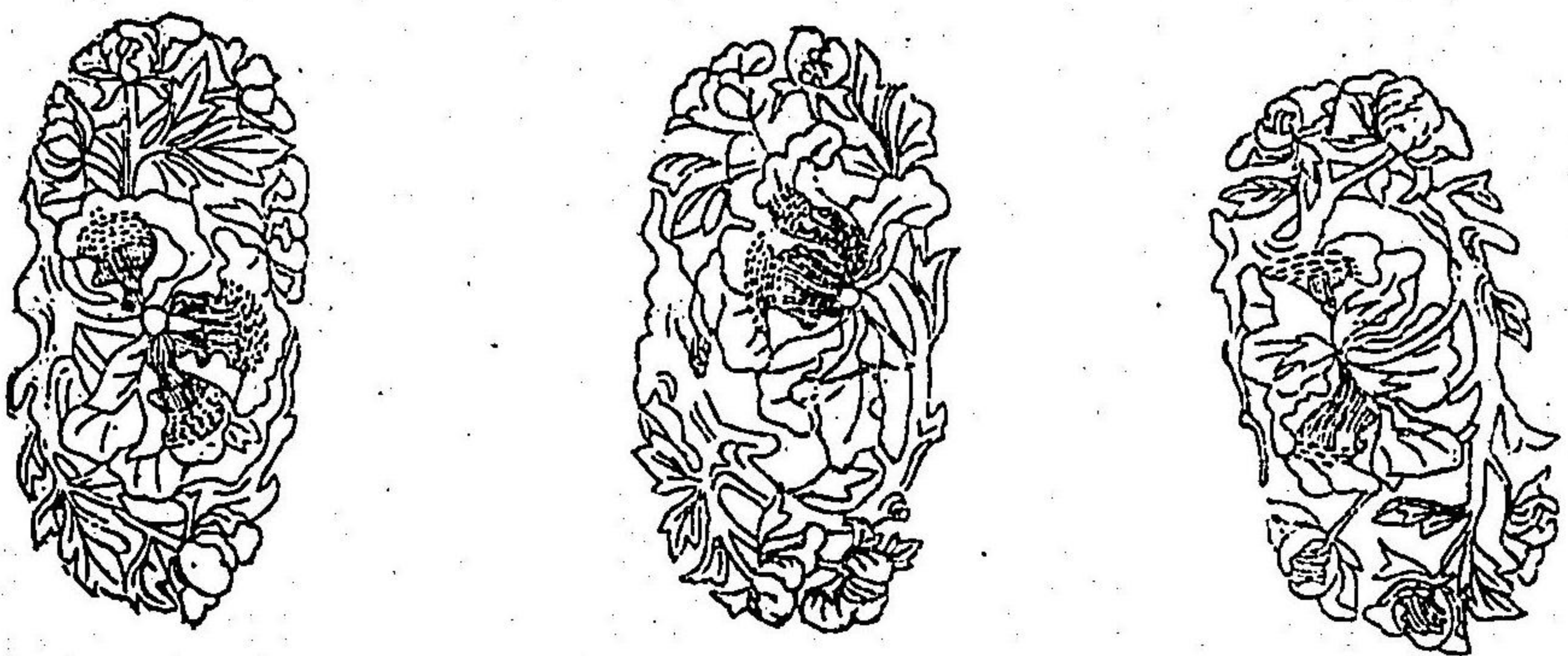

鞞

左端

中央

右端

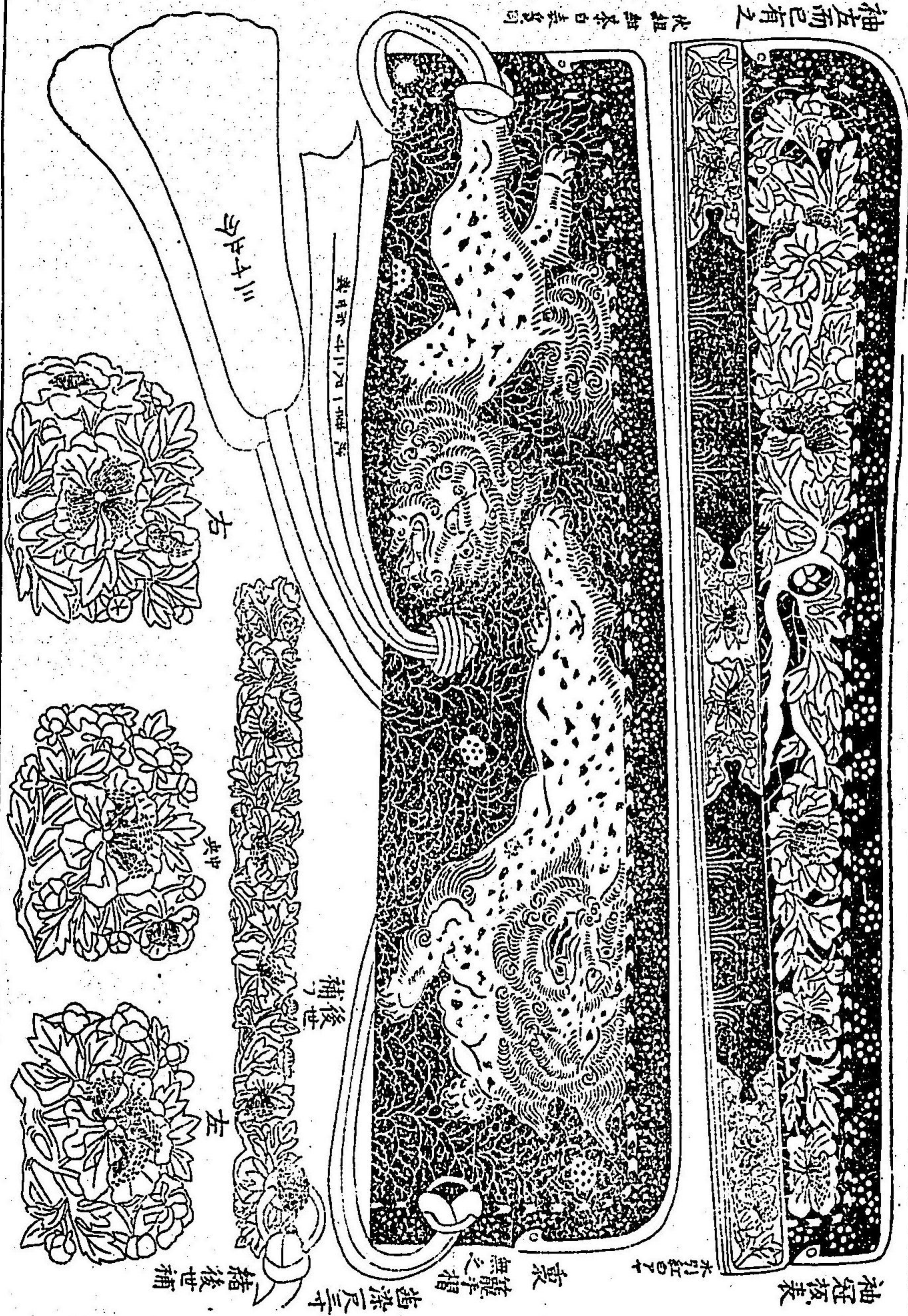

袖左而已有之

伏担 無本白表裏同

サキナ

美目守 二尺一寸 一 無之相

右

中央

左

補世

東 無之相 齒深尺三

裾後世補

神冠板表

水引紅白

甲前全圖

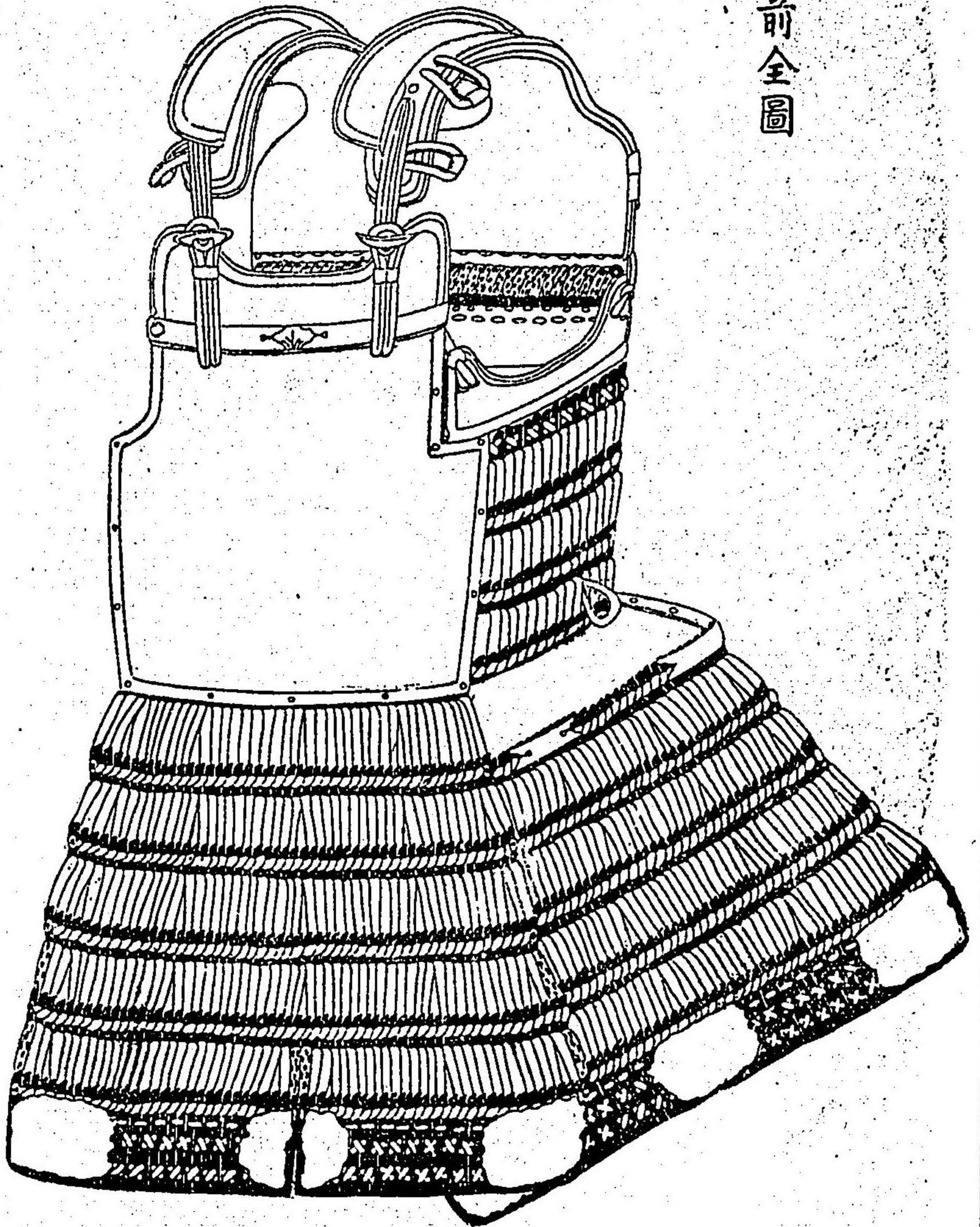

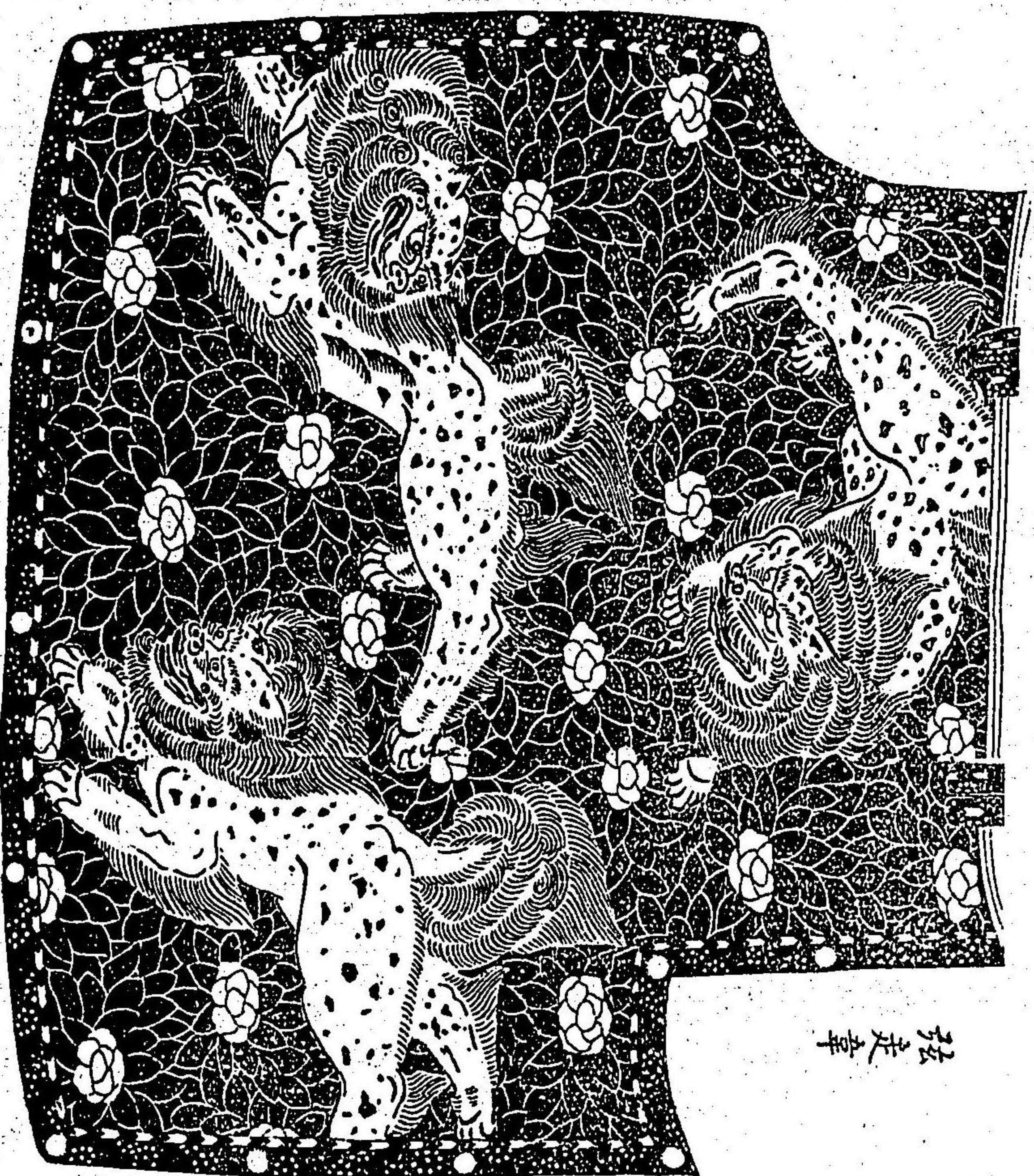

弦走幸

小翠伏組歛後世補

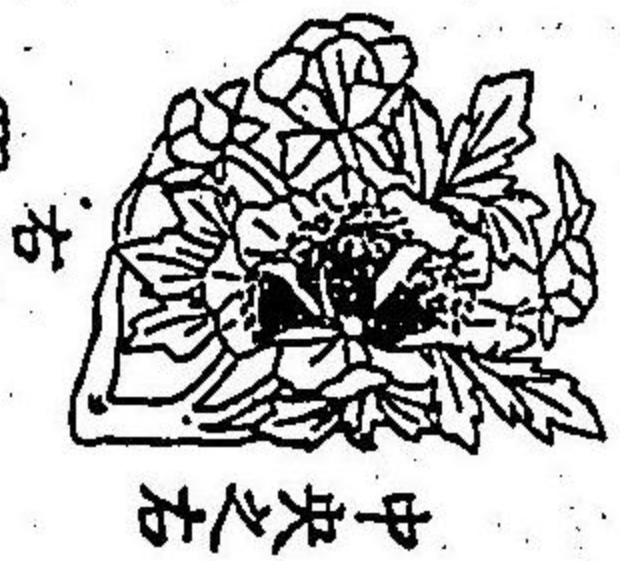

中央之右



中央之左

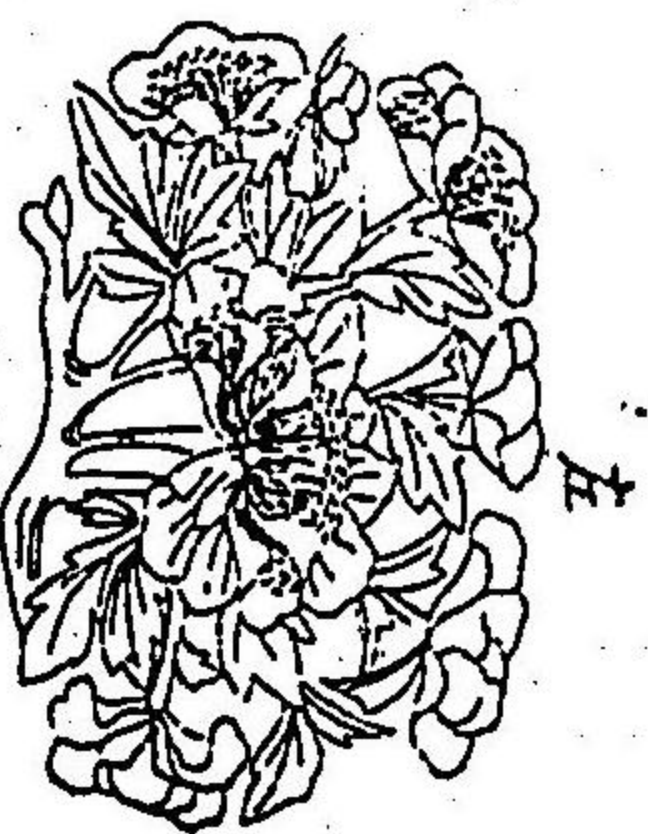

左

前板裾金物

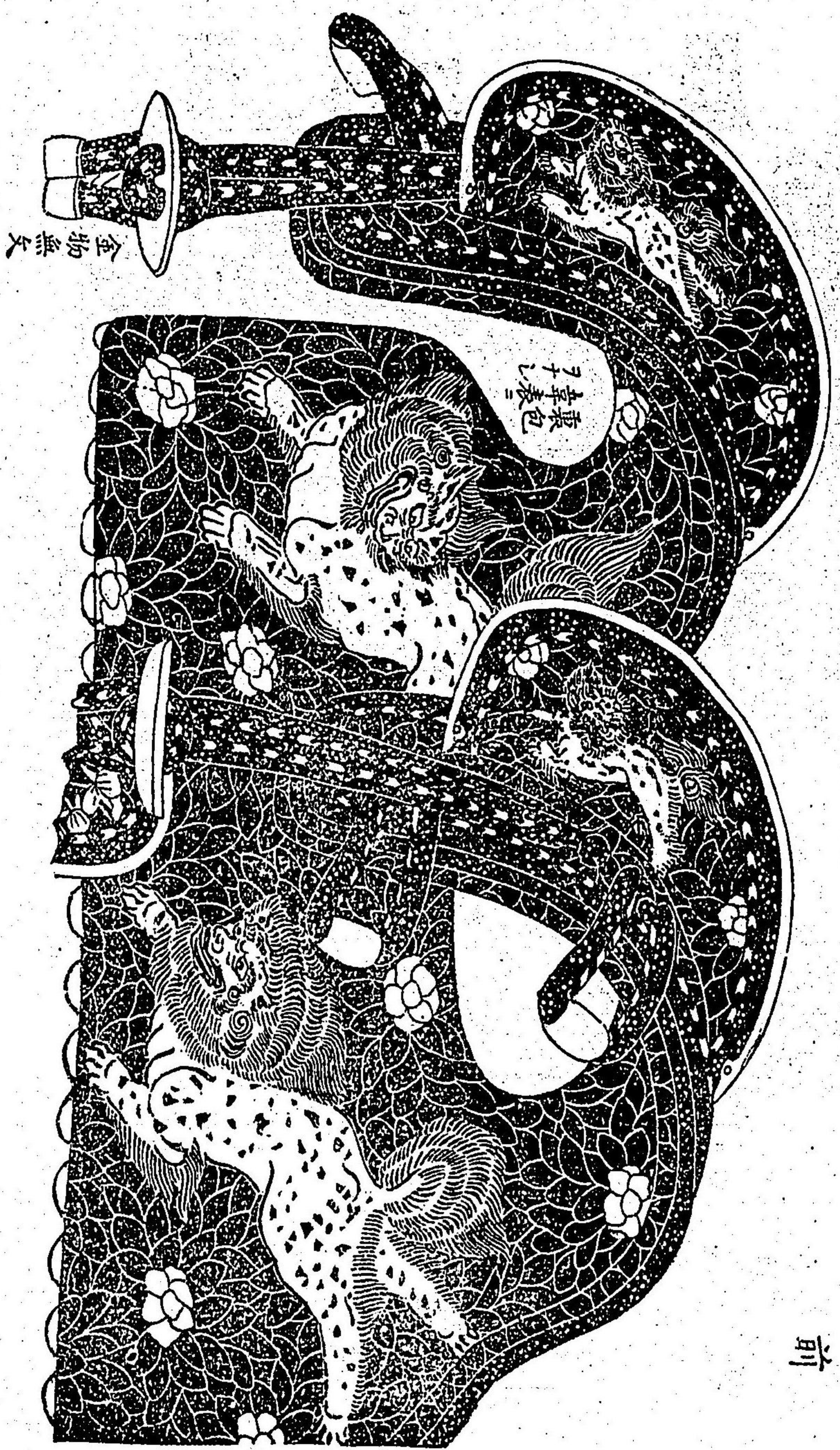

前

金物無文

胸板

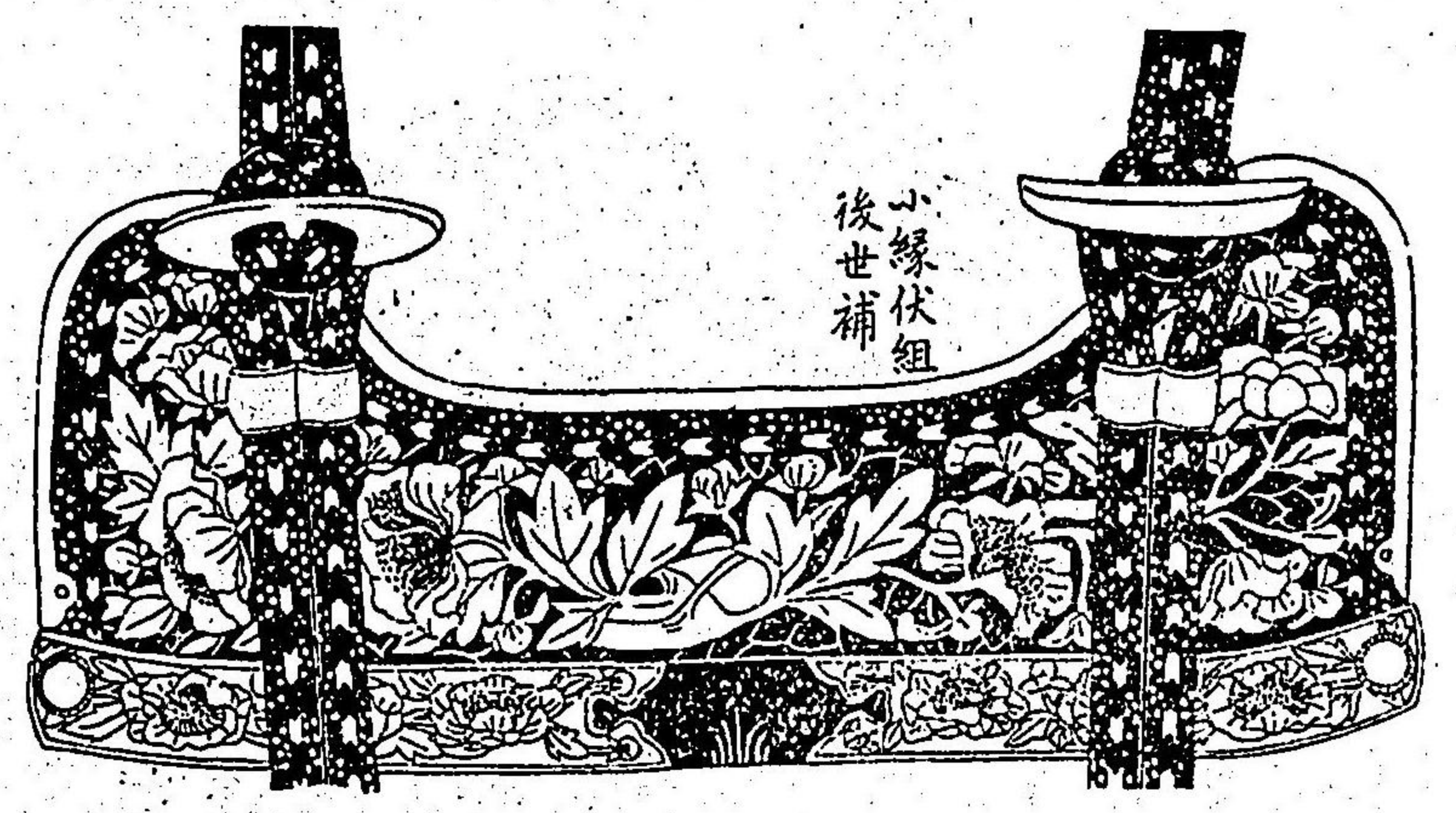

縁メワテ



弓手八双金物

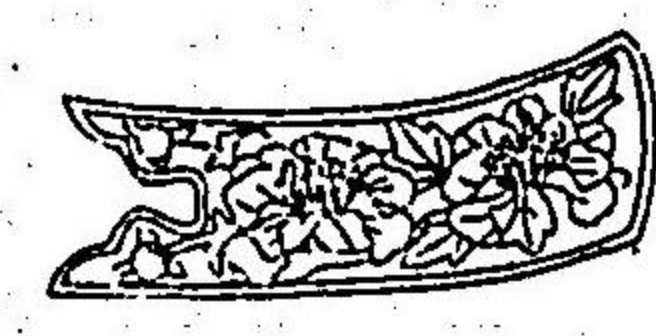

弓手裾金物



中央

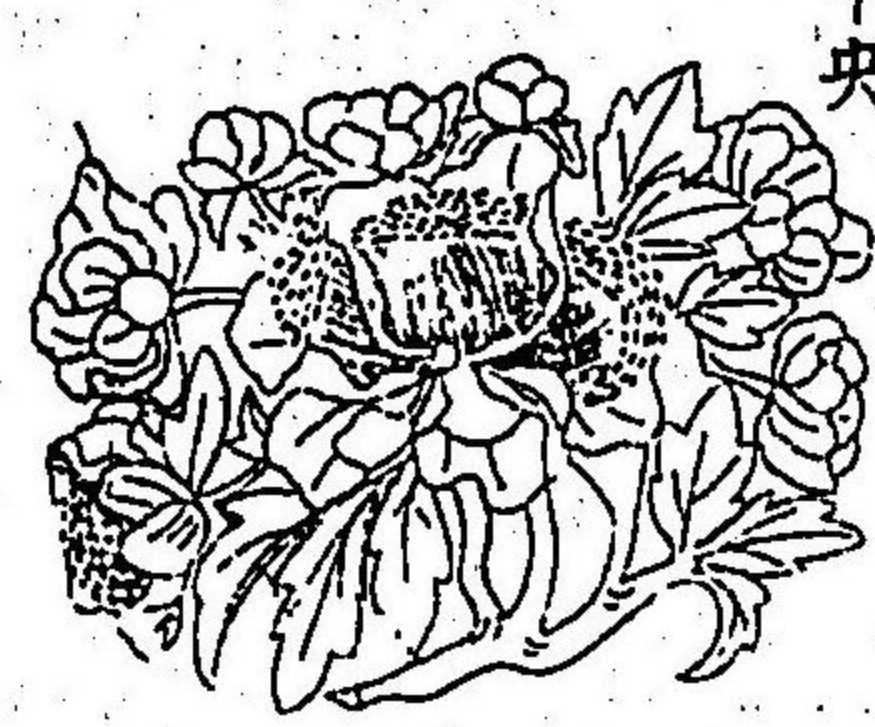
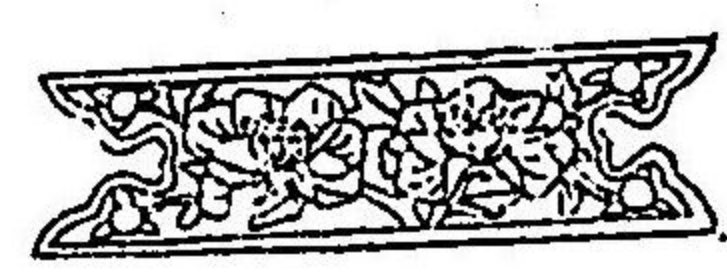

右

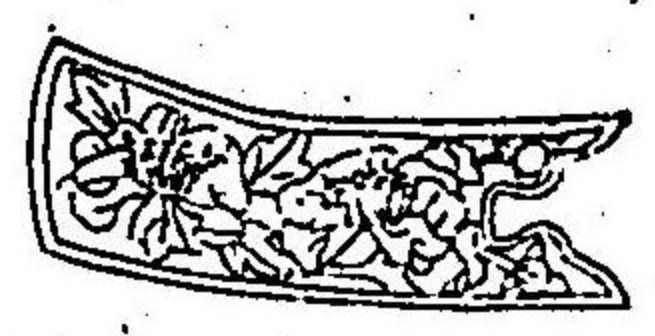

甲後全圖

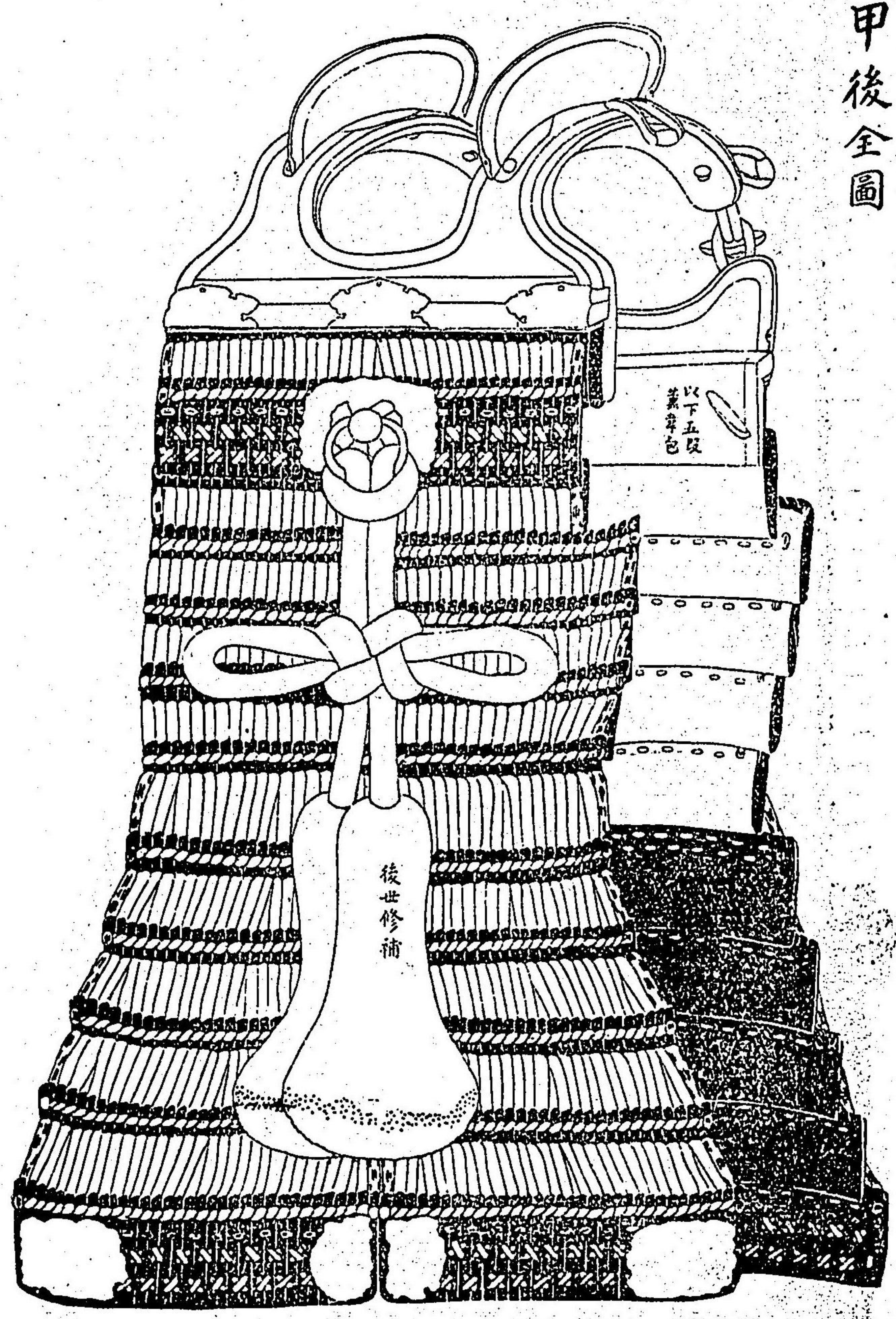

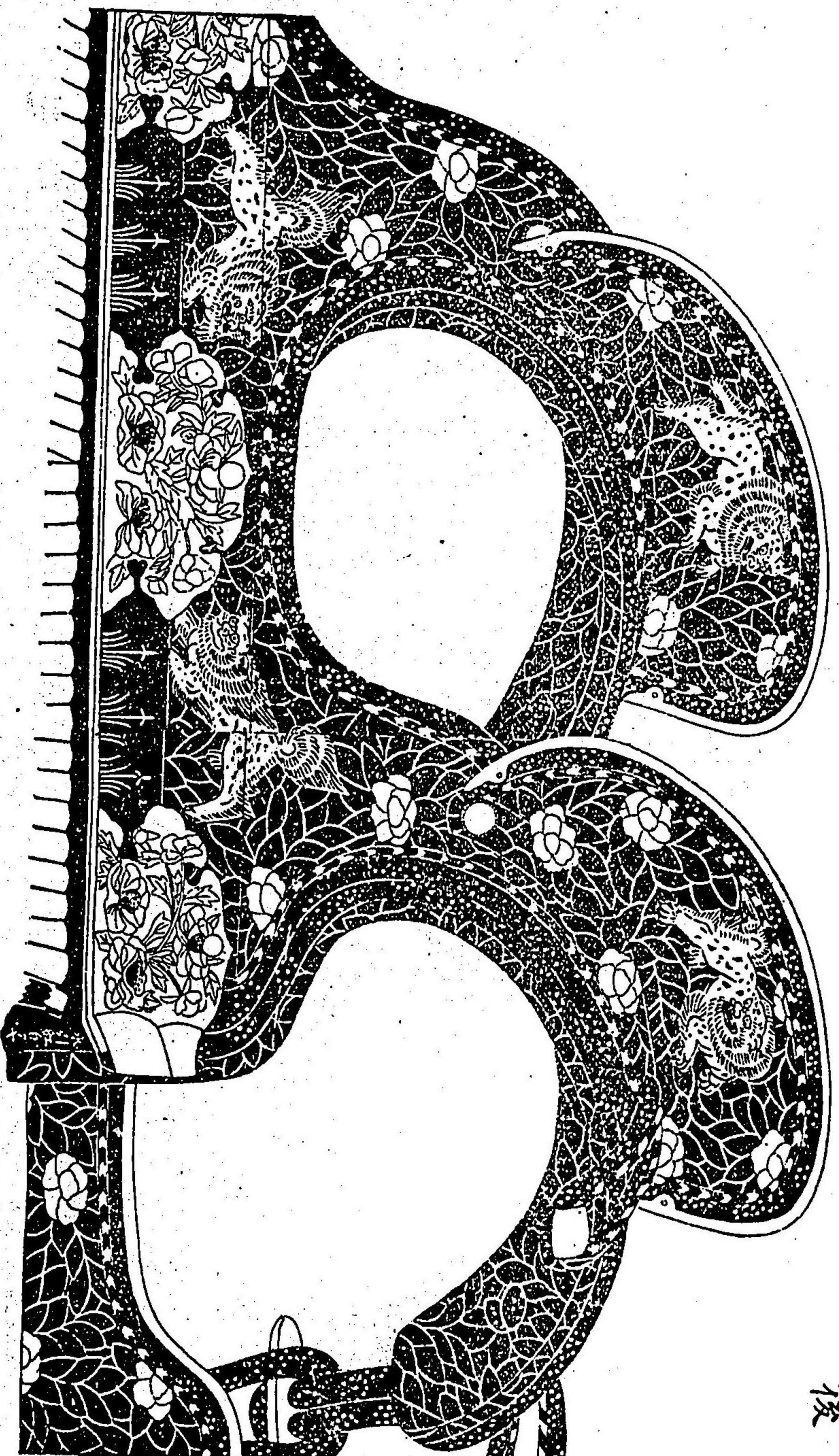

後

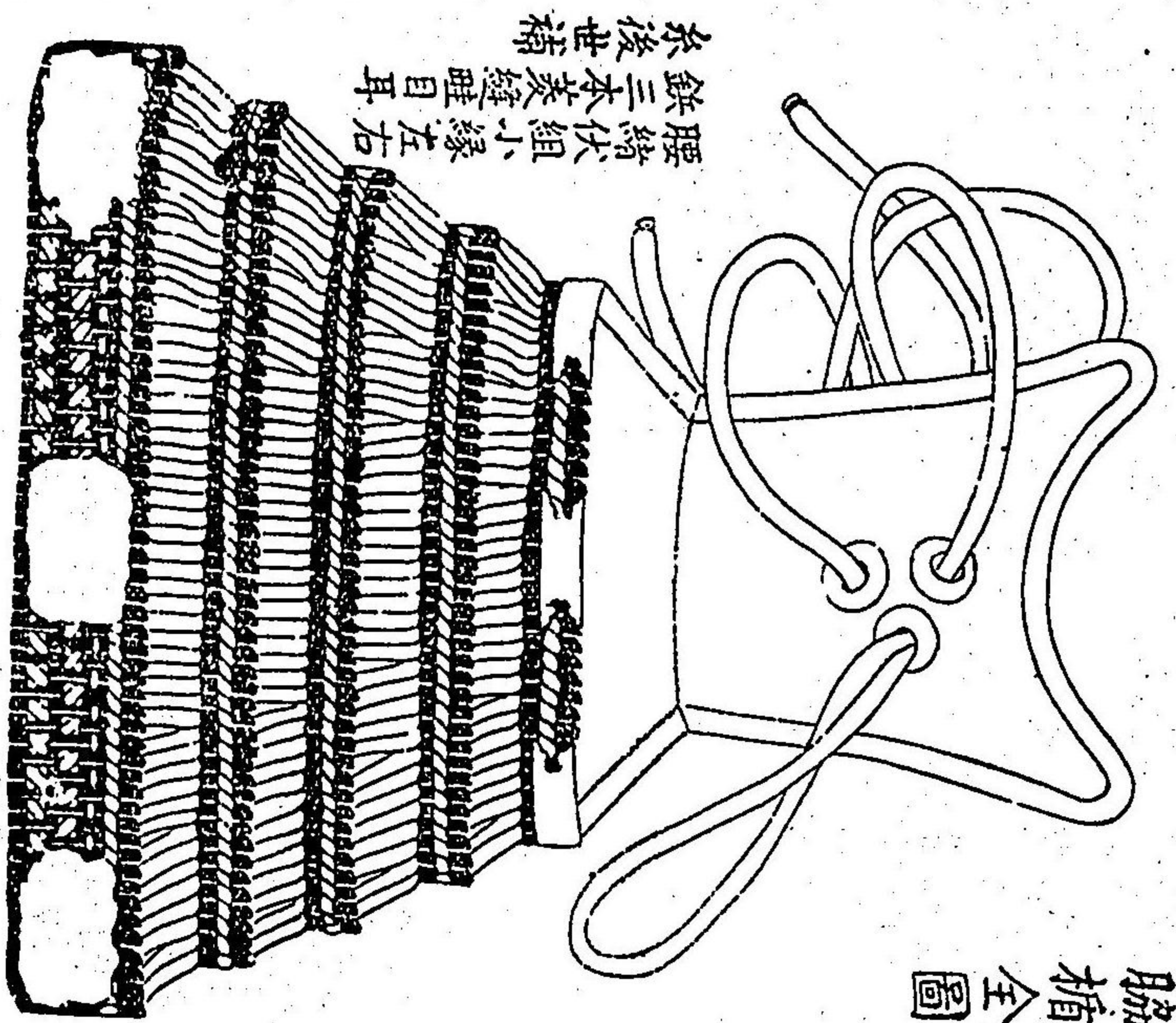

脇楯全圖

腰縮伏組小緣左右
 鉞三本裝縫目耳
 糸後世補

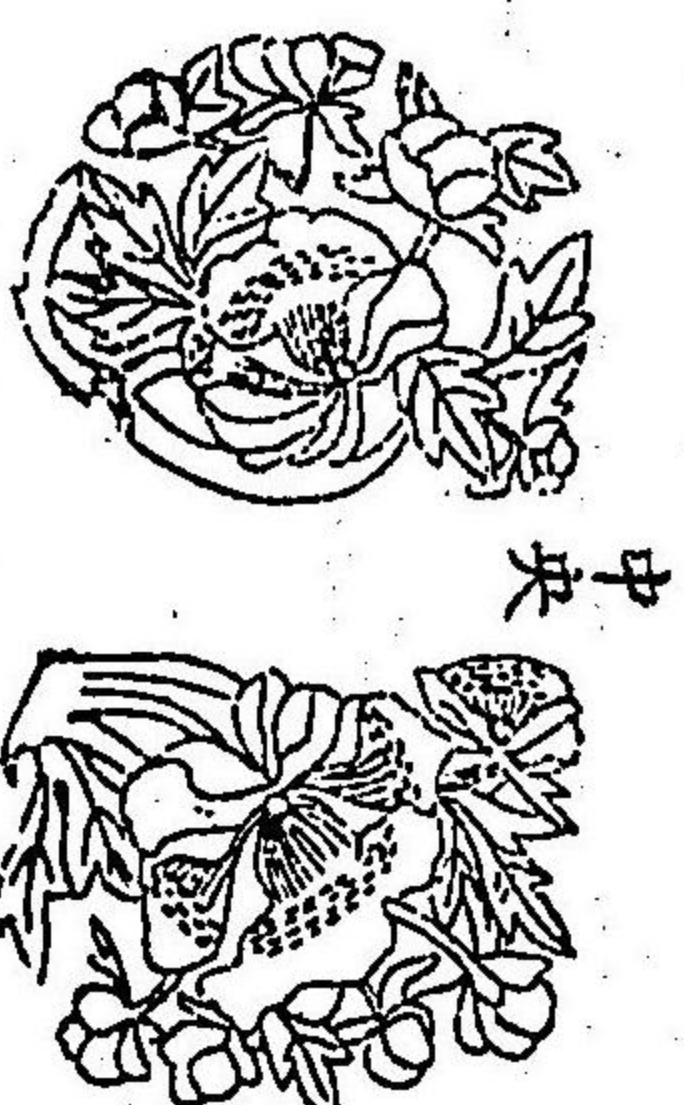

中央

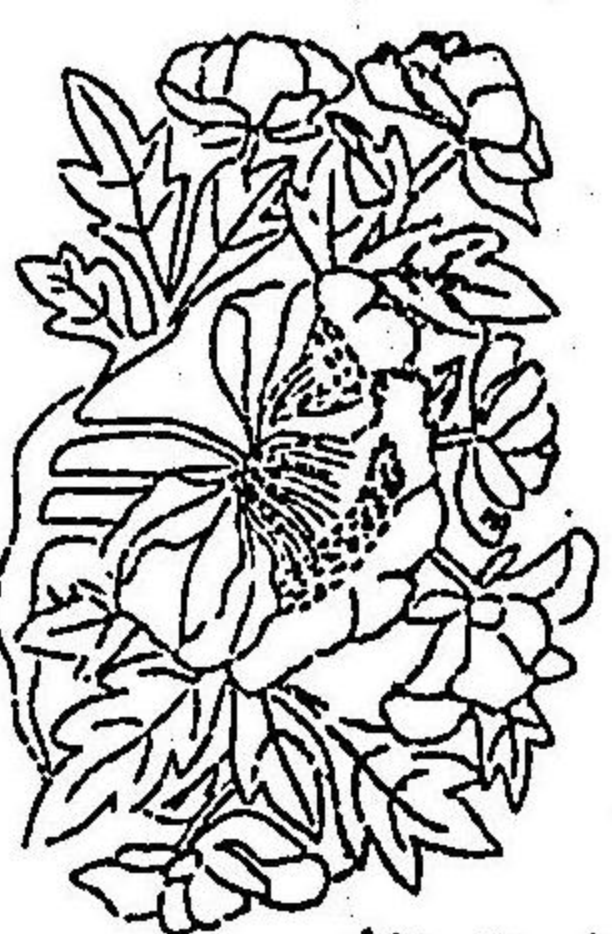

右



左

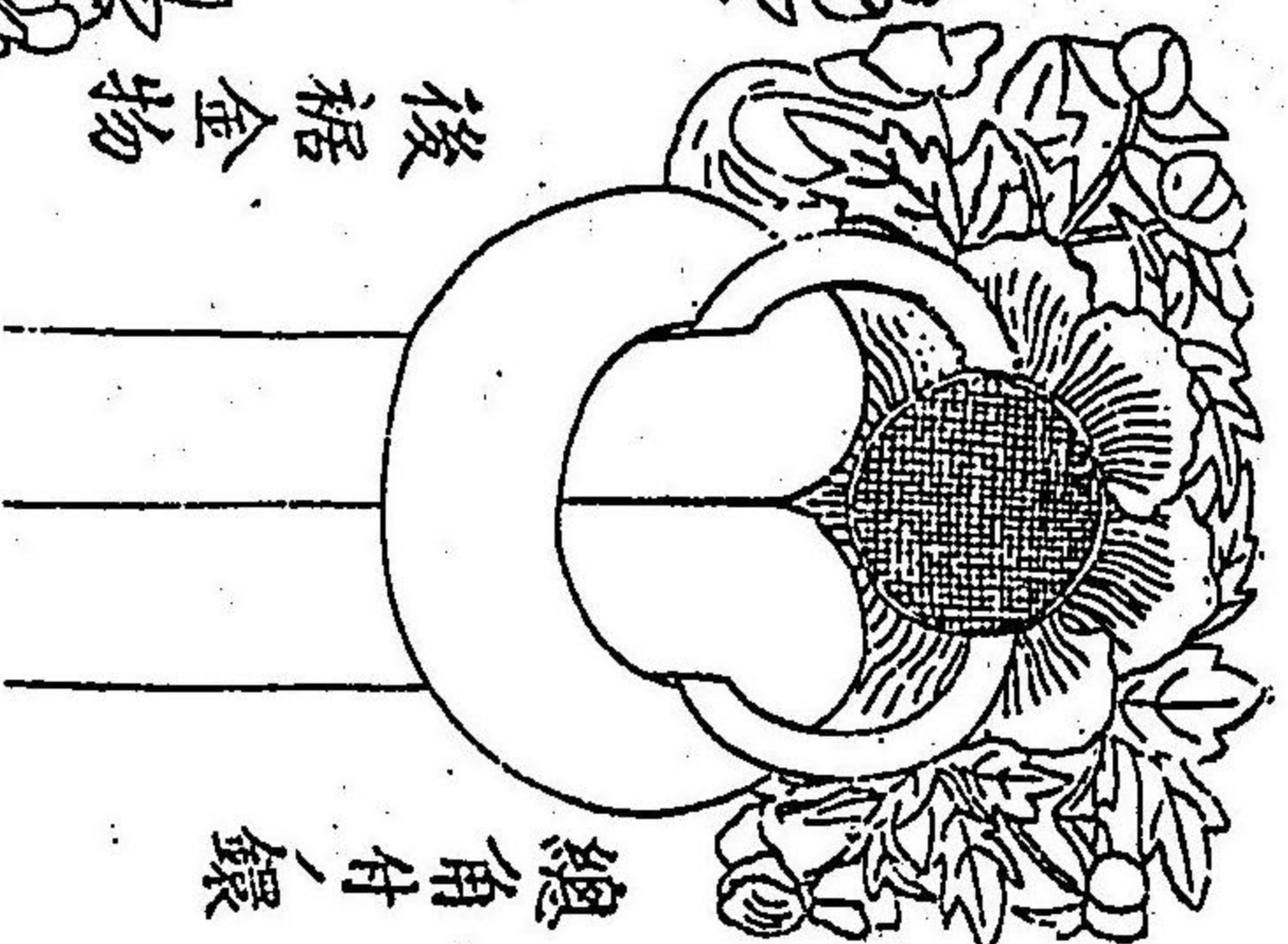

總角付

後裾金物

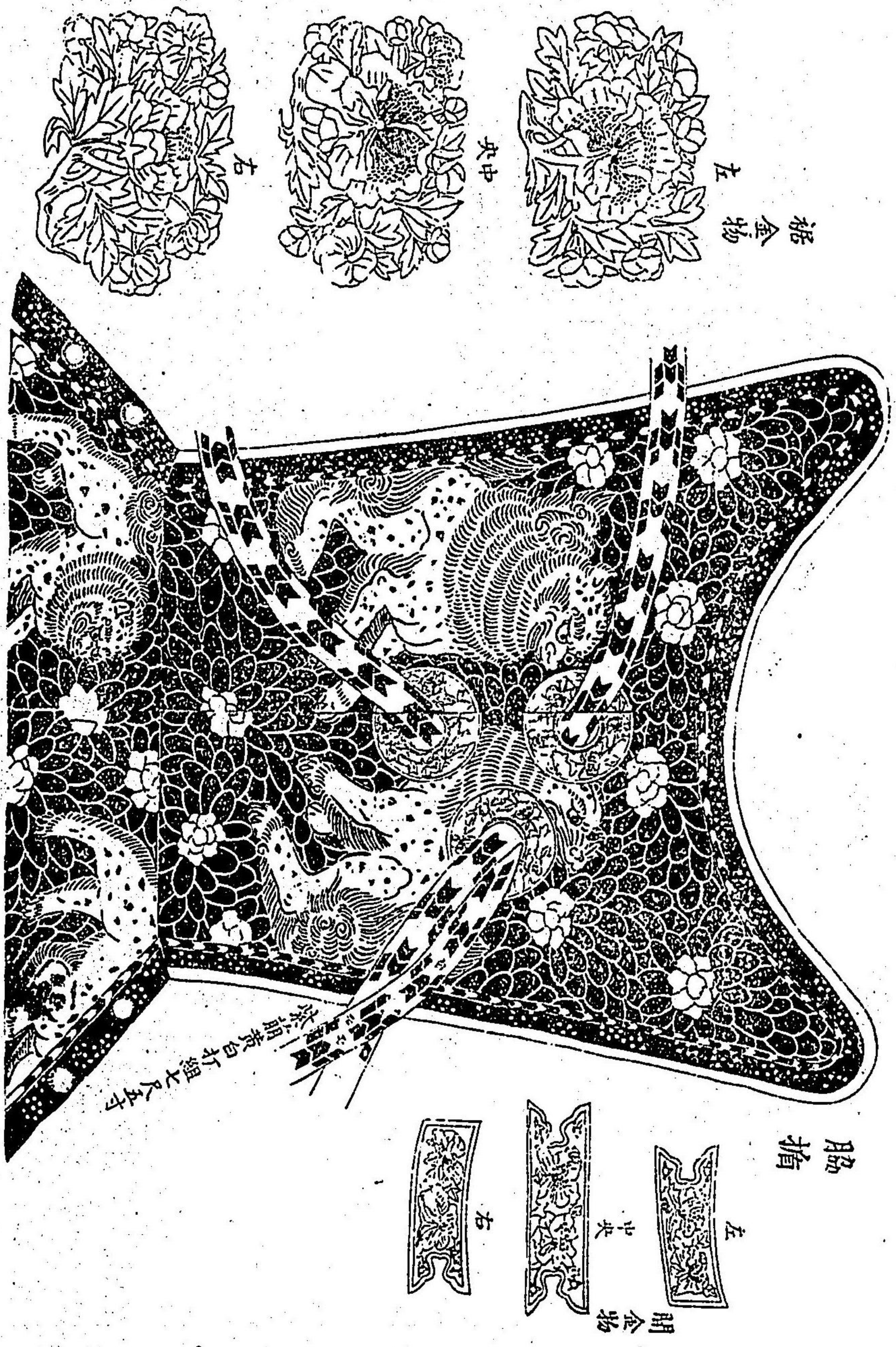

出雲國日御崎社藏喉輪圖



傳云義家朝臣所納

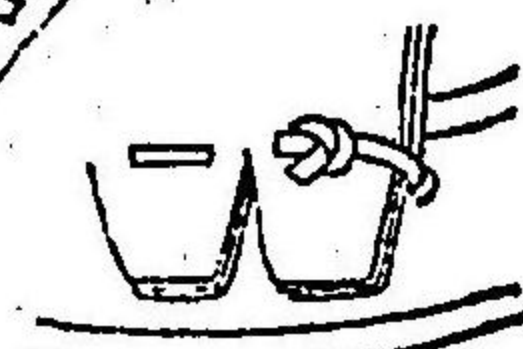
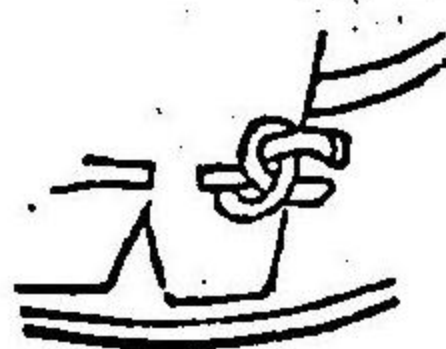
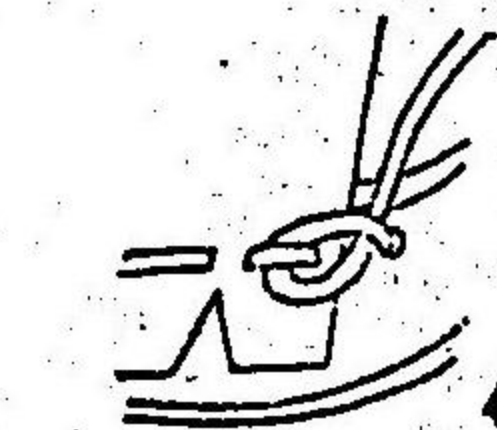
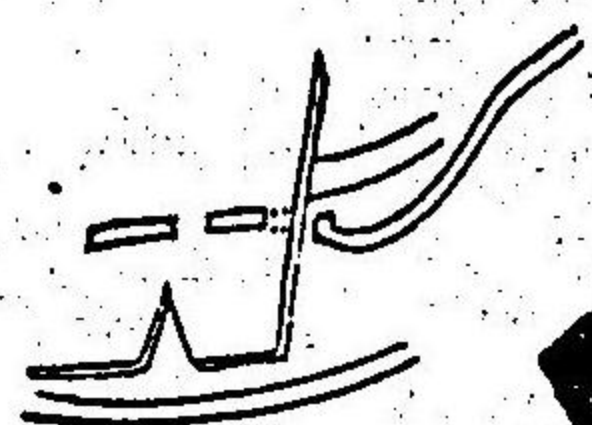
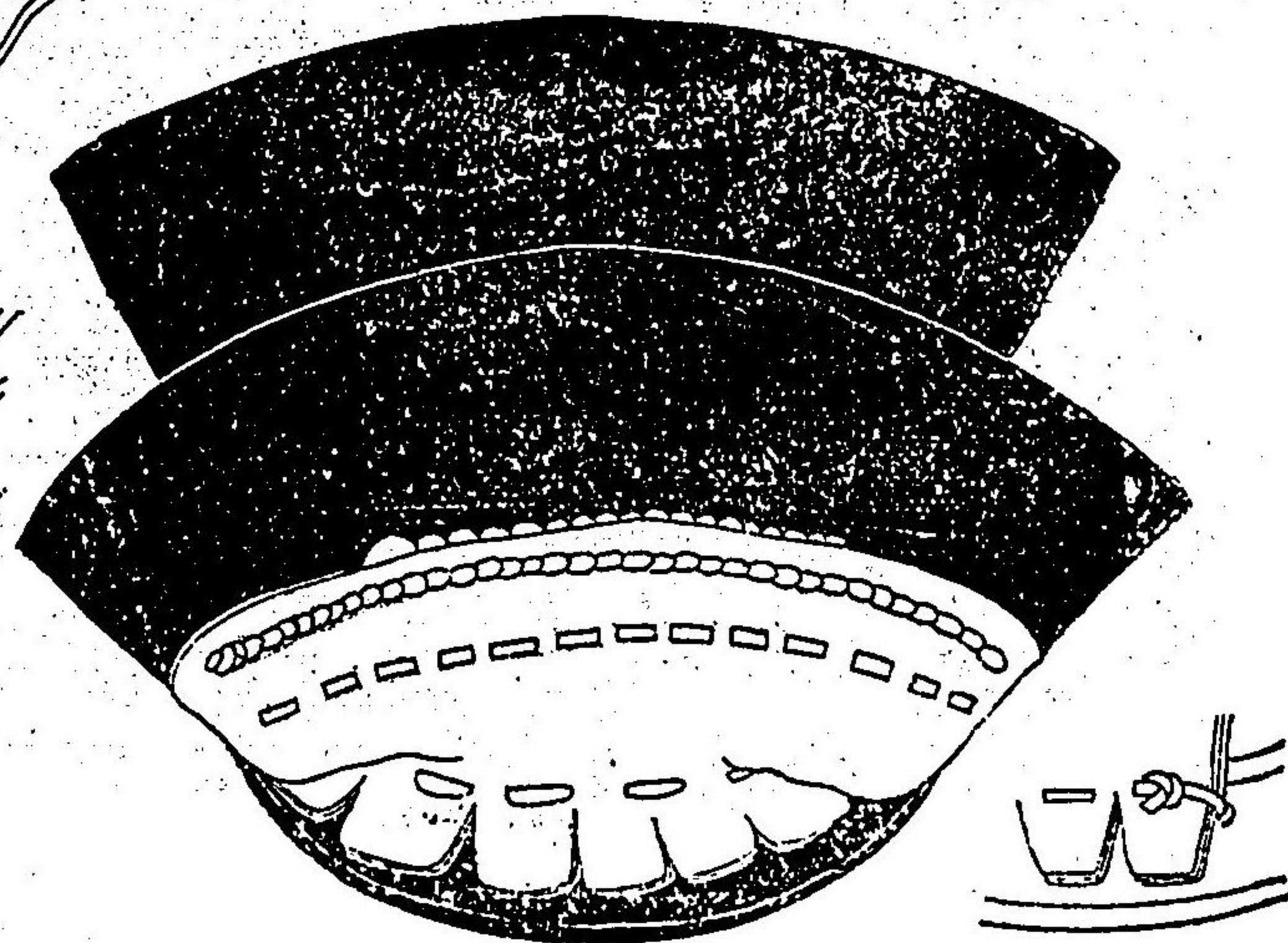
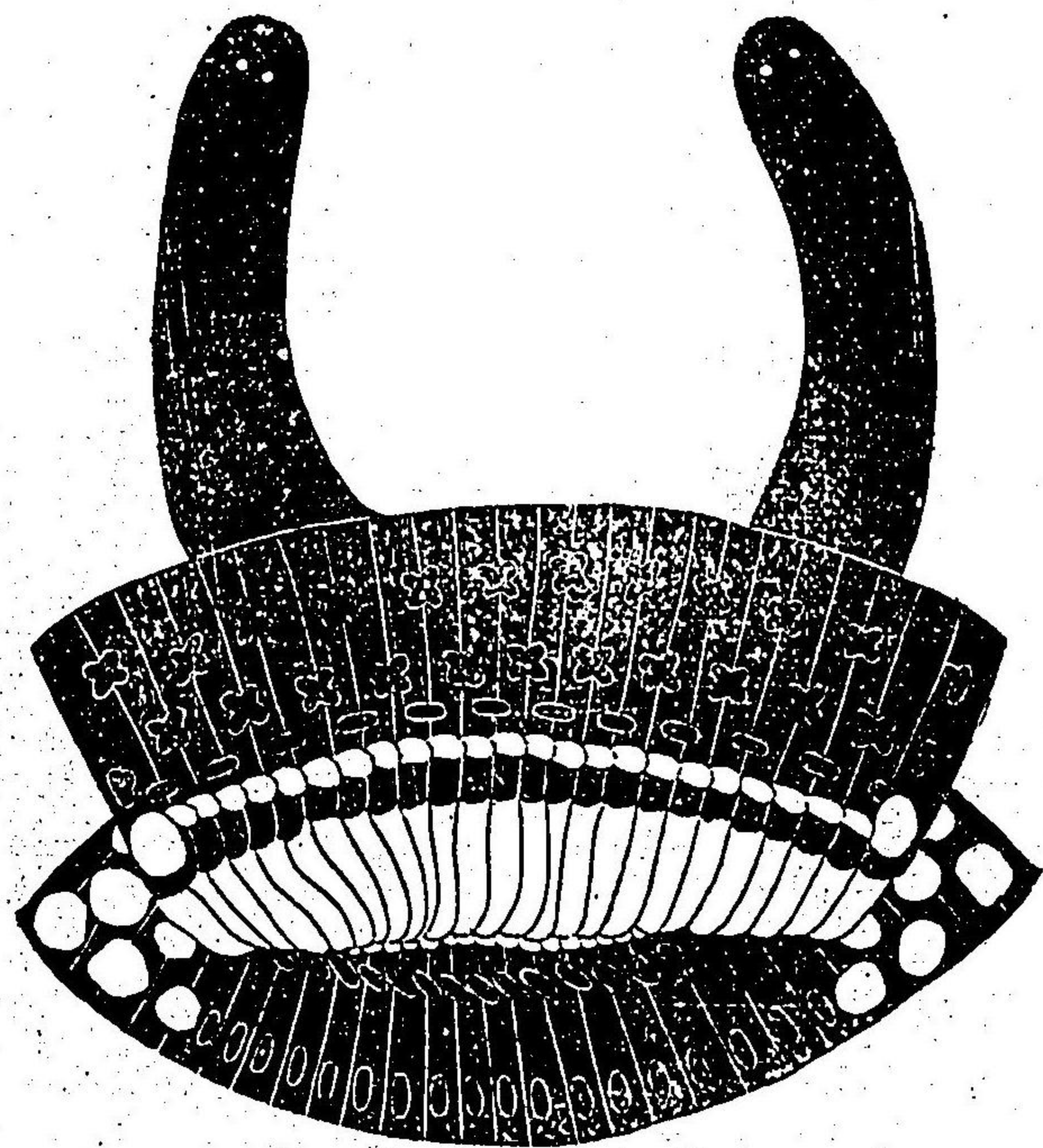

横瀬家藏新田義宗朝臣袖圖

睡目 耳糸紺白紅萌黄打組 金物ノツキ

白糸

緋糸

白糸

藍華

白糸

緋糸

菱糸白

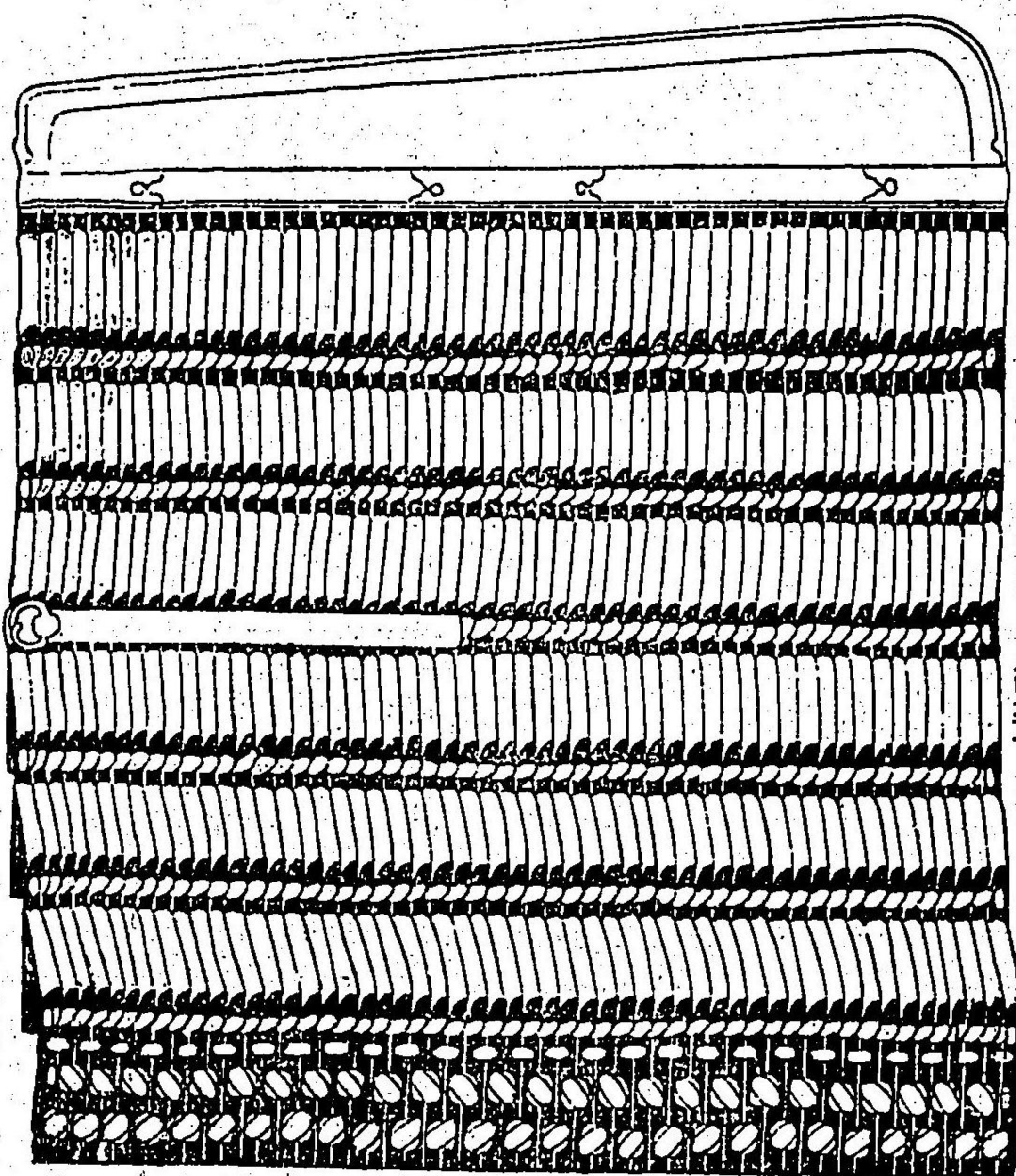



伏組紫白黃胡黃
水引紅白



包草藍地白文
花田藏

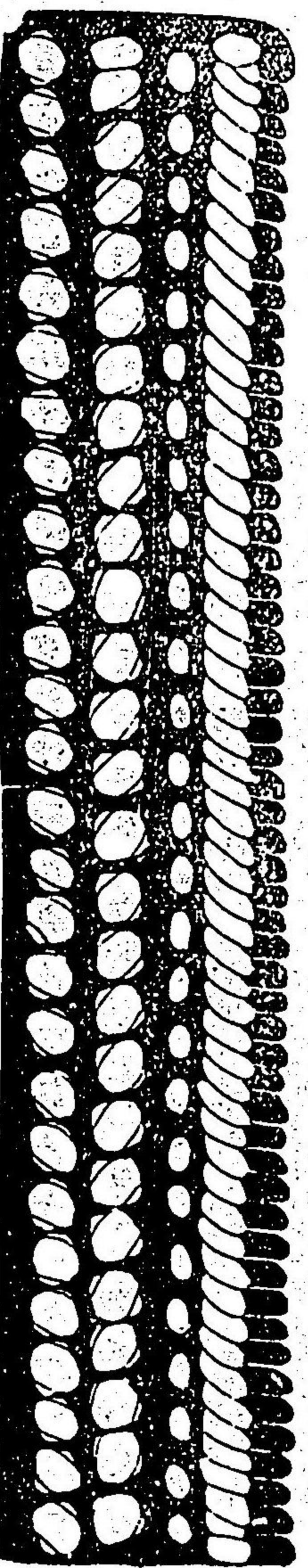

伏組前同

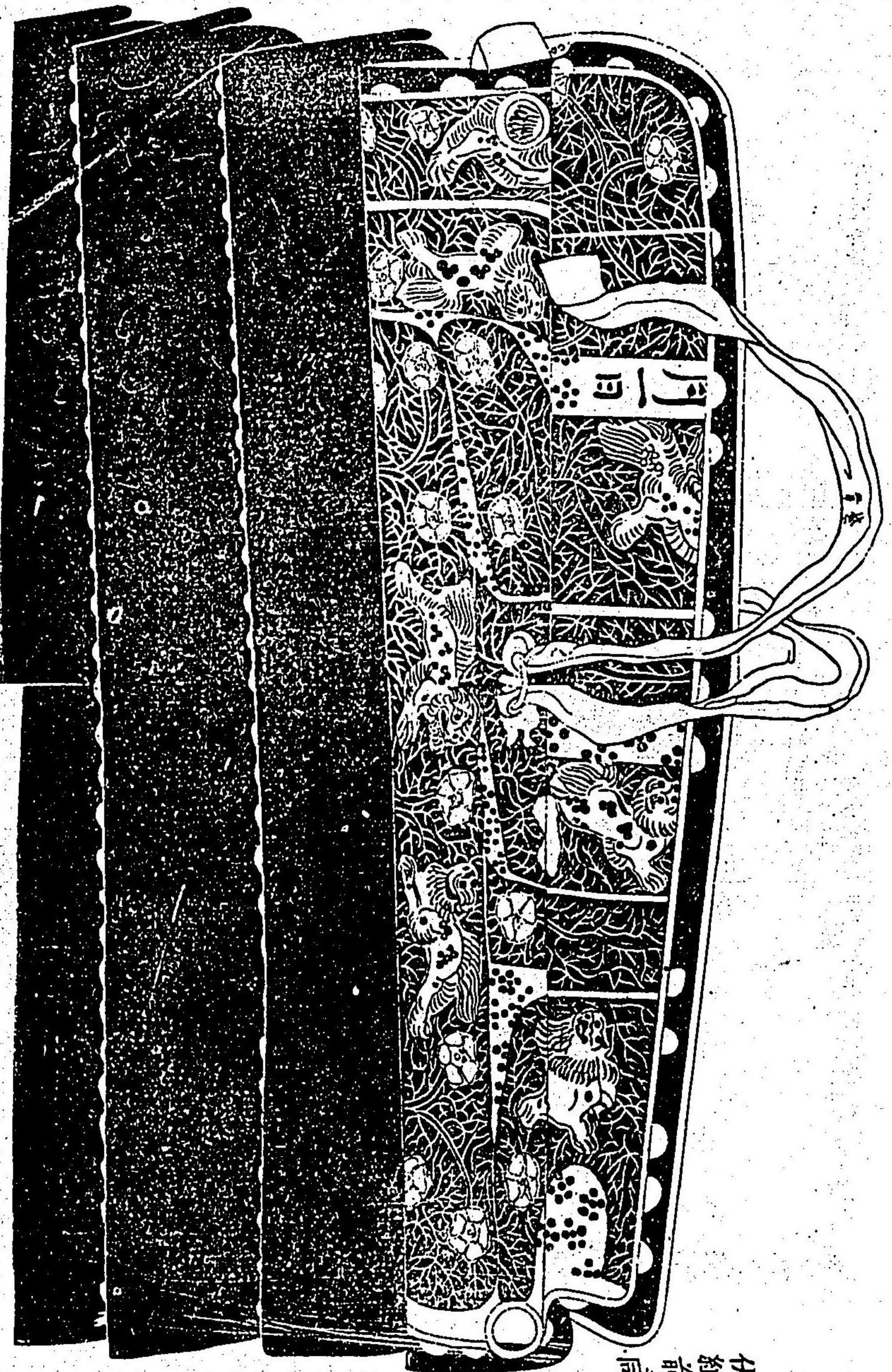

接次圖

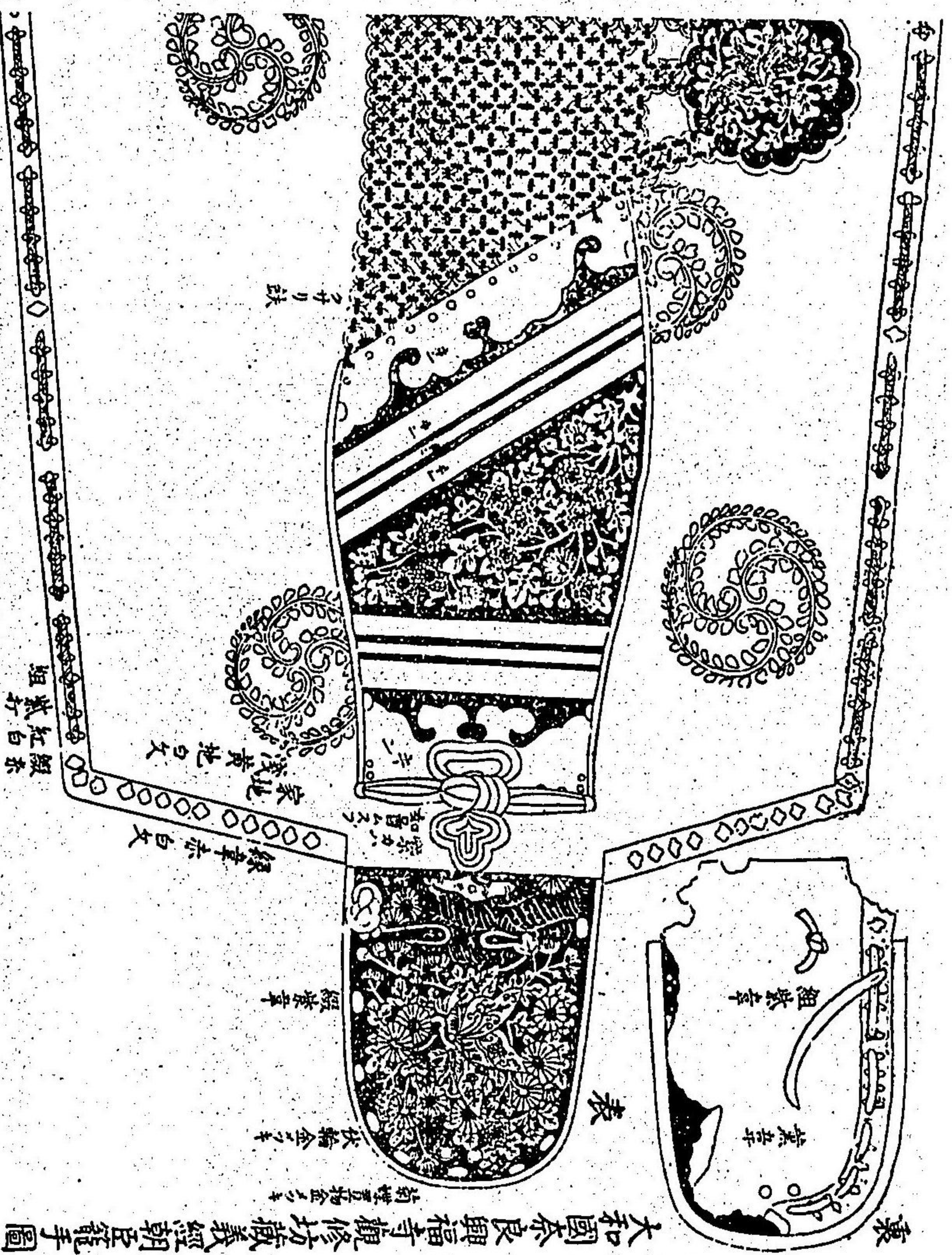

大和國奈良興福寺觀修坊藏義經朝臣籠手圖

接前圖

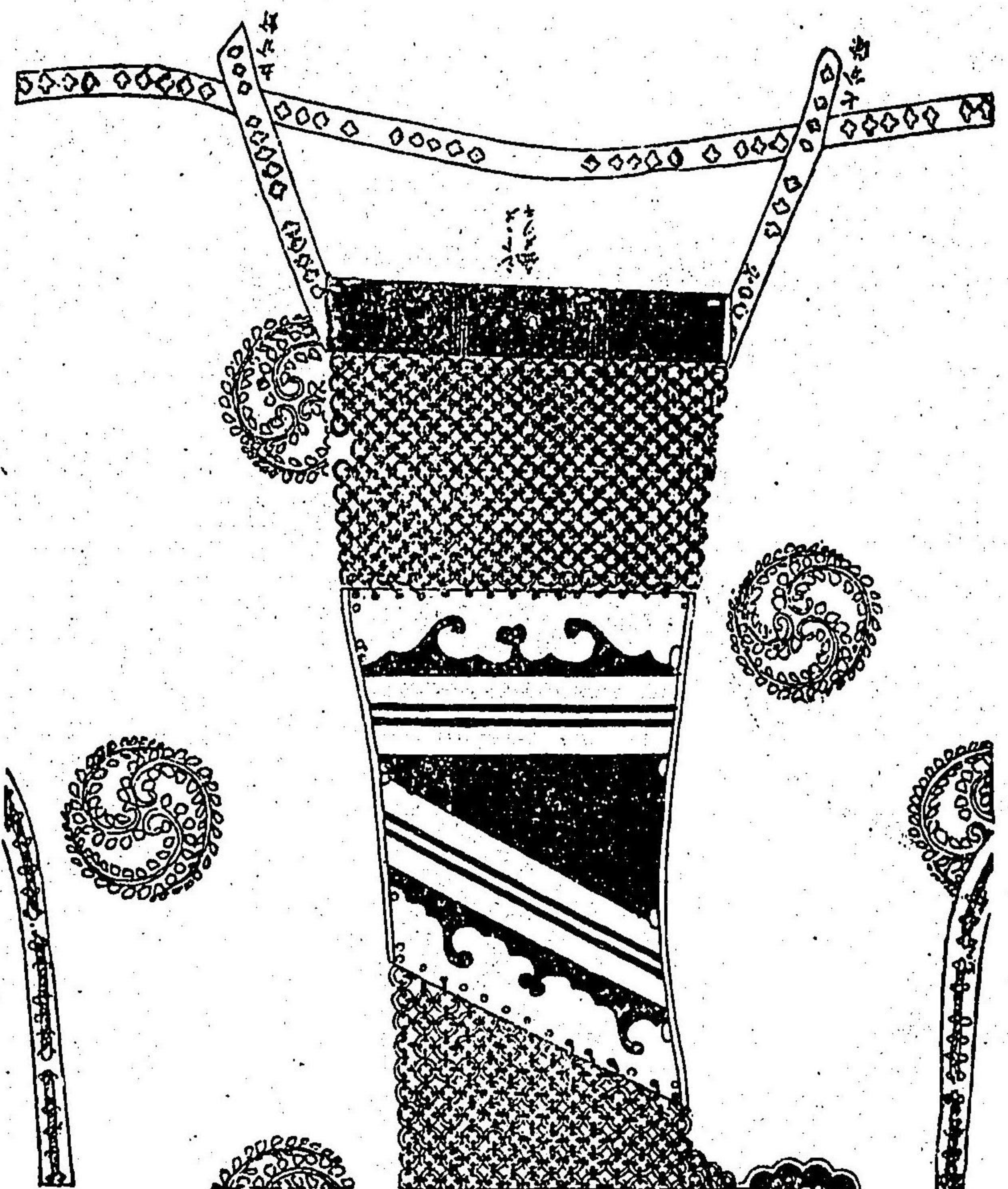

全圖

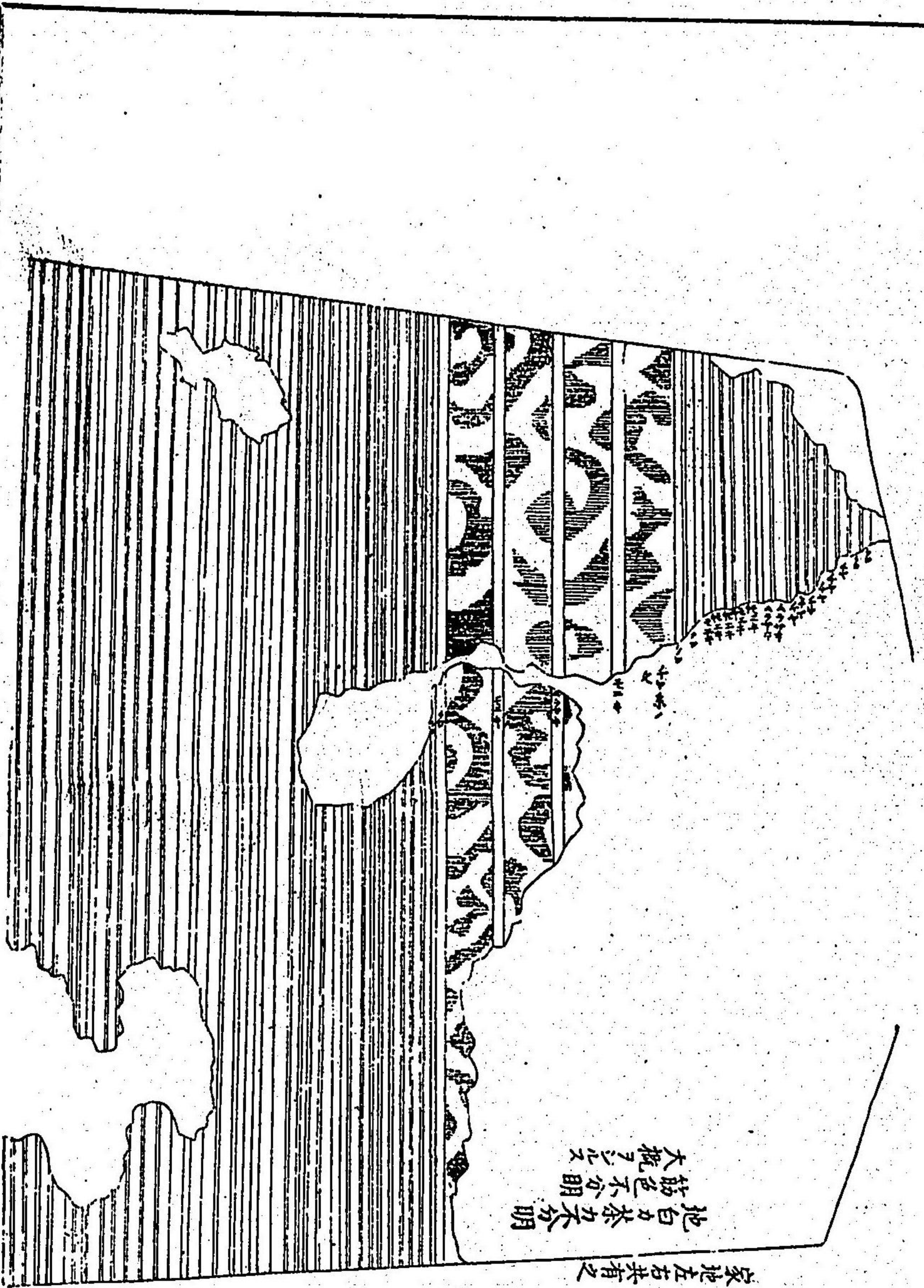
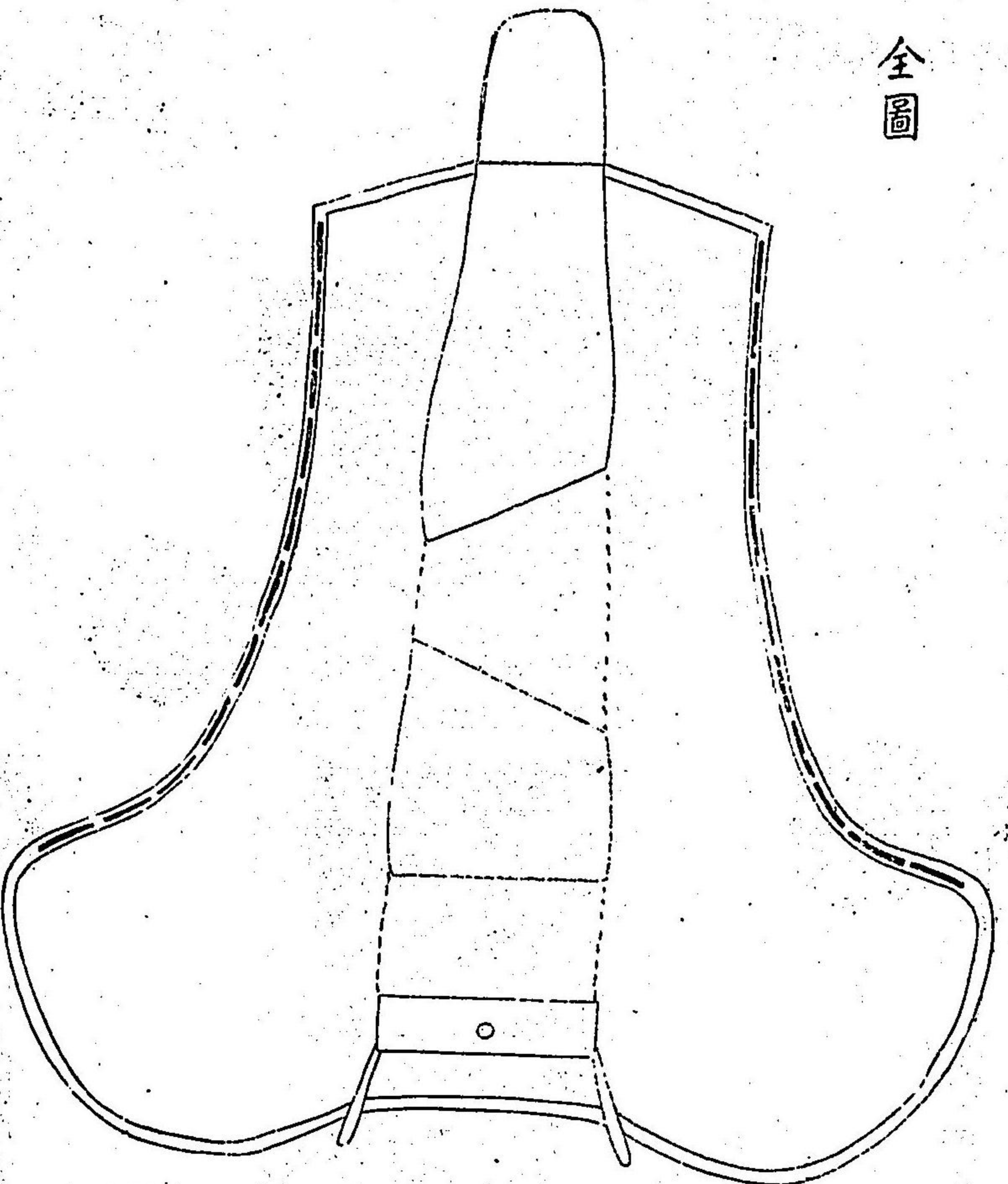

古來右臂手冑地
 傳曰雪之下 一說曰冑地兼
 今破損別稱鐵
 冑地左右共有之
 地白茶刃分明
 筋色不分明
 大概了此矣

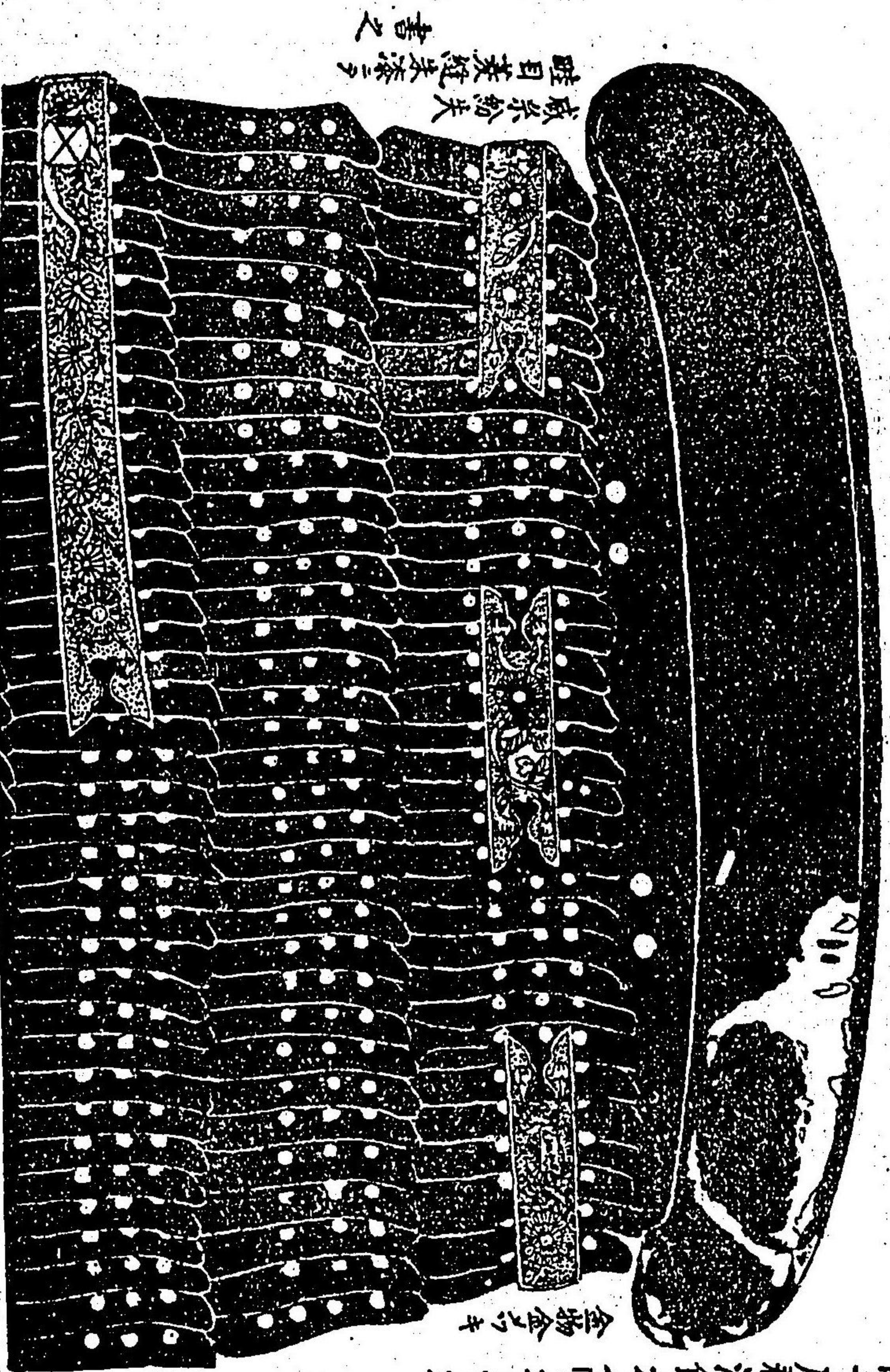

出羽國平鹿郡沼館村八幡社藏袖圖

金物金ノキ

威系紛失
睦目菱縫朱漆ノ
書之

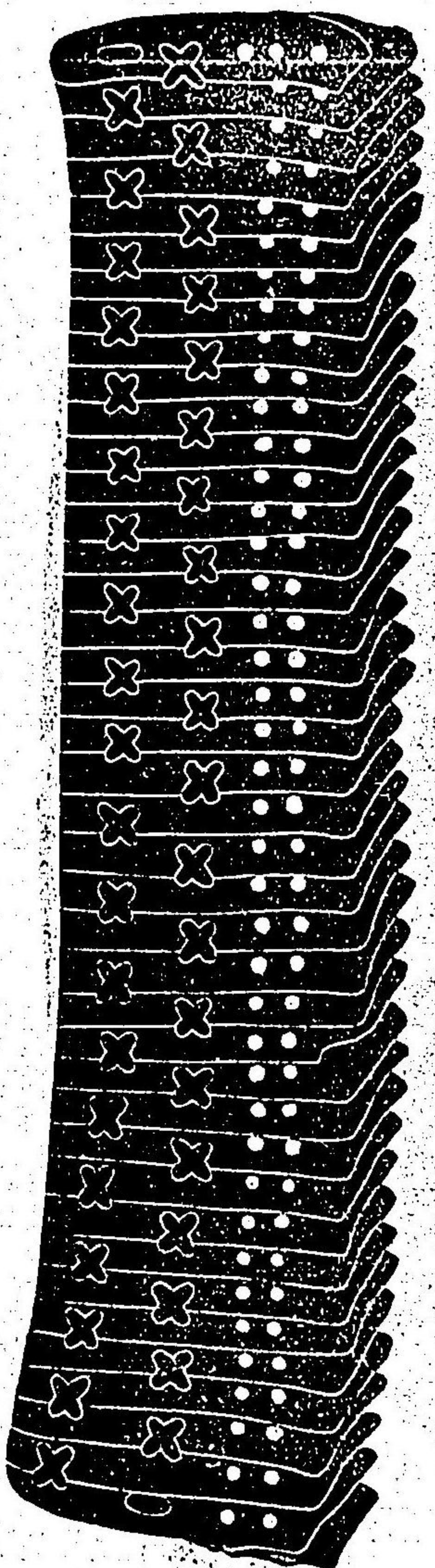
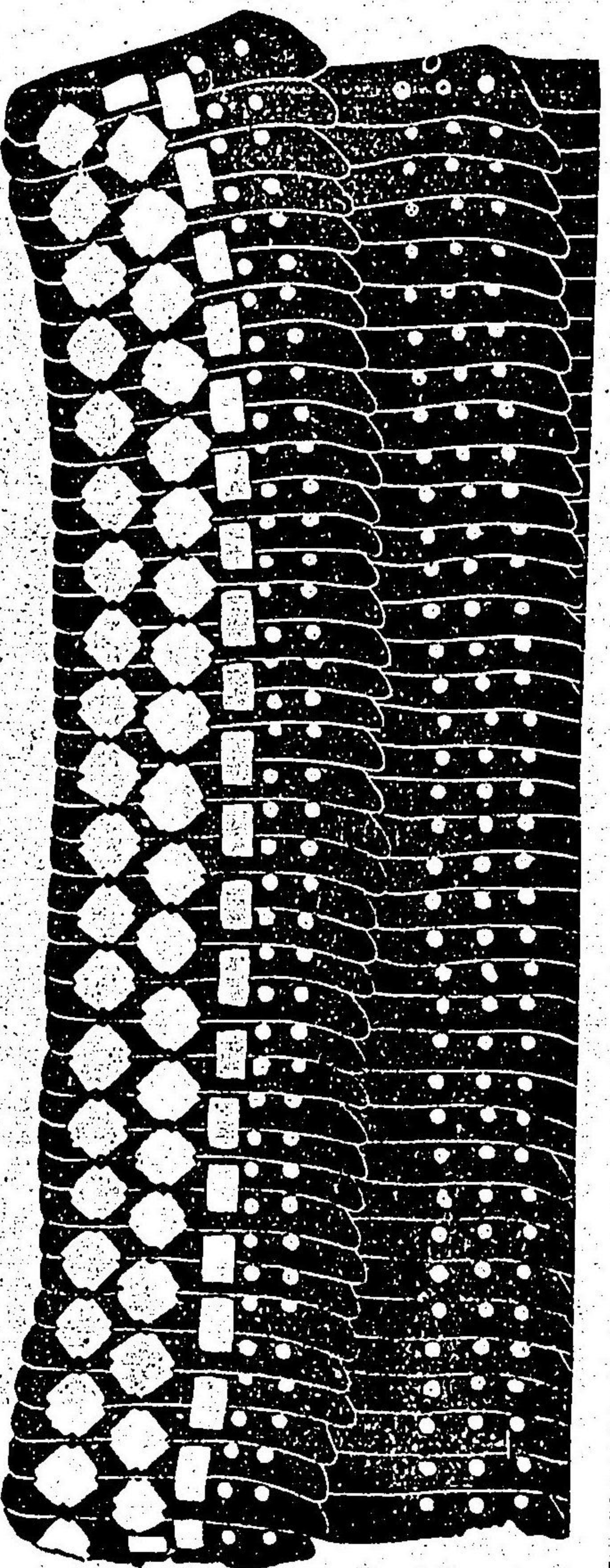

車ノ國

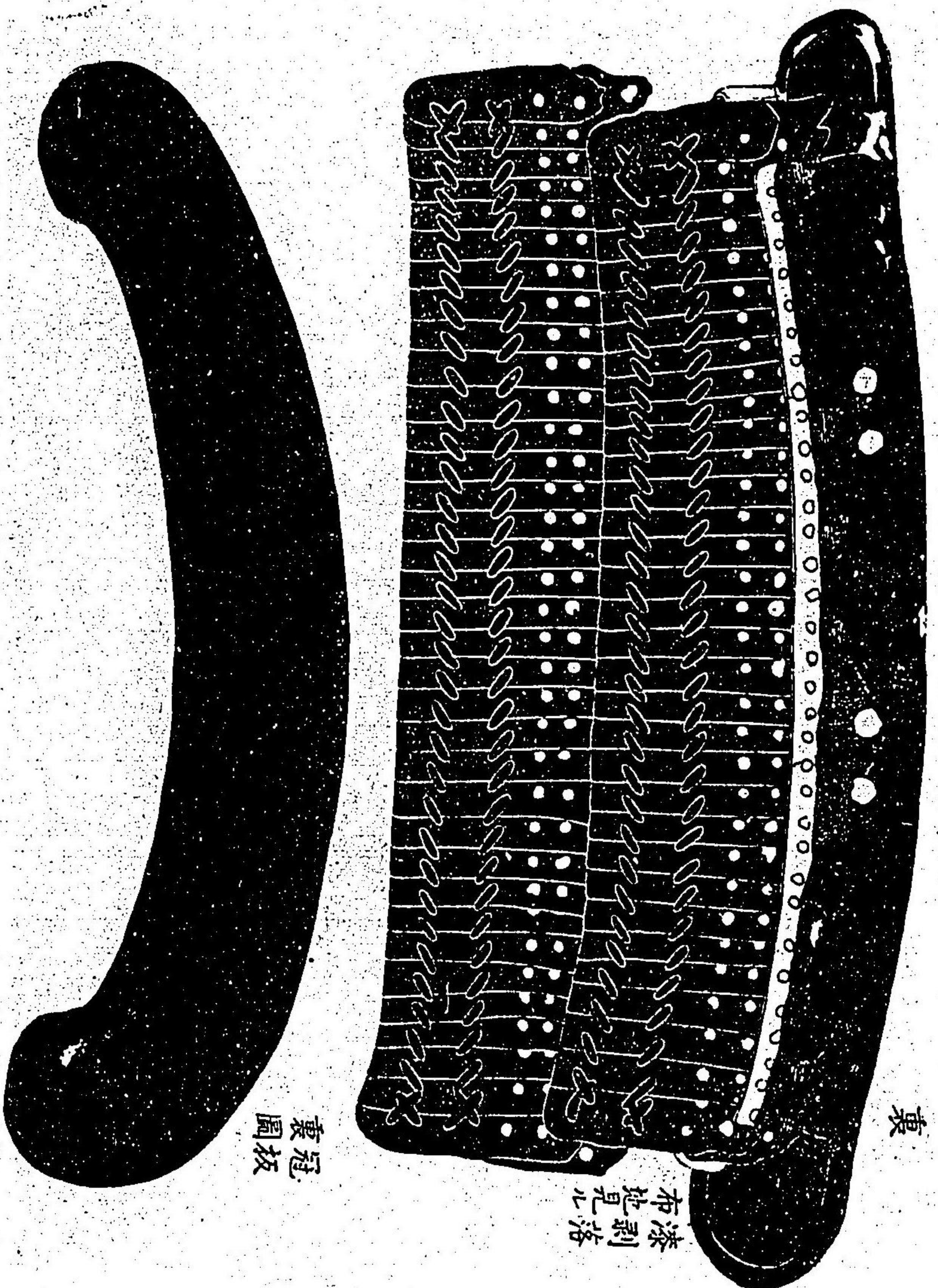

裏

漆剝落
布地見心

冠板
裏圖

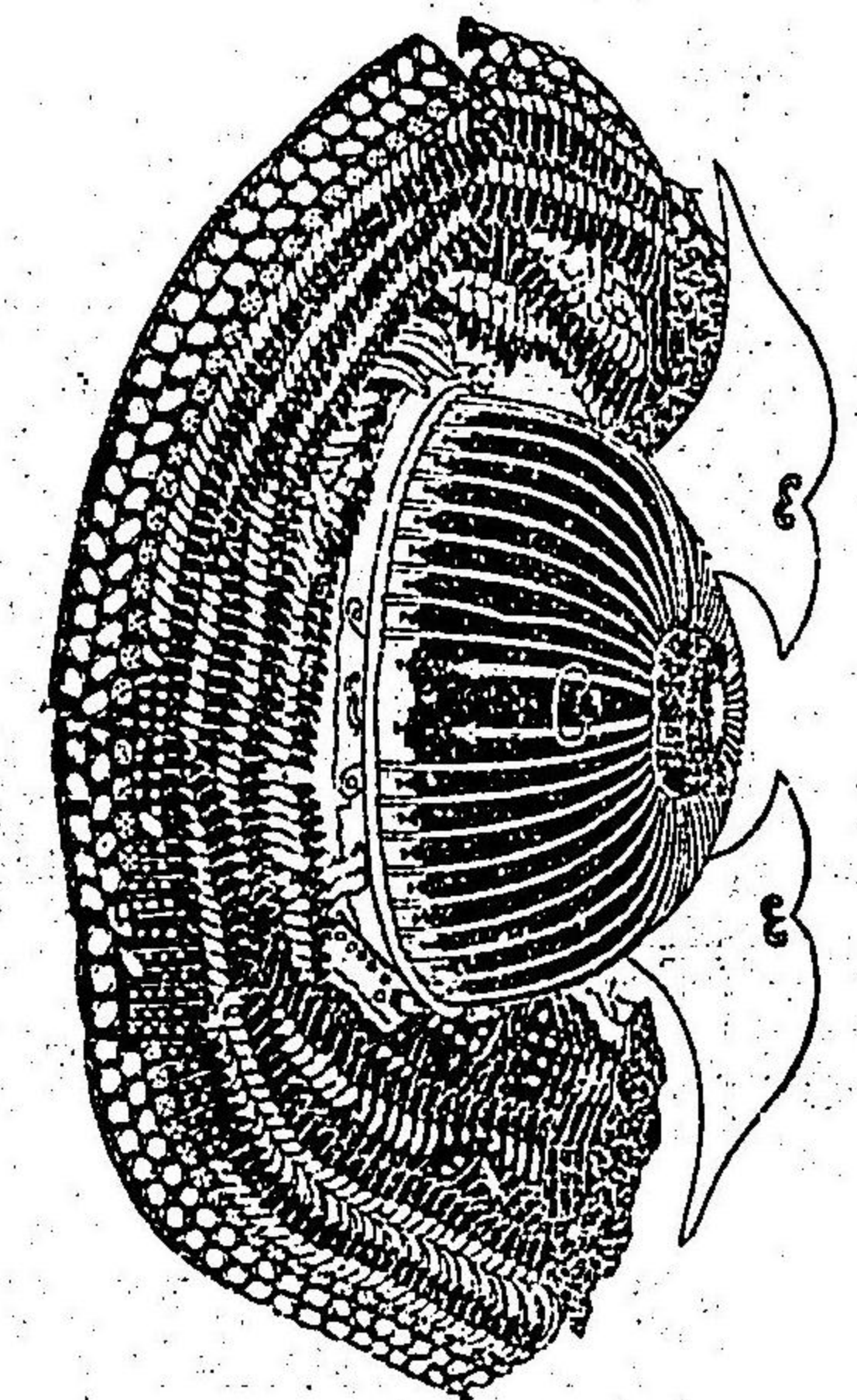

後

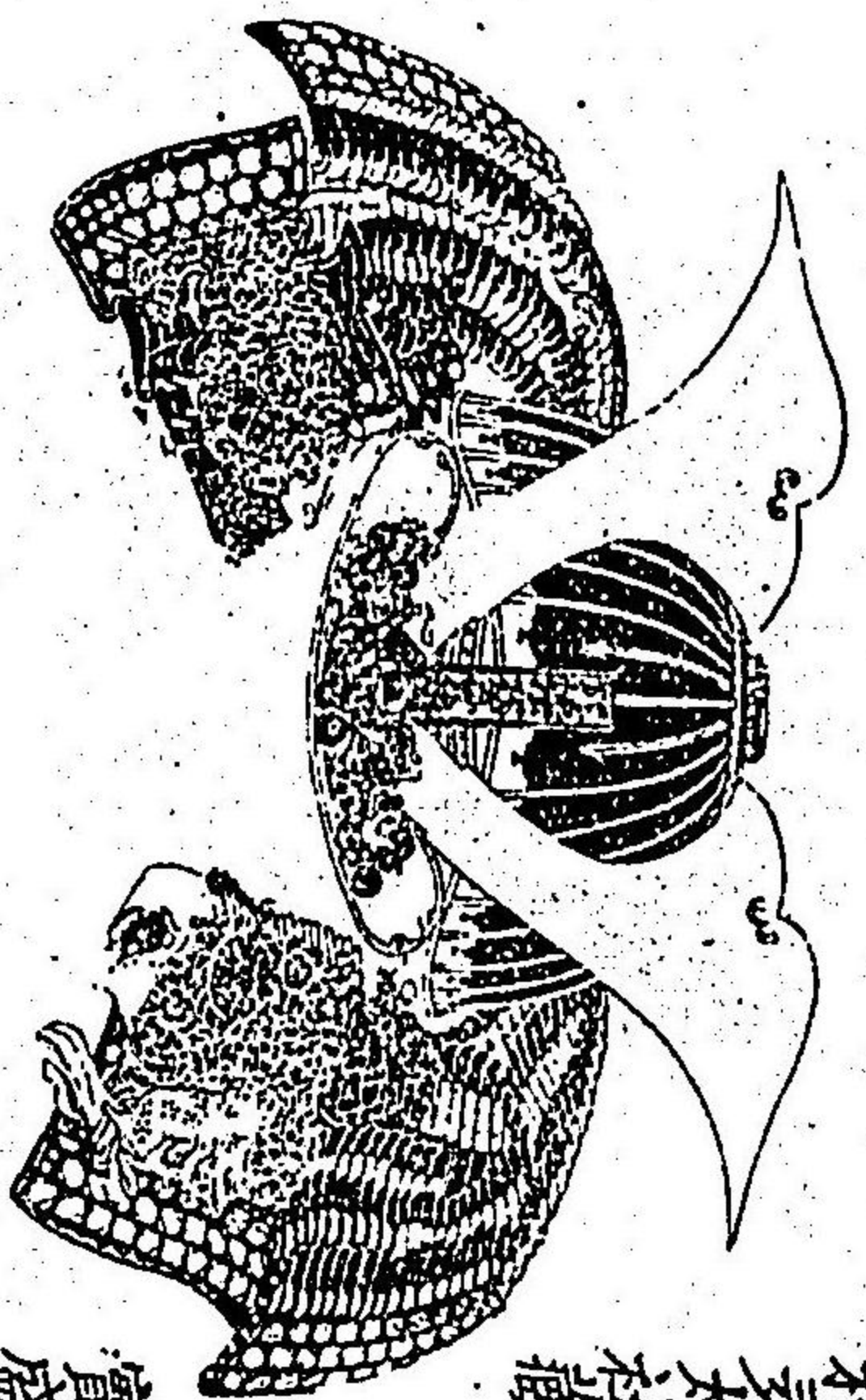

前

威毛不詳

實盛甲冑圖
損失不全

加賀國江沼郡須輪間村多太社藏



一尺三寸四分

拵金物
拵

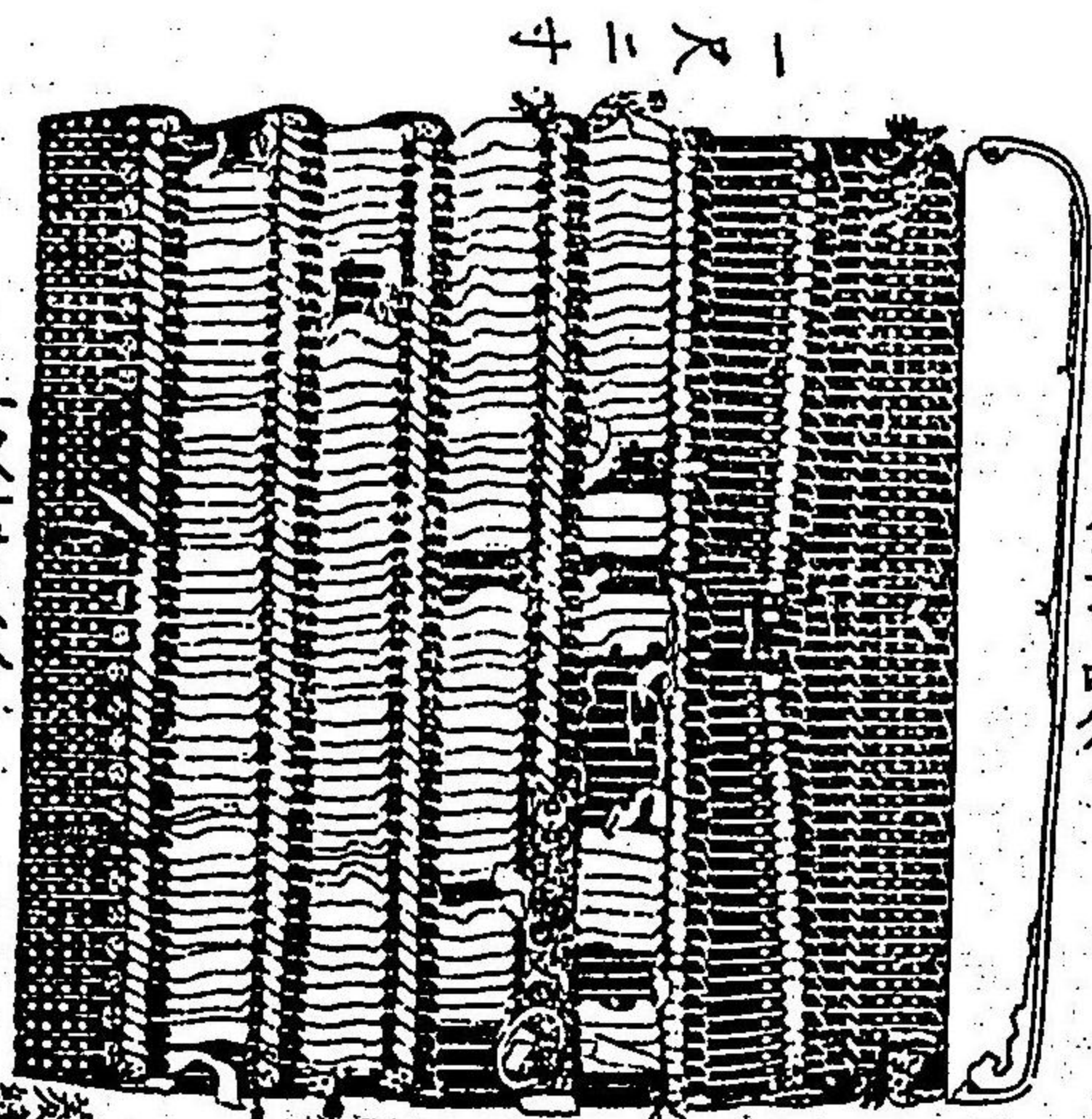

一尺一寸八分

一尺二寸

拵金物

拵

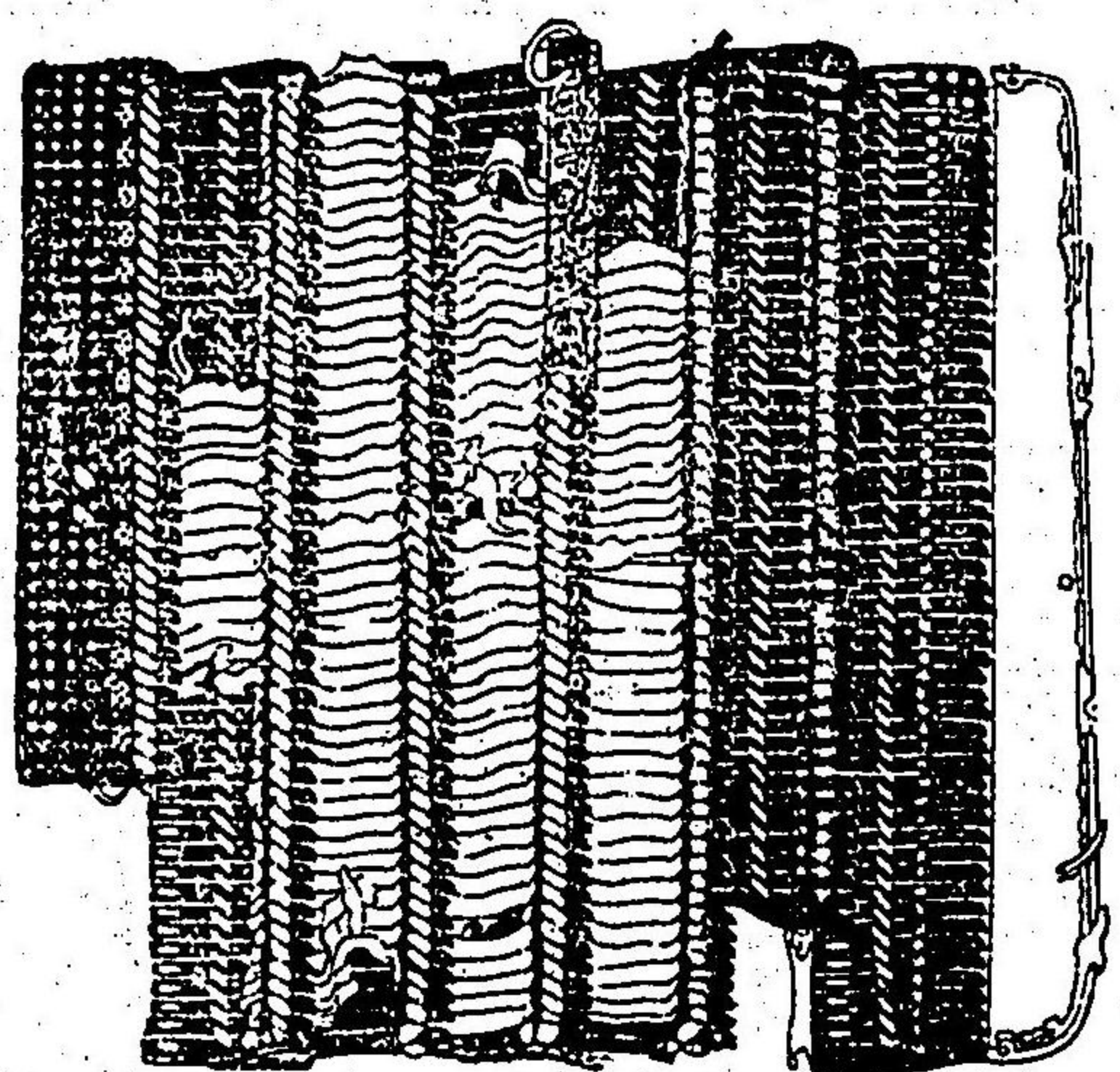
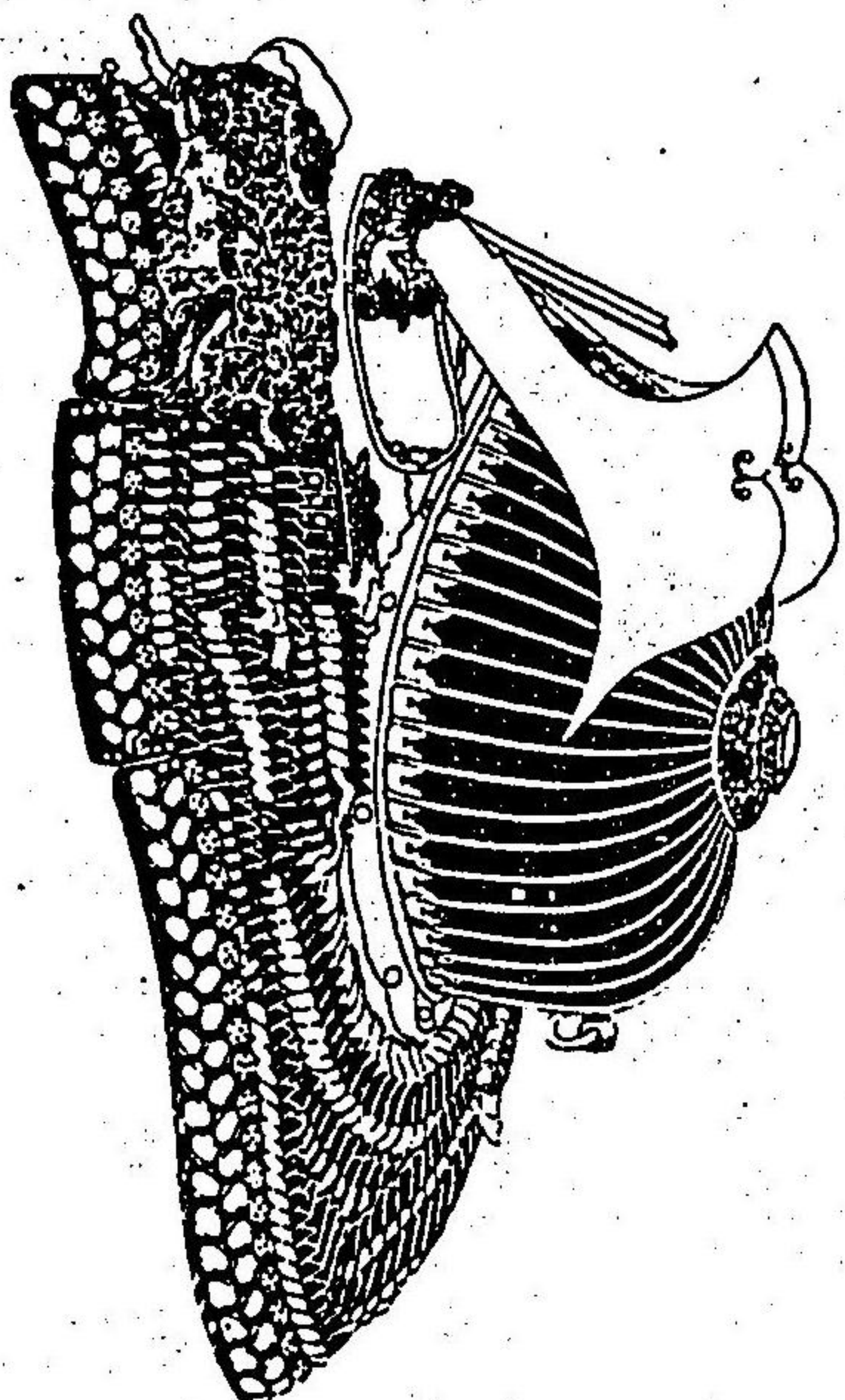

拵

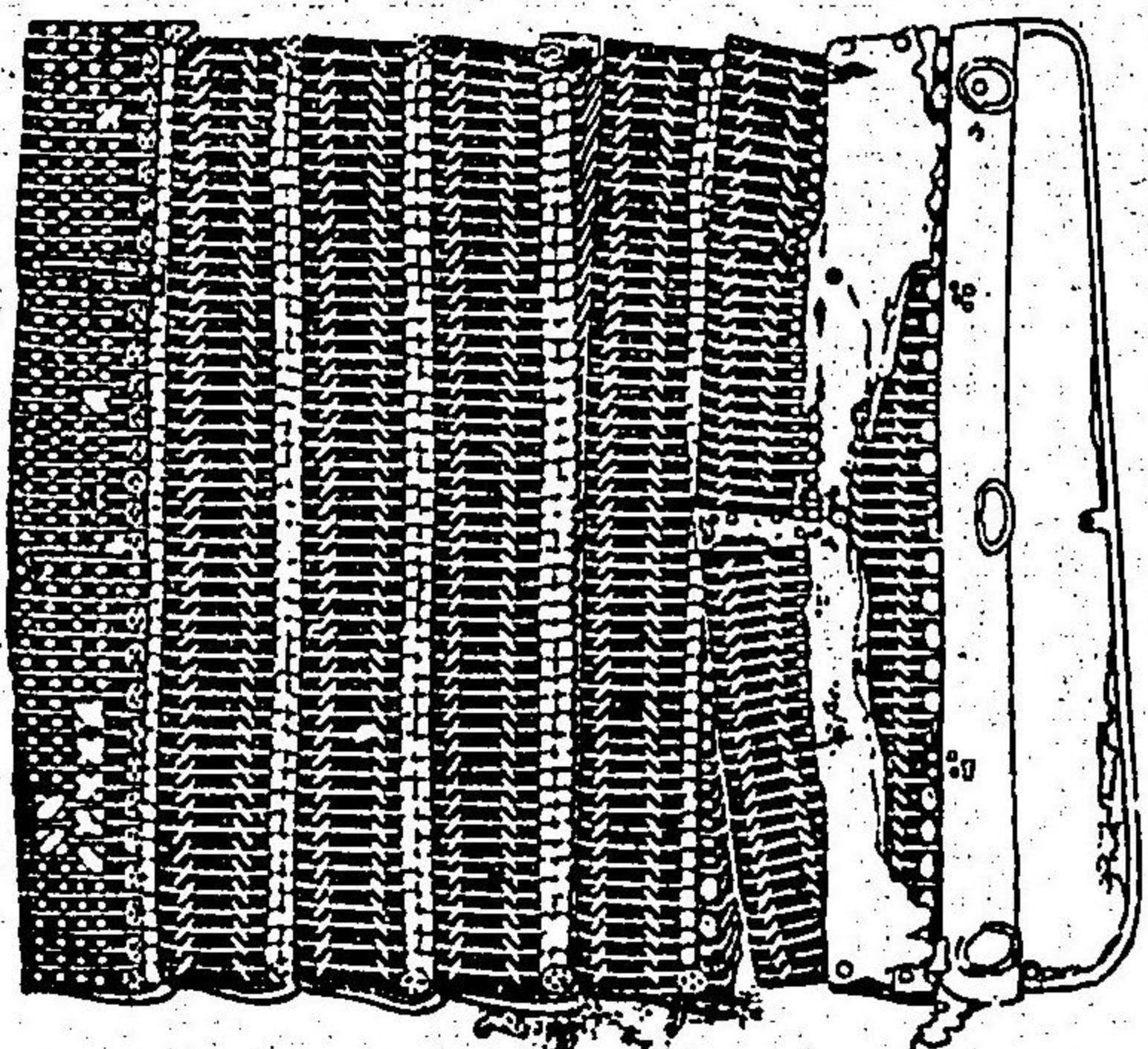

拵

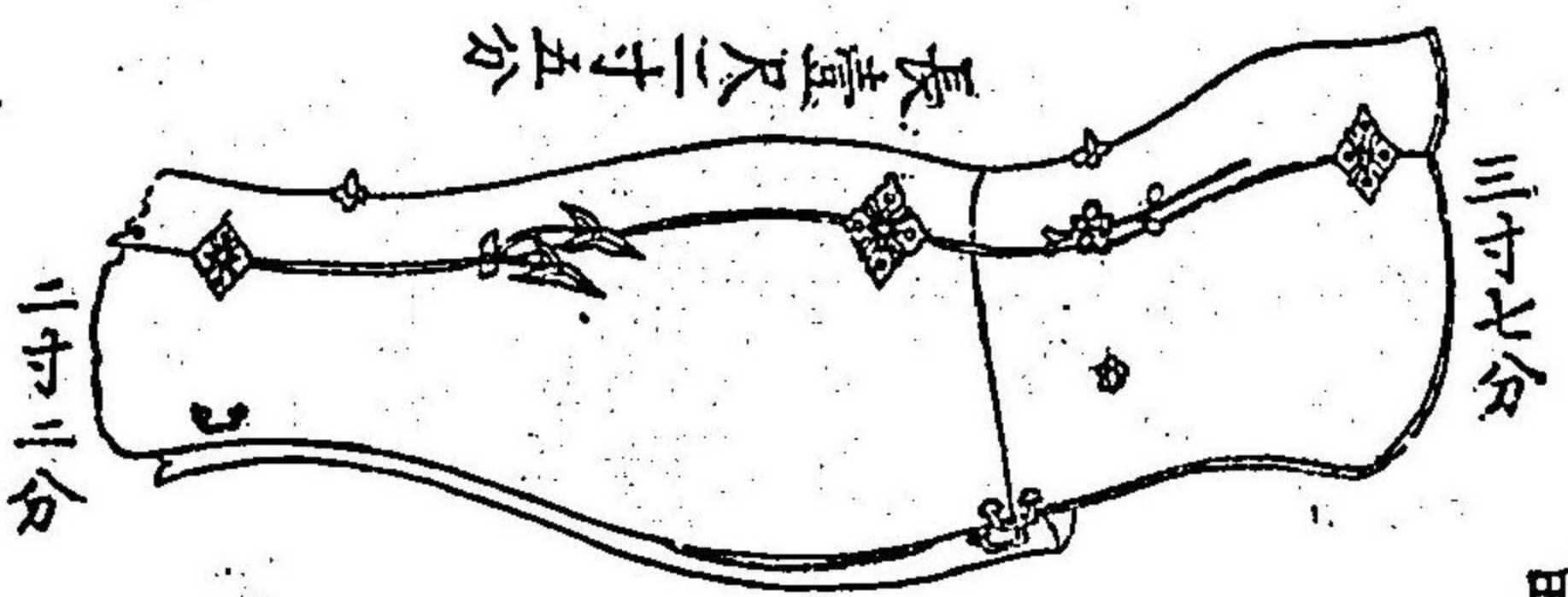
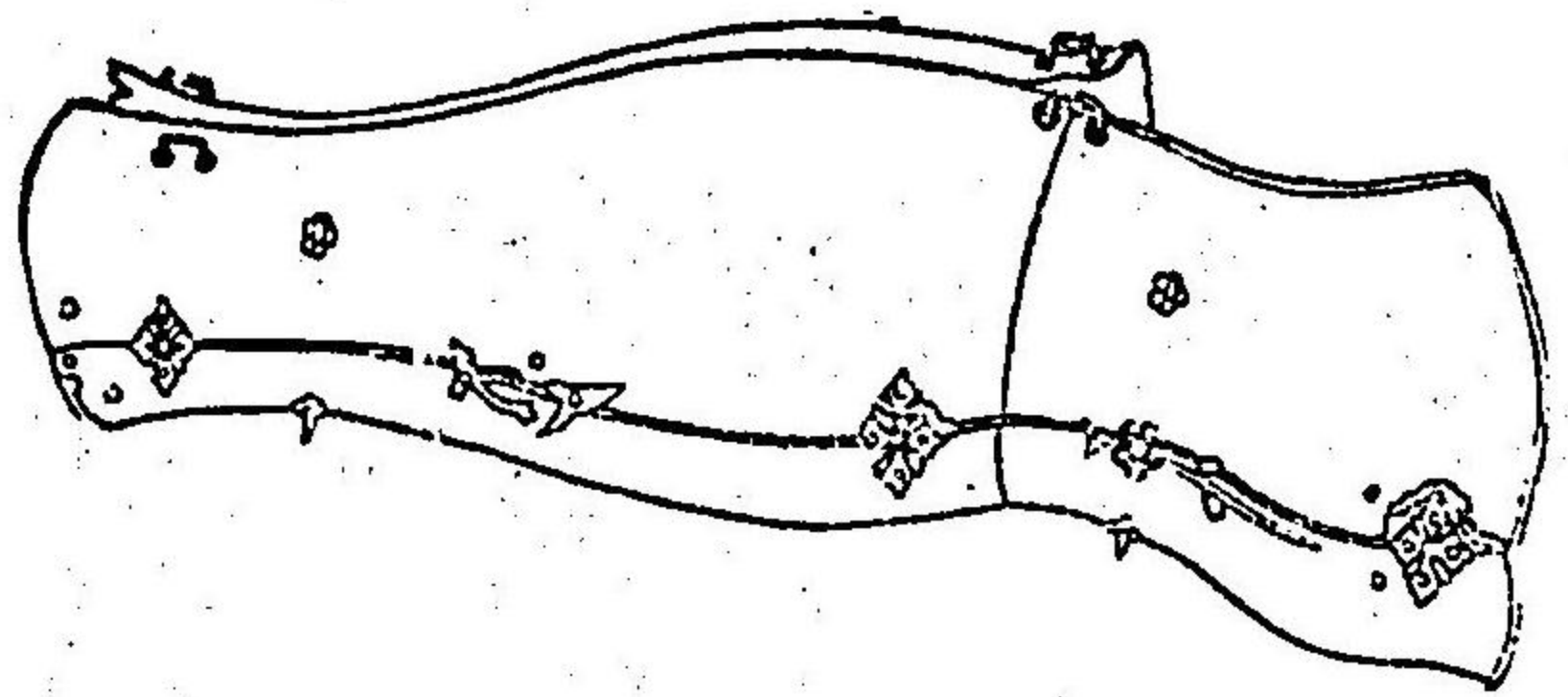

脇當

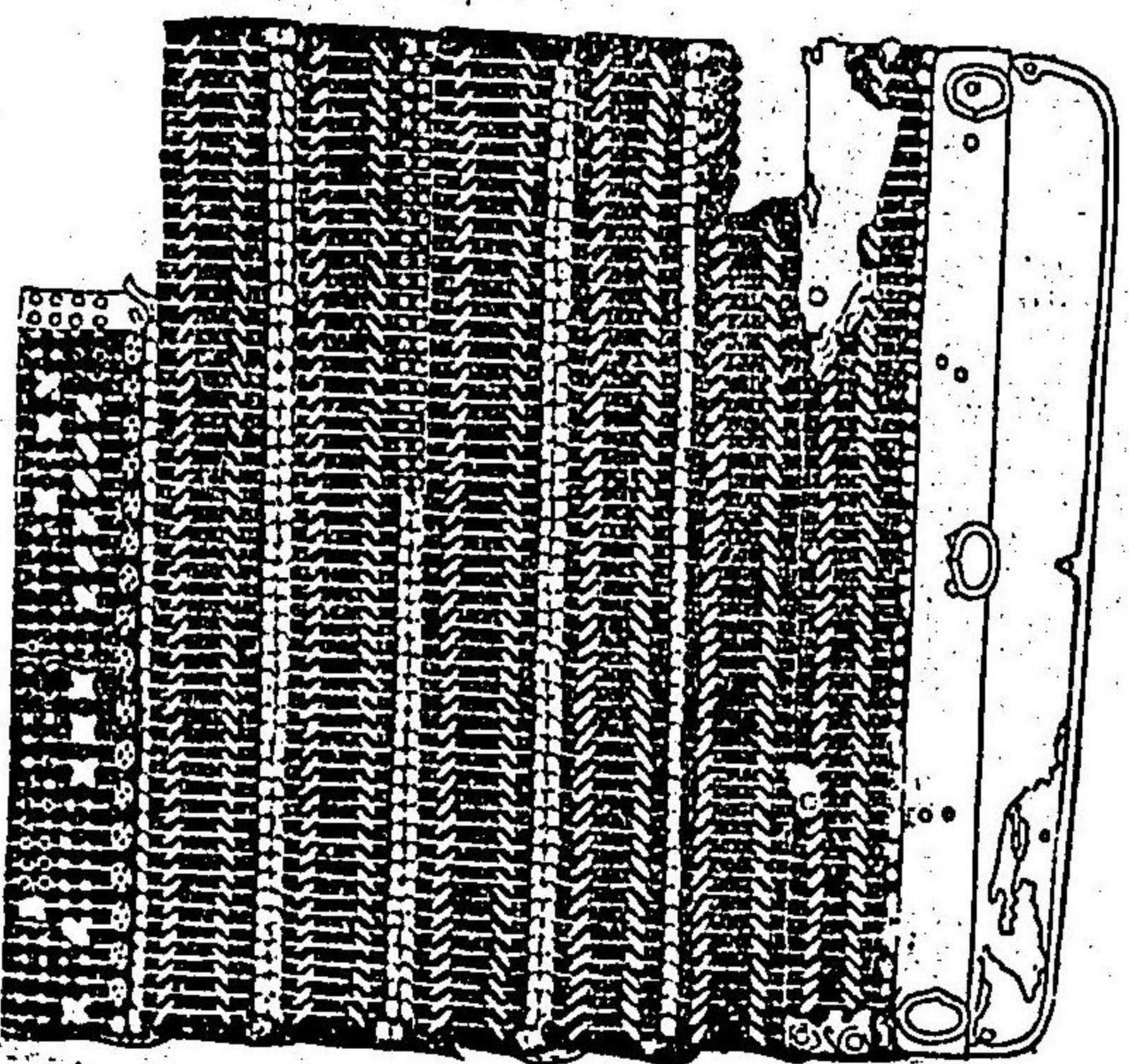

裏

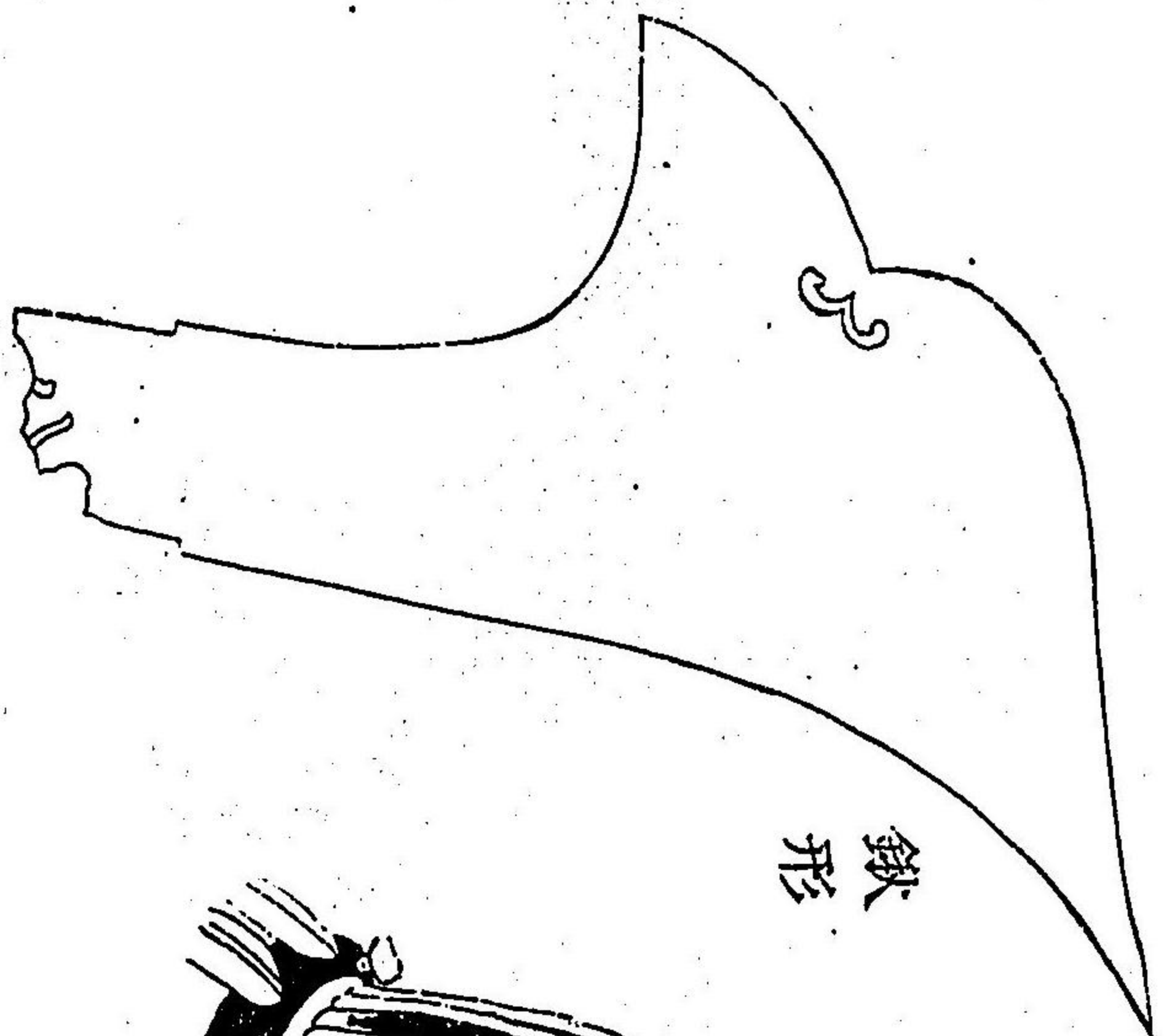

鍬形

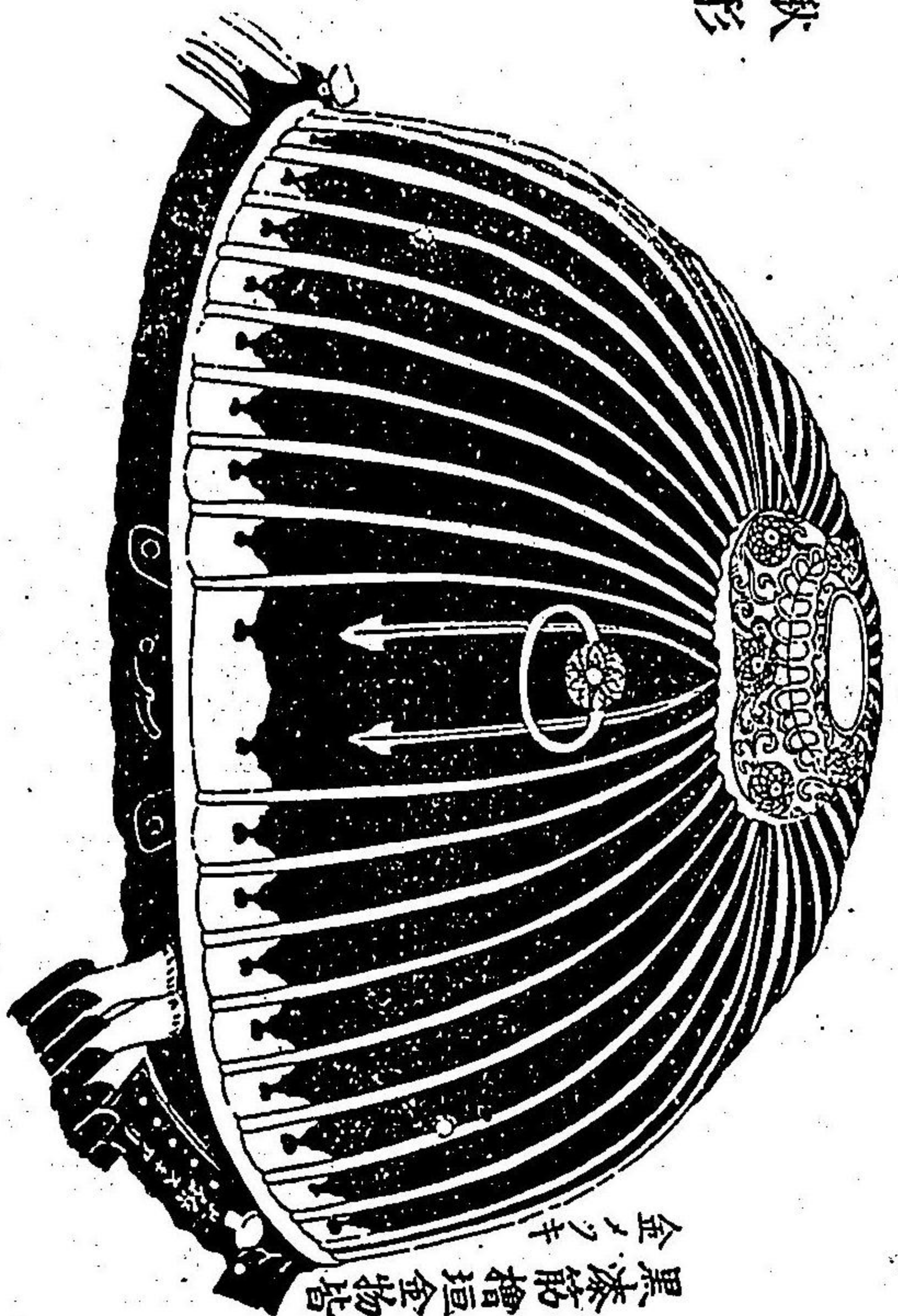

鉢

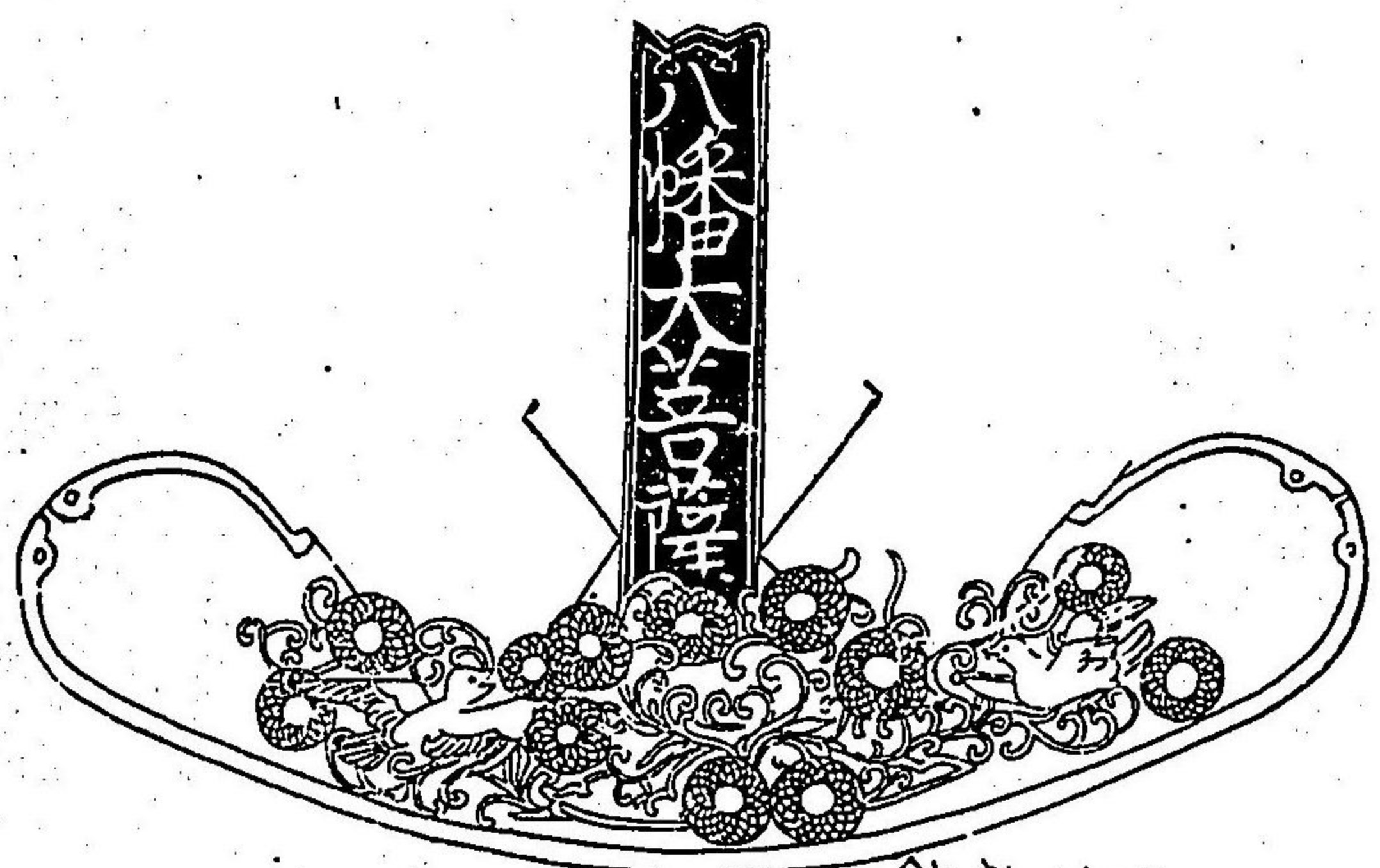

金物金メシキ
包章破損



左吹返

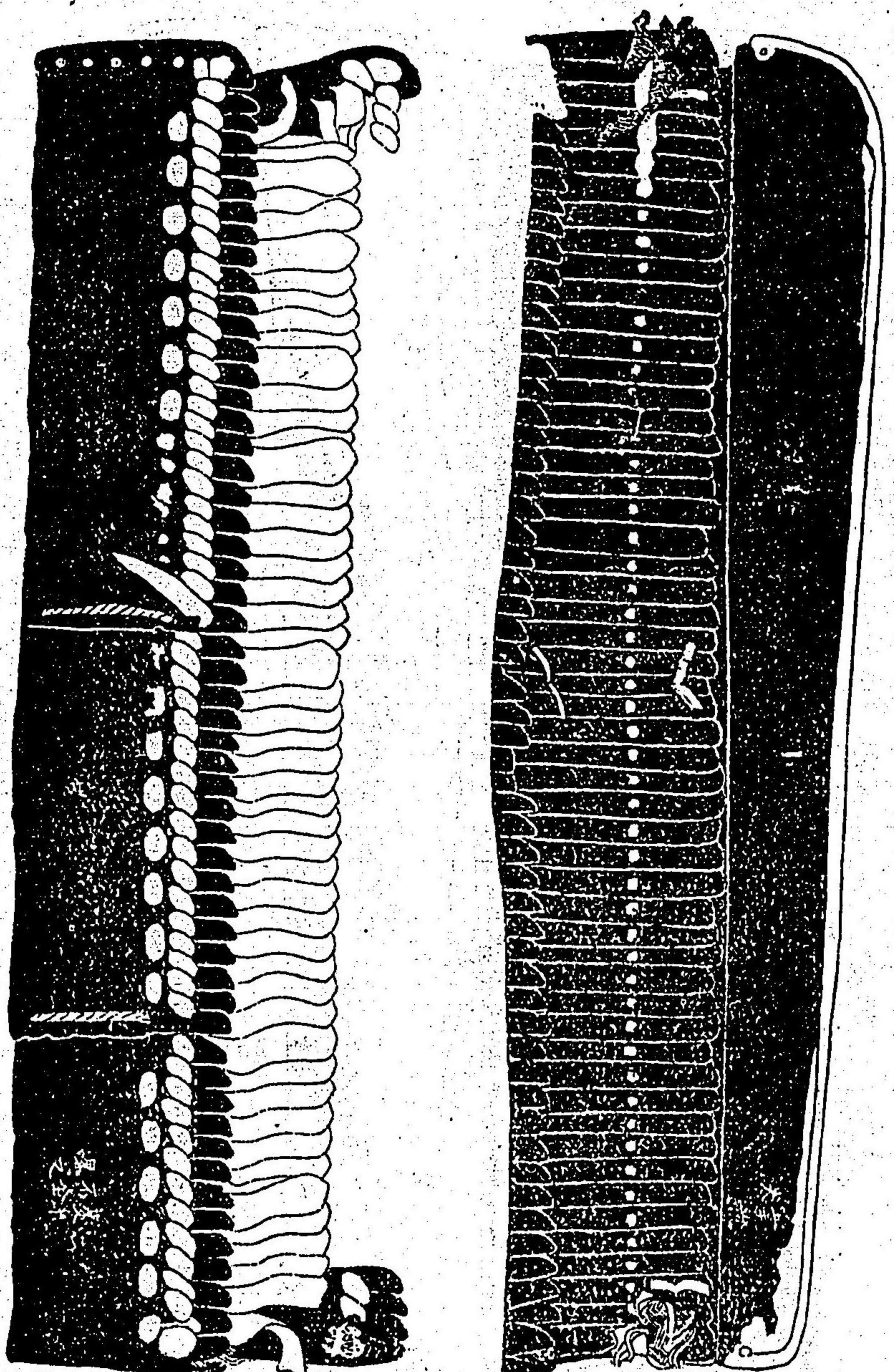

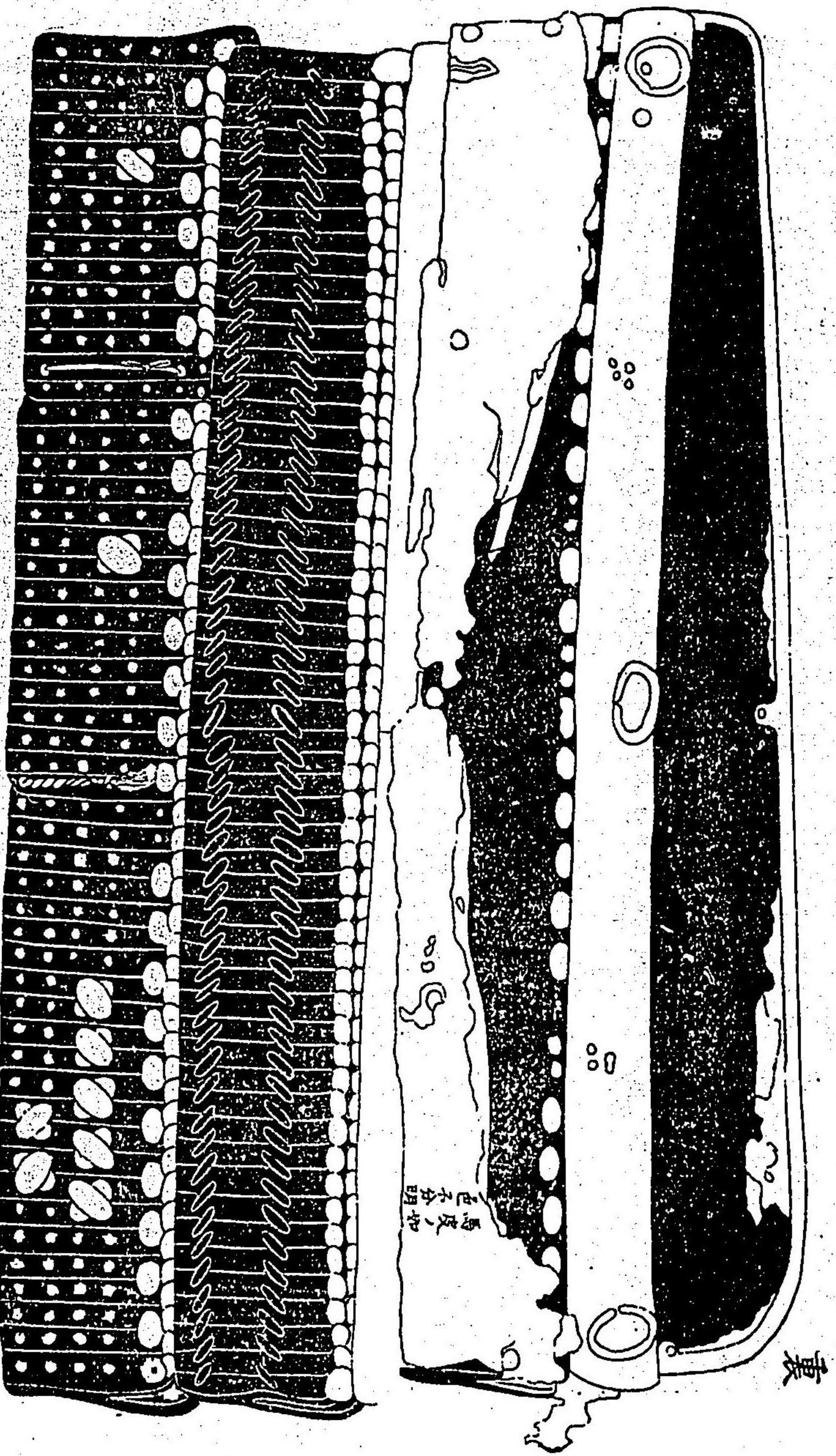

馬皮物
色分附

カ
カ
カ

加切之糸
図七残

裏

立伏組 高針九摺

包草藍地白花四眼

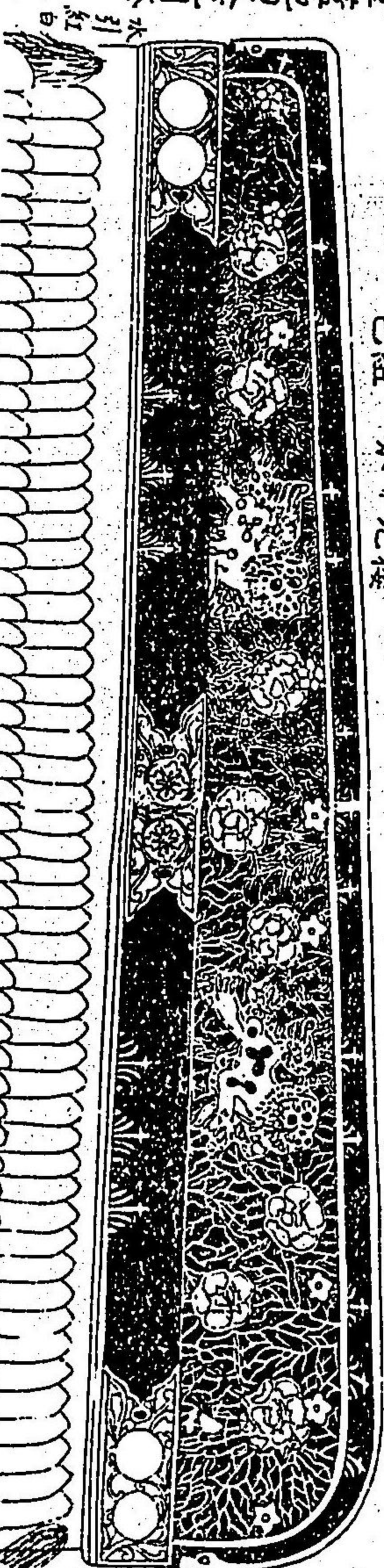

惣金物
金ノキ
金小孔
雌威
四目桜花
系ノ威

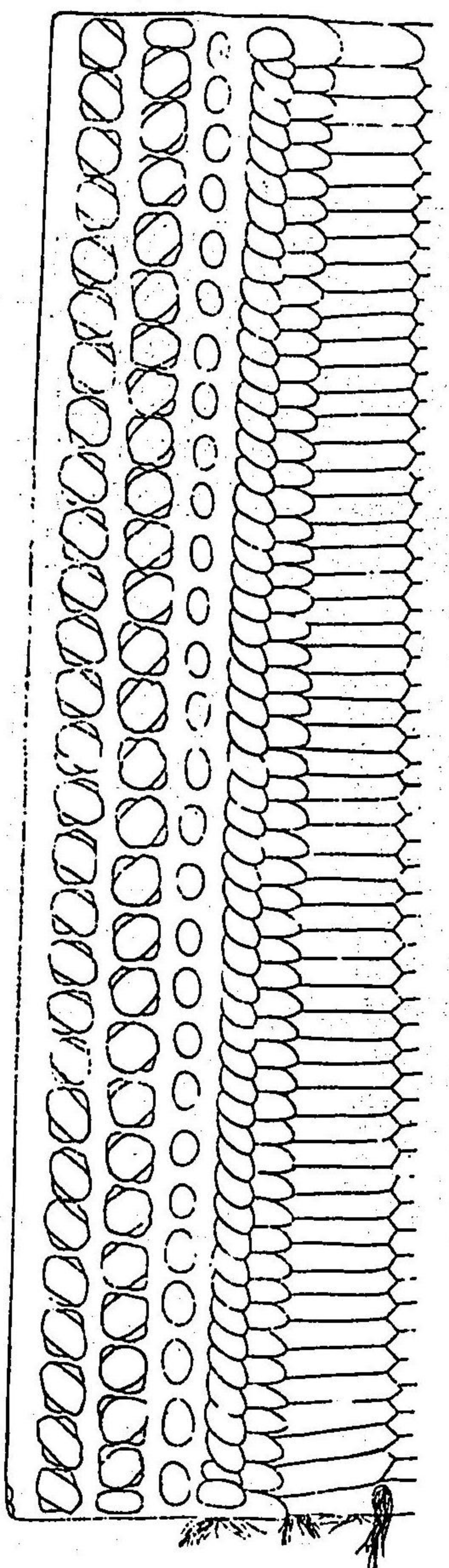
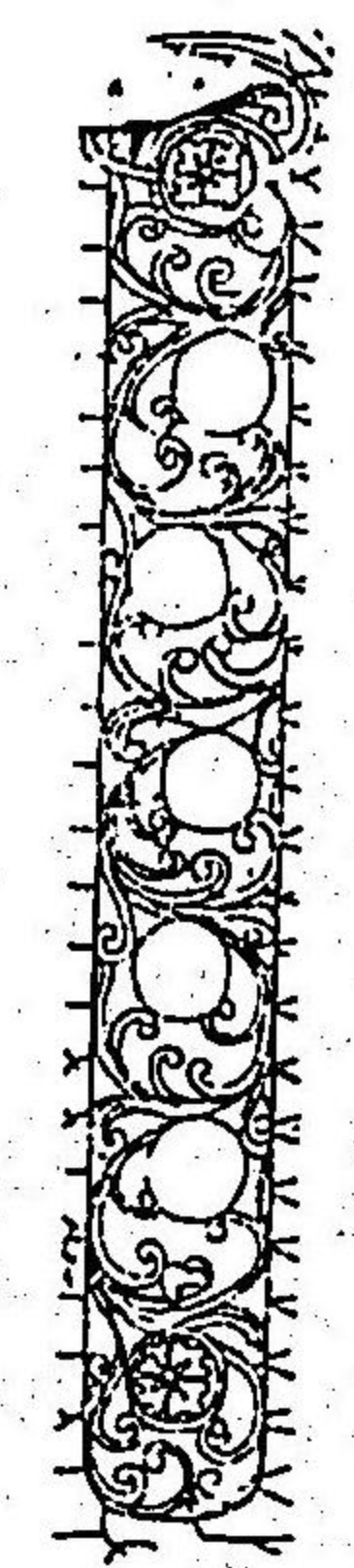

伊豫國三嶋社藏河野通信袖圖

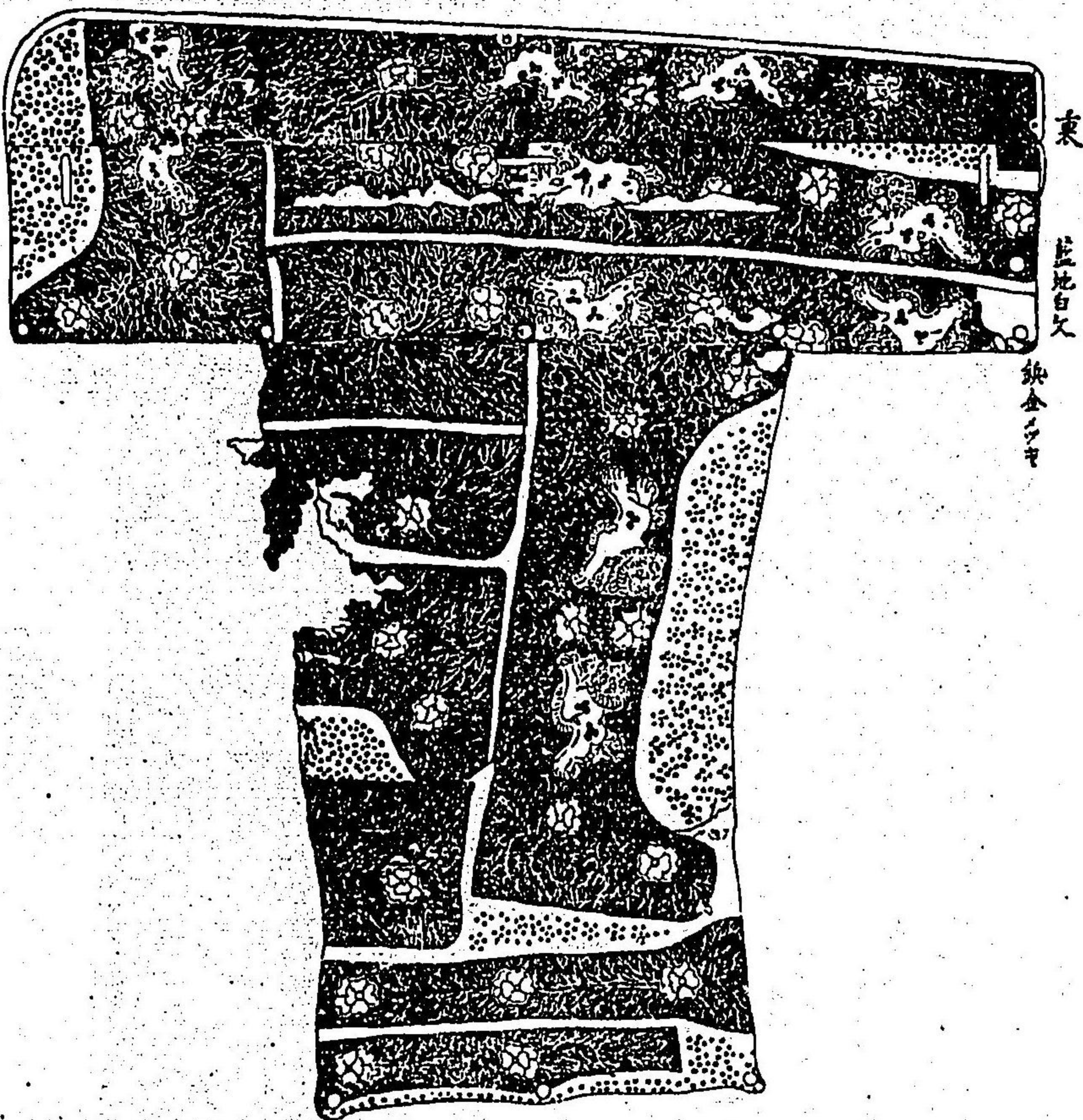

全圖

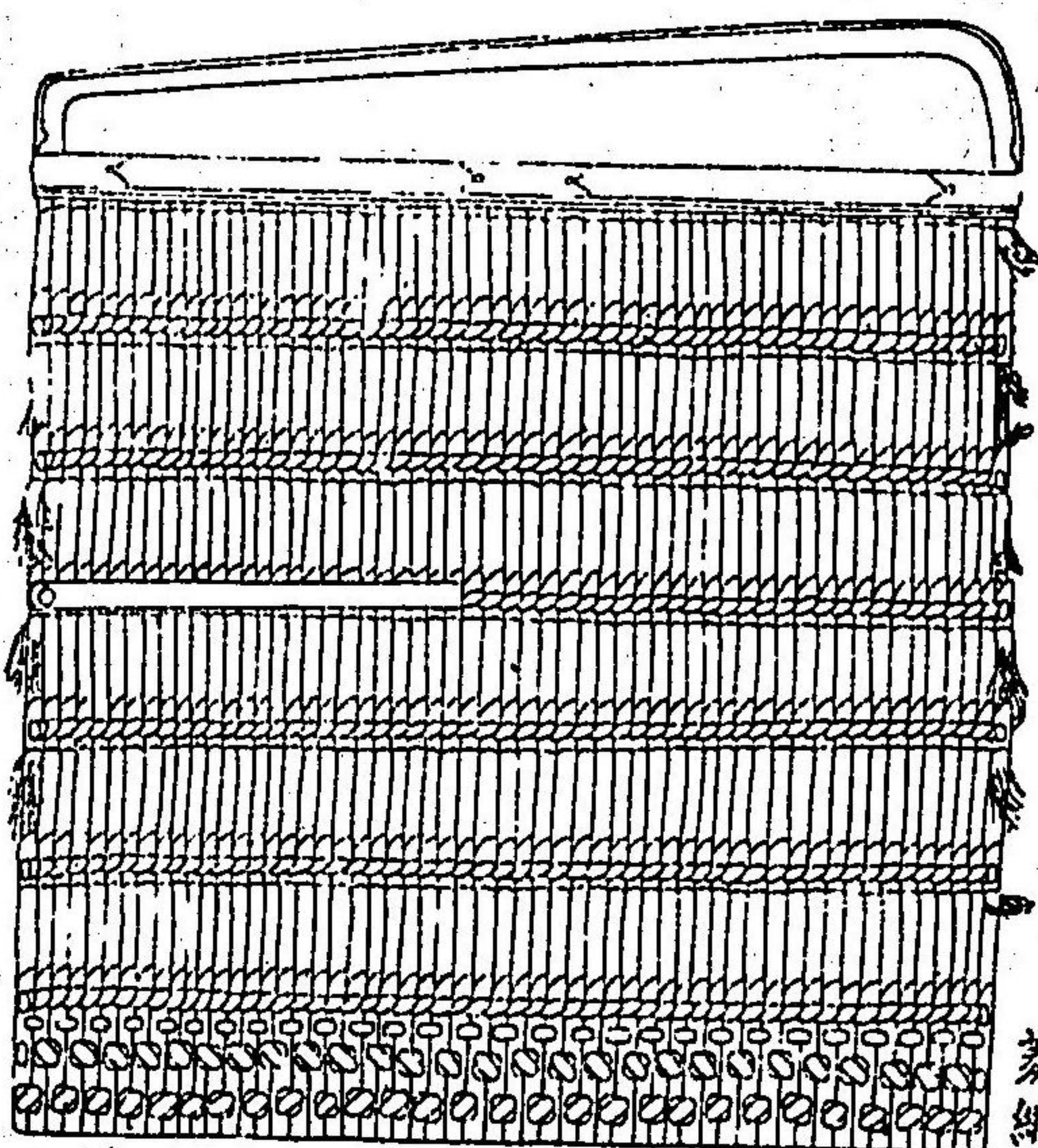

菱緋

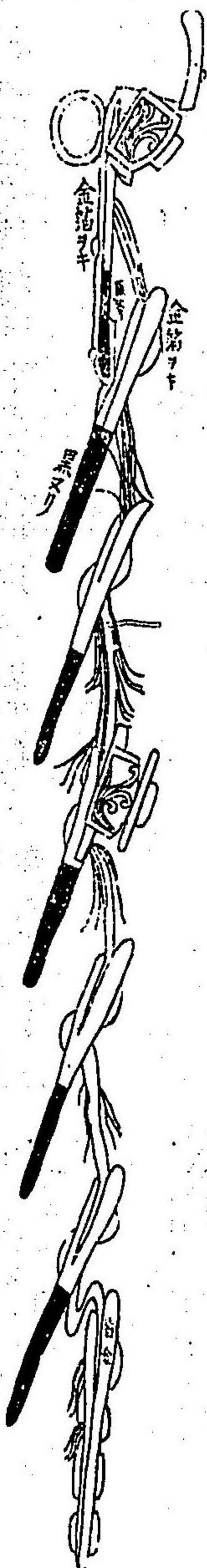

信濃國高井郡保科村清水寺八將權現社藏鐵形圖

古代有八枚今存者一枚清水寺者大同年中建立

鉄ヲ以製ス玉子唐銅

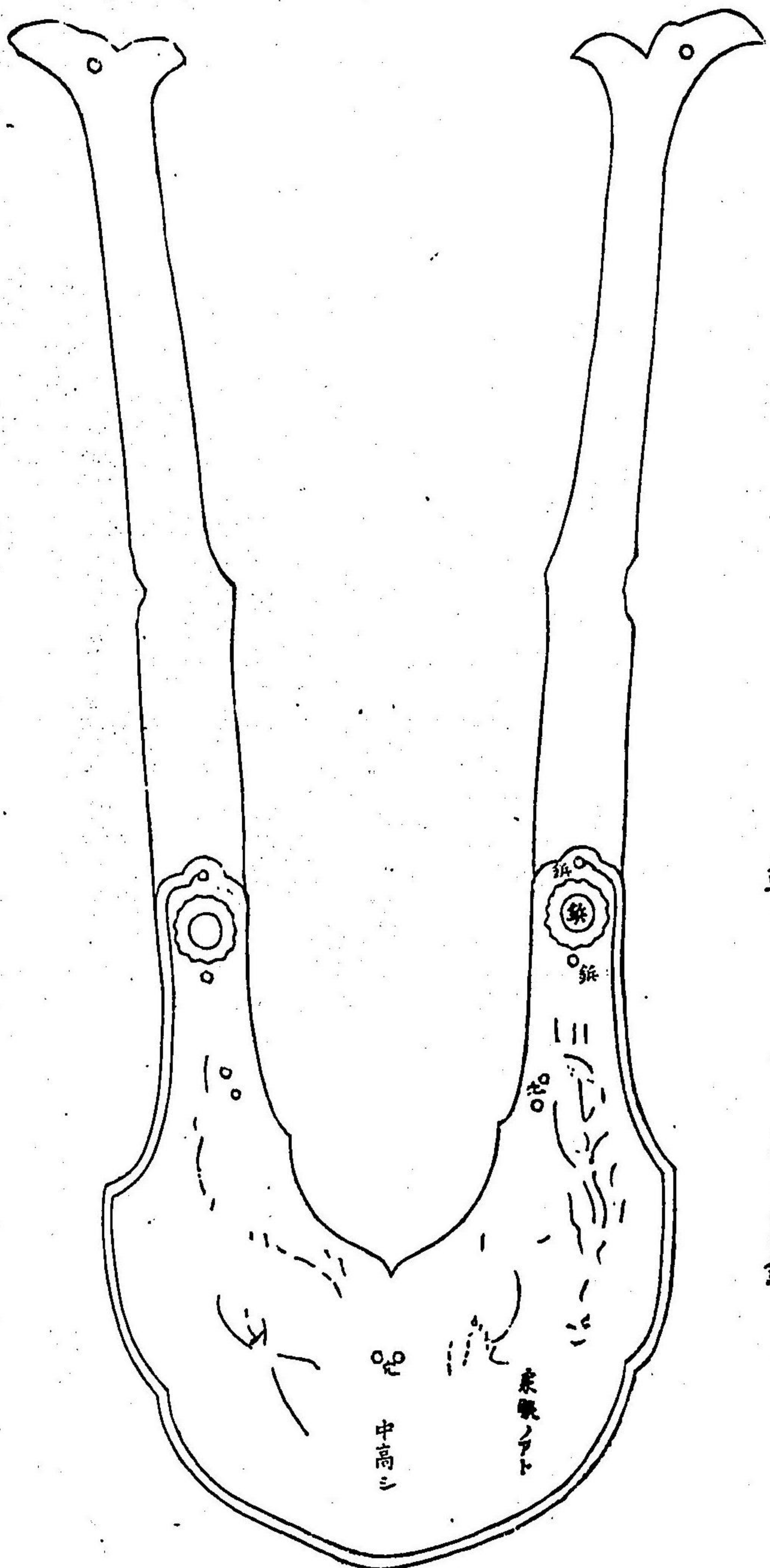

尾張國馬嶋明眼院藏泉清甲冑并盾櫃圖

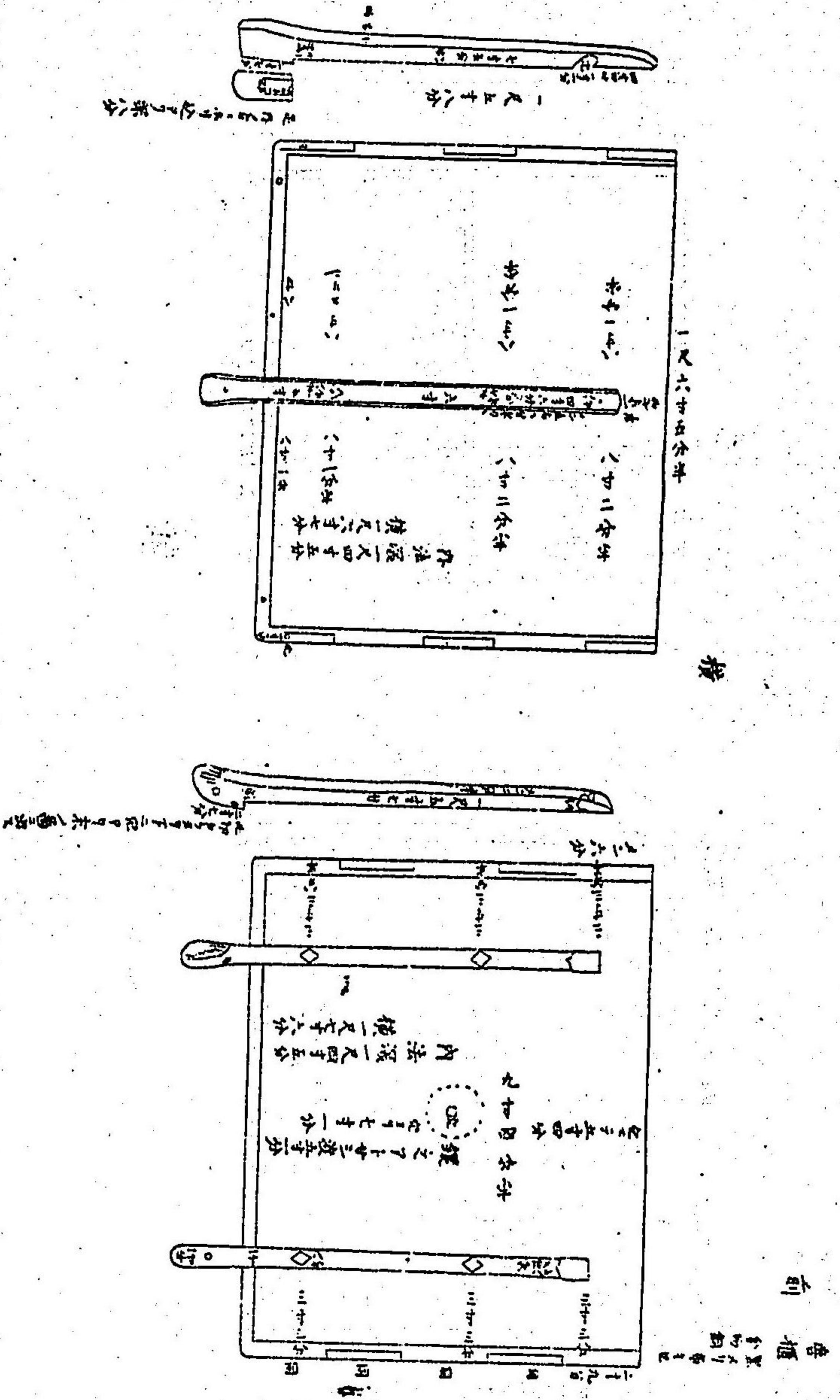

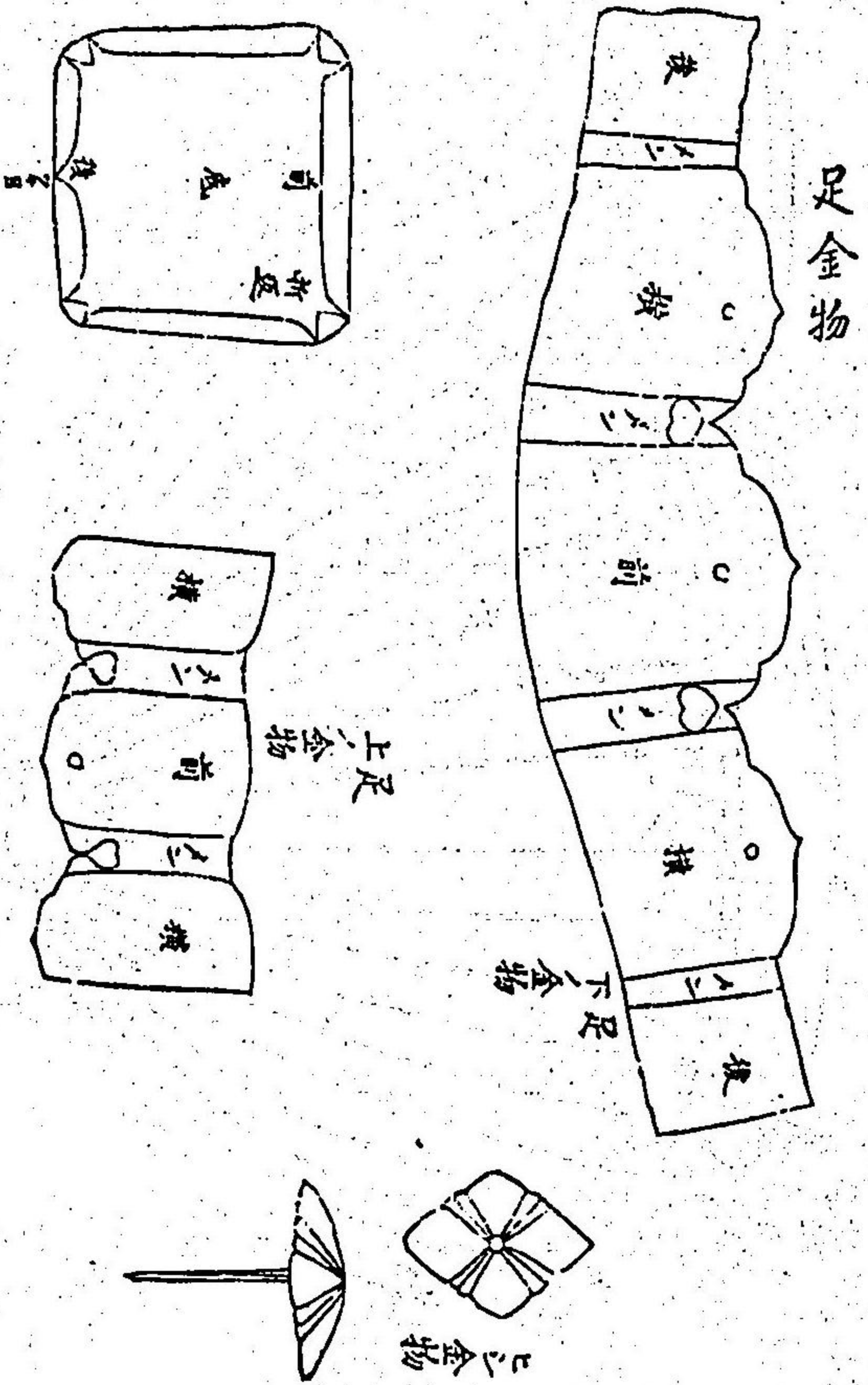
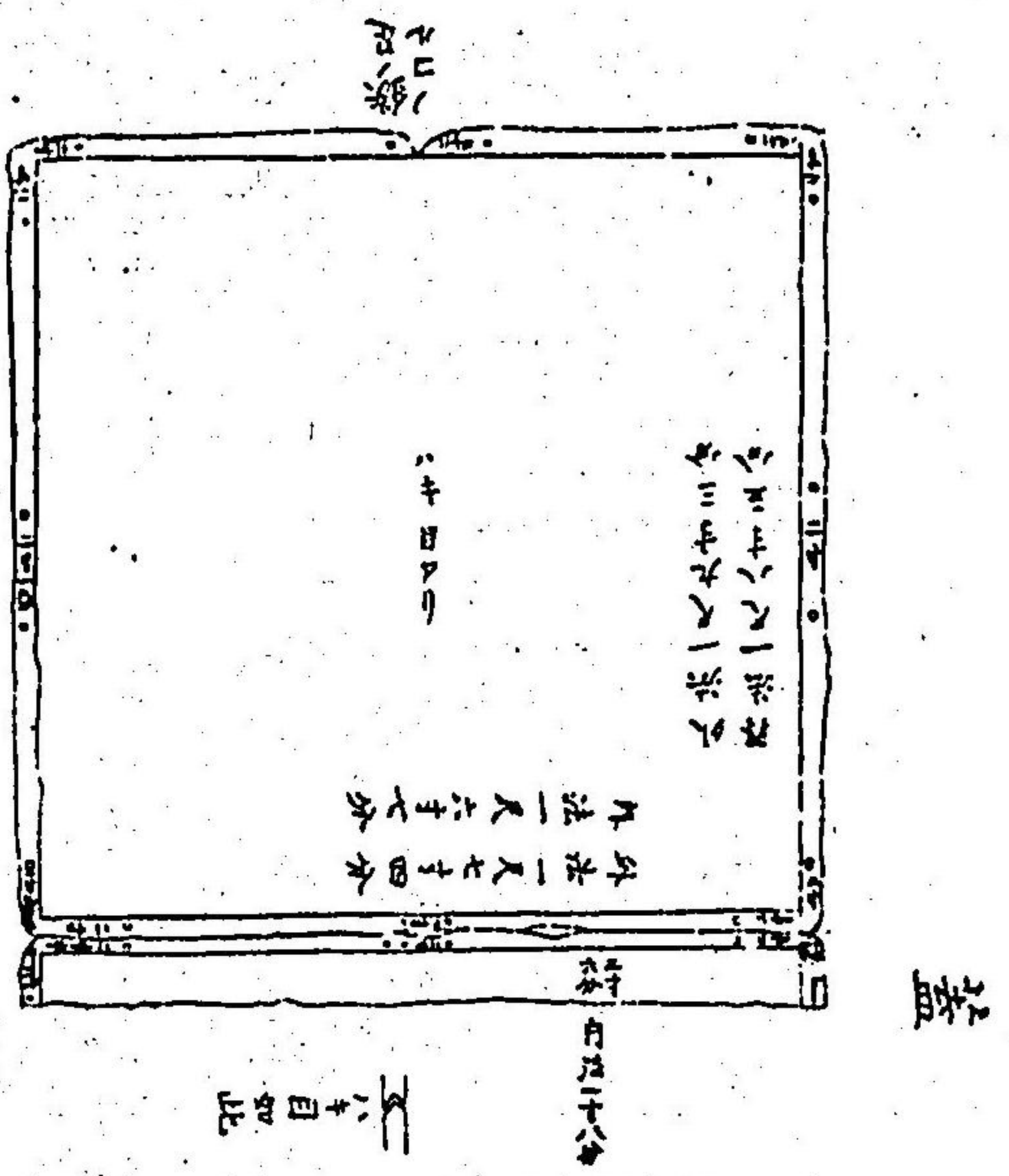
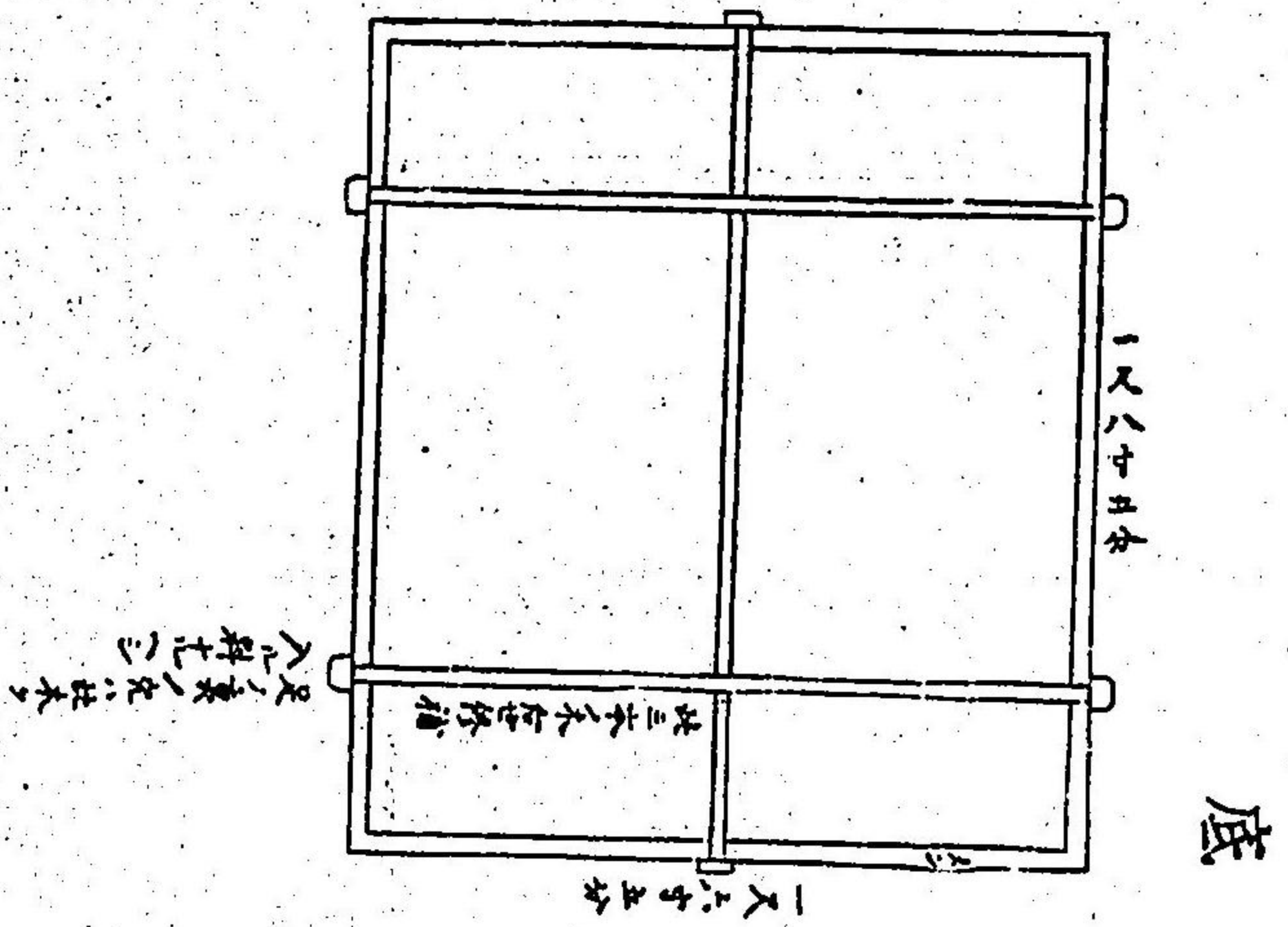

此甲冑實取年間撥修理ヲ加
故後讓下ノ方ニ依テ多ク畏之
甲小札三百五十九札ノ古物也然レ
此皆端ヲ切テ皆所ヲ替テ修理ス
小札古クニニ櫃中ニ之ニ置カス
即末ニ圖

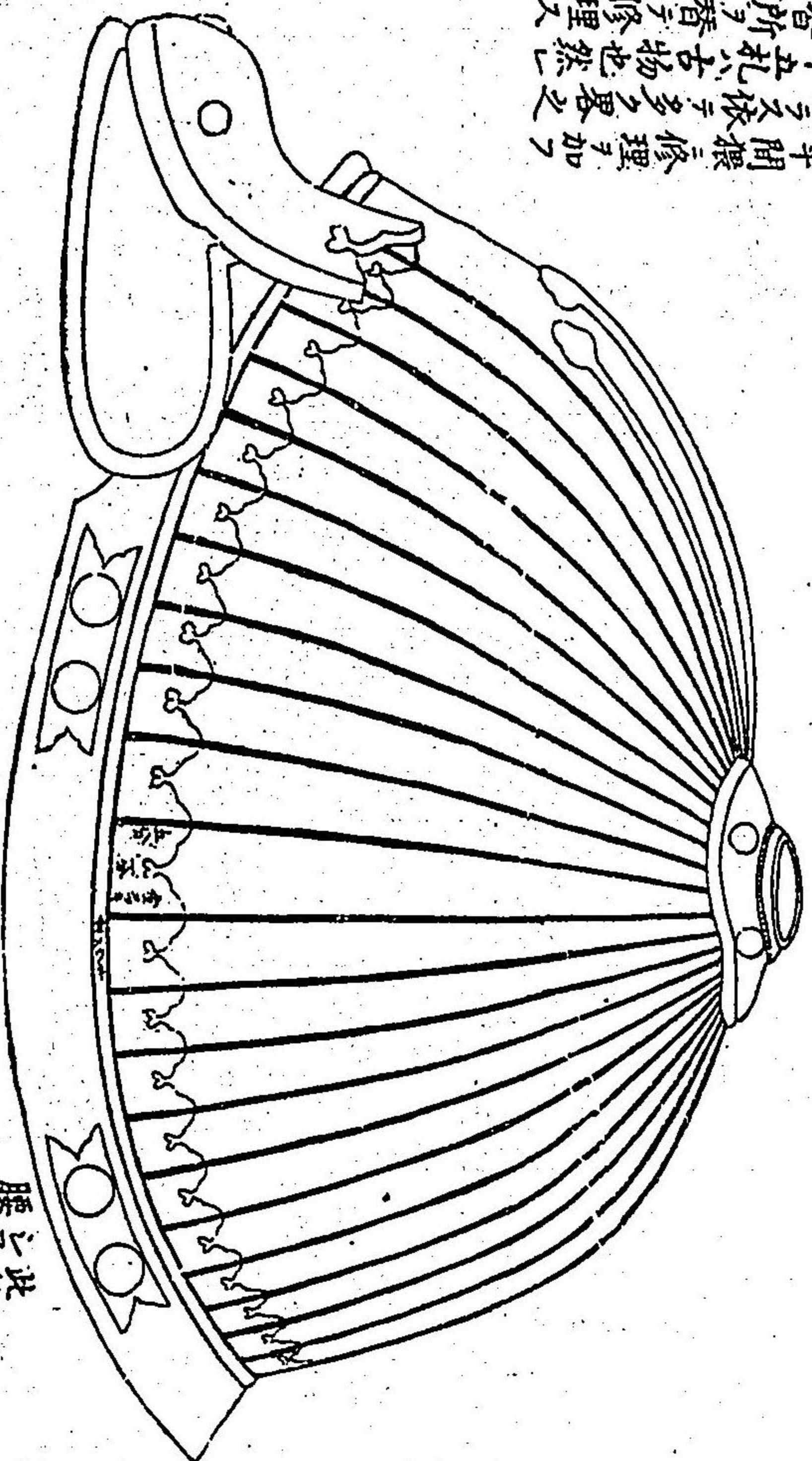

由 金物皆在ノ年
筋ノ間四分充

此銘在左方
之口打右方
腰巻ニ連ル

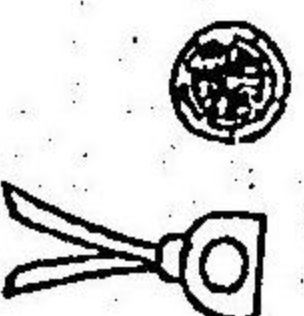
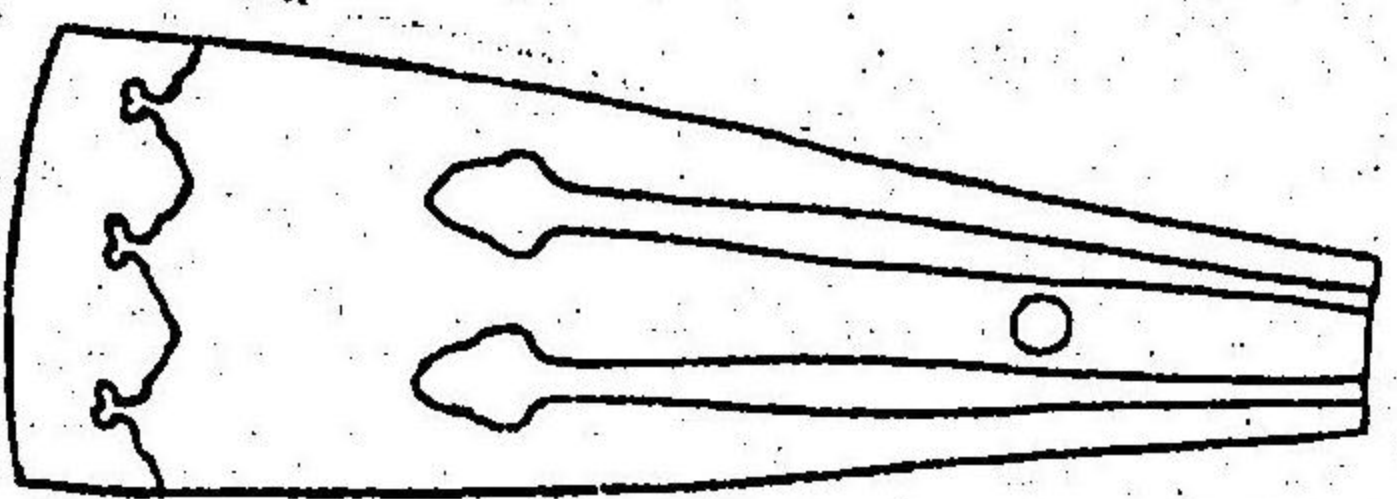

高勝銀

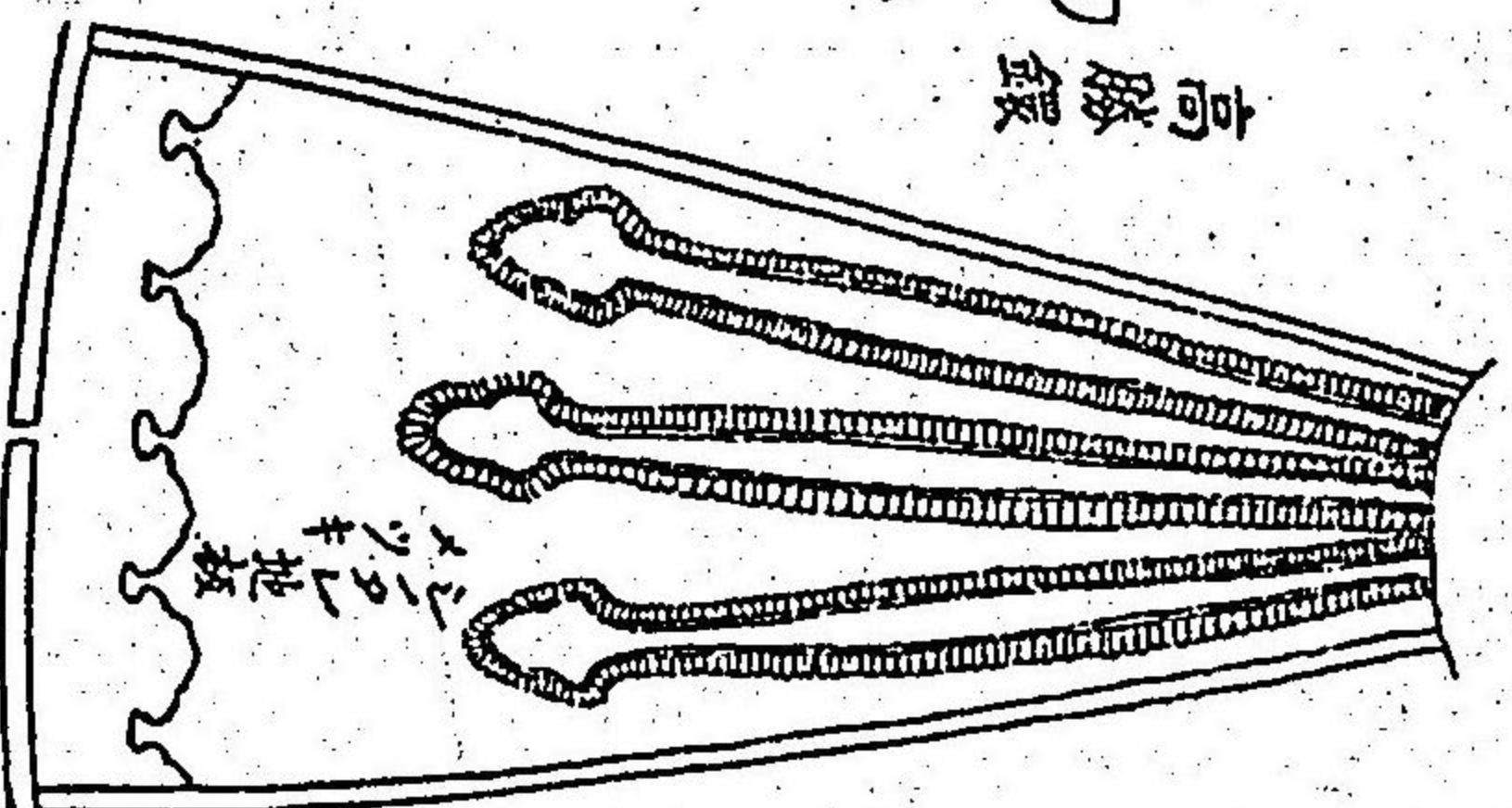

之口打板
ノ口打板

高三分

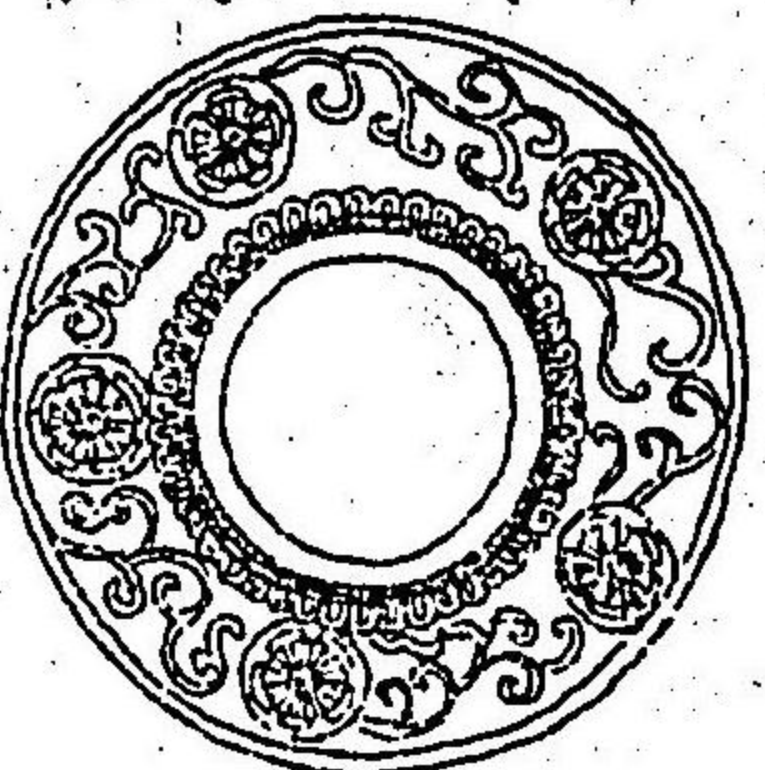

後世仕足

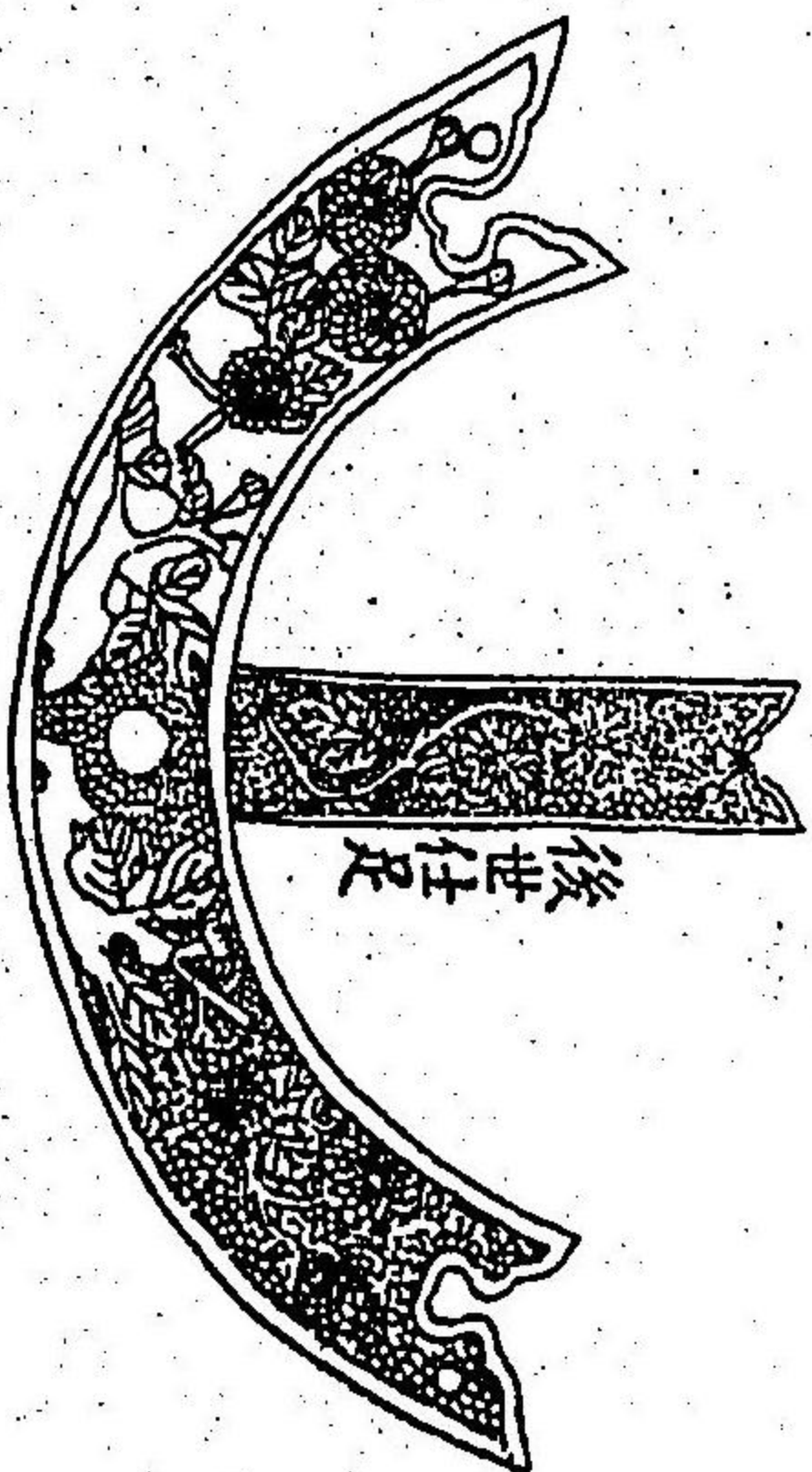

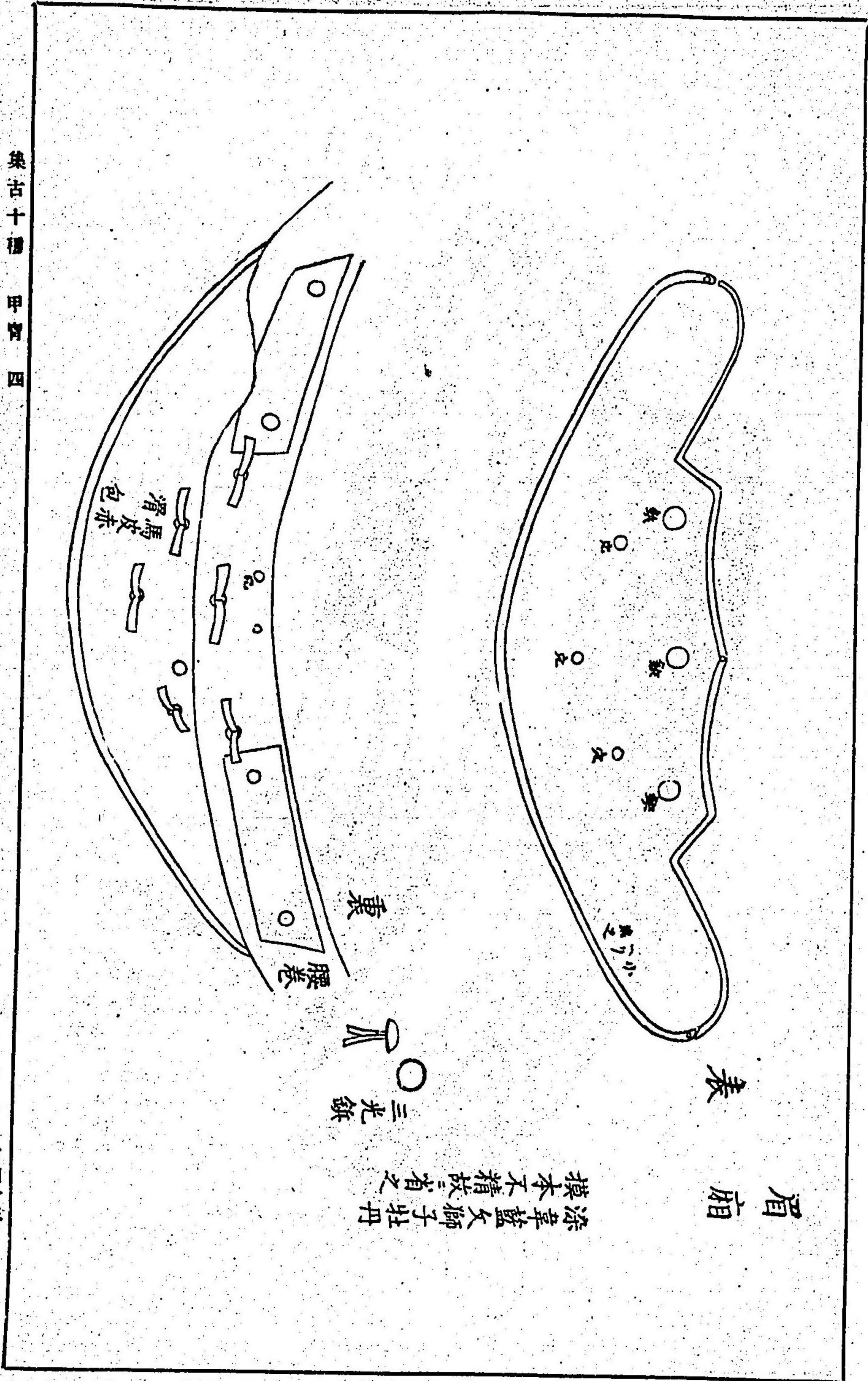
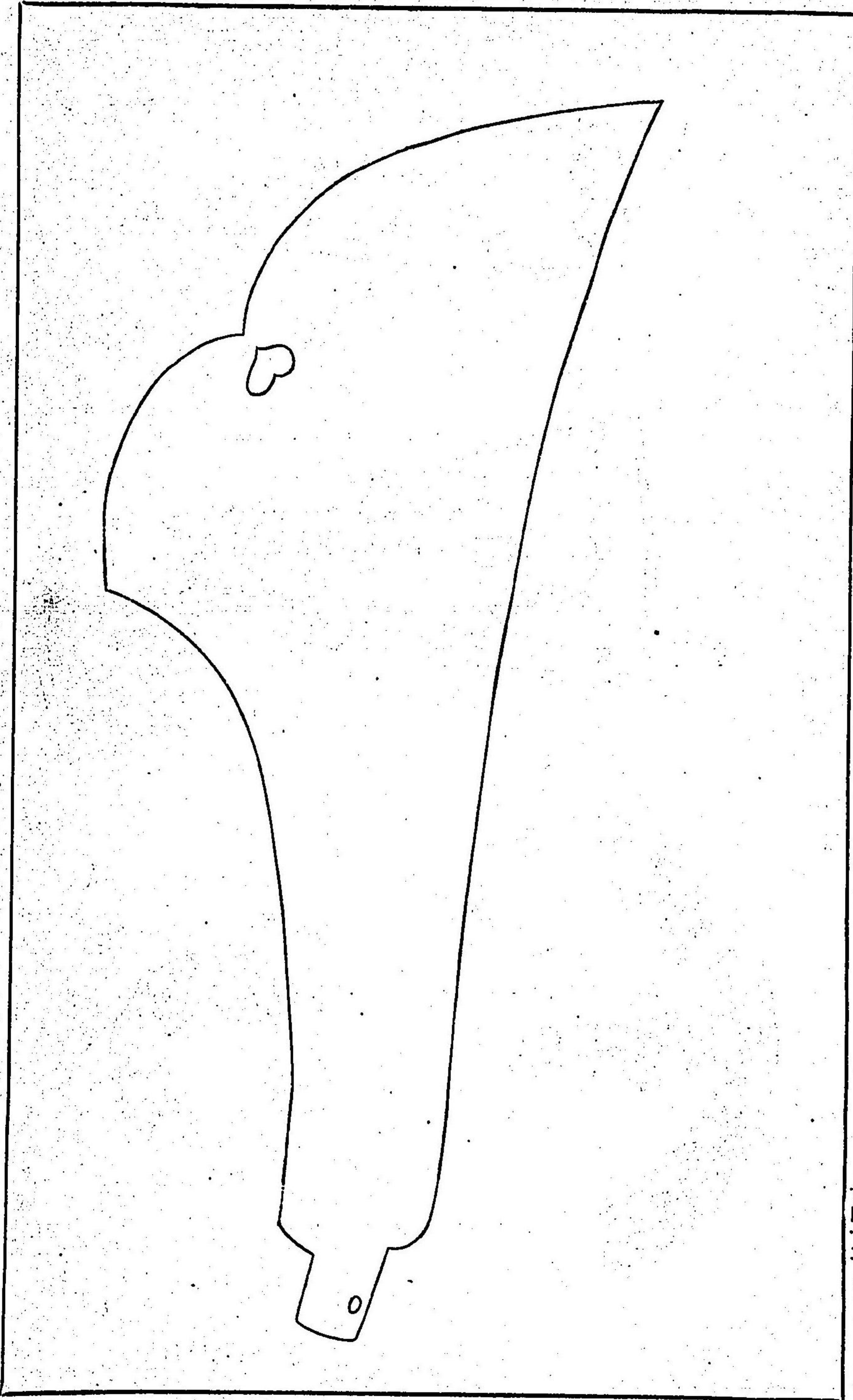

眉盾

表

漆草藍及獅子壯丹
摸本不精故省之

三光鍔

裏

腰卷

滑馬皮赤包

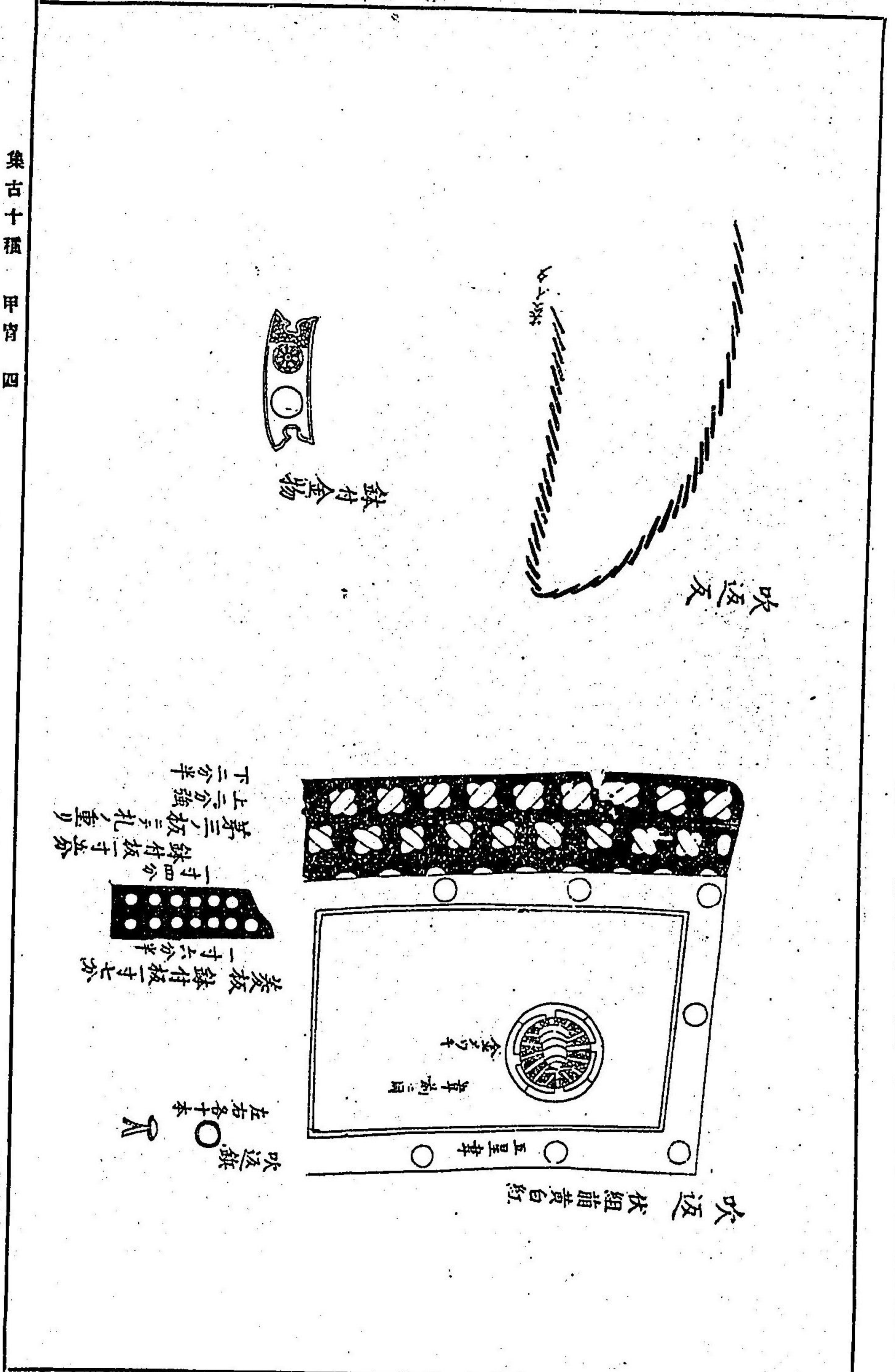
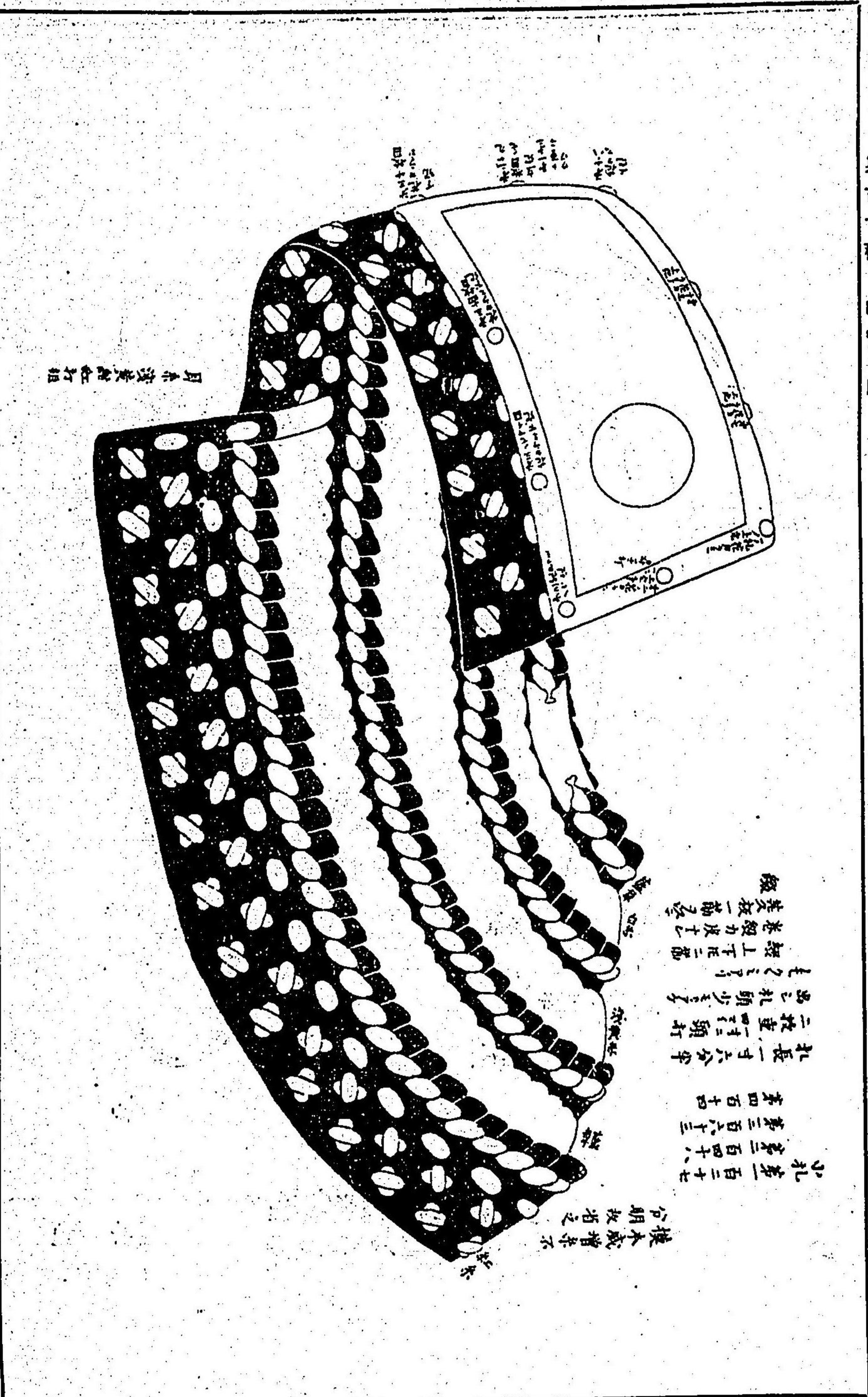

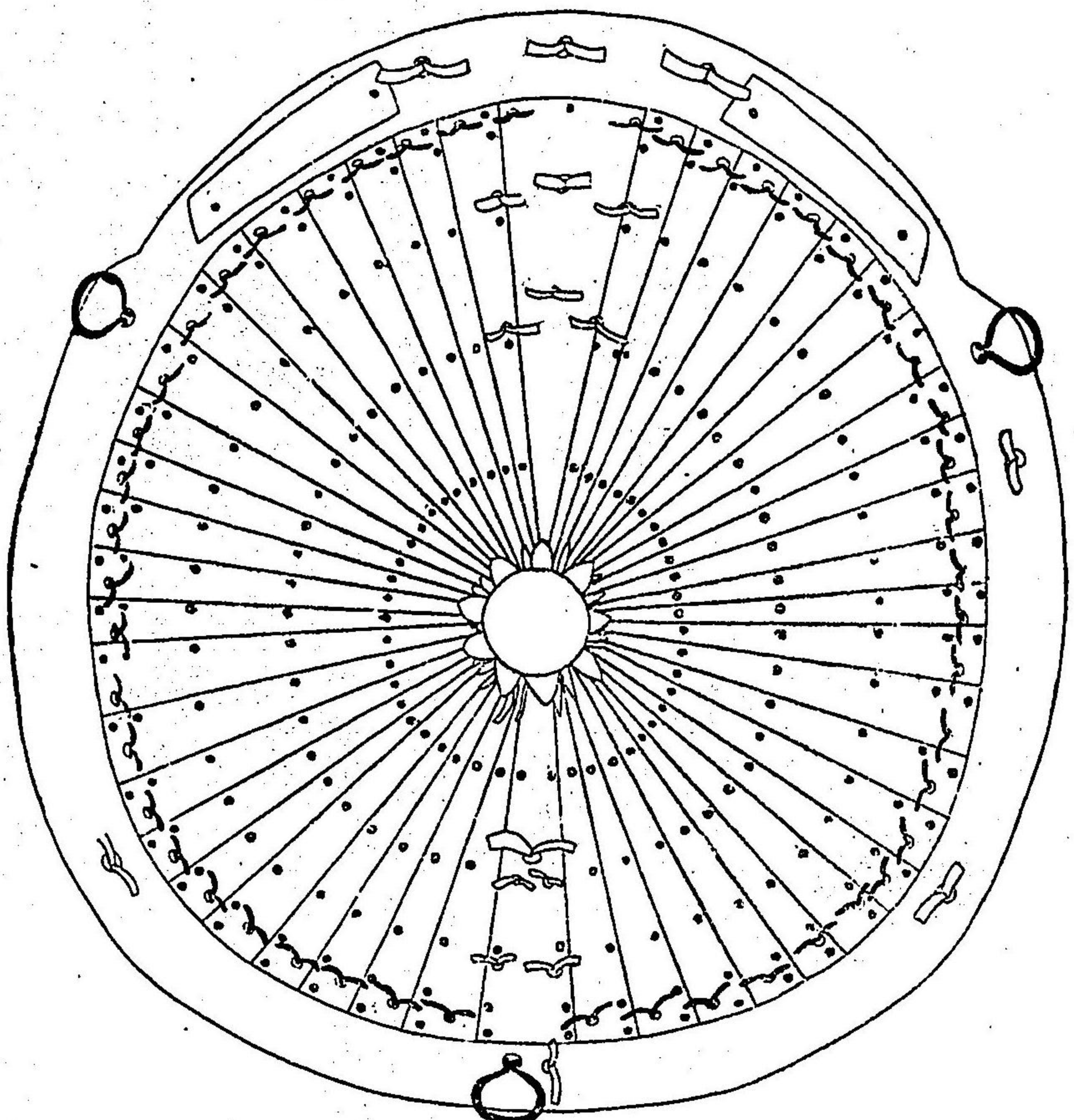

袖冠板等

第一札甲才三以下亡失后世任足
状組黃紅前黃
水引紅白絹

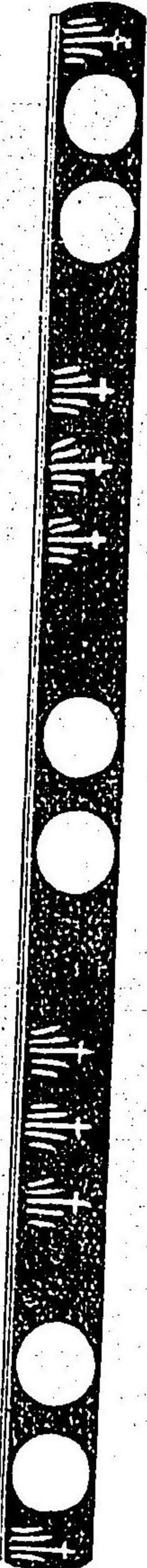
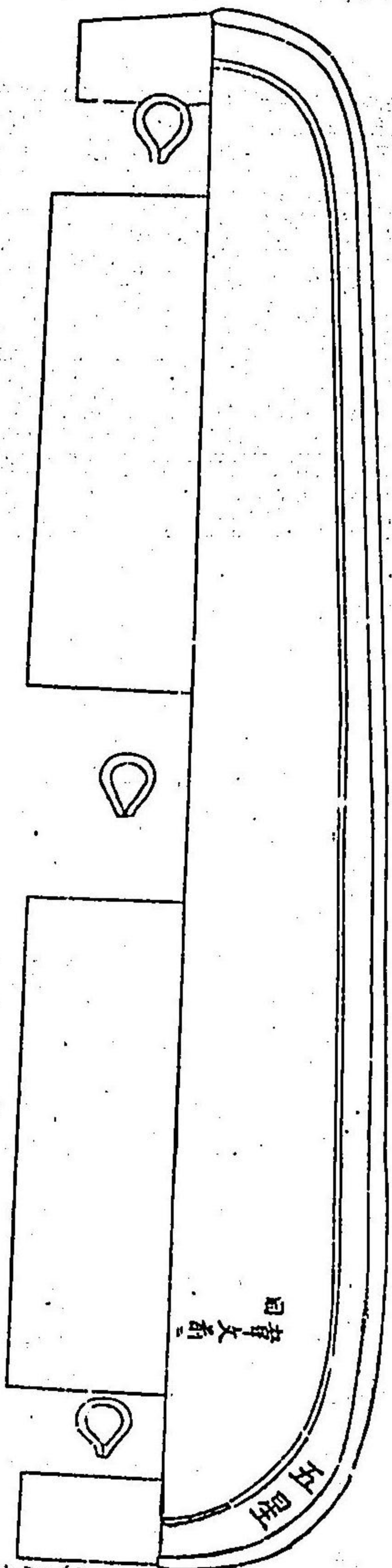

念物三重菊中央丸鉄
小刻三重中央丸鉄念物

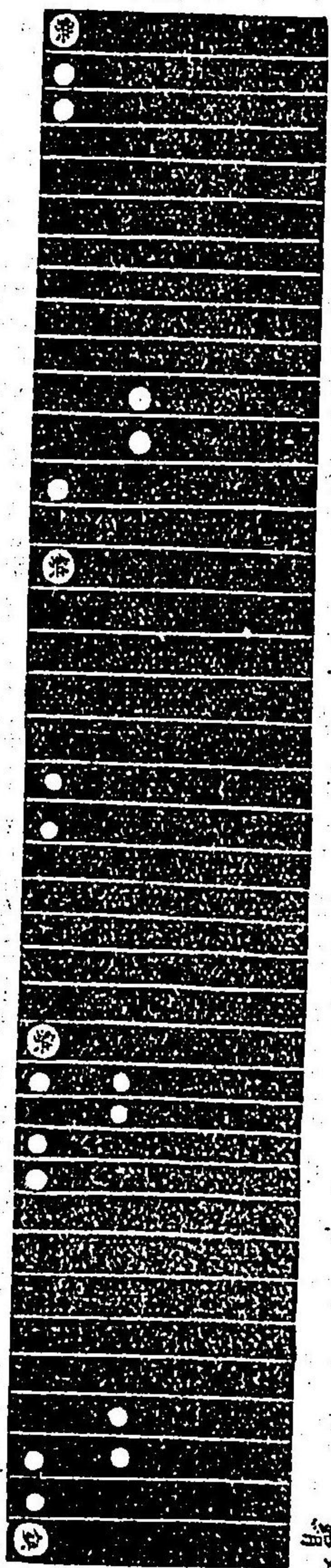

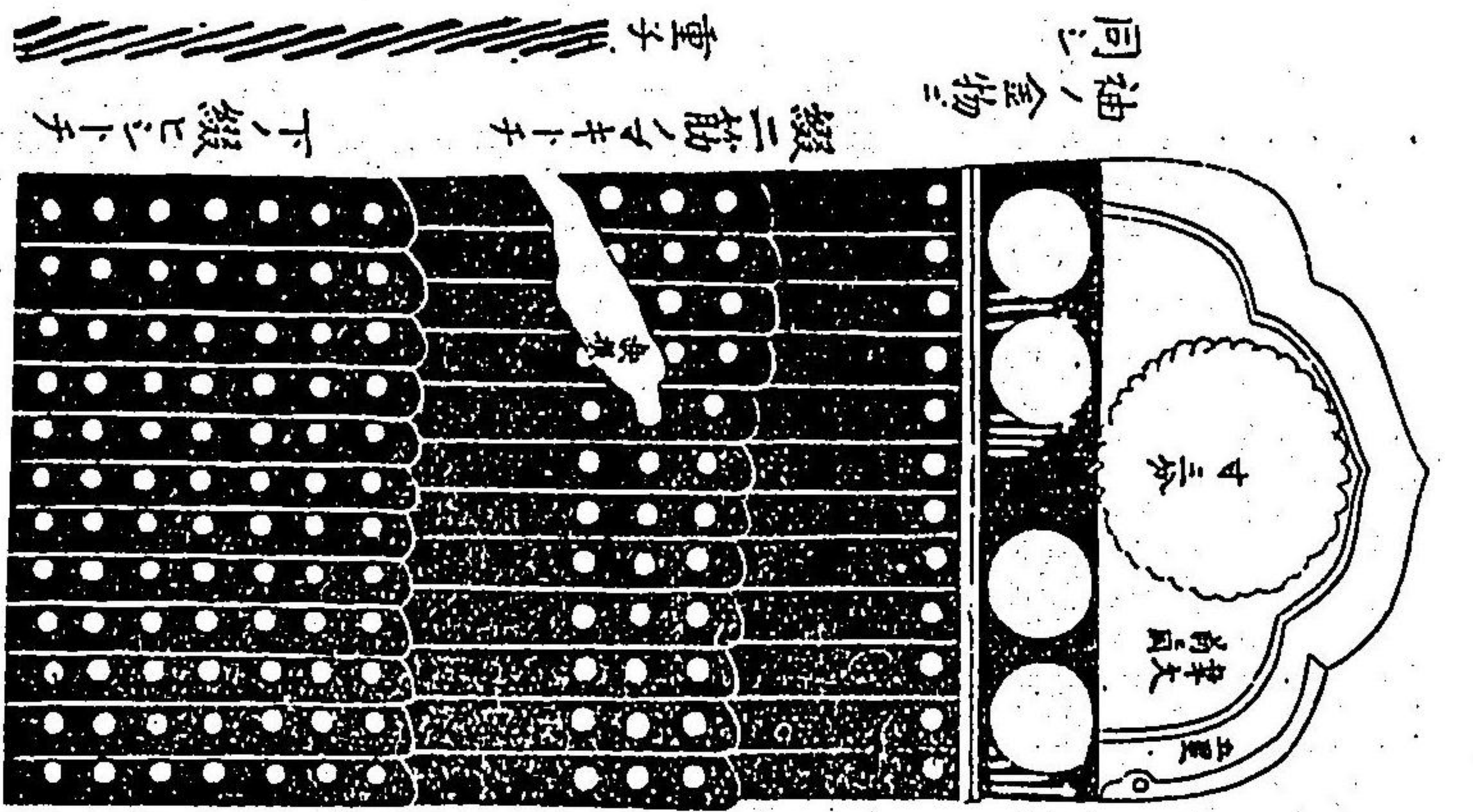

梅檀板

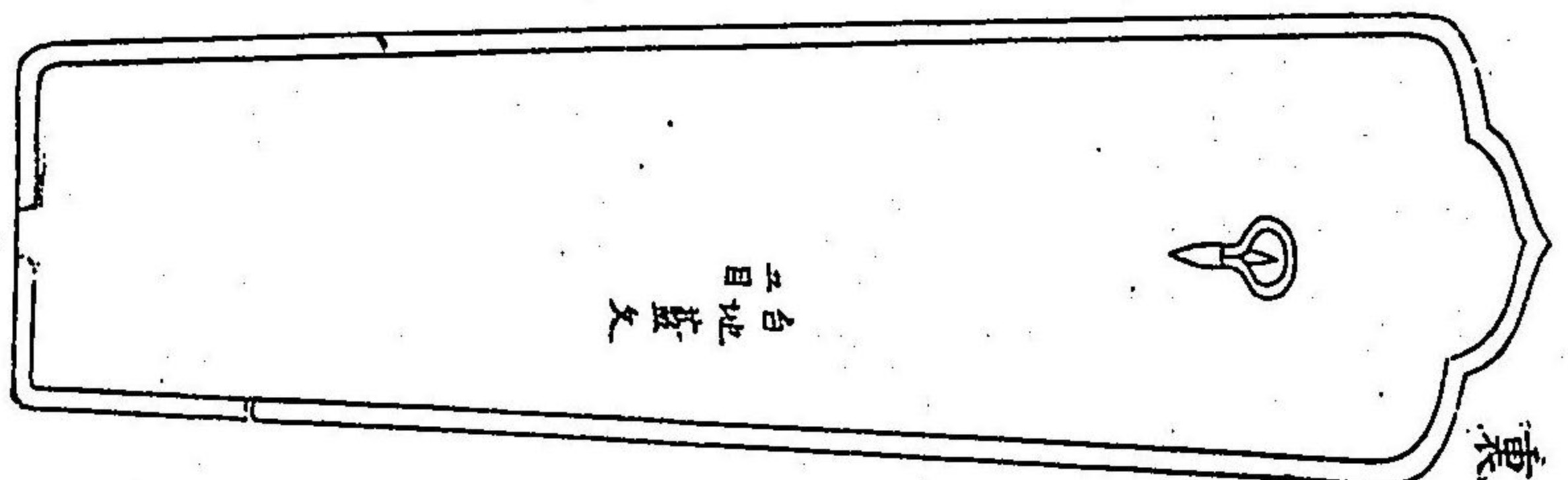

裏

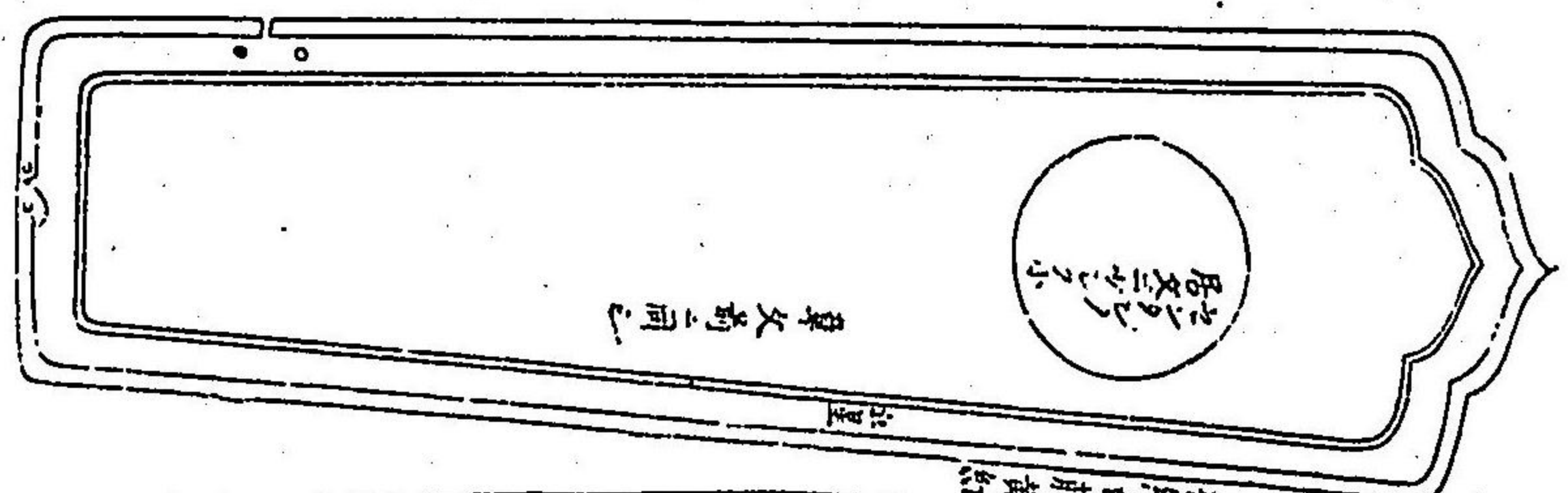

鳧尾板

反

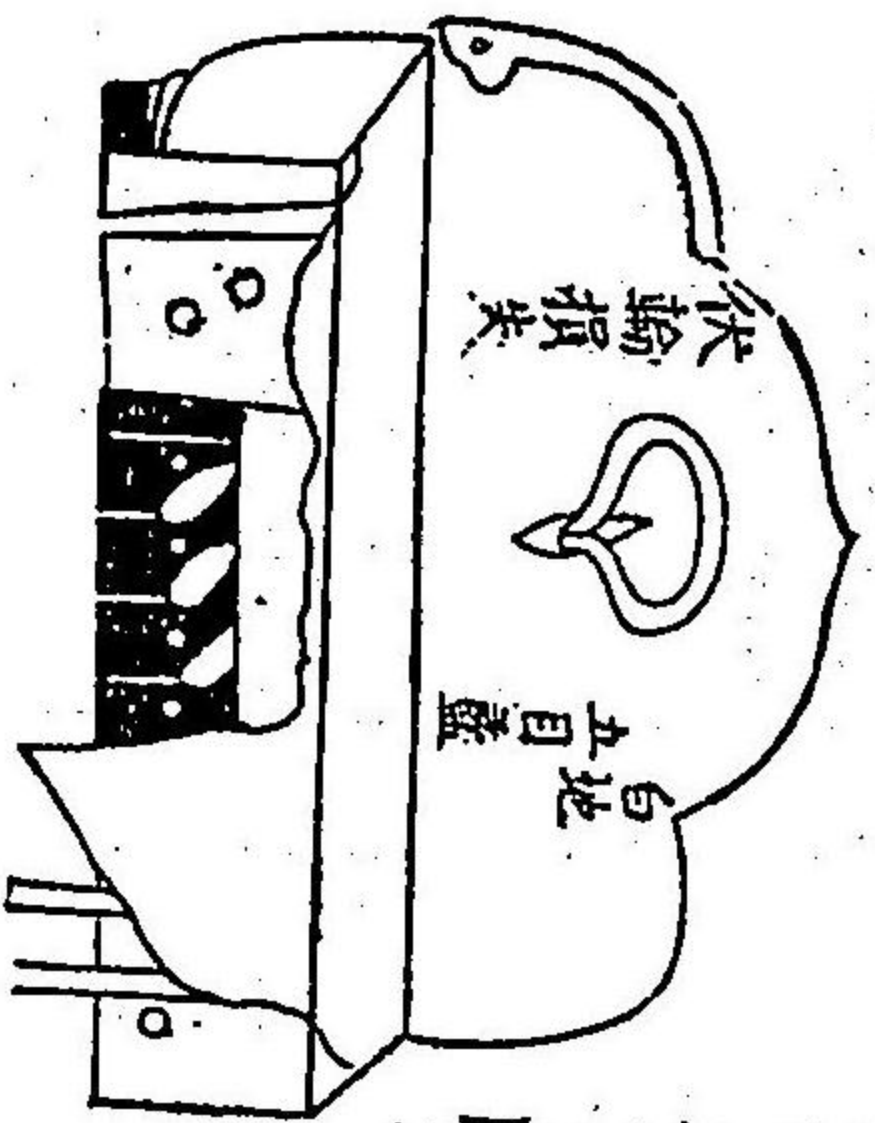

裏包ノ草子圖

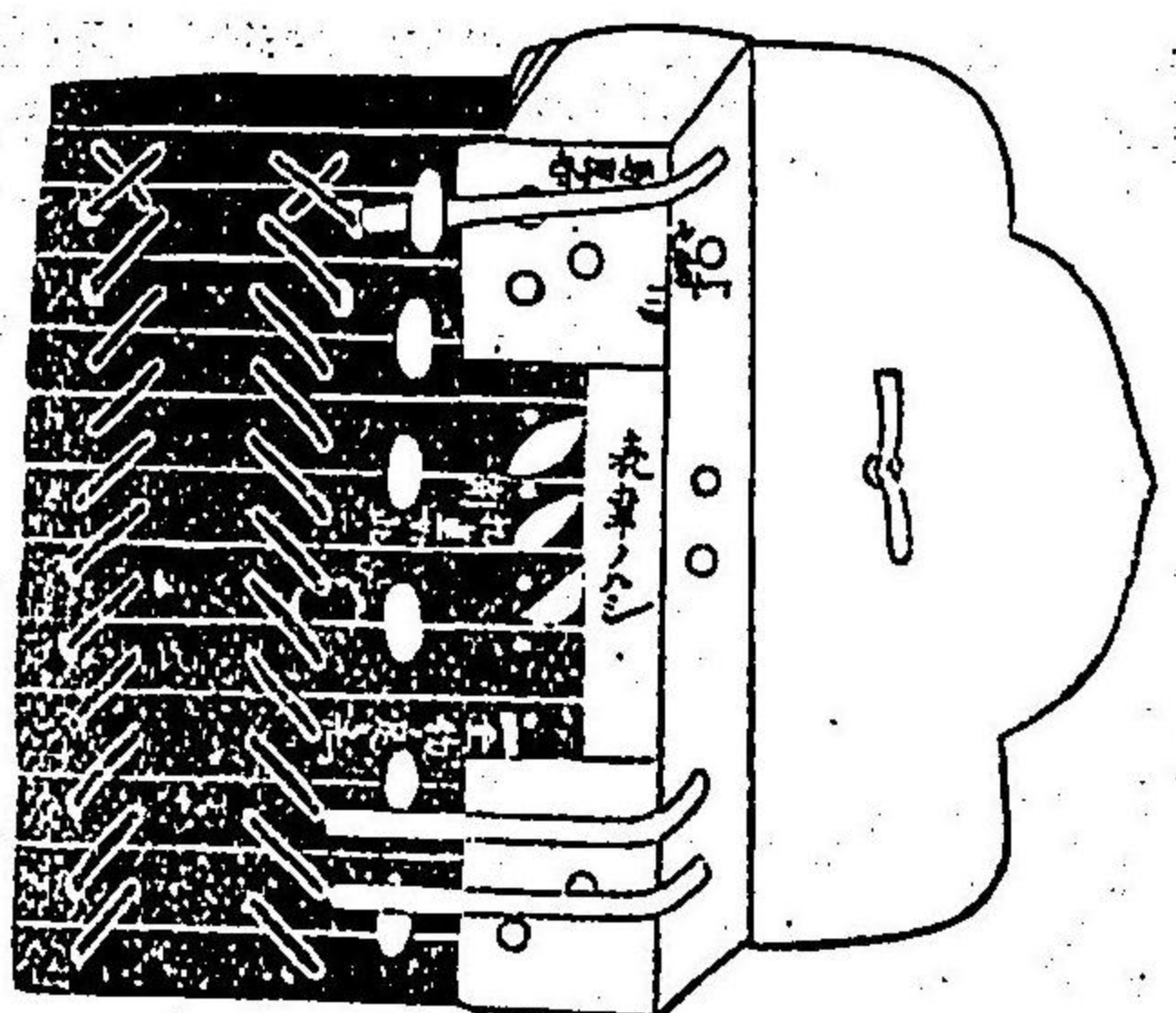

裏

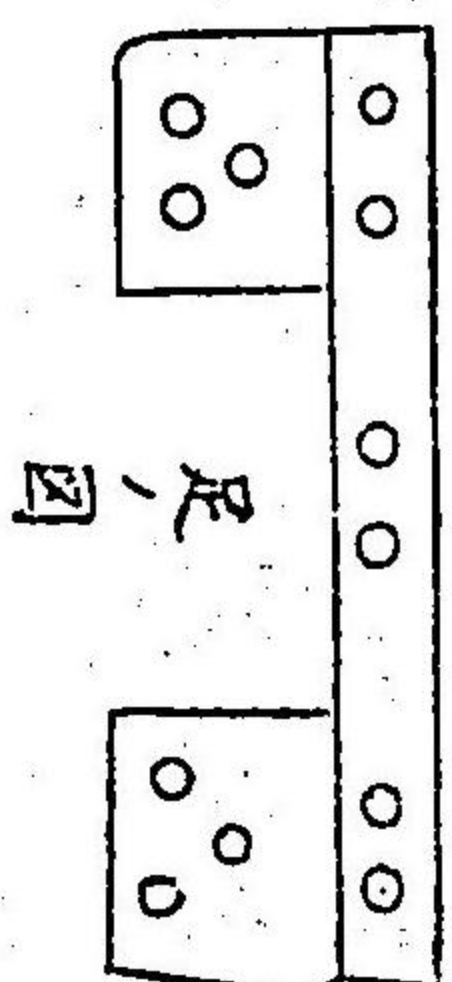
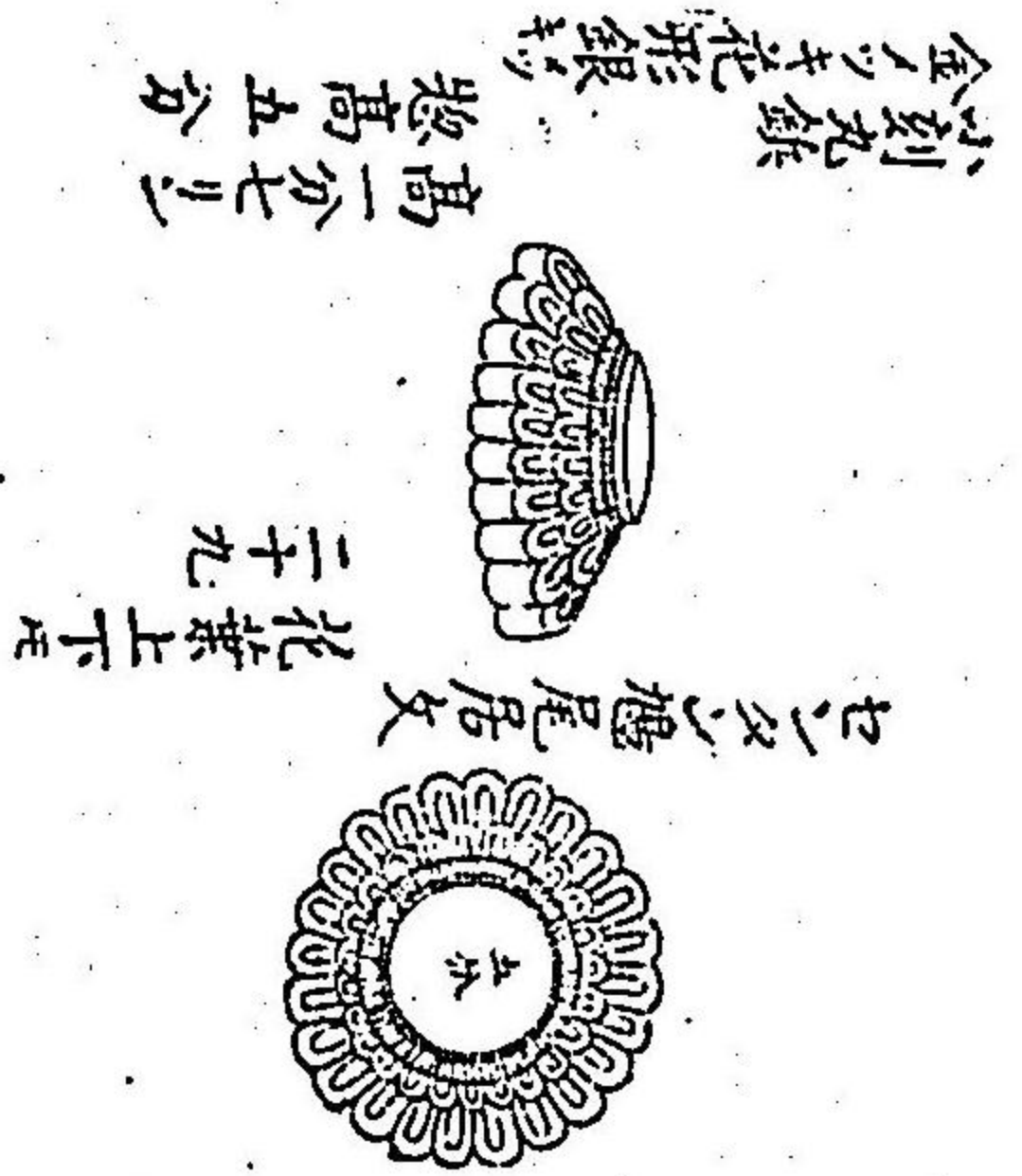

足ノ圖

胸板

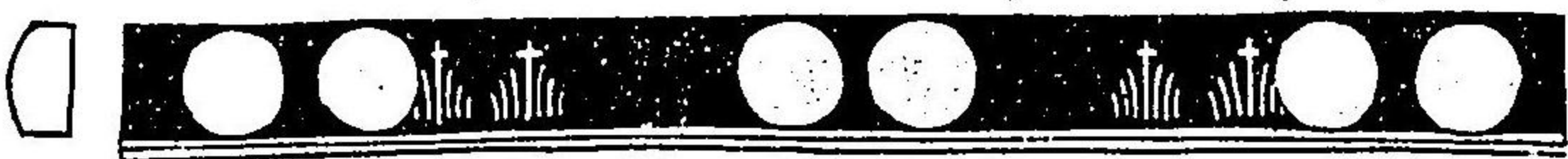
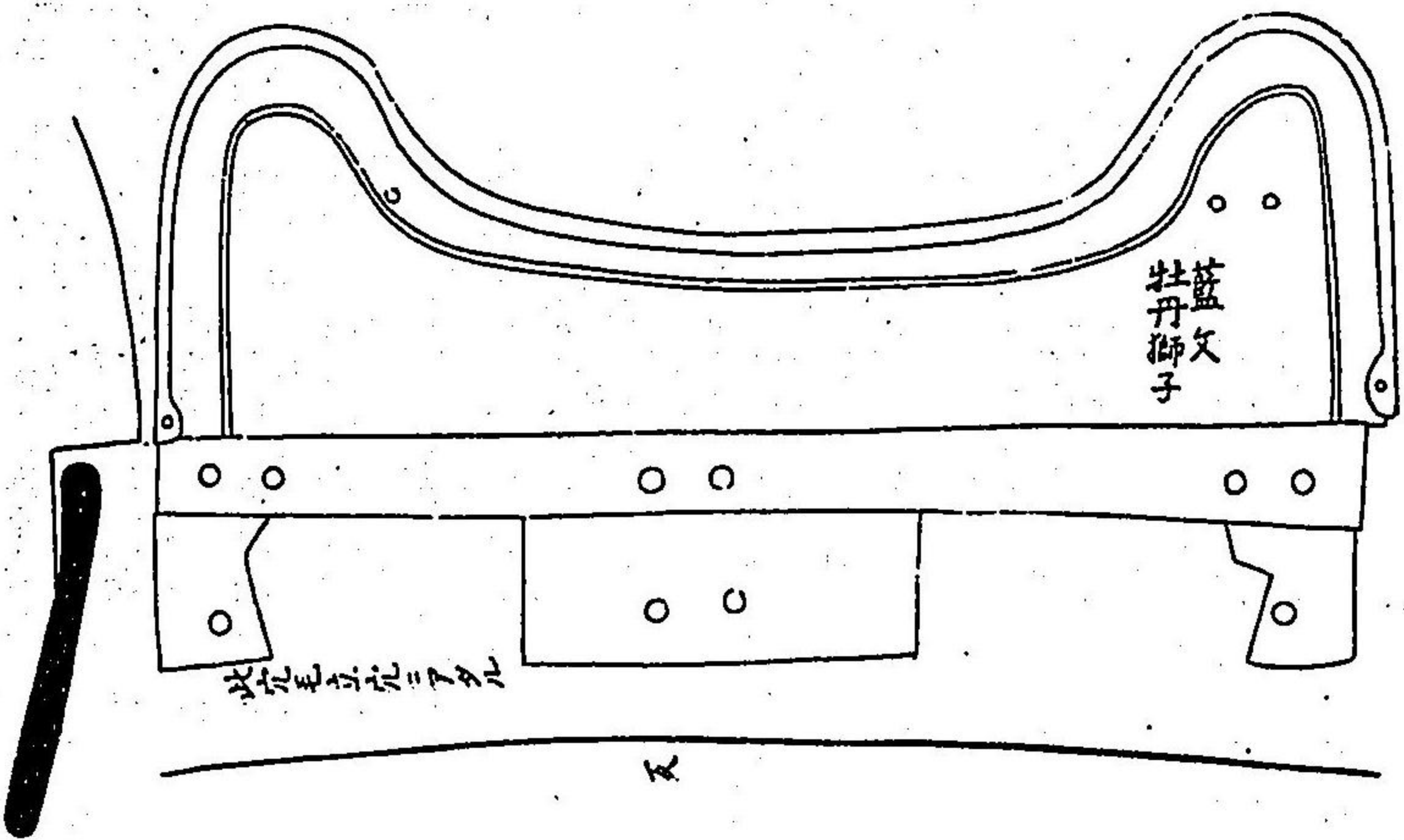

下地分許
板ヲ入
紅白絹
中ヲ入

腰廻り第一札

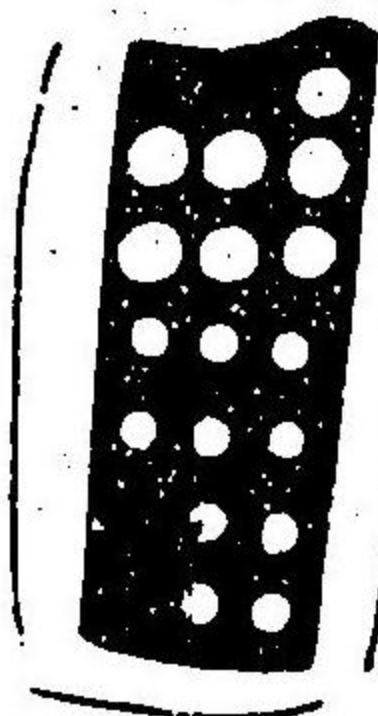

菊二重銀メッキ

高三分

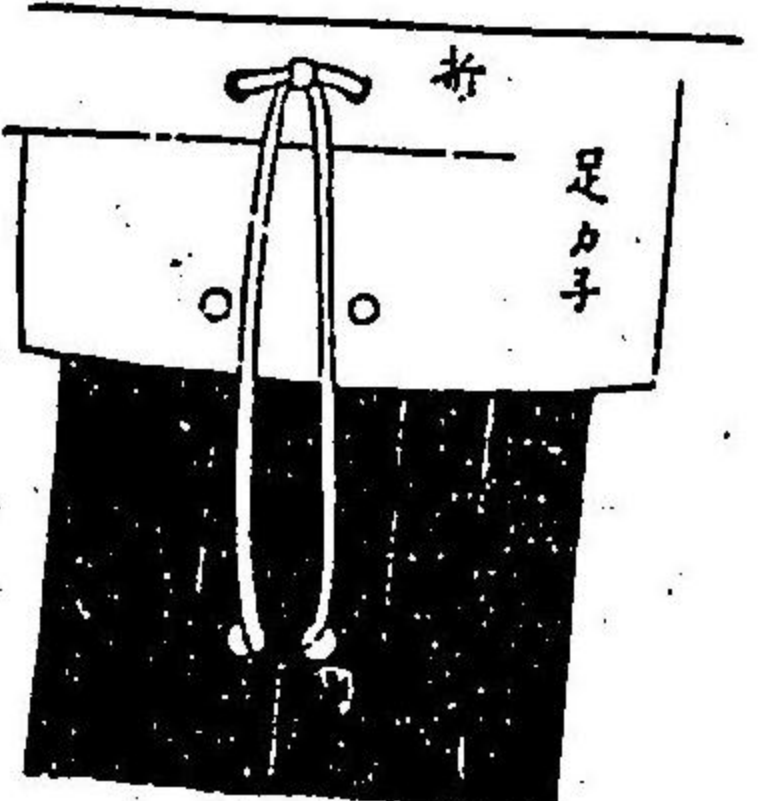
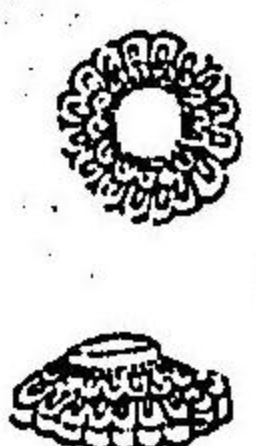

裏トメカク如図

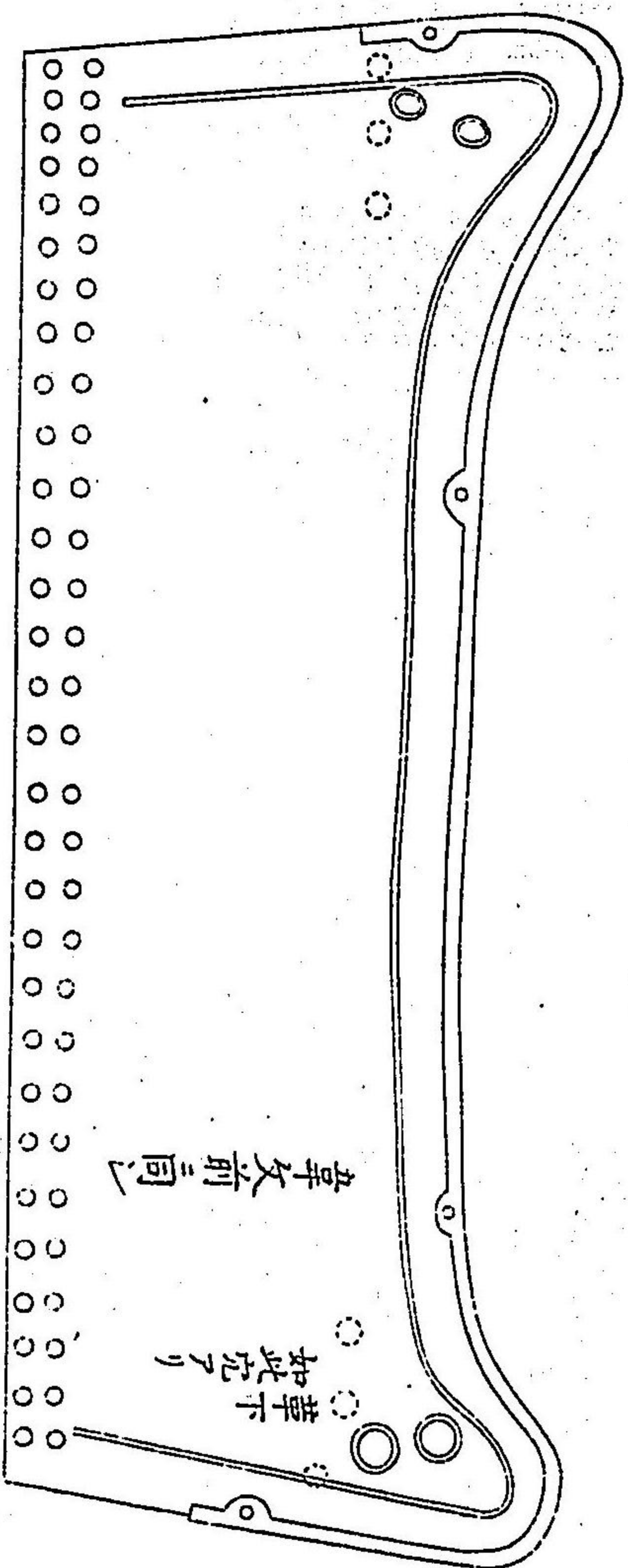

脇板

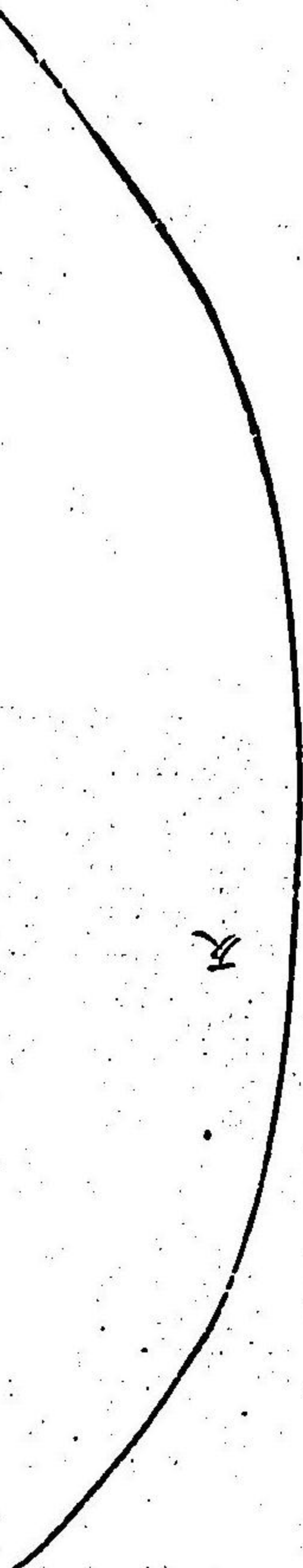

草文前同

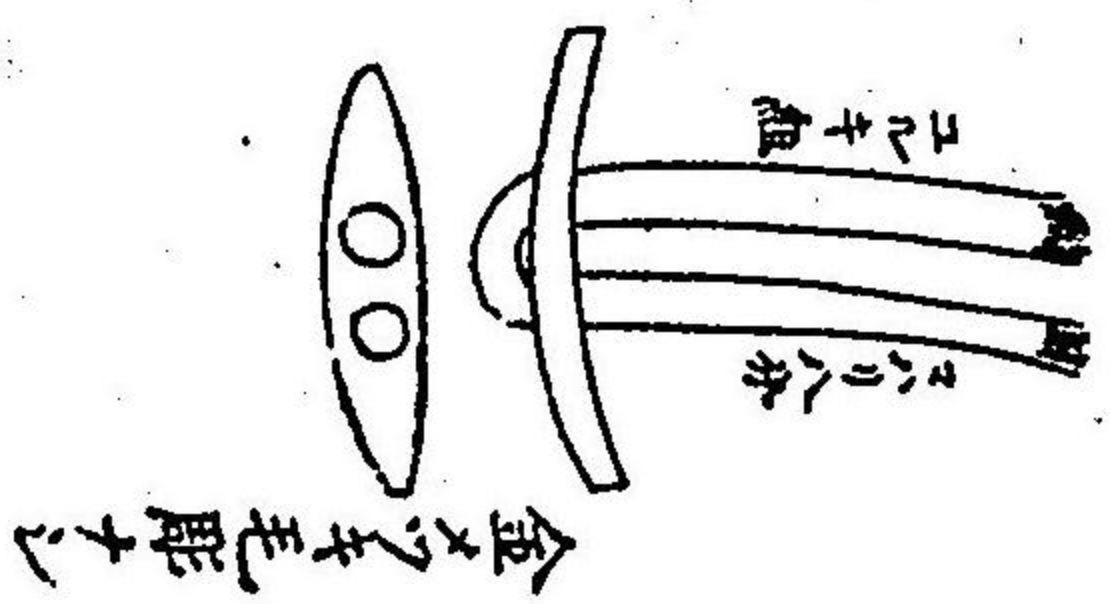
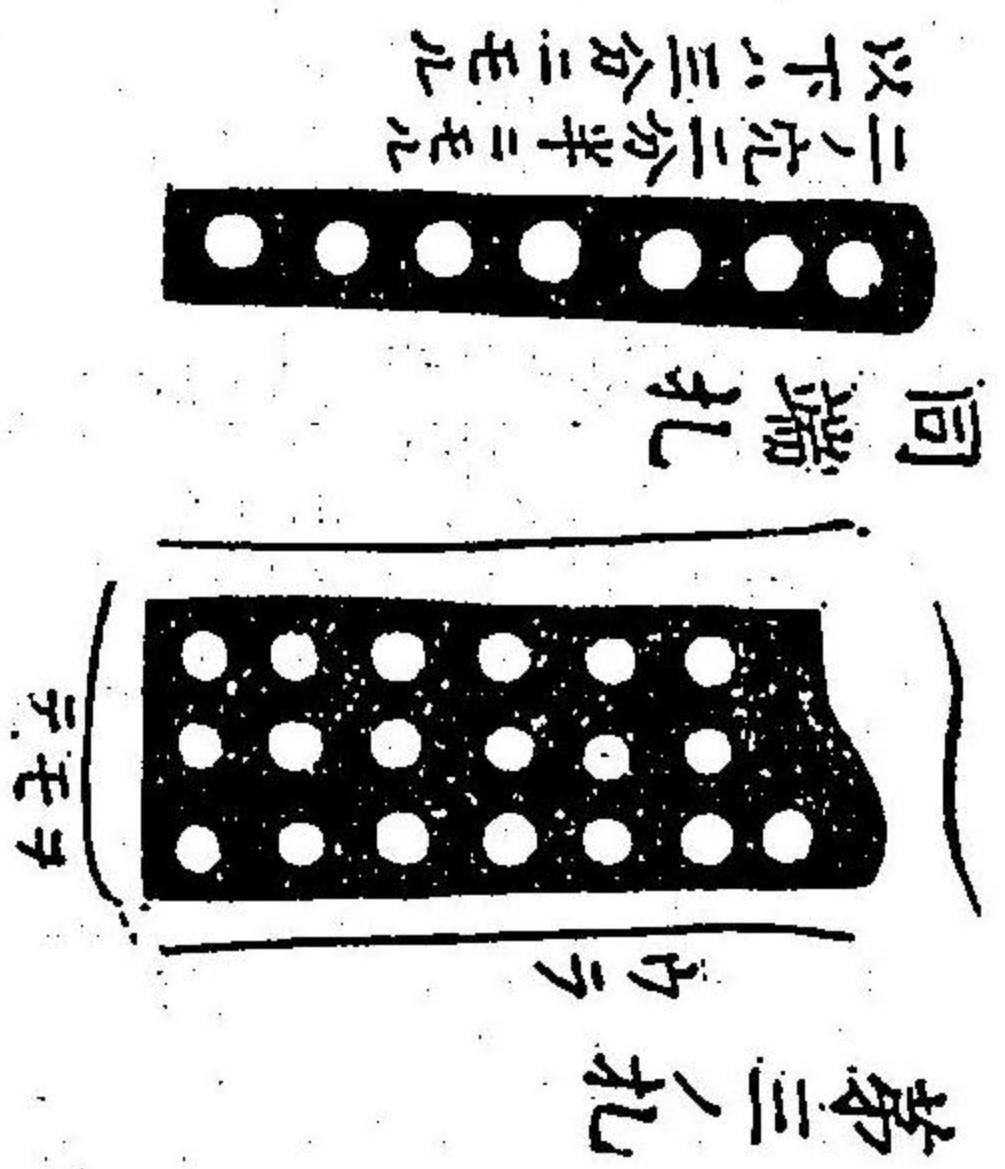
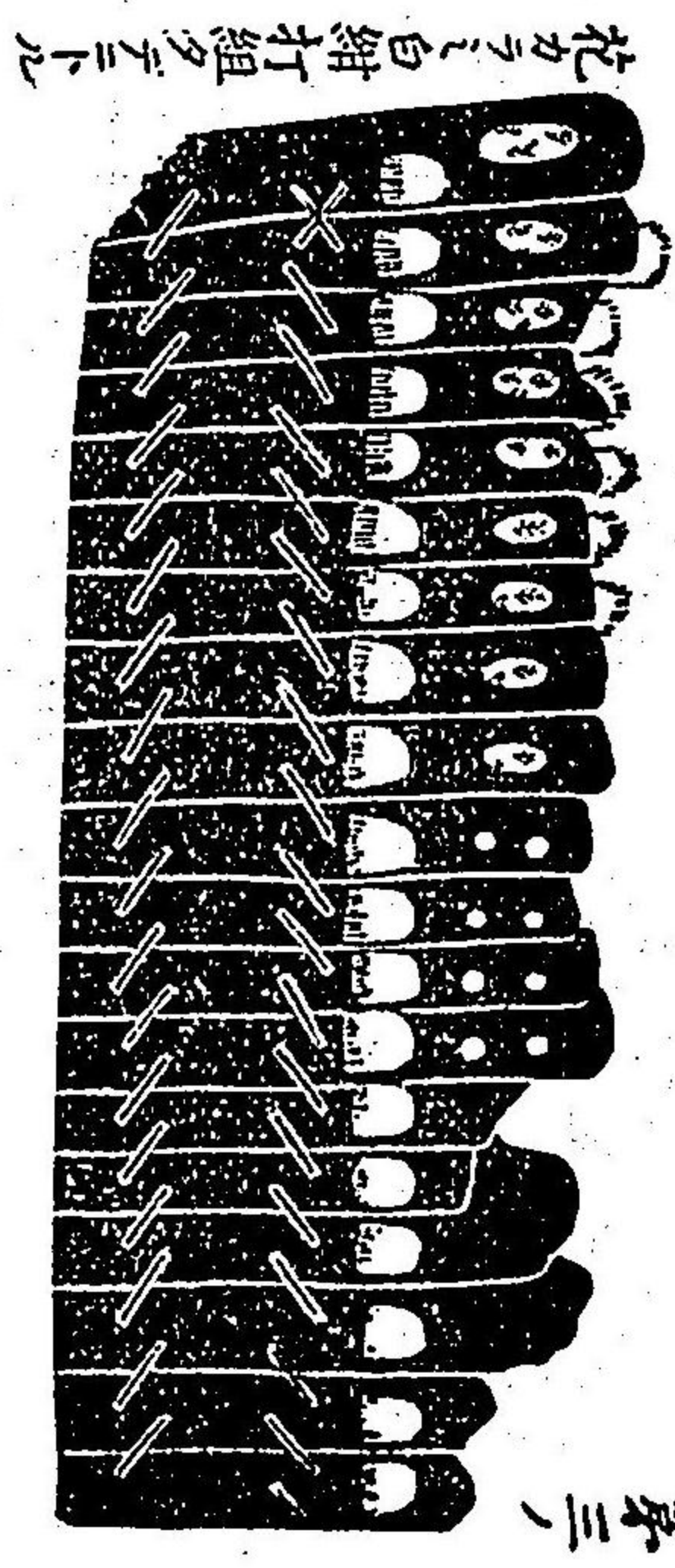
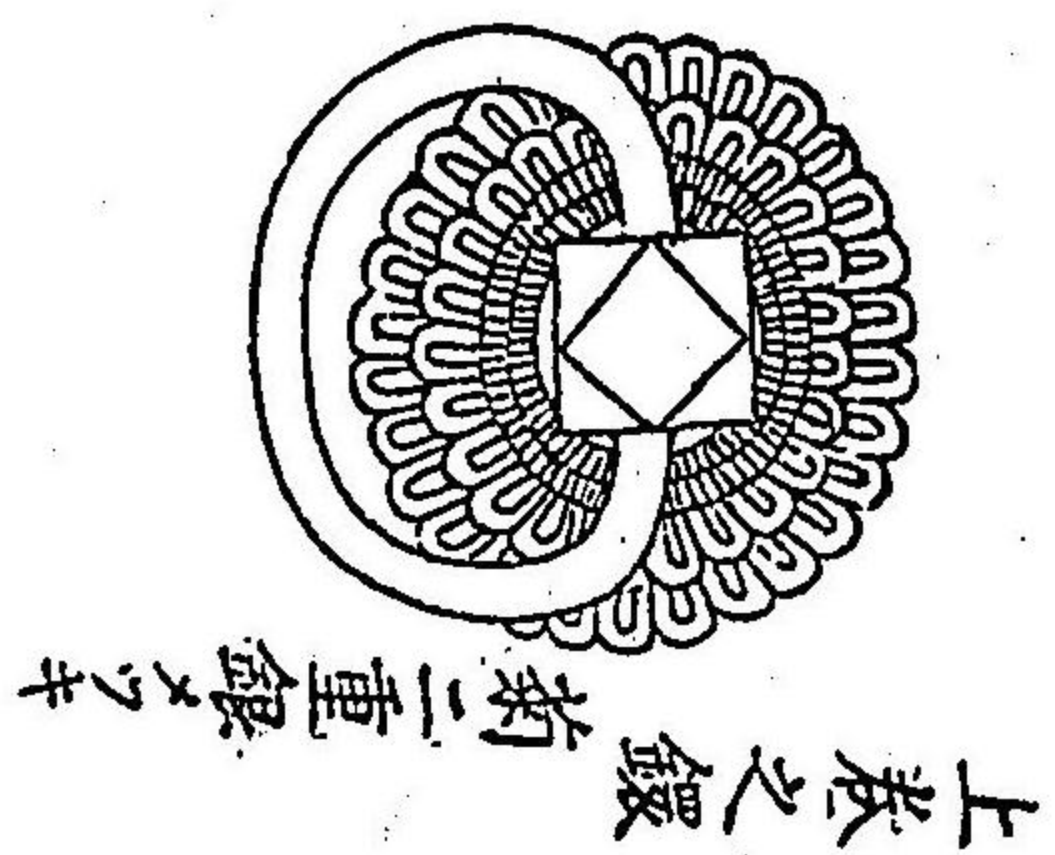

脇楯

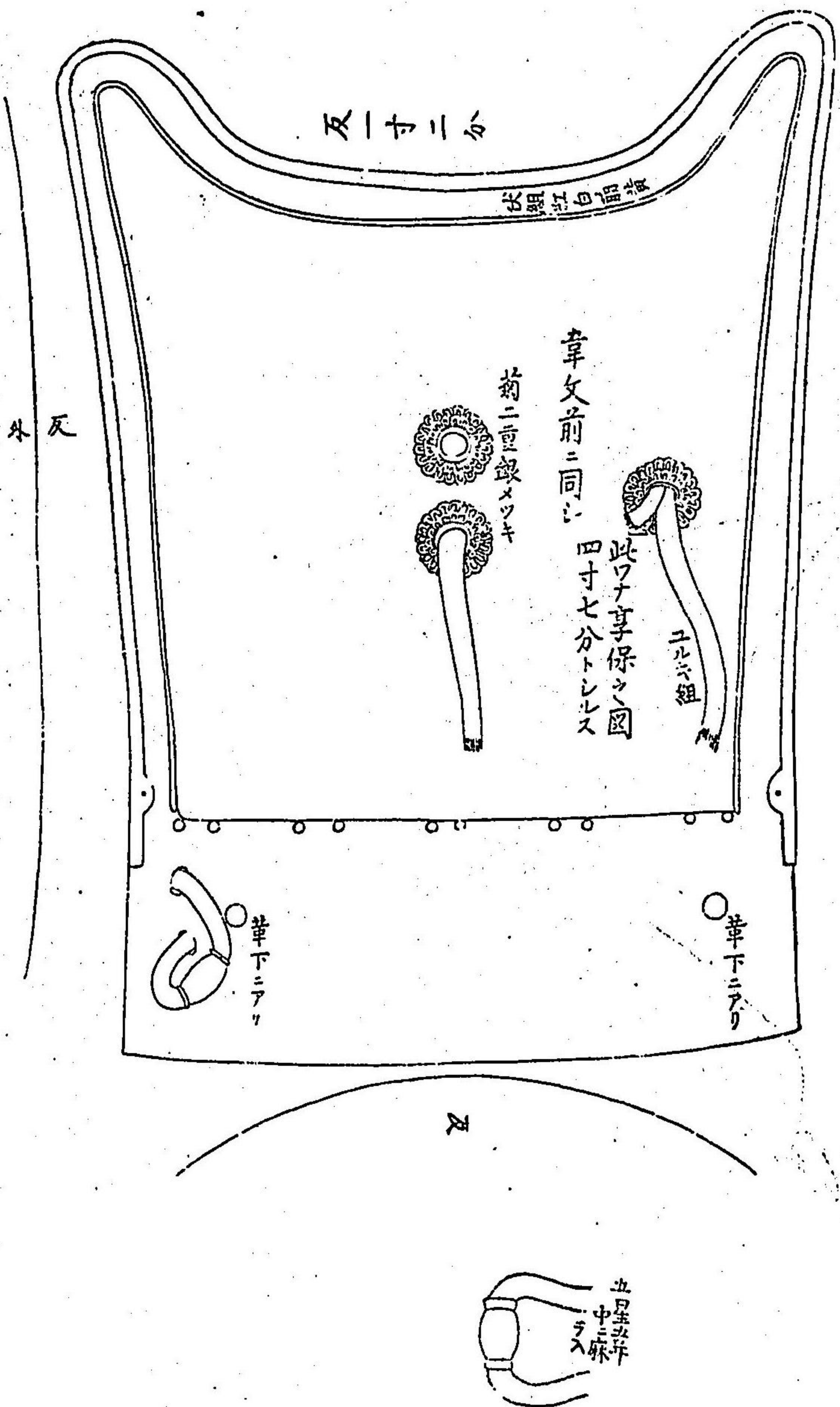

南都春日神庫所藏甲冑圖

甲冑威蓋伏組白紺茶金物金メッキ
耳糸睦目白紺紫崩黄龜甲打組
此末コレニ異ヲシルス

全圖

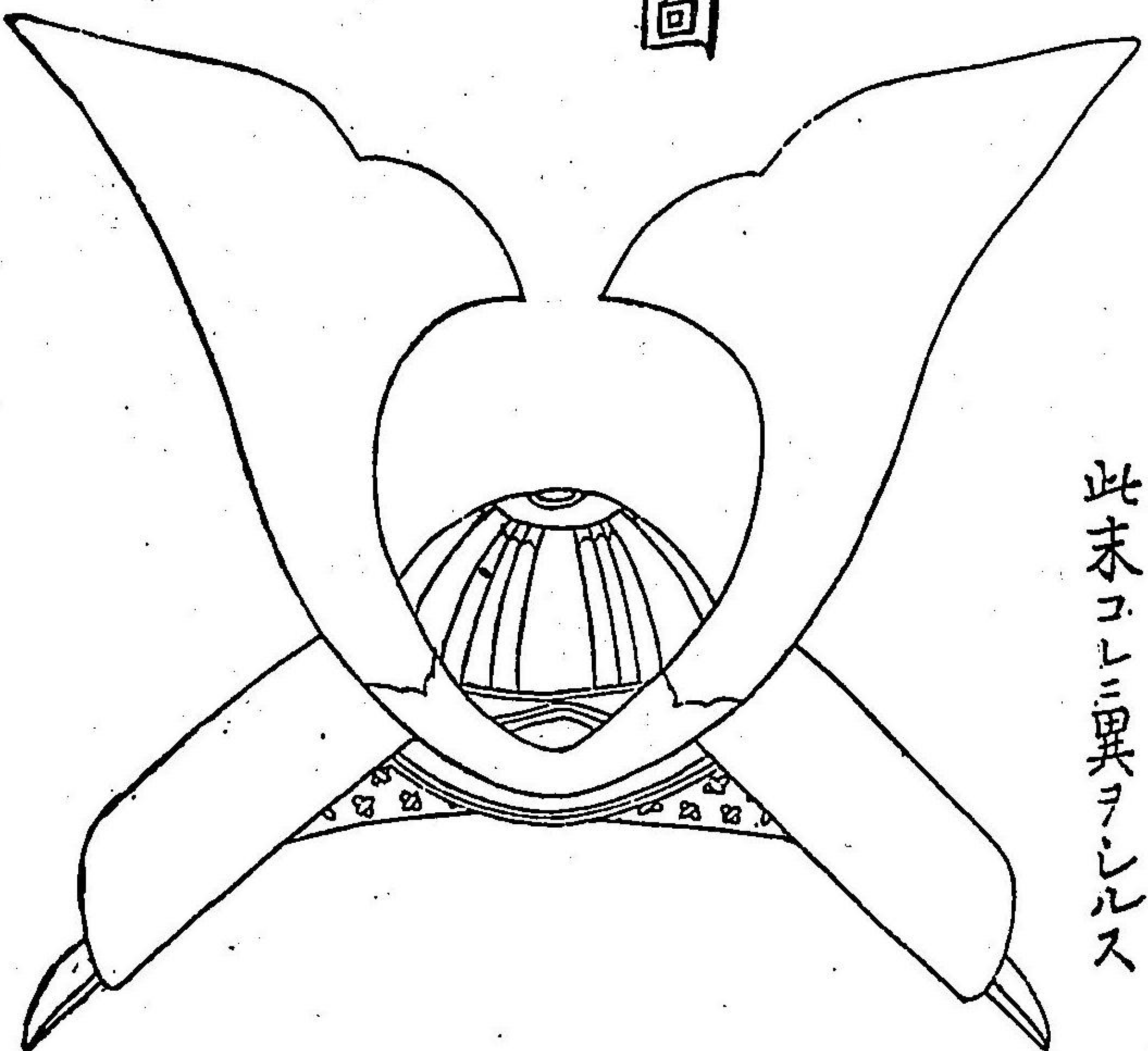

圖中草文聖之處
藍及鈎之處田紫
尤五星草、双鈎、
處白

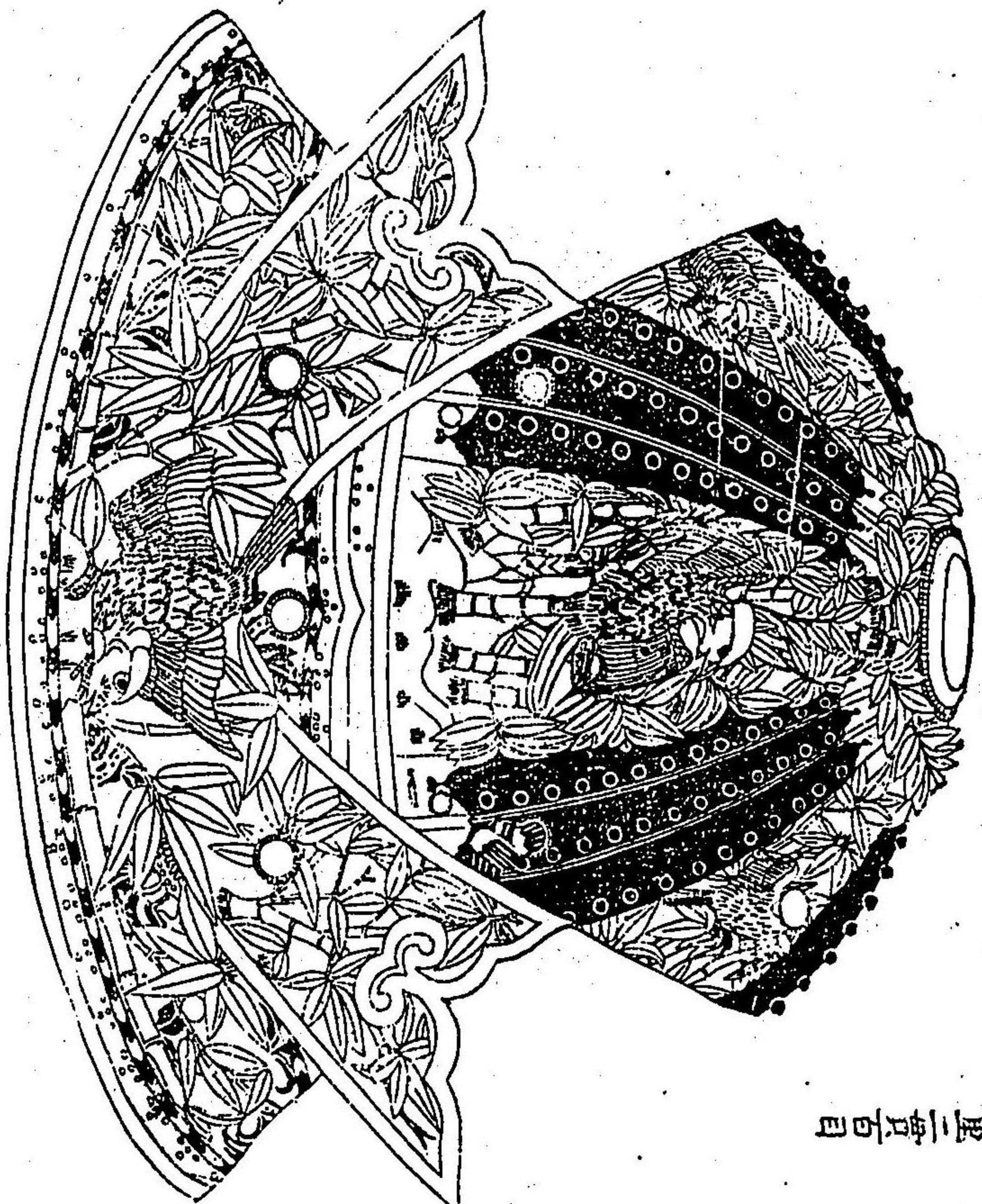

由月靈二貫目

由六方聖筆十八間屋十五地板銀メッキ竹透彫上
金メッキ金物上ニカサレ

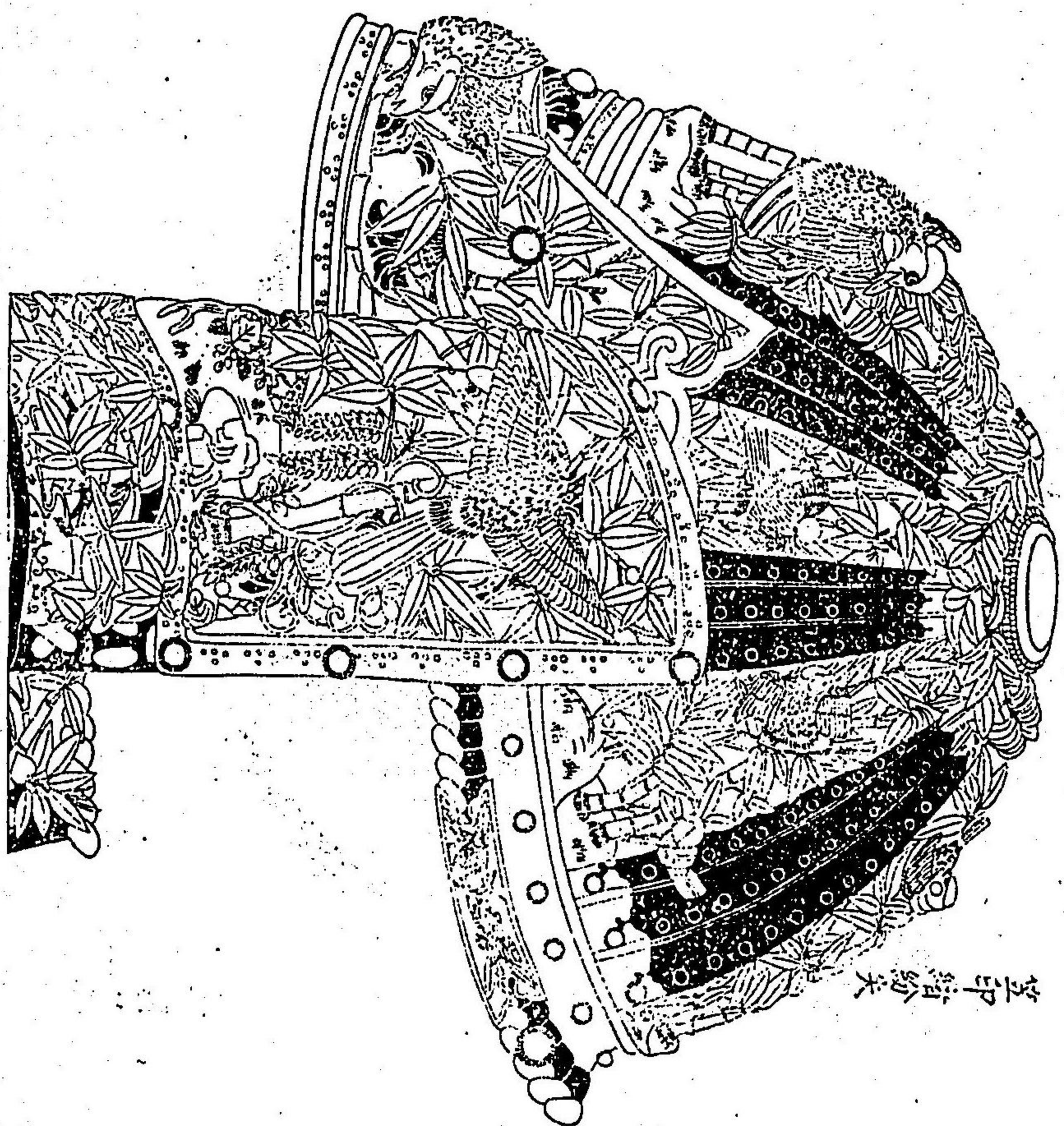

雲印繒紗

鍬形

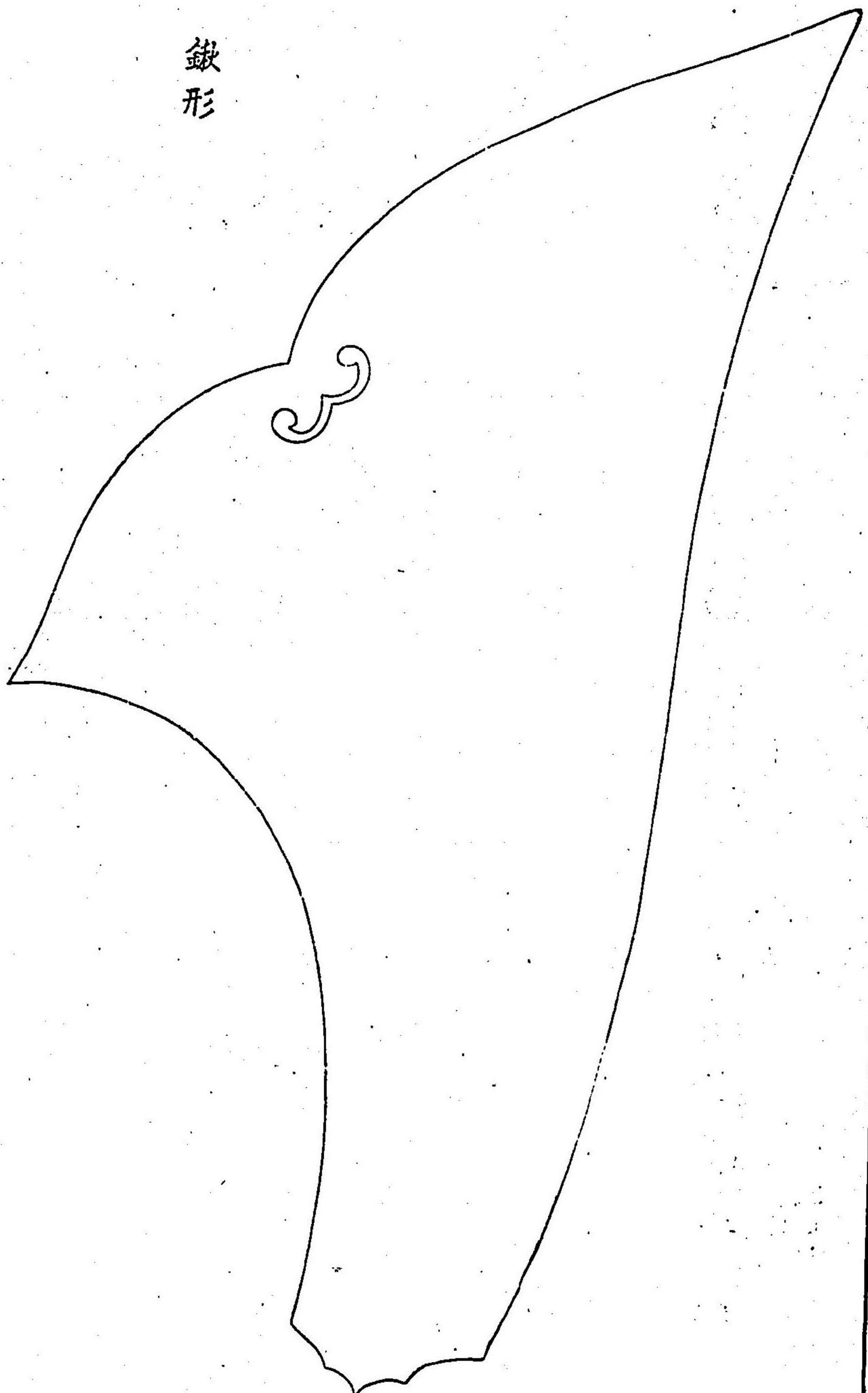

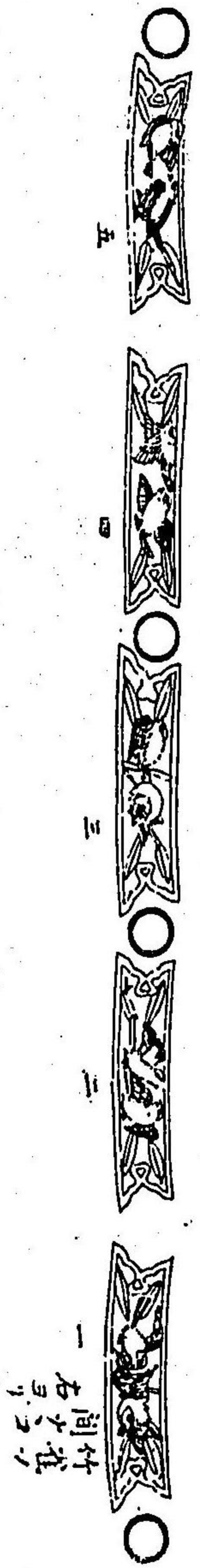
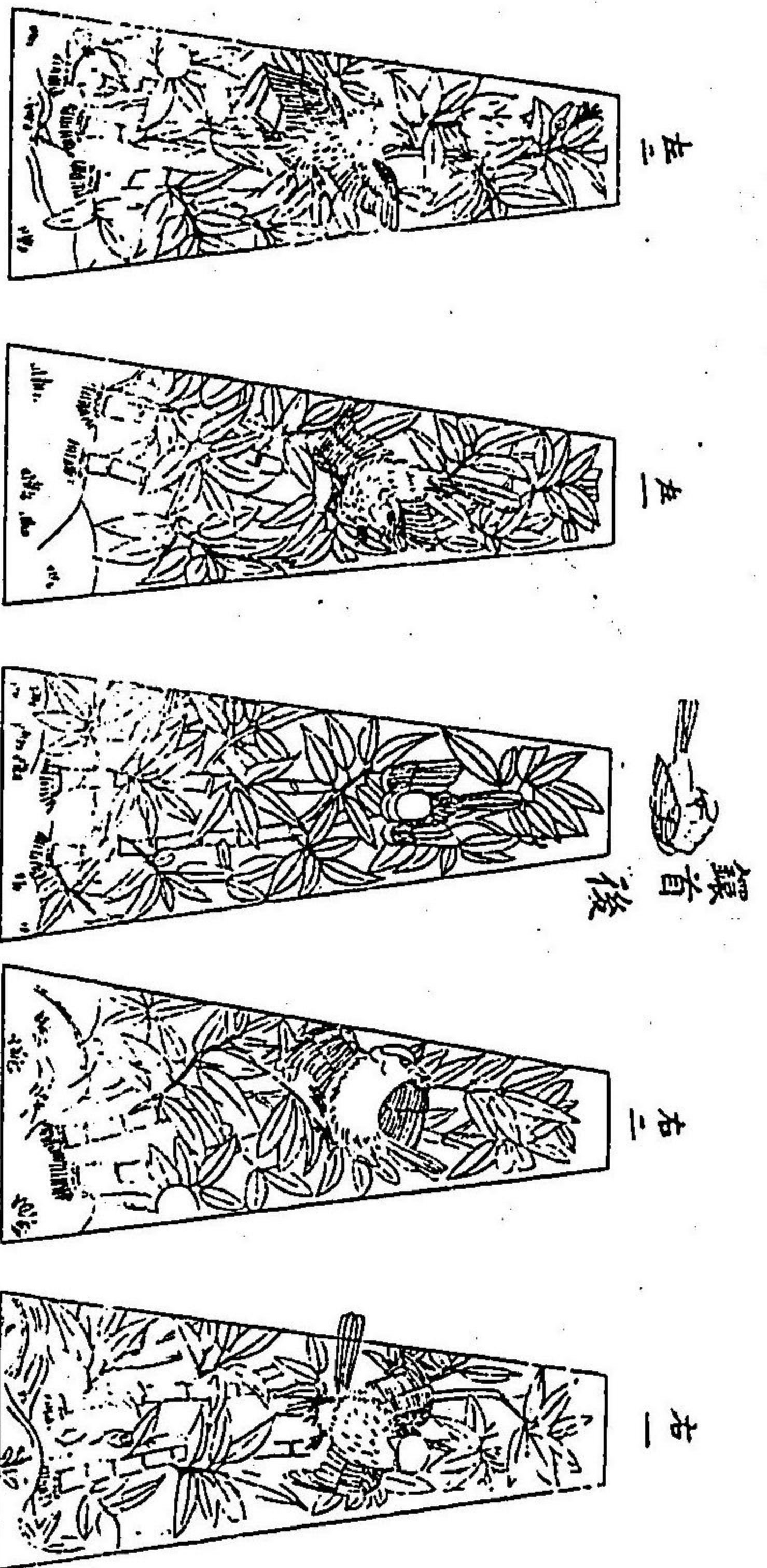

一 右ヨリ
二 同ナリ

吹返金物

左

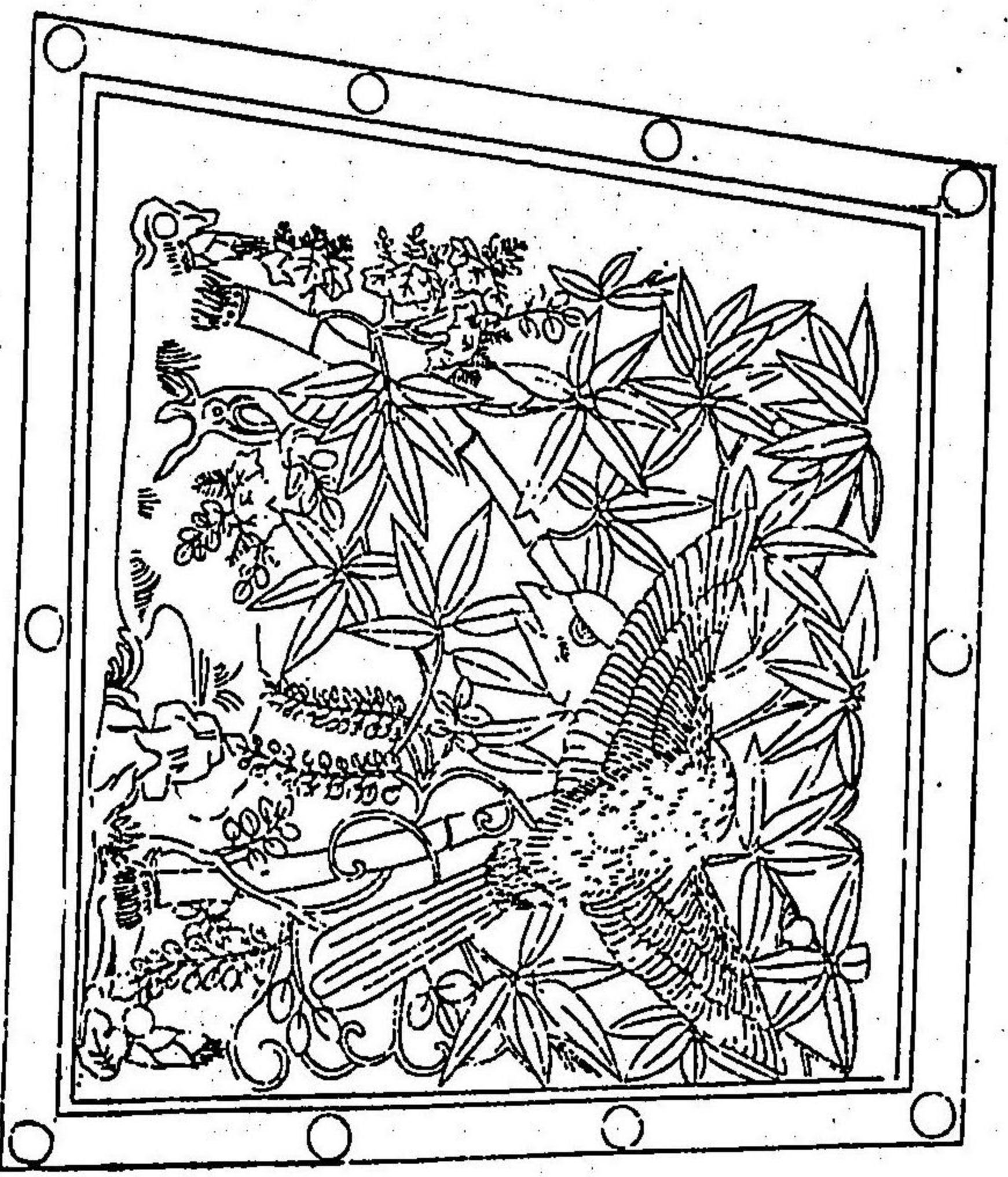

右

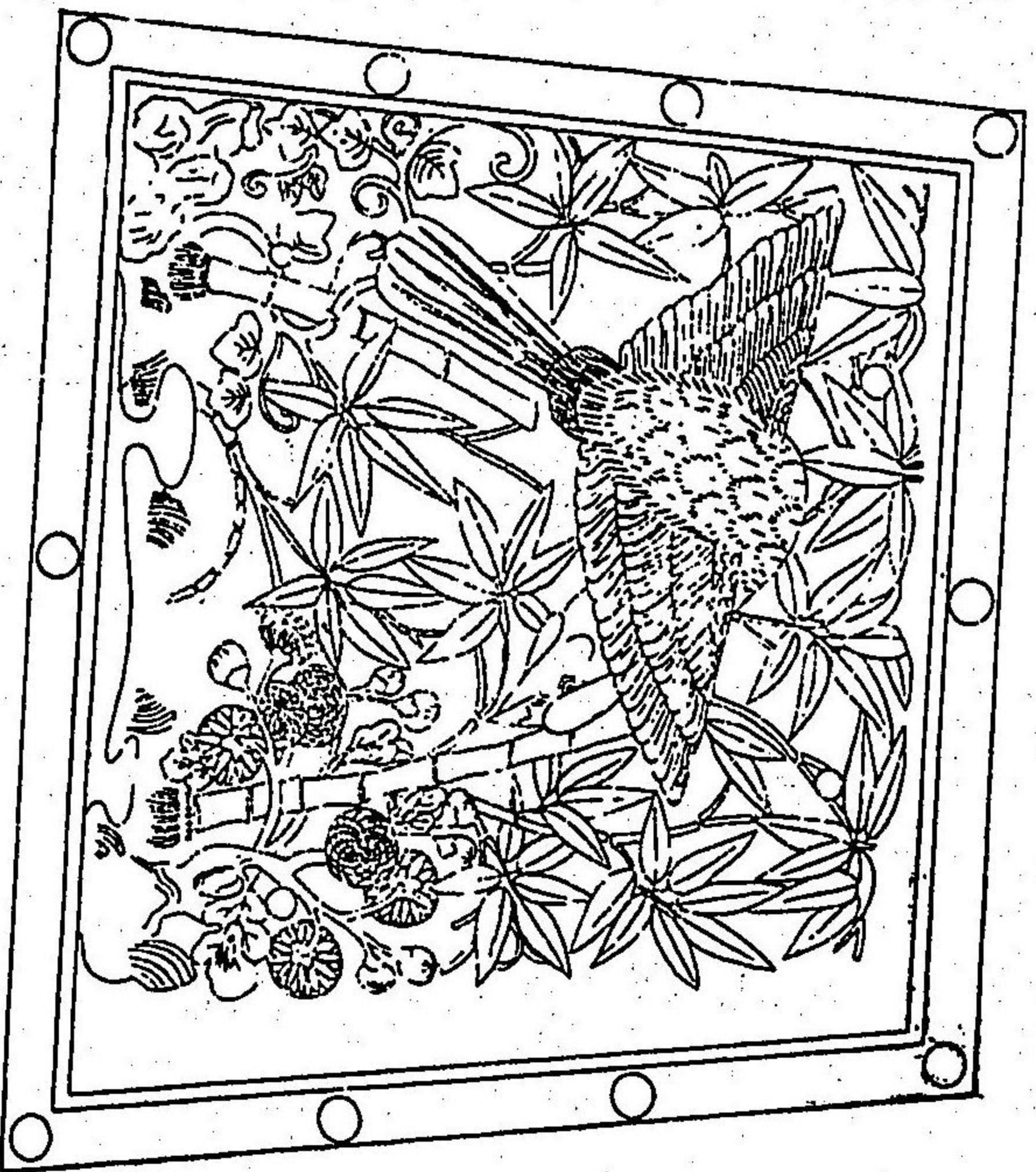



靴 裾 金物
端右



央中後

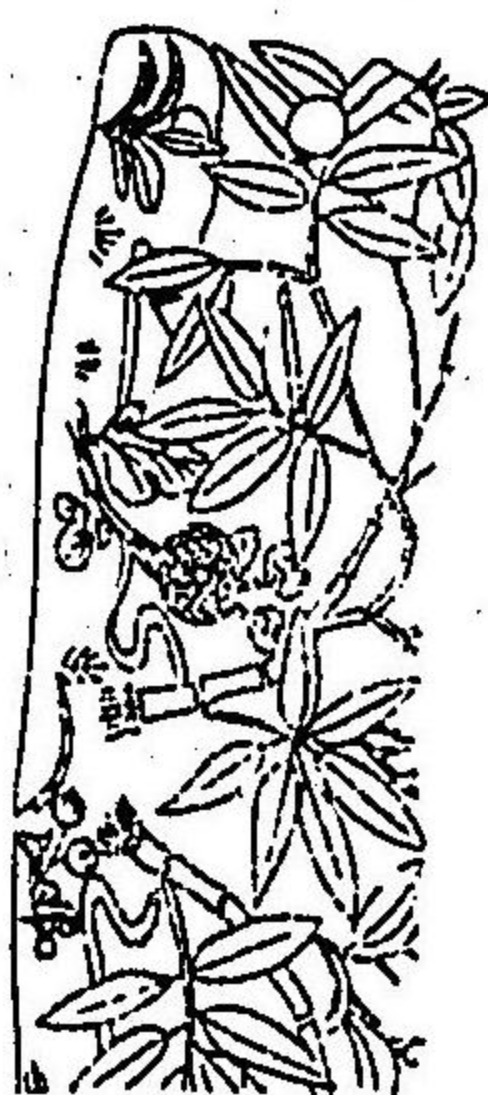

端左



胃裏張
以管如散
其上三章ヲ施
スモノ見ル由

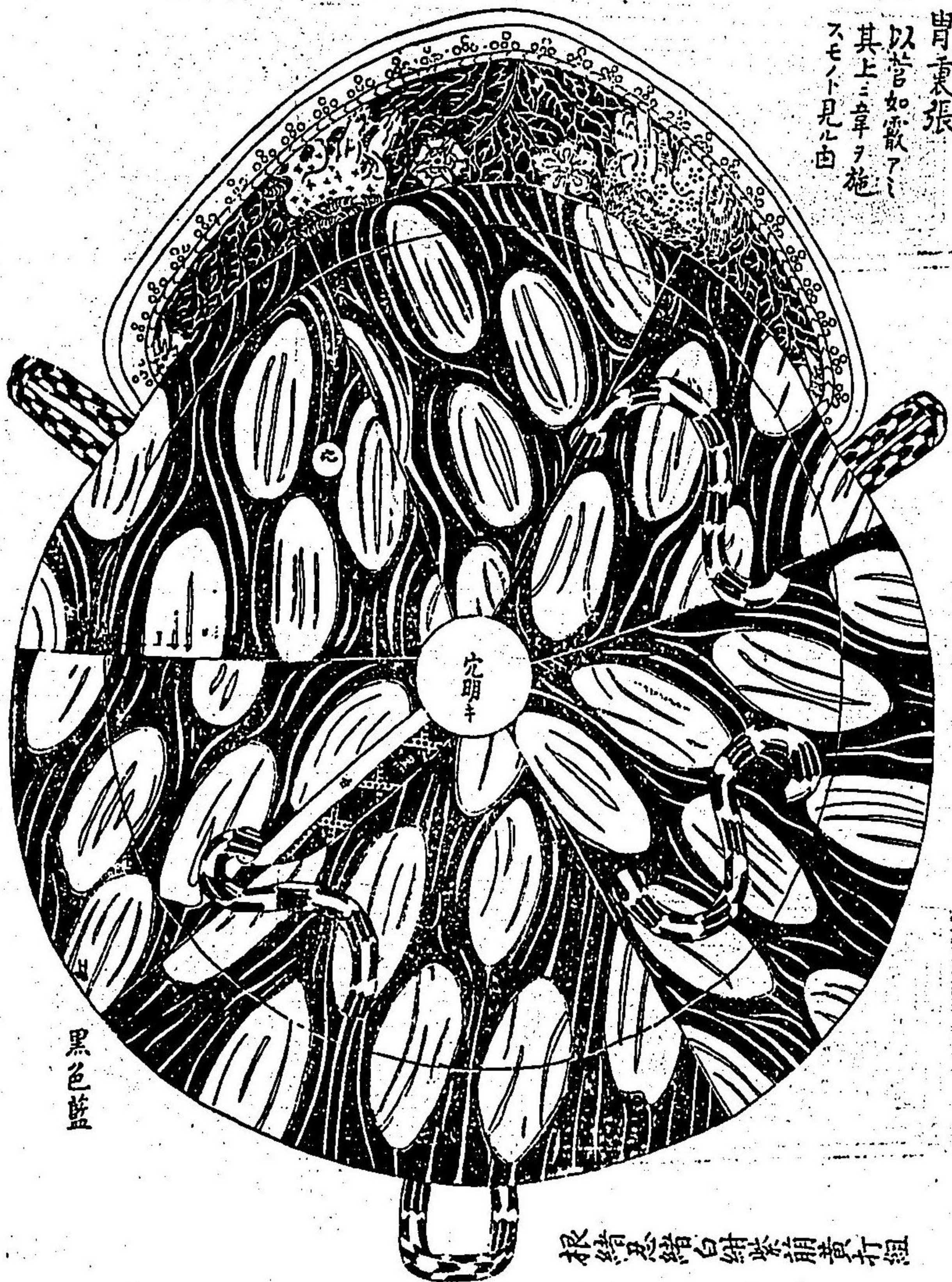

黑色藍

根 結 忍 緒 白 緋 紫 蘭 黃 打 組

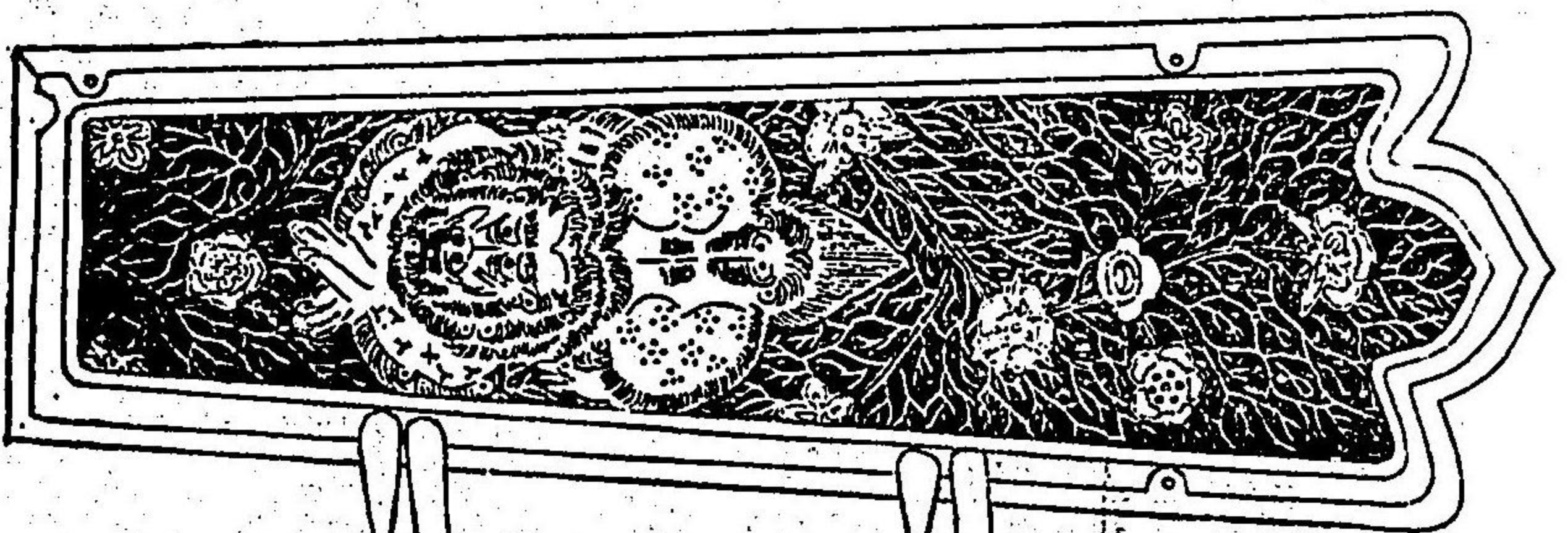

裏

鶴唐組

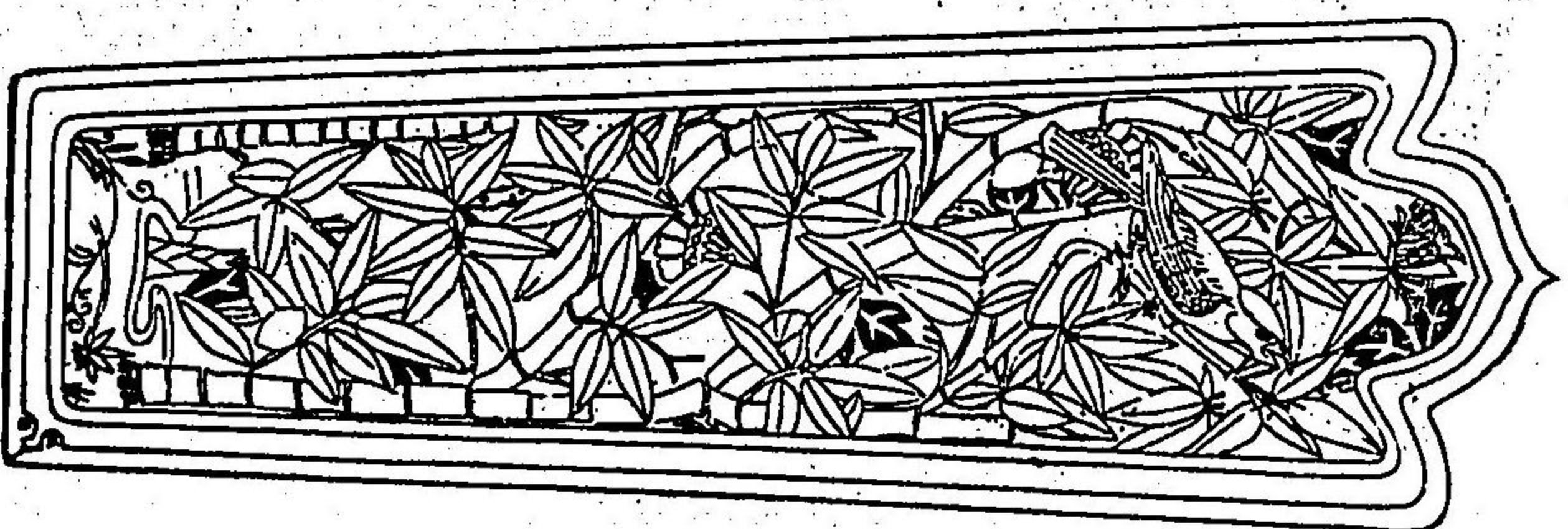

鳩尾板

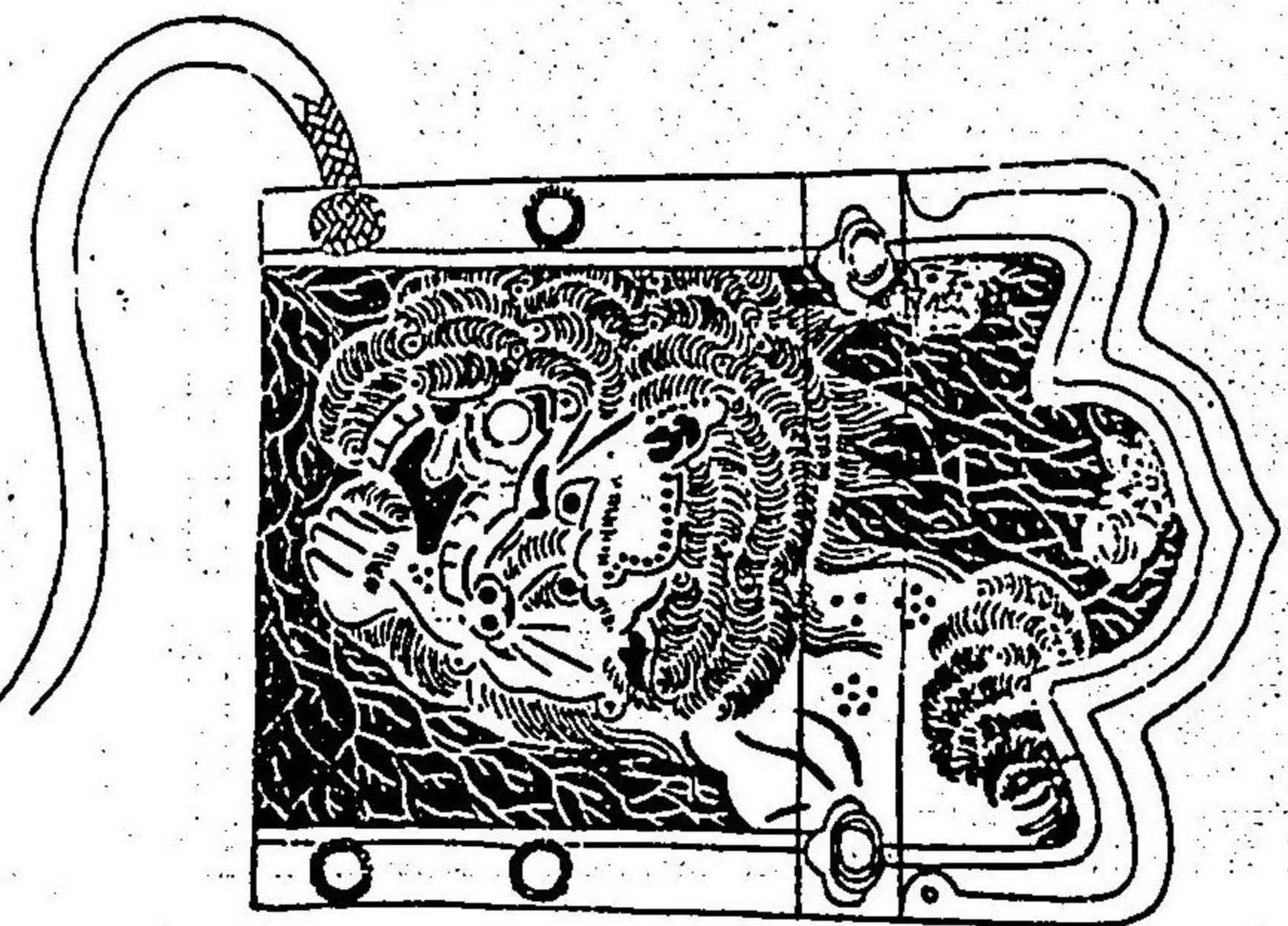

裏

芭加組

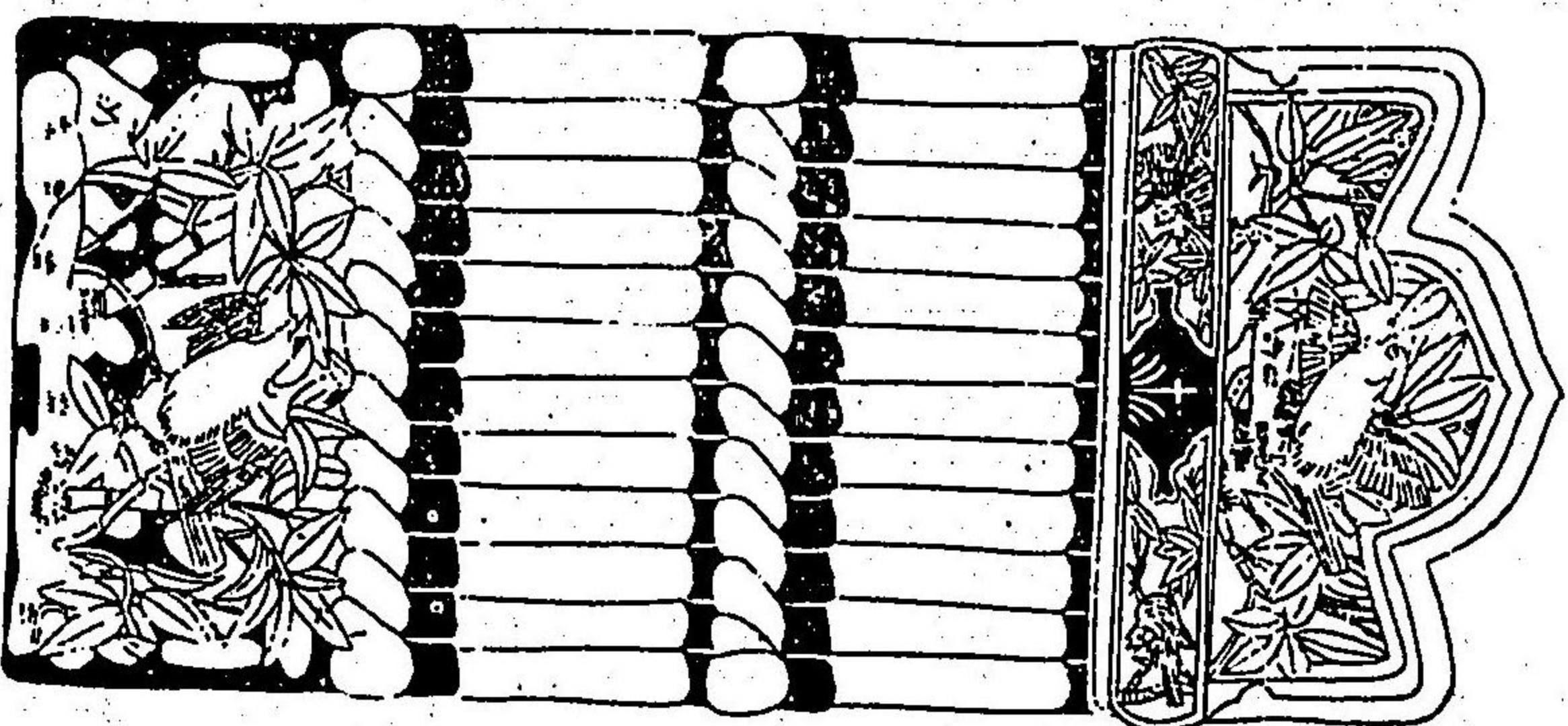

梅檀板

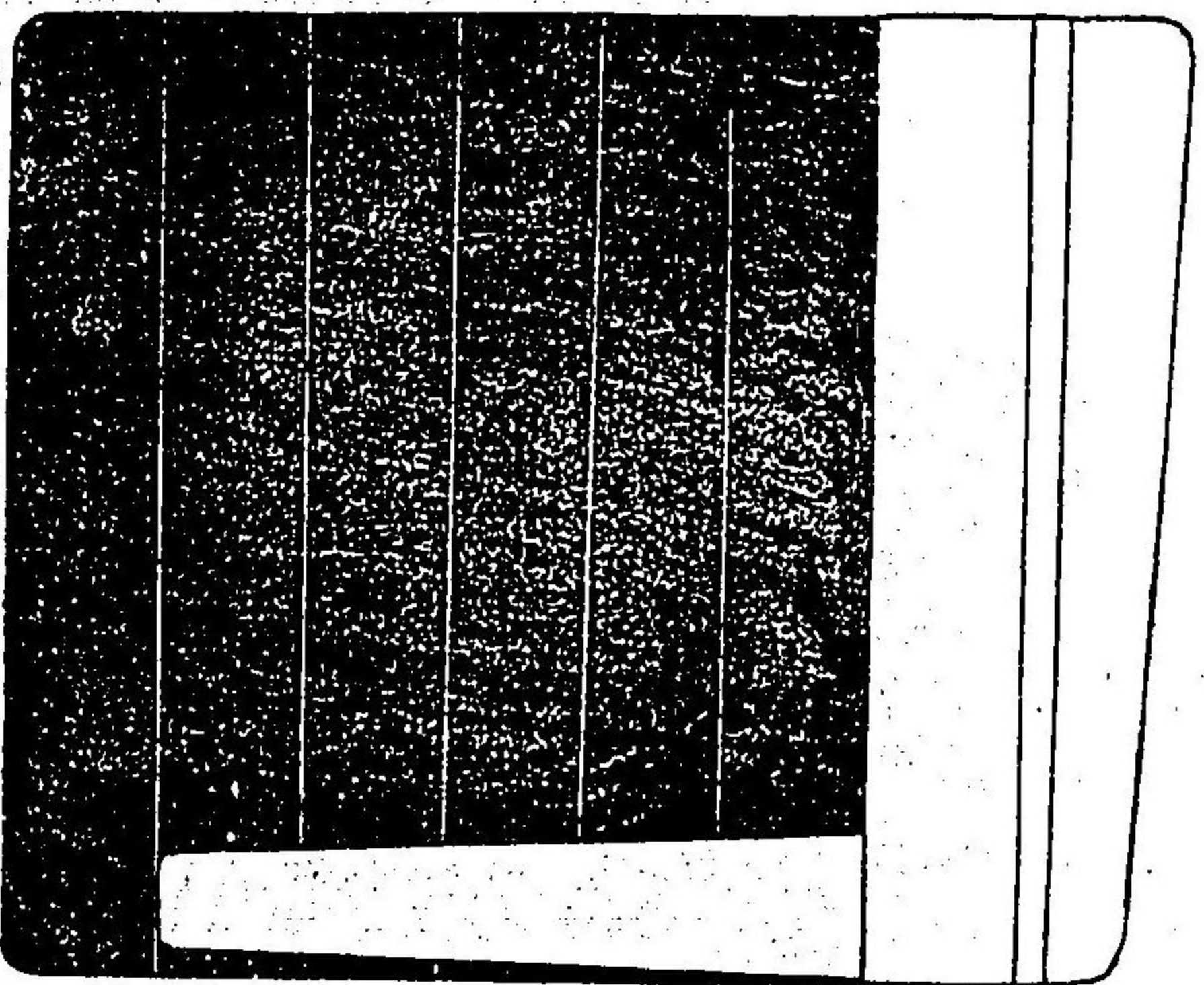

右袖裏
畧圖

小手摺右袖斗有之

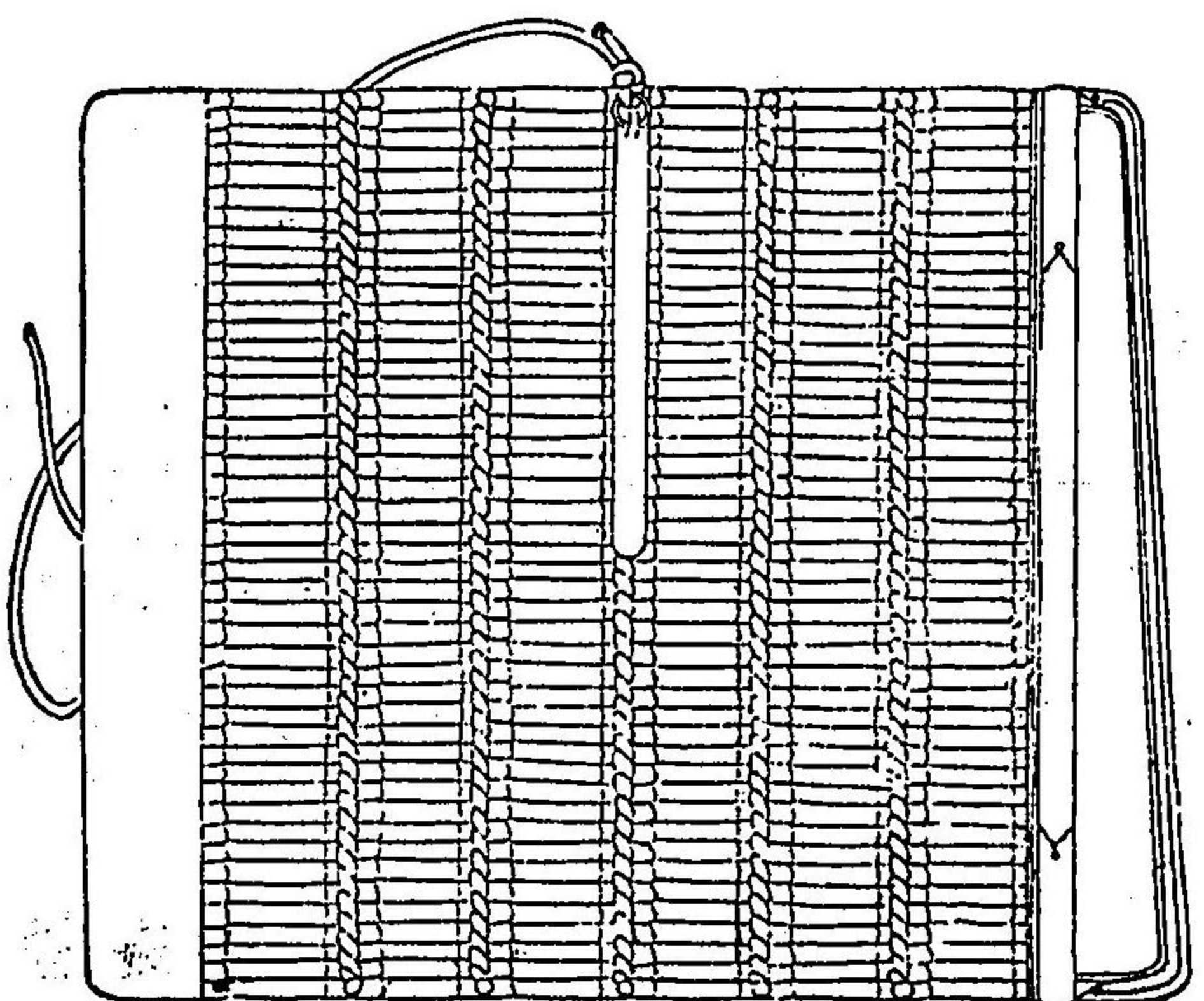

全圖
袖左右一貫七百目

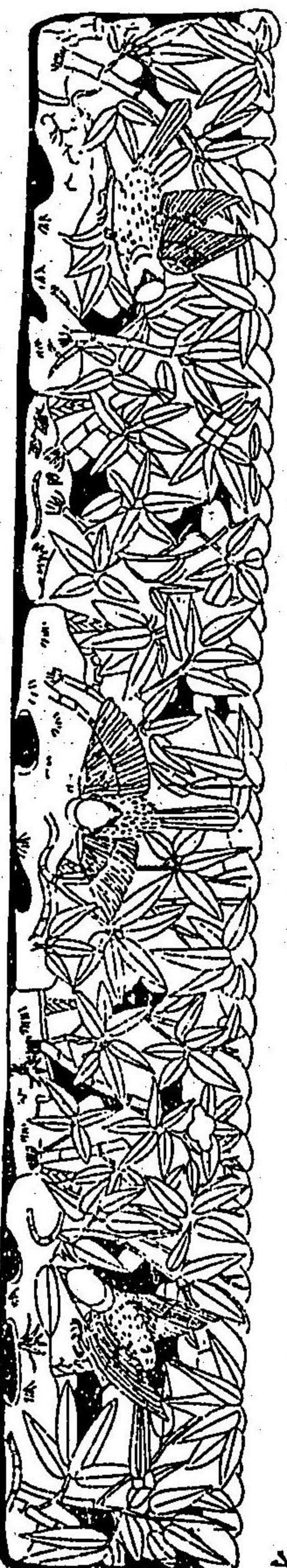

冠板

竹篋間ナリ

水引上紅華下白綾

裾念物

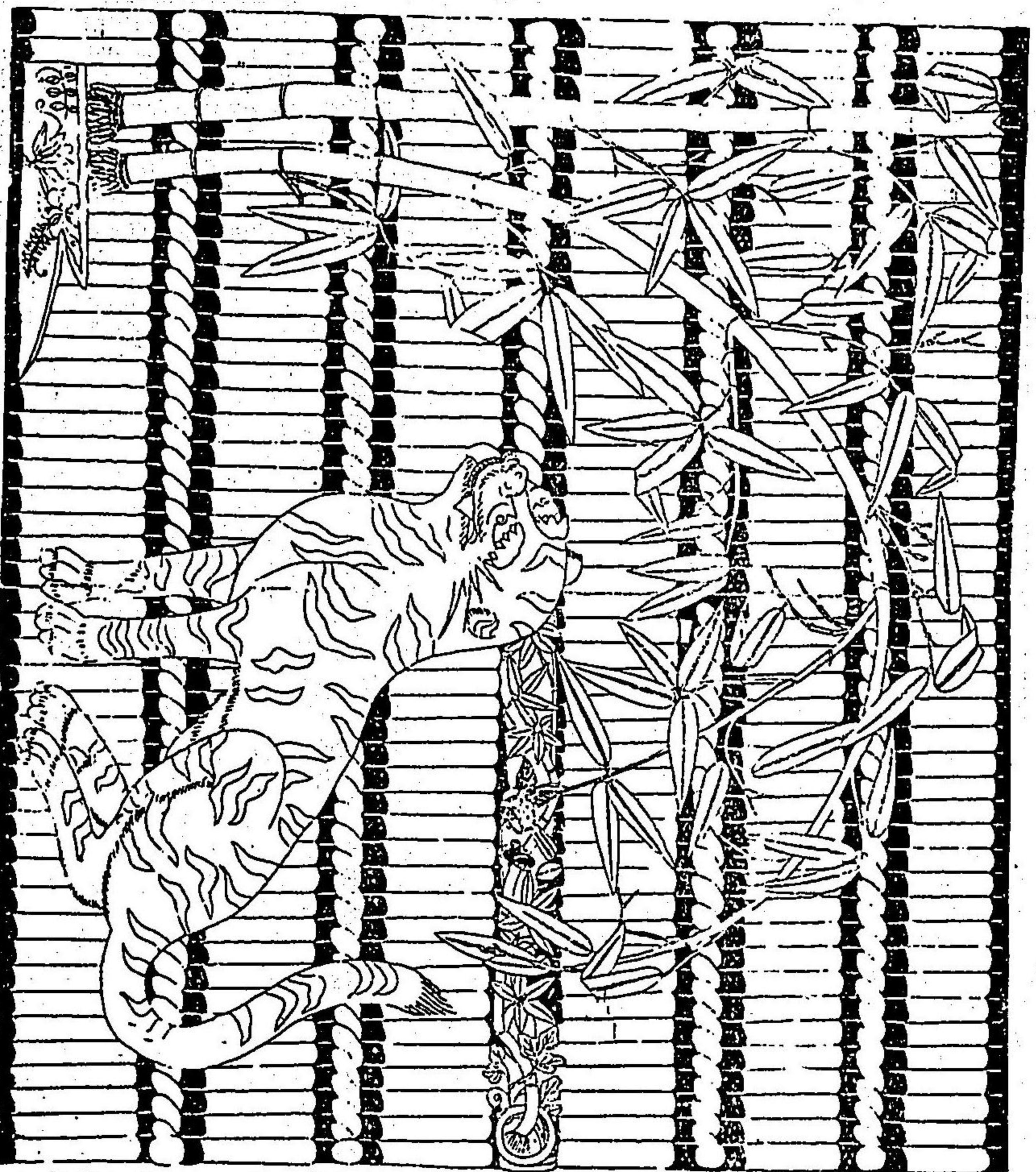

袖金揚

竹虎金物也 白草子以孔三寸之紅水春繪射夫



緒左右共紛失

裏

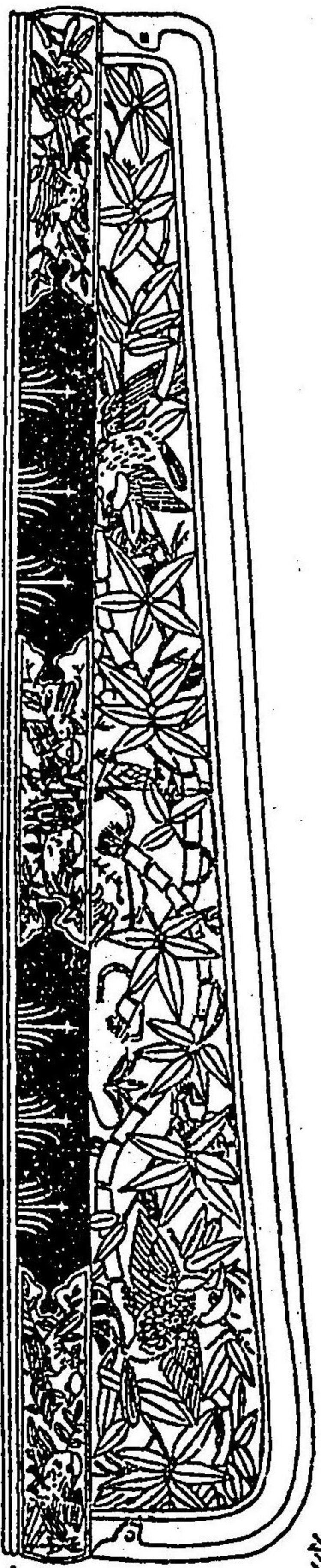

冠板



裙金物

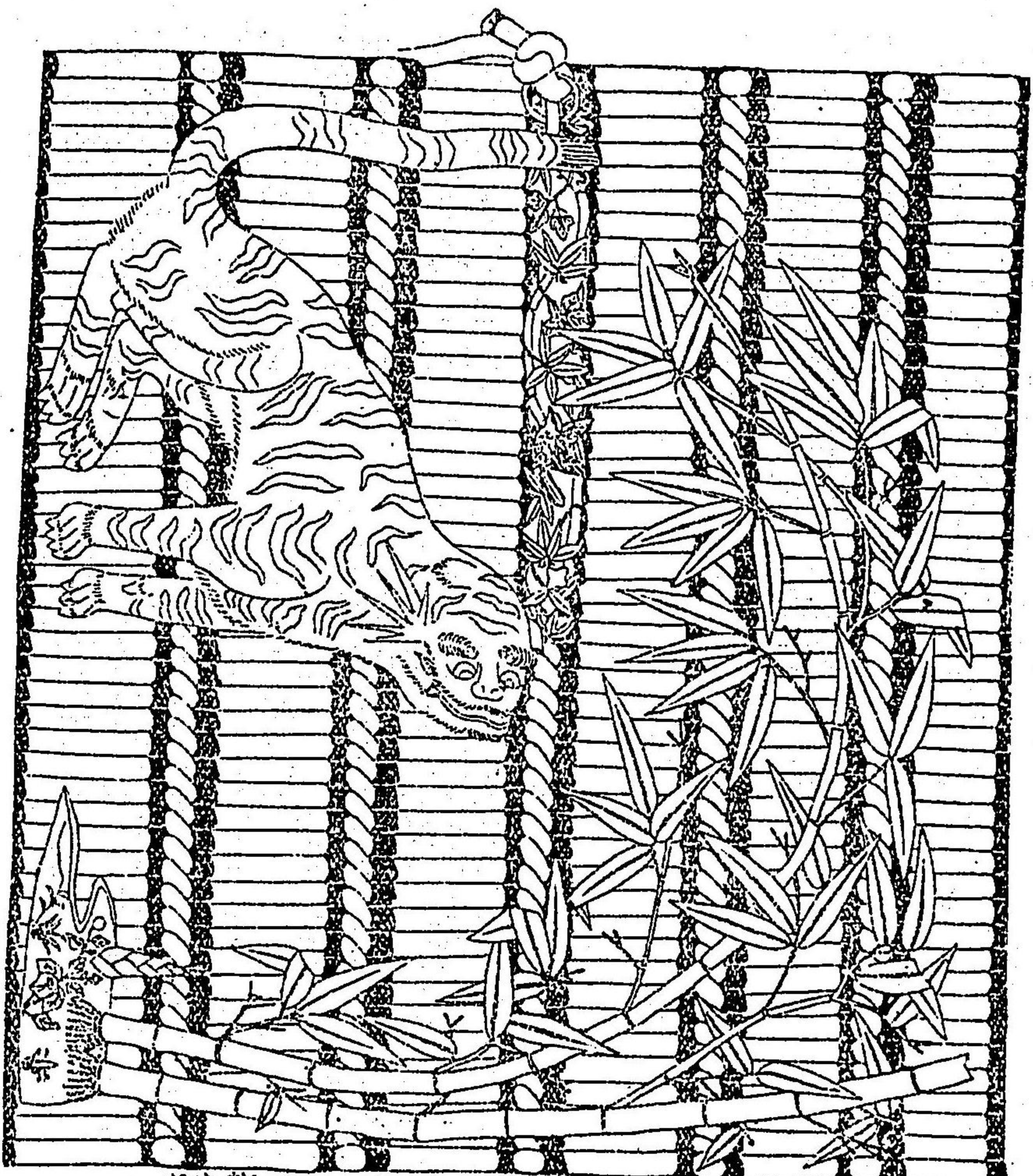

袖金物

袖金物

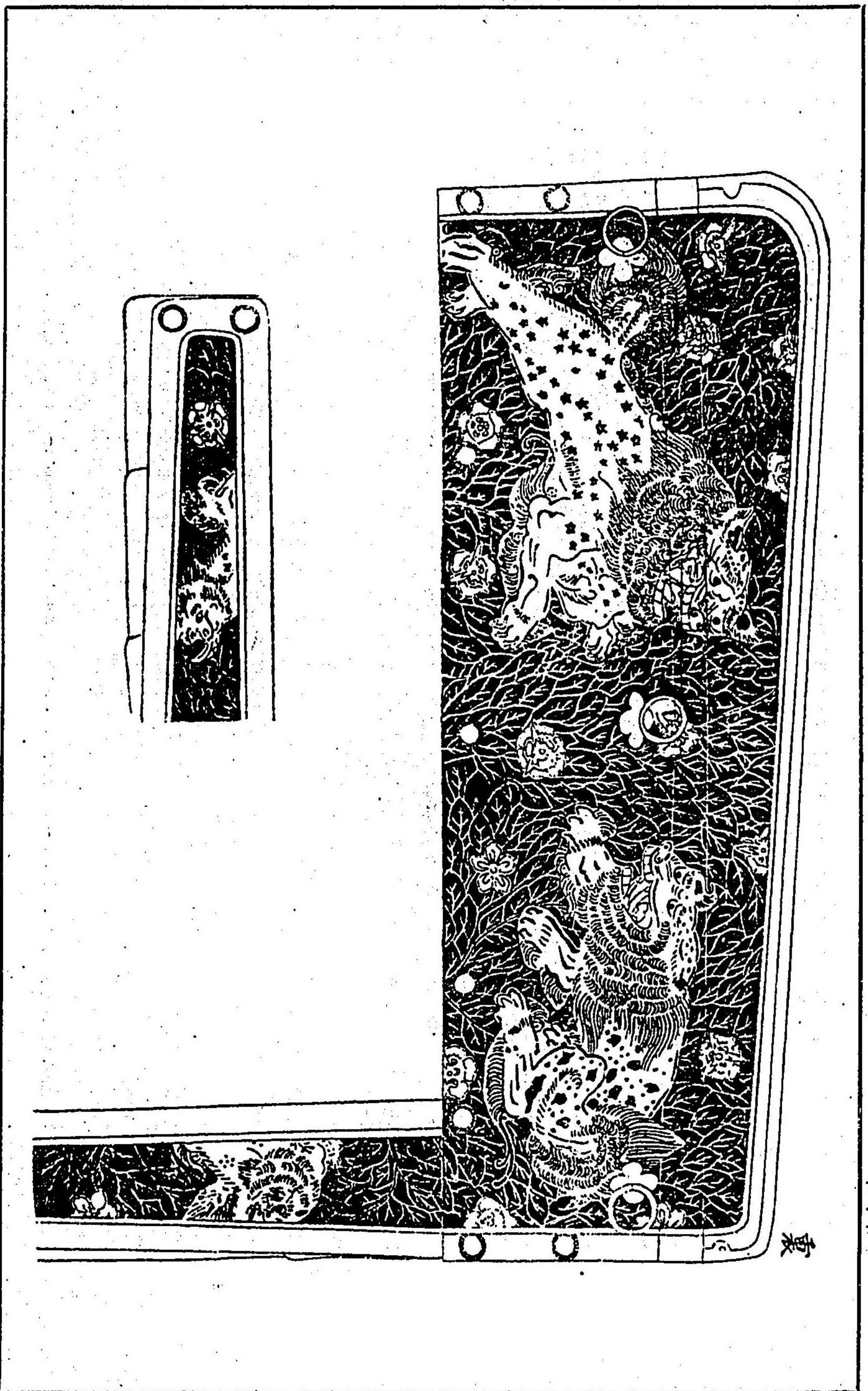

冑

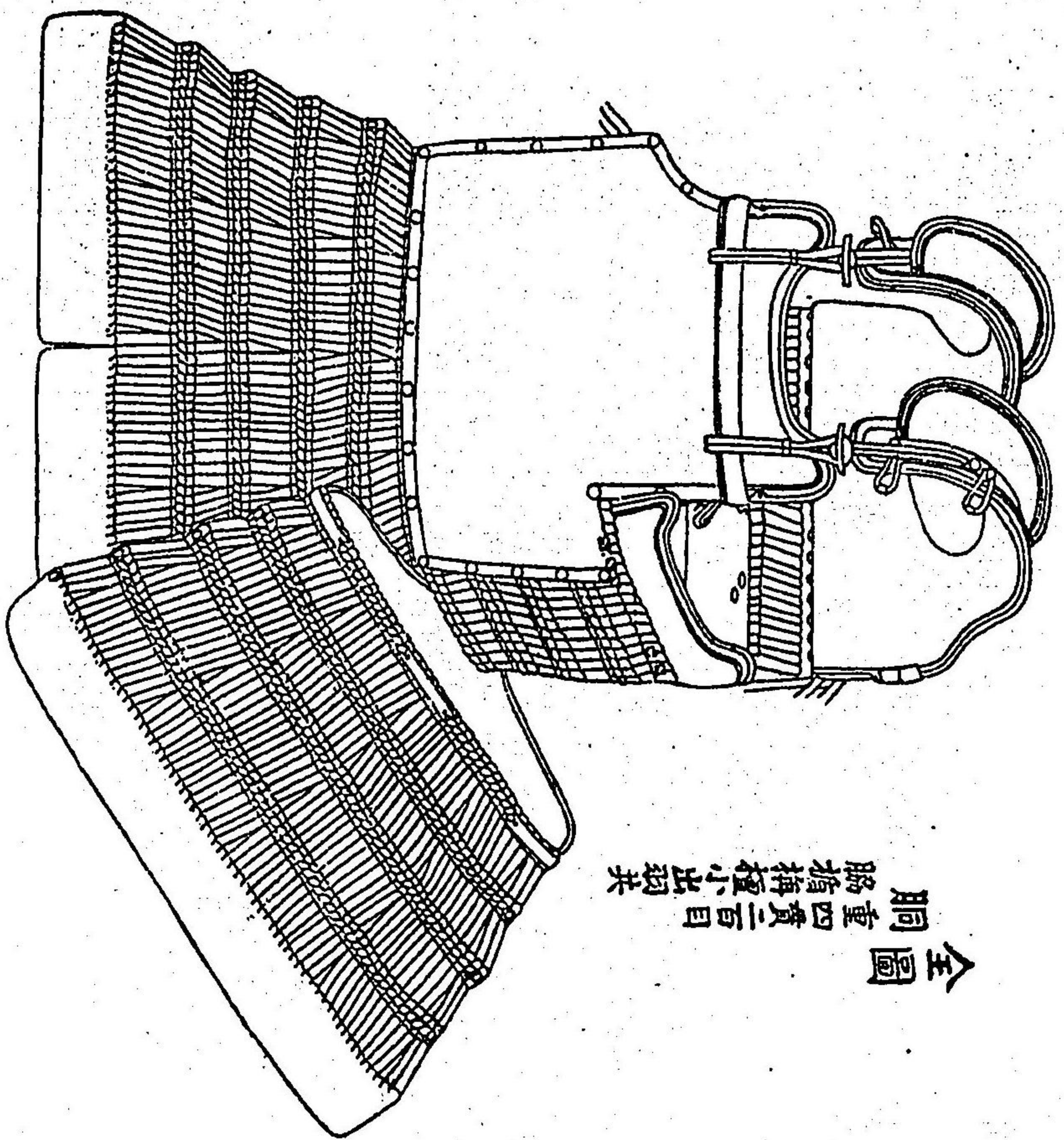

全圖
銅重四貫二百
兩擔梅檀小出類共

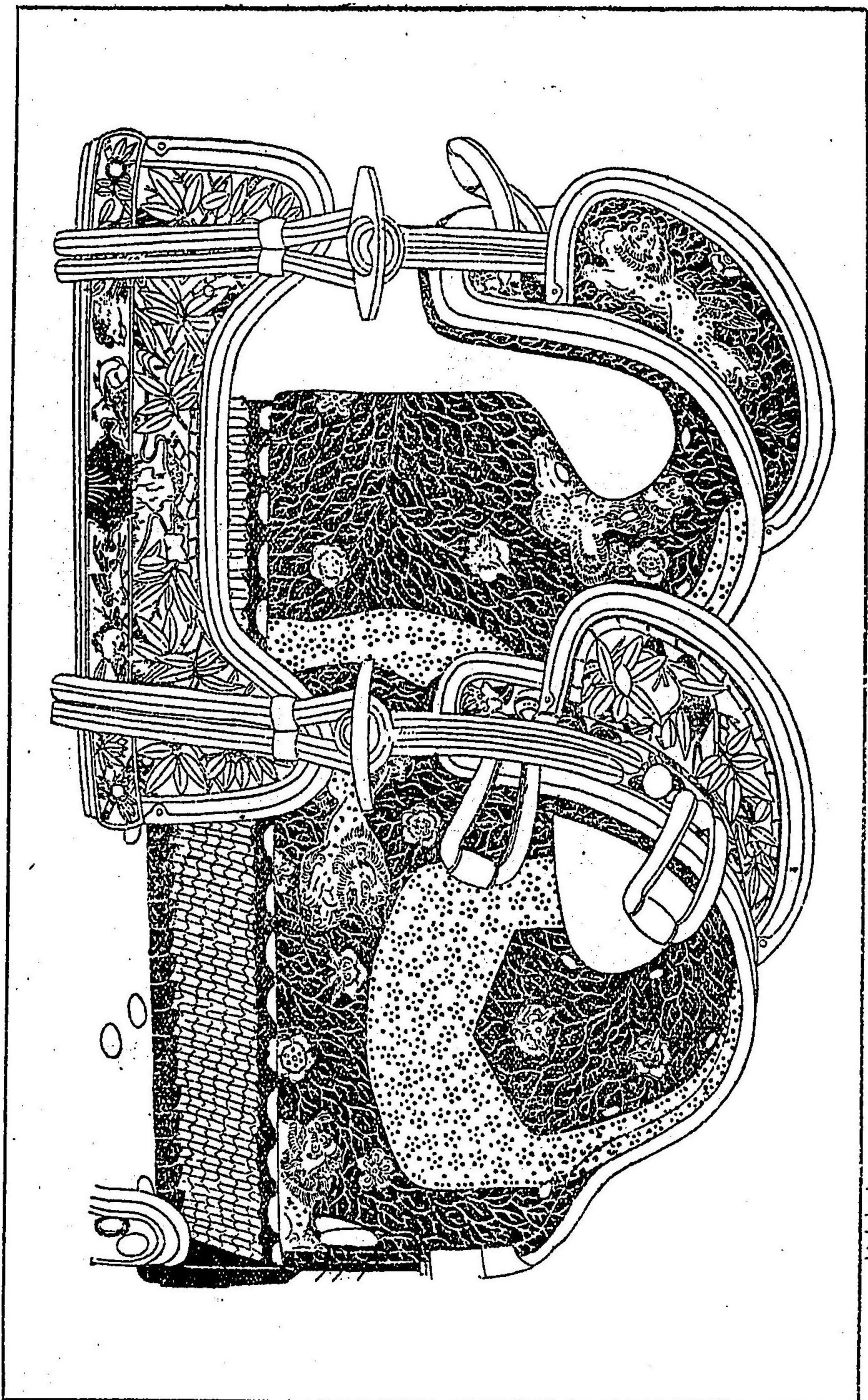

弦走

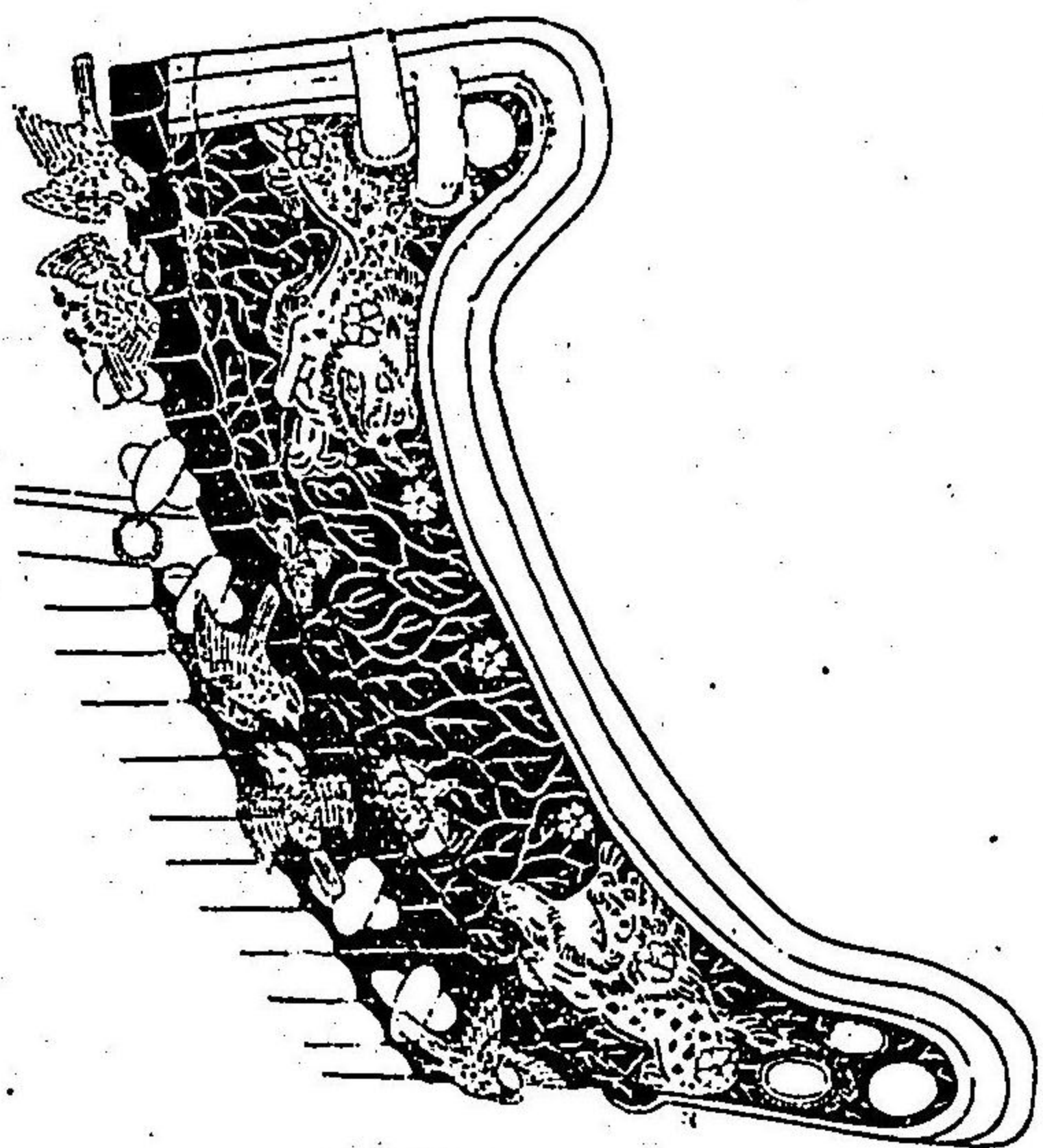

雀頭鉄木

射向

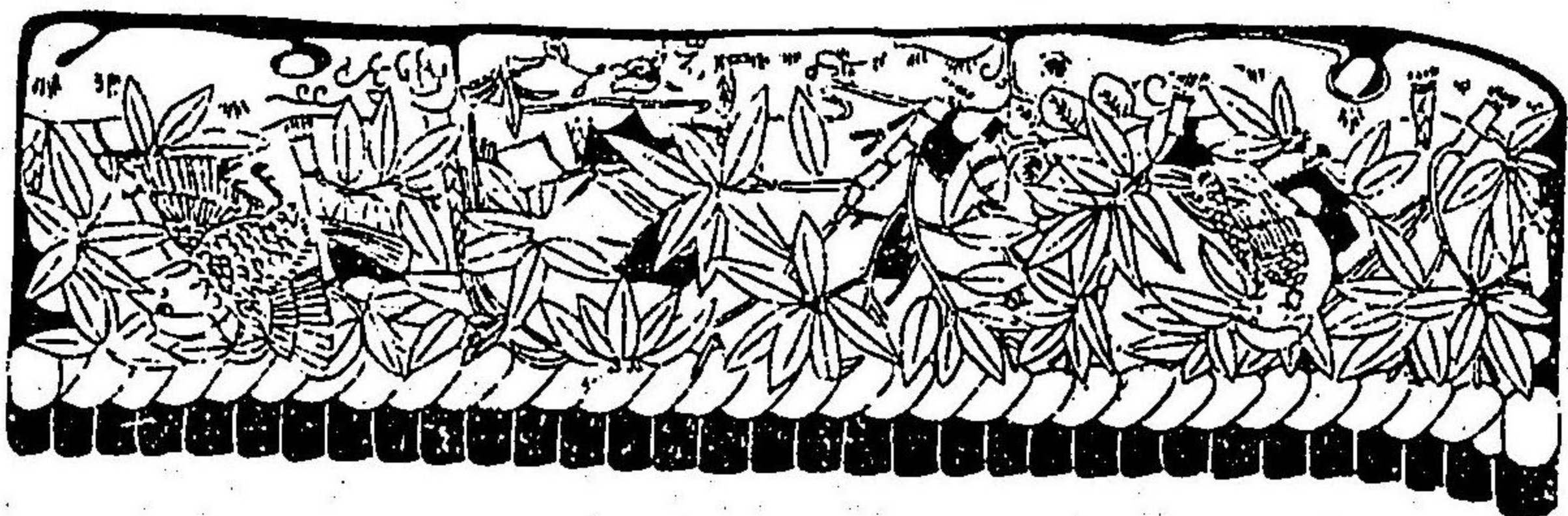
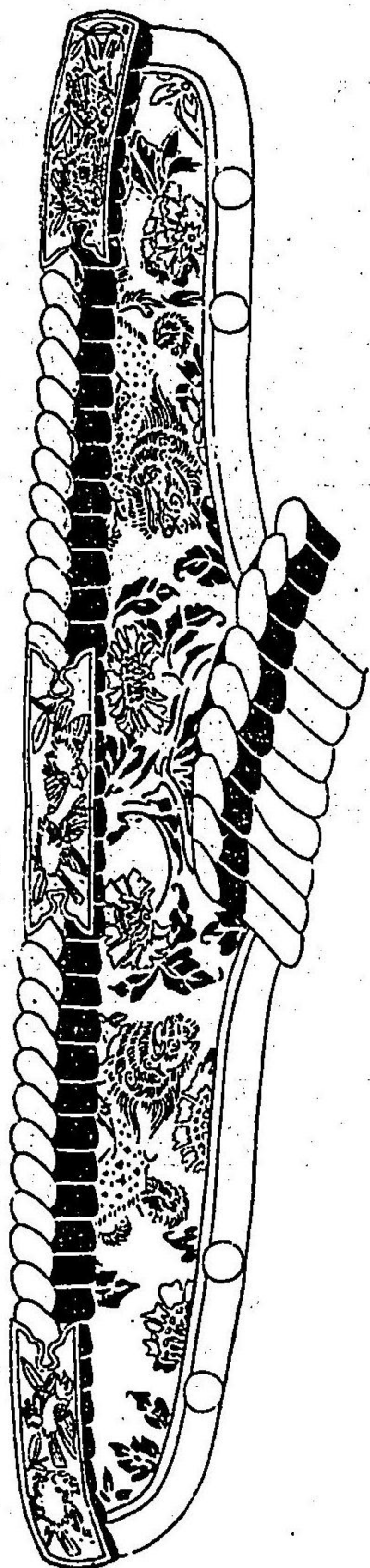

前裾金物

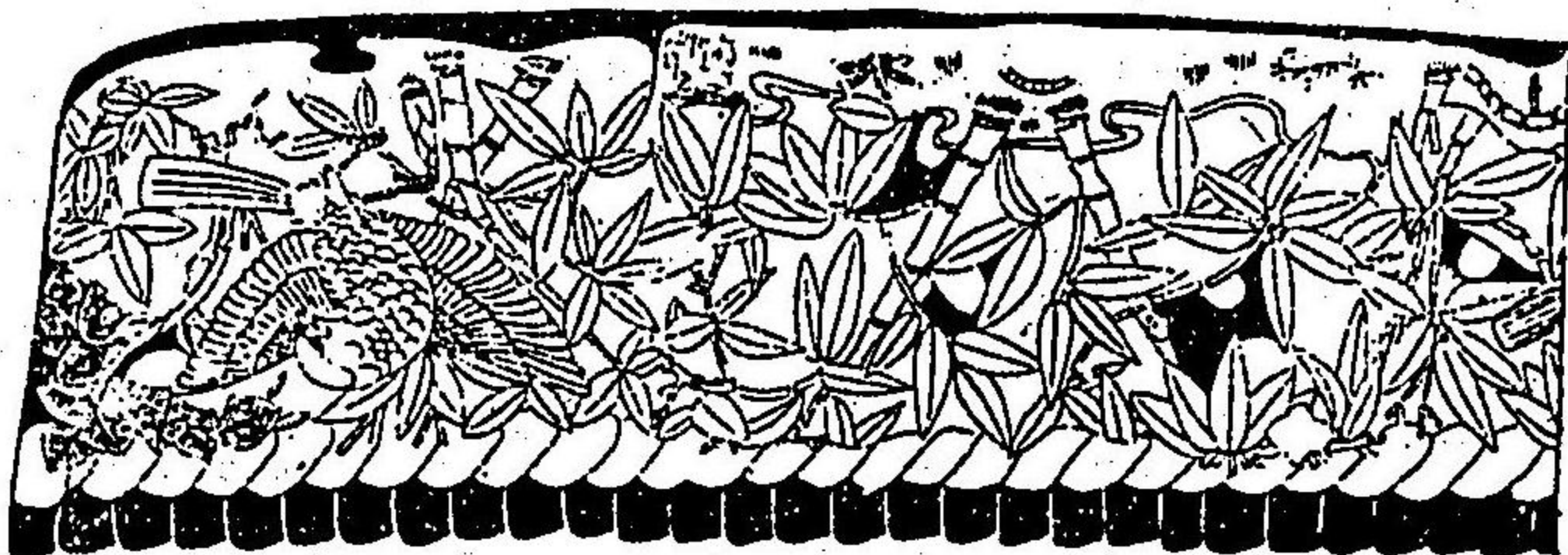
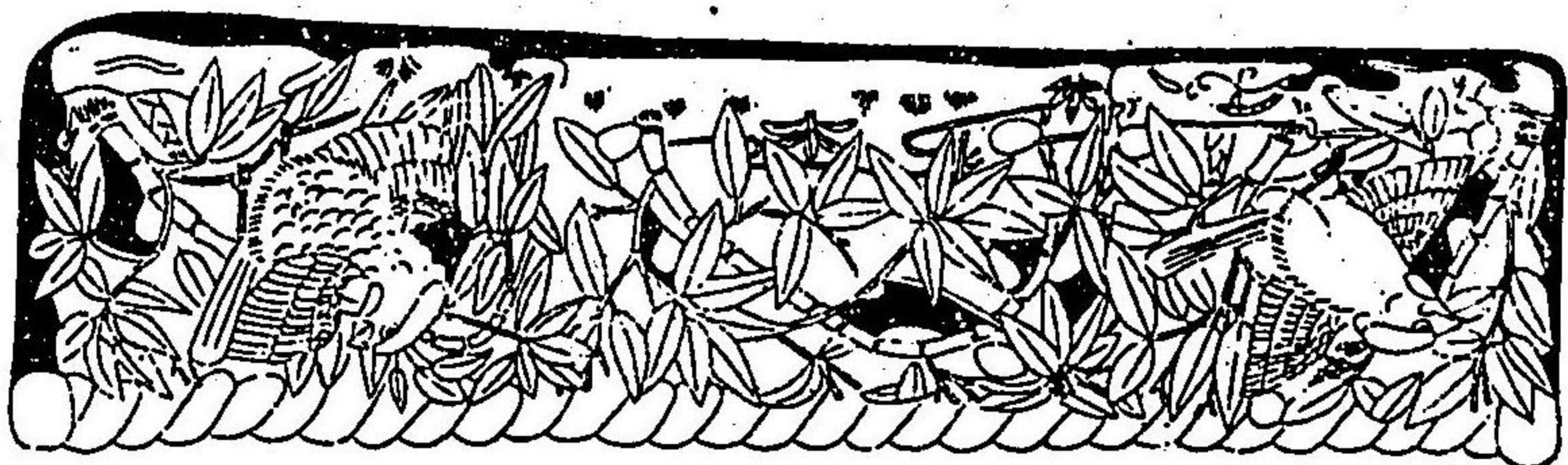

射向裾金物

全圖

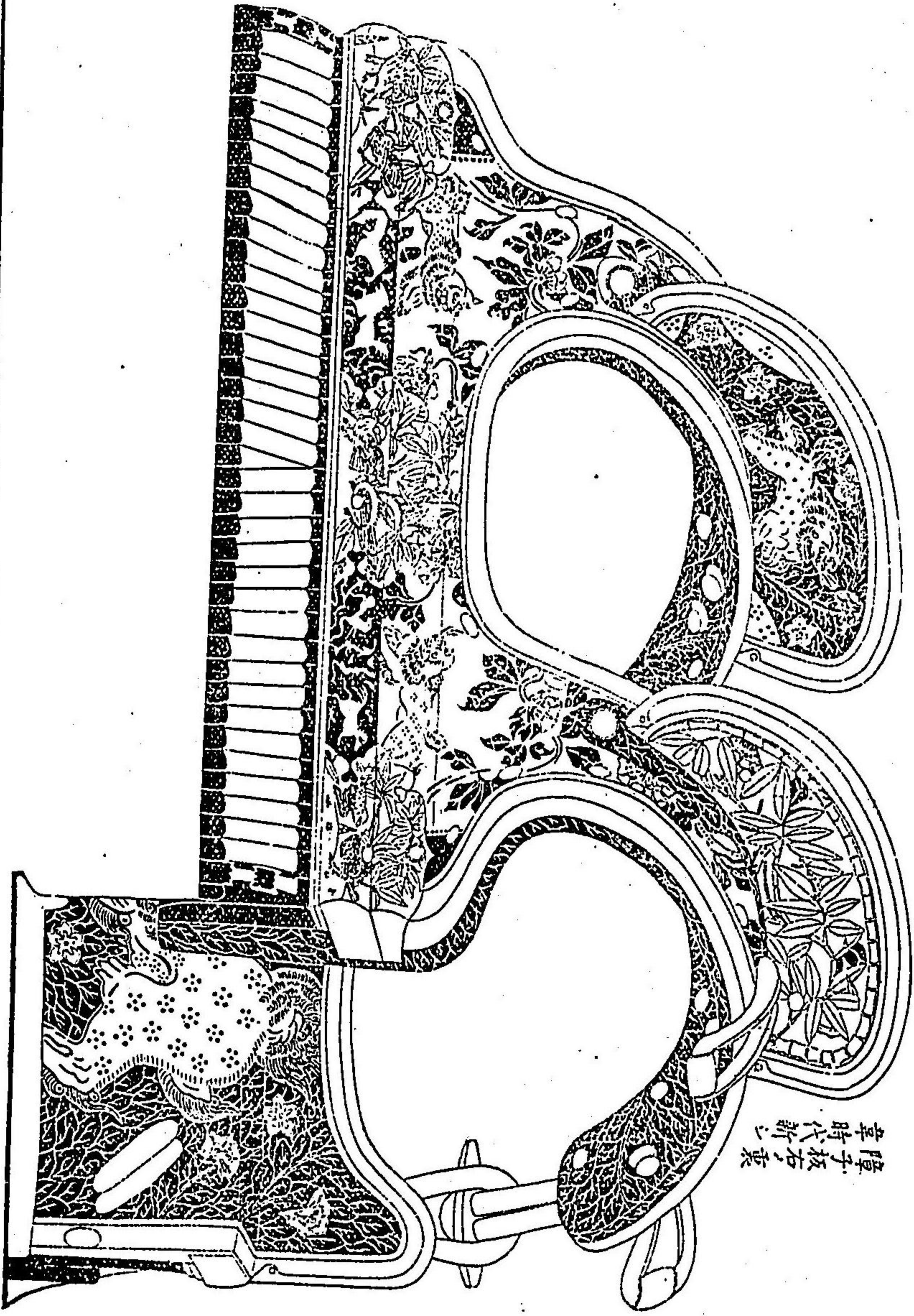
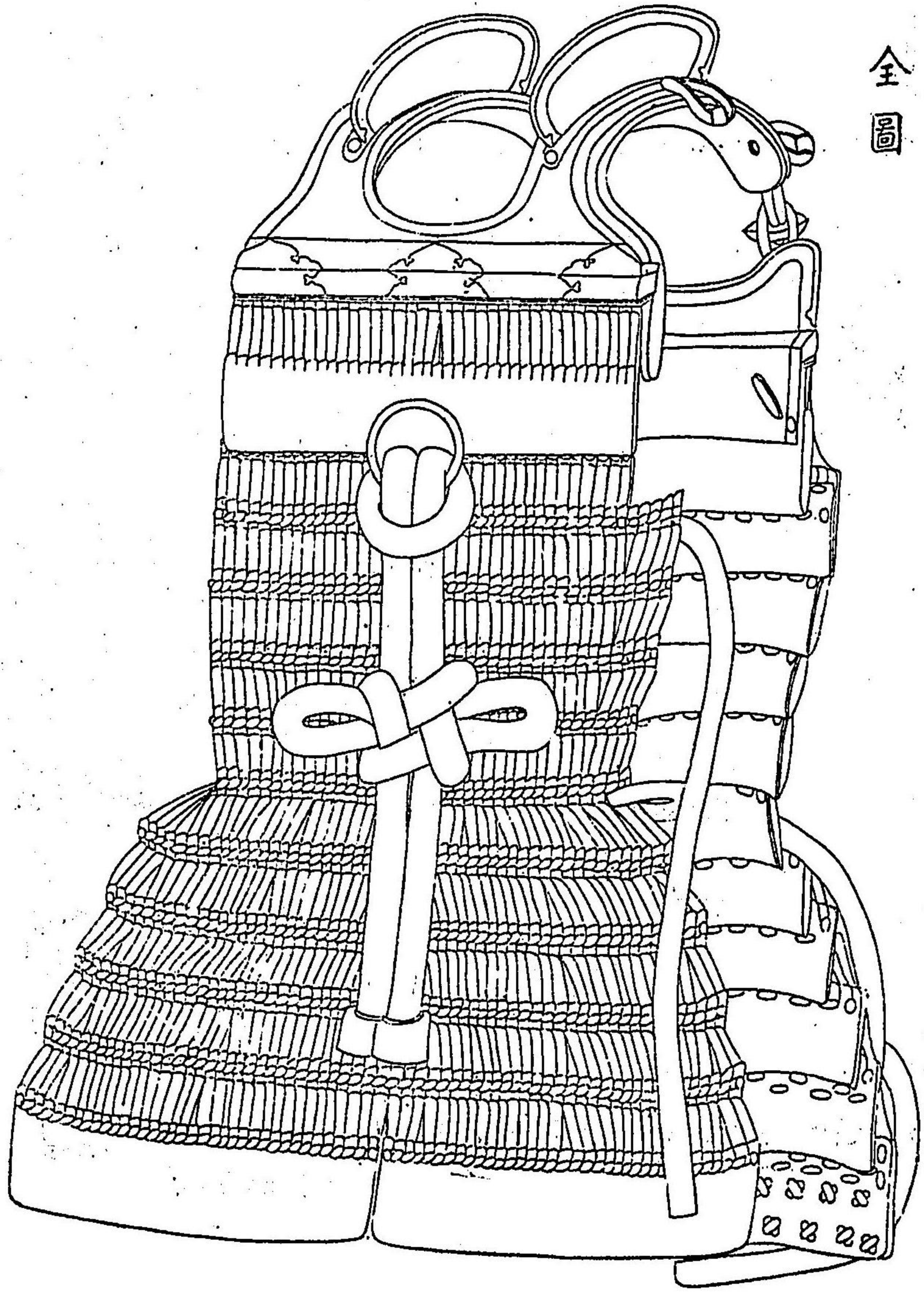

隆子板石之東
皇時代新



逆板
總角

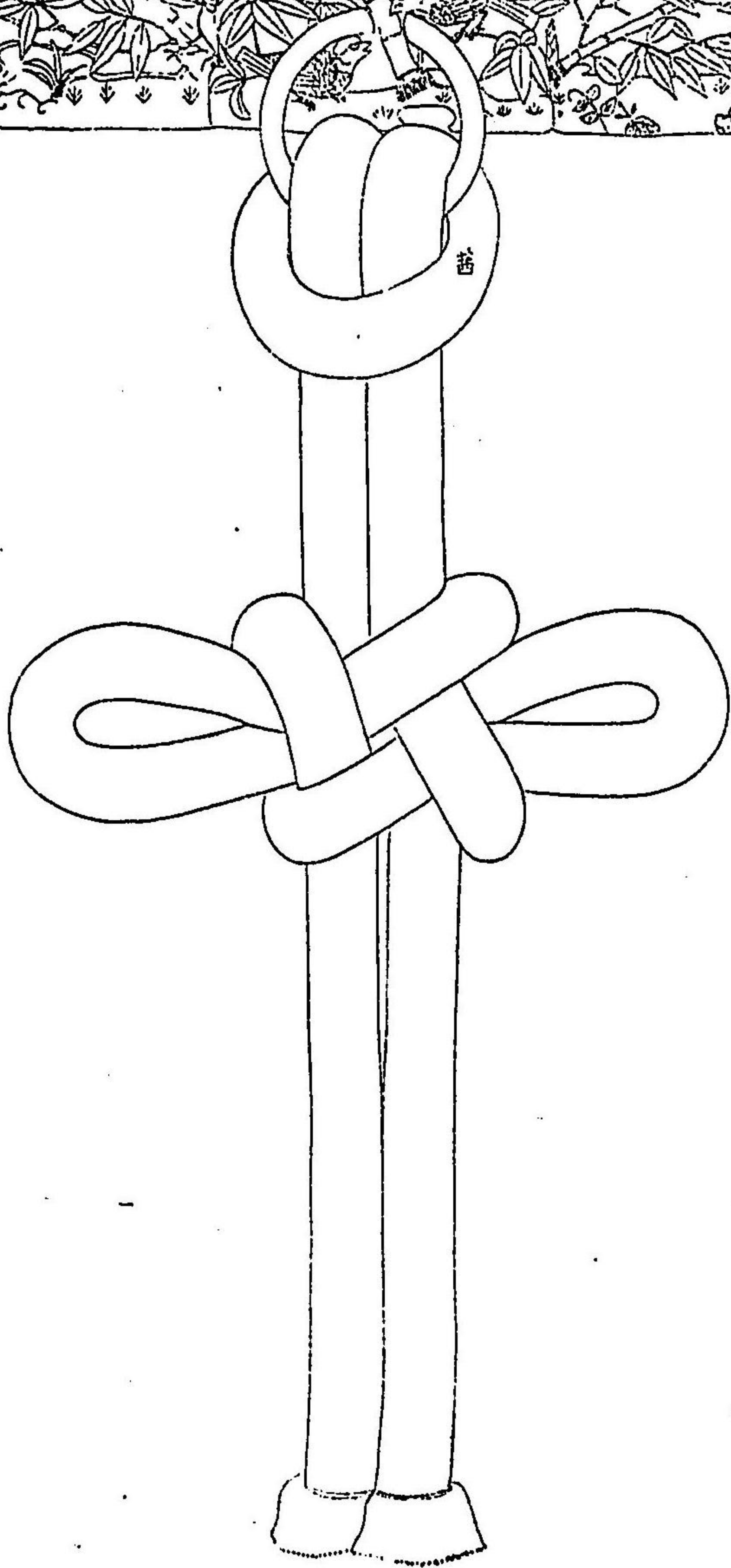

妻手圖

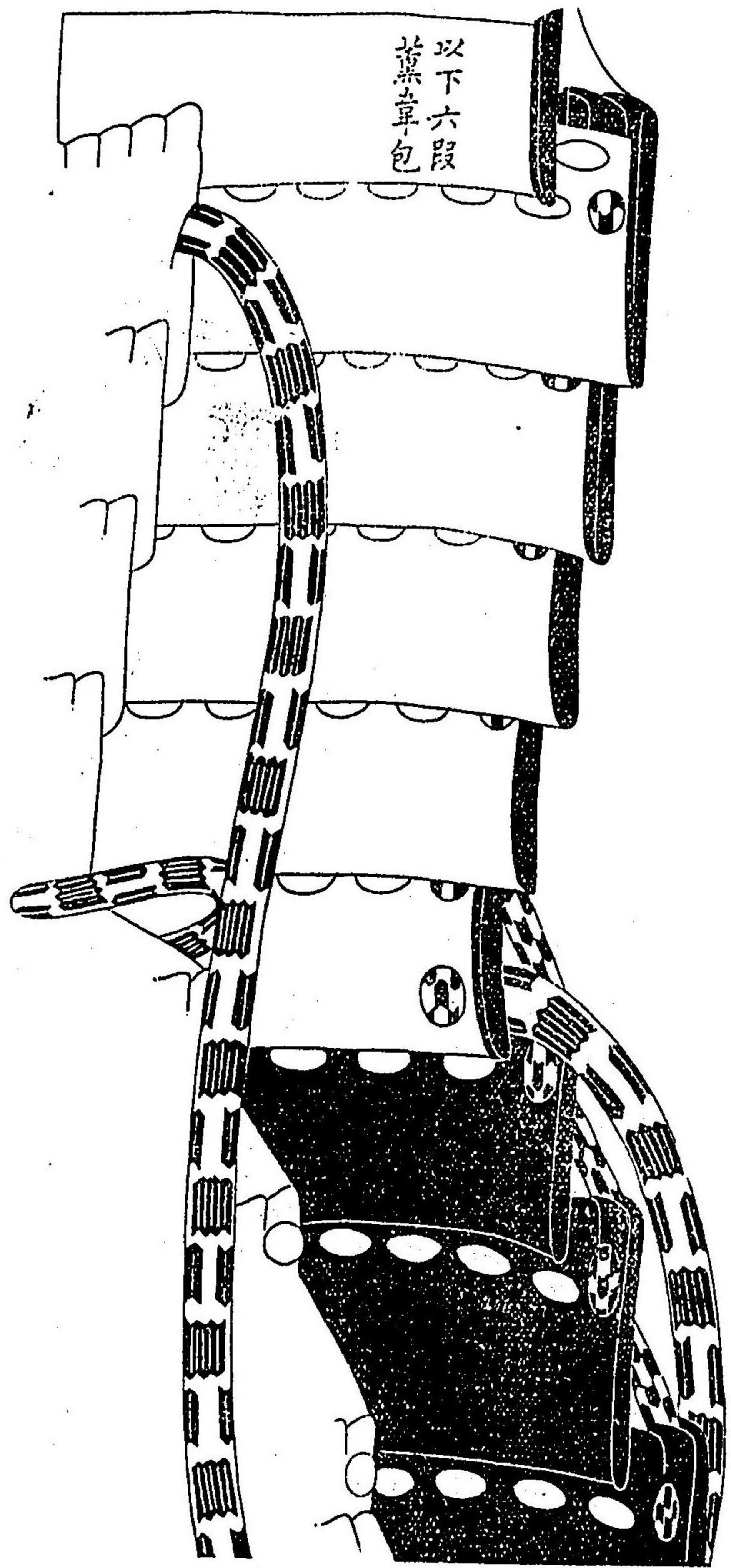

以下六段
葉草包

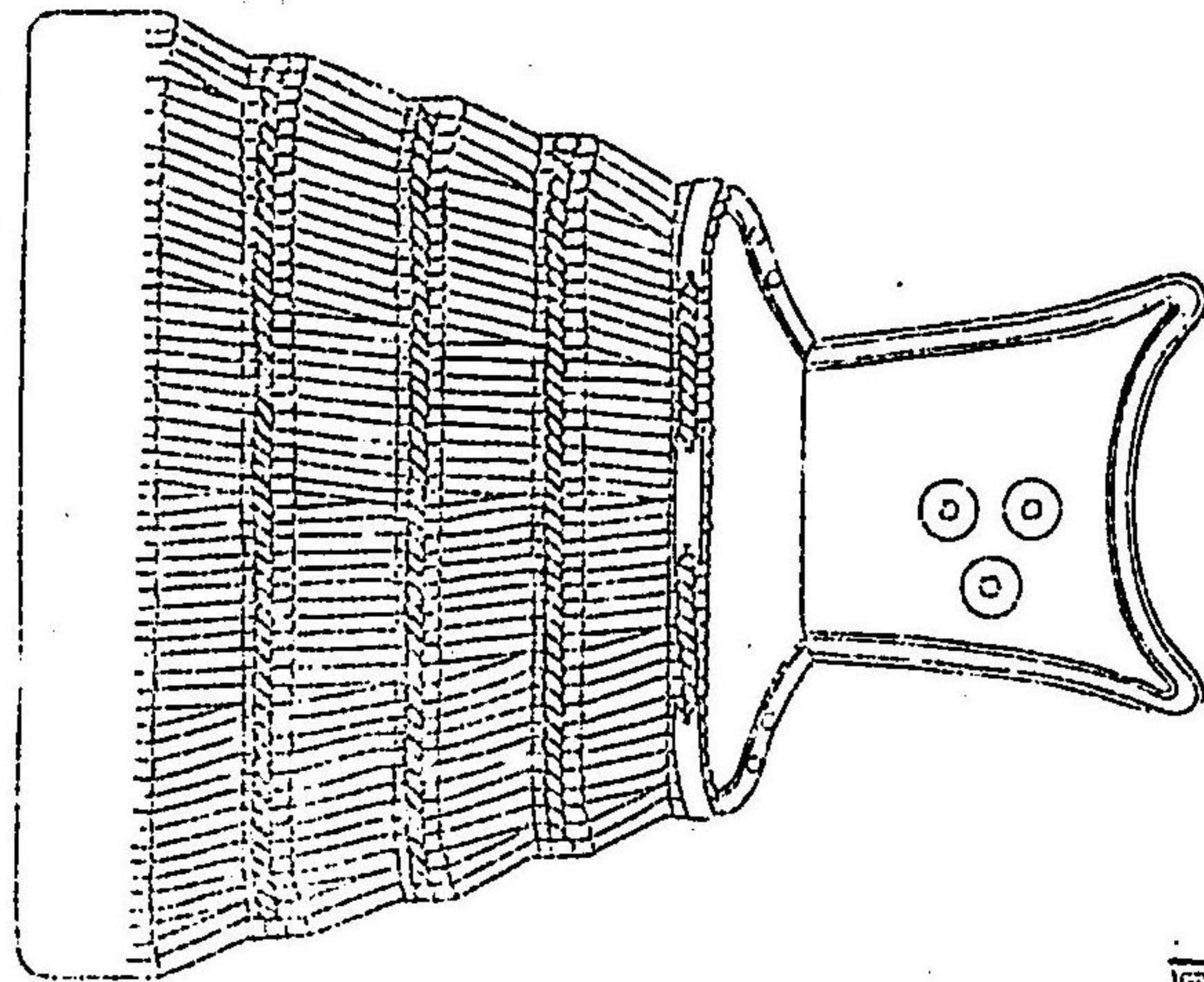

全圖

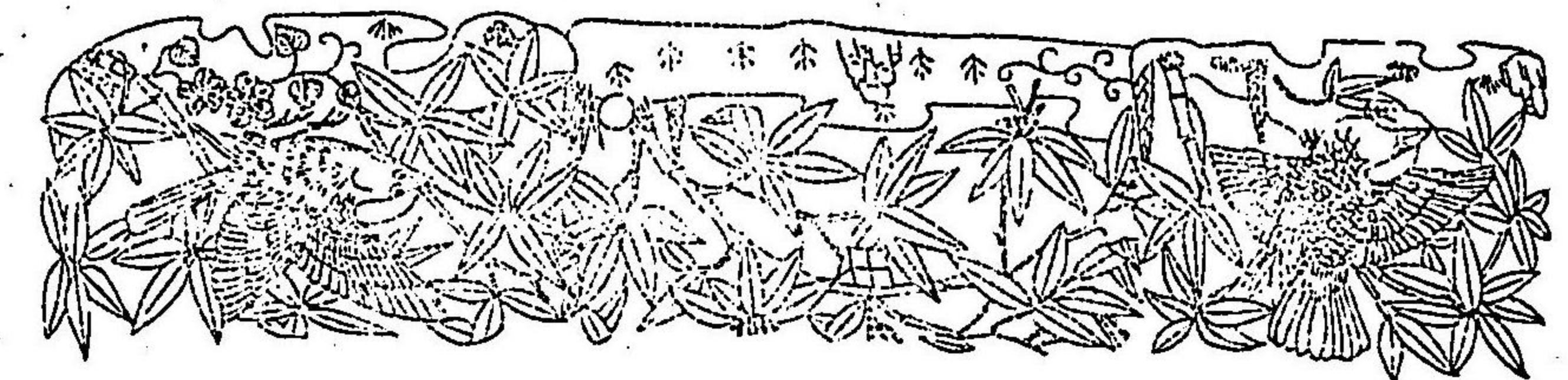
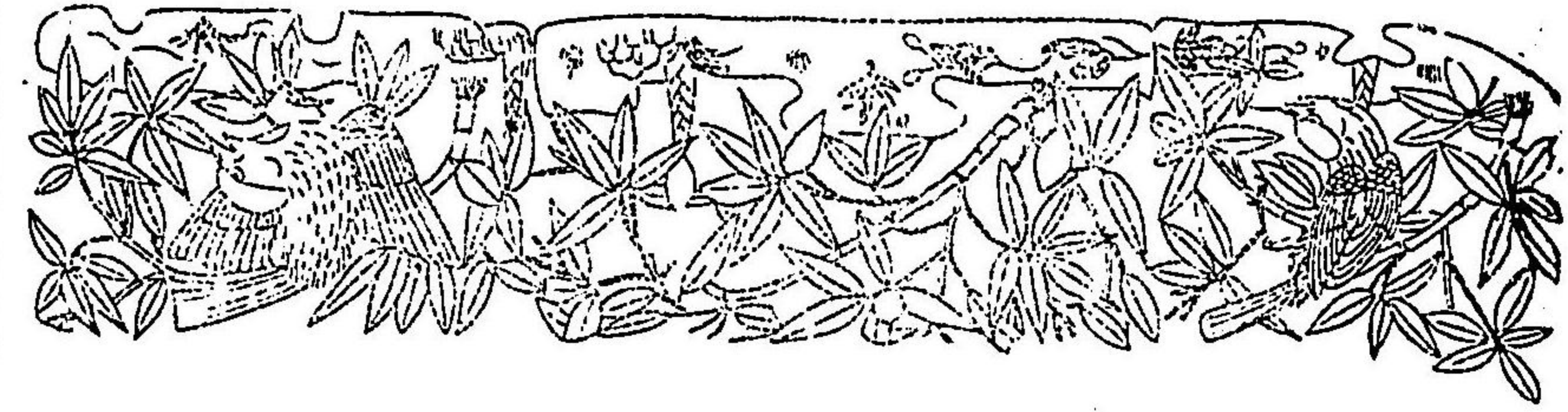

後裙金物

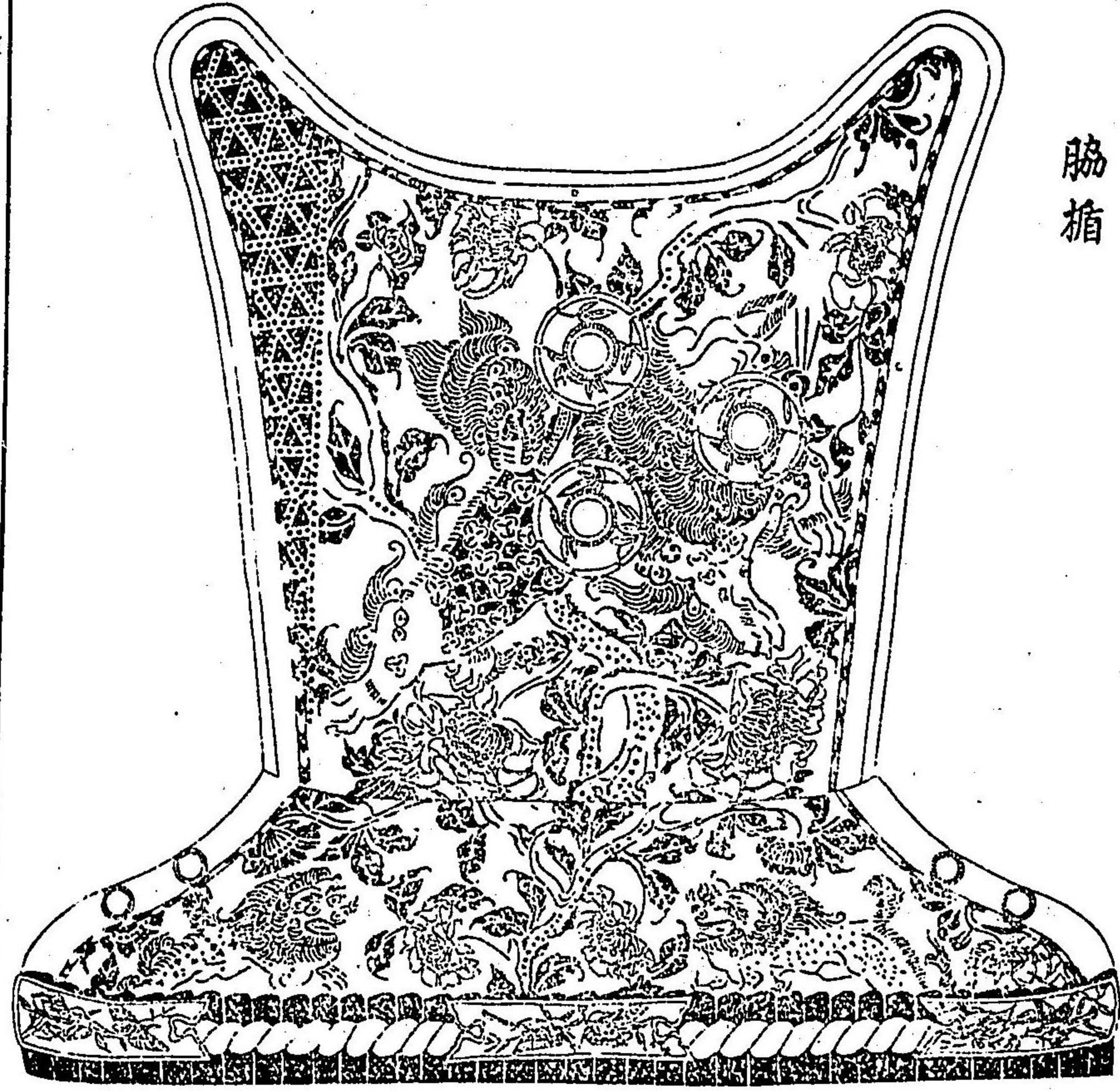

脇楯

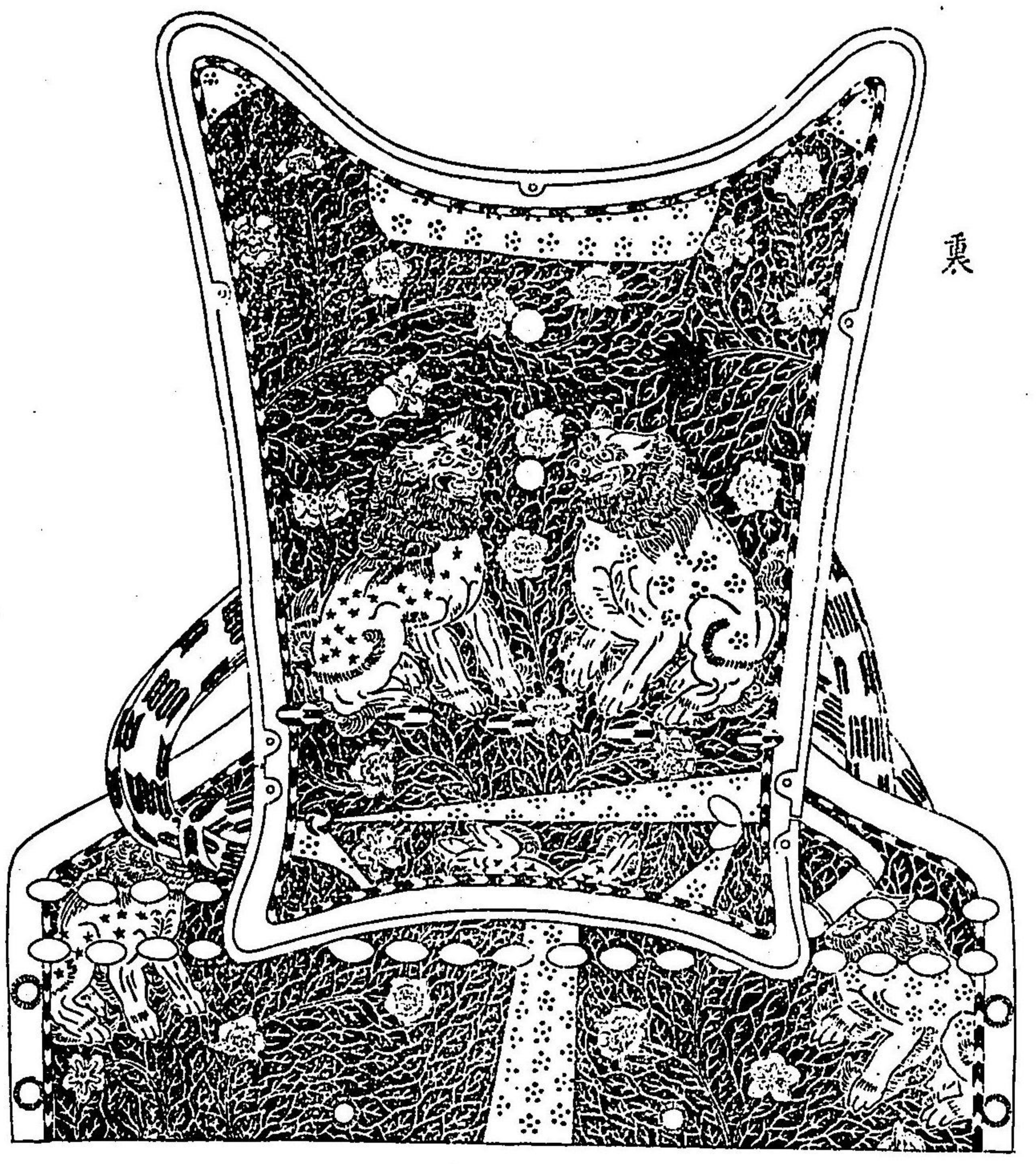

裏

脇楯裾金物



南都木談議屋藏甲冑圖

甲冑共款金物金破金
或黑華菱縫茜漆
磁目耳赤白細崩黃紫
小孔黑漆小綠五星
穴紐白紅紫紺萌黃

冑全圖

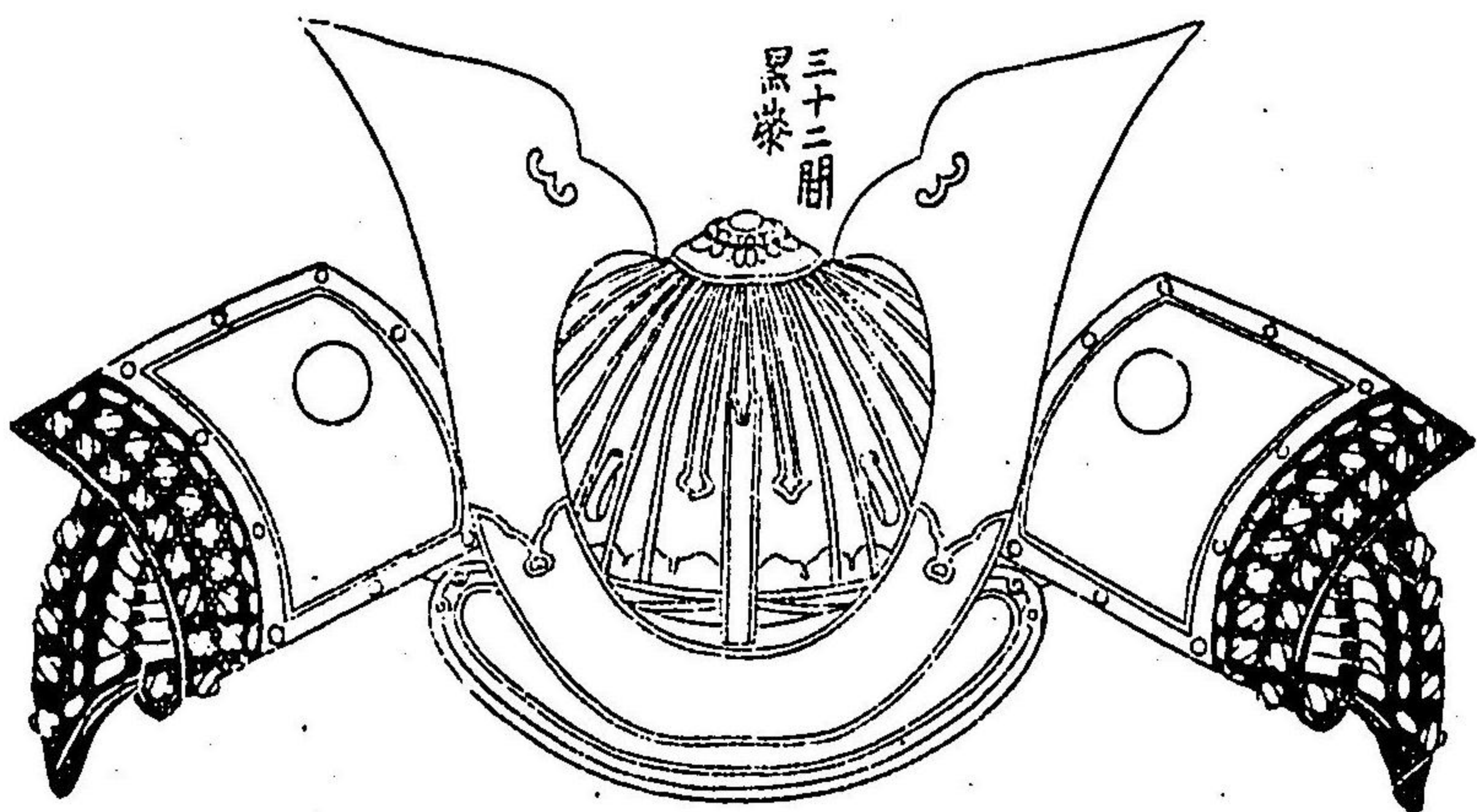

三十二册
黑漆

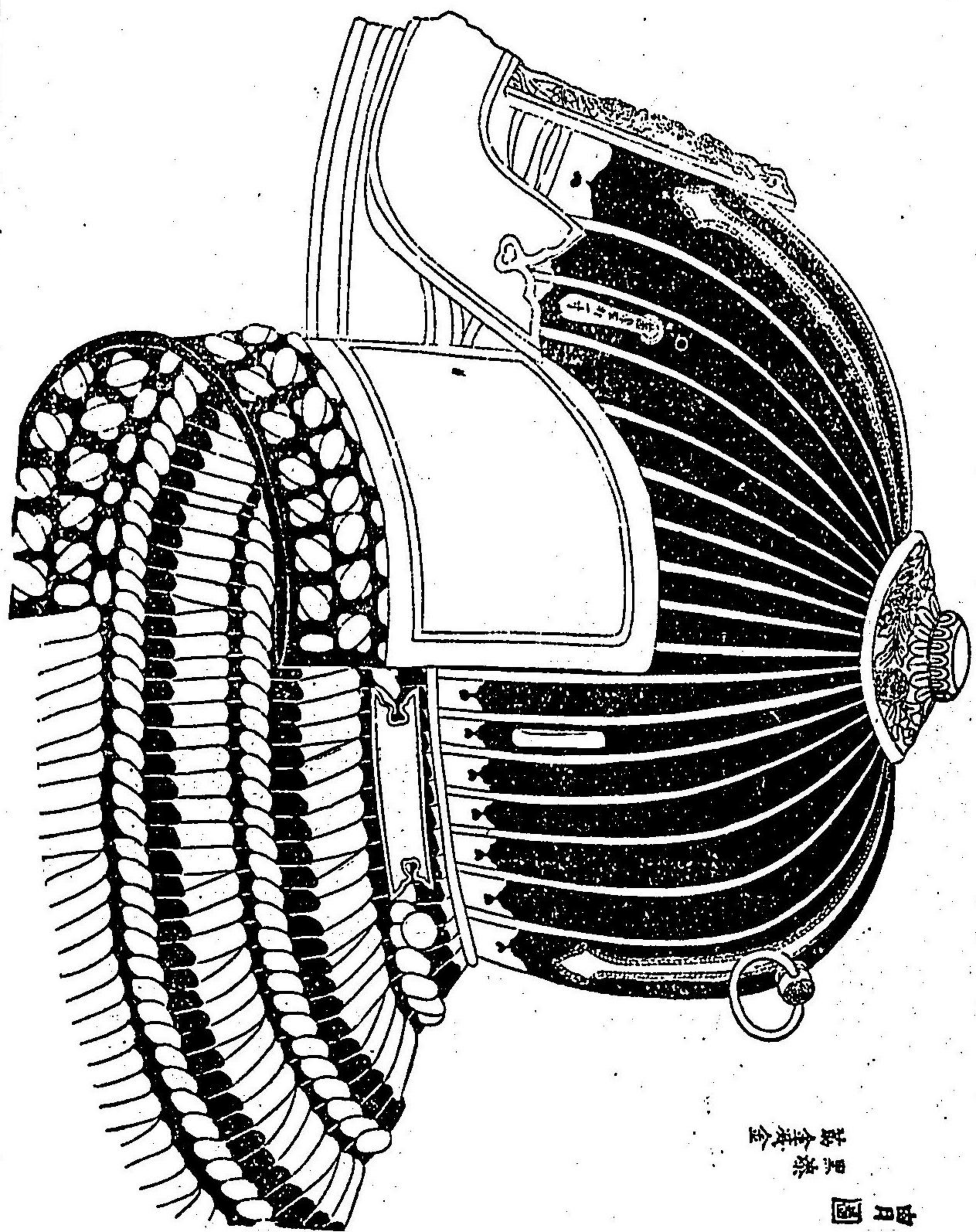

黑漆
破金

冑全圖

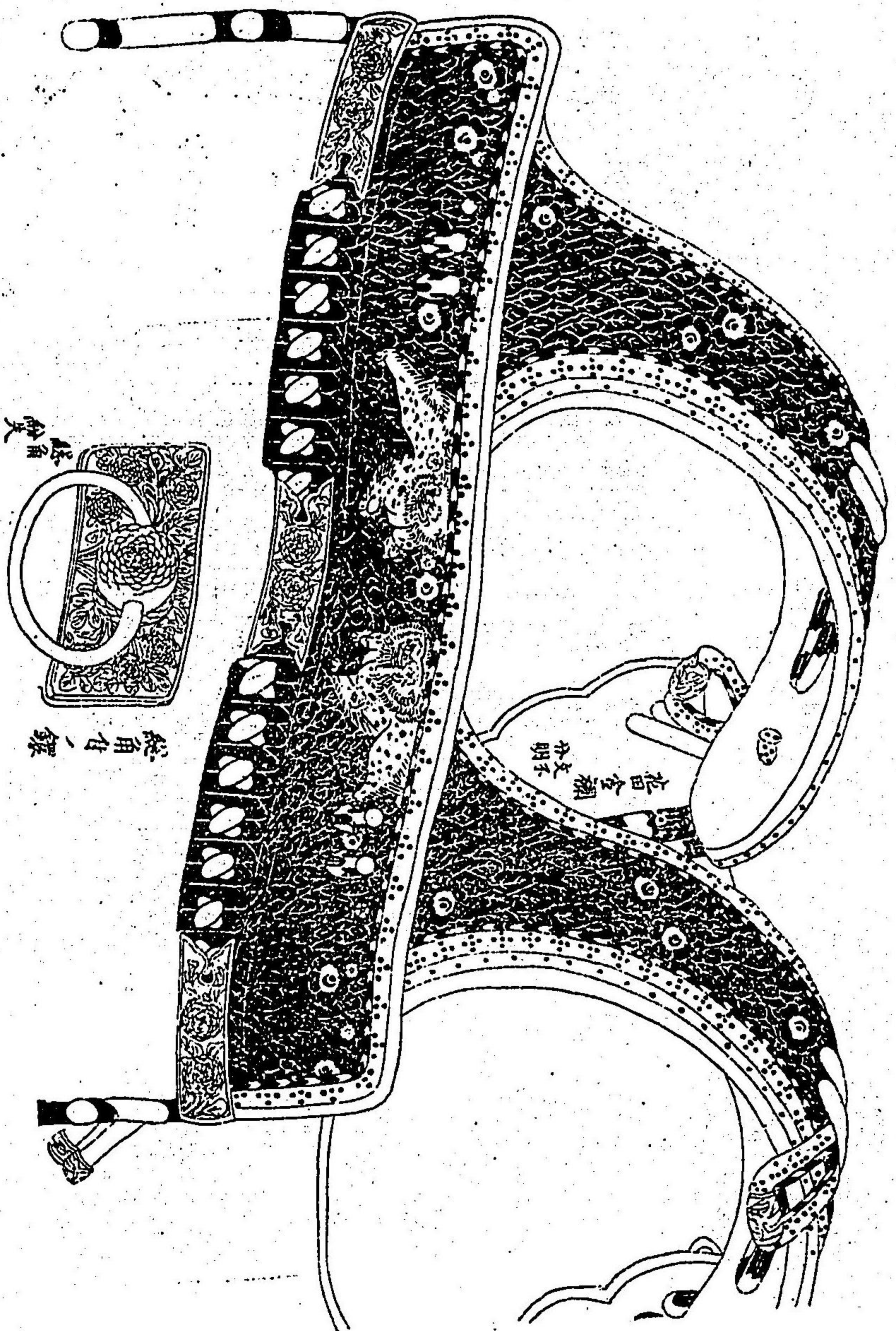
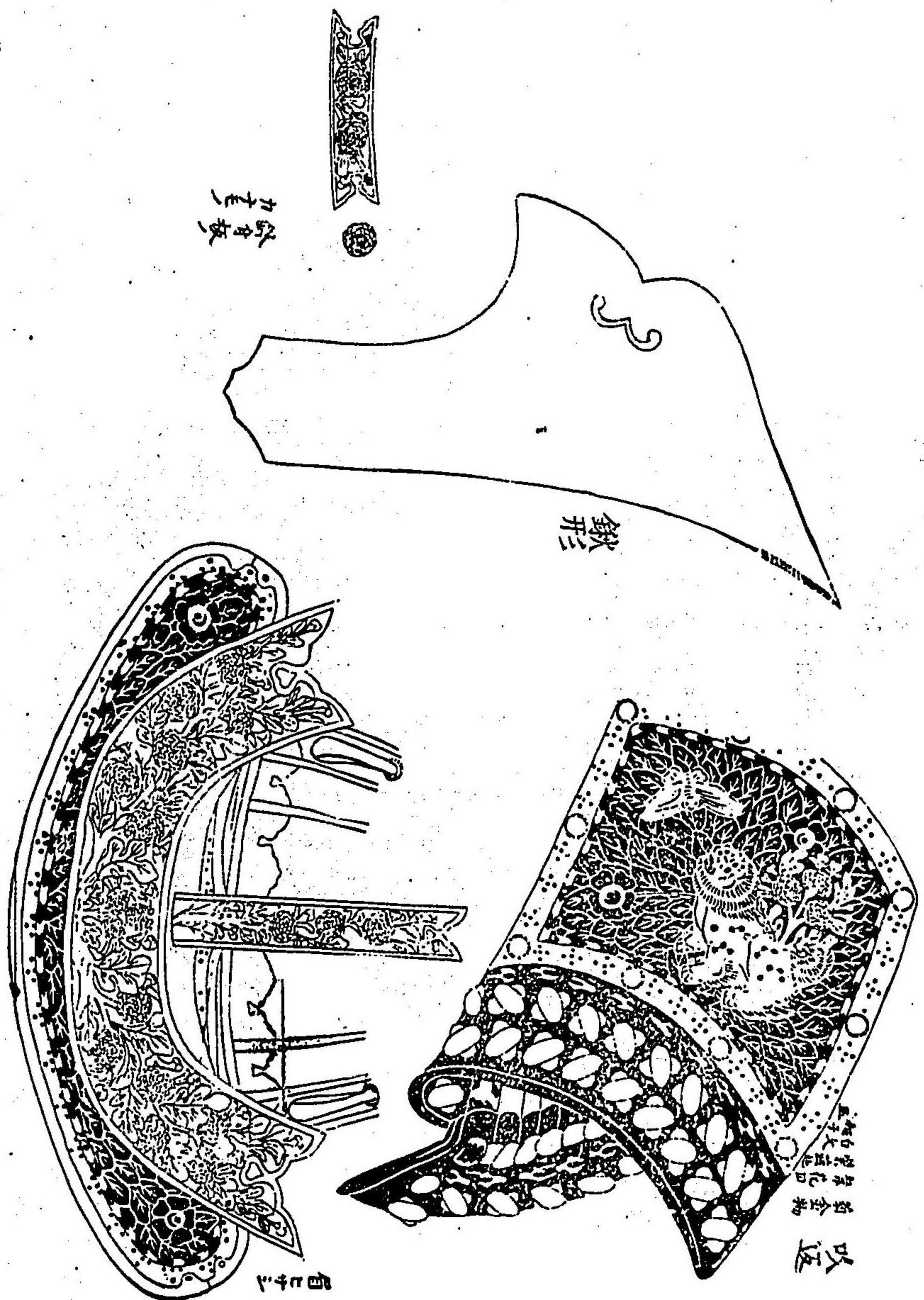

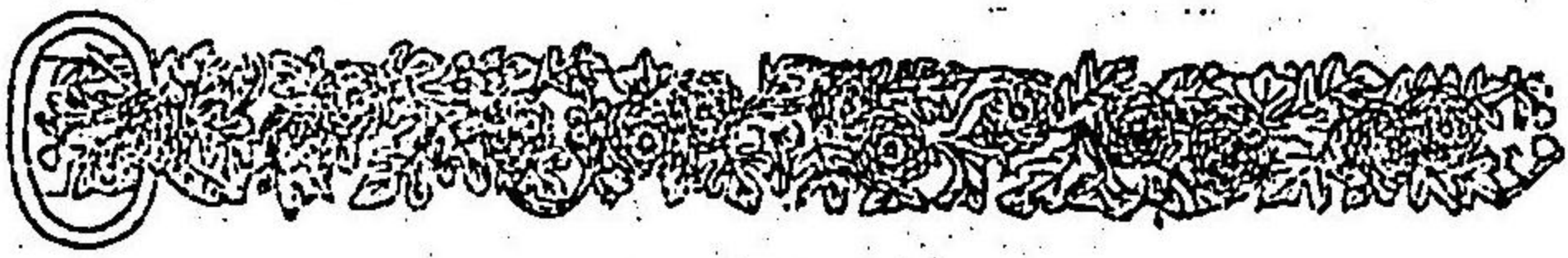

袖全圖

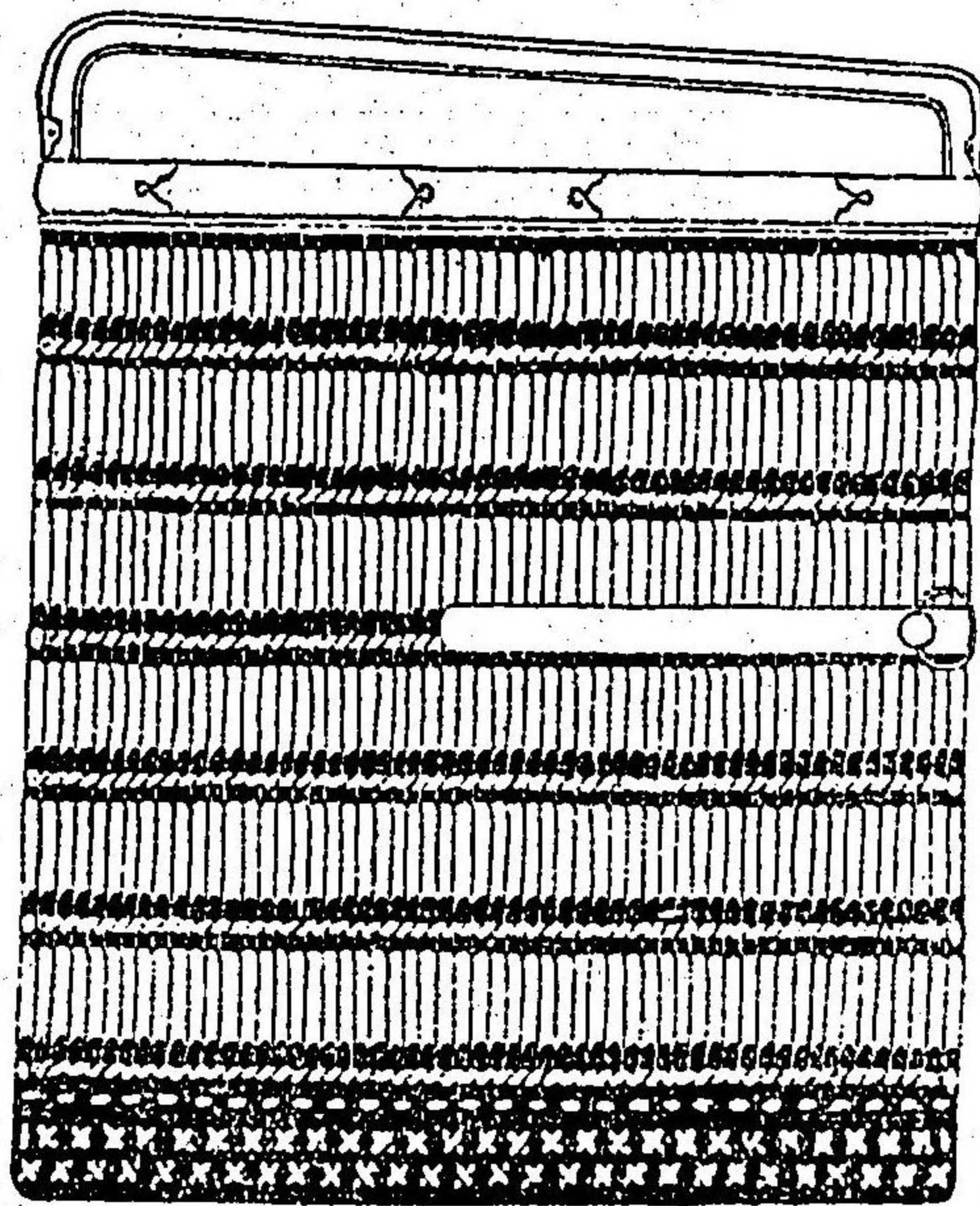

水引紅白發小孔黑漆 水衣結粉火

冠板

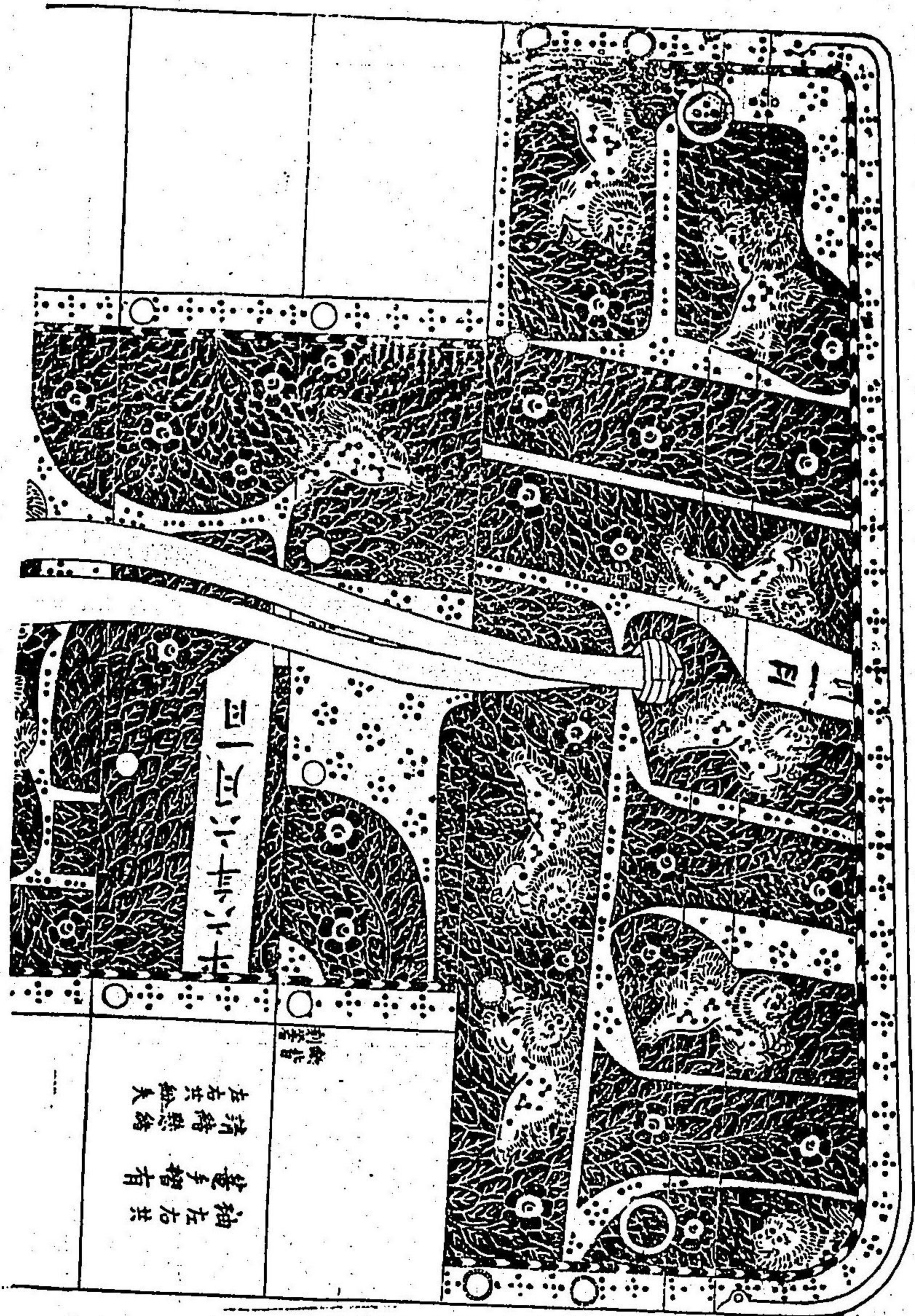
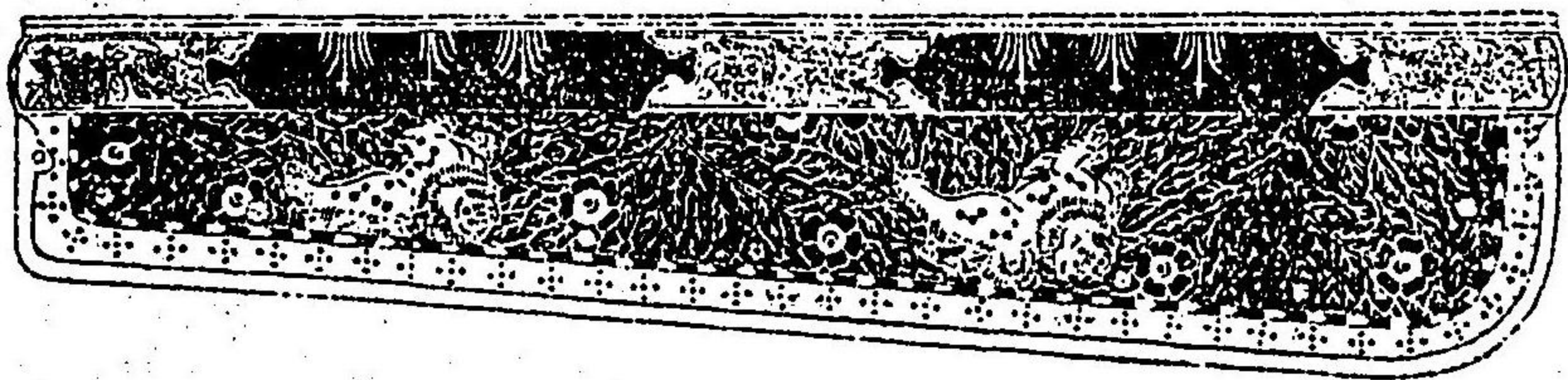

袖

袖左右共
縫身褶右
縫身熱緒
左右共縫大

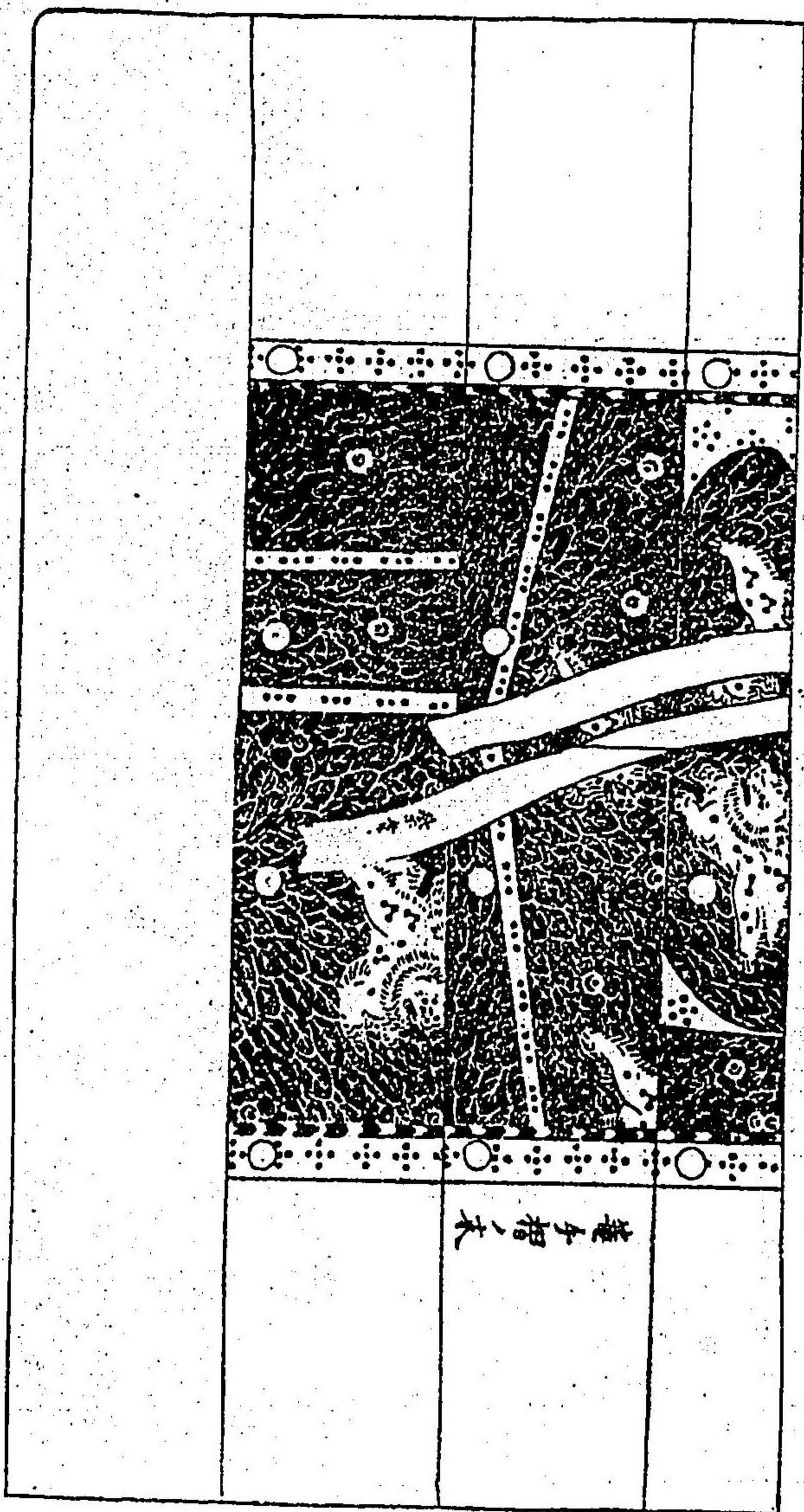

縫子摺ノ末

胴凡前全圖

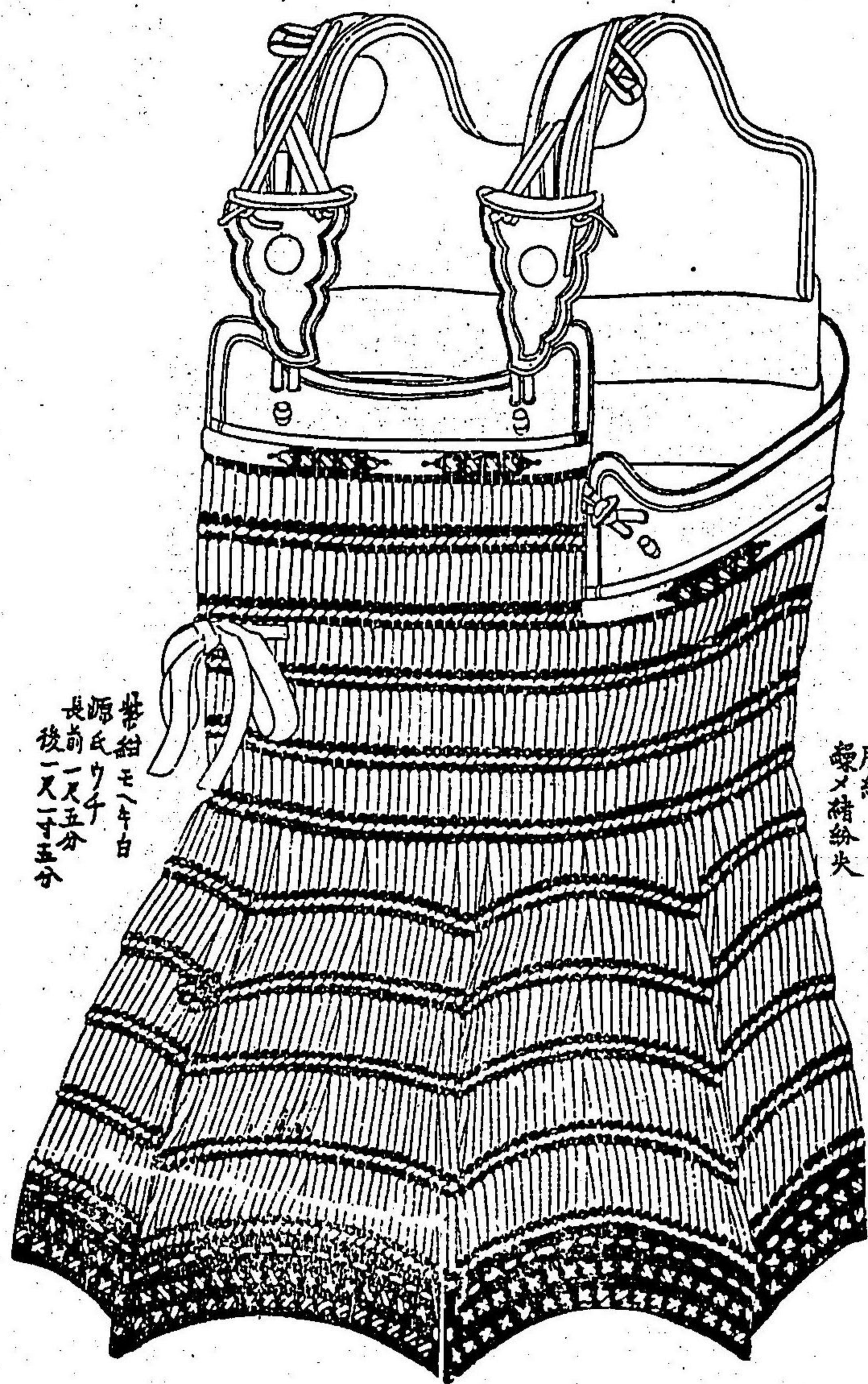

腰緒
蒙ノ緒紛失

胴裏馬皮栗色一段ノ包

母帯紺
源氏ウチ
長前一尺五分
後一尺一寸五分

後全圖

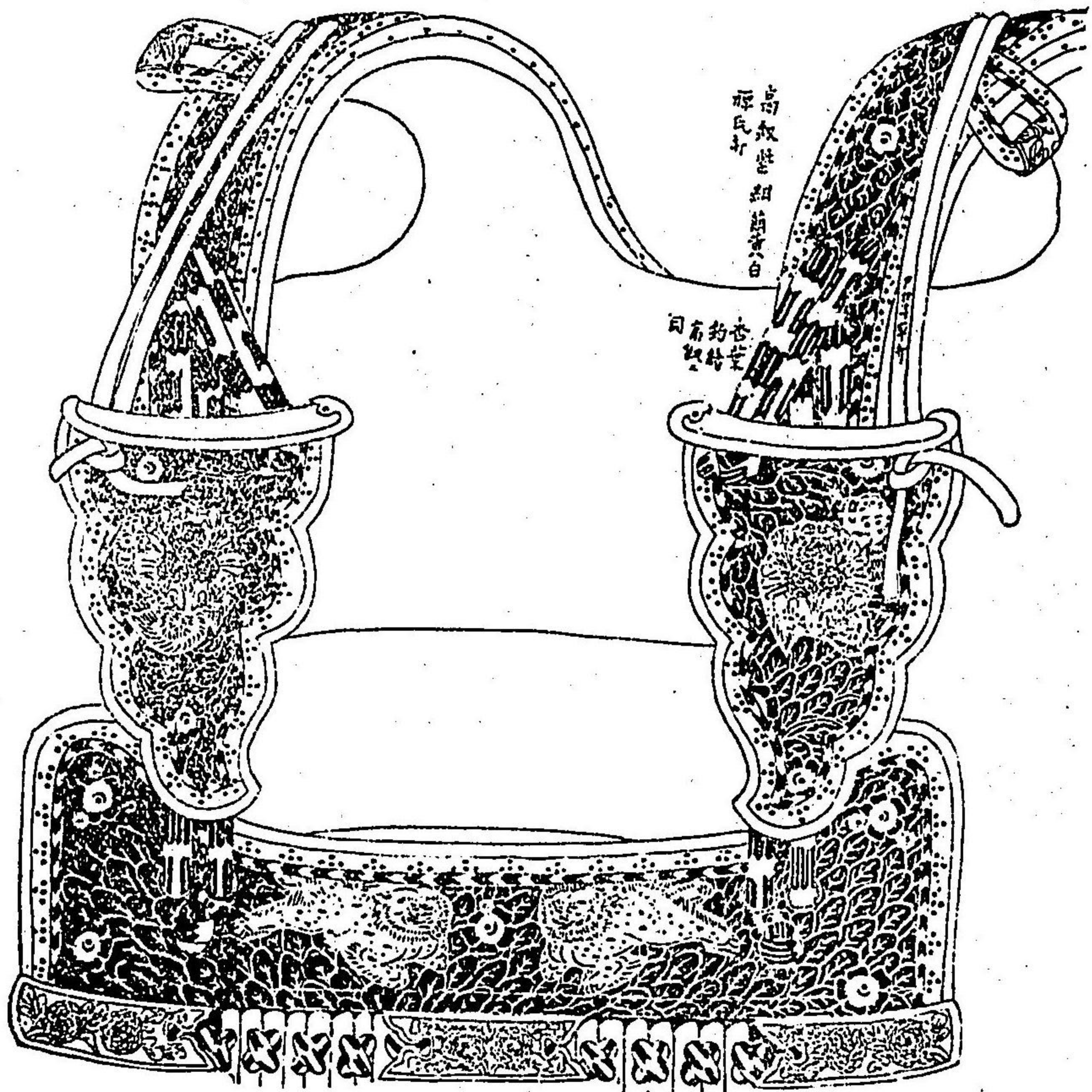
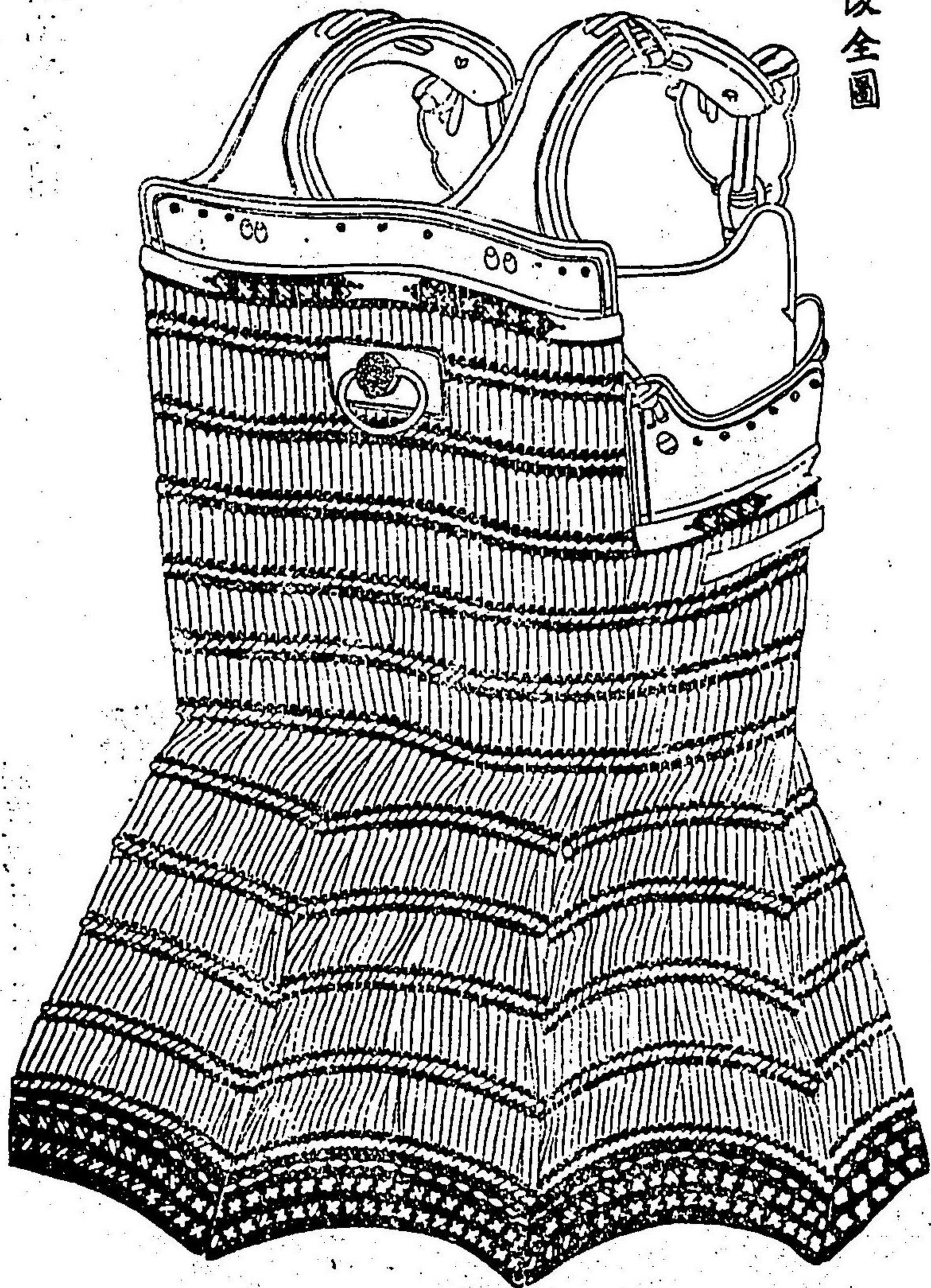

高板裝細結裝白

同為裝裝