



PALGRAVE STUDIES IN
COMPARATIVE GLOBAL HISTORY

Palgrave Studies in
COMPARATIVE
GLOBAL HISTORY



Global History with Chinese Characteristics

Autocratic States along the Silk Road in the Decline
of the Spanish and Qing Empires 1680–1796

Manuel Perez-Garcia

OPEN ACCESS

palgrave
macmillan

Palgrave Studies in Comparative Global History

Series Editors

Manuel Perez-Garcia

Shanghai Jiao Tong University

Shanghai, China

Lucio De Sousa

Tokyo University of Foreign Studies

Tokyo, Japan

This series proposes a new geography of Global History research using Asian and Western sources, welcoming quality research and engaging outstanding scholarship from China, Europe and the Americas. Promoting academic excellence and critical intellectual analysis, it offers a rich source of global history research in sub-continental areas of Europe, Asia (notably China, Japan and the Philippines) and the Americas and aims to help understand the divergences and convergences between East and West.

Advisory Board

Patrick O'Brien (London School of Economics)

Anne McCants (Massachusetts Institute of Technology)

Joe McDermott (University of Cambridge)

Pat Manning (Pittsburgh University)

Mihoko Oka (University of Tokyo)

Richard Von Glahn (University of California, Los Angeles)

Bartolomé Yun-Casalilla (Universidad Pablo de Olavide de Sevilla)

Shigeru Akita (Osaka University)

François Gipouloux (CNRS/FMSH)

Carlos Marichal (Colegio de Mexico)

Leonard Blusse (Leiden University)

Antonio Ibarra Romero (Universidad Nacional Autonoma de Mexico, UNAM)

Giorgio Riello (University of Warwick)

Nakajima Gakusho (Kyushu University)

Liu Beicheng (Tsinghua University)

Li Qingxin (Guangdong Academy of Social Sciences)

Dennis O. Flynn (University of the Pacific)

J. B. Owens (Idaho State University)

More information about this series at

<http://www.palgrave.com/gp/series/15711>

Manuel Perez-Garcia

Global History with Chinese Characteristics

*Autocratic States along the Silk Road in the Decline
of the Spanish and Qing Empires 1680–1796*

palgrave
macmillan

Manuel Perez-Garcia
Shanghai Jiao Tong University
Shanghai, China

Pablo de Olavide University
Seville, Spain



ISSN 2662-7965 ISSN 2662-7973 (electronic)
Palgrave Studies in Comparative Global History
ISBN 978-981-15-7864-9 ISBN 978-981-15-7865-6 (eBook)
<https://doi.org/10.1007/978-981-15-7865-6>

© The Editor(s) (if applicable) and The Author(s) 2021. This book is an open access publication.

Open Access This book is licensed under the terms of the Creative Commons Attribution 4.0 International License (<http://creativecommons.org/licenses/by/4.0/>), which permits use, sharing, adaptation, distribution and reproduction in any medium or format, as long as you give appropriate credit to the original author(s) and the source, provide a link to the Creative Commons license and indicate if changes were made.

The images or other third party material in this book are included in the book's Creative Commons license, unless indicated otherwise in a credit line to the material. If material is not included in the book's Creative Commons license and your intended use is not permitted by statutory regulation or exceeds the permitted use, you will need to obtain permission directly from the copyright holder.

The use of general descriptive names, registered names, trademarks, service marks, etc. in this publication does not imply, even in the absence of a specific statement, that such names are exempt from the relevant protective laws and regulations and therefore free for general use.

The publisher, the authors and the editors are safe to assume that the advice and information in this book are believed to be true and accurate at the date of publication. Neither the publisher nor the authors or the editors give a warranty, expressed or implied, with respect to the material contained herein or for any errors or omissions that may have been made. The publisher remains neutral with regard to jurisdictional claims in published maps and institutional affiliations.

Cover illustration: CPA Media Pte Ltd/Alamy Stock Photo

This Palgrave Macmillan imprint is published by the registered company Springer Nature Singapore Pte Ltd.
The registered company address is: 152 Beach Road, #21-01/04 Gateway East, Singapore 189721, Singapore

This research has been sponsored and financially supported from the GECEM project (*Global Encounters between China and Europe: Trade Networks, Consumption and Cultural Exchanges in Macau and Marseille, 1680–1840*) hosted by the University Pablo de Olavide, UPO, (Seville, Spain), www.gecem.eu. The GECEM project is funded by the ERC (European Research Council)-Starting Grant, under the European Union's Horizon 2020 Research and Innovation Programme, ref. 679371. The Principal Investigator is Professor Manuel Perez-Garcia (Distinguished Researcher at UPO). This research has also been part of the academic activities of the *Global History Network in China* www.globalhistorynetwork.com.



To my wife Marisol Vidales Bernal who has been the best companion and supporter since we moved to China in 2011. She has set an outstanding example showing strength, love, and encouragement to overcome the obstacles in day-to-day life and work during our time in Beijing, and now in Shanghai. Her generous help with my research by digitizing documents when we visited historical archives, website design, curation of images, and diffusion of academic results has been fundamental to the success of my academic endeavours. But above all without her support in difficult moments, this research and book would not have been possible. This book somehow is a reflection of our life and experience in China.

FOREWORD

AGENDA OF GLOBAL HISTORY STUDIES

In 2000, Professor Sølvi Sogner (1932–2017) wrote for the 19th International Congress of the Historical Sciences at Oslo:

Global history is increasingly becoming our common concern. ...The field is still in its infancy and the practitioners are relatively few. Historians have traditionally concentrated on national achievements and dug deep in archival depots to substantiate their findings. The hallmark of the historian's craftfull command of the sources and methodological acumen—may seem at stake when confronting universal history.... The twenty-first century differs considerably from the previous one. The historian must rise to the new challenges and address them.¹

Until the 2020s, we have so many global studies and global history studies ranging from various disciplines and topics to a wide variety of theoretical frameworks and ground archival works. Particularly, procedure of enlarging the field of global studies occurred mostly by absorbing different disciplines such as world sociology, political science, economic history, anthropology, religion, natural sciences, meteorology, maritime studies, health, disease, cultural studies, and history studies. However, as for disciplinary discussion on global study itself seems to be rather limited

¹ *Making Sense of Global History*, Universitetsforlaget, Oslo, 2000, pp. 10–11.

and confined within individual discipline. It is expected for historians to take first tentative initiatives to create a wholly new inter- and multi-disciplinary commission for global history, a meeting place for a budding discipline where researchers in letters and science could meet, exchange ideas, cultivate, and develop a new field under global study's perspectives, as Professor Sogner suggested.

From these disciplinary discussions on global studies, we can recognize the role of global history studies that have the following three levels of discussion. Firstly, global history studies are based on a strong basis of synthesization as discipline with disciplinary consciousness of global analysis. Secondly it has peculiar methodological characteristics of global history study. Then, thirdly, these two layers are supported by archival and contemporaneous source materials with formal and informal archives of human societies with natural environments.

GLOBAL HISTORY WITH LAYERED ANALYSIS

Judging from these criteria above mentioned, theoretical framework, methodological analysis, and historical source materials Professor Manuel Perez-Garcia elaborated in his book *Global History with Chinese Characteristics*, are representing one of the most comprehensive and complete accomplishments of global history studies in Europe and Asia. Firstly, his work is based on empirical research works in many archives both in Europe and Asia. He focused Macao and Marseille as local and peripheral port cities for his start:

Looking at Macao and Marseille, two port cities located on the peripheries of China and Europe, allows us to accurately observe how changes in consumer behaviour, prompted by the intermediation of traders, were correlated with economic growth and how the state bureaucracy and mercantilist policies facilitated or impeded the circulation and entry of overseas goods. The common features shared in both areas is the cross-cultural trade that stimulated local economies, the internal organization of trading families, as well as the assimilation of different cultural forms. (p. 148)

Then, secondly, the upper level of historical stage, region, and regional relations, is introduced:

The analysis of socio-economic transfers and the acquisition of new cultural forms between regions of south China and western Mediterranean Europe, through the economic circuits of Macao and Marseille, might allow us to better understand the connections and global encounters in between far-flung regions. During the early modern period, mainly in the eighteenth century, markets tended to be integrated on a global scale, and the analysis of such connections at a regional level might allow us to identify possible divergences and/or convergences. (p. 149)

Thirdly, global synthesis and dynamics follow by combining empirical archival works connects global encounters and global process of economic development:

The empirical grounding we can gain by cross-referencing European and Chinese sources might help to illuminate the global process of economic development between a specific territory of China, with the case study of Macao, and its European counterpart, Marseille. Therefore, such specific analysis is based on a *jeux d'échelles* [game of scales], from a micro perspective, by analyzing trade networks, to a macro perspective, by taking global markets and goods as the main axis of comparison. (p. 150)

These layers of analytical framework and synthesis of global history through the southern maritime channel between Marseille, Macao, and Manilla is the most important contribution to our global history studies.

GLOBAL HISTORY STUDIES AND CHINA

Scholars in the world now are endeavoring to locate China under global perspective and Professor Manuel Perez-Garcia accomplished unprecedented insightful historical work and presented one of the historical and theoretical response to the question by characterizing China in comparison with Qing China under historical continuity and comparison with contemporary China by putting Spanish empire for the global comparison with Qing empire.

Professor Manuel Perez-Garcia in his basic scheme and idea for this book, questioned a historical issue on China from the global history with “Chinese characteristics”:

The analysis of modern economic growth, the great divergence debate, and the use of macro-economic aggregates such as gross domestic product (GDP) are the main factors that have fuelled the interest for global history among Chinese academic circles. Within this big polychromic canvas, mixing history, politics, economics, and the sociocultural diversity inherent in China, there appears to be what might be called global history with “Chinese characteristics” [*zhōngguó tèsè* 中国特色]. In this sense, the main question that emerges is: Can global history be really implemented and institutionalized within such neonational and patriotic policies which certainly involves academic ecosystems and the university environment? Such a rigid bureaucratic and administrative system diverges sharply from a meritocratic system based on the modernization of academic life that includes three pillars to implement internationalization: mobility, diversity, and scientific excellence. The result is an accommodation within a new national rhetoric in which the uniqueness of China’s history, civilization, and culture represents the consolidation of a new political system and history based on these characteristics. These are presented as unique features of the country. (pp. 2–3)

The answer on globalization is neither unification of the world nor generalization of the globe. Globalization in his analysis is that the world is a common globally layered and connected time and space for demonstrating respective characteristics under reflection between history and contemporary each other.

FURTHER AGENDA FOR GLOBAL STUDIES

Finally, I will add one issue of global studies viewed from the future on the natural environmental issue which is inevitable for global study and for human society. Cyclic and counter-cyclic relation between human society and natural environment are becoming interwoven more closely. As a result, globalization created stronger influence and consciousness of natural environment into human societies and requires new level of global knowledge and identity on the cyclic relationship between human societies and natural environment.

From this point of view on globalization as a discipline, global studies will include research on climate, maritime studies, meteorology, health, disease, and natural disaster together with investigation about reactions of human societies to the ongoing change of natural environment.

The detailed historical accomplishment of this volume by Professor Manuel Perez-Garcia contributed magnificent foundation on questions: what is global history?, how to trace back and summarize history of global history studies?, and how to create and discuss synthesized global history?

July 2020

Takeshi Hamashita
University of Tokyo
Tokyo, Japan

ACKNOWLEDGEMENTS

This monograph presents some preliminary results of the research and academic work of the ongoing GECEM Project (*Global Encounters between China and Europe: Trade Networks, Consumption and Cultural Exchanges in Macau and Marseille, 1680–1840* www.gecem.eu). It is the product of my research and reflection upon imperial China and its relations with Europe from the early modern period until today. I wish to acknowledge the financial support of the European Research Council (ERC)-Starting Grant, under the European Union's Horizon 2020 Research and Innovation Programme.¹ Without the funding and support of the ERC this book would not have been possible.

International conferences, seminars, workshops, academic forums, and visiting professorships to which I have been invited over the last four years since the GECEM Project initiated its activities have contributed

¹This research has been sponsored and financially supported by GECEM Project (*Global Encounters between China and Europe: Trade Networks, Consumption and Cultural Exchanges in Macau and Marseille, 1680–1840*) hosted by the Pablo de Olavide University (UPO) of Seville (Spain). The GECEM Project is funded by the ERC (European Research Council) Starting-Grant, ref. 679371, under the European Union's Horizon 2020 Research and Innovation Programme, www.gecem.eu. The P.I. (Principal Investigator) is Professor Manuel Perez-Garcia (Distinguished Researcher at UPO). This work was supported by the H2020 European Research Council. This research has also been part of the academic activities of the *Global History Network in China* (GHN) www.globalhistorynetwork.com.

to developing and enhancing this volume. Many fruitful conversations with academics during my invitations and stays in Beijing, Canton, Taipei, Tokyo, Boston, Vancouver, Cambridge, Oxford, Lisbon, Paris, Mexico City, Guadalajara, San Jose in Costa Rica, Seville, and Murcia, and of course in Shanghai, have contributed to enriching the book's ideas and drafting of arguments.

I am truly honoured and grateful for the academic collaboration and support of my colleague and friend Professor Lucio de Sousa (Tokyo University of Foreign Studies). After I arrived in China in 2011, we both embarked upon the project of creating an academic network of global historians and specialists in East Asia. This network crystallized in the workshop on global history and East Asian studies we both organized in Beijing at Tsinghua University in the spring of 2012. Thereafter, the *Global History Network in China* (GHN) www.globalhistorynetwork.com has formed an excellent space for academic exchange of ideas and collaboration that has materialized in annual workshops, publications, and in obtaining research funding in China, Japan, and Europe.

The GHN has opened new venues to promote academic debate, knowledge, and ideas with the aim of improving our knowledge of East Asian (mainly China) history and cultural exchanges between China and the Western world. Understanding historical relations between China and Europe in the past helps us to realize how current international relations (political and economic ties) between Europe and China are taking shape, and how future relations might evolve. Thus, new global history research takes on a special vigour in which the renewal of the field indisputably passes through the implementation of new case studies. Economic development and modernization of Asia, Europe, the Americas, and African sub-continental areas and comparisons among polities need to be re-evaluated and analysed by decentralizing the scope of research beyond the conventional divide of core-periphery economic zones.

The academic activities and projects organized by GHN members and collaborators have contributed in shaping the ideas and main core of my research. I obtained my current European Research Council (ERC)-Starting Grant in the fall of 2015, and the publication of this book by Palgrave Macmillan shows preliminary results of the research under the ERC grant.

I have to express my gratitude to academic institutions and partners of the GECM and GHN such as Shanghai Jiao Tong University, Pablo de Olavide University, Tokyo University of Foreign Studies, the Beijing

Center for Chinese Studies at the University of International Business and Economics (Beijing, China), the Macau Ricci Institute at the University of Saint Joseph (Macau), the Faculty of Asian and Middle Eastern Studies at the University of Cambridge, the Center for Global History at the University of Oxford, the Center of Asian Studies at the University of British Columbia, the Center of Global History and European Studies at Pittsburgh University, the Center of Global History at the University of Warwick, the Universidad Nacional Autonoma de Mexico (UNAM), the L'Ecole des Hautes Etudes en Sciences Sociales, the European University Institute, the Autonomous University of Madrid, and the Faculty of Economics and Business at the University of Murcia.

A very special word of gratitude goes to the GECEM staff and its collaborators. I am extremely grateful to GECEM team members such as Omar Svriz Wucherer, Bartolome Yun-Casalilla, Marisol Vidales Bernal, Manuel Díaz-Ordoñez, Nadia Fernandez de Pinedo Echeverria, Felix Muñoz, Maria Jesus Milan, Jin Lei, Wang Li, and Guimel Hernández. The assistance and work of Manuel Diaz-Ordoñez is fundamental to developing the GECEM Project Database's maps, many of which appear in this volume.

I am grateful for the extremely helpful comments and suggestions made by Joe P. McDermott, Patrick O'Brien, Jack Owens, Richard von Glahn, Lucio de Sousa, Hamashita Takeshi, Pat Manning, Kenenth Pomeranz, Bartolome Yun-Casalilla, Anne McCants, Shigeru Akita, Gakusho Nakajima, Mihoko Oka, Carlos Marichal, Dennis O. Flynn, Leonard Blusse, François Gipouloux, Debin Ma, Leonor Diaz de Seabra, Robert Antony, Manuel Barcia, Anne Gerritsen, Giorgio Riello, Olivier Raveaux, Ruth Mostern, James Cook, Alejandra Irigoien, Enrique Dussel, and Antonio Ibarra. I thank the reviewers and editors of Palgrave Macmillan for their comments to improve this book. Any errors are my own.

I should mention my colleagues and collaborators from China. The institutional support by the executive board of Shanghai Jiao Tong University (SJTU) and the School of Humanities at SJTU has been fundamental. Guo Liang (deputy director of the Division of International Cooperation and Exchange at SJTU), the executive team of the School of Humanities at SJTU led by Qi Hong, Liu Jialin, Li Yushang, Song Chunyan, and the international affairs office led by Mo Xiaoling and Zhang Yihan have made the preparation of this book possible through their support and funding for research visits to several institutions, and

through the organization of academic forums to present partial research results.

I would like to thank my colleagues at SJTU for all of their pertinent remarks and observations, especially Professor Liu Shiyung (Michael) for his extremely helpful ideas and comments, but mainly for his friendship and support. Professors Pengsheng Chiu and Chang Chihyun, the personnel from SJTU Library led by Xiaohua Shi, and my former students Huang Xiyang, Ding Yijun, and Shen Mi all deserve recognition. Likewise, I am grateful for my colleagues in Beijing such as Professor Liu Beicheng (Tsinghua University), Li Xuetao (Beijing Foreign Studies University), and Simon Koo, director of The Beijing Center for Chinese Studies (TBC) at the University of International Business and Economics, and Jim Caimo (former director of TBC), for their support to use the book collection at the Anton Library. I should not forget to thank my colleagues from the Macau Ricci Institute (MRI), Dr. Stephan Rothlin S.J. (director of the MRI) and Jarosław Duraj (vice-director of the MRI) and their team for the support they generously gave me when visiting the MRI and Macau Historical Archives.

I would also like to extend gratitude to the PAIDI group HUM-1000 *Historia de la Globalización: Violencia, Negociación e Interculturalidad* at Area de Historia Moderna (UPO) of which I am a member. The Principal Investigator of the PAIDI group is Igor Perez Tostado, funded by Junta de Andalucía (Seville, Spain). Igor Perez, Bethany Aram, and Fernando Ramos Palencia deserve special recognition for their support and help.

This research is also a result of academic activities organized by the GECM Project such as the permanent lecture series in Global and East Asian History held annually at SJTU and UPO, as well as the workshops and international conferences organized within the framework of the project such as the first and second GECM workshop held respectively at the University of Chicago Center in Beijing and UPO in Seville, and the 6th Eurasia Trajeco-GECM international conference held in Seville, October 2018. In addition, this research has been partially presented in world academic forums at the panels organized by the GECM Project such as “Beyond the Silk Road: The Silver Route and the Manila-Acapulco Galleons for the Global Circulation of Goods and People in China, Europe and the Americas” at the XXXVI International Congress of the Latin American Studies Association (LASA)/Latin American Studies in a Globalized World held in Barcelona (Spain), May 2018; and the panel “Social Network Analysis and Databases for New Comparative Global

History Studies in China, Europe, and the Americas” at the XVIII World Economic History Conference/Waves of Globalization held in Boston (US), July–August 2018.

A very special word of thanks to Sara Crowley-Vignau, former head of the editorial board of Humanities and Social Sciences at Palgrave Macmillan (China and Asia Pacific). Sara Crowley and I, as P.I. of the GECEM Project, signed in November 2016 an agreement between Palgrave and GECEM to launch the book series *Palgrave Studies in Comparative Global History*. I should mention other Palgrave associates such as Connie Li (senior editorial assistant at the Shanghai office), Hua Bai (regional director of Palgrave in China), and Leana Li (former regional director of Palgrave in China) who have contributed to this publication. I am thankful for the assistance of Paula de la Cruz-Fernandez and Elisabeth O’Kane Lipartito (editing group Edita.us) for the proofreading, editing, and reviewing of this manuscript.

In addition, I would like to express my gratitude to the Delegation of the European Union to China and EURAXESS China whose generous support and collaboration has been essential in expanding the scientific results and GECEM output to Chinese academic and non-academic audiences. The main goal of the EU Delegation is to transfer knowledge and promote a better understanding of Sino-European international relations, as well as the history and culture of Europe within China. The constant and generous support of Philippe Vialatte (Minister Counsellor, Head of Science and Technology Section of the Delegation of the European Union to China) and Halldor Berg (Chief Representative of EURAXESS China) to the GECEM Project and GHN is of extreme importance to expanding the scientific mission of the project and fostering high-quality academic research among European and non-European researchers based in China.

Finally a very important acknowledgement goes to my family, mainly my father, Manuel Perez-Garcia, for his constant support, advice, and education in human values as to how to carry on in difficult moments, to have the strength to look always ahead, to set high goals and challenges, but also to remain humble. Without his love and care, and without my mother (Encarnita), brothers (Mariano, Angel), and sisters (Maria, Encarnita), I could not have envisioned this book. The family is the main pillar and stronghold of our society.

Shanghai, China
Spring 2020

PRAISE FOR *GLOBAL HISTORY WITH CHINESE CHARACTERISTICS*

“Perez-Garcia’s book exemplifies his ambition and investment of real time acquiring the languages and intellectual credentials required to write a truly impressive foundational text for a series of books in global history revealing the heuristic insights obtainable from reciprocal comparisons.”

—Patrick Karl O’Brien, *FBA, Visiting Professor of Economic History at LSE and former fellow of St. Antony’s College, UK*

“Manuel Perez-Garcia’s book, *Global History with Chinese Characteristics*, outlines a truly ‘global’ history of the development of the early modern trade networks linking China and Europe. This is a work that neither follows the heavy-handed ‘One Belt One Road’ school of world history emanating from China nor the need to explain China’s lack of an industrial revolution that dominates Western analysis. Instead, it unfolds a global history through more localized research of market integration between Asia and Europe in the movement of goods, people, and silver. By not only focusing on the circulation of global goods and trade networks that established transnational communities in places like Marseille, Macao, and Manila, but also how that exchange created a new global consumerism of changed tastes and new habits, Perez-Garcia refocuses our attention on the unofficial links between China and Europe that were the foundation of the pre-modern economy. Conducting global history from the ground up reveals how merchants and merchant networks were the engines of both economic development

and new consumer tastes. This is an important work that will provide a framework for future research in global history and urban development.”

—James Cook, *Associate Director, Asian Studies Center, University of Pittsburgh, USA*

“In a world where global has become the synonym of all that is modern and up-to-date, this trend has not left history and academia out of its influence. *Global History with Chinese Characteristics. Autocratic States along the Silk Road in the Decline of the Spanish and Qing Empire 1680-1796* is one of the finest works of its kind. Dr. Manuel Perez Garcia, one of the leading historians in the field, confronts the existing narratives of global history and pursues the creation of a systematized guideline on methodology and approaches to various readers, academic and even casual. This masterpiece shows the light at the end of the tunnel for historians who seem to believe that a new age of global history is approaching.”

—Liu Shiyung, *Adjunct Professor, Asian Studies Center, University of Pittsburgh, USA, and Distinguished Professor, School of Humanities, Shanghai Jiao Tong University, China*

“Manuel Perez-Garcia challenges (a) 2013 ‘New Silk Road’ politics and (b) Chinese academics (including Marxists), both promoters of historical narratives centered upon narrow concepts of cultural unity. Despite worldwide challenges to (and replacement of) traditional nation-state histories by polycentric global histories today, Chinese scholars typically view global history as a ‘Western’ threat to Chinese culture. Perez-Garcia argues, on the contrary, that Chinese history must be viewed in global context and that Sinocentrism is no improvement over Eurocentrism. His theoretical/methodological framework is used to construct a new case study that compares economic axes of Macao-Canton vis-à-vis Marseille-Seville, both micro-scale areas beyond the dominion of mercantilist and autocratic states of Qing China and Bourbon Spain. Perez-Garcia analyzes the state capacity of Qing China via a new ‘power paradox theory’ and ‘supremacy dilemma,’ which demonstrates that state interventionism entails weak governance. Empirical information gleaned from trade records, probate-inventories, local gazetteers, imperial edicts, and manuscripts are entered into a huge database (an alternative to abstract and misleading macro-economic constructions, such as GDP estimates). Based upon considerable first-hand experience at Chinese and European universities, Perez-Garcia

reveals a database path forward for global histories while acknowledging unique Chinese characteristics.”

—Dennis O. Flynn, *Emeritus Professor, University of the Pacific, USA*

“This is a refreshing new study on global history with ‘Chinese characteristics,’ in which the author argues that the present regime in China has created an all-encompassing ‘New Silk Road’ template that dictates how Chinese scholars rewrite their global past and political leaders frame economic strategies. In this well-researched book, richly illustrated with maps, graphs and tables, the author has a keen eye for pointing out critical issues and raising important questions concerning China’s past and present global economic policies. While not everyone will agree with his conclusions about the Great Divergence, Oriental despotism, and the viability of China’s 18th century Age of Prosperity, the questions he raises will undoubtedly stimulate further debates on these important topics. The book is well worth the read.”

—Robert J. Antony, *Professor, School of History and Culture, Shandong University, China*

“Another new approach to global history has been born here. The uniqueness of this book is that it is an analysis of Chinese socio-economic history combined with a perspective on Chinese political philosophy. A comparison of Chinese socioeconomic development with that of Europe, including a vision on mutual influence after the Great Divergence, makes us think about how the complex world system can grow in the same period with elements in common or in different ways. Readers will find this book very helpful when they try to understand China’s current strategy in the international environment.”

—Mihoko Oka, *Associate Professor, Historiographical Institute, The University of Tokyo, Japan*

“Global History with Chinese Characteristics challenges the last twenty years over the great divergence debate. By presenting a micro-history case study of how merchant networks interlocking Macau and Marseille, Manuel Perez-Garcia advances a holistic understanding about why flourishing material culture went beyond official control both in Qing dynasty

and Spanish Empire. Inquiring how bustling non-official trade and transferred knowledge interwoven with weak state capacity, this book offers a novel and illuminating study of economic growth in early-global world.”

—Pengsheng Chiu, *Distinguished Professor, School of Humanities, Shanghai Jiao Tong University, China*

“Manuel, a Spanish academic who completed his PhD in Italy but spent the last decade as a full time academic in China, has written a remarkable and unique book in Global History. While much of the global history written in the West aims at correcting Eurocentric bias, Manuel’s book also elaborates and debunks the myth of Sino-centrism in the Chinese historiography. Through a careful archival based study of the trading networks of Macao and Marseilles in the early modern era, the book offers an intimate and balanced portrayal of global history linking the world with the local, the macro with the micro. All in all, a stimulating read.”

—Debin Ma, *Professor, Hitotsubashi University, Japan*

“Exploiting a large mass of original documents: account books, commercial correspondence, Perez-Garcia’s highly scholarly volume revisits the question of the great divergence between China and Europe by insisting on the role of institutions and the weak capacity of the imperial administration. It draws our attention to the role of local actors, their practices and the constraints within which they operate. Focusing on exchanges between Macao and Marseille, the book magisterially delineates the role of trading networks struggling with bureaucratic empires and offers a sophisticated account of the socio-economic stakes in late imperial China.”

—François Gipouloux, *Emeritus Research Director, National Centre for Scientific Research, France*

CONTENTS

1	Introduction: The Implementation of the New Global History in China	1
2	The “Global History Paradox” in China: Sinocentred Approaches Along the Silk Road	23
2.1	<i>From Eurocentrism to Sinocentrism</i>	24
2.2	<i>The “New Silk Road” and “One Belt, One Road”: The Awakening of the Middle Kingdom in the Twenty-First Century</i>	31
2.3	<i>The Meaning of “Chinese Characteristics”</i>	48
2.4	<i>From “Soft-Power” to “Soft-Cultural Revolution”: Nationalism and Postmodern Neo-Confucian Practices</i>	56
2.5	<i>The “Western Mirror” in China’s Economic History</i>	60
3	The Mandate of Heaven, the Rule of the Emperor: Self-Sufficiency of the Middle Kingdom	69
3.1	<i>Post-Needham Practices: Uniqueness of Chinese Civilization and Economy?</i>	70
3.2	<i>Institutional Constraints: Feudalism, “Nosphimeric Bureaucratism,” and Mandarinism</i>	79
3.3	<i>Self-Sufficiency and Market-Orientation: The “Supremacy Dilemma” and “Power Paradox” of the Middle Kingdom</i>	92

3.4	<i>The Local Gazetteers and State Capacity in Qing China</i>	101
4	Silver, Rogues, and Trade Networks: Sangleyes and Manila Galleons Connecting the Spanish Empire and Qing China	123
4.1	<i>New Comparisons Through the Mining of New Historical Data: The Great Divergence Through Consumption and Trade Networks</i>	124
4.2	<i>Stereotypes, Casts, and Imagined Communities in the Philippines: The Chinese Sangleyes</i>	131
4.3	<i>Sangleyes and European Networks in Macao and Manila: Decentralizing the Spanish and Qing Empires</i>	143
4.4	<i>Integrating South Europe and South China Markets: The Case of Macao and Marseille</i>	153
5	Conclusions	171
	Bibliography	181
	Index	223

ABBREVIATIONS

AcCap	Actas Capitulares
ACCM	Archive de la Chambre de Commerce de Marseille, France
ADBDR	Archives Departamentales des Bouches-du-Rhône, France
AGI	Archivo General de Indias, Spain
AH/SCM	Arquivo Historico de Santa Casa de Misericordia de Macao, Macao
AHM	Arquivo Historico de Macao, Macao
AHN	Archivo Historico Nacional, Spain
AHPM	Archivo Historico Provincial de Murcia, Spain
AHPS	Archivo Historico Provincial de Sevilla, Spain
AMC	Archivo Municipal de Cartagena, Spain
AMRIM/ARSJ	Archive of the Matteo Ricci Institute of Macau/Archivum Romanum Societatis Jesu, Macao
ARChG	Archivo Real Chancilleria de Granada, Spain
BNE	Biblioteca Nacional de España, Spain
CSEIC	Catalogue of the Swedish East India Company, Macao
FHAC	First Historical Archives of China, China
GA	The Godegard Archive, Sweden
IUDL	Indiana University Digital Library, USA
Jap.Sin.	Japonensis Sinica
LC	Library of Congress, USA
LFZZ	Lu Fu Zou Zhe
NLC	National Library of China, China
NM	Nordiska Museet, Sweden
RUCL	Renmin University of China Library, China

SJTUL	Shanghai Jiao Tong University Library, China
TBCL	The Beijing Center of Chinese Studies Library, China
ZPZZ	Zhu Pi Zou Zhe

LIST OF FIGURES

Fig. 2.1	Traditional China Social Order Based on <i>wǔlún</i> 五伦, Five Relations System	27
Fig. 2.2	AIIB Initial Subscriptions in 2014 (more than 1%)	50
Fig. 3.1	The “industrious revolution” model	74
Fig. 3.2	Per capita GDP (1990 international Geary-Khamis dollars)	77
Fig. 3.3	A western Mediterranean Genealogy: Riquelme and Salafrañca lineages (sixteenth to nineteenth centuries)	83
Fig. 3.4	A Southern (Huizhou) China Genealogy: the Chengs of Shanghe in Qimen County (circa sixteenth to seventeenth centuries)	84
Fig. 3.5	Maddison’s estimates on population growth in China, 1000–1820	104
Fig. 3.6	Population in Suzhou and Huizhou prefectures [<i>fǔ</i> 府], 1371–1376	105
Fig. 3.7	Population in Changshu and Jixi counties, 1371–1376	105
Fig. 3.8	Population Growth in Qing China	107
Fig. 3.9	Silver Income Revenue, 1368–1521	108
Fig. 3.10	<i>Dīng</i> and Tax Returns in Guangdong and Fujian Provinces, 1662–1829	115
Fig. 4.1	Trade tax revenue of the Spanish royal treasury in the Philippines, 1612	148
Fig. 4.2	Debts of the Holy House of Mercy of Macao, 1771–1830	152
Fig. 4.3	Presence of Armenians in Marseille, 1660–1696	155

Fig. 4.4	Genealogy of the Grill Family (Garphyttan and Godegard House of Sweden) operating in Macao and Canton Markets, 1638–1907	157
Fig. 4.5	French-Italian-Maltese trade coalitions: Genealogy of the Stoup-Cayron family, seventeenth to eighteenth century	160
Fig. 4.6	Co-national and transnational marriages among Mediterranean merchants in Southeastern Spain (1730–1808)	161
Fig. 4.7	Transnational marriages in Taiwan, seventeenth century	161
Fig. 4.8	<i>Almojarifazgo</i> levied in Manila of ships arrived from China, 1690–1750	163
Fig. 4.9	Re-exportation of stockings made of silk from Marseille to Spanish Mediterranean ports, 1720–1780	167

LIST OF ILLUSTRATIONS

Illustration 3.1	<i>Dīng</i> and Tax Returns in Hebei Province, 1680	114
Illustration 4.1	Sangleyes or Chinese Casts in the Philippines	133
Illustration 4.2	Couple of Sangleyes as in the <i>Boxer Codex</i>	137
Illustration 4.3	Preparation of a Sino-Japanese-Latin dictionary by Ruggieri and Ricci, circa 1583–1588	142

LIST OF MAPS

Map 2.1	Matteo Ricci's World Map, 1602	26
Map 2.2	China's New Silk Road Grand Strategy, Twenty-First Century	32
Map 3.1	Puzhou town in Shanxi province	103
Map 3.2	Population growth rate in Guangdong and Fujian prefectures according to Local Gazetteers, 1662–1819	110
Map 4.1	Organization of Jesuit Missions in Ming China	141
Map 4.2	Trade tax revenue of the Spanish royal treasury in the Philippines, 1612	149
Map 4.3	Market integration between Asia, Europe, and the Americas through global silk routes, seventeenth to eighteenth century	154
Map 4.4	Roux company trade houses in Mediterranean silk routes connecting Marseille with the Near East, eighteenth century	158
Map 4.5	Typologies of Chinese silks and consumer's networks in the parishes of Seville, 1727–1750	168

LIST OF TABLES

Table 2.1	Share of foreign faculty staff at major universities of China in 2018	42
Table 3.1	Matching the gap on economic growth: from institutional constraints to free market economy	73
Table 3.2	Population of southern China regions, 1371–1376	105
Table 3.3	Population data and growth rate in Guangdong prefectures [<i>fǔ</i> 府], 1662–1819	111
Table 3.4	Population data in Guangdong province, 1662–1819	111
Table 3.5	Population data and growth rate in Fujian prefectures [<i>fǔ</i> 府], 1680–1737	111
Table 3.6	Population data in Fujian province, 1680–1830	112
Table 3.7	Taxes levied in Kangxi <i>dīng</i> registers and Qianlong Canton Customs	118
Table 4.1	Origins of Jesuits settled in China (1552–1701)	140
Table 4.2	The amount of silver from Spain-controlled Americas that entered the East via Europe, 1500–1800	147



Introduction: The Implementation of the New Global History in China

Global History with Chinese Characteristics is the result of reflection and observation upon the meaning of global history in China during the last decade, where historians have made big efforts in redefining old and new narratives. The implicit intellectual exercise to link the theoretical framework with empirical work, however, stands out as a major challenge to implementing and putting global history into practice. Although global historians should take their own experience and consider the research landscape as a point of departure to reflect on global history, the use of new historical sources and case studies is unfortunately missing. Recent works have constantly focused on theories and interpretations rather than refining and applying global history to case studies based on new historical evidence (Olstein 2015; Conrad 2016; Belich et al. 2016; Drayton and Motadel 2018; Beckert and Sachsenmaier 2018). Seeking new approaches to reinvigorate the field thus transforms history itself from an archaic discipline to an extremely lively one. That is certainly the case with China from imperial times until the present day.

Inevitably the past, present, and future affairs of China and the West intertwine when the historian attempts to study the development of the Asian giant through a global lens. International relations, foreign languages, theory and methods in history, sinology, among other fields, all represent the main composition of the interdisciplinary focus when global history is applied to China. Accordingly, it is relevant to pay attention to

the key role played by rising economies in global affairs and socio-political transformations and economic growth, with special emphasis on the East Asian region. Within this context, China currently attempts to exert a political and economic supremacy in global affairs. The historian progressively realizes that the use and abuse of history in China by intellectual and political oligarchies becomes a powerful weapon to legitimize and redefine the new political situation of China.

From the past until the present day, the acknowledgement of a long-lasting and unique civilization serves to legitimize the political direction and the nation's aims. Neo-Confucian policies, implemented by the government, attempt to reorganize all aspects of life and society. In a very pragmatic way, individual and social directions are put in order and reoriented. The conjugation of domestic and international affairs in a still very interventionist, autocratic, and bureaucratic political system, on one side, and a compulsive market economy, on the other side, has given shape to a socio-economic, cultural, and political structure with special features. This type of polymorphic, non-linear system that governs a very diverse and vast country and geography tends to engage internationally without losing its real patriotic and national face.

The directions of the new global era and how to accommodate global challenges with domestic affairs constitute the real challenge in China. This has permeated throughout scholarly debates on how global history should be written, interpreted, and empirically implemented. Rather than decentralizing the world through its polymorphic nodes and polycentric spaces (Frank 1998; Duchesne 2001; Perez-Garcia 2018), there is a constant revival of Eurocentric (Anglocentric) exceptionalism and a turn to a Sinocentric history (Yu 2006; Wu 2009; Darwin 2013; Perez-Garcia 2014). That is why in recent years global history has emerged as both popular and as an outstanding political tool within Chinese academia. The analysis of modern economic growth, the great divergence debate, and the use of macro-economic aggregates such as gross domestic product (GDP) are the main factors that have fuelled the interest for global history among Chinese academic circles.

Within this big polychromic canvas, mixing history, politics, economics, and the socio-cultural diversity inherent in China, there appears to be what might be called global history with “Chinese characteristics” [*zhōngguó tèsè* 中国特色]. In this sense, the main question that emerges is: Can global history be really implemented and institutionalized within such neo-national and patriotic policies which certainly involves

academic ecosystems and the university environment? Such a rigid bureaucratic and administrative system diverges sharply from a meritocratic system based on the modernization of academic life that includes three pillars to implement internationalization: mobility, diversity, and scientific excellence. The result is an accommodation within a new national rhetoric in which the uniqueness of China's history, civilization, and culture represents the consolidation of a new political system and history based on these characteristics. These are presented as unique features of the country. The following chapter explores the origins and development of "Chinese characteristics" in detail.

China's strategic policy named "The New Silk Road" [*zhōngguó xīn sīchóu zhī lù* 中国新丝绸之路] or "One Belt, One Road" [*yīdài yīlù* 一带一路] has political, social, economic, historical, and cultural implications (Wang 2010; Li 2010; Liu 2010; Antony and Schottenhammer 2017). Within Chinese academic circles, this policy demonstrates the exceptionality and long-lasting values of Chinese civilization. History in China has strong political connotations, and one of the objectives of the "Silk Road" policy is to renew the cultural exchanges and encounters between the West and China.

The early origins of such encounters took place after trade routes were established during the Han dynasty (206 BC–220 AD) when trading posts emerged from Xi'an to the eastern Mediterranean by crossing the Middle East regions. However, Ferdinand von Richthofen, a German geographer, traveller, and scientist, was the one who coined the concept of "Silk Road" or "Silk Route(s)" [*Seidenstraße* and *Seidenstraßen*] (von Richthofen 1877). This term is, therefore, a modern concept, a product of the nineteenth century; a period of reconstruction of historical myths that aimed to build and develop the modern nation-states. Contemporaries of the Han dynasty and subsequent dynasties never used the term "Silk Road," it was just simply a modern invention (Chin 2013). As Craig Benjamin has documented for the early period he studies from 100 BCE-250 CE in empires of ancient Eurasia, as well as in my own case as I have never found any evidence in Ming or Qing dynasty historical sources, "the Silk Roads have no basis in historical reality or records" (Benjamin 2018: 6).

The so-called "Chinese characteristics," a term to distinguish the political system of the country with the rest of the world, aims to present a different type of socialism opposed to Western countries. This term was coined by Mao Zedong, later by Deng Xiaoping, and today reused by Xi

Jinping. By knowing the importance of the new landscape in global affairs and international relations, Xi Jinping launched “The New Silk Road” policy in 2013. It is an international-orientated strategy, but with a strong national emphasis. The aim is to keep the vast geography and provinces of China unified, to strengthen regional socio-economic and political power, as well as promoting cultural supremacy.

Today in China the role of global history is to develop a new national narrative to foster the unification of the country through a shared common past of more than fifty ethnic minorities. Thus, this book intends to deconstruct such new nationalism and global history with “Chinese characteristics” by introducing new comparisons across the diverse geography of China, as well as making some comparisons and engagements with western regions during the Qing period.

In this sense, it is pertinent to explore the academic ecosystems of faculty life in which we really can see the implementation of global history. Global history should be considered as an approach to analysing socio-economic, cultural, and political dynamics of change over centuries, as well as potential similarities and disparities between the West and the East. Global history in its nature implies institutional frames of internationalization and scholarly diversity. The implementation and institutionalization of such frames is the responsibility of departments, faculties, and universities. Certainly, in this sense, a very relevant question is how successful are other countries, outside of China, in implementing global history into the humanities and social sciences?

Likely we might find the same answer as in China, but with a different context. It is important to mention the implementation of global history in Latin American countries, other Asian regions (i.e. the case of the Philippines, Japan, South Korea, Taiwan, Singapore, Thailand, among others), Latin Europe and Northern Europe, or even core countries of Europe such as Germany or France. It can be observed in those cases, mainly in countries with a profound colonial past, and in those recently founded as independent nations, that global history confronts and goes against the new national rhetoric and narratives which serve to culturally present a unique national history based on past civilization. We might probably find similarities with the case of China that is presented in this book. In this sense, global history undermines and even places patriotic narratives and national history(ies) under deep criticism.

Ethno-nationalism (Adelman 2017) that represents the rise of patriotism, populism, and anti-global movements is very present in neo-national

narratives of countries that currently rewrite their history with the aim of projecting a new identity and image of the country. Xi Jinping at the beginning of his mandate coined the term “Chinese dream” [*zhōngguó mèng* 中国梦], which is an obvious reference to the so-called American dream, claiming for the unification and glory of the nation. In such rhetorical discourse, the history of China and the construction of new narratives play an essential role. Thus, global narratives challenge national history(ies), and the history of nation-states that were constructed in the nineteenth and twentieth centuries. The collapse of the Soviet Union represented the creation of a new global order. Supra-national trade agreements such as the European Economic Area (EEA) that was established in 1992, the North American Free Trade Agreement (NAFTA) that came into force in 1994, the World Trade Organization (WTO), officially inaugurated in 1994, the South American trade bloc (MERCOSUR) established between 1991 and 1994, and the Association of Southeast Asian Nations (ASEAN), among others, foster the free movement of people and economic capital. Such supra-national institutions created worldwide and across continents attempted to meld political and national interests of the region in which they were created within a global economic agenda.

China joined the WTO in 2001 and launched policies to engage with the new global order. Within this political context, globalization rose with great energy and global history started to play an essential role in the new narratives, re-definition, and identity of nations. Books on global history, mainly by the California School authors, started to be translated into Chinese and soon bestsellers become very popular with the Chinese public. We can first discern this trend by looking at the monumental multi-volume work of Joseph Needham’s *Science and Civilisation* (Needham 2004).

Needham was especially considered as a “friend by [the] Chinese audience” (Mackerras 2018). This is mainly explained by his encyclopaedic presentation of the scientific discoveries in China and the technological development of Chinese civilization which reached its peak in the Song dynasty. This was very well received by the Chinese public as a unique contribution, making him something of an exception since in academic and non-academic circles a Westerner is not seen as legitimate to do, write, and interpret China’s history.

Following other bestsellers, we should obviously include Kenneth Pomeranz's *The Great Divergence* (2000) and Thomas Piketty's *Capital in the Twenty-First Century* (2014). The interpretations, and most importantly the translations from English to Chinese, largely mislead the original concept, topic, and context in which these books were written. We should note that today in China not many academics can read English, and also that Western books and translations go through censorship screening of what is considered to be politically correct.

These three translated books reinforced the uniqueness and value of Chinese history, modern development, and economic growth to the Chinese public. Scientific discoveries since Tang (618–907) and Song (960–1279) dynasties (gunpowder, compass, nautical devices, etc.) presented by Needham's work; the levels of standard of living of some Chinese regions such as the Jiangnan area or lower Yangtze Delta that were equal or higher than other European regions (i.e. Great Britain or Netherlands) in Pomeranz's *Great Divergence* argument; and Piketty's *Capital* presenting the growth of China's GDP as an indicator for the hegemonic role of the Middle Kingdom in the new world order, all presented a set of variables to understand China's economic development.

Scientific developments, uniqueness of history and culture, standards of living, economic growth, as well as the global hegemonic role are the fundamental features for the cohesion of China's historical and cultural identity in the twenty-first century. This new national history and revision of Chinese history is fundamental to the patriotic eyes of the People's Republic of China (PRC), and how this history and identity is portrayed in the society.

Here is when such national narratives attempt to hush the voices of new histories, global and transnational history(ies), which challenge the official and patriotic version of history created by the establishment. The history of the global starts by reducing the geographic scales of comparisons in national and regional units (Subrahmanyam 1997; Gruzinski 2001). The meta-narrative is coherently developed when applying such *jeux d'échelles* [playing with scales] (Revel 1996; Levi 1991) going from a micro to macro perspective (Brewer 2010; de Vries 2019) and cross-referencing historical sources of diverse nature and origin. The aim, therefore, is to create a better approach to understanding the complexity of socio-economic and political structures in the formation and modernization of nation-states.

The composite of transnationality generates resistances in legitimizing national and patriotic histories. This is very present in the development of modern nation-states and the multi-ethnic value of communities, residents, aboriginals, language, and consumer goods. Such process was initiated in the early years of the nineteenth century (Osterhammel 2014), as well as in present times with the new wave of rejuvenation of national history. The ambiguity of political discourses, as well as the identities of inhabitants such as those of the different provinces of China, or of European and American regions, etc., makes that current neo-national (populist) programmes fail in presenting a coherent social frame of unification, in which the identity and solidarity of the people marches under one flag.

For the case of China this has resulted in anxieties, resistances, and a discourse of victimization through the concept of “Chinese,” the meaning of being “Chinese,” and who is legitimized to deal with Chinese history. Since the second half of the twentieth century, and more precisely during the Cultural Revolution, Mainland China’s scholars are presented as only those responsible to write and rewrite Chinese history and its long-lasting civilization.

Theories, methods, and narratives outside the realm of this orthodoxy and school are portrayed as Western contamination. The aim is to keep the core of Asian values through neo-Confucian policies in which society should respect the political order, the social hierarchy, and the willingness of the community, through the motto of letting the other do and rule, to respect the actions of one’s superiors.¹ This is directly expressed in the hierarchical Confucian system of society respecting superiors (Tu 1998: 128; Chan 2004) from “king to subject, father to son, husband to wife” [*jūn wéi chén gāng, fù wéi zǐ gāng, fū wéi qī gāng* 君为臣纲, 父为子纲, 夫为妻纲]. This illuminates East Asian values through Confucian authoritarianism embedded in the autocratic state and governing forms of the emperor and officials across dynasties.

In a recent essay about what constitutes global history, Jeremy Adelman precisely mentions the domination by national narratives when practising and implementing global history: “until very recently, the

¹ See also Benedict Anderson’s (2001: 1283) comment on the importance and power of the language, cultural values, and identities of what is the meaning of “Chinese,” mainlander, and East Asian identities.

practice of modern history centred on, and was dominated by, the nation-state. Most history was the history of the nation.” (2017) This conclusion goes hand-in-hand with what Benedict Anderson has told us about the construction of “imagined communities” and build-up of fictional history with the aim to glorify the past, legitimize the present, and imagine the future of modern nation-states. Adelman’s statement that “every nation cherishes its national history, and every country has a cadre of flame-keepers” (2017) seems a pertinent quote to support the argument that fictional histories are deeply kept in the public psyche.

Adelman’s observation might help us to understand the concept of global history with Chinese characteristics. He points out that “After years of falling enrolments, declining majors and a dispiriting job market, many saw ‘global history’ as an elixir” (Adelman 2017). In other words, some turned to global history as a means of producing a national narrative that could rejuvenate the history of the nation (Bell 2014). This can be applied not only to China, but to any nation that uses its “imagined” history to legitimize its political project and create a discourse of “victimization” against invading nations or searching for “invisible” enemies to validate national narratives. Latin American nations provide an example of this as they have constantly used the myth of the “black legend” (Keen 1969; Kamen 2003; Paquette 2019, 2020) about the Spanish empire as the main cause of their past, present, and even future problems.

However, the “Columbian exchange” (Crosby 1972), and the causes of disparity, was more complex due to biological socio-economic and cultural factors. Political speeches by the president of Venezuela, Maduro, or of Mexico, Lopez Obrador, who have claimed for an official statement to the king of Spain and the Spanish government asking for forgiveness to the Mexican and Venezuelan people for the “atrocities caused by the Spanish empire and conquistadores,” is an example of the constant creation of national and “imagined” histories (BBC News Mundo 2019). Likewise the pernicious and resentful “Ley de Memoria Historica” [Historical Memory Law] issued in 2007 by the Government of Spain puts itself forward an “official” history and purports to be taken as representing a mainstream consensus. Presumably, this effort seeks to shape collective memory and even control the limits of what can be thought, written, and believed about the past. In 2019 stories appeared in the media arguing that teaching the history of Hernán Cortés or even attempting to analyse the period of Cortés’ arrival is an insult according to some Latin American circles. The writing and interpretation of history, or

more precisely the official history, seems to change at the will of presidents and governments. Historians are coerced to follow the mainstream and rarely global history in regions of Latin America, Asia, and even Europe, step outside the official canons.

Although the real institutionalization of global history, curricula development, and research centres under such political frameworks appears utopian, in China the funding of research centres under the “New Silk Road” (or “One Belt, One Road”) aims to showcase the uniqueness of Chinese history and civilization and its connections with the West. Presenting this “new China global history” with strong national characteristics, also applicable in the case of Latin American nations or nation-X in Adelman’s words (2006, 2017), as I have already mentioned, is a contradiction in terms.

Global history is an approach that looks for connections through comparisons (O’Brien 2006) from macro to micro scales presenting divergences and/or convergences across spaces. In the following chapters I will develop this idea on how to implement global history through comparisons and reduction of scale through local case studies. As Jürgen Kocka and Heinz-Gerhard Haupt (Haupt and Kocka 2009) have stated, the implementation of global history is a very demanding task both methodologically and empirically. Without institutional support at the university, faculty, and department levels, then such a task requires constant training of students in foreign languages, history, methods, and theory to deal with a diverse array of sources in several languages, with the likelihood that any attempt to empirically implement global history will fail. Within a strong interdisciplinary package in which the historian can command several languages and apply a toolset of diverse fields such as history, economics, social sciences, digital humanities, among others, it is possible however to minimize the bias in any attempt to implement global history.

There is a very selective process in any historical narrative; what is included and excluded is based on random choices by the historian (Adelman 2017). Such segregation and bias are constantly repeated when historians research the origins of globalization (O’Rourke and Williamson 2004; de Zwart and van Zanden 2019), mass consumer societies, or modern economic growth. The focus on the British empire and England’s economic boom during the first industrial revolution has further blurred the global (historical) analysis through Eurocentric (Anglocentric) perspectives (McKendrick 1982; Brewer 2004; Berg 2005; Humphries 2016). The so-called great divide (Toynbee 1934; McNeill

1963, 1990; Huntington 1996) continued this trend by only approaching global history within the study of the British world, the so-called British exceptionalism (Duchesne 2011; Vries 2015; Berg 2019), and its colonies. The same interpretative model can be seen with other European empires. Therefore, the difficulty in implementing global history is not only caused by institutional constraints in research institutions and universities, but also within the historians' provincialism "who continue to look inwards instead of acknowledging the importance of global history" (Adelman 2017).

The inherent components for institutional reforms that accompanied academic internationalization, which are more than necessary for really implementing core research and teaching global history, are defined by non-linear models of scientific innovation. Such models are characterized by the interdisciplinary scope by which clusters and networks for advancing new education policies are connected to open science and innovation itself. This intrinsic toolset for the implementation of global history can present scientific results in a coherent, transparent, and accessible form for academic audiences and the public in general.

This model of open science to the world certainly might contribute to solving current socio-economic and cultural problems derived from the financial crisis of 2008 and the political aftershock in Western democracies. Nevertheless, it would be a bit naïve from my side to believe that such model is in real terms taking place in academic life. What can be defined as "academic ecosystems" in research institutions and universities, mainly for the case study of this book, global history in China or in nation-X, are deeply rooted in the above-mentioned provincialism and local teleological scope of the historian. Undoubtedly, it is a very valid model, and we should pursue its implementation, but there is still a long way to go due to resistance not only in China, but in Western areas as well.

Global History with Chinese Characteristics analyses global history in China, as well as in connected histories with other spaces (the Americas and Europe), by separating politics and ideological bias from academic work. By doing so I present a brief literature review on how global history is being implemented and perceived in China, and how it has been conceived theoretically and methodologically in academic circles. With the limitations in global history research outlined, I next introduce the theoretical and methodological framework behind a new case study that compares in a specific region/locality of south China (the economic axis

Macao-Canton) and Europe (the economic axis Marseille-Seville), trade networks and transformations in consumer behaviour mainly during the eighteenth century.² Within such a micro-scale, new insights and clues on the micro-foundations of the great divergence by cross-referencing new empirical evidence from Chinese and European historical archives might be found.

Macao and Marseille serve as units of comparisons and linchpins of both Mediterranean and south China markets to understand how social actors (mainly traders) interfered with mercantilist rules and stiff economic interventionism of autocratic rulers such as eighteenth-century Spanish monarchs and Qing dynasty emperors. The correlation of Marseille and Macanese merchants as agents and mediators in local economies and trade affairs in south China (by extension in the Pacific area) and the western Mediterranean contributed to define a new economic scenario in which the languishing Spanish and Qing empires did not have a predominant position. And more intriguingly, this poses the question how were these spaces connected to the so-called imaginary Silk Road?

Through such comparison, mainly in the exercise of political power and state capacity of the two empires, we might find, as Pomeranz said, but through a different angle, “surprising resemblances” and intriguing “global conjunctures” (Pomeranz 2000: 4). Using and cross-referencing both Western and Eastern sources, or at least asking questions of the sources within a different approach, might help to unveil such “global conjunctures” which took place in local socio-economic and cultural interactions. The agency of traders, artisans, missionaries, intellectuals, and travellers fostered such contacts creating a network of transnational alliances, in many cases through unofficial institutions and various forms of trade and partnerships, with native and foreign communities.

Macao and Marseille, as main hubs for the circulation of goods, capital, and people from the sixteenth to the eighteenth century, were closely connected with the Spanish and Qing empires. After the Succession War and the triumph of the French Bourbon dynasty, a massive number of migrants who worked as artisans and merchants (retailers, peddlers, and

²For a better understanding of socio-economic and cultural processes of trans-localism and global history connected to micro-historical phenomena from the perspective of social agents, family groups, and goods, see Trivellato (2011) and de Vito and Gerritsen (2017).

wholesalers), from southern regions of France, mainly Marseille, established their economic activities along the Spanish Mediterranean coast in Alicante, Cartagena, Cadiz, and Seville as main port cities.

The progressive global demand of overseas goods from Asia, such as silks, porcelains, tea, or household furniture from China, or cottons (calicoes and mousselines) from India, made the Spanish economy extremely dependent upon foreign trade. French merchants were the key social agents in fostering such demand creating a new market in Spanish localities and villages, and ultimately changing consumers' choices. The attempts of Spanish monarchs throughout the eighteenth century to ban the introduction of goods from China and find "import-substitutes" clearly failed. Marseille was the business place, the new economic dominion in the Mediterranean market during the eighteenth century, interfering in the economic development of Spain.

Macao exerted the same role in the economic affairs of the Qing administration, similar to what the Spanish empire did (though it was a colony of the Portuguese Crown), by bypassing the regulations and supervision of Qing officials, by becoming the central place for the drain of American silver, and by corrupting local government in areas of the Guangdong and Fujian provinces. Such illegal systems and smuggling activities had branches and extensions in the Philippines. The Manila galleons, officially under control of the Spanish empire, was in fact the main channel of unofficial institutions, families, and trade networks from diverse origins, mainly French, Armenian, Macanese, Cantonese, Fujianese, and southeast Asia communities, and other European social actors.

These transnational networks and trade agents were the de facto rulers of the galleons and the decision makers of trade governance in the South China Sea. The analysis of the diffused community of the *sangleyes*, Chinese traders from south China regions who were allowed to trade with the Spanish empire in Manila, is paramount to understanding the unregulated trade and informal rules in the South China Sea.³ This of

³The study of the *sangleyes* has been partially undertaken by scholars, only referring to the episodes of the daily life of this community in the *parian* (neighbourhood where they lived) of Manila, the massacre of *sangleyes* and their integration with local communities, and limited studies on their trade activities (Ng 1990; Blussé 1991; Ollé 2005; Ruiz-Stovel 2009). Other chronicles of the late sixteenth and early seventeenth century should also be mentioned. See: Biblioteca Nacional de España (hereafter BNE), de Morga, A., *Sucesos de las islas Filipinas*, México: Casa de Geronymo Balli 1609.

course had in the long term a strong negative effect on the Spanish empire's economy during the eighteenth and nineteenth centuries as most economic resources reverted into the hands of individuals, groups, and companies acting in the Pacific region. The Spanish empire failed to create efficient institutions to manage such a long-distance trade, to implement policies, and to manage economic resources in the Philippines in order to control the trade from south China.

The concept of the purity of blood is also important to understanding such transnational alliances among traders settled in Macao and how they developed business partnerships in Canton and Manila. Many of these traders arrived in Macao during the period of the Union of Crowns in the sixteenth and early seventeenth centuries. They had Jewish origins and were escaping from prosecution by the Inquisition (de Sousa 2015, 2018). Hiding their identities through conversion to Catholicism and changing their surnames by marrying people of the same social status or above were their main strategies.

This issue is very important when comprehending how the long-distance trade of the Spanish empire in the Pacific area and its connections in Manila and Macao functioned (Souza 1986). The social agents, families, and partnerships were articulating business and alliances through blood, even though the crowns of Portugal and Spain were separated. The state capacity of the Iberian empires and the performance of institutions cannot be understood without the role, origin, and socio-cultural features of the main agents: traders who had mixed backgrounds of Jewish and Catholic origins.

Thus, Macao and Marseille could be defined as peripheral areas in southern China and Europe whose main feature was to relocate, and divert, economic resources of the Qing and Spanish empires. The statement "There is nothing we don't have that we need from you" made by Qianlong emperor to the Macartney Embassy, can be challenged through the case of Macao which shows that there were many things that the Qing empire (mainly officials, the gentry and business elites from Fujian and Guangdong provinces) needed from foreign powers and European empires. Those items were American silver and the progressive demand for Western goods. Goods of American origins (i.e. chili, potato, sweet potato, corn), and goods of European origins (i.e. mirrors, clocks, crystal glasses, liquors or wines, among others) were among those items that created a new market and demand in China.

Macao and Marseille stand out as a clear example of eighteenth-century economic polycentric areas which were beyond the dominion and centrality of mercantilist and autocratic states of Qing China and Bourbon Spain, connecting trade and routes ruled by trade networks and long-distance partnerships (Perez-Garcia 2018). The vicarious consumption theory, which I developed in previous works and I apply to Qing China in this study, places emphasis on the role of traders creating a new market where initially the demand for foreign goods was scarce or null (Perez-Garcia 2013). The introduction of silver and the above-mentioned Western goods is an example of items that progressively changed consumers' choices in China, ultimately creating new local habits and fashions. This shows the transcultural dimension of the economic circuits and the international trade hub of Macao integrating Western and Eastern markets through trans-Pacific and Indian routes of commerce.

Within the historical context presented above, a concrete definition of space and chronology and referring to scales of comparisons, it is essential to observe how the local socio-economic and cultural changes were influenced by global processes of integration. The delimitation of cross-chronological and geographical sections in temporal sequences of historical facts or events, which took place in the regions to be compared (Werner and Zimmermann 2002, 2006; Douki and Minard 2007), are the main coordinates to implement this case study.

The chronology range from 1680 to 1796 is well-known as the “High Qing” period [*shèng qīng* 盛清], in which the scholarship has given credit to the three emperors Kangxi, Yongzheng, and Qianlong for the development of an efficient state, economy, and trade system. Roy Bin Wong, among other scholars, has presented the Qing state and its institutions and bureaucracy as well-organized and effective in developing “an infrastructural capacity to mobilize and disburse revenues beyond imagination” (Wong 1997: 132, 2015; Deng 2015). But corruption increased among officials when, in the late Ming dynasty, the tax system changed from *corvée* to silver. And this growing corruption was not corrected by the Qing state. On the contrary it was accentuated through low salaries paid to officials, and autarky promoted mainly by the Qianlong emperor when he implemented the Canton System of trade (1757–1842) [*yīkǒu tōngshāng* 一口通商] (Liang 1999) to control foreign trade in China within one single port.

This created a dense and uncontrollable network of Qing officials, Hong merchants, Western trade companies, and the Manila *sangleyes* as

mediators between Western contractors and Chinese buyers. Economic policies were orientated toward merchant initiatives and unofficial institutions. However, the incapacity of the Qing state to control and regulate this system in the southern provinces is well-known. Also the mercantilist policies of the Spanish empire that created the *Real Compañía de Filipinas*, 1785–1834 [Royal Company of the Philippines] (Díaz-Trechuelo 1965; Martínez-Shaw 2007) at the same time as the Canton System were both directed to tackle (unsuccessfully) smuggling (Ho 1959; Huang 1974). Both in the mid and long run, these actions had negative consequences for the Qing and Spanish empires being such dense bureaucratic systems. In both, an endemic inefficiency of officials drove their economies to chaos and collapse.

This proves that when advocating for a micro-level approach it is vital to compare specific geographical units, such as port cities, defined as strategic geopolitical sites and how the state policies implemented by Qing China and Bourbon Spain effected trade, the state economy, and international relations between China and European regions. Macao and Marseille were the “interlopers,” the “unexpected guests,” as trade zones interfering in the affairs of the Spanish and Qing empires. The study of merchant networks that operated in both Pacific and Mediterranean markets is crucial to observing the correlation of state policies in trade and economic affairs. Macao and Marseille were the nodes of such complex socio-economic and unregulated systems in western Europe and the South China Sea. Thus, for an accurate definition of the temporality it is essential to observe through cross-chronological sections, as benchmarks, global socio-economic transformations and its impact on the local economies of these areas.

Such a case study might enrich the debate of the great divergence from a local basis by analysing differences and/or convergences between East Asia and Europe within a specific geographical and chronological delimitation. Southern China and western Mediterranean Europe were regions defined as transnational and transcultural due to the foreign communities that were established. For the case study I present, Macao and Marseille are also geo-strategical sites in the South China Sea and Mediterranean Sea, respectively, as their privileged location allowed them to create trade links with other nearby ports and external areas for international trade and distribution of commodities. Marseille was the transnational entrepôt that connected Europe with Asia through Levantine routes (Panzac 2004), mainly through the trade activities of Aleppo and Armenian merchants

from New Julfa (Aslanian 2011). Whereas Macao was connected to the West via the commerce with India and through the Manila-Acapulco galleons (Boxer 1969; Flynn and Giraldez 1996, 2010). Macao was bounded to the West through the trans-Pacific area and both maritime and land silk trade routes of China.

Global history approaches have been emphasized in order to visualize the progress, form, and method which historians have undertaken when carrying out ambitious research projects analysing and comparing diverse geographical and cultural areas of Asia and Europe. In dealing with comparisons and cross-cultural studies in Europe and Asia, some scholarly work remains vague when defining geographical units as well as the chronology. The result of this research has an application to the present day for a better understanding of perceptions, discourses, and encounters between China and Europe by analysing strategic geopolitical sites as dynamic areas of trade, consumption, and socio-economic networks between China and Europe through specific localities and regions.

How did foreign trade networks and transnational communities of Macao and Marseille operate during the eighteenth century and contribute to somehow transfer respectively European and Chinese socio-cultural habits and forms into the local population? What was the extent of these trade networks and where were the channels of redistribution of European goods in China and Chinese goods in Europe? These are relevant questions when exploring Sino-European trade relations and how the transnational dimension of overseas commodities changed tastes by creating a new type of global consumerism. Such concrete comparison can help to narrow the gap that some researchers have created when widely analysing differences between Asia and Europe without a specific geographical and chronological delineation. This book's originality is based on the use of Chinese and European sources to compare the trade system in both areas and changes in consumer behaviour, as well as establishing connections between the Qing and Spanish empires.

The major peril in such big comparative and cross-cultural studies is that some ambiguities and vagueness might appear when using vast geographical units and a *longue durée* chronology (Sawyer 2015). In some cases, it is not quite clear if we are talking about Europe, northwestern Europe, Great Britain, or the Netherlands, for the West (European) side, and for the East Asian (Chinese), if we are referring to China, the Yangtze region, or its prefecture areas, when we analyse the economic differences between both areas during the period of the industrial revolution and

mid-Qing dynasty. Such large generalities might lead to vague and weak results as Pomeranz mentioned in his work (Pomeranz 2000).

Probably some works on this topic have exceeded the debate of the great divergence grounding their arguments on the interpretation of sources, especially on the Chinese side, mainly guided by sloppy assumptions since some data are considered questionable (Prak and van Zanden 2013; O'Brien and Deng 2017; Broadberry et al. 2017; Maddison 2007). This has misled the analysis about global (economic) differences between the West and Asian territories, mentioning that the big differences between both continents appeared after 1800 (O'Rourke and Williamson 2004) as before this date regions of China and India had stronger levels of economic growth than Europe.

There is still a need for more concrete case studies that can apply such theoretical frameworks by using specific empirical data in order to observe the real framework and micro-foundations of the divergence (Zan and Deng 2017) between the West and East and/or the channels of socio-economic and cultural transfers through the circulation of people, goods, and technology. The analysis of such transfers and new cultural forms might enable us to better understand the early connections and meetings between the West and China in the period of early globalization.

In *Global History with Chinese Characteristics*, the main method presented is to cross-reference and analyse Chinese and European sources such as trade records, probate-inventories, local gazetteers of China [*zhōngguó dìfāng zhì* 中国地方志], imperial edits of the First Historical Archives of China, and manuscripts by Jesuits settled in China, among others. This analysis has been carried out through a multi-relational database and social network analysis (Perez-Garcia 2019). Such method allows quantification of the quantifiable beyond the doubtful GDP data for early modern East Asian economies. This will give us a better understanding of the socio-economic transformation of China, the impact of Chinese goods in European markets, as well as transnational trade networks.

Richard Drayton and David Motadel are correct when they state that “the enterprise of the global will depend on collaboration... more training in languages, particularly non-western ones... this must be matched by an acceleration of the digitization of sources” (2018). I would add to the equation of languages and digitized sources the indispensable need for new multi-relational databases (beyond the rigidity of Excel tables or metadata) as a method for cross-referencing sources of diverse nature

and languages (Perez-Garcia 2019). The equation to implement the new global history should consider the following variables:

- New Global History = collaboration (academic networks)
- + training in languages (non - western ones)
 - + digitized sources (western and eastern archives)
 - + digital methods (multi - relational databases)
 - + cross - referencing primary sources

One of the misunderstandings I wish to clarify concerns the implementation of global history in European and Chinese academia through a new case study and use of new historical evidence to re-examine the great divergence debate from a local basis. In recent years a shift from a Eurocentric to a new Sinocentric approach has emerged in global economic history. The California School has contributed to move the analysis from Eurocentric perspectives to ones that look at global conjunctures. Other Western scholars have also recognized such errors (Brewer 2005; Batchelor 2008) by assuming that the pivotal axis of analysis for the study of global movements, connections, exchange, meetings, and encounters between the West and the East should not be uniquely focused on the European powers and their colonies.

However, this has led in turn to a very Sinocentric focus, first fostered by Chinese scholarship whose particularities on global history are primarily linked with political issues in a neo-Confucianist attempt to glorify Chinese history and civilization (Yu 2004; Cheng 2005; Li 2011). The aim of this perspective is to analyse the economic performance of Qing China by making backwards projections of GDP, from year 1 CE to the present day, an economic indicator which does not work well for early modern China and its diverse provinces and regions.

This will be clarified in *Global History with Chinese Characteristics* by providing new empirical evidence from Guangdong (the commercial axis Macao-Canton) and Fujian provinces, as primary places in China orientated towards international trade. The same will be done for the western Mediterranean region of Europe through the trade connected areas of Marseille and Seville-Cadiz. Western Mediterranean trade zones were integrated with the Pacific and Atlantic market via the Manila galleons through the route from Manila-Acapulco to Veracruz-Cadiz-Seville-Marseille, as well as other South American routes. These

interconnected port cities and trade networks fostered the circulation of Chinese goods in the Americas and Europe, as well as the circulation of American and European goods in China.

Within this polycentric and world network system of trade and circulation of goods, it is important to consider social actors, institutions, and business practices in south China and Europe during the seventeenth and eighteenth centuries. It is particularly relevant to pay close attention to business families' alliances, the *commenda* contracts as the main financial form, as well as the strategies, shrines, and places of religious worship the traders founded in south China and Europe to hide their socio-economic status and professional identities. The case of Huizhou traders is paradigmatic when they founded the ancestral halls, or that of the *neo-conversos*, Portuguese/Spanish Jews who hid their religious past by founding Catholic institutions such as *capellanias* [chapels, churches] to escape from the Inquisition in Iberian territories and colonies, especially when they settled down in Macao. Arranged marriages, trade networks strategies, trust and institutional arrangements through the mediation of family, lineages, religious and trade organizations, the land tenure system, and the entailed-states in Spain and Portugal were all a way to secure economic life, profit, and on occasions extend the social promotion of the family.

The context of the Union of Crowns [the dynastic union between the Kingdom of Portugal and the Crown of Spain from 1580 to 1640 under the Habsburgs] and the post-Union period played a very important role in the trade between China and Western powers, as the British, French, and Dutch took advantage of the separation and weakness of Spain and Portugal in order to take over the lucrative Portuguese oceanic trade of Chinese goods and slaves.

Analysing this European context, in which a new political and economic order was established as the Spanish empire declined and the British empire took over, is essential when considering the chronology of the great divergence. The changes and mutations of western trade networks operating in China under this new political context seem paramount when observing alterations in trade and consumption. The new dynasty in China, the Qing, was established in 1636 and started to rule in 1644, the same period where the separation between Spain and Portugal occurred. This time frame, which brought convulsive socio-economic and political changes demands further attention, whereby

conclusions on periodicity, evaluation, and causes of the great divergence might change.

Providing new micro-level comparisons within regional cases beyond modern Eurasian polities, as well as mining new historical data in the archives instead of using macro-aggregates, the unknown or neglected history, *Global History with Chinese Characteristics* plans to go beyond Eurocentric bias through new comparisons and data from Chinese and European archives, and also from the Americas (Mexico) (O'Rourke and Williamson 2004; Allen et al. 2011; Cox 2017; Broadberry et al. 2018).

In fact, the study of Chinese economic development and its comparisons with European regions does not work well with economic indicators such as GDP and its backward projections to the early modern period. In this way, China has been merely contemplated by economic historians as a modern nation-state for the early modern period. However, we should not talk about China as a modern nation-state until after the May 4th Movement of 1919. It should be considered as a Kingdom in which the Qing dynasty drastically changed its frontiers and borders.

This consideration, which for many sinologists or specialists in China should be an obvious element, has not been quite present in historical analysis that deals with comparisons treating China as a large and homogeneous geographic unit. The Qing expansion to western provinces and the inefficient bureaucracy and institutions could be the real cause of Chinese economic decline, as well as the constant attempt by Qing emperors (mainly Qianlong), a Manchu Dynasty not Han, to legitimize themselves to govern the Middle Kingdom.

Chinese provincial elites and local trade networks created much internal instability in the long run. These elites were composed of Shanxi bankers, Huizhou traders, Hong merchants of Canton, and *sangleyes* [Chinese traders of Manila], among some preeminent social actors. The Qing government made a softer policy to them as a "concession" by not supervising their activities, reducing taxes, and enabling smuggling activities. The failure in the negotiation between the central government of Beijing and local trade elites, mainly from Fujian and Guangdong provinces, seems a crucial factor for the economic decline of China during the Qing dynasty.

Scholarship, mainly from Chinese researchers, has blamed the progressive intervention of Western powers (Great Britain, France) for such decline. However, we should further explore the disruptive political performance of Qing China, mainly from the eighteenth century onwards

through non-official institutions and alliances between south China traders with Western companies, internal shocks, uprisings, rebellions, among other relevant factors. Due to the diversity of the Qing territory the government confronted a serious domestic problem: unification vs. disintegration of the territory.

Global History with Chinese Characteristics examines Chinese historical sources, which have been scarcely used, and contrasts them with European sources, mainly those from the *Archive de la Chambre de Commerce de Marseille* in Marseille, France, and the *Archivo General de Indias*, in Seville, Spain. Trade records, merchant letters, Jesuit manuscripts and accounts, private correspondence, family accounts, and probate-inventories, among others, are used in this book. This makes it possible to compare both Western and Eastern sources in order to give a solid explanation within a micro-scale perspective of the divergence between Europe and China, and disruptions in economic affairs and government institutions through Macao and Marseille as “interlopers” interfering in the Spanish and Qing empires.

To examine such divergence, it is necessary to look closer at the interactions between European (Portuguese, Spanish, French, or Dutch families of Macao) and Chinese social groups. Connections and comparisons will be made as to how European trade networks interacted with Chinese merchants connecting Macao with coastal networks of China, mainly with those of Canton, Amoy (Xiamen), and Shanghai, and inner networks through the lower Yangtze River with Nanjing being one of the main sites that connected the coast with inner regions for the export of silks to Western markets.

The empirical basis provided by using such sources will help in understanding the global process of economic development between a specific territory of China, with the case study of Macao, and its European counterpart, Marseille. Therefore, such targeted analysis is based on a *jeux d'échelles*, from a micro focus, analysing trade networks, to a macro perspective, having pivotal axis port cities as global markets for the circulation of goods.

Finally, this research and its application might contribute to the awareness of historical relations between China and Europe, as well as offering a better knowledge of the concept of Europe and the diversity of Chinese territory beyond nationalistic implications. By no coincidence, the European Delegation in Beijing, since the opening of its office in 2008

through the EURAXESS scientific network, has served as a major platform to diffuse high-quality research outside academic boundaries. This can be visualized through the current scientific programmes and cooperation between Chinese institutions, such as the Chinese Scholarship Council or the Chinese Academy of Social Sciences, and the European Commission with the permanent launch of the European Research Council, the Marie Curie Programmes, the 2020 Horizon Programme or the recent Horizon Europe Programme.

These scientific institutions promote and develop projects in all disciplines, such as the one funding this book, for the awareness in society of the importance of Sino-European socio-cultural encounters, in the past, present, and future. In addition, the vast group of sinologists, global historians, and economic historians dealing with China and Europe are keen to use new historical sources in a very global perspective. Therefore, *Global History with Chinese Characteristics* helps to clarify a wide set of issues such as shifts from Eurocentrism to Sinocentrism in global history, the state capacity in Qing China which has resemblances to the present day, and the engagement in Sino-European trade. In addition, it aims to offer some views on how currently in China global history is marked by national and patriotic issues that constitute a major challenge for its practitioners, and the pedagogical turn and challenges that we should consider when doing global history.

Open Access This chapter is licensed under the terms of the Creative Commons Attribution 4.0 International License (<http://creativecommons.org/licenses/by/4.0/>), which permits use, sharing, adaptation, distribution and reproduction in any medium or format, as long as you give appropriate credit to the original author(s) and the source, provide a link to the Creative Commons license and indicate if changes were made.

The images or other third party material in this chapter are included in the chapter's Creative Commons license, unless indicated otherwise in a credit line to the material. If material is not included in the chapter's Creative Commons license and your intended use is not permitted by statutory regulation or exceeds the permitted use, you will need to obtain permission directly from the copyright holder.





The “Global History Paradox” in China: Sinocentred Approaches Along the Silk Road

This chapter presents a synthesis of the diverse academic traditions in China and Europe to implement global history. Supremacy and exceptionalism have characterized the socio-economic and cultural development of European powers, mainly Great Britain, the Netherlands, France, and Germany, on one side, and, on the other side, there is the long-lasting civilization and uniqueness of Chinese culture and history which is present today in the rise of China’s economy. Such exceptionalism on both sides has been echoed in academic circles and historiographies on global history. The Sinocentric and Eurocentric perspectives reflected in many scholarly works on global history are a consequence of the exercise of power and political hegemony. In current neo-mercantilist policies in the main world economies, where China is an outstanding example, such national exceptionalism has led to a reversal of national narratives. The “New Silk Road” or “One Belt, One Road” [*yīdài yīlù* 一带一路] implemented by the Chinese government in 2013, as well as the concept of “Chinese characteristics” [*zhōngguó tèsè* 中国特色], and neo-Confucian policies are the main elements of China’s current strategies to take the lead as main world power. Academic circles are affected by this national turn, and the writing, conceptualization, and methodology of global history by Chinese scholars is overshadowed by national narratives distinctly lacking in historical analysis. This chapter highlights the Sinocentric perspectives in global history, which is a replica of the

Eurocentric ones. If I had not had the experience of living and working in academic ecosystems in China for the past ten years, arguably this book would have come from a different perspective.

2.1 FROM EUROCENTRISM TO SINOCENTRISM

The cultural divergence between China and the West became more tangible when the Italian Jesuit Matteo Ricci [*lì mǎdòu* 利玛竇] (Po-Chia Hsia 2012; Zhang 2015) did not map China at the centre of the earth [*zhōngguó* 中国]. His 1602 World Map thus challenged two seminal concepts. First, it showed the real position of China according to accurate scientific methods of cartography and cosmology (Day 1995). Second, Ricci challenged the expected attitude of submission, honour, and tribute that foreigners (Westerners) as barbarians should pay in the presence of Chinese officials as superiors (Morar 2019). The subjects of the Chinese emperor believed he was the Son of Heaven [*tiānzǐ* 天子] as he was the protector of such a large and diverse empire securing food, stability, and liberation from natural disasters (Chang 1955; Miller 2003; Selin 2003; Waley-Cohen 2006; Rowe 2009). However, Matteo Ricci and other Jesuit missionaries confronted this profane concept according to the Catholic doctrine of Jesus Christ as the only Son of God (D’Elia 1934; Gernet 1981).

Such confrontation between western regions and the Middle Kingdom can be seen as a continuation of an event in 1524 when the Ming Court closed the so-called “Silk Road” to the west, forbidding western trade relations in China (Li 2017). Seven border garrisons [*guānxī qī wèi* 關西七衛] were located in northwestern regions to ban commercial relations with the west across Eurasia. “Close the door [to the barbarians in west China] and suspend the tribute trade [with them], and never have dealings with them [*bìguān jué gòng, yǒngbù yú tōng* 閉關絕貢, 永不與通]” (Li 2019).

This was an expression of Sinocentrism (Fairbank 1989; Huang 2011) and Great Ming Empire [*dà míng dìguó* 大明帝国] supremacy, as well as the exceptionalism of the Ming dynasty (Brooke 2010) resuming the early origins of Sinocentrism of the Song dynasty when Taoism, Confucianism, and Daoism converged. Ricci’s map of 1602 was the material expression of the perception of the world by the Jesuits and his Chinese collaborators. Through cartography the Jesuits were putting aside the Sinocentric vision of China and the world that portrayed westerners

as barbarians. This was an early attempt to decentralize China’s world position by emphasizing that the origin of civilizations was not China [*zhōngguó* 中国]. Ricci’s map not only argued against China’s supremacy as an Eastern power, but also challenged ethocentric beliefs in general, including the ethocentrism that was historically endemic to the Western economic empire power houses of Spain, England, and France.

Ricci’s map thus aimed to evade such ethnocentrism and can be seen in fact as an early source of mutual collaboration between Europe and China. The Jesuit missionaries and Chinese literati acted as the main actors in such global encounters between the West and China. Their perception of the world was quite divergent, and in many instances at odds, as we can see in the maps of Chinese local gazetteers [*zhōngguó dìfāng zhì* 中国地方志] in the way they represented and conceived the world. Ricci’s map, however, was a common project of depicting the world as being an important landmark of collaboration, mutual curiosity, and conversation between the West and China (Gallagher 1953; D’Elia 1961; Waltner 2012). China, in the map, is under a Christian cosmos, in Ricci’s own perspective—the map only gives the longitudinal and latitudinal coordinates of China, providing no coordinates for European countries (Waltner 2012) (Map 2.1).

The five relations system [*wǔlún* 五伦] embodies the core of Confucian ethical principles of Chinese culture (Fung 1953). This is symbolized in Ricci’s map as the chief point of encounter between China and Europe. The long-lasting Chinese civilization, culture, and history are characterized by these principles from the period of Confucius until today. We might find the application of such principles in the current global affairs of China through the neo-Confucian policies adopted by the People’s Republic of China (PRC) (Kim et al. 2019; Guo 2017; Angle 2012) with the aim to keep all society unified respecting hierarchy and rank, economic success, and education as pillars of China’s political system and its ruling bureaucracy (Lin et al. 2006; Tu 1996). This, of course, has a clear historical precedent with the Song dynasty when scholars and officials in the Court synthesized Confucian thought with the teachings of Daoism and Buddhism (Chan 1986). The three fundamental bonds and five constant virtues [*sān gāng wǔ cháng* 三纲五常] aimed to guide people’s behaviour and keep society in order in traditional China.

The *wǔlún* 五伦 principles (see Fig. 2.1) are represented in the five relationships (ruler-minister, father-son, husband-wife, brother-brother, friend-friend) (Hsü 1970–1971; Nylan 2001). Europeans, mainly the



Map 2.1 Matteo Ricci's World Map, 1602

Source: Ricci, Matteo, Library of Congress (hereafter LC). National Digital Library Program, and LC. Geography and Map Division. Kun Yu Wan Guo Quan Tu. [Beijing, China: Matteo Ricci, 1602] Map. <https://www.loc.gov/item/2010585650/>

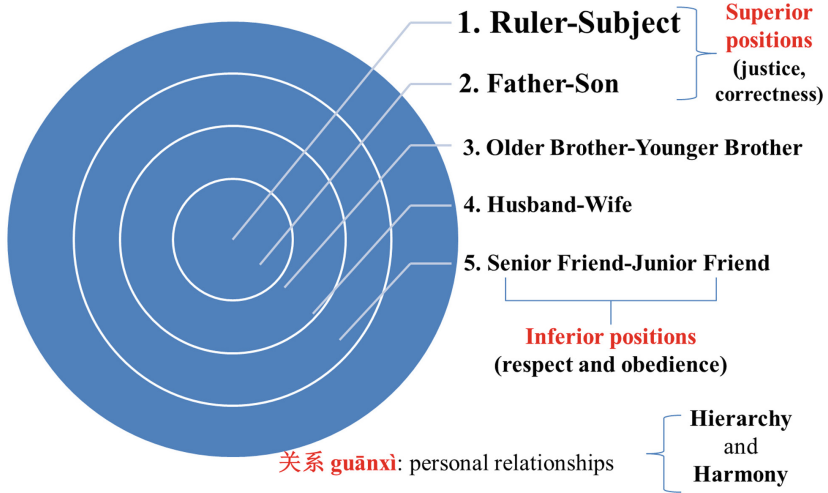

Fig. 2.1 Traditional China Social Order Based on *wulun* 五伦, Five Relations System

Source: Author’s own elaboration

Jesuits, praised the value of *wulun* 五伦 as a universal form that might find its replica in Christian values through tradition, justice, correctness, respect of elders, family loyalty, and personal and governmental morality (Tu 1998). Having good personal relationships [*guānxi* 关系] is a fundamental pillar in this system to maintaining harmony and hierarchy among the ranks of society, families, and clans (Chen 1911). Traditional Chinese scholarship has considered this interpretation of Confucianism as a trend employed by Western and Chinese scholars to rationalize Confucian thought according to Western standards of secularization (Creel 1932; Yang 1957).

Some passages of the *Analects* [*Lúnyǔ* 论语] of Confucius are considered to be agnostic. One might infer some ambiguities in the interpretation by these scholars and classic Chinese thought. However, the subjacent aim of pre-Song and Song commentaries and officials was to keep the unity of China (Bol 2008). In the attempt to reconcile Chinese social life and religion through a rational interpretation of Confucianism through the Sinocentric view and conceptualization of the world, one

might find some resemblances of rationalization and life secularization as occurred during the European Enlightenment.

“The subjects on which the Master did not talk were...extraordinary things, feats of strength, disorder, and spiritual things.”¹

Ricci’s map could be interpreted as a projection of such universal values and virtues, an early form of universality as a convergence between European and Chinese values. In other words, it was a mutual project of understanding new forms of representation and knowledge by embracing both Confucian and Christian tradition by which Jesuits and Chinese literati were the mediators. Ricci’s map, as an example of collaboration and understanding to learn different ways and cultural forms of Europe and China, is the point of departure for this book to illustrate how global history is perceived and implemented in Western and Chinese traditions.

The ways each culture perceived the world, continued today by academic ecosystems in Europe and China, have been inherited since Ricci’s time and are reflected in and have a clear influence on historical narratives. Consequently, the practice of global history in present times has undoubtedly been impacted by such narratives. Sinocentric and Eurocentric perspectives from both Western and Eastern academic traditions have marked the development of global history and comparisons between China and Europe as regions. This chapter provides, therefore, an overview of such divergent academic perceptions that impact the way of thinking, writing, and conceptualizing global history.

Controversies that have arisen between traditional Chinese scholars and those embracing Western forms and concepts are very intense because integrating Western knowledge in China has been perceived as an element of dangerous disruption for China’s social system and civilization (Hucker 1975). For this reason, global history is conceptualized and reshaped in China in a different form compared to the discipline in Western academic traditions. It acquires a special national connotation, applying the so-called concept of “Chinese characteristics” [*zhōngguó tèsè* 中国特色] by which current policies of the PRC attempt to harmonize culture, politics, economics, and social life as homogenizing structures within society. This conceptualization oversimplifies the research agenda of the global historian in China imposing limits to theory, concepts, and methods, as well as the use of sources in Chinese and European archives. This is when

¹ *Lúnǚ*, VII, 20. See Legge (1867) and Yang (1957: 393).

Sinocentrism emerges as the manifest feature of global history in China. The hegemony and exceptionalism of China in current global affairs and economic growth contributes to develop a stiff national narrative within China’s academic circles.

This “Sinocentric turn” is acquiring similar connotations to the preceding Eurocentric, or Anglocentric, focus in global history during the last decades which essentially pays attention to the exceptional momentum, supremacy (Dawson 1967; Brook and Blue 1999), and economic rise of northwestern Europe (mainly Great Britain) during the first industrialization. Here, global history scholarship has mostly focused on core-peripheral economic areas fostering the great divide between the West and East or developed and underdeveloped world (Jones 1987; Landes 1998; Broadberry et al. 2018). Global history was thus essentially part of imperial history, in which Great Britain and its colonies were the main geographic unit to study the global movement of people, goods, and technology to establish comparisons between Europe (essentially England) and the East (Berg 2006, 2015). Any attempt to seek connections univocally needed to deal with the British empire as core economic centre. This created a serious obstacle for historians when comparing areas and regions outside the realm of the British world.

John Brewer noticed such obstacles and at the beginning of the twenty-first century he assumed such historiographic “error” claiming that global history and comparison between the Western and Eastern world should not be focused only on Great Britain and its colonies (Brewer 2004). Craig Clunas also acknowledged that the term global does not exclusively refer to the history of the great powers of Europe and their colonies, a concept that was adopted during the Cold War period (Clunas 1997).

The use of a holistic view to analyse, compare, and assemble the socio-economic, cultural, and ecological structures and transformations of the world economy system seems more adequate to theories, methods, and empirical evidence to new global history research. The so-called polycentric (Frank 1998) approach in comparing and seeking similarities and differences among world regions might help the historian escape from the still ongoing Eurocentric perspectives (Vries 2016; Cox 2017; de Zwart and van Zanden 2018). More studies applying the polycentric approach will help to deconstruct the deeply rooted traditional and ideological Eurocentric view of Marx (1971), Weber (2001), Toynbee (1934),

Polanyi (1944), Braudel (1979), Wallerstein (1980), as well as David Landes (1998) based on the exceptionalism of the West.

Regarding the “Sinocentric turn,” two features should be distinguished. The first one is the attempt by the California School at the end of the 1990s (Wong 1997; Pomeranz 2000; Duchesne 2001) to rewrite the history and economic development of the East (mainly China) and escape from the limits of the Eurocentric perspectives. The second feature has a marked national connotation presenting the “exclusiveness” of the East, mainly the Chinese world and its “unique” characteristics. Comparisons between China and Europe as regions to understand the so-called great divergence and economic development have fuelled a great controversy between Chinese and Western scholars for the real causes and economic backwardness of Qing China (Shi 2011; Pomeranz 2013; Studer 2015; Vanhaute 2019; Deng 2016; Ge 2018).

Thus, the Sinocentric focus has blurred the development of global (economic) history in China due to obvious national constraints and limits in implementing comparisons and applying theories and methods, as well as cross-referencing Western and Chinese sources. The effects of such a limited research agenda, and the exclusive focus on China and its particularities, has entailed a constant repetition of the great divergence debate and the use of debatable data and quantitative methods that has only presented the evolution of China’s gross domestic product and population indices (Deng and O’Brien 2016; Deng 2011). These unreliable indicators and data will be discussed in the following sections.

Most practitioners of global history in China are rewriting a new national history of the country. This group is made up of those who believe that global history is the history of the Western world, but do not look for connections and comparisons, or use and combine diverse historical sources. The result is a new national history of China focusing on the apogee and decline of the Qing empire, as well as its monetary, investment, and fiscal system, and Chinese communities in the rest of the world (Cheng and Lan 2009; Fan et al. 2008; Long 2003, 2006; Wang 2001). This presents a serious lacuna in the application of theories, methods, and sources to make comparisons with other European empires and western regions.

This narrative follows the mainstream and neo-Confucian policies implemented by the Ministry of Education in China. The aim is to revive Chinese history, tradition, and ancestral culture to avoid any external influence that might harm the interpretation of China’s unique past and

culture. For this reason, academics who follow this trend perceive global history as an “imported western intellectual form” that might contaminate China’s history and culture (Xia 2007, 2012). However, due to the hegemonic role of China in international affairs, global history in any of its forms and conceptualizations is an unavoidable field in China’s academic circles. Global history cannot be ignored anymore in China and has become the fashionable field in many academic programmes.

2.2 THE “NEW SILK ROAD” AND “ONE BELT, ONE ROAD”: THE AWAKING OF THE MIDDLE KINGDOM IN THE TWENTY-FIRST CENTURY

The “One Belt, One Road” (OBOR) [*yīdài yīlù* 一带一路] strategy implemented in 2013 by China’s president, Xi Jinping, aims to internationalize the sectors of the country’s economy such as industry, investments, agriculture, services, health, and education with a clear national orientation (Perez-Garcia 2016). The “New Silk Road” (Leverett and Wu 2016) is the geopolitical unit that overarches the partner countries of the OBOR across Southeast Asia, the Middle East, Europe, and also African and Latin American countries being the last two regions added to the so-called “Maritime Silk Road.” This ambitious and euphemistic policy, although with non-clear goals, aims to revive the uniqueness of Chinese civilization, culture, and history. Emphasis is placed on the historical routes of the “Silk Road” (Perdue 2003) where goods of all kinds (mainly silk, porcelain, and tea) were traded from China to western regions across the Middle East, as well as on the people, technology, and cultural exchanges and encounters that took place. The early origins, and more remarkable milestones, included Alexander the Great’s campaigns in Persia and Marco Polo’s travels to China (Frankopan 2015) (Map 2.2).

The economic rise of China in the last decades and its hegemonic role in global affairs fuelled the development of this policy to portray China’s international image through its historical roots, tradition, and culture. The “Silk Road” policy has two main targeted audiences or interpretations: (1) a domestic aim to keep the country unified through culture and history, and (2) to present China as a “soft-power” nation to the international community, with no intention to intervene in other nations’ affairs (Yang 2014; Mao and Shen 1988). This has some resemblance to the aforementioned Qing policies of Qianlong when the British embassy,



Map 2.2 China's New Silk Road Grand Strategy, Twenty-First Century

Source: Author's own elaboration, using the *Global Encounters between China and Europe: Trade Networks, Consumption, and Cultural Exchanges in Macau and Marseille, 1680–1840* [GECEM] Project Database and Software QGIS v3.12 Base map from Natural Earth raster

headed by Lord Macartney, visited the Imperial Court at the end of the eighteenth century. At that time Qianlong's statement to Macartney's embassy, "there is nothing we don't have that we need from you," also had two targeted audiences: (1) a domestic one, since the Qing dynasty was not a Han dynasty and was therefore considered as foreigners, and invaders, but Qianlong's message through firm power and military force aimed to keep the Qing territory unified, and (2) a foreign one, since with this statement Qianlong launched a clear message to Western powers (mainly Great Britain and France) to not intervene in China's economy and domestic affairs (Waley-Cohen 1993; Berg 2006).

We might extrapolate this resemblance from Qing China to current politics of the PRC in which internationalization and domestic policies do not always fit, it being a serious challenge to keep the cultural and

historical essences of the country, but at the same time engage with the international order. Global history and the internationalization of academic circles in China are two issues that find themselves in such cross-roads. As noted earlier, global history today in China is straightjacketed within a stiff national narrative which aims to glorify the past, present, and even future of the nation by consolidating the pillars and survival of the political system. Application of historical methods such as comparisons, text analysis, and critique of primary sources, as well as theories, are totally absent in the toolset of PRC academics who define themselves as practitioners of global history in China. Such practitioners are influenced by the Sinocentric perspective, and the international scope is leftover only to “nickname” any research within the “Silk Road” or OBOR label.

As previously mentioned, the “Silk Road” as a geopolitical coordinate applied to current historical studies and global affairs in China, a somehow vague and non-clear concept, has an obvious political bias. Li Bozhong (2017) has stated that the “Silk Road” as concept is an “illusion” and a very abstract concept, which ended in 1524 when the Ming emperor Jiajing closed trade between China and western regions (Li 2019). Thereafter, in the Qing dynasty some periods of an “open-door” policy with the West did occur such as during Kangxi’s reign, but in general official trade and international engagement of China was very limited. This can be dated mainly from the Qianlong emperor, when he established the Canton system [*yīkǒu tōngshāng* 一口通商] (Liang 1999) to regulate foreign trade in China. The rebirth of the “New Silk Road” in 2013 (Summers 2016; Wang 2015) aims to implement an international agenda, but within a specific national orientation embracing a discourse of globalization, modernization, and consolidation of the country’s ideology.

Escaping from the Sinocentric myopias in Chinese global history narratives is the main challenge of the discipline due to the political and national implications attached to the “Silk Road” and OBOR strategy. The practice of global history by Chinese academics entails problems in the use of theory and methodology as these two basic categories are avoided or ignored due to ideological constraints. For a long time, the use of theory and methods have been avoided by PRC senior scholars due to the belief that historiographical trends, debates, and theories in global history have a Western foundation and are therefore useless. For this reason, to develop and consolidate a pure East Asian (Chinese) thought and indigenous conceptualization of history, any sort of Western theory,

as well as methods, is deliberately avoided. This has been done by the older generation of historians in China, and the new generation has the same lacuna. A professional and consolidated implementation of global history implies a serious pedagogical turn that should be undertaken by researchers with institutional support (departments, faculties, universities). Surely, such a pedagogical turn might not go in line with the current policies of the PRC. A profound reform should be introduced for the development and consolidation of teaching and research programmes in global history.

A first step would be to explain and teach to the academic audience, starting with undergraduate students, but also to senior scholarship, the following questions: What is global history? How can we make and write global history? Indeed, there are conceptual misunderstandings in Chinese academic circles on the meaning and differences in global, world, transnational, or international history. In countries such as China there is a stiff revival of national history that aims to consolidate the roots and foundations of the nation according to cultural identity and policy-making of the government. Within such ideological constraints the global historian or practitioner of global history should not neglect his personal standpoints to reflect and objectively deconstruct how governments and institutions have created an intellectual system as the main foundation of national reconstruction. Only through observation, criticism, and deconstruction of national beliefs and myths can the practice of global history become sustainable. In other words, a new pedagogical turn might be possible by overcoming ideological limits of Chinese academic ecosystems, and we might better understand how global history has permeated within traditional Chinese scholarship, challenging national narratives, and introducing in a more realistic form the engagement between the academic system of China and the rest of the world.

The conceptual limits and constraints are rooted in the national and international legitimation of the political system of the PRC. The image portrayed through history, in this case national history, is essential. For domestic and national purposes, culture and history are the main strongholds consolidating and unifying the political system in the twenty-first century. In international affairs, it portrays an image of “non-aggressive” expansion which consolidates the rise and hegemonic role of China. Establishing frames and cultural categories that acknowledge this image contributes to recreating an idealistic and mythical past: “imagined communities” to revive the glory of the nation. Culture, history,

and language become a form of “soft-power” policy applied to academia. “Countries that are likely to be more attractive in postmodern international relations are those that help to frame issues, whose culture and ideas are closer to prevailing international norms, and whose credibility abroad is reinforced by their values and policies” (Melissen 2005: 4; Nye 2008: 31–32).

According to such national frames of culture, language, and history, global history is confused with a wide range of histories and narratives that are not connected with the history of China. In other words, global history is mixed by academics with any sort of local, national, or continental history outside China’s borders. Therefore, the practice of global history in China becomes an encyclopaedic collection or compilation of the history of nations in a very descriptive way within a chronicler form. I will return to this point later.

Global history is not a homogeneous compilation of histories. The global historian is not a chronicler of the past. Global history is an approach by which the historian is seeking for connections, comparisons, differences, and similarities across world regions and specific chronologies. The foundation of global history lies upon how world spatialities and their historical formations are conceived and structured (Subrahmanyam 1997; Gruzinski 2001; Dirlik 2005; Adelman 2017; Drayton and Motadel 2018; Bell 2014). Our critique and analysis should be based on the development and practice of global history in different academic traditions either in Western or Eastern nations. Understanding how global history has been implemented in Western and Eastern historiographies seems pertinent when using theory and empirical evidence to make comparisons and connections on historical phenomena, spatialities, and temporalities. The spatialization and temporalization of the past through concrete coordinates entails some ideological and political problems, however, as nation-states have been constructed upon expansion, military force, and the creation of borders. Questioning the map of such formation, as the ultimate purpose of global history, presents serious obstacles, and in China these are compounded by the incorrect use of concepts and lack of theories and methodologies.

Global history, as a new field in China’s scholarship, is considered directly connected to the process of globalization and is mistakenly conceived as the history of globalization. The overlap and abstract implementation of fields such as international relations, global or world history,

and international history in China's education programmes has consequently resulted in confusion. The current global hegemony of China and its economic power in which GDP is always presented as the main indicator in academic circles to link global history to the history of globalization and the rise of world powers. Under this principle the definition and differentiation of transnational, international, global, and world history are put aside.

However, it is relevant to make a distinction among these concepts. A basic and general definition should be as follows: (1) transnational history is an approach that challenges national history and the political agenda of nation-states, the origins of such construction started in the early nineteenth century when nations were unified and the ideals of nationalism developed; (2) global history seeks connections across regions and polities to compare and observe similarities and differences of socio-economic, cultural, or political structures, and therefore, study how local societies create an influence and affect the development of global events; (3) world history puts the emphasis on nations as the main geographical unit, and the wide use of civilizations and cultures in terms of organization and structure of society.

An attempt to define the term globalization and international history also seems relevant. Globalization as a postmodern term, inherited from the post-Cold War period and the collapse of the Soviet Union, is based on the political and economic agenda of governmental and supra-governmental institutions to widely expand power across nations in which mass media, technologies, and transnational companies are the main pillars to sustain power. International history, and the field of international relations, presents wide and vague area studies related to the development and modernization of nation-states and their worldwide expansion and power through institutions, policymaking, and diplomatic relations.

After making such definitions, one might realize that the practice and development of global history in China make sense given the country's main principle of sustaining its rising political power and economy. Presenting a unique past, consolidating the rising power of the present, and advancing innovative structure and technology to overcome future problems could be considered the main pillars of the scholarship and practice of global history in China's academic institutions.

In Chinese scholarship, few scholars acknowledge the complexity between global and world history. This has provoked ambiguous and unclear use of concepts and lacunae in applying theory to historical

research. Liang Zhan-jun admitted this mistake (Liang 2006) arguing for an etymological difference between global and world history which might help in developing a clearer narrative in historical research using comparative methods.

From the 1960s to the 1990s global history research has become a fertile ground to debate the socio-economic development of modern nation-states or has, as some scholars have stated, become a “sub-discipline” in academic history departments (McCants 2018). It is characterized by using comparative analysis and moving away from the frames of traditional historical analysis, in other words, from nation-states as the main units of comparison (McCants 2018: 241).² Global history research does not encompass the history of the world. Bruce Mazlish defines it as the study of the process of globalization in its historical formations, and to some extent how it coincides with the history of the world (Mazlish 1998).

Global history is not the history of a globalized world or the interpretations of the world order and the narratives that emerged after the collapse of the Soviet Union in 1991. And neither is it the history of civilizations and the classic conceptualization of world cultures, as Gordon Childe (1950) defined in the mid-twentieth century. Nor is it the compilation of historical facts and events that changed the world order across time. On the contrary, it is an approach using a wide range of comparative methods and interdisciplinary history to seek connectivities, similarities, and differences for the study of economic, socio-cultural, and political transformation of world regions (Schäfer 2004: 108).

The delay in the implementation of global history research in Chinese historiography is due to such misuse of concepts but also to inaccurate translations from English to Chinese of major works in global and world history. The opening of global/world history into China dates back to when Geoffrey’s Barraclough’s work *Main Trends in History* (1979) was translated into Chinese and published in 1987 (Barraclough 1955, 1979). The sentence “a universal view of history” was translated as a “global view of history” [*quánqiú lìshǐ guān* 全球历史观]. Pomeranz’s seminal work, *The Great Divergence* (2000), was translated into Chinese in 2003. In 2000, Liu Beicheng from Tsinghua University translated Andre Gunder

²Mission Statement of the World History Association (WHA) established in 1982. <http://www.thewha.org/about-wha/history-mission-and-vision-of-the-wha>. In McCants, A., “Global History and the History of Consumption,” p. 241.

Frank's *ReOrient* (1998).³ Frank's work was translated into Chinese as "Silver Capital" [*báiyín zībēn* 白银资本].

Later, the works by Ma Keyao, *The History of World Civilizations* (2004), Wang Side's three-volume textbook *General History* (2009), and Liu Xincheng and Liu Beicheng's two-volume *New World History* (2007) came to represent the main historiographical trend and interpretation of global and world history in China based on mere compilations of the history of cultures, civilizations, and nation-states. This historiographical trend lacks source analysis, critical views of historical facts, and a reflection on how to apply global history through case studies by balancing theory, methods, and empirical evidence. The ongoing view of global history, reflected in the above-mentioned works, is based on the approach to traditional textbooks of the West covering large geographical and chronological units.

The translation of Pomeranz's *Great Divergence* in 2003, along with Beijing's Capital Normal University's organization of the 20th annual meeting of the *World History Association* (WHA) in 2011, both represent the milestones of global and world history in Chinese scholarship. From 2011 on forward, departments and faculties in China's universities started to establish centres of global history as well as undergraduate and master courses in the field. The most relevant institutions here are Capital Normal University [*Shōudū Shīfàn Dàxué* 首都师范大学], Nankai University [*Nánkāi Dàxué* 南开大学], and later in 2014 Beijing Foreign Studies University [*Běijīng Wàiguóyǔ Dàxué* 北京外国语大学]. Between 2013 and 2017, Capital Normal University launched the *Global History Review*, the *Translation of Global History Series*, and the *Global History Reader*.

However, the mission and aim of these research institutions have a political orientation based on the constraints of the government's policy "One Belt, One Road" [*yīdài yīlù* 一带一路] to rewrite the national history of China and portray the uniqueness of its civilization, culture, and past. There is a Sinocentric bias in global history following both current policies and long-lasting limits of traditional scholarship in China. The *Historiography Quarterly* and *The Guangming Daily* [History Column] aimed to attract Western scholars such as Pomeranz, McNeill, Barraclough, Stavrianos, or Bentley to portray an international image of

³The original title of Frank's book is *ReOrient: The Global Economy in the Asian Age*.

China’s scholarship. This goes in line with the strategy of academic journals and research institutions in China to appear in top positions of world rankings. However, curriculums to promote interdisciplinary research and programmes in global history have not yet been consolidated. Undergraduate, Master, or Ph.D. programmes have not been established even though Capital Normal University, Nankai University, or Beijing Foreign Studies University aim to promote global history research, but with “Chinese characteristics.” In other words, a new national history of China is very much present. The Sinocentric focus is predominant and, therefore, research centres in Chinese universities only consider global history as the history of nations and regions outside China, i.e. history of Japan, Russia, Germany, etc. The narrative is centred on the study of formation and consolidation of nation-states.

As a result of such homogeneous narratives that compile historical facts and events in a descriptive and non-critical narrative, global history has been treated as a product or direct connection of the “process of globalization” (Wu 2005: 22). Some Chinese scholars consider global history as a reflection of “the new context of ever more frequent communication and exchanges among peoples of today’s world” or “the emergence of global history should be seen as one of the most important achievements of post-war western historical scholarship” (Li 2000: 118; Liu 2000: 123). However, they do not question why this narrative became fashionable among academics after the fall of the Berlin Wall. Historical narratives are the result of our present day and political agenda. Wu Xiaoqun (2005) and Li Longqing (2000) statements go in line with the homogeneous national narrative and political discourse. A different approach for global history to substitute obsolete narratives based on nation-states (Liu 2000) and development of national identities, whose aim is to construct and invent an “imaginary” past (Anderson 1983), should be the turn in China’s historiography that is deeply connected with the “new world history outlook” and image of China (Wang 2003: 32).

So for academics in China who self-attribute as practitioners of global history, their work is more connected with compiling history(ies) in catalogues and encyclopaedic volumes about the history of Western countries. They borrow the global history label, but in these works there is a complete lack of application of theories, methods, and use of sources, as well as an absence of thorough reflection on comparative and connected history. In an article written in 2012, Liu Xincheng referred to the

term “compilers” (Liu 2012: 493) for practitioners of global history in China. Cross-referencing empirical evidence through Western and Eastern sources to study the intensification of global contacts and cultural exchanges across world regions is the major need for the “new” global history (Perez-Garcia 2013). The historical method should be based on the use of different scales, from local to global perspective, the so-called “glocalism,” to better understand the complexities of interconnected communities through the dynamics of transcultural and transnational exchanges.

Reorienting the research agendas to focus more on the complexity of Asian economies or rewriting the history of China (Cheng 2005) to escape from the secular Eurocentrism is just one piece of the complex jigsaw of the global historian. Such stiff reorientation, mainly in Chinese historiography, is contributing to the development of Sinocentrism (Li 2011: 9), however, which is creating obstacles to making comparisons with other world regions when studying their function and role in socio-economic transformation of polities and market integration.

In addition to emerging Sinocentrism, another obstacle for the practice of global history remains within academia itself. China’s academic programmes started to become more internationalized during the 1980s with a clear orientation towards International Relations (IR) studies and public and defense policymaking. Within this context IR departments boosted their structure and logistics and promoted internationally their research programmes and projects in global studies to understand China’s role in international affairs. This meant that global history in China had a political bias as the main subject and issue in social sciences and humanities was to study the different forms and development of Marxism outside China’s borders. Marxism was, and still is considered, a Western thought and philosophy, but it was implemented in China through the idiosyncrasy of the country, with “Chinese characteristics.” Faculties were, therefore, more open due to this fact, but after the Tian’anmen crack-down in 1989, programmes in international studies closed and they did not start reopening until the early 2000s.

Political events of the twentieth century and the different periods of reforms to modernize China have meant that global history is a new and “unknown” discipline not being widely embraced as it is considered a Western cultural form. The discipline is rejected by the predominant group of Marxist scholars who oppose global history on the grounds “that [it] is not a compact, uniform normative narrative” (Wang 2002:

101). Academics of the Marxist school argue that global history is forged through a “neocolonialist strategy” by those in favour of the discipline who might pollute the sense, perception, and interpretation of Chinese history and civilization (Wang 2002; Qian 2001; Yu 2006).

This has resulted in a stiff confrontation between academics who advocate for global history, named as “neocolonialists” by the Marxist school, and the “neo-Confucianists” who have developed a new narrative with the aim to recover the ancient traditions, culture, and history of China raising a barrier against any external agent or intellectual thought that might harm such traditional forms. Such rigid and traditional thinking has fostered some prejudices such as being a global historian indicates that a scholar is being “Eurocentric” (Yu 2005), and consequently the history of human evolution, global history, and the development of modern economies means that “a world history is a philosophical attempt to deal with history in view of such a goal-guided process” (Liu 2012: 495).

This is a teleological and linear process to explain the development and conquest of the “scientific revolution” in the West, which according to the Enlightenment and modern European intellectual history should be historicized as a “quasi-theological conjuncture” (O’Brien 2013). Personally, I believe that any cultural and socio-economic conquests of any civilization is the result of a process of hybridization in which multiple elements and forms, i.e. cultural habits, technological achievements, economic transformations, state and non-state institutions, etc., are intertwined and shared across world regions, having similar features within distinctive results according to indigenous cultures and polities. This creates a world *mélange* of social structures integrated in a constant and reciprocal process of exchange, communication, and interaction (Bentley 2005; McNeill 1990).

However, global history in China has never been used with a proper methodological toolset to present new research and case studies comparing regions, i.e. city ports, villages, or urban areas to seek differences and similarities in the socio-economic and cultural process of development of western and eastern areas. Framing the historical context and rethinking old historiographical debates to present new hypothesis and research questions through delimited spatial and temporal coordinates is commonly absent.

The persistent idea of framing global history as an imported intellectual form from the West means that Chinese academics reject or even do not contemplate the use and learning of theories and methods of

global history. Global history is presented by traditional-Marxist scholars as an intellectual implementation of the “aggression” of Western powers. Therefore, the rewriting of national history(ies) in China, whose aim is to elevate national sentiments, patriotism, and traditional identity in the twenty-first century featured by globalization, is challenged by global history. A good indicator is the low degree of academic internationalization of departments, faculties, and research institutions in Chinese universities (Perez-Garcia 2016) (see Table 2.1). Implementation of global history programmes requires internationalization in the faculty staff.

The rate of internationalization in China’s higher education system is marginal for the area of social sciences and humanities, especially for the field of global history. This may stem from the early days of the foundation of China as a nation-state, the period of the May Fourth (in 1919) era, when students rallied against the “foreign humiliations” (Westad 2012) of China. A new era marked China’s international relations, the engagement with the outside world, and a process of hybrid cultures, socio-political actions, and state development. The mixture between the old generation, those who witnessed the foreign treaties humiliations and lived in the “Old China,” and the new generation that stood up against Western intervention to revive China’s traditions and national idiosyncrasy fostered a secular confrontation with Western powers during the twentieth century against any sort of cultural, intellectual, and socio-economic intervention. Global and world history was the intellectual and cultural expression that might harm the road to China’s modernization

Table 2.1 Share of foreign faculty staff at major universities of China in 2018

	<i>Total number of faculty staff</i>	<i>Overseas faculty staff (%)</i>
Peking University	2900	0.5
Tsinghua University	3416	1.43
Renmin University of China	3580	0.30
Zhejiang University	3502	0.22

Source: Author’s own elaboration, based on information on university websites and percentages from the total number of faculty and the number of foreign faculty working full-time basis. Visiting professors have not been included, http://newsen.pku.edu.cn/Schools_Departments/, http://www.tsinghua.edu.cn/publish/thu2018en/newthuen_cnt/01-about-6.html, <http://www.ruc.edu.cn/humanities-en>, http://www.zju.edu.cn/english/wcademics/list.htm#right_box_02

as a nation-state. It is still a paradox and creates controversies today in China’s cultural reforms and higher education system. This could be defined as the “global history paradox” in China.

Western theories and cultural frames in the late twentieth century and the beginning of 2000 were pushed back through ideological constraints implemented through neo-Confucianist policies and the revival of the May Fourth movement, in what could be defined as a “soft neo-cultural revolution” in China. The aim is to consolidate China’s modernization, economic growth, and hegemony as main world power in which the image projected to the outside world as a nation with a unique culture, history, and civilization is paramount to presenting China as non-aggressive or interventionist country. This is in opposition to the model that the US has developed precisely since 1919 as an interventionist country with the self-determination that the Western world and foreign nations should engage the socio-economic and political model evidenced in Woodrow Wilson’s Fourteen Points to encourage world equality among nations. The secular confrontation among nations fuelled a constant rivalry among civilizations and the forms of writing history (Huntington 1996).

Global and world history is in the midst of this confrontation as it has been wrongly portrayed as a Western intellectual narrative, instead of being acknowledged for what it actually is: a holistic historical narrative that looks for connections, differences, and comparisons among world regions with the aim to overcome the great divide between the West and East, in which the observation of local socio-economic transformations (villages, cities) and the intensification of global exchanges can be better understood. In this way, we might find “surprising resemblances” in the formation and structures of nation-states across continents. Such an intellectual exercise and approach collides with the current national and patriotic agendas, as the fabrication of memories and national histories serves as the main tool to portray the illusionary image of a nation according to political purposes and interests in consolidating the new elites in the exercise of power.

For this reason, after the 1950s world history as a discipline was included in China’s higher education system with the aim to study and observe how Marxist theory and Marxist political systems functioned outside of China’s borders. Developing global history with “Chinese characteristics” stood up as the main objective in shifting the traditional Eurocentric (west-centric) views that were predominant in the

Cold War period that politically and economically divided the world into blocks along North Atlantic Treaty Organization (NATO) allies and the Warsaw Pact signatory countries. This view was predominant in studies about the development of the modern world, with economic transformations fostering the divide between developed and underdeveloped nations (Toynbee 1934; Polanyi 1944; Needham and Wang 1954; Huntington 1996).

Global history was encapsulated, therefore, into a politically correct frame portraying the field as the study of Western powers relegating Asian and other world economies into a secondary position. This perception has been profoundly fixed in Chinese academic circles, during and after the Cultural Revolution, and with the general public. For instance, today, Peter Frankopan's book on the Silk Road is embraced by academic and non-academic circles in China as an innovative study in which the world history view and historical analysis is shifted to central Asia (Frankopan 2015). But the historiographical milestone shifting the observation from Western to Asian economies was Frank's work from the late 1990s, *ReOrient* (1998), followed subsequently by works from the California School historians. Arguably, this shift could be connected back even further to Needham's much earlier work on the development of modern science in China (Needham and Wang 1954). Believing that Frankopan's work is revolutionary in terms of historical analysis on Asian economies, as it is rather a chronicle or description of events along the Silk Road (a modern construct as the Silk Road never existed), stands out as a remarkable instance which shows that critical historical analysis, and the avoidance of innovative theories and historical interpretations such as those by Frank and the California School, is still a vacuum within China's historiography.

At Wuhan University, Wu Yujin aims to study world history through regional and global histories for the fifteenth and sixteenth centuries; however, the scales of comparisons are not clear enough (Wu 1995; An 1993; Zhang 1992; Li 1994). Wu Yujin and academics that follow this trend use Marxist theories and concepts to support the classical Chinese tradition (Marxist) to encounter an acceptance of the postulates and concepts of world history (Luo 2007), following, therefore, Chinese classic and Marxist characteristics. The practice of historizing rather than the rationale of individual theories are deeply rooted in China's historiography. The compilation of stories and description of events stands out as historical method. During the 1980s Wu Yujin and Qi Shirong (Capital

Normal University) were entrusted by the State Education Commission to develop a compendium of world history in several volumes. This was published in 1994 (Wu and Qi). These compilations and historical corpus were supported and promoted by the Ministry of Education of China. China’s open-door policies in 1978 and joining the WTO in 2001 showed the commitment of the country to engage with the rest of the world through a clear-cut cultural agenda in which global and world history in China were marked by the particularities and characteristics of the country, especially the uniqueness of its history and culture.

Following this political and historical agenda, Wu Yujin and Qi Shirong’s work was appraised as “another milestone in the development of world history in China” (Liu 1999: 483) and as “representing the highest level of world history compilation in our country in recent times” (Liu 1995: 12). Indeed, most of China’s academics acknowledged and agreed with this assessment of their contribution.

In the dawn of the twenty-first century, Chinese scholarship followed the same historiographical trend as in previous decades (Yu 2001). The conceptualization of global history and the historical narratives are still adapted to the modes, forms, and needs of the political momentum being, therefore, constrained to institutional and structural systems of universities and research centres. Global history has developed in China a model, narrative, and approach totally different in form and content compared to Western historiographies. This model defines global history with “Chinese characteristics.”

Such ideological and institutional constraint means that global history in China has a particular Chinese indigenous form and narrative which diverges with the pure theoretical and methodological essences of the field. The current neo-Confucian narrative is the main driver in developing global history in China according to the historical and cultural idiosyncrasy of the country. Any intellectual form or episteme divergent from the neo-Confucian framework is doomed to fail or fall in the absolute relegation by China’s scholarship. In today’s globalized world, China’s engagement towards global history is marching inwards through a clear-cut national dimension by projecting the peculiarities of China’s culture and history to the outside world. The national revival of China’s history should be observed through the body of ideas that have shaped the perception of China as a self-sufficient country (with all economic resources at its hands, and no need from Western nations) in which the etymological meaning of the term China [*zhōngguó* 中国], the centre of

the world, outlines the position and aspirations of China (from the past, present, and future) as main world power (Wu and Qi 1994; Ma 1999; Qi 2001; Wang 2001).

This system of understanding China's history and culture might help to explain why global history in China has been reduced to the study of story(ies) and chronicles of "foreign countries outside China" (Luo 2007: 330). This reductionism of global history has fostered academic fragmentation and isolation of the discipline. Global history should not be periodized according to European historical experiences (Luo 2007: 329), mainly those referring to core economies and empires such as Great Britain as the leading region of the industrial revolution. The core-periphery dichotomy to divide rich and poor world regions (Wallerstein 1980) has contributed to developing Western, mainly Anglophone, exceptionalism and the dominant position of main European powers in global history research (Landes 1998). The exceptional momentum of Great Britain and its colonies to transform and modernize its economy in the early days of the formation of nation-states and development of capitalism should not be mechanically juxtaposed or applied to East Asian, in this case China, experiences and/or global history narratives.

The main error by scholars who aim to compare economic growth and modernization between western and eastern regions has been applied to the Western (European) rationale of the Enlightenment in which the revolution of ideas, technology, society, and economy led to upper stages in the modernization of nations. Why did northwestern Europe (mainly Great Britain and the Netherlands) escape from Malthusian constraints and enjoy higher levels of economic development in the last quarter of the eighteenth century and why did East Asian economies (mainly China) fall behind? The formulation of this question has univocally led studies to directly or indirectly put the focus on Great Britain and its colonies. This interpretation has consolidated the dependency theory that explains the divide between rich and poor nations, creating, therefore, an obstacle when comparing other regions and its role in the world economic system beyond the rigid divide between developed and underdeveloped economies and the hegemonic role of Great Britain.

Implementing cross-chronological, geographical, and cultural sections for comparisons to observe local economic transformations juxtaposed to global events, should be a pertinent methodology to observe the

complexity and interaction of economic regions and nodes within a poly-centric approach. Spatial and chronological coordinates, as well as cultural frames, in any attempt to establish comparisons between western and eastern regions are divergent in its own essence. Therefore, looking unidirectionally at the European Industrial Revolution as main historical axis to establish comparisons is in many instances doomed to fail. When comparing long-distances territories and cultures, the historian’s observation should be centred on the indigenous institutions, local communities, and transcultural transfers through the consumption of goods, circulation of technology and information, and formation of social and family networks. This bottom-up approach to see how local forces exerted an influence on state institutions and bypassed government decrees and rules across global regions might provide more accurate conclusions when comparing the experience of world regions in the economic transformation.

How have Chinese academics responded? Wang Jiafan was critical of Pomeranz’s comparative methodology. He claimed that “the most problematic part of Pomeranz’s methodology was to totally ignore the sociopolitical system as an important factor and indispensable context of economy” (Wang 2004: 8). Wang also mentioned that “Frank and Pomeranz’s ideas somehow led people to reminisce and even embellish China’s past glory while at the same time ignoring problems that were long embedded in the Chinese system” (Luo 2007: 346).

Some academics (Hao et al. 1996; Chen et al. 2004; Qi 2005; Tang 2006) have implemented narratives to develop and portray an image of China’s historical exceptionalism. This exceptionalism, following the same pattern as the European (British) exceptionalism mentioned above, has led towards a deeply rooted Sinocentrism and national turn. The Sinocentric narrative, which is not that different from the Eurocentric one in terms of locating core economies, has served to safeguard and praise the uniqueness of China’s history as an ongoing policy of the government (Wang 2004: 8). Practitioners of global history, thus, aim to develop the field through the realm of Sinocentrism. China’s historiography that deals with global (economic) history (Long 2006; Deng 2011, 2015; Li 1998, 2010; Yan 1989; Chen 2006) based their research on market integration, the structural transformation of the economy during the nineteenth century, as well as the Chinese diaspora.

However, in this historiographical trend there is a need for a more comprehensive approach that should include comparative studies to

observe socio-economic transfers between western and eastern regions through the circulation of goods, people, and technology. The lack of transnational research in Chinese scholarship reinforces the thesis of the current development in China of global history with “Chinese characteristics” [*zhōngguó tèsè* 中国特色]. A set of studies deconstructing the formation of China as nation-state and the political transition and performance of the economy from the imperial regime to the People’s Republic of China that goes beyond exogenous factors (foreign intervention as cause of the economic decline) and pays more attention to endogenous factors (state capacity to mobilize revenues, failure of local institutions, and social uprising) is still lacking.

More studies on endogenous factors might shed light on the development of the global role of China and its relations with foreign powers, and on the structure and organization of the country to manage the economic resources and govern the peoples of such a vast land mass characterized by cultural and socio-economic diversity. Yu Pei, director of the World History Institute of the Chinese Academy of Social Sciences, claims for a robust national and patriotic spirit that prevails in China’s world history: “Although today’s China is very different from that of the mid-nineteenth century, patriotism remains the soul of China’s world history studies” (Yu 2004).

2.3 THE MEANING OF “CHINESE CHARACTERISTICS”

China’s economic growth in recent years has overshadowed the Western powers as an unprecedented emergence of the economy and society of the Middle Kingdom. This has led to a world economic change in which China is taking the lead and forcing existing world institutions to become obsolete as the new series of bilateral relationships and institutions developed by the Middle Kingdom have resulted in a new Sinocentric world order. The rise of China and its world influence makes the country and the rich eastern provinces and cities of Beijing, Shanghai, Hangzhou, and Guangzhou, as regions of leverage and persuasiveness to get economic and political achievements in the new geopolitical world order (Chan 2013). Trade, investment, productivity, and domestic demand (Chin 2016; Ren 2016) are the core economic features of China’s “grand plan” or the so-called “One Belt, One Road” (OBOR) [*yīdài yīlù* 一带一路] (Wan 2016; Dollar 2015).

These economic issues are harmonized with the revival of national history and the exceptional culture and civilization of the country. Both economic and socio-cultural aspects of the rise of China in the dawn of the twenty-first century were blended in the geo-economic and cultural toolset to explicitly internationalize the structures of the country, but also to preserve the cultural essences of China’s history and its East Asian idiosyncrasy. This is the so-called internationalization with “Chinese characteristics” [*zhōngguó tèsè* 中国特色], a policy implemented by President Xi Jinping in 2013 (Xi 2013; Johnson 2016). History, East Asian (Chinese) culture, economics, and geo-politic strategy are mixed through the term “Chinese characteristics” [*zhōngguó tèsè* 中国特色]. This means that there is a willingness and commitment to engage and promote relationships with other nations but fostering at the same time stiff national and domestic policies to keep the vast territory of the Middle Kingdom unified in the era of globalization.

China’s dramatic economic growth has dwarfed the Bretton Woods institutions and the post-World War II order. Its large exports of goods, consumer markets, imports, investments, and liquidity of the credit system and the creation of the Asian Investment Infrastructure Bank (AIIB) (Xi 2016; Ransdell 2019; Wan 2016), created as the main financial institution of the OBOR, has generated a sharp response from China’s competitors (US and Japan) who consider this Chinese “grand strategy” as a new Marshall Plan (Humphrey 2015).

In November 2014 Xi Jinping⁴ proclaimed that China will establish a “Silk Road” fund with \$40 billion to support infrastructure, logistics, investments, and new projects in partner countries that participated in OBOR (Callaghan and Hubbard 2016). The OBOR strategy currently involves twenty-one countries initially subscribing to the AIIB (see Fig. 2.2).

AIIB’s essential role is to sustain the economic rise of China being, therefore, a financial instrument for China’s global hegemony. Credits, “soft loans,” and circulation of information are the main tools to seek dominance beyond China’s borders, expanding the influence beyond traditional partners. Countries of the Middle East, Southeast Asia, the Mediterranean basin, Africa, and Latin America became the main strategic

⁴November 2014, The Diplomat: <http://thediplomat.com/2014/11/chinas-marshall-plan-is-much-more/>.

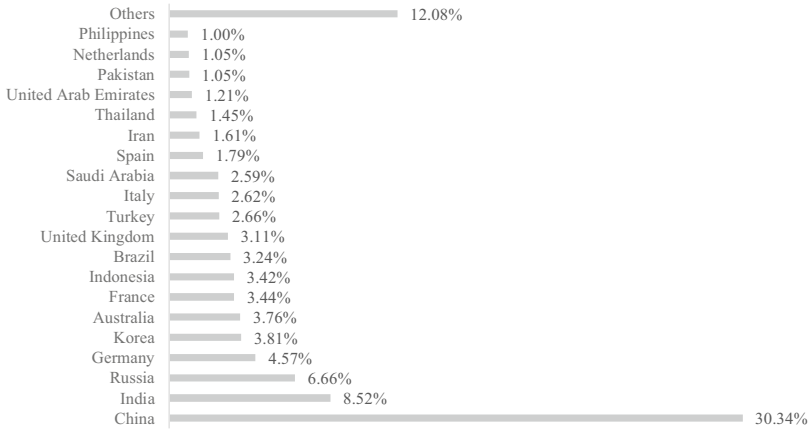

Fig. 2.2 AIIB Initial Subscriptions in 2014 (more than 1%)

Source: Asian Infrastructure Investment Bank

partners (Lichtenstein 2018). PRC scholarship in line with the government insists on the harmonious relations between China and Western powers, as well as the moral capacity, and even legitimacy, of the country to expand its rising power and world influence. These vague concepts are being constantly repeated by government officials and scholars (Yan 2014; Xing 2016) in line with Xi Jinping’s policies with the aim to present China as a “soft-power” and as a non-interventionist country. However, it is clear the opposite is happening as China seeks to be the hegemonic power.

This is the composite and broad definition of “Chinese characteristics” [*zhōngguó tèshè* 中国特色] applied to the current world scenario in which China plays the hegemonic role. This also provides further insight into why unidirectionally global history studies focused on China’s exceptionalism and economic role in which GDP and macroaggregate indicators dominate China’s historiography in global history. The OBOR strategy and China studies in global (economic) history go hand-to-hand in the definition and significance of “Chinese characteristics” [*zhōngguó tèshè* 中国特色] in the era of globalization.

The early origins of “Chinese characteristics” [*zhōngguó tèshè* 中国特色] could be dated to the late Qing dynasty when the state sent students abroad to learn science and technology. And in a broad sense their

learning of Western concepts could be applied for the modernization of China. The pattern to emulate was the process of modernization in Japan, and the boom of its economy, that took place during the Meiji Restoration in the second half of the nineteenth century. China also began to emulate the systems of US and Europe with the aim of modernizing the socio-economic and political structures of society maintaining the East Asian (Chinese) cultural spirit (Li 2014). Although the imperial civil service examinations [*kejǔ* 科举 system] were eradicated when feudalism was over, traditional values of Confucianism remained. And from the outside, values and knowledge were transferred.

The foundation of Tsinghua University, first as Tsinghua College [*Qīnghuá Xuétáng* 清華學堂], in Beijing in 1911 was a consequence of negotiations between Liáng Chéng 梁誠, Qing ambassador in the US, and Theodore Roosevelt to reduce the Boxer Rebellion (Purcell 1963) indemnity imposed by the US and use the funds to grant scholarships to Chinese students to study in the US (Pan 2009: 68). However, during the 1920s, the Soviet impact in China affected the education system and the model of modernizing the country keeping the cultural diversity and indigenous values with the assimilation of Western knowledge and experience.

Communist ideology overshadowed the progression towards modernization and the Yán’ān style of education was implemented. The Yán’ān spirit [*Yán’ān jīngshén* 延安精神] preceded the Long March, and a Soviet-style educational system was established in Yán’ān [in Shǎnxī 陝西 province] in which the Chinese Communist Party (CCP) (Tang 2012) imposed stiff educational policies through a social reform programme that funded the creation of a university for training in anti-Japanese resistance. During the Yán’ān period the new revolutionary ideals and writings on politics by Mao served to develop the national interest and unity above everything through the set of concepts and educational reforms based on socialism with “Chinese characteristics” [*zhōngguó tèsè* 中国特色] (Vladimirov 1975).

Embracing Western theories and Marxist ideology campaigns, social movements and propaganda aimed to keep the nation unified and protect the Central Committee’s authority and Mao’s leadership (Fairbank 2006). The creation of a movement of cadre screening and education was essential (Walder 2017). This was rooted through communist values establishing a socialist education system that was consolidated throughout the PRC (Li 2014: 8; Hayhoe 1984). These ideas and concepts were instilled in the early years of Mao’s education when the new Chinese

republic was founded in 1912 marking a deep influence on China's situation and the new directions for the country (Dingle 1912; Zhou 1968; Gasster 1980).

Deciding what type of training and education should be adopted for China's young generation, whether Western or Chinese, set the country onto a path with a crossroads. The escalate of events and turmoil provoked a swift political and cultural transformation of the structures of China's society, starting in 1915, having as an outcome the abandonment by Chinese radicals of Western liberalism for Marxism and Leninism as a solution to China's difficulties (Ch'en 1983). The student demonstrations of the May Fourth Movement of 1919 moved the new generation to the political stage in which students realized they were the main actors in the change for a new nation and society.

For a group of intellectuals and writers the real revolution was a cultural revolution removing Western concepts and terms that might damage the reconstruction of the country. The goal was to "ditch the classical written Chinese language itself, always mastered only by an elite" (Westad 2012: 267) inventing new Chinese terms and forms related to foreign concepts and ideas in a way to create a new indigenous intellectual construct in Chinese society. Chén Dúxiù, a writer and founder of the CCP and Lǚ Xùn, another writer of the period, were part of this movement. Lǚ Xùn launched strong critiques and mocked the "westernized Chinese bourgeoisie and its ineffectuality in his short story *A Happy Family*" (Westad 2012: 268):

The family naturally consists of husband and wife – the master and mistress – who married for love. Their marriage contract contains over forty terms going into great detail, so that they have extraordinary equality and absolute freedom. Moreover, they have both had a higher education and belong to the cultured élite.... Japanese-returned students are no longer the fashion, so let them be western-returned students. The master of the house always wears a suit, his collar is always snowy white. His wife's hair is always curled up like a sparrow's nest in front, her pearly white teeth are always peeping out, but she wears Chinese dress. (Hsun 1960; Westad 2012: 268)

This excerpt is an illustrative example as to why the new nation of China should be the hegemonic power and society that represents East Asian values. Criticism of daily life and new cultural habits transferred to China through the interaction with Western societies set the platform

to remove external interference in Chinese society. New radical political movements represented by the May Fourth Movement created a call for unity in society as one “big family” through strong forms of action and just state. Socialism was openly embraced as an anticolonial (anti-Western) movement in China. Subsequently, the Chinese Communist Party (CCP) was founded in 1921.

Thus, Mao Zedong’s thought and theories evoked the early uses of the expression of socialism with “Chinese characteristics” [*zhōngguó tèsè* 中国特色] when adopting Marxism and socialism as a Western thought and set of ideas applied to China’s idiosyncrasy and governance (Spence 1999). This goes in line with the self-sufficiency, power, and discipline imposed by Mao Zedong, and his ideas (Maoism), to institutionalize and internationalize his thinking (Westad 2012: 492). The centralization of power, recruitment of party cadres, continual ideological training, and unification of society through a comprehensive education system were central in Mao’s and the CCP campaigns to seal independent thinking and indigenous set of political theories in China as independent from the West. Scholarship has defined this set of reforms and Mao’s campaigns as a sort of logocentric movement (Apter and Saich 1994) injecting hatred and sectarianism into China’s psyche and public opinion to any form of Western expression.

Deng Xiaoping, whose background from the Hakka [*kèjiā* 客家] group that joined local Christian missions in southern China, after the Taiping movement, was part of the Deng clan emerging as outstanding figures of Communist China (Westad 2012: 129). Since the first encounters between China and Christianity in the late Ming dynasty until the late Qing dynasty, many Chinese valued the education provided by Christian missions acknowledging that education and literacy were the cornerstones for modernization and development of the country. At the end of the nineteenth century a great number of Chinese students trained in the US or Europe and became intensively nationalistic, most prominently, for example, was Deng Xiaoping who studied in France between 1919 and 1921. Later, in 1926, he went to Moscow which was the main destination for Chinese students to learn the doctrines of Communism. The generation he belonged to was of the late nineteenth century, the years of the Sino-Japanese War, in which China’s economy was collapsing due to, in their words, “the humiliations of our country” (Ye 2002: 19; Westad 2012: 411). Being born into a “perishing nation,” they realized that “we

instinctively want to know what we shall do to save China” (Ye 2002: 19; Westad 2012: 411).

For the generation of students and intellectuals at the time of the May Fourth Movement in 1919, such as Mao Zedong or Deng Xiaoping, the belief was that the country should be rescued from the “humiliations” suffered from the First Opium War. Chinese communism was embraced to reconstruct the old empire into a modern nation-state. Blending Confucian ideals of rectitude with the planned economy and organization that this young generation of Chinese students learned from the Soviet Union was the main instrument implemented by the new Chinese leaders to modernize the country through rigid power control and advanced technology. This makes it clearer to understand that Chinese Communism is not truly based on Marxism. First, *The Capital* was not translated into Chinese until 1937 (Chan and Pollard 2001) due to the period of wars in China, and mainly the Sino-Japan wars. Second, in Chinese intellectuals’ minds Marxism has also been considered as a Western intellectual form and doctrine.

Such form should be adapted to China’s idiosyncrasy and indigenous peculiarities. This explained the adoption of socialism with “Chinese characteristics” [*zhōngguó tèsè* 中国特色] mentioned earlier. China’s Communist ideals were inspired by Leninism and the Soviet planification for the economy and organizational structures. This allowed Deng Xiaoping, when implementing his “open-door” policy to engage on trade and economic ties with Western countries, to reuse again the term “Chinese characteristics” [*zhōngguó tèsè* 中国特色] seen earlier in Mao Zedong’s social ideals. Deng Xiaoping applied it later in the 1980s to China’s economic planification defining it as a market economy with “Chinese characteristics” [*zhōngguó tèsè* 中国特色]. This meant that all the tools and organizational structures of an interventionist state would be employed, based on what Mao Zedong and Deng Xiaoping had learned from Lenin and Stalin: strict regulations to control party members and people’s lives, as well as rigid party power, militarization, and hierarchy (Westad 2012: 489–490). This went hand-in-hand with the reopening of China’s markets to Western countries, but with stiff restrictions such as tariffs, customs control, and intervention in state and non-state companies.

Deng Xiaoping’s reforms of the 1980s aimed to put an end to China’s isolation and political campaigns of the Cultural Revolution that sank the country in terms of economic development and modernization. After

Mao's death and once he took leadership of the country, Deng's purpose was to import new technologies via Hong Kong and open through testing new political theory (Westad 2012: 632). A good example of such political tests was the setting up of special economic zones (SEZ) [*jīngjìtèqū* 经济特区] to attract foreign direct investment, such as Shenzhen in 1980, followed by the coastal cities of Guangdong, Fujian, and in 1990 the Pudong areas within Shanghai's municipality.

He made clear that the US should be the model for China's technological achievements and modernization, but with “Chinese characteristics” [*zhōngguó tèsè* 中国特色] that defines China's market economy (Liang 1994; Kim 2016). This is a mantra constantly repeated today in China by official and unofficial circles when defining the role of China in the world's economy and globalization. Deng declared himself that a sudden shift reversing Mao's policies and mistakes should be undertaken, paying much attention to “modernization centering on economic construction” (Deng 1981, 1983; Westad 2012: 633). But this of course set China on a path with crossroads that was manifested in the crackdown of Tian'anmen on the 4th of June, 1989 (Sandby-Thomas 2011).

Whereas Communist systems were collapsing all over the world, internal debates within China's political circles were arguing for a change in the political system. This led to the events of 1989 with the student demonstrations in Tian'anmen Square and the brutal suppression of protesters. The protests in Beijing and other cities were seen by political leaders and Deng Xiaoping as a sign of growing foreign influence in China that could potentially put the economic reforms in peril (Lieberthal 2004). In parallel an immense opening up of China's economy was put forward in the 1990s. China entered the twenty-first century as a market economy; the socialist economy remained as a relic (Brady 2008). However, the state keeps its control and intervention by “a party dictatorship that was still Communist in name” (Westad 2012: 654).

When appointed president of China in 2013, Xi Jinping retook the rhetoric of “Chinese characteristics” [*zhōngguó tèsè* 中国特色] but applied it to the internationalization of China with a clear domestic orientation covering education, the economy, and international affairs. China's culture, history, and traditions are key issues of the ongoing policy of internationalization with “Chinese characteristics” [*zhōngguó tèsè* 中国特色] in which the aim is to present China as a “soft-power” to the international community contrary to the military interventionism of the US (Yang 2012). Presenting an international image and engagement through

cultural aspects, attracting foreign students to learn Chinese language and culture, and fostering academic exchanges with countries to host Chinese students, as well as implementing new national policies to sustain the future of the CCP (Li 2014) and the political system, are all part of the government's national and cultural campaigns of the so-called "Chinese dream" [*zhōngguó mèng* 中国梦] (Xi 2013; Wang 2010).

2.4 FROM "SOFT-POWER" TO "SOFT-CULTURAL REVOLUTION": NATIONALISM AND POSTMODERN NEO-CONFUCIAN PRACTICES

The concept "Chinese characteristics" [*zhōngguó tèsè* 中国特色], which has its roots in the reforms and new strategies implemented in the transition from imperial times to the Republic of China, and, thereafter, to the PRC, caused in the long term a backwardness in academic quality and socio-economic and political development (Miao and Cheng 2013; Yang 2006). Even though the CCP changed the emphasis of its policies from class struggle to economic development in the late 1970s, to implement a market economy through marketization, privatization, and decentralization measures, China still faces today the challenge of being internationally and domestically competitive (Mok 2005). Neoliberal reforms introduced in education, and society in a large extension, boosted the competition of the education sector and universities, but still the quest for academic excellence and world-class status is the main priority and agenda (Li 2014: 9).

The quest for economic hegemony in China is rooted in promoting international engagement in education, investment, infrastructure, and social mobility, going in line with the "One Belt, One Road" [*yīdài yīlù* 一带一路] grand strategy. But such engagement has a rigid domestic and national perspective. Neo-national and postmodern neo-Confucian policies are, consequently, implemented. The aim is to keep the order of society, allowing each class and social group its aim and mission in life without interfering in the national governance, and to transfer all benefits of the global engagement to the nation. Autarky and neo-mercantilist economic measures are to some extent behind the scenes of China's world strategy. This is reflected in inbound and outbound flows of capital and investments, bank tariffs, high tax customs for imports, favouring of exports, the absence of social security benefits, and the low international

profile in academic programmes. These features encapsulate that international engagement and acquisition of a world-class status is still on the horizon.

The conceptual controversy and debate regarding the differences between world history and global history goes in line with the issue of internationalization with “Chinese characteristics,” since it has a strong national component. World and global history might have a similar meaning, but they present different connotations depending on the context and academic circles and principles. This is precisely the case in China and why world history is the preferred term as it goes in line with the current national narratives linked with the neo-Confucian policies and is defined as the history of world nations outside of China’s borders. In fact, global history [*quánqiú shǐ* 全球史] or world history [*shìjiè lìshǐ* 世界历史] are usually mixed up and confused in academic debates. These debates emerge on different occasions as a consequence of the political context and “academic ecosystem” in China marked by the revival of a national narrative.

The use and conceptualization of world history [*shìjiè lìshǐ* 世界历史] is, therefore, in line with the ancient recurrent theme of categorizing world history in China through the concept of *cóngshū* 丛书. This term means the compilation and mere description in encyclopaedic volumes and accounts of the national history of China and the rest of the world. This type of narrative does not present any analysis or critical thinking but is just a compilation of historical events and descriptive storytelling. This academic tradition is influenced by Song and Ming dynasty historiographies in which books of story(ies) compilations and knowledge circulated through the networks of the literati. Such tradition remains present today in Chinese academic circles, being part of the policymaking linked to “One Belt, One Road” [*yīdài yīlù* 一带一路] in which recovering China’s unique culture, history, and civilization is a vital component of the government to reconstruct and internationally present a new national history of China.

This vitalization of a new national narrative relates to the “soft-power” policies of China in recent years by which the main purpose is to present in international affairs the mission of the country as non-interventionist. Culture, history, and language are the main devices or tools to present such strategy. The implementation of a “soft-power” policy is attractive to China as it diverges from the military and “interventionist” policies that the US has traditionally applied since the end of World War II. This does

not mean that a “soft-power” nation, as China intends to present itself, stays away from interventionism. On the contrary, “soft-power” policies also present interventionist features which are less aggressive on the surface, but still very coercive, than traditionally interventionist measures of big powers that seek global dominance.

The application of “soft-power” policy is perhaps, in the eyes of Chinese policymakers, more pragmatic as they aim to achieve their goals by apparently using non-coercive means. China dominates the whole spectrum of the current international relations by applying such pragmatism. This can be observed nationally and internationally. In domestic terms it goes in line with the political agenda of keeping society in order, in which each social group and individual should follow his mission in life, obey superiors, and acknowledge group and communal ideals. The aim is to maintain social order and unify the country. Neo-Confucian policies are implemented to keep order in society through stiff regulations in education and political campaigns. This could be defined as a “soft-cultural revolution” implemented by China’s government in the global era to avoid national fragmentation in society. Internationally such implementation can be observed through the expansion of cultural and educational programmes establishing partnerships between Chinese and Western universities.

China has used a wide variety of measures and reforms with the aim of expanding its political influence beyond its frontiers. Culture, language, and history are the main catalysts to successfully implement “soft-power” policies in what can be defined as a new “academic diplomacy.” This “academic diplomacy” consists in developing a consolidated network of Confucius Institutes across the world whose main role is to act as cultural delegations or “embassies.” Confucius Institutes can be found in more than 140 countries.

From the early 1990s until today, there has been a growing flow in academic exchanges of students and scholars between China and the rest of the world. Internationalization of academic activities has become crucial and, consequently, Chinese universities play a crucial role in adopting and implementing the reforms devised by the government. Besides climbing in world universities’ rankings, such reforms in Chinese universities serve to train the new party cadres and give vigour to the structure of the party and political system in the new global era. Xi Jinping made a clear statement on this saying at the CCP’s 19th Congress in 2017 that “Government, military, society and schools—north, south, east and

west—the party is leader of all” (Feng 2017). One year earlier he had claimed that “Chinese universities must be the stronghold of the Party and Communist system” (Phillips 2016).

From 2016, when this statement was made, until today, the control of sectors such as education, investment, and joint ventures between Chinese and overseas partners has increased. The aim is to avoid any sort of interference of Western values in Chinese society (Feng 2017). This is part of the “soft-cultural revolution” model by which the central government in Beijing aims to revive the orthodoxy of Marxist-Leninist values in society, mainly in universities. The government has created CCP departments in some universities to supervise the political thinking of faculty staff (Gan 2017; Feng 2017).

China’s government has established as a priority to defend its mission beyond its frontiers making the Western community understand and acknowledge the worldview of the Middle Kingdom for the twenty-first century. Under a world traditionally dominated by Western values, the shift towards a Sinocentric perspective clearly overshadows the current international order. The central government of Beijing through the “soft-power” policies intends to present to the world through international activities, summits, and partnerships that there is no harm in China’s intentions and its economy and society is engaged in an international agenda. Chinese political elites avoid the use of the terms hegemony or supremacy to show there is no danger behind China’s rising power. In the current multipolar world, Chinese officials are keen to show the power of China as a peaceful one.

The use of vague and arcane concepts such as “harmonious coexistence” is usually present in political spheres, and at official levels, wherein the Chinese government has progressively implemented in recent years neo-Confucian policies to remove any sort of distorted or negative image of China. The Song dynasty’s Sinocentrism, when Buddhism, Taoism, and Confucianism converged, has influenced the policymaking of the Chinese government during the past few years whose main aim is to revive the neo-Confucian teachings of the Song dynasty as a “form of blind obedience to the ruler” to remove any sort of domestic frictions or Western intrusions into China’s political affairs.

The application of neo-Confucian policies has not thwarted the central government of Beijing from leaving the Marxist-Leninist ideals which China embraced in the first half of the twentieth century by fostering socialism with “Chinese characteristics” [*zhōngguó tèsè* 中国特色]. In fact,

the current campaigns of the “Chinese dream” [*zhōngguó mèng* 中国梦] (Wang 2010) follow this trend promoting national and patriotic ideals. The so-called “five principles of peaceful coexistence,” intertwining neo-Confucian teachings, aim to direct China’s domestic and international policies, keep social order in China, and mark the direction of China’s international relations: (1) mutual respect for each other’s territorial integrity and sovereignty; (2) mutual non-aggression; (3) mutual non-interference in each other’s internal affairs; (4) equality and cooperation for mutual benefit; and (5) peaceful coexistence.

2.5 THE “WESTERN MIRROR” IN CHINA’S ECONOMIC HISTORY

“China is a resilient dinosaur” (Deng 2000). This metaphor used by Kent Deng illustrates well the economic development and history of China as a long-lasting civilization. The rise of the Chinese empire, as with other European and Eurasian empires, based its strength on military force and expansion of its borders. The acquisition of new land westwards in the dawn of the Qing dynasty by increasing the size of the territory, population, wealth, and agrarian resources, along with an increase in productivity and trade made for some improvements in the local economies of China’s regions. However, big powers, big empires, required an efficient administration and bureaucracy. In other words, the state capacity in providing a competent and well-organized response to local socio-economic affairs is the paramount pillar to show the robustness of the institutions of the state. The state capacity of late Ming and Qing China will be further explored in the next chapter mainly through examining the tax system and administration reforms.

There is a twofold explanation in understanding the economic development and state capacity of China during the Qing dynasty. First, there are endogenous factors related to transformation of the institutions of the Manchu (non-Han and foreign) dynasty based on military power expansion and autarky. Second, there are exogenous factors with regard to the increasing foreign trade in China and engagement with Western powers. The second one has been regarded as a major cause of China’s impoverished economy during the nineteenth century after the Opium Wars.

Nevertheless, some questions should be formulated to review such scholarly trends that have dominated the studies of China’s economy. For

instance, what was the real impact of foreign (western) communities or the role of the so-called “foreign invasion” in China’s economic decline during the Qing dynasty, mainly at the beginning of the nineteenth century? Was it a conjunction of factors connected to the incompetence of Qing rulers to create a proper administration, favouring a parallel / non-official administration? This could be possible due to the handicapped Qing rulers’ failure to manage the flows of inbound American silver prompted by foreign trade in China. This silver was accumulated in the hands of local elites, and even local officials and governors of south China provinces, creating a new rich elite that was favoured through this engagement in foreign trade. Consequently, a parallel administration, a state inside the state was created. This explanation partially deals with the traditional view that China’s economic decline was due to the “invasion” of foreigners, but mostly with creation of rich local elites in southern regions of China, mainly in Guangdong and Fujian provinces.

Deeply exploring endogenous causes of the economic development in Qing China through the implementation of new domestic policies is crucial. A different and plausible thesis that can be presented is that the three foreign (non-Han) emperors (Kangxi, Yongzheng, and Qianlong) were incapacitated by revenue scarcities to deal with the population growth pressure that arose after 1683, and their bans and decrees on foreign trade aimed to restrain trade networks led by local Chinese elites and gentry. Internal and civil uprisings such as the White Lotus Rebellion, the Taiping Rebellion, or the Boxer Rebellion should be observed as a consequence of revenue shortages and the incapacity of Qing institutions to eradicate corruption and contraband. The epitome of an interventionist state is represented by a large bureaucracy that seems to be inefficient at managing revenues and distributing wealth among the population. Such inefficient systems in the mid-long run spark internal and civil uprisings.

In 1683 the Kangxi emperor established four maritime customs posts with the aim to control overseas trade: Jiang/Jiangsu customs [*jiāng hǎiguān* 江海关], Zhe/Zhejiang/Ningbo customs [*zhè hǎiguān* 浙海关], Min/Fujian customs [*mǐn hǎiguān* 闽海关], and Yue/Canton customs [*yuè hǎiguān* 粤海关].⁵ The Canton customs connected Canton with

⁵First Historical Archives of China (FHAC), Nei Ge Qi Ju Zhu (hereafter NGQJZ) (11th July, Kangxi 23rd Year). Guangzhou Liwan District People’s Government, *Qing Gong Guang Zhou Shi San Hang Dang An Jing Xuan*, Guangzhou: Guangdong Economic Press, 2002, p. 39.

Macao as a geostrategic location to control foreign trade and its networks with local Chinese elites. During the early eighteenth century, the Yongzheng emperor continued Kangxi's maritime customs system. Thereafter, the Qianlong emperor established the one single port for foreign commerce, the Canton system [*yīkǒu tōngshāng* 一口通商] (Liang 1999), as a result of several factors: (1) the Qing state's incapacity to collect maritime customs revenues in several locations; (2) the geostrategic location of Canton due to its regional economic development; (3) strong interventionism of the state; and (4) control of trade through officials institutions with the aim of eradicating contraband.

These three foreign emperors, particularly Qianlong, mirrored mercantilist and autarkic policies of European states such as Louis XIV and the French Bourbon dynasty ruling Spain from the eighteenth century onwards. Bypassing official channels of state tax revenues and failure in the payment was a common feature in the ports of the Spanish empire most evident in the tax evasion of the *almojarifazgos* [royal tariffs levied in the ports of the Spanish empire] (Schurz 1939; Atwell 1982; Chaunu 1960; de Sousa 1986, 2018). Spanish and European galleons, as well as Chinese junks trading in Manila commonly practiced such tax evasion and contraband in Southeast Asia and the South China Sea, through the trade nodes of Macao-Canton, for the exchange of Chinese goods for American silver (Flynn and Giraldez 1996).

With its roots in the sixteenth century, this was the main praxis that continued throughout the seventeenth and eighteenth centuries. The difference in the eighteenth century is that within the Enlightenment period and the arrival of the French Bourbon dynasty to the Spanish throne, Spanish ministers aimed to solve the problem by codifying new decrees and rules to forbid contraband, illegal trade, and the introduction of foreign (Chinese) goods such as silks and textiles that were causing damage to national centres of production.

But of course, such stiff mercantile policies had a negative effect on local economies due to the high dependency on foreign trade. For the case of Qing China, it triggered hatred towards foreign communities as they were deemed by Qing rulers, mainly Qianlong, as the cause of the decline of China's economy due to interference from Western powers. Qianlong could be identified in China as the archetype of European mercantilism, and also a physiocrat monarch, due to a supremacist attitude, self-sufficient economic standards, and development of national production that the imperial Court established. The imperial decrees,

tariffs, and bans aimed to raise capital accumulation, foster national production in local factories, increase exports, and reduce imports.

The survival of the Qing dynasty was based on military force and territorial expansion. The new frontier of the empire depended upon the reaffirmation of its sovereignty over new territories and tributary states, as well as control of commerce and rigid socio-economic and political supervision of institutions. The number of officials and supervisors rose in provinces, prefectures, and villages. The state revenues to sustain such a big, and underpaid, bureaucracy, were insufficient. Consequently, local officials jointly with urban and rural communities engaged in illegal trade creating over the years non-official institutions and solid networks that in real terms managed the political and socio-economic daily life, mainly in the southern provinces.

Realizing this problem, the Manchu emperors launched the above-mentioned decrees and policies over foreign trade and communities, creating an “external enemy,” thus granting privileges to local gentry and new rich Chinese elites who made their fortunes through foreign trade and accumulation of American silver. Blaming external communities for the own faults of the state and not realizing that the “enemy,” or cause of the decline of the Qing economy was of a domestic nature, pushed the Middle Kingdom into a long-lasting spiral of political, social, and economic instability that lasted until the end of the Qing dynasty.

From the Qing dynasty, during the republic period, and up to the founding of the PRC, China has used a “Western mirror” to provide a narrative of the causes of the decline of its economy during the nineteenth century, having the Opium Wars as a cornerstone and the progressive modernization and political changes of the country. The Meiji Restoration in Japan was observed in China as a process of “Westernization” or conquest of East Asia by foreign powers. The Tongzhi Restoration in China, though it failed in the attempt to modernize the country, had some resemblances to the Japanese experience. The French Revolution of 1789 was used as a pattern more than one hundred years later by Sun Yat-sen’s revolutionary campaigns of 1911 to put an end to the Qing empire (Deng 2000). And next of course, there were the Marxist-Leninism ideals with “Chinese characteristics” [*zhōngguó tèsè* 中国特色] with the Communist uprising and the founding thereafter of the PRC with the aim of unifying the nation and modernizing the country without any features of capitalism.

The inference of Western powers in China's economy has been widely present in scholarly research. However, by ignoring the fact that the decline of China's economy during Qing times was also due to endogenous factors through the consolidation of Chinese local elites and the creation of trade networks, any historical analysis is incomplete. Local gentry, officials, and bureaucrats, whose fortunes were made by silver accumulation and engagement in trade activities beyond the official realm, were the strongholds of a non-official system and parallel institutions. They were a state inside the state.

Shanxi bankers, Huizhou traders, the so-called *sangleyes* [Chinese traders in the Philippines], the Hong traders of Canton and their Chinese and Western partners in Macao, were the main social actors that integrated such economic networks and the non-official system in Qing China. The policies of Qing (Manchu) emperors towards these trade and local (Han) communities were soft. This was likely due to the fact the majority of these traders were of Han origin (the Qing dynasty in the eyes of Han was a foreign dynasty), and therefore, any fear of social and civil uprising was always on the minds of the Qing emperors. Granting concessions such as not supervising activities, reducing (or exemption of) taxes, and enforcing smuggling activities was the negotiation made between Qing officials and trade elites of the southern provinces of China.

The growing number of institutions, appointments of bureaucrats and officials, issuing of imperial decrees by the Court of Beijing, and imposition of tariffs to control local and foreign trade had in the mid-long run a negative effect on the state's capacity to manage economic resources, as well as on the economic development and modernization of the territory. Tight control of the socio-economic life of villages and towns, as well as supremacist and self-sufficient attitudes through rigid imperial edicts shows that the state was incapable of managing the extended webs of trade in southern and eastern provinces of China (i.e. Jiangsu, Zhejiang, Anhui, Fujian, and Guangdong) which triggered the rampant corruption that involved local institutions and officials whose salaries and resources were very low. As institutions and official appointments grew, corruption and illegal trade continued to increase (Acemoglu et al. 2002, 2005).

With the arrival of the Qing dynasty, the conquest of the new western frontier by the Qing, not the Chinese, as Peter Perdue very well outlined as "many of the participants were not Han Chinese" (2010: xiv), marked the changing moment in the configuration of the map of the Middle

Kingdom and its road to the formation of a nation-state in the twentieth century. The incorporation of territories gained by the empire such as Mongolia, Xinjiang, and Tibet, dramatically enlarged the size of the Middle Kingdom. Population trebled in size (Ho 1959; Elvin 1973; Cao 2001), non-Chinese minorities were Sinicized and incorporated into the empire’s borders, and a grand scale economic and military programme to control new regions and local economies was launched (Elegant 1980; Spence 1999; Waley-Cohen 2006).

This was a crucial factor that aggravated the problem of the unification of the territory and the capacity of the Qing state to manage the new resources provided by the conquered regions. It was also important to make the non-Chinese minorities, as well as the Han majority, to feel identified with the political programme of a Manchu (foreign) dynasty ruling the vast geography of the empire. State unification was at stake and political campaigns were launched, taking into account that “nationalism” or “nation-states” as a modern Western concept that developed during the nineteenth century was not enrooted in the Middle Kingdom, and therefore landlords, traders, and local communities did not identify themselves with the grand scale of a nation (as we know is the case today), but identified with their own interests in terms of capital accumulation, family honour, and prestige.

The Middle Kingdom (Qing empire) was not orientated to overseas expansion to acquire new territories (colonies) as opposed to European empires whose military and economic power was based on the acquisition of overseas colonies (i.e. the Americas, Africa, Asia) (Toynbee 1934; Polanyi 1944). However, the Qing empire was orientated to overland expansion; it can be inferred that the new incorporated lands through the Manchu campaigns, Turkistan, Mongolia, Tibet, and even Taiwan, were the “colonies” of the Qing empire. These Qing empire “colonies” could be the counterpart of the overseas colonies of the European empires, as any empire per se based its supremacy and military force on the conquest of new lands.

Thus the Qing experience in building a powerful empire by expanding its lands and borders should not be seen as that different to the European experience in building empires. Therefore, Qing China during the second half of the seventeenth and until the end of the eighteenth century could have had a “reversal fortune” experience due to the institutional burden (Acemoglu et al. 2002; Feuerwerker 1958; Levy 1954). The conquest of new regions, the implementation of institutions from the imperial Court

of Beijing in superior prefectures [*fǔ* 府], secondary prefectures [*zhōu* 州], subprefectures [*tīng* 廳], and villages [*cūn* 村] in the incorporated lands was a form of domination and centralization of power from the capital. This was a secular and endogenous cause of the economic decline of Qing China as the western expansion as a form of colonialism by the Manchu emperors was not accompanied by the proper administrative reforms to face the dramatic growth in population, wealth distribution (local officials and bureaucrats' incomes were low), and technological breakthroughs (Rawski 1989; Rawski and Li 1992).

The Qing empire in the Middle Kingdom was composed of deep rooted layers of civilization and culture. With more than fifty ethnic minorities, the transcultural features of the territory depended upon the constant movement of people and goods that challenged the rigid political and Sinicized programme of Qing rulers whose aim was to unify the territory through a standardized cultural and “imagined” identity. On the contrary, the true concept of empire in Qing China could be defined as a “multipolar ethnic empire.” In other words, the Middle Kingdom under Qing rulers was a polycentric state in which the main regional nodes that dynamized the economy were in southern and coastal areas with no dominant space despite the fact that the political centre was in the imperial Court of Beijing.

Western communities mainly led by Jesuits, and European traders (from Portugal, France, Spain, Italy, England, Sweden, among others), in coalition with the *sangleyes* and local elites of Manila, as well as Chinese traders from Macao and Canton, all shaped a dense network of information not only to exchange goods and silver, but also to bypass the strong control of Qing emperors. This complex system of communication, trust, and partnership based on the medieval form of *commenda* (this term will be further explored in the next chapter) was extremely difficult to control by the central government of Beijing and its appointed local officials (who were also engaged in this system) in the southern provinces.

The Qing expansion to the west and the incapacity to administrate the newly incorporated lands, as well as local communities, could be pinpointed as one of the main causes of Qing China's economic decline beyond the traditional narrative of the Opium Wars and foreign interference. Further attempts during the nineteenth century to modernize China were mirrored through Western experience and Japan's Meiji Restoration. The Tongzhi Restoration in China to modernize the economy was doomed to fail because of the political and social outrage of keeping the

East Asian (Chinese) essences versus any sort of Western “invasion” by incorporating or assimilating Western technologies, values, and thought.

Likely such phenomenon presented in the traditional bipolar form of “Orientalism” (Said 1979) versus “Occidentalism” acquired a special form and connotation in China through Sinocentrism, deeply rooted since the Song dynasty, versus Eurocentrism. Such long-lasting confrontation between Western and Eastern values in which the exercise of supremacy and power by both Western and Eastern polities triggered the inferiority complex [*qíngjié* 情结] established in the public psyche of China’s communities from imperial times up to today in which the collective perception of China’s backwardness, social uprisings, and wars during the nineteenth and twentieth centuries were mainly caused by Western powers and foreign communities (Li 2002).

Such an inferiority complex commonly takes place in regions that have passed from being colonies to independent states. Some resemblances of this socio-economic and political process might be found in Latin American states by building their national identity during the nineteenth century (the Bolivarian political campaigns in Venezuela, Bolivia, Mexico, Colombia, among other nations, is a good example) and reinventing until the present day their culture, history, and geography. It is a clear instance of “imaginary” communities and reinvention of the past through continuous political programmes and campaigns by the ruling elites to legitimize their present sovereignty and control the future of the nation by creating an official version of history and a general narrative in the collective imaginary.

Maoism in China as a form of Marxism and Socialism with “Chinese characteristics” [*zhōngguó tèsè* 中国特色] was adapted from Western political thought and ideology. Sun Yat-sen and Chiang Kai-shek respectively adapted Western forms to China’s national movement which were utterly criticized by their CCP counterparts as elements that could contaminate the prospects of unification within the rising nation.

The subsequent triumph of Communism in China and the foundation of the PRC erased any sort of Western thought and elements visualized in the education and scholarly research. In the words of Kent Deng the field of Chinese economic history has been dominated by the West: “not only because of the systematic, effective destruction of Chinese academia under Maoism in the 1950s–1970s but also in terms of analytical tools and methods in use, including Marxism, as well as the sheer volume of scholarly works” (Deng 2001: 1).

As a continuation with the imbedded cultural and educational trends in PRC scholarship, today one might find a stiff resilient attitude in academic (traditional) Marxist circles to embrace and implement global history. Global history is viewed as a Western form and theory which goes against the new patriotic narratives adapted to national Chinese (or better to say PRC) “indigenous” culture, frames, and categories. The consolidation of these frames and categories aims to construct a robust patriotic identity as the process of “globalization” after the fall of the Berlin Wall and collapse of the Soviet Union is seen, mainly by countries non-aligned with the US and main Western powers, as potentially harmful to national history, as well as to local traditions and cultures.

The current use of global history in some cases, mainly in regions of Asia, Latin America, or Africa goes in line with the revival and unification of nations through the construction of a patriotic identity. An illustrative example is the Manila galleon project by UNESCO in which China, the Philippines, Mexico, and Spain were competing for the bid. Finally, the bid was granted to Spain and Mexico, as the Manila galleons that navigated across the Pacific were under dominion of the Spanish empire having as major ports Acapulco (New Spain, today’s Mexico) and Manila (the Philippines).

Open Access This chapter is licensed under the terms of the Creative Commons Attribution 4.0 International License (<http://creativecommons.org/licenses/by/4.0/>), which permits use, sharing, adaptation, distribution and reproduction in any medium or format, as long as you give appropriate credit to the original author(s) and the source, provide a link to the Creative Commons license and indicate if changes were made.

The images or other third party material in this chapter are included in the chapter’s Creative Commons license, unless indicated otherwise in a credit line to the material. If material is not included in the chapter’s Creative Commons license and your intended use is not permitted by statutory regulation or exceeds the permitted use, you will need to obtain permission directly from the copyright holder.





The Mandate of Heaven, the Rule of the Emperor: Self-Sufficiency of the Middle Kingdom

This chapter pays special attention to the analysis of the state administrative capacity of late Ming and Qing China by exploring the reforms introduced from the late sixteenth century up to 1796 regarding tax collection. Institutional constraints will be further explored through the rooted mandarin system and despotic rule of the emperor and officials who fostered the multiplication of institutions, mainly during the expansion to western provinces throughout the Qing dynasty. A highly bureaucratized system thwarted stable economic growth in the Middle Kingdom which reached its peak in the Song dynasty. The self-sufficiency of China showed by Qing (foreign) non-Han despotic rulers under the undisputable power and mandate of the emperor set Qing China onto a divided path. One direction would either modernize the country through acquisition of new technologies and economic reforms via economic and cultural transfers with the West; the other would close the borders and keep tight control of the newly incorporated western territories. This was a “supremacy dilemma” and a “power paradox” model that can be applied to the Middle Kingdom, and by extension to highly interventionist polities and countries. The firm exercise of power and control of society, the coercive forces implemented to keep such dominion, and the creation of a complex bureaucracy with incompetent institutions all prevented sustainable economic growth and state capacity within Qing China. A deep

analysis of the Local Gazetteers of China [*zhōngguó dìfāng zhì* 中国地方志] serves as an indicator to test the low state capacity to regulate Qing China.

3.1 POST-NEEDHAM PRACTICES: UNIQUENESS OF CHINESE CIVILIZATION AND ECONOMY?

The vast geography of China, alongside the variety of economic resources and rich land, provided the Middle Kingdom with advantageous conditions to reach higher levels of economic development than its European counterparts. Scholarly research on China's economic history acknowledges that the Song Dynasty (960–1279) (Deng 2000) was the most prosperous period, surpassing that of medieval Europe. The use of Gross Domestic Product (GDP) as a modern economic indicator, and its backwards projections to year 1 AD, seems invalid when analysing early modern economies and politics of Eurasia, mainly China (O'Brien and Deng 2017). Dwight H. Perkins (1969) and Albert Feuerwerker (1976) acknowledge a dramatic growth in China's marketed agricultural output, circa 20–40%, from the Ming dynasty to the late Qing dynasty. In less advanced areas of northern China, from George William Skinner's analysis, we might deduce some symptoms of proto industrialization (Chao 1986; Wong 1997), earlier than in eighteenth-century western European regions, as farmers increased their incomes from market and artisan activities creating a dynamic trade network connecting rural and urban areas (Skinner 1964, 1971).

In the Song dynasty the large circulation of minted-iron coins, and ingots, dynamized regional markets fostering an economy based on monetary metal for individual transactions, but without a standardized system. The annual iron output during this period reached circa 150,000 tons (Harrison 1972; Hartwell 1963). In addition, during the seventeenth and eighteenth centuries the exports of porcelains, silks, and teas (Perez-Garcia 2013) grew rapidly to satisfy the European craze for Chinese exotic goods. The Middle Kingdom since the Song dynasty had advantageous conditions to reach high levels of prosperity and modernization, much earlier than the western European experience of the eighteenth century, but the Middle Kingdom lacked a sustainable model to keep its economic growth in the long run. I put forward the thesis that institutional constraints and the creation of a complex and inefficient bureaucratic system created in the Qing dynasty, a dynasty based on the

military force to control the newly conquered territories, was one of the main causes that made China's economy stagnant.

The so-called Sinological trend in Chinese economic history research, which was mentioned in Kent Deng's work (Deng 2000), has some special characteristics, perhaps in line with the "Chinese characteristics" mentioned in the previous chapter, beyond the overwhelming praise about the Middle Kingdom's unique conditions of economic development in premodern times at the dawn of the European Renaissance (Mokyr 1990). This scholarly view has more significance following current PRC studies that develop national narratives inherent to Sinocentric views positioning the Middle Kingdom, or China (as modern term), in the centre of the world. This assessment has prevailed from imperial times until today serving in PRC scholarship as a patriotic flag to present the uniqueness of China's history and civilization.

This perspective, but with different connotations, was rooted in the Song dynasty wherein Sinocentrism and neo-Confucianism was established by converging Taoism, Buddhism, and Confucianism. This explicitly set, for the first time in the Middle Kingdom, the concept of supremacy and self-sufficiency by the emperor and his ministers. The improvements during the Song dynasty in agriculture (land use and irrigation systems, efficient labour force, output distribution) (Deng 1993; Ho 1959; Rawski 1972; Perkins 1969; Elvin 1973; Needham and Bray 1984; Huang 1985; Smith 1988), technological discoveries, in which some of these innovations were made in the Tang dynasty, such as metallurgy, gunpowder, the compass, nautical devices, paper making and currency, manufacture of silk, tea, and porcelain, as well as credit institutions and dynamic networks of commerce and transportation, all created the preconditions in a special environment for the possible rise of capitalism and modern science.

But why did the industrial revolution and modern science not occur during the Song dynasty, and why did it take place much later in eighteenth-century western Europe, mainly in Great Britain and the Low Countries? This is the well-known Needham's puzzle that seeks answers about why modernization and economic development did not take place in Song China when it had all the preconditions for a socio-economic and cultural transformation of the country (Needham and Wang 1954). Self-sufficiency and supremacy, however, were embedded within China's institutions (Ma 2012), rulers, and the Mandate of Heaven [*tiānmìng* 天命], symbolized in the emperor as the superior being governing his

subjects and life of the kingdom. This cultural mindset set from the Song dynasty to the deeply rooted alien (non-Han) Qing emperors, to modern China with the Republic and then the founding of the PRC, resulted in the economic and social life of the country being straight-jacketed into the conditions of an interventionist and mercantilist system (de Bary 1993). This motive is rooted in the cultural beliefs and the rigid hierarchized society (Kishimoto 2011). Supremacy of the state limited the social dynamism and economic growth of China from imperial times until today.

Technological and economic breakthroughs have occurred in any historical period across time and space. The key factor in maintaining and stabilizing regional economies, dynamizing markets, and fostering local demand is to implement efficient policies that reduce bureaucracy, the appointment of officials, and any unnecessary institutions. A rise in investments for innovation based on the individual action of the market agents is a crucial element for the sustainability of the economy.

However, the European (mainly in southern European countries, i.e. Spain, Portugal, France, Italy, and also Northern Europe) (de Vries and Van der Woude 1997) and the Asian (Chinese) experience of the early modern period to break free from institutional constraints was doomed to fail (Ogilvie 2011). A clear example is the artisan and merchant guilds of Spain (Pike 1966; Iradiel 1974; Casado 2004; Yun-Casalilla 2019) and Qing China [*huìguǎn* 会馆] (Quan 1993), which aimed to regulate quotas of production, exports, imports, prices, and output distribution thus limiting the action of the market and economic agents (Shiu and Keller 2007). In many cases these institutions acted as self-governing organizations (Chen 2001) controlled by local elites and the gentry creating therefore a parallel institutional system.

The transition from feudal systems to capitalism and a market-driven economy is based primarily in the reconversion of primary sectors of production (agriculture and the traditional workshop system) into the factory organizational system. This transformation of the economy, from medieval and premodern forms of production based on the control and restriction of the forces of production and limiting entrepreneurship, innovation, and specialization of the labour force to foster an efficient economy according to the environment or *milieu*, might be applicable in the long run to better grasp the constraints encountered by socio-economic agents. Institutional constraints derived from a highly bureaucratic system posed limitations to matching the gap on economic growth

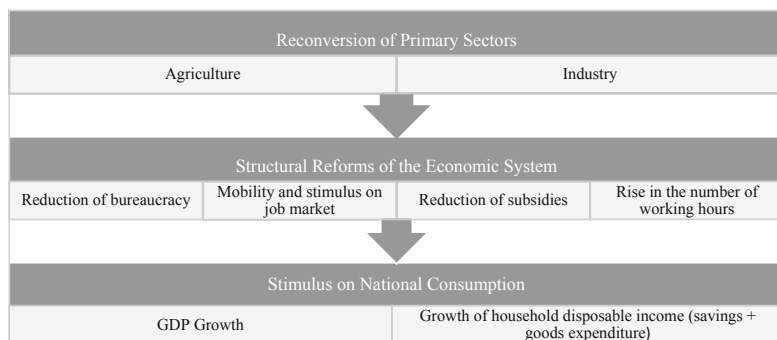
Table 3.1 Matching the gap on economic growth: from institutional constraints to free market economy

Source: Author's own elaboration

between East Asian regions and advanced areas of Western economies (see Table 3.1).

As with agrarian-based economies which are orientated around primitive forms of production with feudal features such as *latifundia* in Latin America (Frank 1969), or even in some regions of Mediterranean Europe during the twentieth century where land management by elites constituted the main source of political power, the transition to a free market system (see Table 3.1) has not taken place equally in East Asian regions. The lack of structural reforms in East Asian regions such as China in which the reduction of bureaucracy and fostering at the same time a stimulus job market based on mobility and incentives (social promotion and meritocracy) might be pinpointed as one of the main reasons for the gap, not only between China and western European economies, but also among socio-professional groups within China's provinces.

Reducing the number of inefficient and unnecessary officials, as well as the elimination of subsidies (see Table 3.1) seems a difficult task in interventionist, self-sufficient, and mercantilist economies. Within such traditional and power-driven societies, the prevalent feature of favour exchanges, deeply rooted in primitive societies in which the "gifts"/"donations" (Mauss 2006; Racine 1979; Caillé 1991) constituted the invisible force for the perpetuation of power of the ruling elites (from feudal lords to landlords and government ministers and officials), limited the possibilities of creating "open societies" and thus widened

the economic gap among social classes, income inequality, and wealth distribution in regions and provinces.

Certainly in different periods of China's economic history from the Song to the Qing dynasty, and also during the twentieth century, the rise in the number of working hours per household allowed for an increase in the level of income due to family members holding several jobs as market producers, and also their participation in local exchanges as market consumers. This has allowed economic historians to detect symptoms of the “industrious revolution” as a previous stage of the consumer revolution and, therefore, economic modernization of the country (Hayami 1976, 2015; de Vries 2008; Perez-Garcia 2013). Features for an “industrious revolution,” “hardworking creates earlier spring” [*rén qín chūn lái zǎo* 人勤春来早] in China might be detected in eastern regions (Li 1996, 1998). However, no economic or technological breakthroughs occurred due to the institutional constraints mentioned above, which only prompted symptoms or “sprouts of capitalism” in coastal areas of China, i.e. Jiangsu, lower Yangtze delta, and Jiangnan (Fig. 3.1).

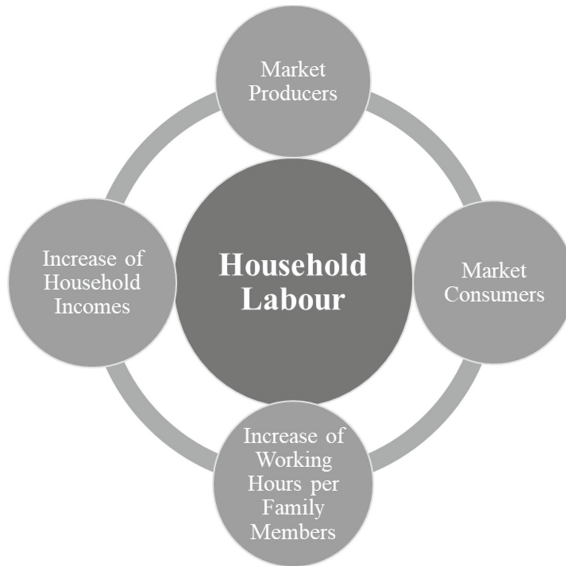

Fig. 3.1 The “industrious revolution” model

Source: Author's own elaboration

GDP is an invalid economic indicator to measure economic growth. The stimulus on consumption constitutes the main artery of a dynamic economy as capital circulates smoothly among the economic agents who are less dependent on credit and subsidies and, thus, the direct intervention and regulation of the state. However, GDP in modern times champions as an economic measure to weigh world economies serving, therefore, as an instrument embedded with nation-states' supremacy and hegemonic power.¹ For the case of China there is no doubt that GDP might be metaphorically related to collective forces of production led by the state, the communal spirit of the nation, against the individualism or sole action of market agents on freely choosing consumer goods. In addition, carrying out entrepreneurship, marginal savings, and health security are features that consequently lead to the modern welfare state and development of the middle class as a cornerstone of developed regions based on a sustainable economic growth model.

China's current economic rise has reinforced the country's hegemonic role through GDP. However, this economic measure is based on production forces of the economy (nation), but not to the wealth and income distribution as major drivers of the demand side which is where the prosperity of any economy and the middle classes lies upon. Thus, GDP somehow has contributed to perpetuate the bipolar economic world (core-peripheries) (Wallerstein 1980) inherited after WWII, in the Cold War period, and between Western and Eastern economies locating one sole economic centre or hegemonic power in either region. This has exacerbated national exceptionalism and the spread of patriotic ideas which today are very much present in China.

During the early 1990s, in the dawn of globalization and after the collapse of the Soviet Union, a time of world economy reorganization within socio-economic and political reforms, Andre Gunder Frank attempted to correct such misleading arguments on economic history analysis by introducing the concept of polycentrism (Frank 1998). This proposes that there is no one dominant economic centre, but rather that

¹GDP served to boost western (Eurocentric) exceptionalism as an economic national measure formulated by Simon Kuznets in 1937 during the time of the Great Depression (Eichengreen 2015), and later adopted at the Bretton Woods conference of 1944 (Eichengreen 2006). As it is a measure created in times of autarky aiming to reach equilibrium of the balance of payments, it has national and neo-mercantilist implications to boost national production and reduce imports (Kuznets 1967). As an economic measure, GDP has contributed to a sort of national exceptionalism in world economies.

a holistic view is essential in which all world regions have a crucial role being interconnected with each other.

Frank shifted the focus of world economies to Asian regions challenging, thus, the prevalent Eurocentric perspectives on global (economic) history analysis (Landes 1998). The challenge to the Eurocentric approaches (Duchesne 2001) was based on the following arguments: (1) living standards of Chinese households were equal to or higher than European regions before 1800; (2) local markets in eastern regions of China (Yangtze delta, Jiangsu province) had an efficient system that could match its European counterpart regions; (3) improved agricultural techniques and irrigation systems were in place; and (4) both Chinese and European regions had to cope with Malthusian pressures.

These four findings established that East Asian regions were the main developers of a world market economy setting the Middle Kingdom in current scholarship as the main economic centre (Perez-Garcia 2014). However, this flourishing economic period ended circa 1796, mainly in China during the so-called “High Qing” period [*shèng qīng* 盛清], and consequently northwestern European regions (Great Britain and Netherlands) took off and China stood behind. This decline, according to the scholarship, was due to the outbreak of the White Lotus Rebellion and the subsequent economic depression during the reign of the Daoguan emperor (1820–1850) (Von Glahn 2018). The Middle Kingdom’s dominion, which was the main territory fostering this global market economy, had ended by the end of the eighteenth century. As I will show in the following sections, the benign view that some scholarship has given to China’s economy of the eighteenth century for the “High Qing” period [*shèng qīng* 盛清] (Wong 1997; Li 1998; Von Glahn 2016) dismisses the fact that the stiff control of trade, mainly during the period of the Yongzheng emperor and the Qianlong emperor and his establishment of the Canton system, created in the long run a negative effect on the economy and society.

In economic terms, the bureaucracy and inefficient administrative system of the Qing emperors showed their inability to manage trade, especially with the constant influx of American silver to private elites that did not revert back into the state coffers. And also, the handicapped economic administration of the alien (Manchu, non-Han) emperors and their dominance of both maritime and inland trade routes aimed to control the Han population to avoid uprisings and internal rebellions. Both rigid mercantilist decrees and control of the Han population deserve to be further

examined as relevant factors which in the long run pushed back China's economy.

Quantitative analyses of China's economic development, mainly those following Maddison's estimates (Maddison 2001, 2007) and research line (Broadberry et al. 2017; Li and van Zanden 2012), dismiss these qualitative dimensions of the Qing economy in the eighteenth century. In addition, the use of macro-aggregates economic indicators such as GDP does not fit well for early modern economies (see Fig. 3.2) (Allen et al. 2005; Broadberry and Gupta 2006; Allen 2009; Broadberry and Hindle 2011; O'Brien and Deng 2017) and has led to conclusions about how the great divergence took place in the late eighteenth century when Great Britain took off during the first Industrial Revolution, and China, therefore, stood behind. According to this interpretation, before the year 1500, Europe had minimal influence in the world economy, but when the Americas became the main supplier of economic resources (Pomeranz 2000) the so-called "European miracle" of industrialization (Sugihara 1996; Pomeranz 2000) came to fruition. This conclusion is blurred by a Eurocentric perspective which puts the accent on the British exceptional momentum of the eighteenth century. Locating dominant centres

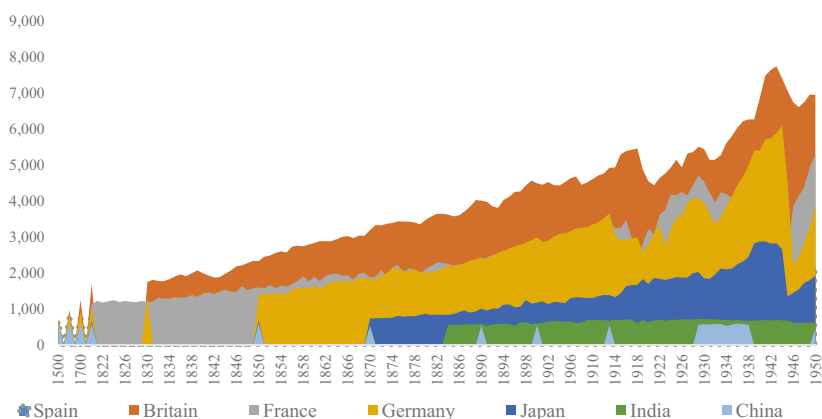

Fig. 3.2 Per capita GDP (1990 international Geary-Khamis dollars)

Source: Maddison, A., *Monitoring the World Economy 1820–1992*, Paris: OECD Development Centre, 1995. Maddison, A., *The World Economy: A Millennial Perspective*, Paris: OECD Development Centre, 2001. Maddison, A., *The World Economy: Historical Statistics*, Paris: OECD Development Centre, 2003

following Wallerstein's analysis of core-periphery dismisses the role of other world regions and connectivities. A more holistic view of such processes of cultural and scientific achievements in which institutional and religious constraints were the main obstacle for economic development is necessary when comparing East Asia (China) and its European counterparts. The role of institutions and elites is crucial in a transition to a scientific revolution, which reduces the intervention of the state, freeing the market, and therefore giving more space to individualism in which scientific and technological innovation is rooted.

To achieve technological innovations and set the path towards modernization, the Scientific Revolution and modern science in Europe emerged from the tensions between Christian theology and natural philosophy during the Renaissance having as a result the displacement of the Aristotelian understanding of the natural world (O'Brien 2013). Religious and political tensions that crystalized in a dense network of institutions, inherited from medieval feudal systems and adapted to European regimes of the early modern period, served as the main obstacle for scientific breakthroughs. It might be inferred, thus, that the Scientific Revolution that took place in some European regimes by the late seventeenth and early eighteenth century following the Galilean and Newtonian methods, also followed as well the Aristotelian tradition of world order and scientific knowledge.

It has been argued, therefore, that this process of acculturation and scientific discoveries turned into a process of global conjunctures in which in some European polities, mainly northwestern Europe (Great Britain and the Netherlands), modern science was reordered into a new cosmographical belief system (Weber 1950, 1951, 1958; Needham 1969). Within this system new institutions were organized into a more productive way so that the forms of production, knowledge, and technologies could serve the formation of modern nation-states and the consolidation of emerging empires. Such an explanation is rooted into the Eurocentric tradition of global economic history by which the British empire and its colonies are located as the hegemonic power during the late seventeenth and eighteenth century.

Thus, the European Scientific Revolution (Gillespie 2008; Huff 1993; Lindberg 2007; Levine 2001), which matured in the first Industrial Revolution at the end of the eighteenth century, has been analysed more as a world economic process than a cultural process that succeeded in specific regions in which individualism was gaining more terrain to the detriment

of semi-feudal ruling elites and institutions that limited innovation and knowledge (Clagett 1959; Epstein and Prak 2008; Hall and West 1976; Gies and Gies 1994; Gimpel 1977). Following such a linear process that assumes the dominant position of northwestern European regions in the world economy after 1750, the analysis and the question of why such European regions took off and China stood behind, or why modern science and capitalism emerged in Europe and not in China, is biased from the beginning through the Eurocentric perspective.

The reason for such bias is that economic analysis and interpretations should consider the cultural aspects and dramatically hierarchized East Asian (Chinese) society which did not undertake the transition to individualism, and/or substitution of semi-feudal institutions and ruling elites that were very powerful in south China provinces where the capital (American) silver accumulation did not revert into technological or scientific investments. This self-sufficient and hegemonic exceptionalism of China was rooted since the Song dynasty in neo-Confucian policies and Sinocentrism where a rigid social hierarchy limited individualism, technological breakthroughs, and, therefore, a scientific revolution that might have consolidated, in the long run, economic growth and development in the Qing dynasty.

3.2 INSTITUTIONAL CONSTRAINTS: FEUDALISM, “NOSPHERIC BUREAUCRATISM,” AND MANDARINATE

According to the interpretations of the California School (Von Glahn 1996; Flynn and Giraldez 2010; Li 1998), and mainly Pomeranz’s work (2000), European regions were progressively surpassing their Asian counterparts through the exploitation of American resources and the implementation of European institutions in the New World. In addition, Europeans were gaining terrain in Asian markets and the Pacific region. American silver and the natural resources of the Americas allowed European regions, mainly northwestern Europe, to develop faster. However, according to the economic resources available in the vast geography of the Middle Kingdom and the growing accumulation of American silver since the Ming dynasty which might have offered both China and northwestern Europe the same conditions for economic growth, then we should ask: why didn’t China achieve a sustainable economic growth when it had both the natural resources and a great accumulation of American silver as main world currency?

I believe the answer lies with a number of factors: the institutions, the inefficient bureaucracy that proved to be handicapped when coping with population growth and tax reforms, as well as the corruption of the gentry and local elites (Chang 1962) who had accumulated American silver through smuggling activities. In addition, the extremely hierarchized society based on neo-Confucian values and self-sufficiency of the state and the mandarinates also prevented China from achieving higher levels of economic growth. In the next chapter, I will develop this argument by cross-referencing historical sources that prove the failure of institutions and state capacity.

The key aspect is to observe whether individualism penetrated into Ming and Qing China to the detriment of the stiff interventionism of the state through feudal institutions, lords, and supervision of government officials. We know that this transition did not take place in China during the imperial period. The Middle Kingdom was from its early days looking inwards as the expansion of its borders was mainly westwards, whereas the expansion of European empires was orientated overseas. According to Euro-centred scholarship, mainly Ricardo Duchesne's work (2001), Europeans were no more rational than Asians as they based the expansion of their territories and extraction of economic resources on military force and implementation of coercive institutions based on slave and colonial trade. This was accompanied by a marginal increase in European wages, as well as costs of production derived from investments in new techniques and technological innovations.

Frank's affirmation that from 1400 until 1800 the hegemon of the world economy was Asia (Frank 1998), and therefore, China was the end-market of silver and gold flows, whereas other interpretations suggest that European powers exerted the monopoly since the sixteenth century (Landes 1998; Vries 2003), should be re-evaluated considering why such silver flows in China did not revert into technological innovations and economic growth.

European feudalism and social groups were based on a rigid social division and separation in estates or castes, i.e. clergy, nobility, businessmen, court and administrative officials, master artisans, artisans, peasants, yeomen, etc. This system was basically dominated by the ruling elites such as military aristocracy and landowners where inheritance and succession were based on primogeniture, where the firstborn son gained all rights.

Chinese feudalism, on the other hand, was based on imperial examinations to select the most talented candidates for the state bureaucracy. The civil service examination system [*kējǔzhì* 科舉制] (Man-Cheong 2004; Miyazaki 1981; Ch'ü 1957) was implemented during the mid-Tang dynasty and reached its apogee in the Song dynasty to ensure that state bureaucrats and officials were the most talented ones. This system of *carrière ouverte aux talents* [open career to talents] had no precedent in European Medieval kingdoms, and its early implementation in China could have potentially created an environment conducive for technological breakthroughs, diffusion of knowledge and innovation, and ultimately economic growth and modernization.

The European Renaissance was based on testing mathematized hypothesis about nature separating scientific and religious laws. This set the grounds for the European transition to capitalism during the sixteenth century in which the main features were discoveries by Galileo, Torricelli, the rise of the bourgeoisie, the emerging city-states, and the Protestant Reformation with its emphasis on individualism, entrepreneurship, and innovation. The role of cities or towns and the exercise of power and intervention of state institutions in Chinese and European regions are relevant when observing the transition from a feudal to modern system.

The management and power executed by individuals in state institutions is essential for an efficient functioning of the administration and ultimately for successful development of the state capacity. Joseph Needham coined the concept “nosphimeric bureaucratism” (Needham 2004) by which we might test the effectiveness of state capacity in social, economic, and political terms in delivering a well-governed society. “Nosphimeric” derives from the sphere of human thought and how the individual’s behaviour is driven for an efficient performance of his tasks based on a set of rules, ethics, and morals. The word derives from the Greek *νοῦς* [*nous* “mind”] and *σφαῖρα* [*sphaira* “sphere”]. The use of this word might have a “non-pejorative” connotation for the word “corruption” as a characteristic of the bureaucracy in China, which was growing during the Ming and Qing dynasties because of the continuous flows of American silver accumulated by the local elites and gentry of the southern provinces. Therefore, civil service, complex bureaucracy, and the mandarin as executive power were intertwined factors that shaped a complex and arcane administration in China based on the hierarchy and mandate of the superior social rank, ultimately limiting social mobility.

These three interconnected factors, plus the self-sufficiency of the Middle Kingdom which reached its peak in the Song dynasty, were in the long run responsible for the stagnation and limited modernization of China. Benign views of China's economic development from the fourteenth century onwards put the accent on Needham's puzzle by dismissing these three factors (civil service, complex bureaucracy, and the mandarinates) plus the self-sufficiency that characterized hegemonic powers, and therefore such scholarship has only limited the analysis to the failure of supply and demand technologies (Lin 1995).

Justin Yifu Lin's re-evaluation of Mark Elvin's high-level equilibrium trap thesis based on the rapid population growth of China as the main factor for the stagnation of China's economy and incentives for technological innovation asserting that "Chinese family's obsession with male heirs to extend the family lineage encouraged early marriage and high fertility" (Lin 1995: 271) is not accurate. The very same problem was encountered by western Mediterranean kingdoms at the end of the fifteenth century (if not earlier) when the Spanish Catholic monarchs repelled the Muslims from the Iberian Peninsula.

Extended lineage based on male primogeniture with the heir to accumulate and expand the wealth of the family by establishing coalitions and arranging marriages with families of similar or higher status was a common feature in Mediterranean Europe, and also in northwestern Europe (Casey 1989, 2007). The entailed state [*mayorazgo*] in the Iberian Kingdoms and the *morgadio* in Portugal (Yun-Casalilla 2019), aimed to keep the lands and assets of the family in the hands of the eldest son, resulting in early marriages and high levels of fertility to find heirs and, therefore, preserving the lineage's wealth. The family size was between two and four members per household (see Figs. 3.3 and 3.4) in which there was a mixture between nuclear and extended family.

Thus, the similarities in extended family lineage systems in both European and Chinese regions could also prove an obstacle for economic development and incentives to invest in new technologies in both regions (Goody 1983). But here we should distinguish between Mediterranean (Catholic) and northwestern (Protestant) Europe (Delille 2003; Stone 1979; Owens 2005). In the Catholic states, kingdoms, landlords, and institutions were a detrimental factor against technological investment as institutions such as the aforementioned entailed state, as well as craft and merchant guilds (Ogilvie 2011), prevented any technological innovation in order to keep a monopoly on the exploitation of the economic

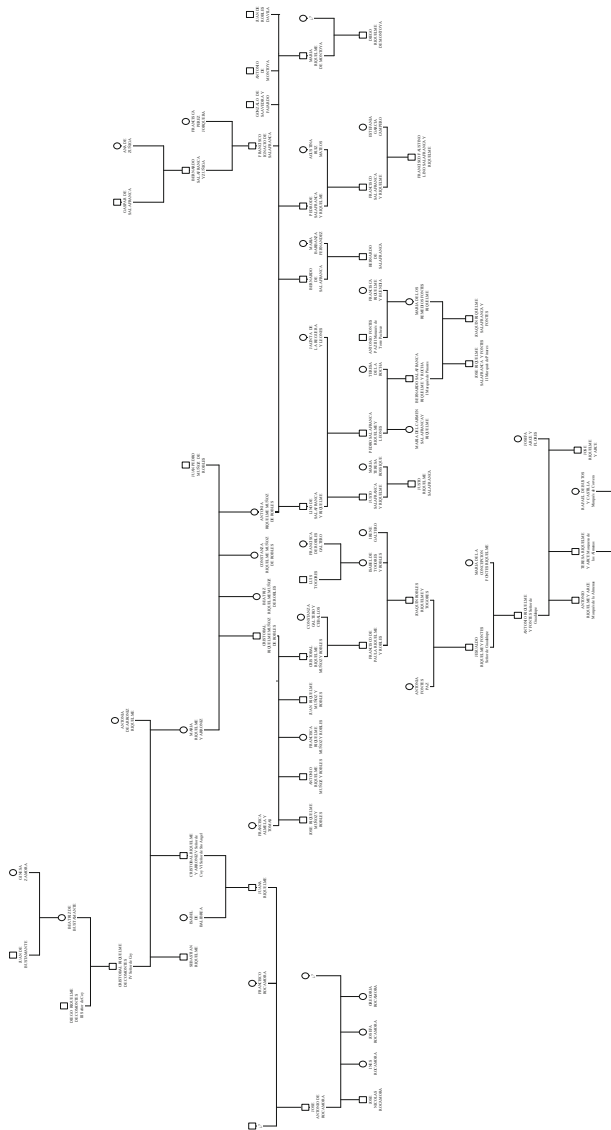

Fig. 3.3 A western Mediterranean Genealogy: Riquelme and Salafraña lineages (sixteenth to nineteenth centuries)
Source: Author's own elaboration. Archivo Historico Nacional (Spain), hereafter AHN, Archivo Real Chancilleria de Granada (Spain), hereafter ARChG

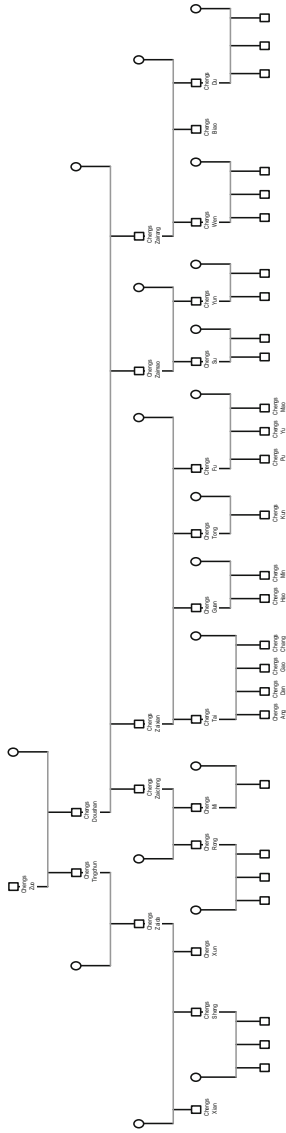

Fig. 3.4 A Southern (Huizhou) China Genealogy: the Chengs of Shanghe in Qimen County (circa sixteenth to seventeenth centuries)

Source: National Library of China (hereafter NLC), Cheng Chang, *Qimen Shanbe Chengshi pu* (1541 ed.), 8, 1a–7a. In McDermott, J.P., *The Making of a New Rural Order in South China, vol. 1, Village, Land, and Lineage in Huizhou, 900–1600*, Cambridge: Cambridge University Press, 2013

resources (land, labour, capital, raw materials, technologies). Whereas in Protestant Europe, entrepreneurship and implementation of new technologies had less constraints due to the cultural implications of the Protestant ethic, less intervention of the state, and the development of individualism.

This goes in line with Max Weber's theory on the Protestant ethic as main driver for the development of modern capitalism (Landes 1998). Its absence in the institutions of Catholic Europe and Qing China was the major constraint that hindered incentives for entrepreneurship, incentive for innovation, and sustainable economic growth (North 1991). Absolute states and multiplication of institutions (Acemoglu et al. 2005) whose main goal was to perpetuate local elites in power, either by the Mandate of Heaven in imperial China (Chao 1986; Elvin 1973; Tang 2006), or the divine monarchies of western Mediterranean Europe (Vilar 1974; Braudel 1949, 1996; Anes 1994), contributed to economic stagnation and lack of modernization. The rationale and despotism of Chinese and European elites could be similar in the use of labour, institutions, and economic resources (Anderson 1987).

As noted earlier, in European regions the power structures and society were divided into ranks based on military-aristocratic feudalism, whereas in China the socio-economic and political structures rested upon bureaucratic feudalism and the civil service examination system established in the mid-Tang dynasty and consolidated in the Song dynasty. In the paradigm of the former type of feudalism, power was managed by medieval knights who conquered new land and conveyed it to next generations in which lineage and family was the main institution to safeguard the wealth of the elites. This system granted relatively small power to the emerging group of merchants in the cities who, in the transition from the medieval to early modern period, assimilated with the old nobility and knights who conquered new lands and managed the economic resources of feudal estates (Perez-Garcia 2020). This transition and the collapse of the medieval feudal system at the dawn of the sixteenth century within the expansion of European powers to the New World prompted the rise of bourgeoisies triggering, in the long run, the road to the Industrial Revolution and incentives to seek technological breakthroughs in some urban areas of northwestern Europe.

In contrast, the hierarchical social structures in Ming and Qing China in which merchant groups were at the bottom of society made social assimilation and promotion much more difficult (rich merchants through

their fortunes could also buy official titles). Ultimately such rigid social structures thwarted a smooth transition from feudal structures to a bourgeoisie-based institutional system as a prelude to forming an open society in which the circulation of people, capital, technology, and goods could open the path to economic growth.

China's bureaucratic feudalism acknowledged the emperor as the sole authority of the territory under which there was a highly powerful and centralized government (Adshead 2004) where the territories were unified around the Middle Kingdom in the Qing dynasty under the scope of the "great unification" (Li 2012, 2014). The absolute power handled by the emperor, officials, and governors prevented merchant groups and business families from achieving social promotion and assimilating with families of higher status who had an official title. The bureaucratic feudalism based on official titles and political status around imperial Court and government institutions was orientated towards consolidating and unifying state power through the recruitment of skilled leadership. So in contrast to European regions where the male heir was the only legitimate successor of land and family assets, China's socio-political power since the Song dynasty was based on recruiting individuals as officials based on talent after passing the official examination system.

As a result, the central government was full of talent. This might provide some clues as to why China's government was more advanced than its European counterparts during medieval times, but this also set China onto a system in which power was highly concentrated into the hands of small elite groups preventing the rest of society's lower-middle classes to achieve social mobility. The high concentration of power held by elites around the Court and government institutions thwarted the unification of the Middle Kingdom when its lands were expanding westwards after the Qing (Manchu alien emperors) arrived in the mid-seventeenth century. Such concentration of power created tensions in the long term between established political elites, "small family dynasties" that passed the examination systems and consolidated their political status around the Court and local institutions in villages and small cities, and the rising new rich families that were making their fortune in trade by accumulating capital (American silver).

Consequently, it seems quite relevant to observe the structure of the formation of bourgeois city-states of western European regions in contrast with the concept of "citizenship" (if we might apply this concept) or urban identity in China. In Ming and Qing cities or urban areas, nodes of

administrative political networks of the central government can be identified. The crucial question is how the state was able to efficiently manage such a complex administration especially in the Qing period when land accumulation and population growth were both rapidly increasing. In the case of some European regions, small city-states were ruled by the lords who granted powers to rich business elites, and these groups in return recognized the power of their lord invested through divine powers.

The city was regarded as land property of the lord, the feudal patron, who protected and defended it (de Vries 1984). This structure of power acknowledged the leadership of the lord and patron, but also granted at the same time some agency to the emerging rich and bourgeois groups participating in local institutions and taking part in the political decisions of the city-state (i.e. Amsterdam, Lyon, Turin, Venice, London, Stockholm, Marseille, Cadiz, are outstanding examples). This allowed for a certain amount of cohesion and a balance of power that generated a unified stance to consolidate the domestic structures of the city and efficiently secure and defend it from potential attacks of other cities or kingdoms. The consequence of the distribution and consolidation of power in the socio-political structures of the city fostered flourishing market-orientated family groups emerging in urban areas where merchants invested profits and institutions and power into the hands of these trade elites.

However, for the case of China, especially during and after the Song dynasty through the implementation of Sinocentrism and neo-Confucian policies, self-sufficiency characterized people's daily lives. This occurred even in periods of scarcity and lack of supplies, as it was the central government who coordinated and administrated rural areas and cities around provinces, prefectures, and counties to assist and aid the cities that were in need. In return, the government levied taxes on local communities and families [*dīng* 丁] (Huang 1974; Ho 1959; Cao 2001; Elvin 1973). In this way, the socio-economic and political structures of ancient central government of China functioned as a trade/business entity among cities and villages (Li 1981). The state created parallel state structures with a clear trade orientation, and in many cases diverted revenues to private pockets.

Therefore, the growing merchant communities of the Ming and Qing dynasties, mainly in the southern provinces, found that there were no proper political structures and ecosystems to institutionalize their activities. They were not operating under the protection of the government,

and consequently they were forced to act outside the officialdom. This unbalanced economic system and unequal distribution of power, in contrast with the emerging city-states and burghs of early modern European regions, doomed imperial China to collapse when domestic tensions emerged in mid-Qing China due to the high accumulation of American silver in new rich communities that had made their fortune through overseas trade.

Questioning the state capacity of Qing China could be linked with Karl Wittfogel's classic thesis on the "Asiatic Mode of Production" (Wittfogel 1931), in which the bureaucratic structures created by the state aimed to control society through despotic and self-sufficient rule. The coined term "Oriental despotism" (Wittfogel 1957) emphasizes this idea of the sole and unquestionable mandate of the emperor (and mandarin system) centralizing power with the goal of keeping the kingdom unified. This ultimately prevented the economy from moving onto the later phases of economic development when China had the preconditions to develop as modern an economy as Great Britain or the Netherlands in the eighteenth century.

The economic unit and main structure and institution in ancient China to sustain such a despotic system of mandate and rule was the family. How families, lineages, groups, and communities responded to state rule and centralized power in the Ming and Qing period is key to understanding the path towards modernization, against the backdrop of domestic and external conflicts, at the dawn of the nineteenth century. The wet-rice production of China during the early modern period seemed enough to maintain stable financial income in family groups leaving, therefore, farmers motiveless to seek efficient and innovative modes of production (Marks 1998; Bray 1986).

A relevant feature of the "despotic" system was derived from the cultural environment that rendered the merchant as a derogatory and negative figure in ancient Chinese society. Due to the "Asiatic Mode of Production" in which the government was the sole agent upholding the power, economy, and socio-cultural structures, the institutions and agents that emerged from this system acted as coordinator between cities and supplier of basic economic resources such as wealth, energy resources, raw materials, and food and shelter. And more importantly the government and its structures were the only capable and legitimate organizer of daily

life and massive infrastructure projects such as building dams and irrigation systems or deflecting the river track to prevent flooding. This was a direct link to the livelihoods of the people, and ultimately the government (and its officials) was placed at the top of the ancient Chinese social hierarchy.

The irreplaceable and unquestionable management function of the government thus engendered high social status to governors, officials, and local bureaucrats. The rise of any emerging power through accumulation of capital, outside the realm of official authorities and central government, was therefore deemed a potential threat. The invisible force of money might jeopardize the power and despotic rule of the emperor creating a parallel or invisible state through non-official institutions within the state. This potential danger appeared to be occurring in southern China, as new rich families, lineages, and communities emerged through trade activities in south China markets, Southeast Asia, and the Pacific markets connected with the Americas and Europe. The accumulation of American silver in private family fortunes that escaped the official coordination of the central government was the major threat, and in the long term the main cause that set China into an economic depression at the beginning of the nineteenth century.

The central government's aim of maintaining intact the superiority of bureaucrats and officials abolished any prospects of social mobility for middle and lower social groups. The rising economic power of merchant groups posed a threat to bureaucrats by endangering their social status and hegemonic position (Rowe 2001). Thus, the government intensified the idea that the merchant class had low social status, ethics, and morals being ruthlessly driven by the worldly and evilly forces of money. The Qing (Manchu, non-Han rulers) despotic emperors, mainly Qianlong, stressed this idea on trade through autarky and mercantilist policies in which the state must be the main power intervening in the economy and trade affairs. Qianlong also indirectly emphasized the concept of race and ethnicity due to the foreign origins of the dynasty. In 1755 in a memorial to the emperor issued by local officials it was described that forty boatmen "without pigtailed" were seen on a trade vessel along the coast of Macao.² Even though it was verified that part of the crew were foreigners who had settled in Macao, Qianlong's concern to control southern China

²FHAC, Lu Fu Zou Zhe (hereafter LFZZ), reference (hereafter ref.) 03-0092-060.

trade groups and maritime activities was growing. Manchu communities had the tradition of keeping their hairstyle with a pigtail—they commonly had the habit of shaving the head and leaving partially a round part of the hair tied back. Han rulers, as the Han ethnic group was the dominant one in China, forbade the cutting of hair as part of traditional Han culture.

In a gesture of symbolic alliance with the Han population, after the arrival of the Manchu (foreign dynasty) and its aim of showing the authority and power of the new dynasty, Shunzhi emperor decreed the “hair shaving order” in 1644: “keep your hair or keep your head” [*liú tóu bù liú fà, liú fà bù liú tóu* 留头不留发,留发不留头].³ In the following years and centuries, insurrections and revolts would sporadically take place. Consequently, Qing emperors had special concerns on racial and ethnic cultural habits and traditions such as “hair identity” as a symbol of loyalty to the empire. Cultural habits in dress style and fashions such as hairstyles were ways to control the population (Zhu 1998).

This created over the centuries a gloomy social environment which prevented, at least in official circles or socially acceptable, merchant groups promoting themselves and becoming assimilated with the upper middle classes. The government aimed to intervene and control merchant groups’ endeavours. The aim of keeping and likely creating a new cultural identity by Qing rulers, who expanded westwards the borders of the Middle Kingdom and therefore controlled new lands and ethnic groups, was a central policy. This was based on maintaining the despotic rule and control of the government with officials and bureaucrats being the main hegemonic social agents. Within this idea the officialdom aimed to perpetuate the mentality that being a merchant was decadent and lacking in ethics and values, while being a government official provided honour and social status for the family and community in ancient Chinese society (Adshead 2000).

As a result, this provoked a social bottleneck between the emerging business families and officials and bureaucrats. This internal confrontation in China created in the long-term social endogenous causes that impeded economic growth and caused the perpetual stagnation of the economy from the eighteenth century onwards. Therefore, there was not an emerging bourgeoisie, or only within non-official circles and institutions, from the sixteenth century when new capital (American silver) was

³FHAC, Han Tan, Jiang Yin Cheng Shou Ji (1673–1704). See also the work by Zhao Ximing (1968).

entering into south China via the Iberian empires. The lack of a bourgeoisie identity which led to the formation of an “open society” for investments and scientific innovation was a crucial factor that aborted any possibility of an industrial revolution bringing modernization and economic transformation to China in the eighteenth and nineteenth centuries.

The central government’s policies in keeping bureaucrats and officials at the core of society set most individuals of the vast population of China to a certain inaction (Chen 2011; Wang 2007). This socio-cultural feature might be linked with the Chinese term *wéi* 为 and *wúwéi* 无为. *Wéi* 为 might be interpreted as the application of the force of will-power. It is based on the social conviction that objects, animals, men, and women should do what it is expected from them and what they are commanded to do. *Wúwéi* 无为 might be defined as the contrary force which respects the course of nature and leaves things and facts to flow alone. The forces of nature are leading events and actions by which individuals might benefit by accepting the outcomes instead of going against their natural flow by not interfering (Fernandez-Armesto 2001). As Bertrand Russell once said: “creation without possession, action without self-assertion, development without domination” (Russell 1922, 1956: 566–578, 584).

In the case of Taoism, ancient China had basic beliefs regarding the surrounding world and its natural phenomena. However, these primitive explanations and legends didn’t later evolve into a systemized religion, which was also supported by deep philosophic background and content. Instead Taoism emerged, which is a social phenomenon somewhere between religion and philosophy (Lu 1999). Such primitive beliefs, together with the deeply rooted inaction feature of individuals according to their social belonging and ranking, were also an important factor that prevented China from achieving higher levels of modernization and stable economic growth in the early modern period (Chen 2013; Yan 2012; Ma 2010).

3.3 SELF-SUFFICIENCY AND MARKET-ORIENTATION: THE “SUPREMACY DILEMMA” AND “POWER PARADOX” OF THE MIDDLE KINGDOM

As noted earlier, scholarship with a marked Eurocentric perspective has predominately focused on core economic areas and hegemonic regions perpetuating the great divide between the West and East and core-periphery economies (Wallerstein 1979; O’Brien 1982). Whereas studies marked by a stiff Eurocentric perspective (Landes 1998) criticized revisionist studies about the global economic role of East Asian economies (mainly China), scholars leading revisionist studies initiated by Gunder Frank and other Californian scholars (Wong 1997; Pomeranz 2000; Von Glahn 1996) reoriented Western theories and socio-economic and cultural achievements of European regions at the dawn of the Enlightenment and the Industrial Revolution. Duchesne launched a counter-attack to Californian scholars defending Eurocentric arguments against the role of East Asian regions (mainly China) in world economic development.

Despite the deficits between Asian and European markets, Eurocentric theses are based on rigid assessments dependent on debatable statistics such as Europe’s share of world trade in 1720 was 69% whereas Asia’s was 11% (Rostow 1978; Aldcroft and Ville 1994). And Asia’s share of the European trade was only 4% in 1830. However, these amounts do not include Asian (basically China) Western imports from Europe and the Americas through the Pacific market, and these imports were based on the re-exportation activities of decentralized and unregulated markets, the smuggling trade, which makes it difficult to draw the traceability of imports-exports.

End-markets show a better picture of the capital flow and circulation of global goods (Flynn 2019; Perez-Garcia 2019). Non-official institutions and other economic agents (Perez-Garcia 2013) were transforming the forces of production and supply through the introduction of changes in the demand. Intra-regional European markets were also at the centre as they were connecting European territories with East Asia. This was more obvious during the eighteenth century when maritime trade and the navigation system became more developed, overlapping regions and integrating markets as Frank envisioned (Frank 1998) and Duchesne showed his scepticism (Duchesne 2001). The key aspect is to show empirical evidence of the trade nodes and networks that were operating in both Pacific and Mediterranean regions in which alliances among

merchants and the trust and information to undertake long-distance business and ultimately circulation of defined global goods, contributed to such overlapping markets escaping the realm of official institutions (Greif 2006).

The “brokerage system” based on merchant alliances, partnerships, through the well-known practice of *commenda* (Pryor 1977) was a premodern mercantile practice of business intermediation to implement maritime insurance contracts, partnership agreements, bills of exchange, and double-entry bookkeeping (Braudel 1949). In international entrepôts such as Marseille in western Mediterranean Europe and Macao in south China, we might observe such overlapping markets in what can be defined as the “Asian-Mediterranean brokerage system” (Perez-Garcia 2019; Gipouloux 2011).

These markets and world regions defined by the multipolar, or polycentric, dimension was introduced by Frank’s work, and needs to be further developed by presenting new empirical evidence from Western and Eastern sources such as the trade records of the *Archive de la Chambre de Commerce de Marseille* and the Historical Archive of Macao, among others, that show detailed information of European demand for Chinese goods (silk, tea, porcelain), and the inbounds of American silver into south China markets. The revenue, in silver, through taxes levied by the Qing state, which were registered in the Local Gazetteers of China, was of lower quantity than the inflows of silver through the smuggling trade. Thus, the question posed by Duchesne: “what percentage of European trade was intra-European? What percentage of world trade was Asian, and what percentage was European?” (Duchesne 2001: 435) seems to be biased as it just seeks to put the emphasis on world core economic regions using official statistics and indices (exports-imports) dismissing local economic interactions through non-official trade and institutions. This informal agency and trade shaped a polycentric world economic system, featured by local connectivities, which demonstrates that the upcoming modern nation-states cannot be defined as the sole dominant players.

Further observation of another variable depicting trade networks, the intermediation and density of economic nodes and social agents, might challenge traditional explanations about why the industrial revolution occurred first in northwestern European regions (i.e. Great Britain and the Netherlands). Unregulated markets, the role of despotic and absolute monarchs and landlords of Southern Europe, or the unquestionable

Mandate of Heaven (Qian 1966) by the emperor in Beijing and the self-sufficiency of the economy of the Middle Kingdom prominently stand out as relevant cultural features that pushed back modernization, technological innovation, and economic growth.

Conventional economic interpretations keep unidirectionally observing Kondratieff “B” contraction and “A” expansion phases as the main phenomena to analyse economic growth and world trade expansion, locating the date of the great divergence and market integration based on price indices in 1820—arguably questionable data and numeracy (Williamson 1985; Chilosi and Frederico 2015; O’Rourke and Williamson 1999; Duchesne 2001; Frank 1998).

According to this rationale following Wallerstein’s thesis that in some historical periods there were circumstances for certain economies to further develop in which a rise in wages and access to cheap supplies (i.e. coal, raw materials, foodstuffs) from the colonies placed European regions into favourable conditions in comparison to their Asian counterparts. Consequently, European areas had the incentives to invest in new technologies. This means that the European Scientific Revolution was based on an economic process rather than a cultural one, which contradicts my argument that hierarchized societies and interventionist states and institutions, mainly those of Catholic Europe or the Qing dynasty, were the main factors for stagnation and economic backwardness.

Overseas trade from the Americas, the Pacific, the Indian Ocean, and the slave trade with Africa generated the capital accumulation and low-cost resources that prompted the Industrial Revolution in northwestern Europe. Despite the counter-arguments stating that oceanic commerce was a marginal factor for economic growth in core areas (O’Brien 1991; Floud and McCloskey 1994; Bairoch 1993; Engerman 1972; O’Brien and Engerman 1991, 1996), the rising consumption of overseas goods and trade profits came from non-official trade and unregulated markets. This generated prosperity in certain areas such as Britain, Belgium, or the Netherlands (de Vries and Woude 1997) in which both official and non-official institutions were intertwined due to the favourable geography for smooth channels of distribution through retailers, peddlers, wholesalers, and environmental conditions.

The repertoire of research that outlined the British exceptionalism (Berg 2005; Overton 1996; Inikori 1989; Williams 1966) during the Industrial Revolution period by giving a predominant role to the supply side, the vast national output of British markets and the inner strengths

of Britain to seek incentives for technological innovations, dismisses the outside forces of the vastly decentralized and unregulated markets from peripheral Europe, i.e. Cadiz-Seville, Lisbon, Marseille, among other relevant entrepôts and trade nodes, that concentrated a high accumulation of overseas goods (mainly from south China markets) and American silver.

This American silver was again relocated in south China which acted as main magnet for the flow of capital due to the rising demand for Chinese goods and re-exportation in European markets. The analysis of such polycentric world trade zones, the connectivities of intra-regional and maritime markets through the agency of merchants and non-official institutions, demystifies the thesis that the major driver that led to economic growth and modernization in Europe was the nature of the British internal economy and its ability to respond to the stimulus of external trade, such as the role of law, constitutional government, and the awareness of liberty and democracy (Vries 2015; Vries 2010; O'Brien 1991; Bairoch 1993).

Instead of providing analysis on endogenous and exogenous causalities on European advanced regions' nature and performance to further develop during the eighteenth century in comparison with East Asian regions through the connection with overseas markets using historical sources from China and Europe, the Eurocentric (Anglocentric) scholarship has constantly focused on the uniqueness and exceptionalism of Western civilization having as pivotal axis the British empire and its colonies with statistical evidence and numeracy from Western sources (Humphries and Schneider 2019; Vries 2015; Darwin 2012, 2013; Berg 2011; Belich 2009; Darwin 2009; Overton 1996; Inikori 1989; Williams 1966).

Once claimed by John Brewer as the "error of our ways" (Brewer 2004), British exceptionalism's failure to undertake proper comparisons among world regions and to think globally is still very much present in recent research which perpetuates as valid the traditional view of Europe (and by extension the British world) as the hegemonic power and culture that brought modernization to the West. This view prolongs the idea that Europe has been the most creative and unique civilization since ancient Greeks developed theoretical science and thinking, citizenship, democratic politics, and in essence, the birth of modern society (McKendrick 1982). Such exceptionalism is coloured with a profound ethnocentric perspective and cultural superiority.

To observe and better understand Needham's question and logic to compare the paths of economic growth and modernization between China and European regions (mainly comparisons have been carried out between China and Great Britain dismissing other European regions), other schools, basically British scholarship, have indirectly followed the same pattern of analysis uniquely leading us to a "Eurocentric (British-centric) trap." This is that Britain was more efficient in managing cheap labour, rising wages, and triggering incentives for innovation and, therefore, had a more productive agrarian system. In China the rationale was the same for cheap labour and supplies (i.e. use of energy sources), but the choice and motivation to invest in innovation, in new technologies, and to increase wages was not the same.

Any transformation was viewed as a loss of the essence of Asian (Chinese) cultural values because such changes were believed to be brought into China from the outsiders (Westerners) seeking control of the Middle Kingdom. This set China onto what we might call a "supremacy dilemma" or "power paradox" within East Asian cultural values. In other words, China was the hegemonic power and most advanced economy in the twelfth and thirteenth centuries when medieval European kingdoms were stagnant. It also led the cultural essences of East Asia over territories and regions (Korean peninsula, Japan, western regions) which some of them were progressively occupied in the Ming and Qing dynasties setting China as the hegemonic power of the region (Ko et al. 2018). Absolutist regimes, in which this Chinese model fits, and as Debin Ma also confirmed in his research, sets the "paradox of strong power and weak governance" (Ma 2014).

Strengthening its power by expanding its borders during the Ming and Qing dynasties fully pushed China into the "supremacy dilemma." This was based on keeping the new territories, and its communities and minorities, unified and controlled by the strong power and coercive forces of the mandarin state and the complex institutions and bureaucracy that held rigid control of society (Zhou 2012). An alternative could have been transforming and adapting the newly acquired regions and growing population through new incentives in productivity, technology, efficient use of natural and agrarian resources, open overseas trade system, rising wages, and reduction of institutions, potentially developing and modernizing the economy in the way that Great Britain and the Netherlands later did during the eighteenth century (Greif 2005).

This implied the use of new technologies, likely most of them discovered in China, but they were more developed in the West. The arrival of Jesuits in the Ming and Qing Court were the main social agents to introduce such technologies and discoveries, but in the end the Jesuits' "Western" technology and its application were dismissed as a potential threat against keeping the Middle Kingdom unified in both cultural and political terms. That is what might define the "power paradox": China seemed to develop further than its European counterparts (Dincecco 2014) having economic features of modern capitalism, but in the long term its economy was stagnant due to the institutional constraints that aimed to control new communities and minorities in southern and western provinces under the mandarin rule that overshadowed the society and culture.

The rigid interventionism that defined the autocratic state of the Qing regime fostered informal socio-economic networks, external resource dependency, a lack of information from the central government in Beijing to long-distance provinces, a non-compliance culture, an inefficient tax system, and therefore a weak state capacity (Ma and Rubin 2019). This plus the highly hierarchized society and governance based on Confucian values (Weber 1951) which prevented social mobility, scientific transformation, and innovation, made the Middle Kingdom "closed" to the outside world for the "inner fear" of losing the supremacy of East Asian (Koyama et al. 2018), and Chinese, cultural values.

Analysing these socio-cultural factors complements the incomplete and biased statistics and numeracy from both Chinese and European historical sources, demonstrating that the debate on the inner causes of economic development between Asia (China) and western regions is in essence based on imperfections and multiple variables of a diverse and growing geography of China's borders in the Ming and Qing dynasties (i.e. population growth, trade indicators, goods and capital flows, implementation of technology, business alliances, energy resources, cultural features of local communities, etc.). The polycentric approach, connectivities between peoples and regions, and the holistic view of the socio-economic process of transformation (Frank 1998) by which the historian can observe it from local changes is paramount to avoid the conventional bias. These are the Eurocentric (Anglocentric) and/or Sinocentric approaches which seem currently to be connected to a neo-Cold War narrative that seeks to set world hegemonic territories. These new narratives might be legitimated by historical research (the -isms) and ultimately perpetuate

the great divide between the West and the East, or superior and inferior world regions.

For instance, the “supremacy dilemma” or “power paradox” that began in the Ming and Qing dynasties continued throughout the twentieth century up until the present day. China has tried to adjust itself to the rules set not merely by Western powers, but through the changes of world scenarios (Acemoglu 2005), and therefore makes a strategic rationale in its “governing dynamics” (Nash 1950) to be a decisive player in the economic and political world order (Fudenberg and Tirole 1991; von Neumann and Morgenstern 1944). The nature of the Chinese market has been merely characterized by mercantilism and autarky protecting, unifying, and securing its borders, and by exporting more than importing ready-to-use goods (Besley and Persson 2010).

From the sixteenth to the eighteenth century, the linchpin and node of south China markets with American markets was through the connection with the Spanish empire in Manila which served as main entrepôt for the constant flow of Chinese goods to American colonies and the outbounds of American silver to China. Thus, Spanish-controlled colonies in the Americas became progressively orientated to: (1) export raw materials, energy sources, cheap labour; and (2) drain off high volumes of silver to Asian (mainly China’s) markets, almost 2/3 of the total share (Flynn and Giraldez 2010), instead of going to Spanish markets. Consequently, in the long run, the Americas predominately became exporters and dependent on more developed economies for the introduction of finished manufactures (Frank 1969).

Analysing commodity chains to study the world economy system is an accurate tool to observe within such decentralized and unregulated markets of the Pacific (connecting China with the Americas) the flows and exchanges of Chinese goods for American silver (Hopkins and Wallerstein 1986). Following Wallerstein’s thesis, the complexity of the economic system of the Pacific region, which geographically encompassed 1/3 of the world market (Flynn 2019), absorbed the small mini-systems, world-empires (Iberian, Ming and Qing China), as well as competing with world economies. This ultimately fostered a high accumulation of capital (American silver) into the hands of private merchants and local gentry in the southern provinces of China which both the Ming and Qing states were unable to control (Chang 1955).

Establishing long-distance trade for the introduction of goods into Chinese but also European and American markets, and linking processes

of the formation of worldwide trade networks and business partnerships, allowed a significant accumulation of capital (American silver) that neither the Spanish nor the Qing empire (Tilly 1990; Huang 1974; Irigoien and Grafe 2013) could control in the eighteenth century even with the implementation of stiff mercantilist and interventionist decrees on overseas trade. The traceability of large amounts of goods (Chinese items in Western markets, and European and American ones in Chinese markets) through cross-referencing historical sources from China and Europe (i.e. probate-inventories, trade records, and confiscation records) allows us to show the worldwide circulation of these goods beyond the realm of state and official institutions.

The structure of these commodity chains goes further than the classic bilinear scheme of raw materials and finished goods. Instead of this rigid format, the complex construction of connections between economic nodes of production, supply, and formation of social network analysis to delimit the trade zones in which business companies (smugglers, long-distance partners, and brokers) operated for the introduction of goods seems a more accurate method. This allows us to analyse and scientifically construct from the local perspective the role of mini-economic systems, capital absorption, and inequality and dependence in the long run of economic zones and their ultimate participation into a more global economic system.

The geographies (*loci*) in which economic agents acted (traders, companies, non-official institutions, etc.) generating operations in the form of simple economic transactions (individual exchanges in local markets) or more complex financial systems (i.e. *commenda*, bills of transactions, credits, loans, or all-risks insurances for maritime trade, etc.) provide us with an accurate evaluation of the diverse operations in decentralized and unregulated markets of the Pacific, and also of Mediterranean regions (Greif and Tabellini 2017). In these spaces, commodities circulated globally creating secular trends and cyclical rhythms in local economies that can be partially observed through the official figures and statistics of import-export data.

The expansion and contraction of such trade cycles were only a product of minimal transformations, interventions, and partial reforms (decrees, bans, prohibition laws) of the states which in the long term could not eradicate or prevent the operations undertaken by non-official or non-state controlled economic agents. Institutions either implemented by the state or in local markets (families, lineages, shrines, guilds, among others,

either in Western or Chinese regions) had a similar logic and function. Regardless of the appearance and structure of these institutions, as feudalist or capitalist, they were all commercial establishments responding to the demand of outer markets with the aim of controlling and securing profits.

The rise, transformation, and metamorphosis of such institutions based on land power, control and access to local and afar markets, and family alliances in the southern provinces of China (Jiangsu, Fujian, Zhejiang, Guangdong), Manila in the Philippines, New Spain, South America (Lima-Callao) (Suarez 2018), Buenos Aires (Ibarra 2019), and Europe (Cadiz-Seville, Marseille) from the sixteenth to the eighteenth century showed the demand for goods and creation of new markets that confirmed the existence and “sprout of capitalism” and features of world economy in the early modern times.

This “sprout of capitalism” was commercial rather than industrial or technological and innovative-orientated in nature, another argument that confirms why China did not modernize earlier than Europe and why the economy of the Middle Kingdom stood behind some of its European counterparts. The less developed regions, i.e. Asian or American (Hausberger 2018), were not isolated from more advanced regions or trade zones (Flynn 2019), but they acted as providers of goods, capital, and information to operate in distant markets creating a polycentric (Perez-Garcia 2019) and decentralized economic system between polities and empires.

However, such market dependency, with less capability to be more technologically advanced and productive, set the region into a self-generated industrialization. In other words due to the self-sufficiency of the Middle Kingdom as provider of all kinds of raw materials and basic supplies but with less capacity to transform manufactures within more sophisticated systems of production placed its economy into a dependency of tributary states of the border of south China and Southeast Asia, and the capital incentives prompted by silver accumulation. In the long term the economy of Qing China pursued self-development by non-participation in the process of global transformation, revolution and breakthroughs in technology, and ideas and political systems compared to some regions in Europe where these changes were progressively introduced (economically in northwestern Europe, and politically in France).

3.4 THE LOCAL GAZETTEERS AND STATE CAPACITY IN QING CHINA

To provide a new evaluation of the great divergence debate within a micro-analysis of the economic performance of specific regions of China, mainly coastal areas and southern provinces, the data of Local Gazetteers of China [*zhōngguó dìfāng zhì* 中国地方志] seems a relevant approach when looking at the state capacity of the Middle Kingdom to manage the economic and human resources (Chu 1942; Wang 1987; Will 1985). I am aware that the data of the Local Gazetteers on population and taxes numeracy are biased and, in many cases, inaccurate, especially data from the Qing dynasty. However, even from such bias and inaccuracy we might infer the incapacity of the Qing state to manage the economic and human resources acquired from the new lands and provinces incorporated within the Qing expansion (Howland 1996; Perdue 2010). Such expansion needed a new mobilization of resources and efficient administration which was not the case for the Qing dynasty. Appointments of new officials, supervisors, and bureaucrats were undertaken, but their skills and techniques were poor when counting households, age of family members working, and the numbers subject to pay tribute [*gòngfù* 贡赋]. As another disincentive to taking a thorough census, the salaries of these officials were very low.

This could be one of the main reasons for the inaccurate data of the census of population [*rénkǒu pǔchá* 人口普查] of the Local Gazetteers of the Qing dynasty. This census was meant to levy taxes on a family based on the number of family members working. The aim in presenting the following section of figures and partial data on the population of parts of eastern and southern China is not to account for population or provide annual series of taxes levied by the Qing state. The goal is precisely to demonstrate within such numeracy the low capacity of the Qing state to manage the economic resources and have an efficient system and bureaucracy for tax collection. This might re-evaluate within a micro level the so-called “footsteps” of the great divergence in provinces, prefectures, and counties of Qing China.

Wealth was localized in some eastern and southern regions such as Guangdong, Fujian, Jiangsu, Zhejiang (Dow 1965), lower Yantze delta, and Jiangnan (Chan et al. 2015; Fang 1996), the latter very well studied by Li Bozhong (1985, 1996). But this wealth was in private hands through the initiative of local merchants and artisans who in many cases

bypassed the state supervision. This shows a disparity, basically high inequality, of the wealth distribution in China regions that shows the contradictions of a wealthy state with enough economic and natural resources, but with an inefficient system to manage such resources and, therefore, provide the incentives to individual entrepreneurship.

Conventional scholarship has used Chinese sources such as the Local Gazetteers to measure population or to look at tax data. In different ways scholars such as Cao Shuji (2001), He Bingdi (Ping-ti Ho) (1959), Mark Elvin (1973, 2004), Roy Bin Wong (1997) or Lee and Campbell (1997, 2002), among the most relevant, have approached this source to measure population growth in China and the Malthusian pressures of Chinese population. Through gazetteers, I re-evaluate the state capacity of the Qing state by presenting a problem previously not solved which is to show the economic interactions of new Qing officials in eastern and southern localities and how this was correlated with an efficient management of local economic resources and population.⁴

The Local Gazetteers are local sources the government administration and local officials or gentry compiled from the tenth century to the late Qing dynasty about general rules, boundaries of the region, topography (see Map 3.1), ancient monuments, official buildings and city walls, water, examinations, population, land and taxes, market towns, local products, local customs, biographies, literature works by local people, and miscellaneous (Ho 1959; Chen 1965; Mostern 2008). In the Song dynasty local authorities collected data more efficiently which was compiled in the Local Gazetteers (Mostern 2011). During the Ming dynasty data (Franke 1983) were compiled to give information for the 1461 general gazetteer, thereafter they were re-edited, and for the Qing period new editions were made for nearly all areas (Leslie 1973) which made the results and information unreliable. John K. Fairbank mentioned that the Local Gazetteers is “more than 3,000 multivolumed works available in collections. They provide a ramified wide-ranging record – geographic and economic treatises, historical narratives with extensive documentation, collection of numerous bibliographies, and essays on customs and religious institutions – for all administrative areas of the Chinese empire,

⁴See the work by Xia Mingfang (2012) for the evaluation of Smithian features of China’s economy during the Qing period.

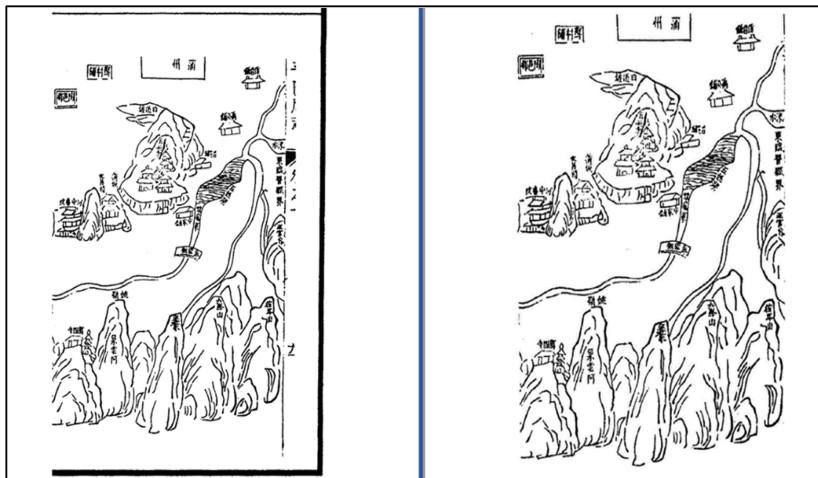

Map 3.1 Puzhou town in Shanxi province

Source: Renmin University of China Library (hereafter RUCL), Rare Book Collection, *Zhongguo Difang Zhi*, Shanxi province, Kangxi reign

from the county on up to the province...Their ‘statistics’ are not those of the modern-minded government statistician or economist” (Ho 1959: ix). I analyse the capacity of the Qing state through the examination of the economic performance at regional level, province [*shěng* 省], prefecture [*fǔ* 府], subprefecture [*zhōu* 州], county [*xiàn* 县] in south China (Hervouet 1957). Rather than using aggregates from GDP data (see Fig. 3.5), an analysis of the administrative system from the local basis might give us a better insight into understanding the functioning of the Qing government and the economic performance during this time.

There are doubts about Maddison’s estimates to measure population growth (see Fig. 3.5) in China from the Song dynasty until the present as this data has been aggregated without counting the disparities of local records from the Song to Qing dynasty, mainly considering the discrepancies and inefficient system of the Qing period to account population as many data were omitted and under-registered.

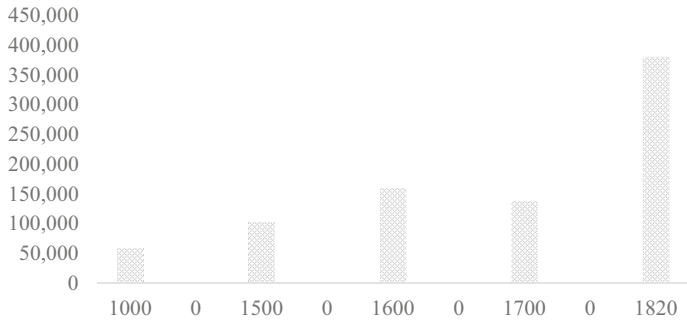

Fig. 3.5 Maddison's estimates on population growth in China, 1000–1820
Source: Maddison, A., *Monitoring*, 1995. Maddison, A., *The World Economy*, 2001. Maddison, A., *The World Economy: Historical*, 2003

There are serious problems and errors in some Chinese sources such as the Local Gazetteers due to an inefficient record system of Qing bureaucrats and officials, such as household and tax registration (Ma and Yuan 2016), which makes it a daunting task for historians to accurately develop a series of annual tax and population data (Shi 2008; He 1998). The shallowness of source analysis, archival collection, and data analysis in PRC scholarship is therefore common (Long 2011; Shi 2011; Zhao 2011). There was under-registration in population data even though appointments of local officials and bureaucrats rose in number in the Qing period. But their salaries were low and therefore their techniques to perform their work got worse (Shi and Yi 2008; Iwai 2004; Hamashita 2006; Wang 1973). The channels of information between the emperor and officials in southern provinces malfunctioned the governance (Sng 2010), and the imperial policy taxation evolved towards a prefixed annual tax quota and informal local taxation (Ma 2014). The fiscal system of the Qing dynasty was a continuity of the preceding Ming dynasty, but the techniques and methods of registering population and tax collection in the Qing period never improved. Public statistical records were subject to deliberate falsification, governmental laxity, and technical limitations for accountability. Table 3.2 and Figs. 3.6 and 3.7 correspond to early Ming China when the system was more workable and efficient than that of Qing China. The households and number of family members of southern counties

Table 3.2 Population of southern China regions, 1371–1376

	1371		1376		1376	
	<i>Households</i>	<i>Mouths</i>	<i>Households</i>	<i>Mouths</i>	<i>Growth rate (%)</i>	<i>Growth rate (%)</i>
					<i>Mouths</i>	<i>Households</i>
Jixi county	9787	41,414	9942	42,483	2.51	1.55
Changshu county	62,285	247,104	61,211	263,414	-1.75	6.19
Huizhou prefecture	117,110	536,952	120,762	549,485	3.02	2.28
Suzhou prefecture	473,862	1,947,871	506,543	2,160,463	6.45	9.84

Source: Chi-his HC (1581 ed.), 3.1b–2b. In Ping-ti, Ho, *Studies on the Population of China*, pp. 6, 7, 17

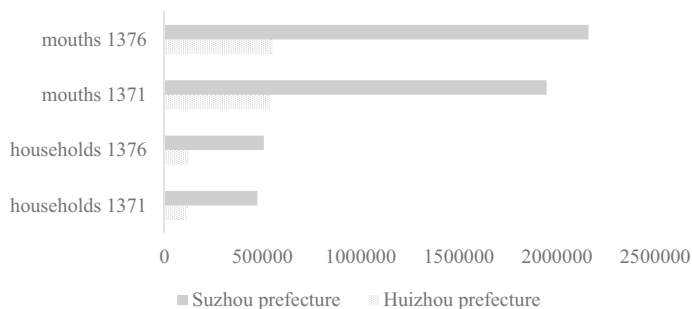
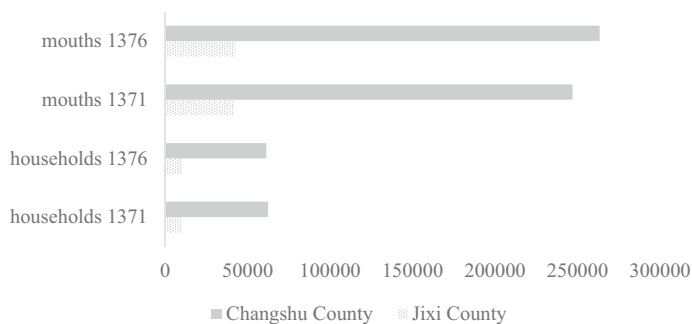
**Fig. 3.6** Population in Suzhou and Huizhou prefectures [*fǔ* 府], 1371–1376**Fig. 3.7** Population in Changshu and Jixi counties, 1371–1376

and prefectures for this period present less disparities in data registration of spans of short periods. Here below are presented data of Jixi and Changshu counties, as well as Huizhou and Suzhou prefectures featured as dynamic local economies. Sudden and irrational changes and contrasts in population and fiscal registration will appear in the Qing dynasty.

The average household in the above tables was four persons per household. The method applied by the Ming government was to manage 110 households into a *li* 邻. The so-called ten *li* [headmen] were chosen from the biggest number of adult males within their household and who paid a higher amount of taxes. The remaining 100 households were divided into ten *jiǎ* 甲 [one *jiǎ* had ten persons as head of households]. Normally a walled city, called *fāng* 坊, had 110 units of households (Ho 1959: 7). The total population of China by the end of the fourteenth century likely reached the figure of 65,000,000. The early Ming population was smaller due to decades of chaos and wars and the eventual defeat of the Mongol dynasty. Population was decreasing in the first half of the fifteenth century, and the second half of the fifteenth century showed a stationary fluctuation of circa 60,000,000 (Ho 1959: 9) (Fig. 3.8).

There are two milestones in China's historical population and fiscal administration system. The first one was the unprecedented and effective fiscal and labour reform by Hongwu emperor 洪武帝 (1368–1398) based on the account of the total population. Records on labour services [called *Huangze* or *Yellow Registers*] were compiled between 1381 and 1382, and thereafter revised in 1391 (Ho 1959: 3). This accounting system incorporated land-survey maps and land-tax handbooks. The second milestone during the same period was the completion and enumerations in nature and quality of such land maps and tax handbooks, the so-called Fish-Scale Maps and Books. It was not until Qianlong's reign, in the last quarter of the eighteenth century, when China had a comparable system in quality like the one of the early Ming dynasty. In 1370 the Board of Revenue was the main institution in imposing on provincial and local authorities to get the population officially registered under their jurisdiction. The Qing fiscal regime was based on hierarchy and centralized power which in nature was a continuity of the Ming system based on Confucian values and the mandate of the emperor as demonstrated in the previous section.

At the beginning of the sixteenth century, and thereafter until the end of the Ming dynasty and during the Qing dynasty, the *li-jiǎ* method to register population by officials became unfeasible. The main reasons were

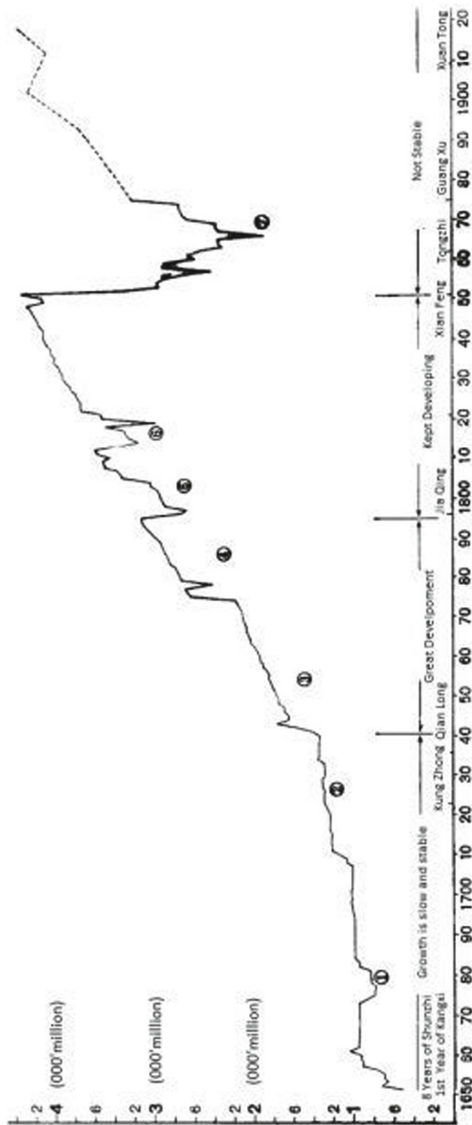

Fig. 3.8 Population Growth in Qing China
 Source: Zhou Yuanhe, "Qing dai renkou yanjiu" [Studies on Population in Qing China], *Zhongguo Shehuihexue* [Chinese Academy of Social Sciences], 1982, vol. 2, pp. 161-188

the following: (1) the corrosive influence of a rising money economy, the steady influx of American silver (Von Glahn 2019; Cao and Flynn 2019; Ho 1959: 11) after 1514 with the arrival of the Portuguese (de Sousa 2010, 2019; Perez-Garcia 2019; Boxer 1959; Boyajian 2008; Oka 2010); (2) alliances between the gentry and local government to evade labour services and land tax (McDermott 2013); (3) protection of rural interests by powerful landlords (Ho 1959: 10, 13; Skinner 1964, 1965a, b). Ownership of land was concentrated in the Lower Yangtze area, Guangdong and Fujian provinces' omission and evasion of population registration was fostered by landlords to protect the gentry; and (4) official peculation was also a factor for under-registration of population (low government payment for officials to perform their duty).

Officialdom was money-orientated due to the influx of high volumes of American silver into early sixteenth-century China. Chinese traders shifted the demand of silver from Chinese and Japanese to American silver which fostered and increased corruption. High appropriation of public revenue (see Fig. 3.9) such as taxes and labour-service payments by provincial and local officials became progressively common in the province of Fujian where trade with Europeans was very active. There was, therefore, a direct

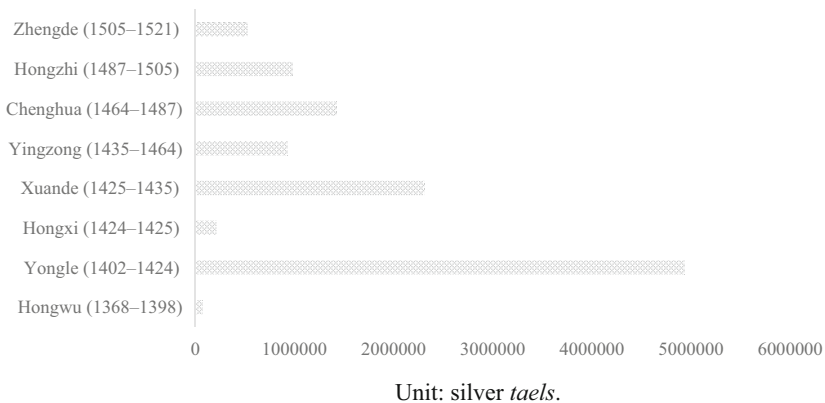

Fig. 3.9 Silver Income Revenue, 1368–1521

Source: Data adapted from Wan Ming, “Mingdai baiyin huobi hua: Zhongguo yu shijie lianjie de xin shijiao” [Silver Monetization in the Ming Dynasty: A New Perspective on China’s Connection with the World], *Hebei Xuekan* [Hebei Journal], 5 (2004), pp. 145–154

correlation between the introduction of American silver and the rising corruptive practices in southern China provinces (Ch'u 1962), mainly in the areas of Canton and Fujian. The under-registration of population due to the unworkable system carried out by local officials during the sixteenth century, and in the Qing period, incentivized these local officials to engage in contraband and illegal commerce which provided major profits in comparison to their official salaries (Brook 1999, 2010).

Contemporaries such as the Ming scholar He Qiao-yuan 何乔远 affirmed such practices and how official revenues were diverted to private pockets and government assistants and subjects. This scholar mentioned that “officially registered male adults, the so-called *guān dīng* 官丁, paid only three tenths [*guān qián* 官钱] of a *tael* to local government. Male adults who are not into the registers are called *sī-dīng* 私丁 [‘private’, *unregistered ting*]. The private *dīng* pays into the pocket of government underlings who charges roughly according to the size and economic status of the family. This is inevitable.”⁵ This system fostered alliances between powerful households and local government authorities in Canton counties to escape the fiscal burden. This provoked clan (lineages) alliances to evade official registration and therefore elude paying taxes.

The above-mentioned practices became progressively common, and, consequently, the system to register population and extract tax revenues in the late Ming period was imprecise. In late Ming, one *dīng* was the equivalent of one male adult aged between 16 and 60 years old subject to labour services or labour service payment (Ho 1959: 22). Thus, the account of families and family members was arbitrarily compiled in the Ming dynasty, and such inaccuracy continued into the Qing dynasty. It is relevant to mention that Qing dynasty tax and labour calculations followed the procedure of compiling the Yellow registers after 1651 on a wider scale than the Ming registers. The Qing Yellow registers were mainly meant to account population and tax returns, whereas the Ming ones were based on accounting population and properties (Ho 1959: 24).

Such deep changes introduced in the Qing dynasty from 1651 meant that the registers collected on population were flawed and implausible. Map 3.2 and Tables 3.3, 3.4, 3.5, and 3.6 are arranged through the Local Gazetteers population and *dīng* data related to prefectures of Guangdong

⁵ Shanghai Jiao Tong University Library (hereafter SJTUL), Dingxiu Database [鼎秀古籍全文检索平台 *dīng xiù gǔjí quánwén jiǎnsuǒ píngtái*], Rare Book Collection, *Minsbu, Chongzhen si nian* (1639). Reference also in Ping-ti Ho (1959: 14).

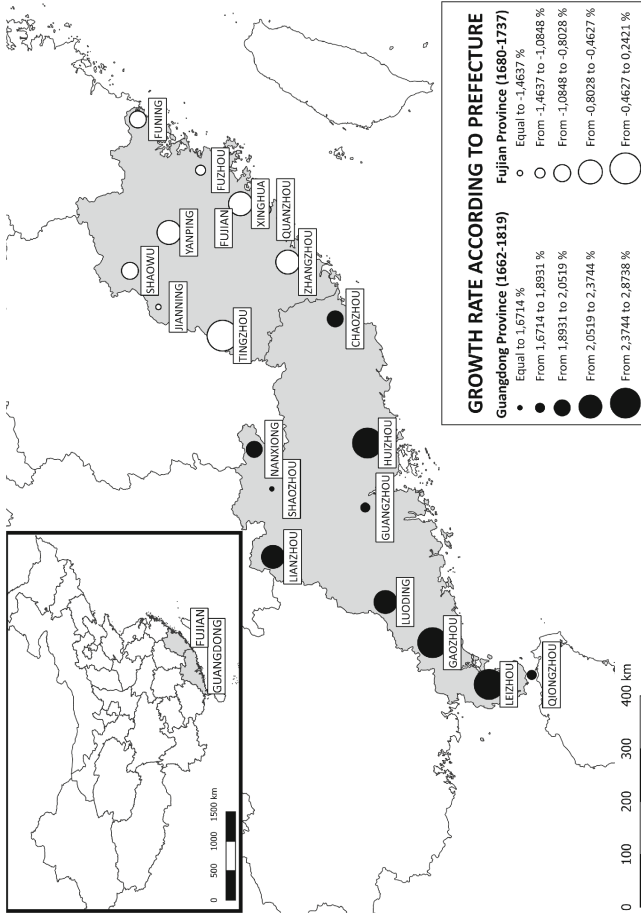

Map 3.2 Population growth rate in Guangdong and Fujian prefectures according to Local Gazetteers, 1662–1819
Source: Author’s own elaboration, using GECEM Project Database and Software QGIS v3.12 Base map from Natural Earth raster. RUCL, Rare Book Collection, *Zhongguo Difang Zhi*, Fujian and Guangdong province, Kangxi, Qianlong and Jiaqing reign

Table 3.3 Population data and growth rate in Guangdong prefectures [*fǔ* 府], 1662–1819

<i>Prefecture</i>	1662	1663	1819	<i>Growth rate from 1663 to 1819 (%)</i>
Guangzhou	200,302	230,855	3,403,966	1.86
Shaozhou	51,720	53,598	602,795	1.67
Nanxiong	9479	11,720	205,393	1.98
Huizhou	34,500	37,359	1,300,030	2.87
Chaozhou	57,043	72,421	1,405,180	2.05
Gaozhou	24,108	25,125	1,207,411	2.68
Lianzhou	4,731	8777	269,960	2.37
Leizhou	4502	6902	368,840	2.76
Qiongzhou	46,733	47,153	728,889	1.89
Luoding	12,578	12,622	374,554	2.34

Source: RUCL, Rare Book Collection, *Zhongguo Difang Zhi*, Guangdong province, Kangxi and Jiaqing reign

Table 3.4 Population data in Guangdong province, 1662–1819

<i>Year</i>	1662	1673	1770	1819
<i>Ding</i>	509,537	573,910	898,088	12,323,616

Source: RUCL, Rare Book Collection, *Zhongguo Difang Zhi*, Guangdong province, Kangxi and Jiaqing reign

Table 3.5 Population data and growth rate in Fujian prefectures [*fǔ* 府], 1680–1737

<i>Prefecture</i>	1680	1737	<i>Growth rate (%)</i>
Fuzhou	449,870	225,287	−1.20
Quanzhou	240,435	129,117	−1.08
Jianning	603,195	260,280	−1.46
Yanping	315,115	217,589	−0.64
Tingzhou	182,565	209,541	0.24
Xinghua	172,595	132,501	−0.46
Shaowu	199,330	125,901	−0.80
Zhangzhou	234,725	171,713	−0.54
Funing	84,685	49,833	−0.92

Source: RUCL, Rare Book Collection, *Zhongguo Difang Zhi*, Fujian province, Kangxi and Qianlong reign

Table 3.6 Population data in Fujian province, 1680–1830

<i>Year</i>	<i>1680</i>	<i>1737</i>	<i>1830</i>
<i>Dīng</i>	2,482,515	1,622,436	17,347,799

Source: RUCL, Rare Book Collection, *Zhongguo Difang Zhi*, Fujian province, Kangxi, Qianlong and Daoguan reign

and Fujian provinces where household registers in the Qing dynasty were not properly carried out before and after Qianlong reforms. The reform introduced by the Qianlong emperor in 1741 changed this system, but data were still weak. The only available data for the Qing period are the annual *dīng* returns. The use of such data to account for population is a very difficult, almost impossible, task for demographers. As mentioned earlier my goal in this section is not to show any alternative to account for population, but rather to show, as illustrative example, that it is precisely this inaccurate data of the Qing dynasty that indicates the low capacity of the state.

Today some scholars (Cao 2001; Zhou 1982) take the model of some early Qing scholarship (Parker 1899; Rockhill 1905; Willcox 1930) which is based on considering the *dīng*, families, and population liable to taxes in the same terms. Their method to calculate the population is to multiply the *dīng* digits for a given year by four, five, six, or anything statistically plausible for them. Early Qing historians who worked on China's population in the late nineteenth and twentieth centuries have been influenced by each other, accepting each other's estimates and figures. This can be observed through the wide acceptance of the estimates of China's population of circa 65,000,000 inhabitants in 1651, and circa 350,000,000 in 1850 (see Fig. 3.8).

As we can see in Table 3.3 and Map 3.2 the growth rate in the population of some prefectures of Guangdong province sharply rose from 1673 (Kangxi reign) to 1819 (Jiaqing reign). The population data system passed from under-registration in the Kangxi reign to over-registration in the Jiaqing reign, despite the Qianlong emperor's reforms. Even though there is a consensus that the population significantly rose in the Ming-Qing transition, figures displayed in Table 3.3 showing the population growth rate in Guangdong prefectures are not plausible according to the data of the census of the Local Gazetteers from the Kangxi to Jiaqing period.

Table 3.3 and Map 3.2 also show that the growth in some prefectures goes from 1.67% to 2.87% which is implausible as China's growth rate was 0.4% per annum from 1400 to 1850 (Ge et al. 2001; Ho 1959; Elvin 1973; Brandt et al. 2014; Lee and Wang 1999; Skinner 1987). The annual rate of growth of the whole population of China, according to Ping-ti Ho, and also confirmed in the data by Zhou Yuanhe, from 1779 (275,000,000 inhabitants) to 1850 (430,000,000 inhabitants), was between 0.63% and 1% (Zhou 1982; Ho 1959: 64). In the twentieth century the peak that China reached was 2.6% in 1968, being 0.32% in the year 2020 (United Nations 2017; Roser et al. 2020).

Arbitrary estimates in accounting population were still carried out after Qianlong's reign. In 1819 during the Jiaqing period the total *dīng* registered in Guangdong province according to Local Gazetteers was 12,323,616 (see Table 3.4) which according to my argument is still an overrated figure. This figure has been taken as valid by current mainland China's scholarship to calculate the population of Guangdong for the year of 1819 as 21,392,000 in the account book of department of revenue [*hùbù* 户部], with an estimate of 21,558,239 as the final figure for Guangdong's population by the gazetteers of Jiaqing reign. Even though China's population was rising in this period, the figure provided by the gazetteers, and still taking as valid by some scholarship, is unrealistic and overestimated (Cao 2001: 191; Zhou 1982; Ye 1999; Jiang 1990). Something similar can be observed in Map 3.2 and Tables 3.5 and 3.6 that show population and *dīng* data of Fujian prefectures.

The growth rate in all prefectures is negative, and only in Tingzhou prefecture in 1737, before Qianlong reforms on population registers, is the growth rate positive. Also, the data regarding the total number of *dīng* in Fujian province (see Table 3.6) had sharp changes from the Kangxi to the Daoguan reign offering an unrealistic view of the population size. This shows that the Local Gazetteers' population registers were both under-registered and overrated during the so-called "High Qing" period [*shèng qīng* 盛清], defined as economically prosperous, and also during and after the Qianlong reign and reforms. The system was unworkable being an indicator of the low capacity of the Qing state to create a stable socio-economic model to manage economic resources, mainly in southern provinces, as it is demonstrated through the data presented on the prefectures of Guangdong and Fujian.

The reconstruction of China's population through Qing period data from 1651 until 1740 is no longer acceptable as the original Qing *dīng* shares of several regions were fixed and later arbitrary evaluations were made. The “original” [*shìzài réndīng* 實在人丁] Qing quotas for *dīng* tax followed the late Ming return system (see Illustration 3.1) (Ho 1959: 32).

Until the end of the Kangxi reign only half of the territories of the Middle Kingdom had completely merged the *dīng* reform from tax labour service to tax land. And according to scholarship, it is only in the Qiang-long years that the data on population and fiscal policies are a bit more, but not totally, reliable. This might lead us to the conclusion that the state capacity of the Qing government was low and inefficient in the implementation of tax reforms and administration of the economic resources of the empire, mainly the newly conquered lands. The *dīng* returns from 1651 to 1740 of the alien dynasty, non-Han (Manchu), were never intended to indicate population, but to collect taxes. As we can observe in Fig. 3.10 below, the tax returns from the *shìzài réndīng* original population of Guangdong and Fujian provinces were quite lower than the *dīng* figures. Even though data on population are not reliable, we might detect the

<p>康熙十九年實在人丁門頭三百二十二萬三千八百八十丁門半內除優免二萬二千六十六丁免徵外</p> <p>實在人丁三百二十萬一千八百一十四丁內分</p> <p>供丁吏承丁五萬五千九百九十二丁</p> <p>新更實在人丁九千七百四十九丁</p> <p>寬丁七千一十丁</p> <p>門頭門丁三百九門</p> <p>行差人丁三百一十二萬八千七百五十四丁</p> <p>共徵銀三十九萬三千四百一兩一錢三分</p>	<p>康熙十九年實在人丁門頭三百二十二萬三千八百八十丁門半內除優免二萬二千六十六丁免徵外</p> <p>實在人丁三百二十萬一千八百一十四丁內分</p> <p>供丁吏承丁五萬五千九百九十二丁</p> <p>新更實在人丁九千七百四十九丁</p> <p>寬丁七千一十丁</p> <p>門頭門丁三百九門</p> <p>行差人丁三百一十二萬八千七百五十四丁</p> <p>共徵銀三十九萬三千四百一兩一錢三分</p>
--	--

Illustration 3.1 *Dīng* and Tax Returns in Hebei Province, 1680

Source: RUCL, Rare Book Collection, *Zhongguo Difang Zhi*, Hebei province, Kangxi reign

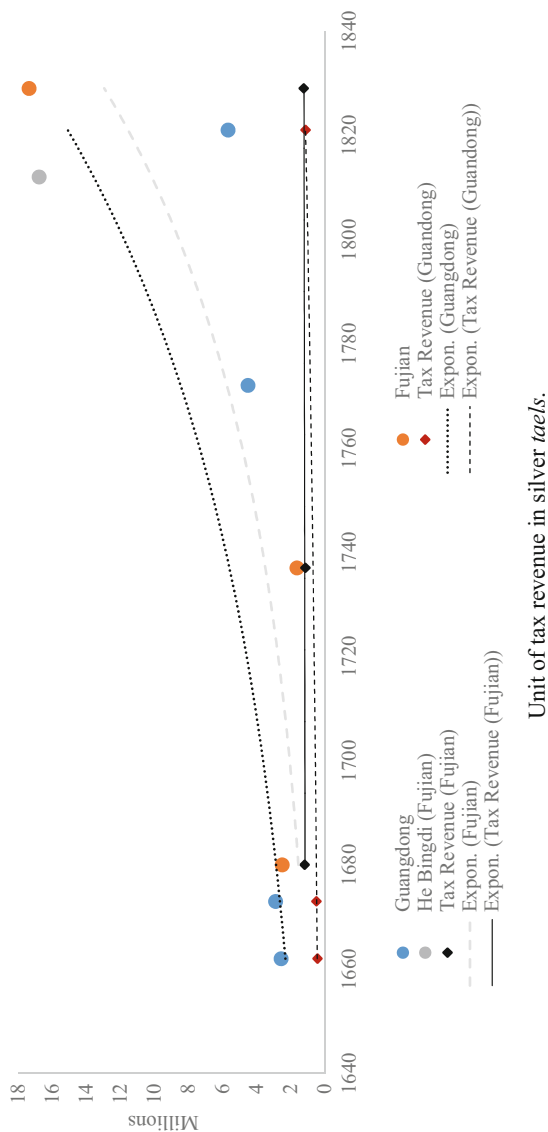

Fig. 3.10 *Ding* and Tax Returns in Guangdong and Fujian Provinces, 1662–1829
Source: RUCI, Rare Book Collection, *Zhongguo Difang Zhi*, Guangdong and Fujian provinces, from Kangxi to Daoguang reign. Ping-ti Ho [He Bingdi], *Studies on the Population*, 1959

low capacity of the state to collect taxes as the tax digits were much lower than those related to population.

From 1741 to 1775, the years of the Qianlong reforms to register population, data were still flawed and the system to register population did not have much in the way of improvements. We still observe (see Fig. 3.10) sharp fluctuations in population figures and a lack of uniformity in methods of population registers in the second half of the eighteenth century, whereas tax collection remained stagnant and with some slight decline. Through the data I present in this section, Ping-ti Ho's conclusions on the ineffective fiscal and population register system of the Qing dynasty (Ho 1959: 36, 37, 38, 198) are proven, mainly in the southern provinces where local alliances between officials and merchants were carried out as more profitable business. Merchants from Fuzhou, Canton, Suzhou, Shanxi, Nanjing, among other relevant areas, were engaged in the lucrative trade of introducing goods from western origins such as tobacco, wines, and liquors, American crops (i.e. sweet potato, potato, chili) (Perez-Garcia 2018; Cao 2004; Ho 1979), clocks, etc., and exporting silk, porcelain, and tea to western regions. This non-official system was rampant and uncontrollable by the central government of Beijing (Chang 1962) and is the subject of the next chapter.

In an effort to improve the system and eradicate such inefficient methods and under-registration of population which was having negative effects in collecting taxes and increasing the government public revenue, the Qianlong emperor decreed in 1740 an evaluation and review of the system of population registration. Ping-ti Ho mentions in his work a very illustrative passage of this decree and the response of the Board of Revenue which shows the low capacity of the state to register population, collect taxes, and most importantly to control the profitable business of long-distance provinces. Indirectly we can infer the worries of the government to control alliances between local officials and transient merchants who were not registered. Qianlong's decree mentioned the following:

In spite of the quinquennial [*dīng*] assessments, provincial officials had hitherto been bound, in matters to the increase and decline [of the number of *dīng*], by administrative formality. They have scarcely realized that this matter is indeed the foundation of good government. From now on the provincial officials, should in the 11th month of each year, send in detailed reports as to the changes in numbers of households and mouths... This will provide me with data for constant reference... (Ho 1959: 37)

The Board of Revenue mentioned that after the completion of the *dīng* assessments “there must not be any omissions and evasions.” Evasions and diversion of public revenues were very common in the southern provinces, and so a group of high officials recommended that the data be compiled from the “original” [*shízài rēndīng*] population and tax quotas:

...the actual increase in population, can hardly be feasible in real practice...assessment has been based on-the-spot surveys and not on the *dīng* registers. Moreover, people are scattered all over the countryside...If the local officials should be ordered personally to enumerate, they could not bear [such administrative burden]. Probably they would entrust such task to their office underlings. Besides some merchants are without fixed residence, as are the transients and those in services and on public errands...It is requested therefore that [the annual population enumeration] be stopped...There is no need to make a door-to-door enumeration. (Ho 1959: 38)

The population of provinces such as Sichuan, Hubei, Hunan, Fujian, or Guangdong was clearly under reported. Despite such attempts and reforms to improve the population and tax administration of China (Zelin 1985), the system was still confusing, and laws and decrees were very ambiguous. Local authorities purposely magnified population data after 1741 to satisfy the Qianlong emperor. The central government’s mismanagement of securing an efficient system of information with local officials in procuring correct data on population could likely be explained as not wanting to put pressure on the local population, mainly Han communities, as high fiscal pressures were seen as an omen of faulty government and consequently might foreshadow the collapse of the dynasty (Ma 2014: 487).

The Manchu (non-Han) government, as a foreign dynasty ruling the Middle Kingdom, had in mind potential uprisings and local rebellions led by Han communities (Hung 2009). Therefore, in this particular issue, fiscal pressure was put more and more on foreign trade, and foreign communities. After his accession in 1736, Qianlong was concerned about the increasing accumulation of American silver by local communities in the southern provinces. In 1757 he established the Canton System [*yīkǒu tōngshāng* 一口通商] (Liang 1999; Cheong 1997; Zhao 2013) enforcing Canton as the only port in China open for foreign commerce.

This measure can be seen as a way for the Qing state to improve its low capacity of collecting taxes (Menegon 2017: 33; Wang 2017) from *dīng* returns and mismanagement in registering population, as well as an attempt to control business alliances and activities through official institutions to eliminate contraband (Perdue 2017; Menegon 2017; Van Dyke 2011: 7–9). Within such measures Qianlong also seized an opportunity in controlling and levying taxes on maritime and foreign trade as a very profitable sector for the imperial treasury. Precisely in the year that Qianlong imposed the Canton System in 1757 and 1758 he collected more *taels* [*liǎng* 两] of silver in the Canton Customs than the under-registered *liǎng* of silver levied in the whole Guangdong province in 1673, during the Kangxi emperor’s reign (see Table 3.7).

Data from the Kangxi period are biased due to such under-registrations of the population system, but to make such comparison illustrates the low capacity of the Qing state to collect taxes and register population. And also, it shows the different contexts of the Kangxi period, when trade was more open, and the Qianlong period when trade was closed to all ports except Canton. These different economic and political contexts of the Manchu emperors, which has been widely recognized by the scholarship as the “High Qing” period [*shèng qīng* 盛清] with its flourishing economy, as portrayed in this section show that a re-evaluation of this period should be made through further research as the capacity of the Qing state was weak and therefore the Chinese economy was stagnant. This implies that the so-called economic boom of the Qing state was a foot of clay. As Debin Ma mentions, such a weak state and

Table 3.7 Taxes levied in Kangxi *dīng* registers and Qianlong Canton Customs

<i>Year</i>	<i>Tax in the dīng registers [silver liǎng 两]</i>	<i>Tax in Canton Customs registers [silver liǎng 两]</i>
1673	491,310	
1757		325,320
1758		370,037

Source: RUCL, Rare Book Collection, *Zhongguo Difang Zhi*, Guangdong province, from Kangxi reign. FHAC: Zhu Pi Zou Zhe (hereafter ZPZZ), 04-01-35-0331-002

low administrative capacity had consequences for the long-run economic divergence between China and northwestern Europe. In particular, in light of the inefficient Qing institutions and bureaucracy, the fiscal system and state capacity should be re-evaluated (Ma and Rubin 2019: 279). China had the conditions to develop faster than its European counterparts but the high concentration of power, the institutional constraints with the multiplication of inefficient bureaucracy, the extra-legal taxation system, corruption practices, and an asymmetric system of information between provinces and the central government were endogenous factors that pushed back the economic development of China.

In 1772 (Ho 1959: 47) the quinquennial *dīng* assessment was eradicated. In central, western, and southern provinces (see the data from Fujian and Guangdong provinces, Tables 3.3, 3.4, 3.5, and 3.6) accounting the population was still done arbitrarily. The long distance from Guangdong and Fujian provinces to the capital in Beijing, as well as the robust and increasing individualism of southern communities and families more orientated towards business and capital (silver) accumulation, which was more profitable, were determinant factors that contributed to corruption of the personnel and officials in provincial and local administration.

Qianlong realized that the [*bǎojiǎ* 保甲] system was not being thoroughly performed in the whole territory of the Middle Kingdom. Some measures were implemented to determine the real population of the empire, but as it is shown in the data presented in this section, such decrees and intervention of the government was not entirely successful as data were still falsified by officials. The goal was to register local population. However, the personnel and officials employed in this system were underpaid and these officials had to act not only as supervisors to register population but also as local police which worsened the performance of their duties (Ho 1959: 48).

The inefficiency of this system, which shows the low capacity of the Qing state, changed alongside with the socio-economic and political circumstances and strategies of the government. It is therefore proven in this section that across provinces, prefectures, and counties, as well as time spans, there existed a profound heterogeneity in the quality of the local accounts to register population due to the complex alliances between socio-economic and political forces (Brandt et al. 2014) and

the difficulties of the central government in consolidating its power in long-distance localities. In the last quarter of the eighteenth century falsifications were still made. Qianlong's prestige and authority declined as he failed to manage and administrate government resources such as the work of provincial and local officials to record accurate population returns. This demonstrates that during the second half of his reign the economic condition of the nation started to deteriorate, being a long-term process of decline that had started earlier at the dawn of the eighteenth century.

The asymmetry in receiving information and communication from the highly centralized and political structure derived from the newly incorporated regions in the Qing expansion (Spence 1990) caused an endogenous problem in the fiscal capacity of the state, affecting its governance in the long term (Ma 2014: 485). The empirical evidence of the Local Gazetteers demonstrates the low capacity of the government to register population and levy taxes through an efficient system.⁶ This explains why the Qing government's tax revenue was not so high. This finding differs to some scholarship's (Wong 2012; Rosenthal and Wong 2011; Pomeranz 2000) belief that light taxation was due to the benevolence of the government following the Confucian rules of the good sovereign. In fact, the Qing emperors, mainly in the eighteenth century, were characterized by their interventionist rules and decrees whose aim was to consolidate their absolute regime and maximize their power and monopoly rents.

⁶Nominal Qing China's revenue (in silver units) was larger than those from the European or Ottoman states in the seventeenth and eighteenth centuries due to the size of China's population after the Qing expansion. But in real per capita terms, tax revenue was the lowest (Ma 2014: 488–489; Allen et al. 2011; Karaman and Pamuk 2011).

Open Access This chapter is licensed under the terms of the Creative Commons Attribution 4.0 International License (<http://creativecommons.org/licenses/by/4.0/>), which permits use, sharing, adaptation, distribution and reproduction in any medium or format, as long as you give appropriate credit to the original author(s) and the source, provide a link to the Creative Commons license and indicate if changes were made.

The images or other third party material in this chapter are included in the chapter's Creative Commons license, unless indicated otherwise in a credit line to the material. If material is not included in the chapter's Creative Commons license and your intended use is not permitted by statutory regulation or exceeds the permitted use, you will need to obtain permission directly from the copyright holder.





Silver, Rogues, and Trade Networks: Sangleyes and Manila Galleons Connecting the Spanish Empire and Qing China

This chapter examines the structure of trade in the South China Sea region through an analysis of merchant networks operating in this geographical area. Trade networks were long-distance partnerships that changed over time after the early arrival of Spanish and European missionaries to the Philippines, Macao, and Canton. The extent and complexity of the traders' operations and the brokerage system that integrated East Asian and European markets can be defined as early globalization, a kind of market integration ongoing before the 1820s' price convergence that conventional scholarship has used to date globalization.

The circulation of global goods in both Asian and Western regions, the intermediation of commercial agents through the *commenda*, and the creation of unofficial institutions in the unregulated market of the South China Sea stimulated the creation of dense trade networks where information, trust, loyalty, and territorial belonging were the key elements shaping the durability and sustainability of such networks.

The role of *sangleyes* (Chinese traders in the Philippines), acting as main trade agents connecting Manila with south China and the Americas through the Manila galleons and exchanges of American silver for Chinese goods, will be deconstructed and fully reexamined. Strong and intricate coalitions between the *sangleyes*, Hong merchants of Canton, and European traders demonstrate that both the Qing and Spanish empires had weak state capacity in regulating long-distance trade and accumulation

revenues through maritime trade taxes. Seville and Marseille in western Mediterranean Europe and Macao and Canton in south China were the main nodes of this unregulated trade that operated through smuggling activities, bypassing state control, and ineffective mercantilist rules and decrees.

4.1 NEW COMPARISONS THROUGH THE MINING OF NEW HISTORICAL DATA: THE GREAT DIVERGENCE THROUGH CONSUMPTION AND TRADE NETWORKS

Kenneth Pomeranz's main work, *The Great Divergence* (2000: 207), following Frank's *Re-Orient* (1998), and others in the California School such as Roy Bin Wong, Richard Von Glahn, James Lee, Robert Marks, Dennis Flynn studied why the Industrial Revolution occurred in Europe but not in China, and revisited the analysis of economic development and comparisons by focusing on Asian regions. Providing new data and comparing standards of living of developed areas in China, such as the lands of Jiangnan in the lower Yangtze Delta in Jiangsu province, and Europe (namely the Netherlands and Great Britain), Pomeranz demonstrated that some European regions had not accumulated the so-called vital advantage of the acquisition of raw materials, capital, and food supply prior to 1800. As a result, and as opposed to assumed explanations of development, some southern and central European regions were no freer of Malthusian pressures than other large economies such as their Asian counterparts.

Empirical evidence proved that the Industrial Revolution was not the outcome of European economic superiority, but rather a result of European "luck," and mainly England's fortune in establishing New World colonies that provided the energy sources and raw materials to power the revolution's early stages. Europeans experienced a similar process of development to some other regions of the world up until 1800. One example was the Jiangnan region of China. Pomeranz's research and subsequent works combined a comparative analysis, taking a purely local focus, with an integrative, global approach (Arrighi et al. 2003; Duchesne 2004; Goldstone 2008; Osterhammel 2009; Coclanis 2011). His perspective challenged the traditional and ideological Eurocentric view of Marx (1971), Weber (2001), and subsequent works of the twentieth century

(Toynbee 1934; Polanyi 1944; Braudel 1979; Wallerstein 1980; Landes 1998) that were purely based on Western exceptionalism.

Once existing along the fringes of traditional historiography, characterized by fragmented and local narratives, global history in the aftermath of the Cold War and the fall of the Berlin Wall has gained extraordinary prominence in academic research. Typically, global history has been viewed as the history of the process of globalization, with a focus on modern economic growth of developed areas (Conrad 2016; Holstein 2015). Today, however, global history is seen as an interdisciplinary approach for the analysis of global processes through contacts, connections, socio-economic, and socio-cultural similarities, as well as differences of diverse territories around the globe (Middell and Naumann 2010; Schäfer 2004).

A major pitfall in comparative, cross-cultural studies with a *longue durée* chronology is that some ambiguities and vagueness are prone to appear (Sawyer 2015; Trivellato and Heudre 2015; Armitage et al. 2015; Krishan 2014; Struck et al. 2011). Europe is deeply diverse—there are great differences in northwestern Europe between Great Britain or the Netherlands, for example. For Asia, and China in particular, the same applies if we are referring to the Yangtze region or its prefecture areas comparing to less developed regions such as Gansu, Anhui or Yunnan, but economic differences between both areas are analysed during the period of the Industrial Revolution and the mid-Qing dynasty. Some scholars have focused too intensely on the debate around the great divergence, others have jumped into conclusions about India and China having had higher economic development levels than Europe pre-1800, or have attempted to use values of GDP for the year 1BC, which seems a weak and unreliable way to measure economic growth even in 1700 (Pomeranz 2000; van Zanden and Prak 2013; Maddison 2007; O'Brien and Deng 2017; Levi 2019).

This chapter focuses on two city ports, Macao and Marseille, both geostrategic entrepôts for international trade in the eighteenth century since they represented the socio-economic nodes integrating Western and East Asian markets allowing the circulation of Western goods into south China and Chinese goods into western Mediterranean markets. Rather than peripheral economies of early modern Europe and China, these areas played a dominant role in the development of Europe and Asia as did other northwestern European countries such as Great Britain (and the British world) (Berg 2019; Washbrook 1997; Bryant 2006) and the

Netherlands (O'Rourke and Williamson 2004; Broadberry et al. 2018; van Zanden and et al. 2012; Li and van Zanden 2012).

Presenting new historical data from a wide variety of communities, villages, regions, and polities, collected through emerging digital tools, moves away from core or central economic areas and offers a polycentric approach when comparing East Asian, European, and American regions (Perez-Garcia 2018; de Sousa 2019; Cao and Flynn 2019; Ibarra 2017; Nakajima 2018; Hausberger and Ibarra 2018). This more holistic view of the world economic system (Frank 1998) seems to be a more accurate scale of analysis than big observations about nation-states.

Using findings from the GECEM Project Database, I focus on trade networks and the consumption of Chinese goods in western Mediterranean Europe (silk, tea, and porcelain), through the economic axis Marseille-Seville.¹ European goods (tobacco, wine glasses, clocks, mirrors, wines, and liquors) (Perez-Garcia 2019) were introduced into south China through the trade hub of Macao-Canton, which was connected to the Iberian empires via the Manila galleons. While using a comparative methodology I thus decentralize the core world economic zones and analyse global conjunctures through regional cases.

By and large, scholarship has focused on England and its colonies, especially when looking at the development of the British empire with its strong trade orientation during the seventeenth and eighteenth centuries (O'Rourke and Williamson 2004; Brewer 2010; Broadberry et al. 2017). It was a society of traders and consumers, and since the mid-1970s economic historians have concentrated their explorations on the British world searching for the roots of the consumer society. England could be identified as a nation of wholesalers, retailers, peddlers, and consumers. The new consumers, largely the urban elites or middle classes, desired and sought out colonial goods such as tea, sugar, or tobacco. This demand spurred the proliferation of networks of retailers and shops in eighteenth-century England (Fairchild 1993).

In particular, Neil McKendrick led economic historians in the search for the birthplace of the consumer revolution during the first Industrial Revolution. The 1980s saw increased historiographical interest in finding the origins of mass consumer societies, and England, as the centre of

¹For more detailed information see GECEM Project (*Global Encounters between China and Europe: Trade Networks, Consumption and Cultural Exchanges in Macau and Marseille, 1680–1840*), www.gecem.eu.

the economic world during the early modern period, was the pivotal axis of historical analysis. The main features of the so-called “open societies” were changes in patterns of consumption that fostered economic growth and new technological changes, where consumer motivations to acquire new goods, market integration, the creation of new fashions and tastes, and an increase in disposable income to spend on luxury goods (i.e. goods not intended to cover basic necessities) all occurred (McKendrick 1982).

During the period of global economic expansion of European regions, consumers and traders of Chinese goods had fostered market integration with East Asia since the sixteenth century. There is a solid scholarship analysing the impact of Chinese goods in Europe (Braudel 1992; Batchelor 2008; Perez-Garcia 2013; Gerritsen and McDowall 2012; McNeil and Riello 2016; McCants 2018; de Vries 2008), as well as that one which studies the arrival of Europeans to the Americas and East Asia during the sixteenth century (de Sousa 2019; Oka 2018; Nakajima 2018).

While in Ming and Qing China there was no consumer revolution on the same scale as in Northern Europe (namely London and Amsterdam), changes in patterns of consumption did gradually occur in late Ming China due to the introduction of American crops (sweet potato, potato, corn, chili) (Perez-Garcia 2018; Ho 1979; Elvin 1973), the increasing demand for American silver through the Manila galleons (Von Glahn 1996; Irigoien 2009; Flynn and Giraldez 2010) (connecting the Spanish trade in Manila with south China), and, later in Qing China, the introduction of goods such as clocks, mirrors, European wine and liquors, and tobacco. These latter commodities changed fashions and, in turn, lifestyles among the Chinese elites.

A key issue to unveil is observing the flows and channels of distribution of goods and its impact in the seventeenth and eighteenth centuries with the arrival of the foreign (non-Han) Qing dynasty to the Beijing Court. The same can be applied to the Spanish empire when the Iberian Union of Crowns came to an end in the mid-seventeenth century with the arrival of the French dynasty, the Bourbons, to the Spanish throne in the early eighteenth century. Both the Qing and Bourbon dynasties implemented stiff mercantilist rules aiming to control trade and the economy. A relevant question is to analyse the real effect of these policies on the socio-economic and political agents and whether a centralized power and autocratic regime had a reverse impact on the economic development

fostering the rise of unofficial institutions to bypass the rigid government regulations.

There were convergences and regional differences up to the eighteenth century, and Macao, connecting with south China, and Marseille, in Mediterranean Europe, can both be defined as transnational and transcultural sites due to the international trade communities that settled in those areas. Macao and Marseille were geostrategic sites as their privileged location in the South China Sea and Mediterranean Sea, respectively, allowed them to develop trade links with other surrounding ports and external areas for international trade and distribution of commodities. Marseille was the transnational entrepôt that connected Europe with Asia through the Levantine routes, mainly through the trade activities of Aleppo and Armenian merchants from New Julfa (Aslanian 2011). Marseille also had links to western Mediterranean commerce through Seville-Cadiz as the main point of entry for Asian goods into Europe. Macao was linked with the West via the commerce with India and also through the Manila-Acapulco galleons.

This new case study comparing Macao and Marseille aims to challenge the research which has treated China and Europe as a whole, without considering regional socio-economic specificities (i.e. the fact that northern Chinese markets and trade groups had a different way of working to those in southern China, mainly in the areas of Guangdong and Fujian; and the same was true between northern and southern European markets) (McDermott 2013; Ma and Yuan 2016). Such territorial holistic and homogeneous schemes and frames of analysis go hand-in-hand with national historical narratives whose objective is to reconstruct and present the exceptional or hegemonic position of the European leading economies during the period of the first Industrial Revolution.

Looking at Macao and Marseille, two port cities located on the peripheries of China and Europe, allows us to accurately observe how changes in consumer behaviour, prompted by the intermediation of traders, were correlated with economic growth and how the state bureaucracy and mercantilist policies facilitated or impeded the circulation and entry of overseas goods. The common features shared in both areas is the cross-cultural trade that stimulated local economies, the internal organization of trading families, as well as the assimilation of different cultural forms. Within this context some concepts such as trust, loyalty, and mediation, which strengthened international trade networks, were vital in these heterogeneous groups. The analysis of patterns of consumption, as well

as possible differences and similarities among these groups, can give us a full view of the transmission of cultural values by these transnational communities. Investigating the introduction of Chinese goods into Europe and Western goods into China might allow us to better observe the process of socio-economic and cultural assimilation. The main mediators for such processes of socio-cultural transfer through the consumption of new goods were the groups of merchants defined as “vicarious consumers” (Perez-Garcia 2013) who stimulated new cultural practices, business intermediation, and social habits in the territory they settled in. Merchants were at the centre of this intricate map of connections. They were agents in the distribution, marketing, and selling of goods, stimulating the demand for new goods and creating new needs, not only in the upper social ranks but also among ordinary people.

The analysis of socio-economic transfers and the acquisition of new cultural forms between regions of south China and western Mediterranean Europe, through the economic circuits of Macao and Marseille, might allow us to better understand the connections and global encounters in between far-flung regions. During the early modern period, mainly in the eighteenth century, markets tended to be integrated on a global scale, and the analysis of such connections at a regional level might allow us to identify possible divergences and/or convergences.

The empirical grounding we can gain by cross-referencing European and Chinese sources might help to illuminate the global process of economic development between a specific territory of China, with the case study of Macao, and its European counterpart, Marseille. Therefore, such specific analysis is based on a *jeux d'échelles* [game of scales], from a micro perspective (Revel 1996; Haupt and Kocka 2009), by analysing trade networks, to a macro perspective, by taking global markets and goods as the main axis of comparison. This approach will help us surpass the conventional division between rich and poor or developed and underdeveloped countries, providing a new case of two different models of development, and how trade networks and merchants shaped cultural models, changed consumer behaviour, as well as political and economic institutions. Thus, key issues in the debate on globalization are being addressed, as new forms of globalization contributed to transform fashions and channel new cultural identities beyond traditional economic models of interpretation (O'Rourke and Williamson 2004).

Instead of looking at this issue from a Eurocentric view (Frank 1998), the focus is based on analysing and discussing the interactions between the

main social agents such as consumers, travellers, traders, and the objects themselves. These were the principal socio-economic and cultural mediators in the process of changing tastes and fashions through the circulation of commodities. Scholars of this subject have focused mainly on the analysis of Chinese objects circulating in Europe in the early globalization (Gills and Thompson 2006), but what about the chains of European goods in China? Thus, it is relevant to introduce the concept of “differential consumption” of Chinese goods in Europe and European goods in China. Establishing typologies of goods and the differentiation of consumers such as the elites and non-wealthy social groups can give us a more accurate picture of the social circulation of certain goods that were intended for luxury markets, as well as how fashions and new consumers increased the demand for such goods.

The historical sources used for this research come from the archives of Macao (*Arquivo Historico de Macao*, hereafter AHM), Marseille (*Archive de la Chambre de Commerce de Marseille* and *Archives Departamentales des Bouches-du-Rhône*, hereafter ACCM and ADBDR), and also Seville and Murcia (*Archivo General de Indias* and *Archivo Historico Provincial de Murcia* and *Archivo Historico Provincial de Sevilla*, hereafter AGI, AHPS, and AHPM). Probate-inventories, trade records, and private merchant letters are crucial evidence to shed light on: (1) changes in consumer behaviour; (2) typologies of goods introduced in south China and Europe and the global drain of American silver which was accumulated by Chinese traders and intermediaries, such as the Chinese merchants of Manila (the so-called *sangleyes*), who evaded the state supervision; (3) the identity of the consumers (elites and/or ordinary people); (4) the socio-economic agents, traders, who introduced such goods; and (5) the official and non-official trade system, and state capacity to regulate such markets. This micro-analysis, which pays attention to socio-economic agents and commercial networks as mediators in the introduction of new goods creating a new market, uncovers the micro-foundations of the great divergence. In addition, it shows how institutions and officials of the Qing state sought to create a whole economic apparatus for sustainable economic growth.

4.2 STEREOTYPES, CASTS, AND IMAGINED COMMUNITIES IN THE PHILIPPINES: THE CHINESE SANGLEYES

From the sixteenth century onwards, after the arrival of European (mainly Portuguese and Spanish) communities in south China (Macao, Canton) and Manila in the Philippines, the role of itinerant Chinese traders, the so-called *sangleyes*, is of utmost importance to understanding the influx of American silver into China, exports of Chinese goods, and imports of Western commodities. In the eighteenth century, in a description of the Philippines, Jesuit Father Pedro Murillo Velarde mentioned the transnational feature of the city of Manila inhabited by communities from territories of diverse continents. They talked in Spanish adapted to their own languages which on many occasions made the communication very difficult.²

The term *sangleyes* has proved difficult to define within the scholarship. It has been mistakenly interpreted by historians as one derived from the Hokkien language (Fujian) referring to Chinese merchants settled in Manila that came from the south China provinces of Guangdong and Fujian, who were allowed to trade in the Philippines³ (Wickberg 1964; Ollé 2002, 2018; Borrego 2016; Gil 2011; García-Abasolo 2011). Historians of the Spanish empire often and erroneously refer to the German Anthropologist Berthold Laufer's argument, who in his work *The Relations of the Chinese to the Philippines Islands* (Laufer 1907: 259) mentioned the large Chinese community in Manila from Fujian provinces (Ruiz-Stovel 2009: 56; Borrego 2016: 214).

However, Laufer does not mention that *sangleyes* is a term from the Hokkien language, and he makes a rather sloppy and vague interpretation of the works describing China by the Dominican friar Domingo Fernandez de Navarrete (1610–1689) and by early seventeenth century Antonio de Morga⁴ (1609) who was a royal official of the Spanish crown in the Philippines. Some scholars mention that the term itself might derive from Hokkienese language, *sengli*, meaning “trader,” others

²BNE, Pedro Murillo Velarde, *Geographia historica de las Islas Philipinas, del Africa y de sus islas adyacentes*, Tomo VIII, Madrid, 1752, p. 52.

³BNE, de Morga, A., *Sucesos de las islas Filipinas*, México: Casa de Geronymo Balli, 1609.

⁴BNE, de Morga, A., *Sucesos de las islas Filipinas*, México: Casa de Geronymo Balli, 1609.

suggest *shanglii*, “traveling merchants,” or *changlai*, “come regularly” (Brook 2008: 167). This scholarship has mainly taken this thesis for granted from Laufer’s work which should be deeply revised (Laufer 1907: 263).

According to Benedict Anderson, and as I also demonstrate, the Hokkien thesis for the origin of the *sangleyes* community is unsustainable as this interpretation derives from the current wave of national micro-histories that claim for the legitimation of “imagined communities” (Anderson 1988). Such imaginaries are fed by nationalism and patriotic local narratives, and “it is a lesson for our nationalistic age that neither the Spaniards nor the Hokkienese could yet imagine ‘Chinese’” (Anderson 1988: 6). The “Chinese” groups of the Ming and Qing dynasties did not describe themselves as *sangleyes* and could not portray the political landscape of the emerging nation-states of the nineteenth and twentieth centuries.

Chinese (or southeast Asian) itinerant communities, which were mainly orientated to business activities, did not refer to themselves as *sangleyes*. *Sangleyes* is a term that we only find in the Spanish manuscripts of the period (i.e. de Morga’s description of the Philippines, the *Boxer Codex*, among the most relevant), and in the Spanish historical sources of the *Archivo General de Indias* at the sections *Real Audiencia*, *Filipinas*, and in the manuscripts from Dominican, Franciscan, and Jesuit communities. In the *Ming shilu* 明实录,⁵ *Qing shilu* 清实录,⁶ or other Ming and Qing dynasty sources such as trade records and memorials of the First Historical Archives of China in Beijing, there is not any record mentioning the term *sangleyes*. The *Ming shilu*⁷ does mention the abundant number of Fujianese traders settling down in Manila, but not the term *sangleye* (Horsley 1950: 78, 186).

It was a stereotyped Western (Spanish) Catholic concept of cast (see Illustration 4.1) referring to the Chinese in Manila who were among the

⁵ SJTUL, *Ming shilu (Veritable Records of the Ming Dynasty)*, Taipei: Academia Sinica Institute of History and Philology, 1962.

⁶ SJTUL, *Qing shilu (Veritable Records of the Qing Dynasty)*, Beijing: Zhonghua Publishing Company, 2008.

⁷ SJTUL, *Ming shilu (Veritable Records of the Ming Dynasty)*, Taipei: Academia Sinica Institute of History and Philology, 1962.



Illustration 4.1 Sangleyes or Chinese Casts in the Philippines.

Source: LC, Murillo Velarde, Pedro, and Nicolás De La Cruz Bagay. *Carta hydrographica y chorographica de las Yslas Filipinas: dedicada al Rey Nuestro Señor por el Mariscal de Campo don Fernando Valdes Tamon Cavallo del Orden de Santiago de Governador y Capitan.* [Manila: Publisher Not Identified, 1734] Map. <https://www.loc.gov/item/2013585226/>

diffuse social group of traders, artisans, smugglers, and pirates or corsairs⁸ that were engaged in contraband activities making the routes from Amoy, Fuzhou (Blussé 1990), Formosa, Canton, Macao, or Nagasaki (Nakajima 2018; Boyajian 2008; Ptak 2003; Qiu 1995). This is defined as unofficial trade *nánbán* 南蛮 (southern barbarian), very well studied by Mihoko Oka who has argued that it “meant vaguely the uncivilized peoples belonging to the south of China” (Oka 2018: 163–182). The *sangleyes* might have some parallels with the term *wokou* which Oka defined as

⁸Caroline S. Hau mentions the possibility of referring to *sangleyes* as pirates, *lannang* (Hau 2003: 192; Scott 1994: 190, 279; Hau 2014: 9).

“mixed-race smugglers mainly comprising Chinese merchants” for the Japan overseas trade relations in south China (Oka 2018: 165; Borao 2005: 25–53).

Sangleyes is a transliteration in the Spanish sources of the Chinese term 商人来 *shāngrén lái* (merchant who arrives). Spanish scribes and notaries who settled in Manila in the second half of the sixteenth century did not know how to write or speak Chinese. Spanish scribes might hear about the term *shāngrén lái* referring to Chinese traders and they transliterated the term as *sangleyes*.⁹ It was likely a general term to identify merchants, mainly from other races and ethnic groups, from Chinese origins. Also, any merchant from Asian origins was labelled as *sangley* in the Spanish sources (the only historical sources mentioning this term). In the *Boxer Codex* the first allusion to *sangley* is when the author is describing the island of Brunei, its lands, its people, and how Brunei became an Islamic state circa fourteenth century under the mandate of the lord of the city Sultan Yusuf. The quote says:

“...not satisfied with this and as a young man with no other goal than to find new lands boarded all his people and sailed back through the northeast and after some days reached port in Chinese lands and requested license to stay and landed to go visit the King of China who he recognized as superior King; and the King of China confirmed him back as King, providing him of badges and weapons that today the King of Borney [Brunei] still has and seeing that sultan Yuso [Sultan Yustuf] was not married ceded him a *sangleya* [*sangley* woman] that happened to be related with the King of China. She was lordess of a city called nantay [Nantay] in the kingdom of China...”¹⁰

In their transcription and translation of the *Boxer Codex* from Spanish to English, George B. Souza and Jeffrey S. Turley, likely echoing previous

⁹From the sixteenth century onwards, we have many examples in the Spanish sources for such transliterations of Chinese terms. *Champan* 三板 [*sam pan*] refers to a variety of Chinese and Japanese fishing ship that was often mentioned in the Spanish early modern historical sources. Such term is frequently mentioned in the sources of the *Archivo General de Indias* in the catalogue of the Philippines related to commerce of East Asian ports such as Nagasaki, Canton, Macao, or Manila, among others.

See *Diccionario Marítimo Español*, José de Lorenzo, Gonzalo de Muga, Martín Ferreiro, 1865. According to this dictionary, this word was designated for vessels, 三板 [*sam pan*], whose meaning is “three thick planks.”

¹⁰Indiana University Digital Library (hereafter IUDL), *Boxer Codex*, [manuscript], ca. 1590, f. 74v.

interpretations such as Laufer's and others, mention that *sangley* is a transliteration from Chinese 常來 *cháng lái* meaning "frequently come" and it was used "for Chinese visitors or settlers in the Philippines, primarily but not exclusively from Fujian" (Souza and Turley 2015: 402). The quotation above portrays a sort of fictional story relating the myth of the Muslim Brunei Sultanate and its relationship with the emperor of China who gave to the sultan a *sangley* woman [*sangleya*] as a wife. The passage mentions that this woman was a relative of the emperor of China and she was the ruler of the city of *Nantay* (the Fujianese city of Quanzhou according to Souza and Turley (2015: 402, 403). This proves that the manuscript itself does not mention any passage that explicitly states that *sangley* is a word from Hokkienese or the origins of the term that the above-mentioned and ongoing historiography (Crossley 2016) keeps repeating without any solid foundation and deep analysis of the term and historical context.

Also, the Spanish Augustinian friar Martin de Rada (1533–1578) mentioned in his description of China that the indigenous people of the Philippines islands "call China *sangley*, and the Chinese merchants themselves call it *zhonghua*" meaning "middle kingdom" (Souza and Turley 2015: 559, 560).¹¹ According to Charles Boxer, many names were used to refer to China, or the kingdom of Cathay as Marco Polo called it, and Chinese communities were corrupted from southern China languages (i.e. Hokkienese or Cantonese). People from Burney [Brunei] were also called Chinese by natives of the Philippines (Souza and Turley 2015: 560, 561; Boxer 1953; Boxer 1968).¹² This does not make any sense and according to Boxer there were errors in the transcription and copies of Rada's work and subsequent descriptions and views by Spanish friars and travellers in the Philippines.

The misinterpretations around the *sangleyes* mainly stem from Spanish (Santamaría 1966; Folch 2002; Ollé 2011; García-Abasolo 2011), Chinese (Hu-DeHart 2013), and Taiwanese¹³ scholarship. Rada had an incomplete image of China (Sola 2018: 176) and created a view and

¹¹ IUDL, *Boxer Codex*, f. 213r., f. 213v.

¹² IUDL, *Boxer Codex*, f. 213v., f. 214r.

¹³ Here I just mention some works of Taiwanese scholarship which proves the incremental and shallowness of the ongoing research in this topic (Li Yu Zhong 2001: 31–48; Fang Chen-Chen 2010: 146–198, 2017: 179–227).

opinion of Chinese society with the aim to project a distorted imaginary (Gruzinski 1988, 2014) to ecclesiastic and civil officials of Spain in the context of Catholic Counterreformation and Inquisition prosecutions. This imaginary and idealistic view was also portrayed in the *Boxer Codex* which described the rich lands and peoples of the Philippines and nearby regions such as China.

The economic crisis at the end of the reign of Philipp II and at the beginning of Philipp III is a plausible thesis to explain the detailed accounts found in the *Boxer Codex*. The goal of the *Codex*, written at the end of the sixteenth century under the administration of Luis Pérez Dasmariñas, Governor General of the Philippines, was probably to convince the authorities, and the king himself, of Spain's need to extract revenues from the rich lands and economic resources of the Philippines and East Asia in a period in which the Spanish monarchy was in bankruptcy (Elliott 1986, 2002; ; Yun-Casalilla 2019; Lynch 1994). One of the illustrations of the *Codex* (see Illustration 4.2) portrayed a married couple of *sangleyes*,¹⁴ which the manuscript describes as rich kings from Cathay (the middle kingdom). *Sangleyes* were mainly merchants and not the sort of nobles or aristocrats as the image portrayed, probably echoing the image of the elites and nobility of Spain. This was likely an unreal image, then, but one with the aim of persuading local authorities of Spain to maintain the *presidios*, *encomiendas*, and colonial institutions of the Philippines, to extract potential economic benefits.

Beyond the etymological meanings and historiographical disputes such denomination had a socio-cultural connotation as a way to refer to a non-Catholic community which was very common within the context of pure blood in the Iberian empires when new colonies in the Americas and Asia were incorporated into the Iberian kingdoms. The conversion to the Catholic faith of peoples and native American and Asian communities that had a lower social status according to doctrines of the European Counterreformation was the main goal of the Spanish settlers in the Philippines. This is the more plausible thesis as it was the Spanish who referred to the Chinese communities as *sangleyes* that should be Christianised (Horsley 1950: 106, 107, 108). A different issue is the vernacular language these transients and migrants from Fujian and Canton spoke when settled in

¹⁴IUDL, *Boxer Codex*, f. 204r, f. 222r.-227r.

Illustration 4.2

Couple of Sangleyes as
in the *Boxer Codex*

Source: IUDL, *Boxer
Codex*, f. 204r, f.
222r.-227r



the Philippines by the “population that the Spanish called the *sangleyes*” (Klötter 2011).

Therefore, it is plausible that the term *sangleyes* was aimed to stereotype a native community that should be converted to the Catholic faith, as well as to the customs and traditions of the Spanish crown. They were stereotyped in the same way as the native communities of the Americas, the “*indios*” [Indians], who were converted by the Spanish conquistadors. In 1594, a royal order was delivered to the governor of the Philippines Gómez Pérez Dasmariñas to report and provide a remedy to the affronts and insults the “*indios sangleyes*” [Indian sangleyes]¹⁵ received after arriving in Manila from China to engage in trade and business.

In 1582 friar Juan Bautista, vicar of the village of Miton (Philippines), wrote a letter to Domingo de Salazar, the bishop of the Philippines,

¹⁵ AGI, Filipinas, 339, L. 2, f. 55r-56r.

regarding the grievances the *sangleyes* received who came back without any will to settle down in the village of Miton. In the letter Bautista expresses his frustration in dealing with the *sangleyes* as he did not understand their language (Chinese) and he also mentioned the complex interactions with the *sangleyes* community orientated in business and how they enslaved their own people for their business. The letter reads:

“I attempted to bring up what your eminence sent me from the *sangleies* [sangleyes] directly and I have to sincerely say that after giving much thought to it for another couple of hours thanks to the naughty youngster that also is unable to understand a thing I asked since after twenty times [many many times] I asked they answered differently—they are *indios* [Indians] after all and that until I was able to find out the real amount they all screamed around saying that 400 *pesos* they had paid taking the cargo because they had paid forty men at ten *pesos* each but I found out that they did not pay 140 because the men that went were thirty five rented men that were not paid more than seven *pesos* of those twenty or twenty four. The rest were slaves and servants [*esclavos y criados*] of the same *sangleies* because who had men to give gave no money. In reference to the depopulation of Indians in this land the *sangleies* I have asked ship captains to bring more people to live there a captain responded that he had brought fifty, another that he had brought twenty, and another one forty, all of them with the aim of settling here. My calculations are that a bit more than two hundred, as I asked about how they were treated and I witnessed how sometimes they forced *rreos* [prisoners] and in *jornadas* [working days ...] other times harassing the rest of the *indios* as usual and particularly by buying their *mercaderia* [merchandise] at a lower price and by force the *alcaldes mayores* [mayors] and sometimes taking Spaniards to their homes and inspecting what they have under their beds and in the boxes and purses, forcing them to open the boxes and purses and buying the goods at a very low price or no price and many other things that I will list and they regretted and came back because they did not want to settle and in this town of Miton of the houses that of the ten houses that there were now there are six empty and from these houses around eighteen or twenty people *indios* and two or three years approximately fifty people that were living here and wanted to settle and in the words of all of the people living in Miton there are around three hundred *indios*, men, that are missing and complain about many other things I could say ... In Miton, today Tuesday of 1562.”¹⁶

¹⁶Translation from Spanish to English, keeping original narrative as literal as possible. AGI, Filipinas, 84, n. 26.

Such misinterpretations of the lands of the Middle Kingdom and its people by the early arrival of the Spanish Augustinians and Dominicans were likely a product of the project of evangelization and socio-economic and political domination of new lands under the reign of Philip II. The above manuscripts and descriptions of China and the East Asian lands showed that there was a lack of knowledge and adaptation by the European (mainly Spanish) newcomers. It was not until the arrival of the first Jesuits to China in the last quarter of the sixteenth century when we find a more accurate view and description of China through European eyes as they were the best learners of the Chinese language and Jesuits also created the more accurate dictionary from Chinese to Latin. This broke down the stereotypes and distorted images constructed by Dominicans, Augustinians, and Spanish conquerors.

There is not any similar reference, as in the way we find in the *Boxer Codex* and other manuscripts, about *sangleyes* in the Jesuit manuscripts of the late sixteenth, seventeenth, and eighteenth centuries. The French Jesuit Jean-Baptiste Du Halde (1674–1743) known in Chinese as *Dù Hédé* 杜赫德 prepared the *Description de la Chine* in 1735, one of the best encyclopaedic works on China about the culture, society, politics, economy, and history of the Middle Kingdom. There is not one mention about the term *sangleyes* in Du Halde's work, which demonstrates that the term *sangley* is a Spanish construct. The accuracy of Du Halde's work is seen in his precise description of Chinese silk and porcelain production,¹⁷ and local producers of these commodities in Europe used his work to discover the secrets of production of these highly appreciated Chinese goods.

The arrival in Asia of the first Jesuit, San Francisco Xavier, founding member of the *Societatis Iesu* in 1552, and thereafter, Father Matteo Ricci in 1583, and his fellow Jesuits meant that knowledge of Asia and China in Europe became much improved (Meynard 2006). The number of Jesuits from different European territories who came to China increased from the end of the Ming dynasty until the mid-Qing dynasty, with the main countries of origin being Portugal, France, and Italy (see Table 4.1).

¹⁷The Beijing Center of Chinese Studies Library (hereafter TBCL), Rare Book Collection: Jean-Baptiste Du Halde, *Description Geographique, Historique, Chronologique, Politique, et Physique de l'Empire de la Chine et de la Tartarie Chinoise*, vols. 1–4, Paris: P.-G. le Mercier, 1735.

Table 4.1 Origins of Jesuits settled in China (1552–1701)

<i>Origin</i>	<i>No. Individuals</i>	<i>%</i>
Belgium	11	5,44
Chinese	10	4,95
Dalmatian	1	0,49
Florentine	1	0,49
French	49	24,25
German	13	6,43
Spanish	5	2,47
Italian	32	15,84
Portuguese	64	31,68
Macanese	2	0,99
Navarra	1	0,49
Neapolitan	2	0,99
Piedmontese	1	0,49
Palermitani	1	0,49
Polish	3	1,48
Sicilian	5	2,47
Tunkin	1	0,49
Total	202	100

Source: Author's own elaboration using data from the Matteo Ricci Institute of Macau/Archivum Romanum Societatis Jesu (hereafter AMRIM/ARSJ), Japonensis Sinica [hereafter Jap.Sin.] 187, Epistola Sinarum, folio (hereafter f.) 3-5v

Their main aim was to organize the Catholic missions in different provinces (see Map 4.1) serving as the main agents of cultural and socio-economic exchanges between Europe and China. Such exchanges were presented in the form of the introduction in China of Christian values and the adaptation to Chinese beliefs and ethics such as Confucianism (Meynard 2015), Taoism, and Buddhism, as well as trans-linguistic and cultural forms by which Western standards were adapted to Chinese culture (Hosne 2011; 2013). This follows the Jesuit classic accommodation method to adapt themselves by preaching in the vernacular language and learning the customs of the place where they had settled down: “*ad usum loci, in quo vivitur accomodatus*” (Muller 2016; Mungello 1989; Elison 1973).

Ricci when arrived in China at the age of thirty years old, he was calling in Europe for priests that should be men of “good,” but also men of “talent” (Latourette 1929: 83). Jesuits also acquired a Chinese name as a sign of adapting to the culture and habits of the unknown Far East

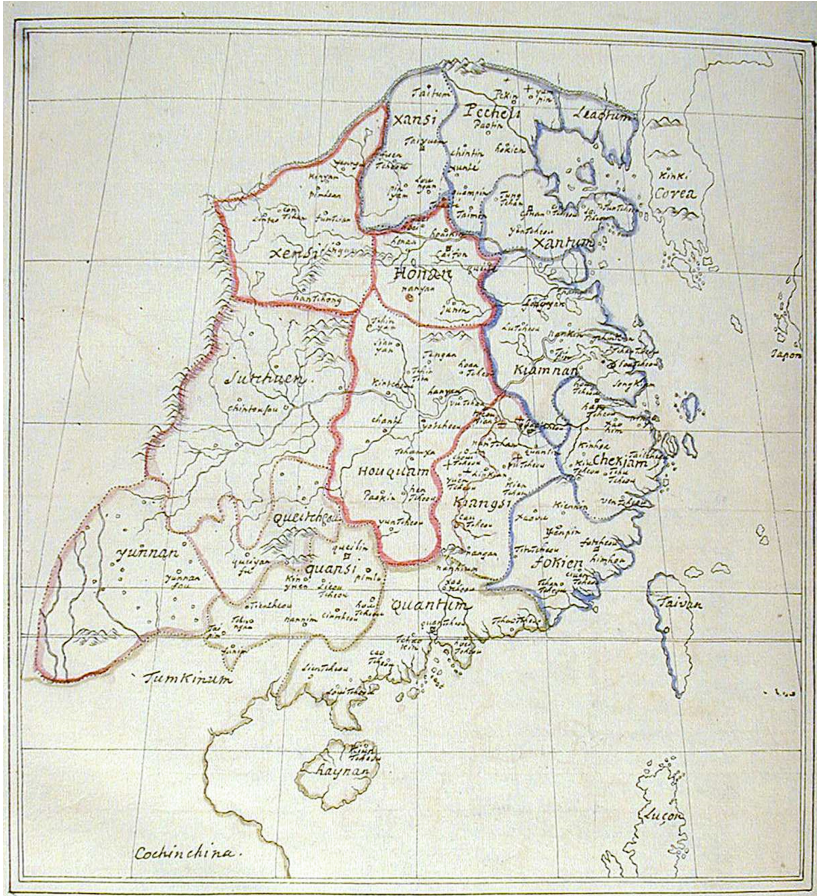

Map 4.1 Organization of Jesuit Missions in Ming China

Source: AMRIM/ARSJ, Jap.Sin. 181, Epistola Sinarum, f. 001

world (Menegon 2009; Standaert 2001; Spence 1985). For instance, the surname of San Francisco Xavier was *fām* 方, the name of Father Matteo Ricci (1552–1610) (Meynard 2013) was *Li Mǎdòu* 利玛竇, and Father Michele Ruggieri (1543–1607) was known in China as *Luó Míngjiān* 罗明坚.

Thus, they were the first to romanize the Chinese language by creating the first Sino-Japanese-Latin dictionary (see Illustration 4.3). Some examples of this process of romanization from Chinese to Latin can be observed through words such as heaven “*caeli*,” 天 *tiān*, and they wrote “*thier*,” which means that they were adapting the dictionary more to the phonological features of the Mandarin dialect of the late Ming dynasty. The dictionary was not based on the northern Beijing dialect, being likely

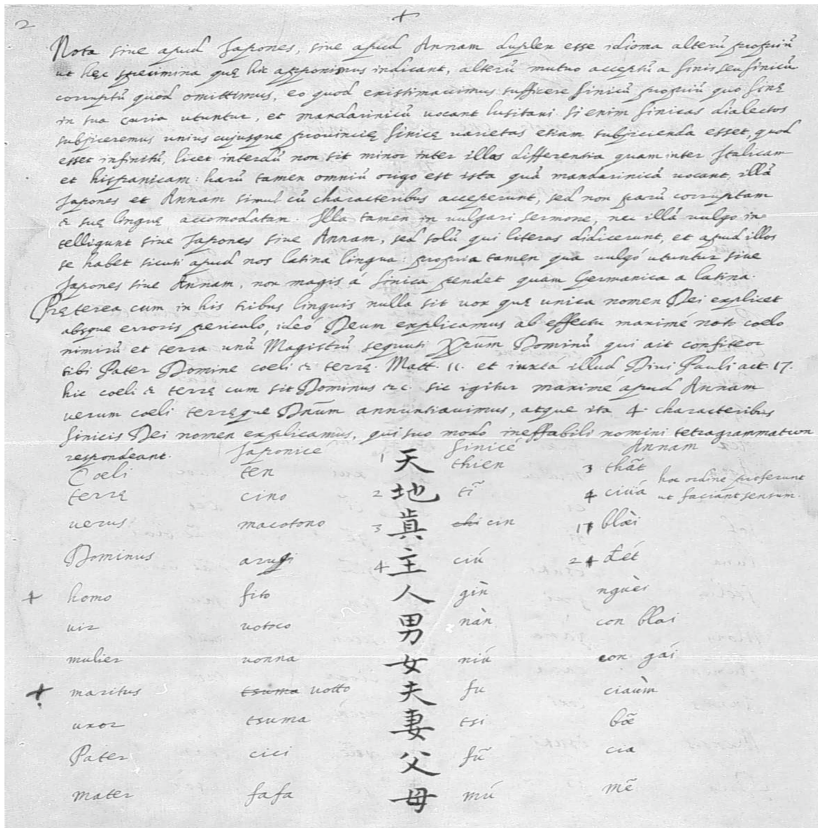

Illustration 4.3 Preparation of a Sino-Japanese-Latin dictionary by Ruggieri and Ricci, circa 1583–1588

Source: AMRIM / ARSJ, Jap. Sin. 187

more based on the dialect of Nanking and its surroundings Ricci and Ruggieri also prepared a Sino-Portuguese dictionary between 1583 and 1588 (Witek 2001: 208–209).

4.3 SANGLEYES AND EUROPEAN NETWORKS IN MACAO AND MANILA: DECENTRALIZING THE SPANISH AND QING EMPIRES

The process of evangelization carried out by the Augustinians alongside the Spanish monarchy's economic project in the Philippines were reminiscent of the strategies involved during the Spanish reconquest of the Moors; land occupation, repopulation, and establishment of institutions and integration of peoples of non-Catholic faith (Perez-Garcia 2020; Ruiz 2004; Herzog 2015). Similarly, as in the territories of Spanish America, the Crown established the *encomienda* system in the Philippines, endowing the extraction of rents, tributes, and lands to Spanish colonizers and religious orders such as the Dominicans and Augustinians.

The transfer of such benefits and tributes provided the Spanish elites and religious orders a stable source of revenue. However, as in the Americas, some difficulties were found in the *repartimientos de indios* or “the temporary distribution of Indians as a workforce for the colonizers” (Yun-Casalilla 2019: 57; Jauregui and Aguilar 2005; Parry 1990; Romano 2004), where in the case of Manila the Chinese *sangleyes* were the main workforce. This was an endogenous factor that contributed to the long-run stagnation of the Philippines' economy as it also had in the Americas (Elson 2013; Coatsworth 2008).

Spaniards often found resistance to their requests for labour and taxation among indigenous populations. Additionally, abuse within the *encomiendas* was common, as several episodes from July 1578 indicate, revealing the lack of control and poor administration by the Spanish elites and colonizers in Manila. There was the case of the *factor* [worker] of ships Andres de Mirandaola who quarrelled with Diego Lopez de Valdepeñas for the poor tax collection, accusing him of diverting the money for his own benefit.¹⁸ There were also some testimonies that the *encomiendas* of Guido de Lavezaris were misused causing great damage to

¹⁸ AGI, Filipinas, 29, n. 29.

the *Real Hacienda de Filipinas* [Royal Treasury of the Philippines].¹⁹ It was mentioned that rice from these *encomiendas* was given to the Indians of the villages of Bitis and Lubao, Chinese settlers and Philippine natives, instead of Spanish officials and soldiers, and that royal soldiers and officials had sacked much of the land.²⁰

Before the arrival of Domingo de Salazar (first bishop of the Philippines) (Gutierrez 1976) and the Governor General Gonzalo de Ronquillo's establishment of the Manila *Parian* as a place of residence for Chinese merchants in 1581 (Cervera 2015; Ollé 2008; Pastells et al. 1925; Aduarte 1640; de la Costa 1950), the Augustinians were entrusted to settle the *sangleyes* and work with them in the village named Miton (which they renamed Santa Fe). They were in charge of the doctrine of Christianity to convert the *sangleyes* to the Catholic faith as well as employing them as the main human capital to economically develop the area. In a memorial the Augustinian friar Andres de Aguirre, *padre provincial* [provincial father], wrote that:

...to convert to the Chinese that comes to trade in Manila and they have settled down there, they have been moved to a nearby place to Manila named Miton as it is called in the language of the *indios* [Indians], and a Church has been erected by two friars, but the bishop has made the proper errands to take this village for its Church. He asks to protect this village to the Augustinian Order and monastery, and to rename the village as Santa Fe, and its monastery San Felipe...²¹

Figures on the number of *sangleyes* settled in Manila are not very accurate. Diego Aduarte mentions that when the Dominicans arrived in Manila in 1587 the number of *sangleyes* settled in the *Parian* ranged from 8000 to 15,000 (Aduarte 1640: 171). From early on it is mentioned in Spanish documents that *sangleyes* were ruthless people and orientated in business and accumulating capital (mainly American silver). Local Spanish elites had serious problems communicating with them as their language was difficult to understand “*no se les entiende bien...y al fin son indios... hasta que yo trate de averiguar con todos la verdad andaban dando voces cada*

¹⁹ AGI, Filipinas, 29, n. 29.

²⁰ AGI, Filipinas, 29, n. 29.

²¹ AGI, Filipinas, 79, n. 14.

uno” [it is impossible to understand...after all they are Indians...until I found the truth with all of them they were yelling...].²²

The *sangleyes* stopped settling down in the village of Miton. The documents also show that the *sangleyes* participated in the slave trade as slave owners [*núli fànzi* 奴隶贩子] (de Sousa 2010), and that they used the “*reos*” [prisoners] as forced labour and engaged in business partnerships [*commenda*] with the captains of vessels. Spanish merchants who were bringing goods from the Americas and Spain, fostering price speculation, were also forcing the “*alcaldes mayores*” [mayors] and other Spanish officials in the Philippines to buy commodities at a low price.²³

This practice continued from the sixteenth century to the eighteenth century, being a major problem for the Habsburgs and Bourbon monarchs of Spain, as the Pacific trade, mainly Manila-Macao-Canton trade node, was the main channel that was funnelling the Spanish silver to China and away from the royal treasury of the Spanish empire whose decline started in the late sixteenth century. Regulations, royal decrees, and even building a new social archetype, the *sangleyes*, in the Spanish Asian colonies did not prevent the loss of Spanish economic resources.

One strategy that aimed to regulate the Atlantic and Pacific commerce was the loss of the monopoly trade by the city of Seville to the port of Cadiz (del Valle Pavon 2011). Such practices were consolidated from times of the Iberian Union of Crowns (1580–1640) (Schaub 2001) under the Habsburgs to the eighteenth century with the arrival of the French Bourbon dynasty to the Spanish throne. Intellectual enlighteners and ministers hoped to regulate commerce in the Pacific (Bonialian 2012) with the establishment of the *Real Compañía de Filipinas* [Royal Company of Philippines] (Díaz-Trechuelo 1965) or the open-trade royal decree to open commerce in several Spanish ports in the second half of the eighteenth century.

Unregulated trade and smuggling activities were prompted by the constant drain of American silver into China, via Manila-Macao-Canton, from the sixteenth century onwards. Silver had become the standard payment for transactions and exchanges, as well as the main currency for the fiscal system, particularly since paper money [*bǎo chāo* 宝钞] had

²² AGI, Filipinas, 339, l. 2, f. 55r–56r.

AGI, Filipinas, 79, n. 14.

²³ AGI, Filipinas, 339, l. 2, f. 55r–56r.

AGI, Filipinas, 79, n. 14.

resulted in inflation and copper coin production had proved insufficient (Von Glahn 2019). Silver was introduced as the main standard after some monetary reforms were introduced by the Ming emperor Xuande in 1436 when he accepted the “Gold Floral Silver” [*jīn huā yín* 金花銀] (Huang 1974: 52; Von Glahn 1996; Twitchett and Grimm 1988). Later in the early sixteenth century the “Single Whip Reform” (Grass 2017: 7–31; Wan and Shu 2015) recognized that silver was officially and legally the main unit for transactions and tax collection. However, the Ming dynasty silver mines, located in Guizhou, Henan, Shanxi, Shandong, Zhejiang, Fujian, Sichuan, and Yunnan, as *Míng shílù* (*Records of Ming Dynasty*) reports, did not have enough production of silver.²⁴ The government had only 100,000 silver *tael* income from domestic silver mines every year (Wan 2004).

These conditions paved the way for the constant influx of American silver into Ming and Qing China. The shortage in domestic silver production could hardly meet the increasing demand, so the Ming government was forced to open maritime trade. Overall, the thirst for silver as payment and the shortage in the supply of this precious metal stimulated a rise in price. Selling silver to the Chinese turned out to be a fat bargain. With the trade surplus advantage, gross inflow of foreign silver met the growing demand for silver money in the middle and late Ming dynasty. In addition, the growing demand in the Americas and Europe for Chinese goods such as silk, porcelain, and tea contributed to the vast amounts of American silver entering China (see Table 4.2).

The arrival of Portuguese and Spanish traders to Macao and Manila was the final factor in consolidating the flow of silver from the Americas to China. Wang Yuxun points out that 1586 was a turning point in this inflow. According to his findings, prior to 1586 about 300,000 *pesos* of American silver came into China every year (Wang 1998). After that the number rapidly increased which is correlated with the settlement of Spanish colonizers and the *sangle* community in Manila. From 1586 to 1590 approximately 2,500,000 *pesos* came into China. Until the end of sixteenth century the volume of American silver in China imported from Manila amounted to two or three million *pesos*. Liang Fangzhong’s statistics shows that 6,800,000 yuan of American silver entered China from

²⁴SJTUL, *Míng shílù* (*Veritable Records of the Ming Dynasty*), Taipei: Academia Sinica Institute of History and Philology, 1962.

Table 4.2 The amount of silver from Spain-controlled Americas that entered the East via Europe, 1500–1800

<i>Year</i>	<i>Production of silver in Spain-controlled Americas</i>	<i>The amount of silver that entered Europe</i>	<i>The amount of silver transferred to the East</i>
1550	3	3	2–3
1600	11–14	10	4.4
1650	10–13	8–9	6
1700	12	10–12	8.5
1750	18–20	18–25	12.2
1780	22	18–20	14.7
1800	30	23–35	18

Unit: Millions of yuan

Source: Attman (1986, p. 33)

1721 to 1740 and 105,000,000 yuan from 1752 to 1800 (Liang 1953; Liang 1989).

Quan Hansheng (1966) surmised that from 1700 to 1830 five billion yuan [one silver yuan equals circa 0.72 *tael*] (Faure 2006, 2007: 58) of American silver arrived in China. He accepted the assumption that nearly two thirds (Attman 1986; Dermigny 1964; Chaunu 1962; Atwell 2005; Flynn and Giraldez 1996) of silver was transferred from the Americas to Manila and then finally transported by Chinese merchants (the *sangleyes*) to China via Macao, Canton, and Fujian as the main trade nodes. However, he corrected his figures in later works declaring that circa six and a half billion yuan were transferred to Macao-Canton through Manila (Quan 1969).

Almost half of the American silver was absorbed by Chinese markets in the late Ming dynasty, China being the largest silver consumer at that period (Quan 1972; Wan 2004). In this framework the *sangleyes* of Manila played a crucial role in the late sixteenth and early seventeenth-century diversion of American silver and tax revenue from the Spanish royal treasury to local traders of south China, mainly those from Macao, Canton, and Fujian. As can be seen in Fig. 4.1 and Map 4.2, a high volume of tax revenue to the royal treasury in the Philippines came from the trade with south China, especially Canton, through the licences granted to the *sangleyes*.

The data provided in Fig. 4.1—although constrained to one year—illustrates the seasonality of south China’s maritime trade due to weather

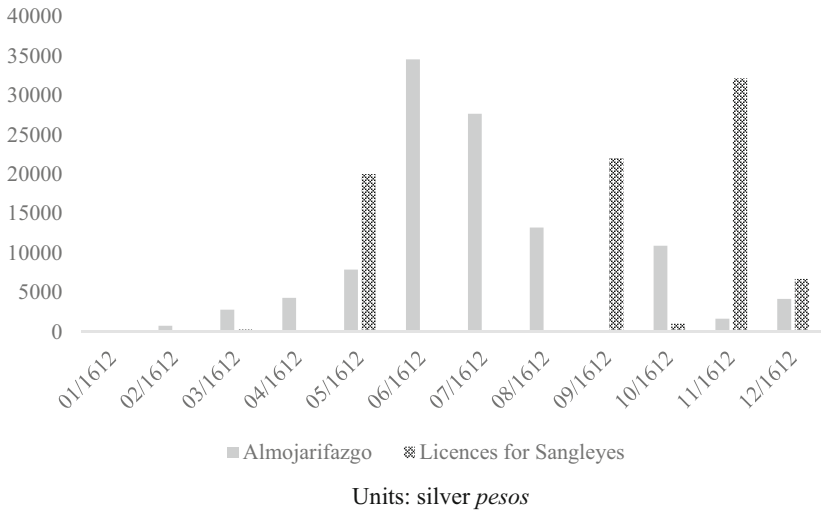
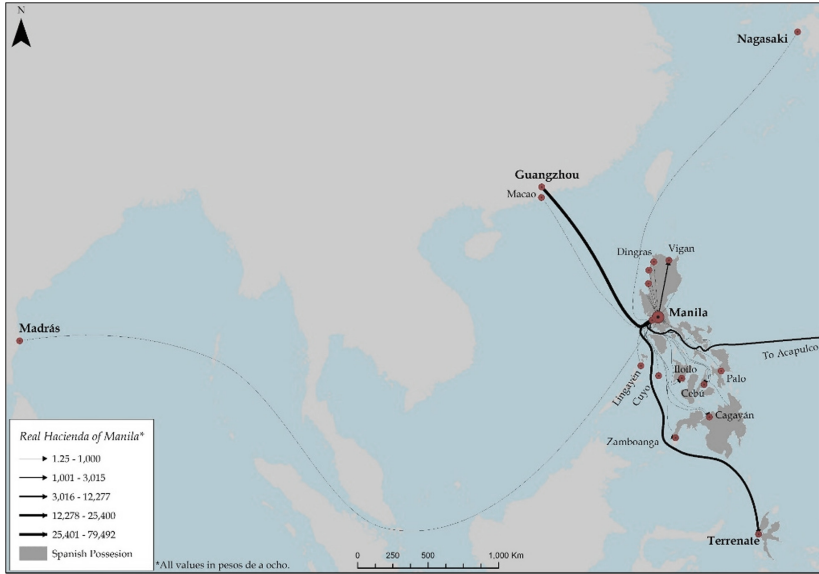

Fig. 4.1 Trade tax revenue of the Spanish royal treasury in the Philippines, 1612

Source: AGI, Contaduría, Cajas Reales de las Islas Filipinas, 1209, f. 640r.-670v

conditions, agriculture, sea-faring activities, and piracy (van Dyke 2017, 2011). The tax revenue accounts were arranged randomly according to such factors. Mark Elvin analysed the system according to the Chinese lunar calendar and defined it as “year-node divisions” related to the solar periods in which the Chinese lunar calendar is divided (Elvin 1973: 350). The licences granted to the *sangleyes*, who on many occasions were linked to smuggling and unofficial trade, accounted for a higher value than the *almojarifazgo* revenue in the autumn of 1612 (see Fig. 4.1 and Map 4.2).

Granting a higher number of licences to *sangleyes* was a way the Spanish authorities devised to somehow control and regulate trade between the colonies (the Philippines) and south China. This was a daunting and unrealistic task, as trade along the coasts of Canton and Macao and the routes connecting to Manila were rife with piracy and smuggling (Antony 2010). In practice the regulation of commerce was in the hands of the local authorities and elites of the Philippines, which acted through non-official channels and coalitions with smugglers along the Manila-Macao-Canton main trade artery connecting south China with American and European territories.



Map 4.2 Trade tax revenue of the Spanish royal treasury in the Philippines, 1612

Source: Author's own elaboration, through GECEM Project Database and Software QGIS v3.12 Base map from Natural Earth raster through data of AGI, Contaduría, Cajas Reales de las Islas Filipinas, 1209, f. 640r.-670v

This trade system that began in the sixteenth century was consolidated over the seventeenth and eighteenth centuries through trade networks and business partnerships between European, American, and Chinese merchants connecting big, medium, and small companies that shared information and capital. The main mercantile system for such exchanges was through letters of credit and contracts for American silver and goods (i.e. silk, tea, or porcelain from China, and European red wines and liquors, as major evidence I have found) enabling a third partner through the so-called *commenda* contract (Pryor 1977) in which small companies or societies were engaged with a non-official business system to ship goods and carry on transactions.

The *sangleyes* were the main agents and mediators in such exchanges since Manila was the nexus for the flow of American silver and exchange of Western and Chinese goods through the trade networks that connected

agents from several origins (East Asia, southeast Asia, the Americas, Europe) (Schurz 1939; Shiu and Keller 2007; Suarez 2018). A brokerage system was consolidated through global trade networks that were formed in local spaces connecting Europe and the Americas with the port cities of Macao, Canton, Xiamen (Amoy), Ningbo, and Shanghai (Ng 1983). The *commenda*, defined as a commercial form of cooperation, integrated several agents and transactors, pooled capital, shared risks, and investments (Reinert and Fredona 2017), as well as profits among the participant agents. Originating in medieval Europe, the *commenda* (van Doosselaere 2009; Greif 2006; Trivellato 2009; Mauro 1990) was found in Ming and, mainly Qing China, where overseas trade connecting the Pacific regions (Manila, Macao, Canton, and also Nagasaki) via Manila galleons had a high risk (among major risks were piracy, shipwrecks, wars, price speculation in south China markets, or the sudden disappearance of one of the partners or contractors). And there were other problems with this mercantile system in terms of trust and loyalty regarding the business partners as the letters they exchanged show:

...I received a letter that from Mr. Obry and which contains a bond and a certification that you gave to Mr. Bene which was given the *Sangley* of some goods of mine sold on credit. I was astonished as when I sent you a letter to the city of Mansiloc you replied me that the *Sangley* said that there were not any goods or money for me, and now I see that you have given a certification of my own goods. If I didn't see it and I wouldn't have seen it with your own signature herein, I wouldn't believe it! But I am in the obligation to believe it or explode in fury; I am grateful for the favors you have made me, and I can only say that you must remember that the mountains are not found but men do...²⁵

This letter was written by the governor of the Philippines, don Simon de Anda y Salazar in 1762 complaining to his partners don Juan Solano and don Jorge de Sanclemente who lived in Masinloc (a province of Zambales in the Philippines) about the payment of a silk cargo bought in Macao and Canton. The *sangley* merchant entrusted to carry on this business through

²⁵The original letter was written in Spanish. Herein I present the English translation for a better understanding of the reader. Archivo Historico de Macau (thereafter AHM), Catalogue of the Swedish East India Company (hereafter CSEIC) /Nordiska Museet (hereafter NM) /The Godegard Archive (hereafter GA), Series: F17, vol. 1A, vol. ID: 17:1A and vol. 1 B, vol. ID: F17:1B, Grill Letters, ref. T1_00729.

credit had delayed delivery on the goods (Chinese silks from Nanjing and Suzhou) to be resold in Marseille. Such delay was infuriating the governor of the Philippines.

Solano and Sanclemente took 500 silver *pesos* from the company, led by John Abraham Grill and don Simon de Anda, and the governor gave 91.5 pesos to the *sangle* to buy the silk manufactures in Canton and ship them to Manila to the governor who would resend them to Marseille through his subsidiary companies.²⁶ Painted silk cloaks with gold and silver embroidery with a value of 336 silver *pesos*, silk skirts with a value of 61 silver *pesos*, plus a commission of 2.5% (12.4 silver *pesos*) out of 500 silver pesos was the total amount of goods and silver. This is an outstanding example of the *commenda* form as the main business instrument undertaken by trade networks connecting China with European markets. It is also very important to mention the British blockage of the Philippines in this period that caused serious damage to the above-mentioned transactions which elevated the business risks.

The Brunet family, Nicolas de Sollicoffre (French citizen and Swedish consul in Marseille), the Roux family, and the Grill family stand out as relevant agents who created a dense trade network connecting big trade houses with subsidiary companies and individuals that had business in Stockholm (Müller 2004), Amsterdam, London, Cartagena, Cadiz, Seville, Veracruz, Lima, Acapulco, Manila, Macao, and Canton.²⁷ Financers from Marseille and Montpellier integrated local markets in western Mediterranean Europe, the Americas, and south China (Hamashita 2015) creating a non-official mercantile system that bypassed the control of both Qing and Spanish empires.

The *sangleyes* from Manila and the Hong merchants of Canton were the main business agents and partners that perpetuated this brokerage system in the eighteenth century which might be defined as an “Asian-Mediterranean brokerage system” (Perez-Garcia 2013; Gipouloux 2011). Through loans of credit and high interest rates these brokers developed

²⁶ AHM, CSEIC Series: F17, vol. 1A, vol. ID: 17:1A and vol. 1 B, vol. ID: F17:1B, Grill Letters, ref. T1_00730.

²⁷ AHM, Documentary CSEIC /NM /G, Series: F17, vol. 1A, vol. ID: 17:1A and vol. 1 B, vol. ID: F17:1B, Grill Letters, ref. T1_00734.

Archivo Municipal de Cartagena (hereafter AMC), Actas Capitulares (hereafter AcCap), 20-12-1712.

AMC, AcCap 30-12-1712.

profitable transactions by buying Chinese silk at low prices and selling it to European traders, and selling European wines and liquors at high prices in Canton markets.

The high risk behind this trade system can be observed through the debts and risks that traders settled in Macao incurred during the eighteenth and nineteenth centuries. In many cases the loans of silver reached an interest rate of 35% or even more (Ng 1983; Von Glahn 1996). The *Santa Casa de Misericórdia de Macao* [Holy House of Mercy of Macao] (Díaz de Seabra 2011; de Sousa 2019) acted as the main institution that channelized the finances and investments of the above-mentioned overseas trade covering risks. Portuguese traders (Souza 1986) issued letters of credit and loans to finance such overseas ventures. It was a very risky system, but very profitable. However, due to the main features involved in this trade such as an unregulated market, piracy, and instability caused by the British occupation of the Philippines, among the more relevant conditions, the Holy House of Mercy of Macao was in debt in the last quarter of the eighteenth century and early nineteenth century (see Fig. 4.2).

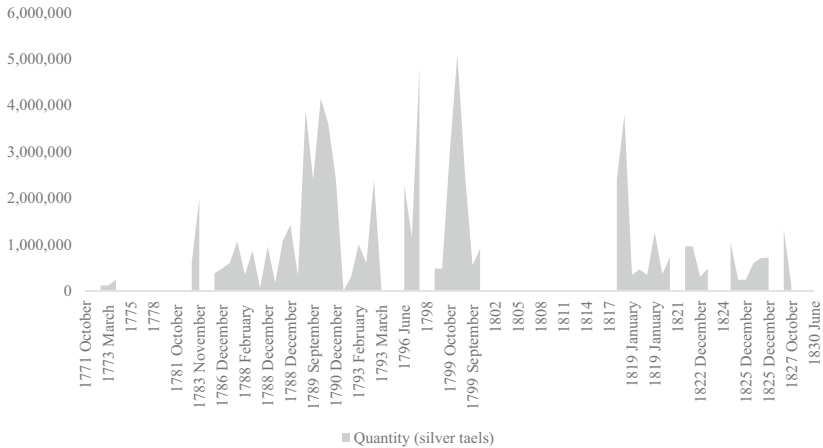

Fig. 4.2 Debts of the Holy House of Mercy of Macao, 1771–1830

Source: Arquivo Historico de Santa Casa de Misericórdia de Macao (hereafter AH/SCM) /40—‘Livro da Conta Corrente dos Mutuários: Dívidas à Santa Casa da Misericórdia (1771/10/30 a 1804/10/22)’, f. 6v.-10. Díaz de Seabra [2011]

4.4 INTEGRATING SOUTH EUROPE AND SOUTH CHINA MARKETS: THE CASE OF MACAO AND MARSEILLE

As an interdisciplinary field global studies has gained a lot of terrain during the last decade, especially with the focus on the processes of socio-cultural transfers that fostered the consumption and circulation of exotic commodities such as tea, porcelain, or ornate clothing in Europe from Asian territories, especially China and India. But what can we say about socio-cultural transfers in southern European and southern Chinese markets through new comparative case studies? Certainly, there was a progressive consolidated market for Western goods in southern Chinese provinces such as Guangzhou and Fujian, with Macao as the main entrepôt (Flores 2000), because as discussed previously American silver was introduced into Chinese markets in the early sixteenth century. This prompted a rising consumption of Western and American goods in Ming and Qing China. European colonies in Asia were the main trade nodes and arteries that fuelled exchanges of Chinese and Western commodities.

Portuguese families, as the first Europeans who arrived in Macao in the sixteenth century (Subrahmanyam 1993), created solid trade networks by being the main mediators and agents of the Jesuit (Menegon et al. 2018) and Sephardim (de Sousa 2010) groups who also interacted with the Armenian community of East Asia (Teles and Cunha 2008; Aghassian and Kévonian 1999; Curtin 1984; Disney 1989). Such groups were settled in Macao and stimulated the consumption of Western commodities as well as the acquisition of new lifestyles by spreading new cultural habits and trade exchanges. The trade routes of the Manila galleons connected with main port cities of Macao, Guangzhou, Xiamen (Amoy), Ningbo, and Shanghai (Li 2010), but also with Taiwan, Korea, Japan, and the South-east Asia region (see Map 4.3). Through such maritime trade networks in the South China Sea, goods such as tobacco, European red wines, and liquors (Perez-Garcia 2019), and American crops (Ho 1979; Perez-Garcia 2018) (i.e. potato, sweet potato, chili, corn, among others) were introduced into southern Chinese provinces through the partnership and alliances between European and Chinese trade networks.

With the potential emulation of new socio-cultural standards through consumption of overseas goods, the inherent transcultural diversity of the network might be correlated with upper stages of economic growth as factors that could transform a traditional society to an open one. Marseille



Map 4.3 Market integration between Asia, Europe, and the Americas through global silk routes, seventeenth to eighteenth century

Source: Author's own elaboration through GECM Project Database and Software QGIS v3.12 Base map from Natural Earth raster through data of AGI, Contaduría [1289], Sobre las embarcaciones entradas en Filipinas, 1646–1758; Archive de la Chambre de Commerce de Marseille (hereafter ACCM); AHM, CSEIC, Grill Letters

and Macao, located in far off regions, are the paradigmatic examples of the progressive integration of long-distance markets and the potential transformation of open societies through global trade, circulation of overseas goods, American silver inflows, and development of modern financial systems to secure economic transactions.

Merchant networks that settled their companies in the port cities of Macao and Marseille exerted an essential role in the distribution and consumption of overseas goods. Thus my analysis of these trade networks focuses on merchant groups: their transnationality, the performance of the network at both local and macro scales (Trivellato 2009; Green 2013), as well as its socio-economic mutation in the places where these

communities settled down according to factors such as trust, shared information, and partnership, all key factors to understanding the complexity of Sino-European commerce.

The most influential social actors of the Sino-European trade were the Portuguese who operated in the South China Sea with Macao as the main centre of business and economic exchange. Under the national flag of Portugal a diverse transnational group, mainly Jesuits and Sephardim (Trivellato 2003; Molho and Curto 2003), managed the network. Likewise, in western Mediterranean Europe, in Marseille, the main social groups that stimulated international commerce during the early modern period were the Armenians of New Julfa (Raveaux 2012; Aslanian 2011; Baladouni and Makepeace 1998) (see Fig. 4.3). However, with their expulsion from Marseille in the late seventeenth century they shifted their trade routes towards the Indian and Pacific Ocean through the interaction with the *Compagnie française des Indes orientales* and the *East India Company* (Carrière 1973).

Olivier Raveaux has made an accurate analysis of these Armenians who introduced goods from Asian markets, especially from distribution centres in Persia (Raveaux 2012: 86), where Chinese silks, semi-elaborated and

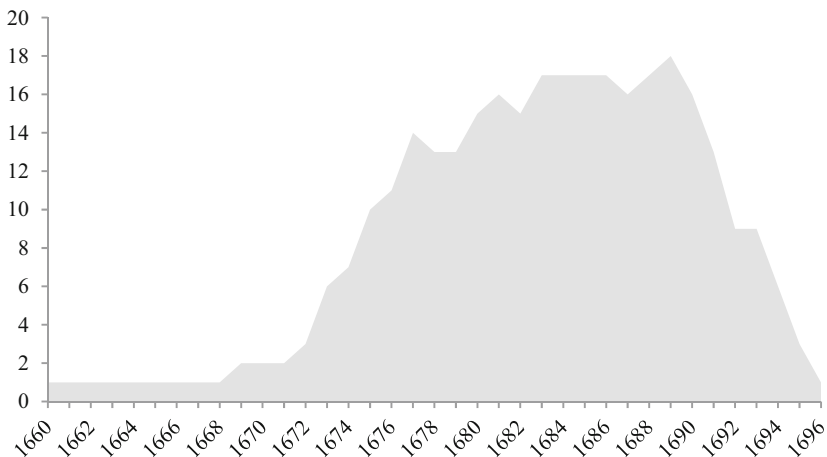

Fig. 4.3 Presence of Armenians in Marseille, 1660–1696

Source: Archives Départementales des Bouches-du-Rhône (ADBDR). In Raveaux [2012: 85, 101]

ready-made goods arrived from Chinese markets through the old Silk Road. These Armenian traders were known as *Choffelins* (Raveaux 2012: 89) since their origin was from New Julfa (Ispahan, capital of the Persia Safavid in the seventeenth century) and they were defined as itinerant merchants practising the *commenda* in the same way that the *sangleyes* and European (Spanish and Portuguese) traders in Manila, Macao, and Canton did, as discussed earlier. They specialized in the silk trade from Asia and the Levant which shows that they were key players in the redistribution and export of silks from China and Middle East Asian regions, as the mediators and main agents for this market between eastern and western regions (Aghassian and Kévonian 1999).

Analysing these inter-group relations offers a precise understanding of the internal organization of trading diasporas and merchant coalitions. The main goal of such interconnected groups was the self-interest of individual actions that can be observed in the micro and macro forms of the network itself. Through the spatiality and agency marked by the global commerce, these merchants integrated east Asian and Western markets. Thus, the geographical and spatial variables were relevant factors to observing the mobility of these groups and how Western and Eastern markets were integrated.

The Mediterranean market in the eighteenth century with Marseille as main entrepôt was connected to the Atlantic and the Pacific via the route Manila-Acapulco and Veracruz linking with Lisbon, Cadiz-Seville, Marseille, and northern markets such as Amsterdam and Stockholm (see Maps 4.3 and 4.4). Beyond the realm of the official route of the Spanish empire, Manila-Acapulco, unofficial trade and contraband operated in South American markets through the nodes Lima-Callao-Buenos Aires (Ibarra 2017; Suarez 2018; Bonialian 2012).

Marseille and Mediterranean localities were also integrated into Far Eastern markets through Indian and intra-Asian trade routes (Gipouloux 2011; Carrière 1973; Raveaux 2012; Aghassian and Kévonian 1999), with Armenian, Sephardi traders, Portuguese, and Mediterranean coalitions of merchants (i.e. French, Italian, Maltese, and Spanish, see Fig. 4.5), as well as northern European groups settled in Marseille and Cadiz such as the Grill family, all composing a transnational network that operated in a polycentric, highly decentralized market connecting Europe, Asia, and the Americas (see Maps 4.3 and 4.4). Such networks and economic agents stimulated Eurasian commerce such as the Swedish Grill company that established business in Macao and Canton in the eighteenth century (see Fig. 4.4) (Perez-Garcia 2019).

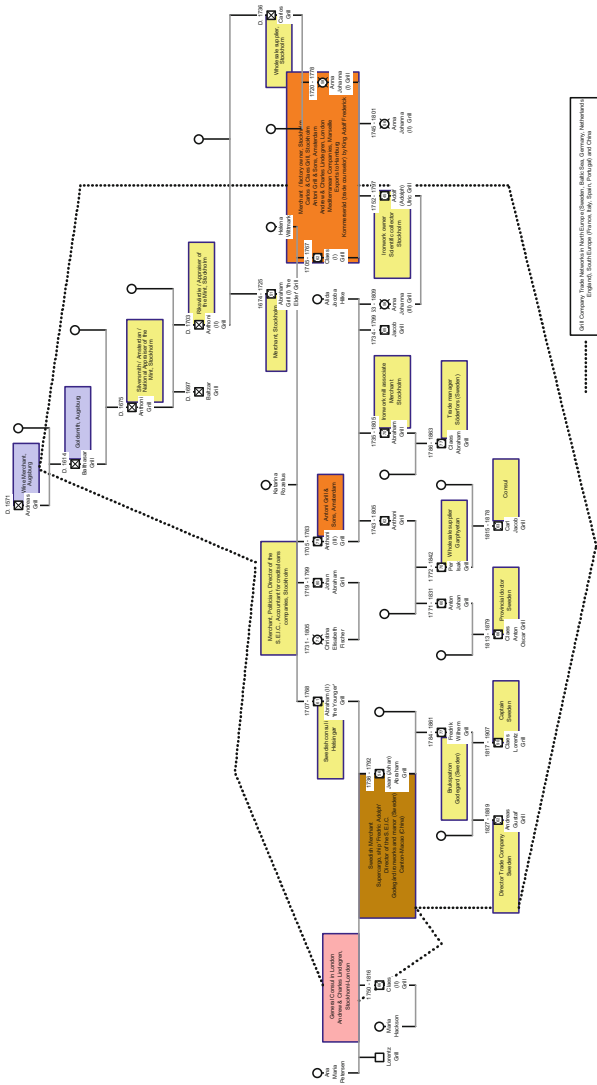
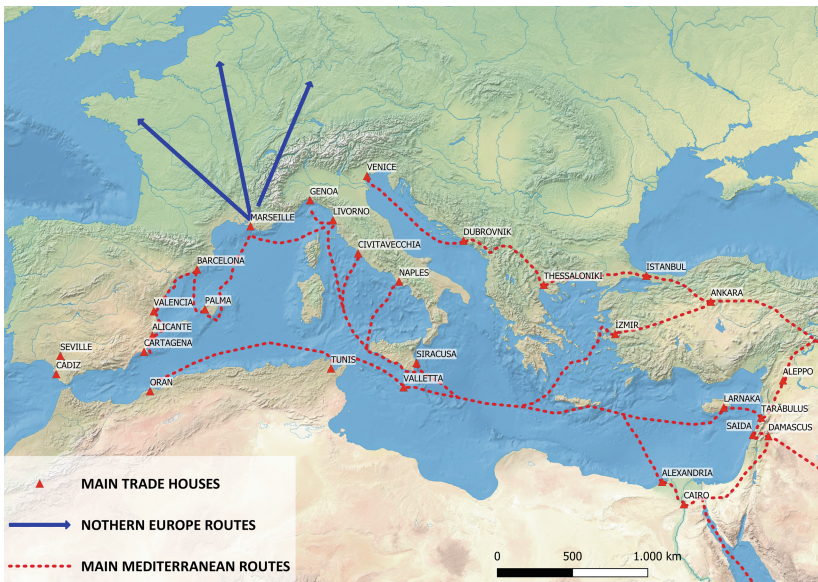

Fig. 4.4 Genealogy of the Grill Family (Garphyttan and Godegard House of Sweden) operating in Macao and Canton Markets, 1638–1907

Source: Author's own elaboration. AHM, CSEIC, Series: F17, vol. 1A, vol. ID: 17:1A and vol. 1 B, vol. ID: F17:1B, Grill Letters, ref. T1_00729 to ref. T1_00741.N.A.S., ref. SE/RA/481/01/01/D/D II dc/27, SE/RA/481/01/01/D/D II dc/27, SE/RA/481/01/01/D/D II dc/27, SE/RA/481/01/01/D/D II dc/27; Ostindiska Kompaniet dokument och personer, Brevkopierbok för skeppet 'Hoppet'. Available at: <http://www.ub.gu.se/samlingar/handskrift/ostindie/dokument/document.xml?id=23>. Grill, (1951); Müller 2004; Perez-Garcia (2019)

Itinerant merchants such as the Armenians of New Julfa, the *sangleyes* of Manila, European trade companies settled in Macao, the Chinese Hong merchants of Canton, and subsidiary companies and partners in American markets (Ibarra 2019; Bonialian 2012; Martinez-Shaw 2007; Malamoud 1986) were collectively connected with western Mediterranean traders and were the key agents bypassing official institutions. This transnational community integrated Eurasian trade arteries by land and sea connecting the Indian Ocean and the Mediterranean Sea through the routes of the Red Sea and the intra-Asian routes, the so-called silk routes via Aleppo and New Julfa (see Map 4.4) (Baladouni and Makepeae 1998; Aslanian 2011).



Map 4.4 Roux company trade houses in Mediterranean silk routes connecting Marseille with the Near East, eighteenth century

Source: Author's own elaboration through GECEM Project Database and Software QGIS v3.12 Base map from Natural Earth raster through data of ACCM

This polycentric market developed a bilateral cooperation between European companies and those that operated in East Asia, more specifically in Macao, as the main linchpin that connected Qing China with Western powers. A good example of this can be found in the coalition between the Armenian and French traders, who jointly operated in Marseille and Macao, as well as in Manila with the *sangleyes* and Spanish local elites. The effect of this decentralized and unregulated trade system boosted the accumulation of capital (American silver) by Western and Eastern traders.

The consolidation of these commercial networks stimulated in Europe, and more precisely in western Mediterranean regions, the consumption of Asian goods such as tea, porcelain, furniture, clothing, and textiles made of Asian cottons and silk. The paradigmatic example is the circulation of Chinese silks (semi-elaborated and manufactured) in western Mediterranean markets. These goods were introduced during the eighteenth century (Perez-Garcia 2013; Carrière 1973) in Marseille and from there re-exported to other Mediterranean ports such as Barcelona, Valencia, Alicante, Cartagena, Cadiz, and Seville.

The main agents for the redistribution of Asian (Chinese) silks in the western Mediterranean were transnational trade groups and subsidiary companies such as Estoup, Cayron, Martin, Bouyon, Vidal, Cailus, Dachary, Aubour, Davide, Funes, Peretti, Pericano, Peseto, Pesano, Sizilia, Socori, Sese, or Ycar (see Fig. 4.5). These small groups were dependent on the big trade houses led by the Roux or Grill family both established in Marseille. These groups created a “Mediterranean emporium” in localities of Genoa, Civitavecchia, La Valeta, Bearn, Oloron, Auvergne, Lyon, Marseille, and Cartagena, as the most relevant places that have been found in the historical sources (see Map 4.4). These trade networks consolidated connections with local and foreign elites of western Mediterranean, American, and East Asian areas (Perez-Garcia 2011; Bartolomei 2007; Buti 2005).

During the early modern period, wholesalers, small retailers, peddlers, and family groups, who mainly operated in the Mediterranean and the South China Sea such as Macao, Canton, Fujian, Manila, or Taiwan, established strategies based on marriage alliances with the aim of perpetuating and boosting business activities that provided high benefits (see Figs. 4.6, 4.7). Within this empirical evidence the nature and origin of relevant social actors and family groups that benefited from East Asian trade has been identified.

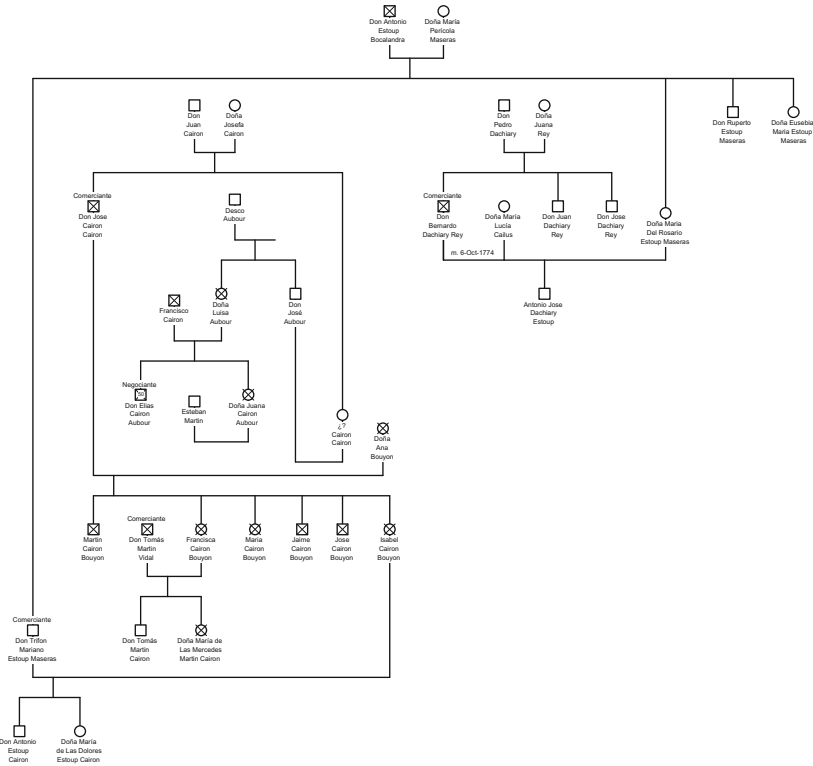

Fig. 4.5 French-Italian-Maltese trade coalitions: Genealogy of the Stoup-Cayron family, seventeenth to eighteenth century

Source: Author’s own elaboration. Protocols of the Archivo Histórico Provincial de Murcia, Spain [hereafter AHPM]

There are several examples of merchants who ran businesses in Macao (Boxer 1959; Boyajian 2008) during the seventeenth century (de Sousa 2019; Souza 1986; Bonialian 2012), such as the companies of Francisco Xavier Doutel and Luis Sanchez de Casares, who traded zinc, porcelain, sugar, or copper. They engaged in marriage strategies with conational groups and local communities creating a transnational network between Portuguese and Dutch families with local groups of Taiwanese (Borao 2002, 2010) (see Fig. 4.7). This trade system and socio-economic

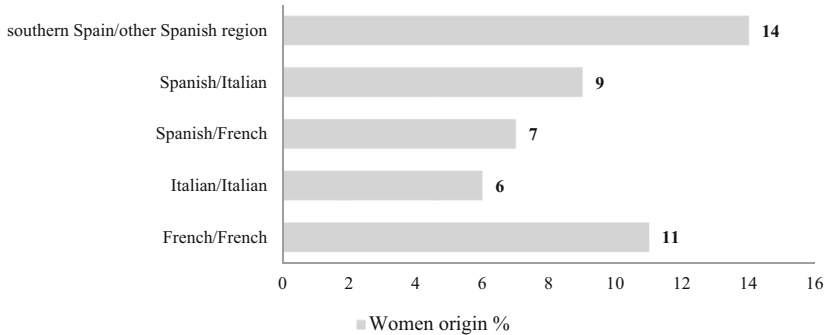

Fig. 4.6 Co-national and transnational marriages among Mediterranean merchants in Southeastern Spain (1730–1808)

Source: Author's own elaboration. AHPM

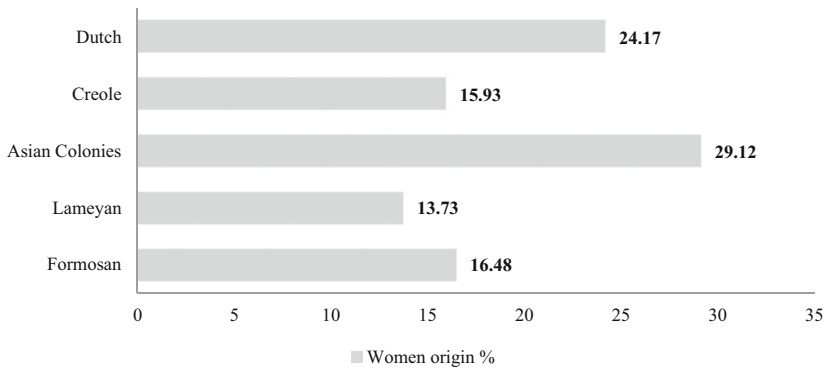

Fig. 4.7 Transnational marriages in Taiwan, seventeenth century

Source: Author's own elaboration. Boraó [2002]; Heyns and Cheng [2005]

alliances started in the sixteenth century, continued in the seventeenth century, and was consolidated during the eighteenth century.

The growing transactions in Macao and Canton through dense trade networks and partnerships by European and Chinese traders led to the Qing government to implement changes within the then-current trade policies. With the lifting of the official ban on overseas trade in 1684, Qing officials established a series of customs posts and Beijing created positions of custom superintendents such as the *Hùbù* 戶部, popularly

known as “hoppo” (Van Dyke 2011: 7–9), in the provinces of Guangdong, Fujian, Zhejiang, and Jiangsu. This stimulated Chinese commerce with foreigners, with Canton, Macao, Taiwan, and Manila as the main trade zone in which the Sino-European, and more precisely Spanish and Portuguese, business activities operated (Boxer 1958; Yuste Lopez 2007). However, there were very strong tariff restrictions attached to this trade with China. The imposition of taxes such as the *almojarifazgo* [royal tariffs levied in the ports of the Spanish empire]²⁸ were in most cases disregarded by merchants, mainly the *sangleyes* of Manila (Chaunu 1960; Schurz 1939) who carried on Chinese good exchanges with European traders by not declaring such goods at port customs and fostering contraband in the south China trade routes. Figures of the total volume of trade, data of shipping and arrivals, and the *almojarifazgo* levied in the Philippines can be found at the *Archivo General de Indias*, which gives us an overview of the official measures undertaken by the Spanish monarchy to clamp down on tax evasion and contraband.

In October 1714 royal officials in the Philippines reported to the Spanish king Philip V that the price of a licence granted to the *sangleyes* to allow them to trade in the Philippines had increased to 1 silver *peso* and 2 *tomines*.²⁹ Furthermore, an additional 2% was added to the existing 6% that was in previous years charged for the *derechos reales de almojarifazgo* [royal rights for the *almojarifazgo*] collection for the ship cargoes that come to the Philippine islands. This tariff, to be charged from the month of January to December, was applied from 1714 onwards. In 1718 the number of licences rose and revenue stood at 2800 silver *pesos*; in 1719 revenue was 1606 silver *pesos*.³⁰

The changes in the *almojarifazgo* levied by Spanish royal officials in the Philippines changed from 5% to 8%, and in other years almost reached 10%, which helps explain the sharp fluctuations in the tax collection of

²⁸The term *almojarifazgo* comes from the Muslim word *al-musrif* meaning supervisor in charge of collecting custom fees at the gates of cities and Muslim ports. The official in charge of levying this tax, the *almojarifé*, was one of the most important positions of the Castilian *Real Hacienda* [Royal Treasury] until the fifteenth century as this official managed the local treasure for the Spanish monarch in every new conquest land (Gonzalez de Arce 2007: 13). This of course applied for the Spanish American colonies and the Philippines.

²⁹Fraction of 1/8 of silver peso.

³⁰AGI, Contaduría, 1289, Caja de Filipinas, 1646–1758.

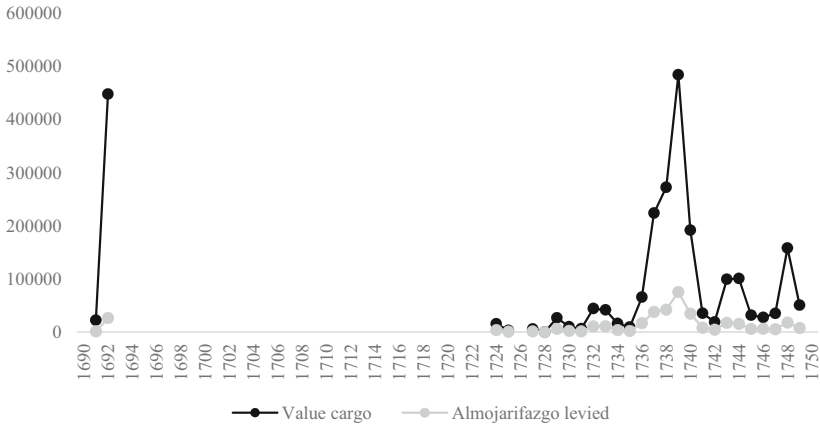

Fig. 4.8 *Almojarifazgo* levied in Manila of ships arrived from China, 1690–1750

Source: Author's own elaboration. AGI, Contaduría, 1289, Sobre las embarcaciones entradas en Filipinas, 1646–1758

the *almojarifazgo* mainly in the years from 1738 to 1740 and from 1743 to 1745 (see Fig. 4.8). The sample of sources arranged at the *Archivo General de Indias* (Spain) of the ships arriving from Chinese ports to Manila for the period from 1690 to 1750 is 577 ships³¹ in which the total value of the cargo and *almojarifazgo* collected is registered.

For these periods the frequency of ships arriving from China to Manila (see the data of Fig. 4.8), mainly from the ports of Amoy (Xiamen), Canton, and Macao, were higher than in the rest of the years as this period is prior to the establishment of the Canton system [*yīkǒu tōngshāng* 一口通商] by the Qianlong emperor setting Canton as the only port to trade with Western powers. In addition, the formation of the Cohong by the Yongzheng emperor fostered the trade monopoly with Manila by the elite and merchant groups of Canton, Macao, and also from Fujian province who were mainly engaged in smuggling activities.

Another important factor to consider is that the evaluation of goods shipped was normally less than the real value of the cargo as officials disregarded it due to technical inefficiency or corruption practices between

³¹ AGI, Contaduría, 1289, Sobre las embarcaciones entradas en Filipinas, 1646–1758.

the captain and officials. In addition, Manila was not the place where the sales were made, so the value of the real transaction is not estimated. The value in many cases was arbitrarily calculated by royal officials. This was a common practice in the Spanish-controlled colonies (Moutoukias 1988; Walker 1979; Lamikiz 2011). As Katherine Bjork (1998) documented in her work for the case of Acapulco and Veracruz that despite officials' ad valorem rates imposed over the cargo for the application of *almojarifazgo*, 5% and 8% as for the case of Manila presented herein (see Fig. 4.8), or in other cases 10% as in Veracruz (TePask and Klein 1986), duties were charged arbitrarily and did not follow a standard manner and constant rate, contrary to William L. Schurz's thesis (1939), which only occurred in the markets of Mexico City or Madrid.

The frequency of ships arriving in Manila from Macao and the *almojarifazgo* levied from 1735 to 1745 (see Fig. 4.8) was affected by the strong dependence of Macao on foreign trade. This provoked cyclical economic crisis in Macao whenever there was a loss of ships and vessels due to shipwrecks and piracy and this happened in the above-mentioned period (1735–1745). The economic and political hegemony of the Netherlands and Great Britain which was rising in the East Asian region provoked Joao V, the King of Portugal, to issue a decree in 1746 prohibiting foreigners from settling down and trading in Macao (Boyajian 2008; de Sousa 2019; Souza 1986). However, the Portuguese monarch made an exception for vessels coming from Manila as they could freely trade being subject to pay less tributes, only 1.5%, whereas Portuguese and other inhabitants of Macao were subject to pay 2% (Bruxo et al. 2017; Carneiro de Sousa 2014; Carneiro de Sousa 2010; Caldeira 2007).

When analysing dramatic variations of the *almojarifazgo* in Fig. 4.8 for the periods from 1690 to 1692, 1738 to 1740, and from 1743 to 1745, some other factors should also be considered: (1) The lump sum for the payment of *almojarifazgo* of a period of years was imposed in a one-year payment. (2) The political context of Qing China for the time periods mentioned included three different emperors, the so-called “High Qing” period [*shèng qīng* 盛清] (Kangxi, Yongzheng, and Qianlong). Kangxi (1661–1722) established some reforms such as setting maritime customs duties which brought about some wealth but the last years of his reign saw increased corruption and expenditure on military campaigns which negated any gains (Rowe 2009). Yongzheng (1722–1735) introduced some reforms (Porter 2016; Rowe 2009; Elliott 2001) to eradicate corruption such as the creation of the Grand Council (Bartlett 1991),

and the grouping of Chinese merchant houses in Canton into one single institution, the Cohong [*gōng háng* 公行] (Po 2018; Rawski 1998; Van Dyke 2011) in 1725 to control trade. The Cohong preceded the main reform on trade introduced by Qianlong (1733–1796) who established Canton as the only port in China allowed to trade with foreign powers, the so-called Canton system [*yīkǒu tōngshāng* 一口通商] (Van Dyke 2005; Gao and Feng 2003). (3) The European (Spanish) political context which included the War of the Spanish Succession (1701–1714) (Kamen 2001) which ended with the arrival of the French Bourbon dynasty to the Spanish throne. And the War of Jenkins' Ear or *guerra del asiento* (1739–1748) in Spain between Britain and Spain for the control of the *asiento* [licence granted by the Spanish crown by which merchants obtained the monopoly on a trade route or good] as the British wanted to gain access to Spanish markets (Martinez-Shaw and Mola 2013; Martinez-Shaw 1982). Later in 1756 the British blockaded Manila and thereafter they occupied the Philippine islands between 1762 and 1764 (Danley and Spelman 2012; Borschberg 2004; Fish 2003).

Behind the rivalry between the Spanish and British empires to be the economic and politic hegemonic power overseas, there was a complex system structure (Gibbons 2001) in which the different players, Spain, England, and also France and the local elites of the Philippines, self-organized their decisions according to the international relations scenario and rationality for decision making on trade and social networks. Whereas Spain and England were engaged in maritime disputes to control trade, French trading houses and small companies seized an opportunity in this conflict to engage in alliances with Manila elites and Macao and Canton traders and brokers (mainly the Manila *sangleyes*). This prompted a progressive creation of spatial and unofficial networks that were interfering in Spanish trade zones and in the East Asian region dismissing the economic and political power of Spain.

Illustrative examples are the trade networks established by the French Roux company and the Swedish Grill House with Manila, Macao, and Canton elites and traders through a dense network of small companies and intermediaries composed of the Brunet, Sollicoffre, Simon de Anda y Salazar (governor of the Philippines), Bene, Obry, Cayron, Dumond, Sanclemente, Poankeequa [Pan Zhencheng 潘振承 president of the Cohong in Canton], among the more relevant socio-economic actors (Perez-García 2019; Van Dyke 2017: 6).

This set of factors made commerce in the South China Sea between Manila and Chinese ports very fluctuant, and according to official sources (see Fig. 4.8) very difficult to estimate, as officials (like their Chinese counterparts in Macao and Canton) did not perform their duties due to the rampant corruption, contraband, and bribes they received (Barrett 1990). Contraband of silver shipments, mainly silk exports from China to the Americas and Europe, via Manila and Indian Ocean routes, was very profitable due to the increasing demand for Chinese silks in Western markets.

The formation and consolidation of the above-mentioned alliances are testified in a series of letters, the so-called Grill letters, in which the Cohong Poankequa [Pankequa], Johan Abraham Grill, the captain and governor of the Philippines, Gregorio Chang (*sangley* in Manila), and the French merchant Dumond were dealing with cargoes of silk.³² Different typologies of silks to be introduced via the Americas (Acapulco-Veracruz) to Mediterranean markets with Marseille as main entrepôt of redistribution to other European territories were checked by Pankequa and Grill sending samples of silks to show the quality: “...*about the qualities of these cargoes and other goods that were introduced in Manila by the Indian [Chinese sangleys] were sent to the Philippines to Acapulco and Europe.*”³³ The high volumes and circulation of American silver *pesos* to buy these silks and clothing (see Fig. 4.9) were emphasized in these letters and transactions.

Silks from Lanquin [Nanquin] were those that were exported in highest volumes from China to western Mediterranean cities such as Marseille and Seville. The city of Nanquin is Nanjing, from Jiangsu province, whose name was the same as Nanjing county in Fujian because the governor of Jiangsu had there a residence as described by Matteo Ricci’s diaries and the Flemish Jesuit Nicolas Trigault. Father Trigault edited and updated Ricci’s diaries and accounts of the Jesuit China mission, and in his work *De Christiana expeditione apud Sinas Suscepta ab Societate Jesu* translated from Italian to Latin and thereafter in Spanish gave an accurate reference about Nanjing:

³²AHM, CSEIC Series: F17, vol. 1A, vol. ID: 17:1A and vol. 1 B, vol. ID: F17:1B, Grill Letters, ref. T1_00732.

³³AHM, CSEIC Series: F17, vol. 1A, vol. ID: 17:1A and vol. 1 B, vol. ID: F17:1B, Grill Letters, ref. T1_00732.

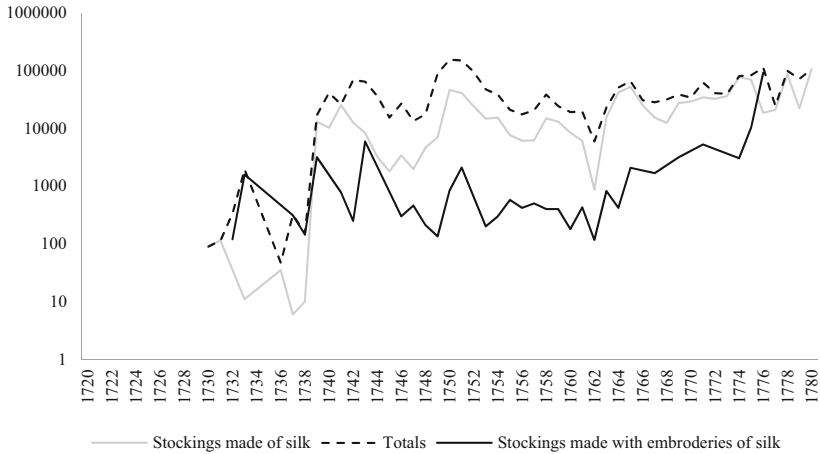

Fig. 4.9 Re-exportation of stockings made of silk from Marseille to Spanish Mediterranean ports, 1720–1780

Source: ACCM, Statistique. Serie I

“This metropolis is named Nanquin, however the Portuguese who heard about this city by which the inhabitants of the city of the province of Fuquien [Fujian] called it Lanquin; because in their language the letter N is changed as L. By the name of other city by which is called in this region [Fujian] with the name of Nanjing [of Jianguo province], because the governor of this city has a residence there...”³⁴

Thus, the import-export market prompted changes in patterns of consumption in western Mediterranean Europe and south China, via the ports of Marseille and Macao, connecting inner China through Macao and Canton, and Marseille with Spanish Mediterranean markets of Barcelona, Valencia, Alicante, Cartagena, Cadiz, and Seville. The entry of these Chinese silks and manufactures (see Fig. 4.9) were introducing new fashions, tastes, and lifestyles creating a new middle class. Merchants can be defined, therefore, as “vicarious consumers” (Perez-Garcia 2013, 2019) who stimulated changes in consumer behaviour. The illustrative

³⁴TBCL, Rare Book Collection, Trigault, N., *De Christiana expeditione apud Sinas Suscepta ab Societate Jesu*, Lugduni: Horatij Cardon, 1616, chapter X, p. 143.

example of the parishes of the city of Seville for the first half of the eighteenth century (see Map 4.5) shows the rising level of consumption of Chinese silks and clothing in middle-class households such as merchants and artisans, as well as the local nobility.

These changes in patterns of consumption and the rising demand for Chinese goods (silk in the case presented in this chapter) was prompted through the polycentric markets and trade networks operating in the Pacific where smuggling activities and unofficial trade during the seventeenth and eighteenth centuries became the main channel of diffusion into European markets. The intrusion of French trading houses in the Manila, Macao, and Canton markets, mainly dominated by the Spanish and Portuguese crowns, provoked a dislocation of the structure of the networks and strategies according to the new political context of the

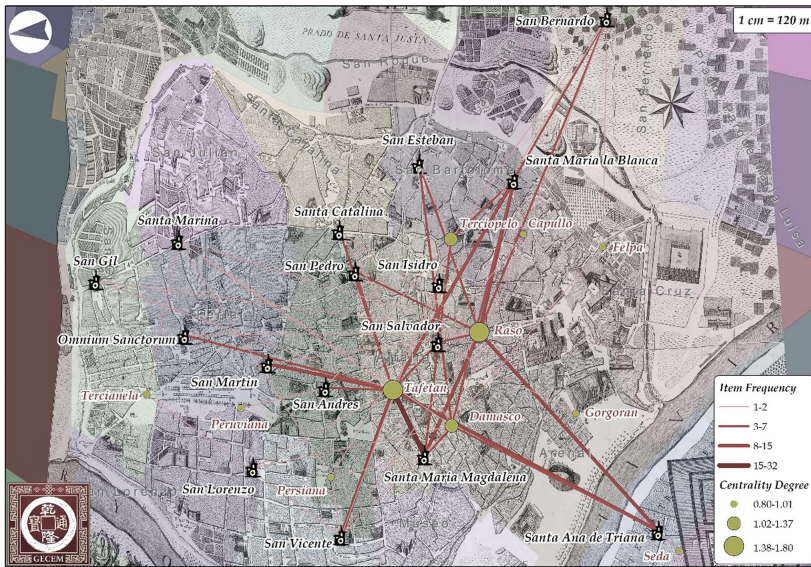

Map 4.5 Typologies of Chinese silks and consumer's networks in the parishes of Seville, 1727–1750

Source: Author's own elaboration through GECM Project Database and Software QGIS v3.12 Base map from Natural Earth raster through data of protocols and probate-inventories of the Archivo Provincial de Sevilla (hereafter AHPS)

eighteenth century. The smuggling culture behind the commerce of the South China Sea, with Macao as the main strategic port of such transactions, contrasted with trade activities of western Mediterranean markets, mainly Marseille, in which commerce was more regulated. Trade exchanges in the South China Sea were defined by contraband or informal commerce (Shimada 2006). For this reason, the state capacity of the Spanish monarchy was too weak to organize trade in the Philippines and control the traffic and cargoes of the Manila galleons (Cheong 1997; Stein and Stein 2000).

This level of contraband, and the inefficiency of institutions and officials to regulate trade and organize the economy of the Spanish colonies in the Pacific, was endemic within the Spanish monarchy ever since the early arrival of Dominican and Augustinian friars and Spanish elites to the Philippines. Trade relations with China were never well regulated. For instance, Pedro de Vargas in 1655 travelled to Northern Vietnam, Tunquin [Tonkin], to buy goods to be resold in Manila without paying taxes.³⁵ His licence to trade in the kingdom of Tonkin was suspended by Juan de Bolivar y Cruz, *fiscal* [prosecutor for the government] of the *Real Audiencia de Manila* [Royal Audience of Manila]. A letter was sent to the Spanish king pleading for the official cancellation of de Vargas' licence. The report made by the *fiscal* also mentioned that several *champanes* [ships] had sailed to the kingdoms of Conchinchina, Siam, Camboya, and Macao to also buy silks without declaring the royal taxes in silver and gold.

Such suspension was due to the contradictions declared in the Audience by Pedro de Vargas to trade in Tonkin with his *champan* because it raised suspicions of potential contraband and illegal activities.³⁶ This demonstrated that both Spanish and Chinese merchants hardly paid royal taxes [the *almojarifazgo*]. Therefore, ships that arrived in the Philippines from Xiamen [Amoy], Canton, Macao, Gulf of Tonkin, and Manila were inefficiently supervised by overseers or accountants.

The socio-cultural transfers related to the assimilation of new cultural forms and daily habits, through the consumption of Chinese goods (silks) for example, consequently brought changes in fashions and habits. By analysing the role and function of merchants and their networks in Europe

³⁵ AGI, Filipinas, 22, r. 7, n. 24, Manila, 19-07-1655.

³⁶ AGI, Filipinas, 22, r. 7, n. 24, Manila, 19-07-1655.

and East Asia, it is possible to shed light on changes in patterns of consumption and, therefore, the formation of long-distance business partnerships. Marseille and Macao can be defined as central transnational regions, where overseas goods circulated beyond the official realm of the Spanish and Qing empires.

These two port cities are the key territories in order to see how European cultural transfers took place in south China through Macao and how Chinese goods penetrated into Europe through Marseille as the main Mediterranean entrepôt of the eighteenth century. Both places connected the West and the East and were the main trade nodes that integrated south China and Mediterranean markets through the mediation of transnational agents (i.e. merchants, missionaries, travellers, diplomats).

Open Access This chapter is licensed under the terms of the Creative Commons Attribution 4.0 International License (<http://creativecommons.org/licenses/by/4.0/>), which permits use, sharing, adaptation, distribution and reproduction in any medium or format, as long as you give appropriate credit to the original author(s) and the source, provide a link to the Creative Commons license and indicate if changes were made.

The images or other third party material in this chapter are included in the chapter's Creative Commons license, unless indicated otherwise in a credit line to the material. If material is not included in the chapter's Creative Commons license and your intended use is not permitted by statutory regulation or exceeds the permitted use, you will need to obtain permission directly from the copyright holder.





Conclusions

The Spanish and Qing empires were connected through the agency of merchants, the trade networks they created, and the circulation of goods which fostered local demand. Trade routes, mainly the maritime economic arteries such as the Manila galleons, connected and integrated Western markets and polities, in this case the Spanish empire with the Middle Kingdom. The constant inflow of American silver into China and the outflow of highly prized Chinese goods (i.e. silk, tea, porcelain) into European and American markets were the main features for such market integration between the Bourbon (French) Spanish empire and the Qing (Manchu, non-Han) dynasty. This surpassed the realm of official institutions of both empires along with their concomitant weak state capacity.

One could argue that both the Spanish and Qing empires were connected through the “imaginary” of the Silk Road, a concept constructed in the late nineteenth century and one reinvigorated in the present day. In reality, however, the Silk Road never existed; in Chinese historical sources from the Han to Qing Dynasty there is no mention of the term “Silk Road.” The Qing and Spanish empires were obviously connected through the Manila galleons linking the Spanish American colonies to China via Manila which was the main route that stimulated the demand for American silver by southern Chinese merchants, as well as the demand for Chinese goods by Spanish traders and local elites of

the Philippines, America, and Spain. The “imaginary” of the Silk Road as a national construct aimed to be the space, likely with characteristics of imperialism and expansion, of the emerging nation-state of twentieth-century China which is being consolidated today in the twenty-first century. This paradigm has indirectly been the main stimulus of current national narratives, either in Chinese or Spanish scholarship, among other world regions.

The “High Qing” period, conventionally defined as a “prosperous age” [*shèng qīng* 盛清], was in fact not as prosperous as a careful analysis of the socio-economic and cultural transformations for this period reveals (Rowe 2001, 2009; Dunstan 2014; Jia 2012; Theobald 2015). The three alien Manchu (non-Han) emperors, Kangxi, Yongzheng, and Qianlong, were incapable of coping with Malthusian pressures after 1683 because of limited revenues and a drop in agricultural production due to deforestation and farmland size. In addition, state interventionism, multiplication of official appointments, rising bureaucracy within the Qing expansion, inefficiency in collecting tax revenues, and the inability to eradicate the rampant corruption mainly in the southern provinces are the key factors that demonstrate that the so-called “High Qing” [*shèng qīng* 盛清] prosperity was a weak illusion, like a giant with clay feet.

The aforementioned deficiencies need to be further examined in future research because some contemporary scholarship still promotes dubious evidence to sustain this narrative of economic prosperity. The challenge to that line of research is mainly presented in chapters three and four of this book regarding tax revenue and the questionable efficiency of the official trade system, which demonstrate that this period cannot be characterized by its “hallmarks,” its “dramatic economic transformation,” (Mann 1997: 20) or as a “time of great stability and prosperity” (Porter, 2016: 134; McMahon 2015: 110). Thus, the question “Does the Kangxi and Qianlong Golden Age really exist?” posed by Li Qiang, Xu Kang-Ning, and Wei Wei (Li et al. 2014; Wang 2014; Chan 2003) who questioned and challenged the flourishing “High Qing” period [*shèng qīng* 盛清] thesis, seems very relevant. They argue that there were no scientific or technological breakthroughs, the economic output was stagnant, military power was unstable, culture was at a standstill, and the despotic rule of the mandarin state was characterized by an obsolete and corrupt feudal system that thwarted economic and social development.

This set of factors, and particularly the stymying of socio-economic advances, demonstrates that the state capacity of Qing China was very

weak just as the state was set into a “power paradox” or “supremacy dilemma” characterized by rigid interventionism and an autocratic execution and use of power (Kuhn 1990) to maintain a complex network of bureaucrats to keep local order. But at the same time at the local level, mainly in Jiangsu, Jiangnan, Zhejiang, or Guangdong areas, features of modern capitalism and development were emerging. As defined in *Global History with Chinese Characteristics*, this placed the Qing state onto a path with a crossroads: either foster economic growth and the elements of capitalism and a market system that were flourishing in some of China’s regions (Li 1998, 1985) or execute stiff rules and economic interventionism through the use and abuse of power (Ma 2014; Ma and Rubin 2019).

Hegemonic states in the early modern period, and even in the present day, could confront this dilemma by choosing well-defined management rules and policies to establish a consolidated welfare state system or choose to perpetuate a small but powerful elite at the expense of the public good. The Qing state chose the second path, one defined by firm socio-economic interventionism and despotic exercise of power. Thus, any relative economic growth in the “High Qing” period [*shèng qīng* 盛清] resulted in stagnation due to the mandarin state’s execution of power which resulted in inefficient institutions that were unable to manage the public well-being and regulate trade in the southern provinces.

The historical data in the Local Gazetteers of China [*zhōngguó dìfāng zhì* 中国地方志] provides an interesting window on this outcome precisely because of its inaccuracy due to the flawed methods local officials used to account population and tax revenue at provincial, prefecture, and county levels. These officials were poorly paid to perform such duties. Therefore, the census of population [*rénkǒu pǔchá* 人口普查] used to levy taxes to household members was imprecise and rendered useless, demonstrating by its ineffectiveness the weak capacity of the Qing state. Analysing the Local Gazetteers through this different lens thus challenges the so-called “High Qing” [*shèng qīng* 盛清] age of prosperity. It also re-evaluates the great divergence debate at the micro level in provinces, prefectures, and counties affirming that the Qing economy stagnated due to institutional constraints, the multiplication of inefficient institutions, a highly extended bureaucracy, despotic exercise of power, and a lack of economic and political reforms to eradicate corruption and smuggling activities.

The “High Qing” [*shèng qīng* 盛清] prosperous thesis is, therefore, reviewed in light of the incremental scholarship of recent decades (Mann 1997; Porter 2016; McMahon 2015; Rowe 2009; Theobald 2015) through an analysis of the low state capacity of Qing China, thereby re-evaluating modern assumptions that have examined the Middle Kingdom’s modernization and economic development through a marked Eurocentric approach which has fostered the great divergence debate. In many cases in that research, using untapped primary sources as new data that might provide or redefine the great divergence debate has been largely absent. Furthermore, the methodological approach presented in this book to re-evaluate the great divergence debate from a local basis proves that index numbers, numeraire, and statistical methods used by economists and historians, mainly by the so-called “Maddison School,” present inconsistent and unreliable results.

The establishment of the Canton system of trade [*yīkǒu tōngshāng* 一口通商] by the Qianlong Emperor in 1757 aimed to regulate trade, eradicate corruption, and establish stiff mercantilist rules. The target was purportedly foreign countries dealing with China, but in real terms the system aimed to control non-official trade and institutions fostered by new local Chinese elites who were seen by the high officials of the Beijing court and the emperor himself as the main threat.

Business alliances through *commenda* contracts by traders from Fujian and Guangdong provinces, the so-called *sangleyes* in the Philippines who established networks with Spanish, Portuguese, and other European traders, was the main channel that poured American silver into China for the exchange of Chinese goods (silk, tea, and porcelain). This created informal trade networks and institutions which allowed local Chinese traders, predominately the Hong merchants of Canton and local traders of Macao, to accumulate high amounts of capital (American silver) representing a major threat to the officialdom and establishment of Beijing. The unregulated trade of the South China Sea region represented through the Canton-Macao-Manila-Acapulco economic axis illustrates the weak capacity not only of the Qing empire, but also of the Spanish empire as more than 2/3 of American silver of Spanish-controlled colonies was transferred to the East via non-official trade.

The *Real Compañía de Filipinas* [Royal Company of Philippines] established in the second half of the eighteenth century, in the same period when the Canton system was created, also proved to be inefficient as smuggling activities were rampant and silver flows continued to

move eastwards. Mercantilist rules and autocratic measures in both the Chinese and Spanish empires demonstrate just how ineffective their tax and fiscal systems were, indicating the weak capacity of both states and their economic and political decline. In addition to the feeble Qing China tax system as evidenced through the analysis of the Local Gazetteers, the royal tariffs levied in the ports of the Spanish empire, the so-called *almojarifazgo*, were disregarded by Chinese and local Spanish traders of Manila, revealing the inefficiency of the Spanish empire to fill the state coffers and control the circuits of inbound and outbound vessels in the Philippines. Flows of silver and exchange of goods in south China, either of Chinese or European origin, kept circulating in high amounts beyond official control.

Chinese and European goods challenged tradition, identity, and created new cultural forms beyond the national borders. Starting in the second half of the sixteenth century, when the Manila galleons trade routes were established, inflows of American silver into China grew exponentially. This prompted an expansion of markets not only across Eurasian polities but also in the Americas. This is viewed as the birth of early globalization, challenging conventional scholarship (O'Rourke and Williamson 2004; Broadberry et al. 2018; Li and van Zanden 2012) which believes that market integration and first globalization occurred after 1820 when prices started to converge.

The progressive market integration between Asian and European regions involved outflows of goods from China to Europe, and vice versa, and inflows of silver from Europe and America to China. The writings by missionaries such as the Augustinians, Dominicans, and Jesuits, as documented in chapter four, demonstrate the level of knowledge and views of the Middle Kingdom through Western eyes. The early perceptions of sixteenth-century Augustinians and Dominicans who settled down in the Philippines were quite distorted as they aimed to establish and differentiate social casts, as well as impose institutional and religious beliefs in light of the “pure blood” statutes (Perez-Garcia 2020) and social model determined by the Catholic European Counterreformation.

Only after the arrival of the first Jesuits to China, such as Matteo Ricci, did the views and descriptions of China become more accurate. Seventeenth- and eighteenth-century publications of encyclopaedic volumes, books, and accounts on China by Jesuit fathers such as the French Jesuit Jean-Baptiste Du Halde showed a more realistic view of China's culture, society, and economy. The Jesuit accommodation

method, the so-called “*ad usum loci, in quo vivitur accomodatus*,” by which the Jesuits adapted to the environment where they settled down, learning the vernacular language and customs, allowed them to be the main socio-cultural agents and catalysts of transferring Chinese culture and tradition to Europe.

If we compare Du Halde’s *Description de la Chine* published in 1735 with the anonymous *Boxer Codex* of the late sixteenth century, the inaccuracies of the latter seem more obvious in light of Du Halde’s more precise account. A paradigmatic example is the Spanish invention of the word *sangle* to describe Chinese (and by extension eastern and south-eastern) traders who arrived in the Philippines. Such denomination only appears in Spanish sources and documents after the publication of the *Boxer Codex*, and there is not one reference of the so-called *sangle* community in any other European or Chinese source. There is no mention of the word *sangle* either in the *Ming shilu* 明实录, *Qing shilu* 清实录, or in any other Ming and Qing dynasty source. It is just a Spanish invention of the early modern period that conventional scholarship from Taiwan (Qiu 1995; Li, 2001; Folch 2002; Fang 2017) and Spain (Ollé 2002; Cano Borrego 2016; Gil 2011; García-Abasolo 2011) over the past few decades has believed to be a sophisticated term originating from the Hokkien language of Fujian province.

The circulation of global goods and trade networks created transnational communities. By the eighteenth century the first European settlers in Macao (Portuguese, Sephardim, Jesuits, and Armenians) operated in the South China Sea through the economic axis Macao-Canton, and into the western Mediterranean through the economic axis Cadiz-Seville-Marseille. This trade changed consumer behaviour, fostered market integration and non-official trade surpassing the state capacity of the Qing and Spanish empires, and transferred knowledge. Indeed the main argument of *Global History with Chinese Characteristics* is that bilateral Sino-European trade relations and the transnational dimension of global goods transformed local economies, changed tastes and traditional habits, and created a new type of global consumerism during the early modern period as trade between European and Asian regions was progressively growing.

In eighteenth-century Europe, trade conditions became more favourable because there were fewer wars and ship construction and circumnavigation techniques had improved. Trade relations between China and Europe were thus shaping a new geostrategic global order

during this time period which only collapsed after the outbreak of the Opium Wars in the mid-nineteenth century. Analysing foreign trade networks and alliances with Chinese local elites in Macao, as the main entrepôt in southern China, is crucial to understanding how foreign trade operated in this region.

Conventional research, however, mainly carried out by economists or economic historians from either a Eurocentric or Sinocentric perspective (Maddison 2007; Broadberry et al. 2017; Li and van Zanden 2012; Allen 2009; Duchesne 2001; Landes 1998; Vries 2003; Lin 1995; Xia 2012) persists in the analysis of market integration or adding to the ongoing great divergence debate through ambiguous geographic and chronological constructs for China and Europe. There is a need for further research to examine the circulation of socio-economic agents and goods, the transfer of knowledge, and changes in consumer behaviour at the local level by mining new historical data as the main foundation towards writing a “new” global history which can review the great divergence debate. Presenting a comparative case study of Macao and Marseille offers new analysis beyond the core-peripheries perspective which mainly pays attention to advanced European powers such as Great Britain and its colonies. Such research relegates or practically marginalizes other geographic areas such as the Mediterranean, Spanish American or Pacific, and south China regions. Macao and Marseille were peripheral economic areas of south China and the western Mediterranean which were integrated into a more complex trade network connecting Eastern and Western markets within a polycentric geography with no dominant economic space.

The very fact of their periphery indicates the importance of choosing Marseille and Macao as units of comparison because they played an essential role in the decline of the Qing and Spanish empires during the eighteenth century. It is traditionally believed that comparative studies only seek similarities between geographies and two spaces or units. The comparison between Marseille and Macao, however, is integrated into a more global geography and the trade routes of both the Spanish and Qing empires, mainly seeking differences, and through my analysis of south China and western Mediterranean markets it can be observed how economic growth was correlated with changes in consumer behaviour.

Within this micro-history case study, then, the long discussions of the last twenty years over the great divergence debate, the divide between rich and poor countries, and the straightjacketed Eurocentric or Sinocentric

narratives can be surpassed. Using wide and ambiguous geographical units of comparison, without locating concrete areas or employing a micro-level analysis, the economic differences between China and Europe will not be properly grasped and the conventional frames of comparisons will continue blurring the analysis of why East Asian economies stagnated and northwestern European ones took off. Moreover, without the micro-level focus, the role of other economic regions such as the Mediterranean, American, or southern China will continue to be absent from the historical analysis. Accordingly, the dynamics of inter-group organizations, merchant coalitions, and the assimilation of new cultural forms that went beyond defined geographical, political, and socio-cultural boundaries will also remain largely absent if the scholarship retains its focus on the macro scale.

Indeed, one of the key findings in this case study is the role of merchants and their influence on consumer decisions, as they can be defined as “vicarious” agents (Perez-Garcia 2013, 2019) who transformed both the supply and demand side, creating new markets and new needs that did not exist in long distance or local markets. Merchant networks and the informal institutions and economic forms they created fostered market integration and changes in patterns of consumption. Strategies in merchant alliances were based on family relations (marriages), national origins, shared information of their trade sector, and trust. These were the main factors for the economic operations and interaction in the local markets of south China and western Mediterranean Europe.

My analysis of Qing China’s state capacity which challenges the “High Qing” [*shèng qīng* 盛清] prosperous era argument, the examination of non-official institutions and trade agents that surpassed state control, and the discussion of concepts such as “power paradox” or “supremacy dilemma” inherent to despotic and autocratic states are a set of factors behind the hypothesis that the economic decline of the Qing (Manchu) alien dynasty, prior to the First Opium War, had endogenous socio-economic and political components beyond the classic explanation of the intervention of foreign powers. The explanation that the economic decline of early modern China, continuing into the nineteenth and twentieth centuries, was the result of interference from Western hegemonic powers (i.e. Great Britain, France, USA, Germany, among others), set in place even up until today, national (Sinocentric and Sinocentred) narratives within historical research.

This perspective has encapsulated history writing in China within a stiff nationalistic view which has been reinvigorated in recent years within the new PRC's policy of "One Belt, One Road" or "New Silk Road" that aims to present nationally and internationally the uniqueness and long-lasting exclusiveness of the history, culture, and civilization of the Middle Kingdom. Within the framework of the government's international strategy, characterized by a national goal of keeping the country unified in the twenty-first century, global history studies in China are of relevant importance for the legitimacy of current social and cultural policies.

Subsequently, most global history practitioners in China's scholarship present a marked Sinocentric and national perspective using the "global" label. This has set China's academics into what I defined in *Global History with Chinese Characteristics* as the "global history paradox." The Sinocentric and Sinocentred approaches, within the framework of the "One Belt, One Road" or "New Silk Road" policy, produces nationalizing global history narratives. The outcome of such studies results in a paradox itself because rigid national narratives contradict in essence the global history perspective and its original aim to deconstruct the formation of modern nation-states which emerged through the paradigm of invented and imagined national histories.

Open Access This chapter is licensed under the terms of the Creative Commons Attribution 4.0 International License (<http://creativecommons.org/licenses/by/4.0/>), which permits use, sharing, adaptation, distribution and reproduction in any medium or format, as long as you give appropriate credit to the original author(s) and the source, provide a link to the Creative Commons license and indicate if changes were made.

The images or other third party material in this chapter are included in the chapter's Creative Commons license, unless indicated otherwise in a credit line to the material. If material is not included in the chapter's Creative Commons license and your intended use is not permitted by statutory regulation or exceeds the permitted use, you will need to obtain permission directly from the copyright holder.



BIBLIOGRAPHY

- Acemoglu, Daron. 2005. Politics and Economics in Weak and Strong States. *Journal of Monetary Economics* 52(7): 1199–1226.
- Acemoglu, Daron, Johnson, Simon, and Robinson, James. 2002. Reversal of Fortune: Geography and Institutions in the Making of the Modern World Income Distribution. *The Quarterly Journal of Economics* 117(4): 1231–1294.
- . 2005. The Rise of Europe: Atlantic Trade, Institutional Change, and Economic Growth. *The American Economic Review* 95: 546–579.
- Adelman, Jeremy. 2006. *Sovereignty and Revolution in the Iberian Atlantic*. Princeton: Princeton University Press.
- . 2017. What Is Global History Now? *Aeon* 2.<https://aeon.co/essays/is-global-history-still-possible-or-has-it-had-its-moment>.
- Adshead, Samuel. 2000. *China in World History*. Basingstoke: Palgrave Macmillan.
- . 2004. *T'ang China. The Rise of the East in World History*. Basingstoke: Palgrave-Macmillan.
- Aduarte, Diego. 1640. *Historia de la provincia del Santo Rosario de Filipinas, Japón y China*, Madrid: Consejo Superior de Investigaciones Científicas.
- Aghassian, Michael, and Kévonian, Kéram. 1999. The Armenian Merchant Network: Overall Autonomy and Local Integration. In Chaudhury, Sushil, and Morineau, Michael (eds.), *Merchants, Companies, and Trade. Europe and Asia in the Early Modern Era*, 74–94. Cambridge: Cambridge University Press.
- Aldcroft, Derek, and Ville, Simon. 1994. *The European Economy, 1750–1914*. Manchester: Manchester University Press.

- Allen, Robert C. 2009. Agricultural Productivity and Rural Incomes in England and the Yangtze Delta, c. 1620–c. 1820. *Economic History Review* 62: 525–550.
- Allen, Robert C., Bengtsson, Tommy, and Dribe, Martin. (eds.) 2005. *Living Standards in the Past: New Perspectives on Well-Being in Asia and Europe*. Oxford: Oxford University Press.
- Allen, Robert C., Bassino, Jean-Pascal, Ma, Debin, Moll-Murata, Christine, and van Zanden, Jan Luiten. 2011. Wages, Prices, and Living Standards in China, 1738–1925: in comparison with Europe, Japan, and India. *Economic History Review* 64(S1): 8–38.
- An, Changchun. 1993. Cong shijieshiguan kan woguo shijieshi xueke jianshe [The Construction of World History Field in Our Country in Light of the Concept of World History]. *Wuhan daxue xuebao [Journal of Wuhan University]* 4: 13–18.
- Anderson, Benedict. 1983. *Imagined Communities: Reflections on the Origin and Spread of Nationalism*. London: Verso.
- . 1988a. Cacique Democracy in the Philippines: Origins and Dreams. *New Left Review* May–June: 3–31.
- . 1988b. *Imagined Communities: Reflections on the Origins and Spread of Nationalism*. London: Verso.
- . 2001. To What Can Late Eighteenth-Century French, British, and American Anxieties Be Compared? Comment on the Three Papers. *American Historical Review* 106(4): 1281–1289.
- Anderson, Perry. 1987. *Lineages of the Absolutist State*. London: Verso.
- Anes, Gonzalo. 1994. The Agrarian ‘Depression’ in Castile in the Seventeenth Century. In Ian A.A. Thompson and Yun-Casalilla, Bartolomé (eds.), *The Castilian Crisis of the Seventeenth Century: New Perspectives on the Economic and Social History of Seventeenth Century Spain*, 60–76. Cambridge: Cambridge University Press.
- Angle, Stephen. 2012. *Contemporary Confucian Political Philosophy*. Cambridge: Polity Press.
- Antony, Robert J. 2010. Piracy and the Shadow Economy in the South China Sea, 1780–1810. In Antony, Robert J. (ed.), *Elusive Pirates, Pervasive Smugglers: Violence and Clandestine Trade in the Greater China Seas*, 99–114. Hong Kong: Hong Kong University Press.
- Antony, Robert, J., and Schottenhammer, Angela. 2017. *Beyond the Silk Roads: New Discourses on China’s Role in East Asian Maritime History*. Wiesbaden: Otto Harrassowitz.
- Apter, David, and Saich, Tony. 1994. *Revolutionary Discourse in Mao’s Republic*. Cambridge: Harvard University Press.

- Armitage, David, Guldi, Jo, and Baudry, Jérôme. 2015. Le retour de la longue durée: une perspective anglo-américaine. *Annales. Histoire, Sciences sociales* 70(2): 289–318.
- Arrighi, Giovanni, Hamashita, Takeshi, and Selden, Mark. 2003. *The Resurgence of East Asia*. London: Routledge.
- Aslanian, Sebouh David. 2011. *From the Indian Ocean to the Mediterranean: The Global Trade Networks of Armenian Merchants from New Julfa*. Berkeley: University of California Press.
- Attman, Artur. 1986. *American Bullion in the European World Trade, 1600–1800*. Göteborg: Kungl. Vetenskaps- och Vitterhets-Samhället.
- Atwell, William S. 1982. International Bullion Flows and the Chinese Economy circa 1530–1650. *Past & Present* 95: 68–90.
- . 2005. Another Look at Silver Imports into China, ca. 1635–1644. *Journal of World History* 16(4): 467–489.
- Bairoch, Paul. 1993. *Economics and World History: Myths and Paradoxes*. Chicago: University of Chicago Press.
- Baladouni, Vahe, and Makepeace, Margaret. 1998. *Armenian Merchants of the 17th and 18th Century*. Philadelphia: American Philosophical Soc.
- Barraclough, Geoffrey. 1955. *History in a Changing World*. Oxford: Basil Blackwell.
- . 1979. *Main Trends in History*. London: Holmes & Meier.
- Barrett, Ward. 1990. World bullion flows, 1450–1800. In Tracy, James (ed.), *The Rise of Merchant Empires: Long Distance Trade in the Early Modern World 1350–1750*, 224–254. Cambridge: Cambridge University Press.
- Bartolomei, Arnaud. 2007. Paiements commerciaux et profits bancaires: les usages de la lettre de change (1780–1820). *Rives méditerranéennes* 27: 1–20.
- de Bary, William T. 1993. *Waiting for the Dawn: A Plan for the Prince, Huang Tsung-Hsi's Ming-i-tai-fang lu*. New York: Columbia University Press.
- Batchelor, Robert. 2008. On the Movement of Porcelains: Rethinking the Birth of the Consumer Society as the Interaction of Exchange Networks, China and Britain, 1600–1750. In Brewer, John and Frank Trentmann (eds.), *Consuming Cultures, Global Perspectives: Historical Trajectories, Transnational Exchanges*, 95–121. Oxford: Berg.
- BBC News Mundo. 2019. AMLO solicita por carta al rey de España y al Papa que pidan perdón por la Conquista de México. *BBC News*. <https://www.bbc.com/mundo/noticias-americas-latina-47701387>.
- Beckert, Sven and Sachsenmaier, Dominic. 2018. *Global History, Globally: Research and Practice around the World*. London: Bloomsbury.
- Belich, James. 2009. *Replenishing the Earth: Settler Revolution and the Rise of the Angloworld, 1783–1939*. Oxford: Oxford University Press.
- Belich, James, Darwin, John, Frenz, Margret, and Chris Wickham. 2016. *The Prospect of Global History*. Oxford: Oxford University Press.

- Bell, David A. 2014. Questioning the Global Turn: The Case of the French Revolution. *French Historical Studies* 37: 1–24.
- Benjamin, Craig. 2018. *Empires of Ancient Eurasia: The First Silk Roads Era, 100 BCE–250 CE*. Cambridge: Cambridge University Press.
- Bentley, Jerry H. 2005. Myths, Wagers, and Some Moral Implications of World History. *Journal of World History* 16: 51–82.
- Berg, Maxine. 2005. *Luxury and Pleasure in Eighteenth-Century Britain*. Oxford: Oxford University Press.
- . 2006. Britain, Industry and Perceptions of China: Matthew Boulton, ‘Useful Knowledge’ and the Macartney Embassy to China 1792–94. *Journal of Global History* 1: 269–288.
- . 2011. The British Product Revolution of the Eighteenth Century. In Horn, Jeff, Rosenband, Leonard, and Smith, Meritt Roe (eds.), *Reconceptualizing the Industrial Revolution*, 47–66. Boston: MIT Press.
- . 2019. Sea Otters and Iron: A Global Microhistory of Value and Exchange at Nootka Sound, 1774–1792. *Past and Present* 242(Supplement 14): 50–82.
- Berg, Maxine, Gottmann, Felicia, Hodacs, Hanna, and Nierstrasz, Chris. 2015. *Goods from the East, 1600–1800. Trading Eurasia*. London: Palgrave Macmillan.
- Besley, Timothy, and Persson, Torston. 2010. State Capacity, Conflict and Development. *Econometrica* 78(1): 1–34.
- Bjork, Katharine. 1998. The Link That Kept the Philippines Spanish: Mexican Merchant Interests and the Manila Trade, 1571–1815. *Journal of World History* 9(1): 25–50.
- Blussé, Leonard. 1990. Minnan-Jen or Cosmopolitan? The rise of Cheng Chih-lung alias Nicholas Iquan. In Vermeer, Eduard B. (ed.), *Development and Decline of Fukien Province in the 17th and 18th Centuries*, 245–264. New York: Brill.
- Blussé, Leonard. 1991. Fuchienese commercial expansion into the Nanyang as mirrored in the Tung Hsi Yang K’ao. *Revista de Cultura* 13/14: 140–149.
- Bol, Peter K. 2008. *Neo-Confucianism in History*. Cambridge: Harvard University Press.
- Bonialian, Mariano. 2012. *El Pacífico hispanoamericano: política y comercio asiático en el Imperio Español (1680–1784)*. México: El Colegio de México.
- Borao, José Eugenio. 2002. *Spaniards in Taiwan, vol. 2*. Taipei: SMC Publishing Inc.
- . 2005. La Colonia de Japoneses en Manila en el Marco de las Relaciones de Filipinas y Japón en los siglos XVI y XVII. *Cuadernos Canela* 17: 25–53.
- . 2010. Familias holandesas y españolas en Taiwan (siglo XVII). In Bestard, Joan, and Perez-Garcia, Manuel (eds.), *Familia, valores y representaciones*, 181–200. Murcia: Universidad de Murcia.

- Borrego, Pedro Damien Cano. 2016. Sangleyes los residentes chinos en las Filipinas españolas. *Revista de la Inquisición, (intolerancia y derechos humanos)* 20: 213–242.
- Borschberg, Peter. 2004. *Chinese Merchants, Catholic Clerics and Spanish Colonists in British-Occupied Manila, 1762–1764*. In Wang, Gungwu and Ng, Chin-Keong (eds.), *Maritime China in Transition, 1750–1850*, 355–372. Wiesbaden: Harrassowitz.
- Boxer, Charles R. 1953. *South China in the Sixteenth Century, Being the Narratives of Galeote Pereira, Fr. Gaspar Da Cruz, O.P., Fr. Martín de Rada, O.E.S.A. (1550–1575)*. London: Hakluyt Society.
- . 1958. The Manila Galleon 1565–1815: The Lure of Silk and Silver. *History Today* 8: 538–547.
- . 1959. *The Great Ship from Amacon: Annals of Macao and the Old Japan Trade, 1555–1640*. Lisbon: Centro de Estudos Históricos Ultramarino.
- . 1968. *Catalogue of Philippine Manuscripts in the Lilly Library*. Bloomington: Indiana University Press.
- . 1969. *The Portuguese Seaborne Empire, 1415–1825*. London: Hutchinson.
- Boyajian, James. 2008. *Portuguese Trade in Asia under the Habsburgs, 1580–1640*. Baltimore: Johns Hopkins University Press.
- Brady, Anne-Marie. 2008. *Marketing Dictatorship: Propaganda and Thought Work in Contemporary China*. Lanham: Rowman & Littlefield.
- Brandt, Loren, Ma, Debin, and Rawski, Thomas G. 2014. From Divergence to Convergence: Reevaluating the History Behind China's Economic Boom. *Journal of Economic Literature* 52(1): 45–123.
- Braudel, Fernand. 1949. *La Méditerranée et le monde méditerranéen à l'époque de Philippe II*. Paris: Armaund. Colin.
- . 1979. *Civilisation matérielle, économie et capitalisme, XVe-XVIIIe siècle, 3 vol.* Paris: Armand Colin.
- . 1992. *The Wheels of Commerce, vol. 2, Civilization and Capitalism (15th–18th Century)*. London: University of California Press.
- . 1996. *Autour de la Méditerranée*. Paris: Fayard.
- Bray, Francesca. 1986. *The Rice Economies. Technology and Development in Asian Societies*. London: University of California Press.
- Brewer, John. 2004. The Error of Our Ways: Historians and the Birth of Consumer Society. *Working Paper* 12. <http://www.consume.bbk.ac.uk/publications.html-bibliography>.
- . 2010. Microhistory and the Histories of Everyday Life. *Cultural and Social History* 7(1): 87–109.
- Broadberry, Stephen., Guan, Hanhui. and Li, David D. 2018. China, Europe, and the Great Divergence: A Study in Historical National Accounting, 980–1850. *Journal of Economic History* 78(4): 955–1000.

- Broadberry, Stephen. and Gupta, Bishnupriya. 2006. The Early Modern Great Divergence: Wages, Prices and Economic Development in Europe and Asia. *Economic History Review* 59: 2–31.
- Broadberry, Stephen., and Hindle, Stephen. 2011. Asia in the Great Divergence. *Economic History Review* 64: 1–184.
- Brook, Timothy. 1999. *The Confusions of Pleasure: Commerce and Culture in Ming China*. Berkeley and Los Angeles: University of California Press.
- . 2008. *Vermeer's Hat: The Seventeenth Century and the Dawn of the Global World*. New York: Bloomsbury Press.
- . 2010. *The Troubled Empire: China in the Yuan and Ming Dynasties*. Cambridge: Harvard University Press.
- Brook, Timothy, and Blue, Gregory. 1999. *China and Historical Capitalism Genealogies of Sinological Knowledge*. Cambridge: Cambridge University Press.
- Bruxo, Jorge, Díaz de Seabra, Lenor, and Escaleira, Lurdes. 2017. *Portugueses no Oriente: Uma narrativa dos seculos XV a XIX*. Macau: Instituto Politecnico de Macau.
- Buti, Gilbert. 2005. Négoce, famillas et pouvoirs en Provence au XVIII siècle. *Annales de Bretagne et des Pays de l'Ouest* 112: 201–215.
- Bryant, Joseph. 2006. The West and the Rest Reunited: Debating Capitalist Origins, European Colonialism and the Advent of Modernity. *Canadian Journal of Sociology* 31(4): 403–444.
- Caillé, Alain. 1991. Donner, recevoir et rendre: l'autre paradigme. *Revue du MAUSS* 11: 3–89.
- Caldeira, Arlinda. 2007. A divulgação do tabaco brasileiro na China. A miragem de um mercado. *Revista de Cultura / Review of Culture, Edição Internacional* 21: 136–153.
- Callaghan, Michael, and Hubbard, Paul. 2016. The Asian Infrastructure Investment Bank: Multilateralism on the Silk Road. *China Economic Journal* 9(2): 116–139.
- Campbell, Cameron, Lee, James Z., and Elliott, Mark. 2002. Identity Construction and Reconstruction: Naming and Manchu Ethnicity in Northeast China, 1749–1909. *Historical Methods: A Journal of Quantitative and Interdisciplinary History* 35(3): 101–115.
- Cao, Jin, and Flynn, Dennis. 2019. Global Quantification and Inventory Demand for Silver in China. *Journal of Iberian and Latin American Economic History*: 1–27.
- Cao, Ling. 2004. Ming Qing meizhou liangshi zuowu chuanru zhongguo yanjiu zongshu [The Overview of the Studies on the Introduction of American Cereal Crops in Ming Qing Dynasty]. *Ancient and Modern Agriculture* 2: 95–103.
- Cao, Shuji. 2001. *The Population History of China, vol.5: Period of Qing Dynasty*. Shanghai: Fudan University Press.

- Carmagnani, Marcello. 2012. *Las islas del lujo. Productos exóticos, nuevos consumos y cultura económica, 1650–1800*. Madrid: Marcial Pons-El Colegio de México.
- Carneiro de Sousa, Ivo. 2010. População e sistema demográfico em Macau (seculos XVI-XVIII). *Revista de Cultura / Review of Culture, Edição Internacional* 33: 75–98.
- . 2014. The First French in Macao: The Jesuit Alexandre de Rodes (1591/93–1660). *Revista de Cultura / Review of Culture, Edição Internacional* 44: 122–144.
- Carrière, Charles. 1973. *Négociants marseillais au XVIIIe siècle. Contribution à l'étude des économies maritimes*. Marseille: Institut historique de Provence.
- Casado, Hilario. 2004. Guilds, Technical Progress and Economic Development in Preindustrial Spain. In Massa, Paola, and Maioli, Angelo (eds.), *Dalla corporazione al mutuo soccorso. Organizzazione e tutela del lavoro tra XVI e XX secolo*, 309–327. Milan: Franco Angeli.
- Casey, James. 1989. *The History of the Family*. Oxford: Basil Blackwell.
- . 2007. *Family and Community in Early Modern Spain*. Cambridge: Cambridge University Press.
- Cervera, José Antonio. 2015. *Cartas del parián. Los chinos de Manila a finales del siglo XVI a través de los ojos de Juan Cobo y Domingo Salazar*. México: Palabra de Clio.
- Chan, Gerald. 2013. China Faces the World: Making Rules for a New Order? *Journal of Global Policy and Governance* 2(1): 105–119.
- Chang, Chung-Li. 1955. *The Chinese Gentry: Their Role in 19th Century Chinese Society*. Seattle: University of Washington Press.
- . 1962. *The Income of the Chinese Gentry: A Sequel to the Chinese Gentry*. Seattle: University of Washington Press.
- Chan, Joseph. 2004. Exploring the Nonfamilial in Confucian Political Philosophy. In Bell, Daniel A. and Chaihark, Hahm (eds.), *The Politics of Affective Relations: East Asia and Beyond*, 61–74. Lanham: Lexington Books.
- Chan, Sin-wai, and Pollard, David E. 2001. *An Encyclopedia of Translation: Chinese-English, English-Chinese*. Hong-Kong: Chinese University Press.
- Chan, Ta-Chien, Pai, Pi-Ling, Shaw, Shih-Lung, and Fan, I-Chun. 2015. Spatiotemporal Evolution of Market Towns in the Jiangnan Area During the Ming-Qing Dynasties of China. *Historical Methods: A Journal of Quantitative and Interdisciplinary History* 48(2): 90–102.
- Chan, Wing-ming. 2003. Official Historiography and Ideological Indoctrination in High Qing: Emperor Qianlong's Compilation of the "Erchen Zhuan" and "Nichen Zhuan". *Oriens Extremus* 44: 253–274.
- Chan, Wing-tsit. 1986. *Neo-Confucian Terms Explained (The Pei-his tzu-i) by Ch'en Ch'un, 1159–1223*. New York: Columbia University Press.
- Chao, Kang. 1986. *Man and Land in Chinese History: an Economic Analysis*. Stanford: Stanford University Press.

- Chaunu, Pierre. 1960. *Les Philippines et le Pacifique des Ibériques*. Paris: Sevpen.
- . 1962. Manille et Macao, face à la conjuncture des XVIe et XVIIe siècles. *Annales: Économies, sociétés, civilisations* 17(3): 555–580.
- Chen, Cheng-siang. 1965. *Chung-kuo fang-chih ti ti-li hsüeh chia-chih*. Hong Kong: Chinese University of Hong Kong.
- Cheng, Meibao. 2005. Globalization, Global History, and History Studies in China. *Chinese Studies in History* 42(3): 51–56.
- Chen, Huan-Chang. 1911. *The Economic Principles of Confucius and His School*. New York: Columbia University Press.
- Ch'en, Jerome. 1983. The Chinese Communist Movement to 1927. In Fairbank, John K. (ed.), *The Cambridge History of China, vol. 12: Republican China 1912–1949, Part 1*, 505–526. Cambridge: Cambridge University Press.
- Chen, Ling. 2011. Interaction of Taoism and Science and Technology. *Philosophical Trends* 11: 41–47.
- Chen, Xiaolü. 2013. Dui da fenliu yuantou de zhuisuo dou peng mu lan da fenliu: ouzhou zhongguo ji xiandai shijiejingji de fazhan [The Pursuit of the Source of the Great Diversion: The Development of European China and the Modern World]. *Journal of Peking University (Philosophy & Social Sciences)* 2: 154–157.
- . 2004. *Shiwu shiji yilai shijie zhuyao fada guojia fazhan licheng [The Courses of Development of the Major Developed Countries in the World since the 15th Century]*. Chongqing: Chongqing chubanshe.
- Chen, Zhiwu. 2006. China's Stock Market in Historical Perspective. *The PB Newsletter* 5: 29–40.
- Chen, Zhongping. 2001. The Origins of Chinese Chambers of Commerce in the Lower Yangzi Region. *Modern China* 27(2): 155–201.
- Cheng, Z. and Lan, R. 2009. *Zhongguo Jinxiandai Jingjishi Jiaocheng [A Standard Economic History of Early Modern and Modern China]*. Beijing: Tsinghua University Press.
- Cheong, Weng E. 1997. *Hong Merchants of Canton: Chinese Merchants in Sino-Western Trade, 1684–1798*. London: Routledge.
- Childe, Gordon. 1950. *The Dawn of European Civilization*. London: Routledge.
- Chilosi, David, and Federico, Giovanni. 2015. Early Globalizations: The Integration of Asia in the World Economy, 1800–1938. *Explorations in Economic History* 57: 1–18.
- Chin, Gregory T. 2016. Asian Infrastructure Investment Bank: Governance Innovation and Prospects. *Global Governance* 22(1): 11–26.
- Chin, Tamara. 2013. The Invention of the Silk Road, 1877. *Critical Inquiry* 40(1): 194–219.
- Chu, Shi-chia. 1942. *A Catalogue of Chinese Local Histories in the Library of Congress*. Washington: U.S. Government.

- Ch'ü, T'ung-tsu. 1957. Chinese Class Structure and Its Ideology. In Fairbank, John K. *Chinese Thoughts and Institutions*. Chicago: University of Chicago Press.
- . 1962. *Local Government in China Under the Ch'ing*. Cambridge: Harvard University Press.
- Clagett, Marshall. 1959. *The Science of Mechanics in the Middle Ages*. Madison: University of Wisconsin Press.
- Clunas, Craig. 1997. *Pictures and Visuality in Early Modern China*. Princeton: Princeton University Press.
- Creel, Herrlee G. 1932. Was Confucius Agnostic? *T'oung Pao* 29(1/3): 55–99.
- Coatsworth, John. 2008. Inequality, Institutions and Economic Growth in Latin America. *Journal of Latin American Studies* 40(3): 545–569.
- Coclanis, Peter. 2001. Ten Years After: Reflections on Kenneth Pomeranz's The Great Divergence. *Historically Speaking* XII(4): 10–25.
- Conrad, Sebastian. 2016. *What Is Global History?* Princeton: Princeton University Press.
- de la Costa, Horacio. 1950. Church and State in the Philippines during the Administration of Bishop Salazar, 1581–1594. *The Hispanic American Historical Review* 30(3): 314–335.
- Cox, Gary W. 2017. Political Institutions, Economic Liberty, and the Great Divergence. *The Journal of Economic History* 77(3): 724–755.
- Crosby, Alfred W. 1972. *The Columbian Exchange: Biological and Cultural Consequences of 1492*. Westport: Greenwood Press.
- Crossley, John Newsome. 2016. *The Dasmariñases, Early Governors of the Spanish Philippines*. London: Routledge.
- Curtin, Philip. 1984. Overland Trade of the Seventeenth Century: Armenian carriers between Europe and East Asia. In Curtin, Philip (ed.), *Cross-Cultural Trade in World History*, 179–206. Cambridge: Cambridge University Press.
- Danley, Mark, and Speelman, Patrick. 2012. *The Seven Years' War: Global Views History of Warfare*. Leiden: Brill.
- Darwin, John. 2009. *The Empire Project: The Rise and Fall of the British World System 1830–1970*. Cambridge: Cambridge University Press.
- . 2012. *Unfinished Empire: The Global Expansion of Britain*. London: Penguin.
- . 2013. Empire and Globe. In Berg, Maxine (ed.), *Writing the History of the Global: Challenges for the 21st Century*, 197–199. Oxford: Oxford University Press.
- Dawson, Raymond S. 1967. *The Chinese Chameleon. An Analysis of European Conceptions of China*. London: Oxford University Press.
- Day, John D. 1995. The Search for the Origins of the Chinese Manuscript of Matteo Ricci's Maps. *Imago Mundi* 47: 94–117.

- D'Elia, Pasquale. 1934. Quadro storico sinologico del primo libro di Dottrina cristiana in cinese. *AHSI* 3: 193–222.
- . 1961. Recent Discoveries and New Studies (1938–1960) on the World Map in Chinese of Father Matteo Ricci, S.J. *Momumenta Serica* 20: 84–164.
- . 2003. *Le maire et le prieur: pouvoir central et pouvoir local en Méditerranée occidentale, XVe-XVIIIe siècle*. Rome: École française de Rome.
- Deng, Kent. 1993. *Development Versus Stagnation: Technological Continuity and Agricultural Progress in Pre-modern China*. London: Greenwood Press.
- . 2000. A Critical Survey of Recent Research in Chinese Economic History. *Economic History Review* LIII 1: 1–28.
- . 2011. *China's Political Economy in Modern Times: Changes and Economic Consequences, 1800–2000*. London: Routledge Press.
- . 2015. The Continuation and Efficiency of the Chinese Fiscal State, 700 BC–AD 1911. In Yun-Casalilla, Bartolome and O'Brien, Patrick (eds.), *The Rise of Fiscal States: A Global History, 1500–1914*, 335–352. Cambridge: Cambridge University Press.
- . 2016. *Mapping China's Growth and Development in the Long Run: 221 BC to 2020*. London: World Scientific Publishing.
- Deng, Kent, and O'Brien, Patrick. 2016. China's GDP Per Capita from the Han Dynasty to Communist Times. *World Economics Journal* 17(2): 79–123.
- . 2017. Quantifying the Quantifiable: A Reply to Jan-Luiten van Zanden and Debin Ma. *World Economics* 18(1): 215–223.
- Deng, Xiaoping. 1981. *Resolution on Certain Questions in the History of Our Party Since the Founding of the People's Republic of China*. Beijing: Foreign Languages Press.
- . 1983. *Muqian de xingshi he renwu [The Present Situation and Tasks], 16 January 1980, Deng Xiaoping wenxuan [Selected Works of Deng Xiaoping], vol. 2*. Beijing: Xinhua.
- Dermigny, Louis. 1964. *La Chine et l'occident: le commerce à Canton au XVIIIe siècle*. Paris: Sevpén.
- Díaz de Seabra, Leonor. 2011. *A Misericórdia de Macau (séculos XVI a XIX) : irmandade, poder e caridade na idade do comércio = Aomen Rencitang (shi liu zhi shi jiu shi ji) : zai mao yi nian dai de hui zhong, ying xiang li, ci shan shi ye = The Holy House of Mercy in Macau (16th–19th century) : Brotherhood, Power and Charity in the Age of Trade*. Macau: University of Macau.
- Díaz-Trechuelo, Lourdes. 1965. *La Real Compañía de Filipinas*. Sevilla: Escuela de Estudios Hispano-Americanos.
- Dincecco, Mark. 2014. The Rise of Effective States in Europe. *Journal of Economic History* 75(3): 901–918.
- Dingle, Edwin J. 1912. *China's Revolution, 1911–1912*. Shanghai: Commercial Press.

- Dirlik, Arif. 2005. Performing the World: Reality and Representation in the Making of World Histor(ies). *Journal of World History* 16(4): 391–410.
- Disney, Anthony. 1989. Smugglers and Smuggling in the Western Half of the Estado da India in the late Sixteenth Century and early Seventeenth Century. *Indica* 26: 57–75.
- Dollar, David. 2015. *China's Rise as a Regional and Global Power: The AIBB and the One Belt One Road*. Washington, DC: Brookings Institution.
- Douki, Caroline and Minard, Philippe. 2007. Histoire globale, histoires connectées: un changement d'échelle historiographique? *Revue d'histoire moderne et contemporaine* 5(54-4bis): 7–21.
- Dow, Francis D.M. 1965. *A Study of Chiang-su and Che-Chiang Gazetteers of the Ming Dynasty*. Canberra: Australian National University.
- Drayton, Richard and Motadel, David. 2018. Discussion: the Futures of Global History. *Journal of Global History* 13(1): 1–21.
- Duchesne, Ricardo. 2001. Between Sinocentrism and Eurocentrism: Debating A.G. Frank's Re-Orient in the Asian Age. *Science & Society* 65(4): 428–463.
- . 2004. On the Rise of the West. Researching Kenneth Pomeranz's Great Divergence. *Review of Radical Political Economics* 36: 52–81.
- . 2011. *The Uniqueness of Western Civilization*. Leiden: Brill Academic Publishers.
- Dunstan, Helen. 2014. The Finance of Imperial Munificence: How Simple Quantitative Work Can Help Us Rethink High-Qing History. *Young Pao* 100(1–3): 164–236.
- Eichengreen, Barry. 2006. *Global Imbalances and the Lessons of Bretton Woods*. Cambridge: MIT Press.
- . 2015. *Hall of Mirrors: The Great Depression, The Great Recession, and the Uses-and Misuses-of History*. New York: Oxford University Press.
- Elegant, Robert S. 1980. *Manchu*. New York: McGraw-Hill.
- Elison, George. 1973. The Accomodative Method, the Jesuit Mission Policy and Cultural Contribution. In Elison, George (ed.), *Deus Destroyed. The Image of Christianity in Early Modern Japan*, 54–84. Cambridge: Harvard University Press.
- Elliott, John H. 1986. *The Count-Duke Olivares: The Statesman in an Age of Decline*. New Haven: Yale University Press.
- . 2002. *Imperial Spain: 1469–1716*. London: Penguin Books.
- Elliott, Mark. 2001. *The Manchu Way: The Eight Banners and Ethnic Identity in Late Imperial China*. Stanford: Stanford University Press.
- Elson, Anthony. 2013. *Globalization and Development: Why East Asia Surged Ahead and Latin America Fell Behind*. New York: Palgrave-Macmillan.
- Elvin, Mark. 1973. *The pattern of the Chinese past*. London: Eyre Methuen.
- . 2004. *The Retreat of the Elephants. An Environmental History of China*. London: Yale University Press.

- Engerman, Stanley. 1972. The Slave Trade and British Capital Formation in the Eighteenth Century: A Comment on the Williams Thesis. *Business History Review* 46: 430–443.
- Epstein, Stephen R., and Prak, Maarten. 2008. *Guilds, innovation and the European economy 1400–1800*. Cambridge: Cambridge University Press.
- Fairbank, John K. 1989. State and Society under the Ming. In Fairbank, John K, Reischauer, Edwin. and Craig, Albert (eds.), *East Asia: Tradition and Transformation*, 177–210. Cambridge: Cambridge University Press.
- . 2006. *China: A New History*. Cambridge: Harvard University Press.
- Fairchilds, Cissie. 1993. Consumption in Early Modern Europe: A review article. *Comparative Studies in Society and History* 35(4): 854.
- Fang, Chen-Chen. 2010. Linen Export of the Chinese Southeast Coast and Taiwan in the Mid and Late 17th Century: A Study Based on Spanish Sources (in Chinese). *Taiwan Studies in Literature and History* 2: 146–198.
- . 2017. The Trade between Manila and South Asia in the Seventeenth Century (in Chinese). *Cheng Kung Journal of Historical Studies* 53: 179–227.
- Fang, Xing. 1996. Qingdai Jiangnan nongmin de xiaofei” [Jiangnan Peasants’ Consumption During the Qing]. *Zhongguo jingjishi yanjiu [Researches in Chinese Economic History]* 3: 91–98.
- Fan, Jinmin, Guoji, Minsheng, Shehui, Mingqing, Yanjiu, and Jingji. 2008. *National Economy and People’s Livelihood in the Ming-Qing Period*. Fuzhou: Fujian People’s Press.
- Faire, David. 2007. *Emperor and Ancestor: State and Lineage in South China*. Stanford: Stanford University Press.
- . 2006. *China and Capitalism. A History of Business Enterprise in Modern China*, Hong Kong: Hong Kong University Press.
- Feng, Emily. April 2017. Ideological Purge Hits China Universities with Western Ties. *Financial Times*. <https://www.ft.com/content/8a7552d8-1f68-11e7-a454-ab04428977f9>.
- Fernandez-Armesto, Felipe. 2001. *Civilizations: Culture, Ambition, and the Transformation of Nature*. London: Pan Books.
- Feuerwerker, Albert. 1958. *China’s Early Industrialization: Sheng Hsuan-huai (1862–1874) and Mandarin Enterprise*. Cambridge: Harvard University Press.
- . 1976. *State and Society in Eighteenth-Century China: the Ch’ing Empire in Its Glory*, Ann Arbor: University of Michigan Press.
- Fish, Shirley. 2003. *When Britain ruled the Philippines, 1762–1764: the story of the 18th century British invasion of the Philippines during the Seven Years War*. Bloomington: Ist Books Library.
- Flores, Jorge Manuel. 2000. China e Macau 2. O tempo da euforia. In de Oliveira Marques, Antonio H (ed.), *História dos Portugueses no Extremo Oriente. 1–2. De Macau à periferia*, 179–213. Lisbon: Fundação Oriente.

- Floud, Roderick, and McCloskey, Dierdre. 1994. *The Economic History of Britain Since 1700. Vol. I: 1700–1860*. Cambridge: Cambridge University Press.
- Flynn, Dennis O. 2019. Big History, Geological Accumulations, Physical Economics, and Wealth. *Asian Review of World Histories* 7: 80–106.
- Flynn, Dennis O., and Giraldez, Arturo. 1996. China and the Spanish Empire. *Journal of Iberian and Latin American Economic History* 14(2): 309–338.
- . 1996. Silk for Silver: Manila-Macao Trade in the 17th Century. *Philippine Studies* 44(1): 52–68.
- . 2010. *China and the Birth of Globalization in the Sixteenth Century*. London: Ashgate.
- Folch, Dolores. 2002. *La construcción de China*. Barcelona: Ediciones Península.
- Frank, Andre Gunder. 1969. *Latin America: Underdevelopment or Revolution*. New York: Monthly Review Press.
- . 1998. *Re-Orient. Global Economy in the Asian Age*. Berkeley: University of California Press.
- Franke, Wolfgang. 1983. *An Introduction to the Sources of Ming History*. Kuala Lumpur: University of Malaya Press.
- Frankopan, Peter. 2015. *The Silk Roads: A New History of the World*. London: Bloomsbury Publishing.
- Fudenberg, Drew, and Tirole, Jean. 1991. *Game Theory*. Cambridge: MIT Press.
- Fung, Yu-lan. 1953. *A History of Chinese Philosophy: volume II, The Period of Classical Learning*. Bodde, Derk (trans.). Princeton: Princeton University Press.
- Gallagher Louis. 1953. *China in the Sixteenth Century: The Journals of Matthew Ricci, 1583–1610*. New York: Random House.
- Gan, Nectar. 2017. Chinese Universities Tighten Ideological Control of Teaching Staff. *South China Morning Post*. <https://www.scmp.com/news/china/policies-politics/article/2108597/china-universities-tighten-ideological-control-teaching>.
- Gao, Shujuan and Feng, Bin. 2003. *Comparative Outline of Chinese and Japanese Foreign Policy: Central Trade Policy in the Final Years of the Imperial Era [in Chinese]*. Beijing: Tsinghua University Publishing.
- García-Abasolo, Antonio. 2011. Los chinos y el modelo colonial español en Filipinas. *Cuadernos de Historia Moderna* X: 223–242.
- Gasster, Michael. 1980. The Republican Revolutionary Movement. In Fairbank, John K. (ed.), *The Cambridge History of China, vol. 11: Late Ch'ing, Part 2*, 494. Cambridge: Cambridge University Press.
- Ge, Jianxiong and Cao, Shuji. 2001. *Zhongguo renkoushi [History of China's Population]*. Shanghai: Fudan University Press.
- Gernet, Jacques. 1981. *China and the Christian Impact: A Conflict of Cultures*. Cambridge: Cambridge University Press.

- Gerritsen, Anne, and McDowall, Stephen. 2012. Material Culture and the Other: European Encounters with Chinese Porcelain, ca. 1650–1800. *Journal of World History* 23(1): 87–113.
- Ge, Zhaoguang. 2018. The “Interior” and the “Exterior” in Historical China: A Re-Clarification of the Concepts of “China” and the “Periphery.” *Chinese Studies in History* 51(1): 4–28.
- Gibbons, Robert. 2001. *A Primer in Game Theory*. London: Harvester Wheatsheaf.
- Gies, Frances, and Gies, Joseph. 1994. *Cathedral, Forge, and Waterwheel: Technology and Invention in the Middle Ages*. New York: HarperCollins.
- Gil, Juan. 2011. *Los chinos en Manila siglos XVI y XVII*. Lisboa: Centro Científico e Cultural de Macau.
- Gillespie, Michael A. 2008. *The Theological Origins of the Rise of Early Modernity*. Chicago: University of Chicago Press.
- Gills, Barry K., and Thompson, Williams R. 2006. *Globalization and Global History*. London: Routledge.
- Gimpel, Jean. 1977. *The Medieval Machine*. London: Victor Gollancz.
- Gipouloux, François. 2011. *The Asian Mediterranean. Port Cities and Trading Networks in China, Japan and Southeast Asia, 13th–21st Century*. Cheltenham: Edward Elgar.
- Goldstone, Jack. 2008. *Why Europe? The Rise of the West in World History*. New York: McGraw-Hill Education.
- Gonzalez de Arce, José Damían. 2017. *El negocio fiscal en la Sevilla del siglo XV. El almojarifazgo mayor y las compañías de arrendatarios*. Sevilla: Diputación de Sevilla.
- Goody, Jack. 1983. *The Development of the Family and Marriage in Europe*. Cambridge: Cambridge University Press.
- Grass, Noa. 2017. Imperial Silver Laundering: The Official Narrative on Gold Floral Silver and the Silverization of Ming State Finance. *Ming Studies* 76: 7–31.
- Green, Nile. 2013. Maritime Worlds and Global History: Comparing the Mediterranean and Indian Ocean through Barcelona and Bombay. *History Compass* 11(7): 513–523.
- Greif, Avner. 2005. Commitment, Coercion, and Markets: The Nature and Dynamics of Institutions Supporting Exchange. In Menard, Claude, and Shirley, Mary (eds.), *The Handbook for New Institutional Economics*, 727–786. Norwell: Kluwer Academic.
- . 2006. *Institutions and the Path to the Modern Economy: Lessons from Medieval Trade*. Cambridge: Cambridge University Press.
- Greif, Avner, and Tabellini, Guido. 2017. The Clan and the Corporation: Sustaining Cooperation in China and Europe. *Journal of Comparative Economics* 45(1): 1–35.

- Gruzinski, Serge. 1988. *La colonisation de l'imaginaire: Sociétés indigènes et occidentalisation dans le Mexique espagnol (XVI-e–XVIII-e siècle)*. Paris: Éditions Gallimard.
- . 2001. Les mondes mêlés de la Monarchie catholique et autres connected histories. *Annales* 51(1): 85–117.
- . 2014. *The Eagle and the Dragon: Globalization and European Dreams of Conquest in China and America in the Sixteenth Century*. Cambridge: Polity Press.
- Guangzhou Liwan District People's Government. 2002. *Qing Gong Guang Zhou Shi San Hang Dang An Jing Xuan*. Guangzhou: Guangdong Economic Press.
- Guo, Yezhou. 2017. Zhonggongzhongguoyangbangongting guowuyuan-bangongting yinfa: Guanyushishi zhonghuayouxu chuantongwenhua chuanchengfazhan gongcheng de yijian. [The General Office under the CPC Central Committee and the State Council Issue: Suggestions on the Implementation of Projects to Promote and Develop Traditional Chinese Cultural Excellence]. *Xinhuashe* January 25.
- Gutierrez, Lucio. 1976. Domingo de Salazar O.P, Primer Obispo de Filipinas, 1512–1594. Estudio crítico-histórico sobre su vida y su obra. *Philippiniana Sacra* XI(33): 449–496.
- du Halde, Jean-Baptiste. 1735. *Description Geographique, Historique, Chronologique, Politique, et Physique de l'Empire de la Chine et de la Tartarie Chinoise, vols. 1–4*. Paris: The Beijing Center Library of Chinese Studies, Rare Book Collection.
- Hall, Bert S., and West, Delno C. 1976. *On Pre-Modern Technology and Science: A Volume of Studies in Honor of Lynn White, Jr.* Malibu: Undena Publications.
- Hamashita, Takeshi. 2006. *Zhongguo jindai jingji shi yanjiu [Research on Modern Chinese Economic History, Maritime Customs Finance in Late Qing and Market Networks of Treaty Ports]*. Nanjing: Jiangsu People's Press.
- . 2015. *Trade and Finance in Late Imperial China: Maritime Customs and Open Port Market Zones*. Singapore: Singapore University Press.
- Hao, Xiajun, et al. 1996. *Zhongxi 500 nian bijiao [Comparison between China and the West in 500 Years]*. Beijing: Zhongguo gongren chubanshe.
- Harrison, John A. 1972. *The Chinese Empire: A Short History of China from Neolithic Times to the End of the Eighteenth Century*. New York: Harcourt Brace.
- Hartwell, Robert M. 1963. *Iron and Early Industrialism in Eleventh-Century China*. Chicago: University of Chicago.
- Hau, Caroline S. 2003. The Question of Foreigners: Bai Ren's Nanyang Piaoliuji and the Re/Making of Chinese and Philippines Nationness. In Siegel, James T., and Kahnin, Audrey R (eds.), *Southeast Asia Over Three Generations: Essays Presented to Benedict R.O'G. Anderson*, 189–222. Ithaca: Cornell University Press.

- . 2014. *The Chinese Question: Ethnicity, Nation, and Region in and Beyond the Philippines*. Singapore: Singapore University Press.
- Haupt, Heinz-Gerhard and Kocka, Jürgen. 2009. *Comparative and Transnational History: Central European Approaches and New Perspectives*. New York: Berghahn Books.
- Hausberger, Bernd, and Ibarra, Antonio. 2014. *Oro y plata en los inicios de la economía global: de las minas a la moneda*. México: El Colegio de México.
- Hausberger, Bernd. 2018. *La globalización temprana*. México: El Colegio de México.
- Hayami, Akira. 1976. Joron: keizaishakai no seiritsu to sonotokushutu [Introduction: The Emergence of Economic Society and Its Characteristics]. In Socio-Economic History Society (ed.), *Searching for New Historical View of Edo-Era [Atarashii Edo-Jidaishizō wo Motomete]*, 3–18. Tokyo: Tōyō Keizai Shimpōsha.
- . 2015. *Japan's Industrious Revolution: Economic and Social Transformations in the Early Modern Period*. Tokyo: Springer.
- Hayhoe, Ruth. 1984. The Evolution of Modern Educational Institutions. In Hayhoe, Ruth (ed.), *Contemporary Chinese Education*, 93–153. London: Croom Helm.
- He, Ping. 1998. *Qingdai fushui zhengce yanjiu [Research on Qing Taxation Policy]*. Beijing: Chinese Academy of Social Science Press.
- Hervouet, Yves. 1957. *Catalogue des monographies locales chinoises dans les bibliothèques d'Europe*. Paris: Mouton.
- Herzog, Tamar. 2015. *Frontiers of Possession: Spain and Portugal in Europe and the Americas*. Cambridge: Harvard University Press.
- Heyns, Pol, and Cheng, Wei-Chung. 2005. *Dutch Formosan Placard-book, Marriage, and Baptism Records*. Taipei: Ts'ao Yung-ho Foundation for Culture and Education.
- Holstein, Diego. 2015. *Thinking History Globally*. New York: Palgrave Macmillan.
- Ho, Ping-Ti. 1959. Aspects of Social Mobility in China, 1368–1911. *Comparative Studies in Society and History* 1(4): 330–359.
- . 1959. *Studies on the Population of China, 1368–1953*. Cambridge: Harvard University Press.
- . 1979. Meizhou zuowu de yinjin, chuanbo ji qi dui zhongguo liangshi shengchan de yingxiang [On the Introduction, Distribution of American Crops and Their Influence on Chinese Agricultural Production]. *World Agriculture* 4: 21–41.
- Hopkins, Terrence K., and Wallerstein, Immanuel. 1986. Commodity Chains in the World-Economy Prior to 1800. *Review (Fernand Braudel Center)* 10(1) 157–170.

- Horsley, Margaret. 1950. *Sangley: The Formation of Anti-Chinese Feeling in the Philippines: A Cultural Study of the Stereotypes of Prejudice*. Ph.D. diss: Columbia University.
- Howland, Douglas R. 1996. *Borders of Chinese Civilization: Geography and History at Empire's End*. Durham: Duke University Press.
- Hsü, Dau-lin. 1970. The myth of the "Five Human Relations" of Confucius. *Monumenta Serica* 29(1): 27–37.
- Hsun, Lu. 1960. A Happy Family. In Hsun, Lu (ed.), *Selected Stories of Lu Hsun*. Beijing: Foreign Languages Press.
- Hosne, Ana Carolina. 2013. *The Jesuit Missions to China and Peru, 1570–1610. Expectations and Appraisals of Expansionism*. London: Routledge.
- . 2011. Shaping Virtuous Friendship: The Jesuit Matteo Ricci (1552–1610) in Late Ming China. *European University Institute Working Papers MWP*(25).
- Huang, Pei. 2011. *Reorienting the Manchus: A Study of Sinicization, 1583–1795*. Ithaca: Cornell University Press.
- Huang, Philip C.C. 1985. *The Peasant Economy and Social Change in North China*. Stanford: Stanford University Press.
- Huang, Ray. 1974. *Taxation and Governmental Finance in Sixteenth-Century Ming China*. Cambridge: Cambridge University Press, 1974.
- Hucker, Charles O. 1975. *China's Imperial Past: An Introduction to Chinese History and Culture*. Stanford: Stanford University Press.
- Hu-DeHart, Evelyn. 2013. Integration and Exclusion: The Chinese in Multiracial Latin America and the Caribbean. In Tan, Chee-Beng (ed.), *Routledge Handbook of the Chinese Diaspora*. New York: Routledge.
- Huff, Toby E. 1993. *The Rise of Early Modern Science: Islam, China and the West*. Cambridge: Cambridge University Press.
- Humphries, Jane. 2013. The First Industrial Nation and the First 'Modern' Family. In Owens, Alastair, Arrizabalaga, Marie-Pierre, Borderías, Cristina and Addabbo, Tindara (eds.), *Gender Inequalities, Households and the Production of Well-Being in Modern Europe*, 41–58. Farnham: Routledge.
- Humphries, Jane, and Schneider, Benjamin. 2019. Spinning the Industrial Revolution. *The Economic History Review* 72(1): 126–155.
- Humphrey, Charles. 2015. *Developmental Revolution or Bretton Woods Revisited?* London: Overseas Development Institute.
- Hung, Ho-fung. 2009. Cultural Strategies and the Political Economy of Protest in Mid-Qing China, 1740–1839. *Social Science History* 33(1): 75–115.
- Huntington, Samuel. 1996. *The Clash of Civilizations and the Remaking of World Order*. New York: Simon & Schuster.
- Ibarra, Antonio. 2017. Mercancías globales y mercados locales en Nueva España: La circulación interior de 'efectos de China' en Guadalajara, a fines de la época colonial. In Valle Pavón, Guillermina, and Ibarra, Antonio (eds.), *Redes*,

- corporaciones comerciales y mercados hispanoamericanos en la economía global, siglos XVII-XIX*, 363–393. México: CONACyT/Instituto Mora.
- . 2019. El mundo en una nuez: de Calcuta y Canton a Buenos Aires en una época de guerra. La introducción de efectos asiáticos en los mercados suramericanos, 1805–1807. *Journal of Iberian and Latin American Economic History*: 1–34.
- Inikori, Joseph. 1989. Slavery and the Revolution in Cotton Textile Production in England. *Social Science History* 13: 343–379.
- Iradiel Murugarren, Paulino. 1974. *Evolución de la industria textil castellana en los siglos XIII-XVI*. Salamanca: Universidad de Salamanca.
- Irigoin, Alejandra. 2009. The End of a Silver Era: The Consequences of the Breakdown of the Spanish Peso Standard in China and the United States, 1780s–1850s. *Journal of World History* 20(2): 207–244.
- Irigoin, Alejandra, and Grafe, Regina. 2013. Bounded Leviathan: Fiscal Constraints and Financial Development in the Early Modern Hispanic World. In Coffman, D’maris, Leonard, Adrian, and Neal, Larry (eds.), *Questioning Credible Commitment: Perspectives on the Rise of Financial Capitalism*, 199–227. Cambridge: Cambridge University Press.
- Iwai, Shigeki. 2004. *Zhongguo jin shi caizheng shi yanjiu [A Study on Early Modern Fiscal History of China]*. Kyoto: Kyoto University Press.
- Jauregui, Luis and Aguilar, Luis. 2005. *Penuria sin fin. La historia de los impuestos en México, siglos XVIII al XX*. México: Instituto Mora-Conacyt.
- Jia, Shubing. 2012. *The Dissemination of Western Music through Catholic Missions in High Qing China (1662–1795)*. Bristol: University of Bristol.
- Jiang, Tao. 1990. Qingdai renkou tongji zhidu yu 1741–1851 nianjian de Zhongguo renkou [The Demographic System of the Qing Dynasty and China Population in 1741–1851]. *Jindaishi yanjiu* 5: 26–50.
- Jiayun, Shi. 2011. A Reevaluation of Chinese and Western Comparative History. *Chinese Studies in History* 45(1): 28–51.
- Johnson, Christopher K. 2016. *President Xi Jinping’s “Belt and Road” Initiative*. Washington, DC: Center for Strategic and International Studies.
- Jones, Eric. 1987. *The European Miracle: Environments, Economies and Geopolitics in the History of Europe and Asia*. Cambridge: Cambridge University Press.
- Kamen, Henry. 2001. *Philip V of Spain: The King Who Reigned Twice*. New Haven: Yale University Press.
- . 2003. *Empire: How Spain Became a World Power, 1492–1763*. New York: Harper Collins.
- Kang, Chao. 1986. *Man and Land in Chinese History: An Economic Analysis*. Stanford: Stanford University Press.
- Karaman, Kivanç, and Pamuk, Çevket. 2011. Ottoman State Finances in European Perspective (1500–1914). *Journal of Economic History* 70: 593–629.

- Keen, Benjamin. November 1969. The Black Legend Revisited: Assumptions and Realities. *Hispanic American Historical Review* 49(4): 703–719.
- Kim, Hun Joon. 2016. Will IR Theory with Chinese Characteristics be a Powerful Alternative? *The Chinese Journal of International Politics*: 59–79.
- Kim, Youngmin, Lee, Ha-Kyoung, and Park, Seongun. 2019. The Confucian Tradition and Politics. *Oxford Research Encyclopedia of Politics Online Publication*: 1–19.
- Kishimoto, Mio. 2011. Property Rights, Land, and Law in Imperial China. Law and Long-Term Economic Change: A Eurasian Perspective. In Ma, Debin and van Zanden, Jan Luiten (eds.), *Law and Long Term Economic Change: A Eurasian Perspective*. Stanford: Stanford University Press.
- Klöter, Henning. 2011. *The Language of the Sangleys: A Chinese Vernacular in Missionary Sources of the Seventeenth Century*. Leiden: Brill.
- Ko, Chiu Y., Koyama, Mark, Sng, Tuan-Hwee. 2018. Unified China and divided Europe. *International Economic Review* 59(1): 285–327.
- Koyama, Mark, Moriguchi, Chiaki, Sng, Tuan-Hwee. 2018. Geopolitics and Asia's Little Divergence: A Comparative Analysis of State Building in China and Japan after 1850. *Journal of Economic Behaviour and Organization* 155: 178–204.
- Krishan, Kumar. 2014. The Return of Civilization—and of Arnold Toynbee? *Comparative Studies in Society and History* 56(4): 815–843.
- Kuhn, Philip A. 1990. *Soulstealers: The Chinese Sorcery Scare of 1768*. Cambridge: Harvard University Press.
- Kuznets, Simon. 1967. *Modern Economic Growth: Rate, Structure and Spread*. Yale: Yale University Press.
- Lamikiz, Xabier. 2011. Flotistas en la Nueva España: diseminación espacial y negocios de los intermediarios del comercio transatlántico, 1670–1702. *Colonial Latin American Review* 20(1): 9–33.
- Landes, David. 1998. *The Wealth and Poverty of the Nations: Why Some Are So Rich and Some So Poor*. New York: W.W. Norton.
- Laufer, Berthold. 1907. The Relations of the Chinese to the Philippine Islands. *Smithsonian Miscellaneous Collections* L: 259.
- Latourette, Kenneth Scott. 1929. *A History of Christian Missions in China, Volume I*. New York: The Macmillan Company.
- Lee, James Z., and Campbell, Cameron. 1997. *Fate and Fortune in Rural China: Social Organization and Population Behavior in Liaoning 1774–1873*. Cambridge: Cambridge University Press.
- Lee, James Z., and Wang, Feng. 1999. *One Quarter of Humanity: Malthusian Mythology and Chinese Realities, 1700–2000*. London: Harvard University Press.
- Legge, James. 1867. *Life and Teachings of Confucius*. London: Lippincott & Company.

- Leslie, Donald D. 1973. Local Gazetteers. In Leslie, Donald D., Mackerras, Colin, and Wang, Gungwu (eds.), *Essays on the Sources for Chinese History*, 71–75. Columbia: University of South Carolina Press.
- Leverett, Flynt. and Wu, Bingbing. 2016. The New Silk Road and China's Evolving Grand Strategy. *The China Journal* 77: 110–132.
- Levi, Giovanni. 1991. On Microhistory. In Burke, Peter (ed.), *New Perspectives on Historical Writing*, 93–113. Cambridge: Cambridge University Press.
- . 2019. Frail Frontiers? *Past and Present* 242(14): 37–49.
- Levine, David. 2001. *At the Dawn of Modernity: Biology, Culture, and Material Life in Europe after the Year 1000*. Berkeley: University of California Press.
- Levy, Marion J. 1954. Contrasting Factors in the Modernization of China and Japan. *Economic Development and Cultural Change* 2(3), 1954: 161–197.
- Liang, Fangzhong. 1935. Shuji pinglun: Ming Wanli kuaijilu [Book Commentary: The Account Book of Ming Wanli]. *Zhongguo jindai jingji shi yanjiu* 3(2): 292–298.
- . 1989. Mingdai guoji maoyi yu yinde shuchuru [Ming International Trade and Silver Imports and Exports]. In Liang, Fangzhong (ed.), *Liang Fangzhong jingji shi lunwen ji*, 132–179. Beijing: Zhonghua shuju.
- Liang, Jiabin. 1999. *Guangdong shi san hang kao* [Study on Guangdong Thirteen Honggs], Guangzhou: Guangdong renmin chubanshe.
- Liang, Shoude. 1994. International Politics with Chinese Characteristics. *Studies of International Politics* 1: 15–21.
- Liang, Zhan-Jun. 2006. “Quanqi shi yu shiji shi yitong chuyi [Comparing World History and Global History: a Chinese Scholar's View].” *Shoudu shifan daxue xuebao shehui kexue ben* [Journal of Capital Normal University] 3: 1–5.
- Lichtenstein, Natalie. 2018. *A Comparative Guide to the Asian Infrastructure Investment Bank*. Oxford: Oxford University Press.
- Lieberthal, Kenneth. 2004. *Governing China: From Revolution through Reform*. New York: Norton & Co.
- Lincong, Wang. 2002. A Brief Comment on the ‘Global View of History. *Shixuelilunyanjiu* [Historiography Quarterly] 3: 101.
- Li, Bozhong. 1985. Sang zheng daotian yu Ming-Qing nongye shengchan juyue chengdu de tigao [Mulberries Take Over Paddy Land and the Intensification of Agricultural Production in Jiangnan during the Ming and Qing]. *Zhongguo nongshi* [Journal of Chinese Agricultural History] 1: 1–12.
- . 1996. Cong fufu bing zuo dao nan geng nu zhi mingqing Jiangnan nongjia funu laodong wenti tantao zhiyi. *Zhongguo Jingji Shi Yanjiu*, 3: 99–107.
- . 1998. *Agricultural Development in Jiangnan, 1620–1850*. London: Palgrave Macmillan.
- . 2002. *Lilun, Fangfa, Qusi, Fazhan*. [Theory, Methodology and Developmental Trends]. Beijing: Tsinghua University Press.

- . 2010. *China's Early Modern Economy: A Study of GDP of the Huating-Lou Area in the 1820s*. Beijing: Zhonghua shuju.
- . 2017. *Guns and Account Books*. Beijing: SDX Joint Publishing Company.
- . 2019. 1524: The End of the Silk Road. Plenary Keynote Speech at the IV Congress of the Asian Association of World Historians, Osaka Japan.
- Li, Bozhong, and van Zanden, Jan Luiten. 2012. Before the Great Divergence? Comparing the Yangzi Delta and the Netherlands in the Beginning of the Nineteenth Century. *Journal of Economic History* 72(4): 956–989.
- Li, Cheng. 2014. China's Communist Party-state: The Structure and Dynamics of Power. In Joseph William A. (ed.), *Politics in China. An Introduction*, 192–223. New York: Oxford University Press.
- Li, Lillian. 1981. *China's Silk Trade: Traditional Industry in the Modern World 1842–1937*. Cambridge: Harvard University Press.
- Li, Longqing. 2000. Embracing a New Framework for Reconstructing World History. *Journal of Central China Normal University [Humanities and Social Sciences edition]* 39(4): 118.
- Li, Peilin. 2012. *Chinese Society: Change and Transformation*. New York: Routledge.
- Li, Qiang. 2011. Global History: A Representative of Those Reflecting on Occident-Centrism. *China Social Sciences Today* 9.
- Li, Qiang, Xu, Kang-Ning, and Wei, Wei. 2013. Kangqianshengshi zhen de cunzai ma? – Jiyujingji shuju cesuan de fenxi [Does the Kangxi and Qianlong Golden Age Really Exist?—An Analysis Based on Economic Data Calculation]. *Beijing Shehuikexue [Social Sciences of Beijing]* 1: 1–21.
- Li, Qingxin. 2010. *Nanhai I and The Maritime Silk Road*. Beijing: China Intercontinental Press.
- Li, Wang. 2014. Internationalization with Chinese Characteristics. The Changing Discourse of Internationalization in China. *Chinese Education and Society* 47(1): 7–26.
- Li, Zhong Yu. 2001. Bei xiang yu nan jin: xibanya dongya zhimin tuozhan zhengce xia de feilubin yu Taiwan (1565–1642) [North and South: The Philippines and Taiwan (1565–1642) under Spain's East Asian Colonial Expansion Policy] In Cao, Yonghe (ed.), *Cao Yonghe xiansheng bashi shou qing lunwen ji*, 31–48. Taipei: le xue shuju.
- Li, Zhinan. 1994. Wusi fengxian, kaituo jinqu: Shenqie huainian Wu Yujin laoshi [Selfless Dedication and Pioneering Effort: Cherishing the Memory of Professor Wu Yujin]. *Shixue lilun yanjiu [Studies in Historical Theory]* 1: 36–42.
- Li, Zonggui. 2014. *Between Tradition and Modernity: Philosophical Reflections on the Modernization of Chinese Culture*. Oxford: Chartridge Books Oxford.

- Lindberg, David C. 2007. *The Beginnings of Western Science: the European Scientific Tradition in Philosophical, Religious, and Institutional Context 600 BC to AD 1450*. Chicago: University of Chicago Press.
- Lin, Justin Yifu. 1995. The Needham Puzzle: Why the Industrial Revolution Did Not Originate in China. *Economic Development and Cultural Change* 43(2): 269–292.
- Lin, Justin Yifu, Cai, Fang and Li, Zhou. 2006. *The China Miracle: Development Strategy and Economic Reform*. Hong Kong: Chinese University Press.
- Liu, Beicheng. 2000. The Challenges of Reconstructing World History. *Shixuelilunyanjiu [Historiography Quarterly]* 4: 69.
- . 2000. *Baiyin Ziben [Silver Capital]*. Beijing: Central Compilation and Translation press.
- Liu, Beicheng, and Liu, Xincheng. 2007. *Shijie Shi [World History], vol. 2, The Early Modern (Jindai) Period*. Beijing: Higher Education Press.
- Liu, Shuang. 2002. *The View of History and Methodology in the Process of Globalization*. *Xuexiyu Tansuo [Study and Exploration]* 4: 123.
- Liu, Xincheng. 1995. Woguo ‘shijie tongshi’ bianzuan gongzuo de huigu yu sikao [A Reflection on the Compilation of ‘World History’ in Our Country]. In *1995 nian zhongguo lishixue nianjian [The 1995 Yearbook of China’s Historical Studies]*, 12. Beijing, 1995.
- . 1999. *Lishixue bainian [A Hundred Years of Historical Studies]*. Beijing: Beijing Chubanshe.
- . 2012. The Global View of History in China. *Journal of World History* 23(3): 493.
- Liu, Xinru. 2010. *The Silk Road in World History*. Oxford: Oxford University Press.
- Long, Denggao. 2003. *Jiangnan shichangshi [History of Jiangnan City]*. Beijing: Qinghua daxue chubanshe.
- . 2006. *Overseas Chinese Business in the Economic Globalization*. Hong-Kong: Science Press.
- . 2011. New Explorations in the Comparative Study of Economic History in China and the West. *Chinese Studies in History* 45(1): 7–27.
- Lopez, Carmen Yuste. 2007. *Emporios transpacíficos. Comerciantes mexicanos en Manila, 1710–1815*. México DF: UNAM.
- Lu, Qiangming. 1999. Exploring the Reasons for Scientific and Technological Development in the West. *Science, Technology and Dialectics* 16(2): 46–53.
- Luo, Xu, 2007. Reconstructing World History in the People’s Republic of China since the 1980s. *Journal of World History* 18(3): 332.
- Lynch, John. 1994. *Spain 1516–1598. From Nation State to World Empire*. London: Wiley-Blackwell.
- Mackerras Colin. 2018. Global History, the Role of Scientific Discovery and the ‘Needham Question’: Europe and China in the Sixteenth to Nineteenth

- Centuries. In Perez-Garcia, Manuel and de Sousa, Lucio (eds.), *Global History and New Polycentric Approaches. Europe, Asia and the Americas in a World Network System*, 21–35. Singapore: Palgrave Macmillan.
- Ma, Debin. 2012. Political Institution and Long-run Economic Trajectory: Some Lessons from Two Millennia of Chinese Civilization. In Aoki, M., Kuran, Timur, and Roland, Gérard (eds.), *Institutions and Comparative Economic Development*, 78–98. Basingstoke: Palgrave Macmillan.
- . 2014. State Capacity and Great Divergence, the Case of Qing China (1644–1911). *Eurasian Geography and Economics* 54(5–6): 484–499.
- Ma, Debin, and Rubin, Jared. 2019. The Paradox of Power: Principal-Agent Problems and Administrative Capacity in Imperial China (and Other Absolutist Regimes). *Journal of Comparative Economics* 47: 277–294.
- Ma, Debin, and Yuan, Weipeng. 2016. Discovering Economic History in Footnotes: The Story of Tǒng Tàishēng Merchant Archive (1790–1850) and the Historiography of Modern China. *Modern China* 42(5): 483–504.
- Maddison, Angus. 1995. *Monitoring the World Economy 1820–1992*. Paris: OECD Publications.
- . 2001. *The World Economy: A Millennial Perspective*. Paris: OECD Publications.
- . 2003. *The World Economy: Historical Statistics*. Paris: OECD Publications.
- . 2007. *Chinese Economic Performance in the Long Run, 960–2030 AD., Rev. ed.* Paris: OECD Publications.
- . 2007. *Contours of the World Economy 1–2030 AD: Essays in Macroeconomic History*. Oxford: Oxford University Press.
- Ma, Keyao 2004. *The History of World Civilizations, vols. 1–3*. Beijing: Beijing University Press.
- Malamoud, Carlos D. 1986. *Cádiz y Saint Maló en el comercio colonial peruano*. Cádiz: Diputación Provincial.
- Man-Cheong, Iona. 2004. *The Class of 1761: Examinations, the State and Elites in Eighteenth-Century China*. Stanford: Stanford University Press.
- Mann, Susan. 1997. *Precious Records: Women in China's Long Eighteenth Century*. Stanford: Stanford University Press.
- Mao, Liuri, and Shen, Guanquan. 1988. *Comprehensive History of Chinese Education, vol. 4*. Jinan: Shandong Education Press.
- Marks, Robert. 1998. *Tigers, Rice, Silk, and Silt: In Tigers, Rice, Silk, and Silt: Environment and Economy in Late Imperial South China (Studies in Environment and History)*. Cambridge: Cambridge University Press.
- Martinez-Shaw, Carlos. 1982. El asiento de 1741 y el abastecimiento de frutos a Nueva España. *Moneda y crédito* 161: 21–36.
- . 2007. *El sistema comercial español del Pacífico (1765–1820)*. Madrid: Real Academia de la Historia.

- Martinez-Shaw, Carlos, and Mola, Alfonso Marino. 2013. España y el comercial de Asia en el siglo XVIII. Comercio directo frente a comercio transpacífico. In Lobato Franco, Isabel and Oliva, María, and Melgar, Jose (eds.), *El sistema comercial español en la economía mundial (siglos XVII-XVIII)*, 325–380. Huelva: Universidad de Huelva.
- Marx, Karl. 1971. *A Contribution to the Critique of Political Economy*. London: Lawrence & Wishart.
- Ma, Shili. 1999. *Shijie shigang [The Outline of World History]*, vols. 1–2. Shanghai: Shanghai Renmin chubanshe.
- Ma, Tao. 2010. Da fenliu: 18 shiji zhongxi fang jingjifazhan daolu de fansi [The Great Divergence: Chinese and Western Path of Economic Development in the 18th Century in Retrospection]. *Journal of Guizhou College of Finance and Economics* 3: 1–8.
- Mauro, Frédéric. 1990. Merchant Communities, 1350–1750. In Tracey, James D. (ed.), *The Rise of Merchant Empires: Long-Distance Trade in the Early Modern World, 1350–1750*, 255–287. Cambridge: Cambridge University Press.
- Mauss, Marcel. 2006. *The Gift: Forms and Functions of Exchange in Archaic Societies*. London: Routledge.
- Mazlish, Bruce. 1998. Comparing Global History to World History. *Journal of Interdisciplinary History* 28(3): 385–395.
- McCants, Anne E. C. 2018. Global History and the History of Consumption: Congruence and Divergence. In Perez-Garcia, Manuel, and de Sousa, Lucio (eds.), *Global History and New Polycentric Approaches: Europe, Asia and the Americas in a World Network System, Palgrave Studies in Comparative Global History*, 241–253. Singapore: Palgrave Macmillan.
- McDermott, Joseph P. 2013. *The Making of a New Rural Order in South China*. Cambridge: Cambridge University Press.
- McKendrick, Neil. 1982. The consumer revolution of eighteenth-century England. In McKendrick, Neil, Brewer, John, and Plumb, J. H. (eds.), *The birth of a consumer society: The commercialization of eighteenth-century England*, 9–33. Bloomington: Indiana University Press.
- McMahon, Daniel. 2015. *Rethinking the Decline of China's Qing Dynasty: Imperial Activism and Borderland Management at the Turn of the Nineteenth Century*. New York: Routledge.
- McNeill, William H. 1963. *The Rise of the West: A History of the Human Community*. Chicago: University of Chicago Press.
- . 1990. The Rise of the West After Twenty-five Years. *Journal of World History* 1(1): 1–21.
- McNeill, Peter, and Riello, Giorgio. 2016. *Luxury: A Rich History*. Oxford: Oxford University Press.

- Melissen, Jan. 2005. *The New Public Diplomacy: Between Theory and Practice*. In Melissen, Jan (ed.), *The New Public Diplomacy: Soft Power in International Relations*, 4. London: Palgrave MacMillan.
- Menegon, Eugenio. 2009. *Ancestors, Virgins, and Friars: Christianity as a Local Religion in Late Imperial China*. Cambridge: Harvard University Press.
- . 2017. Interlopers at the Fringes of Empire: The Procurators of the Propaganda Fide Papal Congregation in Canton and Macao, 1700–1823. *Cross-Currents: East Asian History and Culture Review* 25: 33.
- Menegon, Eugenio, Thai, Philip, and King, Hang. 2018. Binding Maritime China: Control, Evasion, and Interloping. Introduction. *Cross-Currents: East Asian History and Culture Review* 7(1): 1–8.
- Meynard, Thierry. 2006. *Following the Footsteps of the Jesuits in Beijing: A Guide to Sites of Jesuit Work and Influence in Beijing*. St. Louis: Jesuit Sources. St. Louis: Institute of Jesuit Sources.
- . 2013. *Matteo Ricci, Le sens réel de “Seigneur du Ciel*. Paris: Bibliothèque Chinoise, Belles Lettres.
- . 2015. *The Jesuit Reading of Confucius. The First Complete Translation of the Lunyu (1687) published in the West*. Leiden-Boston: Brill.
- Miao, D.G., and Cheng, X. 2013. Development, Current Situation and Trend of Chinese Policy on Studying Abroad: 1949-2009. *Journal of Xuzhou Normal University* 36(2): 1–7.
- Middell, Matthias, and Naumann, Katja. 2010. Global History and the Spatial Turn: From the Impact of Area Studies to the Study of Critical Junctures of Globalization. *Journal of Global History* 5:149–170.
- Miller, James. 2003. Daoism and Nature. In Selin, Helaine (ed.), *Nature Across Cultures. Views of Nature and the Environment in Non-Western Cultures*, 393–410. Dordrecht: Kluwer Academic Publishers.
- Miyazaki, Ichisada. 1981. *China’s Examination Hell: The Civil Service Examinations of Imperial China*. New Haven: Yale University Press.
- Mok, Ka-Ho. 2005. Globalization and Educational Restructuring: University Merging and Changing Governance in China. *Higher Education* 50: 57–88.
- Mokyr, Joel. 1990. *The Lever of Riches: Technological Creativity and Economic Progress*. New York: Oxford University Press.
- Molho, Anthony, and Curto, Diogo Ramade. 2003. Les réseaux marchands à l’époque moderne. *Annales HSS* 58(3): 569–580.
- Morar, Florin-Stephan. 2019. The Westerner: Matteo Ricci’s World Map and the Quandaries of European Identity in the Late Ming Dynasty. *Journal of Jesuit Studies* 6: 14–30.
- de Morga, Antonio. 1609. *Sucesos de las islas Filipinas*. México: Casa de Geronymo Balli.

- Mostern, Ruth. 2008. Historical Gazetteers: An Experiential Perspective, with Examples from Chinese History. *Historical Methods: A Journal of Quantitative and Interdisciplinary History* 41(1): 39–46.
- . 2011. “*Dividing the Realm in Order to Govern*”: *The Spatial Organization of the Song State*. Cambridge: Harvard University Press.
- Moutoukias, Zacarias. 1988. *Contrabando y control colonial en el siglo XVII*. Buenos Aires: CEAL.
- de Muga, Gonzalo, de Lorenzo, José, Ferriero, Martín. 1865. *Diccionario Marítimo Español*. Madrid: Establecimiento Tipográfico de T. Fortanet.
- Muller, Jeffrey. 2016. The Jesuit Strategy of Accommodation. In de Boer, Wietse, Enenkel, Karl A.E., Melion, Walter (eds.), *Jesuit Image Theory*, 461–492. Leiden: Brill.
- Müller, Leos. 2004. *Consuls, Corsairs, and Commerce. The Swedish Consular Service and Long-Distance Shipping, 1720–1815*. Uppsala: Uppsala University.
- Mungello, David Emil. 1989. *Curious Land: Jesuit Accommodation and the Origins of Sinology*. Honolulu: University of Hawaii Press.
- Nakajima, Gakusho. 2018. The Structure and Transformation of the Ming Tribute Trade System. In Perez-Garcia, Manuel and de Sousa, Lucio (eds.), *Global History and New Polycentric Approaches*, 137–162. Singapore: Springer Nature.
- Nash, John F. 1950. Equilibrium Points in N-Person Games. *Proceedings of the National Academy of Sciences* 36(1): 48–49.
- Needham, Joseph and Wang, Ling. 1954. *Science and Civilization in China*. Cambridge: Cambridge University Press, 1954.
- Needham, Joseph. 1969. *The Great Titration*. Toronto: Allen and Unwin.
- . 2004. *Science and Civilisation in China, vol. VII:2, General Conclusions and Reflections*. Cambridge: Cambridge University Press.
- Needham, Joseph, and Bray, Francesca. 1984. *Science and Civilization in China, Volume VI, Biology and Biological Technology, Part II (Agriculture)*. Cambridge: Cambridge University Press.
- Ng, Chin-Keong. 1983. *Trade and Society: The Amoy Network on the China Coast 1683–1735*. Singapore: Singapore University Press.
- . 1990. The South Fukienese Junk Trade at Amoy from the 17th to the Early 19th Centuries. In Vermeer, Eduard (ed.), *Development and Decline of Fujian Province in the 17th and 18th Centuries*. Leiden: Brill.
- North, Douglass C. 1991. Institutions, Transaction Costs, and the Rise of Merchant Empires. In Tracy, James D. (ed.), *The Political Economy of Merchant Empires. State Power and World Trade, 1350–1750*, 22–40. Cambridge: Cambridge University Press.
- Nye, Joseph. 2008. Soft Power and Cultural Diplomacy. *The Annals of the American Academy of Political and Social Science* 616(1): 94–109.

- Nylan, Michael. 2001. *The Five Confucian Classics*. New Haven: Yale University Press.
- O'Brien, Patrick. 1982. European Economic Development: The Contribution of the Periphery. *Economic History Review* 35(1): 1–18.
- . 1991. The Foundations of European Industrialization: From the Perspective of the World. *Journal of Historical Sociology* 4(3) 288–317.
- . 2006. Historiographical Traditions and Modern Imperatives for the Restoration of Global History. *Journal of Global History* 1(1): 3–39.
- . 2013. Historical Foundations for a Global Perspective on the Emergence of a Western European Regime for the Discovery, Development, and Diffusion of Useful and Reliable Knowledge. *Journal of Global History* 8: 1–24.
- O'Brien, Patrick and Deng, Kent. 2017. Quantifying the quantifiable: A Reply to Jan-Luiten van Zanden and Debin Ma. *World Economics* 18(3): 215–223.
- O'Brien, Patrick, and Engerman, Stanley L. 1991. Exports and the Growth of the British Economy from the Glorious Revolution to the Peace of Amiens. In Solow, Barbara. (ed.), *Slavery and the Rise of the Atlantic System, 177–209*. Cambridge, England: Cambridge University Press.
- . 1996. Path Dependency, or Why Britain Became an Industrialized and Urbanized Economy Long Before France. *Economic History Review*, XLIX(2): 213–249.
- Oka, Mihoka. 2010. *Shōnin to senkyōshi nanban bōeki no sekai*. Tokyo: Tōkyō University Press.
- . 2018. The *Nanban* and *Shuinsen* Trade in Sixteenth and Seventeenth-Century Japan. In Perez-Garcia, Manuel and De Sousa, Lucio (eds.), *Global History and New Polycentric Approaches*, 163–182. Singapore: Springer Nature.
- O'Rourke, Kevin, and Williamson, Jeffrey G. 1999. *Globalization and history: The evolution of a nineteenth-century Atlantic economy*. Boston: MIT Press, 1999.
- . 2004. Once More: When Did Globalisation Begin? *European Review of Economic History* 8: 109–117.
- Ogilvie, Sheilagh. 2011. *Institutions and European Trade: Merchant Guilds, 1000–1800*. Cambridge: Cambridge University Press.
- Ollé, Manuel. 2002. *La empresa de China. De la Armada Invencible al Galeón de Manila*. Barcelona: Acanalado.
- . 2005. Comunidades mercantiles en conflicto en los estrechos de Taiwán (1624–1684). *Journal of Iberian and Latin American Economic History* 23: 275–298.
- . 2008. Interacción y conflicto en el Parián de Manila. *Illes i imperis: Estudios de historia de las sociedades en el mundo colonial y post-colonial* 10-11: 61–90.

- . 2018. Proyectos de conquista y de comercio para China y el Sureste de Asia. *Mélanges de la Casa de Velázquez* 48(2): 79–99.
- Olstein, Diego. 2015. *Thinking History Globally*. London: Palgrave Macmillan.
- Osterhammel, Jürgen. 2009. *Die Verwandlung der Welt Eine Geschichte te des 19 Jahrhunderts*. Munchen: C.H. Beck Verlag.
- . 2014. *The Transformation of the World: A Global History of the 19th Century*. Princeton: Princeton University Press.
- Overton, Mark. 1996. *Agricultural Revolution in England. The Transformation of the Agrarian Economy, 1500–1850*. Cambridge: Cambridge University Press.
- Owens, John B. 2005. *By my Absolute Royal Authority: Justice and the Castilian Commonwealth at the Beginning of the First Global Age*. Rochester: University of Rochester Press.
- Pan, Su-Yan. 2009. *University Autonomy, the State, and Social Change in China*. Hong Kong: Hong Kong University Press.
- Panzac Daniel. 2004. *La caravane maritime. Marins européens et marchands ottomans en Méditerranée (1680–1830)*. Paris: CNRS.
- Paquette, Gabriel. 2020. *The European Seaborne Empires: From the Thirty Years' War to the Age of Revolutions*. New Haven: Yale University Press.
- Paquette, Gabriel and Quintero Saravia, Gonzalo M. 2019. *Spain and the American Revolution: New Approaches and Perspectives*. New York: Routledge.
- Parker, Edward Harper. 1899. Notes of Some Statistics Regarding China. *Journal of the Royal Statistical Society* 62(1): 150–156.
- Parry, John H. 1990. *The Spanish Seaborne Empire*. Berkeley: University of California Press.
- Pastells, Pablo, Torres y Lanzas, Pedro, and del Valle, Navas. 1925. *Historia General de Filipinas. Catalogo de los documentos relativos a las islas filipinas existentes en el Archivo de Indias de Sevilla*. Barcelona: Compañía General de Tabacos de Filipinas.
- Perdue, Peter C. 2003. The Economy of the Silk Road. In Mokyr, Joel (ed.), *The Oxford Encyclopedia of Economic History*, 491–493. Oxford: Oxford University Press.
- . 2010. *China Marches West. The Qing Conquest of Central Eurasia*. Cambridge: Harvard University Press.
- . 2017. Interlopers, Rogues, or Cosmopolitans? Wu Jianzhang and Early Modern Commercial Networks on the China Coast. *Cross-Currents: East Asian History and Culture Review* 25: 63–83.
- Perez-Garcia, Manuel. 2011. Les échanges transnationaux et la circulation des nouveaux produits en Méditerranée occidentale au XVIIIe siècle. *Histoire, Economie et Societe* 1: 39–56.
- . 2013. *Vicarious Consumers: Trans-National Meetings between the West and East in the Mediterranean World (1730–1808)*. London: Routledge.

- . 2014. From Eurocentrism to Sinocentrism: New Challenges in Global History. *European Journal of Scientific Research* 119(3): 337–352.
- . 2016. Internacionalización y reformas del sistema de educación superior en China”, Problemas del Desarrollo. *Revista Latinoamericana de Economía* 187(47): 37–61.
- . 2016. The Global Dimensions of “One Belt, One Road” Strategy in China-Latin America International Relations: Toward a Sustainable Economic Growth Model. In Perez-Garcia, Manuel, and Cui, Shoujun (eds.), *China and Latin America in Transition: Policy Dynamics, Economic Commitments, and Social Impacts*, 131–156. New York: Palgrave Macmillan.
- . 2018a. Introduction: Current Challenges of Global History in East Asian Historiographies. In Perez-Garcia, Manuel and de Sousa, Lucio (eds.), *Global History and New Polycentric Approaches: Europe, Asia and the Americas in a World Network System*, 1–17. Singapore: Palgrave Macmillan.
- . 2018b. Challenging National Narratives: On the Origins of Sweet Potato in China as Global Commodity During the Early Modern Period. In Perez-Garcia, Manuel, and de Sousa, Lucio. (eds), *Global History and New Polycentric Approaches: Europe, Asia and the Americas in a World Network System*, 53–80. Singapore: Palgrave Macmillan.
- . 2019a. Creating Global Demand: Polycentric Approaches, Crossroads of Silk and Silver in China and Iberian Empires during the Early Modern Era. *Journal of Iberian and Latin American Economic History*: 1–15.
- . 2019b. Global Goods, Silver and Market Integration: Consumption of Wine, Silk and Porcelain through the Grill Company via Macao-Canton and Marseille Trade Nodes, 18th century. *Journal of Iberian and Latin American Economic History*: 1–36.
- . 2019c. Consumption of Chinese Goods in Southwestern Europe: A Multi-Relational Database and the Vicarious Consumption Theory as Alternative Model to the Industrious Revolution (Eighteenth Century). *Historical Methods: A Journal of Quantitative and Interdisciplinary History* 52(1): 15–36.
- . 2020. *Blood, Land and Power: The Rise and Fall of the Spanish Nobility and Lineages in the Early Modern Period (XVI-XIX centuries)*. Cardiff: University of Wales Press.
- Perkins, Dwight H. 1969. *Agricultural Development in China, 1368–1968*. Chicago: Aldine Publishing House.
- Phillips, Tom. 2016. China Universities Must Become Communist Party ‘Strongholds’, says Xi Jinping. *The Guardian*. <https://www.theguardian.com/world/2016/dec/09/china-universities-must-become-communist-party-strongholds-says-xi-jinping>.
- Picketty, Thomas. 2014. *Capital in the Twenty-First Century*. Cambridge: Harvard University Press, 2014.

- Pike, Robert S. 1966. *Enterprise and Adventure: the Genoese in Seville and the Opening of the New World*. Ithaca: Cornell University Press.
- Pro-Chia Hsia, Ronnie. 2012. *A Jesuit in the Forbidden City: Matteo Ricci 1552–1610*. New York: Oxford University Press.
- Polanyi, Karl. 1944. *The Great Transformation: The Political and Economic Origins of Our Time*. New York: Farrar & Rinehart.
- Pomeranz, Kenneth. 2000. *The Great Divergence: China, Europe, and the Making of the Modern World Economy*. Princeton: Princeton University Press.
- . 2003. *Da fenliu: Ouzhou, zhongguo ji xiandai shijie jingji de fazhan*. [translated by Jianyun Shi] Nanjing: Jiangsu renmin chubanshe.
- . 2013. Writing about Divergences in Global History: Some Implications for Scale, Methods, Aims and Categories. In Berg, Maxine (ed.), *Writing the History of the Global: Challenges for the 21st Century*, 117–127. Oxford: Oxford University Press.
- Po, Ronald C. 2018. *The Blue Frontier: Maritime Vision and Power in the Qing Empire*. Cambridge: Cambridge University Press.
- Porter, Jonathan. 2016. *Imperial China 1350–1900*. Lanham: Rowman & Littlefield Publishers.
- Pryor, John H. 1977. The Origins of the Commenda Contract. *Speculum* 52: 5–37.
- Ptak, Roderich. 2003. Ming Maritime Trade to Southeast Asia, 1368–1567: Visions of a ‘System’. In Guillot, Claude; Lombard, Denys; Ptak, Roderich (eds.), *China, the Portuguese, and the Nanyang: Oceans and Routes, Regions and Trade (c. 1000–1600)*, 157–192. Aldershot: Ashgate.
- Purcell, Victor. 1963. *The Boxer Uprising: A Background Study*. Cambridge: Cambridge University Press.
- Qian, Chengdan. 2001. Probing into the Idea of ‘Global History’: An Impression of the 19th Congress of the International Historical Sciences. *Shixue Yuekan [History Monthly]* 2: 147.
- Qian, Mu. 1966. *Zhongguo lidai zhengzhi deshi [The Gains and Losses of Chinese Dynastic Politics]*. Hong Kong: Great China.
- Qi, Shirong. 2005. *Shiwu shiji yilai shijie jiuqiang de lishi yanbian [Historical Evolutions of Nine World Powers since the 15th Century]*. Guangzhou: Guangdong renmin chubanshe.
- Qi, Tao. 2001. *Shijie tongshi jiaocheng [A Course in World History]*, vols. 1–3. Jinan: Shandong daxue chubanshe.
- Qiu, Xuanyu. 1995. *Ming Diguo yu Nanhai Zhufanguo Guanxi de Yanbian [The Ming Empire and the South China Sea]*. Taipei: Lantai Chubanshe.
- Quan, Hansheng. 1966. Mingdai de yinke yu yinchang [Silver Tax Receipts and Silver Mining Quotas in the Ming Period]. *Xinya shuyuan xueshu niankan* 9: 246–254.

- . 1969. The Inflow of American Silver into China From the Late Ming to the Mid-Ch'ing Period. *Journal of the Institute of Chinese Studies of the Chinese University of Hong Kong* 2: 61–75.
- . 1972. Ming Qing jian Meizhou baiyin de shuru Zhongguo [American Silver Inflow to China during the Ming and Qing Periods]. In Fu, Zhufu (ed.), *Zhongguo jingjishi ji luncong*, 435–450. Hongkong: Xianggang zhongwen daxue xinya shuyuan.
- . 1993. *Zhongguo hanghui zhidu shi* [An Institutional History of Chinese Guilds]. Shanghai: Xinhengming shuju.
- Racine, Luc. 1979. *Théories de l'échange et circulation des produits sociaux*. Montreal: Presses de l'Université de Montreal.
- Ransdell, James. 2019. Institutional Innovation by the Asian Infrastructure Investment Bank. *Asian Journal of International Law* 9: 125–152.
- Raveaux, Olivier. 2012. Entre appartenance communautaire et intégration locale: la colonie marseillaise des marchands arméniens de la Nouvelle-Djoulfā (Ispahan), 1669–1695. *Revue d'Histoire Moderne et Contemporaine* 1(n. 59-1): 83–102.
- Rawski, Evelyn S. 1972. *Agricultural Change and the Peasant Economy of South China*. Cambridge: Harvard University Press.
- . 1998. *The Last Emperors: A Social History of Qing Imperial Institutions*. Berkeley: University of California Press.
- Rawski, Thomas G. 1989. *Economic Growth in Prewar China*. Berkeley: University of California Press.
- Rawski, Thomas G., and Li, Lillian M. 1992. *Chinese History in Economic Perspective*. Berkeley: University of California Press.
- Ren, Xiao. 2016. China as an institution-builder: the case of the AIIB. *The Pacific Review* 29(3): 435–442.
- Revel, Jacques. 1996. *Jeux d'échelles. La micro-analyse à l'expérience*. Paris: Gallimard et Le Seuil, coll. Hautes Études.
- Rockhill, William W. 1905. An Inquiry into the Population of China. *Annual Report of the Smithsonian Institution*: 659–676.
- Romano, Ruggiero. 2004. *Mecanismo y elementos del sistema económico colonial americano siglos XVI-XVIII*. México: Colegio de México.
- Rosenthal, Jean-Laurent, and Wong, Roy Bin. 2011. *Before and Beyond Divergence*. Cambridge: Harvard University Press.
- Roser, Max, Ritchie, Hannah, and Ortiz-Ospina, Esteban. 2020. World Population Growth. *OurWorldInData.org*. <https://ourworldindata.org/world-population-growth>.
- Rostow, Walt W. 1978. *The World Economy, History and Prospect*. Austin: University of Texas Press.
- Rowe, William. 2001. *Saving the World. Chen Hongmou and Elite Consciousness in Eighteenth-Century China*. Stanford: Stanford University Press.

- . 2009. *China's Last Empire. The Great Qing*. Cambridge: Harvard University Press.
- Ruiz-Stovel, Guillermo. 2009. Chinese Merchants, Silver Galleons, and Ethnic Violence in Spanish Manila, 1603–1686. *México y la Cuenca del Pacífico*. 12(36): 47–63.
- Ruiz, Teofilo. 2004. *From Heaven to Earth: The Reordering of Castilian Society, 1150–1350*. Princeton: Princeton University Press.
- Russell, Bertrand. 1922. *The Problem of China*. London: George and Unwin Ltd.
- . 1956. Why I Am Not a Christian. In Egner, Robert E., and Denonn, Lester E. (eds.), *The Basic Writings of Bertrand Russell*, 566–578. New York: Simon and Schuster.
- Russell, Bertrand. 1956. What is an Agnostic? In Egner, Robert E., and Denonn, Lester E. (eds.), *The Basic Writings of Bertrand Russell*, 557–566. New York: Simon and Schuster.
- Said, Edward. 1979. *Orientalism*. New York: Vintage.
- Sandby-Thomas, Peter. 2011. *Legitimizing the Chinese Communist Party since Tiananmen. A Critical Analysis of the Stability Discourse*. London: Routledge.
- Santamaria, Alberto. 1966. The Chinese Parian (El Parian de los Sangleyes). In Alfonso, Jr, Feliz (ed.), *The Chinese in the Philippines, vol. 1*. Manila: Solidaridad Publication House.
- Sawyer, Stephen W. 2015. Time after Time: Narratives of the Longue Durée in the Anthropocene. *Transatlantica. Revue d'études américaines. American Studies Journal* 1: 1–17.
- Shanghai Jiao Tong University Library. 1962. *Ming shilu (Veritable Records of the Ming Dynasty)*. Taipei: Academia Sinica Institute of History and Philology.
- . 2008. *Qing shilu (Veritable Records of the Qing Dynasty)*. Beijing: Zhonghua Publishing Company.
- Shimada, Ryuto. 2006. *The Intra-Asian Trade in Japanese Copper by the Ducht East India Company during the Eighteenth Century*. Leiden: Brill.
- Shi, Jianyun. 2011. A Reevaluation of Chinese and Western Comparative History. *Chinese Studies in History* 45(1): 28–51.
- Shi, Zhihong. 2008. *Qing dai hubu yin ku shouzhi he kucun tongji [Statistics on the Stocks, Receipts, and Expenditures of the Vaults of the Qing Board of Revenue]*. Fuzhou: Fujian People's Press.
- Schäfer, Wolf. 2004. Global History and Present Time. In Lyth, Peter, and Trischler, Helmuth (eds.), *Wiring Prometheus: Globalisation, History and Technology*, 108. Aarhus: Aarhus University Press.
- Schaub, Jean-Frederic. 2001. *Le Portugal au temps du Comte-Duc d'Olivares (1621–1640). Le conflit de juridictions comme exercice de la politique*. Madrid: Casa de Velázquez.
- Schurz, William L. 1939. *The Manila Galleon*. New York: E.P. Dutton.

- Scott, William Henry. 1994. *Barangay: Sixteenth Philippine Culture and Society*. Quezon: Ateneo de Manila University Press.
- Selin, Helaine. 2003. *Nature Across Cultures. Views of Nature and the Environment in Non-Western Cultures*. Dordrecht: Kluwer Academic Publishers.
- Shiu, Carol H., and Keller, Wolfgang. 2007. Markets in China and Europe on the Eve of the Industrial Revolution. *The American Economic Review* 97(4): 1189–1216.
- Shi, Zhihong, and Yi, Xu. 2008. *Wan qing caizheng: 1851–1894 [Public Finance in Late Qing: 1851–1894]*. Shanghai: Shanghai University of Finance and Economics.
- Shuji, Cao. 2001. *The population history of China, vol.5: Period of Qing dynasty*. Shanghai: Fudan University Press.
- Side, Wang. 2001. *Shijie tongshi [A History of the World], vols. 1–3*. Shanghai: Huadong shifan daxue chubanshe.
- . 2009. *Shijietongshi [A General History of the World], 2nd ed., vols. 1–3*. Shanghai: East China Normal University Press.
- Skinner, G. William. 1964. Marketing and Social Structure in Rural China. *Journal of Asian Studies* 24(1): 3–43.
- . 1965a. Marketing and Social-Structure in Rural China. *Journal of Asian Studies* 24(2): 195–228.
- . 1965b. Marketing and Social-Structure in Rural China: Part III. *Journal of Asian Studies* 24(3): 363–399.
- . 1971. Chinese Peasants and the Closed Community: An Open and Shut Case. *Comparative Studies in Society and History* 13(3): 270–281.
- . 1987. Sichuan's Population in the Nineteenth Century: Lessons from Disaggregated Data. *Late Imperial China*, 8(1): 1–79.
- Smith, Paul J. 1988. Commerce, Agriculture, and Core Formation in the Upper Yangzi, 2 A.D to 1948. *Late Imperial China* 9(1): 1–78.
- Sng, Tuan-hwee. 2010. *Size and Dynastic Decline: The Principal-Agent Problem in Late Imperial China 1700–1850*. Evanston: Department of Economics, Northwestern University.
- Sola, Diego. 2018. *El Cronista de China. Juan Gonzalez de Mendoza, entre la misión, el imperio y la historia*. Barcelona: Universidad de Barcelona.
- de Sousa, Lucio. 2015. *The Jewish Diaspora and the Perez Family Case in China, Japan, the Philippines, and the Americas (16th Century)*. Macau: Macau Foundation.
- . 2010. *The Early European Presence in China, Japan, the Philippines and Southeast Asia (1555–1590)*. Macau: Macau Foundation.
- . 2017. The Jewish Presence in China and Japan in the Early Modern Period: A Social Representation. In Perez-Garcia, Manuel and de Sousa, Lucio (eds.), *Global History and New Polycentric Approaches*, 183–218. Singapore: Palgrave Macmillan.

- . 2018. *The Portuguese Slave Trade in Early Modern Japan Merchants, Jesuits and Japanese, Chinese, and Korean Slaves*. Leiden: Brill.
- . 2019. Judaeo-Converso Merchants in the Private Trade between Macao and Manila in the Early Modern Period. *Journal of Iberian and Latin American Economic History*: 1–34.
- Souza, George Bryan. 1986. *The Survival of Empire: Portuguese Trade and Society in China and the South China Sea, 1630–1754*. Cambridge: Cambridge University Press.
- Souza, George Bryan, and Turley, Jeffery S. 2015. *The Boxer Codex. Transcription and Translation of an Illustrated Late Sixteenth-Century Spanish Manuscript, Ethnography and History of the Pacific, South-East Asia and East Asia*. Leiden: Brill.
- Spence, Jonathan D. 1985. *The Memory Palace of Matteo Ricci*. New York: Penguin Books.
- . 1999. *The Search for Modern China*. New York: W. W. Norton.
- Standaert, Nicolas. 2001. *Handbook of Christianity in China: Volume One (635–1800)*. Leiden: Brill.
- Stein, Barbara and Stein, Stanley. 2000. *Silver, Trade, and War: Spain and America in the Making of Early Modern Europe*. Baltimore: John Hopkins University Press.
- Stone, Lawrence. 1979. *The Crisis of the Aristocracy, 1558–1641*. New York: Harper and Row.
- Struck, Bernhard, Ferris, Kate, and Revel, Jacques. 2011. Introduction: Space and Scale in Transnational History. *International History Review* 33: 573–584.
- Studer, Roman. 2015. *The Great Divergence Reconsidered: Europe, India, and the Rise to Global Economic Power*. Cambridge: Cambridge University Press.
- Suarez, Margarita. 2018. The Alternative Circuits of Silver: Lima and the Inter-Colonial Trade in the Pacific During the 17th Century. In Martínez Ruiz, José I. (ed.), *The Spanish Empire in the World Economy (1580–1820)*, 239–260. Sevilla: Editorial Universidad de Sevilla.
- Subrahmanyam, Sanjay. 1993. *The Portuguese Empire in Asia, 1500–1700. A Political and Economic History*. London: Longman.
- . 1997. Connected Histories. *Modern Asian Studies* 31(3): 735–762.
- Sugihara, Kaoru. 1996. *Ajiakan Boeki no Keisei to Kozo [Patterns and Development of Intra-Asian Trade]*. Kyoto: Minerva Shobo.
- . 1996. The European Miracle and the East Asian Miracle: Towards a New Global Economic History. *Sangyo to Keizai* 11(2): 27–48.
- Summers, Tim. 2016. China's 'New Silk Roads': Sub-National Regions and Networks of Global Political Economy. *Third World Quarterly* 37(9): 1628–1643.

- Tang, Anthony. 1979. China's Agricultural Legacy. *Economic Development and Cultural Change* 28: 1–22.
- Tang, Jin. 2006. *Daguo jueqi [The Rise of the Great Powers]*. Beijing: Renmin chubanshe.
- Tang, Xiaojun. 2012. *Concise History of the Communist Party of China*. Beijing: Central Party Literature Press.
- Teles e Cunha, João. 2008. Armenian Merchants in Portuguese Trade Networks in the Western Indian Ocean in the Early Modern Age. In Chaudhury, Sushil, and Kévonian, Kéram (eds.), *Les Arméniens dans le commerce asiatique au début de l'ère moderne, 197–252*. Paris: Éditions de la Maison des sciences de l'homme.
- TePaske, John, and Klein, Herbert. 1986. *Ingresos y egresos de la Real Hacienda de Nueva España*. Mexico City: Instituto de Antropología e Historia.
- Theobald, Ulrich. 2015. Monetary and Non-Monetary Military Rewards in the Early and High-Qing Period (1673–1795). In Leonard, Jane K., and Theobald, Ulrich (eds.), *Money in Asia (1200–1900): Small Currencies in Social and Political Contexts*, 398–419. Leiden: Brill.
- Tilly, Charles. 1990. *Coercion, Capital, and European States, AD 990–1990*. Cambridge: Blackwell.
- Toynbee, Arnold J. 1934. *A Study of History, vol I: Introduction: The Geneses of Civilizations*. Oxford: Oxford University Press.
- Trigault, Nicolas. 1616. *De Christiana expeditione apud Sinas Suscepta ab Societate Jesu*. Lugduni: Horatij Cardon.
- Trivellato, Francesca. 2003. Juifs de Livourne, Italiens de Lisbonne et Hindous de Goa: Réseaux marchands et échanges culturels à l'époque moderne. *Annales HSS* 58(3): 581–603.
- . 2009a. *Cross-Cultural Trade in the Early Modern Period*. New Haven: Yale University Press.
- . 2009b. *The Familiarity of Strangers: The Sephardic Diaspora, Livorno, and Cross-Cultural Trade in the Early Modern Period*. New Haven: Yale University Press.
- . 2011. Microstoria, storia del mondo e storia globale. In Lanaro, Paola (ed.), *Microstoria: a venticinque anni da l'eredità immateriale*, 119–132. Milan: Franco Angeli.
- Trivellato, Francesca, and Heudre, Antoine. 2015. Un nouveau combat pour l'histoire au XXI^e siècle? *Annales. Histoire, Sciences sociales* 70(2) 333–343.
- Tu, Wei-ming. 1996. *Confucian Traditions in East Asian Modernity: Moral Education and Economic Culture in Japan and the Four Mini-Dragons*. Cambridge: Harvard University Press.
- . 1998. Probing the 'Three Bonds' and 'Five Relationships' Confucian Humanism. In Slote, Walter H. and George De Vos (eds.), *Confucianism and the Family*, 3–36. Albany: State University of New York Press.

- Twitchett, Denis, and Grimm, Tilemann. 1988. The Cheng-t'ung, Ching-t'ai, and T'ien-shun reigns 1436–1464. In Mote, Frederick W. and Twitchett, Denis (eds.), *The Cambridge History of China-The Ming Dynasty 1368–1644*, 305–342. Cambridge: Cambridge University Press.
- United Nations. 2017. World Population Prospects: The 2017 Revision. *Department of Economic and Social Affairs, Population Division*. <https://esa.un.org/unpd/wpp/Download/Standard/Population/>.
- del Valle Pavon, Guillermina. 2011. Cádiz y México, núcleos mercantiles en la carrera de indias, siglos XVII y XVIII. *Revista Hispanoamericana* 1.
- Van Doosselaere, Quentin. 2009. *Commercial Agreements and Social Dynamics in Medieval Genoa*. Cambridge: Cambridge University Press.
- Van Dyke, Paul. 2005. *The Canton Trade: Life and Enterprise on the China Coast, 1700–1845*. Hong Kong: Hong Kong University Press.
- . 2011. *Merchants of Canton and Macao: Politics and Strategies in Eighteenth-Century Chinese Trade*. Hong Kong: Hong Kong University Press.
- . 2017. The Canton Trade, 1700–1842. In *Oxford Research Encyclopedia of Asian History*, 1–28. Oxford: University of Oxford.
- Vanhaute, Eric. 2019. Global and Regional Comparisons: The Great Divergence Debate and Europe. In Middell, Matthias (ed.), *The Practice of Global History: European Perspectives*, 133–205. Bloomsbury Academic.
- van Zanden, Jan Luiten, and van Leeuwen, Bas. 2012. Persistent but Not Consistent: The Growth of National Income in Holland, 1347–1807. *Explorations in Economic History* 49(2): 119–130.
- van Zanden, Jan Luiten and Prak, Maarten. 2013. *Technology, Skills and the Pre-Modern Economy in the East and the West*. Leiden: Brill.
- Velarde, Pedro Murillo. 1752. *Geographia historica de las Islas Philipinas, del Africa y de sus islas adyacentes*. Madrid: Biblioteca Nacional de España (B.N.E.) Tomo VIII.
- Velarde, Pedro Murillo, Bagay, Nicolás de la Cruz, and Suarez, Francisco. 1734. *Carta Hydrographica y Chorographica de las Yslas Filipinas*. Manila: [publisher not identified].
- Vilar, Pierre. 1974. *Crecimiento y desarrollo. Economía e historia. Reflexiones sobre el caso español*. Barcelona: Ariel.
- de Vito, Christian G., and Gerritsen, Anne. 2017. *Micro-Spatial Histories of Global Labour*. New York: Palgrave Macmillan.
- Vladimirov, Peter. 1975. *The Vladimirov Diaries: Yenan, China, 1942–1945*. Garden City: Doubleday.
- Von Glahn, Richard. 1996. *Fountain of Fortune: Money and Monetary Policy in China, 1000–1700*. Berkeley: University of California Press.
- . 2016. *The Economic History of China: From Antiquity to the Nineteenth Century*. Cambridge: Cambridge University Press.

- . 2018. Economic Depression and the Silver Question in Nineteenth-Century China. In Perez-Garcia, Manuel, and de Sousa, Lucio (eds.), *Global History and Polycentric Approaches*, 81–118. New York: Palgrave.
- . 2019. The Changing Significance of Latin American Silver in the Chinese Economy, 16th–19th Centuries. *Journal of Iberian and Latin American Economic History*: 1–33.
- Von Neumann, John, and Morgenstern, Oskar. 1944. *Theory of Games and Economic Behavior*. Princeton: Princeton University Press.
- Von Richthofen, Ferdinand. 1877. Über die zentralasiatischen Seidenstrassen bis zum 2. Jh. n. Chr [On the Central Asian Silk Roads until the 2nd century A.D.] In *Verhandlungen der Gesellschaft für Erdkunde zu Berlin* 4: 96–122.
- . 1877. *China. Ergebnisse eigener Reisen und darauf gegründeter Studien [China. Findings of My Own Travels and Studies Based Thereon]*. Berlin: Dietrich Reimer.
- de Vries, Jan. 1984. *European Urbanization, 1500–1800*. London: Methuen.
- . 2008. *The Industrious Revolution: Consumer Behavior and the Household Economy, 1650 to the Present*. Cambridge: Cambridge University Press.
- . 2019. Playing with Scales: The Global and the Micro, the Macro and the Nano. *Past and Present* 242 (Supplement 14): 23–36.
- . 2003. *Via Peking Back to Manchester. Britain, the Industrial Revolution, and China*. Leiden: Leiden University.
- . 2010. The California School and Beyond: How to Study the Great Divergence? *History Compass* 8: 730–751.
- de Vries, Jan, and Van der Woude, Ad. 1997. *The First Modern Economy: Success, Failure, and Perseverance of the Dutch Economy, 1500–1815*. Cambridge: Cambridge University Press.
- Vries, Peer. 2015. *State, Economy and the Great Divergence. Great Britain and China, 1680s–1850s*. London: Bloomsbury Publishing.
- . 2016. What We Do and Do Not Know About the Great Divergence at the beginning of 2016. *Historische Mitteilungen der Ranke-Gesellschaft* 28: 249–297.
- Walder, Andrew G. 2017. *China Under Mao. A Revolution Derailed*. Cambridge: Harvard University Press.
- Waley-Cohen, Joanna. 1993. China and Western Technology in the Late Eighteenth Century. *The American Historical Review* 98(5): 1525–1544.
- . 2006. *The Culture of War in China. Empire and the Military Under the Qing Dynasty*. London: I.B. Tauris.
- Walker, Geoffrey. 1979. *Spanish Politics and Imperial Trade, 1700–1789*. London: Macmillan.
- Wallerstein, Immanuel. 1979. *The Capitalist World-Economy*. New York: Cambridge University Press.

- . 1980. *Modern World System, 2: Mercantilism and the Consolidation of the European World-Economy, 1600–1750*. New York: Academic Press.
- Waltner, Ann. 2012. The Map of Matteo Ricci: Some Preliminary Observations. *Chinese Cross Currents* 9(3): 80–89.
- Wan, Ming. 2004. Mingdi baiyin huobi hua: Zhongguo yu shijie lianji de xin shijiao [Silver Monetization in the Ming Dynasty: A New Perspective on China's Connection with the World]. *Hebei Xuekan [Hebei Journal]* 5: 145–154.
- . 2016. *The Asian Infrastructure Investment Bank: The Construction of Power and the Struggle for the East Asian International Order*. New York: Palgrave Macmillan.
- Wan, Ming and Shu, Yingkai. 2015. *Mingdai “Wanli kuaiji lu” zhengli yu yanjiu [A Collation and Study of the Ming “Wanli kuaiji lu”]*. Beijing: Zhongguo kexue chubanshe.
- Wang, Congcong. 2014. Kāngqiánshèngshì xīngshuāi de nèizài jǐlǐ fēnxī - guójiā yú mínzhòng bóyì de shìjiào [Rethinking Kangxi and Qianlong Heyday from the Relationship of National Power and Civil Right]. *Zhōngguó shìyóu dàxué xuébào (shèhuìkēxué bǎn) [Journal of China University of Petroleum (Edition of Social Sciences)]* 6: 5–20.
- Wang, Fuming. 1987. *Foundation for the Study of Local Gazetteers [Fagzhibixue jichu, Ji'nan]*. Shandong Province: Shandong chubanshe.
- Wang, Helen H. 2010. *The Chinese Dream: The Rise of the World's Largest Middle Class and What It Means to You*. San Francisco: CreateSpace Independent Publishing Platform.
- Wang, Jiafan. 2004. Xixue dongjian' haishi 'xixue dongbian': Peng Mulan de da fenliu dapo 'ouzhou zhongxin zhuyi' lema [Did Pomeranz's The Great Divergence Break Eurocentrism?]. *Wenhui bao [Wenhui Newspaper]*.
- Wang, Jingyu. 2001. *Zhongguo Ziben Zhuyide Fazhan He Bufazhan [Development and Underdevelopment of Capitalism in China]*. Beijing: China's Financial Economics Press.
- Wang, Na 2007. Taoist Culture and the Development of Ancient Chinese Science and Technology. *Journal of Xinxiang Teachers College* 21(2): 73–74.
- Wang, Wang. 2015. China's 'New Silk Road': A Case Study in EU-China Relations. In Amighini, Alessia, and Berkofsky, Alex (eds.), *Xi's Policy Gambles: The Bumpy Road Ahead*, 93–109. Milan: Italian Institute for International Political Studies.
- Wang, Wei. 2003. The 'Global View of History' and World History Research. *Zhengzhou University Journal [Philosophy and Social Sciences edition]* 1: 32.
- Wang, Yeh-chien. 1973. *Land Taxation in Imperial China, 1750–1911*. Cambridge: Harvard University Press.
- Wang, Yunlong. 2002. From Modernization to Globalization. *Xuexiyu Tansuo [Study and Exploration]* 3: 121.

- Wang, Yuxun. 1998. Mingdai baiyin guoneikaicai yu guowailiuru shue shikao [Investigation on Domestic Silver Mining and Foreign Inflows in Ming Dynasty]. *Zhongguo qianbi* 3: 18–25.
- Wang, Yiwei. 2016. *The Belt and Road: What will China offer the world in its rise*. Beijing: New World Press.
- Wang, Zhengzhong. 2017. The regulation of sailors in the maritime trade between Jiangnan and Nagasaki in early Qing China. In Elman, Benjamin A. and Chao-Hui, Jenny Liu (eds.), *The 'Global' and the 'Local' in Early Modern and Modern East Asia*, 221–228. Leiden: Brill.
- Washbrook, David. 1997. From Comparative Sociology to Global History: Britain and India in the Pre-History of Modernity. *Journal of the Economic and Social History of the Orient* 40: 410–43.
- Weber, Max. 1950. *General Economic History*. New York: Collier Books.
- . 1951. *The Religion of China, Confucianism and Taoism*, New York: Free Press.
- . 1958. *The Religion of India*. Glencoe: The Free Press.
- . 2001. *The Protestant Ethic and the Spirit of Capitalism* (translated by Talcott Parsons with an introduction of Anthony Giddens). London: Routledge.
- Werner, Michael and Zimmermann, Bénédicte. 2002. Vergleich, Transfer, Verflechtung: der Ansatz der Histoire croisée und die Herausforderung des Transnationalen. *Geschichte und Gesellschaft* 28(4): 607–636.
- . 2006. Beyond Comparison: histoire croisée and the CHALLENGE of Reflexivity. *History and Theory* 45(1): 30–50.
- Westad, Odd A. 2012. *Restless Empire: China and the World since 1750*. Philadelphia: Basic Books.
- Wickberg, Edgar. 1964. The Chinese Mestizo in Philippine History. *The Journal of Southeast Asian History* 5(1): 62–100.
- Will, Pierre-Etienne. 1985. Local Gazetteers as a Source for Long-Term Economic Change in China: Opportunities and Problems. *Han-hsueh yen-chiu* 3(2): 707–738.
- Willcox, Walter F. 1930. A Westerner's Effort to Estimate the Population of China, and Its Increase since 1650. *Journal of the American Statistical Association* 25(171): 255–268.
- Williams, Eric. 1966. *Capitalism and Slavery*. New York: G.P. Putman's Sons.
- Williamson, Jeffrey G. 1985. *Did British Capitalism Breed Inequality?* Boston: Allen and Unwin.
- Witek, John W. 2001. *Dicionário Português-Chinês [Pu-Han cidian: Portuguese-Chinese dictionary]* by Michele Ruggieri, Matteo Ricci. Lisboa: Biblioteca Nacional.
- Wittfogel, Karl A. 1931. *Wirtschaft und Gesellschaft Chinas, vol. 1*. Leipzig: C.L. Hirschfeld Verlag.

- . 1957. *Oriental Despotism: A Comparative Study of Total Power*. New Haven: Yale University Press.
- Wong, Roy Bin. 1997. *China Transformed. Historical Change and the Limits of European Experience*. Ithaca: Cornell University Press.
- . 2015. Taxation and good governance in China, 1500–1914. In Yun-Casallilla, Bartolome and O'Brien, Patrick (eds.), *The Rise of Fiscal States: A Global History, 1500–1914*, 353–377. Cambridge: Cambridge University Press.
- Wu, Xiaoqun. 2014. Do We Really Need a ‘Global View of History’? *Chinese Studies in History* 42 (3): 45–50.
- Wu, Yujin, and Qi, Shirong. 1994. *Shijie shi [World History] vols. 1–6*. Beijing: Gaodeng jiaoyu chubanshe.
- Wu, Yujin. 1995. *Wu Yujin xueshu lunzhu zixuanji [Self-Selected Academic Works by Wu Yujin]*. Beijing: Shoudu shifan daxue chubanshe.
- Xia, Mingfang. 2007. Modern Chinese History Without “Modernity”: Paul A. Cohen’s Three Dogmas and the Logical Contradictions of the China-Centred Approach. *Journal of Modern Chinese History* 1(1): 53–68.
- . 2012a. *The Bumpy Road: China’s Modernization in Ecological Transformation*. Beijing: Renmin University Press.
- . 2012b. Zhenjia Adam Smith: Cong meiyou fengong de shichang kan jinshi Zhongguo xiangcun jingji bianqian [True and False Adam Smith: Modern Chinese Rural Economy from the Perspective of Market without Division of Labor]. *Zhongguo jindaishi [Modern Chinese history studies]* 5: 77–98.
- Xi, Jinping. 2013a. Deepen Reform and Opening Up and Work Together for a Better Asia Pacific. Speech at the APEC Economic Leaders’ Meeting. FMPRC.http://www.fmprc.gov.cn/mfa_eng/topics_665678/xjpfwynmlxyx21apec_665682/t1088517.shtml.
- . 2013b. Xi Jinping’s speech at the National Propaganda and Ideology Work Conference on 19 August,” in Xi Jinping’s 19 August speech revealed? (Translation). *China Copyright and Media*. <http://chinacopyrightandmedia.wordpress.com/2013/11/12/xi-jinpings-19-august-speech-revealed-translation/>.
- . 2016a. Speech at the Inauguration Ceremony of the Asian Infrastructure Investment Bank in Beijing. *Xinbaunet*.http://news.xinhuanet.com/english/china/2016-01/16/c_135015661.htm.
- . 2016b. The Asian Infrastructure Investment Bank and China’s role in regional economic governance. *East Asian Policy* 8(2): 25–36.
- Yan, Peng. 2012. Jishu yanhua yu zhongxi da fenliu: zhonggongye jiaodu de chongxinshenshi [Technical Evolution and the “Big Divergence” between China and the West: A Re-Examination from the Perspective of Heavy Industry]. *Researches in Chinese Economic History* 3: 95–103.

- Yang, Fengcheng. 2012. From Toward Socialist Civilization to Building a Country with a Strong Socialist Culture. In Li, Zhongjie (ed.), *The Governing Principles of the Communist Party of China*, 149–160. Beijing: Foreign Languages Press.
- Yang, Qingkun. 1957. The Functional Relationship between Confucian Thought and Chinese Religion. In Fairbank, John K. (ed.), *Chinese Thought and Institutions*, 269–290. Chicago: University Press of Chicago.
- Yang, Dongping. 2006. *Zhongguo jiao yu gong ping de li xiang yu xian shi [Education Equity in China: Dream and Reality]*. Beijing: Peking University Press.
- Yang, Rui. 2014. China's Strategy for the Internationalization of Higher Education: An Overview. *Frontiers of Education in China* 9(2): 151–162.
- Yan, Xuetong. 2014. From Keeping a Low Profile to Striving for Achievement. *The Chinese Journal of International Politics* 7(2): 153–184.
- Yan, Zhongping. 1989. *Zhongguo jindai jingjishi, 1840–1894 [Modern Chinese Economic History, 1840–1894], vols. 1 and 2*. Beijing: Renmin chubanshe.
- Ye, Jianhua. 1999. Lun Qingdai Zhejiang de renkou wenti [Population Study of Zhejiang in the Qing Dynasty]. *Zhejiang xue kan* 2: 152–159.
- Ye, Weili. 2002. *Seeking Modernity in China's Name: Chinese Students in the United States, 1900–1927*. Stanford: Stanford University Press.
- Yun-Casalilla, Bartolomé. 2019. *Iberian World Empires and the Globalization of Europe 1415–1668 (Palgrave Studies in Comparative Global History)*. Singapore: Palgrave-Macmillan.
- Yu, Pei. 2001. Quanqiuhua he quanqiu lishiguan [Globalization and Global History Perspective]. *Shixue jikan [Collected Essays of History]* 2: 1–12.
- . 2004. Hongyang zhongguo shijieshi yanjiu de minzu jingshen [Uphold the National Spirit of China's World History Studies] *Shijie lishi [World History]* 5: 4–11.
- . 2005. The 'Global View of History' and a Few Thoughts on Chinese Historiography. *Xueshu Yanjiu [Academic Research]* 1: 5.
- . 2006. Global History and National Historical Memory. *Shixuelilun-yanjiu [Historiography Quarterly]* 1: 30.
- Zan, Luca, and Deng, Kent. 2017. Micro Foundations in the Great Divergence Debate: Opening Up the Perspective. *Accounting History* 22(4): 530–553.
- Zelin, Madeleine. 1985. *The Magistrate's Tael: Rationalizing Fiscal Reform in Eighteenth-century Ch'ing China*. Berkeley: University of California Press.
- Zhang, Guangzhi. 1992. Luelun shijieshi zai ershi shiji de chonggou [On the Reconstruction of World History during the Twentieth Century]. *Xuexi yu tansuo [Study and Exploration]* 5: 124–131.
- Zhang, Qiong. 2015. *Making the New World Their Own: Chinese Encounters with Jesuit Science in the Age of Discovery*. Leiden: Brill.

- Zhao, Gang. 2013. *The Qing Opening to the Ocean Chinese Maritime Policies, 1684–1757*. Honolulu: University of Hawaii Press.
- Zhao, Ximing. 1968. Jiang shang gu zhong lu. In Sun, Yuxiu (ed.), *Tong Shi*, vol. 8, 3–11. Taipei: Guangwen Bookstore.
- Zhan-jun, Liang. 2006. Quánqíúshǐ yú shìjièshǐ yītóng chúyì [Comparing World History and Global History: a Chinese Scholar's View]. *Shōudū shǐfān dàxué xuébào shèhuìkē xuébǎn*, [Journal of Capital Normal University, Social Sciences Edition] 3:170.
- Zhao, Yifeng. 2011. Great Divergence or Great Convergence? *Chinese Studies in History* 45(1): 69–83.
- Zhou, Haiwen. 2012. Internal Rebellions and External Threats: A Model of Government Organizational Forms in Ancient China. *Southern Economic Journal* 78(4): 1120–1141.
- Zhou, Rong. 1968. *The Revolutionary Army: A Chinese Nationalist Tract of 1903*. The Hague: Mouton.
- Zhou, Yuanhe. 1982. Qing dai renkou yanjiu. *Zhong-guo shehui kexue* 2: 161–188.
- Zhu, Zheng. 1998. Bian Zi De Lai Li. *Democracy* 8: 33–34.
- de Zwart, Pim. and van Zanden, Jan Luiten. 2018. *The Origins of Globalization: World Trade in the Making of the Global Economy, 1500–1800*. New York: Cambridge University Press.
- . 2019. *New Approaches to Economic and Social History: The Origins of Globalization: World Trade in the Making of the Global Economy, 1500–1800*. Cambridge: Cambridge University Press.

INDEX

A

- Acapulco, 68, 151, 164
Acemoglu, D., 64, 65, 85, 98
Actas Capitulares, 151
Adelman, J., 4, 7–10, 35
Adshead, S., 86, 90
Aduarte, Diego, 144
Africa, 31, 49, 65, 68, 94
aggression, 42
 non-aggression, 60
agriculture, 31, 71, 72, 148
 agrarian resources, 60, 96
“*alcaldes mayores*” [mayors], 138, 145
Aldcroft, D., 92
Aleppo, 15, 128, 158
Alicante, 12, 159, 167
Allen, R., 20, 77, 120, 177
almojarifazgo(s), 62, 148, 162–164,
 169, 175
 al-musrif, 162
Americas
 Latin America, 4, 8, 9, 31, 49, 67,
 68, 73
 Mexico, 8, 20, 67, 68
 South American routes, 18
Amoy (Xiamen), 21, 133, 150, 153,
 163, 169
Amsterdam, 87, 127, 151, 156
An Changchun, 44
Anderson, B., 8, 39, 85, 132
 “imagined communities”, 132
Andres de Aguirre, 144
Andres de Mirandaola, 143
Anhui, 64, 125
anti-Japanese resistance, 51
Antony, R., 3, 148
Apter, D., 53
*Archive de la Chambre de Commerce
de Marseille* (ACCM), 93, 130,
 154, 158, 167
Archive of the Matteo Ricci Institute
of Macau (AMRIM), 140, 142
*Archives Departamentales des Bouches-
du-Rhône* (ADBDR), 130,
 155
Archivo General de Indias (AGI),
 21, 130, 132, 134, 137, 138,

- 143–145, 148, 149, 154, 162, 163, 169
Archivo Historico Provincial de Murcia (AHPM), 130, 160, 161
Archivo Historico Provincial de Sevilla (AHPS), 130, 168
Archivo Municipal de Cartagena(AMC), 151
Archivum Romanum Societatis Jesu (ARSJ), 140, 142
- Armenia
 Armenian merchants, 12, 15, 128, 153, 155, 156, 158, 159, 176
- Armitage, D., 125
- Arrighi, G., 124
- Asia
 Asian values, 7, 52
 central Asia, 44
 East Asia, 2, 7, 15–17, 33, 46, 49, 51, 52, 63, 67, 73, 76, 78, 79, 92, 95–97, 125–127, 134, 136, 139, 150, 153, 156, 159, 164, 165, 170, 178
 Southeast Asia, 5, 12, 31, 49, 62, 89, 100, 132, 150, 153
- Asian Investment Infrastructure Bank (AIIB), 49, 50
 initial subscriptions, 50
- Aslanian, 16, 128, 155, 158
- Attman, A., 147
- Atwell, W.S., 147
- Aubour, 159
- Augustinian(s), 135, 139, 143, 144, 169, 175
- Autocratic State, 7, 14, 97, 127, 178
- autocratic system, 173, 178
- Auvergne, 159
- B**
 backwardness, 30, 56, 67, 94
 Bairoch, P., 94, 95
 Baladouni, V., 155, 158
 ban(s), 12, 24, 61, 63, 99, 161
 barbarian(s), 24, 25, 133
 Barcelona, 159, 167
 Barraclough, G., 37, 38
 Bartolomei, A., 159
 Batchelor, R., 18, 127
 Bautista, Juan, 137, 138
 Bearn, 159
 Beckert, S., 1
 Beijing, 20, 21, 26, 38, 48, 51, 55, 59, 64, 66, 94, 97, 116, 119, 127, 132, 139, 142, 161, 174
 Beijing Foreign Studies University [*Běijīng Wàiguóyǔ Dàxué* 北京外国语大学], 38, 39
 Belgium, 94, 140
 Belich, J., 1, 95
 Bell, D.A., 8, 35
 Bene, 150, 165
 Berg, M., 9, 10, 29, 32, 94, 95, 125
 Bitis, 144
 Bjork, K., 164
 Blussé, L., 12, 133
 Bolivia, 67
 Borao, J.E., 134, 160, 161
 border garrisons, 24
 Bouyon, 159
 Boxer, Ch.R., 16, 108, 135, 160, 162
Boxer Codex, 132, 134–137, 139, 176
 Boxer Rebellion, 61
 “foreign humiliations”, 42
 humiliation(s), 42
 indemnity, 51
 Boyajian, J., 108, 133, 160, 164
 Brady, A.-M., 55
 Brandt, L., 113, 119
 Braudel, F., 30, 85, 93, 125, 127
 Bray, F., 71, 88
 Bretton Woods, 49, 75
 Brewer, J., 6, 9, 18, 29, 95, 126
 Broadberry, S., 17, 20, 29, 77, 126, 175, 177

- Brook, T., 29, 109, 132
 Brunei, 134, 135
 Brunet family, 151, 165
 Buddhism, 25, 59, 71, 140
 Buenos Aires, 100, 156
 bureaucracy, 14, 20, 25, 60, 61, 63, 69, 72, 73, 76, 80–82, 96, 101, 119, 128, 172, 173
 bureaucratic system, 15, 70, 72
 “nosphimeric bureaucratism”, 81
 business, 12, 13, 19, 86, 87, 90, 93, 97, 99, 116, 118, 119, 129, 132, 137, 138, 144, 145, 149–151, 155, 156, 159, 160, 162, 170
 business agent(s), 151
 businessmen, 80
 Buti, G., 159
- C**
- Cadiz, 12, 18, 87, 95, 100, 128, 145, 151, 156, 159, 167, 176
 Cailus, 159
 Calico(es), 12
 Callao, 100, 156
 Camboya, 169
 Campbell, C., 102
 Canton, 11, 13, 18, 20, 21, 61, 62, 64, 66, 109, 116–118, 123, 124, 126, 131, 133, 134, 136, 145, 147, 148, 150–152, 156–159, 161–163, 165–169, 173, 174, 176
 Canton System [*yīkǒu tōngshāng* 一口通商], 14, 15, 33, 62, 76, 117, 118, 163, 165, 174
 Cao, S., 65, 87, 102, 112, 113
capellánias [chapels, churches], 19
 capitalism, 46, 63, 71, 72, 79, 81, 85, 97, 173
 sprout(s) of capitalism, 74, 100
- Capital Normal University [*Shǒudū Shīfàn Dàxué* 首都师范大学], 38, 39, 45
 capital(s)
 bank tariff(s), 56
 capital accumulation, 63, 65, 94
 flows of capital(s), 56
 Carrière, Ch., 155, 159
 Cartagena, 12, 151, 159, 167
 cartography, 24
 cosmology, 24
 map, 24
 Casado, H., 72
 caste(s), 80
 Cathay, 135, 136
 Catholicism, 13
 Cayron, 159, 160, 165
 Cervera, J.A., 144
 Ch'en, J., 52
Champan(es) [*sam pan* 三板], 134, 169
 Changshu county, 105
 Chan, Wing-tsit, 25
 Chao, K., 70, 85
 Chaunu, P., 62, 147, 162
 Chen Cheng-siang, 102
 Cheng Meibao, 18, 40
 Cheng(s), 84
 Cheng, X., 56
 Cheng, Z., 30
 Chen Huan-Chang, 27
 Chen Ling, 91
 Cheong, W.E., 117, 169
 Chiang Kai-shek, 67
 Childe, V.G., 37
 chili, 13, 116, 127, 153
 China [*zhōngguó* 中国]
 China Social Order, 27
 civilization, 2–5, 7, 9, 18, 23, 25, 28, 31, 36–38, 41, 43, 49, 57, 60, 66, 71, 95, 179
 Han dynasty, 3, 32

- Mainland China, 7, 113
- Middle Kingdom, 6, 20, 24, 48, 49, 59, 63, 65, 66, 69–71, 76, 79, 80, 82, 86, 90, 96, 97, 100, 101, 135, 139, 171, 174, 175, 179
- Ming dynasty, 14, 24, 53, 57, 70, 79, 102, 104, 106, 108, 109, 139, 142, 146–147
- Ming empire, 24
- Mongol dynasty, 106
- People's Republic of China (PRC), 6, 25, 28, 32–34, 48, 50, 51, 56, 63, 67, 68, 71, 72, 104, 179
- Qing dynasty, 3, 11, 17, 20, 32, 33, 50, 53, 60, 61, 63, 64, 69, 70, 74, 79, 86, 94, 101–104, 106, 109, 112, 116, 125, 127, 132, 139, 171, 176
- Qing empire, 11, 13, 15, 21, 30, 63, 65, 66, 99, 170, 171, 174, 177
- Republic of China, 56
- Song dynasty, 5, 24, 25, 59, 67, 69–72, 79, 81, 82, 85–87, 102, 103
- Son of Heaven [*tiānzǐ* 天子], 24
- southern province(s) of China, 15, 63, 64, 66, 81, 87, 98, 100, 101, 104, 113, 116, 117, 119, 173
- Tang dynasty, 71, 81, 85
- Chinese Academy of Social Sciences, 22, 48, 107
- Chinese characteristics [*zhōngguó tèsè* 中国特色]
- “Chinese dream” [*zhōngguó mèng* 中国梦], 5, 56, 60
- “Cultural Revolution”, 44, 54, 56–60
- hegemony, 23, 29
- “soft-cultural revolution”, 58, 59
- Chinese Communist Party (CCP)
- authority, 51
- CCP campaigns, 53
- CCP departments, 59
- CCP's 19th Congress, 58
- Central Committee, 51
- centralization, 53
- Chén Dúxiù, 52
- ideological training, 53
- leadership, 51
- logocentric movement, 53
- Long March, 51
- Lǚ Xùn, 52
- party cadres, 53, 58
- Chinese historiography, 37, 40
- Chinese literati, 25, 28
- Chinese Scholarship Council, 22
- Christian, 25, 28, 53
- Christian theology, 78
- Christian value(s), 27, 140
- city, 41, 87, 102, 106, 125, 131, 134, 135, 145, 150, 164, 166–168
- city-states, 81, 86–88
- fāng* 坊, 106
- civil service examination system
- [*kējǔzhì* 科舉制], 81, 85
- carrière ouverte aux talents* [open career to talents], 81
- Civitavecchia, 159
- clock(s), 13, 116, 126, 127
- Clunas, C., 29
- Coatsworth, J., 143
- coercion
- coercive, 58, 69, 80, 96
- Cohong [*gōngháng* 公行], 163, 165
- Cold War
- allies, 44
- North Atlantic Treaty Organization (NATO), 44
- post-Cold War, 36
- Warsaw Pact, 44

- collective imaginary, 67
- Colombia, 67
- colonial institution(s)
encomienda(s), 136, 143, 144
factor of ships, 143
presidio(s), 136
repartimiento(s), 143
- colonialism
 anticolonial, 53
 colony, 10, 12, 18, 19, 29, 46, 65, 67, 78, 94, 95, 98, 124, 126, 136, 145, 148, 153, 164, 169, 171, 174, 177
 “neocolonialists”, 41
 overseas colonies, 65
- Communism
 Chinese communism, 54
 Communist China, 53
 Communist systems, 55, 59
- Compagnie française des Indes orientales* and the *East India Company*, 155
- comparative history
 comparative analysis, 37, 124
 cross-referencing, 6, 11, 17, 30, 40, 80, 99, 129
 Gruzinski, S., 6, 35, 136
 Haupt, H.-G., 9, 129
jeux des échelles, 6
 Kocka, J., 9, 129
 Levi, G., 6, 125
longue durée, 125
 micro-history, 177
 Revel, J., 6, 129
 Subrahmanyam, S., 6, 35, 153
 trans-localism, 11
 transnational, 6, 11–13, 15–17, 34, 36, 40, 48, 128, 129, 131, 155, 156, 158–160, 170, 176
- compilation, 35, 38, 44, 45, 57
cóngshū 丛书, 57
- Conchinchina, 169
- confrontation, 24, 41–43, 67, 90
- Confucius
 Analects [*Lúnyǔ* 论语], 27
 Confucian ethical principles, 25
 Confucian ideals, 54
 Confucianism, 24, 27, 51, 59, 71, 140
 Confucian system, 7
 Confucius Institute(s), 58
 neo-Confucianism, 71
 neo-Confucianist, 18, 41, 43
 neo-Confucian policies, 2, 7, 23, 25, 30, 56–59, 79, 87
 neo-Confucian teachings, 59, 60
 postmodern neo-Confucian practice(s), 56–60
- Conrad, S., 1, 125
- consumption
 consumer goods, 7, 75
 demand, 12–14, 19, 126, 127, 129, 130, 146, 166, 168, 171, 178
 domestic demand, 48
 global consumerism, 16, 176
 vicarious consumption, 14
 vicarious consumption theory, 14
- copper coin, 146
- core-periphery(ies)
 core-peripheral economic areas, 29
 developed world, 29
 underdeveloped world, 29
 world economy(ies), 75, 77
- corn, 13, 127, 153
- corruption, 14, 61, 64, 80, 81, 108, 119, 163, 164, 166, 172–174
- Cotton(s), 12, 159
- county [*xiàn* 县], 103, 166, 173
- Court, 25, 80, 86, 127, 174
 Court of Beijing, 64
 imperial court, 32, 62, 65, 66, 86
- crystal glasses, 13
- cultural exchanges, 3, 31, 32, 40
- currency, 71, 145

world currency, 79

Curtin, P., 153

Curto, D., 155

D

Dachiary, 159, 160

Daoguan, 76, 112, 113

Daoism, 24, 25

Darwin, J., 2, 95

Davide, 159

de Bary, W.T., 72

D'Elia, P., 24, 25

Delille, G., 82

del Valle Pavon, G., 145

de Morga, A., 12, 131, 132

Deng, K., 14, 17, 30, 47, 55, 60, 63, 67, 70, 71, 77, 125

Deng Xiaoping, 3, 53–55

Deng clan, 53

Dermigny, L., 147

de Sousa, L., 13, 62, 108, 126, 127, 145, 152, 153, 160, 164

de Souza, G.B., 13, 134, 135, 152, 160, 164

de Vries, J., 6, 72, 74, 87, 94, 127

Díaz de Seabra, L., 152

Diego Lopez de Valdepeñas, 143

digital humanities, 9, 18

databases, 17

data mining, 20, 177

Dingxiu Database, 109

GECEM Project Database, 110, 126, 149, 154, 158, 168

new historical data, 20, 126, 177

QGIS, 32, 110, 149, 154, 158, 168

Dinuccio, M., 97

diplomacy

“academic diplomacy”, 58

diplomatic relation(s), 36

Dirlik, A., 35

Disney, A., 153

Domingo de Salazar, 137, 144

Domingo Fernandez de Navarrete, 131

Dominican(s), 132, 139, 143, 144, 169, 175

donation(s), 73

don Jorge de Sanclemente, 150, 165

don Juan Solano, 150

don Simon de Anda y Salazar, 150, 165

Drayton, R., 1, 17, 35

Duchesne, R., 2, 10, 30, 76, 80, 92–94, 124, 177

Dumond, 165, 166

Dunstan, H., 172

E

early modern period, 20, 72, 78, 85, 88, 91, 127, 129, 155, 159, 173, 176

East, 4, 17, 18, 29, 30, 43, 58, 92, 147, 170, 174

economic history, 18, 67, 70, 71, 74, 75, 78

economic rise, 29, 31, 49, 75

economic transformation(s), 15, 17, 41, 44, 46, 47, 91, 172

education

Chinese education, 25, 30, 36, 42, 43, 51–53, 55, 56, 58, 59, 67

comprehensive education system, 53

Yán'ān spirit [*Yán'ān jīngshén* 延安精神], 51

efficiency, 172

efficient, 13, 14, 60, 71, 72, 76, 81, 87, 88, 96, 101, 102, 104, 117, 120

Eichengreen, B., 75

eighteenth century, 11–13, 16, 19, 20, 32, 46, 62, 65, 70, 71, 76–78, 88, 90–92, 95, 96, 98–100, 106, 116, 120, 125–129, 131, 139,

- 145, 148, 151, 152, 154, 156,
158–161, 168–170, 174–177
- Elison, G., 140
- elite(s)
- Chinese elite(s), 61–63, 127, 174
 - local elite(s), 61, 64, 66, 72, 80,
81, 85, 159, 165, 171, 177
 - private elite(s), 76
 - ruling elite(s), 67, 73, 79, 80
 - semi-feudal ruling elite(s), 79
 - trade elite(s), 20, 64, 87
- Elliott, J.H., 136
- Elliott, M., 136, 164
- Elson, A., 143
- Elvin, M., 65, 71, 82, 85, 87, 102,
113, 127, 148
- Embassy(ies), 13, 31, 32, 58
- empire(s)
- “multipolar ethnic empire”, 66
- Engerman, S., 94
- Enlightenment, 41, 46, 62, 92
- European Enlightenment, 28
- entrepreneurship, 72, 75, 81, 85, 102
- environment, 3, 71, 81, 88, 90, 176
- milieu*, 72
- estate(s)
- administrative officials, 80
 - artisan(s), 11, 70, 72, 80, 101, 133,
168
 - clergy, 80
 - master artisan(s), 80
 - nobility, 80, 85, 136, 168
 - peasant(s), 80
 - yeomen, 80
- Estoup, 159
- ethnicity
- ethnic, 66, 90
 - ethnic minorities, 4, 66
 - ethno-nationalism, 4
- Eurasia
- Eurasian empires, 60
- Eurocentrism
- Anglocentric, 2, 9, 29, 95, 97
 - Anglophone, 46
 - Euro-centred scholarship, 80
 - European power(s), 18, 23, 177
 - exceptionalism, 2, 10, 23, 24, 29,
30, 46, 47, 50, 75, 79, 94, 95,
125
 - “exclusiveness”, 30, 179
 - “Occidentalism”, 67
 - western expansion, 66
 - “Westernization”, 63
 - Western liberalism, 52
 - Western power(s), 19, 20, 32, 42,
44, 48, 50, 60, 62, 64, 67, 68,
98, 159, 163
- Europe, 4, 9–11, 13, 15–19, 21–23,
25, 28–32, 46, 51, 53, 70–72,
77–79, 82, 85, 89, 92–95, 99,
100, 119, 124, 125, 127–130,
139, 140, 146, 147, 150, 153,
154, 156, 159, 166, 169, 170,
175–178
- northwestern European region, 76,
79, 93
- European Commission
- EURAXESS, 22
 - European Delegation in Beijing, 21
 - European Research Council, 22
 - Horizon 2020, 22
 - Horizon Europe, 22
- evangelization, 139, 143
- expansion
- border(s), 35, 49, 60, 65, 80, 90,
96
 - overland expansion, 65
 - territorial expansion, 63
 - western frontier, 64
- exports, 21, 49, 56, 63, 70, 72, 92,
93, 98, 99, 131, 156, 166, 167
- F**
- Fairbank, J.K., 24, 51, 102

- Fairchilds, C., 126
 family(ies)
 [*dīng* 丁], 87
 extended family, 82
 family honour, 65
 family size, 82
 nuclear family, 82
 Fang, Xing, 101
 Faure, D., 147
 Feng, B., 165
 Feng, E., 59
 Fernandez-Armesto, F., 91
 feudalism
 Chinese feudalism, 81
 European Medieval kingdoms, 81
 feudal institution(s), 80
 medieval feudal system(s), 78, 85
 Feuerwerker, A., 65, 70
 First Historical Archives of China
 (FHAC), 17, 61, 118, 132
fiscal [prosecutor for the government],
 169
 Fish, S., 165
 Fish-Scale Maps and Books, 106
 Five constant virtues [*sān gāng wǔ*
cháng 三纲五常], 25
 five relations system [*wǔlún* 五伦], 25
 mutual respect, 60
 peaceful coexistence, 60
 Flores, J., 153
 Flynn, D.O., 16, 62, 79, 92, 98, 100,
 108, 124, 126, 127, 147
 foreign
 foreign community(ies), 11, 15, 62,
 67, 117
 foreigner(s), 24, 32, 61, 89, 162,
 164
 “foreign invasion”, 61
 foreign powers, 13, 48, 63, 165,
 178
 foreign trade, 12, 14, 16, 33,
 60–64, 117, 118, 164, 177
 France, 4, 12, 20, 21, 23, 25, 32, 53,
 66, 72, 100, 139, 165, 178
 French Bourbon, 11, 62, 145, 165
 French Revolution, 63
 Franciscan(s), 132
 Francisco Xavier Doutel, 160
 Frank, A.G.
 ReOrient, 38, 44
 “Silver Capital” [*báiyín zīběn* 白银
 资本], 38
 Frankopan, P., 31, 44
 Fujian, 12, 13, 18, 20, 55, 61, 64,
 100, 101, 108–115, 117, 119,
 128, 131, 135, 136, 146, 147,
 153, 159, 162, 163, 166, 167,
 174, 176
 Funes, 159
 Fuzhou, 111, 116, 133
G
 Galileo, 81
 Gallagner, L., 25
 Gan, N., 59
 Gansu, 125
 Gao, S., 165
 Genoa, 159
 gentry, 13, 61, 72, 80, 81, 102, 108
 local gentry, 63, 64, 98
 geopolitical unit, 31
 Germany, 4, 23, 39, 178
 Gerritsen, A., 11, 127
 Gibbons, R., 165
 gift(s), 73
 Gills, B.K., 130
 Gipouloux, F., 93, 151, 156
 Giraldez, A., 16, 62, 79, 98, 127, 147
 “global view of history” [*quánqiú lìshì*
guān 全球历史观], 37
 Global history [*quánqiú shǐ* 全球史]
 “global conjunctures”, 11, 18, 78,
 126

- “global history paradox”, 43, 179
 “glocalism”, 40
 interdisciplinary, 1, 9, 10, 37, 39, 125, 153
 new global history, 29, 18
 “surprising resemblances”, 11, 43
 globalization
 global affairs, 2, 4, 25, 29, 31, 33
 global dominance, 58
 multipolar world, 59
 “Gold Floral Silver” [*jīn huā yīn* 金花
 银], 146
 Goldstone, J., 124
 Gonzalez de Arce, D., 162
 Gonzalo de Ronquillo, 144
 Goody, J., 82
 governance, 12, 53, 56, 96, 97, 104, 120
 governor general, 136, 144
 governor(s), 61, 86, 89, 137, 150, 151, 165–167
 Grafe, R., 99
 Grand strategy, 32, 49, 56
 Grass, N., 146
 Great Britain
 British empire, 9, 19, 29, 78, 95, 126, 165
 British world, 10, 29, 95, 125, 126
 England, 9, 25, 29, 66, 124, 126, 165
 Great Depression, 75
 great divergence, 2, 6, 11, 15, 17–20, 30, 77, 94, 101, 125, 130, 173, 174, 177
 California School, 5, 18, 30, 44, 79, 124
 Great Ming Empire [*dà míng dìguó* 大明帝国], 24
 Green, N., 154
 Greif, A., 93, 96, 99, 150
 Grill
 Grill company, 156
 Grill family, 151, 156, 157, 159
 Grill letter(s), 150, 151, 154, 157, 166
 John Abraham Grill, 151
 gross domestic product (GDP), 2, 6, 17, 18, 20, 30, 36, 50, 70, 75, 77, 103, 125
 Guangdong, 12, 13, 18, 20, 55, 100, 101, 108–115, 117–119, 128, 131, 162, 174
 Guangzhou, 48, 61, 64, 111, 153
 Guizhou, 146
- H**
 Hakka [*kèjiā* 客家], 53
 Hamashita, T., 104, 151
 Han
 Han majority, 65
 Han origin, 64
 non-Han, 60, 61, 72, 76, 89, 114, 117, 127, 171, 172
 Hangzhou, 48
 Hausberger, B., 100, 126
 Hayami, A., 74
 Hayhoe, R., 51
 health, 31
 health security, 75
 Henan, 146
 He Qiao-yuan 何乔远, 109
 Hervouet, Y., 103
 Herzog, T., 143
 “High Qing” period [*shèng qīng* 盛清], 14, 76, 113, 118, 164, 172–174, 178
 Historical Archive of Macao, 93
Historiography Quarterly, 38
 Hokkien language, 131, 135
 Hokkienese, 132, 135
 Holstein, D., 125
 Holy House of Mercy of Macao, 152
 Arquivo Historico de Santa Casa de Misericordia de Macao, 152

- Hong Kong, 55
 Hong merchants, 14, 20, 123, 151, 158, 174
 Hong traders, 64
 Hongwu emperor, 106
 honour
 clan(s), 27
 prestige, 65
 Hopkins, T.K., 98
 Ho, P.T., 15, 65, 71, 87, 102, 103, 105, 106, 108, 109, 113–117, 119, 127, 153
 Horsley, M., 132, 136
 Hosne, C., 140
 household
 bǎojiǎ 保甲, 119
 guān dīng 官丁, 109
 guān qián 官钱, 109
 jiǎ 甲, 106
 lì 邻, 106
 sī-dīng 私丁, 109
 Howland, D.R., 101
 Huang, P., 15, 24, 71, 87, 99, 146
 Hubei, 117
Hùbù 户部, 113, 161
 “hoppos”, 162
 Huizhou traders, 19, 20, 64
 ancestral hall(s), 19
 Huizhou merchants, 20
 Humphries, J., 9, 95
 Hunan, 117
 Huntington, S., 10, 43, 44
- I**
 Ibarra, A., 100, 126, 156, 158
 Iberian empires
 Iberian Kingdom(s), 82, 136
 Iberian Peninsula, 82
 post-Union period, 19
 Union of Crowns, 13, 19, 127, 145
 imperial civil servant examinations
 [**kējǔ** 科举 system], 51
 imperial decree(s), 62, 64
 imperial edict(s), 64
 Imperial edits, 17
 imports, 49, 56, 63, 72, 75, 92, 93, 99, 131, 167
 Import-substitute(s), 12
 incapacity, 15, 61, 62, 66, 101
 income(s), 66, 70, 74, 75, 88, 127, 146
 incompetence, 61
 India, 12, 16, 17, 125, 128, 153
 Indian Ocean, 94, 158, 166
 Indian route(s), 14
 Indiana University Digital Library, 134
 individualism, 75, 78–81, 85, 119
 Industrial Revolution, 9, 16, 46, 47, 74, 77, 78, 85, 92, 94, 124–126, 128
 European Industrial Revolution, 47
 industry, 9, 16, 46, 71, 91, 93
 industrious revolution, 74
 inflation, 146
 ingot(s), 70
 inheritance
 firstborn, 80
 heir, 82, 86
 male primogeniture, 82
 primogeniture, 80, 82
 succession, 80
 Inikori, J., 94, 95
 Inquisition, 136
 neo-conversos, 19
 purity of blood, 13
 institution(s)
 non-official institution(s), 21, 92, 99
 non-state institution(s), 41
 Qing institution(s), 61, 119
 supervision, 63, 80
 internal affairs
 equality, 43, 52, 60

- “harmonious coexistence”, 59
 mutual non-aggression, 60
 mutual non-interference, 60
 peaceful coexistence, 60
 sovereignty, 60, 63, 67
 territorial integrity, 60
 International Geary-Khamis dollars, 77
 internationalization, 3, 10, 32, 42, 49, 55, 57, 58
 academic ecosystem(s), 3, 4, 10, 24, 28, 34, 57
 diversity, 3, 4, 21
 international relations (IR), 1, 4, 15, 35, 36, 40, 42, 58, 60, 165
 interventionism
 interventionist measures, 58
 “interventionist” policies, 57
 interventionist state, 54, 94
 interventionist system, 2, 72
 Western intervention, 42
 investment(s)
 credit(s), 152
 credit system, 49
 financer(s), 151
 foreign direct investment, 55
 information, 49
 interest rate(s), 151, 152
 liquidity, 49
 loan(s), 99, 151, 152
 “soft loans”, 49
 Iradiel, P., 72
 Irigoin, A., 99, 127
 iron coin(s)
 minted-iron coin(s), 70
 Islamic state, 134
 Italy, 66, 72, 139
 Iwai, S., 104
- J**
- Japan, 4, 39, 49, 51, 96, 134, 153
 Japanese experience, 63
 Meiji Restoration, 51, 63, 66
 Jean-Baptiste Du Halde, 139, 175
 Description de la Chine, 139, 176
 Dù Hèdé 杜赫德, 139
 Jesuit(s)
 Jesuit manuscripts, 21, 139
 Jesuit missionaries, 24, 25
 Sino-Japanese-Latin dictionary, 142
 Societatis Iesu, 139
 Jew(s), 19
 Jewish, 13
 Sephardim, 153, 155, 176
 Jiajing, 33
 Jiangnan, 6, 74, 101, 124, 173
 Jiangsu, 64, 74, 76, 100, 101, 124, 162, 166, 167, 173
 Jiaqing, 110–113
 Jixi county, 105
 Joao V, 164
 Johnson, S., 49
 Jones, E., 29
 Juan de Bolivar y Cruz, 169
- K**
- Kangxi, 14, 33, 61, 62, 103, 110–115, 118, 164, 172
 Keller, W., 72, 150
 Kim Hun Joon, 25, 55
 Kishimoto, M., 72
 Klein, H., 164
 Kuznets, S., 75
- L**
- labour service(s), 106, 108, 109, 114
 Huangze Registers, 106
 Yellow Registers, 106, 109
 Lamikiz, X., 164
 Landes, D., 29, 30, 46, 76, 80, 85, 92, 125, 177
 land(s)

landlord(s), 65, 73, 82, 93, 108
 landowner(s), 80
 land tenure system, 19
latifundia, 73
mayorazgo [entailed-state(s)], 82
morgadio, 82
 Latin, 139, 142, 166
 Latourette, 140
 Laufer, B., 131, 132, 135
 La Valeta, 159
 law
 constitutional government, 95
 democracy, 95
 liberty, 95
 Lee, J., 102, 113, 124
 legitimacy, 50, 179
 Lenin
 Leninism, 52, 54
 Marxist-Leninism ideal(s), 63
 Marxist-Leninist value(s), 59
 Levante
 Levantine routes, 15, 128
 Levi, G., 6, 125
 Levy, M.J., 65
 Liáng Chéng 梁诚, 51
 Liang Fangzhong, 146
 Liang, Jiabin, 14, 33, 62, 117
 Liang Zhan-jun, 37
 Li, B., 24, 33, 47, 67, 74, 76, 77, 79, 86, 126, 175, 177
 Li Bozhong, 33, 101
 Li Cheng, 172
 Lieberthal, K., 55
 Li, L., 87
 Li Longqing, 39
 Lima, 100, 151, 156
 lineage, 19, 82, 85, 88, 89, 99, 109
 extended lineage, 82
 Lin, J.Y., 25, 82, 177
 Li Qiang, 172
 Li Qingxin, 3, 153

liquor(s), 13, 116, 126, 127, 149, 152, 153
 Lisbon, 95, 156
 Liu Beicheng, 37, 38
 Liu Xincheng, 38, 39
 Li Wang, 51, 56, 86, 172
 Li Zhong Yu, 176
 Local gazetteers of China [*zhōngguó dìfāng zhì* 中国地方志], 17, 25, 70, 93, 101, 102, 104, 109, 110, 112, 113, 120, 173, 175
 London, 87, 127, 151
 Long, Denggao, 30, 47, 104
 Lopez, C. Yuste, 162
 Louis XIV, 62
 Low Countries, 71
 Lubao, 144
 Luis Pérez Dasmariñas, 136
 Luis Sanchez de Casares, 160
 Luo, X., 44, 46, 47
 Lyon, 87, 159

M

Macao, 11–16, 18, 19, 21, 32, 62, 64, 66, 89, 93, 123–126, 128–131, 133, 134, 145–148, 150–170, 174, 176, 177
 Macartney Embassy, 13
 Lord Macartney, 32
 Mackerras, C., 5
 Ma, D., 71, 96, 97, 104, 117–120, 128, 173
 Maddison, A., 77, 103, 104, 177
 Maddison School, 174
 Madrid, 131, 164
 Makepeace, M., 155
 Ma Keyao, 38
 Manchu
 Manchu campaigns, 65
 Manchu dynasty, 20
 Manchu emperor(s), 63, 66, 118

- mandarinate, 69, 80–82, 88, 96, 97, 172, 173
- mandate of Heaven [*tiānmìng* 天命], 71, 85, 94
- Manila
 Chinese sangleyes, 143
 “*indios*” [Indians], 137, 138, 144
 “*indios sangleyes*” [Indian sangleyes], 137
- Manila-Acapulco, 16, 18, 128, 156
- Manila galleons, 12, 18, 62, 68, 123, 126, 127, 150, 153, 169, 171, 175
- parian*, 12, 144
- sangleyes*, 12, 14, 20, 64, 66, 123, 130–139, 143–145, 147–149, 151, 156, 158, 159, 162, 165, 166, 174
- Mann, S., 172, 174
- Mao Zedong, 3, 53, 54
 Maoism, 53, 67
- marginal savings, 75
- maritime customs post(s)
 Jiang/Jiangsu customs
 [*jiānghǎiguān* 江海关], 61
- Min/Fujian customs [*mín hǎiguān* 闽海关], 61
- Yue/Canton customs [*yuè hǎiguān* 粤海关], 61
- Zhe/Zhejiang/Ningbo customs
 [*zhè hǎiguān* 浙海关], 61
- market
 decentralization, 56
 market economy, 2, 54–56, 76
 market integration, 40, 47, 94, 123, 127, 154, 171, 175–178
 marketization, 56
 market-orientation, 92–100
 privatization, 56
- Marks, R., 88, 124
- marriage(s), 19, 52, 82, 159–161, 178
- fertility, 82
- Marseille, 11–16, 18, 21, 32, 87, 93, 95, 100, 124–126, 128–130, 151, 153–156, 158, 159, 166, 167, 169, 170, 176, 177
- Marshall Plan
 new Marshall Plan, 49
- Martin, 159
- Martin de Rada, 135
- Martinez-Shaw, Carlos, 15, 158, 165
- Marx, K.
 Marxism, 40, 52–54, 67
 Marxist characteristics, 44
 Marxist ideology, 51
 Marxist school, 41
 Marxist theories, 44
The Capital, 54
 traditional-Marxist scholar(s), 42
- Masinloc, 150
- Mauss, M., 73
- May 4th Movement, 20
- Mazlish, B., 37
- McCants, A., 37, 127
- McCloskey, D., 94
- McDermott, J.P., 84, 108, 128
- McKendrick, N., 9, 95, 126, 127
- McMahon, D., 172, 174
- McNeill, W.H., 9, 41
- McNeill, P., 38
- medieval form, 66
- Mediterranean
 Mediterranean basin, 49
 “Mediterranean emporium”, 159
 Mediterranean Europe, 15, 73, 82, 85, 93, 124, 126, 128, 129, 151, 155, 167, 178
 Mediterranean kingdom(s), 82
 Mediterranean Sea, 15, 128, 158
 Mediterranean Silk Route(s), 158
 Spanish Mediterranean, 12, 167
- Melissen, J., 35
- Menegon, E., 118, 141, 153

mercantilism

- autarky, 14, 56, 60, 75, 89, 98
- European mercantilism, 62
- neo-mercantilism, 23, 75
- neo-mercantilist economic measures, 56
- self-sufficiency, 53, 69, 71, 80, 82, 87, 94, 100

merchant(s) guild(s) [*huìguǎn* 会馆], 72, 82

Mexico

- New Spain, 68, 100
- Obrador, Lopez, 8

Mexico City, 164

Meynard, T., 139–141

Miao, D.G., 56

Middell, M., 125

Middle East, 3, 31, 49

military force, 32, 35, 60, 63, 65, 71, 80

Ming shilù 明实录, 132, 146, 176

Ministry of Education of China, 45

mirror(s), 13, 126, 127

Miton, 137, 138, 144, 145

modernization, 3, 6, 33, 36, 42, 43, 46, 51, 53–55, 63, 64, 70, 71, 74, 78, 81, 82, 85, 88, 91, 94–96, 174

Mokyr, J., 71

Molho, A., 155

monetary reform(s), 146

Mongolia, 65

Montpellier, 151

moral capacity, 50

Moscow, 53

Mostern, R., 102

Motadel, D., 1, 17, 35

Mousseline(s), 12

Moutoukias, Z., 164

Müller, L., 151, 157

Mungello, D.E., 140

Muslim(s), 82, 135, 162

N

Nagasaki, 133, 150

Nakajima, G., 126, 127, 133

Nanjing

Lanquin, 166, 167

Nanking, 143

Nanquin, 166, 167

Nankai University [*Nánkái Dàxué* 南开大学], 38, 39

Nantay, 134, 135

Nash, J.F.

“governing dynamics”, 98

national

national governance, 56

national history, 4–8, 30, 34, 36, 38, 39, 42, 49, 57, 68

national identity, 67

national movement(s), 67

neo-national, 2, 4, 7, 56

nationalism, 36, 65, 132

nation-state(s), 5, 36, 65

patriotism, 4, 42, 48

unification, 4, 5, 65, 67, 68

Naumann, K., 125

Needham, J., 5, 6, 44, 71, 78, 81, 96

Needham puzzle, 71, 82

post-Needham practices, 70–79

negotiation, 20, 51, 64

Netherlands, 16, 23, 46, 76, 78, 88, 93, 96, 124–126, 164

new geopolitical world order, 48

New Julfa, 16, 128, 155, 158

Choffelins, 156

Ispahan, 156

Ng, Ch.-K., 12, 150, 152

Nicolas de Sollicoffre, 151, 165

nineteenth century, 3, 7, 36, 47, 51, 53, 60, 61, 63, 65–67, 88, 89, 152, 171, 177

Ningbo, 61, 150, 153

node(s), 2, 15, 47, 86, 93, 98, 99, 124, 125, 156

regional node, 66
 trade node(s), 62, 92, 95, 145,
 147, 153, 170
 Nordiska Museet, 150
 North, D.C., 85
 Nye, J., 35

O

O'Brien, P., 9, 17, 30, 41, 70, 77, 78,
 92, 94, 95, 125
 Obry, 150, 165
 official(s), 6–9, 13–15, 24, 25, 27,
 33, 50, 55, 59, 61–64, 66, 67,
 69, 72, 73, 80, 81, 86, 89–91,
 93, 94, 99, 101, 102, 104, 106,
 108, 109, 116, 117, 119, 120,
 130, 131, 136, 144, 145, 156,
 158, 162, 163, 166, 169, 170,
 172–175
 official level(s), 59
 Ogilvie, S., 72, 82
 Oka, M., 108, 127, 133, 134
 “Old China”, 42
 Ollé, M., 12, 131, 135, 144, 176
 Oloron, 159
 open-door policy(ies), 45
 open society(ies), 73, 86, 91, 127,
 154
 Opium War(s), 54, 60, 63, 66, 177,
 178
 O'Rourke, K., 9, 17, 20, 126, 129,
 175
 Osterhammel, J., 7, 124
 Overton, M., 94, 95
 Owens, J.B., 82

P

Pacific
 Pacific Ocean, 155
 Pacific region(s), 13, 79, 98, 150
 trans-Pacific, 14, 16

padre provincial [provincial father],
 144
 Pamuk, S., 120
 Panzac, D., 15
 paper making, 71
 paper money [*bǎo chāo* 宝钞], 145
 Pedro de Vargas, 169
 Pedro Murillo Velarde, 131
 Perdue, P., 31, 64, 101, 118
 Peretti, 159
 Perez-Garcia, M., 2, 14, 17, 18, 31,
 40, 42, 70, 74, 76, 85, 92, 93,
 100, 108, 116, 126, 127, 129,
 143, 151, 153, 156, 157, 159,
 165, 167, 175, 178
 Pericano, 159
 Perkins, D.H., 70, 71
 Persia, 31, 155
 Persia Safavid, 156
 Personal relationships [*guānxi* 关系],
 27
 Pesano, 159
 Peseto, 159
 Philip II, 136, 139
 Philippines, 4, 12, 13, 15, 64, 68,
 100, 123, 131–137, 143–145,
 147–152, 162, 165, 166, 169,
 172, 174–176
 Phillips, T., 59
 physiocrat monarch, 62
 Pike, R.S., 72
 Piketty, T., 6
 Poankeequa [Pan Zhencheng 潘振承],
 165
 Polanyi, K., 30, 44, 65, 125
 policymaker(s)
 Chinese policymakers, 58
 policymaking, 34, 36, 40, 57, 59
 political sphere(s), 59
 political theory, 53
 new political theory, 55
 polycentrism, 75

polycentric, 2, 14, 19, 29, 47, 66, 93, 95, 97, 100, 126, 156, 159, 168, 177

polycentric state, 66

Pomeranz, K., 6, 11, 17, 30, 37, 38, 47, 77, 79, 92, 120, 124, 125

population

census of population [*rénkǒu pǔchá* 人口普查], 101, 173

Malthusian constraints, 46

Malthusian pressures, 76, 102, 124, 172

population growth, 61, 80, 82, 87, 97, 102–104, 107, 110, 112

shízài réndìng 实在人丁, 114, 117

populism

American dream, 5

anti-global movements, 4

Porcelain(s), 12, 31, 70, 71, 93, 116, 126, 139, 146, 149, 153, 159, 160, 171, 174

Porter, J., 164, 172, 174

Portugal, 19, 66, 72, 82, 139, 155, 164

Portuguese crown, 12, 13, 168

potato, 13, 153

power

domination, 66

hegemonic power, 50, 52, 75, 78, 82, 95, 96, 165, 178

military power expansion, 60

“power paradox”, 69, 96–98, 173, 178

rising power, 36, 50, 59

“soft-power”, 31, 35, 50, 55, 57–59

world influence, 48, 50

Prak, M., 17, 79, 125

prefectures [*fǔ* 府], 63, 66, 87, 101, 105, 106, 109–113, 119, 173

secondary prefectures [*zhōu* 州], 66

subprefectures [*tīng* 廳], 66

production, 72, 73, 75, 78, 80, 88, 92, 99, 100, 139, 146, 147, 172

national production, 62, 63, 75

productivity, 48, 60, 96

Protestant Reformation, 81

province(s) [*shěng* 省], 4, 7, 12, 13, 18, 20, 48, 61, 63, 64, 66, 69, 73, 74, 76, 79, 81, 87, 97, 98, 100, 101, 103, 104, 108, 110–119, 124, 131, 140, 150, 153, 162, 163, 166, 167, 172–174, 176

public psyche, 8

inferiority complex [*qíngjié* 情结], 67

Purcell, V., 51

Puzhou, 103

Q

Qianlong, 13, 14, 20, 31–33, 61, 62, 89, 106, 110–113, 116–120, 163–165, 172, 174

Qimen county, 84

Qing economy, 63, 77, 173

Qing official(s), 12, 14, 64, 102, 161

Qing ruler(s), 61, 62, 66, 90

Qīng shílù 清实录, 132, 176

Qi, Shirong, 44, 45

Quan Hansheng, 147

Quanzhou, 111, 135

R

Racine, L., 73

Raveaux, O., 155, 156

Rawski, E.S., 71

Rawski, T.G., 66, 165

Real Audiencia, 132

Real Compañía de Filipinas [Royal Company of the Philippines], 15, 145

- Real Hacienda de Filipinas* [Royal Treasury of the Philippines], 144
 rebellion(s), 21, 76, 117
 Red Sea, 158
 Renaissance, 78
 European Renaissance, 71, 81
 Renmin University of China Library, 103
 revenue(s), 14, 48, 61, 62, 87, 93, 108, 109, 113, 116, 117, 120, 124, 136, 143, 148, 162, 172
 revenue shortage(s), 61
 state revenue(s), 63
 “reversal fortune”, 65
 revolutionary campaign(s), 63
 Ricci, Matteo [*lì mǎdòu* 利玛窦], 24, 26, 139, 141, 166, 175
 Ricci’s map, 24, 25, 28
 rice, 144
 Riello, G., 127
 Riquelme lineage, 83, 84
 rivalry, 43, 165
 Robinson, J., 64, 65
 Roosevelt, Theodore, 51
 Rosenthal, J.-L., 120
 Rostow, W.W., 92
 Roux, 159
 Roux company, 158, 165
 Roux family, 151
 Rowe, W., 24, 89, 164, 172, 174
 Rubin, J., 97, 119, 173
 Ruggieri, Michele, 141–143
 Ruiz, T., 143
 Russell, B., 91
- S**
 Sachsenmaier, D., 1
 Saich, T., 53
 Salafrañca lineage, 83, 84
 Sanclemente, 151, 165
 Sandby-Thomas, P., 55
 San Francisco Xavier, 139, 141
 Sawyer, S.W., 16, 125
 Schäfer, W., 37, 125
 Schaub, J.-F., 145
 Schurz, W.L., 62, 150, 162, 164
 Scientific Revolution
 Aristotelian tradition, 78
 European Scientific Revolution, 78, 94
 Galilean method(s), 78
 Newtonian method(s), 78
 rationalization, 28
 secularization, 27, 28
 services, 31, 81, 82, 106, 108, 109, 114, 117
 Sese, 159
 seventeenth century, 12, 86, 131, 155, 156, 160, 161
 Seville, 11, 12, 18, 21, 95, 100, 124, 126, 128, 130, 145, 151, 156, 159, 166–168, 176
 Shandong, 146
 Shanghai
 Pudong, 55
 Shanghai’s municipality, 55
 Shanghai Jiao Tong University Library, 109
 Shanghe, 84
 Shanxi, 116, 146
 Shanxi bankers, 20, 64
 Shanxi province, 103
 Shǎnxī 陝西 province, 51
 Shenzhen, 55
 Shi, Jianyun, 30, 104
 Shimada, R., 169
 Shiu, C., 72, 150
 shrine(s), 19, 99
 Shunzhi, 90
 Siam, 169
 Sichuan, 117, 146
 Side, Wang, 38
 Silk Road

- Alexander the Great, 31
 Chinese “grand strategy”, 32, 49, 56
 Marco Polo, 31, 135
 Maritime Silk Road, 31
 “One Belt, One Road” (OBOR) [*yīdài yīlù* 一带一路], 3, 9, 23, 31, 33, 38, 48–50, 56, 57, 179
 Seidenstraße and Seidenstraßen, 3
 Silk Route, 3, 154, 158
 The “New Silk Road” [*zhōngguó xīn sīchóu zhī lù* 中国新丝绸之路], 3, 4, 9, 23, 31–33, 179
 von Richthofen, F., 3
 Silk(s), 16, 31, 71, 93, 116, 126, 139, 146, 149–152, 156, 159, 166–168, 171, 174
 silver
 American silver, 12, 13, 61–63, 76, 79–81, 86, 88–90, 93, 95, 98, 99, 108, 109, 117, 123, 127, 130, 131, 144–147, 149, 153, 154, 159, 166, 171, 174, 175
liǎng 两, 118
peso(s), 138, 146, 151, 162, 166
 silver mine(s), 146
 silver money, 146
tael(s), 109, 118, 146, 147
tomines, 162
 “Single Whip Reform”, 146
 Sinocentrism
 China’s historical exceptionalism, 47
 Chinese minorities, 65
 “Orientalism”, 67
 Said, E., 67
 Sinicized, 65, 66
 Sinocentred, 178, 179
 “Sinocentric turn”, 29, 30
 Sino-European socio-cultural encounters, 22
 Sino-European trade relations, 16, 176
 Sino-Japanese War, 53
 Sino-Japan wars, 54
 sixteenth century, 62, 69, 80, 81, 85, 90, 106, 109, 127, 131, 134, 136, 139, 145, 146, 149, 153, 161, 175, 176
 Sizilia, 159
 Skinner, G.W., 70, 108, 113
 slave(s)
 forced labour, 145
 “reos” (prisoners), 145
 slave owners [*núli fānzǐ* 奴隶贩子], 145
 slave trade, 94, 145
 Smith, P.J., 71
 smuggling activities
 contraband, 61, 62, 109, 118, 133, 156, 162, 166, 169
 corsair(s), 133
 pirate(s), 133
 smuggler(s), 99, 133, 134, 148
wokou, 133
 Socialism, 3, 51, 53, 54, 59, 67
 socialist economy, 55
 social mobility, 56, 81, 86, 89, 97
 social security, 56
 Socori, 159
 South China Sea, 12, 15, 62, 123, 128, 153, 155, 159, 166, 169, 174, 176
 Soviet Union
 economic planification, 54
 Soviet planification, 54
 Soviet-style educational system, 51
 Spain
 “black legend”, 8
 Bourbon Spain, 14, 15
 “Columbian exchange”, 8
 Cortés, Hernán, 8
 Crosby, A.W., 8

- Crown of Spain, 19
 Habsburgs, 19, 145
 Kamen, H., 8, 165
 Keen, B., 8
 “Ley de Memoria Historica”
 [Historical Memory Law], 8
 Paquette, G., 8
 Spanish Catholic monarch(s), 82
 Spanish empire, 8, 12, 13, 15, 16,
 19, 62, 68, 98, 123, 127,
 131, 145, 151, 156, 162, 171,
 174–177
 Spanish monarchy, 136, 143, 162,
 169
 special economic zones (SEZ)
 [*jīngjìtèqū* 经济特区], 55
 Spence, J., 53, 65, 120, 141
 Stalin, 54
 Standaert, N., 141
 State capacity, 11, 13, 22, 48, 60, 69,
 80, 81, 88, 97, 101, 102, 114,
 119, 123, 130, 169, 171, 172,
 174, 176, 178
 Stavrianos, L.S., 38
 Stein, B., 169
 Stein, S., 169
 stereotypes
 Anderson, B., 8, 39, 85, 132
 casts, 131–143
 imagined communities, 131–143
 Stockholm, 87, 151, 156
 Stone, L., 82
 Suarez, M., 100, 150, 156
 Succession War, 11
 Sultan Yusuf, 134
 Sun Yat-sen, 63, 67
 supervisor(s), 63, 101, 119, 162
 supremacy, 2, 4, 23, 24, 29, 59, 65,
 67, 71, 72, 75, 97
 supremacist attitude, 62
 “supremacy dilemma”, 69, 96, 98,
 173, 178
 Suzhou, 105, 106, 116, 151
 Sweden, 66, 157
 Swedish East India Company, 150
 sweet potato, 13, 116, 127, 153

T
 Taiping movement, 53
 Taiping Rebellion, 61
 Taiwan, 4, 65, 153, 159, 161, 162,
 176
 Tang, Jin, 47, 85
 Tang, Xiaoju, 51
 Taoism, 24, 59, 71, 91, 140
 tariff(s), 54, 56, 63, 64, 162
 royal tariff(s), 62, 162, 175
 tax(es)
 Board of Revenue, 106, 116, 117
 Cajas Reales, 148, 149
 Contaduría, 148, 149, 154, 163
 corvée, 14
 [*hùbù* 户部], 113, 161
 imperial treasury, 118
 Spanish Royal Treasury, 147–149
 tax custom(s), 56
 tax evasion, 62, 162
 tax reform(s), 80, 114
 tax revenue, 62, 109, 120,
 147–149, 172, 173
 tax system, 14, 60, 97, 175
 tribute [*gòngfù* 贡赋], 24, 101
 Tea, 12, 31, 71, 93, 116, 126, 146,
 149, 153, 159, 171, 174
 technology(ies)
 compass, 6, 71
 gunpowder, 6, 71
 metallurgy, 71
 nautical device(s), 6, 71
 technological achievement(s), 41,
 55
 technological breakthrough(s), 66,
 74, 79, 81, 85, 172

- Teles e Cunha, J., 153
 TePaske, J., 164
 textile(s), 62, 159
 The Beijing Center of Chinese Studies Library, 139
 The Godegard Archive, 150
The Guangming Daily [History Column], 38
 Theobald, U., 172, 174
 Thompson, W.R., 130
 Tian'anmen, 55
 Tian'anmen crackdown, 40
 Tian'anmen Square, 55
 Tibet, 65
 Tilly, Ch., 99
 Tingzhou, 111, 113
 tobacco, 116, 126, 127, 153
 Tongzhi Restoration, 63, 66
 Torricelli, 81
 town(s), 64, 81, 102, 103, 138
 Toynbee, A., 9, 29, 44, 65, 125
 trade
 illegal trade, 62–64
 nánbǎn 南蠻, 133
 overseas trade, 61, 88, 94, 96, 99, 134, 150, 152, 161
 trader(s), 11–14, 19–21, 64–66, 99, 108, 123, 126–128, 130–134, 146, 147, 152, 156, 158, 159, 161, 162, 165, 171, 174–176
 trade system, 14, 16, 96, 130, 149, 152, 159, 160, 172
 unofficial trade, 133, 148, 156, 168
 trade agreements
 European Economic Area (EEA), 5
 North American Free Trade Agreement (NAFTA), 5
 South American trade bloc (MERCOSUR), 5
 Southeast Asian Nations (ASEAN), 5
 World Trade Organization (WTO), 5
 trade networks
 alliance(s), 19, 153, 161, 165, 174, 177
 Asian-Mediterranean brokerage system, 93, 151
 brokerage system, 93, 123, 150, 151
 commenda, 19, 66, 93, 99, 123, 145, 149–151, 156, 174
 long-distance partnership(s), 14, 123
 social network analysis, 17, 99
 tributary state(s), 63, 100
 Trigault, Nicolas
 De Christiana expeditione apud Sinas Suscepta ab Societate Jesu, 166, 167
 Trivellato, F., 11, 125, 150, 154, 155
 Tsinghua University, 37, 42, 51
 Tsinghua College [*Qinghuá Xuétáng* 清華學堂], 51
 Tunquin [Tonkin], 169
 Gulf of Tonkin, 169
 kingdom of Tonkin, 169
 Turkistan, 65
 Turley, J.S., 134, 135
 twentieth century, 7, 37, 40, 42, 43, 59, 65, 73, 74, 98, 113, 124
 twenty-first century, 6, 29, 32, 34, 42, 45, 49, 55, 59, 172, 179
 Twitchett, D., 146
- U**
 UNESCO, 68
 uprising(s), 21, 63, 76, 117
 civil uprising(s), 61, 64
 social uprising(s), 48, 67
 US, 43, 49, 51, 53, 55, 57, 68

V

- Valencia, 159, 167
 Van der Woude, Ad., 72, 94
 Van Dyke, P., 118, 148, 162, 165
 van Zanden, J.L., 9, 17, 29, 77, 125, 126, 175, 177
 Venezuela
 Bolivarian political campaigns, 67
 Maduro, 8
 Venice, 87
 Veracruz, 151, 156, 164, 166
 Vidal, 159
 Vietnam, 169
 villages [*cūn* 村], 12, 41, 43, 63, 64, 66, 86, 87, 126, 144
 Vladimirov, P., 51
 Von Glahn, R., 76, 79, 92, 108, 124, 127, 146, 152
 Vries, P., 10, 29, 80, 95, 177

W

- Waley-Cohen, J., 24, 32, 65
 Walker, G., 164
 Wallerstein, I., 30, 46, 75, 78, 92, 94, 98, 125
 Waltner, A., 25
 Wang, Congcong, 172
 Wang, H.H., 3, 56, 60
 Wang, Yeh-chien, 104
 Wang, Zhengzhong, 118
 War of Jenkins' Ear
 guerra del asiento, 165
 Washbrook, D., 125
 wealth, 60, 61, 75, 82, 85, 88, 101, 164
 wealth distribution, 66, 74, 102
 Weber, M., 29, 78, 97, 124
 Werner, M., 14
 West, 1, 3, 4, 9, 16–18, 24, 25, 29, 30, 33, 38, 41, 43, 53, 59, 66, 67, 69, 79, 92, 95, 97, 98, 128, 170

- Westad, O.A., 42, 52–55
 Western historiography(ies), 45
 White Lotus Rebellion, 61, 76
 Wickberg, E., 131
 Williams, E., 94, 95
 Williamson, J., 9, 17, 20, 94, 126, 129, 175
 Wilson, Woodrow
 Fourteen Points, 43
 wine(s), 13, 116, 126, 127, 149, 152, 153
 Witek, J.W., 143
 Wittfogel, K., 88
 “*Asiatic Mode of Production*”, 88
 “*Oriental despotism*”, 88
 Wong, R.B., 14, 30, 70, 76, 92, 102, 120, 124
 world history [*shìjiè lìshǐ* 世界历史], 35–38, 41–45, 48, 57
 World History Association (WHA), 38
 World War II, 57, 75
 post-World War II order, 49
 Wuhan University, 44
wúwéi 无为, 91
 Wu Xiaoqun, 39
 Wu Yujin, 44, 45

X

- Xi'an, 3
 Xi Jinping, 4, 5, 31, 49, 50, 55, 58
 Xinjiang, 65
 Xuande, 146

Y

- Yangtze
 Yangtze Delta, 6, 74, 76, 124
 Yangtze region, 16, 125
 Yangtze River, 21
 Yan Xuetong, 50
 Ycar, 159

Yongzheng, [14](#), [61](#), [62](#), [76](#), [163](#), [164](#),
[172](#)
yuan, [146](#), [147](#)
Yuan, W., [104](#), [128](#)
Yun-Casalilla, B., [72](#), [82](#), [136](#), [143](#)
Yunnan, [125](#), [146](#)
Yu Pei, [48](#)

Z

Zambales, [150](#)
Zhang, Qiong, [24](#)
Zhao, Gang, [117](#)
Zhao, Yifeng, [104](#)
Zhejiang, [42](#), [61](#), [64](#), [100](#), [101](#), [146](#),
[162](#), [173](#)
Zhou, Y., [107](#), [112](#), [113](#)
Zimmermann, B., [14](#)