

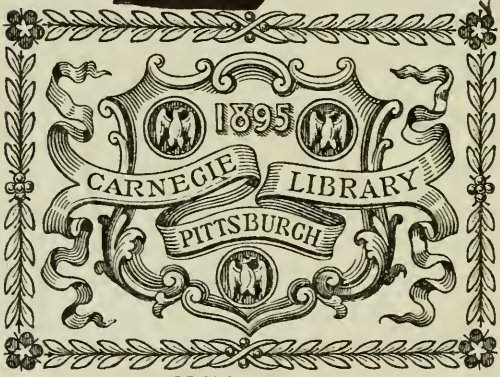

Class [redacted] Book [redacted]

14



PRESENTED BY

Mr Andrew Carnegie











# The Locomotive.

PUBLISHED BY THE



NEW SERIES.

Vol. XIV.

---

HARTFORD, CONN.

1893.



# The Locomotive.

PUBLISHED BY THE HARTFORD STEAM BOILER INSPECTION AND INSURANCE COMPANY.

NEW SERIES—VOL. XIV.

HARTFORD, CONN., JANUARY, 1893.

No. 1.

## The Arrangement of Feed Pipes.

There seems to be something about feed pipes that is troublesome to understand, for we frequently find them put in in unintelligent and dangerous ways. The prevalent idea in some parts of the country seems to be that all that is really necessary is a hole in the boiler, anywhere, with a pipe screwed into it, through which water can be pumped. Now nothing could be more erroneous than this, for the feed pipe is a very important thing, and needs the most careful consideration.

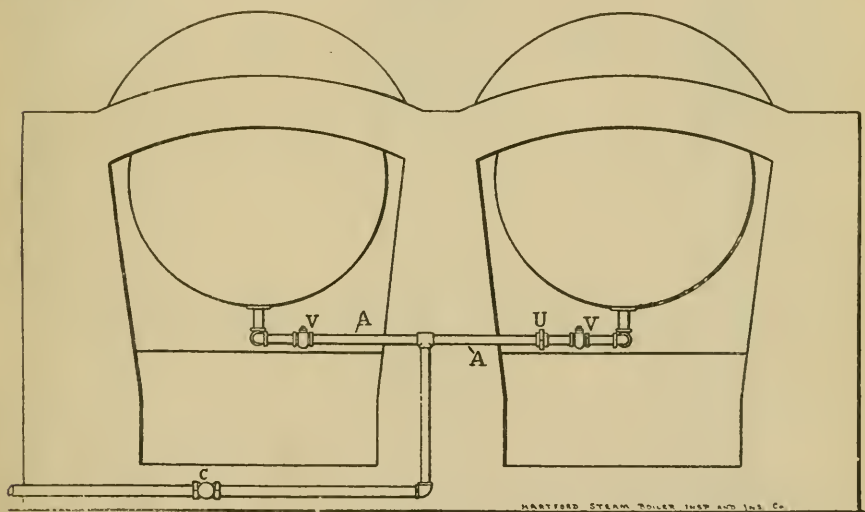

FIG. 1. — A DANGEROUS FEED CONNECTION.

To illustrate some of the common defects that we find in our regular work of inspection, we present Figs. 1, 2, and 3, which are taken from a report recently sent in by a single inspector. Fig. 1 shows the back end of a pair of boilers, the rear wall of the setting being removed for greater clearness. The feed pipe, *C*, comes along the floor until it is nearly opposite the middle of the setting. It then rises and branches to the right and left, turning in through the rear wall of the setting, and then upward into the boilers, which, it will be seen, are entered from the bottom. Stop-valves were provided at *VV*, and a check-valve was put in the main feed pipe at *C*. (*U* is merely a union fitting.) The boilers were set over separate furnaces, and had separate steam drums, with stop-valves in the steam pipes. It will be seen that there is nothing to

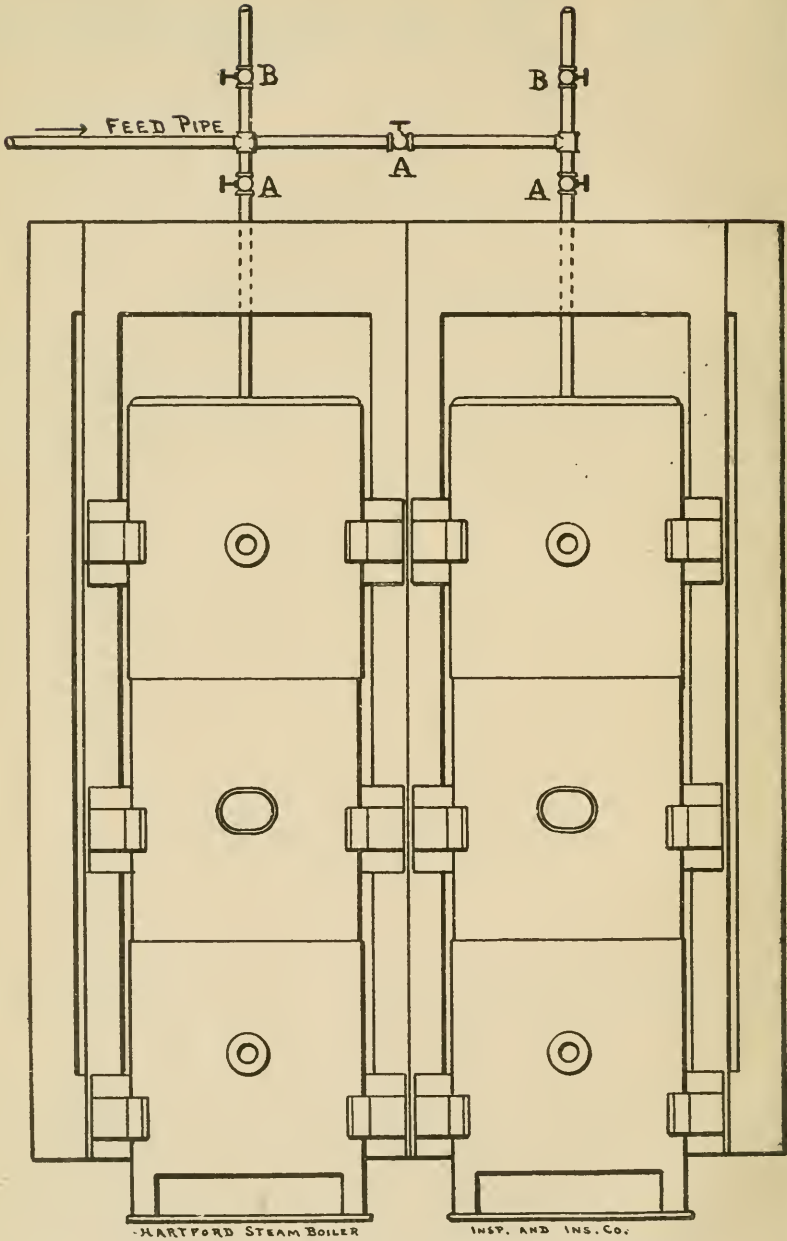

FIG. 2. — ANOTHER DANGEROUS FEED CONNECTION.

prevent the water in one boiler from backing up into the other one, if there should be any difference in pressure in the two boilers. Such a difference in pressure might easily arise from a variety of causes; for instance, if the stop-valve in the steam pipe leading from either boiler were closed, a difference in pressure would immediately result, and a change in the relative water levels in the two boilers would follow, unless one of the valves *VV* were also closed; and as these valves are at the back end of the setting, it would not be strange if the fireman should occasionally forget to attend to them, especially if he left them open habitually, as in the present case. It is also found, in practice, that if the fire in one of the furnaces is brighter than that in the other one, water is apt to back out of the hotter boiler, even when the steam valves are both open, and the pressure apparently equal throughout the system. In any case, the arrangement is a dangerous one, and should not be tolerated when safety can be so easily secured. While we do not approve of the feed entering the boiler at the bottom, as shown in the cut, we

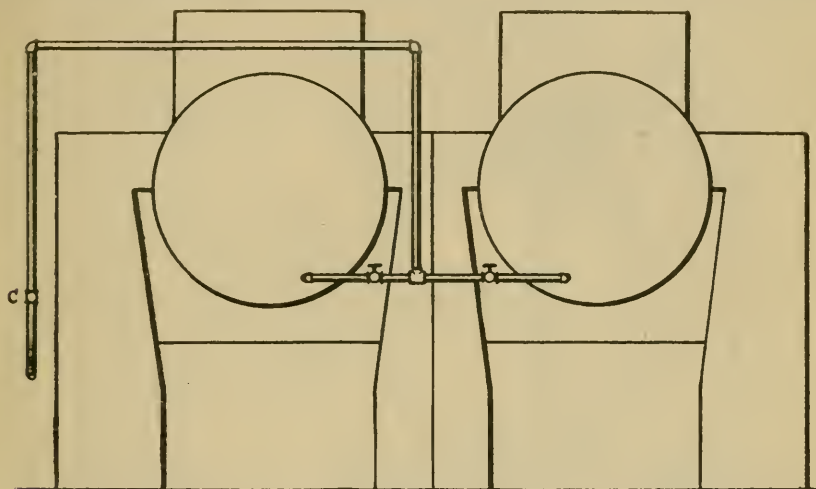
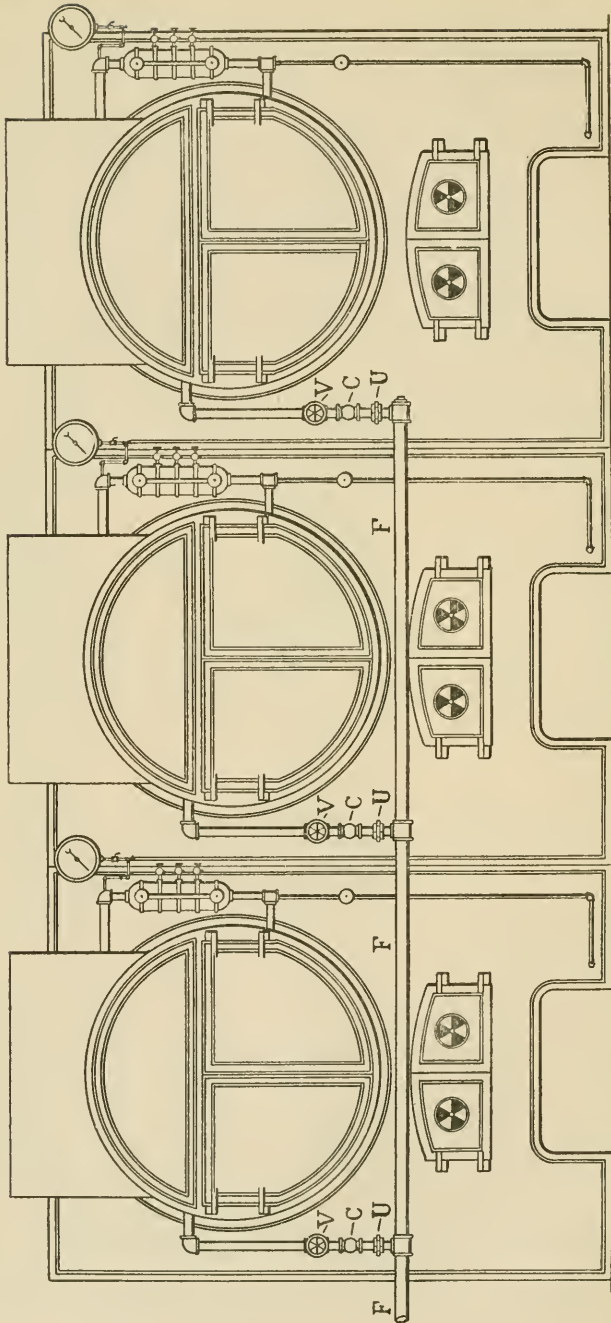

FIG. 3. — ANOTHER DANGEROUS FEED CONNECTION.

may suggest that the greater part of the danger can be removed by putting in check-valves at *AA*, for by this simple change the backing out of water from either boiler can be effectually prevented.

Fig. 2 shows a somewhat similar arrangement, except that in this case there was no check-valve at all, and the pump-valves had to hold the direct boiler pressure all the time. The valves shown at *BB* were only used when blowing off, and were kept closed at other times. Valves *AAA* were ordinarily left open. The boilers were set over separate furnaces, as before, and all the objections that apply to Fig. 1 are equally applicable to Fig. 2. There is also another objection, which is, that since the boilers are fed and blown off through the same pipes, it is not possible to remedy the trouble by putting in a pair of check-valves as before, for it will be seen that no check-valve could be used unless it was put in the main feed pipe (where there certainly *should* be one), or in the cross pipe connecting the two boilers; and even if a check-valve were put into this cross pipe it would not prevent the water in the left-hand boiler from backing up into right-hand one, although it would prevent backing up in the opposite direction. The arrangement shown in Fig. 2 must therefore be unqualifiedly condemned.



ADAPTED FROM STEAM BOILER WORK AND CO.

FIG. 4. — ELEVATION OF A BATTERY OF BOILERS, SHOWING THE PROPER WAY OF ARRANGING FEED PIPES.



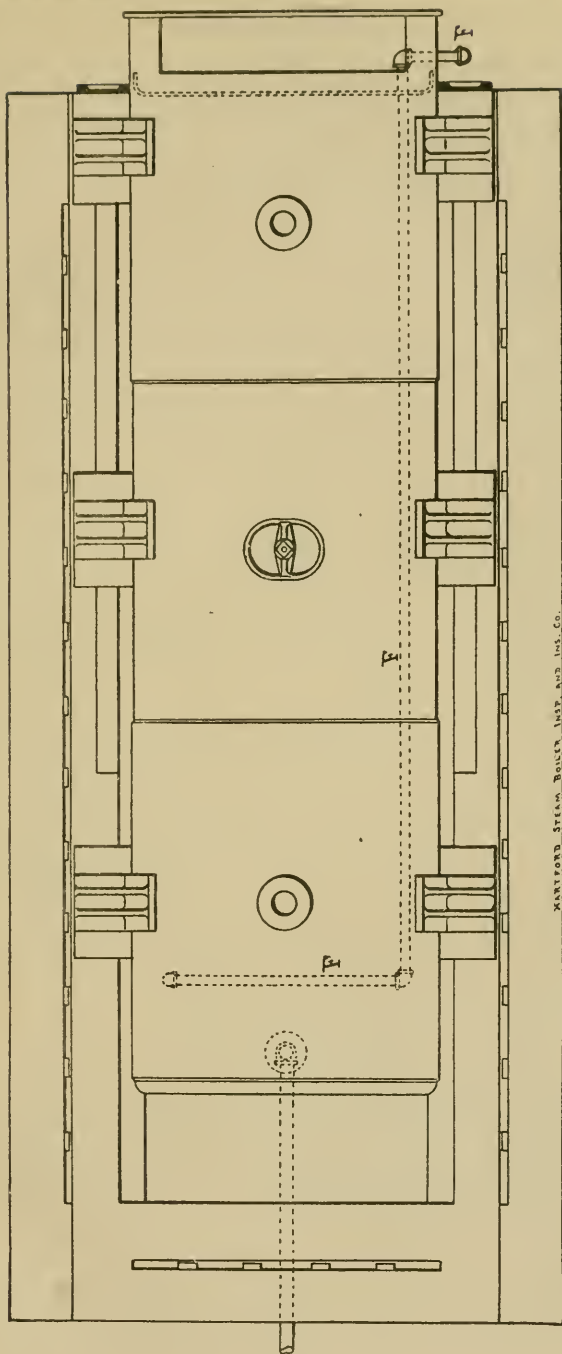

FIG. 5. — PLAN VIEW OF ONE OF THE BOILERS SHOWN IN FIG. 4. THE DOTTED LINES, *F F*, SHOW THE COURSE OF THE FEED PIPE AFTER IT ENTERS THE BOILER.

In both of the cases shown above the boilers are fed at the back end, and the feed-valves were habitually left open: the assumption being, apparently, that when the pump was started the water would enter both boilers equally. This is an unsafe assumption, because it is well known that feed pipes are liable to choke up from a variety of causes, especially when, as in Fig. 2, the bodies are fed and blown off through the same opening. Feed-valves should always be in front, where the fireman can reach them easily. A good man will not neglect them anyway, but it is better not to tempt him to do so by putting them in an inconvenient place. Fig. 3, shows an arrangement in which the feed-valves were at the front end of the battery. There was a check-valve in the main feed pipe at *C*, but the boilers were not provided with individual checks, as they should be. A part of the danger could be removed in this case by putting in individual check-valves between the globe-valves shown in the cut and the tee where the feed pipe branches. This would prevent the water from backing out from either boiler into the other one. But in all of the cases shown thus far there is the serious objection, that the feed water enters the boilers at the bottom. The shell being chilled by the cool feed is subjected to severe strains, and leaky seams and fractured plates are apt to result. Many persons find it hard to realize the magnitude of the strains produced in this way, and are disposed to dispute with us when we urge upon them the dangers to which the bottom feed subjects them. It is a matter of experience, however, that ruptures are produced in this manner, and we have known the bottom seams of a new boiler to be ruptured three times in six weeks from this very cause. The strains produced by the chilling action of feed water can also be calculated, and we hope to touch further upon this point in a future issue. The arrangement shown in Fig. 3 is more objectionable from this point of view than the others, because the feed enters at a hotter part of the boiler.

Figs. 4 and 5 show the arrangement of the feed pipes that we recommend, and experience has proven it to be entirely satisfactory. The main feed pipe runs along the front of the boilers, as shown at *FFF* in Fig. 4, and branch pipes are taken off by means of tees. In each of these pipes there is a stop-valve, *V*, with a check-valve, *C*, below it, and a union connection, *U*. The feed pipe enters the front head just above the upper row of tubes, and after entering the boiler it passes down nearly to the back head, as shown in Fig. 5. It then crosses over to the other side of the shell, and, turning downward, discharges between the shell and the tubes. In this way the feed water becomes well heated before discharging into the boiler, and its chilling action on the shell is greatly lessened. The best place for the discharge of the feed water into the boiler has been carefully considered, and we believe that that indicated in Fig. 5 is freer from objection than any other that could be selected.

In connection with Fig. 2, we said that there should be a check-valve in the main feed pipe. We do not wish to be understood as saying that there should *always* be a check-valve in the main feed pipe; but in the case then under discussion there was no chance to put an effective check-valve in any other place, on account of the peculiar arrangement of the piping. There should always be a *stop-valve* in the main feed pipe, however, and this valve should be near the pump.

## Inspectors' Report.

OCTOBER, 1892.

During this month our inspectors made 6,563 inspection trips, visited 14,475 boilers, inspected 5,621 both internally and externally, and subjected 735 to hydrostatic pressure. The whole number of defects reported reached 11,247, of which 1,147 were considered dangerous; 115 boilers were regarded unsafe for further use. Our usual summary is given below:

Nature of Defects.	Whole Number.	Dangerous.
Cases of deposit of sediment, - - - - -	879	34
Cases of incrustation and scale, - - - - -	1,492	73
Cases of internal grooving, - - - - -	96	28
Cases of internal corrosion, - - - - -	453	61
Cases of external corrosion, - - - - -	868	51
Broken and loose braces and stays, - - - - -	132	39
Settings defective, - - - - -	324	24
Furnaces out of shape, - - - - -	404	48
Fractured plates, - - - - -	251	71
Burned plates, - - - - -	212	46
Blistered plates, - - - - -	297	12
Cases of defective riveting, - - - - -	1,904	50
Defective heads, - - - - -	133	29
Serious leakage around tube ends, - - - - -	2,171	344
Serious leakage at seams, - - - - -	481	41
Defective water-gauges, - - - - -	311	55
Defective blow-offs, - - - - -	133	32
Cases of deficiency of water, - - - - -	29	18
Safety-valves overloaded, - - - - -	52	17
Safety-valves defective in construction, - - - - -	68	20
Pressure-gauges defective, - - - - -	457	39
Boilers without pressure-gauges, - - - - -	15	15
Unclassified defects, - - - - -	85	0
Total, - - - - -	11,247	1,147

## Boiler Explosions.

NOVEMBER, 1892.

TUG BOAT (187). Three men were scalded to death on Nov. 1st, by the explosion of a boiler in the tugboat *Colonel E. H. Grubb*, which was lying at Summit street, Brooklyn, N. Y. The victims of the accident were the cook of the vessel, William Butts, and two of his friends, Michael Waters and Edward Gillson. Shortly after the explosion occurred the accident was discovered by Walter Dunning, fireman of the vessel, as he went on board. He found the men alive, but enveloped in steam and suffering intense agony. They were promptly taken to the Long Island College Hospital, but all died in a few hours. The tug is owned by John McGrath, who is the engineer. Charles Grant is captain. They and the fireman left her at 8 P. M. on the day before, after returning from a trip to Sandy Hook. The fire was banked and left in good order. Butts had

been employed as cook on the boat for some time. He was accustomed to have some friends with him to pass the night. The three men were seen preparing for bed by a watchman aboard an adjoining vessel at 11 p.m. It is thought that they left the furnace door closed, and so much steam was made that the boiler exploded, as the safety-valve did not work. The escaping steam surrounded the men in their bunks, and they were overpowered and scalded in sleep before they could awake.

**SHINGLE MILL (188).** At noon, on Nov. 1st, while the men were away at dinner, H. McQuarrie's saw and shingle mill in Baysville, Ont., was blown up. It is a total wreck. The larger portion of the boiler crossed the river and passed through James Smith's dwelling-house. The inmates escaped without injury.

**SAW MILL (189).** On Nov. 1st two boilers exploded in Strader's saw and grist mill, on Ben Creek, in Logan Co., near Parkersburgh, W. Va., tearing part of the mill to pieces and killing and injuring several workmen. Elijah Jackson was struck by a piece of one of the boilers and instantly killed, and Julius Robinson, another workman, was struck on the head and fatally injured. Hiram Tyrrell had both legs broken, and Jerry Kness was seriously injured. Several other employes were also injured, but none of them seriously.

**THRESHER (190).** A threshing machine boiler exploded on Nov. 3d, on the farm of Andrew Bowers, two miles from the town of Bath, near Aberdeen, S. D. For nearly two days the engine had been undergoing repairs, and no threshing had been done. On the day of the explosion it was steamed up "for the purpose of ascertaining whether the break had been fully repaired." The owner of the engine, a Mr. Johnson, was acting as engineer, and at the time of the explosion was on top of the boiler oiling the machinery. He was not hurt in the least, nor was Frank Murphy, who was standing on the front wheel of the engine; but Ed. Murphy, Peter Winger, and Ed. Hickey, who were standing several feet from the front end of the boiler, were blown to atoms. The fireman, Hans J. Hansen, had his shoulder broken, and was badly cut and scalded about the face and body. At the time of the explosion the steam gauge registered 120 pounds. "This was not thought to be more than the boiler could stand," says the account, "as the engineer had been in the habit of carrying fully that much when the machine was at work." This is the second boiler explosion that has occurred in that vicinity within two weeks. The previous one was briefly described in the December issue of *THE LOCOMOTIVE*.

**BRICK BLOCK (191).** An explosion — presumably a boiler explosion — occurred on Nov. 3d in the boiler room beneath the four-story brick block at the corner of Sheriff and Huron streets, Cleveland, O. It was followed by a slight fire, which was readily extinguished. The damage from fire was about \$100, but the stock of Weiner Bros., commission merchants, on the first floor, was damaged by water to the extent of about \$1,400.

**THRESHER (192).** On Nov. 5th the boiler of a threshing machine exploded on the farm of Thomas Bowers, ten miles south of Waseca, Minn. Frank Western, the engineer, was stooping down, coupling the engine, and was instantly killed. A Mr. Presnall was struck on the forehead, and his scalp was torn off. Both of his eyes were injured, but the attending physician is hopeful of saving one of them. James Henshaw was injured also, though not seriously.

**HAT FACTORY (193).** The D. J. Larned building, corner of Ship and Richmond streets, Providence, R. I., was the scene of a terrific explosion on Nov. 8th. The wreck

was in the boiler room of the Providence hat company. A twenty-horse-power boiler exploded, blowing out all the windows in the shop and doing damage to the extent of several hundred dollars. George Teinelles, an employe of the shop, who was in the room when the explosion occurred, was badly hurt, and was removed to his home. Hose company No. 7 was summoned to the scene and extinguished a fire started by the explosion.

**CAR HEATER (194).** A steam heater in a railroad coach in the Santa Fé yards, Galveston, Tex., exploded on Nov. 10th. A coppersmith, named Fitzgerald, was standing near the heater and received several severe bruises, which, although painful, are not considered dangerous. Both of his feet were badly cut by pieces of iron, which scattered in all directions when the explosion occurred, and he sustained other injuries about the face and arms and other parts of his body. A man named Schriever, a helper to Fitzgerald, was also badly bruised and cut and his face was severely scalded by the escaping steam and water. A hole about six feet square was blown in the top of the coach, the glass and windows were all blown out, and one end of the car was entirely demolished.

**KINDLING WOOD FACTORY (195).** The two big boilers in Blaisdell Bros. kindling wood factory at Austin, Potter county, Pa., exploded with a terrific noise on Nov. 10th, the concussion shaking the town like an earthquake. The air was immediately filled with flying timbers, kindling wood, and débris of all descriptions. Andrew Epal and William Bruner, both firemen, were taken from the ruins of the boiler-house, dead. The other employes escaped injury, and aside from the severe shock are no worse for the explosion. The loss will be \$1,000.

**SAW-MILL (196).** A battery of five large steam boilers exploded in E. M. Short's saw-mill, in Beaufort county, near Washington, N. C., on Nov. 11th. The battery was blown in all directions. The plant is wrecked, and the loss is \$8,000. The fireman was bruised and a watchman scalded. The dome of a boiler was blown in the air, and in falling crushed through the roof of E. M. Simmons's house, landing in a room in which he and his family were asleep. The dry kilns were shattered to pieces. This is the third "blow-up and burn-out" that Mr. Short has sustained in the last few years.

**SODA FOUNTAIN (197).** The boiler used to heat soda water in the candy store of Henry M. Crowell, at Nos. 335 and 337 Fulton street, Brooklyn, L. I., exploded on Nov. 11th. No one was injured, but there was great excitement in the vicinity for a few moments. Superintendent Powers, of the department of steam-boiler inspection, and Police Commissioner Hayden, are trying to extend the powers of the city inspection department so as to include these candy store and drug store boilers.

**LOCOMOTIVE (198).** The blowing out of the "crownsheet" of a locomotive on the Central railroad, four miles west of Tennille, near Savannah, Ga., on Nov. 11th, resulted in the death of engineer John G. Grayson and brakeman Robert Middlebrook. The locomotive was drawing a freight and was running at a fairly good rate of speed. The fireman was in the tender, and brakeman Middlebrook undertook to shovel in coal. As he threw the first shovelful into the furnace there was a loud explosion, and the crownsheet came out in pieces through the opening with terrific force. A large section struck Engineer Grayson squarely in the stomach, lacerating him in a frightful manner and throwing him five car lengths away. Another piece struck Brakeman Middlebrook in the left side, crushing his ribs and landing him alongside the engineer. The explosion stopped the engine. It was not thought, at first, that Middlebrook's injuries would



prove fatal, but a change for the worse came over him and he died the next day. Engineer Grayson never regained consciousness.

**COTTON GIN (199).** On Nov. 13th, at Ben Scott's gin, near Magnolia, Ark., the boiler of the engine exploded while the gin was running at full speed. The engineer, whose name was Robinson, was instantly killed by pieces of the boiler, and a negro, who was warning near the engine, was scalded to death. Two others, who were connected with the works, were fatally scalded, but are still living, and two others were badly, but not seriously, injured.

**LOCOMOTIVE (200).** The boiler of Philadelphia & Reading engine No. 563, drawing a train of empty coal cars, blew up at Conner's Crossing, near Schuylkill Haven, Pa., on Nov. 14th, killing five men and probably fatally injuring another. The killed are Henry C. Allison, engineer; William Mackey, fireman; William Cowhey, William Kendrick, and William Moyer. Brakeman Michael Dobbins was also badly scalded, and will probably die. The engine was north bound, with a heavy train of empty cars. William Cowhey, with his crew, had brought up a train of empties and after running them into the Cressona yards boarded engine 563 at the Mine Hill crossing with the intention of reaching their homes in that way, and, as is customary, took possession of the cab. Dobbins, who escaped instant death, was crowded out of the cab and took a seat on the tender. The men had barely been on the engine two minutes when the terrible explosion occurred. They were thrown into the air in all directions and instantly killed. The boiler and firebox were blown off the trucks and the tracks were so badly damaged that traffic was considerably delayed. The north and south bound midnight Buffalo trains were compelled to run via the Little Schuylkill branch from Tamaqua to Port Clinton.

**AGRICULTURAL ENGINE (201).** A boiler bursted on the plantation of Thomas Lawrey, a few miles from Kershaw, S. C., on Nov. 17th, killing John Hunter instantly, and injuring Frank Lawrey so badly that he died within a few hours. Robert Lawrey was so badly hurt that it is thought he will not recover.

**BATH-HOUSE (202).** A boiler explosion occurred on Nov. 18th in a Hebrew bath-house, at the corner of Franklin and Logan streets, Pittsburgh, Pa., almost destroying it. Fortunately no one was in the house at the time. The house was damaged to the extent of \$1,000.

**SAW-MILL (203).** On Nov. 19th a boiler in the saw-mill of John Kirsch, in Perrigottseck, seven miles from Red Bud, Ill., exploded, and John Kirsch, August Vogest, and Andrew Frisch were fatally injured. The mill was nearly wrecked.

**MACHINE SHOP (204).** Edward Ryder, an electrician at the hardware company's new machine shops in Racine, Wis., was somewhat scalded about the face, on Nov. 21st, from the explosion of a steam-valve, in consequence of which that department had to shut down for repairs.

**BATH-ROOM (205).** Frank Lee's steam-heater in his bath-room, at Leigh, near Scotia, Neb., blew up on Nov. 26th. The bath-room happened to be empty at the time, and no one was injured. The force of the explosion was considerable, as the partition at the rear end of the room was blown out.

**MINE (206).** The bursting of a boiler at the Shakespeare mine in Yuba county, Cal., on Nov. 23th, injured the engineer and two bystanders. A hole between three and four feet long was made in the boiler. Owing to the rain six men were standing in front

of the boiler and only escaped scalding on account of the small amount of water in the boiler. William Miller had two ribs broken by one of the firebox doors, and George White was badly hurt in the arm. Frank Willits, the engineer, received slight bruises on the back.

**GIN (207).** On Nov. 24th the steam boiler of the Love Hancock gin at Fulbright, in Red River county, near Paris, Tex., exploded. Mr. Hancock was at the engine at the time. His body was badly scalded and blown some distance against a log pile. His shoulder and jaw bone were broken. The engine-room was blown to atoms. A sheet of the boiler and some of the bricks were blown fully 150 yards. The flues, with the two ends of the boiler, were carried about 100 yards and driven three feet into the ground.

**DRY GOODS STORE (208).** The steam-heating boiler in the basement of Erickson's dry goods store, in Escanaba, Mich., exploded on Nov. 24th, breaking all the glass in the building. The fire department was called to extinguish the fire, and checked it before any serious damage resulted. Mr. Erickson was standing directly over the boiler and was thrown up to the ceiling, but was not badly injured. None of the clerks were hurt. The interior of the building was badly wrecked. The loss will be \$3,000.

**HEATER (209).** The pay car of the Knoxville, Cumberland Gap & Louisville railroad left Knoxville, Tenn., on Nov. 25th, to pay off employes on the line. On the car were Paymaster Richard P. Johnson, Car Accountant Ralph Laxton, and Prof. E. S. Wertz of the Knoxville Classical School. They sat by the steam heater, and as the car came near Washburne station the heater exploded. Paymaster Johnson was seated nearest the heater and escaped uninjured. Mr. Laxton was fatally hurt, his skull being fractured, his left arm broken, and he is paralyzed on the right side. Prof. Wertz received a cut on the right side of his head, and his skull is thought to be fractured.

**LUMBER MILL (210).** The safety-valve of the boiler of the John Schroeder lumber company, in Milwaukee, Wis., blew off [presumably off the boiler] on Nov. 25th, and August Boettcher, Fred. Brandt, and Fred. Zabel, laborers, were severely scalded about the face and hands by the escaping steam. Brandt died on Nov. 26th, and Zabel died on Nov. 28th. In both cases death resulted from inhaling the steam, and not from the scalds the men received on their bodies. Boettcher, now the only survivor of the accident, lies at the Emergency hospital in a critical condition with the chances against his recovery.

**LOCOMOTIVE (211).** Engine 542, of the Lehigh division of the Philadelphia & Reading railroad, exploded her boiler on Nov. 30th, at the colliery at Brownsville, near Shenandoah, Pa. Engineer William Barry was instantly killed, and Simon Neifert, fireman, was badly scalded, and may also die. No definite cause is assigned for the explosion, but a theory advanced is that the stay-bolts had become weakened.

**SAW-MILL (212).** A boiler exploded on Nov. 30th, in the saw-mill owned and operated by Horace DeWitt, about one mile East of Bear Creek, near Kelloggsville, N. Y. Fred DeWitt, aged 18, the son of Horace DeWitt, was in charge of the boiler when it exploded, and was the only one near it. He was thrown over a log, and another log was thrown across his body. It was found that his face and head were badly cut, and he was bruised in many places. It is feared that he was injured internally. Parts of the boiler and engine were thrown ten rods.

# The Locomotive.

HARTFORD, JANUARY 15, 1893.

J. M. ALLEN, *Editor.*

A. D. RISTEEN, *Associate Editor.*

THE LOCOMOTIVE can be obtained free by calling at any of the company's agencies.

Subscription price 50 cents per year when mailed from this office.

Bound volumes one dollar each. (Any volume can be supplied.)

Papers that borrow cuts from us will do us a favor if they will mark them plainly in returning, so that we may give proper credit on our books.

BOUND volumes of THE LOCOMOTIVE for the year 1892 will be ready shortly. Copies will be sent to any address, postage prepaid, upon receipt of one dollar.

THE annual report of the chief of the Bureau of Steam Engineering (U. S. Navy Department) for 1892, is at hand. In addition to the report proper, which is of the usual character, there are three appendixes, the first of which gives details of a series of evaporative tests of a boiler for the ferry launch at the Portsmouth (N. H.) navy yard. The second appendix, which is of more general interest, gives an account of a series of tests of copper pipes, to determine the influence that banding them has upon their bursting pressure, and also to determine the effect of various thicknesses of material and temperatures of brazing upon the strength of the seam, and of the material adjacent to it. Appendix *C* contains an account of speed and power trials of the United States tugs *Wahnetta*, *Icawa*, and *Narkeeta*.

MR. EMORY EDWARDS has favored us with a copy of his new book, *The American Steam Engineer*, which we have read with much interest. Mr. Edwards discusses the theory of the steam engine, the economical use of steam, the design and setting of slide-valves, the proportions and construction of engines, and many other important subjects. He also gives considerable information about boilers, touching upon their design, their efficiency, and the various coverings that are applied to them. Several standard makes of engine are also discussed in detail. The objection is often urged against American books on engineering, that they devote too much valuable space to foreign practice; but no one will say this of Mr. Edwards's book, which confines itself, as its name indicates, to American practice. We heartily commend it to steam-users generally. (Published by Henry Carey Baird & Co. of Philadelphia.)

IN the *Popular Science Monthly* for January, 1893, there is a very interesting article by Mr. Charles Lane Poor, about the "lost comet of Lexell," which was seen in 1770, but has since disappeared. An elaborate mathematical analysis of the motion of this comet has shown its history to be as follows: Previous to 1767 it was moving through space along a path that, so far as we know, has never been fully investigated. In that year it chanced to come very near to Jupiter, and the attraction of this giant planet for



it became so powerful that the comet was swerved into an entirely different path, and in 1770 it passed the earth, only seven times as far from us as the moon is. The comet was then seen for the first time, and Lexell showed that it was moving in an ellipse, with a period of  $5\frac{1}{2}$  years. It performed one complete revolution in this orbit, but it was not seen when it passed the earth's orbit again in 1775, because we were then on the further side of the sun. It was looked for in 1781, however, but was not seen; and calculation has since shown that this was because it *almost struck* Jupiter on Aug. 23, 1779, and was again pulled out of its orbit, and caused to move in a vaster ellipse, with a period of nearly 34 years. It made about two revolutions in this orbit, but in 1846 the unfortunate comet approached Saturn so closely that it was thrown into a still larger ellipse, with a period of 47 years. It traveled onward in this new ellipse, but it seemed pursued by a strange fatality, for on July 19, 1886, before it had completed one revolution in its new orbit, the center of the comet came *within 60,000 miles of Jupiter's surface*, and its outer envelopes probably brushed against Jupiter. (Jupiter's nearest satellite is 220,000 miles from his surface.) It was again thrown into a new orbit, this time a smaller one with a period of only about 7 years. In the summer of 1889 it came near enough to the earth to be seen, *for the first time since 1770*. Mr. Brooks discovered it on July 6, 1889, but its identity with Lexell's "lost comet" was not suspected until quite recently. It will move in its present orbit for some years to come, and may be expected to return to us in 1896.

### The Discoverer of Steam Power.

The magazine *Invention* tells the painful story of Solomon Caus, a Normandy scholar, who lived in 1576 and thereafter, and wrote many scientific works, all of which led up to his conception of an idea which resulted in the transformation of his whole life into a tragedy. After pestering the king and the cardinal at Paris, he was ordered to be taken to Bicêtre — the madhouse, and there shut up. This was done. They had just one way with mad people in those days. They shut them in iron cages and fed them through the bars like wild beasts. They did this to Solomon Caus. For a long time he stood behind those bars all day and called to those who would listen, and to them repeated the story he had told the cardinal. He became the jest of the place. Some of them gave him writing materials, and then, amid the misery of his surroundings, he wrote down his ideals and amused his jailers so much the more. However, it could not be long before such a life, such surroundings, would shatter any brain. In time Solomon Caus was as mad as every one believed him.

It was in 1624 that an English nobleman, Lord Worcester, went to Paris and visited Bicêtre. As he was passing through the great court, accompanied by the keeper, a hideous face with matted beard and hair, appeared at the grating, and a voice shrieked wildly, "Stop! stop! I am not mad, I am shut up here most unjustly. I have made an invention which would enrich a country that adopted it." "What does he speak of?" the marquis asked his guide. "Oh, that is his madness," said the man, laughing. "That is a man called Solomon Caus. He is from Normandy; he believes that by the use of the steam of boiling water, he can make ships go over the ocean and carriages travel by land; in fact, do all sorts of wonderful things. He has even written a book about it which I can show you." Lord Worcester asked for the book, glanced over it and desired to be conducted to the cell of the writer. When he returned he had been weeping. "The poor man is certainly mad, now," he said; "but when you imprisoned him here he was the greatest genius of the age. He has certainly made a very great discovery."

After this Lord Worcester made many efforts to procure the liberation of the man, who, doubtless, would have been restored to reason by freedom and ordinary surroundings, but in vain; the cardinal was against him, and his English friends began to fancy that he himself had lost his senses, for one wrote to another, "My Lord is remarkable for never being satisfied with any explanations which are given him, but always wanting to know for himself, although he seems to pierce to the very center of a speaker's thoughts with his big blue eyes that never leave theirs. At a visit to Bicêtre, he thought he had discovered a genius in a madman, who declares he would travel the world over with a kettle of boiling water. He desired to carry him away to London that he might listen to his extravagancies from morning till night, and would, I think, if the maniac had not been actually raving and chained to the wall."

Thus, in Bicêtre died the man to whom, after his works were published, many people gave the credit of being the discoverer of steam power, and it is said that from the manuscript written in his prison, Lord Worcester gathered the idea of a machine spoken of as a "water-commanding engine," which he afterward invented. Historians have denied that Caus died in prison, but there exists a letter written by Marion de Lorme, who was with Lord Worcester at the time of his interview with Caus, which establishes the fact beyond doubt. — *Springfield Republican*.

THE annual statement of the Hartford Steam Boiler Inspection and Insurance company for the year 1891 appears in our advertising columns, several months later than usual. The explanation is that a Baltimore company, doing a remarkably multifarious business, applied for admission to do business in Connecticut; but the commissioner there expressed doubt whether, under the laws of Connecticut, a company doing so many different classes of business under one capital could be admitted to do business there. Upon this ground (under what is known as the *Retaliatory Law*), the Baltimore company insisted that the Maryland commissioner refuse admission to the Hartford company to do business in Maryland. A weak point in the argument was that the Hartford company does but one kind of business, restricting itself exclusively to boiler insurance. Moreover, in the course of the investigation, it transpired that, before the commissioner of Connecticut could render a positive decision, the Baltimore company had withdrawn its application. Commissioner Talbott, upon learning of this, promptly issued the license to the Hartford company. Meanwhile, that company's business had not suffered, as the commissioner, in all fairness, had given them full permission to continue to do business as usual, pending his decision. It will be seen that the company's receipts for the year amounted to \$781,981.06, which is by far the largest annual income it has ever had; and that its surplus to policy-holders amounted, January 1st, to \$580,007.08. The company, which has now been in operation for 26 years, amounts to a national institution and is generally regarded as the standard authority upon all matters connected with steam. We, ourselves, can vouch for the satisfactory way in which its inspections are made and its business generally conducted, as we have had our boiler insured and inspected by that company for many years.

An idea of the work done by the company's inspectors may be formed from the following figures. In 1891, 71,227 visits of inspecting were made by them. In the course of these, they examined 137,741 boilers. Of these, 57,312 were inspected internally and a hydrostatic test was applied to 7,859. 526 boilers were condemned and 127,609 defects were discovered, of which 10,858 were considered dangerous. From statistics in the company's possession, it appears that in 1891 there were in the United States 257 boiler explosions, against 226 in 1890, and 180 in 1889. By the 257 explosions in 1891, 263 persons were killed and 371 were injured. In addition to its most important work of prevention, the company also provides indemnity in case of loss, covering by its policies not only damage to property, but also indemnity for loss of life or injury to persons. — Translated for THE LOCOMOTIVE from the Baltimore *Deutsche Correspondent* of Dec. 17th.

## Bromine.

Bromine is a non-metallic element, and is one of the three known elements that are liquid at ordinary temperatures, mercury and gallium being the other two. (Gallium is an exceedingly rare metal, occurring in minute quantities, in certain ores of zinc that are found in the Pyrenees. It was discovered by Lecoq de Boisbandran in 1875. It melts at 86° Fah., and remains liquid until cooled below 60° Fah. It is of no practical use, but it possesses a high theoretical interest because a great Russian chemist had predicted its existence before it was discovered.) Bromine was discovered by Balard in 1826. It had been previously obtained by both Liebig and Joss; but the former supposed it to be a compound of iodine and chlorine, and the latter mistook it for selenion. It is quite volatile, and has a strong and irritating odor, from which circumstance it received its name, *bromos* being the Greek word for "stench," or "bad smell." It is of a dark, reddish brown color, almost black, and its vapor is yellowish red. It is poisonous, and when dropped on the skin it produces ugly sores that are very difficult to heal.

Bromine solidifies at 19° Fah. into a grayish brown, crystalline solid, of a somewhat metallic appearance; and at atmospheric pressure it boils at 138° Fah. At 32° Fah. its specific gravity is 3.1877. The specific heat of solid bromine is .0843, and the specific heat of liquid bromine, at ordinary temperatures, is .1071. It is a non-conductor of electricity. It is sparingly soluble in water, but it dissolves to a much greater extent in alcohol, and in chloroform it is soluble in almost any proportion. Its atomic weight is 79.75, and its chemical symbol Br. The emission spectrum of bromine contains marked lines at wave-lengths 3980 and 6356 (Salet's measures), and its absorption spectrum is distinguished by many lines between wave-lengths 6801 and 5244.

Bromine is a widely distributed but not very abundant element. It never occurs in the free state, but always in combination with other elements, principally with sodium, potassium, and magnesium. Sea water contains it, and so also do many of the mineral springs; and though none of the waters are rich enough to be profitably worked exclusively for the bromine they contain, it is found that the "mother liquor" left when working the sea-water or spring-water for salt, can often be further concentrated, with profit, for the extraction of the bromine that accumulates in it. For many years it was obtained in this way from the mother-liquors of the salt works at Schönebeck, Kreuznach, and other places in Germany. In 1846 bromine was discovered in similar mother-liquors in the United States, "especially those at Natrona and Tarentum, later on at Pittsburgh, Syracuse, and Pomeroy (O.), and in the Kanawha region in West Virginia." Stassfurt has also become an important source of bromine, and the output of this place in 1885 was 260 tons. The annual production of the United States is estimated at 120 tons, and if we add 20 tons as a reasonable estimate of the output from the nitrate of soda works and other places, the total production of bromine in the world is seen to be about 400 tons per annum.

Up to 1860 there was but little demand for bromine, and most of that which was produced was used for scientific purposes. At about that date, however, the demand began to increase rapidly. It is used extensively in medicine, chiefly in the forms of bromide of potassium, sodium, lithium, and ammonia, as these salts have valuable sedative properties. The invention of dry-plates and the consequent simplification of photography also led to a great increase in the demand for bromine, bromide of silver being the sensitive substance used in the preparation of these plates. Later on it was found to be useful in the preparation of certain of the coal-tar dyes (especially eosine.) It is also growing in favor as a disinfectant, since its action is similar to that of chlorine, and it is much more easily handled. It is also increasingly used in chemical analysis, for the same reason; and physicians employ it in the estimation of urea.



Incorporated  
1866.

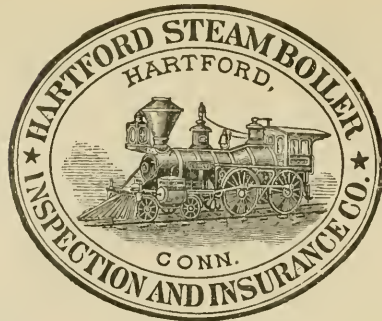

Charter Per-  
petual.

Issues Policies of Insurance after a Careful Inspection of the Boilers,  
COVERING ALL LOSS OR DAMAGE TO  
**BOILERS, BUILDINGS, AND MACHINERY.**

ALSO COVERING  
**LOSS OF LIFE AND ACCIDENT TO PERSONS**

ARISING FROM

## Steam Boiler Explosions.

Full information concerning the plan of the Company's operations can be obtained at the  
**COMPANY'S OFFICE, HARTFORD, CONN.,**  
Or at any Agency.

**J. M. ALLEN, President.**

**J. B. PIERCE, Secretary.**

**W. B. FRANKLIN, Vice-Prest.**

**FRANCIS B. ALLEN, 2d Vice-Prest.**

**E. J. MURPHY, M. E., Consulting Engineer.**

### Board of Directors.

**J. M. ALLEN, President.**  
**FRANK W. CHENEY, Treas.** Cheney Brothers Silk Manufacturing Co.  
**CHARLES M. BEACH,** of Beach & Co.  
**DANIEL PHILLIPS,** of Adams Express Co.  
**RICHARD W. H. JARVIS,** Prest. Colt's Fire Arms Manufacturing Co.  
**THOMAS O. ENDERS,** President of the U. S. Bank.  
**LEVERETT BRAINARD,** of The Case, Lockwood & Brainard Co.  
**GEN. WM. B. FRANKLIN,** late U. S. Commissioner to the Paris Exposition.  
**NELSON HOLLISTER,** of State Bank, Hartford.

**Hon. HENRY C. ROBINSON,** Attorney-at-Law, Hartford, Conn.  
**Hon. FRANCIS B. COOLEY,** of the National Exchange Bank, Hartford, Conn.  
**A. W. JILLSON,** late Vice-Prest. Phoenix Fire Ins. Co., Hartford, Conn.  
**EDMUND A. STEDMAN,** Treasurer of the Fidelity Co., of Hartford, Conn.  
**GEORGE BURHAM,** Baldwin Locomotive Works, Philadelphia.  
**Hon. NATHANIEL SHIPMAN,** Judge United States Circuit Court.  
**C. C. KIMBALL,** Pres. Smyth Mfg. Co., Hartford, Conn.  
**PHILIP CORBIN,** of P. & F. Corbin, New Britain, Conn.

### GENERAL AGENTS.

**THEO. H. BABCOCK,**  
**CORBIN & GOODRICH,**  
**LAWFORD & McKIM,**  
**C. E. ROBERTS,**  
**H. D. P. BIGELOW,**  
**C. C. GARDINER,**  
**L. B. PERKINS,**  
**W. G. LINEBURGH & SON,**  
**A. S. FERRY,**  
**MANN & WILSON,**  
**ZOLLARS & MCGREW,**  
**R. F. MANLY,**  
**W. S. HASTIE & SON,**  
**PETER F. PESCUO,**

### CHIEF INSPECTORS.

**R. K. McMURRAY,**  
**WM. J. FARRAN,**  
**F. S. ALLEN,**  
**H. D. P. BIGELOW,**  
**A. B. ECOFF,**  
**F. S. ALLEN,**  
**J. H. RANDALL,**  
**C. A. BURWELL,**  
**J. B. WARNER,**  
**T. E. SHEARS,**  
**B. F. JOHNSON,**

### OFFICES.

Office, 285 Broadway.  
" 432 Walnut St.  
" 22 So. Holliday St.  
" 35 Pemberton Sq.  
" 29 Weybosset St.  
" 112 Quincy St.  
" 404 Market St.  
" 218 Main Street.  
" 2 Sanford Building.  
" 208 Superior St.  
" 306 Sansome St.  
" Granite B'g, R'ns 3, 4.  
" 1901 First Ave.  
" 41 Broad St.  
" 188 Gravier St.

**NEW YORK CITY.**  
**PHILADELPHIA, PA.**  
**BALTIMORE, MD.**  
**BOSTON, MASS.**  
**PROVIDENCE, R. I.**  
**CHICAGO, ILL.**  
**ST. LOUIS, MO.**  
**HARTFORD, CONN.**  
**BRIDGEPORT, CONN.**  
**CLEVELAND, OHIO.**  
**SAN FRANCISCO, CAL.**  
**DENVER, COL.**  
**BRIMMINGHAM, ALA.**  
**CHARLESTON, S. C.**  
**NEW ORLEANS, LA.**

# The Locomotive.

PUBLISHED BY THE HARTFORD STEAM BOILER INSPECTION AND INSURANCE COMPANY.

NEW SERIES—VOL. XIV. HARTFORD, CONN., FEBRUARY, 1893. No. 2.

## The Effect of Temperature on the Strength of Iron.

This subject has attracted considerable attention on account of its importance in connection with steam boilers and other structures that are exposed, when in use, to a temperature several hundred degrees higher than the ordinary temperature of the air; but notwithstanding the interest that engineers have taken in the matter there seems to have been but little done in the way of experimental investigation.

The first experiments bearing upon the influence of temperature on the strength of iron, so far as we know, were those made by the Franklin Institute, in 1833, and published in the *Journal* of that institution in 1837. There is a difference of opinion among the authorities as to what these experiments really show, but they have usually been considered to show that iron grows stronger when its temperature is raised from, say, 60° up to 500° Fah. Chief Engineer Isherwood of the U. S. Navy has criticised the method

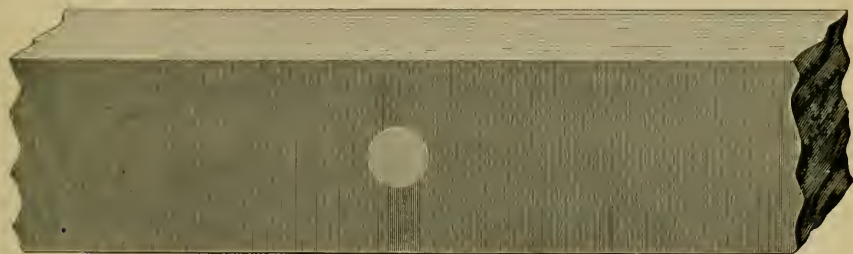

FORM OF THE TEST PIECES USED BY DR. HUSTON IN 1877.

in which they were carried out, and has pointed out a source of error to which they are doubtless liable. (For his remarks see the *Journal of the Franklin Institute* for July, 1874, page 38.)

Ten years later, in 1843, Baudrimont made a series of experiments with wires of gold, platinum, copper, silver, palladium, and iron. According to Isherwood, Baudrimont's average results for iron were as follows: Strength of iron wire, per square inch of section, was 295,000 lbs. at 32° Fah., 279,000 lbs. at 212° Fah., and 301,000 lbs. at 392° Fah. These results are interesting, but they are of no particular importance because iron wire is a very different thing from boiler plate, or bar iron.

In 1856 Sir William Fairbairn published the results of his experiments. They indicated that the strength of common boiler-plate is not materially affected by ordinary changes in temperature, but that as a dull red heat is approached the tensile strength falls rapidly. He says, "I have completed a series of experiments on wrought-iron plates and rivet-iron at various temperatures, from 30° under the freezing point to red heat. These experiments are the more satisfactory as they exhibit no diminution of

strength from 60° to 400°; but an increase of heat from that point to a dull red heat shows a considerable reduction of strength and a great increase of ductility, the plates being in the ratio of 20.3 to 15.5 tons per square inch, as regards strength, and the rivet iron as 35 to 16. The iron suffers little or no diminution in its powers of resistance up to a temperature of 500° Fah."

Next in order, after Fairbairn's experiments, came those made by the British Admiralty at the Portsmouth (Eng.) dock-yard, in 1877. The specimens to be tested were heated in an oil bath, and "the dies for gripping them were also so heated. The process of fixing and breaking occupied about one minute, during which care was taken to prevent, as far as possible, loss of heat by radiation and conduction." The temperature of each test-piece was recorded as equal to the temperature of the bath in which it was heated. Owing to the cooling of the specimens, and the suddenness with which they had to be pulled apart in order to compress the whole experiment into one minute, we cannot consider this series of tests to be very satisfactory, although it made an acceptable addition to what was then a very meagre knowledge of the effect of temperature on the strength of iron. The general conclusions that were reached by the committee having charge of these tests were as follows: "Wrought-irons, Yorkshire and re-manufactured, increase in strength up to 500°, but lose slightly in ductility up to 300°, after which the ductility increases up to 500°, at which point it is still less than at the ordinary temperature of the air. The strength of Landore steel is not affected by temperature up to 500°, but its ductility is reduced more than one-half."

In the same year (1877) Dr. Charles Huston of the Lukens Rolling Mills, Coatesville, Pa., made some tests bearing on this question, at which we were present by his invitation. As they have never been published it may be of interest to give a brief account of them. The test strips were a little less than an inch wide, and about three-eighths of an inch thick, and through the middle of each piece a quarter-inch hole was drilled, as shown in the cut. These holes were filled with fusible alloys, whose melting points were determined beforehand with considerable accuracy. By reducing the sectional area of the piece, the hole also determined the point of fracture. In making a test the piece was fixed in the jaws of the testing machine, and warmed along the central portion, as uniformly as possible, by a Bunsen burner. The piece was gradually put under tension at the same time, and when the strain upon it had approached its tensile strength the machine was stopped until the fusible alloy was seen to be fairly melted, and the piece was then broken by a slight additional pull. It was considered that in this way a very fair idea might be had of the effect of temperature upon the pieces tested. Six specimens were fractured in all. Three of them were cut from plates of the best flange boiler iron, made from cold blast charcoal blooms, and the remaining three were samples of Otis steel, furnished by the Baldwin Locomotive Works of Philadelphia. The results are given in the accompanying table.

RESULTS OF DR. HUSTON'S TESTS IN 1877.

MATERIAL TESTED.	Thickness.	Net width.	Net-sectional area.	Breaking weight.	Strain per sq. in. of original area.	Strain per sq. in. of fractured area.	Averages of these strains.	Contraction of area.	Temperature of specimens.
	in.	in.	sq. in.	lbs.	lbs.	lbs.	lbs.		° F.
Cold blast Iron,	0.385	0.622	0.239	12,500	52,300	70,600	61,450	.26	68°
“ “	.385	.629	.242	16,200	66,940	87,600	77,270	.24	575°
“ “	.380	.622	.236	16,550	70,130	90,000	80,065	.22	925°
Otis Steel,	.335	.642	.215	12,000	55,800	113,200	84,550	.50	68°
“ “	.335	.639	.214	14,200	66,350	111,000	88,675	.40	575°
“ “	.335	.640	.214	13,750	64,250	94,830	79,540	.32	925°



The column headed "net width" gives the width of the piece after the diameter of the hole has been deducted, and the "net sectional area" is obtained by multiplying the net width by the thickness. It will be noticed that the iron shows a material increase in strength as the temperature rises. At 78° it broke at 52,300 lbs. per square inch of original section, but at 575° an additional stress of seven tons per square inch was required in order to break it. The iron even shows a gain in strength between 575° and 900°, but it is doubtful if all pieces would show a gain in strength at this place, for at 925° we are approaching a red heat. The steel also showed a pronounced gain in strength per square inch of original section, as the temperature rose from 68° to 575°, but after this point was reached it fell off again, though even at 925° it remained materially stronger than at 68°. A marked and unexpected falling off in the contraction of area was observed in both the iron and the steel. This is so pronounced in the case of the steel that if the strain is computed per square inch of *fractured* area the steel appears to grow continuously weaker as the temperature rises. The lessening of the contraction is not so marked in the iron test pieces, so that these exhibit an increasing strength whether the original or the fractured area is considered. Although these experiments were not numerous enough to serve as the basis of any very broad generalizations concerning the effect of temperature on the strength of iron, we considered that they showed

#### THE TENSILE STRENGTH OF STEEL AT VARIOUS TEMPERATURES.

Temperature of Test.	Percentage of Strength.	Temperature of Test.	Percentage of Strength.	Temperature of Test.	Percentage of Strength.	Temperature of Test.	Percentage of Strength.	Temperature of Test.	Percentage of Strength.
0°	104.8	0°	104.3	0°	104.5	0	103.8	5	103.9
70	100.0	70	100.0	70	100.0	70	100.0	70	100.0
195	97.2	201	96.1	223	96.1	215	97.2	...	.....
334	117.4	306	100.3	339	109.3	317	102.6	272	101.6
460	125.8	437	111.9	431	111.7	440	115.4	448	113.6
492	122.2	545	116.8	569	116.4	570	115.9	503	115.3
616	123.4	668	114.5	651	106.4	642	112.8	594	115.4
731	102.5	736	101.4	738	103.1	757	106.0	712	98.1
845	108.4	869	86.2	832	102.0	....	.....	861	94.0
934	81.0	959	72.3	960	85.6	912	85.5	...	.....
...	.....	1050	57.2	1021	68.5	1020	75.3	...	.....
1045	47.3	1176	39.2	1198	45.1	1192	43.7	1113	54.5
1235	33.0	1397	30.7	1351	38.7	1395	42.9	1319	35.6

that iron is *at least as strong* at boiler temperatures as it is at the ordinary atmospheric temperature; and hence we felt safe in designing boilers without regard to the possible change in tensile strength that the metal might experience when heated to 300°, 400°, or even 500°.

The most extensive series of tests bearing on the effect of temperature, so far as we know, are those carried out recently at the Watertown Arsenal, with the great testing machine. The specimens were heated by rows of Bunsen burners, which were arranged in a muffle; and the temperatures of the test specimens were inferred from their observed expansions. Each piece was heated to the temperature of the test before being strained, and its expansion was observed by a micrometer. The coefficient of expansion of each grade of metal had been determined before the tests began, so that the temperatures

could be inferred with considerable precision. It will be impossible to give the results of these tests in detail in this place, but the foregoing abstract of five of them shows quite well that the strength of steel is greater at about 500° Fah. than it is at 70°. The temperatures are all on the Fahrenheit scale.

These five series of tests were made with five different qualities of steel, containing, respectively, .09, .20, .31, .37, and .51 per cent. of carbon. The figures given in the columns headed "Percentage of Strength" were obtained by dividing the tensile strength of a sample of steel at the given temperature by the strength of the same quality of steel at 70° Fah.

It will be seen that these specimens were all stronger in the neighborhood of zero than they were at ordinary temperatures; and that, in fact, they all show a *minimum* of strength at 210°, or thereabouts, and a *maximum* of strength at about 550°. This curious property of iron may now be considered to be well established; and it deserves further attention than it has yet received.

### Inspectors' Report.

NOVEMBER, 1892.

During this month our inspectors made 6,013 inspection trips, visited 12,457 boilers, inspected 4,621 both internally and externally, and subjected 714 to hydrostatic pressure. The whole number of defects reported reached 9,952, of which 1,029 were considered dangerous; 40 boilers were regarded unsafe for further use. Our usual summary is given below:

Nature of Defects.	Whole Number.	Dangerous.
Cases of deposit of sediment, - - - - -	795	40
Cases of incrustation and scale, - - - - -	1,344	89
Cases of internal grooving, - - - - -	109	22
Cases of internal corrosion, - - - - -	416	19
Cases of external corrosion, - - - - -	718	75
Broken and loose braces and stays, - - - - -	178	28
Settings defective, - - - - -	246	24
Furnaces out of shape, - - - - -	381	15
Fractured plates, - - - - -	266	52
Burned plates, - - - - -	176	15
Blistered plates, - - - - -	255	5
Cases of defective riveting, - - - - -	1,644	106
Defective heads, - - - - -	82	15
Serious leakage around tube ends, - - - - -	1,797	327
Serious leakage at seams, - - - - -	419	24
Defective water-gauges, - - - - -	306	50
Defective blow-offs, - - - - -	141	27
Cases of deficiency of water, - - - - -	55	20
Safety-valves overloaded, - - - - -	86	11
Safety-valves defective in construction, - - - - -	132	32
Pressure-gauges defective, - - - - -	406	33
Boilers without pressure-gauges, - - - - -	0	0
Unclassified defects, - - - - -	0	0
Total, - - - - -	9,952	1,029



## DECEMBER, 1892.

During this month our inspectors made 6,591 inspection trips, visited 12,938 boilers, inspected 4,984 both internally and externally, and subjected 634 to hydrostatic pressure. The whole number of defects reported reached 10,322, of which 1,130 were considered dangerous; 74 boilers were regarded unsafe for further use. Our usual summary is given below:

Nature of Defects.	Whole Number.	Dangerous.
Cases of deposit of sediment, - - - -	512	66
Cases of incrustation and scale, - - - -	1,280	87
Cases of internal grooving, - - - -	131	19
Cases of internal corrosion, - - - -	496	45
Cases of external corrosion, - - - -	712	45
Broken and loose braces and stays, - - - -	149	54
Settings defective, - - - -	254	34
Furnaces out of shape, - - - -	344	22
Fractured plates, - - - -	310	49
Burned plates, - - - -	170	12
Blistered plates, - - - -	217	14
Cases of defective riveting, - - - -	1,891	117
Defective heads, - - - -	104	34
Serious leakage around tube ends, - - - -	2,289	326
Serious leakage at seams, - - - -	455	30
Defective water-gauges, - - - -	216	55
Defective blow-offs, - - - -	95	30
Cases of deficiency of water, - - - -	23	9
Safety-valves overloaded, - - - -	42	17
Safety-valves defective in construction, - - - -	72	31
Pressure gauges defective, - - - -	361	29
Boilers without pressure gauges, - - - -	5	5
Unclassified defects, - - - -	94	0
Total, - - - -	10,322	1,130

### Summary of Inspectors' Reports for the Year 1892.

During the year 1892, our inspectors made 74,830 visits of inspection, examined 148,603 boilers, inspected 59,883 boilers both internally and externally, subjected 7,585 to hydrostatic pressure, and found 681 unsafe for further use. The whole number of defects reported was 120,659, of which 11,705 were considered dangerous. A summary of the work by months is given below, and the usual classification by defects is likewise given:

#### SUMMARY FOR THE YEAR 1892.

Nature of Defects.	Whole Number.	Dangerous.
Cases of deposit of sediment, - - - -	9,196	513
Cases of incrustation and scale, - - - -	16,351	841
Cases of internal grooving, - - - -	1,043	209
Cases of internal corrosion, - - - -	5,254	453

Nature of Defects.	Whole Number.	Dangerous.
Cases of external corrosion, - - - - -	8,647	591
Defective braces and stays, - - - - -	1,742	572
Settings defective, - - - - -	3,370	301
Furnaces out of shape, - - - - -	4,541	292
Fractured plates, - - - - -	2,646	658
Burned plates, - - - - -	2,142	371
Blistered plates, - - - - -	3,099	146
Defective rivets, - - - - -	20,727	933
Defective heads, - - - - -	1,097	249
Leakage around tubes, - - - - -	22,428	3,133
Leakage at seams, - - - - -	4,901	353
Water gauges defective, - - - - -	3,700	544
Blow-out defective, - - - - -	1,466	363
Cases of deficiency of water, - - - - -	264	122
Safety-valves overloaded, - - - - -	701	210
Safety-valves defective, - - - - -	947	301
Pressure gauges defective, - - - - -	5,227	445
Boilers without pressure gauges, - - - - -	75	75
Unclassified defects, - - - - -	1,095	30
Total, - - - - -	120,659	11,705

## SUMMARY BY MONTHS.

Month.	Visits of inspection.	Number boilers examined.	No. inspected internally and externally.	No. tested hydrostatically.	Number condemned.	Number of defects found.	Number of dangerous defects found.
January,	6,498	12,274	3,828	485	93	8,221	1,199
February,	6,153	12,499	4,196	596	45	8,837	948
March,	6,430	13,710	4,540	537	44	10,566	930
April,	6,099	11,720	5,253	524	58	10,496	862
May,	6,101	11,575	5,171	658	32	10,525	742
June,	6,438	11,688	5,280	707	42	9,740	800
July,	5,887	11,866	6,591	455	45	11,352	1,153
August,	5,610	11,066	4,708	779	37	9,619	908
September,	6,447	12,335	5,090	761	56	9,782	857
October,	6,563	14,475	5,621	735	115	11,247	1,147
November,	6,013	12,457	4,621	714	40	9,952	1,029
December,	6,591	12,988	4,984	634	74	10,322	1,130
Totals,	74,830	148,603	59,883	7,585	681	120,659	11,705

The following short table shows the increase in the work of our inspectors during the past year:

## COMPARISON OF INSPECTORS' WORK DURING THE YEARS 1891 AND 1892.

	1891.	1892.
Visits of inspection made, - - - - -	71,227	74,830
Whole number of boilers inspected, - - - - -	137,741	148,603

	1891.	1892.
Complete internal inspections, - - -	57,312	59,883
Boilers tested by hydrostatic pressure, - - -	7,859	7,585
Total number of defects discovered, - - -	127,609	120,659
“ “ dangerous defects, - - -	10,858	11,705
“ “ boilers condemned, - - -	526	681

Although the total number of defects reported was less in 1892 than in 1891, the number of dangerous defects was greater, and more boilers were condemned as unsafe for further use.

## Boiler Explosions.

DECEMBER, 1892.

**POWER HOUSE (213).** A fatal boiler explosion occurred in Mauch Chunk, Pa., on Dec. 1st, at the power house in course of erection for the Carbon County Electric Railway. Curtin Albright, the constructing engineer of the works, was scalded and has since died. Francis Darward, of this county, was hit by flying débris and may die.

**OIL WELL (214).** A boiler exploded on Dec. 2d in the Sistersville oil field, near Toledo, Ohio. William Robinson, a tool dresser, was instantly killed, and several other persons were seriously wounded. The oil caught fire and 3,000 barrels were consumed, as well as a number of derricks. The loss is estimated at \$25,000.

**SAW-MILL? (215).** On Dec. 6th a boiler belonging to Mr. Waheka, two and a half miles north of Ellinger, Tex., exploded. Both heads bulged out, the tubes drawing out of them at both ends. The boiler was thrown endwise about forty feet. One employe was slightly scalded on the arm. The boiler house was demolished.

**FURNACE (216).** On the morning of Dec. 5th one of the boilers of the Grafton Furnace Company, Leetonia, Ohio, exploded with terrific violence, wrecking the boiler-house and doing considerable damage to the plant. Two brothers named Winters, who were the engineer and fireman on duty at the time, were perhaps fatally injured. The concussion destroyed the hearing of both of them, and an examination showed that the drums of their ears were burst by the shock. The roof of the boiler-house was blown off and a large smoke stack was demolished; and the building then took fire. The loss will aggregate several thousands of dollars. The explosion was distinctly heard in Petersburg.

**STEAMER (217).** Will Brooks and William McNulty were instantly killed on Dec. 5th by the explosion of a steam main on the steamer *Hiram B. Dixon* as she lay at the dock in Duluth, Minn. Several other persons were also injured.

**DRY DOCK (218).** A terrific boiler explosion occurred at Gokey & Son's dry dock, in Hoboken, N. J., on Dec. 5th. The exploded boiler was located on a float, about twenty-five feet out in the river. The regular engineer did not report for duty on the morning in question, and Frank Gokey, Jr., one of the proprietors, undertook to run the boiler. The float was entirely demolished, and the boiler and other machinery went to the bottom of the river. Gokey was killed, and Martin Olsen and Henry Mathison were scalded and bruised and blown into the river. The property loss is estimated at \$5,000.

**PAPER MILL (219).** James H. McClintock and Charles A. Florus were badly injured and scalded, on Dec. 6th, by the explosion of a boiler in a paper mill in Lock Haven, Pa. Although their injuries were serious and painful, they will recover. The damage to property was not great.

**SAW-MILL (220).** At Black Hawk, a small lumbering town nine miles south of Rapid City, S. D., a boiler exploded on Dec. 7th, in J. W. Wilcoxsen's saw mill. Ben Richardson, the engineer, and two other employes named Stewart and Hart, were buried in the ruins of the demolished building. Richardson was killed, but it is thought probable that Hart and Stewart will recover, though they were badly crushed.

**COTTON GIN (221).** A sad accident occurred twelve miles north of Russellville, Ark., on Dec. 7th, at the gin of Mr. Lewis Brashears. John Howard was assisting in rolling some cotton bales away from the gin, when the boiler exploded, killing him instantly. Mr. Brashears was scalded badly but not fatally.

**BRICK-YARD (222).** On Dec. 8th a boiler exploded in the brick-yard of Gillespy & Jacob, near Wheeling, W. Va. The building in which it stood was badly wrecked, but nobody was injured. The boiler had been leaking, and was recently patched.

**PLANING MILL (223).** Williams & Brothers' saw and planing-mills, at Red Springs, near Fayetteville, N. C., were blown up on Dec. 10th by an explosion of the boiler. Two men were killed instantly and a number of others were wounded, some of whom are expected to die. The entire building is a complete wreck.

**JAIL (224).** A section of the heating boiler in the basement of the county jail in Pekin, Ill., exploded on Dec. 11th, flooding the floor with hot water. Nobody was hurt.

**CAR HEATING BOILER (225).** On Dec. 11th a heater exploded in a C., H. & D. passenger car in Wapakoneta, near Cincinnati, O. The top of the car was blown off and the windows were all broken, but, so far as we could learn, there was nobody injured.

**LOCOMOTIVE (226).** The boiler of locomotive No. 17, of the Montana Central Railroad, exploded on Dec. 11 at Mitchell, near Great Falls, Montana. Engineer Bell and his fireman were severely scalded. The track was badly torn up and travel was seriously interfered with for a few days.

**PAPER MILL (227).** A boiler exploded on Dec. 12th at the lower mill of the Ticonderoga Pulp and Paper Company, Ticonderoga, N. Y. The mill was partially wrecked and engineer Provincier was killed. Fireman Pelkey was painfully but not fatally hurt. The boiler-house is a mass of ruins. One-half of the exploded boiler crashed through the mill and landed on a bleacher, and the other half was blown into a neighboring creek. The property loss was estimated by some to be as high as \$25,000.

**ROLLING MILLS (228).** On Dec. 13th two boilers exploded at the Newport Iron and Steel Works, Newport, Ky., completely wrecking the lower half of the establishment. The mill is situated on the Licking river, about half a mile from its mouth, and was built of corrugated iron. Two of the firemen, Herman Wessling and George Reed, were removed from the ruins, but they were so badly hurt that they died. Henry Macke was burned, but not fatally so. Two unknown tramps, who had been loitering about the place, were at first supposed to be buried in the ruins, but their bodies could not be found. The property loss is estimated at \$10,000. Portions of the boiler were found 1,200 feet away, and the explosion was heard in Cincinnati. There was an explosion at this mill six years ago, in which two men were killed.



**SLAUGHTER HOUSE (229).** A boiler exploded in Lewis Frederick's slaughter house in Reading, Pa., on Dec. 13th, blowing the roof off the building.

**TANK HOUSE (230).** The boiler in the New York Central tank house at Churchville, near Rochester, N. Y., exploded on Dec. 14th, with terrific force. The building, which was about twenty feet square, was completely demolished, and the boiler was hurled over telegraph poles and across Black Creek into Samuel Richmond's orchard, twenty rods away. Thomas Mooney, who was in charge of the pumping station, was sitting about six feet from the boiler, but he escaped with only slight bruises. He is said to have been "blown into the ash pit."

**SAW-MILL (231).** The boiler in Swansey's steam saw-mill, situated a few miles north of Columbus, Miss., burst on Dec. 15th, killing Mr. Elward Swansey and his negro fireman, and destroying the mill.

**PLANING MILL (232).** The boiler in the Marshall Lumber Company's planing mill, one-half mile south of Brookhaven, Miss., exploded on Dec. 16th. Henry Webb, the fireman, was blown seventy-five feet, and died in half an hour from his injuries. No one else was near the boiler at the time, all the other hands having just gone to work in the mill. The boiler-house was completely demolished. A portion of the boiler was blown across the Illinois Central railroad track, tearing down the telegraph wires on both sides and falling in an old field 100 yards away. The force of the explosion was terrific. Every house in town was jarred by the concussion and windows rattled. The loss is estimated at \$1,000.

**COTTON GIN (233).** On Dec. 17th a boiler exploded in the Gin house of Joseph H. Lee, Fort White, Fla. Frank Smith was killed, and Mr. Lee and half a dozen others were seriously injured. The building and contents were destroyed.

**PUMP HOUSE (234).** At Venedito, Mexico, on Dec. 18th, the boiler in a pump house belonging to the International Mexican railroad, exploded, killing one man instantly and badly scalding two others. Epimania Garza, who was running the pump, had some section hands wheeling in coal at the time the explosion occurred, and one of these men, who was standing by the boiler, was killed. Garza, and another Mexican, were blown sixty feet into the yard and badly scalded. The pump house was completely wrecked.

**HEATING BOILER (235).** A small boiler exploded on Dec. 18th in the basement of the South Hall in St. Johnsbury, Vt. It wrecked the partitions and ceilings in its immediate neighborhood, but the damage was not great, and nobody was hurt.

**LOCOMOTIVE (236).** A locomotive exploded in the roundhouse of the Grand Trunk railroad in London, Ont., on Dec. 19th, doing considerable damage to the building and surrounding property. The concussion was felt in almost every part of the city. William Connor and William Campbell, Grand Trunk employes, were seriously injured. The loss is estimated at \$15,000. One account says, that "the whole city was shaken like a reed in the wind by the shock."

**HORSE-SHOE WORKS (237).** Three boilers in the large manufactory of the Perkins Horse-shoe Company, at Valley Falls, near Providence, R. I., blew up on Dec. 19th, and Nelson Judson, acting as night fireman, was instantly killed, and another man slightly injured. One of the boilers was blown 200 feet into the Blackstone river. The building was badly wrecked.

**COLLIERY (238).** One of the large boilers in the Victoria colliery, Cape Breton Island, Can., exploded on Dec. 24th, killing George Long, and injuring Daniel McDonald, Cyril McAdam, John McSween, John McPherson, and Murdock McIntyre. The

injured men are nearly all frightfully scalded. McDonald and McAdam can hardly recover. Bricks and massive stonework were hurled everywhere within a radius of a hundred yards. Seven other boilers were displaced and the settings leveled. Not a portion of the boiler-house remains standing. How so many of those who were working around at the time escaped is a mystery, as flying bricks and stones, pieces of timber, and scalding steam and water were thrown with great force in a seething circle.

**COAL YARD (239).** A donkey engine and boiler of about 10-horse power, used in noisting at T. S. Corson's coal yard, New Bedford, Mass., exploded on Dec. 28th. The boiler and engine were blown into the river and lost. The engineer was temporarily absent, and nobody was hurt.

**CARPET CLEANING SHOP (240).** A boiler used by the Electric Carpet-Cleaning Company on Duquesne Way, Pittsburgh, Pa., exploded on Dec. 29th. Jacob O. Cox, foreman of the concern, was blown through the side of the building. He was picked up fifty feet away, unconscious, crushed, and bleeding, and he died shortly after. Clarence Shaw, a boy employed as a driver by the company, who was in the place when the explosion occurred, was badly scalded and bruised, and may die. The building was badly wrecked by the force of the explosion and the flying sections of boiler and timbers. Shaw was hurled with terrible force through a big opening in the north wall of the room. His body passed out, but his feet caught in the wreckage inside the wall, and he hung suspended in the air, head downwards, and fifty feet above the sidewalk. It required some little time to reach him, owing to the fact that the room was filled with broken timbers.

**STEEL MILLS (241).** A boiler at the Illinois Steel Mills in Joliet, Ill., exploded on Dec. 29th, and James J. Eastwood, the fireman, was frightfully scalded by steam. He may live, however.

**SAW-MILL (242).** On Dec. 29th a boiler exploded in Duke & Blurus's saw-mill, in Jaken, Ga. James Wilbanks, Griffin Phillips, and Joe Smith were killed. The property loss was small.

**SAW-MILL (243).** A saw-mill boiler at Oakdale, near Lima, Ohio, exploded on Dec. 31st, blowing the building to atoms and killing Frank Smith and Lon F. Miller. Several others who were near the mill at the time were injured. The shock was felt for miles.

### Summary of Boiler Explosions for the Year 1892.

We present herewith our usual summary and classified list of the boiler explosions that have taken place during the past year. So far as we could learn, the total number of explosions was 269, against 257 for 1891, and 226 for 1890. In several cases, more than one boiler has exploded at the same time. When this has happened, we have counted each boiler separately, believing that in this way a fairer idea of the amount of damage may be had.

It is difficult to make up an accurate list of the killed and injured, because in making out our lists we have to depend largely upon the newspapers, and the accounts we find there are often unsatisfactory. We have spared no pains, however, to make the summary as accurate as possible, and in some cases we have gone over as many as twenty accounts of a single explosion in order to extract such information as we could concerning the injuries and the loss of life involved. So far as we could learn there have been 269 explosions during the year, which resulted in the death of 298 persons, and in

injuries to 442 others. During 1891, there were 257 explosions, resulting in the death of 263 persons and in injuries to 371 others. It appears, therefore, that the explosions of 1892 have been worse, on the whole, than those of 1891; for they have been more numerous, and the number of persons killed and injured has been greater, both absolutely and relatively.

It should be understood that this summary does not pretend to include *all* the explosions of the year. In fact, it probably includes but a fraction of them. Many accidents have undoubtedly happened that were not considered by the press to be sufficiently "newsy" to interest the general public; and many others have, without question, been reported in local papers that we do not see.

CLASSIFIED LIST OF BOILER EXPLOSIONS IN THE YEAR 1892.

CLASS OF BOILER.	NUMBER OF EXPLOSIONS.												
	January.	February.	March.	April.	May.	June.	July.	August.	September.	October.	November.	December.	The Year.
Saw-Mills and other Wood-working Establishments,	3	10	9	6	7	1	7	4	9	3	13	7	79
Locomotives, . . . . .	8	3	1	4	4	1	..	2	4	1	3	2	33
Steamships, Tugs, and other Steam Vessels, . . . . .	..	1	..	..	..	2	1	3	1	1	1	1	11
Portable Boilers, Hoisters, and Agricultural Engines,	1	..	..	1	1	2	6	2	3	4	3	1	24
Mines, Oil Wells, and Collieries, . . . . .	5	..	1	..	1	1	..	..	..	2	1	2	13
Paper Mills, Bleacheries, Digesters, etc., . . . . .	..	..	..	..	1	..	..	..	1	2	..	2	6
Rolling Mills and Iron Works, . . . . .	7	1	3	..	..	..	..	..	2	3	1	7	24
Distilleries, Breweries, Dye Works, Sugar Houses, } and Rendering Works, . . . . .	1	..	..	..	..	..	1	..	..	..	..	..	2
Flour Mills and Grain Elevators, . . . . .	1	1	1	..	1	..	..	..	..	2	..	..	6
Textile Manufactories, . . . . .	..	..	..	..	..	..	..	..	..	..	..	..	..
Miscellaneous, . . . . .	9	3	5	3	..	4	5	5	5	10	10	12	71
Total number of Explosions per Month, . . . . .	35	19	20	14	15	11	20	16	25	28	32	34	269
Persons Killed, . . . . .	45	22	36	13	12	13	30	11	34	24	32	26	298
Persons Injured, . . . . .	46	25	51	24	31	38	36	18	54	49	25	45	442

Miss M.—“Now, Hamilton, you read the lesson to me first, and then tell me with the book closed what you read.”

Hamilton—(reading)—“See the cow. Can the cow run? Yes, the cow can run. Can the cow run as swiftly as the horse? No, the horse runs more swiftly than the cow.” (Closing up the book to tell what he has read)—Git onto the cow. Kin her jiblets run? Betcher life she can run. Kin the cow do up the horse a-runnin'? Naw, the cow ain't in it wid de horse.—*The Rider and Driver.*

# The Locomotive.

HARTFORD, FEBRUARY 15, 1893.

J. M. ALLEN, *Editor.*

A. D. RISTEEN, *Associate Editor.*

THE LOCOMOTIVE can be obtained free by calling at any of the company's agencies.

Subscription price 50 cents per year when mailed from this office.

Bound volumes one dollar each. (Any volume can be supplied.)

Papers that borrow cuts from us will do us a favor if they will mark them plainly in returning, so that we may give proper credit on our books.

It is a matter of continual and increasing surprise to us, that any boiler maker of repute should be willing to send out boilers of over 30 inches in diameter, without the fullest provisions for gaining access to the interior. Corrosion, pitting, grooving, deposit of scale,—these and many other defects can be detected and satisfactorily observed only by direct observation of the inner surfaces; and when a boiler is large enough to admit a man, it should always be provided with a manhole. To omit such an important opening is highly dangerous.

## Boiler Explosions since 1879.

The following tables give summaries of the boiler explosions that have occurred in this country since the beginning of the year 1879. Similar tables were published in THE LOCOMOTIVE two years ago; and in consideration of the interest that those tables

TABLE 1. — SUMMARY OF BOILER EXPLOSIONS BY MONTHS.

YEAR.	JAN.	FEB.	MAR.	APR.	MAY.	JUNE.	JULY.	AUG.	SEPT.	OCT.	NOV.	DEC.	TOTAL.
1879	10	16	9	12	5	10	7	14	8	10	13	18	132
1880	19	14	11	11	12	10	14	11	16	11	16	25	170
1881	22	16	15	8	8	15	8	11	14	16	13	13	159
1882	26	15	16	13	14	11	9	18	14	13	7	16	172
1883	22	12	16	10	17	17	10	18	17	15	20	10	184
1884	14	10	15	12	16	16	19	14	12	12	6	6	152
1885	14	20	14	7	12	12	10	9	11	14	15	17	155
1886	19	18	18	7	9	13	26	17	15	10	17	16	185
1887	26	12	8	17	18	14	14	10	14	21	28	16	198
1888	29	22	22	18	16	19	24	20	25	13	15	23	246
1889	18	14	17	14	9	5	17	16	14	28	19	9	180
1890	24	26	22	13	18	20	8	21	15	20	18	21	226
1891	21	26	19	14	24	14	24	23	15	26	26	25	257
1892	35	19	20	14	15	11	20	16	25	28	32	34	269
Total Number of Explosions.													2,685



aroused it has been thought advisable to extend them so as to include the years 1891 and 1892, and bring them down to date.

According to Table 1 there were 2,685 boiler explosions during the fourteen years between Jan. 1, 1879, and Jan. 1, 1893. These explosions, it will be seen from Tables 2 and 3, resulted in the death of 3,684 persons, and in more or less serious injury to

TABLE 2. — SUMMARY OF DEATHS BY BOILER EXPLOSIONS.

YEAR.	JAN.	FEB.	MAR.	APR.	MAY.	JUNE.	JULY.	AUG.	SEPT.	OCT.	NOV.	DEC.	TOTAL.
1879	18	38	4	9	3	34	12	17	12	11	16	34	208
1880	16	22	31	12	30	30	20	9	14	23	18	34	259
1881	38	18	28	6	11	41	16	19	25	15	18	16	251
1882	15	22	27	31	14	18	6	41	18	16	15	48	271
1883	29	18	17	11	30	25	18	18	30	12	37	18	263
1884	17	7	25	18	30	26	37	13	15	31	22	13	254
1885	24	22	20	9	18	14	7	11	11	19	34	31	220
1886	17	6	28	3	18	14	40	30	10	37	26	25	254
1887	27	6	7	14	25	15	15	7	11	71	40	26	264
1888	22	59	23	20	20	20	17	54	37	13	22	24	331
1889	27	45	18	15	7	6	28	27	34	66	21	10	304
1890	24	31	18	11	16	20	12	30	11	28	25	18	244
1891	33	36	11	7	21	22	23	13	19	36	20	32	263
1892	45	22	26	13	12	13	30	11	34	24	32	26	298
Total Number of Persons Killed,													3,684

5,185 others; so that the total number of persons killed or injured during this time has been 8,869. Many a thriving town has a less population than this.

In Table 4 the number of explosions each year, and the number of killed and in-

TABLE 3. — SUMMARY OF PERSONS INJURED BY BOILER EXPLOSIONS.

YEAR.	JAN.	FEB.	MAR.	APR.	MAY.	JUNE.	JULY.	AUG.	SEPT.	OCT.	NOV.	DEC.	TOTAL.
1879	15	36	30	15	10	20	18	19	11	15	16	18	213
1880	44	23	59	46	59	132	41	21	35	28	33	34	555
1881	35	31	51	11	23	38	19	14	19	32	20	20	313
1882	36	38	31	34	17	23	34	55	28	8	8	44	359
1883	63	23	22	24	38	29	35	17	50	24	65	22	412
1884	19	13	27	15	31	23	35	16	20	17	25	10	251
1885	25	30	28	9	32	6	21	21	13	40	22	21	278
1886	64	25	21	12	19	24	33	24	20	17	27	28	314
1887	31	17	23	43	39	41	20	19	19	65	53	18	388
1888	56	68	37	40	25	38	40	41	56	15	20	50	505
1889	40	33	66	24	18	13	105	36	13	48	19	18	433
1890	44	38	44	19	21	37	12	38	10	32	36	20	351
1891	28	43	31	10	27	25	45	31	15	52	34	30	371
1892	46	25	51	24	31	38	36	18	54	49	25	45	442
Total Number of Persons Injured,													5,185

jured, are shown in such a manner as to facilitate comparison. We see, from the last line of this table, that on an average 1.37 persons are killed per explosion, and 1.93 are injured. That is, 3.30 persons are disabled, on an average, by every boiler explosion.

TABLE 4. — SUMMARY OF EXPLOSIONS AND OF KILLED AND INJURED.

YEAR.	EXPLOSIONS.	KILLED.	INJURED.
1879, . . . . .	132	208	213
1880, . . . . .	170	259	555
1881, . . . . .	159	251	313
1882, . . . . .	172	271	359
1883, . . . . .	184	263	412
1884, . . . . .	152	254	251
1885, . . . . .	155	220	278
1886, . . . . .	185	254	314
1887, . . . . .	198	264	388
1888, . . . . .	246	331	505
1889, . . . . .	180	304	433
1890, . . . . .	226	244	351
1891, . . . . .	257	263	371
1892, . . . . .	269	298	442
Totals, . . . . .	2,685	3,684	5,185

### New Hope for Consumptives.

It is now two years since the Koch lymph made such a stir in the world as an expected cure for consumption. It was in 1882 that Dr. Robert Koch of Berlin made his famous discovery of the bacillus of tuberculosis, a bacillus which has caused greater havoc among mankind than cholera or war; and during the ten years which have elapsed since his first announcement of the cause of consumption, he, together with a host of other bacteriologists and clinicians, has been engaged in devising some means of destroying this germ, or of rendering it innocuous after its entrance into the human body. The distinguished German pursued his investigation upon the hypothesis that the bacillus itself produces during its development, either in its own organism or from the tissues in which it resides, a poison which ultimately destroys it. This is much after the fact that the yeast plant in a fermenting liquid creates alcohol finally in such quantity as to inhibit its growth, or that the germs of putrefaction are self-limited through the deleterious substances to which their activity gives rise.

The lymph which was manufactured and presented to the profession by Koch in the autumn of 1890, was the product of the growth and life of the bacillus of consumption, and the analyses made of it showed that it was composed of a number of organic substances, the chief of which seems to be an albuminous material, to which the name albumose is given. When the bacilli develop in the body this active principle causes a species of death of surrounding tissues known as coagulation-necrosis, and the necrotic tissue thus formed is so unfavorable for the existence of the germs that they die. After much experimentation the lymph was heralded to the world, somewhat prematurely it is true, as a specific for consumption, and doctors and patients flocked to Berlin from every land, the former to secure some of the precious fluid and learn the method of its employment, the latter to grasp at the straw which might save them from an early grave.

Since the first few months of excitement awakened by the glad tidings of the dis-

covery, and the subsequent disappointment engendered by its apparent failure to satisfy the sanguine expectations of the medical profession, and of the unfortunate victims of this awful malady, the public has heard little or nothing of the vaunted cure. But in these two years physicians have not been idle, and everywhere the lymph has been tried and tested over and over again in every species of disease of the human organism to which the tubercular microbe gives rise, in lungs, larynx, brain, bones, joints, skin, and alimentary canal, and an enormous number of patients have been submitted to the influence of lymph injection; in the cases of a majority without much success, but in a few with undoubted advantage.

Yet, certain modifications were made not long ago in the original lymph which seem to have improved its remedial power while lessening its occasionally deleterious effects upon the organism. As will be remembered, the original lymph when injected into the body of a tubercular patient caused malaise and fever. An English physician named Hunter, and a German pathologist named Klebs, have each independently analyzed the Koch lymph and eliminated from it substances which seemed to be foreign to the true remedial principle, and have for some time been using in hospitals and in their practice, the active ingredient of the lymph, to which Klebs has given the name tuberculocidin. It was the foreign and unnecessary elements of the lymph which gave origin to the fever and other disagreeable symptoms. Tuberculocidin is an albumose which Hunter thinks is derived from the plasma of the bacilli themselves. Klebs also considers it a secretion of the germs. In experiments upon animals, fully developed tubercles were found to be entirely reduced by tuberculocidin, while in man, over eighteen per cent. of seventy-five cases of marked pulmonary tuberculosis treated by Klebs were cured. The purified lymph causes no fever, and treatment with it does not interfere with the daily occupation of the patient. Tuberculocidin has been for some time in the hands of the medical profession, and is, therefore, within the reach of every one who applies to his family physician for treatment with it, although none of the usual precautions as regards diet, change of climate, hydrotherapy, and the employment of other drugs found to be valuable in consumption, are neglected by him.

Thus it seems that considerable progress has been made in the lines laid down by Robert Koch in his original announcement, and the great German bacteriologist will deserve the blessings of all mankind, even should his discovery result only in the amelioration of some cases, and a small percentage of cures in others. It was a splendid and beneficent gift to humanity, of which the end is not yet, for, undoubtedly, there will be still greater perfection in the mode of treatment of tuberculosis by the purified lymph. At the same time it must not be forgotten, that while the cure of a disease is a triumph for the medical profession, there are limitations that never can be overcome, and the prevention of disease is of far greater importance to humanity than the mere repair of an injured organism. It is to be hoped, therefore, that the public will become thoroughly educated in all of the arts of prevention, and that particularly as regards tuberculosis, all will be cautious in their selection of milk, careful in the disinfection or destruction of the excretions of consumptive patients, wise in the bringing up of weak-lunged children, and, indeed, observant of all regulations which the family medical authority may prescribe for the government of his patrons.—*New York Sun*.

Incorporated  
1866.



Charter Per-  
petual.

Issues Policies of Insurance after a Careful Inspection of the Boilers,  
COVERING ALL LOSS OR DAMAGE TO  
**BOILERS, BUILDINGS, AND MACHINERY.**

ALSO COVERING  
**LOSS OF LIFE AND ACCIDENT TO PERSONS**

ARISING FROM

## Steam Boiler Explosions.

Full information concerning the plan of the Company's operations can be obtained at the  
**COMPANY'S OFFICE, HARTFORD, CONN.,**  
Or at any Agency.

**J. M. ALLEN, President.**                      **W. B. FRANKLIN, Vice-Prest.**  
**J. B. PIERCE, Secretary.**                **FRANCIS B. ALLEN, 2d Vice-Prest.**  
**E. J. MURPHY, M. E., Consulting Engineer.**

### Board of Directors.

**J. M. ALLEN, President.**  
**FRANK W. CHENEY, Treas.** Cheney Brothers Silk Manufacturing Co.  
**CHARLES M. BEACH, of Beach & Co.**  
**DANIEL PHILLIPS, of Adams Express Co.**  
**RICHARD W. H. JARVIS, Prest.** Colt's Fire Arms Manufacturing Co.  
**THOMAS O. ENDERS, President of the U. S. Bank.**  
**LEVERETT BRAINARD, of The Case, Lockwood & Brainard Co.**  
**GEN. WM. B. FRANKLIN, late U. S. Commissioner to the Paris Exposition.**  
**NELSON HOLLISTER, of State Bank, Hartford.**

**HON. HENRY C. ROBINSON, Attorney-at-Law, Hartford, Conn.**  
**HON. FRANCIS B. COOLEY, of the National Exchange Bank, Hartford, Conn.**  
**A. W. JILLSON, late Vice-Prest. Phoenix Fire Ins. Co., Hartford, Conn.**  
**EDMUND A. STEDMAN, Treasurer of the Fidelity Co., of Hartford, Conn.**  
**GEORGE BURNHAM, Baldwin Locomotive Works, Philadelphia.**  
**HON. NATHANIEL SHIPMAN, Judge United States Circuit Court.**  
**C. C. KIMBALL, Pres. Smyth Mfg. Co., Hartford, Conn.**  
**PHILIP CORBIN, of P. & F. Corbin, New Britain, Conn.**

### GENERAL AGENTS.

**THEO. H. BABCOCK,**  
**CORBIN & GOODRICH,**  
**LAWFORD & MCKIM,**  
**C. E. ROBERTS,**  
**H. D. P. BIGELOW,**  
**C. C. GARDINER,**  
**L. B. PERKINS,**  
**W. G. LINEBURGH & SON,**  
**A. S. FERRY,**  
**MANN & WILSON,**  
**ZOLLARS & MCGREW,**  
**R. F. MANLY,**  
**W. S. HASTIE & SON,**  
**PETER F. PESCUO,**

### CHIEF INSPECTORS.

**R. K. McMURRAY,**  
**WM. J. FARRAN,**  
**F. S. ALLEN,**  
**H. D. P. BIGELOW,**  
**A. B. ECOFF,**  
**F. S. ALLEN,**  
**J. H. RANDALL,**  
**C. A. BURWELL,**  
**J. B. WARNER,**  
**T. E. SHEARS,**  
**B. F. JOHNSON,**

**NEW YORK CITY.**  
**PHILADELPHIA, PA.**  
**BALTIMORE, MD.**  
**BOSTON, MASS.**  
**PROVIDENCE, R. I.**  
**CHICAGO, ILL.**  
**ST. LOUIS, MO.**  
**HARTFORD, CONN.**  
**BRIDGEPORT, CONN.**  
**CLEVELAND, OHIO.**  
**SAN FRANCISCO, CAL.**  
**DENVER, COL.**  
**BIRMINGHAM, ALA.**  
**CHARLESTON, S. C.**  
**NEW ORLEANS, LA.**

### OFFICES.

Office, 285 Broadway.  
" 432 Walnut St.  
" 22 So. Holliday St.  
" 35 Pemberton Sq.  
" 29 Weybosset St.  
" 112 Quincy St.  
" 404 Market St.  
" 218 Main Street.  
" 2 Sanford Building.  
" 208 Superior St.  
" 306 Sansome St.  
" Granite Bl'g, R'ms 3, 4.  
" 1901 First Ave.  
" 44 Broad St.  
" 188 Gravier St.



# The Locomotive.

PUBLISHED BY THE HARTFORD STEAM BOILER INSPECTION AND INSURANCE COMPANY.

NEW SERIES—VOL. XIV.

HARTFORD, CONN., MARCH, 1893.

No. 3.

## A Dangerous Safety-Valve.

We give, herewith, an account of a safety-valve that was condemned by one of our inspectors not long ago. It illustrates a source of danger that happily is not frequently met with—namely, a disproportion of the parts of the valve so great that the strains on some of the parts are much greater than they can safely withstand. Figs. 1 and 2 give a side and top view of the valve, respectively. The lever was about 50 inches long, from the fulcrum pin to the end, and on it three weights were hung. The outer one, *A*, weighed 124 lb., and was 49 inches from the fulcrum pin. The other two, *B* and *C*, weighed 45 pounds each, and their distances from the fulcrum pin were 40 inches

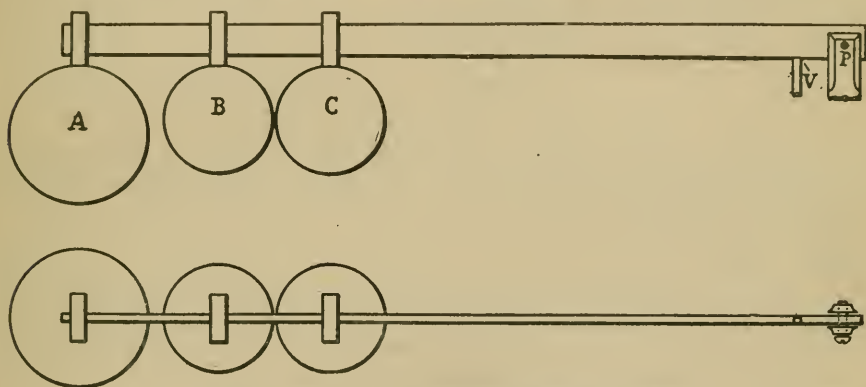

FIGS. 1 AND 2.—A DANGEROUS SAFETY-VALVE.

and 33 inches respectively. The lever weighed 17 pounds, and tapered so little that for practical purposes it could be considered to be of uniform cross section. The fulcrum pin was  $\frac{1}{2}$  inch in diameter, and the distance from its center to the nearest edge of the flat-ended valve stem was  $2\frac{3}{4}$  inches.

The disk of this valve was unusually large, and the calculated blowing-off point was not excessively high, and agreed well with the blowing point obtained by trial with the steam gauge. The real point of danger was in the weakness of the fulcrum pin *P* and the casting supporting it, the dimensions of which are sufficiently indicated in Figs. 3 and 4.

To calculate the strain on the fulcrum pin and its casting, let us first consider what would happen if either of these gave way. Plainly the lever would turn about the point *V* where it touches the valve-spindle, the weighted end falling down, and the fulcrum end tipping up. The only thing that resists this tendency is the downward

pressure of the fulcrum against the lever. (It is plain that although the lever presses *upward* against the pin, the pin presses *downward* against the lever.) Now since the lever does not tip either way, but remains in equilibrium, it must be that the tipping effect of the weights is just balanced by the opposite tipping effect of the downward pressure of  $P$  against the lever. Now the tipping effect, or *moment*, of any force is proportional to the magnitude of the force, and also to the leverage it has. Thus to find the tendency of the weight  $A$  to turn the lever about the point  $V$  as a center, we multiply 124 by  $46\frac{1}{4}$  ( $46\frac{1}{4}$  being the distance of this weight from  $V$ ), which gives 5,735. This means that the weight  $A$  exerts precisely the same tipping effect that a weight of 5,735 pounds would exert, if hung on the lever at a distance of one inch from  $V$ . The distances of  $B$  and  $C$  from  $V$  being  $37\frac{1}{4}$  in. and  $30\frac{1}{4}$  in., respectively, we find that their respective tipping effects are  $37\frac{1}{4} \times 45$  and  $30\frac{1}{4} \times 45$ , or  $1,676\frac{1}{4}$  and  $1,361\frac{1}{4}$ ; so that

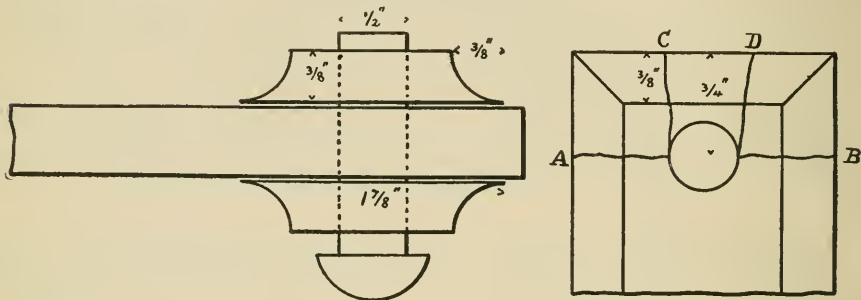

FIGS. 3 AND 4.—DETAILS OF THE CASTING.

the combined effect of the three weights is the same as the effect of a weight of  $5,735 + 1,676\frac{1}{4} + 1,361\frac{1}{4} = 8,772\frac{1}{2}$  lbs. hung on the lever at a distance of one inch from  $V$ . To this we may add the tipping effect of the lever's own weight, which we calculate in precisely the same manner, except that we first assume that it acts as though its weight were concentrated at its center. The center of the lever, being 25 inches from  $P$ , is  $22\frac{1}{4}$  inches from  $V$ , so that its tipping effect is  $22\frac{1}{4} \times 17 = 378\frac{1}{4}$ . Adding this to  $8,772\frac{1}{2}$  we obtain  $9,150\frac{3}{4}$ , which is the weight we must hang on the lever, one inch from  $V$ , to get the same tipping tendency that we get from the actual arrangement of things as shown in Fig. 1. Now since this tendency must be precisely equal to the tendency of the pin  $P$  to tip the lever in the opposite direction, in order to find the downward pressure of  $P$  we have merely to answer the question, what weight must be hung on the lever,  $2\frac{3}{4}$  inches from  $V$ , to get the same tipping tendency that a weight of  $9,150\frac{3}{4}$  lbs. gives when hung at a distance of one inch from  $V$ ? And to answer this question we have merely to divide  $9,150\frac{3}{4}$  by  $2\frac{3}{4}$ , which gives 3,328 lbs. (omitting fractions). Hence we conclude that in the arrangement shown in Fig. 1 there is a shearing strain of 3,328 lbs. on the pin  $P$ , and therefore also a tensile strain of 3,328 lbs. on the casting which support this pin.

We have next to examine the fulcrum pin  $P$ , to see if it is strong enough to withstand this strain. This pin, which is shown best in Fig. 3, was threaded, being, in fact, a heavy machine screw with a round head. Its diameter at the base of the thread was  $.40$  inch, so that its effective sectional area was  $.40 \times .40 \times .7854 = .1257$  sq. in. It will be observed that the pin must be double-sheared, if it fails; and hence if we allow 70,300 lbs. per square inch of single section as the strength of iron exposed to double shear, the ultimate strength of the pin is found to be  $.1257 \times 70,300 = 8,837$  lbs. With

a factor of safety of 5 this gives 1,767 lbs. as the weight the pin can safely sustain; and the actual strain, it will be seen, is nearly double the safe strain.

Passing on to the consideration of the casting which supports *P*, we observe that it can fail in two ways: either by fracturing square across, as indicated by the line *A B* in Fig. 4, or by shearing a piece out, as indicated by the lines *C* and *D* in the same figure. The scotia around the edge of the casting (intended, we presume, to be ornamental) was in the shape of a quarter circle, the radius of the circle being  $\frac{3}{8}$  of an inch. Hence it diminished the sectional area to be fractured or sheared in each of the uprights holding the pin by  $2 \times \frac{3}{8} \times \frac{3}{8} \times .7854 = .2209$  sq. in.

If the casting failed by fracture along the line *A B*, the effective area to resist fracture would be

$$(1\frac{1}{2}'' - \frac{1}{2}'') \times \frac{3}{8}'' = .2209 = .5156 - .2209 = .2947 \text{ sq. in.}$$

in each of the uprights, or .5894 sq. in. in all. Then taking the tensile strength of cast iron as 14,000 pounds per square inch, we find that the resistance of the casting to direct fracture along *A B* is  $14,000 \times .5894 = 8,252$  lbs. Allowing a factor of safety of 5 we see that the casting can safely bear only 1,650 lbs., although it is loaded with a strain of 3,328 lbs.

A calculation of the resistance of the uprights to shear along the lines *C* and *D* shows that they are strong enough in this direction. The facts of the case therefore are, that the pin *P* is decidedly too weak for safety, and that the casting is not nearly strong enough along the line *A B*. The factor of safety of 5 is not large enough for cast-iron in tension, and yet the supports in the present case have a factor of less than 2. All of these calculations have been made on the assumption that the load on the valve is steady and uniform—a *dead load*, as the bridge builders would call it. A slight shock, such as might easily be produced by raising the valve and letting it fall again, would carry the strain on the valve-casting or the fulcrum-pin considerably beyond the elastic limit of the material; and in that case it would be only a matter of time when one of the two would give way, and the contents of the boiler come rushing out of the six-inch opening. It is very probable that someone would be badly scalded, and certainly the boiler would be burned before the fires could be drawn.

There is a strong objection to such a construction as that shown in the cuts, which is, that if the pin *P* does not fit the lever perfectly the lever is very apt to cant to one side slightly. The enormous weight at the end of the lever is then liable to swing to one side, bending the lever as it does so, and cramping it between the supports at *P* so that the valve will not blow until the boiler pressure has risen far beyond the point of safety. There seems to be no sufficient reason why such poorly designed valves should be found in practice, for good lever valves are on the market in abundance, and can be had for reasonable prices. The valve here shown was probably intended for use on a low pressure boiler, perhaps a heating boiler where the pressure was not to exceed 10 pounds or so. A large disk was provided in order to secure an area sufficient to cause the valve to respond promptly to increasing pressure. When a higher pressure was wanted and a new boiler was put in, somebody probably thought there was no use in buying a new safety-valve, and recommended that the old one be kept. It was accordingly put on the new boiler and loaded with more weights until it blew off at 110 pounds or so. We do not *know* that this was the history of the valve in question, but we have little doubt of it because we have seen this sort of thing done many times by inexperienced persons who do not always appreciate the appropriateness of having everything designed specially for the use to which it is to be put.

## Inspectors' Reports.

JANUARY, 1893.

During this month our inspectors made 6,853 inspection trips, visited 14,226 boilers, inspected 4,702 both internally and externally, and subjected 568 to hydrostatic pressure. The whole number of defects reported reached 10,322, of which 1,040 were considered dangerous; 71 boilers were regarded unsafe for further use. Our usual summary is given below:

Nature of Defects.	Whole Number.	Dangerous.
Cases of deposit of sediment, - - - -	596	51
Cases of incrustation and scale, - - - -	1,229	50
Cases of internal grooving, - - - -	83	15
Cases of internal corrosion, - - - -	339	32
Cases of external corrosion, - - - -	717	62
Broken and loose braces and stays, - - - -	180	38
Settings defective, - - - -	247	25
Furnaces out of shape, - - - -	357	22
Fractured plates, - - - -	358	57
Burned plates, - - - -	245	33
Blistered plates, - - - -	217	12
Cases of defective riveting, - - - -	1,613	42
Defective heads, - - - -	199	25
Serious leakage around tube ends, - - - -	2,331	356
Serious leakage at seams, - - - -	498	61
Defective water-gauges, - - - -	325	29
Defective blow-offs, - - - -	115	35
Cases of deficiency of water, - - - -	39	17
Safety-valves overloaded, - - - -	78	15
Safety-valves defective in construction, - - - -	75	21
Pressure gauges defective, - - - -	399	35
Boilers without pressure gauges, - - - -	7	7
Unclassified defects, - - - -	75	0
Total, - - - -	10,322	1,040

## Boiler Explosions.

JANUARY, 1893.

(1.)—A boiler exploded on January 1st, in a mill in Oakdale, near Lima, Ohio. F. M. Miller, fireman, and Frank Schmith were killed, and a number of others were wounded. "The building was blown to kindling wood."

(2.)—The boiler in Lawrence Matthew's mill, near York Station, Alabama, exploded on January 2d. The mill was wrecked and John Eddards, a colored man, was killed. Two other men were badly and perhaps fatally scalded.

(3.)—Two boilers exploded on January 2d in a factory in New Orleans. The fireman, named Webster, was buried in the ruins and crushed to death. The explosion demolished the smoke-stack and timbers and large masses of brick were thrown about



as if from a volcano. Adjacent buildings were terribly shaken, and many persons were hit by falling missiles, but, with the exception of Webster, none were hurt seriously. Engineer Sheehan was within ten paces of the boilers when they burst, and was only saved from his fireman's fate by having stopped to take off his coat while on his way to the boiler shed. He had looked at the boilers only a few minutes before the explosion, and is satisfied that there was 90 pounds of steam on at the time. The boilers had been cleaned and washed out the previous Saturday, and were filled only that morning. The factory was partly demolished and the loss was estimated at \$10,000.

(4.)—A locomotive boiler exploded at Franceville, near Monon, Ind., on January 3d, killing two men and scalding a third, perhaps fatally. The fireman, W. W. McCarthy, was blown into the air and fell dead on the track. The head brakeman, Harry Buck, had numerous bones broken and was so terribly scalded that he died in an hour. Con Cavanaugh, the engineer, was frightfully scalded, but at last accounts was expected to live. A farmer unloading hay about 100 yards from the scene of the explosion, had his wagon torn to pieces, and was himself badly hurt by a flying piece of iron.

(5.)—Freight engine No. 1,185 of the Pennsylvania railroad, burst her boiler on January 4th, at Atglen, near Philadelphia, Pa. Engineer Calvin Umberger and fireman Harris B. Halleiman were severely and perhaps fatally scalded, besides being bruised by flying parts of the engine. Conductor T. J. Gilman had just left the cab when the explosion took place, so that he narrowly escaped injury and perhaps death. Engine No. 1,185 is a "hog" of the latest pattern, and had been inspected on the first of the month and pronounced in good condition. The boiler gave way by failure of the crown-sheet.

(6.)—A heating boiler exploded on January 4th, in the basement of the Phi Gamma Delta Fraternity's house, at State College, Pa. The explosion was so violent that the floors of the rooms above were badly damaged by the flying pieces of iron, and considerable damage was done to the furniture. Fortunately, the house was vacant at the time, or more serious results might have followed.

(7.)—A boiler exploded on January 6th, at William Bryan's mill, north of Leipsic, near Ottawa, Ont. No one was seriously hurt.

(8.)—On January 7th, the boiler in Morrill & Co.'s factory in West Newbury, Mass., exploded, doing considerable damage, but injuring nobody. The factory was obliged to shut down for some time.

(9.)—Engineer Amos Bauder was killed on January 11th by the explosion of a boiler in a mill in Manayunk, Pa. Bauder was missed, and a searching party found his body buried under a pile of brick. The boiler-house was almost ruined and the mill proper was badly shaken, though it was not damaged much.

(10-11.)—A boiler exploded on January 12th in the power station of the Niagara Street Railroad Co., Buffalo, N. Y.; and on January 14th, a tube burst in another boiler at the same place, severely scalding the fireman, Samuel Dunlop.

(12.)—A boiler exploded on January 12th, in a school building in Zanesville, O., and janitor George Miles, who was at work near by, was painfully scalded about the legs and arms.

(13.)—On January 13th, as the steamboat *J. C. Warner* was towing the steamboat *R. T. Coles* through the ice in the Tennessee River, near Chattanooga, Tenn., two flues in the boiler of the *Warner* collapsed. Several of the boat hands were scalded, and two were drowned.

(14.)— On the morning of January 13th, a boiler exploded in Stoddard & Moslander's mill in Evanston, Wyoming, but fortunately nobody was injured. The loss was heavy on account of the large orders that were waiting to be filled.

(15.)— The boiler in the Tower manufacturing works at Mendota, near Pawpaw, Ill., exploded on January 14th. The engineer, James Maxwell, was killed, and two other men were seriously hurt. The building was wrecked, and Mr. Tower estimates his loss at \$15,000. A portion of the boiler is said to have torn through a heavy brick wall and landed a quarter of a mile away.

(16.)— A Mr. Mears was painfully injured in Aurora, Ill., on January 14th, by the blowing out of a plug in a boiler in Corbett & Stadler's shop.

(17.)— On January 16th, a boiler exploded in the Kelley mill in Muncie, Ind. Nobody was hurt, because the explosion took place in the night. The mill was damaged to the extent of some \$3,000. It is supposed that the natural gas which was used for fuel was turned on in some way during the night, perhaps by tramps who wished to warm themselves.

(18.)— A boiler exploded in Des Moines, Iowa, on January 16th, in a building standing on the corner of Fourth and Vine Streets. The main drive belt had broken, and engineer W. C. Lippencott had shut down the engine and left it in charge of an assistant while he mended the break. A few minutes later the explosion occurred. The dome of one of the boilers was blown southwest to a distance of 100 feet. It passed up through the roof, and after going over another building struck the ground near the Des Moines Union tracks. The roof of the boiler-house was entirely blown away, and the heavy brick walls were shattered and a great deal of débris thrown about.

(19.)— A small boiler exploded in John Daley's saloon on North Second Street, Philadelphia, on January 17th. Damage slight. Nobody hurt.

(20.)— On January 17th, a boiler exploded in Fort Dodge, Iowa, blowing the engineer twenty-five feet into the air and landing him in a snow-bank, unhurt. The boiler was blown to fragments, and wrecked everything in its path.

(21.)— A boiler explosion occurred in a factory in Hamburg, N. Y., on January 17th. The setting was blown down, but otherwise little damage was done. Nobody hurt.

(22.)— Hills, McLean & Williams's big establishment in Binghamton, N. Y., was the scene of an explosion on January 20th. The property loss was about \$1,000, and no person was injured.

(23.)— The steamer *Charles McWilliams* left Bridgeport, Conn., on January 20th, with a small tow bound for New Haven. She had hardly reached the outer harbor when her boiler exploded. She was taken back to Bridgeport for repairs.

(24.)— A portable boiler exploded on January 21st, a short distance from Leeds, near Kansas City, Mo. Fragments of the boiler and of the shed in which it stood flew in every direction. Engineer Frank E. Hunt was struck by the head of the boiler and instantly killed. His skull was fractured. Timothy Dwyer also had his skull fractured and died shortly afterwards. George Henry and C. F. Miller were hit by flying timbers and severely but not fatally injured.

(25.)— On January 21st, a boiler exploded in Dean & Burt's mill, in Owego, near Binghamton, N. Y. The mill was somewhat damaged, but fortunately nobody was in it at the time, and there were no injuries to person.

(26.) — A boiler in H. B. Hathaway's mill in Blissfield, near Adrian, Mich., exploded on January 21st. Luke Lanew, George Hathaway, and a boy named Malone, were buried in the ruins, and it was forty minutes before they were all rescued. In a house fifty feet away, Mr. Josenhaus and his wife and three children were sitting at the supper table, when one end of the boiler, accompanied by brick and coal, came crashing through the side of the house within two feet of the table. All received injuries from the flying missiles, and the house was practically demolished. Mr. W. H. Barrow was also injured. He was blown twenty feet but was not fatally hurt. Brick and boiler flues were scattered for rods around, and the property loss was about \$3,000.

(27.) — In Nappanee, Ind., a large steel boiler exploded on January 21st, throwing brick and timbers in all directions for several squares about. C. N. French and David Parker were killed, and F. E. Johnson and Isaac and Jonas Wisler were badly bruised and cut. It is thought that none of the wounded men will die. The boiler had been in operation only a few months. The loss on the property is estimated at \$7,000.

(28.) — J. W. Favors & Co's large mill in Upatoie, near Columbus, Ga., was blown to atoms by the explosion of a boiler on January 24th. Will Griffin and Titus Heath were killed, and Sandy Tinsley, John Grant, and Aaron Watson were fatally injured. Alonzo Johnson, Tom Gammell, John Clark, and John Brookins, were also more or less seriously bruised and scalded, but they will recover. The mill was a complete wreck, hardly a post being left standing.

(29.) — A boiler exploded in Roberts Bros.' mill in Putney, Vt., on January 24th. The loss is estimated at \$3,000.

(30.) — On January 25th, a boiler exploded in Walter's brewery on Clay Street, Louisville, Ky. Ben Helfrig, a milkman, who was coming through the shipping room, was blown twenty feet out into an alley, where he alighted uninjured.

(31.) — A heating boiler exploded in Portland, Oregon, on January 25th, and John Ling, the man in charge, was frightfully scalded. At last accounts it was considered an even thing whether he recovered or not.

(32.) — The boiler in Harry Mulford's residence in Streator, near Ottawa, Ill., exploded on January 27th, damaging the house quite badly. Mr. Mulford was scalded by escaping steam, but no one else was hurt. The loss is estimated at \$800.

(33.) — On January 27th, a boiler exploded in J. A. Ganz's mill in Hardy, Ky. The mill was wrecked by the explosion, and Robert George, William Ganz, and Harrison Moeller were killed outright. Ed Williams, the engineer, was scalded so badly that at last accounts it was thought likely that he would die. Young Ganz was the son of the owner of the mill, and was to have been married on February 1st.

(34.) — The boiler in Mr. S. H. Lonas's mill near Orkney Springs, Va., exploded on January 28th, killing Mr. Lonas's three children, aged 22, 15, and 7, respectively. A man, whose name could not be learned, had his leg broken by his horses running away, they being frightened by the noise. (Orkney Springs is 10 miles west of Mt. Jackson, Va.)

(35.) — A boiler used in hoisting at the Lumbo Island coal mine, near Victoria, B. C., exploded on January 29th, instantly killing contractor M. G. Morrison and assistant engineer John N. Harris. The building in which the boiler stood was completely wrecked.

(36.) — On January 30th, a boiler explosion occurred in the factory of W. F. Stew-

art & Co., Pontiac, Mich., wrecking the building completely. A fragment of the boiler was hurled into a neighboring barn, setting it on fire and destroying it. Several persons were slightly injured. The loss amounted to several thousand dollars, and a citizens' meeting was held at once to raise money to aid the Stewart company in rebuilding.

(37.) — A locomotive exploded in the Missouri Pacific shops in Fort Scott, Kan., on January 31st. Dan Myers, machinist, who was on the top of the boiler, was fatally injured, and engineer Joe Tack was badly hurt also. Myers was hurled high in the air and landed in a coal chute, badly mutilated and scalded. The dome was blown 100 yards, passing through an oil car on the way and demolishing one of the tanks.

### Notes From an Inspector.

One of our inspectors sends us the following notes, which may be of interest to the readers of THE LOCOMOTIVE: "First, and more particularly, I wish to mention a case I met with recently in which oil caused a deal of trouble. There were eight boilers in the battery, each 60 inches in diameter and 16 feet long. They were all connected together, and were supplied with feed water through an open heater. In the course of time a new compound condensing engine was put in in addition to the one they already had. This left only a part of the work for the old engine to do, which caused her valves to rattle badly. The second engineer used oil very freely to stop the noise. The result was that inside of two weeks *all* of the eight boilers began to leak at the seams next to the bridge walls, the leaks being noticed in all of them on or about the same day. An inspection was made, and tallow-like lumps were found standing on the fire sheets over the grates, quite thickly. A sort of glutinous dirt was also found all along the water line and around the opening to the dome. Water was coming out of the boilers in sheets between the rivets, when they were shut down; and, take it altogether, it was the worst case I ever saw. I expected to have to have some of the seams riveted over, sure; but I had the boilers cleaned out at once, and put five pounds of rice in each one. I then looked after the heater to see that the trouble there was stopped, and in a few days the boilers were all right again. This certainly was the worst and most remarkable case of the kind I have ever seen. The engineer is an excellent man, but the best of them get caught with open heaters sometimes. He had used this heater for six years, and knew all about it.

"I want to refer, next, to boilers with man-holes under the tubes. I find that engineers having charge of boilers of this kind are apt to do all their cleaning from below, through the lower manhole. Many times they do not open the boilers on top, and before they know it the boilers are in bad condition above the tubes, and perhaps filled up with incrustation between them. I find it very important, out this way, that they should open on top, as it is impossible to wash the dirt down from the top by doing all the washing from the under side of the tubes.

"Bridge walls are giving some trouble, too, in this neighborhood, for the masons set the bridge-walls and grates up too close to the boiler, and this causes trouble, especially when the boilers are pushed beyond their fair capacity. You have called attention to this many times. I wish we could educate some of these masons out of the notion that a bridge-wall must conform to the shape of the boiler, regardless of what the damage is. If we could do it we could save much in the way of expense to our



patrons, as well as loss to this company. I have tried, as much as possible, to overcome the belief. I tell them a bridge-wall is only for the purpose of keeping the fire from working back, off from the grates. I have more boilers broken and bagged from filling up on top of bridge-walls than in any other way. It is hard to get most engineers and brick masons to understand that heat does not have to be forced up, but that it ought to be distributed as evenly as possible all through under the bottom of the boiler."

### Stopping a Leaky Blow-Off.

A correspondent sends us the following item concerning leaky blow-offs: "An engineer who had been troubled by a failure of the blow-off valve to keep tight, and who had tried various schemes to remedy the trouble, finally put on another valve outside of the one already in use. He found that the trouble was completely cured in his own case and in several others in which it was afterwards tried, and that the two valves, when put on together, would last longer than when each was used separately. The action seemed to be that the first valve took the greatest part of the strain, and that the second valve served to stop whatever slight leakage might pass through the first one. Really, there was as much pressure on the second one as on the first, but they worked so in support of each other that it seemed that the first one did most of the work. The two valves were connected by an ordinary close nipple, and in some cases were of the globe type, while in others the common plug valve was used 'tandem' with equally good results. A pair of asbestos packed valves used in this manner has been giving perfect satisfaction where a single valve persisted in leaking. The second valve has been applied not only after the first one began to leak, but also when the piping was first erected; and has proved capable of preventing any leak whatever during a period much longer than the ordinary life of a valve in the position described."

With regard to this item we may say that it has never been our custom to recommend a double valve on the blow-off, for the reason that we have always found a single valve sufficient. When it becomes leaky we recommend taking it out and putting in a new one. The question would seem to be, not whether a double valve will last longer than a single one, but whether it will last *twice* as long. There is a point in our esteemed correspondent's philosophy that we may also question. It is, that if the first valve leaks, as he assumes it to, and the pressure on the second valve therefore becomes as great as that on the first one, why is not the first one exactly balanced, and how can it relieve the second one? Why is not the strain on the second one precisely the same as it would be if the first one were taken out? Of course if the second valve leaked a little also, the pressure between the two would not be so high as the boiler pressure, and *then* each valve would do part of the work; but in that case the tightness that the second valve was to give is not attained, and the scheme fails to accomplish its object. Lastly we never approve of the use of globe valves on blow-offs. We always recommend straight-way valves with openings the full size of the blow-pipe. All other valves are liable to be choked with scale, and to give trouble.



# The Locomotive.

HARTFORD, MARCH 15, 1893.

J. M. ALLEN, *Editor.*

A. D. RISTEEN, *Associate Editor.*

THE LOCOMOTIVE can be obtained free by calling at any of the company's agencies.

Subscription price 50 cents per year when mailed from this office.

Bound volumes one dollar each. (Any volume can be supplied.)

Papers that borrow cuts from us will do us a favor if they will mark them plainly in returning, so that we may give proper credit on our books.

THE report for 1892 of the chief engineer of the Sächsischer Dampfkessel-Revisions-Verein of Chemnitz is at hand.

DURING the past month there have been several changes in the addresses of our general agents. Our patrons will note that Mr. H. M. Lemon has been appointed general agent in the northwestern department. Messrs. Zollars & McGrew of Denver have removed to Rooms 423 to 426 in the Mining Exchange building; Mr. R. F. Manly of Birmingham, Ala., has removed to the Morris building in that city, and our Boston manager, Mr. C. E. Roberts, has removed to the new Telephone building, No. 125 Milk st.

ON page 38 of the present issue a brief account is given of an explosion near Kansas City, Mo. It appears that the engineer (who was killed) had reason to think an explosion was imminent, and started promptly to haul his fire. One of the papers from which we obtained our information says that "Hunt, instead of making his escape, recklessly endeavored to draw the fire from under the boiler, and while he was thus engaged the explosion took place. It blew out the front of the boiler and shot Hunt's body high into the air." Now we should think that Mr. Hunt ought to be regarded as a sort of hero, rather than as a reckless fellow. He anticipated an explosion, and his plain duty was to haul his fire as quickly as he could. He did not shrink from his duty and unhappily he was killed. He knew he was taking his life in his hands, and it would be a graceful act for our esteemed contemporary to give him credit for his bravery.

## On the Strains Caused by Cold Feed Water.

IN a recent issue of THE LOCOMOTIVE some reference was made to the strains produced in boiler shells by the chilling action of cold feed-water, when this feed water is discharged directly against the hot plates. These strains are often more severe than even experienced engineers might think, and many of the so-called "mysterious" accidents are doubtless due to this cause, either directly or indirectly. We have seen abundant evidence of the destructive action of feed-water when discharged against the shell directly, and in the present article we propose to show by calculation how great these strains from temperature changes may be.

The general principle upon which the calculation is based is as follows: If a bar of metal be cooled by a given amount, it contracts and becomes shorter. Now after it has shortened, suppose we put it in a testing machine and stretch it back to its original

length. The force required to stretch it in this manner is equal to the force that we should have had to exert in order to prevent it from contracting, if we had put it in the testing machine *before* cooling it. In applying this reasoning to boiler shells we consider the portion of the shell against which the feed-water strikes to be analogous to the bar that we put in the testing machine; for it is held in place by the surrounding parts of the shell, and therefore is not free to contract. It is not held as rigidly as it would be in the testing machine, however, for reasons that will appear further on; and hence we cannot expect to realize, in a boiler, the full effect of a strain that is calculated on the assumption that the piece is held immovably.

As a concrete example, let us take as the basis of our calculation a boiler constructed of  $\frac{3}{8}$ -inch steel, carrying steam at 100 pounds pressure. The temperature of the boiler will then be about 337° Fah. Let us suppose, further, that the temperature of the feed-water is 100° Fah., and that it is introduced into the boiler directly over one of the shell-plates, without being allowed to be first warmed by passing through a long pipe, as recommended in the January issue of this paper. If the plate against which it strikes were cooled by the water down to its own temperature — that is, from 337° down to 100° — its fall in temperature would be 237°. Making some allowance for admixture with the water already in the boiler, let us say that the actual fall is 200°. Now the coefficient of expansion of steel is about .0000067 per degree Fahrenheit; so that if we consider a strip of the shell 10 inches long, we shall find that this strip would contract by

$$10'' \times 200^\circ \times .0000067 = .013 \text{ inch,}$$

if it were free to do so. We have therefore to calculate what force would be required to stretch a 10-inch strip of steel .013 of an inch.

The stress, or force, required to stretch steel by a given amount varies considerably with the quality of the steel, but for present purposes we shall accept Rankine's estimate, which is, that if stretching were strictly proportional to the stress applied, a bar of good average soft steel would be doubled in length by a pull of 29,000,000 pounds per square inch. (This number is called the *modulus of elasticity* of the steel.) Of course no steel would stand any such tension as that, but it is convenient to express the fact in this way; and we are to consider, all the time, that what is really meant is that if steel *would* go on stretching, indefinitely, at the same rate that we know it does stretch when small forces are applied, it would be pulled out to twice its length by a force of 29,000,000 pounds per square inch. Another way of expressing the same thing would be to say that average soft steel is stretched one twenty-nine millionth of its own length for every pound per square inch that we pull, provided the pull does not exceed what is called the "elastic limit." After we reach the "elastic limit" (which is about 20,000 pounds per square inch for good steel, though it varies greatly in the different grades) the metal begins to take what is called a permanent set; that is, it no longer springs back to its original length when the tension is removed.

The force required to stretch a body by a given small amount is directly proportional to the amount of the stretch, and inversely proportional to the length of the body: so in the case of steel, we have the following RULE: Multiply the amount of the stretch by 29,000,000, and divide the product by the length of the strip. In the case we are considering the stretch is .013 of an inch, and the length of the strip is 10 inches. Hence we have

$$\text{Force required} = \frac{.013'' \times 29,000,000}{10''} = 37,700 \text{ lbs. per sq. in.}$$

That is, after the feed-water had chilled our imaginary strip of metal by 200° Fah. we

should have to apply a tensile strain of 37,700 pounds per square inch before we could pull it back to its original length, provided the steel stretched always at the same rate as it does when small forces are applied. This means that under the conditions we have imagined the feed-water would produce in the boiler shell a tensile strain of 37,700 pounds per square inch; and this would be sufficient to tear the girth joints apart at once.

Now, as a matter of fact, we know that although feed-water does a great deal of damage when discharged against boiler plates in the way we have described, we know equally well that feed-pipes are often put in as though such an action were specially desired and invited; and we know that although seams are usually started and other damage done, under these conditions, yet the strains that are set up do not actually pull the joints suddenly apart, as our calculation indicates. We shall therefore have to consider why the full calculated strain is not realized in practice. One of the principal reasons is, that although the chilled spot is in large measure prevented from contracting by the surrounding parts of the plate, it is not altogether prevented. There is undoubtedly an elastic yielding of the metal for a considerable distance around the place where the feed is discharged; for we have to remember that the whole boiler is elastic in the same degree as the strip we have been considering. As soon as the chilling occurs and the plate tries to contract locally, the pull is transmitted through the shell to a considerable distance,—let us say for thirty inches in every direction—diminishing in intensity in proportion as we go away from the center of disturbance. If a strip of metal 10 inches long be chilled as we have supposed, and be held at each end by strips 30 inches long whose remote extremities are held rigidly, and if, further, we suppose the strain to be uniform throughout the 10-inch central part and to diminish uniformly as we pass outward along the retaining strips until it becomes nothing at their outer ends, then it is easy to show, by a little mathematics, that the stretch of the two 30-inch strips will relieve the strain on the central part so as to bring it from 37,700 pounds per square inch down to 9,470 pounds per square inch. This state of things does not hold strictly true in the boiler shell, because there the strains radiate from a center in all directions; but it is probably approximately true because those strains which run girth-wise probably relieve themselves by causing the shell to straighten out a little for the moment. This view is also sustained by the fact that cold feed-water rarely affects the longitudinal seams, although its effects are very marked on the girth seams.

The principal objection to the process above considered seems to be that we cannot say with certainty at what distance from the feed-pipe the strains cease to be felt. However, we may feel pretty confident that in the case of the boiler we have been considering, a longitudinal strain of somewhere in the neighborhood of 8,000 or 10,000 pounds per square inch may be produced by the feed-water striking directly upon the plates; and this, in addition to the normal strain produced by the steam pressure, is quite enough to tax the girth seams beyond their elastic limit, if the feed-pipe discharges anywhere near them. Hence it is not surprising that the girth seams develop leaks and cracks in 99 cases out of every hundred in which the feed discharges directly upon the fire-sheets. In some cases the local strains may not be felt as far away from the feed-pipe as 30 inches, and then we should expect them to be greater in amount and correspondingly more severe in their effects.

The reality and the magnitude of the temperature strains in bodies will be readily conceded by those who have had experience with steel hardened by plunging it in water while hot. It is well known that such treatment is apt to warp the steel out of

shape, and pretty certain to leave it in such a permanently strained condition that a slight blow will break it readily. Of course the chilling in such a case is much more violent than it is in boilers, but the action is probably similar, differing in degree rather than in kind.

It may be interesting to examine the effect of sudden and local temperature changes in glass, a body that is notoriously apt to break when suddenly heated or cooled. The method of calculation that we have used above may be summed up briefly in the following formulæ :

$$S = C \times t \times M; \text{ or } t = \frac{S}{C \times M}$$

where  $C$  is the coefficient of expansion,  $M$  the modulus of elasticity,  $t$  the sudden change in temperature, and  $S$  the strain per square inch produced by this change in temperature. In the case of glass we may take  $C$  .000005 per degree Fahrenheit, and  $M = 8,000,000$  pounds per square inch. We may also take the tensile strength of glass as 9,400 pounds per square inch, and by substituting this for  $S$  in the second of the foregoing formulæ we can find out what change in temperature will break the glass. Thus

$$t = \frac{9,400}{.000005 \times 8,000,000} = 235 \text{ Fah.}$$

Any kitchen girl who has had experience in washing glasses could tell us that this estimate is not far from right. Indeed, glasses often break with a much smaller change in temperature, a fact that is sufficiently explained by their shape, but we cannot enter further into the mechanics of this question in the present article. It appears that unless glass has been specially annealed, as it is in making beakers and test tubes and the better grades of lamp chimneys, the elastic yielding of the material surrounding the chilled spot, which we took some account of in the case of steel, does not occur to any great extent, so that the formula gives a fairly accurate result without taking it into account.

### The Just Perceptible Difference.

A lecture was delivered on Friday, January 27th, by Mr. F. Galton on the "Just Perceptible Difference," in which he pointed out that each sense organ has its own internal activities which are too faint to be perceptible in health, but which are not unfrequently perceived in illness, as, for example, ringing in the ear and peculiar taste or smell. Their unfeared effects might, however, concur with an ordinary sense impression and intensify it. He dwelt on the influence of the imagination and adduced instances where imagination produced effects that had been mistaken for faint sensations and sometimes for plainly perceptible ones. One of the most suitable subjects for such experiments he found to be the auditory imagination associated with the words perused by the eye. He described experiments frequently made by himself at meetings of scientific societies, where he had obtained unreviced copies in print of the papers about to be read. Owing to some deafness he often found himself able to follow every word distinctly only so long as his eyes rested on the paper; he could detect the fact of any alteration in the wording, but was quite unable to make out the substituted words. On these occasions when he raised his eyes from the paper he could not follow the reader at all. He usually found it necessary to approach him by one quarter of the previous distance, in order to follow his voice by means of the ear alone. Hence the power of the imagination *plus* the power of the hearing bore the same relation to the



power of the hearing alone as the loudness of the sound at four units of distance did to its loudness at three units. Their proportion was as the square of those numbers, or as 16 to 9. It followed that the power of the auditory imagination had seven-sixteenths of the power of a just audible sound — namely, of those overtones in the voice by which articulate words were distinguished. Similar results may be obtained by comparing the distances at which a play in a foreign language not well colloquially understood can be followed with and without a book of the words. Passing on to the second part of his lecture, Mr. Galton said the angular distance apart of two dots when they first began to merge into one was usually reckoned at one minute of a degree. When a row of 300 similar objects of any size is viewed at such a distance that the space they occupy in the visual field is not wider than that occupied by one inch on the page of a book, they produce the effect of a perfectly continuous and uniform line. If the dots are replaced by disks touching one another and arranged with moderate exactness along any flowing line, even fifty of them to the inch give a fairly good impression of continuity. It was further shown that the positions of fifty equidistant dots can be defined by as many letters, or else by twice as many figures, which, according to the telegraphic scale of five figures to a word, was equivalent in cost to twenty telegraphic words. Counting the top of the paper as north, the bearing of each dot from its predecessor was recorded to the nearest of the sixteen principal points of the compass by means of one or other of the first sixteen letters of the alphabet. The effect of error in laying down any one dot had but a trifling effect on its successors. A severe test of the applicability of this method was made by comparing the profile of a girl copied from a Greek gem with its reproduction from a formula containing 400 letters, which was the equivalent of 160 telegraphic words. The two portraits—the original and the reproduction—were reduced photographically to various sizes. When the scale was such that fifty dots were included in the length of one inch of lineation, the effect was unexpectedly good. When the portrait was reduced to the size of that on a postage stamp, it had all the appearance of a delicate line engraving. This and other tests showed that it was feasible to reproduce characteristic lines of any description from a written formula. It was pointed out that the power of doing so might become of practical utility, considering the large and increasing space given in newspapers to telegraphic intelligence, the gradual introduction of illustrations into the daily papers, and the not infrequent occurrence of local events of high importance which did not admit of a clear description without an accompanying sketch or plan, however rude. The cost of sending by telegram from the United States the formula for any plan or design containing the same total amount of lineations as in the profile mentioned above would be £8. — *London Lancet*.

WE append a summary of the work of the inspectors of this company from 1870 to 1892, inclusive. This summary was crowded out of the February issue by the unusual press of tabular matter there given. The years 1876 and 1878 are omitted, because the data that we have at hand for those years is not complete. The figures, so far as we have them, indicate that the work during those years was in good accordance with the regular progression observable in other years. Previous to 1875, it was the custom of the company to publish its reports on the first of September, but in this year the custom was changed and the summaries were made out up to January 1st, so as to agree with the calendar year. The figures given opposite 1875, therefore, are for the sixteen months beginning September 1, 1874, and ending December 31, 1875.



## SUMMARY OF INSPECTORS' WORK SINCE 1870.

YEAR.	Visits of inspection made.	Whole number of boilers inspected.	Complete internal inspections.	Boilers tested by hydrostatic pressure.	Total number of defects discovered.	Total number of dangerous defects discovered.	Boilers condemned.
1870	5,439	10,569	2,585	882	4,686	485	45
1871	6,826	13,476	3,889	1,484	6,253	954	60
1872	10,447	21,066	6,533	2,102	11,176	2,260	155
1873	12,824	24,998	8,511	2,175	11,998	2,892	178
1874	14,368	29,200	9,451	2,078	14,256	3,486	163
1875	22,612	44,763	14,181	3,149	24,040	6,149	216
1877	.....	32,975	11,629	2,367	15,964	3,690	133
1879	17,179	36,169	13,045	2,540	16,238	3,816	246
1880	20,939	45,166	16,010	3,490	21,033	5,444	377
1881	22,412	47,245	17,590	4,286	21,110	5,801	363
1882	25,742	55,679	21,428	4,564	33,690	6,867	478
1883	29,324	60,142	24,403	4,275	40,953	7,472	545
1884	34,048	66,695	24,855	4,180	44,900	7,449	493
1885	37,018	71,334	26,637	4,809	47,230	7,325	449
1886	39,777	77,275	30,868	5,252	71,983	9,960	509
1887	46,761	89,994	36,166	5,741	99,642	11,522	622
1888	51,483	102,314	40,240	6,536	91,567	8,967	426
1889	56,752	110,394	44,563	7,187	105,187	8,420	478
1890	61,750	118,098	49,983	7,207	115,821	9,387	402
1891	71,227	137,741	57,312	7,859	127,609	10,858	526
1892	74,830	148,603	59,883	7,585	120,659	11,705	681

The following table is also of interest. It shows that our inspectors have made nearly three-quarters of a million visits of inspection, and that they have made nearly a million and a half of inspections, over half a million of which were complete internal inspections. Over a million defects have been discovered and pointed out to the owners, more than one-eighth of which were, in our opinion, dangerous:

GRAND TOTAL OF THE INSPECTORS' WORK SINCE THE COMPANY BEGAN BUSINESS, TO  
JANUARY 1, 1893.

Visits of inspection made,	-	-	-	-	-	-	714,821
Whole number of boilers inspected,	-	-	-	-	-	-	1,416,732
Complete internal inspection,	-	-	-	-	-	-	542,088
Boilers tested by hydrostatic pressure,	-	-	-	-	-	-	94,334
Total number of defects discovered,	-	-	-	-	-	-	1,083,416
“ “ dangerous defects,	-	-	-	-	-	-	142,359
“ “ boilers condemned,	-	-	-	-	-	-	7,809

Incorporated  
1866.

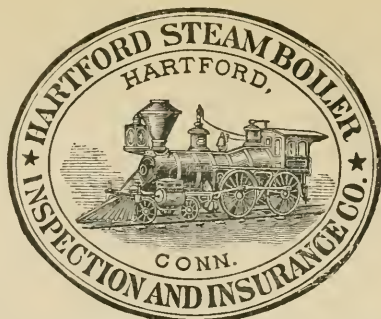

Charter Per-  
petual.

Issues Policies of Insurance after a Careful Inspection of the Boilers,  
COVERING ALL LOSS OR DAMAGE TO  
**BOILERS, BUILDINGS, AND MACHINERY.**

ALSO COVERING  
**LOSS OF LIFE AND ACCIDENT TO PERSONS**

ARISING FROM

## Steam Boiler Explosions.

Full information concerning the plan of the Company's operations can be obtained at the  
**COMPANY'S OFFICE, HARTFORD, CONN.,**  
Or at any Agency.

**J. M. ALLEN, President.**

**J. B. PIERCE, Secretary.**

**E. J. MURPHY, M. E., Consulting Engineer.**

**W. B. FRANKLIN, Vice-Prest.**

**FRANCIS B. ALLEN, 2d Vice-Prest.**

### Board of Directors.

**J. M. ALLEN, President.**  
**FRANK W. CHENEY, Treas.** Cheney Brothers Silk Manufacturing Co.  
**CHARLES M. BEACH,** of Beach & Co.  
**DANIEL PHILLIPS,** of Adams Express Co.  
**RICHARD W. II. JARVIS,** Prest. Colt's Fire Arms Manufacturing Co.  
**THOMAS O. ENDERS,** President of the U. S. Bank.  
**LEVERETT BRAINARD,** of The Case, Lockwood & Brainard Co.  
**GEN. WM. B. FRANKLIN,** late U. S. Commissioner to the Paris Exposition.  
**NELSON HOLLISTER,** of State Bank, Hartford.

**HON. HENRY C. ROBINSON,** Attorney-at-Law, Hartford, Conn.  
**HON. FRANCIS B. COOLEY,** of the National Exchange Bank, Hartford, Conn.  
**A. W. JILSON,** late Vice-Prest. Phoenix Fire Ins. Co., Hartford, Conn.  
**EDMUND A. STEDMAN,** Treasurer of the Fidelity Co., of Hartford, Conn.  
**GEORGE BURNHAM,** Baldwin Locomotive Works, Philadelphia.  
**HON. NATHANIEL SHIPMAN,** Judge United States Circuit Court.  
**C. C. KIMBALL,** Pres. Smyth Mfg. Co., Hartford, Conn.  
**PHILIP CORBIN,** of P. & F. Corbin, New Britain, Conn.

### GENERAL AGENTS.

**THEO. H. BABCOCK,**  
**CORBIN & GOODRICH,**  
**LAWFORD & McKIM,**  
**C. E. ROBERTS,**  
**H. M. LEMON,**  
**C. C. GARDINER,**  
**L. B. PERKINS,**  
**W. G. LINEBURGH & SON,**  
**A. S. FERRY,**  
**MANN & WILSON,**  
**ZOLLARS & MCGREW,**  
**R. F. MANLY,**  
**W. S. HASTIE & SON,**  
**PETER F. PESCUD.**

### CHIEF INSPECTORS.

**R. K. McMURRAY,**  
**WM. J. FARRAN,**  
**F. S. ALLEN,**  
**WM. HEAFORD,**  
**A. B. ECOFF,**  
**F. S. ALLEN,**  
**J. H. RANDALL,**  
**C. A. BURWELL,**  
**J. B. WARNER,**  
**T. E. SHEARS,**  
**B. F. JOHNSON,**

**NEW YORK CITY.**  
**PHILADELPHIA, PA.**  
**BALTIMORE, MD.**  
**BOSTON, MASS.**  
**PROVIDENCE, R. I.**  
**CHICAGO, ILL.**  
**ST. LOUIS, MO.**  
**HARTFORD, CONN.**  
**BRIDGEPORT, CONN.**  
**CLEVELAND, OHIO.**  
**SAN FRANCISCO, CAL.**  
**DENVER, COL.**  
**BIRMINGHAM, ALA.**  
**CHARLESTON, S. C.**  
**NEW ORLEANS, LA.**

### OFFICES.

Office, 285 Broadway.  
" 432 Walnut St.  
" 22 So. Holliday St.  
" 125 Milk St.  
" 29 Weybosset St.  
" 112 Quincy St.  
" 404 Market St.  
" 218 Main Street.  
" 2 Sanford Building.  
" 208 Superior St.  
" 306 Sansome St.  
" Mining Ex. Bldg.  
" Morris Building.  
" 44 Broad St.  
" 188 Gravier St.

# The Locomotive.

PUBLISHED BY THE HARTFORD STEAM BOILER INSPECTION AND INSURANCE COMPANY.

NEW SERIES—VOL. XIV.

HARTFORD, CONN., APRIL, 1893.

No. 4.

## An Accident Due to Bad Workmanship.

Readers of THE LOCOMOTIVE may be interested in an accident that came to our attention a short time ago, and which is fortunately no longer a common one. The circumstances of the accident were as follows:—The boiler in question was 60 inches in diameter, and five years old, and had seven tubes in the lowest row. Of these seven tubes all but the right-hand one had developed leaks just inside the front head, and had been thimbled. It had been recommended that the six leaky tubes be removed and replaced by new ones; but before this was done the seventh tube (that is, the right hand one in the lowest row) suddenly failed when the boiler was running under fifteen pounds of steam, the ordinary running pressure being from 75 to 80 pounds. The end of

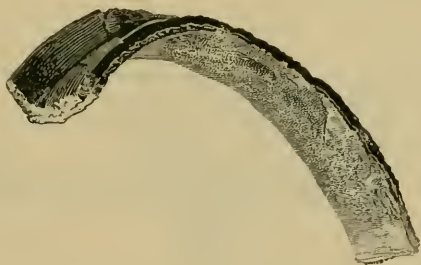

FIG. 1.—A FRAGMENT OF THE TUBE-END.

the tube pulled off, and the tube was drawn back through the head, and deflected towards the right, so that two-thirds of the diameter of the tube-hole was uncovered. The contents of the boiler blew out through this opening, filling the boiler-room with steam and scalding water, and making it impossible to approach the boiler to haul the fire; the result being that it was badly burned.

Part of the detached tube-end is shown in Fig. 1, and an examination of the fractured area of it showed that for a considerable time the tube had been held together only by the merest skin of metal along the inner surface; so that although it had been on the point of giving out for a long time, it had every appearance of being sound and good. When the thimbled tubes were removed, they were found to be in a similar condition, the leaks that had developed in them being caused by pin-holes that had corroded through from the groove that encircled them just along the inner surface of the boiler head.

The head of the boiler was calipered and found to be a trifle less than  $\frac{7}{16}$  of an inch

thick; and an examination of the detached tube-end showed that it had been expanded with a Prosser expander, the tool that had been used being evidently designed for a  $\frac{3}{8}$ -inch head. For the benefit of those who may be unfamiliar with the Prosser expander, we may say that it consists of series of pieces shaped like *A* in Fig. 2, and arranged in a circle around a central pin. This central pin is tapering, and when the expander has been put in position in the tube, the segments are set out forcibly against the tube by driving in the pin. In this way the end of the tube is turned over against the head, and the tube is expanded so as to fit the tube-hole tightly. The tube is also enlarged slightly just inside the head. When the expander has been set out against the tube sufficiently in one position, the pin is drawn out and the tool is shifted slightly and

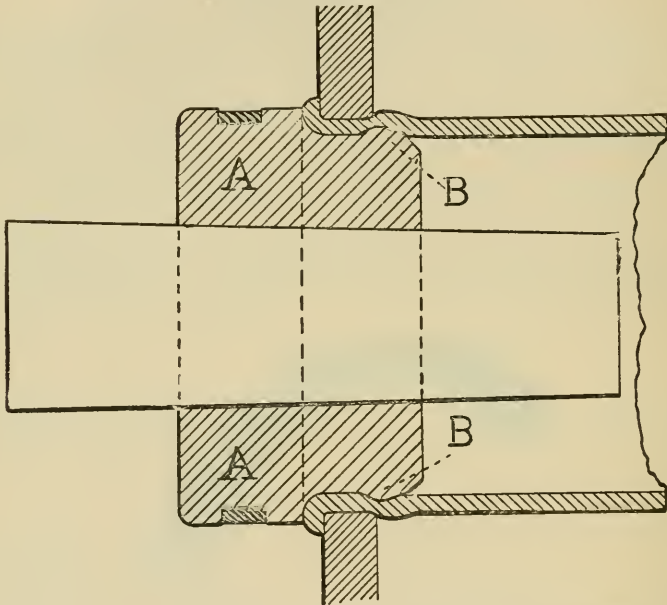

FIG. 2.—ILLUSTRATING THE ACTION OF THE PROSSER EXPANDER.

driven again. In the better boiler shops tube-ends are mostly rolled, nowadays, and except in special cases where the rolling operation is not convenient, the Prosser expander is used very little.

Fig. 2 illustrates what happens when, as in the case under consideration, the tubes are expanded with a Prosser tool that is *too small for the head*. The projection *B*, that is intended to enlarge the tube just inside the head, and which ought to just clear the head on the inside, does not clear it, but forces the metal of the tube against the inner edge of the head, so that the tool and tube sheet act like the two blades of a pair of shears. The inevitable result is, that the tube is badly strained at this point, or, if the tool is new and sharp and the work carelessly done, it may even be sheared in two. At all events, the tube is pretty sure to be so badly strained that its strength is destroyed, and sooner or later it will give trouble.

In the present instance the trouble was no doubt aggravated by the fact that the boiler was fed directly over the fire-sheet. The lower tubes were subjected to the chilling action of the feed-water, and must have contracted violently at times, and experienced

severe strains, which made themselves most felt at the point where the tubes had been weakened by the expander.

### Inspector's Reports.

FEBRUARY, 1893.

During this month our inspectors made 5,762 inspection trips, visited 11,068 boilers, inspected 3,820 both internally and externally, and subjected 588 to hydrostatic pressure. The whole number of defects reported reached 8,662, of which 893 were considered dangerous; 39 boilers were regarded unsafe for further use. Our usual summary is given below:

Nature of Defects.	Whole Number.	Dangerous.
Cases of deposit of sediment, - - - -	591	44
Cases of incrustation and scale, - - - -	1,108	69
Cases of internal grooving, - - - -	39	4
Cases of internal corrosion, - - - -	354	27
Cases of external corrosion, - - - -	514	37
Broken and loose braces and stays, - - - -	214	47
Settings defective, - - - -	226	37
Furnaces out of shape, - - - -	288	26
Fractured plates, - - - -	207	54
Burned plates, - - - -	181	24
Blistered plates, - - - -	208	17
Cases of defective riveting, - - - -	1,439	83
Defective heads, - - - -	82	22
Serious leakage around tube ends, - - - -	1,822	159
Serious leakage at seams, - - - -	302	34
Defective water-gauges, - - - -	340	50
Defective blow-offs, - - - -	126	29
Cases of deficiency of water, - - - -	12	7
Safety-valves overloaded, - - - -	63	25
Safety-valves defective in construction, - - - -	96	46
Pressure gauges defective, - - - -	377	51
Boilers without pressure gauges, - - - -	1	1
Unclassified defects, - - - -	72	0
Total, - - - -	8,662	893

### Boiler Explosions.

FEBRUARY, 1893.

(38.)—A boiler burst on January 31st, in a factory in Newark, N. J. Benjamin Arrowman was painfully but not fatally scalded about the hands and face. No other injuries to person are reported, and the damage to property was not great. [We did not learn of this explosion in time to enter it in the regular January list.—Ed.]

(39.)—On February 1st a boiler exploded at Merion, near Reading, Pa. Nobody was seriously injured, and the loss was small.

(40.)—Another boiler explosion occurred in Vicksburg, Miss., on February 2d.



(This is the second within a month.) The boiler was owned by the Vicksburg Cotton Press Association, and was situated on the corner of Henry and Water streets. James Calder, the engineer, was instantly killed. Joe Finichi was also killed outright, his head being blown off. William Clifton had his skull fractured and died a few hours later. In addition to these, the following men received painful injuries, and two of them may not recover: George Phillips, Burrell Franklin, Gloster Bruin, Moses Mitchell, Henry Campbell, William Brackett, Thomas Robinson, James Edgar, William Miller, Fred. Bodley, Ben. Brown, and Nathan Woods. The property loss was estimated at \$7,000 or \$8,000.

(41.)—By the explosion of a small boiler on West Ottawa street, Leavenworth, Kan., on February 2d, property estimated as worth \$2,000 was destroyed. The boiler belonged to W. H. Rose. Nobody was hurt.

(42.)—Two boilers in a battery of six exploded on February 3d in Girardville, near Ashland, Pa. The explosion occurred in the morning, before the employes had arrived, so that no personal injuries resulted. None of the men employed in the boiler-house were near by. The boiler-house was badly damaged, and the remaining four boilers were dismantled.

(43.)—On February 3d a boiler exploded in the Granger mill in Somerset, Pa. The boiler was blown up through the second floor of the mill, killing Samuel Houpt in its passage. Mr. Frank B. Granger, who was near Houpt, was not hurt, though timbers fell all about him and he was enveloped in steam. He managed to crawl to a window for air, and fell through a hole to the first floor. The mill is a total wreck, and the machinery was blown in all directions. William Stoddard, an employe, was slightly injured.

(44.)—On February 4th a boiler exploded at the Waugh Steel Works, in Belleville, Ill. Three men were killed.

(45.)—A boiler exploded in Tyler, Tex., on February 8th, instantly killing Fireman Julius Raspberry, and seriously and perhaps fatally injuring a Mr. McMahan. The engineer, Burt Wheeler, was also slightly cut and bruised about the face. The explosion did considerable damage to adjacent property. The boiler itself was hurled 200 feet, and fragments of it carried away 50 feet of awnings. From 200 to 300 window panes in the vicinity were broken by the concussion.

(46.)—A slight explosion in C. W. Hayes's factory in Haverhill, Mass., on February 8th, threw 2,000 people out of work temporarily. Nobody was injured and no damage was done, except to the boiler.

(47.)—A small boiler used by some plumbers in Newark, N. J., exploded on February 8th. The workmen were hurled against the walls of the building, and one man, whose name we could not learn, was badly injured.

(48.)—A boiler exploded in Riverton, near McKeesport, Pa., on February 9th. Engineer Ross Leonard was badly hurt about the back, and Fireman Larry Davidson had an ankle broken, and was otherwise hurt.

(49.)—On February 10th a boiler exploded in the Isaac Mott residence, occupied by a Mr. Walker, in Glens Falls, N. Y.

(50.)—A boiler exploded on February 12th in Marshall's mills, in Hickory Grove, near Dexter, Iowa. The building was considerably damaged, but nobody was hurt.

(51.)—On February 13th a boiler exploded in Wiltse's mill in Ashley, near Ithaca, Mich. We have no particulars of the injuries to person or property.

(52.)—A boiler exploded at Norwich, O., on February 16th. Nobody was hurt, and the damage was not great.

(53.)—J. M. Newberry's mill, 75 miles from Pittsburgh, Camp Co., Tex., was blown up by a boiler explosion on February 17th. Romulus Wylie was killed, and C. A. Newberry, William Morris, James Woods, and Henry Clay were seriously hurt. Several others were also slightly injured.

(54.)—Isaac Robinson and William Menefer were scalded to death on February 17th by the explosion of a boiler in Covington, Ind. No other person was hurt, and the property damage was small.

(55.)—A boiler exploded in Forth Worth, Texas, on February 19th. John Mills was instantly killed. W. R. Barrett, S. M. Deats, W. A. Ford, H. E. Haden, and Robert Thompson were severely injured and some of them will be crippled for life. Ford had seven ribs broken, and Thompson had his right leg broken and his face and body badly scalded. His eyesight was also destroyed. The boiler was less than two years old. The explosion occurred in the early morning, and aroused 30,000 people. Glass was broken in buildings eighteen blocks away.

(56.)—On February 21st a boiler exploded in Bowling Green, Ohio. Nobody was hurt. We have no particulars concerning the property loss.

(57.)—A boiler exploded in West Line, Mo., on February 21st, killing Robert Davis and E. C. McMillan instantly, and injuring Nelson McCormick so that he died next day. William Jones and Abraham Grabill were terribly scalded and bruised, and at last accounts Jones was considered likely to die. The report of the explosion was heard five miles away.

(58.)—On February 21st a boiler exploded in William V. Vass's residence, on Fourth Avenue, Brooklyn, N. Y. The building and furniture were damaged to the extent of about \$300.

(59.)—A boiler exploded on February 22d in the residence of Alderman Baldwin, in Buffalo, N. Y. The building took fire, but the fire was put out before much damage was done.

(60.)—A boiler exploded at New Concord, O., on February 22d. The fireman was badly scalded about the head and face.

(61.)—A small boiler exploded in Buffalo, N. Y., on February 23d, and John Bin, the owner, was badly scalded about the arms and body.

(62.)—On February 23d a boiler exploded in the works of the Miner Company, just across the river from New Cumberland, W. Va. Otis Crawford was instantly killed, and a Mr. Covant, who was near by, was fatally injured and was carried to his home in a dying condition. The building was totally destroyed, and the wreckage was scattered many yards about. The explosion was heard miles away.

(63.)—A boiler explosion occurred near Cadillac, Mich., on February 25th. Fireman Patrick O'Neal was killed. Nobody else was hurt.

(64.)—One of a nest of three boilers, at Tyler, McTurk & Co.'s place at New

Castle, Pa., exploded on February 25th. The brick-work and roof of the boiler-house were torn to pieces and hurled in all directions. No person was injured.

(65.)—The boiler in Egbert Naylor's large mill near Leatherwood, Ky., exploded on February 25th. Washington Hudson, the fireman, was blown 100 feet away, and is likely to die from his injuries.

(66.)—On February 28th a boiler exploded in Marthaville, Ont. James Duncan and his engineer were killed, and a man named McKensie fatally injured.

### Leidenfrost's Phenomenon.

Elsewhere in this issue we have acknowledged the receipt of a paper on this subject by the distinguished Italian engineer, Alfredo Gilardi. The phenomenon referred to is commonly known as the "spheroidal state" of water, and many boiler explosions have been attributed to it. In our own experience with boilers we have never found it necessary to invoke any such cause to account for explosions, for, as a general rule, they can be explained in much more obvious and probable ways. Engineer Gilardi's essay on the subject is of considerable interest, and a translation of it is given below :

"It is known that when a liquid at the ordinary temperature is poured upon a red-hot plate of metal, instead of wetting the plate and evaporating rapidly, it assumes a spheroidal form. The mass evaporates slowly at the surface, and is so mobile as to remind one forcibly of a drop of quicksilver; and after a certain interval it flashes suddenly into vapor. This behavior is due to the fact that between the liquid drop and the hot metallic plate an atmosphere of saturated steam is formed, which has a pressure sufficient to sustain the weight of the drop and prevent it from coming into direct contact with the metal. As the metal below the drop gradually cools there comes a time when the tension of the film of steam is no longer sufficient to support the liquid spheroid, which immediately comes in contact with the plate, and is immediately converted into vapor, transforming the heat-energy it receives into mechanical energy.

"It was formerly taught and maintained by the majority of persons that when the liquid mass and the surface at high temperature are large, and are contained in a hermetically sealed enclosure (for instance a steam boiler), the rise in pressure may be so great as to exceed the tensile strength of the material of which the receptacle itself is made, and bring about an explosion. And how many boiler explosions have been erroneously attributed to this cause!

"The object of the present paper is to demonstrate that, even if we admit the possibility of Leidenfrost's phenomenon occurring in a boiler, we should have, as the necessary result of it, a *diminution* of the pressure; and hence, that not one steam boiler explosion can be ascribed to this cause.

"It will be convenient to make various hypotheses and study them separately. We shall first assume the boiler to be fed with cold water, which comes in contact with a plate at a temperature of 800° Centigrade [1472° Fah.], and that the spheroidal state is not produced. In this case the water will quickly absorb the excess of heat contained in the plate, and a corresponding production of steam will occur; the pressure in the boiler will rise, and, if it becomes great enough, the safety-valve will open and the excess of steam be discharged through it.

"If we next assume the spheroidal state to occur, the water will evaporate slowly until the temperature of the plate has fallen to 200° or 300° Centigrade [say 400° to 600°

Fah.], after which the water will come in contact with the cooled metal, which now contains only a fraction of the heat it had in the case of the first hypothesis and will therefore generate steam slowly at the pressure already existing in the boiler. From the law of equilibrium in temperatures, it follows that the temperature, and therefore the pressure, in the boiler must diminish.

“The consideration of a practical case will lead one to admit this assertion, namely, that the spheroidal state would produce a lowering, rather than an increase, in pressure.

“The quantity of heat that a plate can hold, and can give out by a given change in temperature, is directly proportional to its weight and to its specific heat.

“The demonstration that we are about to offer will be the more convincing the more disadvantageous we make the proposed conditions. We shall therefore consider a locomotive of the heaviest type, with a huge furnace, the crown-sheet and first row of tubes of which weigh 720 kilograms [1,587 pounds]. We shall assume the effective pressure in the boiler to be 10 atmospheres, corresponding to a temperature of 184.5° C. [364.1° Fah.]. Let us next assume the water-level to go down till it is 10 centimeters [about 4 inches] below the crown-sheet, and let us also assume that the products of combustion pass through the upper row of tubes until the uncovered metal has a temperature of 800° C. [say 1,500° Fah.], which temperature is certainly the highest possible, as will appear by the following considerations: The maximum temperature realizable in the flame of a boiler furnace depends upon the quantity of air admitted to the furnace in excess of that required for combustion, but it is certainly less than 1,800° C. [say 3,300° Fah.]; and furthermore, this maximum temperature can never be realized at the crown-sheet, partly because the gases are not yet fully burned, and all the heat has therefore not been produced, and partly because some of the heat has already been lost by radiation to the water-leg and otherwise. Estimating the defect of temperature from these causes at 30 per cent., which is certainly not exaggerating it in a sense unfavorable to the spheroidal theory, we may conclude that the maximum realizable temperature of the furnace gases is 1,260° C. [2,300° Fah.]. Under these circumstances a metallic plate which is exposed on the one side to the furnace and on the other bathed in steam and radiating heat into a medium at 180° C. [356° Fah.], can in no case have a temperature greater than 800° C. [1,472° Fah.]. Moreover, such a heat focus as this would provoke the liveliest ebullition, and the water-level would have to go down considerably more than 10 centimeters [4 inches] in order to ensure that the upper part of the furnace should be truly dry.

“In any case we may consider that the circumstances stated above are the most disadvantageous possible so far as this demonstration is concerned, and they will be even more so if we consider the furnace crown to be of iron instead of copper—that is to say, if we assume its specific heat to be 0.111 instead of 0.095.

“Here is the calculation based on these data :

Weight, in pounds, of the uncovered metal=	- - - - -	1,587
Units of heat that the iron contains in excess of that which it would have at 364.° Fah., as calculated from the formula 1,587 × 0.111 (1,472°—364°)=	- - - - -	195,182
Pounds of water required to cover the crown-sheet and the first row of tubes=	- - - - -	1,047
Temperature to which this water, supposed to be initially at 77° Fah., would be raised if all of the foregoing 195.182 heat units were employed in heating it $\frac{1}{2}$ calculated from the formula $195.182 = 1.047 (T - 77°) \frac{1}{2}$ =	- - - - -	263° Fah.

“Therefore, in the case most favorable to the sustaining of the theory that explo-



sions arise from the occurrence of the spheroidal state, we see that all the heat contained in the metal — all of its potential thermal energy when converted wholly into mechanical energy — barely suffices to heat the water introduced into the boiler up to the temperature corresponding to an effective pressure of an atmosphere and a half. It follows that if, as in the case we have considered, the pressure is already greater than this, the introduction of cold water will cause it to fall.

“This same conclusion was reached by the engineers of the Pennsylvania Railroad, who tried to bring about an experimental explosion by injecting cold water into the boiler of a locomotive whose crown-sheet was dry and red hot. The cold water had hardly been introduced when the pressure fell, and naturally the explosion did not take place, though the furnace had been so highly heated that it was afterwards useless.

“In the monthly report for December, 1882, of the Chief Engineer of the Manchester Steam Users Association, which association has been studying steam boilers for twenty years with a view to securing safety and economy in the use of steam, there is quoted the following opinion of an ‘expert’ concerning the explosion of a locomotive:

“‘After a careful examination of all the circumstances accompanying the explosion, I can give no other opinion than that it was due to the instantaneous formation of steam at high pressure, which acted with irresistible force on the furnace and boiler, the production of steam being so copious that neither the safety-valve nor the main steam pipe (which was probably open, since the locomotive was in motion) could discharge it. Explosions similar to this one, and which could be explained only by assuming a sudden generation of steam at high pressure, have occurred before; the most notable one being that of a locomotive belonging to the Caledonian Company, which exploded while running at a velocity of thirty miles an hour, near Carlisle, in April, 1856.’

“To this opinion Chief Engineer Fletcher replied: ‘Such a conclusion is contrary to the experience of the Manchester Steam Users Association. The association has carefully studied a large number of explosions which have occurred during the past twenty years, and has found that such catastrophes result uniformly from simple and preventable causes. The report in question is a step backwards, and tends to shroud boiler explosions in mystery.’

“We may also refer to a recent report of Chief Engineer Fletcher concerning some experiments made by his company on the effects of red-hot furnace crowns. The Manchester Association dissents from the opinion commonly expressed concerning the effect of showering water on red-hot crown-sheets, and considers this opinion to be quite erroneous, although it seems to be profoundly rooted in the minds of the industrial and technical public.

“A few years ago an extremely disastrous explosion occurred in a dockyard of the British navy. The true cause of the explosion was corrosion of the shell-plates, which, in some places, were thinned down almost to the thickness of paper. However, three experts were on hand who, at the inquest, referred the explosion to lack of water. The fireman had neglected his duty, had let the water-level go down in the boiler, and had turned the feed on suddenly; then an enormous pressure was suddenly produced, so much greater than the normal pressure as to fracture the shell and bring about the explosion. Examples of this kind could be multiplied indefinitely. The Manchester Association alone has observed fourteen cases of explosion erroneously attributed to low water; in twelve of these cases the fireman was killed, and in two he was unjustly accused of manslaughter.

“This mistaken view, so generally held, is especially harmful, since it distracts the attention from the true cause of explosions, which is to be sought, almost always, either



in the originally imperfect construction of the boiler, or in the wretched condition into which it has been allowed to get by neglect.

“Considering the usual view to be false (that is, that if water be brought in contact with a red-hot furnace it will be turned into steam so quickly as to cause an increase in pressure so sudden and so great that the boiler could not withstand it), the experts of the Manchester Association had for a long time been impelled to believe that feeding a boiler in which the water level was below the crown-sheet, could not do otherwise than reduce the steam pressure, cooling the furnace also, and preventing its possible collapse. To decide this point experiments were made on a boiler 27 ft. 9 in. long and 7 feet in diameter, with the two internal furnaces, each 3 feet in diameter. The boiler was made entirely of iron, the shell plates and furnace plates being  $\frac{7}{8}$  inch thick, and the heads  $\frac{9}{16}$  inch. The heads each had four gussets above the furnaces, and the front head had two gussets below them, and the rear head one. Each of the two feed valves (which were in front of the boiler) was connected to a feed pipe discharging directly over one of the furnaces, six inches above its highest point. The feed water was therefore sprayed upon the furnaces directly over the grates, and not as usual, back of the bridge-wall. The safety-valves were set at about 25 lbs. per square inch. The experiments consisted in firing the boiler up, letting the water level go down until the highest part of the furnace was bare, keeping the fires bright until the dry furnace became red-hot, and then injecting the cold feed-water. The results of the experiments led to the conclusion that spraying cold water on a red-hot furnace crown does not cause rupture, nor deformation of any kind, nor even a sensible increase in steam pressure; but that, on the contrary, when the safety-valve was blowing freely, the index-needle of the pressure gauge immediately began to travel backward.

“In conclusion, it must be said that the development of the spheroidal state in a steam boiler is a harmless phenomenon, and that, furthermore, in some special cases it may be the means of instantly diminishing a pressure already too high.”

---

A BOILER explosion is reported from Eischisek in the province of Wilna, Russia. The boiler of the public baths at that place exploded on January 6th, killing six persons instantly, and mortally injuring fifteen others. A similar explosion occurred in the Mahommedan baths at Baku, Russia, on March 1st, when the place was crowded. More than 300 women and children fled naked into the streets, and several persons were scalded to death.

---

WORD comes from Panama that a boiler exploded recently on the steamer *Esk*, near St. Thomas. Two firemen were killed, and two engineers were badly scalded while trying to save the firemen.

ONE account of a boiler explosion, recently received at this office, says that “the boiler in the beautiful steam yacht owned by the son of Mr. A. P. Bliss, of Saginaw, Mich., exploded yesterday while steaming across the bath tub [!].” Probably this was a toy yacht.

# The Locomotive.

HARTFORD, APRIL 15, 1893.

J. M. ALLEN, *Editor.*

A. D. RISTEEN, *Associate Editor.*

THE LOCOMOTIVE can be obtained free by calling at any of the company's agencies.

Subscription price 50 cents per year when mailed from this office.

Bound volumes one dollar each. (Any volume can be supplied.)

Papers that borrow cuts from us will do us a favor if they will mark them plainly in returning, so that we may give proper credit on our books.

THE twenty-second *Report* of the Schlesischer Verein for the inspection of steam boilers, of Breslau, Germany, is at hand, and also the twentieth *Report* of the Sächsisch-Thüringischer Verein, of Halle.

CHIEF Engineer Alfredo Gilardi has kindly favored us with a copy of his paper on *Il Fenomeno di Leidenfrost* (Leidenfrost's phenomenon), in which he discusses the spheroidal state of water, and its possible bearing on steam-boiler explosions. His conclusion is, that the spheroidal state, assuming it to occur in boilers, is not adequate to produce an explosion. A translation of this pamphlet is given elsewhere in the present issue.

OUR pleasing little English contemporary, the *Practical Engineer*, gives the following blue-print formulae, quoting them from the *Engineering News*:

(a.) Ammonia-citrate of iron, 120 grains; water, one fluid ounce; aqua ammonia, a few drops, *i. e.*, until the solution smells of it quite perceptibly.

(b.) Potassium ferrieyanide (red prussiate of potash), 105 grains; water, one fluid ounce.

(c.) A saturated solution of oxalic acid.

The oxalic serves to accelerate the printing. To sensitize the paper, mix 5 parts of (a), and 5 parts of (b), and then to the mixture add one part of (c). It is said, that on very dull days, paper sensitized with this solution will print in about one-fifth the time that is required if the oxalic acid be omitted. A larger proportion of oxalic acid still further lessens the time of printing, but the whites do not wash out clear in that case. The advantage of the oxalic paper is not so marked in direct sunlight as on dull days. As an example of the usefulness of the formula the article states, that on February 25th, a blue-print was made during a snow storm in 35 minutes, the light being such that ordinary paper would require the greater part of a day.

THE traveling crane recently constructed . . . for the Columbian Exposition is an all-electric crane. The bridge has a span of 76 feet, and the runway will be 1,400 feet long. There are two trolleys on the bridge, with a lifting capacity of ten tons each. The bridge is provided with an observation platform running its entire length, and upon this platform several hundred observers can be carried from end to end of the machinery

building over the exhibits, and far above the heads of pedestrians. The platform which carries the passengers does not interfere with the hoisting mechanism, so that this crane may be employed to hoist and transport goods and passengers at the same time, or alternately, if desired.— *Journal of the Franklin Institute.*

ONE of this company's inspectors sends the following item, which touches upon a point that often does not receive sufficient attention from boiler owners : " We had a serious accident here this winter, and although you may have full particulars of it, I will give a brief account of it. In a certain mill some of the men were in the habit of going up on the top of the boiler settings to eat their dinners. The boilers are 60 inches in diameter and 16 feet long, and carry 80 pounds of steam. They are fitted with common lever safety-valves,  $3\frac{1}{2}$  inches in diameter, blowing off into the boiler room. The weights were hung close to the ends of the levers, with no hook or catch to prevent them from slipping off. One day, while several men were sitting in front of the discharge opening of one of the valves, somebody, in climbing up, knocked off the ball, and of course the valve immediately opened wide, discharging the steam and half the water in the boiler directly upon the men. Two of them were scalded to death, and others were seriously but not fatally burned. Now a hook on the end of the lever would probably have prevented this accident and saved the men's lives. Too little attention is paid to this point. Only the other day I found a 100-pound weight hung close to the end of a frail, shaky, three-foot lever, and the lever was inclined downwards by from four to six inches, with no hook to prevent the ball from dropping off. I called attention to it, and the owner of the boiler had the lever changed at once. This job was new — was just finished, in fact, — and had been left this way by mechanical men who claim to know their business. It is quite a common thing about here to find levers inclined upward and downward by from three to six inches, and very many of them have no hooks to retain the ball."

### The Early Days of Photography in America.

IN the April issue of the *Journal of the Franklin Institute*, is an interesting article, by Mr. Julius F. Sachse, on "Philadelphia's Share in the Development of Photography." It appears that when the French deputies awarded a pension to M. Daguerre for the disclosure of his process, there was considerable popular opposition to the grant, and to satisfy the people, Daguerre was ordered to give three public demonstrations of his process, which he did. An account of the process, as shown and explained at the Grand Hotel, Paris, on Sept. 17, 1839, appeared in the *New York Star* of Oct. 14, 1839. This article was also copied in the *American Daily Advertiser* of October 16th. Among others who read the account, was Joseph Saxton, an employe in the Mint; and he was so much impressed by it that he improvised a photographic outfit, and determined to try the experiment. For the camera, he used a cigar box, and his lens was a common burning glass. A pasteboard scidnitz-powder box containing iodine, and having a hole cut in the lid, served as a coating box. His mercury bath was made by mortising out a block of wood and fitting a sheet-iron bottom to it, so that the bath might be heated by a spirit lamp. This, with a piece of polished ribbon silver which he obtained at the Mint, completed the outfit. "When all these preparations were completed," says Mr. Sachse, "the ingenious Saxton set his apparatus on the window-sill of one of the second-story

north windows of the Mint, and pointed it northeasterly toward the sunlit buildings beyond. After the exposure, the instructions in the newspaper were followed to the letter, amidst the ridicule of the other attachés who were present, but, to the great surprise of the latter, and the great joy of the experimenter, the attempt resulted in a perfect [*i. e.*, highly creditable] picture. There, permanently impressed upon the silver plate, was the picture of the old Philadelphia High School, and the State Arsenal, which then stood upon the site. Joseph Saxton had proved the truthfulness of the published account of Daguerre's invention, and had made the first heliograph in America." Mr. Sachse gives a reproduction of this daguerreotype. Shortly afterwards, in November, Mr. Robert Cornelius, a Philadelphian lamp maker, made a daguerreotype of himself, and another of some of his children; and it is believed that these were the first portraits ever produced by a photographic process. It was not until the beginning of the year 1840, that a French daguerreotype reached America.

Iodide of silver was the sensitive substance used by the French experimenters, and this is so feebly sensitive to light that Daguerre, in his public demonstration of Sept. 17, 1839, gave his picture an exposure of one hour and twelve minutes. In December, 1839, before the first French photograph by the iodine process had been received in this country, Dr. Paul Beck Goddard of Philadelphia discovered that iodine could be advantageously replaced by bromine, an element discovered by Balard thirteen years before. By the use of this substance, the sensitiveness of the plate was so greatly increased that Dr. Goddard obtained some practically instantaneous views. It was now possible to take satisfactory portraits, and early in 1840, Robert Cornelius fitted up a room exclusively for portraiture. This was the first photographic studio in the world. With reference to this studio, Mr. Sachse says, "An interesting item for the professional photographer of to-day who furnishes a dozen cabinets for one dollar [!], or who turns out thirty-six tin-types for a quarter, is, that so great was the rush for the daguerrean miniatures, as they were called, that prospective sitters had to be "booked" a week ahead, at \$5 for each sitting. Each received his day and hour, subject, of course to sunshine. No sittings were attempted in cloudy weather."

### A Locomotive Smoke and Spark Consuming Device.

Although it is not our custom to describe proprietary apparatus in these pages, we desire to call attention to a smoke and spark consuming device that has been used with success on the Shaw locomotive; and we have the less hesitation in doing so because one of our inspectors has observed it carefully, and reports upon it favorably, and because our previous article on smoke consumption seems to have aroused considerable interest.

Fig. 1 gives a side view of a locomotive furnace with the device applied. *A* is the back water-leg, from which three two-inch pipes, *B*, lead off. Only two of them are seen in the cut, because the third comes directly behind one of those that are shown. (Fig. 2, which is an exterior view of the furnace as seen from the front, shows these pipes better.) The pipes *B* curve upward and pass through the water-leg as shown at *C*, then entering the lower end of *D*, which is a "hollow cylindrical deflecting plate and water circulating heater." The shape of this part is better shown in Fig. 3. It consists of two concentric half-cylinders of sheet-iron, steel, or other suitable metal, stay-bolted together at proper intervals. At its lower end it receives the three pipes already referred to; and its upper end fits into the mouth-piece of the furnace door. Fig. 4 shows this upper end more in detail, as viewed from the cab. Here *D* is the



“cylindrical deflecting-plate” in question, and *A* is the furnace door, which is made smaller than usual, so as to always leave the space *B* open to allow of the entrance of

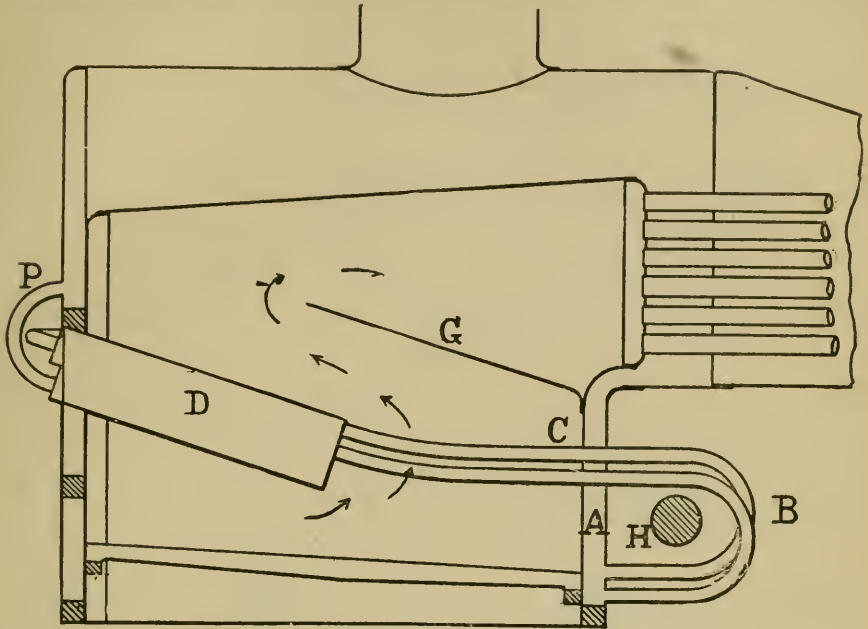

FIG. 1.—SIDE VIEW OF THE FURNACE.

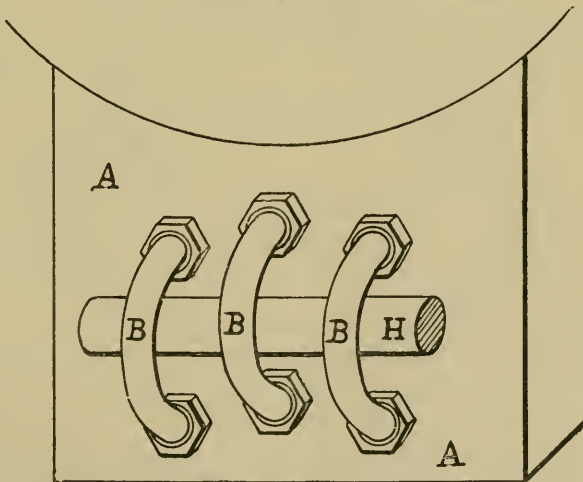

FIG. 2.—THE FURNACE AS SEEN FROM THE FRONT OF THE LOCOMOTIVE.

air to the fire-box. From the “deflecting-plate,” *D*, four two-inch pipes, *PP*, are led off, and these are bent so to re-enter the front water-leg, as shown in both Fig. 1 and Fig. 4.

When the device is in operation, a continual circulation of water is kept up through



these pipes and the metal deflecting-plate, and a current of air is drawn into the furnace through the opening shown at *B*, in Fig. 4. In Fig. 1, *G* represents the usual fire-brick arch, which causes the gases to circulate around the upper part of the fire-box before en-

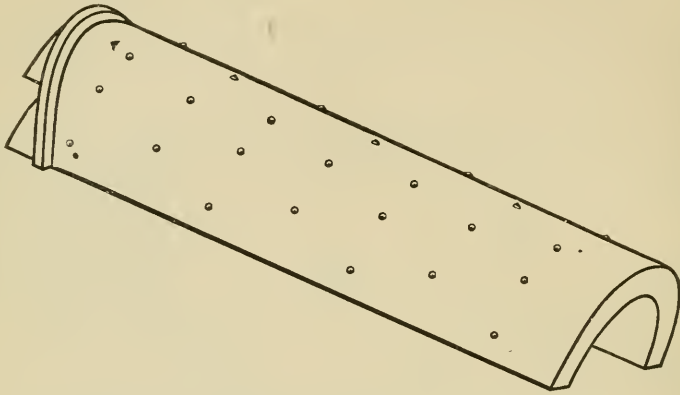

FIG. 3.—THE "CYLINDRICAL DEFLECTING PLATE."

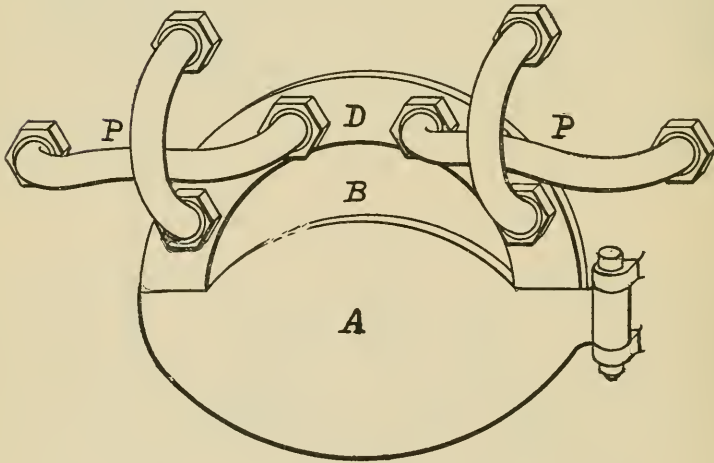

FIG. 4.—THE MOUTH OF THE FURNACE.

tering the tubes. It is claimed that this device increases the efficiency of the locomotive, and effectively does away with smoke and sparks when using bituminous coal.

In conclusion, we must express our thanks to Mr. W. E. Lockwood of 251 South Third street, Philadelphia, to whom we are indebted for sketches and other information used in the preparation of this article.

## Must the Silk Worm Go?

A report has been received at the State Department from Consul Loomis, of St. Etienne, giving some interesting details and information in regard to the Chardonnet process of converting wood pulp into silk. This report will soon be published and distributed as a general answer to numerous inquiries about the process. Of course the great question has been as to whether the new discovery could be made practicably useful and valuable.

Consul Loomis thinks that this question has been answered in the affirmative by M. De Chardonnet, who has built a mill at Besancon, where the "silk" is now being manufactured. The raw material is made from wood pulp, which is carefully dried in an oven and plunged in a mixture of sulphuric and nitric acids, then washed several times in water and dried by alcohol. The product thus prepared is dissolved in ether and pure alcohol, and the result is collodion, similar to that used in photography. This collodion, which is sticky and viscous, is enclosed in a solid receptacle, furnished with a filter in the lower end.

An air pump sends compressed air into the receptacle, and by its pressure the collodion is passed through the filter, which removes all impurities and flows into a tube placed horizontally. This tube is armed with 300 cocks, of which the spouts are made of glass and pierced by a small hole of the diameter of the thread of a cocoon as it is spun by the silk worm. The spinner opens the cock, and the collodion issues in a thread of extreme delicacy (it takes six to make a thread of the necessary consistence for weaving). This thread is not, however, fit to be rolled on the spools, by reason of its viscosity and softness; the matter is as yet collodion and not silk.

To produce the necessary hardness, the inventor resorted to a very ingenious but simple method. The little glass tube already mentioned is surrounded by a small reservoir of the same material constantly filled with water. When the thread issues from the aperture in the manner described, it traverses this water, which takes up the ether and alcohol, and then the collodion becomes solidified; that is to say, it is transformed into an elastic thread as resisting and brilliant as ordinary silk. On account of the materials employed the stuff manufactured was found to be dangerously inflammable—its original combustibility being at the alarming rate of two centimetres [four-fifths of an inch] a second. Mr. Loomis says that M. De Chardonnet has apparently removed this difficulty "by plunging the spun thread into a solution of ammonia, thus rendering it as slow of combustion as any other material."

The consul adds: "This discovery seems to have a great future. I have talked with a great many silk merchants, brokers, dyers, and men who manufacture silk goods, about the Chardonnet method of producing raw silk from wood, and it is universally admitted that the process will eventually yield large, practicable, and profitable results. A great step has been made toward this end in reducing the inflammability of the Chardonnet silk. Another practical difficulty to be remedied in the invention is the frequent snapping of the slender threads issuing from the cylinder by reason of unequal pressure. This makes it impossible to maintain a standard quality for the output, and consequently there may be produced five pounds of excellent silk followed by five pounds of a comparatively worthless quality. This difficulty is being overcome, I am told, but until it is completely removed men of large means will not invest largely in the stock of the company which has been formed to exploit Count Chardonnet's invention."

It appears that down to this time none of the great French manufacturers have invested largely in the new enterprise, although all of them profess to believe in it, and declare that in a few years artificial silk produced by the new process is destined to figure largely in the commercial world. Consul Loomis's report concludes as follows:

"The disposition to-day on the part of the capitalists here is to await developments. When the process is once perfected and its results are wholly satisfactory, there will be a lively struggle for the control of this valuable invention; and, as I have said, there seems to be no doubt of the ability of the inventor to remove every obstacle which stands in the way of perfect practical success."—*New York Tribune*.

Incorporated  
1866.

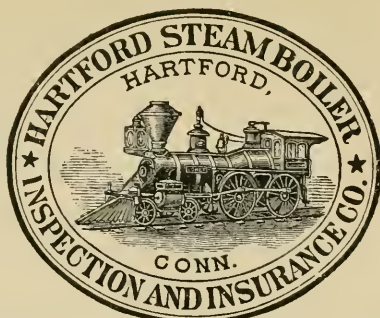

Charter Per-  
petual.

Issues Policies of Insurance after a Careful Inspection of the Boilers,  
COVERING ALL LOSS OR DAMAGE TO  
**BOILERS, BUILDINGS, AND MACHINERY.**

ALSO COVERING  
**LOSS OF LIFE AND ACCIDENT TO PERSONS**  
ARISING FROM  
**Steam Boiler Explosions.**

Full information concerning the plan of the Company's operations can be obtained at the  
**COMPANY'S OFFICE, HARTFORD, CONN.,**  
Or at any Agency.

**J. M. ALLEN, President.**

**J. B. PIERCE, Secretary.**

**W. B. FRANKLIN, Vice-Prest.**

**FRANCIS B. ALLEN, 2d Vice-Prest.**

**E. J. MURPHY, M. E., Consulting Engineer.**

**Board of Directors.**

**J. M. ALLEN, President.**  
**FRANK W. CHENEY, Treas.** Cheney Brothers Silk Manufacturing Co.  
**CHARLES M. BEACH,** of Beach & Co.  
**DANIEL PHILLIPS,** of Adams Express Co.  
**RICHARD W. H. JARVIS,** Prest. Colt's Fire Arms Manufacturing Co.  
**THOMAS O. ENDERS,** President of the U. S. Bank.  
**LEVERETT BRAINARD,** of The Case, Lockwood & Brainard Co.  
**GEN. WM. B. FRANKLIN,** late U. S. Commissioner to the Paris Exposition.  
**NELSON HOLLISTER,** of State Bank, Hartford.

**HON. HENRY C. ROBINSON,** Attorney-at-Law, Hartford, Conn.  
**HON. FRANCIS B. COOLEY,** of the National Exchange Bank, Hartford, Conn.  
**EDMUND A. STEDMAN,** Treasurer of the Fidelity Co., of Hartford, Conn.  
**GEORGE BURNHAM,** Baldwin Locomotive Works, Philadelphia.  
**HON. NATHANIEL SHIPMAN,** Judge United States Circuit Court.  
**C. C. KIMBALL,** Pres. Smyth Mfg. Co., Hartford, Conn.  
**PHILIP CORBIN,** of P. & F. Corbin, New Britain, Conn.

**GENERAL AGENTS.**

**THEO. H. BABCOCK,**  
**CORBIN & GOODRICH,**  
**LAWFORD & McKIM,**  
**C. E. ROBERTS,**  
**H. M. LEMON,**  
**C. C. GARDINER,**  
**L. B. PERKINS,**  
**W. G. LINEBURGH & SON,**  
**BURWELL & BRIGGS,**  
**MANN & WILSON,**  
**ZOLLARS & McGREW,**  
**R. F. MANLY,**  
**W. S. HASTIE & SON,**  
**PETER F. PESCUO,**

**CHIEF INSPECTORS.**

**R. K. McMURRAY,**  
**WM. J. FARRAN,**  
**F. S. ALLEN,**  
**WM. HEAFORD,**  
**A. B. ECOFF,**  
**F. S. ALLEN,**  
**J. H. RANDALL,**  
**C. A. BURWELL,**  
**J. B. WARNER,**  
**T. E. SHEARS,**  
**B. F. JOHNSON,**

**NEW YORK CITY,**  
**PHILADELPHIA, PA.**  
**BALTIMORE, Md.**  
**BOSTON, Mass.**  
**PROVIDENCE, R. I.**  
**CHICAGO, ILL.**  
**ST. LOUIS, Mo.**  
**HARTFORD, CONN.**  
**BRIDGEPORT, CONN.**  
**CLEVELAND, OHIO.**  
**SAN FRANCISCO, CAL.**  
**DENVER, COL.**  
**BRIMINGHAM, ALA.**  
**CHARLESTON, S. C.**  
**NEW ORLEANS, LA.**

**OFFICES.**

Office, 285 Broadway.  
" 432 Walnut St.  
" 22 So. Holliday St.  
" 125 Milk St.  
" 29 Weybosset St.  
" 112 Quincy St.  
" 404 Market St.  
" 218 Main Street.  
" 2 Sanford Building.  
" 208 Superior St.  
" 306 Sansome St.  
" Mining Ex. B'g.  
" Morris Building.  
" 44 Broad St.  
" 188 Gravier St.

# The Locomotive.

PUBLISHED BY THE HARTFORD STEAM BOILER INSPECTION AND INSURANCE COMPANY.

NEW SERIES—VOL. XIV.

HARTFORD, CONN., MAY, 1893.

No. 5.

## Concerning Domes.

As a general rule, we believe domes to be unnecessary; for experience has shown us that if a boiler is properly designed and properly set, dry steam may be had without them. However, many of our patrons prefer to have their boilers furnished with domes, and there is really no objection to them, *provided* they are made and put on correctly.

The most striking source of weakness in a steam dome is the hole that is cut out of the shell to allow the entrance of steam, this hole being often made the full diameter of the dome. Sometimes, however, it is made, say, only seven inches in diameter; and

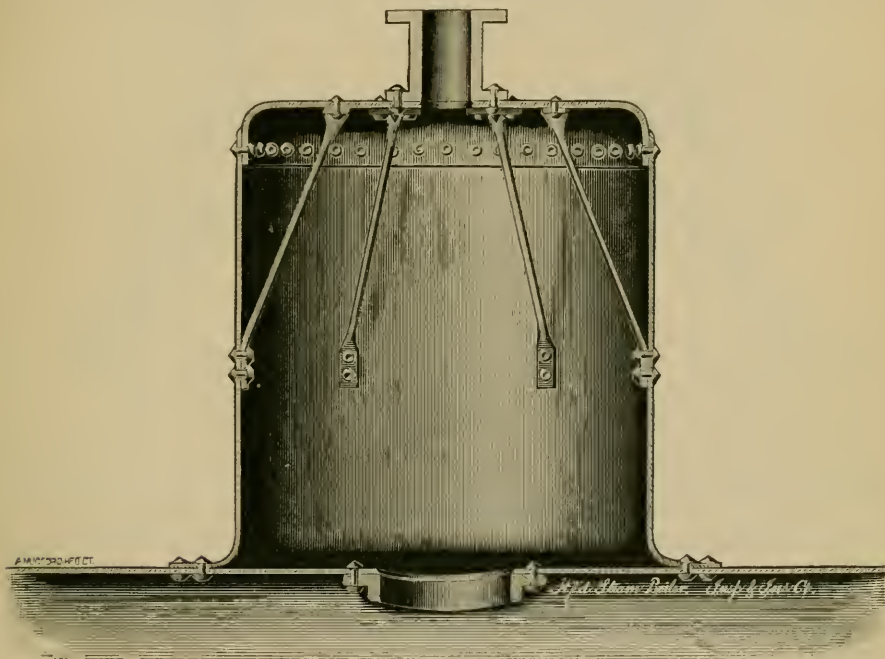

FIG. 1. — A CORRECTLY DESIGNED DOME.

sometimes, too, a number of small holes, three-quarters of an inch or so in diameter, are drilled through the shell in the place of one large one. Each of these methods is liable to objections, which we proceed to consider.

There can be no doubt that a large opening in a boiler shell is an element of weakness, for, although we may re-enforce the periphery of such a hole, and stiffen it as



much as we please, it is always a matter of opinion whether the strength obtained in this way is sufficient to make up for that lost by cutting out the hole. We say it is a matter of opinion, because, although there are rules for this re-enforcement, it does not appear that these rules are based either on a mathematical analysis of the strains, or on the results of extensive experiments. The mathematical questions involved in this problem are of such a character that it is doubtful if many men are competent to handle them; and those who are or have been competent seem to have overlooked the problem

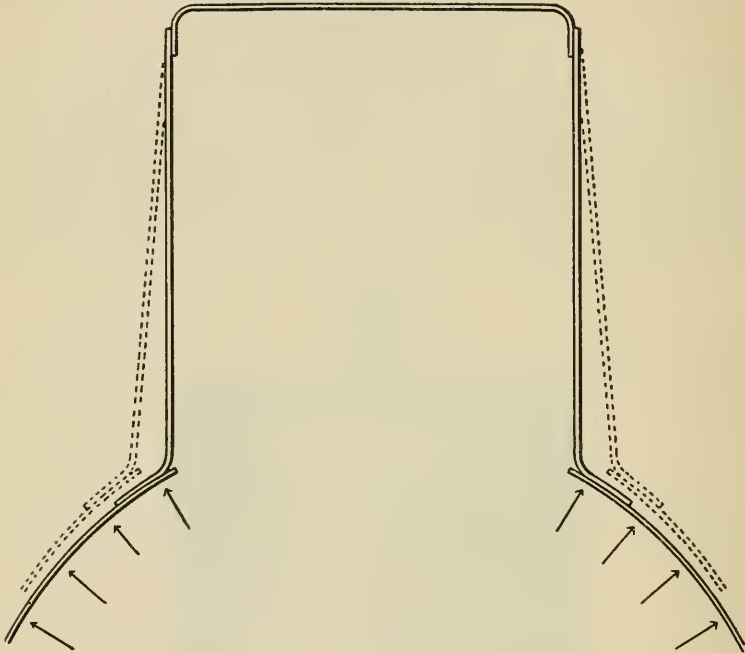

FIG. 2. — ILLUSTRATING THE TENDENCY TO DEFORM THE DOME.

or avoided it. So far as experiments are concerned, we should not know where to look for satisfactory data of this kind, on which to base a rule. Such rules as there are seem to be empirical, and must be regarded merely as an expression of what past experience in the manufacture and use of boilers has indicated to be sufficient, supplemented, perhaps, by a few general mechanical considerations of the most elementary nature. This being the fact, it must be evident that the best thing to do, if domes are to be used at all, is to so proportion the opening in the shell that there can be *no reasonable doubt* about the strength of the structure; we must err on the safe side. Now certainly it is not erring on the safe side to cut the opening in the shell the full size of the dome; for whatever doubt there may be about the value of that part of the shell that lies within the dome, it has never been maintained, so far as we know, that the shell is *stronger* when this part is entirely removed than when it is left. The girthwise strain on a boiler is well known to be double the lengthwise strain; so the tendency of the strains in the shell is to distort the dome in such a way as to increase the diameter in a direction perpendicular to the length of the boiler. (Fig. 2 illustrates this action. The opening



in the shell is shown as equal to the full diameter of the dome, and the dotted lines indicate the shape into which the shell-strain tends to pull the dome.) This deforming tendency of the shell-strain is resisted by two things: the stiffness of the dome itself, and the brace-like action of the part of the shell lying within the dome (when this part is not all cut away). Now if the part of the shell within the dome were under the same strain as the rest of the shell, the problem would be very simple, for the strain on the dome would then be only that which is due to the action of the steam on the dome itself; but as a matter of fact the strain on the part of the shell inside the dome is *not* equal to the strain on the part outside. This is easily understood if one considers the case of a complete cylindrical shell exposed to the same pressure inside and outside — a small cylinder, let us say, with a hole in one end, and placed in the steam space of a large boiler. Obviously there would be no strain at all in such a shell; and since in the actual case the part of the shell that lies within the dome of a boiler is under the same balanced condition so far as steam-pressure is concerned — the pressure being the same above and below it — it follows that the direct radial action of the steam on the shell

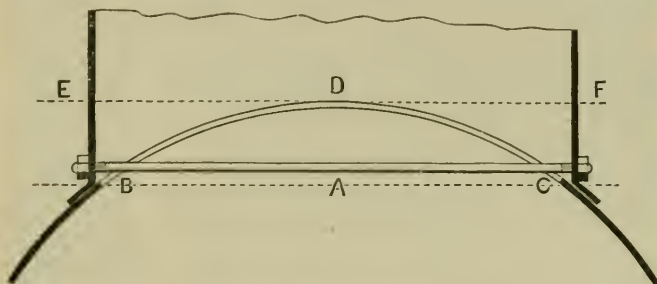

FIG. 3. — A DOME STRENGTHENED BY STAY-BOLTS.

does not produce any strain at all on this part of it, and the only strain that does come upon it, therefore, is that which is transmitted to it by the direct pull of the part of the shell that is outside the dome. There is no doubt that lengthwise of the boiler the strain transmitted in this manner is such that the shell is in substantially the same state inside of the dome as it is outside. Girthwise the case is somewhat different; because here the strain transmitted to the inner part tends to straighten or flatten this part, and hence it is not resisted so effectively, and more of it is thrown on the dome. It has been argued by many that because the shell inside the dome acts merely as a curved brace, so far as resisting girthwise strain is concerned, it is therefore of no use whatever. We cannot quite see the case from that point of view, however, and we consider it important to preserve as much of the shell as is practicable, for the sake of securing as much as possible of whatever resistance it may offer. The case is not entirely analogous to that of a curved brace, either; for the shell cannot be depressed girthwise without being also depressed longitudinally; and it cannot be depressed longitudinally without stretching. Hence it appears that before the part of the shell within the dome flattens girthwise, it must stretch longitudinally; and the analogy with the curved brace is therefore practically destroyed. We do not maintain that this part of the shell is as strong as the rest of the boiler, but we are satisfied that it is of some considerable use, and that it should not be ignored.

We have reviewed the objections to cutting out a hole equal, or nearly equal, to the

diameter of the dome, and we proceed to consider the objections to the seven-inch hole and the series of three-quarter-inch holes. The most obvious objection to these is, that in such cases the interior of the dome is quite inaccessible for inspection and repairs. We hold that the best solution of the dome-opening problem is to make the opening elliptical, 11"  $\times$  15", and to securely rivet to it a manhole frame (see Fig. 1). This makes the interior of the dome quite accessible, preserves a considerable portion of the shell, and so stiffens what remains as to materially increase its efficiency.

In old boilers where the dome is of considerable size compared with the shell, say 30" in diameter on a 48" cylinder, one or two stay bolts may be put across it as shown in Fig. 3. This construction is not recommended for new boilers, but it is often serviceable where the dome of a boiler already in use gives trouble by leakage along the joint where it is riveted to the boiler. The same object may likewise be attained by the construction shown in Fig. 4, which represents two bars of tee-iron riveted securely to the shell.

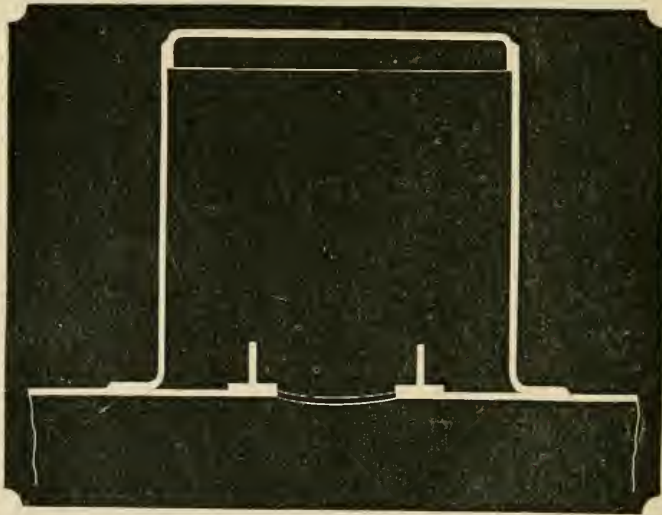

FIG. 4. — ARRANGEMENT OF TEE-IRON FOR STIFFENING THE SHELL.

These bars should be made as long as possible, — that is, they should extend around the boiler shell until they almost touch the sides of the dome. This stiffens the shell admirably, and while we consider the manhole frame better for a new boiler, the tee-irons may perhaps be more readily applied to an old boiler which shows distress around the dome. It may also be well to say in this place that when the opening in the shell is less than the diameter of the dome, small drip-holes should be provided close to the dome at the lowest points on the sides (at the points corresponding to *B* and *C* in Fig. 3), to allow the water of condensation to flow back into the boiler.

We have next to consider the connection of the dome to the shell. Usually the dome is flanged and fastened to the shell by a single row of rivets. In our opinion, this is not good practice, as the joint between the dome and the shell is subjected to very trying strains. In the first place, it will be seen that this joint has to withstand the upward pressure of the steam against the head of the dome. This brings a tensile strain on the rivets, which tends to strip off their heads; and rivets are much weaker when the strain comes on them in this way than when it is entirely of the nature of a shear, as in

the longitudinal and girth-joints of boilers. The dome should always be secured to the shell by a double-riveted joint at least. The flange of the dome re-enforces the shell more effectively when double-riveted than when single-riveted, and the double-riveted joint is better adapted to withstand the girthwise strain on the shell, which we must consider to be transferred to the dome, to some extent.

The head of the dome may be strengthened in any one of four ways. (1) It may be made of cast-iron of proper thickness, and provided with ribs to give it sufficient strength and stiffness. Our experience with heads of this character has been such that we cannot recommend them. We consider that dome-heads should be of wrought-iron or steel, in every case. (2) The head may be dished or bumped into a spherical shape. In making heads in this way, boiler-makers are very apt to bump the heads too little, —

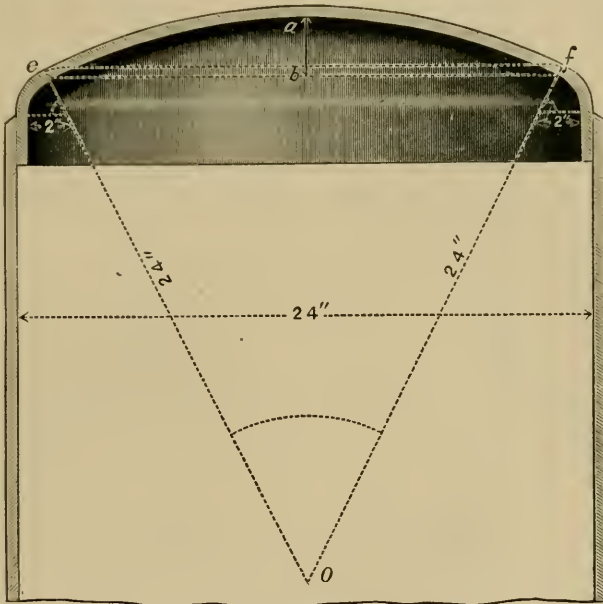

FIG. 5. — A BUMPED-UP HEAD.

giving them a radius that is entirely too large. The strength of a bumped head may be calculated by the ordinary rules for spheres, as, if properly made, the head is a segment of a true sphere. The rule for the strength of a hollow sphere is: Multiply the radius of the sphere by the pressure it is desired to carry (in pounds per square inch), and divide the product by *twice* the strain that the material can safely bear per square inch. The quotient is the thickness the head should have. It will be noticed that this rule is the same as for cylindrical shells, except that we divide by *twice* the working strain, because the sphere has curvature in *two* directions, and the cylinder in only *one*; so that a sphere is just twice as strong as a cylinder of the same radius and same material. (In cases in which riveted joints are used on the *spherical part* of the head, the thickness as calculated above must be divided by the efficiency of the joint that is used.) Usually the thickness of the head is known, and what we wish to find is the radius to which the head must be bumped. For this purpose we may turn the foregoing rule about so as to make it read as follows: Multiply the strain that the material can safely bear per square inch

by *twice* the thickness of the head, and divide the product by the pressure that is to be carried. The quotient is the greatest allowable radius of the head. If it is bumped to a longer radius than this, it is not safe; but there is no objection to the use of a shorter one.

The foregoing rule, when compared with the rule for cylinders, shows that if a cylinder and a sphere are to be made of the same material, and to have the same bursting point, the *radius* of the sphere must be equal to the *diameter* of the cylinder. Hence it is important to bump the head of the dome to a radius equal to the diameter of the dome; for this makes the head and the sides equal in strength. Fig. 5 represents a dome-head bumped in this manner.

We do not recommend the use of bumped heads for high pressures, if it is possible to avoid them; the braced head, presently to be considered, appears to us to be far better. Leaving the bumped head, therefore, we pass to the consideration of (3) the braced head. This form of head is shown in Fig. 1, and is the one most commonly met with in practice. The riveted joint, by which the head is attached to the shell of the dome, is strong enough to stand the entire pressure on the head, provided the head is kept flat, so that the strain on the rivets is a simple shear. The object of bracing is to stiffen the head so that it will not bulge out and produce radial strains that would tear it out around the flanges. In the head of a 30 inch dome, allowing 3 inches all around as sufficiently stiffened by the flange, there are 707 square inches to be braced. Under a pressure of 90 pounds to the square inch this would correspond to a total pressure on the head of 63,630 lbs.; and this, allowing 7,000 lbs. to each brace, would call for nine braces. In practice only eight are used, as the nozzle for the steam-pipe contributes materially toward the stiffening of the head. In general, six braces are used on a 24-inch dome, eight braces on a 30-inch dome, and ten braces on a 36-inch dome; though this cannot be considered an absolute rule, for with high pressures the number of braces may have to be increased. Crow-foot braces should be used, as shown in the cut, and the rivets by which they are held must not be less than  $\frac{3}{4}$  of an inch in diameter. The braces should run to the sides of the dome, as shown in the cut. It might seem unnecessary to say this, but we have occasionally seen the braces in domes *secured to the shell of the boiler, close to the steam opening*; and of course they are of practically no use in such cases.

The fourth method of stiffening the heads of domes, is to rivet tee-irons or angle-irons across them. This method is sometimes used, but we believe it to be inferior to the bracing, because defects are more readily detected by the inspector where braces are used than where the stiffening is obtained by angle-irons only; and also because the strength of braced heads can be calculated more readily, and with greater accuracy.

In conclusion, let us say (1) that we believe that if a boiler is properly designed and properly set, it does not need a dome; but if a dome is to be used, we believe (2) that the shell should not be cut away to the full diameter of the dome, but that an elliptical hole, say 11"  $\times$  15", is much better, and that a man-hole frame should be securely riveted to this opening; (3) that the dome should be secured to the shell by a double-riveted joint, at least; (4) that the head should be of wrought-iron or steel, and that it should be braced to the sides of the shell with a sufficient number of crow-foot braces, secured with rivets at least  $\frac{3}{4}$  of an inch in diameter; (5) that braced heads are superior to cast-iron heads, bumped heads, or heads stiffened only by tee-iron; (6) that if the circumstances are such that bumped heads become necessary, or highly desirable, they should be bumped to a radius not greater than the diameter of the dome; (7) that the curve of the flange of the dome should fit the curve of the boiler-shell exactly, so that the boiler



will not be deformed out of its proper cylindrical shape in riveting the dome on; (8) that the man-hole should not be put on the head of the dome, but on some other part of the boiler.

#### DOMES FOR LOCOMOTIVE BOILERS.

In cases where the pressures carried are very high indeed, as in locomotive boilers, the arrangement shown in Fig. 1 sometimes proves insufficient to prevent distress along the joint where the dome and the boiler are joined. The shell of the boiler seems to yield enough to cause this joint to leak. Various ways of overcoming the trouble have

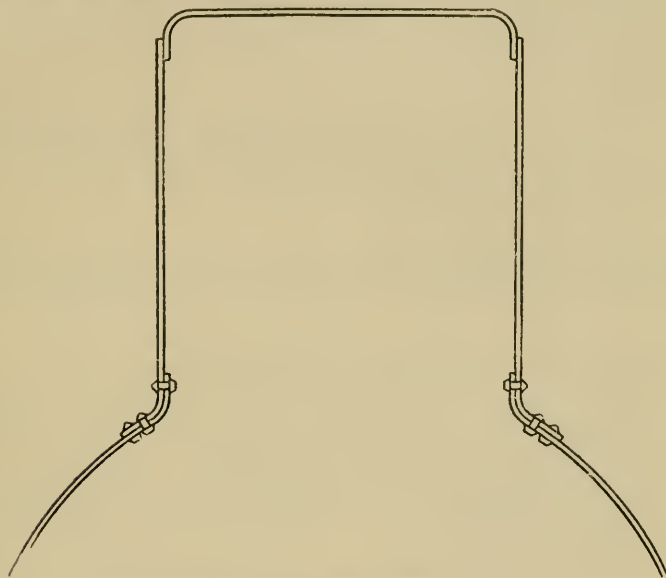

FIG. 6. — A LOCOMOTIVE DOME.

been tried, but the most effective method, and the one now universally adopted in this country, is that shown in Fig. 6. The dome is made in the usual manner, and double-riveted to the shell; but the shell is cut out to almost the full diameter of the dome, and flanged upward to a radius of two inches. The flange so formed fits into the dome, and is secured to it by a single-riveted joint. Although this method leaves the shell open to the full diameter of the dome, it is found that the double flange around the circumference of the opening, and the three rows of rivets, re-enforce and stiffen the shell so perfectly that the dome shows no sign of distress under very heavy pressures; and we recommend this construction when domes are to be used at the high pressures toward which modern practice is tending.

---



## Boiler Explosions.

MARCH, 1893.

(67.)—John Bergher and Ernest Erwin Berwin were thrown forty feet or more by a boiler explosion in Fayetteville, near Mascoutah, Ill., on March 3d. They fell in a large pond. They were rescued from the water, and, although badly hurt, both will recover.

(68.)—A boiler exploded on March 3d at a point fifteen miles north of Pittston, Pa. William Brown was killed outright, and Charles Sinsebaugh, Perry Refenburg, and John Schott were badly injured. Refenburg, who was the fireman, died in the hospital on the following Saturday, and at last accounts Sinsebaugh and Schott were expected to recover.

(69.)—On March 5th a boiler exploded in Hagerstown, near Baltimore, Md., fatally injuring Engineer Smith and Fireman Lefevre, and badly scalding Raleigh Hoke. Lefevre's back was broken, and Smith was badly mangled. Both of these men will die, but it is thought that Hoke will recover.

(70.)—A boiler exploded in Boscobel, Wis., on March 5th, with terrible effect. Timbers and parts of the engine and boiler were blown in all directions, and the damage amounted to thousands of dollars. Fortunately nobody was killed.

(71.)—A boiler exploded on March 10th in Montezuma, near Celina, O. Two brothers named Miller were severely scalded, but both will recover.

(72.)—On March 11th a boiler exploded at the Rupp Building, in York, Pa. Reginald Zeigler was badly injured, and another man slightly so.

(73.)—A boiler exploded at the Clark mill in Marseilles, Ill., on March 13th. W. H. Croker, the firemen, had just left the boiler-room, and so escaped injury. Some damage was done to the building.

(74.)—On March 13th a boiler explosion occurred at Blufftown, Ind. The boiler-room was torn to pieces, and Fireman George Hart was badly bruised. Four other men were slightly hurt. The boiler was blown four hundred feet, cutting down trees in its course, and carrying away part of Fred. Mosima's house.

(75.)—A boiler exploded in St. Elmo, Ulster County, N. Y., on March 13th. Horace Lambert and George A. Shufelt were killed, and James Flanagan was so badly hurt that at last accounts his condition was critical.

(76.)—On March 13th a boiler exploded in the Florence Mills, at Forest City, Rutherford County, N. C. Homer Harrell was instantly killed, and six others were seriously wounded, four of whom will die. The boiler-house was demolished.

(77.)—Mr. Osgood's steam laundry in Marlboro, Mass., was seriously crippled on March 15th by the explosion of the boiler.

(78.)—A boiler exploded in Columbus, O., on March 16th. It was marvelous that nobody was hurt. Engineer William E. Cromwell had left the boiler-room only a few minutes before the accident. The boiler house was wrecked.

(79.)—On March 18th there was a boiler explosion in Mahanoy City, Pa. John Schuyler and William Well were thrown high in the air, and were so badly bruised and

scalded that they cannot recover. The hot coals from the furnace were scattered in all directions, and a number of neighboring buildings took fire and were destroyed. Among those were the residence of James O'Connor and the warehouses of M. O'Brien and William Kopfsky. Other buildings were badly shattered by the concussion.

(80.)—James Duncan and Engineer Legett were killed on March 14th by a boiler explosion in Marthaville, Ont. A workman named McKenzie was also seriously injured.

(81.)—A boiler exploded in Butte, Mont., on March 18th, and H. J. Winkerwoerder and John Kane were instantly killed. Paul Fetherkyle was fatally hurt, and James Mulligan received injuries which, though serious, may not prove fatal. Kane was blown 315 feet.

(82.)—On March 18th a boiler exploded in a mill situated three miles north of Lockbridge, Ia. The building was blown to pieces, and John Adams, Eugene Gates, Townsley Baldozier, and a boy named Eshelman were killed. Theodore Lillyblade and the owner of the mill, Michael Hoover, were probably fatally hurt.

(83.)—Bear Ridge colliery, near Mahanoy Plane, Pa., was the scene of a boiler explosion on March 19th. As the firemen, John and Michael Donnelly, brothers, were cleaning the fires, two of a nest of boilers exploded, killing John instantly, and scalding Michael so badly that he cannot recover. The exploded boilers displaced two others, and demolished the buildings.

(84.)—A boiler exploded in Roanoke, Va., on March 23d, killing Engineer Joseph Marsh, and severely injuring Fireman Jacob Owens, and James Ferguson, an employé.

(85.)—H. E. Lance & Son's mill at Leatherwood, Ky., was destroyed by a boiler explosion on March 26th. Ed. Hensly, the engineer, was instantly killed, and T. A. Bancroft and Eddie Lance, the six-year-old son of the owner of the mill, were fatally injured. George Wicks and Henry Madden also received dangerous injuries. Fireman Pack had started for home, and so escaped.

(86.)—On March 27th a boiler exploded on Tioga Street, Philadelphia, Pa. George Fouster was terribly burned about the face.

(87.)—A boiler exploded on March 27th in Mr. John Pharr's mill, two miles from Docula, Ga. Mr. Pharr was injured so badly that he probably cannot recover, and his son Claude was killed outright. No other person was seriously hurt.

(88.)—A boiler explosion occurred on March 28th near Russellville, Ala. John Burfield was killed instantly, and James Ferguson died a few minutes afterward. Crockett Gray was struck by flying fragments, and at last accounts was dying.

(89.)—McCarthy's mill, situated near Pueblo, Col., was totally wrecked by a boiler explosion on March 29th. The engineer, Charles Langreame, was blown 200 feet and killed. J. M. Hardin was badly injured, and Louis Murphy slightly so. Scarcely a vestige of the plant was left in place.

(90.)—H. R. Knapp's mill, in Snowville, near Pomeroy, O., was the scene of a boiler explosion on March 30th. The damage was not great, and nobody was hurt.

(91.)—Some friend sends us an account of the explosion of a boiler in a butter-dish factory, which resulted in the death of Mr. John Holliday, and in serious injuries to John Wachael and George Brown. Unfortunately, our friend gives neither the date nor the place of the explosion.

---

# The Locomotive.

---

HARTFORD, MAY 15, 1893.

J. M. ALLEN, *Editor.*

A. D. RISTEEN, *Associate Editor.*

THE LOCOMOTIVE can be obtained free by calling at any of the company's agencies.

Subscription price 50 cents per year when mailed from this office.

Bound volumes one dollar each. (Any volume can be supplied.)

Papers that borrow cuts from us will do us a favor if they will mark them plainly in returning so that we may give proper credit on our books.

---

THE twenty-third *Annual Report* (for 1892) of the Norddeutscher Verein zur Ueberwachung von Dampfkesseln, of Hamburg, is at hand.

---

MESSRS. Burwell & Briggs have been appointed general agents in our Northern Ohio department, to succeed the late Mr. A. S. Ferry; and Mr. H. M. Lemon, in the Northwestern department, succeeds the late Mr. H. D. P. Bigelow.

---

## Obituary.

ARTHUR S. FERRY.

It is our painful duty to record the death of Arthur S. Ferry, general agent of this company for Northern Ohio, which occurred at his home in Cleveland, on April 4, 1893. Mr. Ferry had been identified with this company since July, 1887, as special agent for the first four years, and as general agent in the Northern Ohio department since July, 1891. During his connection with us he had traveled over the country very generally, as assistant supervisor of its agencies. Mr. Ferry was a faithful and efficient officer, and was personally very popular with the officers, agents, and other employés of the company. He was a comparatively young man, just entering upon a wider field in his life-work, and it is with feelings of deep sorrow that we record his untimely death.

---

H. D. P. BIGELOW.

Death has thinned the ranks of the early agents and inspectors of the Hartford Steam Boiler Inspection and Insurance Company; only a few now remain. The oldest in service was Mr. H. D. P. Bigelow, general agent of the department of the Northwest. He was appointed a special agent of the company in the early part of 1867, and at that time lived in the city of Milwaukee, and became deeply interested in the success of the company from his first connection with it. We had entered upon a class of insurance that was entirely new and untried, and it was by no means easy to persuade people then that boiler inspection and insurance were necessities. Mr. Bigelow met the incredulous spirit manifested by steam users, when he presented the merits and benefits of the company's system, with such profound earnestness and faith in the value of the

work in which he was engaged that success speedily followed. In 1870 a general agency for the Northwest was established, with its office in Chicago; and Mr. Bigelow was appointed general agent. This office he filled until his death, which occurred on February 3, 1893, after a short illness. Mr. Bigelow was of New England descent. His early home was Lancaster, in Worcester County, Mass. When quite a young man he was honored with various trusts in his native town, and was elected a member of the General Court of Massachusetts. He went West early in life, and became identified with the wonderful progress of that portion of our country. Personally, Mr. Bigelow was a genial, companionable man, strongly attached to his friends, generous in his impulses, and faithful in all matters committed to his care. He was an active and an honored member of the First Congregational Church of Chicago. As our thoughts go back over the twenty-six years of his connection with this company, we are impressed with his unwavering fidelity to the interests entrusted to him; and we announce his departure with profound sadness.

---

### The Comparative Costs of Feed Waters.

It often happens that a boiler owner has two or more sources of feed water open to him, and sometimes he finds it hard to make up his mind which to use. The most troublesome case of this kind, perhaps, is when the choice lies between town water and well water. The town water is probably soft and good, but costs him a stated amount per thousand gallons. The well water, on the other hand, is free, but it contains a good deal of lime, and forms a troublesome scale.

We shall consider a problem of this kind in the present article, and show how it can be solved. We shall take a hypothetical case, and although the conditions of the problem that we proceed to discuss will probably not coincide with those met with in any one given place, the principles involved will be the same in all places and the calculation can readily be modified to suit the changed conditions.

There is a boiler, let us say, that is 60 inches in diameter and 15 feet long (between the heads), having 72 tubes, each 3 inches in diameter. City water, we will assume, costs 18 cents per thousand gallons, and well water in the neighborhood is rather hard, so that in order to use it the engineer has to blow down about 3 inches every day (either in the morning or at noon), and has to open the boiler up once every three weeks and clean it thoroughly.

Let us first estimate the expense of running this boiler three weeks with town water, assuming that this water is so soft that no appreciable scale is formed in this time. A boiler such as we have described will evaporate about 2,200 pounds of water per hour, or 22,000 pounds per day of 10 hours, or 396,000 pounds in three weeks of six days each. Now a gallon of water weighs  $8\frac{1}{2}$  pounds, so that 396,000 pounds of water are equivalent to 47,520 gallons; so that if town water be used, at 18 cents per thousand gallons, for a three weeks' run it will cost \$8.55.

We have next to consider the cost of running with well water of the quality indicated above. In the first place, we should probably have to use 2 pounds of soda ash per day, to "keep up the saturation," as engineers say—that is, to make up for what is blown out, and for the decomposition of the soda ash in the boiler by the sulphates introduced with the feed. In three weeks this would amount to 36 pounds; and to this we must add the 18 pounds or so that we have to put in at the end of the three weeks, before starting up again; so that the total consumption of soda ash in the three



weeks amounts to, say, 54 pounds. At 5 cents a pound this would cost \$2.70. If tannate of soda were used in place of common soda ash, the cost of the solvent would be somewhat greater; but we shall assume that soda ash does the work satisfactorily, and shall take \$2.70 to represent the cost of the solvent for the run of three weeks.

At the end of this time the boiler is opened and cleaned. This involves several items of expense, which we proceed to consider. As a general rule it will be necessary to renew the gaskets; and we may fairly estimate the cost of these at \$1.25. In the absence of an agreement to the contrary, it will probably be necessary to pay the engineer for eight hours' work, and as he will need some help, this item may safely be estimated at \$3.00.

We next come to the heat-loss involved in blowing off and shutting down. If the water is bad it may be necessary to blow down 3 inches every day. This is equal to about 17 cubic feet per day, or, say, 300 cubic feet in three weeks. In addition, we must blow out a boiler-full of hot water at the end of the three weeks. Now a boiler such as the one described will contain about 150 cubic feet of water, which added to the 300 cubic feet blown out during the three weeks, makes 450 cubic feet, or about 28,000 pounds. The blowing-off pressure being, say, 20 pounds, the temperature of the water will be about 260°; and if the temperature of the feed is 60°, this means a loss of 200 heat units per pound of water, or 5,600,000 heat units in all. The boiler, weighing, say, 16,000 pounds, is also cooled by the same amount, and as the specific heat of iron is .114 the loss from this cause is  $16,000 \times 200 \times .114 = 365,000$  heat units. We have also to consider the loss of heat from the brickwork of the setting. To calculate this we shall assume that a layer of brick 8 inches thick, extending all around the inside walls of the setting, cools, say, 600°. To calculate the weight of this layer of brick we first estimate the inner surface of the setting. In the present case this is about 262 square feet. A layer 8 inches thick and having this surface will have a volume of approximately  $262 \times \frac{2}{3} = 175$  cubic feet (the  $\frac{2}{3}$  is the thickness of the layer, expressed in feet). Now a cubic foot of brickwork weighs about 112 pounds, so that the weight of the layer under consideration would be  $175 \times 112 = 19,600$  pounds. Now the specific heat of brickwork is about .20, so that this 19,600 pounds, in cooling 600°, gives up  $19,600 \times 600 \times .20 = 2,352,000$  units of heat. The heat account therefore stands as follows:

Heat units in the hot water blown off, = . . . . .	5,600,000
Heat units lost by cooling the boiler itself, = . . . . .	365,000
Heat units lost by cooling the setting, = . . . . .	2,352,000
	8,317,000
Total heat units lost, = . . . . .	8,317,000

Now in good average good practice, a pound of coal evaporates about 8 pounds of water; which is equivalent to saying that we can obtain about 8,900 heat units from each pound of coal. Hence, to obtain 8,317,000 heat units we should require  $8,317,000 \div 8,900 = 934$  pounds of coal. At \$4.50 a ton this coal would cost \$2.10.

The expense account for three weeks' run now stands thus:

(1.)—RUNNING WITH THE WELL WATER.

Cost of scale solvent, = . . . . .	\$2.70
“ gaskets, = . . . . .	1.25
“ labor, = . . . . .	3.00
“ the heat lost, = . . . . .	2.10
	\$9.05
Total cost with the well water, = . . . . .	\$9.05

## (2.)—RUNNING WITH TOWN WATER.

Cost of 47,520 gallons of water, = . . . . . \$8.55

These figures show that it would be cheaper to use town water than well water, under the conditions assumed in the present article. Whether this would hold true or not in other cases can only be told after examining the new conditions in the same manner.

Several other items, omitted in the foregoing estimate, might also have to be considered under some circumstances. Thus, when running with a water that contains a considerable amount of scale matter, it is not possible to entirely prevent the formation of scale, and it is well known that a slight coating of limy matter diminishes the efficiency of a boiler quite sensibly. This would increase the expense of running with well water. On the other hand it sometimes happens that the town water is not all that could be desired in the way of softness and purity, and in such cases the advantages of town water would be less marked. Under these circumstances we should have to allow for the expense of occasionally cleaning out the boiler when running with town water, in the same way that we allowed for it in the present example with well water. Again, it is a common experience that in running with water containing considerable scale or sediment repairs have to be made oftener than when a purer water is used, and some allowance should be made for this; though it is hard to estimate this expense fairly. If a suitable well is available the expense of sinking one might not have to be considered; but otherwise the boiler-owner must take account of this outlay also. Unless he can find a spring near by, or an underground watercourse near the surface, he will probably find it best to sink several small wells—driven wells, let us say,—in order to obtain a sufficient supply. This will probably cost him from \$700 to \$1,000, according to the locality; and the interest on this outlay will amount to something in the neighborhood of \$50 per annum. Furthermore, in case he has only one boiler he will probably find it necessary, if he relies on wells, to provide a tank of some kind to fill the boiler when it has been put out of use; and this will very likely cost him \$175, or so. All these things should be carefully considered in choosing a water for use in boilers; but we think that the suggestions given above should remove most of the difficulties that will arise, except such as must, from their very nature, always remain matters of judgment. The repair expense, mentioned above, is an item of this sort, which cannot be estimated except by an experienced man who is familiar with the conditions; and even then it cannot be estimated with anything like precision.

### Boiler Insurance Companies.

A correspondent of the *New York Mail and Express*, referring to the explosion of the boiler of the *Oliver Ellsworth* at Middletown, Conn., in 1820, says: "There were no steam boiler insurance companies in those days, and consequently the boiler of the *Oliver Ellsworth* was repaired at the owners' expense, without the assistance of an insurance organization. The accident narrated above must have been frequently repeated since 1820, not only upon boats, but in factories, and in other places where steam power is employed for its infinite variety of purposes. It seems to me there should be a company organized to meet that which must have been a long-felt want in the direction just indicated. With it also might be properly coupled an inspectorship of steam boilers, although especial caution should be exercised on the part of the inspector when he is called upon to thrust his head into boiler flues for minute inspection and examination, unless, indeed, he should be happily provided with a policy of accident insurance in his

coat-tail pocket, so that if anything happens he would have something to leave behind him. There may be, however, just such companies in existence, but I fail to see any record of them in the advertising columns of the *Mail and Express*, and hence am justified in believing that the better class of the reading public, who are probably provided with boilers of their own, can have no knowledge of the active existence, or at all events of the financial standing of any such companies, if they exist at all."

The tone of this item is as guileless as the smile of the celestial who played "the game he did not understand." For twenty-five years the Hartford Steam Boiler Inspection and Insurance Company has been inspecting and insuring steam boilers; it has, up to the first of the present year, made a grand total of 1,416,732 inspections, and at the present writing has in its care between forty and fifty thousand steam boilers; and it flatters itself that the "better class of the reading public" *does* know of its active existence, and of its financial standing. Yet this man signs himself "Insurance Monitor"! In the vernacular tongue, Where has he been at?

MR. G. K. GILBERT has kindly favored us with a copy of an address on *The Moon's Face*, delivered by him last December before the Philosophical Society of Washington. Mr. Gilbert considers the origin of the features of the moon's surface, and gives an interesting and very complete résumé of previous theories, and then propounds a theory of his own, which is a modification of the meteoric hypothesis. He considers it highly probable that a plastic or semi-plastic mass of matter, which was possibly once a satellite of the earth, struck the moon at the place now known as the Mare Imbrium, and spread outward in all directions over the lunar surface. In this way he explains the conspicuous radial arrangement of many of the lunar furrows and other markings. The theory is certainly an inviting one, and Mr. Gilbert sustains it well.

*The Measurement of Electric Currents* is the title of No. 109 of Van Nostrand's Science Series, a copy of which the publishers have sent us. It contains two papers, one by Mr. James Swinburne on *Electrical Measuring Instruments*, and one by Mr. C. H. Wordingham on *Meters for Electrical Energy*. It is an excellent little volume, and we cannot express our appreciation of it better than by endorsing the prefatory remarks of Mr. T. Commerford Martin, who has edited the whole. "The paper by Mr. Swinburne," he says, "is laudably comprehensive, there being in it a description in some detail, or a broad generalization that covers its principle, of well-nigh every instrument that the electrical engineer cares to know anything about. The paper by Mr. Wordingham looks at the question of measurement more specifically from the standpoint of the consumer's installation, but even in this respect it is an admirable and useful supplement to Mr. Swinburne's treatise."

### Problems for Idle Moments.

Some persons derive considerable pleasure from the contemplation and solution of problems. The problems may have no relation to actual life, and the time spent upon them may perhaps be wasted; but so long as they furnish amusement and serve to while away an occasional hour that might otherwise be tiresome, we must recognize them as sources of legitimate recreation. Following are a few of the better ones that have been propounded to us lately. Some of them are old friends, that have been on their rounds for many years. Others, we believe, are comparatively new.

1. A man had five pieces of gold chain, each piece consisting of three links. Wishing to have them united into a single chain of 15 links, he took them to a jeweler, who made him two propositions. He would do the work for 35 cents, or he would charge 10 cents for each link he had to cut. Which was the better offer?

2. Two numbers were multiplied together, but when the example was done, the multiplier and multiplicand were accidentally rubbed out. The rest of the example was as follows:

$$\begin{array}{r} \hline 7677 \\ 5971 \\ 1706 \\ \hline 237987 \end{array}$$

What were the two numbers that were multiplied together, and which of them was the multiplier?

3. A man bought some pigs, some cows, and some hens. He paid 20 cents for each hen, \$4 for each pig, and \$20 for each cow. He bought 100 creatures in all, and they cost him just \$400. How many of each did he buy?

4. If we admit that there are more cows in the world than there are hairs in any one cow's tail, does it follow that there are at least two cows in the world with the same number of hairs in their tails? (All "catches," such as bald-tailed cows and cows without tails, are barred out.)

5. Four men play whist. *A* holds the ace of clubs, the queen, seven and three of spades, and the king, queen, and seven of diamonds. *B* holds the jack and king of spades, the ten and deuce of diamonds, and the nine, eight, and seven of clubs. *C* holds the king and queen of hearts, the king, ten, and six of clubs, and the nine and three of diamonds. *D* holds the ace, ten, and nine of spades, the five of hearts, and the eight, six, and four of diamonds. Every man is supposed to know what every other man holds. Hearts are trumps, and *A* is to lead. It is required to prove that *A* and *C* can win every trick, no matter how *B* and *D* may play (provided they follow suit). This is an excellent problem, and it seems impossible until the underlying principle is perceived. There are no catches to it, and *B* and *D* do their utmost to take a trick.

6. There is an army, 25 miles long, which is marching forward at a uniform rate. At a certain instant a courier leaves the rear of the army, travels to the front and delivers his message, and returns to the rear again without stopping. He travels at a uniform speed, and when he gets to the rear end again he finds that the rear of the army is where the front end was when he started. How far did he travel? (This problem is best solved by algebra, and is a very good one.)

7. If three dogs catch three rats in three minutes, how many dogs (at the same rate) will it take to catch 100 rats in 100 minutes?

8. A man had a rock weighing forty pounds. It fell and broke into four pieces, and he discovered that by using these pieces as weights he could weigh any whole number of pounds from 1 up to 40. What did each piece weigh?

9. Mr. Brown had eight gallons of cider, in an eight-gallon measure, and wished to give four gallons of it to Mr. Smith. Mr. Smith had only two measures, one holding three gallons, and one holding five. How could the cider be divided equally by using only these three measures?

10. There are two spheres of metal, each four inches in diameter, and plated on the outside with copper, so that they look exactly alike. It is known that one is made of lead, and the other of aluminium; but the lead one is hollow, so that it weighs just the same as the other one. How can we find out which is which, without injuring them in any way?

11. What would happen if an irresistible force should be exerted on an immovable body?



Incorporated  
1866.

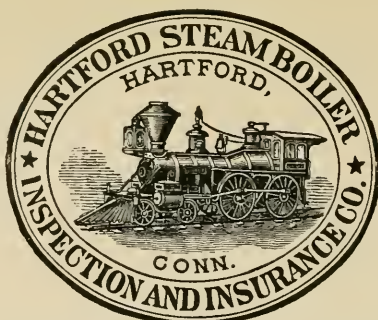

Charter Per-  
petual.

Issues Policies of Insurance after a Careful Inspection of the Boilers,  
COVERING ALL LOSS OR DAMAGE TO  
**BOILERS, BUILDINGS, AND MACHINERY.**

ALSO COVERING  
**LOSS OF LIFE AND ACCIDENT TO PERSONS**

ARISING FROM

## Steam Boiler Explosions.

Full information concerning the plan of the Company's operations can be obtained at the  
**COMPANY'S OFFICE, HARTFORD, CONN.,**  
Or at any Agency.

**J. M. ALLEN, President.**

**W. B. FRANKLIN, Vice-Prest.**

**J. B. PIERCE, Secretary.**

**FRANCIS B. ALLEN, 2d Vice-Prest.**

**E. J. MURPHY, M. E., Consulting Engineer.**

### Board of Directors.

J. M. ALLEN, President.  
FRANK W. CHENEY, Treas. Cheney Brothers Silk Manufacturing Co.  
CHARLES M. BEACH, of Beach & Co.  
DANIEL PHILLIPS, of Adams Express Co.  
RICHARD W. H. JARVIS, Pres. Colt's Fire Arms Manufacturing Co.  
THOMAS O. ENDERS, President of the U. S. Bank.  
LEVERETT BRAINARD, of The Case, Lockwood & Brainard Co.  
GEN. WM. B. FRANKLIN, late U. S. Commissioner to the Paris Exposition.  
NELSON HOLLISTER, of State Bank, Hartford.

HON. HENRY C. ROBINSON, Attorney-at-Law, Hartford, Conn.  
HON. FRANCIS B. COOLEY, of the National Exchange Bank, Hartford, Conn.  
EDMUND A. STEDMAN, Treasurer of the Fidelity Co., of Hartford, Conn.  
GEORGE BURNHAM, Baldwin Locomotive Works, Philadelphia.  
HON. NATHANIEL SHIPMAN, Judge United States Circuit Court.  
C. C. KIMBALL, Pres. Smyth Mfg. Co., Hartford, Conn.  
PHILIP CORBIN, of P. & F. Corbin, New Britain, Conn.

### GENERAL AGENTS.

THEO. H. BABCOCK,  
CORBIN & GOODRICH,  
LAWFORD & McKIM,  
C. E. ROBERTS,  
H. M. LEMON,  
C. C. GARDINER,  
L. B. PERKINS,  
W. G. LINEBURGH & SON,  
BURWELL & BRIGGS,  
MANN & WILSON,  
ZOLLARS & MCGREW,  
R. F. MANLY,  
W. S. HASTIE & SON,  
PETER F. PESCUO.

### CHIEF INSPECTORS.

R. K. McMURRAY,  
WM. J. FARRAN,

F. S. ALLEN,  
WM. HEAFORD,  
A. B. EOFF,  
F. S. ALLEN,  
J. H. RANDALL,  
C. A. BURWELL,  
J. B. WARNER,  
T. E. SHEARS,

B. F. JOHNSON,

NEW YORK CITY.  
PHILADELPHIA, PA.  
BALTIMORE, MD.  
BOSTON, MASS.  
PROVIDENCE, R. I.  
CHICAGO, ILL.  
ST. LOUIS, MO.  
HARTFORD, CONN.  
BRIDGEPORT, CONN.  
CLEVELAND, OHIO.  
SAN FRANCISCO, CAL.  
DENVER, COL.  
BIRMINGHAM, ALA.  
CHARLESTON, S. C.  
NEW ORLEANS, LA.

### OFFICES.

Office, 285 Broadway.  
432 Walnut St.  
25 So. Holiday St.  
125 Milk St.  
29 Weybosset St.  
112 Quincy St.  
404 Market St.  
218 Main Street.  
2 Sanford Building.  
208 Superior St.  
306 Sansome St.  
Mining Ex. B'g.  
Morris Building.  
44 Broad St.  
188 Gravier St.

# The Locomotive.

PUBLISHED BY THE HARTFORD STEAM BOILER INSPECTION AND INSURANCE COMPANY.

NEW SERIES—VOL. XIV.

HARTFORD, CONN., JUNE, 1893.

No. 6.

## Extension Furnaces for Upright Boilers.

IN a previous issue of THE LOCOMOTIVE (the issue for March, 1891,) we illustrated an extension furnace designed and patented by Mr. J. M. Allen, President of this company,

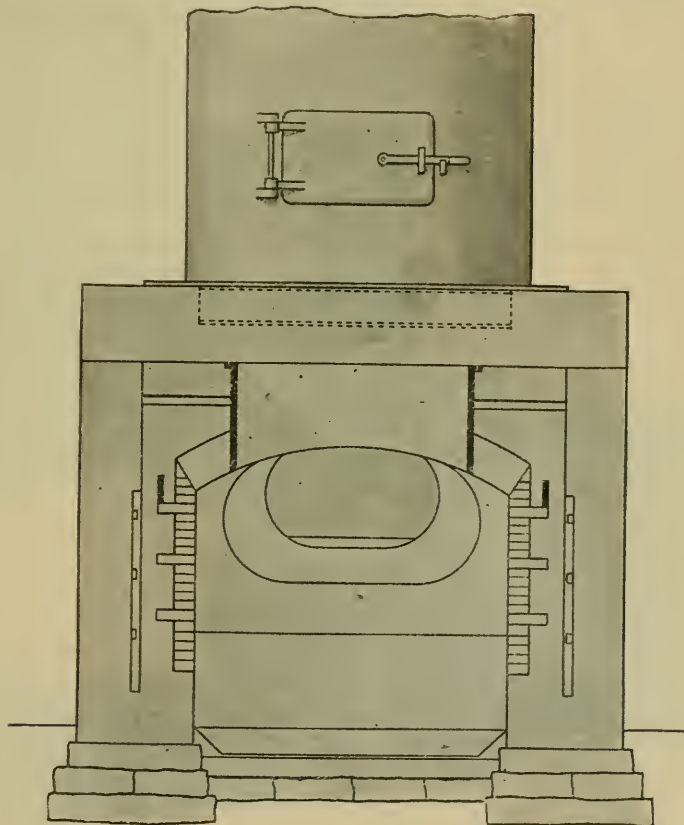

FIG. 1.—FRONT VIEW OF EXTERNAL FURNACE AS APPLIED TO UPRIGHT BOILERS.

as applied to horizontal boilers. Many of these furnaces are in operation to-day, burning the waste of saw-mills, pulp-mills, and tanneries, with good results. The present illustrations show this furnace as adapted to vertical boilers with internal fire-boxes, and

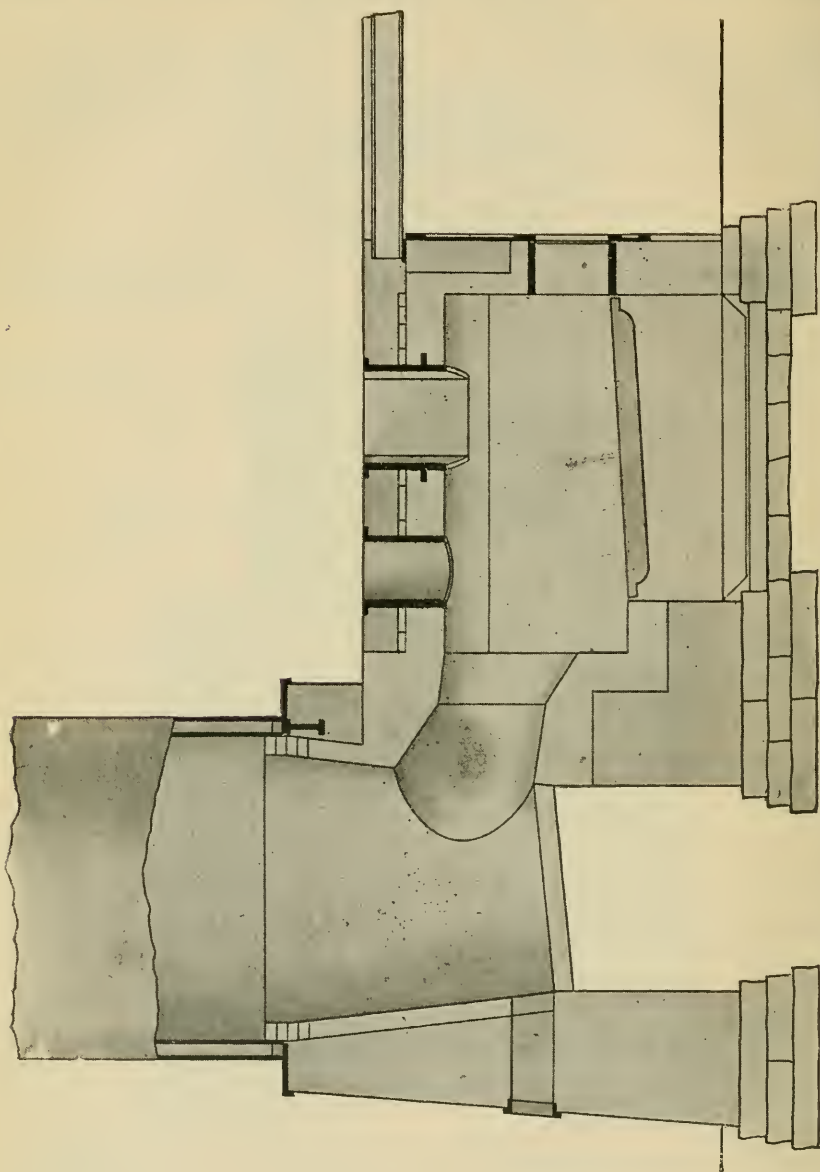

FIG. 2.—SIDE VIEW (IN SECTION) OF THE EXTENSION FURNACE AS APPLIED TO UPRIGHT BOILERS.

the arrangement of the furnace is substantially the same for boilers of the locomotive type. Fig. 1 is a front view of the furnace, showing a section of it through the middle of the front firing-hole. Fig. 2 is a side elevation of the whole, showing it in section as it would appear if cut through at the center line of setting and boiler.

The general arrangement of the furnace, when applied to upright boilers, is the same as when applied to those of the horizontal type. The products of combustion pass out of the detached furnace through an opening in the bridge-wall having approximately the shape of the *venu contracta*. This allows the freest flow of the gases, and tends to mingle them in such a manner as to secure as perfect combustion as possible. The furnace is supplied with fuel through holes in the top, which are fitted with removable covers. The air required for combustion comes through the ash-pit, as in ordinary furnaces. (We call attention to this point because it is sometimes overlooked when using these external furnaces, the draft being needlessly checked by boxing up the furnace front in some way, so that air does not have the requisite freedom of access to it.) A cleaning door is placed in the rear wall, on a level with the flame-bed, for the removal of ashes.

The furnace itself is so placed that the top of it is flush with the boiler-room floor. This may be done either by sinking the furnace in the ground, or by grading the general surface up to the proper level. A pit or cellar extends in front of the furnace for from 9 to 12 feet, as may be convenient. This is floored over either with sleepers and planks, or with I-beams and brick arches. The arches are preferable, being less likely to yield or "give"; but the planking has been used with this furnace, although we do not recommend it. In level ground it is not necessary to excavate below the flame-bed for the rear wall of the furnace, except to secure a good foundation.

The especial features of the particular arrangement of Mr. Allen's furnace shown in the accompanying cuts, are its applicability to fire-box boilers, and its utility when space does not allow of the erection of horizontal boilers, and also its adaptability to burning either wood or coal. This last feature is of considerable importance, for in some localities waste fuel can be obtained for only a part of the boilers, or for only a part of the year. With the fire-box boiler and extension furnace arranged as here described, it is possible to use waste in some of the boilers, and coal in the others; or wood a part of the year, and coal when the wood-waste is unobtainable. When burning wood the ordinary coal-burning grates are removed. The ring around the bottom of the fire-box is protected, when burning wood, by the four courses of fire-brick shown in Fig. 2 as coming well up on the water space of the leg of the boiler. In burning coal these bricks are taken down and laid away, and the regular grate is put in the furnace, the covers are placed over the feed-holes in the extension furnace, and the boiler is fired in the usual manner, the combustion-chamber of the wood-burning furnace forming the ash-pit when burning coal, and the ashes being removed from the cleaning-door mentioned above.

This arrangement affords as good combustion of fuel, in burning coal, as is obtained in ordinary practice, and has the additional advantage of the extension furnace in burning waste fuel. Furthermore, when wood fuel is burned in fire-box boilers the condensation of the wood gases on the plates of the furnace and in the tubes causes a rapid deterioration and wasting of the plates. This trouble is eliminated in the extension furnace, for by the time the gases strike the comparatively cool boiler the combustion is nearly perfect and the corrosive substances distilled from the wood have been completely burned.



## Boiler Explosions.

APRIL, 1893.

(92.) — On April 1st a terrible boiler explosion occurred in a mill in Lacona, Warren Co., Iowa. Henry McKinness (owner of the mill) and his three sons, John, Henry, and Peter, were killed, and the mill was completely wrecked.

(93.) — A boiler exploded in the town of McAlester, I. T., on April 2d, instantly killing L. P. Durnell, F. Fredericks, G. W. Martin, and Henry Landers. Three of the men were thrown eighty feet, and all four were badly mangled.

(94.) — On April 3d a boiler exploded in Broadford, near Johnstown, Pa., and Henry Riekleman, Steven Fairchild, and William Herberger were seriously and perhaps fatally injured about the head and body.

(95.) — A boiler exploded in the Anchor Mill at Meredosia, near Jacksonville, Ill., on April 6th. The engineer, Patrick Cody, was instantly killed, but no others were injured. The mill was new and had just been put in complete order, and the boiler was believed to be in good condition. Pieces of the mill were blown in every direction, and the warehouse adjoining it was also wrecked.

(96.) — A boiler explosion occurred in Thorn, Barton & Co's. mill in Jonesboro, Ark., on April 8th, making a complete wreck of the building, and destroying nearly all of the machinery and other property of the plant. The boiler was carried a thousand feet from the mill, tearing up everything in its way. A piece of flue was blown through the dwelling of an old man named Buck, who lived 150 yards away; and although his dwelling was demolished, he escaped with slight injuries. No one else was hurt.

(97.) — A vulcanizing boiler exploded on April 10th in the Chicago Rubber Company's works, on Grand avenue, Chicago. Philip Fogerty was instantly killed, and James Haugh was so badly burned that he cannot recover. The roof was partly blown off, and all the windows in the building were shattered.

(98.) — On April 13th a small boiler exploded in A. Herr's hat factory on First avenue, New York. No one was hurt, and the damage was small.

(99.) — A boiler explosion occurred on April 13th, in the mill of Mowry & Bro., near Sumner, Ill. Charles Mowry received a severe cut on the arm, and another man was somewhat bruised; but both will recover.

(100.) — Samuel Trickey was scalded to death on April 16th by the explosion of a boiler in the Remington paper mill in Watertown, N. Y.

(101.) — Various reports (one of them illustrated) have reached us of the explosion of the passenger steamer *Nellie Bly* on the Tippecanoe river, near Winamac, Ind., on April 16th. It is said that eight persons were severely injured. Of these, Clarence Fishborn and James Long were badly scalded, J. F. Fishborn was hurt internally (perhaps fatally), Daniel Rhodes was scalded and was "hit with rubbish of various descriptions," and George Train had both legs broken above the ankles, and will have to have them amputated. This account says that the *Nellie Bly* "carries from forty to fifty passengers each trip," and that she was "of light build and made for pleasure only." Furthermore, it appears that "the screams of the affrighted passengers filled the air and pandemonium reigned. The boat filled up rapidly and sunk to the bottom, and those who had not been thrown into the river, but had managed to hold on [to the

wreck] by hook or crook, were obliged to release their holds and take to the water to avoid the dangerous whirlpool [*sic*] which was formed by the sinking steamer. Fortunately much of the woodwork of the boat rose to the surface, separated by the shock, and to this the wrecked pleasure-seekers clung till help arrived." We beg our readers to note all these facts carefully, and also to observe that the entire population of the town of Winamac, some 900 souls, "turned out and went to the assistance of the injured, who were tenderly cared for, being taken to their homes or to those of their rescuers. Many were wild with grief at the fear that members of their families who were missing had met with death or injury in the wreck, and would not be comforted until they learned positively that the objects of their solicitation had not left the docks on the boat." Observe, with even greater care, the following: "The steamer *Nellie Bly* was placed in the river at this point by a stock company controlling several pleasure interests in Indiana. She was to have been run in connection with the attractions at Nye's Park this season, and her owners had looked forward to an especially profitable season. The boat measured forty feet in length." Now it appears that this account is a tissue of lies, evolved, largely, from the unhealthy but prolific imagination of some penny-a-liner. How studied his mendacity was, will appear from the following extract from the *Chicago Tribune*: "There is no steamer *Nellie Bly* on the Tippecanoe river at this place (Winamac). Again, no steamer can run in shallow water of six to eighteen inches in depth. The whole matter in a nutshell is this: Sunday afternoon a party of five, J. W. Fishthron and son, Daniel Rhodes, James Long, and George Frain went down the river in an old scow or sandboat about fifteen feet long and six feet wide. The propelling power was a ramshackled little one-horse engine. The party ran on a sand bar, and the flues in the boiler collapsed. George Frain had both feet scalded, but there is no need of amputation. James Long walks the streets without a scald, and Daniel Rhodes is not injured at all. [The foregoing account said he was blown thirty feet, and "fell on the river bank in a senseless heap, and was picked up by the rescuers."] John W. Fishthron had his hands burnt. Clarence Fishthron had his thigh slightly burnt. Total loss about \$50." The intelligent reader will infer that it is not always easy to make up an accurate list of boiler explosions; though, of course, the case here quoted is an extreme one.

(102.)—Two of a battery of twelve boilers exploded in Wilkesbarre, Pa., on April 16th. Both boilers parted in the middle, and the ends flew in opposite directions. The front ends were blown through a building in which dynamite was stored, and the dynamite was scattered in all directions, though fortunately none of it exploded. Nobody was hurt.

(103.)—On April 16th a boiler exploded in Albert Fuchs's greenhouse, Chicago. Reinhold Schilit, the fireman, was blown through the roof and some 35 feet into the air, landing in the yard unconscious. He is severely injured and may die. Forty thousand square feet of glass were broken, and a large number of plants contracted for by the management of the Woman's Building at the Fair were scattered far and wide, and for a time it rained geraniums, roses, and hyacinths. The loss is estimated at from \$15,000 to \$20,000.

(104.)—A boiler exploded on April 17th at Constitution station, six miles below Marietta, Ohio. The building was completely demolished, so that practically nothing remains of it. Rolla Calder and William Spicer, who were in the mill at the time, were instantly killed.

(105.) — John Kelch's mill, near Versailles, Ohio, was wrecked by a boiler explosion on April 17th. The men were at dinner. Harry Rex and Edward McClurg were instantly killed; and where the mill once stood there is now nothing but a deep hole.

(106.) — A boiler exploded near Hamburg, Mich., on April 17th. Fireman T. C. Wilson was scalded to death.

(107.) — A mill in Glade, Fayette Co., West Virginia, was destroyed on April 17th by the explosion of the boiler. Nobody was injured. The mill belonged to Mr. M. F. Mohler, and will be rebuilt shortly.

(108.) — On April 18th a boiler exploded in Moon's mill, near Providence, R. I. The explosion occurred at 6.25 A. M., and few of the employes were there. Amos Harrington, overseer of the card room, Samuel Perry, and Irving Clark were killed. Alonzo Tyler, the engineer, was in the engine room, and received fatal injuries. The property loss is estimated at \$8,000.

(109.) — A boiler exploded on April 19th in Leach's mill, near Gas City, Ind. William Payne's skull was crushed, and he died within an hour. George T. Leach, one of the owners, was horribly scalded; his left leg was broken twice and he was otherwise injured, and his recovery is considered improbable. Eson Smith was struck in the side by a flying brick, but was not fatally hurt. Fragments of the boiler were blown 600 feet, and the mill was torn to pieces.

(110.) — A boiler exploded in Wilkesbarre, Pa., on April 20th, near the scene of the explosion in that city on April 16th. (See explosion No. 102, above.) Fireman William Slacker was badly burned, but although his injuries were exceedingly painful, it is believed that they are not fatal.

(111.) — On April 20th a boiler exploded in Garrick's mill, in Schultze Creek, Ky. James Bainer was badly scalded from head to foot, and will probably die. Robert Garrick, engineer, was scalded on the head and body, and it is doubtful if he recovers. He was the only son of the proprietor of the mill. John and Samuel Maynard were badly scalded, cut, and bruised; and John Pounds, Ralph Diekerson, Abraham Roberts, Wilson Craft, and Wesley Denning, were all more or less seriously scalded.

(112.) — The boiler in Schirer's mill, near Plain City, O., exploded on April 22d, and Edgar Freece was killed and buried in the ruins. Horace Wilcox, the engineer, was severely scalded and both his legs were broken. He will die. John McCann and Arthur Spring were both badly hurt, and it is feared that their injuries may prove fatal.

(113.) — On April 24th a boiler exploded in M. B. Smith's stone-crushing mill in Carey, Wyandotte Co., Ohio. The building was almost demolished, and a workman named Jacob Morder was fatally injured.

(114.) — On April 25th a boiler exploded in the Redmon flour mill, Redmon, Ill., completely wrecking the engine room and breaking the leg of the engineer, Mr. Ewing.

(115.) — A boiler exploded on April 26th in Mr. Cecil Baker's mill, near Baltimore, Md. Whit Hoffmann, the fireman, was killed, and several others were badly injured.

(116.) — On April 26th a boiler exploded in Los Cerrillos, N. M. Engineer Edward Keene and fireman Isaac Taylor were badly scalded and otherwise injured.

(117.) — The Hanna mill at Hoopston, Ill., was completely wrecked on April 27th by a boiler explosion. Nobody was injured.

(118.)— Isaac Baker's mill, near Loogootee, Ind., was destroyed by a boiler explosion on April 28th, and Francis Baker, a son of the proprietor, was killed.

(119.)— A boiler exploded on April 29th in a mill in Rye, Colo. The engineer, Charles Langraeme, was blown 200 feet and killed. J. M. Hardin was injured badly, and Louis Murphy slightly. The mill is a total wreck.

### Stamps on Boiler Plates.

The makers of boiler plates ought to mark each plate they send out with a stamp as conspicuous as a Columbus memorial stamp. They ought to, but they don't.

It is a common experience among inspectors to find plates either not stamped at all, or with stamps so illegible that it is almost impossible to decipher them. Too often the stamps are so indistinct that all that can be seen of them is a couple of syllables or so, and perhaps three or four ciphers. Then if the inspector is familiar enough with the plate-makers of the country, he may be able to make an intelligent guess about the origin of the plate he is examining. There is no excuse for this slipshod work, for it is very easy to mark plates plainly, so that anyone can tell at a glance where they came from, and what they are. Every shell plate should be stamped *legibly* in five places: namely, on each of the four corners, and in the middle. Then, if the boiler-maker puts them together right-side out (which he usually does), it is easy to tell what the metal is. The heads of boilers should also be stamped in such a manner that it will not be possible to destroy all the stamps in the process of punching or drilling the holes for the tubes or flues. This can be easily done by stamping the head in three or four places near the flange.

The requirements of the United States Board of Supervisors of Steam Vessels, with regard to stamps, are as follows: "Every iron or steel plate intended for the construction of boilers to be used on steam-vessels shall be stamped by the manufacturer in the following manner: At the diagonal corners, at a distance of about four inches from the edges, and at or near the center of the plate, with the name of the manufacturer, the place where manufactured, and the number of pounds tensile strain it will bear to the sectional square inch." It is also provided that "whenever inspectors shall find a plate of iron or steel with stamps differing as to the tensile strength of the material, they shall rate the tensile strength of the same in accordance with the lowest stamp found thereon."

While we are discussing this subject of stamps, it will do no harm to touch upon one point that appears to be worthy of attention. A plate-maker, let us assume, has been sending out plates to some boiler-maker or other for a year or so, at the end of which time the boiler-maker discovers that they are not properly stamped. The manufacturer's name is on them, it is true, and sometimes the grade of the metal also:— that is, "Shell," "Flange," or "Firebox;"— but the strength of the plate is not given. So, when an important job comes up, the boiler-maker sits him down and writes a letter to the plate-maker, calling attention to his remissness, and asking what the strength of the metal is. In a day or two he receives a reply, saying that "you can rely on anything we send you having a strength of 60,000 pounds." So the boiler-maker gets out his stamp and marks all the plates of that make that he happens to have on hand, "60,000 lbs.," regardless of any tests that may have been made. Now we do not say that things of this kind *do* happen; yet it is quite conceivable that they *might*, and it would be well for boiler-makers to avoid all chance of it, and insist on their plates being stamped *in full* by the makers.



### The Helium Meteorite.

Some weeks ago, it will be remembered, a meteorite fell, out West, and struck a statue of John Brown. According to the *St. Louis Republic* the meteoric mass has been found and submitted to chemical analysis. It weighed fourteen pounds and four ounces. As a general rule these celestial visitors are composed almost exclusively of iron and nickel; but it is said that the present one is a conspicuous exception. A considerable portion of it is of iron, but the microscope shows small particles probably of a graphitic nature, and, what is much more interesting, about one-quarter of the mass is said to consist of a metal quite new to science. According to the *Republic* this metal is four times as heavy as gold, very strong, and both malleable and ductile. Upon examination with the spectroscope the new substance is said to have given the characteristic two lines of *helium*, a metal unknown to our mineralogists, but known to exist in the sun. We think this identification of the new metal with the hypothetical "helium" is very questionable. Helium appears to exist chiefly in the outer layers of the solar atmosphere, and from this circumstance it is believed to be very *light*, instead of very heavy—lighter, perhaps, than even hydrogen. The *Republic* says that Prof. Joplin, the analyst who examined the specimen, considers that "the sun is fed by meteors of this material, showing that the universe has an unlimited amount of helium, and that probably the earth has its quota; but on account of its great weight it naturally gravitated to the center when the earth was in a melted state." Now, according to the estimate given above, the specific gravity of the new metal is about 80; and since the average specific gravity of the earth is only about  $5\frac{1}{2}$ , it follows that there cannot be any very great amount of such heavy metal down in the earth's interior. The enormous pressures that exist in the depths of our planet must compress ordinary things so strongly as to give them a density at least as great as 5 or  $5\frac{1}{2}$ , and any considerable amount of the metal described by Prof. Joplin could not fail to bring the average density up to an appreciably higher figure. Admitting the accuracy of Prof. Joplin's measures, therefore, it seems probable (1) that the substance is not helium, and (2) that if it exists at all on the earth it is at least rare. The only thing that indicates that it is helium is the presence of the helium lines in its spectrum; and when the delicacy of spectroscopic tests is considered, it seems probable that these lines were due to a trace of that substance, and that the heavy metal is something quite different.

---

On June 8 Mr. Joseph Bee was thrown from his carriage, in Chicago, by a runaway horse. He struck on the back of his head and received a compound fracture of the skull, from the effects of which he died in the evening, at St. Luke's Hospital. Mr. Bee was the proprietor of the National Boiler Works, on Fulton street, Chicago. He was 57 years of age, and had been in business in Chicago for many years. He had a finely equipped shop, and was well known among the steam-using public for his sterling qualities; and his untimely death is lamented by a large circle.

Mr. Addison Bee, son of Mr. Joseph Bee, was badly hurt in the same accident, but it is believed that he will recover. The business will be carried on by Mr. Bee's sons.

---

THE production of pig iron in the United States during the year 1892 was 9,157,000 gross tons. Of this amount Pennsylvania turned out 46 per cent., Ohio 13 per cent., and Illinois 10 per cent. During the same period there were produced in this country

4,168,435 tons of Bessemer steel, 669,889 tons of open-hearth steel, 84,709 tons of crucible steel, and 4,548 tons of miscellaneous steel, making a total of 4,927,561 tons, which is the greatest amount on record for a single year. Of the Bessemer steel, Pennsylvania produced 57 per cent. The prices of iron and steel have never been lower than at present.

THE *Report* for 1892 of the chief engineer of the National Boiler and General Insurance Company, of Manchester, Eng., is at hand. It is very interesting, and contains many useful suggestions concerning the care of boilers, and the defects they are liable to develop. The number of boiler explosions in the United Kingdom during the past twenty years is said to have been 786. These are divided, in the *Report*, into two classes, one giving the statistics of explosions during the years 1873-1882, and the other during the years 1883-1892. The results are:

	No. of Explosions.	Persons killed.	Persons injured.
First decade,	437	563	855
Second decade,	349	206	480
For the twenty years,	786	769	1,335

From these data it appears that the average number of explosions per year was 43.7 during the first decade, and 34.9 during the second; that the average number of persons killed and injured per year was 141.8 during the first decade, and 68.6 during the second; and that the average number of persons killed and injured *per explosion* was 3.24 during the first decade and 1.96 during the second. The marked decrease in the number and violence of the explosions is largely attributed, by Chief Engineer Hiller, to the regular inspection of a continually increasing number of boilers by the boiler insurance companies.

MESSRS. D. Van Nostrand & Co. send us a copy of Mr. Edward P. Thompson's *How to Make Inventions*, which is a book of 181 pages, designed as a "practical guide for inventors," and treating inventing "as a science and an art." After some short preliminary chapters on the general principles of inventing, the author passes on to a consideration of the facts of acoustics, heat, light, chemical affinity, and electricity. We are sorry to observe that many of these facts are stated inaccurately, so that they would be of no use to a beginner in these subjects. Thus, to select a few instances quite at random, on page 49 it is said that "the atomic weight indicates how much heavier an element is than hydrogen." Again, on the same page, we read that "a hot house becomes warm because the light reflected from objects within is reduced to polarized and heat rays to which glass is opaque"—a statement that would make Tyndall shudder. Towards the bottom of this page we read that "water shaken is increased in temperature about one degree"; no information being given as to how much you have to shake it, and the implication being that you can't heat water *more* than one degree by shaking it. Again, on page 55 we read that "the length of a vibration or swing of an atom in producing the red is .000027 inch, and in the case of violet, .000015 inch." This statement is hopelessly incorrect, and many others of like nature could be given if we could afford the space. Our general impression after reading the book, is that Mr. Thompson had a laudable purpose in view, but that he has been singularly unfortunate in carrying it out. His illustrations of the non-scientific principles underlying the art of inventing, however, are very creditable and interesting.

---

# The Locomotive.

---

HARTFORD, JUNE 15, 1893.

J. M. ALLEN, *Editor.*

A. D. RISTEEN, *Associate Editor.*

THE LOCOMOTIVE can be obtained free by calling at any of the company's agencies.

Subscription price 50 cents per year when mailed from this office.

Bound volumes one dollar each. (Any volume, except 1881, can be supplied.)

Papers that borrow cuts from us will do us a favor if they will mark them plainly in returning so that we may give proper credit on our books.

---

By an unfortunate typographical error in our May issue, the date of Mr. H. D. P. Bigelow's death was stated to be February 3d. It should have been February 25th.

THE *American Mechanic*, an engineers' paper published in Chicago, recently printed a photo-engraving of an "inspector ready for work." The engraving was a good one. It would have been courteous, however, for the *Mechanic* to say that we furnished it.

INSPECTOR Dodge, of our Northwestern department, repeats what he said in a recent issue about washing out boilers from beneath the tubes. "I find," he says, "that engineers out this way are inclined to neglect opening their boilers on top. They do most of their washing from the lower man-hole, under the tubes; and in my opinion this is a very bad practice, for when the stream of wash-water turns to come back over the top of the tubes its force is pretty well spent, and it is of little account for removing the dirt and scale that remain above and between the tubes; a boiler treated in this way may look fine when viewed from the lower man-hole, and yet it may be badly incrustated between the tubes, and a large amount of sediment and dirt may remain above; whereas if they would do most of their washing from the top, they would have no trouble, in most cases, in keeping their boilers clean. For they would then have the force of water above the dirt and scale, where it would do the most good."

## The First Casting Made in America.

The first iron casting made in America was a kettle or three-legged pot, weighing 2 lbs. 4 oz., and holding nearly one quart. It was produced in 1642 at the Saugus Iron Works, and was claimed, as part of the purchase consideration, by the land-owner who furnished the site for the undertaking. He appears to have valued it, and for several generations it descended from father to son as an heirloom; then it passed for two generations through the female line, and lastly into a collateral branch of the family. It has recently been purchased by Mr. John E. Hudson, a lineal descendant of the first owner, and presented by him to the town of Lynn, Massachusetts, which is in part built upon the ground originally occupied by the works. Several other of the citizens combined to add a case containing a tablet, which should be an example of the state of iron-

founding in America in the year 1892, and thus show the progress that has been made in 250 years. The face of the tablet carries a pattern of woven bamboo, and the back is an impression of plaited straw, the whole being untouched by tools. When the presentation was made, Mr. C. J. H. Woodbury, who had been instrumental in obtaining the kettle, gave an account of the rise of the iron industry in America. In 1622 the Jamestown colony built iron works at Falling Creek, a tributary of the James River, for the purpose of reducing bog iron ore. The works had approached completion when the Indians attacked the settlement, killing 350 persons, and burning the buildings (March 22, 1622). The bog iron deposits in the Upper Saugus meadows were discovered by Thomas Dexter, and he informed his fellow-townsmen, Captain Robert Bridges, who went to London and formed a company to work them. It is said of Bridges that he had "suavity and winning social manners," which probably accounts for his success as a company promoter. The works were built, and were voted free by the General Court of all rates and taxes for twenty-one years. They contained a blast furnace, in which bog iron ore was reduced by means of charcoal and lime obtained from oyster shells. The iron was run into long triangular bars called "sow iron," and converted into wrought-iron and steel. Castings were made direct from the furnace. The wrought-iron and steel were made in a bloomery, which may be described as a charcoal fire four feet thick, in a blacksmith's forge. The end of a bar of sow iron was plunged into the fire, and in time a pasty mass of wrought-iron would settle to the bottom. Other portions of the bar would be converted into steel when the process stopped at an intermediary stage. In 1648 the furnace was producing 7 to 8 tons a week. The principal product was bar iron "as good as Spanish," costing £20 (\$100) a ton. The works are not known to have been in operation after 1688, when the tract had diminished to 600 acres, and passed into individual ownership. — *Engineering*.

### The American Inventor.

Of all the countries of the world, none is so prolific in inventions as America. There are several reasons for this. The ease of obtaining patents, and their cheapness, holds out to every man the chance of creating for himself a piece of property by the exercise of his brains. The high rate of wages insures the inventor of a labor-saving appliance a patient hearing from capitalists, while the independence of thought and feeling, which pervades all classes, leads to original views, and to bold attacks on difficult subjects. Hence every one is a potential inventor, especially if he have an acquaintance with science or manufacture. Whatever a man's occupation, he must daily find himself called upon to do or to suffer many things from which he would gladly emancipate himself. The proverb says, "There is a remedy for every ill but death," and seeing how many ills there are, the opportunities for devising remedies are not only numberless, but they are present to all. The unenterprising bear with patience the inconveniences that surround them, but those of active mind busy themselves in devising expedients to lighten the burden of life, and look for their reward under the provisions of the patent law. The inventor is the greatest benefactor of the human race, and especially of that part of it which is indigent; he is the real friend of the poor man, and, indeed, almost his only friend. The rich can always find sources of pleasure, and since happiness is principally a matter of comparison, they probably fared even better in this respect in earlier ages than they do now. The Roman millionaire was certainly far better situated than his American representative of to-day. It is true that he could not travel at 60 miles an hour, his yacht could not steam independently of the winds, and



his letters took days and weeks to reach their destination, and often miscarried. But his expectations had never soared to such rapid transit, nor to such perfect communication. On the other hand, he enjoyed the unspeakable luxury of perfect service; his slaves were drilled like an artillery regiment, and anticipated his slightest desires; his home was decked with everything that was beautiful, and contained the choice products of the entire world; his food and his wines were not only better prepared than those of common people, but these were different in substance. He had the intense satisfaction of feeling himself apart from the herd of humanity which surrounded him; his superiority was patent to all, and was unquestioned. When he journeyed he did not form a unit in a crowd on an unclassified vehicle, as does the American millionaire of to-day, and when he voyaged a thousand steerage passengers did not share equally with him in the latest outcome of the shipbuilder's art. His chariot and trireme were his own, and were beyond the wildest dreams of hope on the part of those beneath him in station and in fortune. We need not confine ourselves to Rome for illustrations to show that the rich derived more benefit from their riches in the past than they do to-day. The case of the mediæval baron is one in point. He lacked the delicacy and refinement of surroundings which characterized the Roman, and was, in fact, subject to much we should consider as hardship. But then he was of rough fibre and hardy nature; his ideal of happiness consisted in mastery, and he enjoyed it to the full. In his own district he reigned supreme, not seldom contriving that the king's writ should be of little avail as against his will. His servants were absolutely under his control, and as regards his tenants he pushed his interference, at any rate under some forms of tenure, into the most sacred relations of life. The opinion that he was of a different order to common humanity was not only held by himself, but was received by his social inferiors, and acts that would have roused the deepest resentment if attempted by others, were accepted as natural and right from him. Even so late as the commencement of the present century the baron's descendant—the English lord—was paramount in his own district. One could neither live in his village without his goodwill nor publish opinions that he disliked. He was surrounded by people who, to all appearance, regarded him as the fountain of knowledge and light. The school children curtsied at the sight of his coach, the laborers doffed their hats before him, while even substantial tenants treated him with extraordinary deference. Every one conspired to give him a good opinion of himself. What a contrast to all this was the life of Jay Gould! In spite of his millions, he could not walk the streets in safety without an escort. On all sides he saw lowering faces, and his ears were assailed by threats and curses; he knew that men hated him, and that even those who, for sake of gain, coöperated with him in business, would have been glad to have seen the money market freed from his preponderating influence, and his securities distributed among themselves. His home was the only spot in the world where he found love and confidence, and, unless the American "help" is much maligned, he must have had to exercise considerable self-control there for the sake of peace and quietness. His wealth resulted from the skill, ingenuity, and enterprise of the American people, but the very forces that created it combined to prevent it bringing him that satisfaction and general adulation which still attaches to the wealthy in slower moving communities.

It is when we compare the condition of the poor to-day with that of previous ages, that we see how much the inventor has done for humanity. To know how hard life must have been before the advent of machinery, we have only to imagine a family set down on an island, and called upon to provide all their food and clothing without the

aid of modern mechanical appliances — to plow and reap; to thresh, winnow, and grind; to raise cattle, kill and dress them; to shear, card, spin, and weave their wool; to make and mend their clothes; to provide soap, candles, tools, cutlery, earthenware, paper, pencils, nails, medicines, leather, boots, ropes, and the thousand and one things that are needed in a home. Evidently it could not be done, even if labor were continued from dawn to eve, and then extended far into the night. And this under the favorable conditions of a yeoman's family without rent to pay. How much worse must it have been under the exactions of a feudal landlord. Two-thirds of what we consider necessities must have been omitted from the list of that day, and to sore toil must have been added scanty fare and insufficient clothing.

Long before America was discovered, the inventor had commenced the amelioration of the lot of the race. The man who devised a form of ship's rigging that would enable a vessel to beat up the wind, unlocked the fetters of thousands of galley slaves, and by rendering communication easier and cheaper, made matters better both for buyer and seller. The windmill and the water-wheel released womankind from the immemorial task of "grinding at the wheel" to provide the daily ration of flour. The movable type and printing press did a still greater work by conveying the knowledge of the few to the many, and thus putting the ignorant and the inapt in possession of the experience of the wise and the skillful. Besides such notable inventions as these, hundreds of a less imposing nature had been made, and their authors had passed away and been forgotten. It was only when the patent law was passed in this country that an enduring record was commenced of the names of those who have endeavored to use their brains to save their time and muscles.

The colonization of America commenced, from an Anglo-Saxon point of view, with the settlements in the early part of the sixteenth century. By that period an immense progress had been made in arts and manufactures, but still the load of labor pressed very heavily on the lower classes. It was only when the windmill and the water-wheel could be utilized that work could be undertaken on a large scale. The sickle, the scythe, the flail, the hand-loom, the spinning-wheel, the sledge-hammer, the axe, the handsaw, the file, the wagon — these were the implements with which the clearing and peopling of the forests of the New World were commenced. Much progress was made by their aid, but only as the result of great suffering, indomitable perseverance, and endless labor. In some cases whole settlements perished for want of supplies, cut off from civilization for lack of means of communication; and in others it was only the bounty of nature, in respect of fish and game, that turned the scale. The rigorous climate prevented outdoor work during several months of the year, and manufacturing operations were not sufficiently advanced to enable labor to be fully utilized under shelter. It was the policy of the home government to make the colonists purely agriculturists, and to pay for their foodstuffs and raw products in goods, and for a long time this was successfully pursued. The American inventor had scarcely a market until the connection with England was snapped. Then the aspect of affairs was changed, and the desire to become manufacturing people soon found expression in the passage of a patent law. The first patents were granted in the year 1790, and there were only three of them for that year. The first was to Samuel Hopkins, for a process of manufacturing "pot and pearl ash"; the second was to Joseph Sampson for manufacturing candles, though the method of dipping candles was very generally followed for 60 years after that. The third patent was awarded to Oliver Evans for a method of manufacturing flour and meal. Thirty-three patents were granted in 1791, 9 in 1792, 20 in 1793,

21 in 1794, 11 in 1795, 37 in 1796, 51 in 1797, which appears to have been a year of unwonted activity in the demand for patents, as only one week passed without one being granted. In 1798 the business fell off one-half, only 25 patents being awarded, and in 1799 39 were granted. Among the patents for those ten years we find 16 for nail-making machines, though nearly all the nails used even during the first years of this century were made by hand, as blacksmiths formerly made horseshoe nails. During this period only two patents were issued for washing machines, but 128 such machines were patented last year, and several thousand patents had already been issued for such devices. We do not find a single patent issued for a churn during these ten years, though the pump was patented nine times. Here we note that Eli Whitney's cotton gin was patented March 14, 1794. Hodgen Holmes of Georgia also patented a cotton gin two years later, March 12, 1796, and John Murray of Georgia also patented one December 23 of the same year. John Fitch's patent for propelling boats by steam was taken out August 26, 1791.

During the ten years beginning with 1790 five patents were awarded for candlemaking, 12 for all kinds of mills for sawing or grinding, 12 where steam was the leading word in the titles, one for the manufacture of boots, one for a bed, four for handling and treating flax, five for distilleries, five for threshing machines, seven for all kinds of tile and brick-making devices, 11 for methods of propelling boats, three for the pendulum, two for the windmill, four for papermaking, three for looms and weaving, four relating to iron and steel, four for iron stoves, three for cleaning rice, two for printing presses, three for bridges, three for pills, two for bread and dough-making, three for salt-making, four for saws, and two for tobacco-making. During these ten years one patent was issued for each of the following articles: A bell, wire, furnace, piano, plow, clock, saddle, boat, broom, cultivator, comb, chimney, window, soap, a fire-engine, and a tooth extractor. During the last decade of the last century only 249 patents were issued by the Government. Even as late as Jefferson's administration, Cabinet meetings were frequently called to consider applications for patents. A thousand patents are now issued for one during the last ten years of the last century.

Thousands of patentees, for only a brief period, enjoyed the ownership of the property their talents created, and even during that period they realized only a very small portion of the benefit flowing from their inventions, the public reaping the larger share in added comfort and lower prices. In order to induce able men to give their time and talent to inventive work, Congress was authorized in the Constitution to secure "for limited times to authors and inventors the exclusive right to their writings and discoveries," in order "to promote the progress of science and useful arts," and all can now see how grandly the useful arts have been promoted by the patent laws. While James Watt made money out of his steam-engine patents, the amount he made compared with the benefit he conferred upon the human race and the wealth his inventions created, is an exceedingly small fraction of the one-thousandth part of a sovereign. We can have no better illustration than this, that the great and permanent value of inventions and discoveries goes to the human family, and lifts the race to higher levels.

Exclusive of applications for the registration of trademarks and labels, the total number of applications received at the Patent Office for the year 1891, including mechanical applications, designs, and re-issues, was 40,552. The total number of patents granted was 23,244, and the total number of registrations was 1,899. The total receipts of the office for the year were \$1,271,286, and the expenditures were \$1,139,713, leaving a surplus of \$131,000 to be turned into the Treasury of the United States. The



balance now in the Treasury to the credit of the patent fund is over four millions of dollars. During the year, 1,928 patents were granted to citizens of foreign countries, 1,538 of them being from England, Germany, Canada, and France. Persia, Peru, Portugal, Roumania, Tasmania, Turkey, Bulgaria, Cape of Good Hope, Ceylon, and Chili asked and obtained one patent each. Japan, San Domingo, Java, Scotland, and South Africa took two each; Brazil, India, and Queensland three each; and South Australia took four.

It is curious to note that while Mississippi takes one patent for every 20,469 of her population, Connecticut takes one for every 1,018 of hers. South Carolina takes one patent for every 23,490 of her population, and Massachusetts one for every 1,055 of hers. North Carolina takes one for every 21,288, and Rhode Island one for every 1,191. Georgia takes one patent for every 14,817 persons, and New York one for every 1,635. Alabama took one for every 18,457, and Illinois one for every 1,944. Where we find the largest general intelligence, the widest diffusion of the benefit of free schools, there we find the largest inventive activity and the best fruitage of mechanical talent.

Many great American inventors have earned world-wide fame: Fitch and Fulton for steamboats, Whitney for the cotton gin, Evans for milling machinery, Whittemore and Jenks for looms, Terry, Ives, and Jerome for clocks, Lorillard for tobacco-making, Edwards for leather-making, Wood for plows, Blanchard for lathes for turning irregular forms, Spencer for geometrical lathes, Hoe, Adams, and Gordon for printing presses, Collins and Root for axe-making, Ames for shovels, Woodworth for wood machinery, Fairbanks and Howe for scales, Howe and Crosby for pinmaking, Knott and Mott for stoves, Stuart for sugar refining, Baldwin and Winans for locomotives, Pullman for sleeping cars, McCormack and Ketchum for reapers, Colt, Sharp, Spencer, Smith, and Wesson for fire-arms, Phillips for matches, Wells for hats, Goodyear for india rubber, Ericsson for naval construction and hot-air engines, Howe, Wilson, Singer, Gibbs, Grover, and Baker for sewing machines, Morse for the telegraph, Tatham for lead pipe, Whipple for screws, Chickering and Steinway for pianos, Burden for horseshoes, Yale for locks, Roebling for wire cables, Corliss for steam engines, Disston for saws, Stephenson for horse-cars, and Gatling for quick-firing guns.

The result of all this activity is to be seen in the comfortable condition of the working classes in America. During the term of his patent the inventor, or his assignee, may make money out of it, but when it expires it practically becomes a gift to the masses. The producing power of the world has been increased manifold, without any corresponding increase in the consuming power of the upper classes. The wealthy do not eat more bread and meat to-day than they did years ago. Yet the output of these commodities has been vastly augmented, and they are consumed in large quantities by a section of the population which once seldom got flesh food, and often went short of bread. And so of nearly every other industry; the working classes take the bulk of what is produced, for the very good reason that they are able, by the aid of machinery, to turn out several times as much work in a day as could their forefathers. At the same time that their production has increased, their actual labor has diminished. A man with a heavy job in a foot-lathe not only worked slowly, but painfully. When his long day was ended every faculty was exhausted, and he tramped home to rest, expended both in body and mind. Now he looks on while the lathe does the work, and in the evening discusses the provisions of the Employers' Liability Act. His hours, too, are shorter than they were, while the appreciation of gold, which has taken place, has enormously increased his wages by augmenting their purchasing power.—*Engineering.*



Incorporated  
1866.

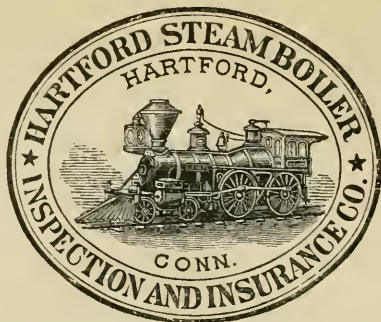

Charter Per-  
petual.

Issues Policies of Insurance after a Careful Inspection of the Boilers,  
COVERING ALL LOSS OR DAMAGE TO  
**BOILERS, BUILDINGS, AND MACHINERY.**

ALSO COVERING  
**LOSS OF LIFE AND ACCIDENT TO PERSONS**

ARISING FROM

## Steam Boiler Explosions.

Full information concerning the plan of the Company's operations can be obtained at the  
**COMPANY'S OFFICE, HARTFORD, CONN.,**  
Or at any Agency.

**J. M. ALLEN, President.**

**W. B. FRANKLIN, Vice-Prest.**

**J. B. PIERCE, Secretary.**

**FRANCIS B. ALLEN, 2d Vice-Prest.**

**E. J. MURPHY, M. E., Consulting Engineer.**

### Board of Directors.

**J. M. ALLEN, President.**  
**FRANK W. CHENEY, Treas.** Cheney Brothers Silk Manufacturing Co.  
**CHARLES M. BEACH, of Beach & Co.**  
**DANIEL PHILLIPS, of Adams Express Co.**  
**RICHARD W. H. JARVIS, Prest.** Colt's Fire Arms Manufacturing Co.  
**THOMAS O. ENDERS, President of the U. S. Bank.**  
**LEVERETT BRAINARD, of The Case, Lockwood & Brainard Co.**  
**GEN. WM. B. FRANKLIN, late U. S. Commissioner to the Paris Exposition.**  
**NELSON HOLLISTER, of State Bank, Hartford.**

**HON. HENRY C. ROBINSON, Attorney-at-Law, Hartford, Conn.**  
**HON. FRANCIS B. COOLEY, of the National Exchange Bank, Hartford, Conn.**  
**EDMUND A. STEDMAN, Treasurer of the Fidelity Co., of Hartford, Conn.**  
**GEORGE BURNHAM, Baldwin Locomotive Works, Philadelphia.**  
**HON. NATHANIEL SHIPMAN, Judge United States Circuit Court.**  
**C. C. KIMBALL, Pres. Smyth Mfg. Co., Hartford, Conn.**  
**PHILIP CORBIN, of P. & F. Corbin, New Britain, Conn.**

### GENERAL AGENTS.

**THEO. H. BABCOCK,**  
**CORBIN & GOODRICH,**  
**LAWFORD & McKIM,**  
**C. E. ROBERTS,**  
**H. M. LEMON,**  
**C. C. GARDINER,**  
**L. B. PERKINS,**  
**W. G. LINEBURGH & SON,**  
**BURWELL & BRIGGS,**  
**MANN & WILSON,**  
**ZOLLARS & McGREW,**  
**R. F. MANLY,**  
**W. S. HASTIE & SON,**  
**PETER F. PESCU,**

### CHIEF INSPECTORS.

**R. W. McMURRAY,**  
**WM. J. FARRAN,**  
**F. S. ALLEN,**  
**WM. HEAFORD,**  
**A. B. ECOFF,**  
**F. S. ALLEN,**  
**J. H. RANDALL,**  
**C. A. BURWELL,**  
**J. B. WARNER,**  
**T. E. SHEARS,**  
**B. F. JOHNSON,**

**NEW YORK CITY,**  
**PHILADELPHIA, PA.**  
**BALTIMORE, MD.**  
**BOSTON, MASS.**  
**PROVIDENCE, R. I.**  
**CHICAGO, ILL.**  
**ST. LOUIS, MO.**  
**HARTFORD, CONN.**  
**BRIDGEPORT, CONN.**  
**CLEVELAND, OHIO.**  
**SAN FRANCISCO, CAL.**  
**DENVER, COL.**  
**BIRMINGHAM, ALA.**  
**CHARLESTON, S. C.**  
**NEW ORLEANS, LA.**

### OFFICES.

Office, **285 Broadway.**  
" **432 Walnut St.**  
" **22 So. Holliday St.**  
" **125 Milk St.**  
" **29 Weybosset St.**  
" **112 Quincy St.**  
" **404 Market St.**  
" **218 Main Street.**  
" **2 Sanford Building.**  
" **208 Superior St.**  
" **306 Sansome St.**  
" **Mining Ex. B'g.**  
" **Morris Building.**  
" **44 Broad St.**  
" **188 Gravier St.**

# The Locomotive.

PUBLISHED BY THE HARTFORD STEAM BOILER INSPECTION AND INSURANCE COMPANY.

NEW SERIES—VOL. XIV. HARTFORD, CONN., JULY, 1893.

No. 7.

## On Separators.

The time was, when manufacturers paid comparatively little attention to the smaller losses that occurred in their mills and factories. Competition was not severe, and it was not considered necessary to keep a watchful eye on the innumerable small leaks through which profits escaped. It is doubtful, indeed, if many of these losses were

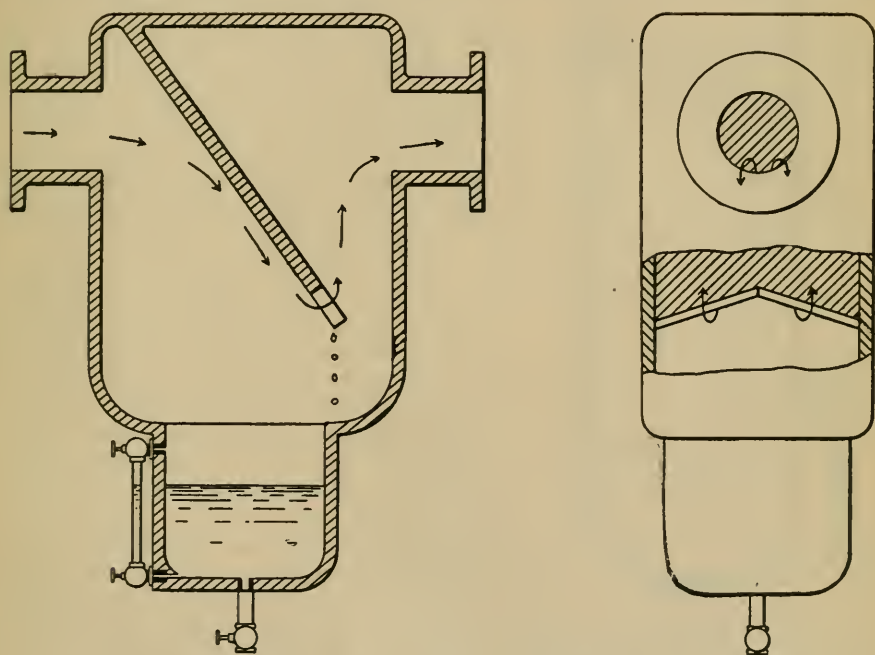

FIGS. 1 AND 2. — DIAGRAMMATIC VIEWS OF THE MOMENTUM SEPARATOR.

properly appreciated, and perhaps many of them were not even perceived. Now, however, all these things are changed. Competition in all lines of manufacturing has increased tremendously, and the narrow margins on which business must be done make the most trifling losses worthy of serious consideration; and it has been well said that the word "waste" is rapidly becoming obsolete. Things that were formerly regarded as worthless, and thrown away without a thought, are now hoarded up with care and

worked over for such pennies as can be extracted from them by improved processes of recovery; and it is not uncommon to find several prosperous companies thriving on what were once the "waste products" of a single large one. The importance of utilizing everything is well illustrated in the soda-ash works, where the greatest ingenuity has been exercised in devising means for utilizing every one of the by-products and every particle of the "waste." This studied economy shows itself, of

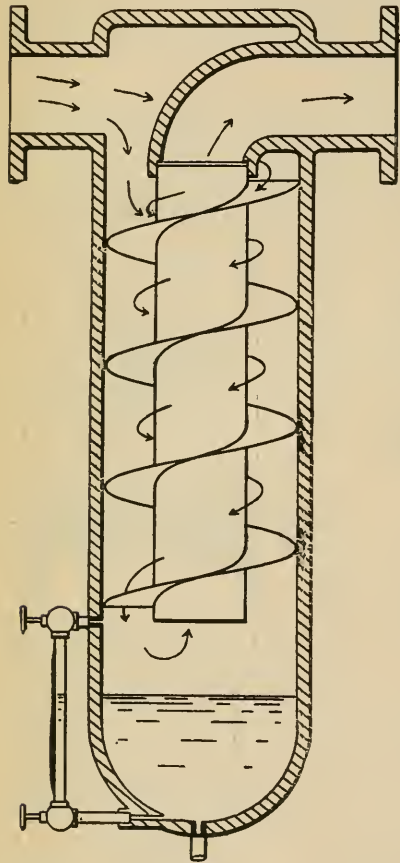

FIG. 3. — DIAGRAM SHOWING THE PRINCIPLE OF CENTRIFUGAL SEPARATORS.

course, in the use of steam; and we find mills fitted out with triple-expansion engines, and running at pressures that call for the utmost skill in designing boilers that shall carry these pressures safely. The drips from the pipes are carefully collected and returned to the boiler-house, and heat that would otherwise be wasted is utilized for heating feed water.

As the utilization of waste is increasingly realized, new problems are continually arising and forcing themselves on our attention. Thus, in saving the heat from exhaust steam, it was soon found that when open heaters are used, the oil particles that are carried along from the engine pass into the feed water, and give trouble in the boilers. The action of oily or greasy matter in boilers will be understood from the following extract from the *LOCOMOTIVE* for March, 1885:

"The action of grease in a boiler is peculiar, but not more so than we might expect. It does not dissolve in the water, nor does it entirely decompose. Neither does it remain on top of the water; but it seems to form itself into what may be described as 'slugs,' which at first seem to be slightly lighter than the water — of just such a density, in fact, that the circulation of the water carries them about at will. After a short season of boiling, these 'slugs' or suspended drops seem to acquire a certain degree of stickiness, so that when they come in contact with the shell and flues of the boiler they begin to adhere thereto. Then under the action of heat they begin the process of 'varnishing' the interior of the boiler. The thinnest possible coating of this

varnish is sufficient to bring about overheating of the plates, as we have found repeatedly in our experience. We emphasize the point that it is *not* necessary to have a coating of grease of any appreciable thickness to cause overheating and bagging of plates, and leakage at seams. The time when damage is most likely to occur is after the fires are banked; for then the formation of steam being checked, the circulation of water stops, and the grease has a chance to settle on the bottom of the boiler and pre-

vent the contact of water with the fire-sheets. Under these circumstances, a very low degree of heat in the furnace is sufficient to overheat the plates to such an extent that bulging is very likely to occur." Of course there is greater likelihood of trouble with some kinds of oil than with others, animal oils being most troublesome, and mineral oils least so.

Various means have been devised for preventing the harmful effects of oil in boilers, and one of the most common of these is the *separator*. The object of this appliance is to free the steam of such particles of water, oil, or dirt as it may hold in suspension. When the object is to remove entrained water, the separator is placed in the steam main, near the engine; and when it is used to remove oil, it is placed in the exhaust pipe between the engine and the heater. There are a great number of makes of separators on the market, but all of them depend for their action on the great mobility of steam, and the inertia of solid or liquid particles. For convenience, however, we may divide them into two classes, which we may call momentum separators, and centrifugal separators, respectively. Our illustrations of these two types are to be considered merely as *diagrams* illustrating the principles of the separator, and in no sense as pictures of appliances that are in actual use.

Fig. 1 shows the principle on which the momentum separator is based. Steam enters it at one nozzle and leaves it by the other, its general course being indicated by the arrows. Directly across the course of the steam there is a plate of iron, called the *baffle-plate*. This baffle-plate causes the steam to deflect downward, but the oil-particles, on account of their momentum, impinge against the plate, and collect in drops until they run down and fall into the receiver below. Usually the baffle-plate is not cut square across at the bottom, but runs obliquely across the casing, as shown in Fig. 2, so as to lead the oil drops to one side and prevent them from falling directly through the main current of steam. The reservoir or catch-basin is provided with a gauge-glass to indicate the height of the oil and water in it, and also with a cock for drawing them off. Some provision should also be made for removing the particles of mud and grit that are liable to collect.

Fig. 3 shows a centrifugal separator, in which the steam is made to circulate spirally around a central core, the centrifugal action so developed throwing the particles of oil and water to the sides of the casing, where they collect and flow down into the catch-basin below, a glass-gauge and a cock being provided, as before.

The principles illustrated in these diagrams are applied in practice in a great variety of ways. Thus, we note in a single trade journal the advertisements of Stratton's, Robertson's, Simpson's, Hine's, Cochrane's, Curtis's, Lowden's, and Stuart's separators, and also the "Climax," and the "Straight Line"; and we do not doubt that there are many other excellent ones. It would be impossible to describe all of these makes impartially in the present article. We have simply set forth the principles on which they are all based, and further information concerning the details can doubtless be obtained readily from the various manufacturers.

WE have received a copy of *A Columbian Tribute*, published for the Worcester (Mass.) Board of Trade. It is a very creditable and interesting publication, containing fine views of the public buildings of Worcester, and much information about the manufactures and other industries of that enterprising city.



## Inspectors' Report.

MARCH, 1893.

During this month our inspectors made 7,071 inspection trips, visited 13,943 boilers, inspected 4,955 both internally and externally, and subjected 737 to hydrostatic pressure. The whole number of defects reported reached 10,454, of which 1,561 were considered dangerous; 52 boilers were regarded unsafe for further use. Our usual summary is given below:

Nature of Defects.	Whole Number.	Dangerous.
Cases of deposit of sediment, - - - -	717 -	38
Cases of incrustation and scale, - - - -	1,314 -	49
Cases of internal grooving, - - - -	109 -	13
Cases of internal corrosion, - - - -	520 -	44
Cases of external corrosion, - - - -	721 -	40
Broken and loose braces and stays, - - - -	117 -	32
Settings defective, - - - -	220 -	24
Furnaces out of shape, - - - -	363 -	14
Fractured plates, - - - -	280 -	48
Burned plates, - - - -	181 -	20
Blistered plates, - - - -	245 -	8
Cases of defective riveting, - - - -	2,217 -	686
Defective heads, - - - -	90 -	20
Serious leakage around tube ends, - - - -	1,876 -	309
Serious leakage at seams, - - - -	466 -	40
Defective water-gauges, - - - -	195 -	27
Defective blow-offs, - - - -	130 -	29
Cases of deficiency of water, - - - -	14 -	5
Safety-valves overloaded, - - - -	54 -	9
Safety-valves defective in construction, - - - -	76 -	25
Pressure-gauges defective, - - - -	438 -	48
Boilers without pressure-gauges, - - - -	33 -	33
Unclassified defects, - - - -	78 -	0
Total, - - - -	10,454 -	1,561

## Boiler Explosions.

MAY, 1893.

(120.)—A boiler explosion occurred on May 2d in Mr. John Holloway's mill, in Pleasant Shade, Greensville Co., Va. Two negroes were killed.

(121.)—A small boiler exploded at Dr. Luce's place, in Buffalo, N. Y., on May 3d. Three large windows were shattered, but it is thought that the damage will not amount to more than fifty dollars. Nobody was seriously hurt.

(122.)—The boiler furnishing power for S. R. Crumbaker's mill in Chandlersville, O., exploded on May 5th. Alexander Barber was struck by flying débris, and his arm was broken, and he received internal injuries that are likely to prove fatal.

(123.)—A fearful explosion occurred on the Mississippi river on May 7th. The steamer *Ohio*, belonging to the Memphis and Cincinnati Packet company, collapsed a flue as she passed Wolf Island, thirty miles below Cairo, Ill., and Hampton Collins, W. W.

Hurshman, Cyrus Myers, Thomas Woods, and three unidentified men were killed. R. W. Carew was fatally wounded, and W. H. Dickey, Aaron B. Johnson, C. J. Pellman, John Ralph, D. R. Randolph, Edward Ross, Gilbert Childres, Evans Freeman, William Henry, James Howard, Charles Jackson, William Jackson, Fred Neil, Albert Robinson, Holden Tate, Charles Thomas, and George Washington were badly scalded, and the physicians said that ten of them will die. When the flue collapsed, the rear head of the boiler also blew out, and the contents of the boiler were discharged among the injured persons. The *Ohio* had headway enough to carry her to the river bank, and she was made fast and attention was given to the wounded men. Two hours after the explosion the *Aegeus* reached the scene of the disaster, and was at once placed at the disposal of the *Ohio*, and the passengers were taken up the river to Cairo, where the wounded were cared for in the Marine Hospital.

(124.)— On May 8th a boiler exploded in O'Brien's feather renovating establishment, in New Bremen, Ohio. Franklin Huencke, an employe, was severely scalded, and narrowly escaped death.

(125.)— A boiler exploded in Kansas City, Mo., on May 8th, killing Edward C. Kelleher, the fireman.

(126.)— On May 8th a boiler exploded near the town of Mitchell, in Martin County, Ind. Francis Baker was fatally wounded, and three others, whose names we have not learned, were injured seriously but not fatally.

(127.)— The boiler belonging to Erskine & Co., in Carbon, near Youngstown, Ohio, exploded on May 9th. William Holliday and Lawrence Ripple, who were in the boiler room at the time, were fearfully injured, and Holliday died shortly after the explosion. At last accounts Ripple was living, but it was thought that there was very little chance of his recovery. After the explosion the ruins took fire, and the entire property would have been destroyed but for the prompt action of Foreman Geddes, under whose direction the fire was soon controlled.

(128.)— On May 10th the electric light station in La Junta, Col., was utterly destroyed by the explosion of one of the boilers. Not a vestige of the large building was left standing. It was valued at \$20,000. Charles Shepard, the night engineer, was blown 100 feet away, striking against a large flouring mill. He was terribly injured, and died in about ten minutes. Lester Edmunds was struck by flying débris, and may die. One of the boilers was hurled entirely through the La Junta planing mill, 100 feet away, destroying a heavy planer in its course. The damage to this mill is estimated at \$3,000.

(129.)— By the explosion of a boiler in a factory in Sheboygan, Mich., on May 11th, Herman Schultz, the fireman, was badly scalded about the face and hands.

(130.)— On May 12th two boilers exploded at Lawrence & Moore's colliery, Mahanoy Plane, Pa. The explosion displaced five other boilers, and wrecked the boiler-house completely. The loss was estimated at \$3,000.

(131.)— Four persons were killed and several injured on May 13th by the explosion of the boiler of engine No. 948 of the Philadelphia & Reading railroad, at Lebanon, Pa. The killed are Levi Yocum, John Yocum, George Solliday, and Willie Loudon. William Anspach was fatally injured, and his daughter Annie, who had just brought her father's dinner, was also seriously and perhaps fatally injured. George Seiler and Isaac Beard were seriously hurt, and several persons who were half a block away received minor injuries.

(132.)—On May 15th a boiler exploded in Morgan Bros.' new mill in Big Sandy, Tex. A. Holland lost a leg and an arm, and died shortly afterwards. J. H. Morgan, one of the owners of the mill, was perhaps fatally hurt. His head was badly bruised and cut, and he is not rational. Bert Rollins, the engineer, escaped with but slight injuries. The boiler-house was blown to atoms, and large timbers, it is said, were blown a full mile away. The property loss was estimated at \$3,000.

(133.)—A boiler exploded on May 15th in Smith & Thallman's mill in Pakota, near Salem, Ill. The explosion occurred at the noon hour, and no one was killed, although the mill was wrecked.

(134.)—On May 16th a boiler exploded in W. D. Arthur's mill in Kingwood, W. Va., completely demolishing the building. The only person hurt was Howard Hileman, whose collar bone was broken, his legs burned, and his hands badly smashed. His injuries are considered very grave.

(135.)—The electric light plant in Eldora, Iowa, was wrecked on May 18th by the explosion of one of the boilers. The power-house and two frame buildings adjoining were completely destroyed, and Dr. A. E. Gier, who occupied one of the buildings, was instantly killed. Louis Templeman, the fireman, was buried under two feet of bricks. His left leg was broken in two places and he is so badly injured about the head that it is believed that he cannot live. A piece of the boiler carried in the end of the Ellsworth House, and several other buildings were injured. The ruined plant was completed one year ago, and cost \$20,000. The total property loss is estimated at \$25,000.

(136.)—On May 19th a boiler exploded at Judd's mill, seven miles north of Columbia City, Ind., completely wrecking the mill, and instantly killing Charley Judd, the eight-year-old son of the proprietor, Christian Judd, who was himself seriously scalded. Frank Hass, a mill hand, was also severely injured. The mill was wrecked.

(137.)—On May 21st a boiler exploded on the steam yacht *Eva* on Lake Winnebago, near Oshkosh, Wis. The yacht belongs to Daniel Jones. Mrs. Jones was seriously injured, and Mr. Jones was injured slightly.

(138.)—One of a battery of five boilers exploded in Keene, N. H., on May 22d, at the Beaver mills. Herbert G. Holton and Lewis W. Starkey were killed, and Frank Droulette, George H. Carpenter, Gregory Carpenter, Michael Roach, George W. Piper, and William Clark were badly injured. Droulette died later in the day, and Piper was so badly cut and bruised that his recovery was considered doubtful. The building was badly wrecked, and the damage was estimated at \$20,000.

(139.)—A boiler exploded on May 17 in Marks Bros.' mill, near Leon, Iowa. Henry Honks and Anthony Marks were badly scalded, the former perhaps fatally so. Honks was blown 25 or 30 feet, over a pile of lumber. His back was badly hurt, his head was cut, and he was severely scalded about the head and shoulders. At last accounts his recovery was considered doubtful. The boiler buried itself in the ground nearly a hundred yards from the mill.

(140.)—On May 25th a boiler exploded in Ring, Merrill & Tillotson's factory in Saginaw, Mich. Some damage was done in the engine and dynamo rooms, but it is thought that the loss will not exceed \$300 or \$400. The fireman received a severe scalp wound.

(141.)—One of the large boilers in Truibb & Co's mill, in Capron, Va., exploded on May 26th. The fireman was somewhat injured. Pieces of the boiler were blown 500 yards. The loss is estimated at between \$10,000 and \$15,000.

### The Comparative Costs of Feed Waters.

In an article under this heading in the May issue of the *LOCOMOTIVE* we compared the costs of town water and well-water, when used in boilers. Several items of expense were omitted, partly to make the article as brief as possible, and partly because we did not wish to appear too much prejudiced against the use of well-water. There is one item, however, that we might have included without laying ourselves open to such a charge, and without making the article too long; and that is, the cost of pumping.

If water is drawn from a well and pumped into a boiler, we have to raise it from the level of the water in the well to that of the water in the boiler, and then we have to force it into the boiler against the steam-pressure. If town water is available, we do not have to raise it at all, and the pressure in the town main helps to introduce the water into the boiler. In some places the pressure of the town water is such that under ordinary circumstances the pump is not needed; but in most cases it will be necessary to pump the feed water into the boilers, whether town water be used or not. The "head" of the town water will make the pumping easier, however, and the "head" of the well-water will make it harder; because in the first case we pump *with* the head, and in the other case *against* it.

To estimate the difference in the expense of pumping the two kinds of feed-water, let us assume that the water in the well is 15 feet below the water-line of the boiler, and that the pressure in the town main is 40 pounds to the square inch (corresponding to a head of about 92 feet.) Then the difference in the expense of pumping is equal to the cost of raising the entire amount of feed-water used to a height of  $92+15=107$  feet. In the May issue we assumed that the boiler evaporated 396,000 pounds of water in the run of three weeks. To raise 396,000 pounds of water to a height of 107 feet would require an expenditure of  $396,000 \times 107 = 42,372,000$  foot-pounds of work. With a good modern multicylinder pumping engine this could probably be done with about 35 pounds of coal; but with the average steam pump used for feeding boilers we could not reasonably expect to do it with less than about 100 pounds. With coal at \$4.50 a ton (the price assumed in the May *LOCOMOTIVE*) 100 pounds of coal would cost 22 cents. This, it will be seen, is smaller than any of the items considered in the previous article, and to charge it up against the well-water might seem like splitting hairs; yet it is the small items that count, in the long run, and they ought always to be carefully considered and investigated, even if they turn out, in the end, to be negligible.

### The Tin Plate Industry.

The following extract from the report of Mr. Ira Ayer, special agent of the Treasury Department for the collection of tin and terne plate statistics in the United States, will be of interest to many of our readers. We are indebted for it to the *Metal Worker*.

"I have the honor to report that during the quarter ended December 31, 1892, 32 firms produced 19,756,491 pounds of tin and terne plate proper. The same number of firms produced during the previous quarter 10,952,725 pounds. Of the production of the past quarter 6,138,739 pounds, or a little less than one-third of the whole, were bright tin plates, of which 5,274,434 pounds, or about 86 per cent., consisted of the class of plates weighing lighter than 63 pounds per 100 square feet; 13,617,752 pounds were terne plates, of which 12,684,646 pounds, or more than 93 per cent., belonged to the lighter class; of the entire product nearly 91 per cent. consisted of the lighter class of plates.



“The amount of American sheet-iron and steel made into articles and wares tinned or terne during the quarter, as shown by the sworn statements of manufacturers received to date, was 2,245,506 pounds, and for the previous quarter 898,233 pounds. This makes the total production for the last quarter, within the meaning of the law, 22,001,997 pounds, against 11,850,958 pounds produced during the quarter ending September 30, 1892, and shows a total production for the six months ending December 31, 1892, including the products from American sheet-iron and steel tinned of 33,852,955 pounds.

“The production of tin and terne plates proper during the first six months of the present fiscal year was 30,709,216 pounds, against 2,236,743 pounds produced during the corresponding period of the previous year, the ratio of increase having been nearly as 1 to 14. The production of the last fiscal year was 13,646,719 pounds, which is considerably less than one-half the production during the first six months of the present year.

“Of the production of 19,756,491 pounds of tin and terne plates proper during the past quarter, 8,043,449 pounds, or more than 40 per cent., were made from American black plates, against 5,920,082 pounds used during the previous quarter. The consumption of American plates in the production of tin and terne plates proper during the first six months of the present fiscal year was 13,963,531 pounds, or 316,812 pounds more than the total product of tin and terne plates proper during the first year that the law became operative. The consumption of American plates for the same purpose during the first six months of the fiscal year ending June 30, 1892, was 1,986,208 pounds, the ratio of increase for the corresponding period of the present fiscal year having been as 1 to 7. The total consumption of American plates, including articles made from sheet-iron or steel and tinned, during the first six months of the last fiscal year was 4,474,755 pounds, and for the first six months of the present fiscal year 17,107,270 pounds.

“Of the 32 firms who submitted their sworn returns for the quarter, nine made and used their own black plates exclusively, four others used only American plates, nine used both American and foreign plates, and ten used only foreign plates. The American plates are generally preferred by manufacturers to the foreign.”

---

THE fearful accident to the British war-ship *Victoria* in the Mediterranean sea has been fully described in the daily papers, and we can add little to their reports except an expression of sympathy for the friends of the 370 men that lost their lives. An eye-witness of the disaster says, “The sight as the vessel finally sank was most thrilling. The enormous twin screws were whirling rapidly in the air, in the absence of any resistance, going at a tremendous rate; and although the sea around the vessel had become at the moment comparatively calm, when the hull settled so that the blades of the screws struck the water, an enormous cloud of spray shot into the air, and in another second, with a sound that appeared to be a giant gurgle, the vessel passed out of sight, and the water for 200 feet in every direction foamed and hissed and rushed towards the maelstrom that circled over the grave of the *Victoria*. The waters were still agitated when two muffled sounds from below and a heaving of the water showed that the boilers had exploded [?] beneath the surface, and then in a few moments the sea became calm, and there was nothing but some floating débris to mark the spot.”

---

THE *Report* for 1892 of the Hannover *Verein zur Ueberwachung der Dampfessel* is at hand. We desire also to acknowledge the *Report* for 1892 of chief Engineer Sinigaglia, of the Naples *Associazione fra gli utenti di caldaie a vapore*.

## The Hodgkins Fund Prize Essays on Air.

Prof. S. P. Langley, Secretary of the Smithsonian Institution, has issued the following circular to the scientists of the world:

"In October, 1891, Thomas George Hodgkins, Esq., of Setauket, New York, made a donation to the Smithsonian Institution, the income from a part of which was to be devoted to the 'increase and diffusion of more exact knowledge in regard to the nature and properties of atmospheric air in connection with the welfare of man?' With the intent of furthering the donor's wishes, The Smithsonian Institution now announces the following prizes to be awarded on or after July 1, 1894, should satisfactory papers be offered in competition: (1) A prize of \$10,000 for a treatise embodying some new and important discovery in regard to the nature or properties of atmospheric air. These properties may be considered in their bearing upon any or all of the sciences — *e. g.*, not only in regard to Meteorology, but in connection with hygiene, or with any department whatever of biological or physical knowledge. (2) A prize of \$2,000 for the most satisfactory essay upon—(a) The known properties of atmospheric air considered in their relationships to research in every department of natural science, and the importance of a study of the atmosphere considered in view of these relationships; (b) The proper direction of future research in connection with the imperfections of our knowledge of atmospheric air, and of the connections of that knowledge with other sciences. (The essay, as a whole, should tend to indicate the path best calculated to lead to worthy results in connection with the future administration of the Hodgkins foundation.) (3) A prize of \$1,000 for the best popular treatise upon atmospheric air, its properties and relationships (including those to hygiene, physical and mental). This essay need not exceed 20,000 words in length; it should be written in simple language, and be suitable for publication for popular instruction. (4) A medal will be established, under the name of the HODGKINS MEDAL OF THE SMITHSONIAN INSTITUTION, which will be awarded annually or biennially, for important contributions to our knowledge of the nature and properties of atmospheric air, or for practical applications of our existing knowledge of them to the welfare of mankind. This medal will be of gold, and will be accompanied by a duplicate impression in silver or bronze.

"The treatises may be written in English, French, German, or Italian, and should be sent to the Secretary of the Smithsonian Institution, Washington, before July 1, 1894, except those in competition for the first prize, the sending of which may be delayed until December 31, 1894. The papers will be examined, and prizes awarded, by a committee to be appointed as follows: One member by the secretary of the Smithsonian Institution, one member by the President of the National Academy of Sciences, one by the President *pro tempore*, of the American Association for the Advancement of Science; and the committee will act together with the Secretary of the Smithsonian Institution as member, *ex officio*. The right is reserved to award no prize if, in the judgment of the committee, no contribution is offered of sufficient merit to warrant an award. An advisory committee of not more than three European men of science may be added at the discretion of the committee of award. If no disposition be made of the first prize at the time now announced, the Institution may continue it until a later date, should it be made evident that important investigations relative to its object are in progress, the results of which it is intended to offer in competition for the prize. . . .

"It is probable that special grants of money may be made to specialists engaged in original investigation upon atmospheric air and its properties. Applications for grants of this nature should have the endorsement of some recognized academy of sciences, or other institution of learning, and should be accompanied by evidences of the capacity of the applicant, in the form of at least one memoir already published by him, based upon original investigation. To prevent misapprehension of the founder's wishes, it is repeated that the discoveries or applications proper to be brought to the consideration of the committee of award, may be in the field of any science or any art, without restriction; provided only that they have to do with 'the nature and properties of atmospheric air in connection with the welfare of man.'"

# The Locomotive.

HARTFORD, JULY 15, 1893.

J. M. ALLEN, *Editor.*

A. D. RISTEEN, *Associate Editor.*

THE LOCOMOTIVE can be obtained free by calling at any of the company's agencies.

Subscription price 50 cents per year when mailed from this office.

Bound volumes one dollar each. (Any volume can be supplied.)

Papers that borrow cuts from us will do us a favor if they will mark them plainly in returning so that we may give proper credit on our books.

WE desire to acknowledge a copy of the April number of the *Rivista Marittima*, published at Rome. It contains an interesting and important article by Chief Engineer R. Bettini on the protective armor of war-vessels.

THE second biennial report (76th and 77th annual reports) of the directors and officers of the American Asylum for the Deaf and Dumb, of Hartford, is at hand. The report includes a brief history of the institution, together with portraits of its founders. The asylum is doing good work, and its officers have our heartiest commendation.

PRESIDENT J. M. Allen was elected one of the judges of awards in the Mechanical Department of the World's Fair. While deeply interested in all that is being accomplished by this wonderful Exposition, regarding it as the greatest educational institution of this or any previous century, circumstances beyond his control compelled him to decline the honor.

PRESIDENT Allen has also been invited by the Hon. Ephraim Banning, Chairman of the World's Congress Auxiliary, to deliver an address or read a paper before the Congress, that meets early in October, relating to industrial property and kindred topics. He has the matter under consideration, and, if he accepts, will probably have something to say on subjects growing out of his experience in the field closely allied to the development of our resources through mechanical agencies.

HERR J. F. Radinger, of Vienna, has kindly favored us with copies of his works on *Dampfmaschinen und Transmissionen in den Vereinigten Staaten*, and on *Dampfkessel und deren Ausrüstung in den Vereinigten Staaten*. Both of these books are clearly written, and they give excellent accounts of the boilers and engines in use in this country. The former (on the steam engine,) contains 256 cuts, and the latter (on the steam boiler) contains 107; so that both are very fully illustrated. The logical way in which Herr Radinger classifies the subject-matter of his books could be imitated with advantage by other writers on these subjects.



PROFESSOR J. RADINGER, of the Technological Department of the University of Vienna, Austria, with his wife, were the guests of President Allen, July 3d and 4th. Professor Radinger is one of the Austrian Commissioners to the Columbian World's Fair. His high attainments, particularly in the field of practical science, are fully recognized in his own country. His notes on the Fair were copious, and we shall expect in due time to receive his impressions of the Great Exposition.

---

### Obituary.

ASA W. JILLSON.

It is with feelings of deep regret that we record the death of Asa W. Jillson, which occurred April 21, 1893. Mr. Jillson had been a director in the Hartford Steam Boiler Inspection and Insurance Company since 1886. He was Vice-President of the Phoenix Fire Insurance Company of this city for many years, but retired several years before his death. He was also a director in the Travelers Insurance Company, the Southern New England Telephone Company, and the Hartford Light and Power Company. He was highly regarded in insurance circles in all parts of the country. He will be remembered by all who knew him as a most genial and companionable gentleman, and at the same time one of strict integrity in all business relations. He frowned upon everything that was tricky or underhanded. We shall greatly miss his pleasant greetings and sound advice in the meetings of our board. Mr. Jillson was 70 years old at the time of his death.

---

EUROPE has her boiler explosions, too. A dispatch from Paris says that on May 15 a boiler exploded in Robert's cloth factory, at Sedan. Twenty persons, it is reported, were killed, and many more were injured. On May 17 a boiler exploded in the glucose factory at Geneva, killing seven men, and completely wrecking the plant, which was valued at \$300,000. On May 19 (according to a Berlin dispatch) a locomotive boiler exploded in Ilmenau, Saxe-Weimar, killing five persons instantly, and injuring a number of others so badly that at last accounts eight of them were in a dying condition. A St. Petersburg dispatch says that as the steamer *Alfous*, employed in the river trade on the Volga, was approaching Romanov, on July 4, her boilers exploded, killing twenty-six passengers, among whom was General Petrushevski. The explosion tore the upper part of the steamer to pieces, and the burning coals blown from the furnaces set fire to the wreck. The boat burned to the water's edge and sank.

---

MASTER Arthur Corbin, the 13-year-old son of our Philadelphia agent, Mr. E. A. Corbin, has had a novel experience on board the Russian man-of-war *Dimitri Donskoi*. For the following particulars of it we are indebted to the Philadelphia *Call*. When the *Dimitri Donskoi* first came to Philadelphia Mr. Corbin took the young man down to see it. He was delighted with the vessel, and being anxious to see her captain, he stepped up to an officer and asked him to point the captain out. The officer chanced to be Capt. Zelonoy himself, and he took the young man down into the cabin and showed him his curiosities. Among other things the captain had a fine collection of stamps, and the lad shrewdly offered to "trade" with him. How this proposition was received does not appear; but within an hour or so Master Corbin had been introduced to the Admiral,



and also to the Grand Duke. He afterwards took luncheon with the officers of the ship, and the Admiral made him a sub-lieutenant, giving the proper cap, shoulder straps, and sword, and instructing his men to salute the little officer with proper respect, which they always did. By special invitation of the Grand Duke, Master Corbin went to New York with the *Dimitri Donskoi*, and while there he attended the big banquet given by the mayor, along with the Russian officers. Subsequently he accompanied the vessel on a two-weeks cruise to Boston. He has a number of interesting mementos from the Grand Duke, among which are two buttons from his uniform, and a photograph on the back of which is written: "Grand Duke Alexander of Russia, to Arthur Corbin, 1893."

### Answers to Problems.

In the May issue of THE LOCOMOTIVE we gave some "Problems for Idle Moments," and as our readers have manifested considerable interest in them, the answers are given herewith.

1. Ten cents for each link cut is the better offer; for by cutting all three of the links in one of the pieces of chain, and using these three links to unite the remaining four pieces, the job can be done with three cuts.

2. The multiplicand was 853, and the multiplier was 279. (The multiplicand is the greatest common divisor of 7,677, 5,971, and 1,706, and it can therefore be found by the rules given in the arithmetics for finding the greatest common divisor.)

3. He bought 80 hens, 19 cows, and 1 pig. (Some problems of this kind have several answers. This has but one.)

4. It *does* follow that there are at least two cows in the world with the same number of hairs in their tails.

5. The hands are played as follows: (a) *A* leads the king of diamonds and *C* plays the nine-spot. (b) *A* leads the 7 of spades, and *C* trumps with the queen. (c) *C* leads the king of hearts, and *A* discards the ace of clubs. (d) *C* leads the king of clubs, and *A* discards the 3 of spades. (e) *C* leads the 10 of clubs, and *A* discards the queen of spades, unless it is the best spade out. (In that case, he discards the 7 of diamonds instead.) (f) If *B* has discarded a club during the play, *C* now leads the 6 of clubs, and follows it with the three of diamonds, *A* taking the last trick with the queen of diamonds. If *B* has not discarded a club, *C* leads the 3 of diamonds, and *A* plays the smallest card that will take the trick, and then leads the card that remains in his hand. (This last card may be the 7 of diamonds, queen of diamonds, or queen of spades, according to the previous play.)

6. The answer, to 7 places of decimals, is 60.3553391 miles.

7. Three dogs.

8. The pieces weighed 1, 3, 9, and 27 pounds, respectively.

9. Mr. Brown filled the 5-gallon measure, and from this he filled the 3-gallon one. This left 2 gallons in the 5-gallon measure. He then emptied the 3-gallon measure into the 8-gallon one, and poured into the 3-gallon measure the 2 gallons that remained in the 5-gallon one. He then filled the 5-gallon measure once more, and poured from it into the 3-gallon measure until the latter was full. He then had the required 4 gallons in the 5-gallon measure.

10. Roll them down an inclined plane, starting them together. The solid one will reach the bottom first. The matter composing it is nearer the center of the ball, on the whole, than is the matter composing the lead ball. Hence the solid one can be set rolling easier than the hollow one.

11. The problem is absurd, for it is self-contradictory. An "irresistible force" is a force that can move *anything*. Hence if we assume that such a force exists, we implicitly assume that immovable bodies do not exist.

## The Eighteenth Century.

We are so accustomed to boast about the achievements of this wonderful Nineteenth Century, that we are apt to look back at the eighteenth, its immediate predecessor, with some little contempt. Many of us, indeed, are too apt to class it with the "dark ages," in which there was almost nothing done to improve our knowledge of things. In this we err greatly; for during the eighteenth century there was great activity in the scientific world, and in the world of letters. Thus it was the age of Bolingbroke, Walpole, Swift, Defoe, Pope, Addison, Steele, Bishop Berkeley, Bishop Butler, Halley, Bradley, Chatham, Frederick, Washington, Turgot, Clive, Hastings, Gibbon, Hume, Adam Smith, Kant, Voltaire, Diderot, Rousseau, Richardson, Fielding, Sterne, Smollett, Johnson, Goldsmith, Cowper, Gray, Reynolds, Gainsborough, Hogarth, Garrick, Cook, Watt, Arkwright, Herschel, Black, Priestley, Franklin, Cavendish, Handel, Bach, Haydn, Mozart, Wesley, Whitefield, Pitt, Fox, Burke, Nelson, Bentham, Goethe, Burns, Coleridge, Wordsworth, and Stevenson, as well as many others whose names are familiar to us all. It also includes the French Revolution and the American War of Independence.

Let us see what the eighteenth century did for science. In the very earliest part of it we have the researches of Sauveur, Bernouilli, Euler, and Lagrange on the musical notes given out by stretched strings, and the laws governing the vibration of such strings. In 1701 Boerhaave began his work at the university of Leyden, in Holland, and in a short time he had laid the foundations of the science of organic chemistry. Others had analyzed inorganic substances, and Boerhaave extended the methods of chemistry to organic substances. In 1705 Newcomen constructed his famous single-acting condensing steam engine, which he used for pumping water. The valves were at first operated by hand; but it is related that a boy who was employed to work the engine devised an arrangement of strings by means of which the machine became self-acting. We cannot vouch for the truth of this story. Indeed, it seems as though Newcomen, if skillful enough to construct the engine, would have enough mechanical ingenuity to provide it with self-working valves. In 1722 Graham discovered the daily variation of the compass needle: that is, he found that the direction in which the needle points varies a little, according to the time of day. This movement is very slight, and Graham deserves great credit for detecting it. A few years later Bradley discovered what is known as the *aberration of light*, and showed that the stars are not exactly in the places they appear to be in, though they can never be more than 20" away from their apparent places. He rightly attributed this to the fact that the velocity of light is not infinitely greater than the earth's orbital velocity. Bradley also discovered *nutation*, which is a slight oscillation of the earth's axis. It is not easy to give a popular explanation of either of these phenomena, but they are of great importance to astronomy. About this time Dr. Hales, an English chemist, made experiments on the quantity of water taken in by the roots of plants, and given out by their leaves. He also discovered the way in which plants breathe through the little *stomata*, or openings in their leaves, which were discovered by Grew in 1670. In 1729 Chester More Hall discovered the very important fact that it is possible to make a prism that will *deflect* light, but which will not *decompose* it into colors. Newton, who died in 1727, believed this to be impossible; but Hall showed how it could be done by using two pieces of glass, one of flint and the other of crown. Nearly 30 years later (in 1757) Dolland took out a patent for lenses made in this way. (He probably did not know of Hall's earlier discovery.) The great importance of this discovery of achromatic lenses will be understood when one reflects that

without them the fine microscopes and gigantic refracting telescopes of the present day would be utterly useless. About the time that Hall discovered the possibility of making achromatic prisms, Ernest Stahl proposed the theory of "phlogiston," to account for various chemical facts. This theory had been stated also by Becher, who died in 1682; but Stahl did so much to establish it that he is commonly regarded as its originator. "Stahl imagined that all bodies which would burn contained an invisible substance which he called 'phlogiston,' and that when a body was burned it gave up its phlogiston into the air." This, as we now know, was a very erroneous idea; but Stahl and his contemporaries and successors explained so many facts by it, that chemists believed in it for many years. In 1732 Du Faye showed that there are two kinds of frictional electricity, one obtained by rubbing glass, and the other by rubbing sealing wax. In 1738 Bouguer first determined the density of the earth, by finding out how the attraction of a high mountain in Peru compared with the attraction of the whole earth. About the same time the celebrated Swiss mathematician Daniel Bernouilli first proposed the molecular theory of gases, a theory which is now universally accepted. He taught that gases consist of innumerable little particles of matter flying about in every direction, and that the pressure of a gas is due to the incessant bombardment of the walls of the containing vessel by the flying molecules composing the gas. In 1740 Lazzaro Moro gave a clear and correct account of the history of the fossils that we find in rocks. In the same year (1740) Hawksbee constructed his electrical machine, in which, for the first time, a globe of glass was substituted for the usual sulphur globe, and silk was used as the rubbing material. In 1741 Linnaeus founded his botanical gardens in Upsala, which have served as a model for many other like gardens, such as those at Kew, England. Albert Von Haller published a beautiful set of anatomical drawings, between 1743 and 1753, which were from dissections by himself; and during the course of these dissections he discovered the way in which muscles contract. It was not far from this time that Fahrenheit and Réaumur devised the thermometric scales now known by their names, and Celsius devised the centigrade scale. In 1746 Franklin began to experiment with electricity, and soon afterwards proposed his "one fluid" theory. About this time Haller took up the study of comparative anatomy, and John Hunter devoted his whole life to it. Others had compared the structure of man and animals, but Haller and Hunter were the first to make a systematic study of the subject. About 1749 Buffon's great work on natural history was published, and this, though it contained many mistakes, gave a great impetus to the study of animals. In 1752 Franklin made his celebrated kite experiment, drawing lightning from the clouds, and proving its identity with electricity. He also invented the lightning rod. In 1753 Linnaeus introduced the specific names by which the various species of plants and animals are distinguished from one another. In 1754 Bonnet made his celebrated experiments on the leaves of plants. In 1756 Black discovered carbonic acid gas. He showed that it combines with quicklime to produce lime carbonate: and because the lime "fixed" it, he called it "fixed air," for want of a better name. Dolland's invention of the achromatic lens, in 1757, has already been referred to. In 1760 Dr. Black discovered that heat disappears, or becomes "latent," when ice is melted, or water evaporated. In 1761 several expeditions were sent out to observe the transit of Venus which occurred in that year; for Halley in 1691 and again in 1716, had pointed out the way to find the sun's distance by observing transits of Venus. About the year 1762 Bonnet and Spallanzani proved by a multitude of curious experiments that many of the lower animals, such as worms, snails, newts, and lizards, can grow new heads, tails, and limbs, if their first ones be cut off. In 1780 Lagrange explained the peculiar motion of the moon known as *libration*; his attention having been



directed to it in 1764 by the prize offered by the French Academy of Sciences. About 1765 James Watt improved the steam engine by adding a separate condenser, and in 1769 he formed a partnership with Boulton, and his engines, further improved by being made double-acting and utilizing the expansive force of steam, were placed on the market. Watt also invented the indicator. In 1766 Henry Cavendish discovered hydrogen. In the same year Captain Cook sailed for the Pacific Ocean, to observe the transit of Venus in 1769. About 1767 Sprengel observed that flowers are fertilized by insects, and made many excellent observations and experiments on this point. In 1768 Linnaeus completed his "Systema Naturae." In 1772 nitrogen was first properly described by Dr. Rutherford. Priestley discovered oxygen in 1774. In the same year Maskelyne determined the density of the earth by the celebrated "Schhallion experiment." About this time, too, Laplace published his theory of the "long inequality" of Jupiter and Saturn; and in 1776 Lagrange proved the stability of the solar system. In 1775 Abraham Werner lectured on geology, in Freyberg. About 1778 Lavoisier, after eight years of experimenting, proved the falsity of the doctrine of phlogiston, and laid the foundation of the modern theory of chemistry. He also determined the composition of carbonic acid gas. In 1781 Sir William Herschel discovered the planet Uranus; and in 1783, after several years of observation, he proved the existence of binary stars — that is, double stars revolving about one another. In 1784 Cavendish discovered the composition of water, and prepared it by uniting oxygen and hydrogen. About 1785 Chladni made his celebrated experiments on the vibrations of plates of metal and glass. About this time Sir James Hall prepared artificial basalt in his laboratory, by melting pieces of rock. He did this to illustrate the igneous origin of the natural basalt. In 1786 Sir William Herschel published his first catalogue of star-clusters and nebulae, containing an account of a thousand of these objects. In 1788 Hutton published his "Theory of the Earth." In 1789 Lavoisier's famous "Elements of Chemistry" appeared. Galvani's celebrated experiments with frogs' legs were performed in 1789; and in this same year Klaproth discovered the element uranium. About this time, too, Jussieu gave us the so-called "natural system" for the classification of plants. This is now universally adopted, though Jussieu's original plan or scheme has been materially modified as our knowledge of plants has increased. De Saussure studied the Alpine glaciers in 1790, and called attention to their terminal moraines. Goethe's essay on the metamorphosis of plants was published in this same year. Herschel proposed his theory of sun-spots in 1793. In 1795 Klaproth discovered the element titanium. Vauquelin discovered chromium in 1797. In 1798 Klaproth discovered tellurium; and in the same year Rumford boiled water by friction, thus proving that heat is not a substance, and laying the foundation for the modern theory of heat. A few months later, in 1799, Davy melted ice by friction, and thereby proved the same thing. Humboldt made his voyage to America in 1799, and in this same year Laplace published his wonderful book on theoretical astronomy, the "Mécanique Céleste."

We have reviewed the work of the eighteenth century very superficially, but enough has been said, perhaps, to show that the scientists of that period were not idle. They did a very respectable amount of work, and paved the way very creditably for the advances that we were destined to make in the nineteenth century. Let us give them full credit, for when the great men of the twentieth century look back upon us, it is just possible that they will not esteem us quite so highly as we are perhaps disposed to esteem ourselves.



Incorporated  
1866.

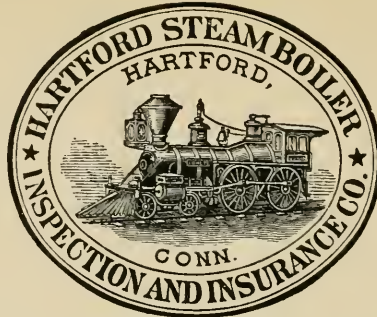

Charter Per-  
petual.

Issues Policies of Insurance after a Careful Inspection of the Boilers,  
COVERING ALL LOSS OR DAMAGE TO  
**BOILERS, BUILDINGS, AND MACHINERY**  
ALSO COVERING  
**LOSS OF LIFE AND ACCIDENT TO PERSONS**  
ARISING FROM  
**Steam Boiler Explosions.**

Full information concerning the plan of the Company's operations can be obtained at the  
**COMPANY'S OFFICE, HARTFORD, CONN.,**  
Or at any Agency.

**J. M. ALLEN, President.**  
**J. B. PIERCE, Secretary.**

**W. B. FRANKLIN, Vice-Prest.**  
**FRANCIS B. ALLEN, 2d Vice-Prest.**  
**E. J. MURPHY, M. E., Consulting Engineer.**

**Board of Directors.**

**J. M. ALLEN, President.**  
**FRANK W. CHENEY, Treas.** Cheney Brothers Silk Manufacturing Co.  
**CHARLES M. BEACH, of Beach & Co.**  
**DANIEL PHILLIPS, of Adams Express Co.**  
**RICHARD W. H. JARVIS, Prest.** Colt's Fire Arms Manufacturing Co.  
**THOMAS O. ENDERS, President of the U. S. Bank.**  
**LEVERETT BRAINARD, of The Case, Lockwood & Brainard Co.**  
**GEN. WM. B. FRANKLIN, late U. S. Commissioner to the Paris Exposition.**  
**NELSON HOLLISTER, of State Bank, Hartford.**

**Hon. HENRY C. ROBINSON, Attorney-at-Law, Hartford, Conn.**  
**Hon. FRANCIS B. COOLEY, of the National Exchange Bank, Hartford, Conn.**  
**EDMUND A. STEDMAN, Treasurer of the Fidelity Co., of Hartford, Conn.**  
**GEORGE BURNHAM, Baldwin Locomotive Works, Philadelphia.**  
**Hon. NATHANIEL SHIPMAN, Judge United States Circuit Court.**  
**C. C. KIMBALL, Pres. Smyth Mfg. Co., Hartford, Conn.**  
**PHILIP CORBIN, of P. & F. Corbin, New Britain, Conn.**

**GENERAL AGENTS.**

**THEO. H. BABCOCK,**  
**CORBIN & GOODRICH,**  
**LAWFORD & McKIM,**  
**C. E. ROBERTS,**  
**H. M. LEMON,**  
**C. C. GARDNER,**  
**L. B. PERKINS,**  
**W. G. LINEBURGH & SON,**  
**BURWELL & BRIGGS,**  
**MANN & WILSON,**  
**ZOLLARS & MCGREW,**  
**R. F. MANLY,**  
**W. S. HASTIE & SON,**  
**PETER F. PESCU,**

**CHIEF INSPECTORS.**

**R. K. McMURRAY,**  
**WM. J. FARRAN,**  
**F. S. ALLEN,**  
**WM. HEAFORD,**  
**A. B. ECOFF,**  
**F. S. ALLEN,**  
**J. H. RANDALL,**  
**C. A. BURWELL,**  
**J. B. WARNER,**  
**T. E. SHEARS,**  
**B. F. JOHNSON,**

**NEW YORK CITY.**  
**PHILADELPHIA, Pa.**  
**BALTIMORE, Md.**  
**BOSTON, MASS.**  
**PROVIDENCE, R. I.**  
**CHICAGO, ILL.**  
**ST. LOUIS, Mo.**  
**HARTFORD, CONN.**  
**BRIDGEPORT, CONN.**  
**CLEVELAND, OHIO.**  
**SAN FRANCISCO, CAL.**  
**DENVER, COL.**  
**BIRMINGHAM, ALA.**  
**CHARLESTON, S. C.**  
**NEW ORLEANS, LA.**

**OFFICES.**

**Office, 285 Broadway.**  
" **432 Walnut St.**  
" **22 So. Holliday St.**  
" **125 Milk St.**  
" **29 Weybosset St.**  
" **112 Quincy St.**  
" **404 Market St.**  
" **218 Main Street.**  
" **2 Sanford Building**  
" **208 Superior St.**  
" **306 Sansome St.**  
" **Mining Ex. B'g**  
" **Morris Building.**  
" **44 Broad St.**  
" **188 Gravier St.**

# The Locomotive.

PUBLISHED BY THE HARTFORD STEAM BOILER INSPECTION AND INSURANCE COMPANY.

NEW SERIES—VOL. XIV. HARTFORD, CONN., AUGUST, 1893.

No. 8.

## Iron Smoke Stacks.

As a general rule, brick chimneys are greatly to be preferred to iron stacks, but there are many cases in which they cannot be used, or in which their use would involve prohibitive expense. Thus the nature of the soil may be such that a proper foundation for a brick chimney cannot be had without an enormous outlay of money. Again, a chimney of some kind may be wanted for temporary use only, to provide additional draft pending the construction of a new chimney, or for some other purpose. In these cases iron stacks are often useful, both on account of their cheapness, and because they can frequently be bought in the market, ready made. They are often used in iron works, too, where they can be readily and cheaply made. They are considered, by some, to be more efficient than brick chimneys of the same proportions, because they do not allow cold air to leak into the flue and chill the heated gases. This action is often perceptible in brick chimneys that have stood for some years, but it is doubtful if the advantage of the iron stack in this particular is sufficient to more than counterbalance the increased radiation of heat which takes place from the comparatively thin plates of which the iron stack is composed. The effect of the weather and of the products of combustion on iron stacks is often very marked, and we have known of cases in which holes were corroded through these stacks so rapidly that the entire stack had to be replaced every year. Of course this is an extreme case, but the same action goes on more slowly in many other cases. To lessen the corrosive effects of the weather, iron stacks should be kept well painted. Many recipes for making paints suitable for this purpose have been published, but it will not be necessary to discuss them in the present article as the paints themselves can be bought, ready for use. Iron stacks are also sometimes lined with brick, to protect them from the action of the hot products of combustion, and add to their stability. Iron stacks are usually held in position by four wrought iron guy rods, secured to a ring of angle iron that is riveted to the stack about two-thirds of the way up, and anchored at a distance from the base of the stack about equal to the height of the ring of angle iron

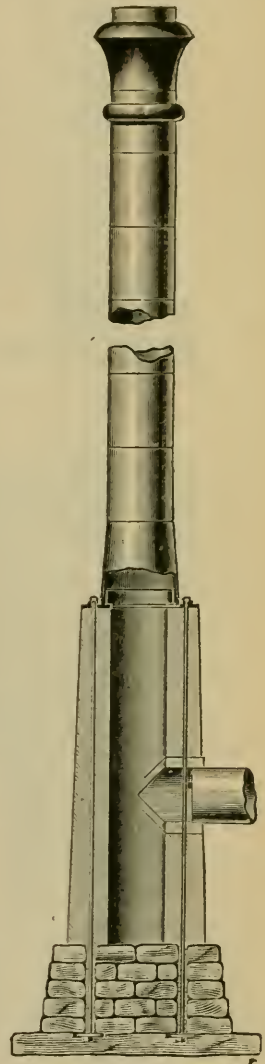

FIG. 1.

to which they are secured above. The sectional area of these guys should be sufficient to withstand the action of the strongest winds that are experienced in the neighbor-

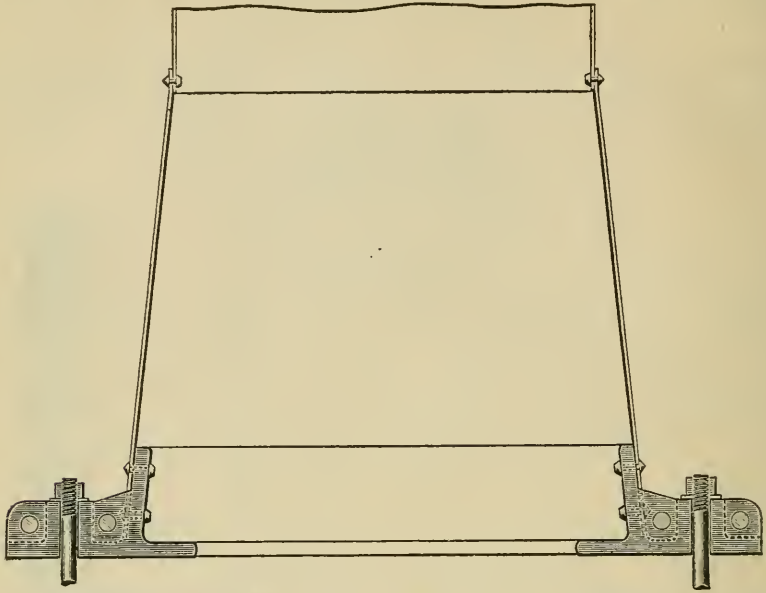

FIG. 2. — SECTIONAL VIEW OF THE BASE PLATE OF FIG. 1.

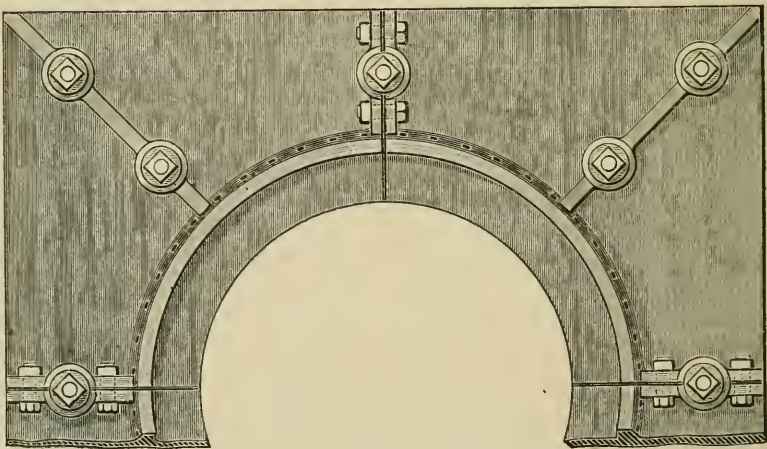

FIG. 3. — PLAN OF THE BASE PLATE OF THE STACK SHOWN IN FIG. 1.

hood of the stack. This should be determined for each locality separately; but engineers often use the following "rule of thumb," which is found by experience to give satisfactory results in most cases: Multiply the height of the stack, in feet, by its diameter in inches, and take the square root of the product. Divide this square root by 100, and the quotient is the least allowable diameter of the guy in inches.

Iron stacks may be designed, however, so that they shall be stable without guys. Such a stack is represented in Fig. 1, and for the convenience of our patrons we shall give some account of its details, it being understood that all dimensions are intended to apply to a stack 48 inches in diameter, and 80 feet high. Stacks having proportions different from these should have their details designed accordingly.

The stack shown in Fig. 1 is composed of wrought-iron plates  $\frac{1}{2}$  inch thick at the bottom, and gradually lessening in thickness towards the top, where they are  $\frac{3}{16}$  inch thick. It rests upon a square brick stump, or base, which is 20 feet high, and 8 feet square at the top, and 9 feet 4 inches square at the bottom. This gives the outer surface a batter of 1 in 30. The brick base rests upon a suitable stone foundation, and receives the flue from the boilers through a circular arched opening as shown in the cut. On the top of the base rests a cast-iron frame or base-plate, to which the stack is riveted, and which is itself secured to the stone foundation by twelve long 2-inch rods or bolts, two of which are shown in Fig. 1. The details of the iron base-plate are better seen in Figs. 2 and 3, Fig. 2 showing it in section, and Fig. 3 giving a view of it as seen from above. It is made in four parts and is bolted together, when in position, by eight  $1\frac{1}{2}$  inch bolts, which pass through ribs cast on the surface of the plate. The long 2-inch anchoring bolts pass through bosses cast along the lines of the ribs, and are secured by suitable nuts and washers. The base-plate is two inches thick, and on its upper surface there is a conical ring twelve inches high, over which the stack fits and to which it is securely fastened by two rows of rivets. A stack such as that here described can be built so that it will be stable in a wind blowing at 70 miles per hour.

Although we believe this stack to be very satisfactory, boiler owners sometimes prefer a cheaper construction, even though it may be less durable. Fig. 4 shows a form of stack that is sometimes used under these conditions. It has no brick stump. It is riveted to a base-plate which is bolted directly to the founda-

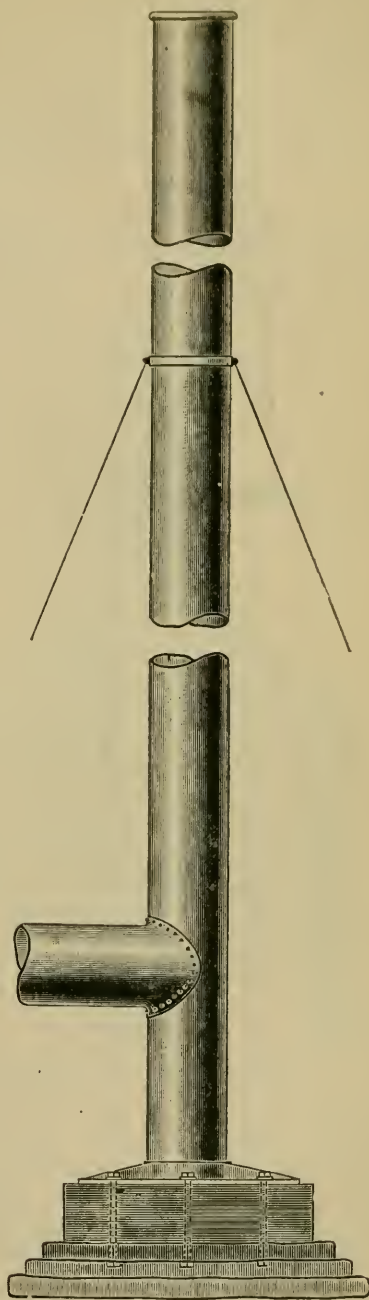

FIG. 4.



tion. The flue from the boilers is flanged outward and riveted to the stack, as shown in the cut. This stack is necessarily weakened by cutting out an opening equal in area to its own cross-section, for the entrance of the products of combustion. It must be braced by guys as explained in the first part of the present article.

Iron stacks are also erected somewhat after the plan shown in Fig. 1, but without the long bolts there shown, the requisite stability being secured by guys. The best stacks of this kind have a brick stump high enough to receive the flue from the boilers, and on the top of this stump the iron stack rests. The retaining bolts are omitted, and guys are provided in the manner explained above. This form of stack is cheaper than that shown in Fig. 1, and many prefer it on that account; but it does not look so well.

Stacks should be so designed and constructed that the opening in them comes directly in line with the boiler flue, as shown in Fig. 5. This is not always possible, and local conditions may render it necessary to make one or more bends in the flue. The straight flue is much to be preferred, however, as it offers less obstruction to the free flow of gases which is essential to a good draft.

When used with boilers having a breeching front, iron stacks are often riveted directly to the breeching,

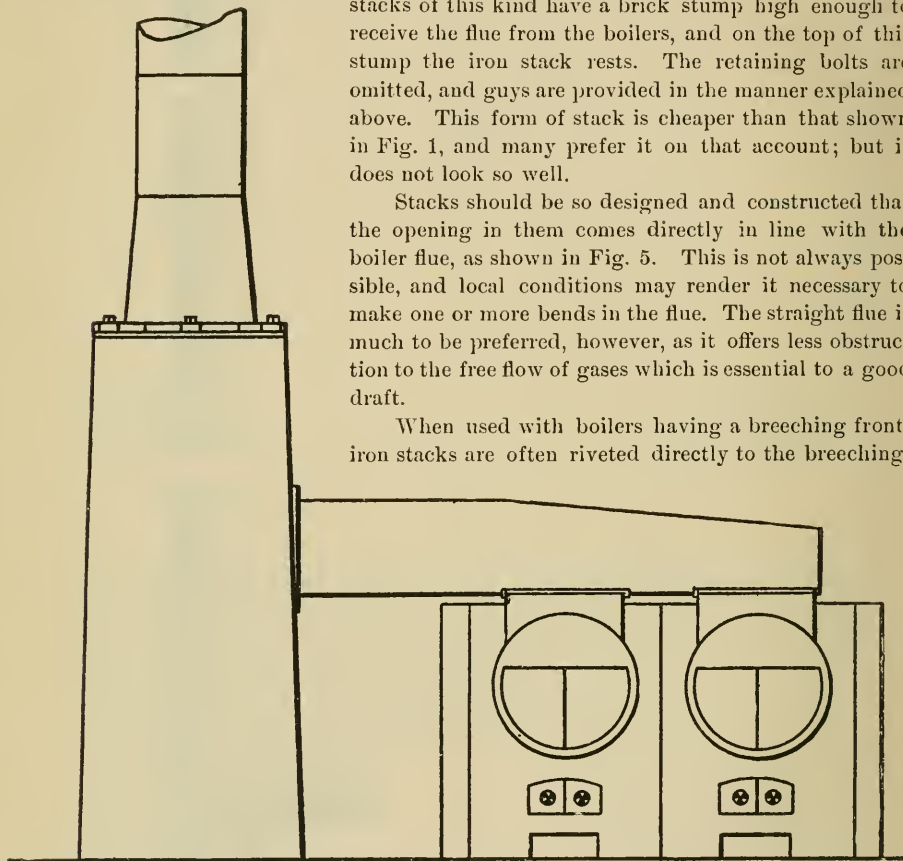

FIG. 5. — ILLUSTRATING THE RELATION OF THE FLUE TO THE STACK.

as shown in Fig. 6. When this is done the gases have a freer exit, even, than when the stack is arranged as in Fig. 5; but care should be taken to have the bolts and other parts of the breeching and boiler front strong enough to sustain the weight of the stack. Stacks that are riveted directly to the breeching pass straight up through the roof of the boiler-house, and it is not unusual, in such cases, to dispense with guys and brace the stack by a sheet-iron sleeve secured to the boiler-house roof, if that be high enough to give the stack sufficient stability.

For temporary use, iron stacks may be secured in a similar manner to the uptake of a flush front or overhanging front boiler, as indicated in Fig. 7. We do not recommend

this as a permanent arrangement, however. In cases of this kind a sort of conical sheet-iron hood, whose section is rectangular at the bottom and circular at the top, is used to connect the uptake with the stack.

## Boiler Explosions.

JUNE, 1893.

(142.)— On June 3d a boiler belonging to the Philadelphia Company exploded at McCurdy, near Pittsburgh, Pa. W. H. Guthrie, who works about the place, had a narrow escape from instant death. He had just tried the water-gauges and walked to the belt house when the explosion occurred. Guthrie says there were two gauges of water in the boiler at the time.

(143.)— A boiler exploded on June 5th at Craigsville, a town near Staunton, Va. The mill in which the boiler stood was owned by Mr. R. P. Young. The boiler fell 100 feet from the mill. Nobody was hurt.

(144.)— A boiler exploded in Dickinson & McKee's shops, in Aledo, Ill., on June 7th. The smoke-stack and the head of the boiler were blown into the air, and the boiler itself went through the roof and came down in another part of the building. James McKee was in the engine room at the time, and was quite badly injured.

(145.)— A boiler explosion occurred on June 10th at Moore & Decker's mill, at Fairland, near Columbus, Ind. The building was destroyed, but as the explosion took place during the noon hour, the men very fortunately escaped. Three valuable horses were killed, and the sound of the explosion was heard for miles.

(146.)— On June 12th a boiler exploded in Lang & Hooker's mill, in the town of Barnet, near St. Johnsbury, Vt. The mill was blown to atoms, and is a mass of ruins; and parts of the machinery were blown several hundred feet away. Elmer Green, Louis Jean, and William Fisher were killed. Gordon Armstrong was badly scalded and cut, and Austin Fisher, brother of one of the men killed, was injured by a flying fragment of stone. Two horses were also killed. The mill stood on the site of the Steel Edge Tool Co.'s works, which were destroyed by fire last spring.

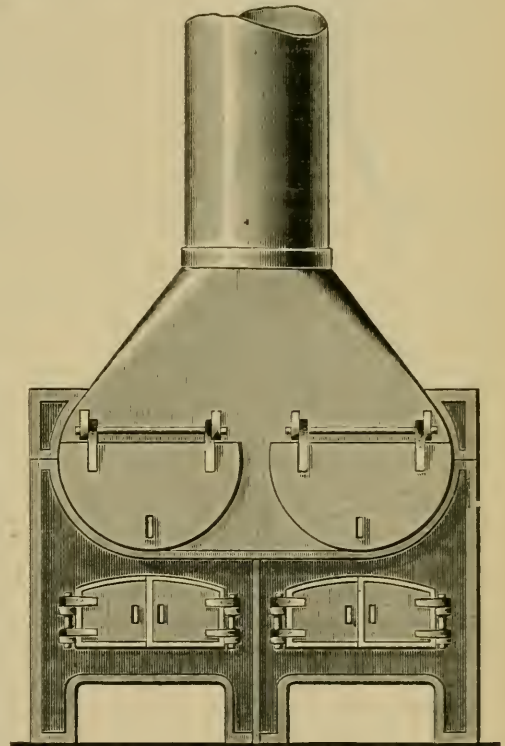

FIG. 6.—ILLUSTRATING THE DIRECT CONNECTION OF STACK AND BREECHING.

(147.)—A boiler exploded on June 12th at the basket factory in Peru, Ind. The boiler room was demolished and the main building was badly wrecked. Samuel Pratt, the night watchman, was killed, together with his eight-year-old son, Samuel Pratt, Jr. The explosion took place at about eight o'clock in the evening, and the boy had just brought his father's supper from home, and was standing by him, conversing. The boiler, it is said, was blown high in the air, falling some 1,500 feet away. At last accounts the body of the elder Pratt had not been found.

(148.)—On June 14th, shortly after the steamer *Ellis* left Harrington's dock, in Seattle, Wash., the loud report of an explosion was heard by those on the water front,

and immediately it was seen that something was wrong with the steamer. She turned from the direction in which she was pointed, and put in at the Ocean dock, where it was found that the main steam pipe had burst, near the boiler. Fortunately, nobody was hurt.

(149.)—A boiler exploded in a factory at Lock Haven, Pa., on June 15th, tearing off part of the roof of the building, and throwing bricks and hot water in all directions. Subsequent examination showed that the rear head of the boiler had blown out.

(150.)—On June 15th a boiler exploded in G. J. Tinsley's machine shop, at 138th street and Third avenue, New York city. Walter Henkel, a lad ten years old, was struck by a piece of the boiler and seriously injured about the head. Timothy Callahan also received serious injuries about the head and body, and William Foulks was badly shaken up. Foulks, after being attended by a physician, was removed to his home. The others were cared for at the Harlem Hospital.

(151.)—A boiler exploded in Ridgewood, N. J., on June 20th. Superintendent John J. Bogert was instantly killed, and his body was blown some distance. Engineer John Harrington was seriously injured, and may die. Mr. Bogert was one of the leading citizens of Ridgewood, and was a police justice, and president of the Ridgewood Protective Association. The explosion demolished the engine house, and the property loss, though not yet known with precision, will amount to thousands of dollars.

(152.)—On June 21st a boiler exploded in G. W. Donart's flouring mill in Mendon, near Celina, Ohio. The building and machinery were totally wrecked, and the loss is estimated at \$6,000. Pieces of the machinery were found an eighth of a mile away. No one was injured except the fireman, who received a severe shock.

(153.)—A boiler exploded on June 27th at Logan Davis's mill in the town of Yale, on the Atlantic & Danville Railroad, near Petersburg, Va. There was a large force of

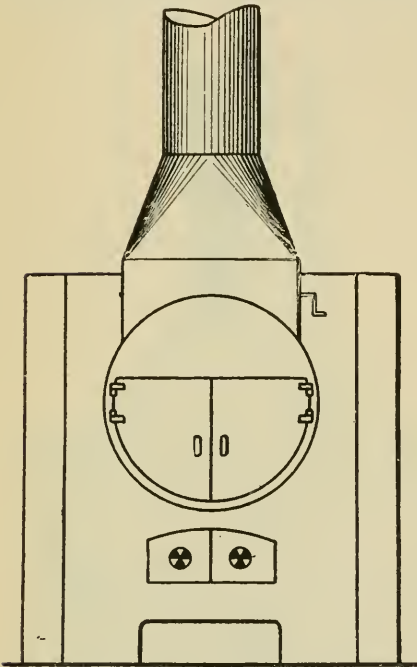

FIG. 7.—DIAGRAM ILLUSTRATING THE DIRECT CONNECTION OF A STACK TO AN OVERHANGING FRONT.

operatives in the mill at the time, and two of them were killed outright, and several others were badly scalded. The mill was wrecked and the loss will be heavy.

(154.)—The city of La Moure, S. D., was considerably shaken up on June 28th by the explosion of a boiler in W. D. Haycock's flour mill. The explosion occurred at the noon hour, and nobody was injured.

(155.)—On June 29th a boiler exploded in P. F. Hancock's mill, near Jefferson, Marion county, Tex. One man was fatally hurt, and five others were injured more or less severely. The machinery, mill, and boiler house were totally demolished.

---

JULY, 1893.

(156.)—On July 11th, a boiler exploded at William F. Saxton's place, at Leonardtown, near Baltimore, Md. The hands were all at dinner, and nobody was injured; but the boiler and machinery were destroyed, and fragments of them were blown all about.

(157.)—By a boiler explosion at Mungen, a town near Finlay, Ohio, John Clark was killed. Clark was known familiarly throughout the oil region as "Hundred Foot Clark."

(158.)—The boiler of one of Willis Elling's steamboats on Spirit Lake, Iowa, exploded on July 16th. We did not learn of any fatalities. The loss was estimated at \$3,000.

(159.)—A boiler exploded in Towanda, Pa., on July 17th, killing Andrew Benjamin instantly, fatally injuring Ross Hatton, and severely burning and bruising a man named Bennett. Another man, named McGovern, is missing, and at last accounts was supposed to be buried in the ruins. After the explosion the buildings took fire and were completely destroyed. The plant was owned by W. S. Golcharles, and the loss is estimated at \$25,000.

(160.)—On July 19th, a boiler exploded at Coalinga, Fresno Co., Cal. We have not heard particulars.

(161.)—A boiler exploded on July 20th, on the *Frank Silva*, a boat plying between Oakland and San Francisco, Cal. The accident happened while the *Silva* was on her first afternoon trip to Oakland, and when she had just entered the ship channel between the north and south training walls. Clouds of steam poured out of the boiler room and enveloped the vessel, and the few passengers that were aboard huddled together on the hurricane deck, expecting every second to be their last. Fortunately the explosion was but slight, and no one was injured. The Davie steamer *Rosalie* took the *Silva's* passengers off, and shortly afterward the *Silva* was towed to the Franklin Street wharf, in Oakland, for repairs.

(162.)—A boiler belonging to Mr. J. R. Brown exploded in Redwood City, Cal., on July 20th, and John Graham was fatally injured. (The cause of the explosion is said to have been defective material in the fire-sheets; though it is possible, of course, that these sheets had been burned.)

(163.)—On July 20th, a boiler belonging to E. C. Ortega, at Belden, near Albuquerque, N. M., exploded, and Carl Pittman, the engineer, was killed outright. Two or three other workmen were seriously but not fatally injured.

(164.)—A big 200-horse-power boiler exploded in Waco, Texas, on July 22d. D. F. Ford and Mingo Rankin were buried under a falling wall. When they were removed from the ruins it was found that both were severely scalded, and that both of Rankin's legs were broken. It is expected that Ford will live, but Rankin will undoubtedly die.



A large amount of valuable machinery was destroyed, and it is believed that the loss will amount to about \$20,000. A neighboring cotton gin was also damaged to the extent of about \$2,000.

(165.)—A boiler in Kenny & Newgard's mill in Hawarden, Iowa, exploded on July 24th, tearing away the west end of the building and seriously injuring Frank Chapman, the engineer. Chapman was sitting just outside the engine room door when the explosion occurred, and was carried three rods away. His face was literally filled with dirt and gravel, and he will probably be disfigured for life. The boiler and engine are complete wrecks, and the machinery throughout the mill is sprung out of shape.

(166.)—On July 26th, two big boilers exploded in Belleville, Ill., tearing the boiler-house to fragments, and badly wrecking part of the main building. Masonry and heavy beams were hurled a distance of more than 250 feet. As the explosion occurred in the early morning, nobody was about except the watchman, and he, being in a remote part of the building, escaped injury. Several bricks were blown into an open window in Charles Knoebel's house, one of them striking his daughter, who was lying in bed, and badly bruising her cheek. Otherwise, no one was injured. The loss is estimated at \$20,000.

(167.)—A boiler exploded on July 26th, in J. M. Weatherwax's mill, in Aberdeen, Wash. The fireman, William Welsh, was instantly killed. His body was blown through an opening 14 inches square, but, strange to say, was neither bruised nor scratched in the passage. Frank Lewis, Jacob Kaiser, and James Cowden were also seriously injured.

(168.)—A boiler explosion occurred on July 26th, near Salem, Crittenden Co., Ky. John Dambron and George Dambron were instantly killed, and William Dambron was frightfully injured. His arm was torn off, and he is likely to die.

(169.)—By a boiler explosion in San Rafael valley, Lower California, on July 26th, Mr. L. Spangler, a prominent American rancher, was instantly killed. Being temporarily without an engineer, he had undertaken to run the boiler himself.

(170.)—A boiler exploded in Raleigh, N. C., on July 28th. The engineer and fireman were blown a considerable distance, but neither was seriously injured.

(171.)—A boiler exploded on July 29th, at Sistersville, near Wheeling, W. Va., and J. H. Rodehaver was burned in a shocking manner about the face and body. At last accounts it was not known whether he would live or not.

(172.)—A boiler exploded on Martha's Vineyard, Mass., on July 31. We did not learn of any fatalities in connection with it.

(173.)—A boiler exploded on July 31st at Newark, Ohio. John Kittle, James Bowers, William Bell, Sidney Bell, and Norman Sillers were killed, and Joseph Shipp, Thomas Edmunds, Albert Kittle, and Luther Sillers were badly hurt. Shipp died the following day, but it is believed that the other injured persons will recover. Two horses belonging to Peter Bell were also killed.

---

NAPOLÉON I. was a fatalist, and among his superstitions was a firmly rooted notion that places and persons whose names began with the letter M possessed immense power over his fortunes for good or for evil. An ingenious Frenchman, evidently inclined to believe that there was some good ground for Napoleon's faith, makes up the following strange list of M's: Six Marshals—Musséna, Mortier, Marmont, Macdonald, Murat, and Moncey—without counting twenty-six division generals. Moreau betrayed him. Mar-

seilles was the place where he encountered the greatest difficulties at the commencement of his career. Marboeuf was the first to suspect his genius and to shove him ahead. His most brilliant battles were Montenotte, Mantua, Miliesimo, Mondovi, Marengo, Malta, Mont Thabor, Montmirvil, Mormans, Montereau, Mery, Montmartre (assault), Mont Saint-Jean, the last at Waterloo. At the siege of Toulon his first point of attack was Fort Maibousquet. There he singled out Muiron, who covered him with his body on the bridge of Arcole. Milan was the capital of his new kingdom. Moscow was the last town that he took. Menon made him lose Egypt. Miollis was selected to capture Pius VII. Malet conspired against him. Metternich beat him diplomatically. Maret was his secretary and his confidant. Montalivet was his minister, and Montesquin his first chamberlain. In March, 1796, he married Josephine, and in March, 1810, he married Marie-Louise. In March, 1811, the King of Rome was born. Malmaison, a well-named unlucky house, was his last residence in France. He surrendered to Capt. Maitland. At Saint Helena, Montholon was his companion in captivity and Marchand his valet de chambre. He died in May, 1821. The letter M also comes to the front in the career of Napoleon III. He married the Countess de Montijo. Morny is not forgotten. In the war of the Crimea we find Malakoff and Mameion. In the Italian campaign we find Montebello, Marignon, Magenta, Milan, Mazzini. Towards the close of his career Mexico appears with Maximilian, Méja, and Miramon. In the war with Germany he pinned his faith upon the Mitrailense, and the names of Moltke and Metz are conspicuous enough in the history of that campaign.—*N. Y. Sun.*

### Inspectors' Report.

APRIL, 1893.

During this month our inspectors made 6,697 inspection trips, visited 13,018 boilers, inspected 5,470 both internally and externally, and subjected 723 to hydrostatic pressure. The whole number of defects reported reached 10,432, of which 803 were considered dangerous; 64 boilers were regarded unsafe for further use. Our usual summary is given below:

Nature of Defects.	Whole Number.	Dangerous.
Cases of deposit of sediment, - - - - -	935	49
Cases of incrustation and scale, - - - - -	1,621	55
Cases of internal grooving, - - - - -	94	7
Cases of internal corrosion, - - - - -	512	20
Cases of external corrosion, - - - - -	818	48
Broken and loose braces and stays, - - - - -	146	36
Settings defective, - - - - -	280	17
Furnaces out of shape, - - - - -	414	19
Fractured plates, - - - - -	338	54
Burned plates, - - - - -	220	29
Blistered plates, - - - - -	290	9
Cases of defective riveting, - - - - -	1,515	66
Defective heads, - - - - -	74	20
Serious leakage around tube ends, - - - - -	1,561	173
Serious leakage at seams, - - - - -	490	25
Defective water-gauges, - - - - -	214	45
Defective blow-offs, - - - - -	158	26
Cases of deficiency of water, - - - - -	13	6
Safety-valves overloaded, - - - - -	56	6
Safety-valves defective in construction, - - - - -	81	16
Pressure-gauges defective, - - - - -	501	46
Boilers without pressure-gauges, - - - - -	31	31
Unclassified defects, - - - - -	70	0
<b>Total, - - - - -</b>	<b>10,432</b>	<b>803</b>

# The Locomotive.

HARTFORD, AUGUST 15, 1893.

J. M. ALLEN, *Editor.*

A. D. RISTEEN, *Associate Editor.*

THE LOCOMOTIVE can be obtained free by calling at any of the company's agencies.

Subscription price 50 cents per year when mailed from this office.

Bound volumes one dollar each. (Any volume can be supplied.)

Papers that borrow cuts from us will do us a favor if they will mark them plainly in returning, so that we may give proper credit on our books.

SIR George Tryon, the unfortunate admiral who went down with the British warship *Victoria*, stood six feet four inches and weighed between eighteen and twenty stone, from 252 to 280 pounds, without an ounce of superfluous flesh upon him. With his uniform and decorations he bore a majestic appearance.—*Ex.*

MISS Mary Proctor, oldest daughter of the late Professor Richard A. Proctor, the astronomer, is raising funds to build a monument over her father's grave in Greenwood Cemetery. Professor Proctor left little property at his death. His daughter lives in St. Joseph, Mo., of which State Professor Proctor was a citizen at the time of his death.—*Ex.*

THE filthy water of the river Nethe is purified for use in Antwerp by being passed through revolving cylinders containing small pieces of iron. Fifteen pounds of metallic iron will purify 1,000,000 gallons of water. The water thus treated is said to be completely free from germs, bacteria, and other objectionable matters. English and French chemists find that the contact with iron reduces the organic matter by from 45 to 85 per cent., and albuminoid ammonia by from 50 to 90 per cent., and all free ammonia is removed. The process has been applied with success to the water of the Delaware river, in Pennsylvania. It is simple and cheap. From all of which it may be inferred that the passage of drinking water through iron pipes does not injure it.—*Baltimore American.*

ACCORDING to a doctor who numbers many babies among his patients, the little folks, whether well or sick babies, whether babies fed on the bottle or fed naturally, may have water to drink in moderation if they want it. The water should be boiled and covered, not very cold, even warm, if the child prefers it so. "So thoroughly," he says, "have I become convinced of the great benefit derived from giving water to sick babies that I now order it in nearly every case with fever, and it is astonishing to see how the restlessness and many of the symptoms we are apt to attribute to the pain and fever disappear when it is freely given. By freely I mean from one-half to two ounces immediately after or between the feedings. If given immediately after the feeding, a smaller quantity will, of course, be required. Time and again I have seen infants with measles,

scarlet fever, or pneumonia, after a period of great restlessness, fall into a quiet sleep when a couple of ounces of cool water had been given."—*Ex.*

---

THE base-ball reporter of the present day has a literary style peculiarly his own, and his productions are held in low esteem unless they are marked by a certain piquaney not to be found elsewhere. The occasion of these remarks is a passage in a recent issue of one of our great daily papers, in which it was said that "Van made one of the most remarkable throws on record. He stopped a hot grounder, looked at Hinckley a moment, and then hurled the sphere through a rat-hole in the grand-stand."

---

WE have received the first number of the *Quarterly Boiler Review*, which is said, on the title page, to be "a magazine published for the perusal of those interested in steam boilers, in which are technically reviewed theory and practice relating to the design, construction, and operation of stationary, marine, and locomotive boilers with the view of helping those connected with their use or purchase, to form an opinion as to the merits and demerits of all boilers, unbiased by certain prejudices due to erroneous assertions and claims made in behalf of many constructions." The present issue is largely devoted to a discussion of the circulation of water in steam boilers — more particularly in water tube boilers. The *Review* is edited by Mr. John J. Hogan, and is published in Middletown, N. Y.

---

"THERE is a time for everything," and a writer in the *Tennessee Bulletin of the Board of Health* cautions the people of that State against indiscreet zeal in disturbing the soil, even for the construction of new and indispensable systems of sewers at the wrong seasons of the year. There is a great awakening throughout that State on the subject of water supply to towns — and large sums of money are being raised for achieving it — and the system of sewers must follow, for the water brought into a town must find an exit: but the health authorities warn the people that they should remember that the hot months of the year are not the ones in which ditches for any purpose should be excavated. They say that the months in which this work can safely be done are from November to May inclusive, when the weather is cool enough to disinfect the noxious exhalations given off.—*Ex.*

---

ACCORDING to the account we have received of the explosion in Haycock's flour mill, in La Moure, S. D. [See No. 154 on page 119], there was great excitement in that city over the explosion; and we read that "the excitement has been augmented by subsequent developments. . . Superintendent Strickles says the water-gauge showed the boiler to be nearly full of water, but at the time of the explosion there seems to have been no water in the boiler. Suspicion is directed towards a discharged employé, and it is generally believed that the boilers were doctored." We have noticed a marked tendency, recently, to attribute boiler explosions to interference by malicious outsiders, and we often hear it said, too, that "the explosion was due to the carelessness of the fireman." In our opinion there are very few cases, indeed, in which discharged employés, or any other persons, willfully meddle with boilers for the purpose of encouraging them to explode. Certainly a suspicion of this kind should not be entertained without the most abundant evidence to support it; and so far as the "carelessness of the fireman" is concerned, it is easy enough for idle persons to make this accusation, and



hard enough for the most conscientious fireman to disprove it, especially as the poor fellow is too often killed by the very explosion his carelessness is said to have caused.

### Early Locomotives.

WE have had several inquiries about the early history of locomotives, and as a general answer to our correspondents, we quote the following from Dr. Thurston's *Manual of the Steam Engine*: "When the steam engine had been so far perfected that the possibility of its application to other purposes than the elevation of water had become generally recognized, the problem of its adaptation to the propulsion of carriages was attacked by many engineers and inventors. As early as 1759, Dr. Robison called the attention of Watt to the possibility of constructing a carriage to be driven by a steam-engine. Watt, at a very early period, proposed to apply his engine to locomotion, and contemplated using either a non-condensing engine or an air surface-condenser. He included the locomotive-engine in his patent of 1784, and his assistant, Murdoch, in the same year made a working-model locomotive which was capable of running at a rapid rate.

"The first actual experiment was made, as is supposed, by a French army officer, Nicholas Joseph Cugnot, who, in 1769, built a steam-carriage, which was set at work in presence of the French Minister of War, the Duc de Choiseul. The funds required were furnished by the Comte de Saxe. Encouraged by the partial success of the first locomotive, Cugnot, in 1770, constructed a second, which is still preserved in the Conservatoire des Arts et Métiers, Paris. This more powerful carriage was fitted with two non-condensing single-acting cylinders thirteen inches in diameter. Although the experiment seems to have been successful, there appears to have been nothing more done with it.

"An American of considerable distinction, Nathan Read, patented a steam carriage in 1790. In 1804 Oliver Evans completed a flat-bottomed boat to be used at the Philadelphia docks, and, mounting it upon wheels, drew it by its own steam-engine to the river-bank. Launching the craft, he propelled it down the river, using its steam-engine to drive its paddle-wheels. Evans's '*oructor amphibolis*,' as he named the machine, was the first road-locomotive that we find described after Cugnot's time. Evans asserted that carriages propelled by steam would soon be in common use, and offered a wager of three hundred dollars that he could build a 'steam-wagon' that should excel in speed the swiftest horse that could be matched against it.

"Trevithick and Vivian built a locomotive-engine in 1804 for the railway at Merthyr-Tydvil, in South Wales, which was quite successful, although sometimes giving trouble by slipping its wheels. This engine had one steam cylinder  $4\frac{3}{4}$  inches in diameter, and carried 40 pounds of steam.

"Colonel John Stevens of Hoboken was undoubtedly the greatest engineer and naval architect living at the beginning of the present century. Without having made any one superlatively great improvement in the mechanism of the steam-engine, like that which gave Watt his fame, without having the honor of being the first to propose navigation by steam, or steam transportation on land, he exhibited a far better knowledge of the science and of the art of engineering than any man of his time, and he entertained and urged more advanced opinions and more statesmanlike views, in relation to the economical importance of the improvement of the steam-engine, both on land and water, than seem to have been attributable to any other leading engineer of that time. In 1812 he published a pamphlet embodying 'Documents tending to prove the Superior Advantages of Railways and Steam-carriages over Canal Navigation.' At this time the

only working locomotive in the world was that of Trevithick and Vivian, at Merthyr-Tydvil, and the rail-road itself had not grown beyond the old wooden tram-roads of the collieries. Yet Colonel Stevens says in this paper: 'I can see nothing to hinder a steam-carriage moving on its ways with a velocity of one hundred miles an hour'—adding in a footnote that 'this astonishing velocity is considered here merely possible. It is probable that it may not, in practice, be convenient to exceed twenty or thirty miles per hour. Actual experiments can only determine this matter, and I should not be surprised at seeing steam-carriages propelled at the rate of forty or fifty miles an hour.' He proposed rails of timber, protected when necessary by iron plates, or to be made wholly of iron. The car-wheels were to be of cast-iron, with inside flanges to keep them on the track. The steam-engine was to be driven by steam of fifty pounds pressure and to be non-condensing. He gives 500 to 1,000 pounds as the maximum weight to be placed on each wheel, shows that the trains—or 'suites of carriages,' as he calls them—will make their journeys 'with as much certainty and celerity in the darkest night as in the light of day,' shows that the grades of proposed roads would offer but little resistance, and places the whole subject before the public with accuracy of statement and evident appreciation of its true value.

"In 1814 George Stephenson, to whom is generally accorded the honor of having first made the locomotive-engine a success, built his first engine at Killingworth, England. In 1815, he applied the blast pipe in the chimney, by which the puff of the exhaust steam is made useful in intensifying the draught, and applied it successfully to his second locomotive. This [the blast-pipe] is the essential characteristic of the locomotive-engine. In 1815, therefore, the modern locomotive steam-engine came into existence, for it is this invention of the blast-pipe that gives it its life, and it is the mechanical adaptation of this and of the other organs of the steam engine to locomotion that gives George Stephenson his greatest claim to distinction. In 1825 the Stockton & Darlington Railroad was opened, and one of Stephenson's locomotives, in which he employed his 'steam blast,' was successfully used, drawing passengers as well as coal trains. Stephenson had at this time become engineer of the road. The time required to travel the distance of twelve miles was two hours. One of the most important and interesting occasions in the history of the application of the non-condensing steam-engine to railroads, as well as in the life of Stephenson, was the opening of the Liverpool & Manchester Railroad in the year 1829. When this road was built, it was determined, after long and earnest discussion, to try whether locomotive-engines might not be used to the exclusion of horses, and a prize of £500 was offered for the best that should be presented at a date which was finally settled at the 6th of October, 1829. Four engines competed, and the 'Rocket,' built by Stephenson, received the prize. This engine weighed four and one-fourth tons, with its supply of water. Its boiler was of the fire tubular type, a form that had grown into shape in the hands of several inventors, and was three feet in diameter and six feet long, with twenty-five three-inch tubes, extending from end to end of the boiler. The steam-blast was carefully adjusted by experiment, to give the best effect. Steam pressure was carried at fifty pounds per square inch. The average speed of the Rocket on its trial was fifteen miles per hour, and its maximum was nearly double that, twenty-nine miles an hour; and afterwards, running alone, it reached a speed of thirty-five miles.

"In America the locomotive was set at regular work on railroads, for the first time, on the 8th of August, 1829. This first locomotive was built by Foster, Rastrick & Co., at Stourbridge, England, and was purchased by Mr. Horatio Allen for the Delaware & Hudson Canal Company's road from Carbondale to Honesdale, Pennsylvania."

### The Bunker Hill of Mexico.

We have received from Mr. Walter S. Logan a copy of an address made by him a short time ago before the New York Historical Society. Mr. Logan's subject was "The Siege of Cuautla," which, as he rightly says, corresponds in Mexican annals to the battle of Bunker Hill in our own. The address is absorbingly interesting, and very earnest and touching. In speaking of the defense—the defense of the city of Cuautla by the patriot Morelos, when it was besieged by Calleja, Mr. Logan says: "Not all the troops of the Royalists, gathered from all Mexico and all Spain, could dislodge Morelos from Cuautla. The weapons of human foes could not prevail against him. But he was finally driven out by an enemy stronger and more irresistible than mortal power. It was hunger. Their food gave out. They stood it like heroes day after day, waiting for relief, but none came. Every effort was made to bring provisions in, but the place was closely invested, and on the open plain the Spanish troops were superior. Famine now prevailed inside the town to a horrible extent. Maize was almost the only sustenance of the troops and there was little even of that. They were hungry enough to eat anything. A cat was sold for six dollars, a lizard for two dollars, and rats and other vermin for one. . . . Disease too began to show itself in its most frightful shape, and nearly three hundred sick were lodged in the hospital of San Diego alone, and yet such was the influence of this man over every one around him that they endured all their sufferings with undaunted heroism. No one spoke of surrender, no one complained, for did not their brave commander share every peril and suffer all they suffered? Heroism is contagious and every heart was full of it; but heroism cannot supply the place of food. Morelos saw that he must evacuate Cuautla. To surrender would destroy the hopes of independence in Mexico, and moreover would be the death doom of every man in the place, for Calleja gave no quarter. Here at this trying moment, the spirit of the patriot and the skill of the commander is shown at its best. One dark night the troops were marshaled silently; the order to proceed was given; Galeano took command of the advance guard, Morelos himself of the center, and the Bravos, Leonardo and Nicholas, of the rear. Silently they marched out, passing right under the guns of the enemy, and so skillfully was it all planned, and so superb was the discipline, that they were not discovered till they had crossed the river, got beyond the intrenchments of the enemy, and the open country was before them. Then, too late, the Spanish camp was aroused and an attack on all sides was ordered. But Morelos was prepared for this. He gave the preconcerted signal, and that army of five thousand men melted away as if by magic and disappeared into the darkness, over the plains and into the mountains, where no enemy could follow. When the Spanish forces came from each direction to where the army of Morelos ought to be all ready to be closed upon and crushed, they saw, through the darkness, only the dim figure of their own battalions, and mistaking friends for enemies, fired upon one another. Morelos had arranged that when he gave the order for dispersion the troops should scatter and meet again as soon as possible at Izucar, some twenty miles away. Two days afterwards they were there, and it is said that of this whole army only seventeen were missing; but among those seventeen was Leonardo Bravo. Ever at the post of danger, he was hindmost of all, and was captured while guarding the rear. [He was afterwards executed in the City of Mexico.] There is nothing in all the heroic records in history which to my mind compares with the retreat, dispersion, and re-assembling of this army of Morelos. The cause of the revolution then appeared almost a forlorn hope. No one knew better than the patriot priest and the troops under him how much they had to contend with and how greatly the chances were against them; and yet, so far as is known,



without a single desertion, these five thousand men scattered over the plains and the mountains and came together again at the call of their leader, filled with the same undaunted enthusiasm which had sustained him all the way through, and preferring rather to die for liberty than to live without it." Morelos was eventually captured by the Royalists, and was executed on December 22, 1815.

One of the most touching parts of Mr. Logan's address relates to the sufferings of Guadalupe Victoria, one of the patriots who preferred solitude and death to the pardon extended to him by the Government. After his refusal of the pardon a price was set on his head, and he was hunted from place to place. "Any village where he obtained food was immediately destroyed; and it was declared to be certain death to know his whereabouts and not give him up." He fled to the mountains, and lived alone in the wilderness for five years, and "for thirty consecutive months he did not see a human being nor taste bread." He lived upon roots, and was glad even to gnaw the bones of dead beasts. His clothing was torn to rags. When found by his friends he was clad only in the remnants of a cotton sheet, and had tasted no food for four days. This man was afterwards the first president of the Mexican Republic.

---

### Russian Platinum Production.

The available information as to the Russian platinum industry has been increased by a visit made by Mr. George F. Kunz to the district, and described by him in the recently published report of the mineral industries of the United States in the Eleventh Census. The two deposits in the Ural mountains are the Goro-Blagodot or Isa region in the basin of the river Isa, and the Nisjne Tagilsk or Demidoff district, on the Martin river. The former is under government control, while the latter is worked by private enterprise. In the latter field there were three large washing plants and a fourth is being erected. Besides these the peasants have many small workings for which they pay two-thirds of the produce as a royalty. The deposits are placers composed of serpentine boulders mixed with chrome iron ore, the platinum-bearing sand forming a layer of 6 inches to 10 inches in thickness on the bed rock at a depth of 30 feet to 40 feet. The sand is mined by driving levels from a shaft, and is only worked in the winter, when the washing plants have to stand idle, as the water is all frozen. For washing the material it is hauled out in cartloads of about 1,500 pounds and emptied into a revolving screen. The small stuff is stirred up in water by two women, and the heavier materials settle in riffles in the troughs. Both the tailings and the heavy sand are reworked. In two shifts of 12 hours—each shift, however, including four hours' rest—about 640 tons of sand are washed, yielding 2.7 pounds of platinum in each machine. The average daily yield of the whole of this district is about nine pounds, worth about £2 [\$10] per ounce, and the yearly production is about 1,620 pounds. No details of the cost of mining are available, but the cost of labor for washing in the three plants for the 180 days during which the work could be done is about £7,000 [\$35,000]. Wages are not extravagantly high, as a driver gets 1.3 roubles a day for himself, horse and cart, and he has to haul 60 loads daily. For each machine 40 drivers, besides 16 workmen at 70 kopeks each, and four women at 40 kopeks each, are employed.—*American Manufacturer*.

---



Incorporated  
1866.

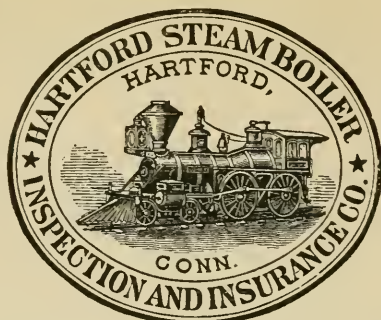

Charter Per-  
petual.

Issues Policies of Insurance after a Careful Inspection of the Boilers,  
COVERING ALL LOSS OR DAMAGE TO  
**BOILERS, BUILDINGS, AND MACHINERY**

ALSO COVERING  
**LOSS OF LIFE AND ACCIDENT TO PERSONS**

ARISING FROM

## Steam Boiler Explosions.

Full information concerning the plan of the Company's operations can be obtained at the  
**COMPANY'S OFFICE, HARTFORD, CONN.,**  
Or at any Agency.

**J. M. ALLEN, President.**

**W. B. FRANKLIN, Vice-Prest.**

**J. B. PIERCE, Secretary.**

**FRANCIS B. ALLEN, 2d Vice-Prest.**

**E. J. MURPHY, M. E., Consulting Engineer.**

### Board of Directors.

**J. M. ALLEN, President.**  
**FRANK W. CHENEY, Treas.** Cheney Brothers Silk Manufacturing Co.  
**CHARLES M. BEACH, of Beach & Co.**  
**DANIEL PHILLIPS, of Adams Express Co.**  
**RICHARD W. H. JARVIS, Prest.** Colt's Fire Arms Manufacturing Co.  
**THOMAS O. ENDERS, President of the U. S. Bank.**  
**LEVERETT BRAINARD, of The Case, Lockwood & Brainard Co.**  
**GEN. WM. B. FRANKLIN, late U. S. Commissioner to the Paris Exposition.**  
**NELSON HOLLISTER, of State Bank, Hartford.**

**Hon. HENRY C. ROBINSON, Attorney-at-Law, Hartford, Conn.**  
**Hon. FRANCIS B. COOLEY, of the National Exchange Bank, Hartford, Conn.**  
**EDMUND A. STEDMAN, Treasurer of the Fidelity Co., of Hartford, Conn.**  
**GEORGE BURNHAM, Baldwin Locomotive Works, Philadelphia.**  
**Hon. NATHANIEL SHIPMAN, Judge United States Circuit Court.**  
**C. C. KIMBALL, Pres. Smyth Mfg. Co., Hartford, Conn.**  
**PHILIP CORBIN, of P. & F. Corbin, New Britain, Conn.**

### GENERAL AGENTS.

**THEO. H. BABCOCK, CORBIN & GOODRICH, LAWFORD & McKIM,**  
**C. E. ROBERTS,**  
**H. M. LEMON,**  
**C. C. GARDINER,**  
**L. B. PERKINS,**  
**W. G. LINEBURGH & SON,**  
**BURWELL & BRIGGS,**  
**MANN & WILSON,**  
**ZOLLARS & McGREW,**  
**R. F. MANLY,**  
**W. S. HASTIE & SON,**  
**PETER F. PESCU, D.**

### CHIEF INSPECTORS.

**R. K. McMURRAY,**  
**WM. J. FARRAN,**  
**F. S. ALLEN,**  
**WM. HEAFORD,**  
**A. B. ECOFF,**  
**F. S. ALLEN,**  
**J. H. RANDALL,**  
**C. A. BURWELL,**  
**J. B. WARNER,**  
**T. E. SHEARS,**  
**B. F. JOHNSON,**

### OFFICES.

**Office, 285 Broadway.**  
" 452 Walnut St.  
" 23 So. Holliday St.  
" 125 Milk St.  
" 29 Weybosset St.  
" 112 Quiney St.  
" 404 Market St.  
" 218 Main Street.  
" 2 Sanford Building.  
" 208 Superior St.  
" 306 Sansome St.  
" Mining Ex. B'g.  
" Morris Building.  
" 41 Broad St.  
" 188 Gravier St.

**NEW YORK CITY.**  
**PHILADELPHIA, Pa.**  
**BALTIMORE, Md.**  
**PROVIDENCE, R. I.**  
**CHICAGO, ILL.**  
**ST. LOUIS, Mo.**  
**HARTFORD, CONN.**  
**BRIDGEPORT, CONN.**  
**CLEVELAND, OHIO.**  
**SAN FRANCISCO, CAL.**  
**DENVER, COL.**  
**BIRMINGHAM, ALA.**  
**CHARLESTON, S. C.**  
**NEW ORLEANS, LA.**

# The Locomotive.

PUBLISHED BY THE HARTFORD STEAM BOILER INSPECTION AND INSURANCE COMPANY.

NEW SERIES—VOL. XIV. HARTFORD, CONN., SEPTEMBER, 1893. No. 9.

## On the Bracing of Boiler Heads.

In days when a 60-inch boiler was considered big, and a pressure of 75 pounds to the square inch was considered high, boiler construction was a simpler art than it is to-day. The tremendous growth of all kinds of industries in recent years, and the attendant competition and consequent demand for economy, has given rise to a demand for larger boilers and heavier pressures; till at the present day the boiler-maker often finds himself hard pressed to satisfy the demands of his patrons, and yet turn out boilers that shall have the necessary factor of safety. He has to provide specially designed joints for the longitudinal seams, and has to consider the bracing of the heads with the greatest care.

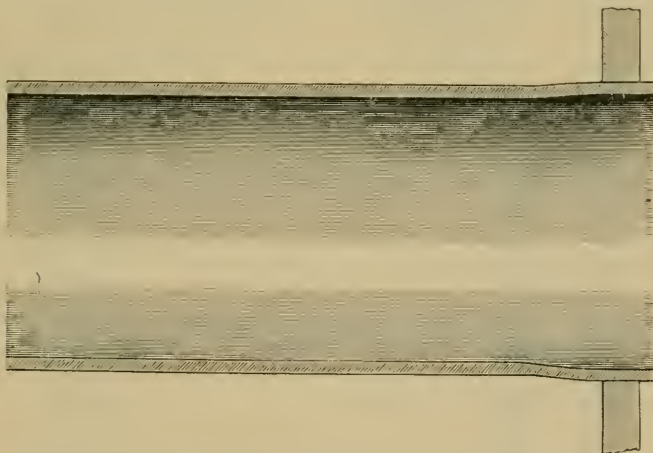

FIG. 1.—A TUBE EXPANDED INTO A BOILER HEAD.

In short, when a large boiler has to be designed so as to be safe under a high pressure, it becomes necessary to proportion every part of it intelligently. We have frequently discussed riveted joints in *THE LOCOMOTIVE*, and from time to time we have touched upon bracing also; and in the present article we propose to give a sort of résumé of what we have published in past issues of the paper on the subject of braced heads.

Before discussing braced heads we may say a word about flat, unbraced ones, in which the necessary strength is secured by great thickness of material. Flat *cast-iron* heads are sometimes used in boilers, but we do not recommend them; nor do we recommend flat, unbraced heads of any kind, when they are subjected to any considerable pressure. Braces are sometimes objectionable—as, for instance, in heaters that contain

paus or coils of pipe; but in such cases dished heads are greatly to be preferred to flat ones, because their strength can be computed with greater nicety.\*

Rankine, Grashof, and Lamé have each given a great deal of attention to the subject of flat heads, and have deduced rules for finding the thickness of them. Rankine's rule for flat, wrought-iron heads is: "Multiply the pressure on the head, in pounds per square inch, by the square of the radius of the flat part (in inches); divide the result by the tensile strain, in pounds per square inch, that the material of the head will safely bear, and take the square root of the quotient." This gives the thickness of the head in inches. Mr. Samuel Nicholls, in his *Theoretical and Practical Boiler-Maker*, has put this rule into useful shape, but unfortunately there is an error in the rule as he gives it, and in the illustrative example also. It should read something like this: "To find the thickness that a flat, unstayed head should have, multiply the thickness of the shell to which the head is to be attached by the radius of the head (in inches), and take the square root of the product. This gives the thickness that the head must have in order to equal the shell in strength." This rule is identical with Rankine's, except that it is put in a different form. As an example, let us take the following: What thickness of plate shall we require for a flat unstayed dome top, the dome being 36 inches in diameter, and  $\frac{3}{8}$  in. thick, in order that the end may be equal in strength to the remainder of the dome? Here the radius is 18 inches;  $18'' \times \frac{3}{8}'' = 6.75''$ , and  $\sqrt{6.75} = 2.6''$  (instead of 1.59 inches, as in Mr. Nicholls' example).

Very few experiments have been made, relative to the strength of flat, wrought-iron heads, and our knowledge of them comes largely from theory. It is true that very careful experiments have been made on small plates  $\frac{1}{8}$  of an inch thick, yet the data so obtained cannot be considered satisfactory when we come to consider the far thicker heads that are used in steam engineering practice, although the results agreed well with Rankine's formula. Mr. Nicholls, being foreman of a boiler shop in England, has since made some experiments on larger heads, and from them he has deduced the following rule, which will probably work well with heads that do not differ very widely from those he experimented with: "To find the proper thickness for a flat unstayed head, multiply the area of the head by the pressure per square inch that it is to bear safely, and multiply this by the desired factor of safety (say 8); then divide the product by ten times the tensile strength of the material used for the head."† His rule for finding the bursting pressure when the dimensions of the head are given is: "Multiply the thickness of the end plate in inches by ten times the tensile strength of the material used, and divide the product by the area of the head in inches."

In Mr. Nicholls' experiments the average tensile strength of the iron used for the heads was 44,800 lbs. The results he obtained are given below, the bursting pressure being calculated in each case, both by Nicholls' rule and by Rankine's, for the purpose of comparison.

1. An unstayed flat boiler head is  $34\frac{1}{2}$  inches in diameter and  $\frac{9}{16}$  inch thick. What is its bursting pressure? The area of a circle  $34\frac{1}{2}$  inches in diameter is 935 sq. inches; then  $\frac{9}{16} \times 44,800 \times 10 = 252,000$ , and  $252,000 \div 935 = 270$  lbs., the calculated bursting pressure according to Nicholls' rule. The head actually burst at 280 lbs. (Rankine's formula gives only 44 lbs. as the bursting pressure.)

2. An unstayed flat head is  $34\frac{1}{2}$  inches in diameter and  $\frac{3}{8}$  inch thick; what is its bursting pressure? The area of the head being 935 square inches, as before, we have

\* See THE LOCOMOTIVE for February, 1890.

† The formula from which this rule is taken is given on p. 146 of Mr. Nicholls' book. In this formula the denominator should be  $C \times T$ .

$\frac{3}{8} \times 44,800 \times 10 = 168,000$ , and  $168,000 \div 935 = 180$  lbs., which is the bursting pressure according to Nicholls' rule. This head actually burst at 200 lbs. (Rankine's formula gives only 21 lbs. as the bursting pressure.)

3. An unstayed flat head is  $26\frac{1}{4}$  inches in diameter, the plate being  $\frac{3}{8}$  inches thick; what is its bursting pressure? The area of a circle  $26\frac{1}{4}$  inches in diameter is 541 square inches. Then, proceeding as before, we have  $\frac{3}{8} \times 44,800 \times 10 = 168,000$ , and  $168,000 \div 541 = 311$  lbs., the bursting pressure according to Nicholls' rule. This head burst at 370 lbs. (Rankine's formula gives only 36 lbs. as the bursting pressure.)

4. A flat unstayed head is  $28\frac{1}{2}$  inches in diameter and  $\frac{3}{8}$  inch thick; what is its bursting pressure? The area of this head is 638 square inches. We have, therefore,

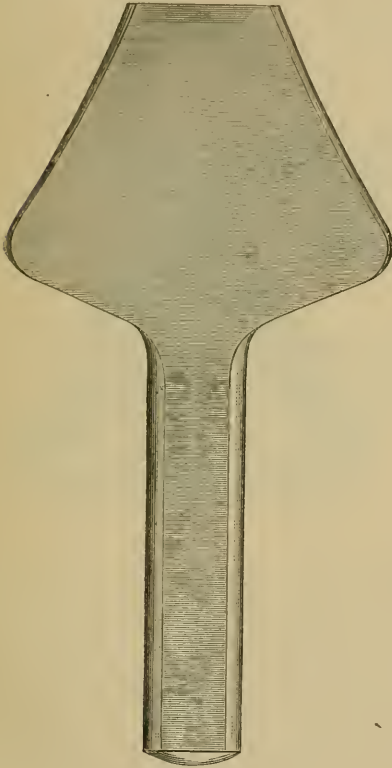

FIG. 2.

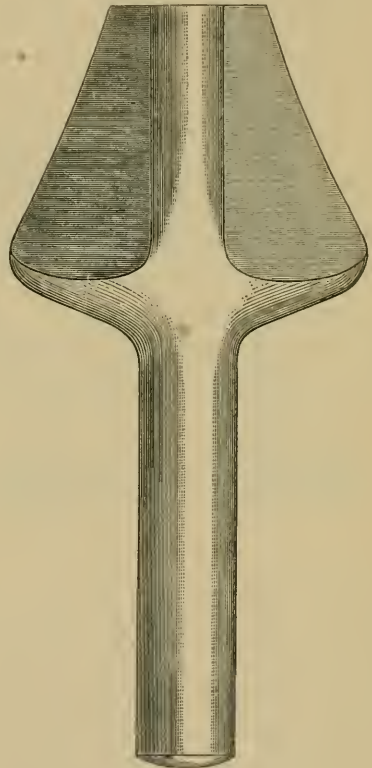

FIG. 3.

$\frac{3}{8} \times 44,800 \times 10 = 168,000$ , and  $168,000 \div 638 = 263$  lbs., the bursting pressure according to Nicholls' rule. The actual bursting pressure was 300 lbs. (Rankine's formula gives only 31 lbs. as the bursting pressure.)

Looking over these results we perceive several important points. In the first place it is evident that Rankine's rule gives results that are very discordant with the facts. Again, it is plain that Nicholls' rule gives results that agree with the facts very well indeed. It might be objected, of course, that though the heads might not burst *immediately* at the pressure given by Rankine's formula, yet they might ultimately fail, after be-



ing in use for a sufficient length of time. Certain facts observed by Mr. Nicholls in connection with the heads described above indicate, however, that this is not the case. For instance, in the third experiment, when the pressure reached 10 lbs. the end had bulged  $\frac{1}{8}$  of an inch; at 20 lbs., it had bulged  $\frac{1}{16}$  inch; at 40 lbs.,  $\frac{1}{8}$  inch; at 60 lbs.,  $\frac{3}{16}$  inch; at 80 lbs.,  $\frac{1}{4}$  inch; at 100 lbs.,  $\frac{5}{16}$  inch; at 120 lbs.,  $\frac{3}{8}$  inch; at 140 lbs.,  $\frac{1}{2}$  inch; at 155 lbs.,  $\frac{9}{16}$  inch; at 170 lbs.,  $\frac{5}{8}$  inch; at 185 lbs.,  $1\frac{1}{16}$  inch; at 200 lbs., the bulge was exactly  $\frac{3}{4}$  of an inch. "The pressure was now reduced to zero," says Mr. Nicholls, "and the end sprang back  $\frac{3}{16}$  inch, leaving it with a permanent set of  $\frac{9}{16}$  inch. The pressure of 200 pounds was again applied on 36 separate occasions during an interval of five days, the bulging and permanent set being noted on each occasion, but without any appreciable difference from that noted above." That is, as we understand it, no tendency to increase in the set could be detected.

It must be remarked, however, that the experiments we have described were confined to plates not very widely different in their dimensions, so that even Mr. Nicholls' rule cannot be relied upon for heads that depart very much from the proportions given in the example above.

It will be seen that, considering the discrepancy in the various rules, and the insufficiency of the data available, our knowledge of the strength of flat unstayed heads is very meager; and the moral is, as in all other such cases in engineering practice, that we should avoid such heads whenever it is possible to do so, and should use in the place of them something that we know more about. Bumped up heads are therefore recommended in cases where braces cannot be used.



FIG. 4.

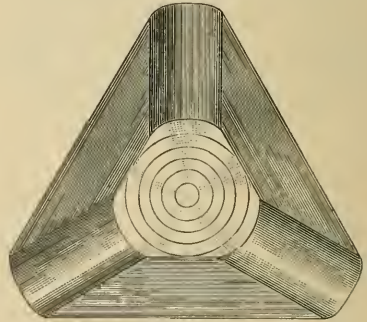

FIG. 5.

In horizontal tubular boilers a considerable part of the head is held by the tubes; and as it is of the highest importance to know to what extent we can rely upon the holding power of tubes, numerous experiments have been made, with tubes set in various ways, to determine this point. In 1880 we instituted two series of tests on tubes rolled with the Dudgeon expander, as there was some question among engineers, at that time, about the effectiveness of this tool. We arranged with Messrs. H. B. Beach & Son, boiler-makers in this city, to prepare for us three specimens composed of tubes three inches in external diameter, rolled into  $\frac{3}{8}$ -inch plate in the ordinary way, without any expanding other than that produced by the apparatus. Figure 1 shows one of these tubes as it appears in section, the cut being one-half the original size. (It should be stated that  $\frac{3}{8}$ -inch plate is thinner than is ordinarily used for boilers of usual dimensions, and that thicker heads would give more frictional surface, and consequently more holding power.) These specimens were delivered to Prof. Charles B. Richards, then consulting engineer at Colt's Armory in this city, with the request that he would subject them to the required test. In his report Mr. Richards says: "The external diameter of the tubes was three inches, and the thickness .109 of an inch. One end of each tube was fastened in an iron plate 6 inches square, being simply expanded into the plate without

the projecting part being flared or beaded. It was therefore held in the plate by friction only. The tube-end where it passed through the plate was increased in diameter by 0.1 of an inch by the expanding process. The thickness of the plate into which the tube was expanded was  $\frac{3}{8}$  of an inch in sample No. 1075, and  $\frac{1}{2}$  of an inch in samples Nos. 1076 and 1077. The test was made by observing the stress necessary to draw the tubes out of the plates, except with No. 1077, where the tube was drawn only partly out. The greatest observed stress sustained without the tube yielding in the plate was 6,000 lbs. for specimen No. 1075; 4,500 lbs. for specimen No. 1076; and 7,000 lbs. for specimen No. 1077. The observed stress which occasioned yielding was 6,500 lbs. for specimen No. 1075; 5,000 lbs. for specimen No. 1076; and 7,500 lbs. for specimen No. 1077. The force was applied parallel to the axis of the tube, and the plate surfaces were held in planes at a right angle to the axis."

These tests indicated a holding power sufficient for ordinary working conditions,

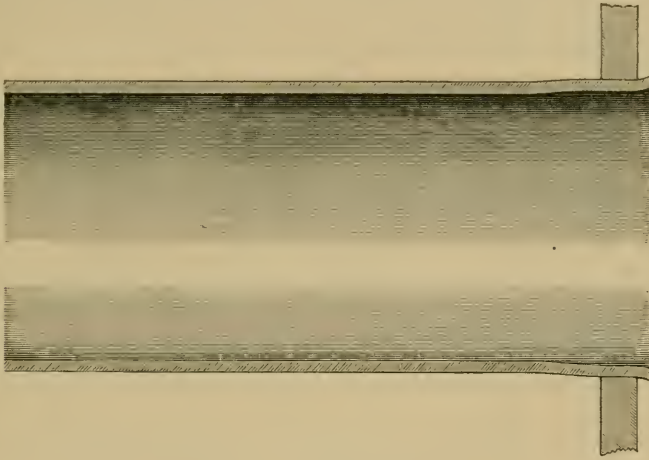

FIG. 6. — A FLARED TUBE.

but since so much depends on the proper use of the Dudgeon expander, some mechanical engineers were not ready to believe that the general run of tubes thus rolled in were as effective as our specimens indicated. This criticism is certainly justifiable, and hence all boiler-makers who take pride in their work and have regard for their reputation should see to it that the tube-rolling at their shops is well done. The riveting-over of the ends of the tubes is quite generally practiced, and when well done this makes a very strong joint; but those who are familiar with this kind of work know that in many cases the ends of the tubes are frayed out and split, and that until the "thumb tool" is brought to bear, the job has a very unpromising look. Such work yields readily to the action of the heated gases, and after a time the riveting or beading fractures and crumbles off, and very little strength remains. This fraying and cracking is sometimes attributed to a want of proper annealing of the ends of the tubes, but it is quite as often the result of unskilled workmanship. We have seen it so often that we are never sure such a job is well done. Another method of fastening tubes into the tube sheet, and one that works well, so far as we have investigated, (the test being boilers in use,) is to adjust the tubes so that they shall project slightly beyond the tube sheet. They are rolled in with the Dudgeon expander, and then with one of the tools shown in

Figs. 2 and 3, the projecting end is flared, or further expanded. Figs. 4 and 5 show these tools as seen endwise. Little explanation of the manner of using them is necessary. After the tubes are rolled in, either of the above tools can be used for expanding the ends. Some prefer the tool with two points of contact, and others use the one with three. The tool is inserted into the end of the tube and driven with a hammer until the end of the tube is brought solid against the tube sheet. Only light blows are required, and the workman can readily tell when the expanding is sufficiently done. Fig. 6 shows a tube which has been expanded by this method. In order to ascertain what the holding power of tubes set in this manner would be, we arranged with Messrs. H. B. Beach & Sons to prepare for us, in this manner, two test specimens, which were then submitted to Prof. Richards as before, and tested by him in substantially the same manner as those described above. The ends of the tubes projected  $\frac{3}{8}$  of an inch beyond the plate, and were flared so that the external diameter of the extreme end was 3.2 inches, the diameter of the tube where it entered the plate being 3.1 inches. (The original external diameter of these tubes was 3.0 inches, and they were 0.109 of an inch thick. The plates into which they were rolled were  $\frac{3}{8}$  of an inch thick and 6 inches square.) Prof. Richards' report says: "The stress which was sustained without the tube yielding in the plate was 20,000 lbs. in specimen No. 1078, and 18,500 lbs. in specimen No. 1079; the observed stress which first produced yielding was 20,500 lbs. in specimen No. 1078, and 19,000 lbs. in specimen No. 1079; and the observed stress which occasioned failure was 21,000 lbs. in specimen No. 1078, and 19,500 lbs. in specimen No. 1079."

It will be seen that there was an enormous increase in strength from the additional expansion, the lowest strain that occasioned yielding in the present case being 19,000 lbs., against 5,000 lbs. in the previous experiments, where the tubes were simply rolled out, and not afterwards expanded.

To show that the holding power of tubes is sufficient to stay the head on the part to which the tubes are secured, let us take a numerical example, choosing for the purpose a head 66 inches in diameter, with 86 3-inch tubes, and a steam pressure of 100 lbs. to the square inch. Assuming the lowest result of the experiments in each case — that is, 19,000 lbs. in the flared tubes and 5,000 lbs. in those not flared — we have, as the holding power of the 86 tubes,  $86 \times 5,000 = 430,000$  lbs. with the plain tubes, and  $86 \times 19,000 = 1,634,000$  lbs. with the flared ones. The tubes being confined to the lower half of the boiler (the upper part being supposed to be substantially braced by methods to be explained later), this combined holding power has to resist only the pressure that acts against the lower half of the head. The area of a 66-inch head is 3,421 square inches, so that the area of the lower half of such a head is  $3,421 \div 2 = 1,711$  sq. in. From this area, however, we have to subtract the combined sectional area of the 86 3-inch tubes; for the steam pressure acts only on the *spaces between the tubes*. The area of a 3-inch hole is 7.069 sq. in., and the combined area of 86 of them would therefore be  $7.069 \times 86 = 608$  sq. in. Deducting this from the area of the half-head under consideration, we have left  $1,711 - 608 = 1,103$  sq. in., as the area against which the steam pressure acts. With steam at 100 lbs. pressure per square inch, the total pressure against this area would be  $1,103 \times 100 = 110,300$  lbs. Comparing this with the combined holding power of the tubes, we find that the plain tubes (not flared) have a factor of safety of nearly 4, and that the flared tubes have a factor of safety of almost 15. It is doubtful if the plain tubes would give perfect satisfaction under these circumstances, for although we have assumed the tubes to be confined to the lower half of the head, it is quite common, and, indeed usual, in boilers of this diameter, to place one of the tube-rows above the center



line. The total steam-pressure to be resisted would therefore be a little larger than we have assumed, and the factor of safety would be correspondingly smaller. On the other hand, we have taken no account of the stiffening action of the flange of the head; and as there can be no doubt that this flange stays the head sufficiently for a distance of at least three inches from the shell, perhaps we could fairly say that the unflared tubes have a factor of safety of 4, and the flared ones a factor of 15, notwithstanding the one row that projects above the center line of the boiler. As a general rule, we consider 5 to be the proper factor of safety for boilers, except in braces and flat heads; the exception being made in the case of braces partly because of the uncertain quality of iron that is used for them, and in the case of flat heads, on account of the general nebulosity surrounding all the formulæ yet proposed for calculating their strength. Hence we should not be inclined to recommend the use of plain, unflared tubes in a 66-inch boiler that is to carry 100 pounds pressure, especially when such an enormous gain in strength may be had by a little extra work. Moreover, all the foregoing calculation has been based upon the assumption, which, as indicated above, is too often erroneous, *that the tube-rolling has been well done.*

It is far better to use the flared tubes; and when these are used, there is not the least chance for doubt about the sufficiency of their holding power. We come, now, to the consideration of that part of the boiler-head which lies above the tubes. The tubes, it has been shown, possess sufficient holding power to amply stay the part of the head to which they are attached, and we may safely consider that they will also possess sufficient staying power to take care of the heads for, say, two inches

above their upper surfaces. The flanges of the heads being securely united to the shell, and being also curved or dished, it may likewise be safely assumed that no braces need be provided for that part of the head which lies within three inches of the shell. The part of the head that requires bracing, therefore, consists of a segment of a circle whose circumference lies three inches within the circle of the shell, and whose base is two inches above the upper row of tubes. Thus in a 66-inch boiler, whose upper row of tubes is 26 inches below the top of the shell, the part of the head that requires bracing consists in a segment of a circle the diameter of which is 60 inches, and the height of which is 21 inches: 21 inches being the measured height (26 in.) minus the 3 inches that lies between the shell and the segment to be braced, and minus the two inches that lies between this segment and the top of the tubes. (This segment is indicated by the dotted lines in Fig. 7.) The area of such a segment is easily found by means of the table given in THE LOCOMOTIVE for June, 1891, on p. 94. Thus  $21 \div 60 =$

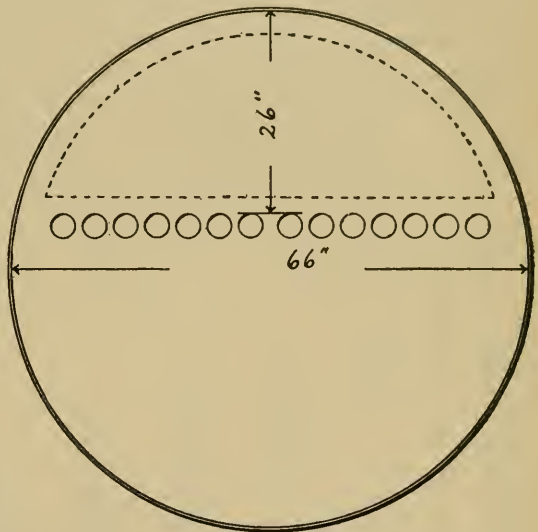

FIG. 7. — ILLUSTRATING THE "AREA TO BE BRACED."



.350, and opposite .350 in the table we find 0.24498. Then  $60 \times 60 \times 0.24498 = 882$  square inches, the area in question. In Table I this calculation has been made for all the sizes of boilers that are ordinarily met with. The area to be braced has been calculated as above in each case, the two-inch strip above the tubes and the three-inch strip around the shell being taken into account. As an example of its use, let us suppose that upon measuring a boiler we find that its diameter is 54 inches, and that the distance from the upper tubes to the top of the shell is 25 inches. Then by looking in the table under 54" and opposite 25" we find 714, which is the number of square inches that requires staying on each head.

In case the measured height from the tubes to the shell is not an exact number of inches we may either call it the nearest even inch and take out the area as before, or we may proceed as in the following example. *Ex.* What is the area to be braced in a boiler 72 inches in diameter, the distance from the top of the shell down to the upper row of tubes being  $31\frac{1}{4}$  inches? For 31 inches the table gives 1,252, and for 32 inches it gives 1,317. The difference between these is 65, and one-quarter of 65 is 16, which is the amount to be added to 1,252, on account of the measured height being  $31\frac{1}{4}$  inches instead of 31 inches. Then  $1,252 + 16 = 1,268$  sq. in., which is the area to be braced in this case.

TABLE I. AREAS TO BE BRACED (SQUARE INCHES).

HEIGHT FROM TUBES TO SHELL.	DIAMETER OF BOILER IN INCHES.							HEIGHT FROM TUBES TO SHELL.
	36"	42"	48"	54"	60"	66"	72"	
15"	206	....	....	....	....	....	....	15"
16	235	....	....	....	....	....	....	16
17	264	297	....	....	....	....	....	17
18	....	331	365	396	....	....	....	18
19	....	366	404	439	....	....	....	19
20	....	401	444	483	519	....	....	20
21	....	....	485	528	568	....	....	21
22	....	....	526	574	618	....	....	22
23	....	....	....	620	668	714	....	23
24	....	....	....	667	720	769	....	24
25	....	....	....	714	772	825	....	25
26	....	....	....	761	824	882	937	26
27	....	....	....	809	877	940	998	27
28	....	....	....	....	930	998	1,061	28
29	....	....	....	....	983	1,056	1,124	29
30	....	....	....	....	1,037	1,115	1,187	30
31	....	....	....	....	....	1,174	1,252	31
32	....	....	....	....	....	1,234	1,317	32
33	....	....	....	....	....	....	1,382	33
34	....	....	....	....	....	....	1,447	34

Reference was made, in a preceding paragraph, to the inferior quality of the iron that is used for making braces. This iron usually has an ultimate strength of about 45,000 lbs. to the square inch, and as it is customary to use a factor of safety of 6 in designing boiler braces, it follows that the strain on such a brace must not exceed 7,500 lbs. to the sectional square inch. In fact, the Rules and Regulations of the Board of

Supervising Inspectors of Steam Vessels (as amended in January, 1892,) require that "no braces or stays hereafter employed in the construction of [marine] boilers shall be allowed a greater strain than 6,000 pounds per square inch of section"; but, in the construction of land boilers it is not usual to require such a large margin of safety as the United States rule just quoted implies, and in land boilers the strain on braces will nearly always run nearer to 7,500 lbs. per square inch than to 6,000 lbs. If we allow 7,500 lbs. as the safe working strain per square inch, we shall find that a round brace, one inch in diameter, will safely bear 5,890 lbs. ( $7,500 \times .7854 = 5,890$ .) From this it is easy to calculate how many such braces a given boiler-head should have. Thus we see from Table I that in a 60-inch boiler whose upper tubes are 28 inches below the shell, the area to be braced is 930 square inches. If the boiler is to carry a pressure of 100 lbs. to the square inch, the braces must withstand a total strain of  $930 \times 100 = 93,000$  pounds; and as each single brace of inch round iron will safely bear only 5,890 pounds, we find how many braces will be required by dividing 93,000 lbs., the total load, by 5,890 lbs., the load that one brace can carry. We find that  $93,000 \div 5,890 = 15.8$ ; so that the proposed boiler will require 16 braces. We have performed this calculation for every boiler included in Table I, and the results are contained in Table II, which gives the requisite number of braces of one-inch round iron for boilers carrying 100 lbs. pressure. As an example in the use of Table II, let us take the following: How many braces of inch round iron are required to stay the head of a 72-inch boiler, the distance from

TABLE II. NUMBER OF BRACES REQUIRED, AT 100 LBS. PRESSURE.

HEIGHT FROM TUBES TO SHELL.	DIAMETER OF BOILER IN INCHES.							HEIGHT FROM TUBES TO SHELL.
	36"	42"	48"	54"	60"	66"	72"	
15"	3.5	....	....	....	....	....	....	15"
16	4.0	....	....	....	....	....	....	16
17	4.5	5.0	....	....	....	....	....	17
18	....	5.6	6.2	6.7	....	....	....	18
19	....	6.2	6.9	7.5	....	....	....	19
20	....	6.8	7.5	8.2	8.9	....	....	20
21	....	....	8.2	9.0	9.6	....	....	21
22	....	....	8.9	9.8	10.5	....	....	22
23	....	....	....	10.5	11.3	12.1	....	23
24	....	....	....	11.3	12.2	13.1	....	24
25	....	....	....	12.1	13.1	14.0	....	25
26	....	....	....	12.9	14.0	15.0	15.9	26
27	....	....	....	13.7	14.9	16.0	16.9	27
28	....	....	....	....	15.8	16.9	18.0	28
29	....	....	....	....	16.7	17.9	19.1	29
30	....	....	....	....	17.6	18.9	20.2	30
31	....	....	....	....	....	19.9	21.3	31
32	....	....	....	....	....	21.0	22.4	32
33	....	....	....	....	....	....	23.5	33
34	....	....	....	....	....	....	24.6	34

the top of the shell down to the tubes being  $29\frac{1}{2}$  inches, and the allowable pressure being 75 lbs.? *Ans.* Under 72 and opposite 29 we find 19.1; under 72 and opposite 30 we find 20.2. The difference between these is 1.1, half of which is .6, which being

added to 19.1 gives 19.7, which is the number of braces that would be required if 100 lbs. were the allowable pressure. For a boiler on which only 75 lbs. are allowed,  $\frac{75}{100}$  of this number of braces will be sufficient,—that is,  $\frac{75}{100}$  (or three-quarters) of 19.7, which is 14.8. Hence 15 braces will be sufficient on a boiler of this size and design, running at a pressure not exceeding 75 lbs. to the square inch.

When the proper number of braces is known, the next step is to distribute them as equably as possible over the area to be stayed (*i. e.*, the segment shown by the dotted lines in Fig. 7). As the arrangement will vary with the number of braces, it will not be possible to give any general rule for it, except the one above,—namely, to cover the segment to be braced as equably as possible. Fig. 8 shows the head of a 66-inch boiler, with 86 3-inch tubes. The distance from the top of the tubes to the top of the shell is  $28\frac{1}{2}$  inches. For 100 pounds pressure, Table II calls for 17.4 braces. The cut shows nine-

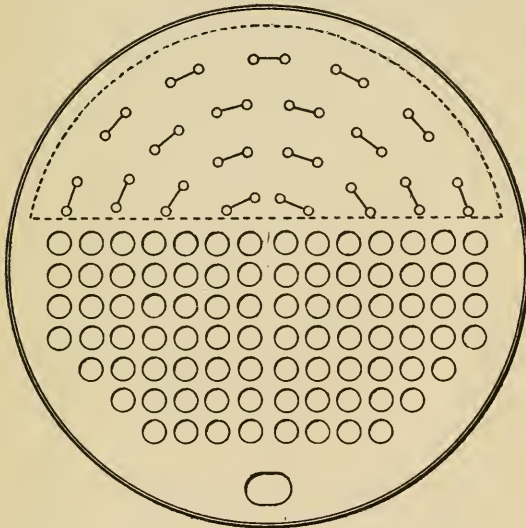

FIG. 8. — DISTRIBUTION OF THE BRACES.

teen braces, as it is a little easier to distribute nineteen braces equably, than eighteen. The rivet-holes for securing the braces to the head are shown by the little circles, and the segment to be braced is shown by the dotted lines. It will be noticed that the braces are arranged along four concentric circles, the innermost circle being represented by two braces, the next one by four, the next by six, and the outermost by seven. The style of brace intended to be used on this head is shown in Fig. 9. It is the old-fashioned "crow-foot," which we believe to be the best form of brace yet proposed, if it is forged up without a weld, and carefully made. We have found many braces of this style broken

short off, with nothing to indicate how it was done, leaving it to be reasonably inferred that the original construction was faulty.

Braces are often secured to the heads of boilers by angle irons. When this is done, we recommend the arrangement of angle iron shown in Figs. 10 and 11. Fig. 10 shows the pieces riveted to the heads above the tubes (of which only the upper row is shown in the cut) in a *radial* position. By making this disposition of them we are enabled to use a straight brace, and the resulting pull on the brace is more direct than it would be with the brace in any other position. (The small circles in Fig. 10 represent the rivets. The braces are attached to the web of the tee irons, *between the rivets*, as shown in Fig. 11.) We recommend the **⊥** iron, in preference to **L** iron. The **⊥** irons should be of the best quality obtainable,  $4 \times 4 \times \frac{1}{2}$  inches. The rivet-holes in their flanges, both for the attachment of the **⊥** iron to the head and for the attachment of the brace to the **⊥** iron, and also the rivet holes in the boiler-head, should be drilled, not punched. This makes a much better job. Fig. 12 shows the form of brace recommended for use with the foregoing arrangement of **⊥** irons. These braces should

be made of the very best round iron, one inch in diameter, and of single lengths. The ends should be upset until sufficient stock is obtained to form the jaw and foot for attachment to the shell. This involves somewhat more labor than making them with welds, but a sound brace is insured, which is not the case with a welded brace. It is no unusual thing to find braces just welded up, and by good workmen too, which may be snapped in two like pipe-stems by striking them a sharp blow across the corner of the anvil. This is the usual way of testing such work in some shops.

Fig. 13 shows a very common method of bracing the heads of tubular boilers. Two pieces of L iron are riveted horizontally across the head of the boiler above the tubes. The braces are then attached by pins passing through, and are held between the L irons as shown. Fig. 14 is an enlarged view of this brace. It differs from Fig. 12 only in the form of the head, which is single instead of double. This makes a fairly good form of brace if it is properly constructed, but, as a general rule, it is not. If the braces were

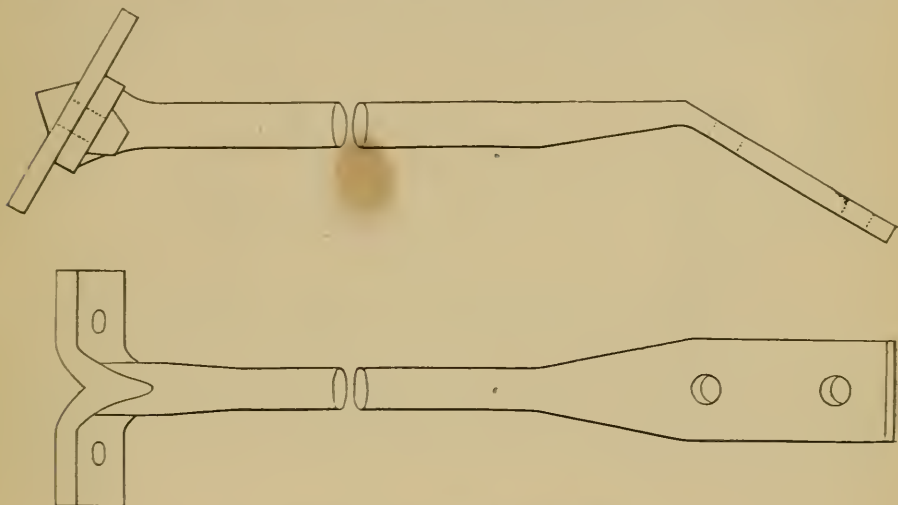

FIG. 9. — CROW-FOOT BRACES.

swung horizontally to the shell of the boiler, they would need only a comparatively slight twist, which could be put into the round portion of the body, to bring the foot fairly on to the shell, and they would then remain taut; but many boiler-makers bend them directly upwards to meet the shell. This necessitates a short bend near where they are attached to the boiler-head, in consequence of which they do not remain taut for any length of time. When we wish to resist a direct pull we should always use a straight piece of material to do it with. It is always wrong in principle to put a crooked brace into a boiler. It is, moreover, entirely inexcusable, and many accidents have resulted from it.

Some boiler-makers run the braces right through, from head to head. The chief objection to this kind of brace is that it is very much in the way when the boiler is being cleaned, inspected, or repaired. There is no necessity of tying the two heads of a boiler together in this way, for it is well known that boiler shells have an excess of strength lengthwise, and can carry all the pressure that can come on the heads; and therefore it is plain that ample strength is secured by bracing well back on the shell.



On a diagonal brace (which term will apply to any brace which is not parallel to the direction of the stress applied to it, such as gussets, braces attached to heads and having the other end attached to the shell, etc.), the strain is theoretically somewhat greater than it would be if the brace were parallel to the direction of the stress applied.

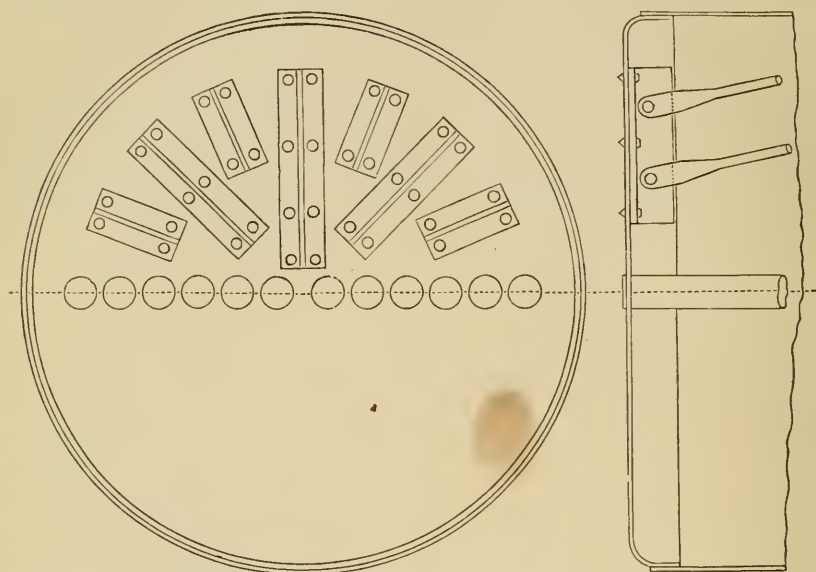

FIG. 10. — SHOWING RADIAL ARRANGEMENT OF TEE-IRONS.— FIG. 11.

The actual stress on the brace may be found by dividing the total pressure on the area supported by the brace by the cosine of the angle between the brace and the direction of the stress. Or, to arrive at the result without resorting to calculation, lay out the

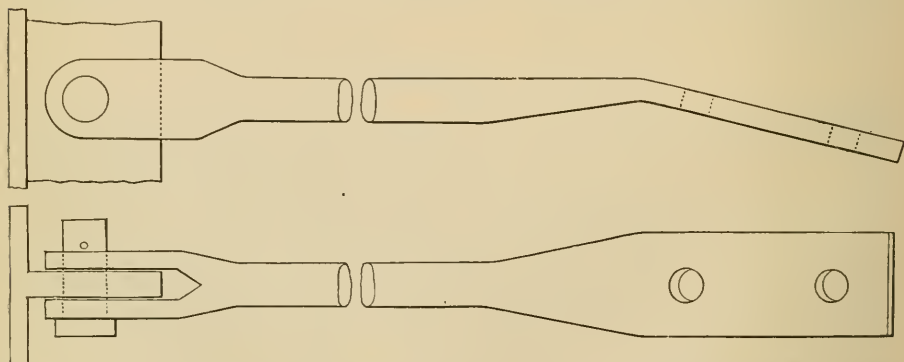

FIG. 12. — BRACES USED IN CONNECTION WITH THE RADIAL TEE-IRONS SHOWN ABOVE.

brace in correct proportions, as shown in Fig. 15. Then, if the pressure on the area to be braced is represented by the length of the line *AB*, the length of the brace *BC*, measured on the same scale, will represent the actual stress upon it. With the ordinary proportion of braces, this difference may be neglected; but where the brace makes a comparatively large angle with the shell, as may be the case with gusset stays, it should

be taken into account, and the brace made correspondingly larger. It is partly on account of this obliquity of the braces that a larger factor of safety (*viz.*, a factor of at least 6) is recommended for them. No brace should be shorter than three feet and a half, and braces of this length should only be allowed for the outer course of braces, nearest the shell. If shorter braces than this were used, the angle between them and the shell would be greater than it should be.

The attachment of braces to the heads of boilers should receive careful attention;

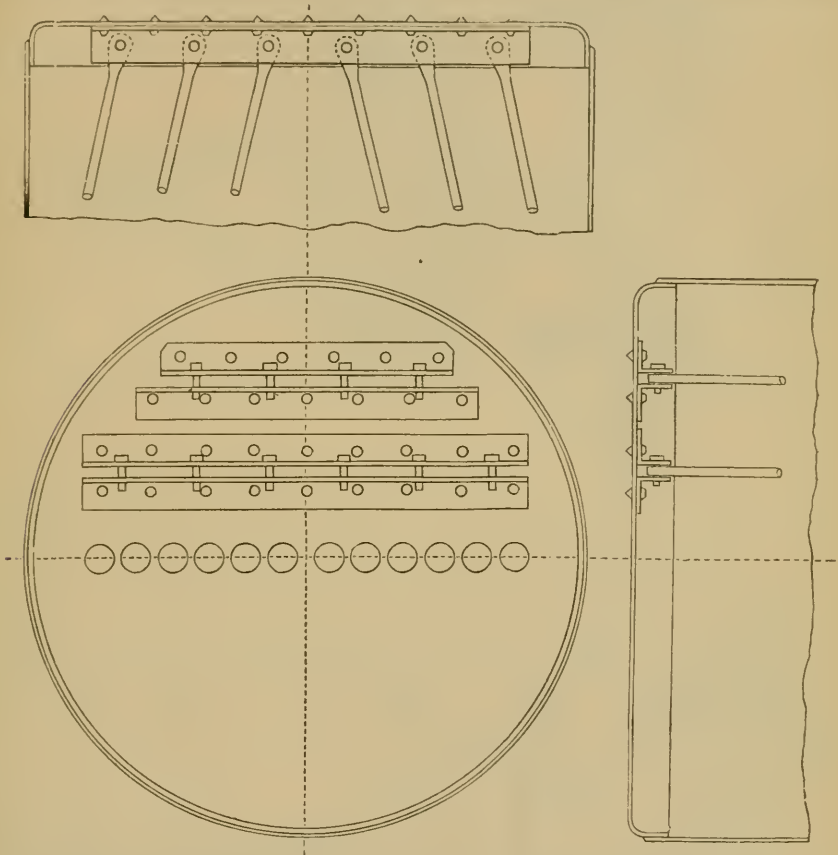

FIG. 13. — SHOWING THE USUAL WAY OF ARRANGING ANGLE IRONS.

for a brace may be utterly useless, no matter how well it is made, if it is not properly fastened. Fig. 16 shows the method we recommend for the attachment of braces to the ordinary crow-foot, tee, or angle iron. The holes through the crow-foot and the jaw of brace are drilled, not punched, and a turned pin or bolt, preferably a bolt, is fitted to the jaw. The nut is screwed up into contact with the jaw of the brace, and prevents any spreading of the jaw which might otherwise occur. Fig. 17 shows the jaw of a brace fastened to a crow-foot by a split pin, and illustrates the careless way in which braces are sometimes secured. The drawing is not an imaginary sketch, but was made from an actual brace, as accurately as we could measure it. We have seen much worse

cases many times. These forged and split pins are generally at least  $\frac{1}{16}$  of an inch tapering, and the holes into which they fit, being usually finished with a drift-pin, are in about the same condition. Then again, if we consider the fact that the holes hardly

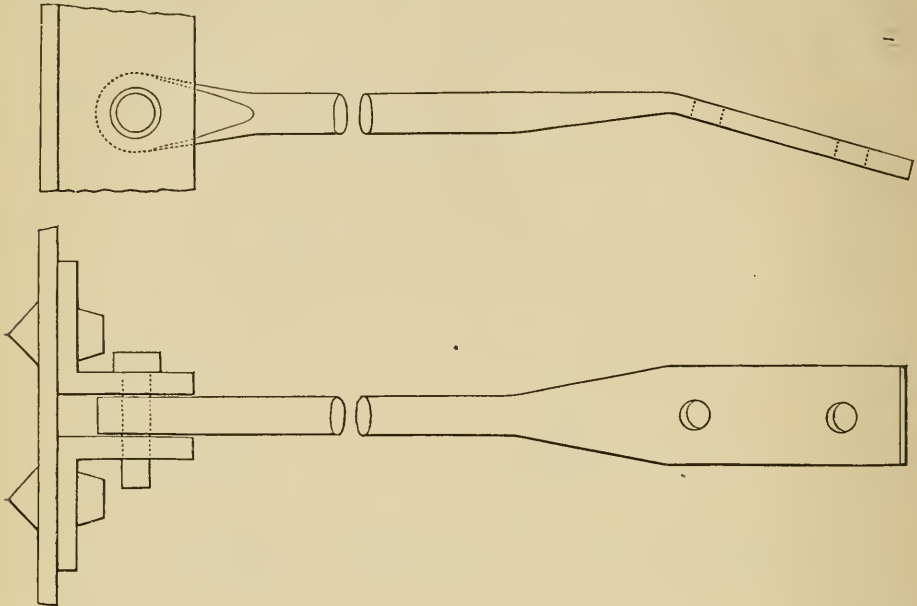

FIG. 14. — BRACES TO BE USED WITH THE ANGLE IRONS SHOWN IN FIG. 13.

ever come fair, and that the pin is driven into place whether they do or not, it will readily be seen that the general bearing between the pin and the jaw of the brace will be very apt to be quite defective. "Askew" is the word that best expresses the pin's position in the majority of cases. And right here we would enter a strong protest against the

practice which prevails in many shops of driving these pins in when the brace is not just the right length. Where it is done, it is not possible to obtain a uniform tension on the braces under

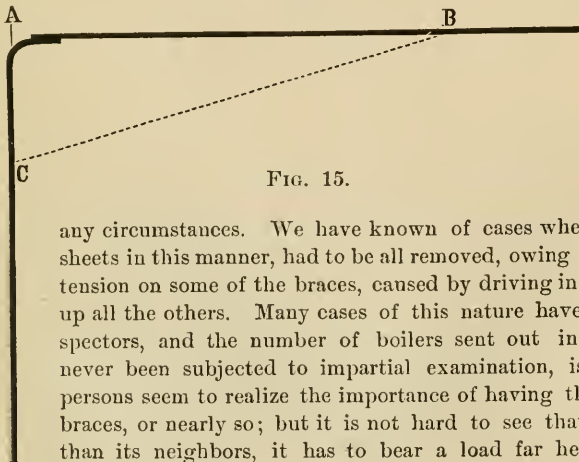

FIG. 15.

any circumstances. We have known of cases where braces, put on flat crown sheets in this manner, had to be all removed, owing to the fact that the unequal tension on some of the braces, caused by driving in these tapering pins, loosened up all the others. Many cases of this nature have been discovered by our inspectors, and the number of boilers sent out in this condition, which have never been subjected to impartial examination, is probably very great. Few persons seem to realize the importance of having the tension uniform on all the braces, or nearly so; but it is not hard to see that if one brace is much tighter than its neighbors, it has to bear a load far heavier than its proportionate

share. The result is, that it is liable to give way, and throw its load upon whichever of the remaining braces is tightest. In this way, it will be seen, the braces in a boiler, if not properly put in, may snap off in quick succession, releasing the head and causing an explosion. It is not a hard matter to put braces in right. If they

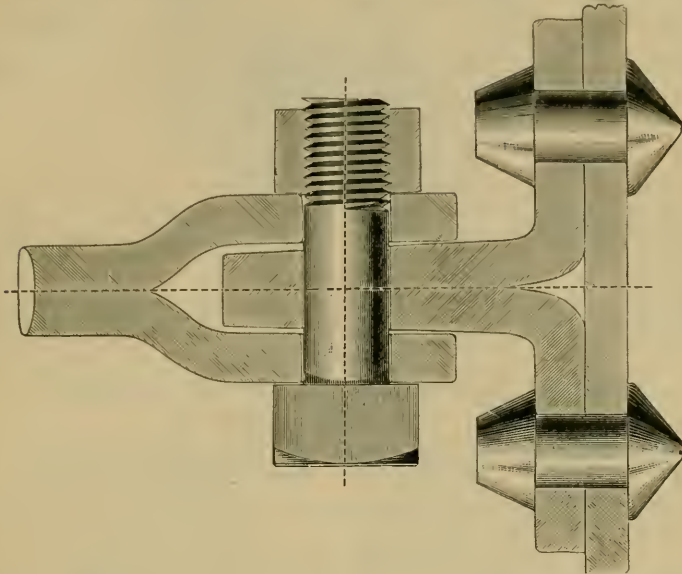

FIG. 16.

are too long or too short, they can readily be upset or drawn out a little, and then if the holes are not quite fair, they can be reamed out till they are so. They should never be driven together with a drift pin.

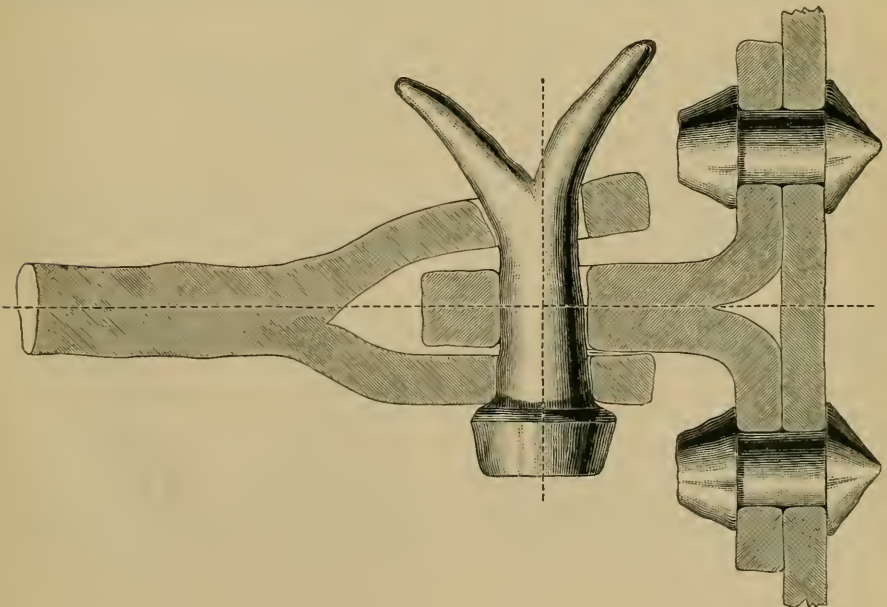

FIG. 17.



Incorporated  
1866.



Charter Per-  
petual.

Issues Policies of Insurance after a Careful Inspection of the Boilers,  
COVERING ALL LOSS OR DAMAGE TO  
**BOILERS, BUILDINGS, AND MACHINERY**

ALSO COVERING  
**LOSS OF LIFE AND ACCIDENT TO PERSONS**

ARISING FROM

## Steam Boiler Explosions.

Full information concerning the plan of the Company's operations can be obtained at the  
**COMPANY'S OFFICE, HARTFORD, CONN.,**  
Or at any Agency.

J. M. ALLEN, President.

W. B. FRANKLIN, Vice-Prest.

J. B. PIERCE, Secretary.

FRANCIS B. ALLEN, 2d Vice-Prest.

E. J. MURPHY, M. E., Consulting Engineer.

### Board of Directors.

J. M. ALLEN, President.	Hon. HENRY C. ROBINSON, Attorney-at-Law, Hart- ford, Conn.
FRANK W. CHENEY, Treas. Cheney Brothers Silk Manufacturing Co.	Hon. FRANCIS B. COOLEY, of the National Exchange Bank, Hartford, Conn.
CHARLES M. BEACH, of Beach & Co.	EDMUND A. STEDMAN, Treasurer of the Fidelity Co., of Hartford, Conn.
DANIEL PHILLIPS, of Adams Express Co.	GEORGE BURNHAM, Baldwin Locomotive Works, Philadelphia.
RICHARD W. H. JARVIS, Prest. Colt's Fire Arms Manufacturing Co.	Hon. NATHANIEL SHIPMAN, Judge United States Circuit Court.
THOMAS O. ENDERS, President of the U. S. Bank.	C. C. KIMBALL, Pres. Smyth Mfg. Co., Hartford, Conn.
LEVERETT BRAINARD, of The Case, Lockwood & Brainard Co.	PHILIP CORBIN, of P. & F. Corbin, New Britain, Conn.
GEN. WM. B. FRANKLIN, late U. S. Commissioner to the Paris Exposition.	
NELSON HOLLISTER, of State Bank, Hartford.	

### GENERAL AGENTS.

THEO. H. BABCOCK,  
CORBIN & GOODRICH,  
LAWFORD & McKIM,  
C. E. ROBERTS,  
H. M. LEMON,  
C. C. GARDINER,  
L. B. PERKINS,  
W. G. LINEBURGH & SON,  
BURWELL & BRIGGS,  
MANN & WILSON,  
ZOLLARS & MCGREW,  
R. F. MANLY,  
W. S. HASTIE & SON,  
PETER F. PESCUO,

### CHIEF INSPECTORS.

R. K. McMURRAY,  
WM. J. FARRAN,  
F. S. ALLEN,  
WM. HEAFORD,  
A. B. ECOFF,  
F. S. ALLEN,  
J. H. RANDALL,  
C. A. BURWELL,  
J. E. WARNER,  
T. E. SIEARS,  
B. F. JOHNSON,

### OFFICES.

Office, 285 Broadway,  
432 Walnut St.  
" 22 So. Holliday St.  
" 125 Milk St.  
" 29 Weybosset St.  
" 112 Quincy St.  
" 404 Market St.  
" 218 Main Street.  
" 2 Sanford Building.  
" 208 Superior St.  
" 306 Sansome St.  
" Mining Ex. B'g.  
" Morris Building.  
" 44 Broad St.  
" 188 Gravier St.

NEW YORK CITY.  
PHILADELPHIA, Pa.  
BALTIMORE, Md.  
BOSTON, MASS.  
PROVIDENCE, R. I.  
CHICAGO, ILL.  
ST. LOUIS, MO.  
HARTFORD, CONN.  
BRIDGEPORT, CONN.  
CLEVELAND, OHIO.  
SAN FRANCISCO, CAL.  
DENVER, COL.  
BIRMINGHAM, ALA.  
CHARLESTON, S. C.  
NEW ORLEANS, LA.

# The Locomotive.

PUBLISHED BY THE HARTFORD STEAM BOILER INSPECTION AND INSURANCE COMPANY.

NEW SERIES — VOL. XIV. HARTFORD, CONN., OCTOBER, 1893. No. 10.

## An Unusual Accident.

A short time ago one of our inspectors received an urgent call to visit an electric power station in Texas. There were six boilers in the battery, and they had been working all right, until, without warning, boilers Nos. 1, 2, and 3 were seen to be losing their water rapidly. The feed pump was started as fast as possible, and the water rose in Nos. 2 and 3; but No. 1 still showed no water, and its feed valve was closed. The fires were hauled immediately upon the first signs of trouble being perceived, so that boiler No. 1 suffered no damage beyond the starting of leaks about the

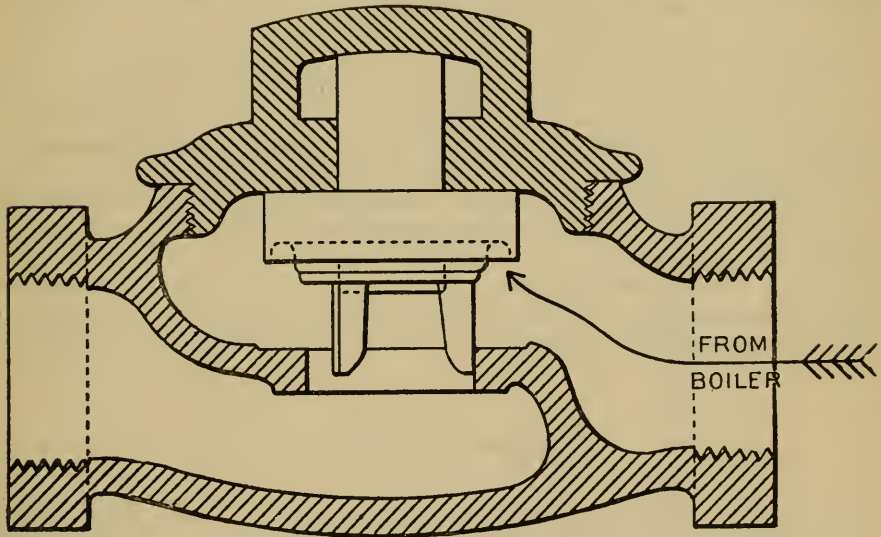

THE CAUSE OF THE ACCIDENT.

tubes at both ends, and at the girth joints and some of the longitudinal joints. The prompt hauling of the fires also saved Nos. 2 and 3 from being damaged; and after re-rolling the tube ends and caulking the joints in boiler No. 1, all the boilers were ready for use again, except that it was first necessary to discover the cause of the accident, and take measures to prevent its recurrence.

The report of the inspector says: "Arriving at the plant, I found that boiler No. 1 had not been touched after the accident had occurred. The plates were ordered removed, and as soon as the boiler was cool enough an internal examination was made. No damage to either tubes or shell could be detected from the inside. The feed pipe was

in place, and the end of it was perfectly free. All openings to outside attachments were also free.

"The bonnet on the blow-off valve was removed, and the valve was examined. No defect was found. It is possible that there was a very slight leak just beginning, but the valve was practically tight. I next removed the cap on the check valve in the feed pipe, between the stop valve and the boiler. This check valve is shown in the accompanying sketch. It has a  $\frac{3}{8}$ " lift, taken by a spiral lead, and a  $\frac{1}{2}$ " edge. When raised, it fits snugly up in the bonnet, so that no pressure can reach the top of the valve to force it downward. With pressure in the pipe, the flow could therefore readily change from feeding the boiler to emptying it, the flow of water *holding the valve open*, instead of closing it. As no defect was found in the blow-off pipe connections, or elsewhere, it is believed that the check valve on the feed pipe *did* act in this manner, under the peculiar conditions presently to be mentioned, and that it was the cause of the accident. The feed water is pumped into a live steam purifier, fitted with shelves, and from the purifier it falls into the boilers by gravity. The purifier became full of water and began to back water through its live steam supply pipe into the main steam pipe; so that it became necessary to blow it off, to drain it to the proper level. The live steam supply to the purifier was stopped, by shutting off that end of the main steam pipe; so that the pressure in the purifier fell below the 115 lbs. boiler pressure. As this pressure gradually decreased, the blow-off valve on the purifier being open, the pressure in the boiler forced the water in the boiler back through the feed pipe, its check valve refusing to act, and out through the purifier blow-off. If the pressure had not been shut off the purifier, the accident would not have happened. Also, if the internal feed pipes had not been run down to within a few inches of the lower sheet, so much water would not have been backed out of the boiler."

It is proper to say that this article is not inspired by a desire to depreciate the particular check valve shown in the cut, but merely to call attention to the particular combination of circumstances that led to trouble in the present case. Possibly this same combination may not occur elsewhere, for years; yet it is well to call attention to accidents of this character, because they sometimes throw light on other accidents, which, even though quite different in details, may nevertheless be of the same general nature.

## Inspectors' Report.

MAY, 1893.

During this month our inspectors made 7,300 inspection trips, visited 14,160 boilers, inspected 6,082 both internally and externally, and subjected 722 to hydrostatic pressure. The whole number of defects reported reached 10,834, of which 919 were considered dangerous; 52 boilers were regarded unsafe for further use. Our usual summary is given below:

Nature of Defects.	Whole Number.	Dangerous.
Cases of deposit of sediment, - - - - -	916	54
Cases of incrustation and scale, - - - - -	1,728	93
Cases of internal grooving, - - - - -	143	23
Cases of internal corrosion, - - - - -	546	40
Cases of external corrosion, - - - - -	709	43
Broken and loose braces and stays, - - - - -	134	26

Nature of Defects.	Whole Number.	Dangerous.
Settings defective, - - - - -	258	41
Furnaces out of shape, - - - - -	404	16
Fractured plates, - - - - -	245	41
Burned plates, - - - - -	252	24
Blistered plates, - - - - -	297	16
Cases of defective riveting, - - - - -	1,579	56
Defective heads, - - - - -	135	34
Serious leakage around tube ends, - - - - -	1,736	197
Serious leakage at seams, - - - - -	535	43
Defective water-gauges, - - - - -	315	47
Defective blow-offs, - - - - -	129	37
Cases of deficiency of water, - - - - -	18	10
Safety-valves overloaded, - - - - -	51	11
Safety-valves defective in construction, - - - - -	65	20
Pressure gauges defective, - - - - -	552	32
Boilers without pressure gauges, - - - - -	15	15
Unclassified defects, - - - - -	72	0
Total, - - - - -	10,834	919

#### JUNE, 1893.

During this month our inspectors made 6,817 inspection trips, visited 13,000 boilers, inspected 6,118 both internally and externally, and subjected 827 to hydrostatic pressure. The whole number of defects reported reached 10,401, of which 1,005 were considered dangerous; 27 boilers were regarded unsafe for further use. Our usual summary is given below:

Nature of Defects.	Whole Number.	Dangerous.
Cases of deposit of sediment, - - - - -	808	39
Cases of incrustation and scale, - - - - -	1,523	55
Cases of internal grooving, - - - - -	123	12
Cases of internal corrosion, - - - - -	616	36
Cases of external corrosion, - - - - -	785	33
Broken and loose braces and stays, - - - - -	142	30
Settings defective, - - - - -	286	29
Furnaces out of shape, - - - - -	395	38
Fractured plates, - - - - -	255	61
Burned plates, - - - - -	226	29
Blistered plates, - - - - -	332	12
Cases of defective riveting, - - - - -	1,593	156
Defective heads, - - - - -	94	28
Serious leakage around tube ends, - - - - -	1,627	217
Serious leakage at seams, - - - - -	436	22
Defective water gauges, - - - - -	228	61
Defective blow-offs, - - - - -	161	58
Cases of deficiency of water, - - - - -	20	14
Safety-valves overloaded, - - - - -	31	8
Safety-valves defective in construction, - - - - -	69	20



Nature of Defects.	Whole Number.	Dangerous.
Pressure-gauges defective, - - - -	574 -	- 44
Boilers without pressure-gauges, - - - -	3 -	- 3
Unclassified defects, - - - -	74 -	- 0
Total, - - - -	10,401 -	- 1,005

## Boiler Explosions.

AUGUST, 1893.

(174.)—At Mt. Joy, near Portsmouth, Ohio, a boiler exploded on Aug. 2d, killing two men outright, and injuring several others. Those killed instantly were Sanford Wolfe and James Alexander. John Riter had his skull fractured and was otherwise injured, and he cannot live. Frank Wallace had his right arm blown off, and it is believed that he will die also. [Wallace died on Aug. 4th.]

(175.)—On Aug. 2d one of the boilers in the waterworks at Anthony, Kan., exploded, entirely demolishing the building and machinery. Clement L. Perry, the engineer, was instantly killed, and Lewis Sargent was seriously injured. There are but few wells in the town, and as the weather was very dry, the people suffered greatly, while the damage was being repaired, from lack of water.

(176.)—A boiler exploded near Medina, Ohio, on Aug. 4th, blowing itself and its engine to pieces, and setting fire to a building. Nobody was injured.

(177.)—A boiler exploded on Aug. 5th in Isaac Howell & Son's mill, at Pittsburgh, near Vandalia, Ill. The mill was badly wrecked, and Isaac Howell was instantly killed. William Howell, the son, was badly scalded, and it is said that he cannot recover.

(178.)—A boiler explosion occurred on Aug. 8th in the Cadwallader Milling Company's mill, in Fostoria, Ohio. Glancy Davis, secretary of the company, was killed outright, and Fred Myers, a book-keeper, was fatally injured, and died a few hours later. Three other men were also injured, but not fatally. The north wall of the mill was blown out, and the whole building was so badly shaken and cracked, that it was on the verge of falling in. The loss was estimated at from \$10,000 to \$15,000.

(179.)—By the explosion of a boiler in Marshall, Tex., on Aug. 9th, Thomas Hill, Henry Smalley, and Augustus Saunders were killed, and John F. Hill and Joseph Bright were dangerously scalded.

(180.)—A boiler used for operating a toy engine exploded at Martin's Ferry, Ohio, on Aug. 10th, fatally injuring a lad named Grayson. His companion, Thomas Mitchell, was thrown fifteen feet away, but escaped serious injuries.

(181.)—On Aug. 11th two flues blew out in one of the boilers at the Keystone Driller works, at Beaver Falls, Pa. We did not learn that any one was injured.

(182.)—A boiler exploded on Aug. 12th in York, near Marysville, Ohio. Charles Cronley was killed, and eighteen others had a very narrow escape.

(183.)—The boiler of a distillery in Elora, Ala., exploded on Aug. 12th, wrecking the plant and scalding to death George Couch, the engineer, and James Smith, the fireman. Couch died instantly. Smith lived several hours, suffering intensely.

(184.)—By a slight explosion in Detroit, Mich., on Aug. 13th, Robert Hardenburg was scalded on the breast, arm, face, and neck, and received internal injuries, probably

by inhaling steam. At last accounts he was suffering great pain, but was expected to live.

(185.)—On Aug. 14th Bartlett Brothers' mill in North Adams, Mass., was destroyed by fire. During the progress of the fire a 60-horse-power boiler exploded, and two firemen had a narrow escape from being killed by it. The employes were at dinner. The loss is variously estimated at from \$10,000 to \$20,000.

(186.)—The Union Pacific steamer *Annie Faxon* was blown up on Aug. 14th by the explosion of her boiler, while off Waite's bar, four miles west of Almota landing, twenty miles from Colfax, on the Snake river, in the State of Washington. The decks were ripped asunder, and the cabins whirled up in the air and fell piecemeal into the water. The passengers and crew were also blown high into the air, and the survivors, nearly all of whom were injured, struggled for life in the swift water till picked up by rescuing boats. The killed are William Kidd, George Farrell, Paul Allen, H. E. Bush, John McIntosh, Thomas McIntosh, Mrs. Patrick Poppinell, and one unknown person. Some of the bodies were frightfully mangled by being blown through the decks of the steamer. The seriously injured are Sage Aiken, Jake Moritz, William Mohl, C. Lawton, Roger Morris, Captain Baughman, an unknown passenger, and three Chinese employes. The *Faxon* sank after the explosion.

(187.)—A freight train on the Ferry branch of the S., F. & W. railroad was piled up into a terrible mass of wreckage, near Lakeland, Fla., on Aug. 15th, by the explosion of the boiler of the locomotive. Strange to say, the engineer and fireman were the only persons hurt; they were badly scalded.

(188.)—A boiler exploded on Aug. 16th in the Wellington Mills, in Wellington, near Lexington, Mo. Richard Johnson and Frank Albin were instantly killed. The boiler house was wrecked.

(189.)—On August 17th, a boiler exploded in the town of Nord, near Chico, Cal., killing William Vettel, and injuring Robert Withrow and Alva Cook.

(190.)—A boiler explosion occurred on August 18th, at Roxabell, near Chillicothe, Ohio. The killed are Robert Basson, Harry Roberts, and Benjamin Quinn.

(191.)—A slight boiler explosion took place at C. H. Sharpe's ice cream manufactory in Middletown, N. Y., on August 19th. The damage was not great, but Mr. Sharpe, who was near the boiler at the time, was badly scalded about the face, hands, and body.

(192.)—On August 19th, the head of a mud-drum blew out in Lambert & Bishop's mill, in Joliet, Ill. George Parkins, Corey Robinson, and John Wightman were badly hurt. Parkins was fearfully injured internally by inhaling steam. He died the next day. Robinson, who was general manager of the mill, was terribly scalded on the throat, breast, abdomen, legs, and arms. His physician thought he would recover, however. Wightman, who was superintendent, was scalded all over the front part of his body, from his face to his knees; and he was also struck by flying timbers. He will probably recover. The property loss was estimated at about \$2,000.

(193.)—A boiler exploded in Morton, Miss., on August 20th, killing a man named Jackson.

(194.)—On August 21st, a boiler exploded in McNutt's mill, in Plymouth, Ohio. The mill was not running at the time, but the boiler had been fired up for testing a new piece of machinery. There were but three men in the mill at the time, one of whom,

Curtiss McNutt, escaped without injury. Rollin McNutt, who was firing the boiler, was instantly killed. Oliver Gravatt had his back broken, and died on the following day. The property loss was estimated at \$2,500.

(195.)—A big boiler exploded on August 21st, in Franklin, Ind. John Dennis, the engineer, was caught under the falling debris and terribly burned all over the body. He cannot recover. Martin Dennis, his father, was also badly scalded, but not fatally so. One-third of the boiler, weighing about a ton, was blown over one hundred yards from the building. Immediately after the explosion the building caught fire and was totally destroyed, together with all the valuable machinery. The loss is estimated at \$25,000.

(196.)—A boiler exploded at Baird's foundry, Woodstock, Ont., on August 22d, and Mr. R. T. Crawford was badly scalded.

(197.)—On August 22d, a boiler exploded in J. W. Willett's mill in Bushnell, Mich. George Austin was instantly killed, and two others were seriously and perhaps fatally injured.

(198.)—A boiler explosion occurred on August 23d, near Napa, Cal. John Landsburger, the fireman, was blown 200 feet, and instantly killed.

(199.)—A boiler exploded on August 25th, on Lightship No. 46, which has been stationed, since July 31st, at the Wolf-Trap shoal, near Matthew's Courthouse, Va. The engineer, James Scott, was killed, and another man was badly scalded.

(200.)—On August 26th, a boiler exploded at Adair, near Vinita, I. T. Dr. G. E. Garrettson, and a man whose name we have not learned, were instantly killed.

(201.)—By a boiler explosion at Humerick, near Oakland, Ill., on August 28th, George Noble was killed, and Alexander Litton and John Thomas were fatally injured.

(202.)—A boiler exploded on August 31st, in Langford, S. D. Austin Christianson, C. E. Christianson, Louis Uptiman, and one other man, were badly scalded and bruised.

### The "John Bull" Train.

The Pennsylvania Railroad Company has a very interesting exhibit at the World's Fair, and one of the most interesting things to be seen there is the old Stephenson locomotive, *John Bull*, of which venerable relic the Pennsylvania Company gives the following account:

"The history of the locomotive dates back to a period when locomotion by steam was in the earliest age of experimentalism. For several years previous to 1830 experiments attended with more or less success had been made in England with locomotives to be propelled by steam. In 1830 the *Planet*, constructed by George Stephenson, was the best example of a machine of this character, and after witnessing a trial of its powers in 1830, Mr. Robert L. Stevens, the founder of the Camden and Amboy Railroad, placed an order with Stephenson to build an engine on the same lines for shipment to this country. This engine, christened *John Bull* after its arrival in America, was completed in May, 1831, and shipped to Philadelphia, where it arrived in August of the same year. It was then transshipped to Bordentown. The boiler and cylinders were in place, but the other component parts were packed in boxes, and it was with the utmost difficulty that they could be put together and adjusted by mechanics who had never before seen a piece of mechanism of a similar character.



“The original weight of the engine was about ten tons. The boiler was 13 feet long and 3 feet 6 inches in diameter. The cylinders were 9 inches by 20 inches. There were four driving wheels, 4 feet 6 inches in diameter, made with cast-iron hubs and wooden spokes and felloes. The tires were of wrought-iron  $\frac{3}{4}$  inch thick, and the depth of the flange was  $1\frac{1}{2}$  inches. The original gauge was 5 feet. The interior arrangements were primitive in the extreme, and the handling of the levers used in starting or reversing involved a considerable amount of hard work on the engineer's part. When the engine had finally been successfully articulated and placed upon the track laid for the experiment, the boiler was pumped full of water from a hogshead, a fire of pine wood was lighted in the furnace, and at an indication of 30 pounds steam pressure the engineer, nervous with excitement, opened the throttle, and the locomotive moved over the rails. Several other trials were subsequently made with equal success, and the locomotive was taken apart again, modifications were made here and there, a tender was improvised, and it was held in readiness to await the completion of the railroad.

“Between 1831 and 1836 the *John Bull* underwent considerable modification, as changes suggested themselves to the watchful eyes of the American mechanics, and in the latter year the engine was in active service on the Camden and Amboy Road, just as she appears to-day. During the more than half century of its life the sturdy old machine suffered many vicissitudes of fortune. After years of admirable service, the modern machinist succeeded in producing improvements which relegated the old engine to the side track, and it was stored away in Bordentown for a number of years. In 1876 it was rescued from the oblivion which was enveloping it in the quiet Jersey town, and exhibited at the Philadelphia centennial, where it attracted much attention. Its next public appearance was at the Chicago Exposition of Railway Appliances in 1883, and, then being presented to the United States Government by the Pennsylvania Railroad Company, it has since been a notable feature of the world of curiosities collected in the National Museum at Washington. The Pennsylvania Railroad Company, through Mr. Theo. N. Ely, Chief of Motive Power, who has charge of the company's exhibit, borrowed it from its present owners to place it on exhibition at the company's building at the World's Columbian Exposition.

“One of the most notable features of the *John Bull* is the pilot, commonly known as the cow-catcher. As originally constructed in England there was no pilot attached, but when the engine was placed in service on the Camden and Amboy Road, it was found absolutely necessary to provide a pilot in order to assist the machine in taking curves. Mr. Stevens set himself the task of planning one, and, although it was a crude and awkward affair, it served the purpose. The first pilot was a frame made of oak, 8 feet by 4 feet, pinned together at the corners. Under the forward end were a pair of wheels 26 inches in diameter, while the other end was fastened to an extension of the axle outside of the forward driving wheels, as it was found that a play of about one inch on each side of the pedestal of the front wheels was necessary in order to get around the curves. At first it required a considerable pile of stones to hold the pilot down to its work, and even then it is a matter of tradition that it had a pernicious habit of getting off the track on very slight provocation. When the engine was to be turned the pilot had to be removed, as the turntables of that day were too short to accommodate it. The pilot which now adorns the front of the *John Bull* is a somewhat less cumbersome modification of the one first constructed by Stevens.

“Wood was the original fuel used, but the furnace has been changed now for coal. The inclosed tender contains a storage capacity for about 2,200 pounds of coal



and a tank holding 1,500 gallons of water. The water is sufficient for a run of 30 miles, and the coal will last through 90. The curious contrivance resembling a poke bonnet, which surmounts the tender, was called the 'gig-top.' In it sat the forward brakeman, who not only kept a sharp lookout for other trains approaching on the same track, but signaled to the rear brakeman when occasion required, and worked the brakes on the locomotive and tender by a long lever which extended up between his knees. There was no bell-cord nor gong on the locomotive, so all communication between engineer and brakemen was by word of mouth. All these original features are retained in the restored engine.

"Hardly less unique than the locomotive itself are the passenger coaches of this historic train. Some twenty-five years ago a farmer, near South Amboy, bought one of the discarded coaches of the old Camden and Amboy Railroad. He removed it from its trucks, and, planting it on posts in the ground, converted it into a chicken coop. It served in this capacity until a few months ago, when a representative of the Pennsylvania Railroad, looking for relics, happened upon it, and entered into negotiations for its purchase. The thrifty farmer, realizing that lapse of time had endowed his henery with increased value, demanded a price which represented compound interest on the original purchase money; but the matter was adjusted, and the passenger coach of fifty years ago, transformed into a chicken coop, is once more fixed upon its trucks and will go to Chicago as a part of the *John Bull* train. After its recovery the coach was refitted and reupholstered, so that it appears now in all the pristine glory of its palmy days. The history of the other coach is not quite so romantic. It was found some years ago in a lumber yard, in a New Jersey town, among a mass of rubbish, and quietly tucked away in the Meadows shops by a far-sighted official of the company, who foresaw that just such an occasion as this would bring it into requisition some day.

"The old coaches present many reminders of their predecessors of the road before iron rails were known. They are, indeed, but an advanced development of the stage coach. No space is wasted in their construction. They are low and narrow, being but 30 feet long, 8 feet wide, and 6 feet 5 inches high inside. The interior finish is severely plain. There is an entire absence of any attempt at ornamentation of any kind. The roof has no ridge for ventilating purposes, as in the cars of the present time, but is slightly convexed, the surface being covered with a figured cloth. Ventilation is secured by adjustable slats above the windows. The twenty double seats, which are very narrow, and the four single ones, are made of boards upholstered with a greyish material, similar to the stuff used in old stage coaches. The backs are devoid of upholstery, with the exception of the band at the top to support the shoulders. The aisles are very narrow, as are the double doors, and it seems a problem how the crinoline of our grandmothers could accommodate itself to the narrow confine accorded to it. There are no toilet rooms nor any provisions for drinking water. This latter luxury was not introduced until 1840, when it was supplied from wooden kegs with a brass spigot, from which the water escaped into a tin cup. There was little travel by night in the olden days, so the only illuminating agents were a tallow candle encased in a glass holder, one at the rear and the other at the front of the car. The window lights resemble the panes of glass in a child's playhouse, and as the windows could not be raised, a movable slat, capable of being lifted up or down on the principle of the blinds of a stage coach, is inserted between each light for the purpose of admitting the air. A sloping projection, a few inches in width, above the windows, and another at their center, protected the interior to some extent from the beating in of the rain when the slides were open. The cars, like the locomotive, are painted a rich olive-green, and

bear no lettering of any kind. The coaches weigh 14,250 lbs., and are mere pygmies beside the 90,000 lb. Pullmans of the evening of the nineteenth century. Each coach has its own brakeman, and as the brake-rods are not fitted with ratchets or 'shoes,' the sturdy muscle of the brakeman must hold the brake tight until his grip is released by the proper signal from the man in the crow's nest."

### The Mont Blanc Observatory.

Not very long ago it was considered a great feat to climb Mont Blanc, and only the sturdiest and most courageous travelers attempted it. Now, however, an observatory has been erected on the very summit of the mountain, and it is proposed to occupy it continuously during the warmer half of the year. Concerning the completion of this building the *Scientific American* says: "The observatory on the top of Mont Blanc is at last completed. The work was facilitated by the use of windlasses, which drew the materials up the icy slopes. Some of the builders remained on the summit for twenty days, the August weather being very favorable. The construction of the observatory was begun over two years ago. The builders hoped to cut through the ice-cap to solid rock, but this was found to be impossible, after they had gone down a distance of thirty or forty feet. So at last it was determined to let the building stand upon the ice and snow. The observatory was made in sections at Paris, under the immediate direction of M. Janssen. The pieces were transported to Rochers-Rouges on the backs of men, and were finally brought to the summit by the aid of windlasses. The building is thirty-eight feet high, but only one-third is above the snow. The upper story is used exclusively for observatory purposes, while the lower stories shelter attendants and parties of tourists. The observatory rests on ten heavy screws, so that the building can be easily leveled. The interior is lighted by small dormer windows with double panes of thick glass. All wood used in the construction is fireproofed, and all necessary precautions against fire have been taken. Anthracite coal will be burned. It is seldom that the cold exceeds thirty-two degrees below zero. (!) The observatory will be occupied from May to November, and a great deal is expected from the self-registering instruments during the winter. If possible, it is intended to connect the instruments with Chamounix by electricity, but no steps toward this end have been taken yet. M. Janssen was carried to the top of Mont Blanc last year in a litter borne by thirteen porters. The new observatory will enable scientists to carry out important experiments and observations in physics, meteorology, spectrum analysis, and vegetable and animal physiology."

---

MR. E. H. GRIFFITHS has just published his monumental work on the "Redetermination of the Mechanical Equivalent of Heat." The results of five years of untiring struggle do not differ among themselves by more than 1 part in 10,000, if we abstract one group of experiments; and this group deviates from the mean by only 1 part in 4,000. Mr. Griffiths finds that it takes 778.99 foot pounds to raise one pound of water from 59° Fah. to 60° Fah. Joule's value, with air thermometer corrections according to Rowland, was 778.5, at the temperature 54.9° Fah. Rowland himself observed 780.1 at the same temperature. A very satisfactory outcome of these experiments of Mr. Griffiths is the exact accordance between the temperature scale as determined by the comparison of his platinum thermometer with the air thermometer made by Callendar and himself in 1890, and that of the nitrogen thermometer of the Bureau International at Sèvres. These observations also bear out Professor Dewar's discovery that the electrical resistance of certain pure metals vanishes at absolute zero.—*Engineering*.

# The Locomotive.

HARTFORD, OCTOBER 15, 1893.

J. M. ALLEN, *Editor.*

A. D. RISTEEN, *Associate Editor.*

THE LOCOMOTIVE can be obtained free by calling at any of the company's agencies.

Subscription price 50 cents per year when mailed from this office.

Bound volumes one dollar each. (Any volume can be supplied.)

Papers that borrow cuts from us will do us a favor if they will mark them plainly in returning, so that we may give proper credit on our books.

WORD was recently received at Vancouver, B. C., that the boiler of a steamer plying on the Japanese coast exploded on Aug. 24th, and that over 30 people were killed.

THE newspaper correspondent is at it again. "The engineer," he says, "lost the upper half of his head by the explosion. The severed portion was afterwards found, still in his hat."

THE Berlin Iron Bridge Co. of East Berlin, Conn., has issued an interesting book, giving views of a large number of bridges and roofs constructed by them. Each engraving is accompanied by descriptive matter, and as about 150 roofs and bridges are shown, the book promises to be very useful for reference. It reflects credit on the company that issues it, and we shall be glad to give it a place on our shelves.

WE desire to acknowledge a copy of *The Heating and Ventilation of Residences*, by James R. Willett. This is a reprint of an address delivered by Mr. Willett to the Engineering Societies of the University of Illinois, on March 23, 1893. It discusses hot water heating, steam heating, and hot air heating, and contains numerous useful suggestions. It is illustrated with 18 plates, showing the disposition of boilers, pipes, and furnaces, in cases taken from Mr. Willett's own practice.

THE New York *Sun* says that "a warning against the dangers of the barber's chair has been raised by Dr. Blaschko of Berlin in a discourse from which quotations are made by the *British Medical Journal*. The warning is given on account of the existence in Berlin of a malady known as dermatomycosis tonsurans, the infection of which may be communicated by the barber's shaving brush, by the lather, the razor, the sponge, the towel, the powder puff, the comb, or the brush. After making a special study of this Berlin epidemic, Dr. Blaschko takes up some of the other maladies that may be contracted in barbers' shops there, among which are herpes tonsurans, impetigo contagiosa, trichorrhæxis nodosa, acme varioliformis, impetiginous eczema, alopecia areata, tuberculosis, and cholera." And all for ten cents. Ho, barbers all, shut up your shops! "We'll never go there any more."



Mr. Emory Edwards has kindly sent us a copy of the latest edition of his *900 Examination Questions and Answers, for Engineers and Firemen*. It is a handy volume for the pocket, and is filled with interesting and useful information for engineers and others. Mr. Edwards is himself an engineer of large experience, and thoroughly acquainted with his subject. His book, as he says himself, is designed "to help worthy men do good, intelligent, and faithful work, and to better their condition in life." (Henry Carey Baird & Co., publishers, Philadelphia, Pa.)

---

IN one account of explosion No. 182, on page 148 of this issue, we read of an ingenious and interesting way of finding out what pressure a boiler can safely carry. It is marvelous that this idea has not occurred to somebody before. There it has lain, staring us out of countenance these many years; and all the great men have passed by on the other side. Gentle reader, see for yourself how it is done: "Young Penhorwood says that just before the explosion he noticed there were two gauges of water in the boiler, and that it was under a pressure of 85 pounds of steam, *although the steam gauge would admit of 240 pounds.*"

---

WE have received from the Hon. C. J. Ward, Honorary Commissioner for Jamaica, a copy of *Jamaica at Chicago*, a very attractive book descriptive of the colony Mr. Ward represents. It contains a descriptive account of the island, sketches of its earlier and later history, and essays on the attractions the island offers to tourists, in the way of amusement, scenery, and climate. There is also a considerable amount of statistical information appended. It is neatly printed, and is illustrated by fifty excellent photo-engravings. The engraving of Martha Brae at Falmouth, on page 31, strikes us as particularly good, from an artistic standpoint.

---

IT is always dangerous to calk leaky joints, or screw up nuts, about boilers that are under pressure, and many accidents result from doing so. The other day we learned of an accident of this kind that took place a short time ago in the basement of Shoneman Brothers' store in Philadelphia. Christian Reibner, the engineer, undertook to tighten up a leaky cap on a sectional boiler while the boiler was under steam pressure. A slight twist did not seem to do any good, so he gave the cap a good, vigorous wrench. Immediately steam and boiling water began to pour out, increasing in quantity every instant. Reibner could not get out of the way quickly enough, and was severely scalded all over the upper part of his body. His assistant, Thomas Service, was down in a pit in front of the boiler, and was immediately overcome by the scalding cloud. Officer Blackburn attempted to rescue him, but was driven back by the intense heat, even though protected by a blanket. Service was dead when the cloud had subsided enough to allow of his removal.

---

THE big Yerkes telescope in the Manufactures Building at Chicago is of great interest to visitors that are astronomically inclined. It stands in the center aisle, and is the largest refracting telescope in the world. It is the gift of Mr. Chas. T. Yerkes to the University of Chicago. The lens will be finished some time next year, and the telescope will then be ready for erection on its permanent site. The object-glass is to be 40 inches in diameter in the clear. The tube is made of sheet steel, riveted together in courses. It is 64 feet long and 52 inches in diameter, and weighs six tons.



The declination axis of the instrument is 12 inches in diameter and 11 feet 6 inches long, and weighs a ton and a half. The polar axis is 15 inches in diameter and 13 feet 6 inches long, and weighs three tons and a half. Both these axes are of steel, and they run on ball bearings. The weight of that part of the telescope which must be moved by the clock (in following the stars across the heavens) is 20 tons. The clock itself weighs a ton and a half. It is situated in the upper part of the pedestal, or "column," of the telescope. The main driving wheel by which the clock is geared to the polar axis is eight feet in diameter. The clock is wound automatically by an electric motor, and is controlled by a double conical pendulum. The column and head of the telescope are made of cast-iron; they are 43 feet high, over all, and weigh 50 tons. The total weight of the instrument is 75 tons. All the "quick motions" and "slow motions" and clamps can be operated by hand by the observer, and also by electric motors controlled by a switchboard within easy reach. The telescope can also be fully controlled by the assistant astronomer, who is stationed on the balcony surrounding the head of the telescope. This balcony, and the clock room, which is entered from it, are reached by a spiral staircase at the south side of the column. The mounting of this telescope was made by Messrs. Warner & Swasey, of Cleveland, Ohio, and the object-glass is being made by Messrs. Alvan Clark's Sons, of Cambridgeport, Mass. The 26-inch telescope in the U. S. Naval Observatory at Washington, and the 36-inch one in the Lick Observatory, were made by the same firms.

---

### The Ferris Wheel.

The *Review of Reviews* for September, publishes an exceedingly interesting article on "Engineer Ferris and His Wheel," descriptive of that singular exhibition of American ingenuity and progress. The writer says :

Given the circumstances, in no other country than America would the wheel have ever been built. It took three years to complete the Eiffel Tower. Even here it took two years to build the St. Louis bridge. Both were comparatively simple work. The builder of the Ferris wheel had not only to construct a work equaling these, but in such a way that it would move, and, moreover, move perfectly — a far greater problem.

On December 28th every scrap of iron and steel used in the wheel was "pig." On June 21st, less than six months later, 2,200 tons of this "pig," converted into a revolving mechanism as perfect as the pinion wheel of an Elgin watch, began to turn on its 70-ton axis, and has been turning without let or hindrance, without creak or crack, ever since.

It is not easy for the mind to grasp the stupendous nature of this undertaking. The wheel itself is two hundred and fifty feet in diameter; at its highest point it is two hundred and sixty-eight feet above the earth. That is to say, if Bunker Hill monument was used as a yardstick to measure it, the towering monolith would fall short fifty feet. If the wheel were set in Broadway, by the side of Trinity spire, it would lift the passengers of its cars to a level with the apex of that soaring steeple. The obelisk of Luxor or Trajan's pillar, at Rome, would not be long enough to serve for a radial spoke.

Then, again, as to its enormous weight. The Niagara cantilever, just below the Falls, was looked upon as an engineering wonder when it was built. Its construction required three years. The Ferris wheel was built in five months, and its weight is four times that of the Niagara bridge. The St. Louis bridge was another wonder, and its weight is about equal to that of the big wheel complete. The Cincinnati cantilever is another huge bridge; it is 1,300 feet, a quarter of a mile, long, and it would about bal-

ance the scale with Mr. Ferris' big toy. And the one is set immovable, resting on two supports, while the wheel is swung upon an axle lifted one hundred and forty feet in the air. It has thirty-six cars, and in these two regiments of soldiers could be seated and swept with an almost imperceptible motion high above the White Wonder.

I said: "Precisely what does the great wheel represent in mechanics?" "Well," Mr. Ferris replied, "I suppose you might consider it as typifying the present progress, the latest development, of mechanical engineering. You know there are really two wheels, one built thirty feet within the other. These are joined by truss work, such as is used in our finest bridge construction. Beyond all that, the wheel develops to a degree hitherto never realized the capacities of a tension spoke. You know that the wheel is not only a perfect pinion wheel, but a tension wheel as well, and these, I suppose, may be regarded as its chief points. I do not know whether you have stopped to consider, but it is as perfect a pinion wheel as the little wheel that goes flicking back and forth in your watch. In all that immense diameter there is less deflection proportionately, from a true circle, than from the pinion wheel of the most perfect watch made. This is due to the fact that it has, instead of stiff spokes, the tension or jointed spokes. When I first proposed to build a tension wheel of this diameter the feat was regarded as impossible. It was held that the spoke rods on the upper side of the wheel at any given moment, instead of sustaining the weight of the upper part of the wheel, would, from their own weight as they hung vertically, pull down the arc of the wheel which they bore upon, and thus cause the wheel to become elliptic. As a matter of fact, they do nothing of the kind. There is absolutely no deflection from the perfect circle.

"Considering some of the mechanical difficulties in the construction of the wheel, you will note that it stands directly east and west: thus the southern side of the wheel receives the entire brunt of the sun's rays, whereas the northern side is not only shaded by the southern, but by the cars as well, causing a difference in expansion varying from the heat to which it is subjected of from three to six inches. All these little problems had, of course, to be met, for even this slight variation of five or six inches in the total diameter of two hundred and fifty feet would be sufficient unless properly dealt with to cause a disturbance in the working gear.—*New York Observer*.

### Explosion of a Steam Mangle.

On August 24th a steam mangle exploded in the Hell Gate laundry, on East 104th street, New York city, and nine of the ten persons in the room were hurt, three being scalded so badly that it was thought probable they would die. The mangle that exploded was 42 inches in diameter, 6 feet 8 inches long, and 1½ inches thick. It was blown from its fastenings, and hurled against the rear wall of the building. This wall abuts on the side wall of a Second Avenue tenement, and the two walls have a united thickness of 32 inches. The mangle smashed a hole ten feet long and four feet wide through this wall, and piled a ton or more of bricks and mortar on the floor of the kitchen of the tenement (which, fortunately, was not occupied). The engineer, Martin Phelan, was placed under arrest. He said he had 64 pounds pressure on the boilers, and could not account for the explosion. A Mr. J. W. Cameron, who had been engineer at the laundry until last July, offered a few observations on the subject of the explosion, and these, if he be correctly reported, prove him to be a philosopher of unusual calibre. "He said that the laundry girls had told him that the steam exhaust pipes from both cylinders [mangles] had got out of order. This would tend to permit the steam to condense in the cylinders. The water thus formed would lessen the steam space in the cylinders, and if the girls did not watch the gauges carefully it was enough, Cameron said, to cause the explosion."

Of course, we cannot say what the real cause of the explosion was, as we did not make a personal examination of the fragments and the piping. A pressure of 64 pounds to the square inch in a cylinder 42 inches in diameter and  $1\frac{1}{4}$  inches thick, would produce a tensile strain in the material of the cylinder of 1,075 pounds to the square inch of sectional area. Cast-iron ought to bear that load safely, and unless we could prove that the steam gauge was inoperative or out of order, or that blow-holes or other defects existed in the casting, we should have to conclude that the accident did not result from pressure alone. If the return pipes from the cylinders were out of order, as Cameron says, it is not unlikely that water accumulated in the cylinder, and that the explosion resulted from some kind of a water-hammer action.

### Spiders as Weather Prophets.

In *Zadkiel's Almanac* for 1893 (an interesting and curious astrological annual, published in London), we find the following article on the influence of coming changes of the weather on spiders:

"In the year 1787, when the Prussian army entered Holland, under the command of the Duke of Brunswick, Quatremere Disjonval, an adjutant-general in the Dutch service, who had taken part against the stadtholder in the commotions in the United Provinces, was thrown into prison, and remained a prisoner until 1795, when he was released on the arrival of General Pichegru at the head of a French army. During the seven years of his imprisonment he had nothing to amuse him but the spiders in his prison, which he tamed. Gathering together a great number of spiders of various species, he alleviated the irksomeness of his solitary hours by carefully observing their manners and habits of life. He arranged his observations in order, and published them in a little book under the title of 'Araneology.' These observations are mostly original, and confute the charge made against spiders that they devour one another. It is true that they do this on rare occasions, but only when they are driven to it by dire necessity.

"The most remarkable observation of Disjonval proved that spiders are most excellent prognosticators of changes in the weather, being more certain than the barometer, giving their indications a much longer time beforehand, and having the additional advantage that they cost nothing. For example, Disjonval remarks on the common house-spider: 'On the approach of fine weather it peeps out its head, and stretches its legs out of its nest; and this the farther, the longer the fine weather will last. Against bad weather it retires farther back, and against very tempestuous weather it turns quite round, showing nothing but its hinder parts to the observer, thus acquainting him with the approaching change of the weather. At the commencement of fine weather, the web with which it surrounds its corner is but of moderate extent; if the fine weather will be lasting, it enlarges it two or three inches; and if it do this several times repeatedly, we may be certain the weather will continue fine for some time.' On the 22d of July, 1795, Disjonval foretold, from the behavior of his spiders, a fortnight beforehand, that the water of the Rhine would fall so as to render it passable by a bridge of boats; and in this manner it was actually passed.

"In winter spiders are as certain prognosticators of approaching cold. If frost and snow be coming on, they either seize upon webs already made, in which case obstinate battles often ensue, or they make new ones and labor diligently at them. Disjonval found, from several careful observations, that, from the first of the spiders putting themselves in motion to the setting in of the frost, nine days generally elapsed. We have a



striking instance of the justness of this observation in the beginning of February, 1793. The weather was fine, warm, and there was not the least symptom of approaching frost. It might have been supposed that fires would be no longer required; but on the 4th of February, Disjonval announced that a great alteration in the weather would soon ensue, as beside other remarks of a similar kind, he had seen three spiders' webs, one over another, in a place where there was not one on the previous evening. On the 9th of February there was ice, and by the 13th all the canals were frozen over. It was now probable that with the breaking up of this frost the winter would terminate. This was the opinion of Disjonval himself; and he felt no small satisfaction in having been able to foretell the freezing of the canals to a whole town, when such a frost was least expected. A complete thaw, in fact, came on; but on a sudden he observed, contrary to all expectation, a general bustle among his spiders on the last day of February. They ran backwards and forwards, began diligently to spin webs, and attacked one another. Hence he inferred that some remarkable change was taking place, and that very dry weather at least, if not very cold, would ensue. This forecast he announced to the principal bookseller in the town, and through him to the public. Two days after, it rained, which seemed no way favorable to his prognostication; and this rain continued for five days, so that the validity of his forecast appeared daily more questionable. Still, however, attentive to the proceedings of his spiders, he wrote daily to the same bookseller, telling him he continued firm in his persuasion of the approach of cold or dry weather. On the 8th of March the wind blew hard, on the 9th snow fell, and on the 10th the frost was so sharp that all the canals were again frozen over.

"The greatest and most remarkable instance of the importance of these observations, and the reliance that may be placed on forecasts of weather based on them, is the conquest of Holland by the French in the winter of 1794-95. Disjonval's keeper was inclined to the patriotic party, and in consequence treated his prisoner with some consideration. Through his means, Disjonval gave notice to the patriots that a hard winter would ensue, which would render all the rivers and canals passable on the ice. The taking of the town by the French afforded him the only hope of being emancipated from his long imprisonment; it may therefore be supposed that he observed his spiders with the utmost care and attention. In the beginning of December he heard, to his great alarm, that the people talked of a capitulation, which would have at once annihilated his hopes. He used every means in his power to make known that, from the operations of his spiders, a severe frost would inevitably come on, and this within a fortnight at farthest. The people gave credit to his prediction, did not capitulate, and on the 29th of December the frost was so hard that the French were able to pass the Waal. The aristocratic party flattered themselves, notwithstanding, that the frost would soon break up, as on the 12th of January the water rose and was turbid, which was considered a certain indication of a thaw. Disjonval, in the meantime, wrote from his prison to the editor of the *Utrecht Gazette*, saying that before three days would have elapsed, a severer cold than the former would take place. On this occasion the spiders proved incomparably better prophets than the turbid water; on the 14th of January the wind rose, on the 15th frost set in, and on the 16th the French entered Utrecht, and the prisoner regained his liberty. Disjonval continued carefully to observe the spiders he could find, in order to give the French general fresh information, which was of great importance to him in his daring enterprise. On the 20th of January a sudden thaw came on. The general was alarmed for the fate of an army of a hundred thousand men, with a train of artillery, and began to think of a speedy retreat. But Disjonval had recourse to his spiders, and they foretold frost. He sent a couple of these little prophets to the French general—they were credited, their prophecies were fulfilled, and the French conquered Holland.

"The Meteorologic Office would do well to foster a collection of spiders. The heads might then command respect for their forecasts."



Incorporated  
1866.

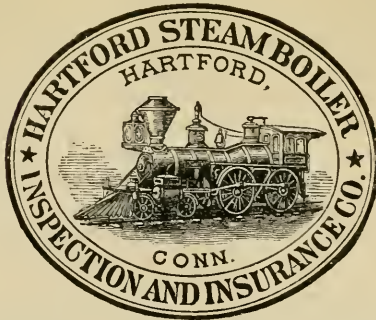

Charter Per-  
petual.

Issues Policies of Insurance after a Careful Inspection of the Boilers,  
COVERING ALL LOSS OR DAMAGE TO  
**BOILERS, BUILDINGS, AND MACHINERY**

ALSO COVERING  
**LOSS OF LIFE AND ACCIDENT TO PERSONS**  
ARISING FROM

# Steam Boiler Explosions.

Full information concerning the plan of the Company's operations can be obtained at the  
**COMPANY'S OFFICE, HARTFORD, CONN.,**  
Or at any Agency.

**J. M. ALLEN, President.**

**W. B. FRANKLIN, Vice-Prest.**

**J. B. PIERCE, Secretary.**

**FRANCIS B. ALLEN, 2d Vice-Prest.**

**E. J. MURPHY, M. E., Consulting Engineer.**

### Board of Directors.

**J. M. ALLEN, President.**  
**FRANK W. CHENEY, Treas.** Cheney Brothers Silk Manufacturing Co.  
**CHARLES M. BEACH,** of Beach & Co.  
**DANIEL PHILLIPS,** of Adams Express Co.  
**RICHARD W. H. JARVIS,** Prest. Colt's Fire Arms Manufacturing Co.  
**THOMAS O. ENDERS,** President of the U. S. Bank.  
**LEVERETT BRAINARD,** of The Case, Lockwood & Brainard Co.  
**GEN. WM. B. FRANKLIN,** late U. S. Commissioner to the Paris Exposition.  
**NELSON HOLLISTER,** of State Bank, Hartford.

**HON. HENRY C. ROBINSON,** Attorney-at-Law, Hartford, Conn.  
**HON. FRANCIS B. COOLEY,** of the National Exchange Bank, Hartford, Conn.  
**EDMUND A. STEDMAN,** Treasurer of the Fidelity Co., of Hartford, Conn.  
**GEORGE BURNHAM,** Baldwin Locomotive Works, Philadelphia.  
**HON. NATHANIEL SHIPMAN,** Judge United States Circuit Court.  
**C. C. KIMBALL,** Pres. Smyth Mfg. Co., Hartford, Conn.  
**PHILIP CORBIN,** of P. & F. Corbin, New Britain, Conn.

### GENERAL AGENTS.

**THEO. H. BABCOCK,**  
**CORBIN & GOODRICH,**  
**LAWFORD & MCKIM,**  
**C. E. ROBERTS,**  
**H. M. LEMON,**  
**C. C. GARDINER,**  
**L. B. PERKINS,**  
**W. G. LINEBURGH & SON,**  
**BURWELL & BRIGGS,**  
**MANN & WILSON,**  
**ZOLLARS & MCGREW,**  
**R. F. MANLY,**  
**W. S. HASTIE & SON,**  
**PETER F. PESCOD,**

### CHIEF INSPECTORS.

**R. K. McMURRAY,**  
**WM. J. FARRAN,**  
**F. S. ALLEN,**  
**WM. HEAFORD,**  
**A. B. ECOFF,**  
**F. S. ALLEN,**  
**J. H. RANDALL,**  
**C. A. BURWELL,**  
**J. B. WARNER,**  
**T. E. SHEARS,**  
**B. F. JOHNSON,**

**NEW YORK CITY.**  
**PHILADELPHIA. PA.**  
**BALTIMORE, Md.**  
**BOSTON, MASS.**  
**PROVIDENCE, R. I.**  
**CHICAGO, ILL.**  
**ST. LOUIS, MO.**  
**HARTFORD, CONN.**  
**BRIDGEPORT, CONN.**  
**CLEVELAND, OHIO.**  
**SAN FRANCISCO, CAL.**  
**DENVER, COL.**  
**BIRMINGHAM, ALA.**  
**CHARLESTON, S. C.**  
**NEW ORLEANS. LA.**

### OFFICES.

Office. **285 Broadway.**  
" **432 Walnut St.**  
" **22 So. Holliday St.**  
" **125 Milk St.**  
" **29 Weybosset St.**  
" **112 Quincy St.**  
" **404 Market St.**  
" **218 Main Street.**  
" **2 Sanford Building.**  
" **208 Superior St.**  
" **306 Sansome St.**  
" **Mining Ex. B'g.**  
" **Morris Building.**  
" **44 Broad St.**  
" **188 Gravier St.**

# The Locomotive.

PUBLISHED BY THE HARTFORD STEAM BOILER INSPECTION AND INSURANCE COMPANY.

NEW SERIES — VOL. XIV. HARTFORD, CONN., NOVEMBER, 1893. No. 11.

## Cracked Plates.

There are certain classes of defects in boilers, that boiler owners know about, and endeavor to avoid. Among these are the deposit of sediment and scale, leakage around tube-ends and along riveted joints, and overloaded safety-valves. These defects rather force themselves on the attention of the owners; but there are many other kinds of defects that are not so obvious, though they may be fully as dangerous. Among these less patent defects are cracked plates.

Frequently cracks start from the edge of the plate, opposite a rivet-hole, in the girth-joint that comes over the fire. Such cracks are often due to distress at the joint arising from an improper arrangement of the feed-pipe; for if the comparatively cold

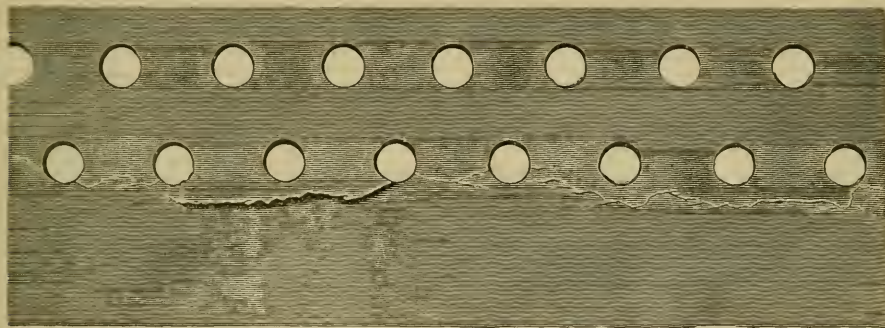

FIG. 1. — A CRACKED PLATE.

feed-water is discharged on or near the fire-sheet, it chills the shell in that vicinity, and produces a powerful local contraction of the metal, which is quite sufficient to start the joints, or, under some circumstances, to even crack the solid plate. But whatever the cause of the cracks, they are likely to first appear at the edge of one of the fire-sheets, and to extend gradually inward. Often they are stopped by running into the rivet hole, and do not extend further. Frequently, however, they run past the rivet-hole, or cross it and extend into the sheet on the further side of it. It then becomes very important to check their further progress. This may often be done by drilling a small hole through the sheet at the very extremity of the crack. This hole may afterwards be filled with a rivet, or it may be tapped and filled with a screw plug.

Besides these fire-sheet cracks there are numerous other kinds, due to different causes. For example, the strength of a plate may be injured by overheating, or "burning," so as to develop a serious crack under the ordinary running conditions, without any assignable reason except that it has become too weak to withstand the strain that comes upon it in ordinary usage. Cracks are often discovered, too, along flanges

that have been turned to too short a radius. Careless flanging is apt to start small cracks through the skin of the iron, and these frequently extend inward and eventually become dangerous. Incipient cracks on the inside of a boiler sometimes develop into deep grooves, the slight yielding of the shell, under varying pressure, opening up the interior of the metal to the corrosive action of the water. Defects of this kind usually occur along the edge of lap-joints, or near stay-bolts, where the shell is partially stiffened, and the buckling action of the plates more pronounced.

The accompanying wood-cut (Fig. 1) shows a crack due to a different cause, and it ought to carry with it a useful lesson. It represents a piece of plate that was cut from a boiler in active service, and which was believed to be in good condition. The boiler from which it was taken was 48 inches in diameter, with tubes 15 feet long; and the plates were of steel.  $\frac{1}{4}$  of an inch thick. The piece of plate shown in the cut formed the edge of one of the sheets, where two sections of the shell were united by a longitudinal, double-riveted lap-joint. It was taken from the upper part of the boiler, and was not exposed to the fire. It contained one well-marked crack extending completely through

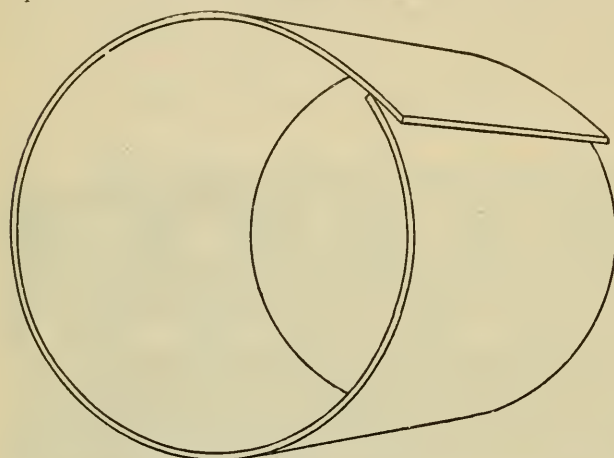

FIG. 2. — ILLUSTRATING THE "OFF-SET" OF THE LAP.

the plate, besides many other shorter ones, running into one another in all sorts of ways, some of them extending through the plate, and others not quite through it. All these cracks were entirely covered by the inside lap of the joint, so that they could not be seen from the interior of the boiler; and on the outside, the boiler was covered at this point by a thick layer of non-conducting asbestos covering. We mention these points in order that

the reader may understand how easy it would be to overlook this defect. Yet it would not be putting the case too strongly to say that although the boiler appeared to be in good condition, it was actually on the verge of explosion. For a considerable distance along the joint the strength of the plate was entirely destroyed; and at other places it was held together by the merest skin of metal, as was afterwards shown by breaking the plate across along the line of the cracks. The fractured area was almost entirely black, though bright spots were noticeable at intervals of two or three inches or so.

The cause of this defect will be sufficiently obvious to those who are familiar with the processes of boiler making. In rolling plates into the cylindrical form, preparatory to riveting them up into shells, it is customary to bend one end of the plate to what is judged to be the proper radius, by the use of the sledge-hammer. The plate is then run through the rolls and rolled into shape, the end that was previously bent being introduced first. When the plate has been rolled all but the last five or six inches, the last end slips off of the first roll, and the rolls can no longer "grip" the sheet. The result is, that the last end of the sheet is not bent to the proper radius, but remains straight or



nearly so. The shell (if rolled from one sheet) then looks something like Fig. 2, one end of it "standing off" from the rest of the shell. (This feature has been somewhat exaggerated in the cut, in order to show more distinctly what is meant.) In order to bring the outer lap to the proper curvature, it is customary for one man to hold a sledge against the projecting edge of the lap, while another workman strikes the shell on the inside. In this way the lap is bent down into place, and after the shell has been brought to conform with the "sweep," or templet, in every part, it is ready for riveting.

Now it will be seen that the treatment required for bringing the laps together in this manner is rather violent; and it follows that nothing but the best of materials will stand it without being greatly distressed and permanently weakened. Under the sledging operation the material is likely to be strained beyond its elastic limit, unless it possesses great ductility. The greatest strain on it comes on the outer lap, at or near the line where it touches the inner one in Fig. 2. We have no doubt that the cracks shown in Fig. 1, were started in this way, and that they afterwards crept into the plate gradually, as the boiler yielded slightly under varying pressures, until they reached the highly dangerous state described above.

If the sledging were done while the sheet is hot, it would not be so objectionable; but the great majority of boiler makers will not attempt to heat the plate before sledging the lap down, because when the sheets are hot they are apt to buckle out of shape, and give great trouble.

In the early days of steel boilers, before the manufacture of that material was understood as well as now, plates were much more apt to be injured by sledging than they are at present. Steel having a high tensile strength is almost certain to be deficient in ductility; and for this reason it is customary, in the specifications sent out from this office, to make the maximum allowable strength of plate 65,000 pounds to the square inch, when such plate is to be exposed to the fire. We also specify that the steel used shall show an elongation of twenty-five per cent. in a length of eight inches, that it shall show a reduction of area of not less than 56 per cent., and that its elastic limit shall be at least fifty per cent. of its ultimate strength. The plate should also be capable of being bent double and hammered, when either hot or cold, without showing cracks; and it is also desirable that it should stand this same test after being heated and quenched in water. Steel that possesses these qualities makes excellent boilers, and it will stand a great deal of abuse, in the boiler shop, without developing defects in after service.

In conclusion, we may say that cracked plates are not so uncommon as the average reader might suppose. This may be seen by glancing at our inspectors' reports, as published from month to month in *THE LOCOMOTIVE*. Thus we find that during the year 1892, our inspectors discovered no less than 2,646 plates that were cracked in one way or another, of which 658 were considered to be dangerous.

---

THERE was an explosion in Minneapolis a short time ago, and in connection with it the *Minneapolis Tribune* tells the following story: "There is a little mother in northeast Minneapolis who has a 16-months infant son who is the apple of her eye, and whom she evidently regards as something of a heavy weight. She lives only a few squares from the scene of the explosion, and her house was one that felt the shock. A friend afterwards expressed his sympathy. 'And did you really feel the explosion?' he asked. 'Yes, indeed,' she replied: 'it shook the house from garret to cellar.' 'What did you think was the matter?' he curiously questioned. 'I thought baby had fallen out of bed,' was the unexpected answer."



## Inspectors' Report.

JULY, 1893.

During this month our inspectors made 6,413 inspection trips, visited 10,557 boilers, inspected 7,711 both internally and externally, and subjected 671 to hydrostatic pressure. The whole number of defects reported reached 11,138, of which 1,039 were considered dangerous; 58 boilers were regarded unsafe for further use. Our usual summary is given below:

Nature of Defects.	Whole Number.	Dangerous.
Cases of deposit of sediment, - - -	947	48
Cases of incrustation and scale, - - -	1,920	92
Cases of internal grooving, - - -	107	10
Cases of internal corrosion, - - -	677	29
Cases of external corrosion, - - -	841	48
Broken and loose braces and stays, - - -	137	44
Settings defective, - - -	312	34
Furnaces out of shape, - - -	453	21
Fractured plates, - - -	288	50
Burned plates, - - -	248	37
Blistered plates, - - -	373	10
Cases of defective riveting, - - -	1,378	43
Defective heads, - - -	91	31
Serious leakage around tube ends, - - -	1,586	248
Serious leakage at seams, - - -	456	62
Defective water-gauges, - - -	327	63
Defective blow-offs, - - -	153	35
Cases of deficiency of water, - - -	18	9
Safety-valves overloaded, - - -	74	27
Safety-valves defective in construction, - - -	95	25
Pressure gauges defective, - - -	559	57
Boilers without pressure gauges, - - -	14	14
Unclassified defects, - - -	84	2
Total, - - -	11,138	1,039

## Boiler Explosions.

SEPTEMBER, 1893.

(203.)—On September 1st, a big boiler exploded in J. C. Probst & Son's factory in Pomeroy, Ohio. The building and machinery were wrecked, and James Starkey, the engineer, was fatally injured. The explosion took place just before seven o'clock in the morning. Had it occurred a few minutes later, two hundred employes would have been in the building. Several neighboring residences were much damaged, and the loss was heavy.

(204.)—The boiler of Dr. Walter Seward Webb's steam yacht *Elfrida* blew up near Plattsburgh, N. Y., on September 2d, badly scalding two of the crew. Peter Mott, chief engineer, was scalded about the face and body, and at last accounts was in a critical condition. Fred Hunt was scalded about the head, hands, and feet, but

his injuries were not considered dangerous. The tug *Robert H. Cook* towed the *Elfrida* to Plattsburgh, where the injured men were cared for. Dr. Webb was not on board.

(205.) — A boiler exploded in Galesville, near Monticello, Ill., on September 3d. The fireman, S. D. Dukes, had just fired it up, and had left it for a few moments. No person was hurt.

(206.) — While D. A. Gardner was at work on the boiler in his foundry in Plymouth, Wis., on September 5th, the boiler exploded and Mr. Gardner was badly scalded. One of his workmen, Fred Byerstead, was also quite seriously hurt.

(207.) — On September 5th a boiler exploded at Hart's Creek, Lincoln county, West Virginia, in Brumfield's mill. John H. Boyd was instantly killed. Mrs. Brumfield, who happened to be near by, received injuries from which she afterwards died, and six other persons were badly injured. (Hart's Creek is the place where the murders in the famous Brumfield-McCoy feud took place, and Mrs. Brumfield was one of the persons shot in ambush during the feud.)

(208.) — A boiler explosion occurred on September 5th, at Highland Park, near Detroit, Mich. John Roberts, the engineer, was instantly killed, and his body was blown through a board fence fifty feet away. August Krohn, a boy 12 years old, was blown fully a hundred feet, and at latest accounts he was dying. Arthur Hamilton, an employe, was knocked senseless, and a Mr. Filmore was badly hurt about the hips.

(209.) — A boiler exploded on September 7th, near Union City, Ind. Charles Lambert, the engineer, was badly scalded, so that he died a few hours later. Albert Siphe had his collar bone and two ribs broken, and was also injured internally. It is thought that he may die.

(210.) — A boiler exploded at Devil's Lake, N. D., on September 12, killing Engineer Gustave T. Fleck instantly. Edward Walters was fatally injured, and died soon afterwards. A later account says that one of the injured men, John Hathaway, has also since died. George Wolf was so badly hurt that he was not expected to live. [It is said that this boiler was condemned a year ago by the state inspector.—ED.]

(211.) — On September 12th, a boiler exploded in East St. Louis, Mo., fatally scalding the engineer, Louis Laux, and severely injuring the fireman, James Smith.

(212.) — By the explosion of a boiler near Hopkinsville, Ky., on September 13th, Nathaniel McKee was torn to pieces and instantly killed. Ernest Haynes was fatally injured, and James Crutchfield was terribly burned. Two other men were also badly hurt.

(213.) — A boiler explosion took place September 13th, on the steam yacht *Alegra*, owned by Colonel S. Van Rensselaer Cruger, while she was on Long Island Sound, conveying the owner and Mrs. Cruger to their summer home. James Gill, the fireman, was instantly killed, and D. E. Barrett, the engineer, was badly scalded and burned. Mr. and Mrs. Cruger escaped injury. The *Alegra* was disabled, and had to be taken in tow by the *Helvetia*, a steam yacht owned by C. Oliver Iselin, who is also one of the owners of the cup defender, *Vigilant*. At the time of the explosion the *Alegra* and *Helvetia* were racing. The *Alegra* is 76 feet long, 10 feet beam, and 3 feet 6 inches draught. She is equipped with a Seabury triple expansion engine, and a safety water-tube boiler. She met with an accident on August 28, 1891, when an elbow of the

boiler blew out, and Engineer James Shaw and Fireman James T. Haines were severely scalded. Another accident of a similar character occurred last summer, but nobody happened to be injured that time. Extensive repairs were necessary, however.

(214.) — A boiler exploded on September 14th, in the town of Elba, near Columbus, Wis. Eben<sup>1</sup> Owens was instantly killed and William Pritchards was somewhat injured. The boiler was blown more than 300 feet. The explosion occurred during the noon hour, or the list of killed and injured would undoubtedly have been greater.

(215.) — On September 15th, a boiler exploded in a sugar house on the Irion Plantation, owned by Mr. E. Desobry, near Plaquemine, Mexico. A man named Stafford, who was about 100 feet away from the boiler, was killed. Peter Bright was seriously injured.

(216.) — A boiler exploded on September 14th, at Loyoma, just across the Ohio river from Gallipolis, Ohio. Engineer Jones and three other men were killed outright.

(217.) — A fearful boiler explosion occurred on September 18th, near Whittier, Swain county, North Carolina. Richard Nichols, James Kelley, Benjamin McMahan, Gates McMahan, Henry Smith, and Jesse Gunter, were instantly killed, their bodies being blown to fragments. In fact, every man about the mill was instantly killed, and the building was torn to atoms. It is said that this is the largest number of deaths that has resulted from any one accident in this part of the State since 1883. (In that year 26 men were drowned at the convict camps near the scene of the present disaster.)

(218.) — A boiler exploded on September 18th, at the Temple furnaces, near Reading, Pa. Nathaniel Hawkins, the engineer, was badly scalded. William Bosler was struck by fragments of the boiler and fatally injured, and George Bosler, his father, was badly cut about the face.

(219.) — A battery of boilers exploded at the works of the Allegheny Salt Company, near Pittsburg, Pa., on September 22d. The roof of the boiler house was blown off, and the sides of the building next the street were blown out. Fortunately no person was injured, but it is believed that the damage to property will amount to several thousand dollars.

(220.) — A locomotive boiler exploded at Kingsbury, Ind., on September 22d, as the result of a collision between a passenger train and a freight train, on the new extension of the Wabash railroad.

(221.) — On September 23d a boiler exploded in the brick and tile factory at Jefferson, Iowa. The explosion set fire to the building, and between explosion and fire the factory was totally destroyed. Loss about \$4,000.

(222.) — A boiler exploded on September 23d, at the Connelly gas works, in New Castle, Pa. The building was demolished and a number of employes were injured.

(223.) — On September 26th, a boiler exploded in Powell & Howard's mill at Bidwell, near Gallipolis, Ohio. The mill was completely wrecked, and David Moffett and Amos Clark were fatally injured.

---

LATER advices concerning the boiler explosion off the coast of Japan, noted in our last issue, give the following facts: "The steamship *Wago Maru* was on her way to Anamizu on August 24th, when her boiler exploded, causing the vessel to sink. Eighty passengers are missing."

IN connection with the boiler explosion at Towanda, Pa., (No. 159 in our August issue,) it was said that Mr. Andrew Benjamin was killed instantly. We have since learned that this was not the case. The body of Le Roy Vanderpool was found buried in the ruins, but Mr. Benjamin, although fearfully injured, did not die until the day following the explosion. His right leg was crushed, and amputation was necessary; and he was so much weakened from loss of blood before receiving medical attention, that he failed to recover from the operation. It also appears, from later accounts, that Ross Hatton's injuries were not fatal, as was at first reported. John McGovern, who was reported missing, was afterwards found. He had sustained painful, but not fatal, injuries. James Ackley and Barney Coates were also injured to some extent, though they were able to walk to their homes. A later estimate places the total property loss at about \$75,000. This is the third time within four years that the Towanda Nail Mill has been partly or wholly destroyed. On Aug. 27, 1889, a boiler exploded there, damaging the mill to the extent of \$15,000 or \$20,000, and killing five men and injuring six others; and in February, 1891, the mill was entirely destroyed by fire.

---

### The Loudest Noise Ever Heard.

No thunder from the skies was ever accompanied with a roar of such vehemence as that which issued from the throat of the great volcano in Krakatoa, an islet lying in the Straits of Sunda, between Sumatra and Java, at 10 o'clock on Monday morning, Aug. 27, 1883. As that dreadful Sunday night wore on the noise increased in intensity and frequency. The explosions succeeded each other so rapidly that a continuous roar seemed to issue from the island. The critical moment was now approaching, and the outbreak was preparing for a majestic culmination.

The people of Batavia did not sleep that night. Their windows quivered with the thunders from Krakatoa, which resounded like the discharge of artillery in their streets. Finally, at 10 o'clock on Monday morning, a stupendous convulsion took place which far transcended any of the shocks which had preceded it. This supreme effort it was which raised the mightiest noise ever heard on the globe. Batavia is ninety-five miles distant from Krakatoa. At Carimon, Java, 355 miles away, reports were heard on that Monday morning which led to the belief that there must be some vessel in the distance which was discharging its guns as signals of distress. The authorities sent out boats to make a search; they presently returned, as nothing could be found in want of succor.

The reports were sounds which came all the way from Krakatoa. At Macassar, in Celebes, loud explosions attracted the notice of everybody. Two steamers were hastily sent out to find out what was the matter. The sounds had traveled from the Straits of Sunda, a distance of 969 miles. But mere hundreds of miles will not suffice to illustrate the extraordinary distance to which the greatest noise that ever was heard was able to penetrate. The figures have to be expressed in thousands. This seems almost incredible, but it is certainly true. In the Victoria plains, in West Australia, the shepherds were startled by noises like heavy cannonading. It was some time afterward before they learned that their tranquillity had been disturbed by the grand events at Krakatoa, 1,700 miles away. — *Youth's Companion*.

---

THE Clyde, Ohio, *Reporter* says: "The steam boiler in the *Enterprise* office sprung a leak Tuesday afternoon, and Editor Jackson's moustache was clipped off and used to caulk the seam."



# The Locomotive.

HARTFORD, NOVEMBER 15, 1893.

J. M. ALLEN, *Editor.*

A. D. RISTEEN, *Associate Editor.*

THE LOCOMOTIVE can be obtained free by calling at any of the company's agencies.

Subscription price 50 cents per year when mailed from this office.

Bound volumes one dollar each. (Any volume can be supplied.)

Papers that borrow cuts from us will do us a favor if they will mark them plainly in returning, so that we may give proper credit on our books.

MR. T. E. SHEARS, chief inspector at Denver, Col., has called our attention to an article on photography which appeared in *Blackwood's Magazine* for April, 1842. It is highly interesting reading, in view of the position photography now holds, though it must have been dampening to the ardor of the enthusiasts of half a century ago. We shall reproduce it in an early issue.

MR. JOHN W. LAUTERBACH, a well-known and highly respected citizen of Columbus, Ohio, died at his home on September 18th, from the effects of a severe cold contracted at the time of the Metropolitan Opera House fire in that city. Mr. Lauterbach was a member of the insurance firm of Lauterbach & Eilber, and was the Columbus agent for a number of years of the Hartford Steam Boiler Inspection and Insurance Company. He was born in Klimenglis, in Hesse-Kassel, on June 16, 1834, and in his twentieth year he came to this country and established himself in business in Columbus. He was an estimable gentleman, and he will long be remembered by a wide circle of friends.

## This Year's Railroad Accidents.

The New York *Tribune*, in a recent issue, devoted two columns to a discussion of the railroad accidents that have occurred in this country during the first ten months of the present year. Following is a list of these accidents, together with the number of killed and injured:

	KILLED.	INJURED.
Jan. 6 — New York Central, Mott Haven, collision, misplaced switch,	1	..
Jan. 13 — Chicago & Eastern Illinois, Chicago, rear-end collision, . . . .	..	15
Jan. 19 — Pennsylvania, Harrison, N. J., rear-end collision, . . . .	1	14
Jan. 20 — Lake Erie & Western, Peru, Ind., falling bridge, . . . .	2	14
Jan. 21 — Pennsylvania, Docklow, Pa., rear-end collision, . . . .	..	8
Jan. 21 — "Big Four," Alton Junction, Ill., collision, misplaced switch,	24	35
Jan. 23 — Northern Pacific, Tacoma, Wash., collision, . . . .	1	3
Jan. 24 — Illinois Central, Dixon, Ill., wreck, broken rail, . . . .	..	8
Jan. 24 — Penn., New Brunswick, N. J., express ran into freight train, ..	..	3
Jan. 27 — Erie, Wallace, N. Y., wreck, misplaced switch, . . . .	1	4
Jan. 28 — Great Western, Kent, Ill., over embankment, broken rail, . .	3	26

KILLED. INJURED.

Feb. 3	— New York & New England, East Douglass, Mass., rear-end collision, icy rails, . . . . .	4	
Feb. 4	— Northern Pacific, Vining, Minn., train over embankment, . . . . .	8	
Feb. 7	— Old Colony, Leominster, Mass., rear-end collision, . . . . .	1	5
Feb. 7	— "Big Four," Pana, Ill., wreck, broken rail, . . . . .	1	31
Feb. 10	— Lehigh Valley, Wilkesbarre, Pa., rear-end collision, . . . . .	2	9
Feb. 21	— Pennsylvania, Schuylkill Valley, Spring City, Pa., rear-end collision, . . . . .	3	2
Feb. 21	— West Shore, Palmyra, N. Y., over embankment, broken rail, . . . . .	1	14
Feb. 22	— Pittsburg, Fort Wayne & Chicago, Columbia City, Ind., wreck, broken rail, . . . . .	1	22
Feb. 22	— Pennsylvania, Morton, Pa., rear-end collision, . . . . .	4	15
Feb. 25	— Erie, Vandalia, N. Y., train over embankment, . . . . .		11
Mar. 1	— New York, New Haven & Hartford, Norwood, R. I., rear end collision, . . . . .	1	6
Mar. 6	— New York Central, Rhinebeck, N. Y., rear-end collision, . . . . .	1	
Mar. 16	— Erie, Lackawaxen, Pa., rear-end collision, . . . . .		12
April 1	— Denver & Rio Grande, wreck, spreading rails, . . . . .		16
April 25	— Bare Rocks R. R., Somerset, Pa., collision, train ran away on grade, . . . . .	7	
May 6	— "Big Four," Lafayette, Ind., train left track, air brakes failed, . . . . .	10	11
May 30	— Pennsylvania, Vail Station, Pa., train over embankment, . . . . .	5	10
June 21	— Long Island, Parkville, L. I., misplaced switch, . . . . .	8	28
June 24	— New York Central, Corfu, N. Y., rear-end collision, . . . . .		7
June 27	— Union Pacific, Portland, Ore., train derailed by a cow, . . . . .	1	2
July 13	— West Shore, Newburg, N. Y., collision by train jumping track, . . . . .	6	22
July 17	— Grand Trunk, Chicago, collision with street car at crossing, . . . . .	5	12
July 18	— Western New York & Pennsylvania, East Aurora, N. Y., misplaced switch, . . . . .		22
July 14	— Southern Pacific, Houston, Tex., rear-end collision, runaway engine, . . . . .	2	
July 25	— Baltimore & Ohio, Monroe Falls, Ohio, track spread, . . . . .	3	35
July 25	— Old Colony, Providence, R. I., collision with car on side track, . . . . .	2	10
July 25	— Ohio Valley, Morganfield, Ky., train derailed and burned, . . . . .	3	
July 25	— St. Louis, Chicago & St. Paul, St. Louis, train fell through trestle, . . . . .	1	3
July 25	— West Pennsylvania, Pittsburg, rear-end collision, . . . . .		5
Aug. 6	— Lake Shore, Lindsay, Ohio, collision by jumping track, . . . . .	3	25
Aug. 16	— Atlantic & Danville, Milton, Va., train through trestle, . . . . .	7	4
Aug. 26	— New York & Harlem, Pawlings, N. Y., head-end collision, . . . . .	5	4
Aug. 27	— Long Island Railroad, Berlin, rear-end collision, . . . . .	16	17
Aug. 31	— Boston & Albany, Chester, Mass., train fell through bridge, . . . . .	14	28
Sept. 3	— Chicago, Burlington & Quincy, Streator, Ill., train fell through bridge, . . . . .	2	3
Sept. 5	— "Big Four," Cincinnati, rear-end collision, . . . . .	6	20
Sept. 5	— Cincinnati, Portsmouth & Virginia, Harding, Ohio, misplaced switch, . . . . .	3	2

	KILLED.	INJURED.
Sept. 7 — Pittsburg, Fort Wayne & Chicago, East Harwood, Md., head-end collision, . . . . .	12	9
Sept. 9 — Lehigh Valley, Mumford, N. Y., rear-end collision, . . . . .	..	3
Sept. 18 — Illinois Central, Mantena, Ill., rear-end collision, . . . . .	8	15
Sept. 20 — Lehigh & Hudson, Lake Grinnell, N. J., head-end collision, . . . . .	1	1
Sept. 21 — Baltimore & Ohio, Ravenna, Ohio, rear-end collision, . . . . .	1	2
Sept. 22 — Wabash, Kingsbury, Md., head-end collision, misplaced switch, . . . . .	14	45
Sept. 27 — Grand Trunk, Bellevue, Mich., rear-end collision, . . . . .	3	5
Sept. 28 — Louisville & Nashville, collision, train jumped track, . . . . .	3	7
Sept. 28 — Chicago, Burlington & Quincy, Streator, Ill., head-end collision, . . . . .	1	10
Oct. 10 — Pennsylvania, Whiting, Ind., misplaced switch, . . . . .	2	3
Oct. 13 — Michigan Central, Jackson, Mich., rear-end collision, . . . . .	13	40
Oct. 14 — Baltimore & Ohio, Cumberland, Md., landslide, . . . . .	..	2
Oct. 15 — Chicago, Rock Island & Pacific, Paxito, Kan., head-end collision, . . . . .	2	3
Oct. 16 — Wabash, Nameaki, Ill., train over embankment, . . . . .	..	72
Oct. 17 — Pennsylvania, Wellsville, Ohio, collision on switch, . . . . .	4	3
Oct. 19 — Illinois Central, Kankakee, Ill., head-end collision, . . . . .	..	8
Oct. 20 — Grand Trunk, Battle Creek, Mich., head-end collision, . . . . .	27	36
Oct. 21 — Baltimore & Ohio, Clarksburg, W. Va., rear-end collision, . . . . .	1	7
Oct. 22 — Staten Island Rapid Transit, misplaced switch, . . . . .	1	1
Oct. 22 — Pittsburg, Fort Wayne & Chicago, Monroeville, Ohio, head-end collision, . . . . .	..	6
Oct. 25 — Pennsylvania, Trenton, N. J., head-end collision, . . . . .	4	2
Oct. 26 — Toledo, Ann Arbor & Northern Michigan, Hamburg, Mich., ran into sink hole, . . . . .	3	..
Oct. 26 — Southern Pacific, Houston, Tex., train jumped track at switch, . . . . .	3	3
Oct. 26 — Chicago Great Western, Red Rock, Minn., train fell through bridge, . . . . .	..	3

Here is a gruesome enough list — 72 disasters, with a total of 260 persons killed, and 841 injured. Yet it is by no means complete, for there have been many freight-train accidents, and many grade-crossing accidents that do not appear in it. Doubtless a considerable number of employes have also been injured, or killed, in the discharge of their regular duties. However this may be, the list as it stands is quite long enough and impressive enough. After such an experience in one season, it would be strange if thoughtful railroad men have not learned some useful lessons in the art of running passenger trains safely.

### The Corrosion of Iron Stacks.

A Wisconsin correspondent writes as follows: "We notice in your August issue some points about iron smoke stacks. Will you kindly inform us why such stacks corrode? We have a stack which has not lasted as long as we think it should, and would like to know if our methods of using it are at fault. We burn wood and refuse shavings, mixed with coal, and on some days we use coal alone, and on others only wood and shavings. The engineer wets down his ashes so that the steam goes into the fire-box or ash-pit. We were told that this causes the formation of creosote. Is that correct?"

In reply we may say that in our own opinion iron stacks are not very satisfactory when used with wood fuel. If the combustion of the wood is perfect, the only gaseous products from it will be carbonic acid gas and steam; but in practice it is seldom possible to burn the wood perfectly, and the result is that portions of it are subjected to "dry distillation." The dry distillation of wood gives rise to several definite chemical substances, among which is acetic or pyroligneous acid. In fact, the great bulk of the acetic acid of commerce is obtained in this way, the material being distilled in the woods, and the resulting acetic acid being taken up by lime, and shipped to the refining works in the form of acetate of lime. The acetic acid produced in ordinary wood fires passes up the stack in the form of vapor. It is probable that this acid vapor would attack the iron of the stack to some extent, even if it were perfectly dry; but it is quite certain to do so in the presence of moisture. In actual practice there is, of course, a considerable amount of water vapor present in the products of combustion; and if this condenses to any extent on the inside of the stack, we shall have, instead of pure water, dilute acetic acid. Hence it is, that wood fires are apt to corrode iron stacks.

Passing to the consideration of the coal used, it may be remarked that there are great differences in the quality of coals, some of them containing, among other impurities, a considerable quantity of sulphur; while other varieties contain almost none. Thus, according to an analysis quoted by Bauerman, a certain coal mined in Peru contains 10.35 per cent. of sulphur. On the other hand, an analysis of a West Virginia coal that is before us shows less than one-quarter of one per cent. of sulphur. We have no complete analysis at hand of coal found in our correspondent's neighborhood, but one analysis of a coal from Iowa shows 7.32 per cent. of sulphur, and various analyses of Illinois coal show percentages of sulphur ranging from 0.71 to 9.62. The sulphur in coal is converted, in the furnace, into sulphur dioxide, and this is doubtless oxidized, to some extent, into sulphuric acid. (Mr. Thomas Wills has calculated that the amount of sulphuric acid poured into the air in London alone, on account of the sulphur existing in coal, is about 240,000 tons per annum.) The sulphuric acid formed during the combustion of sulphurous coal will attack iron stacks, and corrosion from this cause is often quite marked. We have even known dry-sheets on boilers to be eaten completely through in a short time, from this cause.

We do not know the quality of the coal used by our correspondent, but on general principles we should say that his trouble comes from the combined action of the acetic and sulphuric acids produced by the combustion of the fuel. There appears to be no satisfactory remedy. The formation of acetic acid could probably be materially lessened by careful firing, the object being to obtain as perfect combustion of the wood as possible. It also seems probable that better results could be had by taking pains to have the fuel as dry as possible, and we should recommend the engineer *not* to wet his ashes, if it can be avoided. The formation of sulphuric acid cannot be prevented in any way, except by using coal that is comparatively free from sulphur. We understand that in the iron regions, where iron stacks are used to such an extent, care is exercised to obtain coal as free from sulphur as possible. This is particularly important, of course, in the case of the fuel to be used in blast furnaces; and as the waste gases from these furnaces are used under the boilers, the great bulk of what goes through the stacks contains very little sulphur. Moreover, it is customary to line the big stacks with a course of fire-bricks, and this serves to protect them from what acid vapors there may be present.

In conclusion, we may say that it is doubtful if an iron stack can be made to last very long, where wood is used as fuel to any considerable extent. However, our general advice would be: Try to obtain as perfect combustion as possible, and do not wet the ashes.



## Boiler Explosions in England.

The *Report* of the English Board of Trade concerning the working of the boiler explosions acts of 1882 and 1890, is very interesting. It appears that formal investigations under the provisions of these acts were held in 32 cases during the year ending June 30, 1892, and that preliminary investigations were held in 56 other cases. Of the 88 explosions thus investigated, 46 were of land boilers, and 42 of boilers on board vessels of one sort or another. In the formal investigations the court placed the responsibility for the accident as follows: The owner was blamed for neglect in 13 cases; the engineer and his superintendent were blamed for neglect in 1 case; the owner was blamed for "reckless management" in 1 case; the "user" of the boiler was blamed for neglect in 1 case; the owner was blamed for not employing a proper engineer, or for employing an improper one, in 2 cases; the owner was held responsible for the neglect of his engineer in 3 cases; the owner was blamed for neglecting his insurance company's advice in 2 cases; the owner was exonerated in 4 cases; the maker of the boiler was blamed for misrepresentation in 2 cases; the seller of the boiler was blamed in 1 case for neglecting to ascertain the boiler's condition; a boiler insurance company was held responsible for the negligence of its inspector in 1 case; and a "person who ignorantly advised the owner as to the working pressure" was blamed in 1 case. The responsible persons were ordered by the court to pay costs, the amount of which varied, but which were as high as \$500 in several instances.

The causes of these explosions are classified, in the report, as follows:

Deterioration, corrosion, and defective fittings,	- - - - -	34 cases.
Defective design, workmanship, material, or construction, or undue working pressure,	- - - - -	25 "
Ignorance or neglect of attendants,	- - - - -	21 "
Miscellaneous,	- - - - -	8 "

Appendix *D* gives a report upon the formal investigations that have been made, under the acts of 1882 and 1890, since August, 1889. Seven such investigations were ordered in 1889, twenty-eight in 1890, and twenty-seven in 1891. Five of these cases were not proceeded with, for various reasons; so that the actual number of cases formally investigated in these three years was 57. The vessels that exploded were as follows: Vertical boilers, 16; cylindrical boilers, 14; Cornish boilers, 11; Lancashire boilers, 3; locomotive boilers, 5; chimney [?] boilers, 1; return flue boilers, 2; stop valves, 1; copper cylinders, 1; Kiers, 2; lard pans, 1; total, 57. These explosions caused the death of 35 persons, and 116 persons were injured.

"No instance has occurred," says the report, "in which the explosion has been attributed to 'accident,' although in one case the owner appeared to have taken every precaution except that of the application of a hydraulic test, and the examination of the boiler while under such test. To another case a singular cause of explosion was assigned, a tube having corroded and burst, owing to the solvent action of chlorine upon the iron. The corrosion might have been avoided by the judicious use of proper feed water and alkali wherewith to cover the tubes, and the explosion of the corroded tube might have been prevented had the boiler been properly examined by a skilled person. In 29 cases no examinations were made by competent persons, these boilers having been worked for periods varying from 3 to 40 years without examination, although this might have been done at a trifling expense. In 10 cases examinations were made in a careless or perfunctory manner, and defects, which in fact existed, were not discovered. In 4 cases examinations were made by competent persons, and the owners' attention was called to

defects, but they failed to remedy them. In all these 43 cases, if proper examinations had been made by competent persons, and the defects discovered and pointed out had been remedied, the explosions would have been prevented; but it follows that in order to be really effective the examination of boilers must be undertaken by competent persons at sufficiently frequent intervals.

“The remaining 14 explosions were attributed to the following causes: To shortness of water and consequent overheating, 6; to absence of safety-valves, or defects therein, and consequent over pressure, 6; to a safety-valve that had been wedged down, 1; to faulty construction, 1.

“These investigations have been conducted in public, and reports of the proceedings have appeared in the local newspapers. The commissioners' reports have dealt exhaustively not only with the cause of the explosion in each case, but with all the attendant circumstances, including the operations of the insurance companies. It is beyond question that the publicity given to the judgments of the commissioners as to the relations between the insurance companies and the owners of boilers, and the culpability of the various parties whose conduct has been called in question during these investigations, must have a beneficial effect in directing increased attention to the obligations resting upon all concerned. The Commissioners have throughout adhered firmly to the principle of holding the owners or users of boilers responsible for their safe working condition, and also for the acts of their servants. Owners or users of boilers have accordingly been found to blame in 48 cases.

“It is fair to say that many owners are chargeable with ignorance or thoughtlessness rather than with willful negligence in failing to have their boilers examined by competent persons. They have bought boilers and used them without a thought as to their working condition, and this has been proved over and over again by the fact that small users of steam have been working with their employés in the vicinity of the boiler when it exploded, and in several instances the owners themselves fired, fed, and worked the boilers. The risks thus incurred may be well illustrated by citing the facts of one or two cases. A miller had used a boiler for many years without examination. The mill faced a village green across which children passed on their way to and from school. The boiler exploded a very short time before the school hour, the mill was wrecked, and the green was covered with bricks. One child was killed, but had the boiler exploded a few minutes later, when the children were passing in greater numbers, the loss of life would have been terrible. This was a case of simple ignorance. The miller merely acted as the rest of his neighbors had done, for it was proved at the investigation that it was a common practice in the neighborhood to work boilers for twelve or thirteen years without any examination. In another case a respectable timber merchant worked a boiler for forty years without any examination by a competent person. He assumed that the boiler would work safely until it was worn out, and he continued working it until it exploded and caused very serious injuries to the attendant who had been in charge of it for the whole period. In another case a miller worked a boiler for thirty-two years without any proper examination, believing that so long as he could generate steam in it the boiler was in a safe condition, an opinion shared by many other owners in the neighborhood whose boilers were never examined. The boiler, in places, became reduced to the thickness of paper; and it exploded and killed the attendant.

“In the cases investigated seventeen boilers were insured and forty were not insured. The relations between the owners and users of boilers and the companies that insure them, have naturally been a prominent feature of these inquiries. It has been found, as might have been anticipated, that owners of boilers endeavor to relieve them-

selves of responsibility for their safe working condition upon the ground that the insurance of their boilers is to them a guarantee of safety; but the Commissioners have uniformly refused to accept a plea of this kind, and have laid it down that the responsibility for the condition of a boiler rests upon the owner or user, and not upon the insurance companies, and that in point of law they [the insurance companies] are at perfect liberty to insure a boiler which is entirely worn out, if they choose to take the risk. On the other hand the Commissioners have impressed upon the companies the consideration that, having regard to the safety of life, the insurance of a boiler ought always to be based upon a thorough examination. [It may be said, parenthetically, that in this country, where the liability of the boiler insurance company frequently runs up to \$40,000 or \$50,000, it would hardly be necessary for the Commissioners to 'advise' any reputable company to make a thorough inspection of the boiler before insuring it! In England, we believe, the liability of the insurance company is always quite small; and in that case a not very scrupulous company might sometimes be tempted to gamble on the chance of explosion. Hence the wisdom of the Commissioners' admonition. ED.] Decisions in these terms have been publicly delivered upon several occasions, but it is due to the companies to add that while in some few cases policies have been issued before a thorough examination has taken place, they do not in practice take extreme risks; and further, that they are usually found to make reasonable efforts to examine a boiler before it is covered by insurance. The whole question of insurance of boilers, like that of marine insurance, undoubtedly involves many and complicated considerations. It is sufficient for the present purpose to say that these investigations prove that insurance operates as a preventive of explosions in spite of certain difficulties. The companies provide for 'working examinations,' and 'thorough examinations,' and they occasionally insure boilers after a working examination, in expectation of obtaining an opportunity for a thorough examination within a reasonable time. The insurance usually covers a period of twelve months, and although efforts are made to obtain a thorough examination before its expiration, it is frequently inconvenient to the owner to stop the working of his boiler for the purpose, and consequently no such examination takes place. In the absence of a report of a thorough examination within the twelve months many of the companies would refuse to renew the policy, and a reckless owner may then transfer his risk to another company, and the same result may follow in the succeeding year. This is no doubt done in certain cases, but, so far as can be ascertained, in only a very few. Insurance of this kind is of course worse than useless as a preventive of explosions. Again, it is found that many steam users do not, so to speak, rush after insurance. On the contrary, in outlying districts it is frequently only by considerable persuasion on the part of the insurance company's agent that the owner is induced to insure his boiler at all, and in the absence of insurance or compulsory examination it is kept working by the owner in ignorance of its condition until it leaks or explodes. The culpable recklessness of some owners is occasionally displayed in another form. In two cases it has transpired that proposals for insurance having been refused on account of the condition of the boiler by one company, the owner obtained insurance with another company, concealing the fact of the previous refusal. This conduct was of course condemned by the Commissioners in severe terms. The mere fact of making insurance companies and their inspectors parties to these investigations when necessary has had, and will, I think, continue to have, a beneficial effect in making the companies more careful in accepting proposals for insurance, in inducing them to employ competent and thoroughly trained inspectors, and in making those inspectors extremely careful in their examinations. The



conduct of mutual insurance companies has also been investigated. In one case in which a tug boiler had been insured with one of these companies the Court commented on the fact that a report of survey was made by directors of the association in which they described the boiler as in good condition without having made any examination of it. In another case an insurance company or its responsible officer was found to blame for not discontinuing a policy after the failure by the owner to repair defects pointed out on the examination of the boiler. In four cases inspectors of companies have been found to blame for defective examinations.

“The Commissioners have also animadverted on the conduct of boiler makers, boiler vendors, boiler repairers, and engineers having the management of boilers, as well as upon the conduct of owners. In two cases the vendors of boilers were found to blame for misleading the purchasers as to the condition of the boilers. In one case the maker of a boiler was found to blame. In four cases boiler repairers were found to blame. Skippers of vessels have been found to blame in two cases. In one case the agent of a colliery was exonerated from personal blame, but as representing the owners he was held responsible for the negligent acts of their servants, and he was ordered to pay \$500 towards costs. The Board were advised, however, that in the circumstances the amount could not be recovered against the agent. In twelve cases engineers and managers in the employment of the owners have been found to blame, and in one case a consulting engineer was found to blame.

“If the number of boiler explosions be not regarded as excessive in comparison with the very large number of boilers in use in the United Kingdom, these investigations confirm the conclusions already generally accepted, that explosions are very seldom the result of accident, but that the great majority of them are clearly preventable, and that periodical inspection by skilled persons, coupled however with an obligation to repair the discovered defects, is by far the most effectual means of prevention. It may further be deduced that to the extent that the insurance of boilers leads to their examination by competent persons, it operates as a preventive.”

In conclusion we may quote the following table from appendix *C* of this interesting report. It gives the number of boiler explosions in Great Britain since the passing of the first boiler explosions act, in 1882, together with the number of lives lost. As we understand it, the “year” given in the table ends on June 30; so that, for instance, “1882–83” means “from June 30, 1882, to June 30, 1883.”

BOILER EXPLOSIONS IN GREAT BRITAIN SINCE 1882.

YEAR.	No. of Explosions.	Persons Killed.	YEAR.	No. of Explosions.	Persons Killed.
1882–83	45	35	1887–88	61	31
1883–84	41	18	1888–89	67	33
1884–85	43	40	1889–90	77	21
1885–86	57	33	1890–91	72	32
1886–87	37	24	1891–92	88	23



Incorporated  
1866.

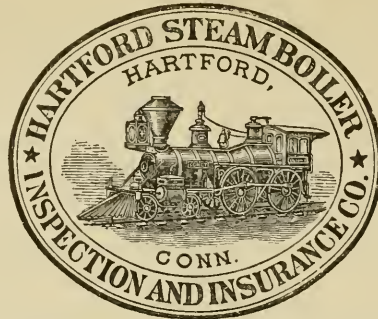

Charter Per-  
petual.

Issues Policies of Insurance after a Careful Inspection of the Boilers,  
COVERING ALL LOSS OR DAMAGE TO  
**BOILERS, BUILDINGS, AND MACHINERY**

ALSO COVERING  
**LOSS OF LIFE AND ACCIDENT TO PERSONS**

ARISING FROM  
**Steam Boiler Explosions.**

Full information concerning the plan of the Company's operations can be obtained at the  
**COMPANY'S OFFICE, HARTFORD, CONN.,**  
Or at any Agency.

**J. M. ALLEN, President.**  
**J. B. PIERCE, Secretary.**

**W. B. FRANKLIN, Vice-Prest.**  
**FRANCIS B. ALLEN, 2d Vice-Prest.**  
**E. J. MURPHY, M. E., Consulting Engineer.**

**Board of Directors.**

**J. M. ALLEN, President.**  
**FRANK W. CHENEY, Treas.** Cheney Brothers Silk Manufacturing Co.  
**CHARLES M. BEACH, of Beach & Co.**  
**DANIEL PHILLIPS, of Adams Express Co.**  
**RICHARD W. H. JARVIS, Prest.** Colt's Fire Arms Manufacturing Co.  
**THOMAS O. ENDERS, President of the U. S. Bank.**  
**LEVERETT BRAINARD, of The Case, Lockwood & Brainard Co.**  
**GEN. WM. B. FRANKLIN, late U. S. Commissioner to the Paris Exposition.**  
**NELSON HOLLISTER, of State Bank, Hartford.**

**HON. HENRY C. ROBINSON, Attorney-at-Law, Hartford, Conn.**  
**HON. FRANCIS B. COOLEY, of the National Exchange Bank, Hartford, Conn.**  
**EDMUND A. STEDMAN, Treasurer of the Fidelity Co., of Hartford, Conn.**  
**GEORGE BURNHAM, Baldwin Locomotive Works, Philadelphia.**  
**HON. NATHANIEL SHIPMAN, Judge United States Circuit Court.**  
**C. C. KIMBALL, Pres. Smyth Mfg. Co., Hartford, Conn.**  
**PHILIP CORBIN, of P. & F. Corbin, New Britain, Conn.**

**GENERAL AGENTS.**

**THEO. H. BABCOCK,**  
**CORBIN & GOODRICH,**  
**LAWFORD & McKIM,**  
**C. E. ROBERTS,**  
**H. M. LEMON,**  
**C. C. GARDINER,**  
**L. B. PERKINS,**  
**W. G. LINEBURGH & SON,**  
**BURWELL & BRIGGS,**  
**MANN & WILSON,**  
**ZOLLARS & McGREW,**  
**R. F. MANLY,**  
**W. S. HASTIE & SON,**  
**PETER F. PESCUO,**

**CHIEF INSPECTORS.**

**R. K. McMURRAY,**  
**WM. J. FARRAN,**  
**F. S. ALLEN,**  
**WM. HEAFORD,**  
**A. B. ECOFF,**  
**F. S. ALLEN,**  
**J. H. RANDALL,**  
**C. A. BURWELL,**  
**J. B. WARNER,**  
**T. E. SHEARS,**  
**B. F. JOHNSON.**

**NEW YORK CITY,**  
**PHILADELPHIA, Pa.**  
**BALTIMORE, Md.**  
**BOSTON, MASS.**  
**PROVIDENCE, R. I.**  
**CHICAGO, ILL.**  
**ST. LOUIS, MO.**  
**HARTFORD, CONN.**  
**BRIDGEPORT, CONN.**  
**CLEVELAND, OHIO.**  
**SAN FRANCISCO, CAL.**  
**DENVER, COL.**  
**BIRMINGHAM, ALA.**  
**CHARLESTON, S. C.**  
**NEW ORLEANS, LA.**

**OFFICES.**

Office, 285 Broadway.  
" 432 Walnut St.  
" 22 So. Holliday St.  
" 125 Milk St.  
" 29 Weybosset St.  
" 112 Quincy St.  
" 404 Market St.  
" 218 Main Street.  
" 2 Sanford Building  
" 208 Superior St.  
" 306 Sansome St.  
" Mining Ex. B'g.  
" Morris Building.  
" 44 Broad St.  
" 188 Gravier St.

# The Locomotive.

PUBLISHED BY THE HARTFORD STEAM BOILER INSPECTION AND INSURANCE COMPANY.

NEW SERIES — VOL. XIV. HARTFORD, CONN., DECEMBER, 1893. No. 12.

## A Disastrous Boiler Explosion.

A short time ago a boiler exploded in New York city, destroying a large amount of property, killing five men instantly, and severely injuring twelve others, two of whom died from their injuries a short time afterwards. Owing to its location, in the midst of the city, this explosion attracted more attention than such accidents usually



FIG. 1. — GENERAL VIEW OF THE RUINS.

do, and the daily papers devoted considerable space to it. Most of our readers will therefore be already familiar, in a general way, with the facts of the explosion.

The accident occurred shortly after the noon hour, and the men, who were at work in various parts of the building, were buried under falling walls without the least warning. Fig. 1 is a general view of the scene of the explosion, reproduced from a photo-

graph that was taken a short time after it occurred. The entire building, it will be seen, was transformed into a mere shapeless mass of ruins. The exploded boiler was located on a level with the sidewalk, about 30 or 40 feet back of it, and nearly opposite the center of the mass of debris. It was composed of five courses of sheets, and was torn into three pieces, the lines of fracture running circularly around the middle sheet, just inside the girth joints. The front end, consisting of the head and two courses of the shell, appears to have passed through the front of the ruined building somewhere between the second and third floors. It then passed across Fourteenth street, striking a division wall between two tenement houses, and falling down to the sidewalk. Its final resting place is shown in Fig. 2, which also shows the damaged wall where it first struck. Several persons were in the exposed room on the second floor, and they doubtless owe their lives to the fortunate accident of the fragment striking against the division wall between this tenement and the next one, as already mentioned. Indeed, it is not unlikely that the entire front wall of this house would have fallen out, had the boiler struck it fairly.

The rear end of the boiler, consisting of the back head and two courses of sheets, was projected with equal force in the opposite direction. It crashed through a sixteen-inch brick wall, and was stopped by a similar wall in the rear of a Fifteenth street building.

The middle sheet of the boiler, including the dome, was thrown into an adjoining basement.

One of the newspaper accounts says that "one of the men killed was the engineer, whose carelessness must have caused the explosion." Sergeant Mullin, of the Police Bureau of Inspection, is also reported to have declared it "evident that an overpressure of steam, greatly in excess of what the boiler was licensed to carry, [*i. e.* greatly in excess of 90 pounds,] had caused the explosion." The first of these suppositions is of course wholly gratuitous, as the reporter, so far as we could learn, had no evidence to show that the engineer had not discharged his duties faithfully. So far as Sergeant Mullin's theory is concerned, we may say that although the pressure *may* have exceeded that allowed by the police board, it does not seem to us necessary to assume that it *did*, for the explosion can be sufficiently accounted for even if the pressure was within its normal limits. We do not wish to be understood as criticising Sergeant Mullin in the least, as his opinion, if correctly quoted, was given immediately after the explosion, and probably before he had had an opportunity of examining the fragments of the boiler carefully.

An examination of the middle sheet of the exploded boiler showed what was in all probability the cause of the explosion. On the outside of this sheet there was an area about 12 inches wide and 18 inches long, which was corroded to such an extent that in places the metal was not over a tenth of an inch thick. The corroded place was near the dome, and, judging from the general course of the lines of fracture, it was undoubtedly the point of initial rupture. The cause of this explosion, therefore, may be said to have been external corrosion of the shell.

The exploded boiler was 18 feet 8 inches long and 44 inches in diameter, with 46 tubes, and a dome 28 inches in diameter and 24 inches high. In addition to the loss of human life, some thirty horses were either killed outright, or so much injured that they had to be shot; and the total loss from the explosion may be summed up somewhat as follows: Seven persons killed and ten injured, thirty horses killed (valued at \$5,000), \$20,000 loss on the building, \$10,000 loss on the grain and feed stored in it, and \$5,000 loss on machinery. This makes the total estimated property loss \$40,000.





FIG. 2. — SHOWING THE DAMAGE DONE BY THE FRONT HEAD.



## Inspectors' Report.

AUGUST, 1893.

During this month our inspectors made 6,641 inspection trips, visited 15,311 boilers, inspected 5,292 both internally and externally, and subjected 577 to hydrostatic pressure. The whole number of defects reported reached 9,449, of which 884 were considered dangerous; 54 boilers were regarded unsafe for further use. Our usual summary is given below:

Nature of Defects.	Whole Number.	Dangerous.
Cases of deposit of sediment, - - - -	801	41
Cases of incrustation and scale, - - - -	1,378	66
Cases of internal grooving, - - - -	92	9
Cases of internal corrosion, - - - -	514	51
Cases of external corrosion, - - - -	719	54
Broken and loose braces and stays, - - - -	149	30
Settings defective, - - - -	265	28
Furnaces out of shape, - - - -	418	29
Fractured plates, - - - -	291	44
Burned plates, - - - -	212	17
Blistered plates, - - - -	277	9
Cases of defective riveting, - - - -	1,288	66
Defective heads, - - - -	153	61
Serious leakage around tube ends, - - - -	1,335	147
Serious leakage at seams, - - - -	403	32
Defective water-gauges, - - - -	382	84
Defective blow-offs, - - - -	128	28
Cases of deficiency of water, - - - -	10	5
Safety-valves overloaded, - - - -	52	22
Safety-valves defective in construction, - - - -	59	19
Pressure gauges defective, - - - -	476	42
Boilers without pressure gauges, - - - -	0	0
Unclassified defects, - - - -	47	0
Total, - - - -	9,449	884

SEPTEMBER, 1893.

During this month our inspectors made 6,693 inspection trips, visited 12,835 boilers, inspected 5,405 both internally and externally, and subjected 647 to hydrostatic pressure. The whole number of defects reported reached 8,881, of which 734 were considered dangerous; 26 boilers were regarded unsafe for further use. Our usual summary is given below:

Nature of Defects.	Whole Number.	Dangerous.
Cases of deposit of sediment, - - - -	788	30
Cases of incrustation and scale, - - - -	1,259	58
Cases of internal grooving, - - - -	99	7
Cases of internal corrosion, - - - -	445	19
Cases of external corrosion, - - - -	614	39
Broken and loose braces and stays, - - - -	169	53

	Whole Number.	Dangerous.
Settings defective, - - - - -	232	22
Furnaces out of shape, - - - - -	370	20
Fractured plates, - - - - -	200	30
Burned plates, - - - - -	200	30
Blistered plates, - - - - -	212	16
Cases of defective riveting, - - - - -	1,134	47
Defective heads, - - - - -	79	9
Serious leakage around tube ends, - - - - -	1,486	167
Serious leakage at seams, - - - - -	445	24
Defective water gauges, - - - - -	333	33
Defective blow-offs, - - - - -	121	28
Cases of deficiency of water, - - - - -	14	7
Safety-valves overloaded, - - - - -	44	12
Safety-valves defective in construction, - - - - -	66	15
Pressure-gauges defective, - - - - -	522	61
Boilers without pressure-gauges, - - - - -	2	2
Unclassified defects, - - - - -	47	0
Total, - - - - -	8,881	734

## Boiler Explosions.

OCTOBER, 1893.

(224.) — On October 3d, a boiler exploded in the town of Gillets, N. Y. Both heads blew out, and one of the sheets was also torn open. One of the employes had his sight destroyed by the escaping steam, and another was seriously burned about the body.

(225.) — On October 3d, two boilers in a battery of eight exploded at the Centralia colliery in Ashland, Pa. The boiler house was wrecked, and the fireman, Joseph McGuire, was seriously burned.

(226.) — A boiler owned by Mr. G. F. Spurlin of Camden, Ala., exploded on October 4th. Fortunately, nobody was hurt. The damage to property was not great.

(227.) — A boiler exploded on October 6th, in the consolidated mine, at Staunton, Ill., and the fireman, Harry W. Gerlock, was instantly killed.

(228.) — On October 7th, a boiler exploded in Wahpeton, N. D. John Vogelsang, the engineer, was badly hurt, but it is believed that he will recover. H. G. Willard was also injured. Nicholas Orchiner and Roy Russell were killed. Considerable damage was done. The explosion was heard seven miles away.

(229.) — During the progress of a fire in Sioux City, Iowa, on October 12th, a boiler exploded, blowing the burning building to atoms, and setting fire to a dozen adjoining buildings. Four blocks were burned before the flames could be controlled, and the total loss is estimated at half a million dollars.

(230.) — Five men were seriously, and perhaps fatally, scalded on October 12th, by an explosion in Marshall Field & Co.'s new building on Wabash Avenue, Chicago. The injured are Martin Kehoe, John Sousy, Patrick Quinn, John Miller, and William Ellis. The physician at St. Luke's hospital pronounced Sousy's injuries to be fatal, but said

that the other men "had a chance to recover." All the injured men were scalded by steam and water.

(231.)—A boiler exploded in Peel county, Ontario, on October 17th. A Mr. Brownlee and two other men were badly scalded, but all three will recover.

(232.)—One of the battery of seven boilers in the Yorktown colliery, near Hazleton, Pa., exploded on October 18th. It parted at the middle, and the ends were blown in opposite directions. James Hurley, the watchman, was apprised of the explosion by a boiler head crashing into his shanty. He was not hurt, but he had a very narrow escape. The other end of the boiler shot into a culm pile and was buried almost out of sight. The boiler house was wrecked, and work at the colliery was suspended for some days.

(233.)—On October 19th, a boiler exploded in Spokane, Wash. Mrs. John Beam, H. Holland, Rose Turner, and Miss Azee were killed. Next to the building in which the explosion occurred was a book store owned by Henry Friese. Friese was waiting on some customers when the explosion took place, and a wall fell into the store and buried him, and three other people. Friese was carried out by a fireman, badly wounded. Sidney Smith, who was in the book store, was taken out, badly injured. He may die.

(234.)—The steamer *Ben Wood* of the Ella Layman Towboat Co., was disabled at Charleston, W. Va., on October 20th, by the bursting of a flue in her boiler. Joel Nichols was fatally scalded, and two others were badly hurt.

(235.)—A boiler exploded on October 21st, near Abbeville, S. C. James Perrin was killed, and two other men were injured.

(236.)—On October 22d, a locomotive boiler exploded near Birmingham, Ala., instantly killing Engineer William Mills and Fireman J. W. Buchanan. Mills' body was blown through the roof of a residence 300 yards away, and Buchanan's body was blown 200 yards in another direction. The locomotive, which was just taken from the shop, was totally wrecked.

(237.)—One of the boilers of the steamer *Bellevue* exploded on October 22d, while she was lying at the Ludlow street landing in Cincinnati, Ohio. Reuben Simons was fatally hurt, and William Lightbody, Perry Redman, and Capt. W. F. Rose, were injured. An unknown woman, who was on the boat, was also injured.

(238.)—A locomotive boiler exploded on October 22d, at Raysville, near Chillicothe, Ohio. It was drawing a west-bound express train on the Cincinnati, Hamilton & Dayton railroad, and at the time of the accident it was running at 50 miles an hour. The locomotive was blown to pieces, and the baggage car left the track and plunged down a twenty-foot embankment. The baggage-master was stunned by the shock, and on recovering consciousness he found himself in a closet, with the door closed, and baggage piled up against it. He was not seriously hurt, however, and after a time he succeeded in releasing himself. Engineer F. M. Arnold and Fireman S. S. Shields had a wonderful escape from death. They received only a few scratches. All the glass in the three passenger cars was broken, and the passengers were badly frightened, and severely shaken up.

(239.)—A boiler exploded in Rev. E. J. Prendergast's residence, in Philadelphia, Pa., on October 23d. A servant girl had a narrow escape from injury. The damage to property was slight.

(240.)—A boiler exploded on October 23d, in the Warren Manufacturing Co's. factory at Warren, near Baltimore, Md. George Stifler, a fireman, was killed. The roof of the boiler house was blown off.

(241.)—On October 24th a water-tube boiler in the basement of the Pleasanton Hotel, San Francisco, Cal., burst five of the headers over the tube ends, and one tube. Fortunately, no damage was done, except to the boiler.

(242.)—The boiler of the Clear Spring colliery, West Pittston, Pa., exploded at noon on October 26th. Two men had a narrow escape from death, and a large number of hands were thrown out of employment. The property loss was estimated at \$4,000.

(243.)—Six workmen were horribly burned on October 26th, by the explosion of a digester in a pulp mill in Ashland, Wis. Joseph Long and Charles Bottick were the most seriously injured, and it is feared they will die. The others will probably be crippled for life. The pulp mill had been in operation only two months.

(244.)—A boiler exploded on October 26th in Boone County, W. Va., instantly killing Charles McDarmon and Engineer James Hoffman. Charles Barker was also fatally injured.

(245.)—On October 26th, a boiler exploded at Plum Coulee, near Winnipeg, killing Andrew Stran and seriously injuring Michael Daun. Pieces of the boiler were found a quarter of a mile away.

(246.)—On October 26th, a boiler explosion occurred not far from Inglewood station, near Los Angeles, Cal., and Edward Leahy, Fred Baker, and Andrew Hansen, were badly injured. Hansen's injuries were quite serious, but at last accounts he was getting better, and it was believed that he would recover. Thirty men were at work near the boiler, and it is remarkable that no more were hurt.

(247.)—On October 26th there was a slight explosion on the steamer *Frank Silva*, near San Francisco, Cal. It was of a similar nature to the accident to this vessel described elsewhere in the present issue.

(248.)—By a slight explosion in Elizabeth, N. J., on October 28th, W. T. Taylor was severely scalded about the face, neck, and hands, and had a narrow escape from losing his life.

(249.)—On October 28th, a boiler exploded in the suburbs of Henderson, Ky., demolishing everything about it. The engineer was severely scalded, but will recover.

(250.)—On October 28th, a boiler exploded in the little village of Ste. Anne du Sault, Arthabaska County, Quebec. Olivie Gonpil, owner of the mill, David McCarthy, and Saul Elie, were killed, and the mill was wrecked. It appears that this boiler had been inspected in July by Mr. O. E. Granberg, of the Boiler Inspection and Insurance company of Canada, and that he condemned it, and advised that it be broken up for old iron. Notwithstanding this, the boiler was sold, and erected at Ste. Anne du Sault. It had been used only five days when the explosion occurred. On July 19th, Mr. Granberg wrote to the head office of his company, stating that he had inspected this boiler and refused a certificate, and that the boiler was unfit for steam pressure. "I object to a boiler of that kind going to kill people," he added, "and if I knew of any way to stop it, I would; for it is a death trap."

(251.)—A boiler used for heating school No. 18, Buffalo, N. Y., exploded on October 30th. The boiler house was wrecked, and a general panic ensued among the mothers of the neighborhood, who feared for the safety of their little ones. At first it was feared that some of the children might be buried under the ruins, but the search of the fire department showed that this was not the case. The boiler was cared for by a crippled 12-year-old boy, who was one of the pupils. One of the newspaper reports we have received, says that the boiler was "a heater of the refractational type," whatever that may be.



---

# The Locomotive.

---

HARTFORD, DECEMBER 15, 1893.

J. M. ALLEN, *Editor.*

A. D. RISTEEN, *Associate Editor.*

THE LOCOMOTIVE can be obtained free by calling at any of the company's agencies.

Subscription price 50 cents per year when mailed from this office.

Bound volumes one dollar each. (Any volume can be supplied.)

Papers that borrow cuts from us will do us a favor if they will mark them plainly in returning, so that we may give proper credit on our books.

---

THE boiler of a steam tug on Lake Doga, Russia, exploded on October 18th. The tug was blown to pieces, and every man on board of her was either killed outright, or drowned.

THE *Annual Report* for 1893 of the Chief of the Bureau of Steam Engineering in the United States Navy is at hand, and we have found it of unusual interest. The section treating of the personnel of the department is especially suggestive.

THE present issue completes the fourteenth volume of THE LOCOMOTIVE, and bound volumes for the year 1893 will be ready shortly, and may be had, upon application at this office, at the usual price of one dollar each. Indexes and title pages will also be furnished, free of charge, to those of our readers who have saved their copies and desire to have them bound.

WE have received, from the Scottish Boiler Insurance Company, of Glasgow and Manchester, an interesting pamphlet entitled *Some Boiler Explosions*. It contains seven excellent plates showing the destruction caused by boiler explosions, one plate showing an inspector ready for his work, and portraits of three of the company's officers. There is a plate in colors, too, exhibiting, graphically, the number of boiler explosions in the United Kingdom since 1862, together with the number of the killed and injured. There is also a considerable amount of information in the text that accompanies the plates; and the pamphlet, as a whole, is neat and creditable to the company that issues it.

IT was not long ago that we recorded, with considerable satisfaction, the first crossing of the Atlantic ocean in less than six days. It was then considered a great feat, and navigators had been looking forward to it for years. The six-day record, however, has now itself become a back number. Last year the *City of Paris* crossed in the phenomenal time of 5 days, 14 hours, and 24 minutes; and this remained the record until October 6th of the present year, when the *Lucania* completed the westward passage in 5 days, 13 hours, and 45 minutes. Within the next few days this record was twice broken. On her next eastward trip the *Lucania* crossed in 5 days, 13 hours, and 30 minutes, and one day later the *Campania* reached Sandy Hook after a passage of only 5 days, 13 hours, and 23 minutes. Even this remarkable record was not to stand for long.

On Saturday, October 28th, the *Campania* passed the Sandy Hook lightship at 9:00 A. M., on her outward trip, and she reached Daunt's Rock, off Queenstown, at 1:45 A. M., on Friday, November 3d. If we allow 4 hours and 35 minutes for the difference in time due to the change in longitude, her record becomes 5 days, 12 hours, and 10 minutes, which is one hour and twenty minutes better than the best previous eastward record, and one hour and thirteen minutes better than the best previous westward one.

---

WE desire to acknowledge the first volume of Prof. Alexander Ziwet's excellent *Elementary Treatise on Theoretical Mechanics*, a copy of which he has kindly sent us. Most of the better elementary treatises on this subject are intended for students who have not yet entered upon the study of the calculus. Prof. Ziwet rightly considers that in this country, where calculus is commonly studied first, there is no reason why it should not be used in the study of theoretical mechanics. In our own opinion, there are two advantages in using it for this purpose. For the theorems of mechanics are established much more readily and simply by it, and the student also becomes better acquainted with the uses of the calculus itself, which is a very distinct advantage; for too many college young men regard this branch of mathematics as a mere system of consistent intellectual gymnastics. Prof. Ziwet's book brings out the importance of the calculus, as an instrument of investigation, very clearly. He is thoroughly acquainted with his subject, and his treatment of it is everywhere clear and elegant. We believe that this is the first extended work he has published in this country; but he is well and favorably known in the mathematical world for his translation, from Russian into German, of Somoff's *Theoretische Mechanik*. The present volume treats of Kinematics, and the two forthcoming ones, which we look forward to with considerable interest, will treat of statics and kinetics, respectively.

---

IN the August issue of THE LOCOMOTIVE we mentioned an explosion on the steamer *Frank Silva*. (See No. 161 in our regular monthly list.) The data from which our account was made out were in newspaper clippings. Capt. W. A. Phillips, United States local inspector of steam vessels at San Francisco, requests us to publish the following item, which gives more exact particulars of the *Silva's* accident:—

“CAPT. W. A. PHILLIPS,

U. S. Inspector of Boilers, San Francisco, Cal.,

DEAR SIR:—On board the steamer *Frank Silva*, on July 20th, a circulating pipe,  $1\frac{1}{4}$  inches in diameter, split for a distance of from  $1\frac{1}{2}$  to 2 inches. When the accident happened we were abreast of Goat Island. I kept the boat under way until we reached the mouth of the creek, when we dropped anchor. I then proceeded to repair damages. In the meantime steamer *Rosalie* took off our passengers. There was nothing to indicate that anything unusual had happened,—no explosion whatever. The boat simply kept slowing down until she stopped altogether. It was simply impossible to keep steam with the water spraying over the grate surface. Very respectfully,

C. H. TERRY,

Late Chief Engineer, steamer *Frank Silva*.

Subscribed before me, W. A. Phillips, U. S. Local Inspector, San Francisco, Cal., this first day of November, 1893.”

### The Deterioration of Rails.

Mr. T. D. Cook of Boston has kindly called our attention to an experiment witnessed by him in the Government Building at the World's Fair. A rail that had been in use for some time was placed in the testing machine, and it was found to break readily, without any material bending, when supported at the ends and loaded at the center. The same rail was then placed in a furnace and reheated, after which it was again tested. This time it was found to be much stronger; it bent through a considerable angle, and did not break. The rail was not worn to any great extent, but had a fine, smooth polish on the top, from the action of the wheels. Mr. Cook suggests that this experiment may throw some light on the breaking of rails while in use.

Mr. J. E. Howard, who has charge of the great testing machine at the Watertown Arsenal, in commenting on this experiment in a letter to Mr. Cook, says: "The steel rail in question was exhibited for the purpose of showing how a rail, originally tough, would, after exposure to the wheel pressure, become devoid of toughness, and fracture in a very brittle manner when bent with the head on the tension side; and how the metal might have its toughness restored by annealing:—in this manner showing that loss of toughness was not, at least in this case, the result of incipient cracks forming in the head, but that exhaustion in toughness is an independent feature in the deterioration of metals. The softer the rail, or the lower its elastic limit, the sooner will it yield under the wheel pressure, and the sooner reach a state of brittleness, so far as the metal immediately at the top surface of the head is concerned. Rails which were planed off  $\frac{1}{8}$ " on the head bent as well as the annealed sample. Of two samples of the rail which you saw at the World's Fair, when loaded at the middle on supports 30" apart, the one which was loaded on the head sustained 99,800 lbs. total load, and bent 40 degrees without rupture; whereas the other piece, loaded on the base, thus bringing the head on the tension side, fractured, without appreciable bending, under the load 63,900 lbs. This behavior of rails which have yielded and the metal in the head flowed over the sides under the wheel pressure, has been verified in a number of instances. The rails which are harder at the start appear to be affected in a similar manner, but in a less marked degree.

Yours respectfully,

J. E. HOWARD."

---

### Professor John Tyndall.

A few days ago the world lost one of its foremost men of science, in the death of Professor Tyndall. The *Scientific American* speaks of him as follows:

"On the evening of December 4th, Professor John Tyndall died. The son of an Irish policeman, a man whom he himself described as 'socially low, but mentally and morally high,' he had before him the task of working his own way up in the world. He was born August 21, 1820, in Leighlin Bridge, near Carlow, Ireland. He left school at the age of nineteen, and joined the Irish Ordnance Survey. Here he may be said to have begun his scientific career. In 1841 an official asked him how he employed his leisure hours, and told him that with five hours a day at his disposal they 'should be devoted to systematic study.' He added, 'Had I when at your age had a friend to advise me as I now advise you, instead of being in a subordinate position I might have been at the head of the survey.' Next morning, it is said, Tyndall was at his books at five o'clock, and for twelve years followed the advice given him.

"He became dissatisfied with his slow progress, and in 1844 wished to emigrate to



America. But a position as railroad engineer in England was obtained for him, and he remained. In 1847 he took the position of master of Queenwood College, Hants, Hampshire. He showed great talent for teaching and began to contribute scientific papers to scientific periodicals. In May, 1847, his father died. In 1848, with Frankland, since professor of chemistry in the Royal Institution, he went to Germany. There, under Bunsen, Knoblauch, and Magnus, he studied science for two years, receiving his degree in 1850. In 1851, on his return to London, he met Faraday. He was at once taken up by the great master, and was associated with Faraday in his work at the Royal Institution of Great Britain. He was appointed to the chair of Natural Philosophy there in 1853, and after Faraday's death in 1867 succeeded him as superintendent.

"He published many works and papers on scientific subjects. His books, written for the popular taste, are excellent examples of scientific exposition. In 1872, when at the height of his fame, he made a lecturing tour of the United States. His lectures, given in this city [New York], were received by large audiences, no experimental lectures, probably, ever being greeted with such *éclat*. The daily papers reported them with illustrations of the experiments, in some cases — testifying to the interest in them on the part of the public. His receipts from the lectures — some \$13,000 — he presented to Harvard University, Columbia College, and the University of Pennsylvania, founding scholarships in aid of students who devote themselves to original research.

"A great Alpine climber, for many years he visited Switzerland, and there met his wife, also an enthusiast on mountain climbing, whom he married when he was 56 years old."

Professor Tyndall had been ill for some time, and was taking both chloral and sulphate of magnesia. By some means or other the bottles containing these medicines were confounded, and at 8.30 on the morning of December 4th a large dose of chloral was administered to him, in place of the magnesia sulphate which it was intended to give. The mistake was immediately detected, and measures were promptly taken to save him. The physicians made every effort to stay the action of the drug, but he died at half-past six on the afternoon of the same day, ten hours after taking the fatal dose.

### He Saw The Boiler Explode.

Boiler explosions are by no means uncommon, and yet they are seldom observed by "disinterested spectators." One of our inspectors, from the Hartford office, had the good fortune, a short time ago, to actually see a boiler blow up, under steam at a high pressure. The boiler was torn apart and thrown in various directions. The inspector relates his experience as follows:

"About 12.30 o'clock on the afternoon of August 14, my attention was attracted by a fire which had just broken out in a shingle mill at North Adams, Mass. The flames spread rapidly, and were fast consuming the wooden mill, and communicating with the adjoining buildings; and when the fire department arrived and got to work it bent its entire efforts upon saving the surrounding property. Hence no water was thrown on the burning building in which the boiler was situated.

"The boiler was of the locomotive type, and was rated at about 35 horse-power. It was unjacketed, and all its parts were exposed to the elements. It was provided with a two-inch pop-valve, which would be of ample size to relieve it of excessive pressure under working conditions. The boiler, being under our care, was recently inspected, and was in good condition for a working pressure of 110 pounds to the square inch.

"The mill was situated on the bank of a small pond, and the boiler was set at right



angles to this bank. The position taken up by the writer at the time of the explosion was on the opposite side of the pond about 200 feet away from the mill.

“The boarding which covered the mill soon burned away, leaving only the frame, and the stock for about 250 panel doors. This stock had been piled up over the boiler to dry, and when it was released by the burning away of the mill it fell down about the boiler in a heap and burned fiercely, so that the entire outer part of the shell became the heating surface of the boiler. The safety-valve was blowing freely, and could be heard distinctly above the roar of the flames. It was doing its utmost to relieve the enormous

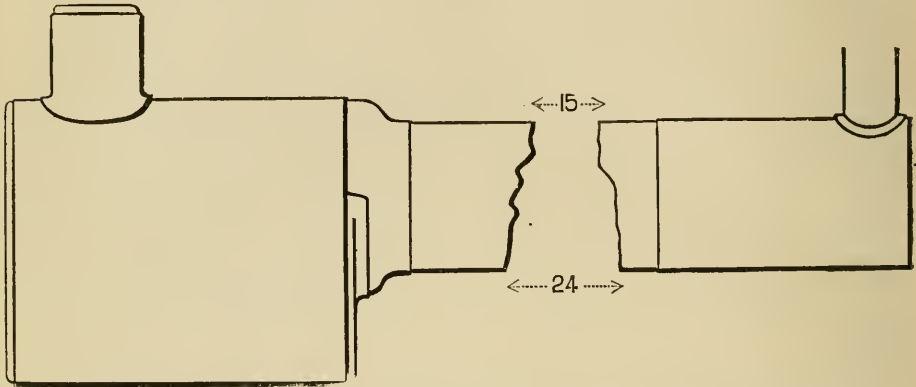

FIG. 1.—DIAGRAM SHOWING WHERE THE RUPTURE OCCURRED.

pressure that was fast accumulating. The iron stack had fallen into the pond, and the smoke-arch at the front end had become red-hot. A few moments later there came a deafening explosion, like the report of a blast, and the burning timbers were hurled in every direction. One piece, about 6 inches square and 8 feet long, which was probably

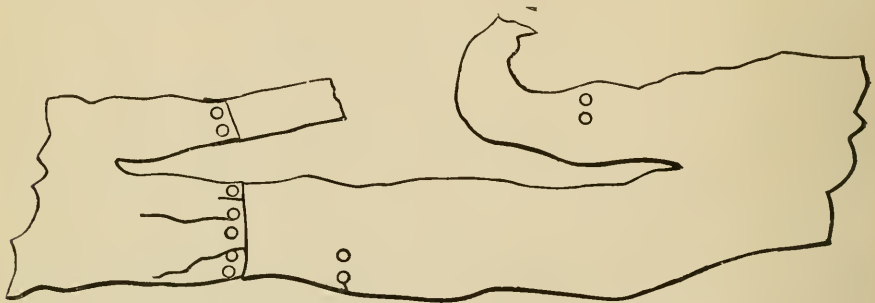

FIG. 2.—SKETCH SHOWING THE GENERAL SHAPE OF THE PIECE TORN OUT.

over the point of rupture, was thrown high in the air, so that it was hardly visible to the eye; it must have gone up 300 or 400 feet. The point of initial rupture was on the top of the barrel, and the boiler was torn in three pieces (see Fig. 1). The front end was thrown into the pond, about 50 feet from where it stood before the explosion; and the fire-box end, with the protruding tubes, was blown about 75 feet in the opposite direction, narrowly missing two firemen who were standing by. The central portion of

the barrel was laid flat on the floor where the boiler stood. (Its general form is shown in Fig. 2.)

“Investigation showed that the boiler was nearly filled with water at the time of the explosion. The shell, above the water line, had been overheated and softened, and the enormous pressure that accumulated caused the explosion. The shell was bulged outward in several places along the top to a depth of nearly half an inch.”

### Photography.

The labors of human ingenuity cannot be restrained, and all the present clamor against machinery is only a clamor against the exercise of the human understanding. But we have never been able to discover any practical use in all the daguerreotype inventions, except in their having got the inventor a handsome pension from Louis Philippe. The process is certainly curious, pretty, and new. But we have never been able to hear of its producing any actual result, beyond the making of extremely indistinct copies of drawings, feeble imitations of the ciphers on buttons, and most terrific *facsimiles* of the human visage. Not that I should desire to act truculently on this occasion, and break up all the little zinc cups and saucers which cover so many ladies' thimbles with deposits of the “genuine copper,” nor prevent any individual from having his lineaments exhibited in the most alarming deformity; but that the invention, though now of some half-dozen years' growth, is still so “little of its age,” that it threatens to be a dwarf the longest day it lives. And this we shall admit to be the case with hundreds of inventions once much more promising. The balloon, for instance, has been half a century before the world's eye, and what has the world made of it after all, or who has been the better for it, but Mr. Green, who is really a very clever climber of the clouds, but who has disappeared from fame since his offer of ballooning it from America? We hope he is not drowned, gas and all.

The daguerreotype system, however, is now superseded, in its minor points at least, by younger rivals, and nobody seems to remember it, except, perhaps, the Chancellor of the French Exchequer. A new exhibition has appeared in London, and with the advantage of a new title; a Mr. Fox Talbot has applied himself to making it effective for taking likenesses, and this is the statement of an exhibition of his art a few days since by an operator employed for its display: “In effect, as far as the sitter is concerned, there is no material difference between the plan employed by him and that at Mr. Beard's rooms in the Polytechnic Institution. The person whose likeness is to be transferred is required, but for a few seconds, to place his face in front of the glass of a camera obscura, and the light, a powerful one, impresses upon a piece of paper placed therein a *facsimile* of the features, with this peculiarity, that the lights in the original are shadows in the copy, and, *vice versa*, the shadows in the original are lights in the copy. The position of the face is also reversed. This paper is afterwards turned down upon another piece of prepared paper, and by a simple process a complete transfer is made, the lights, shadows, and position being again reversed, so that the original appearance is reproduced. The portraits, those at least we have seen, are very satisfactory. There is a rough air of truth about them, which reminds one of the first, and sometimes the best, sketches of the artist, a sort of free sepia, or, rather, lithotint drawing, full of broad effects and vigor. One of the advantages of the art is, that from the original portrait, any number of *facsimile* copies may be taken, and an additional inducement is, that the charge is small.”

Such is the narrative in the *Morning Post*, and we have not seen the process; but the likenesses which have been produced by the former system are so absolutely fearful, that we have but little hope of ever seeing anything tolerable from any machine. It must want color, it must want living expression, it must want the play of features, which the pencil has the singular power of seizing and fixing; and its best likeness can be only that of a rigid bust, or a corpse. All expression, except that of fright, is impeded by the powerful glare to which the face must be exposed; for the eyes must be kept all but shut, and the features rigid and wrinkled to keep them so. We altogether doubt that any contrivance of the kind will produce a portrait half so good, natural, or expressive, as a decent artist might produce with a burnt stick. Still it is worth trying for a while, improving it, if it can be improved, and if *not*, worth throwing away or turning to button making. — *Blackwood's Edinburgh Review* for April, 1842, under topic, "Things of the Day."

### Red-Hot Crown-Sheets.

In the April issue of *THE LOCOMOTIVE* we gave a translation of Alfredo Gilardi's paper on "Leidenfrost's Phenomenon," in the course of which (on p. 56) there occurs the following passage: "This same conclusion was reached by the engineers of the Pennsylvania Railroad, who tried to bring about an experimental explosion by injecting cold water into the boiler of a locomotive whose crown-sheet was dry, and red-hot. The cold water had hardly been introduced when the pressure fell, and naturally the explosion did not take place, though the furnace had been so highly heated that it was afterwards useless."

A correspondent having asked us for the details of these experiments, we communicated with Mr. J. M. Cains, superintendent of motive power of the Pennsylvania Railroad, and received from him the following courteous reply:

"To the Editor of *THE LOCOMOTIVE*,  
Hartford, Conn.

"DEAR SIR:

"I beg leave to acknowledge the receipt of your letter of November 25th, inquiring about certain experiments made by the Pennsylvania Railroad Company, concerning the effect of spraying feed water on red-hot crown-sheets of locomotive boilers; and in reply I would say that I cannot refer you to any book or journal in which there is an account of these experiments, nor am I aware that any account of them has been published.

"The tests you refer to were made in April, 1868, at Kittanning Point, the object being to blow up a boiler by introducing cold water on a red-hot crown-sheet, the maximum steam pressure being on the boiler at the time. The experiments were conducted in this way: The boilers were fired up until 125 pounds of steam were obtained and the water was low, and then through 1,000 feet of hose cold water was forced into the boiler by means of a steam fire-engine; and every attempt at exploding the boiler in that manner failed. Two boilers were experimented on, the first one becoming leaky after several trials, and being of no further use in that way. The second boiler was tried a few times, and finally blew up when least expected, seemingly from excessive pressure and weakened fire-box. The crown-sheet blew down and the boiler turned a complete somersault, and then rebounded and fell down the side of a hill, the spectators scattering very fast and seeking shelter behind convenient trees. Nobody was hurt.

"We have not been able to find any data on these experiments from our records, and what information is contained herein, is from memory.

Yours truly, J. M. CAINS, Supt. Motive Power, P. R. R."

A short time ago we published a notice of Mr. Edward P. Thompson's *How to Make Inventions*. Mr. Thompson now writes to us as follows:— "In your review of my book on *How to Make Inventions*, you enter a certain criticism. I am willing to concede to the editor that the scientific facts are not stated as accurately as might be, and this purposely. My object is the use of terse sentences giving to inventors (who are as a class quick of perception) the gist of facts; the leading idea conveyed, if the fact were stated with all its surroundings. For example, instead of stating that water has its greatest density at four degrees upon a certain thermometer, at a certain geographical level, at a certain degree of purity, etc., etc., I would prefer to convey the main idea somewhat thus:— From about four degrees above the freezing point of water, the same expands, whether heated or cooled. When a fact is stated in some such language, it is easily remembered, and has a certain suggestiveness about it in behalf of the inventive mind."

Now we had no idea of criticising the terseness or simplicity of Mr. Thompson's diction. What we objected to was the obscurity of some of his passages, and the erroneous statements that he has occasionally given as facts. For instance, on page 33 he says, "Water vapor in contact with red-hot material is decomposed into hydrogen and oxygen, which are combustible, relatively." We consider this sentence obscure, because we can't make out what the latter part of it means. Again, on page 40 we read that "What is true of light is true of heat, because light is usually heat; but what is true of heat is not necessarily true of light, because heat exists without light." There is something elusive about this sentence. We have worked hard over it, but we can't seem to surround the idea it is intended to convey. On page 41 he says that "A gas will pass through platinum at as high temperature as through porous earthenware, but not to such a degree." Now we should like to know, just for the gratification of our editorial curiosity, what that sentence means. Maybe the author knows, but we find it inscrutable.

Having illustrated what we mean by calling Mr. Thompson's style obscure, we proceeded to quote two or three erroneous statements, in order that the reader may judge whether or not our criticism was justifiable. On page 36 he says that sound "moves faster and faster from the source until a certain maximum is obtained." We should like to be referred to the experiments, or equations, on which this statement is based. On page 39 we read that "in solids the distance between the molecules is less than in liquids, and less yet than in gases." This is sometimes true, and sometimes not. In a substance that contracts when it melts, the molecules are *further apart* in the solid form of the substance than they are in the liquid form of it. On page 40 it is implied that the temperature of a body is proportional "to the rate of vibration of the molecules." This is not in accordance with the kinetic theory of gases, and unless Mr. Thompson is prepared to overthrow that theory, he must admit that the passage cited is erroneous. Again, on page 43 it is said that "the vapors of liquids relatively insoluble produce double the pressure of either." This does not accord with Dalton's law, and in fact it refutes itself; for it implies that at a given temperature the vapor pressure of all mutually insoluble liquids is the same; and, as everyone knows, this is not the fact. Again, on page 44 we read that "water boils in glass vessels at 106° C., and in metal vessels at 100°. A piece of metal placed in the glass vessel makes the water boil at 100°." This would be an extraordinary fact, if it were a fact, which unfortunately it is not. On page 46 it is said that light comes to us from the sun in about eight *seconds*. The true time is about eight *minutes*.

We have said enough, perhaps, to justify our previous critical remarks, and we trust Mr. Thompson will not feel hurt because we have not changed our opinion of his book. It is not at all easy to produce such a work as his, and have it free from errors, and we trust that in future editions he will see to it that the obscurities and inaccuracies in his book are removed. It is only fair to him to say that we found the book in question to be interesting and suggestive. We criticised nothing but the scientific end of it.



Incorporated  
1866.



Charter Per-  
petual.

Issues Policies of Insurance after a Careful Inspection of the Boilers,  
COVERING ALL LOSS OR DAMAGE TO  
**BOILERS, BUILDINGS, AND MACHINERY**

ALSO COVERING  
**LOSS OF LIFE AND ACCIDENT TO PERSONS**

ARISING FROM

**Steam Boiler Explosions.**

Full information concerning the plan of the Company's operations can be obtained at the  
**COMPANY'S OFFICE, HARTFORD, CONN.,**  
Or at any Agency.

**J. M. ALLEN, President.**

**J. B. PIERCE, Secretary.**

**W. B. FRANKLIN, Vice-Prest.**

**FRANCIS B. ALLEN, 2d Vice-Prest.**

**E. J. MURPHY, M. E., Consulting Engineer.**

**Board of Directors.**

**J. M. ALLEN, President.**  
**FRANK W. CHENEY, Treas.** Cheney Brothers Silk Manufacturing Co.  
**CHARLES M. BEACH,** of Beach & Co.  
**DANIEL PHILLIPS,** of Adams Express Co.  
**RICHARD W. H. JARVIS,** Prest. Colt's Fire Arms Manufacturing Co.  
**THOMAS O. ENDERS,** President of the U. S. Bank.  
**LEVERETT BRAINARD,** of The Case, Lockwood & Brainard Co.  
**GEN. WM. B. FRANKLIN,** late U. S. Commissioner to the Paris Exposition.  
**NELSON HOLLISTER,** of State Bank, Hartford.

**HON. HENRY C. ROBINSON,** Attorney-at-Law, Hartford, Conn.  
**HON. FRANCIS B. COOLEY,** of the National Exchange Bank, Hartford, Conn.  
**EDMUND A. STEDMAN,** Treasurer of the Fidelity Co., of Hartford, Conn.  
**GEORGE BURNHAM,** Baldwin Locomotive Works, Philadelphia.  
**HON. NATHANIEL SHIPMAN,** Judge United States Circuit Court.  
**C. C. KIMBALL,** Pres. Smyth Mfg. Co., Hartford, Conn.  
**PHILIP CORBIN,** of P. & F. Corbin, New Britain, Conn.

**GENERAL AGENTS.**

**THEO. H. BABCOCK,**  
**CORBIN & GOODRICH,**  
**LAWFORD & MCKIM,**  
**C. E. ROBERTS,**  
**H. M. LEMON,**  
**C. C. GARDNER,**  
**L. B. PERKINS,**  
**W. G. LINEBURGH & SON,**  
**BURWELL & BRIGGS,**  
**MANN & WILSON,**  
**ZOLLARS & MCGREW,**  
**R. F. MANLY,**  
**W. S. HASTIE & SON,**  
**PETER F. PESCU,**

**CHIEF INSPECTORS.**

**R. K. McMURRAY,**  
**WM. J. PARRAN,**  
**F. S. ALLEN,**  
**WM. HEAFORD,**  
**A. B. ECOFF,**  
**F. S. ALLEN,**  
**J. H. RANDALL,**  
**C. A. BURWELL,**  
**J. B. WARNER,**  
**T. E. SHEARS,**  
**B. F. JOHNSON,**

**NEW YORK CITY,**  
**PHILADELPHIA, Pa.**  
**BALTIMORE, Md.**  
**BOSTON, MASS.**  
**PROVIDENCE, R. I.**  
**CHICAGO, ILL.**  
**ST. LOUIS, MO.**  
**HARTFORD, CONN.**  
**BRIDGEPORT, CONN.**  
**CLEVELAND, OHIO.**  
**SAN FRANCISCO, CAL.**  
**DENVER, COL.**  
**BIRMINGHAM, ALA.**  
**CHARLESTON, S. C.**  
**NEW ORLEANS, LA.**

**OFFICES.**

Office, 285 Broadway.  
" 432 Walnut St.  
" 22 So. Holliday St.  
" 125 Milk St.  
" 29 Weybosset St.  
" 112 Quincy St.  
" 404 Market St.  
" 218 Main Street.  
" 2 Sanford Building.  
" 208 Superior St.  
" 306 Sansome St.  
" Mining Ex. B'g.  
" Morris Building.  
" 44 Broad St.  
" 188 Gravier St.

# INDEX TO VOL. XIV, NEW SERIES.

ARTICLES MARKED WITH A STAR (\*) ARE ILLUSTRATED.

- Accident due to bad workmanship, \*49.  
from calking joints under pressure, 155.  
an unusual, \*145.  
railway, of 1893, 168.  
to the *Victoria*, 104.
- Addresses of agents, changes in, 42, 74.  
Agents, changes in, and in addresses of, 42, 74.  
Air, the Hodgkins prize essays on, 105.  
Allen, Prest. J. M., his extension furnace as applied  
to upright boilers, \*81.  
election of, as judge at World's Fair, 106.  
invited to speak at World's Fair, 106.
- American inventor, the, 91.  
*American Mechanics*, the, 90.  
Answers to problems, 108.  
Arrangement of feed-pipes, the, \*1.  
Atlantic record, the, 184.  
Babies, their need of water, 122.  
Baby fell out of bed, she thought, 163.  
Barber's shop, dangers of, 154.  
Base-ball literature, 123.  
Bee, Mr. Joseph, death of, 88.  
Bigelow, Mr. H. D. P., death of, 74, 90.  
Blow-off, stopping a leaky, 41.  
Blue-print paper, formula for, 58.  
Boiler explode, he saw the, \*187.  
explosion at Towanda, 167.  
in Japan, 154, 166.  
engineer's courage at a, 42.  
described by a witness, \*187.  
discovery made by means of a, 155.  
on the *Frank Silva*, 185.  
on Lake Doga, Russia, 184.  
a disastrous, \*177.  
on a toy yacht, 57.  
in Eischischek, 57.  
on the *Oliver Ellsworth*, 77.  
on the *Esk*, in Panama, 57.  
at Haycock's mill, 123.  
explosions in England, 89, 172.  
in Europe, 107.  
intentional, 123.  
horrible accounts of, 154.  
spheroidal theory of, 54.  
Pennsylvania Railroad's experi-  
ments upon, 190.  
monthly lists of, 7, 23, 36, 51, 72,  
84, 100, 117, 119, 148, 164,  
181.  
annual summary of, 26.  
since 1879, summary of, 28.
- Boiler Explosions.—See also *Explosions*.  
*Boiler Explosions*, *Some* (notice of), 184.  
Boiler heads, on the bracing of, \*129, \*135.  
insurance companies, a field exists for, 77.  
plates, stamps on, 87.
- Boilers, cleaning them from above, 40, 90.  
comparative costs of feed waters for, 75,  
103.  
upright, extension furnaces for, \*81.  
Bound volumes of *THE LOCOMOTIVE*, 12, 184.  
Boy tells what he has read, 27.  
Bracing boiler heads, on methods of, \*129.  
Breeching, use of, with iron stocks, \*117.
- Bridge-walls, note concerning, 40.  
Bromine, 15.  
Bunker Hill of Mexico, the, 126.  
Burwell & Briggs, appointment of Messrs., 74.  
Cains, Mr. J. M., on red-hot furnace-crown experi-  
ments, 190.  
Calking joints under pressure, dangers of, 155.  
a joint with an editor's moustache, 167.  
Caps, danger of tightening them under pressure,  
155.  
Casting, the first, in America, 90.  
Caulking.—See *Calking*.  
Caus, Solomon, the discoverer of steam power, 13.  
Century, the Eighteenth, 109.  
Check-valve, accident caused by a, \*145.  
Chicago.—See *World's Fair*.  
Children, young, their need of water, 122.  
Chimneys.—See *Stacks*.  
*City of Paris*, the, 184.  
Cleaning boilers from above, 40, 90.  
Cocks, double, on blow-offs, 41.  
Cold feed water, on the strains caused by, 42, 161.  
Collisions, railway, of 1893, 168.  
Columbian Exposition.—See *World's Fair*.  
Combustion of wood, imperfect, 170.  
Comet of Lexell, the lost, 12.  
Connections, feed pipe, \*1.  
Consumptives, new hope for, 30.  
Cook, Mr. T. D., on the deterioration of rails,  
186.  
Corbin, Master Arthur, 107.  
Corrosion of iron stacks, 170.  
Cow and the horse, small boy's reading lesson on the,  
27.  
Cracked plates, \*161.  
Crane, traveling, for the World's Fair, 58.  
Crown sheets, red hot, Pennsylvania Railroad's ex-  
periments on, 190.  
Cuantla, the siege of, 126.  
Cut of an inspector ready for work, note concerning  
a, 90.  
Daguerreotype, the first in America, 59.  
early criticism of the, 189.  
Death of Professor Tyndall, 186.  
Deterioration of rails, the, 186.  
Device, locomotive smoke-consuming, \*60.  
Difference, the just perceptible, 45.  
*Dimitri Donskoi*, Master Corbin's experiences on the,  
107.  
Discoverer of steam power, the, 13.  
Ditches, proper time for digging, 123.  
Domes, concerning, \*65.  
Dodge, Inspector, notes from, 40, 90.  
Early locomotives, 124, 150.  
Edwards, Mr. Emory, notice of his *American Steam  
Engineer*, 12.  
of his 900 *Examina-  
tion Questions*, 155.
- Eighteenth Century, the, 109.  
*Ellsworth, Oliver*, Explosion on the, 77.  
Engineer, heroism of an, 42.  
England, boiler explosions in, 89, 172.  
Engraving of an inspector ready for work, note con-  
cerning an, 90.

- Equivalent of heat, redetermination of the mechanical, 153.
- Eruption of Krakatoa, the, 167.
- Essays on air, the Hodgkins fund, 105.
- Europe, boiler explosions in, 107.
- Examples. — See *Problems*.
- Excavation of soil, proper time for, 123.
- Exhibition.— See *World's Fair*.
- Expanding tool, accident from the improper use of, \*49.
- Expanding tools for tubes, \*131.
- Explosion, interesting information elicited by an, 155.
- of a steam mangle, 157.
- boiler, in Towanda, 167.
- of a boiler in Japan, 154, 166.
- made her think baby had fallen out of bed, 163.
- of a boiler, described by a witness, \*187.
- of a boiler on the *Oliver Ellsworth*, 77.
- boiler, on the *Frank Silva*, 185.
- of a tug boiler on Lake Duga, Russia, 184.
- a disastrous boiler, \*177.
- of the boiler of a toy yacht, 57.
- Explosions, boiler, in England, 89, 172.
- intentionally produced, 123.
- in Europe, 107.
- P. R. R. Cos.' experimental, 190.
- horrible newspaper accounts of, 154.
- Explosions. See also *Boiler Explosions*, and *Accidents*.
- Exposition.— See *World's Fair*.
- Extension furnaces for upright boilers, \*81.
- Extractors, grease, \*97.
- Fair, the World's, 58, 106, 107, 150, 155, 156, 186.
- Fatigue of metals, 186.
- Feed-pipe, failure of a check-valve in a, \*145.
- Feed-pipes, arrangement of, \*1.
- Feed-water, cold, on the strains caused by, 42, 161.
- Feed-waters, comparative costs of, 75, 103.
- Ferris wheel, the, 156.
- Ferry, Mr. A. S., death of, 74.
- Fireman, heroism of a, 42.
- Flared tubes, \*133.
- Flues, connection of, to stacks, \*116.
- Furnaces, extension, for upright boilers, \*81.
- Gauge, steam, "would admit of 240 pounds," 155.
- General agents, changes in, etc., 42, 74.
- Grates, setting them too near the boiler, 40.
- Grease in boilers, trouble from, 40.
- extractors, \*97.
- Griffith's redetermination of the mechanical equivalent of heat, 153.
- Hartford Steam Boiler Insp. & Ins. Co., extract concerning the, from the *Deutsche Correspondent*, 14.
- Heads, boiler, on the bracing of, \*129.
- stamps on, 87.
- Health, Board of, on proper time for disturbing soil, 123.
- Heat, redetermination of the mechanical equivalent of, 153.
- Heaters, open, trouble from, 40.
- Helium meteorite, the, 88.
- Heroism vs. recklessness, 42.
- Hodgkin's fund prize essays on air, 105.
- Holding power of tubes, \*133.
- Howard, Mr. J. E., on the deterioration of rails, 186.
- Imagination, effects of the, 45.
- Industry, the tin plate, 103.
- Inspector, notes from an, 40.
- description of an explosion by an, \*187.
- "Inspector ready for work," note concerning a cut of an, 90.
- Inspectors' reports, 7, 20, 36, 51, 100, 121, 146, 164, 180.
- annual summary of, 21.
- work since 1870, summary of, 46.
- Insurance companies, boiler, existence of a field for, 77.
- Inventions, how to make* (notices of), 89, 191.
- Inventor, the American, 91.
- Iron, effect of temperature on the strength of, \*17.
- exhaustion of "toughness" in, 186.
- casting, the first in America, 90.
- pig, production of, in 1892, 88.
- purification of water by, 122.
- stacks, \*113.
- corrosion of, 170.
- Janssen, M., and the Mont Blanc observatory, 153.
- Japan, boiler explosion in, 154, 166.
- Jillson, Mr. Asa W., death of, 107.
- "John Bull" train, the, 150.
- Joints, dangers of calking them under pressure, 155.
- lap, off-set of, \*162.
- Kettle, iron, the first casting in America, 90.
- Koch, Dr. Robert, 30.
- Krakatoa, the eruption in, 167.
- Lap joints, off-set of, \*162.
- Laundry, explosion in a, 157.
- Lauterbach, Mr. John W., death of, 168.
- Leak stopped by the editor's moustache, 167.
- Leaky joints, danger of calking under pressure, 155.
- blow-offs, 41.
- Leidenfrost's phenomenon, 54.
- Lemon, Mr. H. M., appointment of, 42, 74.
- Lesson in reading, the small boy's, 27.
- Lever "safety" valve, a dangerous, \*33.
- Lexell's lost comet, 12.
- LOCOMOTIVE, THE, indexes and bound volumes, 12, 184.
- Locomotive smoke and spark-consuming device, a, \*60.
- the "John Bull," 150.
- Locomotives, early, 124.
- Lowest noise ever heard, 167.
- Lucania*, the, 184.
- Lymph, Dr. Koch's, 30.
- Mangle, explosion of a steam, 157.
- Manholes, the importance of, 28.
- under tubes, 40, 90.
- in domes, reinforcement of, \*65.
- Manly, Mr. R. F., his change in address, 42.
- Maryland, the retaliatory law in, 14.
- Mechanic*, the *American*, 90.
- Mechanical equivalent of heat, redetermination of, 153.
- Metals, the fatigue of, 186.
- Meteorite, the helium, 88.
- Mexico, the Bunker Hill of, 126.
- Mont Blanc observatory, the, 153.
- Moustache, Editor Jackson's, 167.
- Napoleon as a fatalist, 120.
- Nethe, purification of the water of the river, 122.
- Newspaper accounts of explosions, horrible, 154.
- Noise, the loudest ever heard, 167.
- Notes from an inspector, 40.
- Obituary, Mr. A. S. Ferry, 74.
- Mr. H. D. P. Bigelow, 74, 90.
- Mr. Joseph Bee, 88.
- Mr. Asa W. Jillson, 107.
- Mr. John W. Lauterbach, 168.
- Professor John Tyndall, 186.
- Observatory, the Mont Blanc, 153.
- Ocean steamship records, 184.
- Off-set of lap joints, \*162.
- Oil separators, \*97.
- trouble from, in boilers, 40.
- Oliver Ellsworth*, explosion on the, 77.
- Openings in the heads of boilers under the tubes, advantages of, 40.
- Openings.— See also *Manholes*.
- Overhanging fronts, connection of iron stacks with, \*118.
- Oxalic acid in blue-print work, 58.
- Paris, the City of*, 184.
- Patents.— See *Inventor*.
- Pennsylvania R. R. Co's exhibit at the World's Fair, 150.
- experiments with red-hot furnace crowns, 190.
- Phenomenon, Leidenfrost's, 54.
- Phillips, Capt. W. A., on the *Frank Silva's* explosion, 185.
- Photographs, possibility of sending them by telegraph, 46.



- Photography in America, early days of, 59.  
 selection from Blackwood's magazine concerning, 168, 189.
- Pictures, the telegraphy of, 46.
- Pig-iron, production of, in 1892, 88.
- Pipes, feed, arrangement of, \*1.
- Plate industry, the tin, 103.
- Plates, cracked, \*161.  
 stamps on, 87.
- Platinum, production of, in Russia, 127.
- Portraits, sending, by telegraph, 46.
- Pot, iron, first casting in America, 90.
- Pressure, safe working, new way to determine, 155.
- Prize essays on air, the Hodgkin's fund, 105.
- Problems for idle moments, 78, 108.
- Proctor, Richard A., proposed monument to, 122.
- Prophets, weather, spiders as, 158.
- Prosser expander, accident from improper use of, \*49.
- Publications:
- LOCOMOTIVE, THE, bound volume of, 12, 184.
  - Annual Report*, Bureau of Steam Engineering, 12, 184.
  - American Steam Engineer* (Edwards), 12
  - Report of the Sächsischer Verein*, 42.
  - Report of the Schlesischer Verein*, 58.
  - Il Fenomeno di Leidenfröst* (Gilardi), 58.
  - Report of the Norddeutscher Verein*, 74.
  - The Moon's Face* (Gilbert), 78.
  - Measurement of Electric Currents*, 78.
  - Electrical Measuring Instruments* (Swinburne), 78.
  - Meters for Electrical Energy* (Worthingham), 78.
  - Report of the National Boiler Insurance Co.*, 89.
  - How to make Inventions* (Thompson), 89, 191.
  - A Columbian Tribute*, 99.
  - Report of the Hannover Verein*, 104.
  - Report of the Naples Associazione fra gli utenti di caldaie a vapore*, 104.
  - Revista Marittima*, the, 106.
  - Report of the American Asylum for the Deaf and Dumb*, 106.
  - Dampfmaschinen und Transmissionen* (Radinger), 106.
  - Dampfkesseln und deren Ausrüstung* (Radinger), 106.
  - Quarterly Boiler Review* (Hogan), 123.
  - Note concerning Griffiths's *Redetermination of the Mechanical Equivalent of Heat*, 153.
  - Berlin Iron Bridge Co's pamphlet, 154.
  - Heating and Ventilation of Residences* (Willet), 154.
  - 900 *Examination Questions and Answers* (Edwards), 155.
  - Jamaica at Chicago* (Ward), 155.
  - Report of the British Board of Trade*, concerning the boiler explosion acts, 172.
  - Some Boiler Explosions* (issued by Scottish Boiler Insurance Co.), 184.
  - Theoretical Mechanics* (Ziwet), 185.
  - How to make Inventions* (Thompson), 89, 191.
- Puzzles.—See *Problems*.
- Radinger, Professor J., his visit to Hartford, 107.
- Railroad accidents of 1893, 168.
- Rails, on the deterioration of, 186.
- Reading lesson, the small boy's, 27.
- Recklessness vs. Heroism, 42.
- Record, the Atlantic, 184.
- Retailory law in Maryland, the, 14.
- Roberts, Mr. C. E., his change of address, 42.
- Russia, production of platinum in, 127.
- Russian man-of-war *Dimitri Donskoi*, the, 107.
- Saehse, Mr. Julius, on the early days of photography in America, 59.
- Safety-valve, a dangerous, \*33.
- Safety-valves, dangerous lever, 59.
- Scale, removal of by washing, 40, 90.
- School incident, a, 27.
- Sediment, removal of, by washing, 40, 90.
- Separators, \*97.
- Sewers, proper time for constructing, 123.
- Shaving, dangers of public shops for, 154.
- Sheets, red-hot crown, 190.
- Shell-plates, stamps on, 87.
- Shells, on the strains produced in, by cold water, 42.
- Siege of Cuautla, the, 126.
- Silk, artificial, 63.
- Silva, Frank*, explosion on the, 185.
- Smash-ups, railway, of 1893, 168.
- Smithsonian Institution prizes for essays on air, 105.
- Smoke-consuming device for locomotives, a, \*60.
- Smoke-stacks, iron, \*113.  
 corrosion of, 170.
- Soil, proper time for excavation of, 123.
- Sound, the loudest ever heard, 167.
- Spark and smoke consuming device, a, \*60.
- Spheroidal state of water, 54.
- Spiders as weather prophets, 158.
- Stacks, iron, \*113.  
 corrosion of, 170.
- Stamps on boiler plates, 87.
- Statement, annual, quotation concerning our, 14.
- Steam power, the discoverer of, 13.
- Steel, effect of temperature on the strength of, \*17.  
 production of in 1892, 88.
- Strains caused by cold feed water, 42.
- Strength of iron, effect of temperature on, \*17.
- Summary of inspectors' reports, 21.  
 work since 1870, 46.
- of boiler explosions, 26, 28.
- Talbot, Fox, his photographic process, 189.
- Telegraphy of pictures, 46.
- Telescope, the big Yerkes, 155.
- Temperature, effect of, on the strength of iron, \*17.
- Terry, Mr. C. H., on the *Frank Silva's* explosion, 185.
- Tin plate industry, the, 103.
- Tools for expanding tubes, \*131.
- Towanda, the boiler explosion at, 167.
- Train, the "John Bull," 150.
- Tryon, Sir George, 122.
- Tube expanders, \*131.
- Tube, failure of a, through improper use of the Prosser expander, \*49.
- Tubes, flared, \*133.  
 holding power of, \*133.  
 expanded, \*129.  
 washing them from the top, 40, 90.
- Tuberculous patients, new hope for, 30.
- Tyndall, death of Professor, 186.
- Unusual accident, an, \*145.
- Upright boilers, extension furnaces for, \*81.
- Valve, check, accident caused by a, \*145.  
 "safety," a dangerous, \*33.
- Valves, double, on blow-offs, 41.  
 "safety," dangerous lever, 59.
- Victoria*, loss of the, 104, 122.
- Volcano of Krakatoa, eruption of, 167.
- Volumes, bound, of THE LOCOMOTIVE, 12, 184.
- Wago Maru*, explosion on the, 154, 166.
- Washing boilers out from the top, 40, 90.
- Water, cold feed, on the strains caused by, 42, 161.  
 purification of, by iron, 122  
 should be given to babies, 122.  
 spheroidal state of, 54.
- Waters for boilers, comparative cost of, 75, 103.
- Weather prophets, spiders as, 158.
- Well water vs. city water for boilers, comparative costs of, 75, 103.
- Wheel, the Ferris, 156.
- Whist problem, a good, 78, 108.
- Wood, effects of imperfect combustion of, on iron stacks, 170.
- Workmanship, bad, accident due to, \*49.
- World's Fair, the, 58, 106, 107, 150, 155, 156, 186.
- Worm, the silk, must it go? 63.
- Yacht, toy, explosion of, a, 57.
- Yerkes telescope, the big, 155.
- Zollars & McGrew, Messrs., change in address, 42.













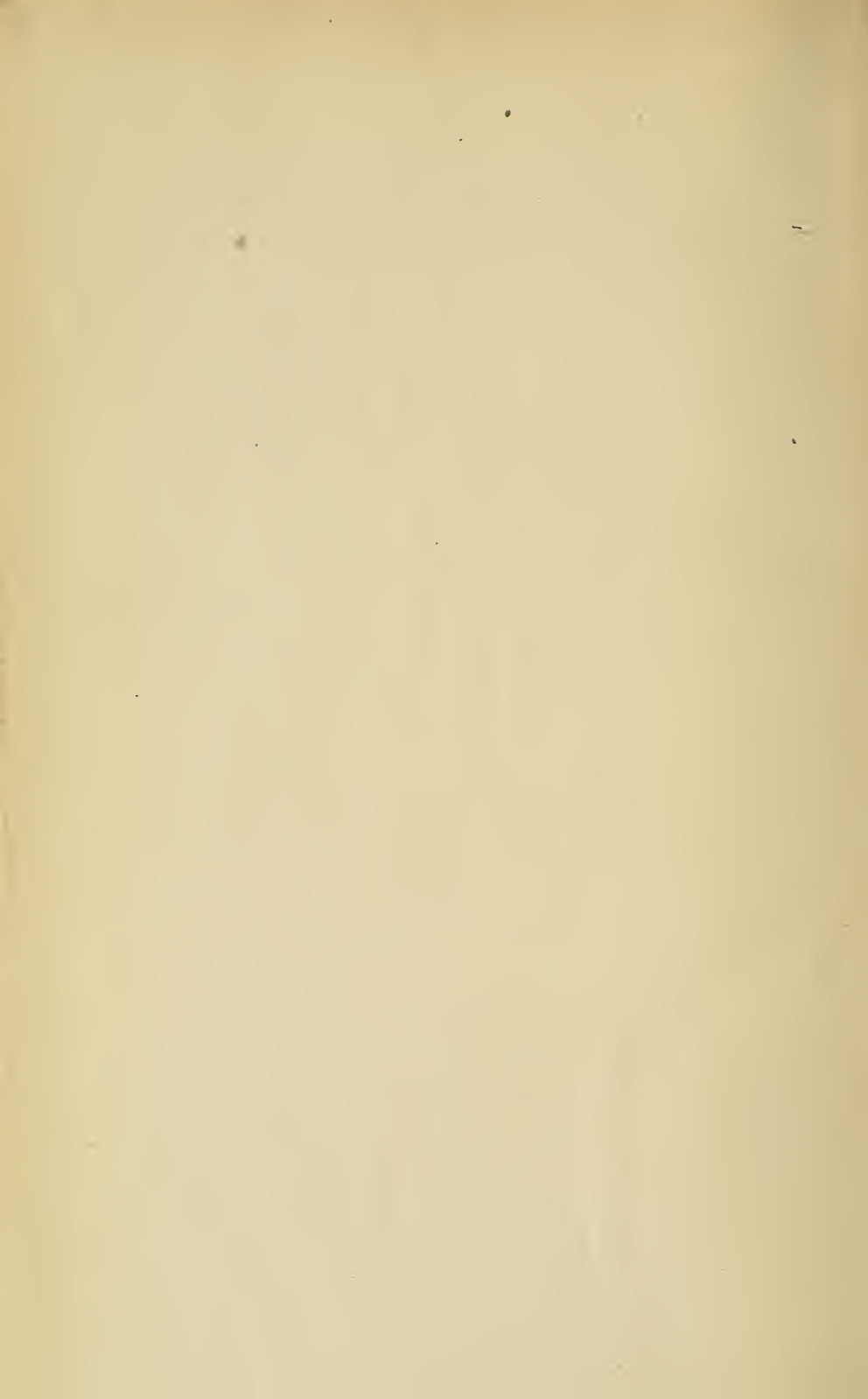



CARNEGIE LIBRARY OF PITTSBURGH



3 1812 04248 1185