

Digitized by the Internet Archive
in 2009 with funding from
Lyrasis Members and Sloan Foundation

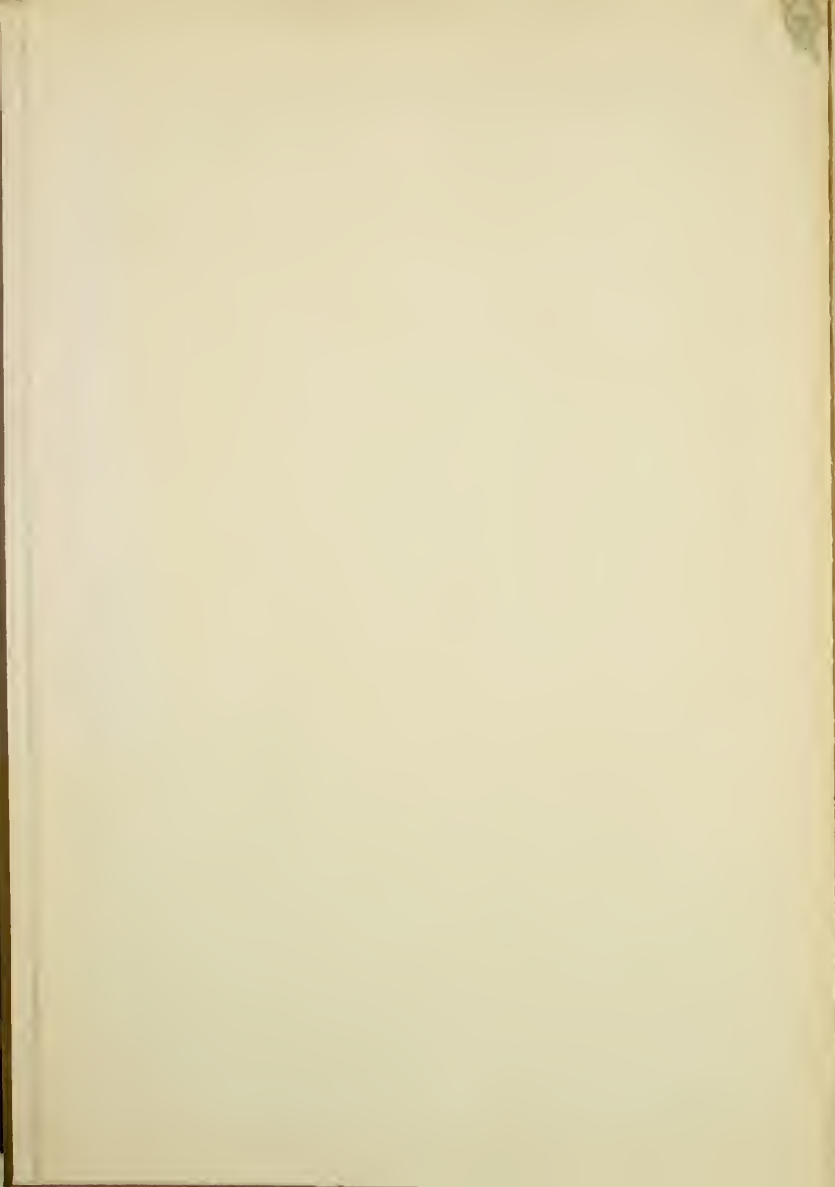

THE PRACTICAL ENGINEERING JOURNAL of RAILWAY MOTIVE POWER AND ROLLING STOCK.

INDEX TO VOLUME VII.

[Articles marked with an asterisk (*) are illustrated.]

GENERAL.

A
 Accident, peculiar on Lehigh Valley, 11; analysis of a report of, 241, on the Delaware, Lackawanna & Western Railroad, 36, from broken cross rail, 63; narrow escape with powder, 120
 Air, application of, to chain hoist, 291; for electric cars, 38
 Air brake association, convention of, 99
 Air brake situation, the, 230
 Air brake valves, decision of the 3, 20, 26
 Air brake system, diseases of the, by Paul Synnott, 8, 40, 81, 107, 141
 Air brakes, keeping in working order, 120
 Air brakes and friction, see Brakes
 Air compressor, now a new compound for shops, 209
 Air condenser and friction, see Brakes
 "Aisle cock, a lock up, 31, A. M. Watt's improved, 61; extra connections on, a source of danger, 97; improved, 135, 200; moving the, by vibration, 170
 "Aisle valve, one more safe, 204
 Apparatus, how fitting, 25
 Ash pan, the fuel waste, 79
 Ash pan damper, a safety, 269
 Association, officers of the National R. R. Blacksmiths, next place of meeting of Railway Air Brakes, 221; meeting of the M. M. and the M. C. B. to manage their own business, 151, 165, 190, Union of the Mechanicals, 151, letters to investigation, by M. M., 204; meeting of the Traveling Engineers, 204; meeting of the Master Blacksmiths, 204; subjects and committees for Master Car Builders, 233; meeting of the Railroad Air Brakes, 209, 235
 Axles, making, from scrap, 199

B
 Babbit metal, 134; causes excessive wear of, 200
 Baker car heater, water-filling coil for the, 144
 Baker heater, growth of the, 16
 Balanced valve, a new, 26
 Ballasting tracks with ballast, 129, 6
 Bearings, roller, 129; factors on, 200
 Beam lever used for railroad car springs, 95
 "Blacksmith shop, kinds, 195
 Block signaling, 22, 26
 B.M. & C.icals, location of, 392
 "Boiler compound, means of applying, 16
 "Boiler compound, on the Ericsson shop, 17; twenty-seven vent up, 17
 "Boiler making, the elements of, by C. E. Fow, 205, 21, 119, 126, 130, 214, 215, 220
 B.M. & C.icals, micro, 27
 Boilers, inspection of, 112 that do not break away, 113; fastening the, 110; improved C.M. & B. boiler, 114; evaporation in locomotive, 205; from iron-pipe water in red hot, 103; dangerous, 120
 Boilers, water car, 207
 Boilers, means for starting, 103
 "Boilers, a business, with automatic arrangement, 219
 Boilers, 115
 Boiler efficiency and fractional resistance, 26
 Brake wheels, "Haskell's plan, 104, Lee's, 106
 Brake men, danger of, 103, 115, 24
 Brake shoes, best material for, 121
 Brakes, train in Erie, 201; preventing defects of, 207, 210, see also, at terminals, 207
 Brick at shops, see Foreman's opinion on, 107
 British Railway, 101; railroad users in, 201
 British railways, 101
 "Brooks, train of locomotives for Brazil, 300-1

C
 Car, weight of, 241
 Car locks, lost for making, 235
 "Car report, a graphic, 267
 Car seats, new patent in, 131
 Car wheels, compressed air device for loading, 202
 Cars, growth of the sleeping, 17; "St. Charles chair, 17; 1 super, 18; repairing freight, by piece work, 18; "Car boats, 31; development of the American, 61; metal super-framing for freight, 61, the compartment, decolored, 61; clining, on English railways, 61; where piece work on, was first used, 60; the Iron Car Co.'s style of iron, vindicated, 101; passenger, construction, 28; parts which the owner of, should be responsible for, 60, 31; amending the rules of the interchange of, 61; number of, with and without air brakes, 61; "Shop track for lifting ends of empty, 107; for Russian Emperor, 246; iron, composite intensive use, 246; cleaning, with osalic acid, 200; safety coils for freight, 131; Pullman's cheapening of, 24, to strengthen, with steel, 24; rolling quick transfer of, 24; percentage of, in the country, based by steam, 230; increase the load of freight, 235; interchange of, in Erie, 100; 101; disputes in interchange, 200; reduce dead weight of, 201; keeping new, out of the shop, 39; ventilation of, 201; brake leverage for freight, 200
 Castings, Beaver steel, 120
 Catalogues, Manning, Maxwell & Moore's, 61
 "Rodger Ballast Car Co.'s, 111; Taylor Electric Truck Co.'s, 110; standard size of, 20
 Chain hoist, application of, at, 16, 205
 Cheap labor and fire boxes, 25
 Chemists, advocating railroad, 249
 Cinder pit, who has the best, 203
 "Circumference indicator and tire gauge, 153
 Cleaning by air, 121
 "Cleveland Twist Drill Co.'s conator box, 141
 Coal, loss to, in storage, 99
 Coal bills, large saving on, 16
 "Cock, water filling, of the Baker car heater, 241
 "Collision, a head on, 20
 Compartment car, the, defended, 40
 Compound, report for softening, 139, means of applying, boiler, 20
 Compound air compressor, 200
 Compound locomotives, reported and real condition of, 17; an adoption of English design, 29
 "Starting valve of Baldwin, no, Q. 156, 158-161, 157; without starting mechanism, 157; starting valve of the Richmond 1200 cylinder, 22; back pressure in, in High Sharp, 201; "Ponik, 87
 Compound line for use of a lap valve, 107
 Compressed air, means of applying, 139
 Compressed air device for loading car wheels, 202; cleaned cars with, 202
 Compressed air, extending the use of, 213
 Compressed air, painting, sanding and whitewashing by, 307
 Conduletary, train running for the, by Carter S. Conroy, 115
 Conduletary, Locomotive Engineers, 121; of railroad men, 120; the M. C. H. & M. M., 120
 "Traveling Engineers, 201; Mechanicals, 200
 Copper refining, discovery in, 20
 Copper-nickel, railroad, by John Fuller, Sr., 205, 212, 213
 Corrosion, chemical, "Mexico, 48, 235, 237
 Train brakes, 101, 237; crossing the line, 137; "In Holland, 237
 "Counterbalancing, reforming the, 108
 "Counterbalancing, experiments on locomotive, 108, 120
 Couplers, drop tests of car, 208; device for holding, while waiting in yards, 208; "The Tower, 206
 Crane, a new dummy, 100
 Crane for handling chest covers, by P. M.

Arthur, 131; a new patent locomotive, 131, 20
 "Jand-weighting pneumatic, 230
 Cranes, portable, 230, "Sellers' electric, 218-9
 "Cylinder cock, a simple, 21
 Cylinder condensation, 21
 "Cylinder spring compressor, 20
 Cylinders, device for centering line through, 101; steam jackets for, 21
 "Cutter, a, that cuts, 200

D
 Dead weight, of trains, reducing, 136, of cars, 20
 Devises, conflicting opinions on common, 20
 "Die for punching keyway in tail bolts, 65
 "Dies, hammer, for making car links, 131
 Discipline without punishment, by George R. Brown, 48, 107, 20, 220
 Dog traps in Manitoba, 121
 "Don'ts", some, for young engineers and firemen, 120
 Draft appliances, 28
 Draft appliances, diverse experience with, 26
 Drawer, new patent continuous, 129
 Drawers, height of, 104
 "Drawbridge, running, 21, 129
 Drills, new method of driving, 120
 Driving boxes, "Mackenzie's, 207; weak cast iron and strong steel, 207; best material for, 207
 Driving brakes, independent, 20
 Driving wheels, cast steel centers, 108, circumference in friction with cast steel, 209
 "Drop pat on the M. K. & T., 164
 "Dummy coupling, a new, 319

E
 Economy in engine supplies, 49
 Edison's railroad career, 207
 Engines of inspection, 23
 Electric battery, the elementary, 219
 Electric motors for machine shops, 136
 Electricity for power transmission, 136
 "Elements of boiler making, by C. E. Fournes, 85, 120, 121, 209, 210, 216, 220, 221
 Empire State Express, 111
 Employees, unnecessary reduction of, 40
 Engine, the Wells, and her train, 21; growth of the steam, 20
 Engineering, the hard soul of self-instruction in, 137; hand-books, 137, 200
 Engineers, 200 honored, 30
 Engineers young at forty-five, 20
 Engines, duplex, compound, 200
 Roads, by Henry G. Lester, 201; English 200, Americana, 200
 Engines, monthly up rating, 135; use of the M. & B. R. by, 135; failures of, 201, P. & B. Equipment Notes, 135, 136, 137, 200, 208, 210, 214
 "Exhaust pipe, the Wells, 200
 Expenses, reducing, operating, 21
 "Explosion of a locomotive boiler at the Erie shop, 104, 21
 Express locomotive practice in England and America, by Hugh Sharp, 270

F
 Factors wanted, 4
 Paints, engine, on the Ohio Pacific, 21
 Fast run, 200; broken, 24
 Fast run with a too-weak engine, 20
 Fast water, a new compound for softening, 108
 The Sheet, plan for preventing distortion of, and fast sheet of fire-brick, 20
 Flies, how to bore with air, 124; strange destruction of, in a railroad shop, 20
 Fog and snow-storms, identifying locality during, 20
 F-40, 207, 208
 Foreman, members of a coal shop, 2
 "Forest fire, the heroes of the great, 101, 207

"Forging a hex. nut with a collar, 230
 Forsyth, fuel-saving firebox, patented by M. N. 24
 Fireboxes, fuel-saving, patented by M. N. Forsyth, 24; cracking, and sheets of, 126
 Four kniblers, locomotive, 121; Leslie, 120
 Furnace, how they should be selected, 120
 Frame bolts, a caution for shooting out tight, 131
 "French compound locomotive, 8, 207
 Freight cars, increase the load of, 138
 Freight cars, repairing, by piece work, of frictional resistance and brake efficiency, 20
 Friends, we are advertised by our loving, 26

G
 "Gates rock crusher, 204
 "Gauge, glass-cutter, a new, 16; abolish the water, 16
 Geometry, a bit of railroad, by Geo H. Cooper, 164
 "Great Northern Spokane shops, 131

H
 Hall signals for the Delaware, Lackawanna & Western Railroad, 24
 "Hammer die for making car links, 131
 Hand-books, errors in, engineering, 200
 "Harrington's hoist and traveler, 132
 Haskell's brake lever plus, 100
 Heat measurer, improved, 59
 Heroes of the great fire, 214, 207
 High train speeds, 127
 Hobbs Island transfer, the, 50
 "Hoist and traveler, Harrington's, 132
 Hoop, tunnel, diameter in the, 201
 "How, Anaximila, 17
 Hose-fitting apparatus, 27
 Hot boxes, 24; Rabbit metal, 120
 "Humboldt, Cal., lack of railroads in, 51
 Human flesh and blood as steel tempering material, 355

I
 Inadmissible pencils for car inspectors, 104
 "Indicator diagrams, from Union Pacific locomotive, 20; the water for horse-power, 46
 Indicator, "The Taber, Houghnimb's reducing motion for, 200; a railway station, 200
 Inferior goods for railroads, 200, 214, 102, 103, 104, no difference in work of, with enlarged tie plate, 121, 217
 Inspection, 104
 "Interpreting books, 207; Richmond Locomotive Works, 207
 Inter-Atlantic, 207
 Intermediate, Commercial Locomotive reports, 24
 Inventors' consideration shown for the rights of, 207
 Iron, good makes standards desirable, 207; to be left in stock, 244; wrought and steel for, 137 and hand-books, 207

J
 Jack track, shop, 207
 Jerusalem railway, failure of, 107
 "John-on-always state, the, 21
 Journal boxes, hot, 27
 Judge of distator, 20

K
 Kemp, triple expansion locomotive, patented by Wm., 25

L
 Laboratories, railroad, advocated, 207
 Laboratory Locomotive for Cornell University, 207
 Lake Shore, a M. Southern, improvements on, 107
 Lake Street Heavy J. Railroad, Chicago, ready for business, 2
 Landmarks, 27
 Lath, power improvers of the, 20

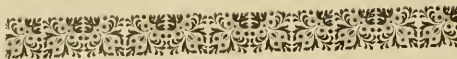

SPECIAL OFFER FOR 1895.

WITH A YEAR'S SUBSCRIPTION for 1895 we will send a neat little book, entitled "**Standard Form of Examination of Firemen for Promotion, and Engineers for Employment.**" This is the uniform plan of examination adopted by the Traveling Engineers' Association, at the Annual Meeting, September, 1894. Every Engineer and Fireman **MUST** know the answers to the questions in this book sooner or later. You get the book **FREE** with the paper for 1895.

We shall also send out a **Dictionary Chart of Sleeping and Passenger Cars**, similar to the famous "999" transparency of 1894, and a fine **Colored Picture**, for framing, of a handsome, modern, **Ten-Wheeled Passenger Locomotive.** This picture will be the finest thing ever attempted in the Locomotive line.

The paper itself will be the best and most interesting Railroad Paper ever printed we will leave it to you if it is not.

CASH COMMISSION TO CLUB RAISERS.



Locomotive Engineering



A Practical Journal of Railway Motive Power and Rolling Stock.

VOL. VII, No. 1.

NEW YORK, JANUARY, 1894.

12 Cts. Monthly
\$2.00 Per Year

Some American Locomotives for Chile.

The Rogers Locomotive Co., of Paterson, N. J., have just turned out twelve 10-wheeled locomotives for the Government of Chile. Six A Rogers locomotives were among the first used in that country and have a good reputation there, yet the new ones just built have a few European features, especially noticeable in the tank.

The illustration on this page gives a very good idea of the general appearance of the engines. Their principal dimensions are as follows:

Range of road, 5 ft 6 in.
Fuel, bituminous coal.
Total wheel base of engine and tender, 12 ft 6 in.
Total wheel base of engine, 23 ft. 8 in.
Tender, 11 ft.
Driving-wheel base, 13 ft. 4 in.

The Cheapest Tools in the Market.

In the course of the last few years we have had a great deal to say about the expensive policy of purchasing inferior material for use on railroad rolling stock, and several persons influential in the purchasing of goods have informed us that they have been converted by the sound business principles inculcated in these pages. Our labors in this direction have generally been devoted to the advocacy of first class material for the construction of locomotives and cars. A conversation which the writer had in a railroad office during a recent journey moves us to say something about the policy of purchasing inferior tools to be employed in the repairing of railroad machinery. A request has been made for certain badly needed tools,

which would examine the tool shops and planing mills of the companies that make locomotives and cars, they would learn that the best is not too good for such places. Why should less than the best be forced into railway shops should receive the best railroad shops? There is special reason of everything, for they are rarely granted renewals while a tool will hold together.

The practical effect of saving a few hundred dollars and getting a cheap tool is that the cost of finishing work is higher than it ought to be, and the saving in first cost is wasted in a year or two by the added cost of labor to make the product pass inspection. Every year the tool becomes poorer and less efficient. At a period of its life when a first-class tool would be as good as new, the inferior article is stopped for heavy repairs. A company must be

so that we can make out the work's intended. We also like to have the writing confined to one side of the paper. Men who have ideas, and especially facts, will be acceptable writers for this paper if they will follow the suggestions made. We don't care for opinions and don't pay for them. We give them away gratis to people who visit this office. That is, those which we think our readers don't want, and they are easily satiated with that kind of mental hash.

A peculiar accident happened on the Lehigh Valley during the recent strike. Some of the men put to running locomotives didn't know any more about it than the law allows, and one of them ran into the rear of a freight train, the collision was not a severe one, but it smashed up a

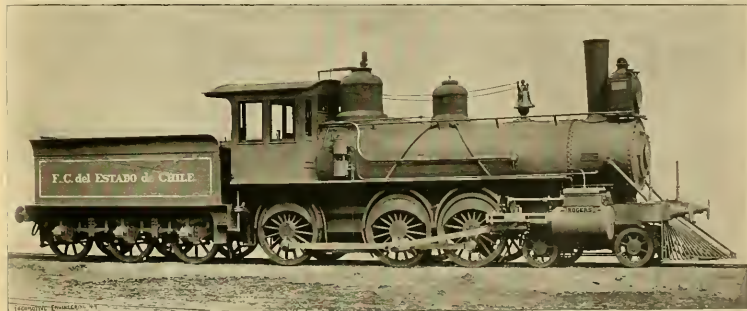

FOR THE GOVERNMENT RAILROADS OF CHILE. BUILT BY ROGERS LOCOMOTIVE CO.

Weight in working order on drivers, 20,000 lbs.
Weight in working order on truck, 32,000 lbs.
Total weight, 112,000 lbs.
Cylinders, 18x24 in.
Diameter of driving-wheels, 56 in.
" " truck " 28 in.
Style of boiler, wagon top with crown bars.
Diameter of boiler, 54 in.
Size of firebox inside, 67 in. long x 43 in. wide x 30 in. deep.
Material of boiler, steel.
" of firebox, copper.
Tubes, material, brass
" number, 152
" outside diameter, 2 in
" length, 12 ft. 2 1/2 in.
Grate area, 20 sq. ft.
Boiler feed, two No. 9 Monitor injectors
" 11 x 10 in.

Weight ready for service, 72,000 lbs.
Wheels, number, 10
" diameter, 45 1/2 in.
" kind, steel tire.
Kind of tender frame, steel slabs.
Tank capacity water, 2,500 imperial gallons.
All wheel centers, both on engine and tender, are of wrought iron, the counter-weights being forged in the drivers.
Order was received at the works October 5th, and the first engine was completed eight weeks later. Considering that some of the material had to be ordered from Europe, this is a very creditable performance indeed.

and the matter was under consideration. The general superintendent, who had the deciding voice, was considering prices. The quotations of first-class firms were surprisingly low, but even these were not as a maker of decidedly inferior tools were examined, and the decision was rendered that the tools at that price were good enough for these times.

The selecting of tools for a machine shop or for a planing mill is nearly as serious a matter as the selecting of a wife, for they are likely to be with a man all his lifetime. Every tool of this kind ought to be strong, durable, and sufficiently accurate to turn out good work. If it does not possess these attributes, it is an unsatisfactory article from the first day it is converted with the Ten per cent. difference in the price of a good tool and of one not likely to prove satisfactory ought to cut no figure in the selection of the best. Private concerns and manufacturers who have to meet competition are aware that they cannot afford to use inferior tools, and railroad managers ought to understand that their company's interests are perverted when tools are purchased that will keep the expense of production at a high figure.

If the men who decide on the quality of tools to be purchased for railroad shops

rich to stand the drain of all its shops equipped with the cheapest tools in the market.

Wanted, Facts.

A particularly bright engine-house foreman, who is of most observing habits and full of ingenious ideas about his business, was asked to give the readers of *Locomotive Engineering* the benefit of his experience and observation by writing some articles for the paper. He tried to escape by pleading that he knew little about grammar, was a poor speller, and was ignorant of the rules of composition. As there are other men, running over with information that would be valuable and interesting to our readers, who print the flowers of their knowledge to bluish ink because grammar and spelling are stumbling-blocks between them and the light of day, we want to say that we are always ready to trim the grammar and spelling if people will send us *Facts* worth publishing. Several of our most admired correspondents display extreme independence concerning orthography and syntax, but that does not restrict their ideas on railroad rolling stock, and their articles are always readable and duly paid for. What we want is the writing to be plain enough

couple of cars, disabling the train struck but not the train or engine doing the striking. The "hog" was "in the hitching" and wide open, and commenced to back up her train. The crew having "hit the grit" there was no one to stop her, and she was soon sailing down on the up track, and met engine "300." President Wilbur's special engine, with her train. She "hit the band wagon" (as a striker described it) and tumbled up the rear car of her train and the "300," but did not derail anything. Then she kept on backing, with her captured special added, until they met the fourth train and smashed into that. Having crippled four trains within fifteen minutes, and being low on steam the "hog" took a rest to get a better hold—and a new canal boat engineer to run her.

Valentine & Co have recently completed additions to their storage room for varnish at their factories in Brooklyn. The new tank room has a capacity of 145,000 gallons, and the two old ones 70,000, giving storage room of 219,000 gallons at the works alone, exclusive of the storage capacity of the many agencies and the stock in the factory proper. Varnish, like other popular and slippery liquids, improves with age, and anyone would think this supply would give some of it a chance

* Diseases of the Air Brake System;

By PAUL SYNNESTVEDT.

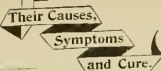

In submitting the following work to the railroad public it is proper that the author should begin with a few words of explanation.

I do not wish, like many authors, to apologize for what I have done, and I do not wish to belittle my own exertions, for the preparation of the work has cost considerable labor, but I do wish to ask the

Eight-Inch Westinghouse Pump—Plate 2.

The disorders that arise in this pump may be classed under two general heads:—
 1st. Trouble in the upper or steam cylinder.
 2d. Trouble in the lower or air cylinder. The parts in the upper cylinder most liable to derangement are the main-valve (7), reversing piston (23), reversing valve (16), reversing-valve stem (17), and the reversing-valve plate (18).

MAIN VALVE.

If the main valve (7), the packing rings (12 and 9) become worn so as to cause quite a blow into the exhaust, in which case they must be taken out and new ones fitted.

When this is done, the bushings (15 and 20) should be carefully calipered and replaced with new ones, if they are worn out of true (larger diam-

REVERSING PISTON (23). The reversing piston is generally the first thing to require attention in case the pump stops. This is due largely to the fact that when a pump is run short of oil, the reversing piston gets scarcely any on account of its location, the oil tending downward rather than upward. The rings (24) when they are loose or worn so as to open wide at the joint should be replaced, as also the bushing, if it is out of true or worn large in the opening through which the rod works.

Often the rod breaks off just at the point where it joins the piston head. This will render the pump liable to frequent stoppage, due to the head being without a guide, traveling so far upward as to partially close the upper ports, or tilting over so as to catch.

Rapping the pump lightly on the top of the outer cap will often start it by jarring the reversing piston head down into place. It may here be noted that a pump that requires frequent rapping to keep it going is in need of overhauling.

REVERSING VALVE (16) AND STEM (17).

The reversing valve itself does not give so much trouble as the spindle or stem (17) which operates it. If the valve seat becomes badly worn, a new valve should be substituted and it should be a pretty close fit inside of the bushing. Any derangement of the reversing valve or spindle generally results in an erratic stroke of the pump, jumping, or "juggling," or half stroke, caused by its reversing at a wrong time. The spindle should fit snug-

generally wears the most rapidly, and must not be overlooked in making an examination. If the reversing rod gets bent slightly it may run against the plate hard enough to cause the pump to reverse at the wrong time.

Straightening the rod is of course all that is necessary to remedy this. In putting the top head on after repairing, the copper gasket should be examined to see that it does not cover the small port through which steam goes to the reversing valve cavity in the top head.

LOWER OR AIR CYLINDER.

The parts in the lower or air cylinder most liable to derangement are the air-valves (30, 31, 32 and 33). They become worn so as to lift too far, which will result in the pump pounding. They must be re-ground on top filed down just enough to give them the right amount of lift.

Authorities differ slightly as to what this should be. Some say about 1/16 of an inch. The discharge-valves (50 and 51) should not have as much lift as the receiving-valves (31 and 33).

Sometimes the valve-chamber bushings (43 and 34) become worn so badly where the valves seat that they must be replaced.

Occasionally one of the air-valves gets broken. Any difficulty with these valves can generally be detected by careful examination of the suction of the air at the inlet ports. If the air blows back at the beginning of the stroke, the receiving-valve does not seat properly. If the suction is

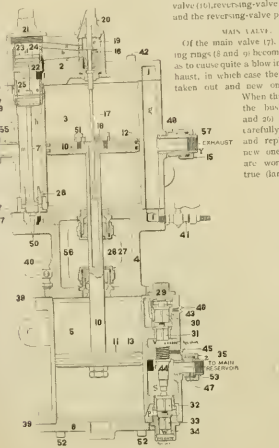

WESTINGHOUSE EIGHT-INCH PUMP—PLATE 2.

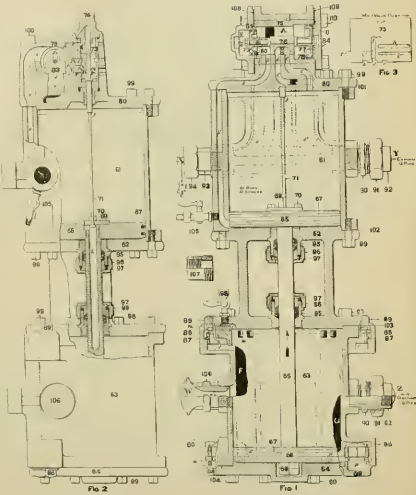

NINE-AND-ONE-HALF-INCH WESTINGHOUSE PUMP—PLATE 3.

indulgence of critical readers, submitting it as a truth, self-evident, that no man's work is infallible, and acknowledging in all humility that many air-brake doctors, some of them in their lines more competent than I, may find fault with many of the prescriptions that I have written.

In spite of all this, however, I am not without hope that my work, incomplete and imperfect though it may be, will, in a measure at least, supply a long felt want.

To those desirous of becoming good air-brake "doctors," I would say: Always use your REASON first and your HANDS afterward.

Never try to fix more than one thing at a time.

Never take anything to pieces without having some reason for doing it.

Treat your case just as a doctor does his patient, first finding out the nature and cause of the disease, and then prescribing and applying the remedy.

The time that can be saved and the vexation that can be avoided by pursuing this course will atonish any one willing to give it a fair trial.

eter in the middle than at the ends)

Quite frequently the small nut on the top of the main valve works loose and comes off, sometimes causing stoppage of the pump. This may require removal of the valve-rod. The nut should be made to go on hard, and should be riveted fast when screwed down.

If the small stop-pin (50) gets broken or worn too short, the pump will stop because of the main-valve traveling down so far as to allow the lower small packing ring to expand below the bushing and catch.

Although a little thing to repair in itself, it requires considerable work and much care. Some have done it without taking the pump apart by forcibly pulling out the main-valve, drilling out the stub of the pin (50) and inserting a new one from above by means of a stick with a socket in the end. This forcible removal of the main valve will generally break the small ring or spindle, or both, and necessitate their replacement.

ly, both where it passes through the bushing and at its bearing in the top cap. If badly worn in either place, the spindle and often the cap and bushing, also, should be replaced with new ones. Another place very liable to excessive wear is where the spindle is struck by the reversing plate (18), and the shoulder and button on the spindle, and both sides of the plate should be carefully examined, especially if a pump pounds badly. The under side of the plate

very weak, either the discharge-valve is not seating properly or else the packing ring (13) in the main piston head is blowing. The latter difficulty, which is very common, can be detected by taking off the lower head and working the pump very slowly, holding a light under the piston head.

These rings (13), as also those in the steam cylinder (12), not infrequently require renewal.

REBORING CYLINDERS.

Of course, when either the upper or lower cylinder becomes badly worn, it is re-bored. Putting new rings into a cylinder which is unevenly worn does not do very much good.

Another trouble that has been found in the lower cylinder is the working loose of the nut (58) that holds the piston-head on the rod. This will result in stopping the lower head before the piston has traveled far enough to reverse or it will cause the piston-rod to wear into the head, constantly aggravating the difficulty. One case came under the writer's notice in which the rod had punched its way entirely through the head.

SYMPTOMS.

In general, the various disorders of the pump of most common occurrence are:

- "Stoppage" (complete) Cannot be remedied by rapping or coaxing.
- "Stoppage" (temporary or occasional) Pump can generally be started by rapping.
- "Pounding."
- "Heating."
- "Jiggling" or "Fluttering."

Unequal stroke (fast on one stroke, slow on the other).

Fairly rapid stroke, but low effective capacity (pumps little air).

"STOPPAGE" COMPLETE.

This may be due to the stop-pin (50) being broken (see page 7); the small nut on top of the main valve being loose (see page 7); the small port to the reversing-valve chamber being obstructed (see page 31); or the nut (58) working loose.

"STOPPAGE" (TEMPORARY OR OCCASIONAL).

This may be due to lack of oil in the steam valves, especially the reversing-piston (23), broken reversing piston-rod (see page 9), loose nut on top of steam-valve (see page 7); badly worn packing-rings in main steam-valve, or reversing-piston; or sometimes excessive wear of the reversing-valve plate (18), (see page 9).

"POUNING."

Pounding may be due to any one of a great variety of causes.

It may be a pounding of the steam-valves, air-valves, or main piston itself. Anything which will allow the main piston to strike either cylinder-head before the pump reverses will cause a heavy "pound." This may result from too tightly fitted steam-valves or rings, or rings too loose, either causing sluggish motion in the reverse movement, dryness in the steam-cylinder-valves, badly worn reversing-valve plate or stem, or too long a reversing-valve stem.

A pump may also pound if the air-valves have too much lift. This can generally be detected by a careful examination of the suction ports, to see whether the air is drawn in properly at the very beginning of the stroke.

"HEATING."

This most frequently results either from dirt or gum in the discharge passages or too much clearance of the piston in the air-cylinder. Of course, if a pump is run full speed for a long time it is sure to heat more or less, one inevitable consequence of compressing air being the accumulation of heat. This is a matter of great importance, prevention is worth a pound of cure. If a pump gets very hot it must be practically stopped and allowed to cool before much can be done to it. If notice is taken of it before it reaches what might be called the "explosive" point, a slight reduction in speed with a very little good valve oil in the air-cylinder may save further trouble.

Many have asked the writer if water should be used to cool it.

There certainly can be no serious objection to this provided the pump be stopped before the water is poured on, so that it will not seep into the cylinder. All oil-sealitic air-compressors used in mines or similar service are "water jacketed."

A pump that has been "dosed" for

some time with too much oil in the lower cylinder is almost sure to heat, simply because the air-discharge passages become clogged with gum.

"JIGGLING" OR "FLUTTERING."

This term is used to designate a kind of jumping or short, catching stroke, and is almost always due to some trouble in the reversing-valve or stem. (See page 9).

"GROANING."

This may be said to indicate lack of oil, yet it has been noted by many men that the pumps that have been getting the largest quantities in the air cylinder are most liable to make this noise.

This fact is hard to explain. The writer will only say that a "groaning" pump is frequently helped by thorough cleaning of the air cylinder and careful use of oil thereafter.

long enough to enable any one to write a very complete account of the disorders to which it is subject, and a few remarks concerning it will suffice at present.

All the valve motion for the steam cylinder is in the top head, so that in the case of any failure to work properly a new head can be substituted until the old one can be fixed. There are a number of points in which this pump is similar to the 8-inch pump, and in which it will be liable to the same troubles.

It has the same arrangement of hollow piston-rod, reversing stem and valve, and a similar bushing in which this valve works, and as these parts perform practically the same function in this pump that they do in the other, any irregularity in their action will produce practically the same effect. If the reversing-valve stem

they are fitted, and the bushing in which the valve works, will also wear so as to require renewal, but I have not heard of any of these pumps which have been in service long enough yet to make such treatment necessary.

New York Duplex Pump—Plate 4.

The duplex pump not having been in service as long as the Westinghouse 8-inch pump, it is hard to find men well enough acquainted with it to say just what are its weakest points. The point on which the writer found the most complaint was a noticeable tendency to leak, especially in a case of any carelessness in regulating the quality or quantity of its oil supply. "An ounce of prevention is worth a pound of cure," is a saying that is even more applicable to this pump than any of the others in avoiding trouble from heat.

Of course, the main pistons and their packing rings in this pump will wear the same as in any pump, and after a long period of service the cylinders will become worn out of true and require re-boring.

This state of affairs will manifest itself by a blow at the steam exhaust or a noticeable reduction in the efficiency of the pump without any apparent reduction in speed of stroke. There will also be an aggravation of the tendency to heat, due to a part of the air being churned back and forth by the packing rings. Let us repeat here what was intimated before in treating of the other pumps, that nothing will cause a pump to heat so badly as leaky packing rings or too much clearance in the air cylinder. If there is practically no air left in the cylinder at the end of each stroke so an entirely new supply may be drawn in each time from the atmosphere there will be little trouble from heating.

If this pump begins to pound very badly the reversing valves (1 and 6), stems (7 and 8), and plates (20) must be carefully examined to see if they are worn in any part, and new ones should be substituted if necessary. The points where this wear is greatest are the shoulder and button on the stem and the plate itself.

The Pennsylvania Railroad people some years ago began putting the sandboxes for locomotives under the running boards, the idea being that there would be less obstruction to the view of the engineer on curves than there was with the sandbox on the boiler. The thing has not worked well, however, and it is likely that in future sandboxes will be put on the boiler. The difficulty that brings about the change is dampness, and the sand forming into a solid core in the bottom of the tapered boxes. A curious thing has been discovered in connection with the sand getting wet in sandboxes. It was found that the sand in wrought-iron boxes was nearly always damp, while that in cast-iron boxes was seldom in that undesirable condition. Wrought-iron and pressed steel sandboxes were coming rapidly into use, but there was so much trouble with damp sand in them that they are being abandoned and the rejected cast-iron substituted.

There has been some talk about an absurd movement on the part of a combination hotel keepers in Chicago to sue the railroad companies for not reducing their fares earlier in the season, so that more people would have been able to visit the World's Fair. From what we saw of the Chicago hotels early in the season we think that the suit ought to be in the other direction. The general capacity displayed by the Chicago hotel keepers when the Fair was first opened no doubt prevented thousands of people from visiting Chicago who intended to go. The belief became wide spread that Chicago hotel keepers were going to rob tourists, and it was only when the small volume of strangers kept nearly hotels empty that prices were made really reasonable.

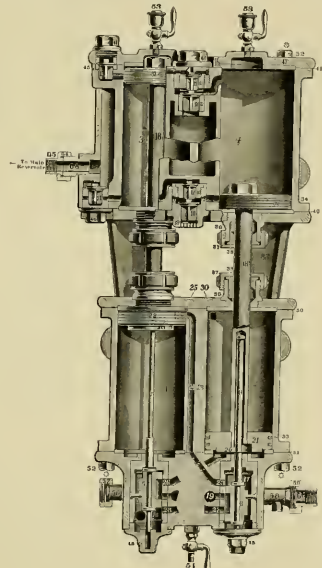

NEW YORK DUPLEX PUMP—PLATE 4.

"UNEQUAL STROKE."

This is generally caused by unequal lift of the air discharge-valves (30 and 32). If the up stroke is slower than the down stroke valve (30), has less lift than valve (32) and vice-versa.

"FAIRLY RAPID STROKE, BUT LOW EFFECTIVE CAPACITY."

This trouble is always found in the air-cylinder. Either the valves do not seat properly, the piston has too much clearance, the rings (13) leak, or the cylinder is worn out of true. (See page 11).

Nine-and-a-Half-Inch Westinghouse Pump—Plate 3.

The latest design of pump furnished by the Westinghouse Company is shown in Plate 3. It has not yet been in service

is too long between the shoulder and button the pump will pound and may not be prompt in reversing, and the same thing will occur after the reversing-valve plate or this shoulder or stem become badly worn. If the distance between the shoulder and button be too small the pump will have too much clearance and will heat in consequence.

An unequal stroke will result in case the lift of the upper and lower air-valves wears unevenly.

"Jiggling," or short imperfect stroke, will result in case any wear or unevenness causes a movement of the reversing-valve (73) at any point other than the limit of stroke, when the shoulder or button of the stem is struck by the reversing-valve plate.

Of course, the small packing rings in the two heads of the differential pump will wear out in course of time and will then have to be renewed. The grooves in which

Engine Failures on the Union Pacific Railroad.

Some Interesting Figures from a System where a Delay of Five Minutes is Charged as an Engine Failure.

A great deal of interest has been manifested lately in the subject of "engine failures," and there is likely to be considerable good done by the agitation in the way of reducing failures. But one of the first things to settle in this connection is the question, "What is an engine failure?"

In the November issue of the *American Engineer and Railroad Journal*, Mr. M. N. Torney publishes a table of engine failures on a large road (not named) having upward of a thousand locomotives.

This table is so good so far as it goes, but it does not go far enough.

An engine failure is properly any defect of any part of the engine or tender that delays a train, and such defects may properly be put into three classes, as follows:

1. Failures of machinery
2. Not steaming
3. Running hot

The road named classed only with the first of these, and if the second and third were included the totals would be greatly increased.

The Union Pacific makes a sort of penalty of engine failures, and we do so, in order to get a report from that road, and to be able to give our readers the benefit of it.

On this road any delay of five minutes to a train is called an engine failure, even if a hose under a coach bursts.

All delays of five minutes or more are reported to the general manager by the superintendent of car service, these are charged up as engine failures, and the superintendent of motive power is notified of all the engine failures of the day.

Each failure is noted on a separate blank, provided for that purpose, and sent to the division master mechanics, in charge of the engine that failed and he investigates. A special blank is provided for a manager's report, every minute lost is noted down, and the place designated and the cause given. Thus each case is followed up and delays are reduced to a minimum, by getting at and remedying the cause.

To those who are not familiar with the topography of the road on this engine, we will say that they have grades in the narrow gauge system of 25 feet to the mile. On the broad gauge system the longest grade is from Cheyenne to Sherman, a distance of thirty-four miles, where the average grade is 30 feet to the mile. In other divisions the grades run as high as 145 feet to the mile. From Evanston to Ogden, distance seventy-five miles, there is a difference in the altitude of 3,000 feet, the maximum grade being 40 feet to the mile.

The largest number of failures, occurs on the division in Wyoming, the fact that division they have the heaviest grade and very bad water. On the district between Rawlins and Green River, a distance of 137 miles, the water is of such a character that the engines have to be washed out at each end of the trip, and cannot make but 120 miles without having the boiler washed. All failures of engines being included in this report.

They have in service 95 consolidation engines, 127 10-wheeled engines, with 103 24-inch cylinders, 132 10-wheeled engines, with 18 24-inch cylinders, 235 8-wheeled engines with 18 24-inch cylinders, 151 8-wheeled engines with 17 24-inch cylinders, and 87 8-wheeled engines with less than 17-inch cylinders. There are a number of 6-wheeled switchers, and some odd sized engines and 82 narrow gauge engines, making a total of 1,029 locomotives on the system.

The number of engines in daily service on passenger and freight amounts to from 600 to 700 engines per day, and during the twelve months ending November 1, 1893,

the number of engines making trips was 231,834, with a total of 4,768 failures, or less than three-quarters of one per cent. Of this number 386 were passenger failures and 1,102 freight failures. Number of engines making trips on passenger during the month 333, delayed trains on account of failure to steam, 1,159 from machinery failures, and 232 by running hot.

The mileage made by passenger engines for the twelve months was 5,202,000, and freight engines, 15,600,000, making a total of 24,000,000 miles in the twelve months. This does not include mileage made by switch engines or engines in work-train service.

We have before us the twelve monthly

statements, and the report of cause goes to the superintendent of motive power—the man that applies the remedy, if he can find it. A record is made, and then all the papers in the case are filed together, and form a history of every failure.

It is remarkable how much this kind of a record keeps down petty failures. Men try not to go on record with a failure.

When you come to send out between six and seven hundred engines a day for a year, a total of 231,834 trips, making an annual mileage of 24,000,000 miles, with less than three-fourths of one per cent. of engine failure, where they count everything a failure, it is a record to be proud of.

Car Construction and Collisions.

The trouble in getting up devices for insuring safety in collision is that when we get into a collision the things never behave the way that we figure on. We can build a car with a bottom of solid steel, it will make a nice, heavy battering-ram when it happens to get above the platform of the car ahead of it and the car ahead stops

suddenly—it will go right through. You can build the sides of solid steel, if the two cars happen to get a little six inches out of the line they are going into each other, and the heavier you make them in cases of that kind the further they will go. Now, any one who has observed the telescoping of cars, has found that it is not the floors and the sills, and very often it is not the sides that give way. It is the ends; and those cars, instead of keeping in line with each other as we figure on and build them to do, get a little to one side and in the end, and clear out the whole inside of the car. Any one who has had a few years' experience on a railroad knows that I have seen cars telescoped with the platform almost intact. How the other car got up there I don't know, but it got there,

UNION PACIFIC SYSTEM.

Comparative Statement by Divisions of Delays to Trains caused by Engine Failures, as Reported by Supt. Car Service to General Manager.

Month of January, 1893.

PASSENGER TRAINS.

DIVISION	No. of Engines in Daily Service	No. of Engines in Serv. during mo. ending Jan. 1, 1893	STATEMENT OF FAILURES				TOTALS	P-CENTAGE OF FAILURES
			Not Steaming	Machinery Failures	Running Hot	Total		
Nebraska	44	1,394	1 1/2	7	11	19	34	
Wyoming	26	866	1 1/2	3	2	10	32	
Kansas	17	527	1 1/2	3	3	7	13	
Colorado	21	651	2	0	0	2	4	
Idaho	27	937	0	2	0	2	4	
Utah	30	110	0	3	1	4	7	
Pacific	18	558	1	0	0	1	4	
Fort Worth	7	217	1	0	0	1	4	
TOTALS	179	6,270	1 1/2	8	19	55	100	

FREIGHT TRAINS.

DIVISION	No. of Engines in Daily Service	No. of Engines in Serv. during mo. ending Jan. 1, 1893	STATEMENT OF FAILURES				TOTALS	P-CENTAGE OF FAILURES
			Not Steaming	Machinery Failures	Running Hot	Total		
Nebraska	54	1,664	2 1/2	7	2	11	24	
Wyoming	110	3,410	1 1/2	4	2	7	19	
Kansas	60	1,866	0	9	0	9	27	
Colorado	107	3,007	0	14	2	16	30	
Idaho	121	2,611	0	4	1	5	4	
Utah	14	434	1 1/2	0	0	1 1/2	11	
Pacific	74	2,192	1 1/2	5	0	6 1/2	11	
Fort Worth	20	920	1 1/2	2	4	6	5	
TOTALS	630	16,430	1 1/2	18	105	131	100	

PERCENTAGES.

	Passenger		Freight	
	Not Steaming	Machinery Failures	Not Steaming	Machinery Failures
Running Hot	14%	5%	14%	6%
TOTALS	100	100	100	100

J. H. McCONNELL,
Supt. M. P. & M. Machinery

Ogden, February 20, 1893.

statements, from November, 1892, to November, 1893, and select no as a sample in its summary shows the responsible officer at a glance where he is having the most engine failures, what proportion of the engine service it amounts to, whether freight or passenger, and what is giving trouble; this means can be supplied to remedy defects.

It is shown that here, as everywhere else, breakage to machinery causes most of the engine delays; and that trouble from this cause is not greater when the diversified styles, kinds, makes and ages of engines is taken into consideration, is a wonder.

It is plainly shown that speed has much to do with engines running hot, for the percentage of "hots" on passenger engines is three times as great as on freights, while trouble from "not steaming" seems to be about equal on both branches of the service.

The U. P. system of tracing and keeping a record of engine failures is to be commended. In the first place, there is no lying of train or engine men. The con-

ductor does not "cook up" a reason for delay—"not steaming" being the easiest. Any delay to a train of five minutes is reported to the superintendent of car service, who daily reports to the general manager the engine failures—on what division they occurred, when, what train and what engine.

The general manager sends to the superintendent of motive power an inquiry blank, giving the delays to all engines for the day. The superintendent of motive power sends a special inquiry blank to the division master mechanic who gets a written report from the engineer.

If the trouble is something the division master mechanic can rectify, so much the better, but he adds any information he

and I am inclined to think that the excessive weight of cars is a greater threat of danger to us to-day, in the matter of collisions, than almost anything else.

"Now, instead of looking at a train, the track, the engine and all the cars, as a machine, and designing the different parts of the proper strength, what do we do? One party makes the track, another makes the locomotive, another makes the coaches in the front of the train, another makes the sleeping-cars in the rear of the train, and taking the whole thing, I do not believe we could get up a better machine for killing people in case of collision than what we have now. It is really a fact, and until we take the whole thing into consideration and work out the thing as a whole, I do not believe that we will make any improvement. We may patch plate-steel on here and there and brace it up, and so on, but we will never get a reasonable freedom from telescoping and difficulty of that kind in collision, until we take the thing as a whole and work it up in that way."

The above remarks were made by Mr

J. N. Barr at a meeting of the Western Railway Club. The purpose of the remarks is to raise objection to the introduction of steel in car construction. In doing so, we are afraid that our friend Mr. Barr has taken an untenable position. It is all right to hold that the strengthening of the train should be taken up as a whole, but the difficulty is that the different interests that take a part in building the cars for a through train cannot be prevailed upon to weaken either for common good.

This being the case, it becomes the duty of the individual railroads to strengthen their own cars so that the people they carry will not be crushed in any accident that may happen.

It is perfectly true that a heavy, strong car will act as a battering-ram upon weaker ones, but that is no argument against the sound principle that a strong car is safer for travelers than a weak one, and that there is no material too strong for car construction. The same argument there employed applied with much stronger force in the days of cross framing, light platforms and loose couplers. The companies owning cars of this character objected to the use of the Miller platform on the grounds that it would crush through the weaker cars, but the battering-ram platform forced its way into favor, and the vicious forms of construction which brought forth weak cars had to go out. In Europe, where the Pullman cars are liable to crush the weaker compartment cars in collision like eggs, it is had for the weak cars to have Pullmans beside them, but travelers are not exclaiming, "Banish the battering-ram cars!" They are demanding day cars as strong as the Pullmans.

We suspect that the progress towards the use of steel in car construction will not be retarded by any fear that in case of accident the steel structures will crush those of wood. In the early days of railroading in this country, when passenger cars were structurally weak, the most disastrous accidents were due to the crushing of the cars. This source of danger has been materially eliminated by improvements in car construction, but the car is yet by no means perfect in this respect, especially at the high speeds becoming common. When trains are run at a very high speed it is inevitable that they will occasionally be brought to a sudden stop by striking unexpected obstructions. When this happens the strength of the car must be relied upon to save the lives of the people inside. Steel cars of a given weight will resist severe shocks much more successfully than those of wood; and this is a good reason for the introduction of steel in car construction. Patching the ends with plates of steel, and binding the framing with the same strong material, have already made car ends stand shocks with impunity, which would have bent a given weight of wood. We feel certain that the teaching of experience is in favor of the strong material.

An Old-Time Broad Gauge Mill.

The ancient and honorable citizen whose portrait is here shown was a famous engineer for speed on the old Hackensack & New York road, now a part of the New Jersey & New York.

The "Hackensack" was built by the Rogers Locomotive and Machine Works in 1850, and for many years hauled passenger trains, until ruled off the course by the narrowing up of the line. Her principal dimensions were:

- Range of road, 6 ft.
- Fuel, bituminous coal.
- Cylinders, 2 x 10 in.
- Diameter of driving-wheels, 5 ft.
- " of truck-wheels, 36 in.
- Style of boiler, wagon top.
- Diameter of boiler, 24 in.

Firebox fitted with combustion chamber 24 in long. Smokestack had a "variable cone" operated by levers from cab, as shown. The engine was fitted with Loughridge air-brake. Her eccentrics were 20

the axle, between the firebox and the driving-box.

Taken altogether, the "Hackensack" was a queer-looking passenger locomotive to be built for service as short a time ago as 1850.

Doctor Skeever's Sure Cure for Throttle Fever—Shake Well Before Taking.

Jim Skeevers don't always confine his object lessons to the firemen, sometimes he works one up on other engineers, the foreman, the master mechanic, or the superintendent, and he has been known to illustrate a point to the fourth vice-president.

One of Skeever's object lessons converted an intolerable nuisance of a roundhouse foreman into a reasonable human being, and if there is anything in the doctrine of perdition, saved the souls of a lot

half on account of the reduction of shop force and a 10 per cent. encourager for shopmen to do as little as possible.

Skeevers don't kick much, as a rule, but when he reported, "Right check ground in and cylinder packing down on the right side," trip before last, he felt sure the engine couldn't do her work much longer without it; but when Davidson told him he "ort to hear Jim Bishop's engine blow," and that "Baldy Bates' fireman got out on the running board with a pail of water and the coal pick every time he shut off the injector," Skeevers said that he hadn't noticed it, and perhaps the "618" was all right after all, but she needed washing out awful bad, anyhow.

Davidson laughed. "Lord," said he, "Dave Keller's had the '66' on the express for four months without washing. Dave is a good man with an ingen, you know," he added parenthetically, "ma-

chine Davidson followed him around and Skeevers" jollied" him a little.

"Been runnin' you pretty hard lately, 'aint they, Skeevers?"

"Well, yes, tolerable, but then, you know, we get paid for it. I got in fifty-one days last month."

"Fifty-one, four times fifty-one, by George that's \$204! The old man only gets \$150."

"Yes, but he's just a master mechanic, you know," said Skeevers in a pitying voice which made Davidson's \$204 seem meanly and small. "Pete gets almost as much as that. I've often wondered why you didn't go out ravin'—a man like you 'ort to be makin' decent pay—the idea of bein' tied down to a roundhouse is hard lines. Runnin' is pleasanter, better paid and less responsibility, and knowin' as much about engines as you do 'ort to get a great reputation on the road, some of

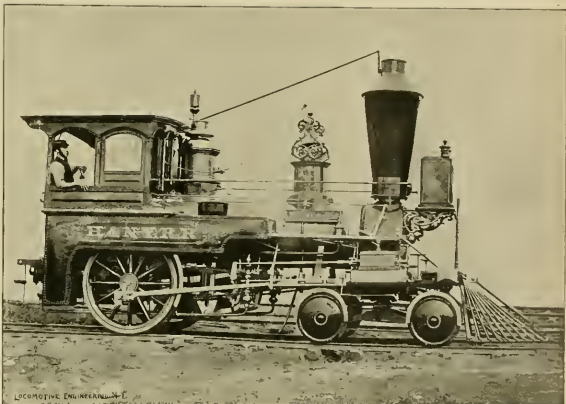

THE "HACKENSACK"—AN OLD-TIME BROAD GAUGE MILL.

of men who were before prone to blasphemize every time they talked to the here-before mentioned foreman.

This foreman was one of those restful mortals who make you feel satisfied with your lot, when you kick about cylinder packing that blows, valves that leak, or rods that pound, by telling you how much worse some other fellow's is—this helps yours.

He was one of the kind that sneers at everything the engineers do on the road in an emergency, and tell what they ought to have done.

The kind that kick about giving orders for the little engine supplies as if he had to pay for 'em.

The kind that scratches off all the work put on the book if he does a little of it.

One of the kind who believe in "good enough" jobs.

One of the kind who always wanting to get out on the road to run—and has never done any running, or firing, or either.

Skeevers laid for Davidson for over a year, and finally got him. Davidson had been wanting to ride over the road with Skeevers the first Sunday that he went out in the morning. So he got him alone last Sunday. Skeevers was marked up for an extra freight at \$40.

Skeevers' engine had been double-worked all summer, on account of World's Fair business, and running repairs were cut down half on account of the engine being out most of the time, and another

chinent runner, too; he doesn't shut off on the road at all, just ran her on froth—soda water."

Skeevers was glad he was going to get that extra Sunday morning. It would surely be empty coal cars—about two more, but the engine ought to have. He knew the road would be crowded with trains—there's no God on the railroads.

He knew Davidson would go out with him—and Skeevers smiled.

Skeevers called on the train dispatcher who would be on duty the next day, talked a few minutes, and—they laughed. Skeevers hunted up Billy Woods, his conductor, they had a cigar, chatted a few minutes, then, well—they laughed real loud.

Davidson came down the next morning smiling—to have a holiday. Skeevers got around later, got into his overclothes and commenced to oil around. Billy Woods came by and gave them both a cigar, remarking to Skeevers that they were going to be four loads short of a full train (they had three too many), and that the "618" would just play with the train—sure to have a nice easy trip.

Pete Doyle had a cushion on his seat for the foreman, and let him have the window all to himself and be right in his way—Pete knew it wouldn't last all the trip or he had lacked lazily, and who could blame him.

As Skeevers dropped a little 13 cent oil on the well worn bearings of his en-

gine that's not do about preaching," Skeevers knew he tickled the governor in the right place there.

"Well I sh'd say so. Why Gies come in last night with the piston blocked wrong and the—"

"Here's your orders Skeevers," said the conductor, and holding up one, read

"Run to Junction City extra. Trains 21 and 107 are abandoned. Don't pass Hope without orders. You may use fifty minutes on the time of No. 8, Cole conductor. Meet light engine, Smiles, east at Preston."

Skeevers and Davidson swung up into the cab, and, after comparing time with the conductor, the 618 commenced to cough and wheeze getting the train started. The packing in the right hand cylinder roared lustily and, though Skeevers was used to it, he cocked his ear and pretended to listen—Davidson listened too.

"When did you clean her nozzles, Skeevers?"

"Yesterday."

"Got a funny sound in one, guess the tip is loose on the stand."

"Nozzles be damned," said Pete Doyle, "that's one ave the jobs Skeevers has asked youse for the don't these many times, every turn ave her wheels mean a shoveful of coal or mesel to sling. I never heard cylinder packin' blow the equal ave that."

"That ain't her packin', is it Skeevers?"

"Yes, but that's nothing—you o'rt to hear it blow on Jim Bishop's engine!"

"Then he whistled for a road crossing to keep Davidson from answering.

They were not ten miles from home when they had to stop for hot pin on the left side.

"Maybe you've got her keyed too tight," suggested Davidson.

"No, it's the main rod and it pounds itself hot."

They looked at it, and, sure enough, it was awful loose on the pin. Davidson offered to file it right there, and promised to do it in ten minutes. Skeevers led him on, looked at his watch, and said if it could be done in fifteen it would be all right.

They had to cool the pin and strap, then take it down. Skeevers had a file, but no tools except the regulation set, and they had trouble in getting the strap off the rod and more trouble to get the back half of the brass out. Then there was no place to hold it and nothing to square the brasses by or with. Davidson had his store clothes greasy by this time, and was in a good sweat, hard at work, when the conductor came up and wanted to know why in 'he blankety-blank they didn't overhaul the engines in the shop, looked anxiously at his watch, ordered the head brakeman to run and flag No. 2 (which wasn't due for an hour), and made a howl in general.

When the main rod was up again they had not time to make the next town for No. 2, so they backed up and headed in. When they got to the next telegraph station there was a three-minute delay, the hour and forty minutes' delay.

Skeevers wrote a bland explanatory message, and the reply came over the wire that whoever caused that delay would hear from *me* on Monday. This was signed by the superintendent, and it made Davidson very ill at ease.

The next twenty-eight miles was level or slightly down grade, and Skeevers seduced Davidson over to his side, and finally got him on his seat and hold of the throttle. This was all very nice for half an hour, and Davidson was getting a little confidence in himself. Skeevers went over on Pete's side and sat down, and in going had hooked the end door behind the new runner.

The "618" commenced to work water, and Skeevers remarked that she was full and the injector had better be shut off.

Davidson shut it off. The check stuck up, there was a growl, and in just one second the boiler of the "618" commenced to blow off through the overflow of that injector, and the new engineer was trying to get out of the side window. Skeevers was there and stopped him.

"It's the check stuck up," he yelled, "go out on the running board and pound it. I'll hand you a pail of water."

Davidson got a shower bath getting by that overflow, for he didn't think to shut it, and let her blow into the tank he'd thought of that in the shop.

When he was half way out to the check Pete pulled the whistle open, and he came back in a hurry and shut the throttle. Then Skeevers opened it as he handed out a pail of water. Davidson lodged back again, thinking it had worked open. Finally he hammered and cooled the check into taking its seat.

Davidson was wringing the water out of his vest and swearing, when Skeevers made it all right. He told him about Buddy Bates' engine, and how her check stuck.

Davidson made up his mind to get back on the fireman's side. But when he looked around for Skeevers, he was back on the first box car, with his legs hanging over the side talking to the brakeman, and Davidson had to "keep her a going."

Pete watched his chance, and when Davidson whistled he started the left hand injector it was level and easy for the next two hours' run, and Davidson never thought of the injector again.

Presently, Skeevers came over, and the first thing he asked was if the check stuck up again.

"No, ain't used it."

"How's your water?"

Davidson's face was ashy white in an instant, and his hand trembled as he reached for the lower gauge-cock; it reddened when he found water.

"Haven't you put any water in her for the last two hours?"

"Not a drop—she don't use much, does she?"

"Mister Skeevers," said Pete, "its mesel youse can thank for the watter. The boss av the roundhouse is hell on runnin' engines as is standin' still—if Pate Doyle hadn't put on his squirt, youse wud a had the mud ring melted against now."

Davidson tried the gauge-cocks every two minutes all the rest of the day.

When they stopped at Slocum for water, Skeevers found use for the salt hammer and asked Pete for it.

Pete looked all through the box and reported a drouth of soft hammers.

"Oh! It's there. I saw Davidson get it to pound that check."

"In course ye did, sorr, and he left it on the runnin' board and it's jiggled off entirely."

"And it's lost."

"Gone till the devil, an' it's himself as stid up an his hind legs and cursed me."

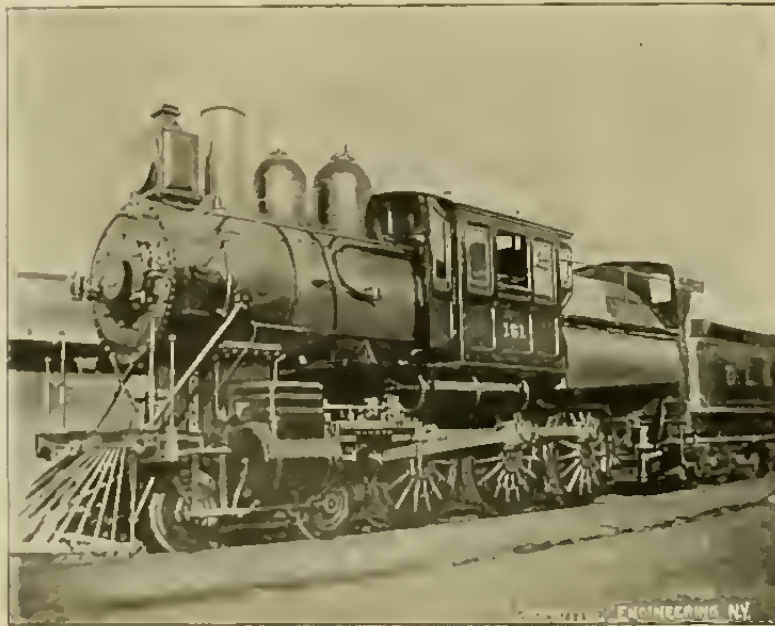

Hyd Coal Steer Bursler, D., L. & W. Ry.

Pate Doyle, for hem' that kerless as to drap off the last one. He sed he'd never give you nor me another salt hammer so long as the Lord left him wind to breed wid."

Davidson couldn't help hearing, but he laughed and said he'd give Pete an order for a new one.

Skeevers gave Davidson his orders, made him read them, and told him to go ahead—he was going back to the caboose.

Just as they struck Hope yard, Pete slyly let down the right tank valve, gave the lazy cock of his injector a quiet kick, and it broke. He told Davidson that his injector was "kicking up" and that he'd better start his own. Davidson tried. The more he tried, the more excited he got. Pete told him to unhook the door, and he would show him how to start it. This was humiliating. Of course it started all right for Pete.

They were sailing right through the little town, when, all at once the emergency went on (from the rear), and as Davidson pulled his head out of the front sash he looked back, and the conductor, Skeevers, and both brakemen were flopping their wings like windmills.

"Are ye tryin' to kill everybody, ye crazy loon?" yelled the front brakeman. "Gimme a red flag, quick, Pete."

Skeevers came over on a run, and pushing poor Davidson out of the way, backed the engine inside of the switch limits.

"What's up, for God's sake?" asked Davidson.

"Up? Why didn't you read them orders. 'Don't pass Hope without orders.' It's a sure discharge for going by a 'do not,' besides we might a had a collision."

Davidson got over on Pete's side, and Skeevers had to run her in, and they got along all right.

At the end of the road they got supper, and Skeevers proposed a walk around town before they went to bed; but the caller came for them before they could get away, and at nine o'clock the "618" was hooked onto a row of freight cars up in the big yard.

Skeevers got Davidson on his side to "learn him the yard," and with all the switch lights and switch engines dodging out and in, and the signals from three crews, the whistling and answering whistles, Davidson was a little muddled. Maybe Skeevers made some extra moves, got some extra signals, and done some extra whistling, but it all served to mystify Mr. Davidson, and to increase his respect for the engineer who understood it all and was so cool about it.

That night, going down, Davidson learned that he couldn't handle automatic air nearly so well on an engine and a grade as he could in the roundhouse.

He learned how pleasant it was to put

at once—and backed off a switch to boot.

He was down with a lantern looking at his "luck," all the switchmen were cursing the air blue, and the "618" was blowing off wildly when the conductor came down with an order for him to run engine "618" into the terminal, as Skeevers was wanted to run Carlton's engine west, Carlton was sick.

Davidson's heart was faint when he thought of the eighteen miles of down hill ahead of him, and that pesky automatic that he knew so well how to *tell* others to use, but could not seem to *shove* the how very successfully, besides that the "618" was off the track.

He was more at home getting her on than running her. He looked her over carefully and yelled up to Pete to bring the "blockin'."

"We ha'nt got no blockin'."

"Well, get out the jacks."

"They've all been took off, sorr."

"Say, neighbor," said the conductor, "do you think we've got time to raise this engine up on jacks. She's a blockin' the main line. Git up there, Pete, and when I say 'when,' give her the tit."

He ran around the engine, threw in a couple of links here and there, and—said the "when."

Pete pulled her open; there was a great fuss and wiggle and slip and shake—but she got on all O. K.

"That's the way to do business—on the road," said the con.

They got home at last. Davidson sent word to the roundhouse that he wasn't able to come down, and went to bed, but he asked that the "618" lay in and have work already reported done.

The next day as Skeevers was packing the throttle, a helper, working on the rods, struck Davidson for a job of firing.

"You're a fool, young feller," said Davidson, "why don't you finish your trade?"

"The firemen make more money than most of the machinists do. I've worked three years at it now, and that ought to help me about gettin' promoted."

"Well, they earn it. Why, confound it, man, they don't eat regular, nor sleep any to mention; and as for your machinist experience helpin' you, why, it ain't worth a damn. They ain't supposed to repair engines on the road, and any fireman on the division can give *me* points about fixing up a breakdown. Running an engine is a separate trade, sir, a separate business.

An engineer don't know much about putting in springs and facing valves; but don't think he don't know nuthin'. There's just as much difference between the machinist trade and engine-running as there is between diamond-cutting and sausage-stuffing. Why, I wouldn't run the best engine this company's got for fifty dollars a day. It takes a different kind of man from me or you either. You go on and line them guides, and thank the Lord you ain't gettin' four dollars a day on an engine, and earning twelve."

Some of the railroads in the West, where gravel and stone are scarce, have been ballasting their tracks with burnt clay, which is popularly called *gumbo*. This material costs nearly as much as broken stone and more than gravel, but it makes a very unsatisfactory ballast. It is very good when first put in, is clean, fairly free from dust and easily handled, but a few years' exposure to the weather brings it back to its original condition of clay. As soon as this material begins to disintegrate it lets the track-down badly, and is harder to keep up than gravel. A roadmaster who has had charge of a division where *gumbo* has been largely used said that the material did not stand up any better than prairie black earth.

The interests in the Wadley Continuous Drawbar Co. have been purchased by the Gould Coupler Co.

The Raub Locomotive Works and Farm Land Improvement Schemes.

Ever since we said something about the Raub locomotive, that was construed to infer that we did not believe that it was the coming locomotive, "the boys" have wanted to know "what sort of a lookin' critter is she anyway?" So here is a bird's-eye-view of the great American junk-shop on wheels.

(The picture shows her before her water tanks and coal scuttles were mounted and the other shows her complete and ready for the road—one can just imagine her crawling about here and Chicago at the moderate hustle of 100 miles an hour—in her mind.)

You see how the two small boilers are

of rivets of sizes varying from 14 to 17 inch. The rivets were driven in one assortment at 25 tons and in succession, the others at 33, 50, 66, 75 and 100 tons. The rivets in the last lot of plates were driven by hand. The pieces were then milled down through the center of the row of rivets and etched with acid. It was found that when the higher pressures were employed upon the smaller rivets that the sheet around the rivet was distorted. An examination of the condition of the plates and rivets showed just what pressure could be best applied to make the rivet fill the hole solidly, and at the same time not spring the sheet. The hand-riveting filled the holes very satisfactorily. On the larger rivets the pressure of 100 tons could be employed without doing any damage to

shop half the time. The English engines had small squeaking whistles, but the Rogers had a roarer that frightened the natives. You should have seen how they took to the woods when I opened that whistle. One day I passed a procession of mules with leather sacks of water on their backs. About the time I was opposite them I wanted to whistle and opened her out. For a minute the air was black with water bags. Peruvians, and mules' heels. When the dust cleared away the road looked like a battle-field, but every last mule was making for the timber.

"The superintendent paid no attention to the complaint made, but it struck him that he could use the Rogers' whistle elsewhere to good advantage. The natives were sleepy and lazy, and nothing could

away from the road, have many incompetent men on their trains and engines, and the public is afraid to ride over the road. The most of the men are out in the cold, without employment, and some of them without supporters. Several lessons have been learned, however, and these may, in the end, be worth the price paid. One of them shows to what ends an overbearing official may carry things. Another shows how useless and expensive a strike is, and forces home the question, "Isn't there some other way?" Another lesson well learned in this strike has been how useless was the combination known as "system federation." The lessons will be better ones to many of the men—and the Lehigh Valley Railroad are not anxious for another fight. The whole thing is to be deplored, take it from any standpoint you may.

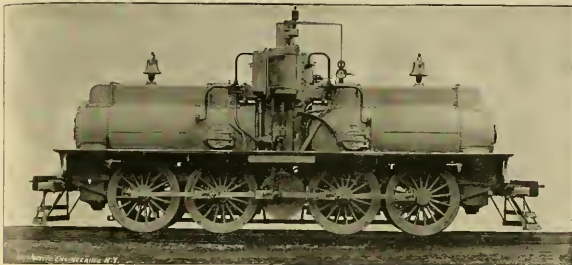

RAUB LOCOMOTIVE WITH TWO TASKS, CAR AND COAL BASKETS

led up and the engines located; how a smoke flue runs along the top of each boiler and forms a single stack in the center. How the four fire-doors are arranged, and, perhaps, have wondered how a man was going to fire the thing.

Words simply grate on the ear, a good look at the two pictures is enough.

Only one of these hybrid what-ods has been built, and that is hibernating in a shed at Paterson, N. J., and has been for a couple of years.

There are going to be several works built to turn out these locomotives, and all land and stock—mostly stock. The Raub people just sling building sites around loose. The last place to subscribe something like \$50,000 and donate land in order to get these works was Mayville, Cattaraugus Co., N. Y.

Some one, with no regard for the feelings of the Raub locomotive people, showed them a copy of *LOCATIVE ENGINEERING*, in which reference was made to their mechanical contraption, and we are told that the inventor and father of the central-power stock scheme stated that the reason we attacked his invention was that he at one time tried to get money from him for exploiting his device, but that he sternly refused to be blackmailed—hence these tears. All of which is just as true as the statement that his device is a locomotive capable of doing useful work. It might be worked as a siphon mill, but the greenest boy in Cattaraugus County wouldn't ever mistake it for a locomotive—not for a minute.

A Valuable Test of Hydraulic Riveting.

In the Baldwin Locomotive Works they have very powerful hydraulic riveting machinery. In using these riveters a question came up to the effect that the work or material might be injured by the pressure used being too great. To obtain some information on the subject, Mr. Vaucian made seven assortments of cuttings from steel sheets, 7/8-inch diameter, six pieces in each lot. These he drilled to take a row

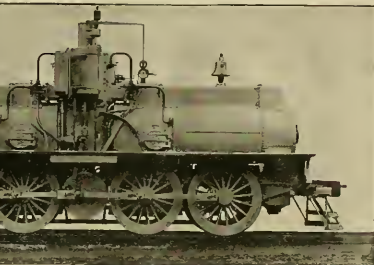

RAUB CENTRAL POWER LOCOMOTIVE COMPLETE

of sheets. At the same time the large rivets were driven so perfectly that scarce a line distinguished the juncture of rivet and sheet.

High Uses for Whistle and Bell.

"It is funny the uses the people of Peru find for some railroad appliances," remarked W. W. Thompson, at the last meeting of the Flat Wheel Club.

"When I first went to Peru I took a Rogers locomotive, the first American engine ever seen in that part of the country. They had nothing but English engines before that, and the Yankee, as they called my machine, excited amusement and prejudice. They all predicted that she would be knocked out in no time by the solid-looking English locomotives, but the knocking out was entirely the other way. She could pull the ends off the others and not feel the wrench besides, she worked along, day in and day out, without repairs, while the others were in the

rouse them in the morning. She would put the whistle in the shops and roused out the sleepers with it. It worked all right for a week or two, but the natives soon got so that they would slumber peacefully through the tune played by that whistle as they would under the notes of a guitar.

"The engine bell was a novelty and declared to be a useless nuisance. It was taken off and consigned to the storehouse. Its fame had, however, spread through the country, and many applications came in from churches for the donation of the bell. It was given to one of the most influential of the applicants, and was hung with imposing religious ceremonies. That Rogers bell is now the pride of the region, where it is daily heard calling sinners to prayer."

The Lehigh Valley strike has been settled. Both sides lost. The company has lost hundreds of thousands of dollars in machinery destroyed and business driven

in their own hands, as there was no law compelling the men to work on Sunday. He intimated that refusing to go out on Sunday would stop the practice.

The Government of New South Wales have been extremely liberal in providing transportation for politicians, but there is now a strong inclination to treat politicians as if they were made of common clay. A statement was made lately that the abolishing of special street cars and trains for assemblies would save the colony \$20,000 annually.

The Missouri, Kansas & Texas, the Boston & Albany, and other railroads that are using Miller's Asbestom roof for cars, pump very favorably concerning various good points possessed by the roof. The material is remarkably tough, it is easily applied, and the indications are that it will last during the entire life of a car. The roof is handled by Mr. H. R. Miller, Havemeyer Building, New York.

has been done in the making and selling of parts of patented devices by concerns which paid no attention whatever to the rights of the inventors. It ought to be distinctly understood by purchasing agents that they are running the risk of patting their companies into suits for damages when they order parts of patented articles from unauthorized makers.

If the inquiry is made it is generally found that the authorized manufacturer of a car copler or other patented article is prepared to sell the details as cheaply as the pirates can do it. The legitimate maker has a pride in seeing that the article is of good quality and well made, while the unauthorized maker cares for nothing but the production of a thing that looks like the real article and can be sold cheaply. The men who lead railroad companies into the invidious position of purchasing pirated goods are not worthy wile, even when the mean species of stealing is not found out, for they generally pay the same money for an inferior article as they would for one of the greatest sufferers from the pirating of parts of patented devices is quietly collecting evidence of companies which are purchasing the parts from concerns not authorized to make them. When the accumulation becomes heavy enough the offenders will find on their hands lawsuits calling for damages of amazing proportions.

Identifying Locality During Fogs and Snowstorms.

On another page an engineer tells of the common occurrence of a man in charge of an engine losing his whereabouts in a fog and learning his location only when he heard the click of a frog. An officer of the road advised him to keep a log by watching the click of the wheels on the joints, and said that was the way engineers in the neighborhood of New York kept a record of where they were in foggy weather. This is just another example of how little some men comfortably relying on their own practical knowledge of what an engineer meets with in certain kinds of weather. A man who advised an engineer to keep track of the mileage he was making by counting the joints would be a fine person to decide whether or not an engineer was to blame when an accident happened. The thing is utterly impracticable, even if it were not so slow on the rails. We do not believe that any man ever attempted to measure speed in that way unless there was some other engineer to attend to the working of the engine.

Of course a man can tell how fast he is running by counting the joints passed over in a given time, but experienced engineers do not require to measure speed in that way. They know about how fast they are going by the skill begotten by experience, and few of them can tell just how they know. They learn it just as a mechanic learns to push a file level. We say this properly after it has helped the art of direction a little in acquiring the man to learn how to do it.

People who have no experience on locomotives have no idea of the difficulties an engineer labors under in a severe snowstorm or during a thick fog. On the elevated railroads around New York engineers often find difficulty during fogs in telling where the stations are, although the structures are dotted with things that are landmarks to the experienced eye. The utmost caution is necessary at such times to prevent collisions. When an accident happens, the practical men in charge are always ready to allow for the difficulties of the situation.

The severe snow-storms encountered in some parts of the country are even more bewildering than the fog. In a prairie country, where there are no prominent landmarks, no groves of trees at the side of the track, and few cuttings deep enough to give character to a spot, it is quite common for engineers to lose themselves. The

writer has very vivid recollections of a night spent toiling through a snow-storm in a sparsely settled district, where the station-houses were all alike and the track laid through great stretches of unbroken prairie. The only times we knew where we were, was when a water-tank was reached, and these seemed sometimes to be running ahead fast and sometimes to be standing still. The men who prate about counting the joints to identify distance ought to have been with us on that trip.

Inspectors in Contract Shops.

During the discussion at the New York Railroad Club of a paper on "Inspection of Boilers" considerable talk arose concerning the advisability of railroad companies having inspectors at locomotive and car building works to watch that no bad material or poor workmanship be put upon the rolling stock in course of construction. The statement had been made that small concerns having one or two locomotives under construction, and which could not afford to have an inspector in the works, were at a disadvantage compared with richer companies, and were likely to receive inferior engines. The representative of one of the locomotive building works, speaking on this point, said: "If a trained inspector on behalf of the railroad company, is sent to a shop where the work is in progress, he is evidently sent there for one of two reasons—either to instruct them how to build the boiler, or else to keep a watch on them for fear they should be dishonest and put in bad work. If he is sent there for the first reason, it seems to me that the railroad company is taking a good deal on itself to say that the inspector knows more about boiler construction than the builder. The builder has been building boilers for a large number of years, and knows the experience of probably one hundred master mechanics. It seems to me that they should know infinitely more about boiler construction and design than the inspector. On the other hand, if he is sent to keep a watch on them, if the builder starts out to be dishonest, you may have a dozen inspectors and he will get the best of you. In fact, the worst piece of work I ever knew to be done, was done right under the nose of a trained inspector."

One might preach a very long sermon on this text. Those who have worked in a contract shop of any kind are aware that it is impossible to watch men close enough to prevent them from doing inferior work if they are so inclined. So many details are put out of sight in the process of finishing, that bad work cannot be detected until the machine exposes it by the strains of service. This is a reason for objecting to such work as is done by workmen permanently in their shops. A man who has a steady job knows that hidden bad work will come back on him, and he experiences no motive to fall into the habit of producing inferior work because it cannot be detected immediately. The outside inspector is very much like a sportsman and comes to a machine and so makes a thing to show his authority and the reason for his being there.

Actuated by these considerations and a sense of duty he keeps a keen eye on the workmen, and a defect that would pass the shop inspector is taken up by him as cause for rejecting a finished part. This causes the workman to be more careful, and so often the latter proceeds to see how much he can deceive the inspector. When a contest of this kind arises the workman is almost certain to get the best of the other. When antagonisms of this kind arise, it would be much better for his employers if the inspector was given a commission and so made at some watering-place or winter resort. Most of the inspectors are competent men, who understand human nature as well as the construction of railroad rolling stock, and they do no harm; but when the wrong man is in the wrong place, we do not know of any position where he can do more mischief as acting inspector in the con-

struction of locomotives or cars. The writer has been in the place of the workman, and has seen a whole shop conspiring together to make an obnoxious inspector.

Judges for the Prize Designs.

We take pleasure in announcing the committee who will decide on the merits of the prize designs offered by LOCOMOTIVE ENGINEERING for the best and safest arrangement of cab and boiler fittings. The men selected stand second to none in their chosen calling, and the simple mention of their names gives assurance that the designs offered will be carefully considered and a just and honest decision made.

The committee stands as follows:
 Jos. H. McConnell, Supt. M. P. Union Pacific Ry.
 Sam'l M. Vanclan, Supt. Baldwin Loco. Works.

W. F. Dixon, Chief Draftsman Rutgers N. Y. Co.
 Geo. H. Hogan, Traveling Engineer N. Y. C. & H. K. Ry.

Sam'l D. Hutchins, Engineer C. C. C. & St. L.
 Please send in your best ideas. These gentlemen shall say which ones are the best, and we will do the rest.

We have no bound volumes or back numbers of *LOCOMOTIVE ENGINEERING* in one of the old paper, but will have loose copies until February 31, and no longer. We have a few bound volumes for 1893, and a few extra copies of the last six months of the year—nothing else. Within a month there will be no back numbers of *LOCOMOTIVE ENGINEERING* in any shape, for sale, except those for January, 1894.

BOOK REVIEW.

ADDRESS DELIVERED IN 1893 BY THE WORLD'S GREAT RAILWAY EXPERTS. Published by the Railway Age and North-western Railroaders. Chicago. Price, 50c.

This is the official report of this "Congress" that met in Chicago in June, 1893, and contains upward of thirty addresses by the many able speakers who took part in the great meetings, and these addresses are on almost every subject connected with railroads. It is very interesting and well worth the price asked.

We understand that Mr. C. A. Hammond, superintendent of the Boston, Revere Beach & Lynn, has resigned. Mr. Hammond is an ideal superintendent for a road where that official has to manage every detail of operating and do the greatest possible amount of work at the least possible expense. With ordinary management, the road would have fallen into the hands of a receiver long ago, but Mr. Hammond fostered the business so skillfully and ran the road so cheaply that he always got both ends to meet and had a little over. If Mr. Hammond does not receive a good salary, and the directors and presidents of railroads are kinder than we take them to be.

One of the most accomplished electricians in the country, a man of affairs and one who has had large business experience and success in the same, remarked the other day in a lecture on electric lighting plants that are returning the best dividends to the stockholders are driven by Westinghouse engines. He could not tell what the reason was, because he did not like the Westinghouse engine, but he was certain that the companies using it generally made money.

Those who have paid any attention to heat problems may be familiar with the name of Professor Tyndall, the English scientist and author of "Heat a Mode of Motion," and of many other valuable scientific books. Professor Tyndall died last month, and in his death science has lost one of the most industrious toilers and lucid experimenters.

PERSONAL.

Mr. W. V. S. Thorne has been appointed superintendent of the Eastern Minnesota, succeeding Mr. F. A. Merrill, resigned.

Mr. C. W. Nelson has been appointed superintendent of the La Porte, Houston & Northern, with headquarters at Houston.

Mr. J. M. Sheer has resigned as master of rolling stock of the Baltimore & Ohio Southwestern, and the office has been abolished.

Mr. E. B. Wall, assistant to the first vice-president of the Pennsylvania lines west of Pittsburgh, has gone to Europe on business connected with the company.

Mr. George W. Cushing, the well-known master mechanic, has accepted the position of master mechanic of the Queen & Crescent, with headquarters at Ladlow, Ky.

Mr. M. E. Olmstead has been elected president of the Buffalo & Susquehanna road. Mr. F. H. Goodyear taking the position of vice-president and chairman of the board.

Mr. M. V. Sullivan is now general manager and Mr. Frederick Settlele superintendent of the Jacksonville, Mayport & Pablo Railway & Navigation Company, with headquarters at Jacksonville, Fla.

Mr. W. J. Vance, for several years general foreman of the Cleveland, Akron & Columbus shops at Mt. Vernon, Ohio, has been appointed master mechanic of that road, with headquarters at Mt. Vernon.

Mr. C. M. Lawler has been appointed general manager of the Philadelphia, Reading & New England, with office at Hartford, Conn. He was, until quite recently, on the Reading as superintendent.

Mr. George Royal, Jr., representing the Ajax Metal Company, Coolbaugh & Pomroy, and the American Balance Lid Valve Company, has moved his office from the Rialto to No. 1007 Monmouth Building, Chicago.

Mr. Henry Schacks, formerly superintendent of machinery of the Illinois Central, has accepted the position of superintendent of machinery and rolling stock of the Denver & Rio Grande, with headquarters at Denver, Col.

Calvin Youmans, who for many years has been foreman in the Rome, Watertown & Ogdensburg shops, at Oswego, N. Y., has resigned to accept a better place in the new shops of the N. Y. Central & Hudson River, at Depew.

Mr. Geo. K. Lovell has been made general superintendent of the Louisville, New Albany & Chicago. He was previously assistant superintendent of the same road, and earned the promotion by the ability displayed in the lower position.

Mr. T. G. Duncan, formerly superintendent of the car department of the Baltimore & Ohio Southwestern, has been appointed assistant master mechanic of the Ohio division of the consolidated road, with headquarters at Chillicothe, Ohio.

Mr. George R. Cassie has been appointed master car painter of the Lake Shore & Michigan Southern, with headquarters at Cleveland, Ohio, and will have general oversight and direction of all the painting done at the different shops, reporting to the general master car builder.

Mr. C. Skinner, who has been general foreman of the mechanical department of the Ohio & Mississippi at Washington, Ind., has been appointed assistant master

LOCOMOTIVE ENGINEERING.

to chairman of the Mississippi Extension of the Baltimore & Ohio Southwestern, with headquarters at Washington, 1st.

John De Lancey, who has pulled the limited express between Boscawanna and Hornellville for the past twenty-five years, is the inventor of a variable exhaust nozzle that is quite extensive use on the Erie road. Mr. De Lancey is the inventor of the balanced slide-valve that bears his name.

Mr. A. L. Mohler has resigned the position of general manager of the Great Northern. Mr. Mohler has been on the road for eleven years and developed decided ability as a general manager. There can be no strong man near Mr. Mohler for any length of time, so there has been a change of government.

Mr. I. G. Buchanan has accepted the position of general agent for the Union Mt. Mt. Co. of Depew, N. Y. Mr. Buchanan has been remarkably successful in selling railroad supplies, and we feel assured that this new car company have done a good stroke of business in securing his services. His office is in the Havemeyer Building, New York.

Mr. J. J. Casey, superintendent of motive power of the Yazoo & Mississippi Valley, has been appointed assistant superintendent of machinery of the Illinois Central with headquarters in Chicago. Mr. Casey rose through the car department and is exceptionally good in everything relating to it. He was for some years superintendent of the Missouri Car & Foundry Co. at St. Louis.

Mr. H. P. Whitcomb, late general manager of the Milwaukee, Lake Shore & Western, and now general manager of the Wisconsin Central, was recently elected upon by the conductors of the first annual road, and presented with a handsome by engrossed set of resolutions and an opinion, one with a solid gold handle, as a token of the high esteem in which he is held by the employes of the road.

The day before, Mr. John D. Campbell who has been assistant superintendent of motive power of the New York Central for the last three years, left the Depew shops he was presented with a very handsome set of desk furniture by his officers and a silver service subscribed for by the workmen. The Depew shops were built, equipped and put in operation under Mr. Campbell's supervision. The work done is a good monument to the ability of the man who carried it out.

Mr. W. L. Boyle has been appointed master mechanic of the New York, Susquehanna & Western, with headquarters at Jersey City. Mr. Boyle was raised on the Erie and rose there to be foreman of the machine shops at Jersey City. He is general foreman of the New York Central shops at West Albany for several years, and had immediate charge of the construction of the famous "1292," and has been teaching applied mechanics in an industrial school in New York since he left West Albany.

Mr. Isaac D. Barton, who has been general superintendent of the New York & New England since January, 1892, has resigned that position, and the duties of the office will be assumed temporarily by Vice-President Oblet. Mr. Barton was general superintendent of the Long Island railroad before going to the N. Y. & N. E. There is talk of his returning to the Long Island, the time for the periodical shaking up of the officers of that road having come around. Rumor says that Mr. Barton has got tired of his highly ornamental general manager and intends to fall back upon utility again.

One of our correspondents, on the Rome, Watertown & Ogdensburg, writes: "Of course we are all much interested in the promotion of Mr. G. H. Hazelton to be assistant superintendent of motive power of the New York Central. Mr. Hazelton has been master mechanic here for thirteen years, during which time several entire changes of management have taken place, none of which have affected him. His entire railroad experience has been gained on the R. W. & O., having started in as water-boy on a work train. Then he learned the machinist trade in the shops at Rome, from which he rose, step by step, to be superintendent of motive power."

Mr. Amos S. Watts, master mechanic of the C. J. & M., at Marshall, Mich., had rather an exciting experience last month, one which every officer compelled to discipline transgressors is liable to go through. An engineer named Calloun had brought his engine in with the heater

The event was the greatest sensation Topeka has seen since the dual Legislatures were struggling for supremacy.

Mr. Frank Hedley, who was appointed master mechanic of the Lake Street Elevated Railroad of Chicago, about a year ago, has acted as superintendent ever since he went to the road. Col. Alberger, the general manager, quickly perceived that Mr. Hedley was a man of many resources and a good executive officer, so the details of putting the road in working order were left to him. The successful work he performed has now received practical recognition in his appointment to be general superintendent of the road. We congratulate the management on the excellent appointment. Mr. Hedley rose in the Manhattan Elevated Railroad shops to be general foreman, and from there was appointed master mechanic of the Kings County Elevated Railroad of Brooklyn. Most of our readers are aware that he is

blood vessel to the brain. He was born in Lansingburg, N. Y., Sept. 12, 1838, and in early life located in Chicago, where he was foreman of the Chicago & Fond du Lac shops. From Chicago he went to Kenosha, Wis., to accept a similar position with the Kenosha & Rockford Railway shops. During the war he was established in Winona, Minn., and had charge of the construction of the first railway west of the Mississippi. In 1865 he returned to Fishkill, N. Y., where for seventeen years he was master mechanic of the Newburg, Dutchess & Connecticut Railway shops. He then accepted a similar position with the Cleveland & Marietta Railroad at Cambridge, Ohio, remaining there five years, and went to the Terre Haute & Indianapolis as master mechanic at Paris, Ill., four years ago.

Mr. A. B. Underhill, long superintendent of motive power of the Boston & Albany, has resigned, owing to ill-health.



A HEAD-END VIEW OF THE FIRE CYLINDER OF FRAME NO. 101 IN CENTER OF WORKS.

troven, and Mr. Watts gave him a lecture about his neglect. The man went home and told his wife that he had made his last run on the road. Then he went out and got crazy drunk, and imbibed enough courage to make him savage. Next he armed himself with a revolver and tried to shoot his wife. She escaped, so the man proceeded to Mr. Watts' residence and fired several shots at the master mechanic. As the shots did not reach their intended victim, the drunken animal grappled with Mr. Watts, and was in a fair way to commit the murder when help arrived and the man was disarmed.

We have received from Topeka, Kan., a marked paper with an article relating to our genial friend Mr. James B. Brady. It seems that Jim took his diamonds with him when on a visit to Topeka, and his appearance took away the breath of the hotel clerk. Jim walked down to the office with his underclothes in his arms and asked to have them put in the safe. When he turned upon a log to show why the underclothes needed a place in the safe, the clerk declared that it gave him such a turn that any one might have knocked him over with a sledge-hammer. News of this being a man in the hotel worth \$40,000 worth of diamonds used as buttons went through the city like a Kansas sand-storm, and Jim was besieged with reporters and people anxious to examine the treasures.

grand nephew of William Hedley, of England, who built the first locomotive that did practical railroad work.

Another man who began life on the lowest rung of the railroad ladder has just reached the top. Mr. C. W. Case has been promoted from general superintendent of the Great Northern to be general manager of the same road. He began in 1851 as brakeman on the Chicago, Milwaukee & St. Paul and rose on that road through the steps of fireman, engineer, station agent, general freight and ticket agent to the position of superintendent. He went from there to be general superintendent of what is now called the Great Northern. Mr. Case did not rise by staying qualities, but by the native energy that will not rest in a subordinate position. He was not only ambitious to rise but was industrious in educating himself to be equal to the requirements of higher rank. Like many other self-made men, Mr. Case is a great admirer of his creator, but he is an exceptionally good railroad man and will succeed on the Great Northern until he excites the jealousy of the chief stockholder.

W. G. Van Busker, division master mechanic of the Terre Haute & Indianapolis (Vandalia line) at Paris, Ill., died suddenly on board a train at Terre Haute, Ind., Nov. 20, death being due to the rupture of a

Mr. Underhill learned the machinist trade at the Amoskog Works, in Manchester, N. H., where he mastered the art of locomotive building. For two years he was employed at the Manchester Locomotive Works, and then went to Boston, where he held a responsible position with the Hincley Locomotive Works. In 1859, he was made superintendent of the Boston & Worcester railroad shops. In 1859, he went to Meadville, Pa., and was for a year master mechanic of the Atlantic & Great Western Railroad. In May, 1864, he returned to Boston as master mechanic of the Boston & Worcester. When that railroad became a part of the Boston & Albany, he continued in the position, until in 1880 the business grew so that the office of superintendent of motive power was established for him. He has since been in entire charge of locomotive building and repairing on the road.

The older generations of railroad men will remember Chauncey Hibbard, who was at one time general manager of the New York Central. Like many another railroad man who has been successful in early life misfortune came to Mr. Hibbard in his decline of life. Consolidations and change of proprietorship threw him out of a position at an age when re-employment was difficult. After vainly striving to obtain a railroad position, he accepted the selling agency for track

sales. While following this business, he called one day upon Marvin Hught, then general manager of the C. & N., and asked if he could sell him a track scale. Mr. Hught was a railroad man of a later generation, and Mr. Hubbard supposed that he was talking to an entire stranger. After he had explained the merits of the scales, Mr. Hught said: "We will take ten of these scales." Mr. Hubbard was perfectly amazed, for he sometimes had weeks of labor to sell one set of the scales, and he had never before sold more than two in one order. On beginning to express his surprise and gratitude, Mr. Hught stopped him, and asked, "Did you ever see me before?" The old gentleman looked searchingly but could not remember Mr. Hught's face. "Do you remember a telegraph messenger boy, who once came to your office and asked a pass to Buffalo because he wanted to go West, and was too poor to pay fare? Do you remember how readily you granted the favor?" The old man faintly remembered something about it. "That's me," said Mr. Hught. "I was that boy. We need track scales, and it does me good to be able to order them through you."

Boiler Inspection.

The steam pressure carried on many locomotives is now so intense that the danger of explosions is greatly increased, a condition of affairs that has caused much nervousness among the men connected with locomotives. For the last year or two the most fear has been made manifest by discussions about boiler inspection, and inquires into how locomotive boilers can be kept in safe condition. This is a very wise and judicious line of investigation. It is so where increase of knowledge will be certain to promote increase of security. Locomotive designers and builders are so well-informed as to the strains which a boiler will withstand safely, that when it is so there may be no more apprehension concerning the safety of a boiler carrying 200 pounds of steam than there is with one carrying 10 pounds. Railroad men need not suppose that they can promote the interests of safety by sending inspectors to watch that high-pressure boilers under construction are properly braced or stayed. There is not the least ground for suspicion that the new boiler will not be strong enough. The season for justifiable misgiving is when the boiler has been twisting and moving for months under the variations of heat and pressure and the fastenings are beginning to fracture or become loose. Then is the time for efficient inspection to step in and make the boiler secure. If that is carried out properly a boiler can be maintained as safe as it was when it left the builder's hands.

Efficient inspection is, however, more spoken of than practiced. To render the inspection efficient, it must be done systematically and by skillful men. The leading source of danger is the stay-bolts. A portion of these have a short life, and only constant vigilance by men who are skillful enough to detect defects can prevent accidents. The weak thing about many of our railroads is that the boilers are not systematically inspected. The work may be done regularly at certain points, but at others the work is neglected, and an engine may happen to be sent to the place where loose members prevail at the time when the boiler needs the most vigilance. On other roads good systems of inspection are organized, but they are merely on paper. The real work is not done regularly. When business is light or normal the inspection will be done as arranged, but when an unusual demand exists for power inspection is omitted. This is inadvisable.

Answer Circulars.

The chairman of several of the committees appointed by the Master Car Builders' and Master Mechanics' Associa-

tions to investigate subjects for report at next convention are making the old complaint that they cannot get members to answer circulars. The members expect that good reports will be submitted at the conventions, reports that will be creditable to the associations, but too many of them throw upon others not only the labor of compiling the reports but all the labor of finding out information. There are few members of either association who are not in a position to supply some facts bearing upon the subjects under discussion. Those who possess these facts and do not send them in are acting unfairly to the association and to themselves.

Many people are not aware that the act of collecting information on any subject is a good educational process. There is no man who has ever been a chairman of a committee and prepared a report, who has not learned a great deal about the subject investigated that he would never have known but for the work entailed. In a smaller degree, every man who collects

information, which the well-known wearing quality of the "Ajax" metal warrant them to expect. They have added to their present plant a large machine shop and laboratory and will be in position in the near future to serve their friends. They will make finished castings made of Ajax metal, a specialty for all kinds of service, acid metal and fittings, etc., of every description. The laboratory will be under the control of a graduate of the University of Pennsylvania, whose authority cannot be disputed in an analytical way. This is done in order to accommodate their friends and patrons, and they propose making it a particular branch of their business. This company had already a large plant but it was found inadequate in good times, so that now they can promptly fill orders of any size with which they may be favored. —*Railway Review.*

If there are any railroad men in the neighborhood of Cleveland who are inclined to magnify the minor troubles of

writing about these cars say, that two trains of them does the work of four trains of ordinary flat cars.

Mr. Henry L. Leach has resigned the position of master mechanic of Tunnel division of Fitchburg Railroad, with which he had been connected for thirteen years as draughtsman, general foreman and division master mechanic, and will devote his time entirely to the introduction of the excellent track sanding device of which he is the inventor. Judge Hammond has just decided that Mr. Leach is the rightful owner of these patents, and he proposes to push their introduction.

The New York Central people have decided to send the fast locomotive "99," which was exhibited at the World's Fair, to San Francisco for exhibition at the California Mid-Winter Exhibition. The intention is to have the engine pull the Wagner train which attracted so much attention at the World's Fair, as that train also

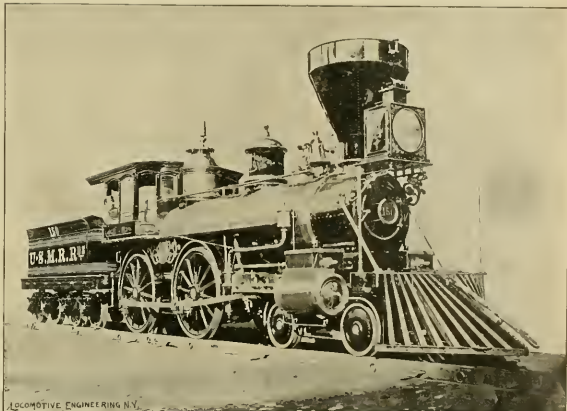

PORTER LOCOMOTIVE, BUILT FOR UNITED STATES MILITARY RAILROADS DURING THE WAR

information to answer circulars, increases his own stock of knowledge. We can, therefore, repeat the appeal for members to answer circulars, on the ground that they are going to receive benefit from the work they do.

The Traveling Engineers' Association committees are sending out their first circulars. We appeal to the members of this association not to fall into the habit of neglecting to answer circulars.

Do Your Duty.

The following circular has been sent out by Secretary Sinclair to the members of the Railway Master Mechanics' Association.

"Sweet is the man who wins his advice," says a Scotch proverb, and the same philosophy adds, "e'en on the diel will sha the wye tak Perth."

Members ought to be prompt answering circular questions of committees—'tis as cheap and as easy to "go advice," or to point out the right road to a traveler.

Committees do lots of work for the benefit of the association. Lend a hand. It is a duty and ought to be a pleasure.

The Ajax Metal Co., of Philadelphia, Pa., are preparing for a very large busi-

ness, and to grow caked care out of us, we would endeavor them to pay a visit to the household of George W. McGuire, of the Butler Drawbar Attachment Co. His numerous friends will be pained to learn that George is suffering from a dangerous malady, liable to prove fatal at any moment, yet of a nature that may spare his life for many years. Mr. McGuire has been in delicate health for years, and lately has been confined to bed for a month.

With these conditions to make plain, there is no more cheerful household in Cleveland. The writer spent an evening there lately and was impressed beyond words with the courage of the husband, and the wife, cheerful, enterprising spirit of the brave wife.

The Rodger Halfast Car Co., Mononock Building, Chicago, have just issued a very handsome illustrated catalogue of their car, showing the methods of handling ballast when Rodger cars are employed. Every man interested in ballasting railroad tracks ought to study this catalogue. It would show many a railroad manager how he could, at small expense, change mud runs with all the resulting shortcomings to ballasted roadbeds capable of sustaining traffic without driving the ties out of sight. A railroad vice-president

was sent to California as one of the attractions of the Mid-Winter Exhibition.

The train of Krabel cars that was exhibited at Chicago was sent to the Chicago & Alton shops at Bloomington for some alterations, and the work has been finished. The train will be employed during the winter in excursion business between Chicago & California.

Mr. W. T. Small, superintendent of machinery of the Buffalo, Rochester & Pittsburg, has been in the hospital getting a painful surgical operation performed. We are pleased to learn that the operation was successful. He is recovering rapidly.

The Boston & Albany have just put two traveling engineers into service for the first time, they having gotten along all these years without them. Engineers Horton and J. W. Chamberlain being the men selected for the positions.

Baldwin's have received an order from the Norfolk & Western for nine consolidation compounds, cylinders 14 in. and 24x24 in., to weigh 155,000 lbs.

The Buffalo, Rochester & Pittsburg have just contracted for the building of eight locomotives and 200 cars.

LOCOMOTIVE ENGINEERING.

Proverbial Philosophy in Railroad Management.

The late N. E. Chapman used to tell ironworkers about the way things were managed on the Baltimore & Ohio when he was superintendent of motive power of that railroad. In the early years of railroad history the Baltimore & Ohio had been the most enterprising and progressive railroad in the country, but under the way of the Garretts fell into a state of conservatism. Twenty years ago, a manager of the property conceived the idea that the machinery of all kinds and the methods of operating the same had reached perfection, and that no change could be made without spoiling something. The same sentiment crystallized was long ago when Mr. Chapman was appointed in 1882.

Before taking hold, Mr. Chapman was required to meet President Garrett, to receive instructions concerning the policy that must be pursued in his department.

After dwelling at considerable length upon the grounds of the Baltimore & Ohio for an outsider to assume the management of the property, the president said: "In the management of this great property I have found it wise to adhere to the principles contained in certain maxims. You will find safety and assurance by adhering to them. There are a few maxims which I do not think away anything that may be useful." A. Make certain that you are right before you make a move. B. Let well enough alone. If you guide your will by these principles you will make a success of the Baltimore & Ohio."

At this Mr. Chapman got very hot, and he expressed to the president his philosophy, in which the rule was arranged had no more chance. The motives were too absurd for reaching the recurring difficulties of railroad service and important matters had not to go into detail while the session was a slight breeze for the president to let the case. The thing came to mind in a distant way the case of the King of France, whose foot got entangled in a turpentine, and who had to hang himself at least with his feet in the air until the official authorized to touch the opening of the trap could be found.

It was 1882 that Mr. Chapman decided to hold his my-mine camel lock engine by working it in through the company's motive and turnouts. Nothing belonging to the B & O that might be useful had ever before been passed into the mouth of a new furnace, and it was a question how authority could be obtained to perform an operation that smacked of innovation. Mr. Chapman sent a formal notice to the president of what he intended to do, and waited three months for an answer, and none came. Then he sent the locomotives to be converted into new iron and steel. Eleven months after that he received a letter asking on what authority he sent the engines to be rebuilt in his thorough fashion. He turned up the corner of the letter and wrote thereon: "Silence gives consent." That settled the case. He had found a motto to suit.

Reputed and Real Condition of Compound Locomotives.

Nearly everybody is aware that hundreds of appliances designed as improvements on railroad machinery have been condemned by the prejudices that hold them out to be worthless before they were tried. Under the withering breath of prejudice, meritorious devices have been often tried merely for the opportunity to give them emphatic condemnation. There is some danger that the same repeated process will be found at this year of grace and reputed enlightenment condemning compound locomotives. To condemn and to condemn compound locomotives is as much the fashion at present as the shoulder harness on women's dresses. When builders or inventors find their compound locomotives discredited, it is a

good plan to insist on getting figures of performance.

People in New England have been familiar for the last year or two with gossip about two Vaucian compounds on the New York & New England which were reputed to be the worst kind of failures. The subject came to be so much talked about that a representative of the Baldwin Locomotive Works went to Boston to investigate the matter. He found Mr. Barton, superintendent of the road, emphatically opposed to compound locomotives for the following expressed reasons—

1. The company had no money to experimenting.
2. They wanted locomotives to earn money.
3. They wanted locomotives to pull cars.

per cent. more cars, and did the work with 25 per cent. less fuel. During one month that the compounds were reported to have behaved very badly, the records showed that they had made the greatest mileage during their history, and their monthly mileage at all times exceeded that made by the hardest run simple engine. The records proved, moreover, that the compounds cost less for repairs per mile run than the simple engines. The saving of fuel alone was computed to be \$1,650 a year, nearly enough to pay the wages of engineers and firemen.

The figures produced for the company's own records could not be presented. The converse of the picture first presented of the compound locomotives was finally accepted as the true one. The company

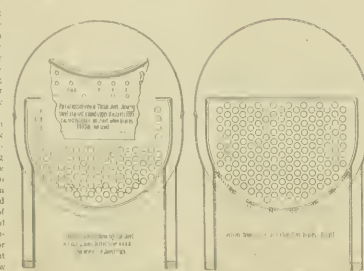

4. They wanted locomotives that would keep going.
5. Compounds were in the shop too much.
6. Compounds cost too much money for repairs.
7. Compounds did not maintain their economy.

8. Would wait for compounds when they were perfected.

This was a very imposing array of charges against the use of compounds, and Mr. Barton was exceedingly emphatic in giving them expression. When he was asked for figures to sustain his objections to the locomotives that had been in service for eighteen months, he had no data to give, but he was perfectly willing to provide every assistance in obtaining records of the engines. With the means of securing facts, the representative proceeded to investigate. He obtained the performance sheets of the road, and with the aid of the motive power clerk selected ten of the best simple engines as a basis of comparison for the compounds. Compared with these it was found that the compounds pulled 10

decided to order more compounds on the grounds that:

1. They earn more money.
2. They pull more cars.
3. They do the work on less fuel, and they cost less for repairs than simple engines.

A very exhaustive circular has been issued by Mr. A. E. Mitchell, chairman of the Master Mechanics' Association committee on tire treatment. He asks for information of a very comprehensive character in relation to tires, which includes facts about shrinkage and about methods of fastening the tires, how to measure wear, etc.

The mechanical department of the Long Island Railroad have been making some tests to ascertain the relative value of compound and simple locomotives. The work was done by the officials belonging to the road. They found that the compounds saved 17 per cent. of water and 37 1/2 per cent. of fuel as compared with good simple engines.

Plan for Preventing Distortion of Fire Sheet and Front Sheet of Firebox.

Master mechanics who have had trouble with springing of front sheet to firebox and the lower portion of fire sheet may pick up a valuable pointer in the sketches shown herewith, which illustrates the method employed to overcome this trouble by Master Mechanic D. Brown, of the D., L. & W. road.

Mr. Brown found they were having trouble in the place indicated. There was a tendency for the fire sheet and front sheet of water leg to bulge in, as shown in dotted lines in upper left-hand cut, producing cracks between flue holes, as shown, and the outside of the front sheet showed evidence of being pulled in, there being considerable cracking around the stay-bolts.

It was concluded that the long flat surface between the top row of stay-bolts, in the front of the box, and the lower row of tubes, that is practically without stays—was the cause of the trouble.

In some new fireboxes this trouble was cured in a very simple manner, as shown in the right upper sketch.

The flange of the front firebox sheet was tapered some three inches longer than necessary for the seam, and extended back into the water space. This was drilled with a row of holes, and fork and brace were attached from well ahead to the second and third course sheets of the barrel of the boiler. This stays the weak spot very nicely, and makes a neat, workmanlike job, and is not liable to collect scale and mud at a dangerous place as are short, rigid braces tapped and riveted into the firebox sheet and fastened to the first course ahead. This plan seems to have many things to recommend it and nothing to condemn it.

The round jaw nonparallel ratchet made by the Keystone Manufacturing Co., Buffalo, is making steady progress in use in railroad shops. As soon as one is tried in a shop it quickly causes other orders to be made, for the men using it call it the handiest tool for running repairs that he had ever tried. There are so many places in doing locomotive and car repairs, where an ordinary wrench cannot be turned, that much time is wasted, and much property impaired. In such places the round jawed ratchet takes hold and the nut can be worked off from almost any position. We have heard the tool talked of so highly by the men using it, that we cordially advise railroad men to try it.

A new folder has been gotten up by George H. Daniels, general passenger agent of the New York Central, and is called, "An Object Lesson in Transportation." It describes the Wagner train exhibit in the World's Fair, and also a train exhibit by the London & North-western. In addition to that there are descriptions and illustrations of the "1099," the compound locomotive "Queen Emma," and the "De Witt Clinton" with its train. Persons anxious to have a souvenir describing this interesting and historical railroad rolling stock will find the new folder a good thing to keep.

The repair shops of the Baltimore & Ohio, at Mount Clare, Baltimore, are reported to be working full time with the extra force of men. In the depression case, these shops were put on short time working five days a week. Business on the road did not diminish a great deal, and had order cars and worn-out locomotives have accumulated more rapidly than they could be cared for. A full force of men is now wrestling with the depression, when the days are short and the gas-light long. This is the way to provide employment for idle hands.

A patent has been granted to Mr. James McCre, Houston, Tex., on the car brake apparatus which dispenses with the use of brake beams, and which we illustrated some months ago.

Practical Letters
from Practical Men.

Write on one side of the paper, state your point plainly and briefly, and then quit. We respect the generalities. No letters noticed unless name and address accompany.

Facts Wanted.
There's a glut of Opinions.

Why Those Men on the Exploded Locomotive Might Not Have Heard any Report.

Editors.
In your November issue you give particulars of a boiler explosion on the Seaboard Air Line, which took place on the 27th of July last. Three men riding on the locomotive at the time of the explosion say that they did not hear any report, although the first barrel sheet of the boiler was entirely blown away. Permit me to offer the following explanation of the phenomenon:

The accident happened in the latter part of July. In computing the velocity of wind, a probable atmospheric temperature of say 80° F. should be allowed. The velocity of sound in air at this temperature is 1,150 feet per second. (See "Trautwine's Civil Engineer's Pocket-Book," 1881.) The initial velocity of escaping steam at 70 pounds pressure is 2,400 feet per second (see Bourne's "Hand-Book of the Steam Engine," 1873). The pressure in the boiler at the time of the explosion, it is said, was 125 pounds. It is therefore probable that the initial velocity of the steam escaping from the exploding boiler would be in the neighborhood of 2,000 feet per second. This velocity would be, with small loss, imparted to the flying pieces of debris, as the boiler was torn apart.

Comparing these facts it will be apparent that if it were possible to maintain the velocities unaltered for one second, then a broken rivet or piece of boiler plate would travel 850 feet further than the wind of the explosion in the same time, although both began to move simultaneously.

In reality, however, the velocity of wind does not diminish, though its intensity may do so. The speed of the irregular pieces of metal and debris, though thrown with a higher initial velocity, would steadily lose their velocity in the air until brought to rest on the ground after a comparatively short flight.

The three men in the cab of the engine who did not hear any report may reasonably be supposed to have been sitting about five feet from the center of the explosion. At that short distance, the decrease of velocity of steam and debris, due to the resistance of the air, may practically be disregarded. With initial velocity of 2,000 feet per second, the rush of steam and broken metal, etc., will have struck these men in the one two-hundredth (1/200) part of a second after the explosion, and instantly overpowered them. The sound of the explosion, starting out at the same moment with velocity of 1,150 feet per second, would reach the men—provided they were not blown further away—in the one hundred and fiftieth (1/50) part of a second. Strange as it may seem, therefore, the seventeen forty-six hundredth (1/1746) part of a second (very close to being 1/18 part of a second) actually elapsed from the time the rush of steam and debris struck the men and stunned them until the impulse of sound passed over them and filled their unconscious ears.

Geo. S. HUBBINS.

Windsor, Ont., Can.

What Pressure Shall We Carry With the New Brake-Valve?

Editors.
A question often asked, especially by roadmen, is what pressure is now being vigorously discussed on this road is...

much with an opinion on this subject by those who have had some experience in this matter. My position is that there must be such an amount in main reservoir, that it will fill an empty train-pipe to a higher pressure than can be obtained in the brake-cylinders and auxiliary-reservoirs by an emergency application, and as with a 12x33-in. piston and 10-in. brake-cylinder with 8-in. reservoir travel 60 pounds can be obtained, and some pistons even travel 6 in. with an increase of 2 pounds on the inch, so that it would not be safe to figure the amount in auxiliary at less than 140 pounds, while the friction on the slide-valve would be at least 1 pound more. It would then be doubtful if in case of an emergency application, some brakes would come off till the pump pressure the pressure up to 60 pounds, unless there was sufficient capacity in either volume or pressure, in main reservoir, to promptly supply such an amount to train-pipe. Suppose a red light should be met on a bad grade just coming around a curve, the train-pipe would be exhausted, and if the flag was picked up immediately, the release position for an instant and train started as is often the case down hill, and some of the brakes could (and if the train were long enough probably would) stick on until air enough had been accumulated to release them. Meanwhile the cars that had been started with the brakes set would be likely to slide their wheels, and on steep grades cause loss of time in starting the train.

In looking up this matter, I measured several engines, getting on an average 60 feet of 1-in. pipe that was exhausted by an emergency application, and after measuring a number of coaches and Pullmans, found over 60 ft. of pipe to a car, not counting the crossover pipe, cavities in train-pipe strainer, triple-valve, pipe to conductor's valve or hose couplings, which would average 100 cubic inches more. Now, a 12x33-in. reservoir expanding into a 10-in. brake cylinder at 8-in. piston travel, equalizes at 1/2 auxiliary reservoir pressure, which is 70 pounds, as there is a 25-in. depression at either end of call it reservoir. It would not be safe to call it over 23 in., which makes 12x12=144x.784, giving 113.09 square inches x 20=3,160 cubic inches, while a 10-in. brake cylinder gives 10x10x100x.7854=78.549 cubic inches x by 10-in. piston travel = 628 cubic inches; then by 628 cubic inches, added to 3,160 cubic inches, will reduce 70 pounds pressure to 200 pounds, and a reservoir will reduce two-sevenths at an reasonable pressure if its volume be added to in the same proportion as the brake cylinder stands to the auxiliary, which, for easy figuring, we will say is as one to five, and allow the 26 cubic inches over in the reservoir for thickness of sides and ends. The pressure two-sevenths of 200 is 59.54, which the Westinghouse company page 31, tells us contains 10,500 cubic inches. If the pressure be 90 pounds, a reduction of two-sevenths would give 64.30 pounds, and 3,500 cubic inches, or five-fifths in proportion, added to main reservoir volume, would be sufficient to accomplish this reduction, the train-pipe on engine and tender would furnish 60x12 in. = 720 in. x 78.54 = 565.4880 cubic inches, and for each car 100 cubic inches is added, so that four coaches and engine would only lack 75 in. of the required amount, and consequently if no brakes except the train-pipe, there would be 6 in. more would just release, and with five or more coaches would be apt to drag till the brakes pumped off. Of course, in this

case the main reservoir must be considered too small with 100 pounds pressure, but no doubt there are a great many such in service.

In the supplement entitled, "Description of Improved Air-Brake Apparatus, 1892," on pages 16, 15 and 16, from 15 to 20 pounds excess is said to be usually sufficient, but I believe that in many cases, where the brakes drag where the new valve is used, it will be found that the main reservoir has not volume enough at that pressure to insure prompt release unless time can be given to allow the pump to assist also. Might not this be done by making links with our friends with the Plate D pattern valve, as with a rotary valve making itself a seat in running position, I should think that a valve in that condition would not be reliable on lap.

OTHER QUESTIONS.

Mr. Rejely asks the right stand as to purchasing instead of making parts for repairs and as for the reducing-valve, Fig. 5, Plate D, 28, the diaphragm-out, No. 8, could not have been screwed down on diaphragm, Plate No. 6, and therefore not giving lift enough to supply valve No. 5. Brother De Sanno hits the nail on the head as to the lagging on air-pumps. Why cause them at all?

If our East Albany friend will apply his brake, put his brake-valve handle on lap, and then watch the black hand a

are a great many of the men practice it here, and can tell within a car or two of how many they have, and it is a very easy matter for engineer approaching a stopping place to move the handle to full release. If he finds air has been cut he will have time enough to get his train under control by the old Armstrongs before it is too late. It comes easy with very little practice, such as draping the lever in corner when shut off, and many save engineers from doing time for an air-brake failure.

W. G. WALLACE.

Rolling Flues by Power.

Editors.
I send you herewith the drawing of a flue-rolling machine I had made here. It is all blacksmith work, with the exception of the pin for rollers and the pin with the square end to go into the attachment with the flexible shaft, which we are for power. Fig. 1 is a front elevation of a 50x1/2-inch shaft, as shown; Fig. 2 is a longitudinal section through the smoke arch and front flange sheet, showing the machine ready for work. We get our power from a flexible shaft through a compound box, an attachment to a shaft for tapping and reaming. The square hole in the spindle of our box to hold the tap or reamer is 3/4 in., so we drilled a round hole the same size, 1/4 in., clear through the spindle to allow the round end on the long pin. Fig. 4, to pass

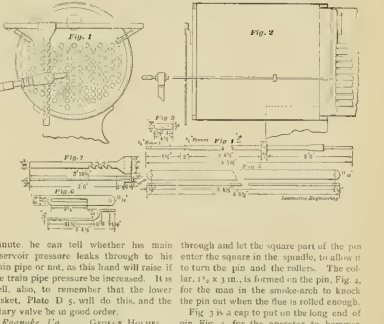

How to Tell if All Your Air is Coupled Up.

Editors.
Engineers are depended on to make the stops, and a failure often results in an accident, because when they find the air is not working it is too late, being the train to a stop by the hand-brake. A great many accidents have occurred when the train-line has been cut, and when reductions were made brakes would not work. I would like to call your readers' attention to an article written some time ago by Paul Synnstedt, which, if practiced, will enable the engineer to tell how many cars of air he has in train before he applies the brake to stop. He says, in order to tell how many cars are working, pump up train-line pressure to 20 pounds, with brake-valve handle in running position, and 20 or 25 pounds excess on main reservoir pressure will reduce to 100 pounds, and the train-pipe on engine and tender would furnish 60x12 in. = 720 in. x 78.54 = 565.4880 cubic inches, and for each car 100 cubic inches is added, so that four coaches and engine would only lack 75 in. of the required amount, and consequently if no brakes except the train-pipe, there would be 6 in. more would just release, and with five or more coaches would be apt to drag till the brakes pumped off. Of course, in this

through and let the square part of the pin enter the square in the spindle, to allow it to turn the pin and the rollers. The collar, 1 1/2 x 3/16 in., is formed on the pin. Fig. 4, for the man in the smoke-arch to knock the pin out when the flue is rolled enough. The rotary valve is in good order.

Roomer, Va. GEORGE HOLMES.

Fig. 3 is a cap to put on the long end of pin. Fig. 4, for the operator to hammer against to drive the pin into the rollers as the pin and rollers revolve. This is the round end of pin from battering. A small set-screw is put in the cap flush on the outside and projecting about 1/2 inch inside, running in a groove in the pin to prevent the cap and box from falling off. Fig. 5 has two clamps, Fig. 6, riveted on to it for attaching it to the smoke-arch for a slide, the slides in Fig. 6 allow the slide to be moved in any direction to get it level.

Fig. 7 slides on the slide Fig. 5, and holds the long pin Fig. 4 level, steady and in line with the flues. The notches being cut down the sides to correspond with the flue centers (in this case the flues are 2 1/2 in. diameter and 3 in. centers) one side to the high row and the other side to the lower row, the operator changing the pin into the different notches to correspond with the flue he wishes to roll. In changing from a high to a low row, the opposite, the operator pushes the long pin into any convenient flue far enough to clear Fig. 7, then draws it out again on the other side as needed.

This machine rolls the flues heavy or light just as wanted, the operator after rolling a few knots, just when to stop to get the required result.

CHAS. E. FURNESS, Dubuque, Iowa.

Some Brake Questions.

Here is a pump which pumps out 70 or 80 pounds pressure at 20 and 300, then it hand falls back to black one, and both fall back a few pounds, and pump goes to work again. What is the trouble?

Engine coupled on to train, pump pumps up to 70 and 80 pounds, turn quick-stick off behind tank and will only pump a few pounds. Where is the trouble. It is too hard for me.

Suppose on a train of fifteen cars there was quick-sticking triple valves on the first car, on second five old style triple valves, and five quick-sticking. Can an emergency action be got out of rear five, if brake supplied from head end of train?

WALD M. PHILIP.

VALMONT, IOWA.

Reily's Reducing-Valve Puzzle.

I should say that the trouble with Mr. Reily's reducing-valves, referred to in December number of *LOCOMOTIVE ENGINEERING*, was in the diaphragm not so having the grooves filled up with dirt, so that a new one was put on without knowledge of it, which would fit close to packing-valve body No. 2, making a close fit and preventing the air from getting through to the diaphragm No. 7 as fast as it should. Another thing might cause a kind of trouble spoken of in the article, but the article on the subject is so long that the application No. 4 is retained to the 4 or nearly so, while the new one will strike the body No. 2. As this was the same reducing-valve that had been in use before, and given satisfaction, I am inclined to give any other reason why it should not work properly, barring gun or boiler.

F. B. ARMSTRONG.

VALMONT, I. A.

THE ANSWER.

There is a shoulder which passes through the diaphragm and across down the diaphragm plate. The shoulder is 1/8 inch rubber, and about 1/4 inch thick, has a hole in the center to let the shoulder on to it. This shoulder, being only about 1/8 in. wide, holds the diaphragm firmly to plate No. 2. Diaphragm stem 2 touches valve 3 and presses it down until stem 3 (which is double-strikes) reaches 2, allowing air to pass to train signal-pipe. No you see that stem 2 must go through nut 4 far enough to touch valve 2. Now, whenever it is new the diaphragm in this valve didn't cut the hole large enough to let the shoulder of stem 2 through, consequently the air was screened down on the diaphragm, which prevented the stem 2 coming through the nut far enough to touch valve 2 before nut touched body 2, or at least it merely broke the point of valve 2 just enough to allow air to leak through very slow.

SPRINGFIELD, N. J. W. F. REILLY.

Can an Engineer Get Lost on His Engine?

I believe I can move to west to learn, and I am after information. I have run a locomotive for twenty-two years, and in a recent conversation with one of our officers I made the remark that I had been lost in a snow-storm and also in a fog on the road, when I could not possibly tell where I was until my engine struck a switch-trail, and could then tell by the click of the switch-rail or the frog when I crossed it. He said it would never do to let a jury, that nowadays they would not listen to me or exonerate me from blame on a statement of that kind if I had an accident between switches. He said I should keep a log—that is the remark he made—so, to explain, I should keep track of my mileage by the click of the rails on the road between stations, as engineers did not have any

just close to do practically nowadays. They turn on injector, etc., etc. let her go, and all the new improvements would do the rest, and then keep your eye on the gun and listen for the click.

Well, I looked pleasant and told him I had never heard of any thing of that kind before, and he said: "Well, you have heard it now, and I told you," I said, "Well, I will venture \$10 there is not a man in the country can tell exactly how far he has run in that way," he said, "In-
ferred there is; I will bet there is ten thousand." Another party in the crowd was looking on and he said: "Oh, yes; that is the way they run in the fog rigs around London and New York City." Well, the next trip out I made an attempt to keep a log (in my head) and, well, say I could not keep up with the clicks when I got under motion, there was about five inches of snow over the rail, and pretty soon there was no click only a road. Now, what I want to find out is this: can you produce a man down that Eastern country, or one that is quite English, you know (A. B.), that can tell where they are by that click that gets away from me.

Possibly I can't do a little slow in catching them, or possibly I run too fast to keep them, but I am still willing to learn and want to keep up with the times; however, I do not claim but that a man can estimate pretty close to where he is, judging by the speed he is running and length of time he has been running. I am not a theoretician tell exactly, in a fog you think you can cut off hanks any size so want, or a snow storm that hanks front and wind cut your face open when you stick your head out. Oh! by the way; do they steer ships by the log or by the compass, or is it all green and about water craft or the navigation of them.

GREEN BAY, WIS. H. HANBY.

What a Patent is Worth.

Editor.

My attention has been called to article headed "What is a Patent Good For?" in your excellent journal for November, 1893.

Patent law is so different from railroad that both your correspondent and the Editor seem to be in the dilemma of the snow-maker's apprentice who got into Sunday school "shooting the green" and "sneaking in a wagon-wheel, but did not know the number of Commandments in the Decalogue.

Many of your numerous readers are observing and practical men, liable at any time to make valuable inventions, and it is desirable that they should understand how to best secure the reward of their ingenuity.

It is true our patent system is not perfect, the words of the grant in a patent for an instance, are not as clear as they should be and are easily misunderstood. "The exclusive right to make, use, and vend the invention" is what is a Patent Good For?" to exclude all others from making, using, and vending, said invention," as that is all that a patent really grants any one.

The right to make, sell, and use every thing, new or old, exists in every body undisturbed by the law. The right to cut off by a patent to some one, and the right to sue for infringement, or even deny his limits, it simply gives him the power to hunt some one else. "Said invention" refers to the description contained in the specification and claims. And here mistakes often arise. The claims are the "mistakes and bounds" of the invention, and must be clear, for this cover is often necessary to be shown to make the invention understood. It is the same as with a real estate deed, which names the section, town, county, and State, to describe the land granted, while perhaps only forty acres, or even less, is conveyed. And the same is true with patents, only what is claimed is considered, not all that is shown, or described.

In shorting a patent all that is to be

settled is: What did the applicant invent?

What did he add that is new? Whether this device, as a whole, shows an infringement is not inquired into, that is a separate matter, but any patent attorney will report upon, but it will not be determined by the process of soliciting. This inquiry should be made—and usually is by good business men—before manufacturing begins. Mr. Michael's friend A. could have found all about that right you old patent matter, but it would be easy to do, but it was extra work, outside the case, not asked for or paid for by A. when he got his patent.

These matters are noticed and explained in nearly all patent attorney's circulars, and if A. chose to proceed without taking proper advice, he alone is to blame and not the "ignorance or cupidity" of the attorney, nor the system of the patent law.

If A. was sued for infringement, his patent was not considered, and could not be: it was the plaintiff's patent, and the device made by A., which device, to be infringed, must be shown to have been claimed by the plaintiff's patent. And it would be an infringement exactly the same, whether A. had a patent or not. Only when A. suits some one for infringing his own patent, could he lose it or have it construed by a court, or even considered.

The process, by which men invent is according to natural law, and the statute law must conform to it. We must deal with the nature, qualities and functions of things, and the working of the minds of men as we find them.

Let us examine this briefly. Usually inventions grow from simple to complex, like a tree, first the trunk, then the branches.

All inventors seek to do something, for instance, to stop a moving train.

Some natural law is always active—friction in this case. A mechanical invention is organized to utilize this natural law: this is the invention, the patentable thing.

Generally the simplest structure, the fewest and necessary parts are first combined. These, in this case are the wheel, the shoe to slide on the wheel, and the lever to press the shoe against the wheel. Suppose this invention to be patented to A., the claim would be the combination of wheel, shoe and lever. This is a generic patent, the first of the kind, and the trunk of the tree, which, with its many branches is the complicated air-brake system now in use, the contribution of many separate inventions. Now B. adds to this invention of A., the hand wheel, windlass and compound levers, thus inventing the hand-brake. A patent to B. would claim the combination of wheel, shoe and lever—the old combination of A.—the compound lever, windlass and hand wheel—the new of B.—a "combination on a combination" it is said, as though the attorney could avoid it. It is in the nature of things that the first of the kind, and so for these inventors? evidently only what it does. B. must not use what A. invented. If he could, then a mere improver could take for nothing the work of others. Nor can A. take what B. adds; otherwise no improvements could be held by the inventor. A. may have claimed only what he has invented. So that if B. says that B. is helpless, he cannot make an operative device without A.'s patented wheel, shoe and lever. If a man buys land having no road to it, he cannot therefore trespass, he had due notice of that fact, and must pay for a right of way. If a man enters a field, and finds it being infringed, he is in the same situation, he must invent around the obstacle, wait till the older patent expires; or procure a license from A. The mistake in such a case is in supposing that by issuing a patent to B. on a combination of his new elements with the old elements of A. So that if B. is assured of non-infringement. This is not true: an infringing combina-

tion may be patentable, and often is patented.

Many infringing patents are annually issued, and the question of infringement is never considered by the Government or attorney in soliciting a patent, and no decision by any Government officer can be had on that question under the rules of the Patent Office, if they are by a court. Novelty, utility and invention are the only grounds in the Patent Office. The larger combination of B. stands these, although it contains and infringes the smaller combination of A.'s patent. And B.'s rights, in spite of the words of the patent to him, are limited by A.'s patent. Now, to protect the air-pump, and avoid the rules of the Patent Office, and we have the straight air-brake. He goes round B. and infringes on A., we have now the wheel, shoe and lever of A., plus the air apparatus of C. operated by steam, in place of the hand-operated apparatus of B. Then comes the vacuum-brake, another system invented by D., using steam, but avoiding the pump, boiler, and valve, etc. of C. and we now have three separate branches, each embodying the combination patented to A., all using his wheel, shoe and lever. Each is independent of the other, and are three different and specific means of applying power to A.'s combination, and each infringing his patent. Now E. provides the reservoir, triple-valve, etc., and apparatus, the combination of C. and A., leaving out B. and D., here are three combinations in series, A. and C. and D. C. infringes A., and D. infringes both A. and C. So we might go on until the entire alphabet would not furnish inventions enough to illustrate the development of the brake systems in use. Driver-brakes, air-pumps, valves, couplings, auxiliary reservoirs, triple-valves, emergency or quick-triple-valves, etc., are found on one branch only.

There is a tangle of interests, of course, but it is because of the nature of the invention, process, and unavoidable. No law of man made at or by Congress can handle the natural relation of these many inventors or their relative equities. Therefore, experienced men must be consulted who can and will advise accurately and safely where each inventor stands. Every year trains become more complicated, and more machinery and apparatus must be cared for and operated. Suppose a train in charge of an experienced man should land in the ditch, because of neglect of some precaution familiar to an experienced crew. Who would you blame—the system of railroads or the management? That was the trouble with Mr. Michael's friend A. He did not seek the advice that he needed.

It is the British law, demanding all applications as filed, puts the work of outguessing the new from the old solely on the attorney, who, in this country, is held in check by examination, and refusal to allow broad or excessive claims. This would help the trouble complained of by Mr. Michael's friend A. The Government patent issued by any government on each side, deserves to determine or define the limits of the patentee; the limitations of his right to make, sell and use, must be found by examining the patents to others in force against him. His own patent means absolutely nothing in the inquiry, it shows only what he can stand for.

L. RICH V. MORTON.

Patent Attorney.

Grand Rapids, Mich.

[We are under obligations to Mr. Moulton and to Mr. Whittless for the very clear statements made—we were the boy who was in the boat. The statements were but have called out a clear understanding of the case; that could otherwise have been secured, and are therefore glad that we did not know better—our readers profit by it.]

The New York, Ontario & Western have ordered 500 cars from the Pennsylvania Car Works.

Cory's Force Feed Lubricator.

At the present time of very fast trains, making long runs between stops, the question of facilities for thorough and positive lubrication of all journals, eccentrics and links of the fast-moving engine becomes very important. The introduction of the device herewith illustrated and described marks a distinct advancement in securing the highly desirable means of oiling all important bearings of the locomotive, while it is running at full speed, and this is fully accomplished direct from the cab, from where it is possible to oil each bearing successively, or any particular bearing,

release the engineer from the responsibility of adjusting his present oil cups and inspecting and oiling by hand when first taking engine out from terminal station, the same as if engine was not equipped with the force-feed lubricator. There is simply placed at the disposal of the engineer a gallon of oil, that can be forced from the cab to any desired bearing as occasion requires.

There are now a number of locomotives running equipped with these lubricators, some having been in service for two years, and have never failed to perfectly perform their work, and none have required repairs of any kind to lubricator or any piping.

Train Running for the Confederacy.

BY CARTER S. ANDREWS.

It was March, 1865. General Sheridan had beat General Early back up the Shenandoah Valley, near Waynesboro. It was evident—and a very serious consideration it was—that if General Sheridan was allowed to pass Rock Fish Gap and cross over the Blue Ridge into the eastern portion of Virginia, that it would seriously affect General Lee's rear and his main source of supplies for his army at Richmond, where he was still waiting and watching the crouching lion, Grant. Lee

General Early if he so ordered, or to be sent flying down the grade to Mechum's River if the god of battle so decided. One day while there, shifting, unloading and reloading commissaries, Capt. A. D. Wren (the father of our present C. & O. passenger conductor, W. D. Wren), who was in charge of the commissaries at Greenwood, acting under Maj. H. M. Bell, G. M., came running over to the depot in great haste. "The depot stands on a spur track about a hundred yards across from the main track." "Finks," said Capt. Wren to Conductor J. B. Finks, who had charge of one of the trains, "I want you to take your engine and run over to Waynesboro,

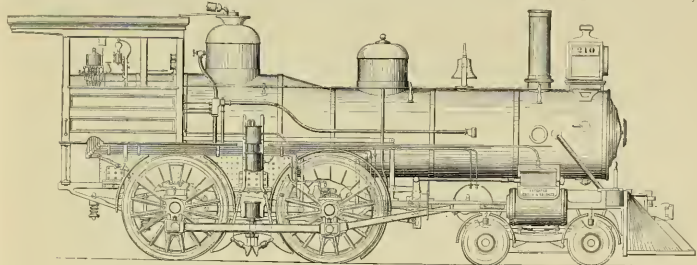

ENGINE EQUIPPED WITH CORY'S LUBRICATOR.

repeatedly, that may be giving temporary trouble by heating.

The lubricator is placed convenient of access in the cab, and consists of an oil supply reservoir of one gallon capacity; at the lower part of this reservoir is seated a hollow conical valve *V*, the cavity in this conical valve will hold about $\frac{1}{4}$ of a gallon. This space inside of conical valve is termed the oil discharge reservoir, and connects to oil supply reservoir by small valve *B*, seated in upper part of hollow valve.

The side of hollow valve is perforated by a hole *E*, $\frac{1}{4}$ inch in diameter, that can be brought to coincide with any one of the sixteen outlet holes at base of oil supply reservoir, that each connects with a line of pipe to a given bearing.

There are sixteen notches on the upper rim of lubricator, so that when lever is brought to engage with any one of these notches, the hole in the side of conical valve coincides with a given hole in base to outlet pipe.

When the lever is thus placed for any bearing desired to supply with oil, the valve shown attached to base and connected to either steam or air pressure, is opened and pressure enters through small valve *C* into oil discharge reservoir, closing valves *B* and *D* and forcing contents of oil discharge reservoir through hole *E*, and through line of pipe connecting with bearing that is desired to oil.

This requires but a moment, when pressure should be shut off and lever placed midway between any two notches, and in about five seconds the discharge reservoir will again be filled and ready for discharging to any desired bearing, when lever is placed in notch corresponding to bearing to be oiled and pressure again turned on. For all main journals three way tips are furnished for ends of pipe, thus the wedges and jaws are filed as well as the journals.

The engineer has, thus at his command a positive means of oiling all parts of his engine, however fast the engine may be running and however long distances he is obliged to run without stops, preventing any dangerous and destructive heating and cutting of bearings, delays of trains and possible accidents that might occur.

The use of this device is not intended to

The piping can be either $\frac{3}{4}$ -in. wrought iron or copper pipe.

This device is being placed upon the market by M. C. Hammett, Troy, N. Y.

Last summer, when we described the building of the new machine shop of the Pittsburgh Locomotive Works over the old one, we mentioned the fact that Superintendent Wightman had painted a few machine tools white—just as an experiment. Mr. Wightman has since painted all the tools in the works white; everything, even to the foundry. Blacksmith shop and boiler shop, has white tools. He says the advantages are so many and the disadvantages so few that eventually machine tools will always be painted this color. A streak of oil or other dirt is so painfully evident that the man in charge of a tool will not allow it to become dirty. The advantages of light are also of great value.

The Lake Shore & Michigan Southern Railway people are getting out drawings for the erection of large shops to be used principally for the repair of freight cars. President Overall has made up his mind that repairing cars on unprotected tracks does not pay. The men are not able to do a fair day's work in cold weather, and stormy weather frequently stops work at times when the use of the cars is highly important to the company. We understand that the intention is to provide the new shops with the best facilities that can be found for doing the work expeditiously.

A circular has been issued by Mr. J. Davis Barrett, chairman of the Master Mechanics' committee on oiling devices for locomotives, calling for information on the subject.

had no soldiers to spare to send to meet Sheridan, as all he could do now was to hold his own in front of Richmond. General Early, therefore, prepared to give battle at Waynesboro, and thus attempt to prevent the passage of Rock Fish Gap, one of the very few passages through the

to carry whiskey to Gen'l Early's men. I have just received an order to hurry it on as a fight is expected very soon. Just roll a barrel on the tender, back over to the platform, and come right back. Don't get out off there on the other side of these mountains and bridges."

"Good sir," said Finks, whose family lived at Waynesboro, "I want to get a clean shirt any way and tell the old lady good-bye."

Mr. R. W. Goodwin, his engineer, was informed, and soon got ready to load a barrel of the liquid fire. It was corded up with the wood in the tender of the "Albemarle" (C. & O. No. 17), a Rogers engine, built at Paterson, N. J., about 1853. It was a very fine engine, if it got good fuel, but would slip unless you gave her plenty of sand. The boys used to say that if you were to spit on the track old "Albemarle" would never go over it. As the engineer, Mr. R. W. Goodwin, was the most prominent character in my narrative, allow me to say that this Christian gentleman still lives and earns his daily bread by pulling the "Albemarle" over the C. & O. No. 123, ten wheels connected. As an almost daily witness of this man's conduct for thirty years, I can truthfully say that his life disproves the oft-repeated assertion that a railroad man cannot be a Christian. His religion is recognized by us all, and no one would dare ask him to deny his Master.

Backwards sneaked the old Roger through four tunnels and over Smith River Bridge. When it came up to the platform at Waynesboro, Mr. James Wallace, the agent, took charge of the barrel. "Bob," then said Conductor Finks, "I'll run home, and tell the old lady good-bye, and be back in ten minutes."

"All right," answered Mr. Goodwin, "but I am afraid Mrs. Finks will not let you return, as times are so equally around here. If you are not back in twelve minutes I shall leave you." "Just look here," said the excited Agent Wallace, who was standing close to the "Albemarle." "Finks, our men are defeated! Look up the ridge! Look how they fly!" No one can give a description of the sight of cavalry scout fighting that will do it justice. To see a road full of fleeing

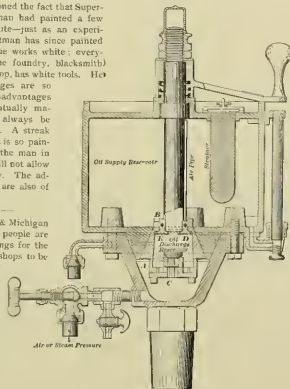

CORY'S LUBRICATOR, SECTIONAL VIEW.

Blue Ridge. General Early very proudly held his supplies at Greenwood Depot, a station on the eastern slope of the Blue Ridge and just east of the last of four tunnels which lie between that point and Waynesboro.

Waynesboro is at the western base and Greenwood at the eastern. Two of our trains were held at Greenwood partly loaded, while a good many supplies were in the depot ready to be moved over to

cavalrymen, then their enemies' bold pursuit, is something one cannot forget, but which cannot be described. It must be seen to be appreciated. It must be seen in the bushes, and you had better see it. The best time was on this turf is not on record, it lies buried in the grave of the "Great Unknown."

But the fleeing cavalry made it. Conductor Finks saw a plenty, and heating a moment over the military question, he presented itself with his anxious soul. "Shall I desert my train and share the fate of my family, or leaving them to the tender mercies of the enemy, shall I save my train and commissaries?" Finally with one foot on the platform steps he said: "The Albatross!"

"Bob," James, tell my folks I feel it is my duty to go and save my train, but don't do that I will try to get back to them again as possible."

He now pulled up on the "Albatross." Mr. Goodwin needed no further signal to pull over the bridge, and heating a moment over the military question, he found the heavy crew, where he had seen the flying cavalry and pursued commissaries. When the "Albatross" pulled about a station four miles east of Greenwald, some of General Lee's cavalry had already passed, surprisingly enough, it was only a few minutes to Greenwald, and everything was on the move.

The train of commissaries was heading down on main track ready to go. The motor Finks and Mr. Goodwin were ordered to run in on the spur track to get the engine cars, which had been loaded with commissaries, out at a time.

The shouting about in there came from the engine, were very near, and the firing could be heard. The long train on the spur track pulled out. The switchman, in confusion, threw the switch wrong and derailed one car, led Engineer Goodwin, realizing the necessity, promptly stopped in order to escape, reversed his engine, and gave her all the steam he had command. The car cut back on the track to the north. In double quick time the engine, pulling of three cars in front of the "Albatross," and four behind as seen from the north.

The sound of a conductor Finks, who had thrown the switch, pulled up on the engine, saying, as he did so: "Bob, I am afraid they have got us." Mr. Goodwin pulled cautiously out of the eastern portal and cut approach of Greenwald tunnel, and entering the tunnel, and the passenger officer exclaimed: "Great heavens! Job, we are gone," as he saw the Federal cavalry all about and around the depot and crossing. Conductor Finks, thinking, of course, that they were captured, jumped off from the opposite side of the engine from where the passenger officer sat. The freeman, Jim Whiting (colored), and the brakeman, Jim Cowling, also colored, all jumped off. Mr. Goodwin followed Captain Finks to the steps of the engine with the intention also of jumping off, but suddenly changing his mind he went back to remain and run the gasometer.

In the meantime the engine was rolling slowly towards and getting close to the enemy. Springing to the throttle, Mr. Goodwin attempted to open it wide and thus increase his speed and prevent the soldiers boarding the train. The throttle being hard to open, his effort failed, and so he ran by the cavalry at a rate not exceeding fifteen miles an hour. After his effort to increase his speed failed, he fell to the board and stretched himself out like a lizard on a log in order to avoid being shot by a cavalry soldier, who by this time was within ten feet of the engine and trying his best to shoot Mr. Goodwin. But the engine and tender received the seven carbine bullets, which were intended for Bob.

One bullet severed the cushioned seat, which was at this time occupied, and then punched a hole in the tank, but too high to waste much water.

By the time the cavalryman had wasted

his seven bullets the engine had arrived at a point where he could not ride farther, on account of the termination of the high earth and stone platform leading from the passenger depot to the Tinwaldle Hotel, and upon which the cavalryman had ridden. Bob realized his advantage, and did not fail to make good use of it. He again jumped to the engine, and having made a feeling the machine respond to his touch, and under a shower of curses from the cavalryman the "Albatross" darted forward.

All old V. C. men remember the "Albatross's" whistle, and when Bob got clear off he gave a yell, which he captures a loud and long farewell. Mr. Goodwin will always attribute his escape to a kind Providence, in whom he trusted, when he prayed as he did while the cavalryman's bullets fell harmless around him.

Any railroad man knows that an engine and seven cars, when running on a twenty-five foot grade, will very soon attain a speed which is dangerous. Mr. Goodwin began to look around, realizing his still critical situation, and looking about for some of his crew, he saw

a colored brakeman, a green hand, on the opposite side of the engine from where the firing had been coming, clinging on the side of the boiler, and holding to the hand-rail. He was frightened nearly to death. Then looking back in the sound on the tender he discovered Davy Spratt, among the assistant depot agent at Waynesboro, who had secreted himself there to avoid capture. Mr. Goodwin soon had them both in the train and not a minute too soon, for it took a reversed lever, a full head of steam and all that the brakes could do to prevent a rear-end collision with the front train which had stopped in the mountain slope for wood.

After leaving Pierre, the train reached Mechem-Kriver, a station fourteen miles from the eastern portal of Blue Ridge tunnel, and the foot of the grade being 1,000 feet lower than where it had started, the train was now on a steep going east. Mr. Goodwin encountered a pretty stiff grade rising by his hill.

He feared trouble, for he was out of sand. He soon became convinced that he would either have to cut loose and leave some of the cars there or be captured by Sheridan's cavalry, who were following the train, which they thought they were taking in full view where he stood spinning his drivers. He ran back, intending to cut off two cars of the rear of the train, but Captain Wren, who had charge of the commissaries, begged so hard that he should not do it, that he concluded to try her once more, and see if he could, by using dirt on the track, by this means get her to pull the seven loaded cars up the grade. If he could have had sand, it would have been no doubt for the "Albatross" with plenty of sand she could have pulled the eight cars up the grade without any further trouble.

Mr. Goodwin became convinced that it was useless and dangerous to lose any more time, and so he was obliged to cut loose the two rear cars loaded with commissaries and leave them standing on the main line.

When the Federal cavalry came by next morning the third day the brakes and led them to get to Mechem-Kriver. The structure 75 feet high and 90 feet long, and amounting bridle cars with oil, burnt all to ashes. Mr. Goodwin rested awhile at Charlottesville, and then resumed his trip to Richmond, which he completed the third day from the time he left Greenwald, arriving at the engineer and fireman the whole way, six miles. Two young men who were assisting Captain Wren were killed at Greenwald as this train pulled away. Mr. Randolph J. Altemarre and a Mr. McCrory, Captain Wren and Mr. McCrory were crushed behind on one safe of the engine cars, but Captain Wren said that Mr.

Creary lost his life by looking around from behind the safe to see what was going on against Captain Wren's caution.

Captain Finks was captured, but released by General Sheridan, after strenuous and persistent intercession of the citizens of Waynesboro. According to the customs on both sides in those days, however, he had to forfeit his watch and boots.

Manning, Maxwell & Moore's Catalogue.

Several years ago Manning, Maxwell & Moore, New York, got out a catalogue of the tools and mechanical appliances handled by the firm, which probably was the most complete catalogue of this character ever published. This firm have now published an enlarged catalogue for 1904, which is as far ahead of the old one as it was superior to others. This catalogue is a volume of nearly 1,100 pages, 10x12 1/2 inches, splendidly bound and filled with engravings and descriptions of all the tools and steam-engine appliances we have ever seen, besides a great many that are new to us. We know of a case where a railroad official was directed to make out an equipment of tools for large shops, a

but it took a great many changes before the heater was made to work satisfactorily. The president interested himself in what he perceived was a valuable investment, and was patient under failures, and made no complaint because changes were necessary. After persistent labor the heater was perfected, and it worked so well and gave so much satisfaction that it was applied to most of the cars belonging to the company.

One time that Mr. Phillips, who was then general superintendent of the Michigan Southern, was on his way to Boston, he was surprised and pleased with the way the cars on the New York, New Haven & Hartford were heated, and he looked into the Baker heater and ordered one for his road. It caused quite an excitement in the West, and a railroad man made long journeys to see it. George M. Pullman was never slow to see the advantage of any improvement in car equipment, and he soon found out about the Michigan Southern heater. He watched its action very carefully for several weeks and then adopted it for sleeping cars, the progress of the Baker heater into favor was very rapid after that.

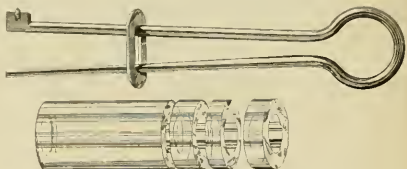

A NEW GAUGE GLASS CUTTER.

restriction being made on the money to be spent. He took the old catalogue of Manning, Maxwell & Moore, and used it as a guide, counsellor and friend, and is to-day enthusiastic about the help received. The present catalogue will be found perfect as a reference of this character. When a man wants to buy a tool of any description, large or small, he will find full particulars about it here. If he wants a tool for some operation that he does not know there is a tool for doing, let him examine this huge book, and he is certain to find what he wants.

Growth of the Baker Heater.

The agitation in favor of safe methods of car-heating was carried on long before anything practical was done to dispense with the dangerous car-stove. Every accident that happened, which gave the red-hot stove the name of being a "hotbed" of agitation for safer methods, but no one could see how a car could be heated by any other means. Besides its tendency to set fire to the car in case of accident, there were other grave objections to the stove, for it was an inefficient means of heating, as it would burn at the stove but would be uncomformably hot, while its parts farther away would be at a freezing temperature.

When the first agitation was at its height in favor of improved methods of car heating, Mr. William C. Baker was engaged in house-heating, and he conceived the idea that a car could be heated with hot air circulated from one heater that could be made strong enough to be safe. When he expressed his views to railroad men they dismissed him as a crank. Those who made pretense to know something of natural philosophy, said that the man who proposed a hot water heater and downward flow did not know what he was talking about.

In 1850, after much effort spent in convincing him that a hot-water method of car heating was practicable, the president of the New York, New Haven & Hartford consulted to let Mr. Baker put a heater into his private car. The work was done,

A New Gauge Glass Cutter.

The engraving shown herewith will make clear the general form of a new glass tube cutter just put on the market by Stannard & White, of Apolton, Wis.

The cutter is carried on one of a spring steel wire, bent into the form of a split key. At the two ends of the wire slide a washer that serves to keep the ends together and as a gauge to cut to. There is no danger of applying too much pressure with this cutter, as the spring applies all that is necessary. The cutter does its work on the inside of the tube. This little tool would be a first-class trick in any engineer's seat box.

Saves Money, but Makes Grid.

A drummer who was an old engineer walked into an engine-house belonging to the New York Central and began questioning the foreman about the various engines. "I see you are using brick arches," he remarked, "do they save fuel?"

"Do you know anything about locomotives?" answered the foreman, looking furiously at the plug of the drummer. "Well, I've ran an engine in my time, but she had no ornament of that kind in her firebox."

"Now, friend," said the foreman, "you may be a master mechanic or a general manager. If you are, and are trying to cut something about brick arches, I can give you a partner. If your coal is very expensive, you will save money by using a brick arch. If you object to seeing the black smoke roll out like ink from the top of the smoke stack, the brick arch will help your firemen to keep that stream white, but it will give you so much grief in other directions that you will wish, the worse saving and smoke prevention had never been invented."

The fifty-five passenger cars for the Long Island Railroad have gone to Pull-

Car Shops and Car Builders.

Growth of the Sleeping Car.

Referring to the facts recently published in LOCOMOTIVE ENGINEERING concerning early sleeping cars, a correspondent who is exceptionally well informed on histor-

enger train conveniences, but they failed to do so, and private enterprise sowed the seed and reaped a rich harvest.

The first two sleeping cars constructed according to Mr. Pullman's plans were built by the Chicago & Alton Railroad, at

of passengers, and making the beds of a character that would attract patronage. When the success of the sleeping car business on the Alton was assured, some new cars were ordered from the Wagon Mfg. Co., and they were considered marvels of luxury and comfort. The first one cost \$5,000, which was then considered an enormous sum to pay for one car. It paid even as an advertisement for it excited as much attention as the latest development in the sleeping car line excuted at the late Exhibi-

prosperous, there was, for a time, an epidemic of new sleeping car companies, but none of them ever amounted to anything except the Wagner, which was under the Vanderbilt protection and encouragement. It is a close corporation, most of the stock being held by members of the Vanderbilt family. Wagner cars are now as good as Pullmans, but for many years the cars were very inferior and the service worse. The service is still open to improvement.

Special Shop Tools.

One of the subjects on which a report will be submitted to the next convention of the Railway Master Mechanics' Association is "Special Shop Tools." There have been reports repeatedly submitted on shop tools, but they generally dealt with the latest improvements in machine tools, and contained little that could not be learned by an examination of a good descriptive catalogue. The subject to be reported on at next convention is of much wider scope and is likely to contain information of a highly valuable character. The chairman of the committee is Mr. T. W. Gentry, who is one of the bardest working members of the Association, and a man who has done as much for any one we know to design the appliances which we look upon as special shop tools.

Some railroad shops are celebrated for the variety of special appliances contrived to facilitate work or to secure increased accuracy. There are few shops to be found where there is not some labor-saving device in use, devised by an ingenious workman or inventive foreman. A curious thing about these appliances is, that they may be used for years in one shop without others knowing anything about them. The people using them get to look upon the articles as common because they see them every day, when all the time they would be considered the greatest novelties if seen by strangers.



SMOKING-ROOM IN CHAIR CAR, ST. CHARLES CAR WORKS.

ical railroad matters says that there were a great many attempts to establish sleeping car service long before Mr. Pullman made the business a commercial and mechanical success. The long railroad journeys that became possible on this continent more than forty years ago stimulated inventors to design cars in which travelers could obtain rest and sleep at night. Most of the early inventors made modifications of the sleeping berths found in steamboats, most of them having provision for converting the berths into seats for day use. The sleeping arrangements, on the whole, were satisfactory enough and were a great improvement to tumbling about in a seat all night, and travelers who enjoyed the privilege of a bed in a car acknowledged that a system of sleeping cars that did not entail change of car at the connecting point between different railroads was greatly needed. Railroad companies that attempted to introduce sleeping cars did not make a success of the business. The managers appeared to have enough to do without devoting special attention to what was regarded by many as a dangerous innovation, and the sleeping car service was neglected. A magnificent source of revenue was lost through the short-sighted policy of men who were afterwards the first to denounce the robbery of railroad companies by owners of sleeping cars.

The Pullman Palace Car Company turned out to be as heartless a corporation as ever abused public confidence, but to its head the traveling public is indebted for the comforts now enjoyed during long journeys. George M. Pullman was a mechanic who could devise ingenious methods for converting a car into an array of comfortable beds. In addition to this he was a man of affairs, who perceived how sleeping cars might be operated upon a business basis. On charges for berths which had runed others he built up a lucrative business. The leading railroad companies of that day ought to have worked up a sleeping car business as part of their pas-

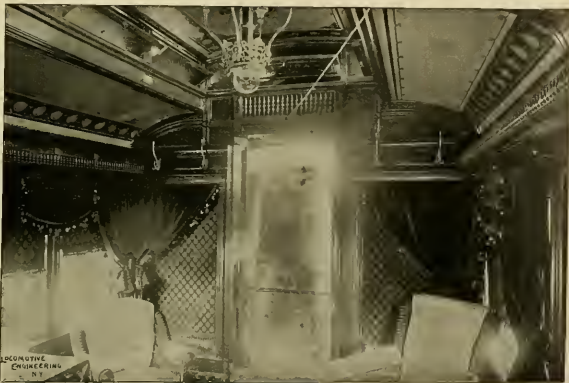

PARLOR CAR INTERIOR, ST. CHARLES CAR WORKS.

Bloomington, in 1859. The work was done under the supervision of Mr. David Shields, who was then master car builder of the road. Mr. Joseph Townsend, now master car builder at Bloomington, was a foreman in the shop at the time, and attended to the details of the work. When the cars first went into service, Mr. Pullman ran with one of them as conductor, and in that capacity began studying the methods required to make the business pay. He was greatly in favor of increasing the comfort

tion. Pullman gave the cue in 1860, and insidious furnishings have been on the increase ever since. The Wagner sleeping cars came later, and their style of construction and methods of operating followed after Pullman. The leading features of the cars did not admit of being secured by foundation patents, and so the style of berths were not materially different in any of the sleeping cars that were brought out as rivals to the Pullman. After the Pullman Company became

The peripatetic mechanical journalist has done a great deal to bring ingenious shop knicks and convenient mechanical tools into public notice, but there are still hundreds of these that flourish unseen in obscure tool rooms and in the recesses of machinists' tool boxes. When the writer goes through a railroad shop with a master mechanic, master car builder or foreman, he always asks if he have any special tools or shop knicks. Sometimes he will be taken to look at a fine turret lathe or a

wheel-horing mill of the newest design, or a wood-working machine with wonderful capabilities, but ingenious minor tools are seldom known, and they have to be discovered by patient search.

These minor special shop tools and special methods of doing work are what the Committee ought to investigate most thoroughly and make known to the Association, and through that to all railroad men interested. There are many simple devices that would be greatly valued if they were only generally known.

The electric trolley vs. threatening railroads with competition in a new form. As a means of transmitting power to street railroads it has seriously crippled the suburban business of many railroads, and it has now been applied to supplying power for the propulsion of canal boats. An experiment was made on the Erie canal last month with a boat having a canal last month with a boat having a screw propeller operated by a dynamo, to which electricity was conveyed through a trolley system. The work was done by the Westinghouse Electric Company and

have adopted the piece-work plan for running repairs to cars. Not only do they pay their own car repairers the fixed price for work done, but they let out their repairs to contract shops on the piece-work basis.

Material fluctuates in value, and it is found necessary to separate material from labor, making a price for labor and another for material, and this is done in every case that we know of.

The plan followed by a well-known private car line, which has its general repairs done in a contract shop, is to make

credit was given the car from which it was removed, with 10 to 20 per cent. All orders to be credited at market rates and second-hand wheels and axles, fit for further use, shall be credited according to the Master Car Builders' Association Rules.

Each month the contractors fill out a blank price list of material as given below. This states from what day in a certain month to another day the prices are to hold, and changes in the market price of material during that time does not affect the price list—both sides know what they are doing, and have to do

PRICES OF MATERIAL. . . . 1894 . . . 1894
Axles, steel, per 100 lbs.
" iron,
Butter draw-bar attachment, each
Bar iron, flat, per 100 lbs.
" " round, per 100 lbs.
Bolts, " " "
Chains, " " "
Cast iron, " " "
Draw-bars, M C B, yokes, each—
" cast iron, link, pin (with top
bolt), each.

Draw-bars, malleable iron, link pin (with
yokes), each.
Dust-guards, each.
Flooring, per 1,000 ft.
Forgings, per 100 lbs.
Hickory, per 1,000 ft.
Journal bearings, per 100 lbs.
Lag-screws, each.
Malleable iron, per 100 lbs.
M C B knuckles, (steel), each
Nuts, tapped, per 100 lbs.
Nails, wire, " " "
" cut, " " "
Oil, lubricating, per gallon.
Oak, per 1,000 ft.
Paint, ready mixed, per gallon.
Rivets, per 100 lbs.
Springs, draw-bar, each.
" truck elliptic, each.
" " coil
Southern pine, per 1,000 ft.
White, " " "
Washers, cast, per 100 lbs.
" wrought, per 100 lbs.

Waste,
Wheels, 550 lbs., each
" feet, "
NOTE—The above prices include the 10 per cent. over actual cost. All material, timbers, forgings, castings, paints, etc., shall be of the best quality, and all work must be done in a substantial and work-



LOCOMOTIVE ENGINEERING N.Y.

C. M. & S. P. STEARNS' DESIGN FOR SEATING CAR WORKS

ing railroad companies would profit much from their introduction into general use. The Committee has sent out a circular calling for information about special tools for railroad work, which ought to receive careful attention. We consider this subject of importance second to none that will come before the convention.

Inventing Car Couplers.

A peculiarity about the invention and patenting of car couplers is that the greatest part of the applications to the Patent Office go from small country towns where there are no railroad shops or establishments engaged in car building. The origin of a great many of the inventions is that a man of an inventive turn hears about the injury and destruction to life that is caused yearly in the work of coupling cars, and he proceeds to design a coupler that he supposes will work automatically. He has not any idea of the real requirements of a car coupler, but he is intent principally upon getting up something which will couple with another of the same form when both come together on a straight line. This is the origin of so many link and pin couplers being patented long after those of the vertical type have been made standard.

The inventor in numerous instances do not know what a vertical plane coupler is. They get the inventing idea into their heads and work it out by examining the couplers of the cars they find standing on side tracks. The link and pin coupler is still in the majority, and the rustic inventor naturally supposes that the majority is the side he ought to keep in with. The consequence is that the Patent Office continues to receive a good revenue every month from the inventors of car couplers of a form that no railroad company will ever apply to a single car.



LOCOMOTIVE ENGINEERING N.Y.

ANDREWS' DESIGN FOR SEATING CAR WORKS

was perfectly satisfactory. The objections are that the practice is going to be reversed and that the trolley will kick the festive mile out of the canal path.

Repairing Freight Cars by Piece-Work.

Schedule of Prices Paid for Labor by one of the Large Lines.

For some years past several of our large roads, including the Pennsylvania, and quite a number of the private car lines

a monthly agreement about prices of certain specific parts, and then have the following general rule, covering all material not enumerated in the monthly price list.

MATERIAL.

"All new materials to be charged at market rates with an addition of 10 per cent.

"Proper credit must be allowed for all scrap and good material removed from every car—such credits to be deducted from the charges against the car from which they were removed.

"When second-hand material, in good condition, is resupplied it shall be charged against the car at the same price for which

made in a manner, subject to proper tests and inspection.

Air-brakes to be repaired at actual cost of labor and material, plus 10 per cent. All tenons to have one coat of paint.

Prices for labor are contracted for by the year, and the prices given in this article have been found very satisfactory, being the results of some two years' practical trial. The line finds that their cars are kept in good condition for much less money than they formerly spent in a shop of their own, while the contracting firm are well enough satisfied with the arrangement to be glad to sign a long contract

Indicator Diagrams from Union Pacific Locomotive.

The indicator diagrams shown on this page illustrate the work done by passenger engine "84," belonging to the Union Pacific, while pulling a train over the division from Omaha to Grand Island, the profile of which accompanies the diagrams. The engine was built at the Omaha shops under the supervision of Mr. J. H. McConnell, superintendent of motive power, and the dimensions and proportions represent his ideas of what form of locomotive is best adapted for the work to be done. The engine is of the eight-wheel type, and has cylinders 18 x 26 inches, and driving wheels 69 inches outside diameter. The boiler is of the wagon-top form, with crown-bars supporting the crown. The boiler is very substantially made, and carries a pressure of 160 pounds to the square inch.

In speaking about the engines, Mr. McConnell says that he has done all in his power to make the exhaust passages as

Engines of this class pull a train of six or seven passenger cars from Omaha to Denver, a distance of 59 miles, in fourteen hours, making nineteen stops. They make time with this train very regularly.

The diagrams were taken with a Tabor indicator, spring 80 pounds to the inch, and represent the work done by one side of the engine. The cards show a remarkably good distribution of steam, with very little pressure to be desired in the way of expansion. An engine working along for a whole day using the steam in the fashion shown by these diagrams, leaves little opportunity for improvement by compounding, for the steam is exhausted as close to atmosphere pressure as the necessities of maintaining draft on the fire will admit. A criticism that readily occurs to one analyzing the diagrams is that the valves were not very well set, and the work done on the forward and back strokes is not so uniform as it might be. A difference of more than an inch on one side, when the steam is cut off at nearly half stroke, is too much. The saddle-pin needs to be set

pressure when the diagrams shown were taken is 173 pounds, and the average initial cylinder pressure is 125 pounds, an average drop of 48 pounds, equal to 25 per cent.

the throttle nearly closed. It may be that the alkaline feed water causes the steam to come through the steam pipe so wet that an advantage is obtained by throat-

PARTICULARS OF DIAGRAMS.

No. of diagram	Speed in miles per hour.	Revolutions per minute	Boiler pressure in pounds	Initial cylinder pressure	Mean cylinder pressure	Opening of throttle	Cut-off forward end of cylinder in in.	Cut-off back end of cylinder in in.
1	20.8	101	165	128	83.2	59	14 1/2	13 1/2
2	18.3	88	175	137	91.2	59	14 1/2	13 1/2
3	15	118	175	125	84	59	14 1/2	13 1/2
4	41.6	203	175	105	35.64	59	5 1/2	5 1/2
5	50	243.4	160	125	37.6	59	5 1/2	5 1/2
6	45.8	229.7	175	135	40	59	8 1/2	7 1/2
7	29	141.2	175	115	44	59	12 1/2	11 1/2
8	41.3	204.4	175	145	48	59	12 1/2	11 1/2
9	58.3	274	170	137	40	59	5 1/2	5 1/2
10	14	263	175	145	45.4	59	8 1/2	7 1/2
11	10.7	100	175	102	28	59	8 1/2	7 1/2
12	62.7	304	170	100	22.5	59	5 1/2	5 1/2
13	62.7	300	170	115	33.4	59	5 1/2	5 1/2
14	62.7	300	165	130	37.6	59	5 1/2	5 1/2
15	51.4	250	165	140	39.30	59	8 1/2	7 1/2
16	48	210	175	137	30	59	8 1/2	7 1/2

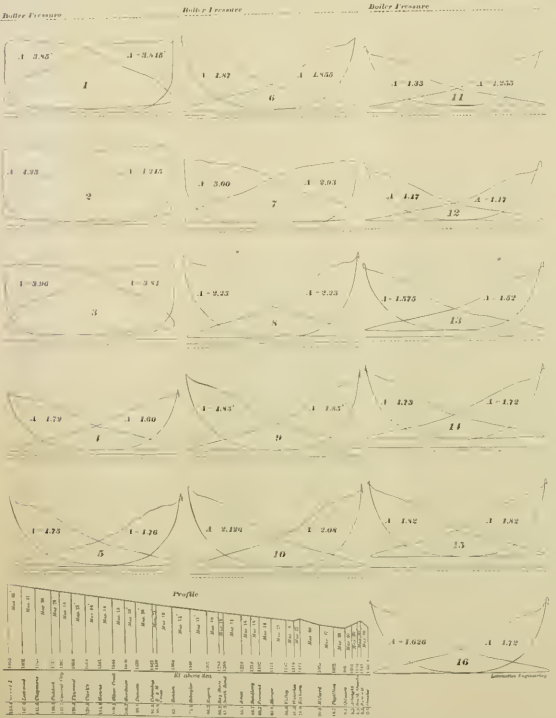

ling, which induces some superheating. If the water used on the division between Omaha and Grand Island is good enough to make steam that has no tendency to prime, the way this engine was worked led to considerable loss in the use of steam.

There is nothing more definitely settled in steam engineering than the loss due to throttling of steam. We should calculate that the loss in this engine would reach 20 per cent. There was no excuse for this, because the reverse lever is finely notched, so that the engineer can set the lever to suit the call for power. Take, for instance, diagram 4. Here the reverse lever is in the twenty-eighth notch and the cut-off is 5 inches, the throttle valve being 1/2 inch open. There is every reason why the lever should have been hauled back so that the cut-off should take place 2 inches earlier, and the throttle valve opened out. This change would have produced as large a card width, perhaps, 25 per cent. less steam. Nearly all other cards are open to similar objections.

It is evident that the engine has been well designed for doing work economically. She was not hauled to make good use of the steam, but circumstances, and not the engineer, may be to blame for this.

Every year after the Interstate Commerce Commissioners' report comes out it becomes the text for whimsical statisticians to highten out and expatiate upon the number of miles a man must travel in a railroad train before his time for meeting an accident comes round. It is no doubt very amusing for the people who like that kind of amusement to pursue that kind of figuring, and it may reassure some timid people that their time for getting killed is still far distant, but calculations of that character are despised by those who understand how accidents happen. The average number of miles traveled by each person between accidents proves nothing. They do not indicate where accidents are common and where they are rare. Sensible people had better not to depend upon the general average, but rather to watch the railroads where accidents are rare, and travel by them in preference to the roads where accidents are of frequent occurrence.

There is close relation between good rolling stock, good signals and the most approved methods of operating, and the exemption from accidents.

A new paper has been found for anti-friction rollers. James Clayton, of Brooklyn, N. Y., has applied them to valve eccentrics and patented the arrangement. The eccentric is cast with cavities, which are open at the periphery of eccentric. Anti-friction rollers are fitted into the cavities at the eccentric's straight ends on them. This is not open to some of the objections raised to anti-friction bearings for cars.

large as possible, and that this policy is followed with all the locomotives on the road. The effect of this can be seen on the diagrams, which are noted for the small amount of back piston pressure.

back a little or other adjustment made. A characteristic about the diagrams that we do not like is the low initial cylinder pressure of the steam. The average boiler

This is due to the vicious practice of throttling the steam, which is apparent in all the diagrams. There may be some reason why locomotives on the Union Pacific should be worked habitually with

*Railroad Coppermithing—V.

By JOHN FULLER, SR.

OUTLETS.

We will now turn our attention to outlets, which it is often necessary to construct to convey water or steam in some direction which is not in the direction of a main pipe. They are made, placed and secured in position in two ways as a rule, that is, they may be riveted and soft soldered, or they may be brazed after having been properly prepared and fixed in their positions, as the circumstances of the case require. In some kinds of work where it is necessary to have outlets, some of the most common varieties, they are more often soft soldered in their positions than hard soldered; but in marine and locomotive work, as a rule, they are all hard soldered, excepting those which are worked out and formed from the material of the main pipe, which can be of any size to suit the requirements of the job and made up to the size of the main pipe to lead from.

We will suppose, in the first example before us, Fig. 54, the pipe is 7 inches in diameter, and an outlet 4 inches diameter is required at the point *I*. A short piece of pipe of the length required to form the outlet is cut to fit the pipe, the outlet being previously drawn out a little at the bottom end, the edges are then filed and rounded up smooth and free from burrs, and a flange from 1/4 to 1/2 inch wide is laid off from the bottom edge, the flange being next nicely fitted close to the main pipe. The hole in the main pipe is cut out about 1/2 inch smaller than is required to be when finished, and a burr is worked out from the main pipe, as shown at *F*, and made to stand up 3/4 inch inside the outlet when it is placed on the pipe. Let the burr fit close and snug on the inside of the outlet, and the outlet flange fit nicely down on the main pipe. When the outside flange has been fitted, clean the place it is to occupy, either by filing or by the heating process, using salt and water before making hot, also clean the outlet in the same way.

When this is done, spread an even coat of fine spelter on the flange of the outlet so far into the outlet as the burr of the main pipe is likely to reach, as at *H*. Now, take it to the fire and run the solder just hot enough to run smooth and evenly all round the flange. (This is to answer the same purpose that tinning does when making soft solder joints.) When done, cool it in clean water. The face of the flange should look now like a piece of fresh clean sheet brass. Place the outlet in position and wire it fast to the main pipe. It may now be brazed on the brick

work, Fig. 56, by laying solder between the outlet and the joint, one-half of which should be on the outlet flange and the other on the main pipe, heat the main pipe slowly until it is blood red in the shade; by this time the borax and spelter on the joint should have the appearance as if varnish was among the spelter, and by holding the flange close, now offer the solder to a moderate brisk fire of sufficient power to make it run and flow with ease, filling the joint right through to the edge of the burr inside. If, however, the job is of such a nature that it is inconvenient to handle at the brick forge on account of size and weight, now offer the solder to a balloon fire may be brought into service with advantage, and by its agency the fire may be taken to the work instead of taking the work to the fire, as in Fig. 59. This firepot is called a balloon firepot, from its similarity to a balloon. It is made of a half iron, and is about 12 inches long, with a conical point at the bottom, at the end of which is an opening about 1 1/2 inches in diameter, through which the flame is driven by the blast, which is conveyed from the supply-pipe to the firepot by

means of a hose or other pipe. The cover there is a flat piece of heavy boiler plate. Before using this firepot it must be lined on the inside with about 1/2 inch of fire clay.

The work is first made ready for this fire by heating it as near as can practically be done to a red heat, so that the pot may not have to supply too much heat to the parts which surround the joint, but that all its power and intensity may be concentrated on the point where it is required and most necessary; when this instruction has been carried out the work is ready to proceed. The pot having been previously hung in position to the traveler, it is now filled with live hot coke, which is made to be close and compact in the pot, when all is ready it is brought to the joint and the fire with a brisk blast is thrown on the spelter, which will quickly run if it has been properly handled and kept in condition with a sufficiency of borax, and the parts adjacent to the joint have been kept hot.

Outlets intended to be soft soldered should be fitted with the same care as are those for brazing, and may be riveted as at *I*, in Fig. 54, in addition, in some cases this is quite necessary and should

there are only two in common use as a general rule. These are when the three passages are all one size, as in Fig. 60, and when the inlet is equal to the two outlets, or the reverse, as in Figs. 61 and 62. The first is formed by making two saddle pieces, a cap or bottom piece, and a gusset, *A*, as in Fig. 60. This piece of work would look better without a gusset, as in Fig. 63, which can be done by leaving the corners on the saddle pieces and squaring them up before putting together, but there is the advantage of economy in favor of the gusset, as there is always a good supply of pieces available in all shops. The tee in Fig. 61 is formed of two taper pieces, the larger end being equal to one-half the circumference of the inlet at one end and half the circumference of the outlet at the other. This can be made with or without a gusset, as desired. The stem or large end should be kept the same thickness or diameter right through to the bottom cap, and the other two taper off as if two frustums of cones were joined together at the base, the small ends having a short distance of them parallel from the end for the flange to fit on, to make the necessary connections with other pipes. I

being that the area of the stem is equal to that of the other two branches, as shown in Fig. 66. British pieces are made of pieces similar to those described for Fig. 61, excepting the etotch piece at the bend or turn is cut a third through on each side, as shown, and a gusset, *A*, cramped in the turn and brazed; then the other two side pieces are thrued, cramped and brought together and wired, the seam dressed down and chattered loose, then brazed.

CROSS, OR FOUR-WAY PIECES.

Small cross or four-way pieces are made similar to three-way by joining four saddle pieces together with a gusset, unless some special purpose calls for another method. In large work, two ways are adopted, according to the skill of the workmen engaged.

The first is by cutting out two pieces, as shown in Fig. 67, and tazing down the throats and making the four joints by cramping the pieces together in the four throats or saddles, and brazing. The other by making it in two halves, with the seam on the side and cramping together, as shown on Fig. 68. To do this with the least amount of labor, we must reduce

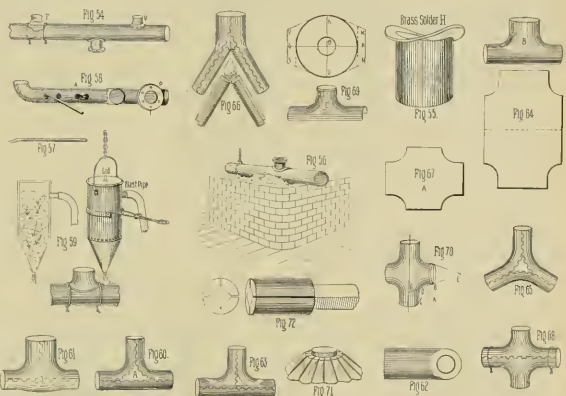

not be omitted. To work outlets from the main pipe, which it is sometimes better and more convenient to do, we proceed as follows. On the pipe, Fig. 58, at the point where the outlet is to be, measure off the distance equal to one-half the circumference of the outlet required; from the two extremities of this half-circumference and between them, measure each way a distance equal to the turn to be made for the flange *J*. Now drill two small holes, and with a file round up the edges of the holes smooth; then make the part red hot and insert the burring pin, Fig. 57, and with the bent end jar or drive out the collar while the pipe is yet hot; when it is out as far as necessary, slit it down between the holes as at *K*, Fig. 58, and open it out easy until completed as shown. Care must be taken to file the edges of the outlet let up round and smooth and keep them that way, so that no rough burrs be left on. With ordinary mechanical ability and a little close attention an outlet can be worked out from the main pipe long enough to get a flange on, as shown at *J*, Fig. 58, by which to make connections with other pipes. This makes a good job.

have made small tees from one piece cut from the sheet, as in Fig. 64, by working down the throats or saddles into shape with a razing hammer, and forming the two outlets by bending the pattern in the middle and bringing the two edges together. The stem is thus in two halves, while the parts forming the two outlets is one continuous piece, having the seams in the two throats, as shown in *B*, Fig. 64. There is no reason why a large tee should not be made in the same manner with economy in labor, but I never made a large one this way nor saw one made; we must go on according to custom.

THREE-WAY PIECES.

Three-way pieces are similar to tee pieces, the difference, however, is in the form of construction, as will be seen by reference to Fig. 65. Here, it will be noticed, they are made by putting together three saddle pieces and a gusset, the branches being an equal distance apart and usually all of one size. It is sometimes necessary, as in the case of tees, to have one branch equal in area to the other two, like a British piece.

the surface of one-half of the piece to a flat sheet of metal, as in Fig. 64, proceeding as follows. From the point *A*, Fig. 70, with the radius *A B*, describe the arc *B C*, divide *B C* into three equal parts, through the two points *B D* of one of the parts draw the line *G E*, on the opposite side of the figure draw *E H* similar to *G E*; then *B I H G* will represent a frustum of a cone. Now find the convex surface of a frustum, which is thus represented. Let *B H*, Fig. 70, be a frustum of a cone, and let *I R = 3* and *H I = 4* and *H G = 5*. Then the convex surface of the frustum =

$$3 \times 5 \times \frac{1}{2} \times 2 \times 4 = 50.2656,$$

and converting this into circular or disc inches we have

$$\frac{50.2656 \times 144}{3.1416} = 2284.4$$

Now add the square of the diameter *B I* multiplied by three, divided by 4, = 73, the convex surface of *B I H G* in circular inches, extracting the square root we have

$$\sqrt{2284.4 + 73} = 48.544$$

or a disc of sheet metal 48.544 in diameter, as in Fig. 69. Draw the line through the center *O*, and from the points *F* and *G* draw the lines *N M P* and *S G I* at right angles with the diameter *P G*, and meas-

THE PIECES. The pieces are made in several ways to suit the job they are to be used for, but

BRITISH PIECES. British pieces are similar to three-way pieces, the difference in their construction

Copyrighted by John Fuller, Sr., Benson, Kas. All rights reserved.

draw off from the points *P* and *Q* north of the circumference of *I*, *I*, Fig. 20. Now draw the lines *M*' and *I*' a distance from the circumference of the circle equal to the length the straight part is required to be at the ends, join *M*' and *I*' and, and *K*' and *I*', which are tangent to the circle. Then the pattern *I*' *S*, *M*, *I*, Fig. 20, will equal approximately the surface of *I*, Fig. 19. Having cut out two pieces of sheet copper like the pattern, Fig. 20, they are ready for forming after the edges have been rounded up with a smooth file. Beside this process by striking on the pattern, Fig. 21, they are made by using hammer. Fig. 22, take down the wrinkles on a suitable mandrel, Fig. 22 secured in the mandrel block of a bench strap, to form the flange, and when it is of sufficient length cut the two ends to form the cross-arms.

Practice and experience only can supply the place of an instructor when fitting this form. Care must be taken during the striking not to press the metal too severely, nor work it when it is hard, but anneal it at the edge of every course, so that it has been properly formed, the surplus stuff can be trimmed off from the edges and the edges thinned by striking on the inside. To take the crown out of the cone, about 1/8 inch from the edge, round up the edge with a file from rags and chisel marks, and finish on the edge level with a file, and forming the part of the outlet, thus extending the length that much longer. It is next annealed with salt water, then the seams are made as much in clean water, scoured with sand and dried. The halves, after they have been crimped, are brought together and wired fast, the seam is annealed and brazed, the work being done in the tray left clean from overhead steam heating. When the seams are crimped and flattened off and the work done in clean water, it is put in shape and annealed in a coil. The seam is smoothed down and the piece planished with a smooth and harden it. The mandrel, Fig. 23, a piece of cast iron or steel, is turned to the diameter, having a neck space look in the center, so that it will hold on a square bar, the four sides of the neck and plane, turned or cast from a pattern with a diameter of four circles above to 2 1/2 inches in diameter to suit the different size power cylinders. The mandrel is fixed in length. It is necessary to possess several of this mandrel of different sizes and length to suit different work.

Committees and Subjects for Investigation at the Next Meeting of the National R. Blacksmiths' Association.

Curves and Lanes—H. Williams, Ludlow Ky. Ed. Carlson, Pullman, Ill., Frank Peck, Toledo, Ohio, J. E. Mink, Chillicothe, Ohio, A. A. Ræe, Elkhart, Ind., A. L. Woodworth, Lima, Ohio, R. A. Mould, Galion, Ohio.

Ironing Wrecks—James Walker, Aurora, Ill., Frank Peck, Toledo, Ohio, A. L. Woodworth, Lima, Ohio, Ed. Tather, Chicago, Ill., A. D. Wilkins, Pittsburg, Pa., Wm. Henderson, Tacoma, Wash.

Ironing Forging and Bending Machines—*Report of Dies, etc.*—*Paper to be offered by the following Committee*—Henry Linkens, St. Paul, Minn., Harry Jeffries, Pittsburg, Pa., Joseph Hughes, Bloomington, Ill., Ed. Carlson, Pullman, Ill., S. Uren, Sacramento, Cal., M. F. Foster, New Albany, Ind.

Steel and Best Method of Preparing Scrap for and Manufacturing with—W. M. McLellan, Denver, Colo., Ed. Carlson, Pullman, Ill., A. Younger, Sacramento, Cal., J. C. Hemstedt, Pittsburg, Pa., Thomas Boyd, Peoria, Ill., D. T. Hughes, Frankford, Ind., John Hanahan, Springfield, Ohio.

Proper Material for and Best Method of Making Side Rods, Crank Pins and Motion Work in general—Harry Jeffries, Pittsburg, Pa., John Buckner, Chicago, Ill., J. C. Stewart, Brainerd,

Minn., Joseph Hughes, Bloomington, Ill., Henry Linkens, St. Paul, Minn., Wm. Young, Springfield, Ill., W. J. Barrett, Lima, Ohio.

Spokes—W. M. McLellan, Denver, Colo., Henry Thompson, Kaskaskia, Mo., Thomas Wake, McComb, Miss., Sam Harne, Davenport, Iowa, A. D. Wilkins, Pittsburg, Pa., Joseph Northwood, Meadville, Pa.

Welding, Best Methods and Best Results—S. Uren, Sacramento, Cal., James Walker, Aurora, Ill., Wm. Alexander, Milwaukee, Wis., Ed. Tather, Chicago, Ill., Thomas Dahrey, Huntington, Ind., Horace Pentecost, St. Paul, Minn., Wm. Priest, Pullman, Ill.

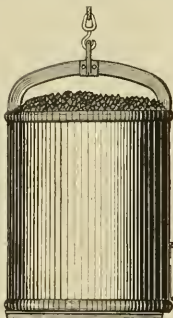

A New Bottom Dump Coal Bucket.

Our attention has been recently called to a coal bucket in use on the Toledo & Ohio Central, the Lake Shore and other roads.

This bucket instead of having to turn over to discharge its load—and requiring a man to turn it—dumps from the bottom and can be dumped by the fireman from the deck or by the man on the platform, by simply pulling the tripping cord.

The illustrations on this page show the bucket full of coal and also partially emptied.

The bottom is hinged nearly in the center and there is a shelf below, with an incline from the side side to the hinge, under this the short end, back of the hinge of the movable bottom, swings up.

The locking device is a simple lever that engages the bottom when level, to this is attached a catch lever that forces it to the unlock position.

With this bucket it is possible to put the coal just where you want it, the bucket can be made stronger with less weight of material and there is no danger of burning men as is often done by the turn-over bucket. It is manufactured by the Excelsior Iron Works Company, Cleveland, O.

Cartoons Before the Days of "Puck."

"Mebby none of you fellers was bevind when the old engine 'Novelty' was well-intentioning the world on the Reshling, away back in the forties," remarked the old-timer, as he slowly filled his pipe out of the president's pouch.

"The 'Novelty' was got up by Leroy Kirk, the master mechanic, and G. A. Nicholls, the superintendent, she had her engine separate from the boiler, the engine was very light and ran ahead of the boiler, the steam-pipe from one to the other being flexible. The engine was put to hauling

coal, she was a queer scrap, and had to have two engineers and two firemen.

"The first men to run her were Seth Ham and Barney Butz, although Dave Clark, that's now master mechanic of the I. V., at Hazelton, Pa., run her afterwards.

"Ham had a party good notion of his importance and allus referred to the other runners as 'them common engineers'—'a'course this made him popular with the boys.

"Well, one morning there was great excitement in the Palo Alto House—where we all stopp'd—because of a cartoon picture of the 'Novelty' that was drew in the white sand on the floor. This here picture took off the new engine and her crew to a single alseip.

"Representin' the engine was one of them animals as used to chat with Mr. Balsam—a jackass. On his neck sat Seth Ham, with a hand on each ear, representin' startin' bars. Behind the jack was an elephant, representin' of the boiler, with his trunk a disappearin' into the jack in the neighborhood of the tail—representin' of the flexible steam-pipe. On the top of the elephant, with one of them as Mahler's hooks, sat Barney Butz, big as life. Behind the elephant was a regular tender, with George Curtis and Bill Schrier—the two firemen—shovelin' coal into the elephant.

"Say? mebbe you fellers think Seth wasn't mad. Why, man, he wanted to run the engine to 'Reshling' light to report the matter to Kirk and Nicholls. The boys made so much fun of him and the cartoon that he quit, and, well, nobody never told who was the artist—'cause they didn't know."

Evans Wanted to Build Railroads 100 Years ago.

The probability that vehicles driven by steam would be the future means of trans-

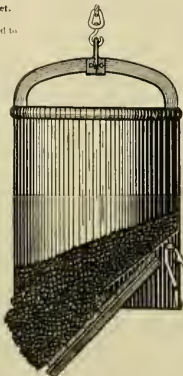

portation on land was very well foreseen twenty years before last century closed, by Oliver Evans, of Philadelphia, the inventor of the high-pressure steam engine. As early as 1796 he petitioned the Legislature of Pennsylvania for the exclusive right to use his inventions for road wagons to be propelled by steam. The word locomotive had not then come into use. This privilege was denied, but the Maryland Legislature granted the right for fourteen years. There appeared at one time good prospects of Evans obtaining the necessary financial support to apply his steam engine to the propulsion of boats and road wagons, but

some cautious capitalists of that day determined that B. H. Latrobe, an accomplished architect and engineer, report upon the schemes that Evans was advancing. Latrobe reported strongly against the steam engine, saying that the inventor was a visionary. This report ruined Evans's career, and deprived America of the benefits of the steam engine in transportation for two generations longer.

By a curious irony of fate, none of this casting Latrobe performed important engineering services in building the Baltimore & Ohio, the first railroad in this country where a steam engine was used successfully.

A Reformer Loose on Railroads.

An intensely funny story was written by Mark Twain for the December number of the *Comstockian*. It is called, "Traveling with a Reformer," and relates principally to small abuses encountered by railroad travelers.

The modern Don Quixote whom Mark Twain brings into existence attacks abuses in a highly practical fashion, moral suasion and diplomacy being his favorite material of war. His mission was to root out all forms of rudeness and petty imposition, and to do it in a fashion that would reform the offender. In dealing with rude brakemen, saucy conductors, and others, his power is being slowly related to the president of the company. His president is being brother-in-law of the president or general manager. His brother-in-law would make a big army. After starting out, their first adventure is with the supercilious telegraph operator, who tries to snub the public. After being snubbed when he tries to send a message, the reformer writes a telegram. His president of the Western Union, inviting that personage to come and dine with him that he may explain how business is conducted in one of the offices. Of course, the clerk collapses. He is forgiven and the lesson is left behind.

The reformer, who is an army Major, and his friend enter a street car late at night and three villainous roughs come in who make vile remarks, and make a disagreeable time for conductor and the women and children in the car. The reformer is troubled, and takes in the situation for a minute, and then exclaims, "Conductor, put off these swine, and I will help you." The boys make a rush at the reformer, but he hits each with a blow like a trip hammer and kicks them off the car. This was called an emergency case, where a fist is the best persuader.

The reformers go to Boston over the Consolidated roads, and the various trainmen get squeezed into politeness through fear of the president of the Western Union. The great fun comes when the two go to Chicago. While traveling on Sunday they see the parlor car conductor stop a game of cards, and the Major volunteers to join the game, that he may vanquish the conductor and demonstrate that a railroad company is not authorized to stop card playing on any day of the week. The conductor comes and saying that card playing on Sunday is against the rules, orders the game stopped immediately.

"Nothing is gained by hurry," says the Major. "Who authorized the company to issue such an order?"

"My dear sir, that is a matter of no consequence to me, and—"

"But you forget that you are not the only person concerned. It may be a matter of consequence to me. I cannot violate a legal requirement of my country without dishonoring myself. I cannot allow any man or corporation to bring their activities with illegal rails—a thing which railways companies are always trying to do without dishonoring my citizenship. So I come back to that question, by whose authority has the company issued this order?"

The argument proceeds at great length, and the conductor is greatly embarrassed,

but he cannot produce any legal warrant to the order to stop card-playing, so he lets the game proceed, but is dreadfully worried. The train conductor comes on, and was going to put a peremptory stop to the game, but the sleeping car conductor took him aside and explained the matter, and then no interference was offered.

"When the party starts to return from Chicago, a sleeping car in which they have engaged a stateroom is not on the train, and a section is offered in another car."

"The Major refuses the section and demands his stateroom."

"It's the best we can do," explains the conductor, "we can't do impossibilities. The train will take the section or go without."

"A mistake has been made and can't be corrected at this late hour. It's a thing so happens now and then, and there is nothing for it but to put up with it, and make the best of it." Other people do."

"Ah! That's just it, you see. If they had stuck to their rights and enforced them you wouldn't be trying to trample on me under foot." It's my duty to protect the next man from this imposition. So I will get on my feet, otherwise I will wait in Chicago and see the company for violation of its contract."

"I'll see the company for a thing like this."

"Certainly."

"Do you really mean that?"

"Indeed, I do."

"The conductor looked the Major over carefully and then said: "It beats me—his brand new I've never struck the mate of it before. But I wonder I think you'd do it. Look here, I'll stand for the station master."

"When the station master came he was surprised at the trouble raised—not at the cause of the trouble—but he had not even reached the Major, when he decided to go to a stateroom for the party."

"When they were in the dining car the Major asked for broiled chicken, and the waiter said: "It's not on the bill of fare."

"That gentleman yonder," said the Major, "is eating a broiled chicken."

"Yes; but that is different. He is one of the superintendents of the road."

"Then all the more must I have broiled chicken. I do not like these discriminations. Please hurry. Bring me a broiled chicken."

"The waiter brought the steward, who explained in a low and polite voice that the thing was impossible, it was against the rule, and the rule was rigid."

"Very well, then, you must either apply it impartially or break it impartially. You must take that to the gentleman's kitchen away from him or bring me one."

"The steward was puzzled, and did not quite know what to do. He began an incoherent argument, but the conductor came along just then, and asked what the difficulty was."

"The steward explained that he was waiting on having a chicken when it was dead against the rule and not in the bill."

"The conductor said: "Stick by your rules. You can't have any option. Want a moment, it is the gentleman's!" Then he laughed and said: "Never mind your rules. It's my advice, and you'd give anything he wants, and don't get started on his rights. Give him whatever he asks for, and if you haven't got it, stop the train and get it."

"The Major ate the chicken, and said he did it from a sense of duty and to establish a principle, for he did not like chicken."

"Patents have recently been granted to Mr. George W. Smith of Newark, N. J., for improvements in car couplers. They are all of a highly practical character and relate to appliances intended to open the knuckle without going between the cars."

"The Association of Railway Air-Brake Men will hold their next meeting at Columbus, Ohio, on the second Tuesday in April, 1894."

Origin of Standard Measures of Length.

BY JOHN H. COOPER.

In reference to the origin of the measures of length, the literature of the subject is found to be quite voluminous, but the gist of it may be given in few words, which are here presented. For a first broad statement—they are derived from parts of the human body.

"Their values, roughly estimated, as well as their names, establish this beyond a doubt. The foot, the digit, the palm, the span, the cubit, the nail, the arm, etc., are in all languages derived from the same source, and in the popular view of measurement, they do not considerably differ in length. In former times, when authentic measures were not so easily to be obtained, the hands, arms and feet were much more frequently used than they are at present."

"Taking these measures from a well-proportioned man, the fathom is reckoned to equal his height, the girth, or the pace $\frac{1}{2}$ his height, the cubit, or distance from the elbow to the end of the extended middle finger, $\frac{1}{2}$ the foot, the span $\frac{1}{4}$; and the breadth of the palm, $\frac{1}{8}$."

"The actual employment of dimensions

English foot is so nearly identical with the ancient foot—two-thirds of this cubit—that the origin of these two English units of length may not improbably be traced to these two earliest standard units. We know that the double cubit was used in ancient times as a measure of length. An old Egyptian double royal cubit found in the ruins at Karnak may be seen in the British Museum. We know also that a measure very nearly equal to two natural cubits was used by the Romans under the name of *ulna*, or ell. The *ulna* is mentioned by Pliny when describing the measurement of the girth of a tree, as half the length of the extended arm of a man. It may thus be fairly assumed that the measure of the double natural cubit, or three feet, under the name of ell or yard, came into use in old times as a very convenient measuring unit, and found its way into England as the standard unit of length."

With such an array of historical precedent can any objection be reasonably raised against the physiological data adduced in support of my new unit of measure, based as it is upon the needs of the eye and hand, as the units of the ages were derived from convenient parts of the human body?"

That is to say 1st. Make the least

so that it will soon be the only universal language to be found everywhere, if it is not so already. Doctrinaires of the kind may scream penny-school girls with French metres and centimetres, and kilograms; but our yard grew and will remain as the natural standard of length until the stature of the human race alters. For it is the length from the tip of the nose of which is generally considered the best height, and that height is two such lengths, and so is the stretch of his arms, and a yard is the natural length of his walking-stick."

"A metre would be the yard of a nation of giants. With the yard, too, goes the equally natural and still older measure of a foot, which all nations had, with such small variations as would occur in times when they had no scientific provisions for preserving exact standards."

"Some great authorities believe inches to have been the oldest measure of all, and the Egyptian cubit, which was unquestionably used in building the Pyramids from the many simple multiples of it which occur there, confirmed by the discovery of one accidentally built up in a wall at Thebes, was probably twenty of their inches, being a little more than twenty of ours; and the "sacred cubit" of the Jews was twenty-five, according to Sir Isaac Newton."

Night Schools Needed.

In spite of the extremely depressed condition of the industrial establishments in New York City, the evening classes, that are conducted for the education of workmen and others, have opened with the prospects of a highly successful season. New York City is remarkably well provided with evening schools, where artisans may receive instruction concerning the scientific phases of their business. The Cooper Institute is at the head of the organizations which provide facilities for enabling men or women, engaged all day in the shop or the factory, to acquire a technical education by attending evening classes. It is a sort of college, with the classes held at night. Students are given certificates for efficiency in the branches of study they pursue, and these certificates are highly valued by many owners of shops and factories when they are looking for foremen and others required to take charge of departments.

Besides this institute, there are many excellent night schools where good technical education is imparted. It is a great pity that every town in the Union, where a machine shop or a factory is to be found, is not provided with evening schools similar to the many already existing in a nation in which America is away beyond every other country having a population engaged in manufacturing pursuits. We are so intensely independent in our habits that the education of the artisan class is left to the individuals. All over Europe the authorities of cities, where mechanics and workmen are numerous, have recognized their business to provide the means of education for the men who have to follow work that requires acquired skill or special knowledge; but here the same class is left to work out its own salvation, or fall into the chasm of common, unskilled labor. This is wrong, and is a species of immorality.

A great deal has been done for the higher technical education in this country within the last thirty years, but remarkably little for the lower species of technical education, which is the need of the workman. There is a general feeling that the young men may acquire an excellent technical education, but they are away beyond the reach of the intelligent workman who wishes to learn the fundamental principles of his business. The educated workman is the most useful and potentially important in the world; while the ignorant, unskilled, and self-sufficient, who are the most difficult to be made good and hundreds of who are hungering after this standing the means of reaching the condition they are

of the human body for the purpose of determining the unit of the length is not, as one might be inclined to think, a matter of a very remote past, in proof of which I will quote a book on surveying, published in Germany by Jakob Koebel, about 140 years ago. In this book the author gives the following instruction (accompanied by a wood cut, which is reproduced here), as to how the length of a foot is to be found:

"To find the length of a rod in the right and lawful way, and according to scientific usage, you shall do as follows:

Stand at the door of a church on a Sunday and bid sixteen men to step, tall ones and small ones, as they happen to pass out when the service is finished, then make them put their left feet one behind the other, and the length thus obtained shall be a right and lawful rod to measure and survey the land with, and the sixteenth part of it shall be a right and lawful foot."

See E. A. Geesele's lecture before the Franklin Institute, February 7, 1881.

From *Nature Series*, "Weighing and Measuring." H. W. Chisholm says: "The existing imperial yard is so nearly identical in length with the old standard yards of Henry VII and Queen Elizabeth that it exceeds them by little more than a hundredth part. It differs in a different frequently found in foot-roads more commonly used. There can also be but little doubt that our imperial yard is substantially the same length as the old Saxon yard."

We have no further direct trace to its origin. But the English yard is so nearly the same length as double the natural cubit of the Egyptians and Hebrews, and the

dimension on the scale of a width equal to the smallest visible space which can be transferred from the scale to the work by the unaided eye. 2d. Take two of these last spaces for the inch, which I have shown in a previous article to be equal to $\frac{1}{15}$ standard inches, and 3d. Make the foot of ten of these new inches—which would make the foot $\frac{1}{15}$ standard inches long—the two-foot rule, so universally used because of its convenience, would then be 30 inches long.

I close this presentation of measures—their origin and their use—by an English view of the subject from the pen of Sir Edmond Becket, Bart., President of the British Historical Association.

"The length of a seconds pendulum so nearly resembles the French metre of 39 3/4 inches, that some persons may fancy that that most ridiculous and mischievous revolutionary measure had an origin even as rational as being the length of a seconds pendulum in some latitude. But it has not. It was intended to be the 40 millionth part of a meridian of the earth—about as rational a standard as if we enacted that the yard should be the 420 millionth of the mean distance of the moon, which it is, very nearly, and astronomers know that the Earth is within a less fraction than the difference of the metre from what it pretends to be, but is not."

"Yet there are people who want to force on all the world this absurd, inconvenient and useless measure, invented by a nation whose language is declining over all the world; while the English language, with that standard of measures which every man carries in his arms, his legs, and in his head, is spreading over all the world,



EMERSON'S ILLUSTRATION.

striving for. There is not a town of any size in the country where young men are not laboring to learn the science of the business they are engaged in during the day. It may be a machinist trying to learn drawing and mechanical science, it may be a telegraph operator or linesman trying to acquire a knowledge of electricity, it may be an engineer or fireman anxious to find out the principles of combustion or of steam engineering, or it may be the cases of others in various hues of industry laboring to find out the technical part of their business. Men or women indulging in this kind of knowledge ought to be encouraged. Their road to learning ought to be made as easy as circumstances will permit.

The indications are that this country is going through an industrial crisis which will end in close competition to hold the market for home producers. In the struggle that is coming, knowledge and skill will be on the side of the victors. This being the case, it seems a national duty to give the mechanics and workers in the shops and factories the opportunity to educate themselves in the science that will enable our own breadwinners to hold their own against all competitors.

A Strange Coincidence.

Sitting by a copy fire the other day were a party of railway supply and newspaper men, and the conversation soon drifted to the subject of coincidences and peculiar happenings.

Mr. S. G. Scarritt, the head of the great St. Louis furniture and car-seat manufacturing, put his feet on the fender and said:

"I don't know as I believe in anything so serious as all that, but there is something strange in what happens often in our lives. I'll tell you of an incident—coincidence, if you like—in my life.

"As you may know, the Scarritt furniture factories were established in St. Louis by my father in 1838. I was a young boy, away from home at school in 1849, when the entire place burned down and father had to start at the bottom again. He wrote me (quite fully about the fire, his plans for the future, etc., and was strong and hopeful throughout—the fire made a strong impression on me.

"I always kept my father's letters, and after I came home, they, with other personal papers, were kept in an old desk in my office.

"Years passed away, the war came and I spent three years in the saddle, the business grew, and we changed quarters and offices, but I kept my old desk with its time-worn documents—valueless except to me.

"We were established in a great building occupying half a block, built, as we believed fire-proof, but one morning in 1887, I came down to business to find everything in ashes—it was enough to take the heart and spirit out of almost any man.

"The firemen had been able to get out some of the furniture and papers from the office—there was the records and bills and letters of forty years' business there. The little that had been saved from the fire was across the street in an alley and in other buildings, and everything was in great disorder, and most of the papers valuable. Among the things saved was my old desk, empty and charred and broken—but still on deck.

"There was two feet of papers and books on the floor, and, stepping among the wreckage the first thing that caught my eye was a piece of blue writing paper, such as was used years and years ago. I picked it up, remarking to myself that there was undoubtedly an old-timer. The edges of the folded letter were charred so that it came apart in small pieces the size of the letter, and turning over the first leaf I read:

"The brave become bolder the darker the night."
"It was in my father's hand, and the letter was the one telling me of the fire of '49—thirty-eight years before.

"That seemed to me, at that time, like a message from the clouds, an inspiration that could not have been so effective or complete from any other source, why, that scrap of paper, penned nearly forty years before by my father, when he was undergoing the same strain and anxiety that I was now undergoing, should turn up then and there with such words of encouragement will always be a mystery to me."

A New Drill Press.

The accompanying cut represents a new 21-inch stationary hand, wheel and lever feed combined, upright drill, with back gears, recently placed on the market, by J. E. Snyder, of Worcester, Mass. This machine is made with or without the back gears. The back gears are quickly connected or disconnected by means of a lever descending parallel with the column. The table and arm can be adjusted to any desired height on the column by means of a crank in connection with worm and worm gear. The quick return to spindle

is obtained by a hand wheel on the left side of drill. The rack, and also the pinion gear for feeding the spindle, are made from iron steel. The novel gears and back gearing are all cut from solid stock. The arm which supports the table can be swung around the column, and heavy work can be done by bolting the same to the base, which is planned square with the column. The spindle is made from best steel, and the hole in same conforms to the Morse taper (in accordance with large cones and pillars, this machine is capable of doing quite heavy work. This drill is thoroughly well made, and will be found a very handy tool for general machine-shop purposes.

Mr. Snyder makes a specialty of upright drills, and therefore excels in his line. One electrical plant have in use nearly one hundred of his drills in various sizes.

Danger of Defective Brake Mechanism.

The automatic air-brake cannot fail to work if it is in proper order. This fact has been persistently preached to railroad men, and the teaching has been well heeded as a whole, but occasionally we find on some railroads the brake mechanism so shamefully neglected that those in charge appear to court failure. It is still too common to find men in charge of railroad machinery who consider that they have performed their whole duty when they have applied brakes to locomotives and cars. A prevailing source of danger is neglecting to take up the slack of the brake gear. An engineer told the writer last month that he ran past the station one morning at his first stopping-place. Feeling certain that something was wrong, he went back to inspect the brakes, and

found three cars out of the six with the brake piston up against the head. Men responsible for trains going out in this dangerous condition ought to be punished.

There are other defects to be found which are almost as dangerous. A writer in the *Engineer's Journal* last month gives particulars of a curious case of brake failure. A passenger train ran through a freight train on a crossing, and the engineer reported that he applied the brakes and that they failed to work. Here is the full story:

"As usual, the engineer was suspended and an investigation instituted. The brake was carefully examined on all the cars constituting the train, and nothing being found wrong the division superintendent decided that the blame lay with the engineer. It happened that the general superintendent was well acquainted with the engineer, and had so much confidence in the care and judgment of the man that he ordered a special investigation after it had been decided by the division authorities to saddle the engineer with the blame. A meeting of old engineers was called in the office of the general superintendent to discuss the case. They were all anxious to exonerate the man in the rack, but when they were taken separately and questioned about how they thought the accident could have happened, they invariably concluded that the engineer got a little excited and turned the valve lever the wrong way.

"This did not suit the general superintendent, and he placed the matter in the hands of the road foreman of engines, a smart, intelligent young man.

"The United States contains a very large mileage of railroads, and the number of trains moving daily is almost beyond computation. It is natural that there should be a great many accidents among all the vast number of trains, but they are more numerous than they ought to be. Better mechanical provisions for operating and improved discipline would certainly reduce the accidents. An analysis of a report in the *Railroad Gazette* of accidents during the past year shows us that there were accidents on passenger trains and 111 freight trains, involving 76 deaths and injuries to 168 persons. Collisions were the most numerous, and caused the greatest loss of life and suffering. The accidents were spread over nearly the whole territory in the United States.

"Those who are intimate with Mr. M. N. Forney are aware that he is an ardent believer in the use of a firebox which will transmit to the tubes of a boiler all the heat generated by the act of combustion in the ordinary firebox, surrounded by water, a material portion of the heat generated is absorbed by the firebox sheets, which keeps the furnace temperature comparatively low. Mr. Forney proposes to use the firebox with fire-brick or other refractory material, and he has patented an arrangement of this kind, which he is very much interested in noting the measure of success in fuel saving attained by a firebox constructed according to Mr. Forney's patent.

"It was about the year 1822 that a Maudsley slide-rest lathes found its way to Philadelphia. It was taken hold of and greatly simplified by Rufus Tyler, who when at that time made small iron foot-lathes, he having adopted the steel mandrel, conical in its front bearing, running in hardened steel collars, and also the push pitman to the treacle instead of the ordinary hooks.

"Isaac Luken was chiefly engaged in making turn clocks, but found time to finish two or three small lathes a year. He also got up a simple form of slide rest. To cut the screws for it, he converted one of his little iron shear foot lathes into a very effective slide lathe, with gearing to cut screws of various pitches. The bedplate of his slide rest was wrought iron forged with a drop stud or spindle that was turned to fit on the ordinary rest carrier, to take the place of the common rest. The face of this bedplate was 9 inches long by 3½ inches wide, the cross-head having a travel of 5 inches and the tool-carrying block or head a traverse of 2½ inches.

"The moral of this accident is that the brake mechanism should be maintained as nearly perfect as possible. It appears to point to the advantage of having the trainmen so drilled that they would pull open the conductor's valve when a call was made for irakes by the engineer."

Pioneer Improvers of the Lathe.

"The best machine tools in the world are now made in the United States. For a few years after the manufacture of machine tools was commenced on this side of

the Atlantic, there was a tendency to follow British models, but our mechanics soon fell into the habit of making improvements to suit themselves, and now American tools are imitated by all other makers. The first important improvement on the lathe was the invention of the slide-rest, by Henry Maudsley, of London. There is an impression that Maudsley perfected the engine lathe, but that is far from the truth. The first engine lathes brought to America were very clumsy, inefficient affairs. The first of our mechanics to make his mark on this tool was Rufus Tyler, of Philadelphia. George Escoe Sellers, writing in the *American Machinist* some years ago about the development of the lathe, says:

"It is hard for the machinist of the present day to realize that, at comparatively so recent a time bed-post-lugs, spade handles, rolling-pins, and the like, were turned on spring pole lathes operated by a foot treadle, one half of the time being lost to the backward motion of the piece being turned. It was not till two or three years previous to the opening of the Franklin Institute (1824) that the wooden hand-treadle wheel for calicut saws, slide rest, bed post lugs gave place to the cast-iron wheel and flat belt. This innovation was made by Isaac Luken.

"It was about the year 1822 that a Maudsley slide-rest lathes found its way to Philadelphia. It was taken hold of and greatly simplified by Rufus Tyler, who when at that time made small iron foot-lathes, he having adopted the steel mandrel, conical in its front bearing, running in hardened steel collars, and also the push pitman to the treacle instead of the ordinary hooks.

"Isaac Luken was chiefly engaged in making turn clocks, but found time to finish two or three small lathes a year. He also got up a simple form of slide rest. To cut the screws for it, he converted one of his little iron shear foot lathes into a very effective slide lathe, with gearing to cut screws of various pitches. The bedplate of his slide rest was wrought iron forged with a drop stud or spindle that was turned to fit on the ordinary rest carrier, to take the place of the common rest. The face of this bedplate was 9 inches long by 3½ inches wide, the cross-head having a travel of 5 inches and the tool-carrying block or head a traverse of 2½ inches.

"The United States contains a very large mileage of railroads, and the number of trains moving daily is almost beyond computation. It is natural that there should be a great many accidents among all the vast number of trains, but they are more numerous than they ought to be. Better mechanical provisions for operating and improved discipline would certainly reduce the accidents. An analysis of a report in the *Railroad Gazette* of accidents during the past year shows us that there were accidents on passenger trains and 111 freight trains, involving 76 deaths and injuries to 168 persons. Collisions were the most numerous, and caused the greatest loss of life and suffering. The accidents were spread over nearly the whole territory in the United States.

"Those who are intimate with Mr. M. N. Forney are aware that he is an ardent believer in the use of a firebox which will transmit to the tubes of a boiler all the heat generated by the act of combustion in the ordinary firebox, surrounded by water, a material portion of the heat generated is absorbed by the firebox sheets, which keeps the furnace temperature comparatively low. Mr. Forney proposes to use the firebox with fire-brick or other refractory material, and he has patented an arrangement of this kind, which he is very much interested in noting the measure of success in fuel saving attained by a firebox constructed according to Mr. Forney's patent.

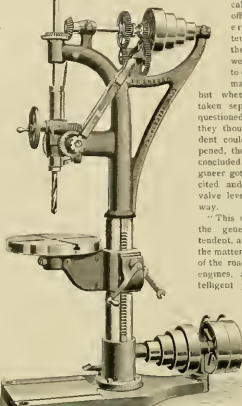

Experiments on Locomotive Counterbalancing.

Professor Goss, of the Purdue University, La Fayette, Ind., has been experimenting with the counterbalancing of locomotives. As most of our readers are aware, the engineering school connected with that university has a Schenectady locomotive, which is secured on large revolving rollers, which enable those making experiments to run the engine at any required speed. This enables the engineers in charge to make tests that are more conclusive and accurate than locomotive tests made on the road, where outward conditions are never constant.

In making tests to show the effect of the counterbalancing of the drivers, wires $\frac{1}{8}$ in. diameter and about as long as the circumference of the driving wheels were fast between the line of contact of the driver and carrying wheel. The ordinary weight of the engine flattens the wire to about $\frac{1}{4}$ inch. The action of the counterbalance weights flattens out the wire at the points where the resalting extra pressure comes.

The *Railroad Gazette*, describing the experiments made, says:

Speed of circumference of wheel sixty miles an hour or 88 ft. per second. Revolutions per minute about 320. Diameter of wire $\frac{1}{8}$ in. Drivers lift from the rail so as to give a short length of full sized wire above a speed of forty miles an hour is reached. The drivers lift when the counterbalance is up. Since the engine was received the counterbalance has been increased so that now the weight of the reciprocating parts is completely counterbalanced. The longitudinal oscillations of the engine known as "galloping" are very small and are caused by the angularity of the connecting rod which makes it impossible to counterbalance perfectly with a finite length of rod. The shorter the connecting rod with reference to the crank, the less is the possible perfection of the counterbalance.

At sixty miles an hour, the length of the full section of the wire is 30 in., corresponding to about 55 deg. of revolution. The exact height of the lift of the wheel cannot be measured with the present apparatus, but it is known that the wheel is $\frac{1}{4}$ in. from the rail at the beginning of the 30 in. and is going up rapidly, and reaches a distance of $\frac{1}{4}$ from the rail in its downward course at the end of 55 deg. The total lift may be as much as $\frac{3}{8}$ or $\frac{1}{2}$ in., probably not more, at a speed of sixty miles an hour.

It is evident that the wheel travels upward less rapidly than it falls, as the distance measured on the wire from the full flattened part to the point of the com-

inch in 125 deg. of revolution, thus showing that the fall of the wheel to the rail is more rapid than the rise from the rail. These forces act downward with the motion of the wheel. The most important conclusion from

forty miles an hour and upward. Other conclusions may be drawn from the results, but this is the principal and the safest one.

Accidental Discovery in Copper Refining.

The key that led to some of the most important inventions known to the world has been discovered by accident. Another invention that is likely to prove of the highest value in this country has just been added to the list of accidental discoveries. Chemists in all parts of the world are constantly experimenting to find out new processes by which metals may be separated from the impurities present in the ores. So much work has been done in this line to separate copper from the ores that it is surprising that any possible method had been overlooked, yet a singular accident revealed something in the Baltimore Copper Works which is likely to bring into use a new refining process.

At the establishment referred to the reverberating furnaces are connected with a great chimney by means of long underground passages, called "culverts," in which more or less oxidized copper, as well as sulphides, arsenides and other compounds, is carried off in the form of dust and smoke. These are deposited in the culverts, and are subsequently collected to be worked over again. Amid an accumulation of such stuff, a few days ago, there were found indissoluble, mosslike masses, which upon examination proved to be pure copper. How the transformation was effected was a mystery, until it was discovered that petroleum, which saturated the soil in the vicinity (having escaped from a neighboring refinery) had entered the culverts through a crevice. Under the influence of high heat it was volatilized, and the resulting gases had "reduced" the oxides and sulphides into pure metal.

Hose Fitting Apparatus.

The apparatus illustrated in the annexed engravings is in use in the Eric shops at Meadville, Pa., and is employed for applying the fittings to air-brake and heating-pipe hose. It was got out by Master Mechanic Smith and his assistants. The apparatus consists of an arrangement of cylinders and holders, which hold the hose and force into place the fittings. When a hose is laid down in the machine a grip grasps it and holds it steady, while the ram from a piston forces in the coupling casting. This is then released, and a clamp forces the band round the hose and holds it there until the bolt is tightened up. All the appliances for operating the apparatus are within easy reach of the man doing the work and every movement of his hand counts. With the aid of this invention one man can apply fittings to 250 hose in one day as compared to thirty-five finished hose when the work was done by hand.

The valve-stems of locomotive "912," N. Y. C. & H. R. R., were packed Dec. 5, 1892, with Vulcanobest concave and convex rings, were "set up" Dec. 6, 1892, and have not been touched since.

The engine has been in constant use on express train between New York and Albany, and has been run over 100,000 miles, the stems moving over 27,000,000 times in each direction, or about 22,000,000 feet (over 4,200 miles).

The packing rings seem to be as good as when put in, the rods are not worn or scratched and are perfectly smooth.

The machine requires general repairs and must go into the shop to be overhauled, otherwise the rings would be continued in use.

A rotary engine has been patented by Mr. James F. McElroy and assigned to the Consolidated Car Heating Co., Albany, N. Y. It is very ingeniously worked out, and is intended for use in connection with car heating.

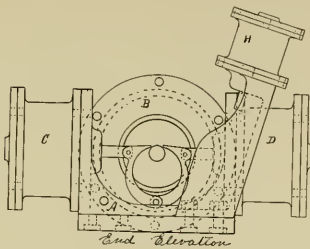

End Elevation

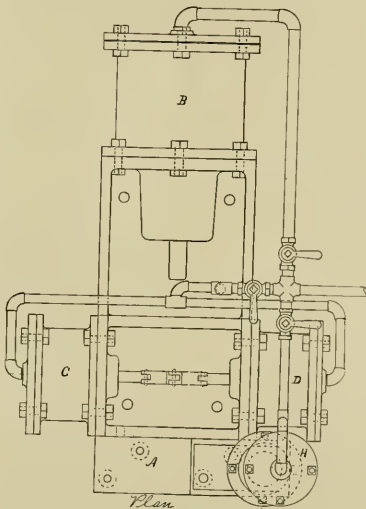

Plan

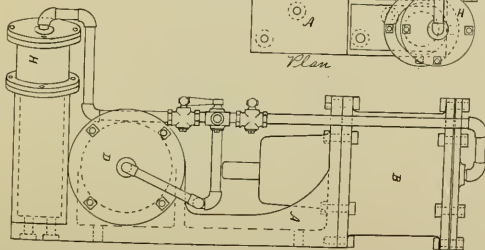

Side Elevation

This is in accordance with the theory of action, for the reason that going up the wheel lifts against the force of gravity and the driving-spring, while coming down

these experiments is that under normal conditions the drivers lift from the rail, and probably this takes place in every-day practice where locomotives are run at

measurement of the full section is greater than the distance during which the drop takes place. Apparently the wheel rises $\frac{1}{4}$ of an inch in 65 deg. and drops $\frac{1}{4}$ of an

The Intercepting-Valve.

The description and illustration of the valve motion of the Baxter compound locomotive, which appeared in the December number of *LOCOMOTIVE ENGINEERING*, deserve to be closely studied by those whose interest in the history of the compound locomotive. The mechanism described is not so complicated as it is often represented to be. It is a simple and effective device, and one that is well adapted to the compound locomotive. We have no doubt that the inventor, Mr. Van Borries, is entitled to the credit of having first introduced the intercepting-valve into the compound locomotive. The mechanism described is not so complicated as it is often represented to be. It is a simple and effective device, and one that is well adapted to the compound locomotive. We have no doubt that the inventor, Mr. Van Borries, is entitled to the credit of having first introduced the intercepting-valve into the compound locomotive.

We understand that the builders of compound locomotives in this country have used an intercepting-valve long before the invention of Van Borries. We have no inclination to advise people to attempt avoiding to pay the full toll of royalty on inventions that have made plain the way to successful use of engineering appliances, but we think that the intercepting-valve idea belongs to the Baxter engine, and that later inventors are not entitled to royalty on it unless it be for later improvements. As the cylinders of the Baxter compound locomotive are still intact there would be no difficulty in proving that a practical intercepting-valve was used with them.

Locomotive Test.

Mr. F. V. Wimpy, proprietor and inventor of the locomotive "James Tooleman" exhibited at the World's Fair, has been in

use of it. He had been lucky enough to get after supper we got to talking engine as usual. Doc related some of his troubles after this fashion:

"When I was up north I saw something that took my eye. It was a check-valve in the train-pipe close to the driver-brake triple-valve set at 20 pounds, so you could not set the driver-brake till the train-brake was set tight, and then it would take hold. The engineer said all their engines were fixed that way and it worked bully. Driver-brake shoes would last a year, engine didn't ride hard, wedges and boxes didn't get any shock. I says to him 'That would be a good thing on a dining car, wouldn't shake up the victuals when you make a fly stop.' 'Not much,' says he, 'don't want to have them on cars, it wouldn't be safe there, you couldn't stop at stations if only part of the cars had their brakes set.' 'Well,' says I, 'it ain't any harder work to stop a car with no brake working on it

'Now, we are talking about air-brake. My fireman, Billy Brown, is always talking air-brake with the boys, but he never says much to me. Some time ago we had hold of a fast stock train ready to pull out. We had tried the air and waited for the yardmaster to figure out about putting another car on the train, when we pulled down to the main line switch. I set the brake pretty tight. Before it had time to take hold on the train we got a signal to come ahead. I let it off, and Billy sang out: 'Hold on, your air ain't working right.' 'How do you tell?' says I. 'Cause,' says he, 'you hear a long blow of air from train line exhaust when you set the brake on a train, and a short one when you have just set the engine and tender. Didn't you hear a blow from train-line exhaust when you let the brake off?' That's a good sign you have only your engine working air. It don't do it with a train.' I squalled for brakes, we

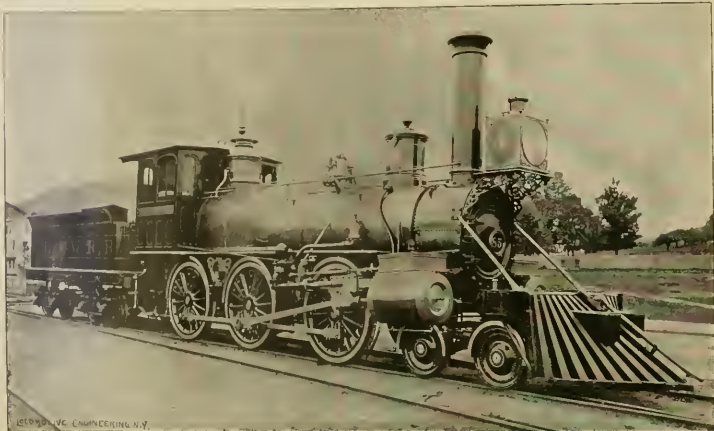

OLD-TIME WHITE "A. L. S. D. L. & W. R.

exhaust stems which is from the high-pressure cylinder.

Attempts were made to remedy this weakness by admitting steam to the receiver, but this was not an effectual remedy, because the live-steam pressure in the receiver acted as back pressure against the high-pressure piston. To prevent the live steam in the receiver from working against the high-pressure piston in starting the intercepting-valve was invented.

Van Borries is generally given the credit of inventing the intercepting-valve, which is designed that it closes the passage to the high-pressure piston at the moment when the engine is starting, thus preventing the live steam admitted to the receiver from flowing back through the exhaust port against the high-pressure piston. This was an important invention, but an examination of the drawings of the Baxter compound locomotive reveals the fact that it was used on that engine ten years before Van Borries' compound locomotive was built. This is an historical fact of the first importance, that no one thought of providing means to close the high-pressure exhaust port against the live steam from the receiver until Van Borries worked out the problem.

The East trying to arrange a test of his engine with some of the other locomotives that were on exhibition. He is particularly anxious to try the powers of his engine against the New York Central "999," but the company decline to go into any race or test. The Baldwin people say that they are quite willing to run their engines against the "James Tooleman" on ordinary hard fast train service, and they are satisfied that they will not come out of the contest with anything to regret. This is not the kind of trial Mr. Wimpy wants, but it is probable that he will consent to it when a spectacular race cannot be arranged.

Not a few engineers who examined the "James Tooleman" are anxious to see her tried in competition with an American locomotive of similar capacity. The service test would certainly be the most satisfactory, and we hope to see arrangements made to carry one out.

Doc Has Trouble.

BY F. V. WIMPY.

My friend Doc was up in the North Woods hunting deer last week. When he came back past our town, of course, he had to stop off and show me a couple of

than an engine. It don't weigh any more." "Oh, yes," says he, "you don't look at it right. See all the reserve power you have for an emergency when you want it. You can draw forty pounds off your gauge and your driver-brake is set tight, too." "That's a fact," says I. "We didn't talk any more about it for I see he knew he was right. But just the same I want all my brakes to set alike, not part of them full on and part of them not at all. Give me a good working brake on every wheel, and you don't break half as many emergencies, because you can't run by stations, and when you see a red light loaming up close in a fog, you know all of them will work at once. I used to cut out my driver and tender-brake when I had a good working train, and didn't tumble to the fact that it wasn't safe, till one day when a flat car fouled the main line, the link broke in the tender when the brake on the cars took hold. Before I could tip her over and get stopped, my steam-chest was under the car that did not clear. I got ten days or that mishap. You can bet when I got to work again the brake on engine was not cut out any more. Likely that engineer thinks he is saving his engine by making the train do all the braking, if that is a fact, what is the use of having any brake on the engine

stopped; sure enough, they had cut air off behind the tender to take on the other car, and when we went without it they didn't cut us in again. When the head man got up on the engine, Billy says to him: 'Another case of tramp tramping the air cock.'

"The next crack Billy got at me was when we broke in two between the two cars we had on the head end of train, leaving one car of air with my engine and one car of air with eighteen heads. I pulled her wide open to keep out of the way of the hind end of train, but the brakes stalled me when I got about three car lengths away. When the hind end run down and struck me it broke two drawheads. Billy was laughing at me, and says: 'That was your own fault, you will learn something about the air-brake by and-by if you have enough of this kind of practice.' 'Sonny,' says I, 'I had this brake business down fine ten years ago before you was big enough to railroad any.' Says he, 'you learned most all you know about it fifteen years ago, and ain't learned any more since. Next time you break in two this way, shat her right off quick, and the brake will hold you so you won't get over ten feet away from your train, and you won't get hit hard enough to break anything. The idea of pulling

any day from a moving train will not enough brakes on it to stop it, when you ought to know your brake will stall you and let the hind end run into you. A man that has learned anything about the brake lately ought to think of that. An old engineer's first impulse is to get away from the hind end and keep away, but you can't do it if the brake is set on you." You bet I was not to have him call me down that way, but said nothing—was too mad.

That is where the young fellows are getting ahead of us on the brake. They learn it as it works now, and don't have any old-fashioned straight air mixed up with it. Clint, you have jacked me up lots of times for being an old foggy, but we are getting there just the same. I skidded a pair of wheels on my tender last summer when they commenced to slide, dropped some sand, but they slid just the same and made a flat spot on the No. 1 wheels. If I could let the brake off so the wheels would begin rolling a little they wouldn't get skidded so much, but my tender brake never lets off till the last thing. What is the reason for that, and why did only one pair of wheels get flat?

Another thing puzzles me. I was second engine on a double header. There is a cut-out cock in the train-pipe near my brake-valve, so I had to carry my brake on lap to let the head engine work the brakes. Every time he let off the brakes the air would blow out of my train-pipe exhaust valve. Billy said it was because he carried more air than I did. So he made a plug, and put it in the exhaust elbow. She cut right after that—my brake-valve was O. K., not a leak in it anywhere. What makes it do that? I see our traveling engineer, Ike, in a sweat the other day. My engine don't exhaust square, he was looking her over to see what the trouble was, as he could not find it for a long time. She had a light exhaust and a heavy one. The machinist run her valves over and said they were set square, so they took out the exhaust-pipe; thought that was stopped on one side, found it all clear; tried the connecting-shaft arms, they were O. K.—and gave it up. Come to find out the steam-ports on one side were $\frac{1}{4}$ inch wide, on the other $\frac{1}{4}$ inch. Both valves were the same length, the travel the same, but the valve on the wide port had $\frac{1}{4}$ -inch lap, while the other one had $\frac{3}{4}$ -inch. Of course, the wide port cut off last and used the most steam. I chuckled to myself when I see him looking around for it, for all the rest of them had give it up. I did not know what ailed her, but I heard one of the machinists say something about wide ports on one side, so I told Ike. He measured the tram marks on her valve-stems, and, sure enough, her lead was the same on both sides, but the cut-off was way out of being the same.

My generous friend, Doc, is not very far away from the old rat, but he has been walking in terro for many years. He acknowledges that his freeman, by inquiry and study, together with close observation, has caught on to a good many facts about the working of the air-brake that Doc has not got down very fine. To tell the honest truth, Doc respects Billy for what he knows, and would like to know all these things himself, but it is a good deal of trouble to learn them and unlearn the old notions of twenty years ago. I had a long talk with him. The next day we went down to the shop, put a gauge on the tender auxiliary reservoir and one on the driver-brake reservoir, and shewn him that one 8-inch cylinder full of air taken out of a large reservoir to set the brake, did not reduce the pressure as much as two driver-brake cylinders did the same. The driver-brake reservoir by 8 pounds, and the train-pipe pressure had to be raised 8 pounds after the driver-brake let off to let off his tender brake. Then we went up on a double header just ready to pull out, and tried the other experiment by carrying more air on the head engine valve on the second engine, with second brake-valve on lap. I won't say just how

this experiment turned out—try it yourself—but Doc was satisfied he knew more about it. He says he gets along just as well, makes just as much money, and has as good a run as the fellows who are worrying themselves to find out something. Maybe so.

Gail Hamilton says that she always considers railway fare a great waste of money, for one needs all the money to buy things at the end of the journey. Gail has a very low opinion of the Interstate Commerce Law which gives railroad managers an excuse for refusing passes

that the low running-board prevents them from seeing the rods, pins and crosshead when running, and that it makes the motion and axle-boxes more difficult to reach.

During the month of October last the 498 road locomotives on the Santa Fé



A WIDE SHOT IN THE SIKARIA, CANADIAN PACIFIC RAILWAY TRAIN IN UPPER RIGHT CORNER.

"Things are looking pretty blue are they not?" asked a reporter of a southwestern paper in a carshop locale. "Well," answered the machinist questioned, "times might be worse if our bosses would try a little harder. They have cut off all passes, they forbid us to smoke in the shop, and the pay-car has not been run for three months. The shop is damp enough to freeze cranberries on the floor, the roof leaks and the place is badly heated. But they let us work here without charging anything. Times might be worse."

We have received from Mr. R. F. Brown, mechanical superintendent of the Intercolonial Railway, a blue print of a locomotive designed by him for the Canadian Pacific nine years ago. In this engine the style of low running-board seen on the compound locomotive built by the Pennsylvania Railroad at Altoona is employed. At first glance this style of running-board looks more convenient than those in general use. The men handling the engines, however, object to it on the ground

that it costs 5,865 as an average mileage. The total cost of operating the locomotives was 19.69 cents per mile, a remarkably low figure when we consider the country traversed by the road, the bad feed water used, and the high cost of coal in some districts. The expense is made up of the stems .014 cent for stores, .02 for oil and waste, 7.42 for fuel, 6.77 for engineers and firemen, 1.23 for other attendants and 3.93 cents for repairs. The total miles run was 2,273,337.

A Lock-Up Angle-Block.

The illustration herewith shows very plainly the lock-up plug and key used on an ordinary angle-block to prevent its being



turned accidentally. This lock is the invention of Mr. G. M. Tower, foreman of the locomotive repair shops of the Fitchburg shops, at Fitchburg, Mass.

A New Balanced Valve.

The valve balance illustrated on this page is so plain as to scarcely need description. It consists of the usual neck or shoulder extending from the back of the valve toward and within about 1/4 in. of the steam chest lid or balance-plate. On the outside of this is fitted a plain ring having a cut, which is effectively closed by a lip on the outside, having a returning flange on the under side, which bears against the neck on the valve, its upper edge bearing against the balance-plate. It is securely riveted to one end of the ring, leaving the other end free to expand or contract, at the same time making it practically as tight as a solid ring.

Steam pressure tends to close all parts together, which causes it to wear tight with use.

Two or more pins secured in the ring pass through slots in the neck on the

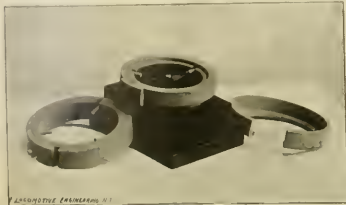

valve, and rest on the arms of a radial spring. This spring has a set screw in the center by which any degree of tension can be given to hold the ring up against the balance-plate. The screw points next as a fulcrum, on which the whole oscillates freely, to conform to any irregularity. The clip end extends entirely around, forming a double ring like the one lying on the left side. In this case the pins pass loosely through holes in the inner ring and are secured in the outer one, which supports the former on its flange. It can be cut like the inner one, as shown, or not.

The rings can be supported by four spiral springs outside of the neck in place of radial spring shown, if preferred. On the right side is shown a clip-ring turned up, with one clip cut out. Ten clips can be cut from one ring.

The work is all plain lathe work, inexpensive in first cost and easily repaired. This, with its ability to stand hard usage, the inventor thinks makes it especially adapted for locomotives. It has been patented by Mr. E. P. Cowles, of New Decatur, Ala., a manufacturer of steam engines and tramroad locomotives.

A Simple Cylinder-Block.

Mr. W. T. Thompson, master mechanic of the Kings County Elevated road, in Brooklyn, has recently put on his engines a very simple cylinder-block rigging that seems to answer all requirements, and to be very inexpensive.

As can be seen by our sketch, four small pipes enter the valve case, one from each end of each cylinder, a single plug-cock controls the flow from them all. On the opposite side of the valve-case there is connection for a 2-inch pipe, and this is carried back under the engine for 6 feet, with a fall of 1/4 inches, and on the end there is a cap and two small pipes leading to the drip-cups on either side of the engine—of course nothing can be dripped while the engine are over the streets. On each of the four little pipes there is an automatic drip-valve that opens when the pressure is

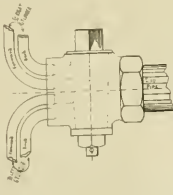

relieved, allowing the condensation to drip away when cylinder-cock proper is closed.

The single plug, of decent size, and the direct and simple rigging necessary to handle it will commend it to many master mechanics who are worrying with the four-plug valve variety of abomination.

There has been on exhibition at the Windsor Hotel, New York, the Tower car coupler, which has attracted much attention from railroad men. This coupler is of the M. C. H. pattern, and bears the traces of having been designed by a mechanic who understood how to provide against the complex shocks and strains to which a car coupler is subjected. It has a very simple and substantial locking device which is not likely to get out of order readily, and part of the locking mechanism is employed to throw open the knuckle when uncoupling has done. The knuckle is a simple form that can be easily made strong, and it is so designed that in pulling or buffing the shock comes upon the coupler body and not upon the pivot pin.

The Cleveland Twist Drill Company have closed up their factory for the holidays and to make such general repairs as are necessary, also to take inventory of stock. Until this brief slitting-down took place, they were running full time, but with a reduced number of hands. They have a full stock of goods on hand and are in a position to fill orders promptly.

? A. • Want You • ? A.

Don't ask questions that simply require a little figuring to determine; make each question separate. No notice taken of anonymous questions.

(1) Inquirer, Water Valley, Miss., asks—Has the extent of an article any influence on the amount of expansion and contraction? That is, will a sheet 1/2 inch thick expand or contract as much as a sheet 4 inch thick? A.—There will be no difference if they are the same length.

(2) W. S. Fort Howard, Wis., asks—Is there an automatic vacuum brake patented in the United States, and if so, where can I get a description of it? A.—Yes. It is an English patent—not made or used in U. S. Is a non-lifting injector as efficient a boiler feeder as a lifting injector? A.—Yes.

(3) H. A. C., Los Angeles, Cal., asks—Are locomotives direct or indirect valve-motion engines, and where is the difference? A.—An indirect valve motion has a rocker—the valve goes back while the eccentric blades goes ahead. Direct valve gear, the valve-travel with the eccentric—the stem is connected directly to the link. Both kinds are used, but most locomotives in America have indirect valve motion.

(4) Foreman, St. Louis, writes—Is there any rule for establishing the proper speed of grindstones? Our grindstones were run so slow that lots of time was wasted at them. I have speeded them up, and some of the men say that they run dangerously fast. They certainly throw the water badly. A.—The proper peripheral speed for a grindstone for tool work is about 250 feet per minute. If it makes the water fly off it is running too fast.

(5) A. M. S., Indianapolis, Ind., says— I have several small iron and steel articles that I would like to cover with a thin film of copper to keep them from rusting. How can it be done? A.—Clean the surface of the article thoroughly by dipping in a mixture of sulphuric acid and water. Then wash off the acid thoroughly and immerse the articles in a solution of sulphate of copper, leaving them long enough for the required thickness of coating to be formed.

(6) C. A. R., St. Thomas, Ont., says—What is the use of making the valve of the low-pressure cylinder of a compound so that it will cut off before the end of the stroke? A.—A cut-off is used in the low-pressure cylinder because it results in economy of steam. Many attempts have been made to use the steam in the low-pressure, through the full stroke, but the arrangement never worked satisfactorily. To explain the reputed causes of this would require more space than we can devote to this department.

(7) Wm. O. D., Conneaut, O., asks—What is the exact number of pounds of air we get in brake-cylinder from train line in emergency application, train line and auxiliaries charged to 20 pounds when application was made? A.—It all depends on size of cylinder and travel of piston—in other words, in the volume the air has to expand into. The best way to state it would be, the amount of pressure taken out of train-pipe, in an emergency application, by the quick-action valve = we do not know exactly, but it is a very small amount.

(8) C. W. G., Saginaw, Mich., asks—1. Why does a high stack have more draft than a low one? A.—The less the height of a stack the greater the amount of heat required to create draft. Intensity of heat is as the square root of their height. 2. Where and how can I get a copy of the Westinghouse air-brake instruction book or catalogue. A.—Write to W. A. B. Co., Wilmering, Pa. 3. How is steam admitted to low-pressure cylinder

on Baldwin four-cylinder compound. A.—Through the piston-valve that admits live steam to the high-pressure cylinder.

(9) R. Young, Boston, writes—Suppose a locomotive with a boiler pressure of 140 pounds is pulling a train regularly, and can do most of the work when cutting off at 4 stroke and slightly throttling. Would there be any gain by increasing the boiler pressure to 150 pounds? A.—We think there would be loss instead of gain. The engine would have to be throttled more, and there would be loss from slipping, without any gain in steam expansion. The throttled steam would be a little superheated but that gain would not be enough to offset the losses.

(10) J. M. Atkinson, Kambloop, B. C., writes—

1. What is the chief cause and remedies for air-pumps running hot in air-cylinder, also air-pumps knocking? A.—Read "Diseases of the Air-Brake System, their Causes, Symptoms and Cure," in this paper. 2. What is the best preparation and mode of using same for case hardening? A.—Case hardening is produced by heating articles to a cherry red in a close vessel, in contact with carbonaceous material, and then plunging into cold water. Bones, leather, hoofs, horns, etc., are usually used for this purpose—being first burned to a crisp and pulverized. This process converts the surface of iron into steel by cementation. It hardens the surface but reduces the strength about to per cent.

(11) J. B., Syracuse, N. Y., asks:—Is it possible or likely that a man who is in good health and has passed a rigid examination for color blindness would become color blind in two years afterwards? The company decided that he was not safe to be upon a locomotive. A.—It may be possible for this to happen, but it is very improbable. There is one form of color blindness, however, which has been fatal to not a few railroad men that may develop in the length of time stated. It is almost certain to be rapidly developed in a man who takes an unduly active interest in labor organizations or makes himself obnoxious to men in authority. We have known a variety of cases where men of this kind suddenly became color blind and at once lost sight of their jobs. It is surprising how much lack of color a company's surgeon can see in the eye of a man who is considered objectionable.

(12) Arthur Graham, Adel, Ia., asks—

1. Where can I obtain a book treating of the construction and operation of the English locomotive? A.—Ask for Reynolds' "Locomotive Engineering," Engineers' Literature Co., East River, N. Y. 2. What is meant by "driving" water tubes of a chimney? A.—U-shaped glass tube, partially filled with water, has one end open to the atmosphere and the other inside the chimney. The partial vacuum in the chimney will let the air force water down in the outside tube, and this will be read in inches—the difference in air-pressure inside and outside the chimney. 3. What is meant by a "24-inch vacuum" in a condenser? A.—If a U-shaped tube partially filled with mercury has one end open to the air and the other to a practically perfect vacuum, the pressure of the air above it will depress the mercury down, practically 29 inches; 29 inches is sealed off to read degree of vacuum; 24 inches in a condenser would mean that 1/4 of a practically perfect vacuum. 4. Does the vacuum gauge register in inches or pounds? A.—Inches.

SYNOPSIS

OF THE

Air-Brake Law Suit Decisions

VERDICT FOR THE

Westinghouse Air-Brake Co.

When the Westinghouse Air-Brake Co. began making pneumatic air-brakes in 1852, the Westinghouse Air-Brake Co. brought suits against them for infringement of patents on the quick-action triple-valve mechanism, and of a piston covering an engine's brake-valve. Nearly a year ago the suits were heard before Judge Townsend, in the Circuit Court of the United States for the Southern District of New York. Judge Townsend has recently rendered a decision in these suits, and the principal points are given below.

Character of Patent.

The device at issue was non-infringing, and of a very early type, upon the theory that the inventions claimed had been previously described by Westinghouse in his patents.

History of Air-Brake Development.

In studying the decision, the judge gave a brief history of air-brakes. The first practical air-brake is known as the *Wagon Brake*, and was patented in 1850. It consisted of a pump operated by the locomotive engine, which compressed the air into a reservoir located under the locomotive's *foot-plate*. This reservoir communicated by a pipe with a cock which was operated by the engineer's valve, and was so fitted as to be easily manipulated by the engineer.

From this valve a pipe extended back toward the tender and was connected to a piston pipe under the entire length of the train by a flexible hose. Each of the succeeding cars had a pipe similarly connected, which was called the train-pipe. From the train-pipe of each car a branch pipe connected with the forward end of the cylinder called a brake cylinder. This cylinder was provided with a piston, the stem of which was connected with the brake levers on the car. When the engineer wished to apply the brakes he opened the engineer's valve and the compressed air from the main reservoir flowed back through train-pipe and branch pipes into the brake-cylinder of each car, pushing the pistons backward, causing the piston stems to operate the brake levers and force the brake shoes against the wheels.

When he wished to release the brakes he moved the valve so as to shut off the flow of compressed air from the main reservoir and to open a port leading from the train-pipe to the open air. Thereupon the compressed air in the brake cylinders escaped into the open air, the pressure of the pistons was removed and the pistons were pressed forward again by means of springs, moving the brake shoes away from the wheels.

Weak Points of Straight Air-Brake.

This was a good practicable continuous brake, but it was subject to certain objections. It was too slow when used in a long train, and there was danger of collision in case one part of the train broke away from the other for there was nothing to stop the part of the train detached from connection with the engine.

Invention of the Automatic Air-Brake.

About 1875 Mr. George Westinghouse, Jr., invented an improvement on the old brake, making it work automatically in

case of accident. This is known as the automatic brake. It embodied the addition of an auxiliary reservoir and a triple-valve on each car. Each reservoir was of sufficient capacity to operate its brakes and supplied air to the brakes when they were put in action. The triple-valve was located at the junction of connections between pipes leading to the train pipe, the brake-cylinder and the auxiliary reservoir. In addition to the three ports connecting the triple-valve with these parts, there was a fourth port leading to the open air.

Operation of the Automatic Air-Brake.

This brake was radically different from the plain brake. In the plain brake, all the compressed air to be used was stored in the main reservoir on the locomotive and not in the train, the main and auxiliary reservoirs and train-pipe were always charged with compressed air at working pressure to prevent the application of the brakes. When the engineer wished to apply the automatic brake, he moved the engineer's valve so as to cut off the flow of compressed air from the main reservoir and open a port from the train-pipe to the open air. The effect of this was to reduce the air pressure in the train-pipe. This caused the pressure in the auxiliary reservoir to be greater than the pressure in the train-pipe, which pushed down the piston of the triple-valve, closing the port from the branch-pipe to the train-pipe, and opening the passage between the auxiliary reservoir and the brake-cylinder. Thereupon the compressed air in the auxiliary reservoir flowed into the brake cylinder and applied the brakes. The brakes were released by recharging the train-pipe with the main reservoir air, but that was of greater pressure than the air in the auxiliary reservoir. This pushed up the piston of the triple valve, cutting off the flow of air from the auxiliary reservoir and opening the brake-cylinder to the atmosphere.

The effect of this arrangement was that in case of accidents, where the train pipe was ruptured or opened, the brakes on all the train were applied automatically.

The Graduating Feature of the Automatic Brake.

Important features about an efficient air-brake are those that enable it to be used so that the power may be gradually applied to effect what are known as *service-stops*, or to apply the power instantly with full force to effect what are known as *emergency-stops*. In the first case, air-brake pressure of 7 or 8 pounds in the brake-cylinders may be sufficient. In the latter case, a pressure of 50 or 55 pounds may be necessary. This distinction came out strongly in the brake suit.

Automatic Brake Not Satisfactory With Very Long Trains.

The automatic air-brake worked perfectly on short trains, but on very long trains it was not satisfactory. When the railroad companies began to apply air-brakes largely to freight trains, it was found necessary to avoid work brakes, suddenly applied, would work on trains of fifty cars. Under the auspices of the Master Car Builders' Association a series of brake trials were made at Burlington in 1884. In these tests, it was found that so

much time elapsed between the period of application on the first and on the last cars of a train, that destructive shocks resulted. The lesson of these tests was that the necessity existed for improvements on brakes which would make the application so quick that no severe shocks would be experienced by very long trains.

Burlington Brake Trials.

The brake trials at Burlington were renewed in 1887, and the Westinghouse Air Brake Co. used an improved apparatus covered by patent No. 36,070, granted to George Westinghouse, Jr. This brake did not materially reduce the shocks caused by sudden application to very long trains. The experts who attended these trials came to the conclusion that air-brakes, actuated by electricity, were necessary to prevent shocks when the trains were very long.

Essentials of a Brake for Long Trains.

- Several essentials appeared necessary for a brake to work satisfactorily on very long trains, and it was thought that they could not be secured by air pressure alone. The following were the leading requirements:
 - The regulation of the force to be applied to the brake-shoes so as to secure all necessary gradations, from the mere slackening of speed to the emergency stop from the service stop to the emergency stop.
 - The automatic operation of the brakes in case of accident.
 - The practically simultaneous operation of the brakes on each car, so that, in long trains of freight cars, shocks might be avoided.
- The control of all these operations by the engineer.
- Certainty of operation under all conditions.

The Quick-Action Air-Brake Invented.

In this condition of affairs, George Westinghouse, Jr., set to work to overcome the difficulties. The result of his labors was the production of what is now known as the quick-action automatic brake, which was patented in January, 1888, in Patent No. 376,537. This brake was capable of banding a train of fifty freight cars successfully without causing shocks or dangerous strains to the machinery.

In the improved brake, the quick-action element was added to the automatic apparatus by such an arrangement of the triple-valve in connection with vents on each car as to make the opening of such vents and the consequent reduction of train-pipe pressure practically simultaneous on all cars. This emergency action is secured by means of a separate supplementary piston and valve in a supplemental valve-chamber below the main slide-valve of the triple-valve device. One chamber connects the train-pipe with the train-cylinder, communication between them being regulated by the supplemental valve opening outwardly or downwards, and a check-valve opening inwardly or upwards. In the bushing which forms the stem of the main slide-valve, four parts governed by this slide-valve, one of these parts leads to the brake-cylinder, two lead to the supplemental valve-chamber on the upper or inner side of the supplemental piston, and one leads to an exhaust-port.

Emergency Action.

When an emergency stop is to be made the engineer throws his engineer's valve wide open, thereby causing a sudden and material reduction of pressure. The excess of auxiliary reservoir pressure then forces the main piston stem against the spring and draws the main piston to the extreme limit of its stroke. This moves the prism leading from the auxiliary reservoir to the supplemental valve chamber

The auxiliary reservoir pressure drives the supplemental piston outwardly or downwardly against the stem of the supplemental valve and forces it from its seat. Thereupon the preponderance of train-pipe pressure in the train pipe opens the check-valve and the air from the train-pipe rushes directly from the brake-pipe to the brake-cylinder.

The result of this operation is two-fold, it hastens the application of the brake on the car on which it is operated, and, by venting the train-pipe, hastens a similar reduction of pressure and consequent similar operation in the next succeeding triple-valve device on the next car.

Outlines of First Suit.

In the suit based upon Patent No. 376,537, it was alleged that the New York Air-Brake Company infringed the claims 1, 2, 3 and 6.

Claims of Patent 376,537.

The first claim is "In a brake mechanism, the combination of a chamber or casing, having direct connections to a brake-cylinder and to a brake-pipe respectively, a valve controlling communication between said connections, and a piston or diaphragm which is independent of and connected with a triple-valve piston, and is actuated by pressure from an auxiliary reservoir in direction to impart opening movement to said valve, substantially as set forth."

The second claim includes a check-valve controlling communication between said valve and the brake-pipe passage of the chamber.

The third claim is "In a brake mechanism, the combination of, with a triple-valve of a supplemental chamber or casing having passages leading to a brake-cylinder and to a brake-pipe respectively, a supplemental piston operating independently of the triple-valve piston, and adapted to impart opening movement to said supplemental valve, and a passage establishing communication between said supplemental piston and an auxiliary reservoir, substantially as set forth."

Devices used by Defendants.

Defendants have used two devices, the first known as their "quick-action triple-valve," the second as their "modified quick-action triple-valve." It is claimed that both are infringements of the Westinghouse patent.

Each of these devices has a chamber or casing, with direct connections to brake-cylinder and train-pipe, and a controlling valve as in the Westinghouse patent. Each has an emergency piston and valve, and check-valve.

New York Air-Brake Co.'s Triple-Valves.

The first form of defendants' apparatus has two emergency pistons and valves, of rather one emergency piston and valve, actuated by a sudden or large reduction of pressure, as in the Westinghouse apparatus, and connected by means of a piston and supplemental piston and valve with the check-valve, like the single emergency piston-valve and check-valve of the complainants.

The second or modified apparatus differs from the first in the elimination of one of the pistons and its valve, and part of the emergency actuation and modification of the check-valve.

Pretense of Defendants.

The defendants claim that their emergency apparatus, as well as that of the Westinghouse, is merely the combination of an automatic relief-valve described by Westinghouse and others in 1875, in patent No. 167,494. The purpose of this inven-

son was to facilitate the escape of air from the brake-cylinder in the old straight air-brake. The claim was made that this old invention was embodied in the Westinghouse patent 376,837, on which this suit was brought.

The Quick-Action Mechanism a New Invention.

In this connection, Judge Townsend says: "I do not think this patent anticipates or limits in this connection patent No. 376,837, for the following reasons:

"The sole object of the invention was to quickly release brakes in the direct system. It was intended to obviate the difficulty arising from the fact that, in the direct system, the escaping air being expelled simply by its own expansion, came out very slowly. It was not adapted to the application of brakes or in any way to the automatic brake system, although that system had then been invented.

"Counsel and experts for defendants admit that radical and material modifications were required before it could be practically applied to railroad service and the automatic system.

"There is no suggestion in the patent in any way in which it could be adapted to the automatic system, nor, if so adapted, to apply the brakes, does it appear how it could be operated to release them. No provision is made for graduation for ordinary service stops in any case."

A New and Valuable Invention.

"Counsel for defendants having argued that the invention referred to, having shown a low air could be released quickly through a pipe, it was easy to apply it in a different way. This point is met by the fact that, if this was a thing that any competent mechanic could do, why was George Westinghouse the only person to do it?"

"Even if Mr. Westinghouse, in patent No. 376,837, did, as claimed by the defendants, did throw his mind back to patent No. 46, and use it as a basis for part of the contrivance of patent 376,837, he did not invent patent 376,837, but he invented and created a new device, adapted to new conditions, and developed in new combinations, which produced new and different results."

"Various decisions were quoted to sustain this opinion.

Each Patent Marked Decided Progress in Brake Mechanism.

"Counsel for defendants contended that all the essential elements in the patent under which the suit was brought were anticipated in patents 162,465, and 360,070, the latter covering the improvements embodied in the Westinghouse brake tried at Burlington in 1887. This contention was fully considered, and evidence was quoted to prove that each of the various patents involved had important elements which did not conflict with or anticipate the others. The opinion was expressed that each of the patents 162,465, 360,070, and 376,837, marked a forward step in the progress of the freight brake system, and that each contributed an important and essential element of invention thereto.

First Element of Quick-Action Apparatus.

"It appears that the apparatus constructed under patent 376,837 was the first successful embodiment of these great inventions, and furnished the first and only practical solution of the problems of automatic quick-action freight brakes.

"It seems to me most significant that within a few months, and under the pressure of competitive trials, no one so grasped the inventions claimed to be disclosed in patent No. 376,837 as to embody them in a successful working apparatus until after

the patent in suit had been applied for, and that when defendants constructed an apparatus, they adopted the emergency piston and valve of the patent in suit.

The Patent Has Been Infringed.

"As patent 376,837 accomplished this result by the use of a separate piston, and as defendants' apparatus have accomplished this result also by the use of one or two separate pistons, they must be held to have infringed the first and third claims of said patent."

"After considering and overruling objections based on the language of the claims of patent 376,837, the decision proceeds:

Action of Defendants' Triple-Valve.

"It remains to further consider certain suggestions in regard to the piston and supplemental piston of defendants' earlier device.

"When this emergency piston is called into operation by a sufficient reduction of pressure, it is not, as in complainants' device, so driven by auxiliary reservoir pressure as to act directly on the emergency valve, but when so forced down it opens a port whereby the reservoir pressure is admitted to the upper side of the other piston, which, being thereby forced down, imparts opening movement to an emergency valve leading to the brake cylinder.

"We have here the triple-valve piston and two other pistons used to accomplish the work of the one piston in complainants' device, and defendants claim that in their device there is not the combination of triple-valve piston and emergency valve, because the first of the two pistons does not impart opening movement to the emergency-valve, its only function being to uncover a port whereby air is admitted to the brake-cylinder, and the train-pipe is vented.

"The former further claims that the second supplemental piston in said device is not actuated by reservoir pressure, but by train pressure.

"Of the two separate or emergency-pistons of the defendants, one opens a port which admits train pressure to the other. The former is directly actuated by pressure from the auxiliary reservoir. The latter is directly actuated by train pressure but is indirectly actuated by the pressure from the auxiliary reservoir in the sense that such pressure necessarily results in operating it through the intermediate operation of the former.

Practically the Westinghouse Quick-Action Triple-Valve.

"The question is, whether this combination of devices is the same as device of complainants. It seems to me that it is. The component parts of the combination operate to perform the same function and to produce the same result.

"It is merely dividing complainants' piston into two parts, so arranged that the action of one necessarily causes the action of the other in the same way as though they were one."

"Reference was made to claims of defendants as to differences in their device when not in action, and to admissions that it was inferior to that of complainants concerning these points the decision says:

"The question, whether the operation of defendants' device when not in action is the same and produces the same results as that of complainants?"

"What has already been said has been directed chiefly to the combination described in the first claim of complainants' patent. The additional claim-claim valued in the second claim is found in the defendants' first device.

"The elements of the third claim are in the main the same as in the first claim, and the additional element, a passage between the supplemental piston and auxiliary reservoir, is found in defendants' device.

Both Defendants' Triple-Valves are Infringed.

"As a result of these considerations, I have reached the conclusion that the first form of defendants' apparatus, the 'Quick-Action Triple Valve,' infringes the first three claims of the patent in suit, and that the second form, the 'Modified Quick-Action Triple Valve,' infringes the first and third claims of the patent in suit."

Divisional Patent.

"Consideration is next given to the alleged infringement of claims 1 and 2 of patent 448,827, granted to George Westinghouse, Jr., in 1891, for an air-brake. This was a divisional patent, having been originally applied for as a part of patent 376,837.

"To provide means for effecting the rapid admission of fluid under pressure to a desired fluid receptacle by means of, and coincidentally with, a reduction of pressure in the receptacle of a fluid supply," and that the means by which this object was to be attained could be used with or without a triple-valve apparatus.

"The defendants admit infringement, but urge that the claims are void, alleging that the appliances had been described in previous patents, that alleged amendments to the patent were enlargements, not amendments, and that the claims were undesignedly too broad.

The Divisional Patent Good.

"Among the points made in excluding this suit are the following:

"This divisional patent fairly represents an invention distinct from those which preceded it. The problem presented was, how to provide for a certain, sure operation of the emergency valve, and how to rapidly apply brakes for an emergency stop, or by means of an emergency reduction of pressure."

"The solution was accomplished by a valvular appliance so arranged as to operate independently of the triple valve, although capable of being used in the combination with it.

Essence of the Invention.

"The essence of the invention lies in providing a means whereby the emergency apparatus may be directly brought into efficient operation, although the triple-valve may be stuck fast."

"The distinct invention in patent No. 448,827 is the combination of the valve with the triple-valve mechanism, under such relations that it does not need any movement on the part of the triple-valve mechanism in order to operate it.

"If the invention embodied in patents Nos. 360,070, 376,837 and 448,827 be considered in its entirety, we shall see that it is for the fluid-pressure air brake, consisting of various combinations, operating in different ways. The object to be attained by such invention is the successful practical operation of the brakes on all occasions.

"One of the exigencies to be guarded against in providing for all contingencies is the possible sticking or wedging of the triple-valve. While, therefore, the apparatus covered by patent No. 448,827 is adapted to be used in connection with the triple-valve device and in combination with a brake apparatus normally operated by such device, yet it is designed to be so constructed that upon a considerably greater reduction of pressure than that required for a service stop, the pressure from the reservoir on top of the diaphragm will cause it to work in any case. By this means the most serious dependency of the emergency part of the device is eliminated, and the movement of the other part is eliminated."

"I am forced to the conclusion that George Westinghouse described, in the original specification of this patent, an improvement upon previous inventions, which

was capable of use independently, or as part of a combination, but which owed its utility in such combination to its independence of operation in emergencies, in supplying the lack of the other part of the combination, and that this useful element involved invention, in order to adapt it to such combination, and to the exigencies of the automata quick-action freight brake system."

The Engineer's Valve.

In the suit for infringement of patent 222,003, granted George Westinghouse, Jr., on engineer's valve, the defendants deny infringement. In deciding this suit the inventions are compared, and their identical and differing features pointed out. The following are extracts from the decision:

"Defendants' device has a greater capacity for automatic closing of the escape-valve than that of the complainants."

"But which in these respects the device of defendants may be an improvement upon that of complainants, it does not seem to me to show that defendants have not appropriated the invention of complainants."

"And because of these conclusions, supported by the admissions of defendants' experts that the device of defendants contains the elements combined, as claimed by complainants. I am of the opinion that defendants' device infringes claims 2, 3, and 4 of patent No. 222,003."

Petition of Defendants for Permission to Sell Brakes.

After these decisions were rendered the New York Air-Brake Company petitioned the Court for permission, pending an appeal to the Court of Appeals, to sell about 3,000 car equipments which are finished.

Would Pervert the Decision of the Court.

"In refusing to grant the petition, the following reasons are given:

"To permit the defendants to sell the infringing equipments at a fixed rate for each apparatus, would be to pervert the decision of the Court from an injunction into a license. It would deprive the patentee of the monopoly granted him under the law of the United States, and establish an infringing rival in a competing business."

"Furthermore, as it is impossible, in this case, to estimate the damages and profits from the infringement, an injunction is complainants' only available remedy."

"The motion of defendants is, in effect that they may be permitted to make a profit of about one hundred thousand dollars out of apparatus manufactured with full notice of complainants' rights, and during the pendency of the suits in which they are now engaged."

"From the statements contained in a circular letter sent out by defendants immediately after the filing of the opinion, and produced at the hearing on these motions, it would appear that the demoralization of the motion causes operate harshly upon the defendants. In such circular they stated that, "so far as the freight triple-valve is concerned, the decision is unimportant, for no principle is involved, and only trifling and unimportant changes are necessary to make our triple-valve free, in view of the very narrow construction given to the Westinghouse patents by the court."

"If this statement does not apply to the equipments on hand, they need only be held, subject to the final decision of the appellate court."

"But the defendants cannot complain, if they are merely subjected to the necessity of making trifling and unimportant changes in such apparatus as they may manufacture during the intervening period."

RAU MANUFACTURING CO.,

Manufacturers of
METAL SPECIALTIES, ENGINEERS' TORCHES & OILERS.
 THE PERFECTION VALVE OILERS.

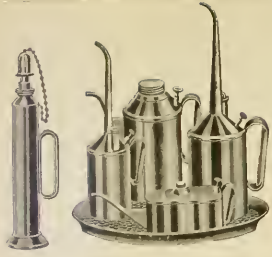

LABOR-
 SAVING
 AND
 ECONOMICAL.

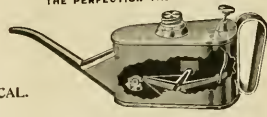

SAVES
 BOTH
 OIL
 AND
 TIME.

We do a general contracting and jobbing business on orders, and would be pleased to figure on specifications for what you may use in our line. Correspondence solicited.

122 to 128 MICHIGAN STREET, CHICAGO, ILL.

PUT LEACH'S SAND FEEDING APPARATUS INTO SPECIFICATIONS WHEN ORDERING LOCOMOTIVES.

H. L. LEACH, 65 Oliver Street, Boston, Mass.

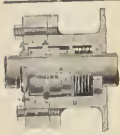

JEROME METALLIC PACKING.

This is the Standard Metallic Packing all over the world, and is more generally adapted and in use on more locomotives than any metallic packing in use. Give the JEROME a trial and be convinced. Put it in competition with any other packing and be satisfied of its superior merits.

Packing ring opened ready to apply without disconnecting the Piston from the crosshead. It runs longer and wears the rod less than any other packing in use.



Office and Works, Nos. 35 and 37 Canal St., Chicago, Ill.

C. C. JEROME, Inventor and Proprietor.

SEND FOR CATALOGUE.

THE BOYER Railway Speed Recorder



The only Recorder made that gives a chart of the run that can be read at sight, and has a flat indicator carried into the cab so Engineer can see at a glance, any time, what speed he is running.

Boyer Railway Speed Recorder Co.
 244 DICKSON ST.,
 St. Louis, Mo., U. S. A.

Books for Railroad Men.

- LOCOMOTIVE ENGINE RUNNING and MANAGEMENT. By ANDREW SINCLAIR. Price, \$2.00.
- INDICATOR PRACTICE. By FRANK F. HEWENSWAY. Price, \$2.00.
- ELEMENTS OF MECHANICS. By T. M. GUNTER. Price, \$2.50.
- COMPREHENSIVE EXAMINATIONS FOR ENGINEERS AND FIREMEN. By JOHN A. HILL. Price, 50 cents.
- AIR BRAKE PRACTICE. By J. K. FORTAN. Price, \$1.00.
- COMPOUND LOCOMOTIVES. By A. T. WOODS. Price, \$2.00.
- CATERING OF THE LOCOMOTIVE. By M. N. FORTER. Price, \$2.50.
- SIMPLE LESSONS IN DRAWING FOR THE SHOP. By O. H. NEWBOLD. Price, 50 cents.

Send price of any of these or of any other books of THE ENGINEERING LITERATURE COMPANY, East Orange, N. J., and they will be promptly mailed to any part of the world. Send for Catalogue.

OUR ENGRAVINGS.

Of late we have had a great many inquiries as to who made the fine half-tone plates shown each month in LOCOMOTIVE ENGINEERING. Credit is due the expert artists where and we are glad to recommend the engravers of our plates to those wanting good work at reasonable prices. All the half-tones and reproductions we use are made by the STRAY ENGRAVING & PRINTING CO., 607 & 609 Sanson St., Philadelphia, Pa. SINCLAIR & HILL.



Trade Mark
OIL LIPS
 GREAT WATER PUMPS
 (Patented June 1, 1881.)
 Manufactured by
 THE ORIGINAL BURY PATENT
 The following is a true and correct description of these pumps which are made each.
THE BURLY PATENT CO.
 East Cambridge, Mass.

RICHARD DUDGEON, 24 and 26 Columbia St., New York.

Maker and Patentee of Improved Hydraulic JACKS,

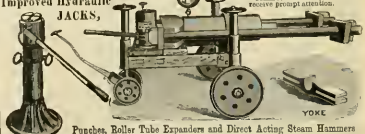

Punches, Roller Tube Expanders and Direct Acting Steam Hammers



THE CHAPMAN JACK. PATENTED.

THE screw being lubricated and protected, the Jack is always ready for instant service. Railroad men appreciate the importance of having Jacks always in good working condition. Serious delays frequently occur in getting common Jacks so they can be worked when suddenly required in train service. Common Jacks are frequently destroyed in efforts to make them work quickly after the screws are set with rust and dirt. This consideration alone makes the Chapman Jack the most economical one to purchase.

THE CHAPMAN JACK CO., CLEVELAND, OHIO.

THE LONG & ALLSTATTER CO., HAMILTON, OHIO.



Horizontal Punch. Made in 12 Sizes.

Drill, Single, Angle-Bar, Gang, Extra, Small, Twin, Buller, Spacing, Gate, Multiple, Belt and Screw-Drives
PUNCHES AND SHEARS.
 Over 300 Sizes.

THE O. K. BRAKE ADJUSTER.

Insures the Maximum Pressure on the Brake Shoes at all times.



Manufactured by PRATT & LETCHWORTH, BUFFALO, N. Y.

TANCY'S HYDRAULIC LIFTING JACK.



A good, reliable Jack for lifting or forcing in any direction. You have to be pumping it up, the key works and stops at any point, when it is again ready for lifting, forcing, etc. in any direction.

Various sizes made, from 4 tons to 400 tons.

Joseph F. McCoy Co.
 26 Warren St.,
 NEW YORK.

Locomotive and Car Axles,
Coupling
Links and Pins.

M. C. B. Passenger Coupler
Used in Place of Miller Hook
WITHOUT CHANGE IN PLATFORM.

M. C. B. STANDARD
Automatic Freight Car Coupler.

New York Office, . . . 120 Broadway,
Chicago Office, . . . 941 Rookery,
St. Louis Office, 319 Commercial Build'g.

GOULD
Goupler Co.

BUFFALO OFFICE AND WORKS,
AUSTIN ST.

Gould Continuous
Platform and Buffer.

GOULD VESTIBULE.

SEND FOR CATALOGUE.

STARRETT'S FINE TOOLS

ARE WARRANTED ACCURATE

U. S. STARRETT, ATHOL, MASS.

THE SMILLIE COUPLER is the Strongest and Simplest M. C. B. Coupler.
Only 4 Pieces.

Tensile Strength (Fairbank's Test) 139,640. Drop Test, 700 lbs. hammer dropped 18 ft. 22 times failed to break the knuckle.

ALL LOCKING PARTS ARE THE BEST OF STEEL.

NEW YORK OFFICE, 52 BROADWAY,
Office and Works, 91 Clay St., Newark, N. J.

Strictly M.C.B. Lines.

JOHNSTON COUPLER

JOHNSTON CAR COUPLER COMPANY,
204 WALNUT PLACE,
PHILADELPHIA PA.

THE TROJAN CAR COUPLER Co., Troy, N. Y.
The knuckle may be thrown open for coupling by the hand rod at the side of the car, rendering it unnecessary for the trainmen to go between the cars to open the knuckle.

M. C. B. TYPE. THE STRONGEST AND THE ONLY SAFETY COUPLER.

New York Office: 49 WALL ST.

THE NATIONAL MACHINERY CO.,
TIFFIN, OHIO.

SPECIALISTS IN
Bolt and Nut Machinery.

Bolt Cutters. Bolt Headers. Bolt Pointers
Upsitters and Benders. Nut Teppers. Nut Machines.

CATALOGUES ON APPLICATION.

NONE BETTER FOR TWICE THE MONEY.

"Locomotive Running Repairs," by L. C. HAYMOND, General Foreman "New Shops. A practical treatise on running repairs, by a practical man. Numerous diagrams and illustrations. Just what is needed by men who handle and repair locomotives.

"Simple Lessons in Drawing," by GEORGE H. REYNOLDS (Chief Draughtsman Northern Pacific Railway). A splendid book. Shows how to learn the elementary principles of mechanical drawing and sketching. Every student of locomotive engineering and every explorer in the field of mechanics should have it. Reduced from \$1.00.

"Progressive Examinations of Locomotive Engineers and Firemen," by JOHN A. HILL, Editor LOCOMOTIVE ENGINEERING. A capital little book for new beginners. An excellent pocket companion. Three hundred questions and the answers. Seventeen colored plates showing position and color of all signals carried on engines and trains adapted to standard code. This plan of examination has been adopted on several roads. Twelve thousand of these books sold in less than two years.

Send 50 cts. for any of the above Books to
DEBS PUB. CO., TERRE HAUTE, IND.

THE ACME MACHINERY CO.
CLEVELAND, OHIO,
Manufacturers of
ACME BOLT & RIVET HEADERS
ACME SINGLE AND DOUBLE
AUTOMATIC BOLT CUTTERS,
Cutting from 1/4 in. to 1 1/2 in. diam.
Also, SEPARATE HEADS AND Dies

LOCOMOTIVE SPRINGS
WITH PATENT V SHAPE BANDS.
Gives more Elasticity to Short Plates
and Better Riding Qualities.

A. FRENCH Pres. **ELLIPITIC AND SPIRAL SPRINGS** Gen'l Mgr
OF ALL DESCRIPTIONS.

A. FRENCH SPRING CO.
PITTSBURGH, PA.
Manufacturers of

THE MURPHY STEEL CAR ROOF.

It has no surface nail or screw holes. It has no joints where rain or fine snow can get through. It allows for contraction and expansion, and has ample elasticity to provide for sagging, twisting, bending and warping of the car body. It is so solid as to bear the roof itself. It has an soldered joint. It can be repaired readily, and without taking off more of the roof than is damaged. It is much cheaper than any other metallic roof now in use, and is cheaper than the double board roof, made of good lumber. It is unlike any other metallic roof for the reason that everything is furnished to make it complete; so that the parties buying it have no expense other than to apply it.

This ROOF can be applied on OLD LEAKY BOARD-ROOF CARS without making any changes in the board roof; thereby saving the expense of replacing the old boards with new, and thus utilizing material that must otherwise be thrown away.

Manufactured by the **P. H. MURPHY MFG. CO., East St. Louis, Ill.**



VALENTINE & COMPANY, Railway Varnishes and Colors,

Manufacturers of High Grade

BRANCHES:

Chicago, 300 Wabash Ave.
Boston, 104 Purchase St.
Paris, 11 Rue de Lognon.

57 BROADWAY, NEW YORK.

JOHN W. MASURY & SON, PAINTS AND VARNISHES.

NEW YORK and CHICAGO.



THE CLEVELAND VARNISH CO. Mfrs. RAILWAY VARNISHES. CLEVELAND, O.

MATCHLESS VALVE AND CYLINDER OIL.

Warranted not to corrode the iron or destroy packing, and to make more mileage than tallow or lard. Sold only to Railroad Companies direct or through our authorized agents. Matchless Cylinder Oil cannot be Bought of Dealers. In use on 60 Railways.



—OILS FOR RAILROAD USE A SPECIALTY.—
ECLIPSE LUBRICATING OIL COMPANY, Limited,
MANUFACTURERS OF EVERY PRODUCT OF PETROLEUM.

Main Office: FRANKLIN, Pa. Refineries: FRANKLIN, Pa. OLEAN, N. Y. FREE, Pa. OIL CITY, Pa.



CUYAHOGA FALLS, O.

BILLED HOLLOW STAY BOLTS ARE STRONGER AND SAFER THAN DRILLED ONES.

Made rolled from the finest charcoal iron. All sizes, from 3/8 to 1 1/2 inch, with any sized hole to square from 3/8 to 1/2 inch. Let us send you a sample and quote prices.

A set for one fire-box will convince you of their merits, safety and economy.

AGENTS IN CANADA. J. & N. TAYLOR, 751 Craig Street, - - Montreal, Canada.

LEONARD & ELLIS.



TRADE MARK
OILS FOR RAILROADS.

VALVOLINE OIL has long been used on many of the leading railroads in this country and abroad. It has no equal in quality and economy.

W. A. BOYDEN, General Agent,
157 Chambers Street, NEW YORK.

SIGNAL OIL WORKS,
LIMITED
FRANKLIN PA
MANUFACTURERS OF
SIBLEY'S Perfection VALVE OIL.
The only perfect Locomotive Valve Lubricant
J. C. SIBLEY Patent

GALENA OIL WORKS,
LIMITED.
Galena Engine, Coach and Car Oil,
the Standard Lubricating Oil
of America.

SAFETY SPEED and ECONOMY are the results of the use of Galena OIL. COLD TEST, it is 15 BELOW ZERO. These oils do not freeze in the coldest weather while they are adaptable to the hottest climate. In the use of Galena Oil there is an entire freedom from hot spots, except when those are caused by mechanical defects. In many cases, the leading railway corporations by a large majority of the leading railways of this country are in evidence of their superiority. The fact that the same roads use these oils to-day that used them more than 20 years ago, is an evidence of their uniformity from year to year and year to year. Galena Oils are in evidence, and are used there continuously from Boston and New York to the Pacific coast, and upon our continuous line from the City of Mexico to New York, thus demonstrating their adaptability to all temperatures and climates. And it is not only so, but their oils are not affected by dirt and sand as other oils are. We also manufacture SIBLEY'S PERFECTION VALVE OIL, which is also used exclusively upon a majority of the leading railways of America.

GALENA OIL WORKS, Limited,
CHARLES MILLER, President,
CHICAGO BRANCH OFFICE, Franklin, Pa.
Please address to J. C. SIBLEY.

Our Line Engravings are made by the wax process, a plan securing accuracy and distinct lines on original copper plates. They are made by BRADLEY & POTTER, 251 William Street, New York City.

THE Standard Steel Works,

PHILADELPHIA.

STEEL TIRES

MANUFACTURED BY AN IMPROVED PROCESS INSURING SOLIDITY.

Wrought Iron Centres.
Steel Tired Wheels.

REPRESENTATIVES:

Chicago, 1013 Monadnock Bldg., St. Louis, 516 North 3d St.,

FITZ-HORN & SPENCER.

ANDREW WARNER.

WROUGHT IRON WHEEL CENTRES.
VAULAIN'S PATENT.

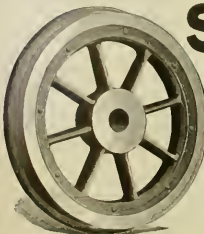

The Sample Tells the Story.

A sample of Dixon's pure, flake lubricating Graphite, with interesting and instructive pamphlet.

Sent Free of Charge.

Every engineer and machinist should make himself better acquainted with Dixon's Pure Ticonderoga Flake Graphite. It will save both time and labor, and is infinitely superior to the common forms of plumbago or black lead.

JOS. DIXON CRUCIBLE CO.,
JERSEY CITY, N. J.



29 BROADWAY, NEW YORK CITY.

THE CAMERON STEAM PUMP.

COMPLETE WITH BOILER.

THE A. N. CAMERON STEAM PUMP WORKS,
Post Office No. Twenty-third St.,
NEW YORK.

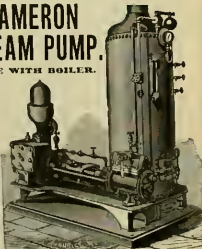

Send for illustrated Catalogue.

THE ROTARY.

For full Particulars, Address

The Leslie Bros. Mfg. Co., Paterson, N. J.

Boiler, Locomotive and Smoke Stack STEELS.

QUALITY UNSURPASSED

Plates up to 100 ins. in width.

SHOENBERGER & CO.,

PITTSBURGH, PA.

FIRE BOX STEEL.

PURITY AND DUCTILITY AND SOFTNESS.

LUKENS IRON AND STEEL CO., Coatesville, Pa.

ESTABLISHED 1810.

INCORPORATED 1890.

THE OLD MILL.

THE FIRST TO MAKE BOILER PLATES IN AMERICA, STEEL AND IRON PLATES. FIRE-BOX STEEL PLATES A SPECIALTY.

We can roll plates up to 116 inches wide, and from 1/2 in. to 1 1/2 in. thick.

CHARLES HUTTON, Pres't. & F. HUTTON, Vice-Pres't. CHARLES L. HUTTON, Gen'l Mgr. ROBERT B. HARRIS, Jr. Sec'y. JOSEPH HORTON, Treas.

New York. Boston. Chicago.

HOWE, BROWN & CO., (Limited) PITTSBURGH, PA.

STEEL.

HOWE'S SPECIAL TOOL CAST STEEL for Taps, Dies, Reamers, Cutters, Punches, Chisels, Drills, Shear Blades, Lathe Tools, etc., etc. Crucible Spring Cast Steel, Crucible and Open Hearth Firebox and Sheet Cast Steel, Forgings, etc.

THE FIRST TO MAKE BOILER PLATES IN AMERICA, STEEL AND IRON PLATES. FIRE-BOX STEEL PLATES A SPECIALTY.

We can roll plates up to 116 inches wide, and from 1/2 in. to 1 1/2 in. thick.

MEYER'S MODERN LOCOMOTIVE CONSTRUCTION.

1,030 ILLUSTRATIONS, 4to CLOTH, \$10.00.

CONTENTS:

Classification of Locomotives, Train Resistance, Tractive Force, Weight of Engines, Construction of Cylinders, Steam Pipes, Slide Valves, Valve Gear, Construction of Links, Construction of Pistons, Cross-Heads, Sides, Stuffing-Boxes, Frames, Axle-Boxes, Driving-Axles, Driving-Wheels, Counterbalance, Main Rods, Side Rods, Crank-Pins, Thriftle Pipes, Thriftle Valve Gear, Safety-Valves, Whistle, Pumps, Checks, Spring-Gear, Boilers, Grate Surface, Heating Surface, Riveted Joints, Extension Fronts, Ash-Pans, Smokestacks, Escalator-Pipes, Sand-Boxes, Bells, Pilots, Braces, from Boiler to Frames, Engine Trucks, Oil-Cups, Cocks, Injectors, Tenders, Useful Rules, Formulas and Data, Compound-Engines.

FINE DRAWING INSTRUMENTS.

Drawing and Blue Print Papers. DRAWING & MATERIALS OF EVERY KIND.

QUEEN & CO.

1010 CHESTNUT STREET, PHILADELPHIA.

SEE CATALOGUE ON APPLICATION.

JOHN WILEY & SONS, Publishers, New York.

FLAT-TURRET LATHE

STRAIGHT AND TAPER FRAME BOLTS, ETC.

SEND FOR A COPY OF "RAPID LATHE WORK."

By New Method - Halfness System.

JONES & LAMSON MACHINE CO.

SPRINGFIELD, VERMONT, U. S. A.

HENRY CAREY BAIRD & CO.,

Industrial Publishers, Booksellers and Importers.

810 WALNUT ST., PHILADELPHIA.

Get our New and Revised Catalogue of Practical and Scientific Books, of every size, and our entire Catalogue of Scientific Apparatus, which comprises every branch of Science applied to the Arts, and free of charge to any one in any part of the world who will furnish his address.

SHERBURNE'S AUTOMATIC TRACK-SANDING APPARATUS.

Three Ways Instead of One. Mind Your Steps.

On slippery rails sand the track automatically when brake is applied, avoiding rear collisions and derailments.

In starting, touch Lever and obtain jet of Sand and "get there."

The old Rod and Lever retained as usual. For particulars apply to

SHERBURNE & CO., 53 Oliver Street, Boston.

CHARLES MURRAY

ENGRAVER ON WOOD

53 ANN ST. - NEW YORK.

BOSS SCREW PITCH GAUGE.

Price \$1.35, by Mail.

A FULL LINE OF Machinists' Fine Tools.

SEND POSTAL CARD FOR OUR NEW 1893 CATALOGUE.

STANDARD TOOL CO.,

Box G, ATHOL, MASS.

THE Perforated Article Log is the best in the world. The lightest, most elastic, most enduring and perfect in nature. For detailed information address:

WHEELER & BOWEN, 2201 Chestnut St., Phila., Pa.

OPEN HEARTH STEEL CAMBRIA COFFIN TOUNGHENED

CAMBRIA IRON COMPANY,

Office 218 SOUTH 4TH ST. PHILADELPHIA, PA.

WORKS AT JOHNSTOWN, PA.

Driving, Truck, Passenger and Freight Axles, Piston and Side Rods, Crank Pins.

COOLBAUGH & POMEROY SPECIAL R.R. SALES AGENTS. 29 BROADWAY NEW YORK.

BENT & DRILLED

TOUGHENED BY COFFIN PROCESS, PATENTED

OPEN HEARTH COFFIN PROCESS TOUNGHENED

STEEL BEFORE TOUCHING STEEL AFTER TOUCHING

CAMBRIA STEEL

D. C. SETTLEMIRE, President.

DEO. W. EVANS, Vice-President.

W. C. ARTHUR, Secy and Treas.

FRANK SNYDER, Supt.

Mt. Vernon Car

MANUFACTURERS OF
FREIGHT CARS OF EVERY DESCRIPTION, OA-
BOGGE AND REFRIGERATOR CARS,
MT. VERNON,



Manufacturing Co.

CAR WHEELS, CAR CASTINGS, AND GENERAL
FOUNDRY WORK.
Capacity, 15 Cars and 300 Car Wheels,
ILLINOIS.

THE
ALLISON MFG. CO.,
MANUFACTURERS OF
FREIGHT CARS AND
LOCOMOTIVE BOILER TUBES.
WROUGHT IRON PIPE OF SUPERIOR QUALITY.
PHILADELPHIA, PA.

Miller's ASBESTOM Gar Roof.

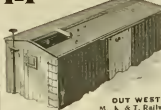

THE COMING ROOF!
HEAVY WILL WEAR LONGER THAN
ANY METAL ONE.
LINES FROM 6125 TO 6115 LBS PER
SQUARE YARD. CAN BE PUT IN BY ONE-
HALF THE TIME. **STRONG**
WILL WEAR THE LIFE OF THE CAR.
OUT WEST? HEAR WHAT THEY SAY! DOWN EAST?
ABOUT IT— Boston & Albany R. R.

B. R. MILLER, Proprietor, 1302, NOVEMBER 26 CORTLAND ST., NEW YORK.

DRAKE & WEIRS, Cleveland, Ohio.
ASPHALT CAR ROOFING

The Cheapest, Best and Most Durable Car Roof Known. In use by Seventy
Railroads. Twelve years successful use without a single failure. A new roof furnished free for
every car that falls in the year.

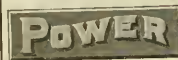

A MONTHLY JOURNAL devoted to Steam
Engineering and Practical Work relative
to the Economic Generation and Transmission
of Power. 56 to 64 pages, size of this paper,
profusely illustrated. Price, \$1.00 a year.
Send for Sample Copy—FREE. Address.

THE POWER PUBLISHING CO.,
WORLD BUILDING, NEW YORK.

MALLEABLE DAYTON MALLEABLE
REFINED AIR FURNACE IRON CO., DAYTON, O.
CASTINGS FOR IRON CASTINGS
RAILWAYS
A SPECIALTY. ORDERS AND CORRESPONDENCE SOLICITED.

ALBANY, N. Y.
936 Broadway,
New York City,
115 Broadway.

STEAM COUPLERS
AND
FIRE PROOF
HEATERS.

CONSOLIDATED
McElroy, Sewall, Westinghouse and other Patents.
CATALOGUES UPON APPLICATION.
Special Appliances and Extra Strong Fittings of Every Kind.
AUTOMATIC CONTROL OF HEAT.
CAR-HEATING CO.

CHICAGO.
200 Phenix Bldg.
Canada,
COASTOWN, P. Q.

COMMINGLER,
DRUM,
AND
DIRECT STEAM
SYSTEMS.

PAUL S. REEVES, Philadelphia.
PHOSPHOR BRONZE IN INGOTS AND CASTINGS. **LOCOMOTIVE AND CAR BEARINGS**
A SPECIALTY.
BRASS and PHOS. BRONZE CASTINGS from 1/4 lb. to 5,000 lbs. in WEIGHT.

PATENTS
FOR INVENTIONS.
GEO. P. WHITTLESEY,
Atlantic Building, Washington, D. C.
EXPERT SEARCHES AND OPINIONS.
R.R. RAILROAD INVENTIONS A SPECIALTY.

RODGER BALLAST CARS.

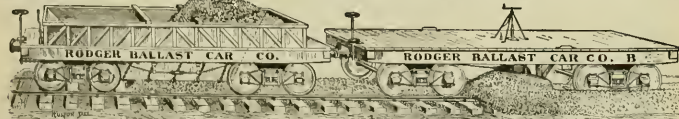

These cars are 34 feet long, and are built either 20,000 or 30,000 lb. capacity, M. C. B. Standard. They carry from 15 to 20 cubic yards of gravel or broken stone. In using them no ballast is thrown in the ditch, and none is wasted, as the precise amount of ballast needed can always be distributed. A train of 20 cars, carrying 400 yards of ballast can be unloaded and the ballast distributed, leaving the truck perfectly cleared and fanned, as shown in the cuts. In from 12 to 15 minutes. This is all done by the regular "train service" in unloading and two brakemen, in extra help being required. The truck is perfectly cleaned by the operator, so that a train can immediately pass over it at any rate of speed, without needing any obstruction. No aprons are needed, no wire cable are used. There is no protrusion of ballast from between the cars, and in clearing the track with shovels. The ballast is left between the line and on their side directly in position for dumping, when the truck is raised, without being dished in from the sides. The average saving per mile, in the amount of ballast needed to make a "pile" of 10 or 12 inches, will amount, to from \$20 to \$40, and in broken stone it often amounts to \$40.

These cars are in use on the Great Northern Ry. the Illinois Central, the Gulf, Colorado & Santa Fe, the Chicago & Eastern Illinois, the Penn. Lake Erie, and other roads.

Detailed information will be furnished by circular by addressing the

RODGER BALLAST CAR COMPANY, No. 1215 Monmouth Building,
CHICAGO, ILL.

SCHOEN MFG. CO.

**PRESSED
STEEL MATERIAL
FOR CARS.**

**PITTSBURGH,
PA.**

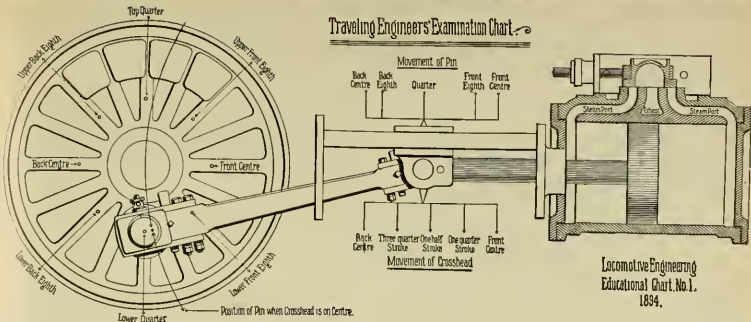

The Angularity of the Main Rod

Is one of the things few men fully understand. Our Educational Chart No. 1 explains it better than anything else. The above picture gives some idea of this Chart. The piston, piston-rod and cross-head, as well as the valve are made of celluloid and move back and forth in slots. On the back of this Chart there is a short, plain explanation of the angularity of the rod and its effect on the piston and the valve. Then there are thirty-six questions to be answered, by placing the valve and piston in the proper positions—if a man can answer all these questions in this way he must know something about the subject. The answers to these questions cannot be learned parrot fashion, the student must know why.

The Names of All Parts.

Educational Chart No. 2 will be a fine, transparent picture of a modern locomotive, with the name of every part given. This will be as fine as steel and worthy of a frame in the home of any man who knows a locomotive from a sausage mill.

The Triple Valve

Is another Educational Model, No. 3, with moving celluloid parts, on the same plan as the first one. This will show just what takes place in the triple valve when re-charging in service application and in emergency, and with the "few well chosen words" on the back will make this subject clearer to any train man than fourteen pages of explanation in type.

These three models will be sent free to every subscriber to **LOCOMOTIVE ENGINEERING** for 1894. The paper will come out in a new dress and a cover on January 1st, and we are spending a lot of money for articles from the best writers on mechanical subjects in this country. Some special articles on Block Signals will be very interesting.

The Prize Designs.

In the past ten years there have been 796 engineers and firemen cooked to death under engines! This year we are offering prizes of \$350 cash for the best designed cab fittings for an eight-wheeler and a consolidation engine. We furnish drawings of the engine and boiler, all the designing we want is the arrangement of throttle, lever, all the gauges, injectors, lubricators, pipes, cocks, hose, draft-rig, etc. The design must aim at: 1st. The safety of the engineer and fireman; 2d. Convenience in handling; 3d. Accessibility and economy in keeping up running repairs. \$100 for first prize for each class of engine; \$50 for second prize, and \$25 for third. We will also pay \$5 each for all designs not winning prizes which we consider worth publishing. This contest is open to the world. Readers of **LOCOMOTIVE ENGINEERING** get the benefit of it. A competent board of railroad men and locomotive builders will award the prizes in June, 1894, and we will pay them by July 4th. See other posters for particulars. Here is a chance for engineers, firemen and shop men.

The Dull Times

Are not worrying us—we have spent over \$3,000 per month on the paper in the last year, and will spend more next. New features will be added and the best of everything in our line will be captured at any cost. We don't propose to give our worst enemy the least excuse to say that the words on our seal are not the truth, the whole truth, and nothing but the truth.



If there is anybody getting up a club in your district, give him \$2.00 and your name—if not, send direct to us. We pay a cash commission to club raisers or give watches or other premiums—you can make the price of a \$100 gold watch or get yourself a new overcoat by a little overtime. Send for terms to club raisers.

New England Agents,
SHERBIRNE & CO.,
No. 53 Oliver St., Boston.

CHICAGO SPLICE BAR MILL.

Morris Sellers & Co.,

OFFICE,
216 PHENIX BUILDING,
CHICAGO.

Manufacturers of the new "GREER" Railroad Track Spike and the Celebrated "SAMSON" Bar.

Fourteen years' unexampled success has demonstrated the fact that under all varieties of Railroad Service they will prevent "low joints," battered rail ends, and in a remarkable degree withstand the test of breakage. More than 10,710,000 Bars in use on 176 different Railroads, equivalent to 15,813 miles of track.



The "Greer" Railroad Track Spike is the latest and best spike offered to the Railroad managements of this country and Great Britain. Indestructible. A holding power of from one to two tons more per spike than any $5\frac{1}{2}$ x 9-16 spike. Automatically sharpened to chisel edge, it cuts; does not tear the wood fiber. Hand packed in kegs—every spike perfect. Particularly adapted for use on Bridges, Trestles, and on Switches.

SEND FOR TESTS AND PHOTOGRAPHS.

DAVE J. BROWN, President

HENRY LEAH, Secretary and Treasurer

JOHN T. SMITH, General Manager

SMITH'S TRIPLE-EXPANSION EXHAUST PIPE.

NOZZLE OPENING AS LARGE AS THE EXHAUST PORT.



A—Air.
B—Steam.

This improved pipe will not clog up with any kind of fuel.

Reduces back pressure to a minimum.

Prevents spark throwing, they are left in the firebox where they belong.

Almost noiseless, and burns a fire as clear and strong as any nozzle can.



Requires no netting or other traps in the front end.

Keeps smokebox temperature down.

Saves delays, repairs and expense.

We guarantee to prevent sparks, reduce back pressure, prevent clinkers and save coal—we are doing this on the Reading Road, where the pipe has been adopted, after a two years' trial.



A—Air.
B—Steam.

WRITE FOR TERMS AND CATALOGUES TO THE SMITH EXHAUST PIPE CO., Doylestown, Pa.

THE JANNEY FREIGHT CAR COUPLER



THE MCCONWAY & TORLEY COMPANY

W. M. CONWAY—PRESIDENT.

48th ST. & A. V. RY.—PITTSBURGH, PA.



A PERFECTLY CONSTRUCTED METAL BRAKE BEAM.
 The Cheapest, Lightest, and Most Durable.
 NOW STANDARD on a MAJORITY of RAILROADS THROUGHOUT the COUNTRY
 General Office and Works: 40th & Hopkins Sts., Chicago.
 CITY OFFICE: NEW YORK OFFICE:
 518 Phenix Building, Chicago. 30 Broadway, - - Room 118.
 E.P. Correspondence solicited. Fard's G. Ex. Eastern Agent.



**THE WASHBURN
 Car-Wheel Company,**
 HARTFORD, CONN.,
 MANUFACTURERS OF
**CRUCIBLE
 STEEL-TIRED WHEELS**
 For Parlor and Sleeping Cars,
 Passenger Coaches, Locomo-
 tive and Tender Trucks.



C. E. ROOD, H. M. BROWN
**ROOD & BROWN,
 CAR WHEEL WORKS,**
 BUFFALO, N. Y.
 Railroad, Car, Engine, Tender and Truck Wheels, Made from Best Charcoal Iron.
 Office and Works: HOWARD and THOMAS STS.

C. M. FARRAR, JOHN TRETTS, C. E. ROOD
EAST BUFFALO IRON WORKS,
 FARRAR, TRETTS & ROOD, PROPRIETORS.
GREY IRON CASTINGS
 of every description. Special Attention Given to Car and Locomotive Work.
 Works: N. Y. C. & N. H. R., Broadway Station, East Line. General Office: 60 Perry St., Buffalo, N. Y.

**C. E. ROOD,
 MALLEABLE IRON,**
 QUALITY GUARANTEED.
RAILROAD WORK A SPECIALTY.
 Office and Works: LANCASTER, NEW YORK.

**TAYLOR
 IRON & STEEL COMPANY,**
 MANUFACTURERS OF

MANGANESE STEEL WHEELS
 Made of Hadfield's Patent Manganese Steel. Practically unbreakable, with phenomenal wearing qualities; also
STEEL TIRED WHEELS
 With centers interlocked and welded in.
 Plate and Spoke for Passenger Cars and Locomotives.
 High Grade Wheels at Moderate Cost. No permanent investment in expensive centers. No re-tiring.
 CHILLED WHEEL, IRON and STEEL AXLES, WHEELS FITTED TO AXLES. STEEL CASTINGS FOR RAILROAD and GENERAL PURPOSES.
 Licenses in this country for making Hadfield's Patent Manganese Steel.
 Steel Tired Wheel. General Office and Works: HIGH BRIDGE, NEW JERSEY. Manganese Steel Wheel.

RAMAPO IRON WORKS, Hillburn, N. Y.

Brake Shoes for Steel Tired Wheels.
 ROSS, for Steel Tired Car and Tender Wheels,
 ROSS-MEEHAN, for Locomotive Drivers,
 SHEPPARD, for Blind or Bald Tired Drivers.

NARROW GAUGE CARS, SWITCHES, AUTOMATIC STANDS.
 YOKED, BOLTED and SPRING RAIL FROGS,
 CROSSINGS, TRACK EQUIPMENT,
RAILROAD AND MACHINERY. CASTINGS, HEAVY AND LIGHT.



President, E. A. DIMOCK. Treasurer, J. L. OTIS.
 Established 1867. - - Capital \$100,000.
**NORTHAMPTON
 Emery Wheel Co.**
 MANUFACTURERS OF
 PATENT
**SOLID EMERY and
 CORUNDUM WHEELS
 and MACHINERY.**
LEEDS, MASS.
 CHICAGO OFFICE,
 20 South Canal St.
 Send for Catalogue.

THE MILLER PACKING

IS WHAT YOU WANT FOR THE
ENGINE, PUMP, HAMMER, HYDRAULIC LIFT OR CRANE, AND AIR PUMP.
It matters not whether your engine is High Speed or Low Speed; whether you are Pumping Hot or Cold Water, Oil, Acids or Ammonia.
 It is **THE** packing for ICE MACHINES. It can be run by TIGHTENING with the FINGER-NAILS only. It gives the minimum of friction and the maximum of wear.

It is rapidly being substituted for the Tuck packing in the inside of pistons. When so used it will give twice the wear. The next time you take off the cylinder-head to pack, use MILLER. It is the **ONLY** packing that may be used in a stuffing box and for the inside packing with like satisfactory results. For inside work you have been using the old, hard, square packing. Try MILLER and note the improvement. It does the work every time, and it does it in a **BETTER** manner than any other packing. If you are pumping heavily it is what you want right now. See that our trade-mark, "CABLED" is in the maulin wrapping. Patents in all countries.
 Any and all initiators will be presented. The MILLER will stand 700 degrees heat - dry or moist. It is the **ONLY** packing that will work on AMMONIA and AIR PUMPS without HEATING.
 MANUFACTURED AND SOLD BY THE
MILLER PACKING CO.,
 SAMPLES ON APPLICATION. 3015 Chestnut St., Philadelphia, Pa., U. S. A.

ASHTON
 Valves,
 Mufflers and Gages,

Received Highest Awards at World's Fair.
THE ASHTON VALVE CO.,
 BOSTON, NEW YORK, CHICAGO.

RAMAPO WHEEL AND FOUNDRY CO.

MANUFACTURERS OF
BOLTLESS STEEL-TIRED WHEELS
 FOR PASSENGER and LOCOMOTIVE SERVICE.
 Tires with Annular Web and Hook,
 Best Charcoal Iron Double-Plate or Spoke Centers,
 Wedge-Shaped Retaining Ring.
 SECTION OF BOLTLESS PARTS
 A Continuous Circumferential Fastening. SIMPLE, + SAFE, + ECONOMICAL.

CHILLED IRON WHEELS OF SUPERIOR QUALITY, Draining Booms, Passenger and Freight Cars, Locomotives, Tenders, Plantation and Mine Cars.
CONGDON BRAKE SHOES FOR CHILLED IRON WHEELS, Outwear from 4 to 6 ordinary shoes and enhance mileage.
CELENDER PACKING RINGS.
 Office and Works: RAMAPO, N. Y.

LOCOMOTIVE ENGINEERING
PUBLISHED BY
THE
P. B. BULLARD CO.

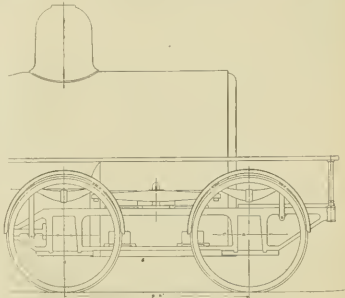
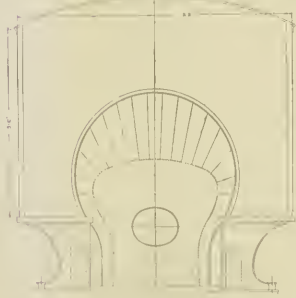
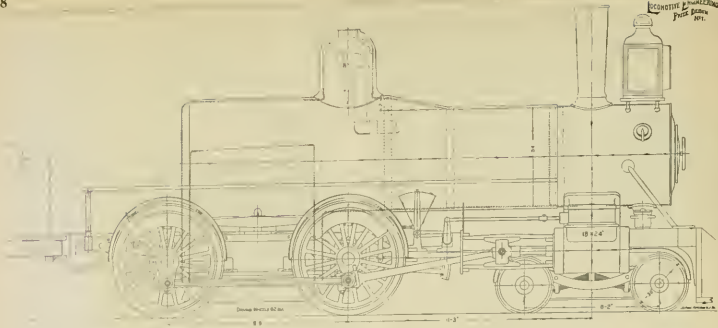

Chance to Earn \$100, \$50 or \$25. See Particulars on Page 43.

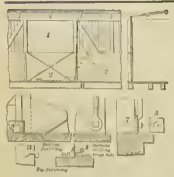

Steel Grain Door Come to Stay.

COMPARISON.

Loss of Doors in Two Years:
500 cars equipped with steel doors lost two doors.
500 cars equipped with wooden doors lost 80 per cent. in the same time.

MICHIGAN RAILWAY SUPPLY CO.,
DETROIT, MICH.

BORING AND TURNING MILLS.

37, 51 and 63 inch swing, with two Regular Heals. 42 inch swing, with Turret Head and Screw Cutting Attachment.
All gears accurately cut. All feeds positive. Machines are self contained and therefore do not require an expensive foundation.

BRIDGEPORT MACHINE TOOL WORKS,

E. P. BULLARD, Propr.
Bridgeport, Conn.
New York Office, 39 CORTLANDT ST., Room 86.

THE PHILADELPHIA CORUNDUM WHEELS,

MADE BY THE PHILADELPHIA EMERY & CORUNDUM WHEEL CO.

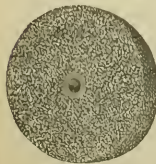

THESE Wheels are absolutely superior in all things to any Emery Wheel made. They are constructed to wear entirely of pores and last longer than any other wheel. They are a very free, fast cutting, open and porous, durable and lasting wheel. Will not load, do more work and last longer than any other wheel made. Will not glaze or fill up, nor wear away too fast. Also will run in temper, will wear even and true and not get out of balance. Will not heat tempered steel enough to draw the temper, cause cracks or burn it when run dry, and run most of the best in hole made for running in water. Are one of the strongest and safest wheels made, and not as liable to break as most other wheels are. Every wheel made exactly as indicated at any time; they are sold on their merits, are sent on trial and approval, guaranteed to give entire satisfaction, and if they do not do so an emery wheel is returned.

THE MADDOX COTTON AND WIRE BELTING, MADE OF CABLE STEEL WIRE AND COTTON WOVEN TOGETHER.

Is absolutely the strongest, toughest, most powerful, flexible, durable and lasting belting made, without any exception whatever. It is stronger, tougher and more durable and will transmit more power than any other belting made. It is woven and is not affected by water, steam, dampness, moisture, heat, dryness, oils, grease, acids, chemicals, dust, etc. It is cheaply well adapted for RAILROAD SHOPS AND PLANING MILL SAWMILLS.

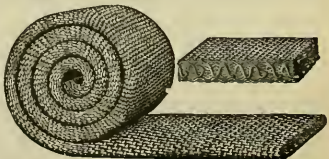

It is a sample of a trial. It will not be returned unless it is found to be defective. It is a sample of a trial. It will not be returned unless it is found to be defective.

GIVE IT A TRIAL.

H. N. GREEN, General Agent, 12 Wooster St., New York City.

LOCOMOTIVE ENGINEERING
PATENT OFFICE
N.Y.C.

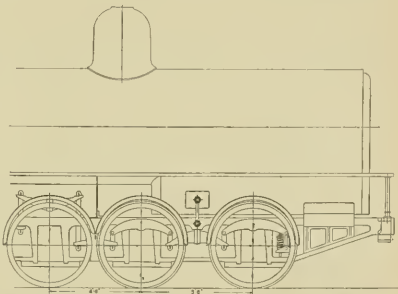
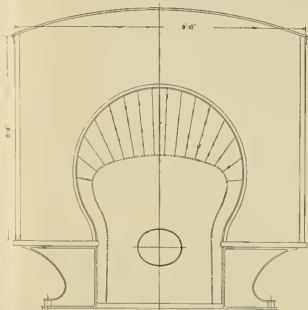
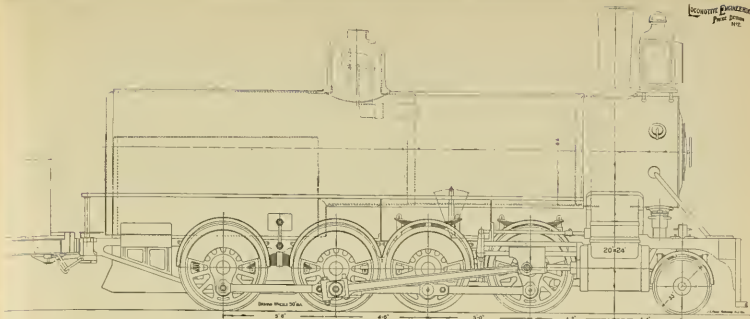

\$175.00 in Prizes to Finish this Design. See page 43.



Head
Roll
Seat.

THEIR SUPERIORITY
IS PROVEN BY
THEIR POPULARITY.

FINEST SEATS.
Coach, Parlor Car,
Sleeping Car,
Street Car,
Rattan Elevated

IN USE ON ALL THE
PRINCIPAL RAILROADS
IN THE UNITED STATES

Spring
Edge
Seat.

THE HALE & KILBURN MFG CO.,

Simplicity,
Durability,
Elegance,
Comfort,

Com-
bined.

IT IS SAFE TO SPECIFY THE

H. & K. SEATS

PHILADELPHIA,
NEW YORK,
CHICAGO.



PEDRICK & AYER,

Milling Machines. Cylinder Boring Machines.
Richardson's Patent Open Side Planers.
Portable Valve Seat Planers.
Otto Patent Flue
Cleaners.

Universal Grinders.
Pneumatic Hoists. Tire Heaters.
Portable Crank Pin Machines.

SPECIAL TOOLS FOR RAILWAY REPAIR SHOPS

1001 & 1003 HAMILTON STREET,
PHILADELPHIA.

THE WESTINGHOUSE AIR-BRAKE CO.

Is now prepared to fill orders, at an hour's notice, for One or One Thousand Sets of

AIR-BRAKES FOR FREIGHT CARS,

having, at their New Works, an annual capacity for turning out Air-Brakes for 250,000 Freight Cars, 6,000 Passenger Cars, 10,000 Locomotives; besides repairs for the 350,000 Freight and Passenger Cars, and 26,000 Locomotives already equipped by

THE WESTINGHOUSE AIR-BRAKE CO.

LOCOMOTIVE ENGINEERING PRIZE DESIGNS.

\$350

In Rewards for Best Designs in Cab and Boiler Fittings.

SEE DRAWINGS ON PAGES 40 AND 41.



THE number of men scalded and cooked to death in wrecks is so great that little notice is taken of it. Practically nothing at all has been done, or attempted, to make Locomotive Boiler Fittings safer for those who handle them. The details of some of these wrecks are heart-rending. Instances are on record, and are common, where men have been held down by wreckage, but uninjured, until slowly cooked by escaping steam—one fireman was found with steam pouring out of his mouth and nose; the small pipe to the steam gauge had broken off and the end had partly penetrated his side (a wound of little consequences had there been no steam there). This is only a sample.

Nor does this danger exist for engine-men alone. Only last year a locomotive on the Colorado Midland Road struck the side of a loaded passenger car. The check broke off and killed the passengers—the force of the collision was not enough in itself to overturn the car. The Quincy wreck on the Old Colony was so frightful because the victims were imprisoned in a car crushed over the wrecked locomotive. Half the fatalities of railroad wrecks, and more than half the tortures can be prevented if the steam can be kept in the boiler.

Many locomotives are extremely uncomfortable and unhandy; boiler fittings are located in places where they are liable to be broken; are hard to handle or to pack; seats are poor and located where men cannot use them and handle the engine properly. Brake valves are located where they get hot and stick; where they are hard to reach, etc. Those who ride the engines day after day know how uncomfortable many of them are. All this can be made better.

The running repairs are troublesome and expensive. Grinding in valves takes time; takes the engine out of service, and is long neglected on that account. Is it necessary to grind in valves? Half the repairs of injectors is to the priming apparatus. Are primers necessary? Half the steam pipes in a cab are where they will be touched in handling some valve, where some of them are sure to be broken off in a wreck, and are in the way of the crew. Are they all necessary or can't they be shortened? There are a thousand reasons for improvement—life-saving reasons; and comfort-promoting reasons; time-saving and money-saving reasons.

For all of these reasons LOCOMOTIVE ENGINEERING opens a prize contest to see if the brains of American railroad men can't be employed to make a bad thing better than it is.

THE ENDS SOUGHT.

The above amount, \$350, will be paid in prizes for the best design of Boiler and Cab Fittings for two classes of Locomotives—freight and passenger—showing the greatest improvement over present practice, tending to:
1st. Greater safety for the lives of the engine crews under any and all circumstances—especially in wrecks.
2d. Convenience in handling the locomotive, comfort of crew—consistent with best road service.
3d. Economy of time and money in keeping up running repairs.

THE PRIZES.

Design No. 1. One Hundred Dollars (\$100) cash for the best design for the Eight-Wheeled Passenger Engine. Fifty Dollars (\$50) cash for the second best design. Twenty-five Dollars (\$25) cash for the third best design.
Design No. 2. One Hundred Dollars (\$100) cash for the best design for the Consolidation Freight Engine. Fifty Dollars (\$50) cash for the second best design. Twenty-five Dollars (\$25) cash for the third best design. Five Dollars (\$5) cash to be paid for each design published that has not taken a prize.

THE JUDGES

will be selected by lot from the following callings: One Superintendent of a Locomotive Works; One Superintendent of Motive Power, from a road having over 300 locomotives; One Chief Draughtsman of a locomotive works or general railroad shop; One Traveling Engineer, selected from the membership of the Traveling Engineers' Association; One Locomotive Engineer in actual service, from a list of the most prominent B. of L. E. men in this country. The names of the members of this Committee will be announced in the January number of LOCOMOTIVE ENGINEERING. They will meet at the Master Mechanics' Convention at Saratoga Springs, N. Y., in June and award the prizes, and the cash will be paid on or before July 4th. In case there is an absence in the Committee, the remainder of them will elect a man from the same employment, if possible, as the absentee.

CONDITIONS.

Separate designs and written descriptions must be submitted for each class of engine. Persons submitting design must place on the drawing some distinguishing mark (such as initials, *nom de plume* or device), and no name must appear on the drawings or in the written description of same. Drawings for one class only, together with written description, must be sent in one package and a sealed letter stating the name of the person or persons who submit the drawings marked as described. This letter will not be opened until the judges have made the awards—they will judge on the merits of the designs alone. Nicety of drawing will not secure the reward, though it is to be commended—it is the *idea* that is wanted—the suggestion that can be used by railroads and by locomotive builders for the improvement of locomotives in the three lines we have laid down, namely: safety of crew under all circumstances; convenience in handling, and economy in keeping up running repairs.

One person may submit as many designs as he cares to, but each must be separate, and use a different distinguishing mark. More than one person can have an interest in one design if desired. Drawings must be on white paper with black ink—no other will be considered. The printed drawings may be finished out, or new and larger ones submitted, but in each case they must be complete, and the same as printed design. Written description must briefly point out the intended improvement in each device and explain the working of same, but the intention is that the drawings shall tell the whole story. Unusual or new devices may be shown in sectional sketches on margin of drawings, but be it remembered that this is not a contest of merits of engine devices; the rewards will be given on the merits of the whole arrangement. The cab must be limited in width to the height and width marked on drawings. It can be made as long as desired and placed on engine in any position wanted.

WHAT WILL BE FURNISHED.

Drawings of a complete locomotive, except cab and operating handles, lubricators, injectors, air brakes, etc. The throttle valve stem is left ready to connect. Designer can put on any kind of a throttle he thinks best and bring it out wherever he likes.

The tumbling shaft arm extends up the usual height ready to connect to the reach rod.

WHAT TO DO.

Take either of the incomplete drawings and finish them. Put on everything necessary that is not shown. Everything above the running boards.

The passenger locomotive must be equipped with automatic air brakes, sight feed lubricators, steam heat economizer and whistle signals.

The freight locomotive will have air brakes, sight feed lubricators and all modern improvements.

Locate and draw in the main drum, engine air brake equipment complete, throttle, reverse lever, gauge cocks, steam and air gauges, blower, cab light, etc. Decide on kind of injector and valves and locate all of them, arrange all hose connections between engine and tender. Locate whistle lever or cord, lay out windows of cab and arrange to locate and fasten them, choose design of check valves and all piping and boiler connections. Locate tank hand brake, either in sketch or description, locate shake levers, dampers and slide pulleys, lead lever, cylinder-cock lever, seats, arm rests, etc.—in fact, everything used to handle the locomotive.

WHO MAY SUBMIT DESIGNS.

This contest is open to the world. There is absolutely no limit as to who may take part. Large prints of the drawings, in tubes (not folded), will be sent free, on request to any regular subscriber of LOCOMOTIVE ENGINEERING, or those who send subscriptions for a year with the request. We will have to ask others to send 20 cents for postage.

All the Announcements as to Prize Winners and Engravings of Successful Designs will be printed only in LOCOMOTIVE ENGINEERING.

THE
**CORRESPONDENCE
SCHOOL
OF MECHANICS.**
CONDUCTED ON THE SAME PLAN AS
THE CORRESPONDENCE SCHOOL
OF MINES.

FOR WHOM DESIGNED.

For all those who desire to acquire a mechanical education, and who are unable to attend a regular school or college. The course is conducted by correspondence, and the student may study at his own convenience, and at his own expense. The course is divided into three parts: the first part is devoted to the study of the principles of mechanics, the second part to the study of the application of these principles to the construction of machines, and the third part to the study of the construction of locomotives.

COURSE OF STUDY.

1. ARITHMETIC.
2. ALGEBRA.
3. GEOMETRY AND TRIGONOMETRY
4. ELEMENTARY MECHANICS.
5. HYDROMECHANICS.
6. PNEUMATICS.
7. HEAT.

OBJECT.
THE CORRESPONDENCE SCHOOL OF MECHANICS

offers ambitious mechanics, pattern makers, engine drivers, firemen and other employed about machinery, an opportunity to secure a mechanical education. It teaches its students all the branches included in a complete mechanical education by Correspondence.

METHOD.

A SYSTEMATIC COURSE OF STUDY under the supervision of the faculty. The student receives the INSTRUCTION AND QUESTION PAPERS prepared for his specialities. All notes and materials are sent by mail. THEY ARE WRITTEN IN THE SIMPLEST POSSIBLE LANGUAGE and *begin at the beginning*. Each student EXPLAINS THE PRINCIPLES AND DETAILS and the methods of combining and applying them. EACH STUDENT IS A CLASS BY HIMSELF. HE IS NOT BOULDED BY HIS CLASS. HE IS COMPELLED TO LEARN HIS LESSONS THOROUGHLY. HE IS IN TOUCH WITH HIS TEACHERS and receives the benefit of their advice. DIPLOMAS ARE AWARDED to students who pass the final examination.

SCHOLARSHIPS AND PRICES.

The Mechanical Drawing Scholarship, Price, \$25.00 In Advance, or \$30.00 In Installments.

The Complete Scholarship, Price, \$35.00 In Advance, or \$40.00 In Installments.

HOW TO LEARN MORE ABOUT THE SCHOOL.

As it is impossible to describe the school in detail, we have prepared an outline of the course of study, and a list of the names of the faculty. This outline and list are sent by mail on application. They are sent free of charge, and will be sent to you in any language.

THE CORRESPONDENCE SCHOOL OF MECHANICS,
SCRANTON, PA.

The Brotherhoods' Jeweler.



THE only substantial, moderate-priced clock on the market. Movement has escapement jeweled; case cast bronze; front screws on; side wind; 6-inch, porcelain dial. Very elegant and accurate.

The rod-hand, shown at V1 o'clock, is on the handle of the glass and moved by a knurled nut on the outside. This is John Alexander's "Red Remover." When it is moved out of its regular position it acts as a key, it is put at the time of the watch being taken out of the case and serves to remove the dirt from the watch. It is a very useful and necessary part of the watch. No extra charge for the "Remover." Clock furnished with or without it.

PRICE, \$12.

JOHN J. McGRANE,
187 BROADWAY, NEW YORK.

WILLIAM D. HALL, President. H. S. GILMORE, Treasurer. MELVILLE F. HALL, Secretary.
S. WARD 101 SO. General Agent. C. W. BEEWSTER, Sales Agent.
HENRY B. DAVIS, Mech. Eng. Lecturer. A. J. WILSON, Supl. Electrical Contr'or.

THE
Hall Signal Company,

Principal Offices, 80 Broadway, New York.
115 The Ames Building, BOSTON. Equitable Building, BALTIMORE.
Western Office, 927 The Rookery, CHICAGO.

The Hall Systems of Automatic Electric Signals are in operation and in process of erection

ON A LARGE NUMBER OF PROMINENT ROADS.

Every Conceivable Form of Railway Signals.

Wire Circuit and Rail Circuit Automatic Electric Signals.

We have added to our Automatic Electric Signal System

Mechanical and Auto-Manual Block Signaling

IN ALL ITS BRANCHES,

Having obtained control of the BEZER LOCK AND BLOCK SYSTEM, BEZER & BURLEY INTER-LOCKING MACHINE, besides the best known forms of Semaphore, Compensator, Selector, etc.

THE
LOCOMOTIVE INSPIRATOR

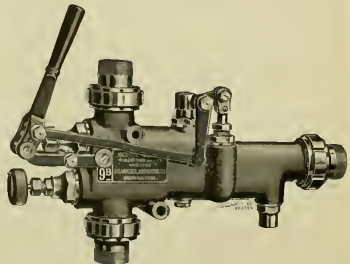

These machines are especially constructed for, and adapted to railroad service and

STANDARD FITTINGS

in common use. Modern locomotive service is more exacting in its demands, and requires a more efficient apparatus to meet its requirements, and we believe that these are not in this instrument more fully than ever before. It is simple in construction, easily taken apart, and readily repaired at small cost.

It will lift water, or take it under a head, as desired. It will lift water when Inspirator and suction pipe are hot, or when water is at a temperature of 120 degrees Fahr., and deliver to boiler at steam pressure of 35 to 200 lbs. without adjustment.

It has a maximum capacity of less than 50 per cent. of its maximum by actual test and service.

The Capacity increases with the increase of Steam Pressure up to 200 pounds. We guarantee it to be reliable and effective under all conditions and requirements of railroad service. Correspondence solicited.

THE HANCOCK INSPIRATOR CO.,
BOSTON MASS.

BEMENT, MILES & CO. PHILADELPHIA, PA.

BUILDERS OF

METAL-WORKING MACHINE TOOLS,

FOR

Locomotive and Car Builders,
Railroad Shops, Machine Shops,
Steam Forges, Ship Yards,
Boiler Shops, Bridge Works.

STEAM HAMMERS
FOR WORKING IRON OR STEEL.

NEW YORK OFFICE: EQUITABLE BUILDING.

GEORGE PLACE, Agent.

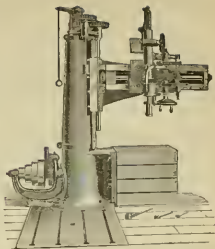

William Sellers & Co. Incorp.
PHILADELPHIA, PA.



MANUFACTURERS OF

IMPROVED MACHINE TOOLS.

New Boring Mill for Car Wheels—With Automatic Chuck, *closing* when table is started, *opening* when table is stopped; and with Patent Safety Power Crane. Operator spared all hard work.

Lathes, Planers, Drill Presses, Steam Hammers, Steam and Hydraulic Riveters, Punches and Shears, Bolt Cutters, Wheel Presses, Car-Wheel Boring, etc. High Speed Power Traveling and Swing Cranes, Testing Machines, etc. Turn Tables for Locomotives. Shafting, Pulleys, Couplings, Hangers. Self-Adjusting Injector of 1876. Self-Acting Injector of 1887.

ECONOMY in Repairs, Saving in Labor of Application, Absolute Protection to Draft Springs are a few of the Claims for the Butler Drawbar Attachment.

The Yoke Device is becoming a general favorite with users of **AUTOMATIC COUPLERS.**

Try it and be convinced.

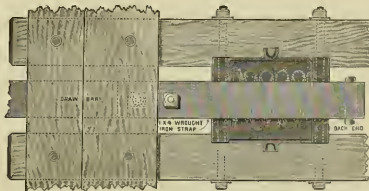

The number in use constantly increasing, and the new strengthened castings are giving entire satisfaction.

THE BUTLER DRAWBAR ATTACHMENT CO., CLEVELAND, OHIO.

The Sturtevant Steel Plate Exhausters

For Removing Smoke from Forges, Refuse from Wood-Working Machinery, Etc.

THE STURTEVANT STEAM HOT BLAST APPARATUS

For Heating Railroad Shops, Drying Lumber, Etc.

STEEL PRESSURE BLOWERS FOR CUPOLA FURNACES AND FORGE SHOPS.

B. F. STURTEVANT CO., Boston, Mass.

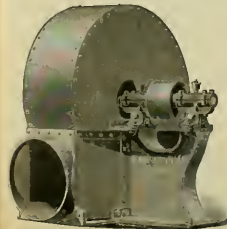

BRANCHES:

91 Liberty St., New York. 16 So. Canal St., Chicago. 135 No. Third St., Philadelphia.



SOME NEW FEATURES!!

LOCOMOTIVE ENGINEERING will have quite a number of entirely NEW FEATURES for 1894. New Dress! New Cover! New Ideas!

1234 Locomotive Designs.

\$350 CASH IN PRIZES

For the Best Plan of Arranging Cab and Boiler Fittings on a Locomotive for the safety of the crew, comfort in handling the engine, and economy of repairs. The prize-winning designs will be published during the year.

The Injector. An ever interesting and instructive subject. A series of articles on injectors will appear during the year. These are from the pen of an injector-maker, who has used them on a locomotive as well as made them. They will tell all the how, when and why about injectors.

Keeping Shop Accounts.

A System of Keeping Accounts of Material and Work in Railroad Repair Shops. These articles are by a well-known railroad officer and describe a system with which he is thoroughly familiar, if not the originator of most of it.

Railroad Coppermithing.

By JOHN FULLER, Sr.

Already commenced, will be continued and finished—these articles are a school for sheet-metal workers.

PROMINENT AMONG THEM WILL BE THE INTERESTING:

Block Signals.

We have secured from the pen of D. B. McCoy, Signal Engineer of the N. Y. C. & H. R. R. Co., a series of able articles on Block Signals. The writer tells us: "What a Block Signal is," "What It Does," "If you want to post up on block signals, just read these articles."

Profit-Sharing for Railroad Employees.

A Plan of Settlement of the Capital and Labor Controversy, by M. E. Ingalls, President of the C. C. & St. L. and the C. & O. Railroads. A live subject by a live man.

The Commercial Value of Compound Locomotives.

An Opinion on Compounds from the Financial Side of the House will be contributed by Mr. S. M. Felton, President and Receiver of the Queen & Crescent Road.

Economy in Compressing Air for Shop Use

Will be the Title of a Paper by R. W. Dixon, Engineer of the Safety Car Heating and Lighting Co., no engineer of his country has a more varied knowledge of air, gas and other vapors.

Discipline Without Punishment.

One of the Most Successful General Superintendents in Railroad Work will explain how he keeps up discipline of train and enginemen—and he never lays a man off or fines him.

Sampson Fox,

the Great English Steel-maker, the father of the Pressed Steel Industry, has promised us an article on Boiler Steel, its Manufacture, Inspection, Test and Care. Mr. Fox writes and talks on steel in the most entertaining way—because he is the master of the business.

Locomotive Tenders.

A Comparison of the Weight, Cost, Repairs and Capacities of the American Six-Wheeled Tenders, and an interesting subject by a man who knows something about both kinds—Mr. W. F. Dixon, Chief Draftsman of the Rogers Locomotive Company.

1894

THESE ARE A FEW OF THE MANY INTERESTING ARTICLES WE HAVE LAID PIPES TO.

WATCH THE PAPER.

DON'T FORGET that we send THREE EDUCATIONAL CHARTS to every subscriber whose name is on the list to December, 1894—and to no one else.

YOU DON'T want to miss a chance at those Prize Designs. If you don't compete you want to see what schemes are proposed.

LOCOMOTIVE ENGINEERING will be made so interesting for 1894 that every subscriber will be ashamed that he took so much for the money.

Blessings are scarce this year! Are you one of the Anointed?

REQUIRES NO ATTENTION.

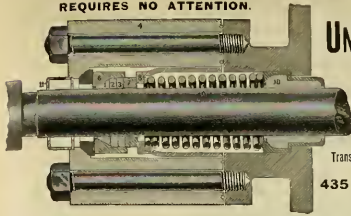

IN USE ON THREE HUNDRED RAILROADS.

UNITED STATES METALLIC PACKING CO.

THE UNITED STATES METALLIC PACKINGS have stood the test of years, and are acknowledged to be superior to all. Renewal of packing rings made without disconnecting, by cutting them in halves and breaking joints. Swab and Oil Cups furnished with every packing.

Transportation Building, Section O. S., WORLD'S COLUMBIAN EXPOSITION, Bet. Columns 2 and 3.

435 NORTH BROAD ST., and 614 RIALTO BUILDING, PHILA. CHICAGO.

SEND FOR CATALOGUE AND SPECIFICATIONS.

OFFICE:

Rooms 723, 724, 725, No. 218 LA SALLE STREET.

MASON AIR BRAKE AND SIGNAL CO. CHICAGO, ILL.

Now in successful operation on some of the leading roads of the country.

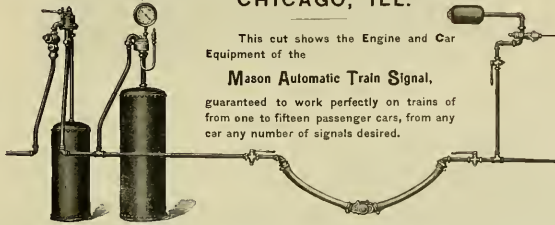

This cut shows the Engine and Car Equipment of the

Mason Automatic Train Signal,

guaranteed to work perfectly on trains of from one to fifteen passenger cars, from any car any number of signals desired.

The only PERFECT SIGNAL in use to-day.

ENGINE EQUIPMENT.

CORRESPONDENCE SOLICITED.

CAR EQUIPMENT.

THE TABOR MANUFACTURING CO.,

MANUFACTURERS OF

113 LIBERTY ST.,

NEW YORK.

Our Duplex molds both parts of flask at one operation of machine.

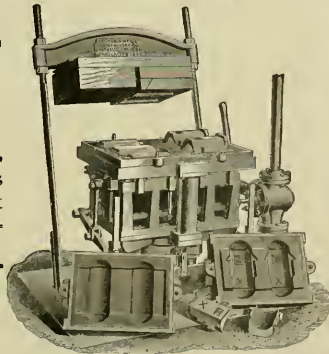

Our system produces better and cheaper castings than any other.

DUPLEX.

Automatic + Molding + Machines

Especially adapted for CAR BRASSES, BOXES and BRAKE SHOES.

Cast Steel Works of FRIED. KRUPP, ESSEN, Germany.

Represented by THOMAS PROSSER & SON, 15 GOLD ST., NEW YORK.

These works cover an area of 1,200 acres, employ about 18,000 men, have the most improved plant, and stand unique, from the fact that they have their own Ore and Coal Mines, Blast Furnaces, etc., and that every stage of manufacture is under their own supervision, and are not (like others) dependent on the open market for a miscellaneous assortment of crude material; which, in connection with 75 years' experience, enables them to turn out a product of a very superior quality, second to none, and at the same time the different grades of Steel are always of the same uniform quality.

Locomotive Tires, Crank Pins, Piston Rods, Spring Steel, Steel-Tired Wheels, Etc.

After a test of over 25 years the "KRUPP TIRE" has proved itself the best in the market. If a reliable article is wanted, which will give satisfaction, get KRUPP'S.

SCHENECTADY LOCOMOTIVE WORKS, SCHENECTADY, N. Y.

LOCOMOTIVES
OF
STANDARD
DESIGN
FOR ALL
CLASSES OF
SERVICE.



OR FROM
DESIGNS
FURNISHED
BY
RAILROAD
COMPANIES.

EDWARD ELLIS,
President.

WM. D. ELLIS,
Vice-President and Treas.

A. J. PITKIN,
Superintendent.

A. P. STRONG,
Secretary.

COMPOUND LOCOMOTIVES, Showing an Economy of 15 to 30 per cent. in Fuel and Water. Annual Capacity, 400.

M. J. HENMAN, Pres. and Treas. DAVID HANSELL, Mgr. H. TANDY, Ass't Mgr.



Brooks Locomotive Works, DUNKIRK, N. Y.

Builders of Locomotive Engines for any required service from our own designs or those of purchasers. Perfect interchangeability and all work fully guaranteed.

COMPOUND LOCOMOTIVES

FOR PASSENGER AND FREIGHT SERVICE.

THE PRATT & WHITNEY Co., HARTFORD, CONN., U.S.A.

MANUFACTURERS OF
STANDARD CYLINDRICAL SIZE AND U. S. STANDARD THREAD GAUGES
Special classes of every variety of interchangeable production
REAMERS, TAPS AND DIES.

In all usual styles for Malleable, Pipe Fitters and Boiler Makers

Renshaw Ratchet Drills, Combination Lathes, Chucks, Die Stocks, Bolt Cutters
Lathes, Planes, Drilling, Milling, Cutter Grinding, Die Sinking,
and Drop Forging Machines, Forging and Trimming Dies.

MONITOR MACHINES FITTED WITH TOOLS

For Sinking to Sample, Boring, Studd, Locomotive Fitters, Plumbers and Gas Fitters' Brass Goods
CATALOGUE LIST SENT ON APPLICATION.

STEVENS' PATENT FINE JOINT
HERMAPHRODITE CALIPERS
No. 89 E.
Price List, sent by mail

1/2" to 1 1/2"	80 Cts.	1 1/2" to 2 1/2"	90 Cts.
2 1/2" to 3 1/2"	1 00	3 1/2" to 4 1/2"	1 10
4 1/2" to 5 1/2"	1 20	5 1/2" to 6 1/2"	1 40

Send and Leader Forging Dies and Calipers, Iron, Surface Gauges, Bevels, Chisels, and Pipe
"Diamond" Tools. Light, durable, and lasting very long.

J. STEVENS' ARM & TOOL CO., P. O. Box 5104, Hingham Falls, Mass.

TOOLS.

STEVENS' UNIVERSAL
THREADING TOOL.
No. 95. Price \$1.00.
With Square Thread Cutter, S.S. die,
and 1/2" and 3/4" Dies.

Latrobe Steel Works

MANUFACTURERS OF

TIRES

FOR LOCOMOTIVE AND CAR WHEELS.

Main Office and Works, Latrobe, Pa.
Branch Office, Bullitt Building, Philadelphia.
Chicago Office, Phoenix Building.
New York Office, Columbia Building.

EDWIN S. JACKMAN COMPANY, STEEL AND COPPER, RAILWAY SPECIALTIES.

Refined Cast Steel for Shop and Track Tools,
Railway Spring Steel, Firebox and Boiler Steel of Extra Quality.
Warehouse: West Water St., near Randolph. General Office: 901 Rookery Building, CHICAGO.

A. W. SOFER, Pres. ROBT. ANDREWS, Vice-Pres. C. H. HOWARD, Sec. W. R. THOMAS, Treas. R. M. DIXON, Engineer

THE SAFETY CAR HEATING AND LIGHTING CO.,

160 Broadway, New York.

HEATING SYSTEMS.—By hot water circulation and direct steam with regulating devices. Reliable and uniform heat. Economical and rapid circulation. Gibbs automatic coupler of Westinghouse type, absolutely steam-tight.

LIGHTING SYSTEM.—The celebrated Pintsch compressed oil gas method. In use on over 40,000 cars in Europe and America. Adopted by the U. S. Lighthouse Board for lighting Buys. The best, most economical and only safe light for Railroad purposes. In brilliancy and cleanliness unsurpassed.

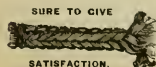

DUVAL METALLIC PACKING

Send for Catalogues, Prices and detailed information to

THORNTON N. MOTLEY & CO.,

SOLE AGENTS,

43 John Street, NEW YORK.

Locomotive Engineering



A Practical Journal of Railway Motive Power and Rolling Stock.

VOL. VII, No. 2.

NEW YORK, FEBRUARY, 1894.

10 Cts. Monthly
\$2.50 Per Year.

The Unexpected in Mechanics.

Every-day things, which are perfectly familiar to mechanics of one class, are totally unintelligible to the workers in another branch, remarked Professor Sweet in talking on the above subject. Men who have worked a life time in fashioning cast-iron under the lathe, are greatly surprised on learning that the same material, when employed in the heating-pipes of a blast furnace stove, grows from six inches to a foot in length from constant use. The furnace man is equally unprepared to hear that the core bars for casting pipes lose as much as three inches in casting twenty or thirty pieces.

In practice we use a piston-rod packing

without apparent cause, to shake end-wise, and before night had shaken itself loose. As no harm resulted and work was pressing, the repairing of the foundation was postponed until vacation time, about a month distant. Before that time arrived the shaking ceased and the engine ran perfectly smooth in spite of the impaired foundation.

Another curious case was two similar boilers which were connected by necks at top and bottom and a fire started under each of them, the boilers being about half full. The water behaved very strangely, all going from one boiler to the other. When the play was at its height the boss, considering the lives of the men and safety of the premises of more value

Pittsburgh Compound Passenger Locomotive.

The Pittsburgh Locomotive Works exhibited at the World's Fair, among other locomotives, a compound eight-wheeler that attracted universal attention and admiration. She was painted green, and her rods, cross-heads, guides, etc., were finished so elegantly that many railroad men thought they were nickel-plated—there was no nicer finished engine there.

Both cylinders were lagged up to the same size, and both piston-rods had extensions through the front cylinder head-tail rods.

The Pittsburgh two-cylinder compound differs from other two-cylinder compounds

the moving of reverse lever one or more notches opens valve which admits pressure to reversing appliance, and intercepting-valve is moved to position shown by Fig. *Z*. The dropping back of lever to full stroke again changes the valve, and the engine is thrown into simple as before.

Complete drawings shown herewith will make every detail of construction plain, and sizes are given in the specifications as follows

WEIGHTS AND GENERAL DIMENSIONS.

Gauge of track, 4 ft 8 1/2 in.
Total weight of engine in working order, 112,550 lbs.
Total weight on drivers, 72,000 lbs.
Driving-wheel base of engine, 8 ft.



PITTSBURGH COMPOUND PASSENGER LOCOMOTIVE

of easy fitting babbit bushing. When these bushings become sufficiently worn to leak, we close them by compressing them in the cylinder of a hydraulic press. In this operation a mandrel somewhat smaller than the piston-rod is put inside, and with all the pressure we can bring to bear, we have never been able to compress the bush so as to grasp the mandrel tight. Yet occasionally we have those bushes seize the rod so tight when the engine is running that the firm hold breaks the bushes assunder.

When the lawn mower was first introduced, the inventor was considered little short of a mechanical heretic to imagine that he could get sufficient traction with two light wheels to rotate a cylinder six times their own weight, at six times that velocity and cut the grass at the same time.

The worm that drives a Sellers' planer does not wear out half so fast as theory says it should, and there is possibly something unexpected about it even to the makers themselves.

An engine which had been running a year at 185 revolutions a minute on an unusually solid foundation, began one day,

than the interests of science, ordered the fires drawn and the cause could never be determined.

The readers of this paper have done us proud with their congratulations. We appreciate all of them, and will try to deserve the most of them. Modesty forbids that we publish a few hundred letters on the subject; we don't even keep them, as reading any number at once might produce swelled-head, or make us satisfied with *LOCOMOTIVE ENGINEERING*. This we are not, and don't intend to be—each succeeding issue must be better than the last one.

The Fall Brook Railway have recently raised the running boards on some of their consolidation locomotives and it seems to be an improvement. The running boards on very large boilers are much too low to stand on to do anything on the top of the boiler, while the board is too low to make inspection of the engine as easy as it might be, besides, where no wheel-guards are used, it keeps things cleaner, or rather exposed where they are more liable to be cleaned.

in that, when working simple the high-pressure cylinder exhausts direct to the atmosphere, and they can be run simple as long as desirable.

The cross section through cylinders shows the arrangement of intercepting and reducing-valve, steam pipes, passages, etc., and the small engravings show the details of these valves.

Fig. *A* shows position of intercepting-valve when working simple, the passage to receiver being open to reducing-valve, which is free to act and admit live steam to receiver. The high-pressure exhaust is also open to the atmosphere, as shown. In Fig. *B* the intercepting-valve is shown in forward or proper position for working compound, with passage between reducing-valve and receiver closed, while the exhaust of high-pressure cylinder is diverted from the open air to receiver, as indicated. In the cab is placed an automatic air or steam reversing cylinder, actuated by movement of the reverse lever, as follows. When lever is down or at full stroke, the intercepting-valve is in position indicated by Fig. *A*, permitting admission of live steam to receiver; but

Total wheel base of engine, 21 ft 10 in.
Total wheel base of engine and tender, 47 ft 5 in.
Extreme length of engine and tender, 57 ft 9 1/2 in.
Length of main rod, center to center, 85 1/2 in.
Height from rail to top of stack, 15 ft.

CYLINDERS, VALVES, ETC.

Cylinders cast in one piece with half-saddle.
Transverse centers of cylinders, 80 in.
Diameter of high-pressure cylinder, 19 in.
Diameter of low-pressure cylinder, 29 in.
Stroke of pistons, 26 in.
Kind of pistons, cast steel with followers.
Piston-rods, steel, 3/4 in. diameter.
Size of steam-ports, low pressure, 1 1/4 x 16 in.
Size of steam-ports, low pressure, 1 1/4 x 18 in.
Size of exhaust-ports, high pressure, 2 1/2 x 16 in.
Size of exhaust-ports, low pressure, 3 1/2 x 18 in.

Kind of valves, Richard-on-Lansuce.
 Greatest travel of slide-valves, high pressure, 5 in.
 Greatest travel of slide-valves, low pressure, 7 in.
 Outside lap, high pressure 1 in
 Outside lap, low pressure, 7 in
 Inside clearance, high pressure, $\frac{3}{16}$ in
 Inside clearance, low pressure $\frac{1}{8}$ in
 Lead of slide-valve in full stroke, high pressure, $\frac{1}{8}$ in
 Lead of slide-valve in full stroke, low pressure, $\frac{1}{16}$ in

BOILER

Material in shell (Carnegie Steel Co.)
 (Ld) (homog means steel)

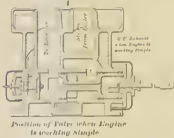

Material in firebox (Carnegie Steel Co.)
 Thickness of shell, throat and back
 Thickness of firebox sides, door, crown
 Thickness of tubes, 1/2 in, 3/4 in and 5/8 in
 Diameter of boiler, inside of shell
 Diameter of boiler at smallest ring, 48 in
 Diameter of boiler at back head, 63 in
 Weld of horizontal seams, butt joints
 Weld of lap and sextuple riveted
 Weld of circumferential seams, double

Double, light and diameter, 18 in
 Crown sheet, supported by radial stays,
 1 1/2 in diameter
 Stay-balls, iron, Brown & Co
 Stay-balls, 1 in diameter, spaced 4 in,
 from center to center
 Tubes, Spang, Challant & Co
 Number of tubes, 20
 Diameter of tubes, 2 in
 Length of tubes, over tube sheet, 10 ft
 Length of firebox in tile, 10 in
 Width of firebox in tile, 40 1/2 in
 Water space, sides, back and front, 1 in
 Water hole, 1 1/2 in thick, double riveted
 Water test, 25 lbs
 Steam pressure, 150 lbs
 Kind of grate, cast-iron, rocking
 Grate surface, 20.8 sq ft
 Heating surface in tubes, 1,100.88 sq ft

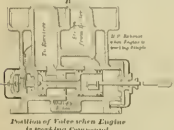

Heating surface in firebox, 121.12 sq ft
 Total heating surface, 1,221.00 sq ft
 Smokebox, extended, with deflector, netting and spark-eyector
 Kind of smoke-stack, straight
 Smallest inside diameter of smoke-stack,
 15 1/2 in.
 Kind of exhaust-nozzle, single
 Diameter of exhaust nozzles 14 sizes,
 4 1/2 in, 5 in, 5 1/2 in, and 5 3/4 in.
 Brick arch in firebox, supported on tubes,
 2 1/2 in. dia., No. 6 W. G.

WHEELS, ETC

Diameter of driving-wheels, outside of
 tires, 72 in.
 Diameter of driving-wheels, centers,
 66 in.
 Make of tires, Latrobe Steel Works

Size of tires, 18 x 7 in
 Kind of driving axles, steel
 Diameter and length of journals, 8 x 10
 Kind of crank-pins, steel
 Diameter and length of main crank-pin
 journal, 5 1/2 x 10 in
 Diameter and length of main crank-pin
 parallel rod journal, 2 1/2 x 4 in
 Diameter and length of back crank-pin
 parallel rod journal, 4 1/2 x 4 in

ENGINE TRUCK

Type of truck, 4-wheel, truck center.
 Type of truck wheels, cast-iron spoke
 center, steel lined.

Make of tires, Latrobe Steel Works
 Size of tires, 2 1/2 x 5 1/2 in.
 Kind of axles, steel.
 Size of journals, 5 1/2 x 10 in

TENDER

Weight of tender, empty, 30,600 lbs
 Weight of tender, with fuel and water,
 73,720 lbs.
 Kind of tender frame, channel iron
 Type of tender truck, diamond
 Diameter and kind of wheels, 30 in
 chilled plate
 Make of wheels, Pittsburgh Car Wheel
 Co.
 Kind of axles, steel

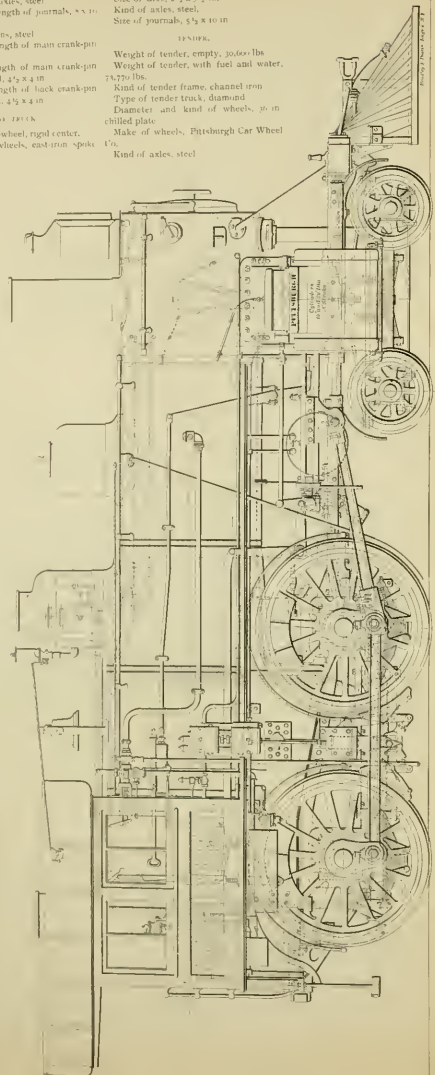

PITTSBURGH COMPOUND-PASSING LOCOMOTIVE, EXHIBITED AT WASHINGTON FAIR

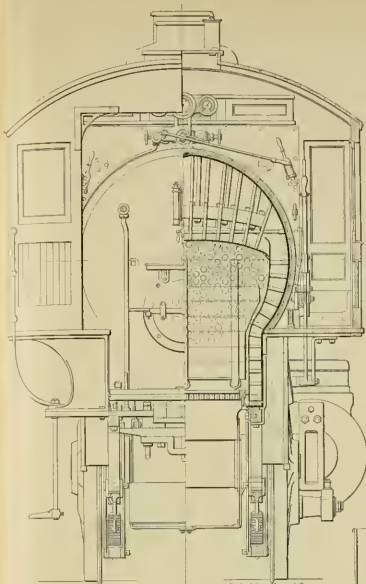

REAR ELEVATION.

SECTION THROUGH FIREBOX.

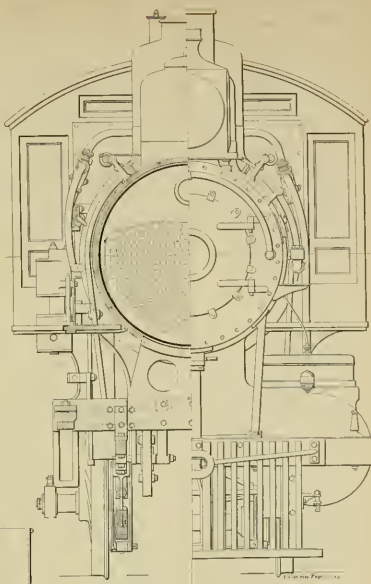

SECTION THROUGH BOILER, LOOKING BACK.

FRONT ELEVATION.

Size of journals, 4 1/2 x 8 in.
Capacity of tank, 3,500 U. S. gallons.
Tender brake-beams, Schenck pressed steel.
Tender brake heads and shoes, Christie

PRINCIPAL FEATURES.

Boilers, steel, Lard type.
A. cast-heads, cast-steel, with brass gibs, Lard type.
Connecting-rods, steel.
Type of rods, "I" section, parallel rods with solid ends.
Pilot, oak, with wrought iron bull-nose.
Lagging on boiler, cylinders and dome, wood.
Jacket, planished iron.
Cylinder-head casings, pressed steel.
Steam-chest casings, pressed steel.
Dome top casings, pressed steel.
Sand-box top and lid, pressed steel.
Smokebox front and door, pressed steel.

FITTINGS.

Type of brakes, Westinghouse auto-matic.
Train signal, Westinghouse
Brake shoes, Ross Meehan
Make of injectors, Monitor
Size of injectors, No. 9 right side, No. 5 left side.
Safety-valves, Crosby.
Whistle, Crosby Chime.
Steam-gauge, Ashcroft.
Head-lamp, Williams
Lubricator, No. 9 Nathan.
Metallic packing, Jerome.
Engine and tender springs, A. French Spring Co., Ltd.

CAPACITY OF THE ENGINE.

The makers state the net hauling capacity of the engine in tons of 2,000 pounds, as follows

At 40 miles per hour.

Level	450 tons
1/2 % grade, or 13.2 feet per mile,	315 "	
1 % "	264 "	215 "
1 1/2 % "	206 "	180 "
2 % "	152 "	140 "

At 30 miles per hour.

1/2 % grade, or 16 feet per mile,	100 tons
1 % "	79.2 "
1 1/2 % "	62.4 "
2 % "	45.6 "
2 1/2 % "	32 "

Superfluous Information.

There is a railway station in Glasgow called Maryhill! The name made a poor Irishman the laughingstock of his friends in the early days of railroading. The railway had not long been in operation when Pat wanted to take a ride on the train to experiment on how it would feel. He was perfectly at sea about how to proceed to obtain permission to board the cars, but he determined to watch others. Placing himself at the entrance to the platform near the ticket-office window, he waited to hear what the first intending passenger would say. This turned out to be a woman, who said, "Maryhill, single."

Pat had now learned what to say, and he boldly walked up to the window and shouted, "Patrick Murphy, married, wan wife and two childer!"

The flue-sheet strengthening device illustrated in the January issue of this paper was designed by Mr. James Hughes, foreman boiler-maker for the D., L. & W. Railway at Scranton, Pa. Mr. Hughes has applied for a patent on the device

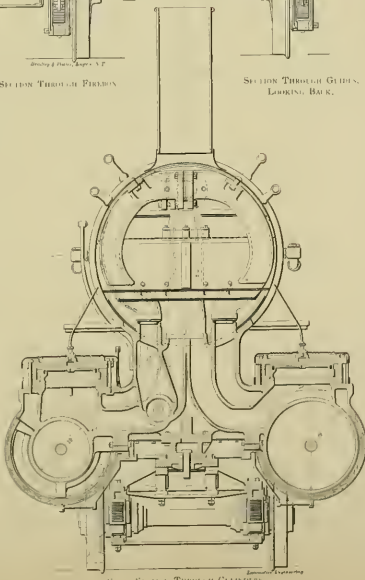

CROSS SECTION THROUGH CYLINDERS.

and used all their efforts, and so managed that not a sheep was injured. I mention this, deeming it worthy of your notice, that the men on engine No. 56 and train No. 65 should receive your commendation as making the extra effort in the interest of your company, even if in the line of duty.

We put up a notice that at the end of the year, we will pay a cash premium of \$60 to every freight conductor whose services have been *entirely* satisfactory. It speaks well for the men when our report shows that forty-five out of fifty-six conductors were awarded premiums. The reasons the other eleven failed are given below, which shows that some of them lost it through no fault of their service.

1. Brought car of freight Newberry Junction to Corning as an empty car.
2. Absent on vacation about half a year.
3. Stood in Billboro side track to switch car in spur, set one brake back of car to be switched. Rear end ran down and collided with car going in spur.
4. Only worked part of year; resigned.
5. High speed Beaver Dams to Watkins, and from Log City to Long Point.
6. Violation of rules. He supposed engineer had sent a flagman.
7. Put two cars off end of side track at

himself suffers, and he only in reputation at headquarters.

We are very careful in the selection of our men, promote all our own engineers and conductors, and in a few months or a year or two our record tells us whether they are "adapted for the business" or not.

We have engineers who have been running here more than twenty-five years, without a scratch of the pen against them; while others, who have been running as many months, have quite a page full of irregular "circumstances;" but down near the bottom of such a page can generally be found the word "discharged"—incomplete.

When a man commences to "make a record" (in the book), we call him in and talk with him. It is reminded that, if this gets too long, we shall have to consider him a failure for our service, show him his weakness—if we know it—and give him another chance. But he understands that it will not be entirely for the last offense that he is dismissed—the "suspended sentence" cases are against him.

With this system the good men are retained, developed, benefited and encour-

aged, or men who are not familiar with our road or work. If the responsible officer takes such an offender into his office, talks the matter over dispassionately and tells him that he is considered too good a man to be discharged for incompetency, that the accident has cost so much, which the company will stand "this time," but perhaps not the next, and tells him to "go and sin no more," this has a tendency to make better and more successful railroad men of the ones that are naturally adapted to railroad work—and the "next time" comes only too soon to the man out of his sphere.

There is nothing in this to disgrace him among his fellows, nothing to make him feel revengeful or maltreated; but everything to make him feel as though he was encouraged and helped, and that his final success depended solely upon himself. Can as much be said of the plan that disgraces a man among his fellows, that takes the comforts and, perhaps, the necessities from his home, that makes him a loafer for thirty or sixty days and puts him in the way of temptations that he would not find at his work, and that leaves him, in many cases in debt to

pointed out, and both the man and the manager have learned something. I am sure this rule makes and keeps up a friendly feeling between the men who plan the work and those who execute it. Roads that can afford to let one department fight another, who can afford to have hundreds of employés dissatisfied and dissatisfied with their work, who can afford to have the officers "out" with the men, and the men glad to see any hoped-for improvement a failure, are few and far between.

The suggestions set forth in this article may not be practicable everywhere, but on a moderate sized road (Fall Brook has 257 miles all single track, with an average tonnage of about 6,000,000 yearly) where the superintendent knows all the men, or most of them, it has worked so well for years that I have an abiding faith that it will work anywhere, and in every case in the interest of better service.

Wanted—A Railroad.

On this page we publish a view of a train on the Humboldt Logging Railway, in Humboldt Co., Cal. Humboldt is one



TRAIN OF REDWOOD, ON THE HUMBOLDT LOGGING RAILWAY, CALIFORNIA.

Dresden by giving back-up signal without receiving same from the man on rear end of the train. Broke telegraph wires. Did not report it until next day.

8. Ran double header to Beaver Dams, and only took cars that one engine should haul. (Since discharged for drinking. Now proprietor of saloon in Corning.)

9. Allowed 3d 70 to pass Cooks less than ten minutes behind, the second section overtook them south of Presbo and collided.

10. Let car of horses at Humboldt Junction that were slipped at Watkins. Man in charge told him it was an error on bill. Settled difference in freight, \$4.50, besides losing premium.

11. Engine "John" (pony engine used by officers of company) found train south of Earles; his flagman not out proper distance, conductor in caboose and could see flagman plainly.

We also pay premiums to section foremen for best kept track.

For the trainmen we keep a record-book. This book is never shown to any employe, except that page which is his personal record.

In it I write down a brief statement of every irregularity for which a man is responsible; this record takes the place of the "lay-off," and is readred fully and as much the man goes to work at once as no such but

aged and the culls are got rid of to the betterment of the service all around.

It is well understood that we do not wish to retain in the service men who deliberately deceive us about mishaps on the road; we want the "straight" of every matter and we want it at first hands. It would be a very lively spotter who could get to my office sooner than some of the men who are responsible for accidents. If it is not serious enough for dismissal the matter is overlooked or made a matter of record, and the man goes out on his regular run. Then the "Miscellaneous Board" has another object lesson on it.

If there is anything that will stimulate a good man, who has become careless enough to make a lapse of duty that "gets him in the book," more than that simple record, it is not to know what it is. They beg not to be "put on record," but when the record is made and the victim warned to look out and attend to business in future, and to take his run out in the morning, he goes away with a mental vow not to be caught again—and some of the records are years apart. In some cases one memorandum is made, and never an occasion given for a second one.

Good men who have made some little mistake, are less likely to do so again, than men who have not yet tried the responsibilities of running trains and

the dealers who furnish his family supplies.

On many roads there is a great want of cordiality or confidence between the men and the officials immediately over them. In too many cases a suggestion from a trainman to an officer would be resented as an unwarranted interference. It seems to me this is not in the interest of the railroad company, however much it may enhance the dignity of the official—who is himself only "one of the hired hands," with a little more responsibility.

I have found suggestions from the men of vital importance in matters of detail, and every man in the service knows that the rule and motto at headquarters is, "Suggestions are Always in Order."

Train and enginemen see and know things about the road that an operative officer could never find out in his office. At their suggestion, we have frequently made minor changes in time-table, etc., and every change has been an improvement. The humblest man on a section may suggest something that will save the company hundreds of dollars, and besides this encourages men to think and become more interested in their work, and feel at liberty to modestly offer other suggestions.

When a suggestion is made that is considered impractical the reason that it is iso-

lated of California's northern coast counties, and is walled off from the rest of the State by the Coast Range Mountains. Communication with the outside world is mainly by water.

The Humboldt Logging Railway is owned by the Excelsior Redwood Co. The road is operated only in summer, and hauls from 20,000,000 to 30,000,000 feet of logs, besides 5,000 or 6,000 cords of shingles and shake bolts, piles, and other such material. The load shown in the picture is not an unusual one, but just an every-day load. The road is only ten miles long, and runs from Humboldt Bay, along Freshwater Creek into the forest. The redwoods of this region are giants and the scenery correspondingly grand.

There are nine or ten such logging roads, standard gauge and well-equipped, but only one passenger road, the Eureka & Eel River Railway.

The one thing lacking to the development of one of the richest counties in a rich State is railroad communication with the commercial world.

Are you taking an interest in our prize designs? Someone is going to get some money for an idea or two—it might be you.

Brooks' people have received an order from the Lake Shore for ten locomotives.

Sight-Feed Lubricators.

How to Set Up and Run Them—A Description of Those Most in Use.

There are two things now in common... that have made a revolution in locomotives, and in the handling of them, within the past twenty years...

There are many kinds of sight-feed lubricators, up-feeds and down-feeds, sprays, flashers, etc. but they are in use only on stationary engines.

Both of these instruments use the Gates foundation invention of the up-feed, a drop of oil arising by virtue of its specific gravity through a glass tube of water.

OPERATE.

There is little or no difference in the way these two makes of lubricators should be put up in the cab. It is of the first importance that the following instructions be carried out:

- 1. Support lubricator with a heavy bracket... 2. Connect the top of the steam dome or condensing chamber, to the dome or the turret direct to boiler is best. For this use dry steam space in the boiler, good 1/2 inch copper pipe and a good globe valve...

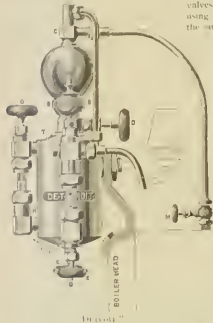

FIG. 1.

On the inside of the boiler and in building engines... it is an impossibility to set up such a unit of lubrication among the men who put these things up...

There is nothing so dangerous about the working of either of them, and when the principle is understood it is as plain and as easy as a child's play.

...some credit upon the writer got up to a new locomotive for a job, and noticed that a fine, nickel plated Detroit cup was empty, and that at every slight of the fireman's oil the water through the oil cups that had been left in and the pan connected through them.

"A little personal experience with this cup had proved that it would work if given a show, so the engineer was asked how it worked."

"Well, it feels all right for about half an hour. Then the glass all fills up with oil and it won't feed." That description made the trouble perfectly plain, the hand oil cups on the old style lubricator were valves that shut off connection to the top of the glass, or fountain, and they had tried to run the cup with these shut, the cup fell until the cavity above the glass was filled with oil, then it filled the glass. He filled the cup then and there, it worked and it was not taken off.

Now the engineer, fireman and traveling engineer had all talked with that cup and couldn't make it work, and there was a card of directions tacked to the cover of the engineer's seat-box, too. Engineers and firemen are constantly asking such questions as:

- "Can't both feeds go to one cylinder cross-feed?" "You can't tell but what the feed is gone into the boiler, can you?" "What's in the oil pipe to the chest oil, or water, or steam?" "How can the oil go to the chest to the cylinder against the steam pressure?"

- 3. Connect the top of the steam dome or condensing chamber, to the dome or the turret direct to boiler is best. For this use dry steam space in the boiler, good 1/2 inch copper pipe and a good globe valve, and be sure you place this next to boiler, it there is considerable pipe between steam supply and the valve it may get broken off some day and kill somebody. The Detroit company insist that this pipe shall be lower at all points than its connection to the cup. This drains the surplus

pipes to the union couplings on the fitting above the feed glasses.

4. Be sure you take the valves out of the oil pipe connections over the steam chests. This is very important.

Whatever cup you have, if it is run up neatly this way it will work if properly handled.

1. Fill the cup with oil, through the filling plug in front—and be sure you strain the oil, a very small piece of waste, stick or other foreign matter will stop up the feed.

2. Open steam-valve, admitting steam to the dome for condensation. It is always best to fill the cup when the engine goes in or at the end of the trip, then open steam-valve before the engine is taken from the house at all; or if the cup is empty close water-valve at back and open steam valve. This allows for condensation and the glasses are full of water.

3. Never open feed-valves below the glasses unless the glass is full of water.

4. On the back of each cup, just over the supporting stand, there is a valve, known as the water valve; this admits water from the condensing chamber to the bottom of the cup; open this after the glasses are full of water and before you start your feed.

5. Open feed-valves below the glasses, admitting the number of drops per minute that has been found necessary for your work. A large engine requires more oil than a small one, and where there is bad water and foaming or priming in consequence, more oil will be needed.

6. To stop the feed, close the valves below the glasses—leave all the others alone.

7. To refill the cup, close that water-valve at the back, this shuts off the supply of pressure from the lower part of cup; then close your feed-valves below the glasses and draw off the water at plug below the cup. It is best to draw this into a cup, as where a pipe is connected it is hard to tell when

valve, whether you want to start the feed or not.

9. In the "Nathan" never close the valves on top of the glass gauges, except when a glass breaks, then close the one over the broken glass, and the feed valve under it, and use the hand oil cup for that side of the engine—in this no way inter-



"DETROIT" NO. 2. FRONT VIEW.

fers with the feeds of the rest of the cup, be there one or two. In the "Detroit" there are check-valves over the glasses, so that when one breaks the top connection is automatically closed, and it is only necessary to close the feed-valve. Use the hand cup for that side. These valves also protect the tops of the glasses, prevent their cutting away and breakage. As these valves are always working in oil, they will not line up, and will positively close in case of breakage of glass.

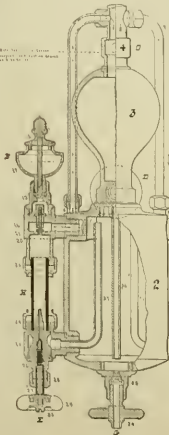

SECTIONAL FRONT VIEW "DETROIT"

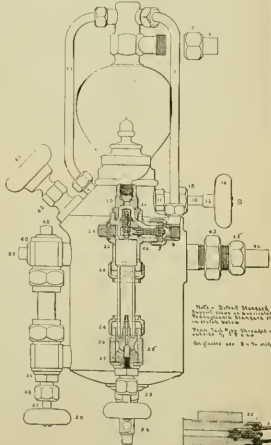

SECTIONAL SIDE VIEW "DETROIT" NO. 3.

condensation back to the boiler, allowing dry steam to pass through the equalizing pipes, and secure a uniform feed. 3. Connect the regular tallow, or oil

the water is all out and good oil running to waste. 2. Just as soon as you fill the cup and reduce the filling plug, open the water

10. Always carry extra glasses and gaskets. To replace a glass, first shut off the steam from the cup all-together. Close the water-valve at rear. If it is a

"Nathan," unscrew the packing-nuts on the broken glass, knock it out, and if you are on the road put the nuts in a pail of water to cool them off. Take a wrench and unscrew the box of the valve a half of an inch, and drop the glass in from the top, hold it partly up, slip on a new gasket, then the upper nut (notice that threads are *up*), then the lower nut, another gasket, and drop the glass into cover fitting. Replace the valve and box and tighten up the packing-nuts—not too tight at first. Open water-valve and allow glass to fill, wait until it fills with

side of the glass, it shows that the oil is too near the specific gravity of the water—too heavy. A little black engine-oil will remedy this.

Where very light-colored oil or tallow is used, it's a good plan to put in just enough black oil to darken it. The drop can be seen much better, especially at night.

To those who are interested in how a thing is done, the following description of the two kinds of lubricator will be valuable.

THE "DETROIT"

The numerous illustrations of this device here given will make plain the construction of both kinds, the one simply feeding each cylinder, and the one also feeding oil to the air pump.

Take the No. 2, and in the front and side views any one may become familiar with the construction.

There is no connection between the condensing chamber and the oil reservoir except through the water-valve shown at *D*. The pipe admitting water is shown in the center of the front view, reaching almost to the bottom.

When a drop of water goes down this pipe it displaces a drop of oil, water being heavier than oil, it remains at the bottom, and as there is no other means of escape, the drop of oil must go down one of the oil tubes—the curved pipes shown on either side—practically there is a pressure of oil in these valves below the glasses regulates.

When the oil drop appears on top of the nipple in the glass and slowly grows in size until its bulk displaces enough water, it is pulled off the nipple and rises through the glass, lifts the little check-valve and passes through another nipple, this nipple is surrounded by steam escaping from the top connections of the condensing

The hand rollers are connected by passages around the check valves, so that when the cup is shut off or broken these can be thrown at any time by simply closing the throttle.

The No. 3 device is just like the No. 2, except that in place of a tube in front to show the level of the oil in the cup, there is a sight-feed glass here that supplies the air pump. There is a bridge right across the cup, and the feed-pipe connection is through the stud that supports the cup, as shown in the cut.

The way all these passages are made is plainly shown in the detailed drawings.

THE "NATHAN"

has its equalizing tubes inside the condensing chamber, and the water level here is up to the small perforations in these pipes, as shown in the front view of the lubricator, and the passages down these tubes and past the top valve of the glass and around the upper nipple is plainly shown in the right hand cut of the plan view—which shows a cup cut through the top bracket horizontally.

The passage from the condensing chamber to the cup through the water-valve is shown in the side view. All pipes and passages in this lubricator are straight and have plugs opposite them, so that they may be cleaned or inspected.

Only one oil pipe is used, this is in the center of the oil cup, and fills a cross passage at the bottom that supplies oil to both feed valves.

Oil passing up through the glass does not have to lift a check, but has an uninterrupted passage to the upper nozzle

Where They Get Lost.

There have been a great many claims made lately that the stockholders of the New York, Pennsylvania & Ohio are suffering injustice at the hands of the Erie, and that efforts will be made to have the property returned to the owners. If among those who are howling in favor of independence there is one with real property interests in the N. Y. P. & O., we

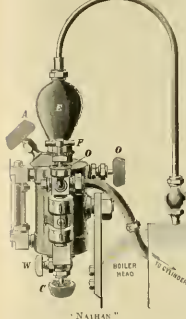

water, then open the feed, if the cup is "Detroit," shut it off from the boiler and close the water-valve at back and the feed-valve, take off packing-nuts same as before, and then with a wrench take out the feed-valve box and put glass in from the bottom, get the nuts and gaskets on right and replace valve, proceeding as before.

11. Always clean the lubricator at least once in two weeks. Do this by opening every valve in it wide open, except the filling plug, and then turn on steam.

12. Don't try to put in a glass running. The cup is hot, the jar prevents your handling such small work, you may drop and lose some of the parts, it takes your attention from your regular duties—and the hand-roller is all right anyway. *Don't monkey with old gaskets.*

POINTS.

Both kinds of lubricators are made of bronze or gun metal and are tested to about 100 pounds, yet we often see them badly bulged—this is because a careless or ignorant man has not followed instructions. If the steam connection and the water valve are opened after filling, the cup can never get more than boiler pressure on it; but if coal oil is put in until it runs over and left bottled up, it will expand when it gets hot and it will burst the cup if it can't bulge and stretch it enough to take care of the expansion.

When you see glasses all oil inside, with the feed going up along the glass, you may know that the man who started it did not wait until the glass was full of water.

Some prefer to take the live steam directly from the boiler, as the pressure is more constant than from a fountain or turret, but under ordinary circumstances the feed will be constant under any handling of the throttle.

Cylinder lubricators were not successful until a spray of live steam was introduced into the oil-pipe beyond the feed-nipple, this carries the oil to every part of the chests and cylinder.

When the drop of oil "squats" on the nipple in the feed-glass, gets very large and seems slow to go up, often taking the

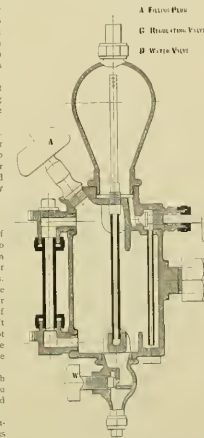

SECTIONAL SIDE VIEW "NATHAN"

chamber, and is carried to the chest and cylinders.

In this lubricator the connection to the boiler is below the connection of the equalizing tubes, and the makers claim an advantage here, as nothing but live steam can pass through the equalizing tubes. Water stands in the chamber up to the steam connection.

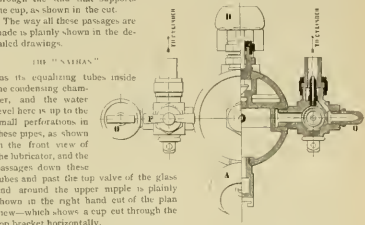

PLAN "NATHAN"

expect he is like the valiant Roman who was spouting for a fight and called out, "How'd me, Barney, or I'll hit some one yet 'me shabellah!" They are screaming fight in hopes of gaining some advantage from their valiant bearing, but they would be all broken up if the Erie company should take them at their word. A much better railroad could be built through the route of the N. Y. P. & O. at one-third its cost. The assertion is made and retorted that the Erie is letting the N. Y. P. & O.

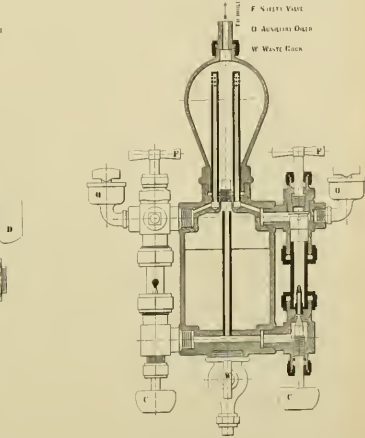

SECTIONAL FRONT VIEW "NATHAN"

The hand rollers are entirely independent of the cups. Shut the throttle and use them same as the old rollers.

When an extra feed-glass for the oil pump is used on the "Nathan," the glass is put on the side of one of the regular feed-glasses and the oil passage at bottom is extended to it. This leaves the gauge-glass in front intact.

rolling stock run down, but every practical man who is familiar with the plant knows that it never was in better condition.

The New York, Ontario & Western have placed an order with the Pennsular Car Co for 500 coal cars. They will be equipped with Gould couplers and Schoen pressed steel center plates.

LOCOMOTIVE ENGINEERING

A MONTHLY PUBLISHED BY
ANGUS SINclair, Editor and Proprietor,
JOHN A. HILL, Editor and Proprietor,
Geo. W. Wollaston, Sec. and Adm. Dept.

125 Broadway, New York
Published Monthly by
ANGUS SINCLAIR, Editor and Proprietor,
JOHN A. HILL, Editor and Proprietor,
Geo. W. Wollaston, Sec. and Adm. Dept.

Subscription Price.

\$5.00 per year, in advance. Single copies, postage paid by post office, 15 cents. Single copies in this form by Express, 25 cents. Post Office Order or Registered Letter.

The editor reserves the right to use for editorial matter any material published in this journal. The reading matter will not be sold. Correspondents must give their names and addresses, but need not send them. Making address can be changed as often as necessary. Send all notices, orders and advertisements in care of the editor, and if possible give postage notice when your paper falls due to you properly.

Entered as Post Office, New York, as Second-class matter.

For Sale by Newsdealers Everywhere.

NO BACK NUMBERS BEYOND THE CURRENT YEAR.

PUBLISHERS' AGENTS.

Amesbury News Company, New York
International News Co., London, England
W. Williams & Co., Ltd., Melbourne, Australia.

25,000 of this Issue Printed.

Two Kinds of Railroad Management—Is the New an Improvement?

Consolidation and combination, and road and tract, and combine are in the air. In no business has consolidation reached such proportions as in the railroads of the country, and with this substitution of one great corporation for many smaller ones has come a consolidation of stock and the bestowing of the same ownership, for the very thinly covered management of a few blanket officials is found out so thin that they cannot lie on it.

To the slaves gone by, when a railroad with a thousand miles of track was a good sized road, there are now a few big ones who have the training, the experience and the grasp of detail that made them able to successfully handle the property entrusted to their care.

These men "had all the say," were just and honest, and managed the railroad property in their hands just as if it was their own—to make it pay.

The great corporations have been of comparatively slow growth, yet before the manager, who finally "came out on top," knew what had happened, he had a very high opinion of his hand.

There was more work than any living man could do and do right, and this detail and that detail was lost sight of or given over to the care of some subordinate, and the new general manager of the great road dealt only in "glittering generalities."

A very successful man once said, in reply to a question about the foundation of his success, "I look after the pennies."

That explained the whole thing—grasp of detail. No man has yet been born who can manage a 10,000-mile road half as well as a thousand-and other men can manage a 500-mile road.

But there are other things that have worked to make so many of our roads "no-dividend" lines or put them into the hands of receivers. Perhaps a few extracts from a private letter from one of the ablest and best railroad managers in this country will make our meaning clearer than we can.

"I note all you say about the condition of our railroads. Many of them are in desperate straits, no doubt, and if the pressure of hard times continues for another six months or so it has in the past six, many more of our great consolidated railroads and manufacturing concerns will have to succumb to the inevitable and go into the hands of receivers.

I agree with you thoroughly as to the

cause of much of this trouble. One of the greatest mistakes has been the consolidation of so many lines into great systems and the putting of their management into the hands of comparatively few officers.

How much better our roads were managed when they were comparatively short lines, operated by "railroad men" who knew every man on the road, and were familiar with all the details of operation and the duties of every employé.

The successful operation of any line of road requires a constant and intelligent personal supervision of trained and experienced officers in all departments, all of them working under the general supervision of honest, capable and intelligent general officers, who devote their entire time to the property under their control.

Too many railroads are managed by broken-down merchants and lawyers as presidents, who haven't a single idea of the details of railroad work. They spend most of their time riding about the country in private cars, and in figuring how they can best serve their own personal interests at the expense of the railroad company. There are too few Allan Mansiehl, Hugh Rutledge and Marvin Hightmire, and many similar men, who had the knowledge enabling them to handle every detail and the ability to select suitable men for their assistants, who are able to manage and control properly.

The life blood of a railway might say most of our great railroad systems is being drained by want of experience, good sound practical knowledge, and more than all, good use per cent honesty. There is not enough disposition to work faithfully for the best interest of the companies by the traffic managers and general non-owner agents—they are the great trouble.

Did you ever think that into the hands of these men, and not the hands of the manager, has been placed the financial interests of the road?

A large share of freight traffic is handled by men who are not trained for it, for the reason that of late years so-called "traffic managers" pretend to know that freight can be hauled at a cost of $\frac{1}{4}$ of a cent per mile, taken as an average.

Let me cite an instance or two of the decline of rates. During the past sixteen years the Missouri Pacific freight rates, per ton per mile, on a general average, has fallen from 24 cents per ton per mile to $\frac{1}{16}$ of a cent, a decrease of 64 per cent in rates, the gross tonnage handled has largely increased without a corresponding increase of earnings. The Santa Fé road shows a similar result. Yet the directors, general managers and presidents seem powerless to remedy these troubles that they know full well are bringing ruin to their roads.

The traffic men of to-day "make a special rate," on nearly every chicken coop shipped over the line—a tariff-book or sheet is made up for them whatever. It has resolved itself into a case of getting the freight at any rate the shippers will pay, and piling up the gross tonnage without regard to the cost of handling or net results.

The general passenger department is handled much in the same way, and either profits or is worth nothing to the occupant than the salary of general manager or president. You hear these things, my boy, and think, perhaps, they are fairy tales or the magnifying of diseased minds, but they are not, but stern, cold facts.

Another great trouble is that many of our roads are calculated for that never did and never will pay expenses, and issuing watered stock or bonds per mile, large sums of money have been realized by the promoters of these schemes. But the

capital of the road is thus increased to such a great extent that it has become impossible to keep them running, and with increased expense and a decline of business, such as the present, they can neither pay dividends or interest.

For the past fifteen years I have said, time and time again, that many of our great railroads would, in the end, have to be recognized, and that the immense capital depended on earning reasonable dividends and interest, or that their stockholders and bondholders would have to wait many long years before they began to realize on their money.

Not one of these great lines is one half benefited. Their superintendents and other railroad officers are so entangled in such red tape reports, estimates and statements—trying to make simple railroad problems plain to men who know nothing about the business—that they have very little time to go over their lines and look after their work with that thoughtful and painstaking care that is so important to the service. The general superintendents, general managers and division superintendents have, as a rule, fifty twice as much territory as they can give proper attention to. The results that their work is never more than half done, and what is done is in a hurried, unprofitable and unsatisfactory manner. * * *

The old sole exception of this rule is the Vanderbilt systems. They operate their different roads entirely separate, and if big combinations must come that is the best way to manage them. * * *

There is a good deal of horse-sense in these extracts of a letter from one railroad man to another. The consolidation of a number of railroads under one management is just the same as one pilot trying to steer three ships at once—it can only be done by proxy. The proxy may know where all the rocks are, which may be desirable, but the pilot knows where they are not which is much more important.

The Slaughter on the Delaware, Lackawanna & Western.

For the first time in many years the D. L. & W. has sustained a frightful wreck of passenger trains.

This road has long been pointed out as an example of how successfully a road may be run on the old plan. The system of protecting trains on the Morris & Essex division, one given up almost entirely to suburban passenger traffic, is just the same as it was in 1839 or 1840—no better, no worse.

Eternal vigilance has been the watchword of operators, officers and men, and for this alone has saved trouble, but sooner or later there is sure to be a failure of one or more human machines, and then disaster is certain.

On the 15th of January, in a dense fog, an express train slowed up to see if the signal was all right. The signal was all right and another express train ran into them, killing nine passengers outright, one other dying in a few days and two others beyond recovery, besides over forty badly hurt—some crippled for life.

These trains are due to arrive in Hoboken, opposite New York, just three minutes apart. They have lost a little time, and the man behind was nearly on time.

The flagman tried to go back, then ran to the cars, and tried to get the passengers out, he placed no torpedoes, and used no flag—it is doubtful if a flag or light could have been seen. The engineer of the second train was badly hurt by jumping.

It is blamed by the officers of the company.

No one can blame the first engineer for "feeling" for that unprotected draw, the second man had a perfect right to run on time until stopped, except that good judgment never warned him to caution the first train, but he must not be forgotten that behind him, only five minutes, was another express thundering across the two

unprotected draws and the meadows—to lose much more time to be endanger the rear of his own train.

This road runs 160 passenger trains per day into and out of Hoboken station, besides some other trains.

The Lackawanna is a rich road, the Morris & Essex division is a double track road running from New York and the Oranges, the most populous suburban district around New York. Between Hoboken and Newark, a distance of eight miles, there is a long tunnel, two drawbridges and a grade crossing—the tunnel has some sort of home-made signals, and the grade crossing some wire-handled boards.

Neither drawbridge or the grade crossing are protected by distance and home signals, nor has any one of the three that simple safety device—the derailing switch.

We feel sorry for Superintendent Reasoner, who is being severely criticized, for he has used every precaution to keep the Lackawanna system of train running (or rather lack of system) a success, and has succeeded in a great measure. He is not responsible for not providing block signals, he was doing the best he could with what he had to do with. But the move moves, and the old idea of trusting to a rear brakeman to stop the train has failed again—as it must always fail, sooner or later.

It has long been recognized as true that a distance interval between trains—as afforded by the absolute block system—is the best of all known devices for protecting trains. True signals of any and all kinds are mere excises, as prolific of danger, and more so, than no signals at all.

The best roads in this country have been investing quite extensively in block signals, and it was high time they did. Most of them were forced in the matter, more or less, by serious accidents, but the Lackawanna management has held back and stood out on its past reputation, preferring to reach poorer and slower service than its neighbors rather than buy modern appliances.

On many roads a want of money has furnished some excuse for not buying such expensive equipment, but it is well known that the Lackawanna is a prosperous road, earning large dividends, having a large surplus and stock selling at 170.

The papers announce that President Sloan says, in effect, that block signals are no better, if as good, as the present system of running trains, yet they will invest in them right away.

Block signals would have prevented this accident, and though the officials may reach poorer and slower service than the public will care to tolerate any longer the carelessness of human life evinced on this line, by trying to do a heavy passenger business without modern safeguards of approved and tried value. On the management of the company, and on it alone, should fall the blame and the cost of the frightful slaughter. It was as useless as it was deplorable.

Discipline Without Punishment.

We would direct attention to the article on another page from the pen of Mr. Geo. R. Brown, general superintendent of the Fall River road.

Mr. Brown is one of a class of managers well high extant—that class who only controlled moderate sized roads, and were personally familiar with every detail and every man—the great systems have done away, in a great measure, with such services, much to their detriment.

Mr. Brown has a plan, or rather explains a practice of his in the disciplining of men that deserves more than passing notice from the men in similar positions on other roads.

Has he not offered something better than the general run of suggestion—lay off blacks, etc. etc.

This was a mere suggestion from a

young and inventive officer it might be passed over lightly, but it is not, it is backed by a dozen years of successful operation and no railroad man can inspect the Fall Brook road and not notice the excellent service and good discipline.

As the writer's mind went back to the days of his road service, days that occupied much of the railroads' good time in devising punishment by a few officers and resulting in the creation of a committee, he came to the conclusion that what would do on a little road wouldn't do elsewhere, and that, maybe, there was a screw loose somewhere. He said to himself, you can't change human nature, and railroad human nature expects to be bullied and suspended and discharged without any explanation.

The more thought of the matter, the firmer was the conviction that human nature was unchangeable, and that perhaps Mr. Brown knew better how to handle human nature than other men.

Looking into matters on the Fall Brook road it was a pleasure to find much of the unexpected. It is a bigger road than it looks like, by the general committee's vote, and interested men everywhere.

The Fall Brook is a coal road, but does quite a general business. It is 275 miles long, all single track, and hauls an annual tonnage of over six millions.

During the past two years they have had but one wreck that cost \$1,000. This one was caused by broken material, not by carelessness. The men cost \$1,500.

We found that the men were making good pay, but that the overtime paid was more than 50 per cent. less than in former years. That shows good train handling, both in the office and on the road.

We found that the cost from wrecks was 12 1/2 per cent. less than the average of former years, and we found that the cost of discipline in the office was some \$35,000 less than the average of the seven previous years—the tonnage was greater, something else was at work, what was it?

In the first place, good wages. Engineers get \$3.25 the first year, \$3.50 the second and \$3.75 thereafter for 100 miles or less. Conductors get \$2.25, \$2.40 and \$2.50, and a prize of \$60 per year if they receive no satisfaction, and this \$60 commences the first year. Brakemen get \$1.62 1/2 the first year, and \$1.75 thereafter; flagmen \$1.85; firemen \$2.20, and all are paid for overtime.

The prize helps out in attention to every detail by conductors.

There are three prizes of \$40, \$30 and \$10 for each division for the best kept section—some of that \$15,000 saving comes from this.

Men are promoted on merit, the oldest having the preference if equally bright.

Every man in the service knows that he will get fair treatment, that he will be explained with and given a show to explain his case and to do better, and that no one but himself and "G. R." will know what was said or done. Every one of them knows that he is expected to be thoughtful and careful, and to try and render the best service; but that he is not expected to be infallible nor to never make a mistake.

The spirit of frugeness, and frankness, and co-operation is in the air, and it's a poor man that don't want to do his whole share toward making a success of his daily work under such conditions.

Isn't there a lot of railroad officials in this country who would secure better service for their companies if they would imitate some of the Fall Brook methods? Is a good discipline necessarily a butcher or an executioner?

"THE IRON FOUNDER'S SUPPLEMENT" is a new volume on the art of casting in iron, supplementing and bringing up to date the well-known book, "The Iron Founder," by the same author, Mr. Simpson Holme. The work contains some 500 engravings, and has 400 pages. Price, \$2.50. Published by John Wiley & Sons, New York.

Inferior Cast-Iron Wheels.

Since the Master Car Builders' and the Master Mechanics' Associations adopted standard specifications for cast-iron wheels, there has been less trouble experienced with breakage of wheels than there had ever been since heavy loads and fast time became common. This highly desirable improvement arose from the fact that the standard specification for cast-iron wheels made them formerly. It was high time that a change for the better came about, for the breakage of cast-iron wheels was becoming so common that a feeling was growing that cast-iron wheels were not reliable enough to be employed in trains that ran faster than twenty miles an hour.

A good cast-iron wheel is perfectly safe and reliable for use on any of the common train speeds, but a badly-made cast-iron wheel is too dangerous to be employed under any act. The practice of making inferior cast-iron wheels arose from reckless competition, which encouraged a demand for cheapness. A good cast-iron wheel could be sold at such a ridiculously low price that the most careless and penny-pinching buyer had no reason for rejecting it in his mind; but competitors volunteered to do this, and figures were quoted that good cast-iron could not be purchased for. The reckless maker of the cheapest wheels got the business, and reputable makers were compelled to adopt cheap material and cheap methods of loss sale. Not a few wheels made in this way, some of which were used, and the consequence was that their works were nearly idle, while the works of the cheap makers were crowded with orders.

The standard specifications referred to had for a time a most depressing influence upon the manufacture of inferior wheels, and everybody except those who thrive on rascality in the iron business, some of whom are on a level and every one received business according to his capacity for securing it, the railroad companies received reliable wheels which gave good service and were safe, and the trammis were not in constant danger of disasters due to the breakage of wheels. There was no reason why this desirable condition of affairs should be changed, but we regret to learn that a change for the worse is going on. The depression in business has rendered the word "cheap" unusually attractive, and the disreputable wheel maker is around seducing purchasing agents into ordering wheels at a price too low for the manufacture of a good article. Railroad companies have reaped the benefit of the low price of cast-iron for the price of wheels has gone down about as market quotations, but some buyers are not satisfied with this and are ready to put under cars wheels furnished at a price about which good iron costs in the pig. We do not understand how these makers are going to get away with this, but we are going to try to help them to meet the requirements in some way. They are not making wheels that will stand the drop-test and the test of service. This is a good time for all concerned to make certain that the wheels supplied are qualified to pass through the drop-test. If the men in charge of the mechanical departments are not a little vigilant at present in seeing that worthless wheels are not accepted, the tendency towards inferior material will be checked before much damage is done.

The memory of purchasers of railroad supplies is exceedingly short, so the difference between the wear of good wheels and inferior wheels is a little vigilant at present in seeing that worthless wheels are not accepted, the tendency towards inferior material will be checked before much damage is done. The memory of purchasers of railroad supplies is exceedingly short, so the difference between the wear of good wheels and inferior wheels is a little vigilant at present in seeing that worthless wheels are not accepted, the tendency towards inferior material will be checked before much damage is done.

vice on account of sharp flanges. The broken and cracked wheels of the worst material are used, while that of the best maker was less than one per cent. About the time this record was made another road that was buying \$7 car wheels, had to remove 4,300 in twenty-eight days for dangerous defects.

When we consider the expense and inconvenience resulting from cars being taken out of service, and the fact that the wheels which changed will be found that the practice of using inferior wheels is too expensive for most roads to prosper under.

It would be well for those immediately responsible for the purchase of cheap wheels to reflect on some of the probable results of this pursuit of short-sighted economy. A saving of one or perhaps two dollars a wheel may be effected by the purchase of the worst wheels in the market, and the probabilities of accidents to rolling stock increased ten-fold. This means increase of ultimate expense out of all proportion to the saving in first cost, and it involves reckless trifling with the lives of every person riding on trains where there is any possibility of an accident. The speed of which trains are now run calls regularly for powerful application of the brakes and the protracted action of the brake-shoes on cast-iron wheels has a searching action upon the best of them. For this reason inferior wheels are likely to be much more dangerous to-day than they were eight or ten years ago, and the havoc they will do will be more fertile than it was at that time when the accidents caused by breakage of inferior wheels stirred up an agitation to prohibit the use entirely of cast-iron wheels on the ground that they were all dangerous. It would be well for railroad companies to refrain from practices likely to arouse another agitation of this character, for there are some demands for safer wheels in a manner not to be denied. The neglect of simple appliances that were calculated to prevent accidents to men coupling cars led to the enactment of laws relating to automatic couplers. The use of inferior cast-iron wheels might work up public sentiment in favor of laws to compel railroad companies to use steel wheels under all their rolling-stock.

Engineers Young at Forty-five.

During the recent trouble on the Lehigh Valley road one of the officers remarked that it was a good thing, as they wanted to get rid of some of their young men, that he "didn't want any engineers that were forty-five years old."

We would arise to remark that the man who said this was an officer in the transportation department, and not in the motive power department—the latter would better, —at his very old, and he was generally an engineer ought to be 55 years of age, he has experience, judgment, and is usually a steady, regular and reliable man. There is too much of this dividing men into classes, "the old-time rocks" and the "young blood, with progressive jays"—as one of them remarked to the writer.

Men with ten or twenty years experience are too prone to be called "the kids," or "tiddies," as he calls the younger runners. If a man is cut out for the business he can be a good engineer at twenty-five, but he will be a better one when he gets to be forty-five. The young man who was designed by nature for a car-driver or the ministry won't do any good work at twenty-five or forty-five years of age. The two best locomotive engineers whom the writer ever knew—and he knows some thousands—were more than sixty years old and the other was not yet twenty-three.

Both of them knew their business thoroughly. Both knew their own strength and power, and had at all times, and what not to do. Ah, there is where so many men miss it. Did you ever stop and think that a locomotive engineer is paid just as much for knowing what not to do as he is

for knowing what to do? Life, property, and reputations depend on his knowing the not as well as the do, while that.

All honor to the man, of any age, who studies his business and tries to be a good engineer, and all honor to him as his years of experience increase. However good he may be while young and frisky, he'll be better at forty-five than he ever was before. He may not be as "fly" but he will go on. He may not be just the same—"and you depend on him."

Where Oil is Charged to the Engineer, Not to the Engine.

On the Fall Brook road the engineers are allowed to use 30 cents worth of lubricating oil for 100 miles run with engines having four drivers coupled, 35 cents for six-wheel coupled engines and 40 cents for consolidators.

At the end of each month the bulletin shows how much over or under the amount of allowance has been charged, and at the end of the year a grand total is put up. Oil is charged to the men, their cans are all marked, the engines are arranged to be loaded up, and put on again when they are going out. We have before us the report for the first eleven months of 1923. It shows that some of the men run on half the amount of oil that others do. The best man on the list has \$5.10 to his credit, the poorest man is \$23.76 "in the hole," but his average is 80% worse than that of the others it is not fair to assume that something was wrong with his engine, though he used more of every kind of oil than any of the others. The general average shows that the men who used more oil than they ought to drew \$243.25 worth over their allowance, but the men who used less saved the company \$54.18.

Superintendent Brown says that, taken all up, it will be found that the best men on the oil record are the best men on everything else. We suggest that if the company will say to these men, "We will give you half what you save," and then cut the allowance five cents per class, they will be more money in at the end of the year and the boys will be making something out of the oil saving encouragement to try to get like well paid for trying. But prizes have been known to make thieves of men, and too much "economy" of oil has cut many an eccentric.

The Pullman Palace Car Co. has been compelled to pay \$150, stolen from a passenger's oil fossils, and this company never pays any damages until compelled to do so, and this case was taken to the Supreme Court, but was finally decided against the company. A sleeping car company holds an undefined position in its relation to patrons. It is not liable as a common carrier, and it is not liable as a hotel keeper. For this reason sleeping car companies have escaped being held when common sense indicated that they were responsible for loss of property. The decision made against this company in the present case was given on the grounds that its servants were bound to watch over the property of sleeping passengers, and this duty was neglected. The decision is likely to be highly important as a precedent. Perhaps it may interfere with the quiet slumbers of the ordinary sleeping car porter, who watches over the passengers with his eyes shut and his mouth open.

When an announcement is made that the office of general manager, superintendent of motive power, chief engineer, or purchasing agent has been abolished, it means that one higher in authority has been trying to get rid of the existing incumbent, and that he had the moral courage to ask him to get out.

We have no back numbers of any kind, bound or unbound, beyond this year. Will keep back numbers only during current year.

PERSONAL.

Mr. E. M. Hedley, master mechanic of the Brooklyn Elevated Railroad, has resigned.

Mr. B. R. Hanson has been appointed master mechanic of the Texas Midland Railroad, with headquarters at Terrell, Tex.

Mr. William Saxton has resigned as master mechanic of the Washington & Columbia River, and the office has been filled.

Mr. James Henry has been appointed manager of the Lehigh Valley Transportation Company, in place of Mr. John Gordon, resigned.

Mr. Thomas B. Purves, Jr., has been appointed master mechanic of the Boston division of the Boston & Albany, in place of Mr. Taft promoted.

Mr. Edwin Priest has been appointed master mechanic of the Boston & Albany, of East Albany, succeeding Mr. T. B. Purves, Jr., transferred.

Mr. Clarence F. Parker has been appointed assistant general manager of the St. Louis, Alton & Terre Haute, with headquarters at St. Louis, Mo.

Mr. James A. Grohen has been appointed master car painter of the Cleveland, Cincinnati, Chicago & St. Louis, with headquarters at Indianapolis, Ind.

Edward Richardson, master mechanic of the Pittsburgh, Shenango & Lake Erie, died at Greenville, Pa., Jan. 31, of paralysis. He was 64 years of age.

Mr. James W. Dally has been appointed division superintendent of the Kansas City, Wyandotte & Northwestern, with headquarters at Kansas City, Kan.

Mr. John C. Smith has been appointed superintendent of the supply department of the Lehigh Valley, at Hazleton, Pa., in place of Mr. T. M. Santee, resigned.

Mr. W. R. Woodward has been appointed general manager of the Toronto, Hamilton & Buffalo, with headquarters at Bradford, Ont., in place of Mr. James N. Young, resigned.

Mr. C. C. Riley has been appointed chief clerk of the car service department of the Cleveland, Cincinnati, Chicago & St. Louis at Indianapolis, Ind., in place of Mr. G. M. Lowe, resigned.

Mr. E. M. Humstone has been appointed master mechanic of the Philadelphia, Reading & New England, with headquarters at Hartford, Conn., in place of Mr. J. L. Ellis, resigned.

Mr. William H. Taft, who has been for seven years master mechanic of the Boston division of the Boston & Albany, has been promoted as acting superintendent of motive power of the road.

Mr. Henry Limbaker, assistant time-keeper of the Baltimore & Ohio, at Newark, Ohio, has been appointed general car inspector of the Elgin, Joliet & Eastern, with headquarters at Joliet, Ill.

Mr. J. N. King, assistant train-master of the New York & Albany at Sayre, Pa., has been appointed superintendent of the Seneca division of that road with jurisdiction from Manchester to Coxton, Pa.

Mr. Joseph Hill, assistant general manager of the Terre Haute & Indianapolis (Vandalia Line), has been appointed general superintendent of that road, with headquarters at Terre Haute, Ind.

Mr. J. A. Conant, chief clerk to the general superintendent of the Baltimore & Ohio Southwestern, has been also appointed superintendent of car service of that road. Headquarters, Cincinnati, O.

Mr. J. M. Winslow has been appointed superintendent of motive power of the Washington & Columbia River, in place of Mr. William Saxton, master mechanic. Headquarters, Hunt's Junction, Wash.

Mr. R. B. Starbuck, superintendent of the Peoria, Decatur & Evansville, has been appointed general agent for the receivers of that road, in charge of the operating department. Headquarters, Mattson, Ill.

Mr. C. R. Church has been promoted to the position of roundhouse foreman of the St. Louis & Southwestern with headquarters at Pine Bluff, Ark. Mr. Church has been a machinist and gang foreman in the repair shops of the company.

The United States Metallic Packing Co. have opened a new western office in the rotunda of the Grand Pacific Hotel, Chicago. Mr. Harry A. Pike and Mr. Edwin N. Hurley have been put in charge, and propose to cultivate the field assiduously.

Mr. H. O. Hukill has been appointed purchasing agent of the Pennsylvania lines west of Pittsburgh, with headquarters at Pittsburgh, Pa., to succeed William H. Mills, deceased. Mr. Hukill has heretofore been assistant in the purchasing agent's office.

We shall soon publish an interesting article from the pen of W. F. Dixon, chief draughtsman of the Rogers Locomotive Co. Mr. Harry A. Pike and Mr. Edwin N. Hurley have been put in charge, and propose to cultivate the field assiduously.

Mr. P. P. Fowler has been appointed division master mechanic of the Western New York & Pennsylvania, with headquarters at Oil City, Pa. He is currently the general foreman of the West Shore shops at Buffalo, and is spoken of as an excellent mechanic and manager of men.

Mr. M. P. Barry, formerly connected with the Wisconsin Central, has been appointed general superintendent of traffic manager of the Rice, Lake, Dallas & Menomonee, which was recently completed from Rice Lake to Cameron, Wis., 7 1/2 miles, and which is being extended to Menomonee.

Mr. Alexander Mitchell, superintendent of motive power of the Erie, has been appointed superintendent of the Wyoming division of that road, with headquarters at Wilkes-Barre, Pa., and the office of superintendent of motive power and rolling stock has been discontinued.

Mr. John W. Mulford, traveling engineer of the Central Railroad of New Jersey, died on January 21. He learned the machinist trade in early life, and in 1855 began work on the Central as locomotive engineer. Ten years later he was promoted to the position of traveling engineer and retained it till he died.

Mr. N. K. Elbott, superintendent of transportation of the Terre Haute & Indianapolis, has been appointed superintendent of the main line and Michigan division, with increased duties. He will also have supervision of shops, road work, engineering work, and the operation of trains. Headquarters, Terre Haute, Ind.

Mr. W. T. Rupert, general foreman of the Missoula shops of the N. P. R. R., has resigned. Mr. S. W. Gosley has been appointed as general foreman in Mr. Rupert's place. Mr. Rupert goes to Ionia, Mich., to take charge of shops there under Super-

intendent of Motive Power B. Haskell, of the Detroit, Lansing & Northern Railway.

Press dispatches from San Francisco lately intimated that Mr. A. N. Towne, general manager of the Southern Pacific, was about to retire. The report, which appears to come up periodically, is vigorously denied by President Huntington, who appears to have a fair estimate of Mr. Towne's qualifications as a railroad manager.

Mr. William S. Eaton has resigned as treasurer of the National Tube Works Co., of Boston. Mr. Eaton has held the position for twenty-four years, and a great deal of his admirable financial management. It is reported that the company is only doing 50 per cent. of the business done a year ago. Its railroad business is said to be falling off very much.

Some of the committees of the Master Car Builders' Association appear to be determined to exhaust the subjects they have terminated to report upon. The committee on "Freight Car Tracks," of which Mr. J. J. Hennessey is chairman, have sent out a circular containing nineteen questions; the committee on "Lubrication of Cars and Prevention of Hot Boxes," of which Mr. A. M. Wait is chairman, have sent out a circular containing forty questions. If the members will answer questions good reports will be presented.

Mr. Joseph Billingham has been appointed master mechanic of the Baltimore & Ohio, with headquarters at Garrett, Ind., in place of Mr. G. K. Ott, deceased. Mr. Billingham was for some time a traveling engineer on the Chicago, Milwaukee & St. Paul, and left there to be a master mechanic on the Atchison, Topeka & Santa Fé. From that he was appointed to take charge of the machinery of the Gulf, Colorado & Santa Fé, a position he held with much credit until a new ruler came in who knew not his worth. He is a very able mechanic, and will succeed on the Baltimore & Ohio.

In a reminiscent article which appeared in our January issue concerning the pioneer railroad manager, Chauncey Vibbard, the printers made the name join with H. This has brought us a flood of corrections. Owing to the personal connection, we quote a letter from Mr. Wm. Foote, of the Nathan Mfg. Co., as follows: "In your article on a veteran manager of the New York Central Railroad, long since passed away, you speak of Chauncey Vibbard. I presume you mean Chauncey Vibbard I can give you the correct name, but you do not recall no Chauncey Vibbard, but I knew Chauncey Vibbard very well, and he was a good one. After leaving the New York Central he was of the firm of Foote, Vibbard & Co., and that was the last of his real active life."

Mr. J. K. Bole has resigned his position as managing director of the Otis Steel Co., of Cleveland. It is generally admitted that Mr. Bole did the most valuable work in pushing the Otis Steel Co. to the high position it held for several years. Two or three years ago an English syndicate secured control of the Otis Co., and they are now moving to take the entire management of the company into their own hands. The management of American companies by English capitalists has generally proved highly beneficial to rivals and competitors. The new owners of the Otis Steel Co. ought to have held on to Mr. Bole, if they wanted to retain their entire management. No man is more popular in his field, and his place cannot be filled, so the company is certain to suffer, even though some strong men are retained.

Mr. John G. Neuffer has been appointed general manager of the Baltimore & Ohio Southwestern Railway, with head-

quarters at Cincinnati, Ohio. Mr. Neuffer deserves great credit for the progress made, as his age is about 35 years. He entered service in the shops at Chillicothe, O., as an apprentice in the machine shop. After he served his time, he went on the road as fireman; he fired but a short time, then he was promoted to engineer; he served as engineer for a few years, then he was promoted to roundhouse foreman, at Portsmouth, O., he was shortly afterwards appointed round foreman of engines, and served in that position about one year; he was then appointed master mechanic of shops at Chillicothe, O., and since the consolidation of the B. & O. with the C. & O. W. Railroad, Mr. Neuffer has been appointed general master mechanic of the whole system, B. & O. S. W. Railway.

A correspondent writes us "We have all been expecting that you would say something nice about the promotion of Mr. Smith to be general foreman of our shops. He is a well known and experienced ENGINEER, and all his friends think that you might have said something good about him." We have received complaints of this character before, but we are not to blame for not giving the expected personal notice. Unless a printed bulletin of promotion is issued, we are unlikely to learn about it except through the letters of correspondents. If any one who is interested in the promotion of any railroad officer will send us particulars, we will gladly publish them. Some facts about the railroad career of the men promoted are always welcome and interesting. Send in the facts, and you will have no reason to complain that LOCOMOTIVE ENGINEERING neglects the personal announcements.

A notice has been sent us by Secretary Cloud, of the Master Car Builders' Association, intimating that lithographs of the standards are ready for sale. The sheets, which are on transparent paper, suitable for making blue prints, cost only twenty-five cents each, and ought certainly to come into general use. The drawings of M. C. B. standards which we find in drawing offices are very rarely accurate, and the departures from the proper dimensions cause no end of annoyance. All these drawings ought to be burned and the accurate lithographs put in their place. The production and sale of these standards is important to the company they serve and they act unjustly towards all roads interchanging cars with them.

The following notice has been issued by Mr. Joseph Wood, general manager of the Pennsylvania lines west of Pittsburgh, and explains the information we gave last month on page 40. Mr. E. B. Wood has been appointed assistant to the general manager. He will have supervision of all requisitions for the purchase of articles in general use in every department of the company's service, and will be specially charged with the purchase of fuel, crosses and new equipment. It is his duty to make a modification of a requisition, either as to its character, quantity or quality, he shall communicate direct with the officer in whose department the requisition originated, to the end that the question may be properly adjusted. He will frequently visit the shops and other points, as the lines where material is consumed, and all officers are directed to afford him full information in connection with the character, quantity and quality of supplies received. The purchasing agent will consult freely with him on all matters relating to his department.

EQUIPMENT NOTES.

The Armour Packing Co. of Chicago, have ordered 200 refrigerator cars from Wells Fench.

The Consolidated Car-Heating Co. have ordered the usual semi-annual dividend of three per cent.

The Lake Street Elevated Road, of Chicago, have ordered twenty-three coaches of Pullmans.

The Delaware & S. S. R. are in the market for ten very heavy mogul locomotives and 500 cars.

The East Tennessee, Virginia & Georgia are reported to have ordered some passenger cars from Pullmans.

The Atlantic Coast Line are reported to be in the market for four mogul locomotives intended for the heavy freight service of the road.

The Lake Composite Mfg. Co. intimate by a circular that they have made new arrangements which will enable them to supply their roofing and paint materials much more promptly than hitherto.

An injunction has been issued by Judge Cook, of the United States Circuit Court, restraining the Eames Vacuum Brake Co., from continuing them from manufacturing air brake apparatus that infringes the broad claims of the Westinghouse patents.

The Consolidated Car-Heating Co. Albany, N. Y. has received a second order from the Burlington for direct steam storage heating equipments. These equipments are so arranged that the temperature in each compartment can be separately regulated.

The Burlington, Cedar Rapids & North-west have ordered 100 stock cars from B. K. & Smith, Dayton. They will be equipped with all modern improvements, including Westinghouse air brakes, M. C. E. couplers and National hollow brakebeams.

The gauge-glass cutter, handled by Stannard & White, Appleton, Wis., received the highest award at the World's Fair. It is an inexpensive little device which might be used in every engine-house, but it will save its cost in gauge-glasses every year.

The Chicago, Burlington & Quincy have ordered twenty Rodger ballast cars for immediate delivery. Several other railroad companies are figuring on the purchase of Rodger ballast cars, the depression of business being the only obstacle to the placing of orders.

Some time ago the Schenck Mfg. Co., of Pittsburgh, sent out for trial on various roads brake-shoes made of pressed mild steel. The tests of service on chilled wheels show that the steel brake-shoes outwear eight cast-iron shoes. While giving this great increase of service, they do the work of stopping the trains as well as the best cast-iron shoes, and produce no perceptible wear on the wheels.

Sherburne & Co., of Boston, are putting upon the market a lampshade made of silver-covered strips, braided in basket shape, but retaining the ordinary form. It has a peculiar power of reflecting the light, and seems to be particularly well adapted for use in street lamps. It is more attractive and efficient than the ordinary porcelain shade, and will prove cheaper, as it is not subject to breakage.

On another page will be found an article arguing for better cast iron wheels. Since this article was written we have come across some actual cases of cheap wheels. When a 500-pound wheel can be furnished with a five-year guarantee, for \$5.25, there's something rotten in Denmark.

We know of several offers of \$5.00 for this weight of wheel. Good, even ordinary, wheels cannot be made for the money.

The C. C. & C. St. L., otherwise known as the "Big Four," the Lehigh Valley, the New York, Ontario and Western, the Fall Brook, the Connecticut River, and the Boston & Albany railroads have recently abandoned all other patterns and have made the Schenck coupler their standard. The Consolidated Car-Heating Co. of Albany, N. Y., has sold over 10,000 Swallow couplers since the beginning of the present heating season.

The Jerome Metallic Packing Co., of Chicago, are fairly busy with the manufacture of their well-known gland packing. A new industry has been added to the shop in the form of an aluminum horse-shoe, invented by Mr. Jerome. The most valuable feature about this shoe is its lightness, but Mr. Jerome has added the quality of durability. He presses crushed hardened steel into the bottom of the shoe, and thereby imparts wearing qualities far beyond anything attained by an iron shoe.

The Lake Street Elevated Railroad of Chicago have ordered ten new compound locomotives from Rhode Island. Of twenty-five locomotives that the company have in service, twenty are compounds of the two-cylinder type. This is a road where the compounds are decidedly more popular with the men than the simple engines. They are as easily worked, and are decidedly more economical in the use of fuel. The locomotive performance sheet of the company for last December is before us, and it shows that the simple engine used 30 pounds of coal per train-mile, while the same work was done by the compounds on 35 pounds of coal. The best performance of the simple engines was 30 pounds of coal per train-mile, and the best performance of the compounds was 29 pounds. This is a saving of about 36 per cent. The total cost of operating per mile is 1 1/2 cents for the simple and 1 cent for the compounds, the saving in this is 20 per cent. The water consumption of the compounds agrees very closely with the saving of coal effected.

Trying to Change the Methods of Railroad Purchasers.

There are some peculiarities about the railroad supply business that are not to be found in other lines of supply trade. Railroad purchasing agents, and the men behind them who inspire orders, like to get the full worth of the money expended, but they do not usually buy at the lowest price or require a strict guarantee as to the quality of the goods. Confidence in the integrity of the seller is considered of greater value than guarantees or low prices. Guarantees have so often proved a delusion and a snare, and low prices the assurance of inferior material, that the personal equation has gradually grown into favor, and goods are selected because it is known that the seller is reliable.

It is well for people who wish to secure the best results to understand that it can be done. Guarantees, through the recognized channels, in which agents are looked upon as guaranties that the material supplied is of the quality represented. There have been repeated attempts to break down this system, but it always resulted disastrously to those who kicked against the price.

We have within our memory a firm selling steel plates, which decided that special agents for the railroad business were not in harmony with the firm's dealogue of organization. The heads of the firm saw no reason why railroad men in want of steel should not understand that it can be had for the money, so the flat went forth that railroad companies in certain districts wanting steel plates should conduct their negotiations through the local

agents. It is needless to say that the other fellows got the business.

A most striking instance of the faculty of trying to compel railroad companies to depart from their established habits was a firm which had built up a fine, lucrative business in the manufacture of several staple articles used by railroads. The concern was worked up from a very humble beginning by the skill, energy and business ability of the originator. He made nothing but first-class goods, and had the sagacity to employ sales agents who had a friendly acquaintance among railroad men and knew how to explain the merits of the goods they had for sale. Business grew rapidly, large extensions were made in the works, and a stock company was formed, but the man whose personal ability had carried the business held on to sufficient stock to control the others and with an increased business he held on to the old methods that had earned the confidence of buyers.

In the course of nature, however, the old man was called hence and a son entered into control. This son has many good qualities, and might have been as successful as his father, had he been his working life with a hammer in his right hand. But he began at the top, and the details that contribute to the success of a business were not understood. He was a believer in arbitrary organization. The impression came to him that the selling department of the concern was not perfectly organized, so he commenced on the men who had done the selling in the old way and established a system of geographical agents. The personnel of the agents he considered a secondary matter. The reputation of a great firm was, in his opinion, the secret of success. Railroad companies, he supposed, would never be so insane as to purchase from small concerns while his great spread eagle existed to attract attention.

The old man had insisted on the policy that the best article that could be made in a commercial way was not too good for railroad use. The young man adopted the policy that railroad companies in want of cheap goods should be supplied with what they were willing to pay for.

The hard times have come, and no concern in the country has been struck so hard as the firm we are writing about. The geographical organization did not work well. Purchasing agents did not go out looking for sales agents they had never seen, and the orders were given to other firms who were unwilling to catch the business train when it was ready to stop. The rivals, seeing the weak point in the armor of their adversary, shouted for the best material only, and supplied it. The large firm is prostrated for want of business, and small ones are building themselves up on what it has lost.

An English schoolmaster once moved into a western country, and finding that teachers were not in demand, he put all he had into a village store and turned general merchant. His old business, being that of instruction, he presumed that he could engrain the principles thereof upon the new business. When a housewife ordered anything that was not in stock, he insisted on her taking the thing in stock that most closely resembled it. When a hired girl came for goods, he told her to send her mistress, as he preferred to deal with the principal. His business was not a roaring success, and on the day that the sheriff took possession of his property, he was seen by a surprisingly independent people.

Those who set out to change the ways of railroad buyers to suit their own organization are liable to make the acquaintance of sheriffs.

Good Iron Takes Stay-bolts Durable.

A talk which Mr. J. N. Lauder gave in the New England Railroad Club, on broken stay-bolts sustains the principles which we have advocated so strongly in

favor of first-class material. Mr. Lauder says:

"We have such good results in this matter of stay-bolts in bolsters of our design, and of recent build, that I am forgetting to tell you in Western firms, because they will not believe it. Now, I will make a statement which can easily be verified, which is, that in the last ten years there have been built seventy-five boilers under my supervision and of my own design, and we have had just seven broken stay-bolts. They have been running from two months to eight years. The first boiler we built to carry a pressure of 175 to 180 pounds, and in that boiler we have had up to this time three broken stay-bolts.

"I have been seen boilers within two years that had every stay-bolt in the boiler taken out in less than two months after their delivery. The stay-bolts were not broken but were cut too small, and did not fill the holes. A stay-bolt should have a good thread, the hole should be carefully threaded, and the bolt should fill the hole. The less pounding done on the end of that stay-bolt the better. My iron for stay-bolts costs six and one half cents in the ton.

We are informed that the iron referred to is "Taylor" best Yorkshire stay-bolt iron.

Improved Measure.

It is many years since the scientific world began to devise appliances for measuring high temperatures, but the progress in this department of inquiry has been very unsatisfactory. The temperatures that can be measured by mercurial or spirit thermometers are obtained with reliable accuracy, but when the heat gets above the range of the ordinary records are very unsatisfactory. One of the most accurate methods for measuring high temperatures is to place a piece of refractory metal of known weight and capacity for heat in the place to be tested, leave it there till it becomes of the same temperature and then plunge it in a vessel containing an accurately measured quantity of water. By finding the rise of temperature due to the metal a simple calculation shows the temperature of the place where the metal was heated. The objection to this means of measuring temperature is that it cannot be used conveniently in many cases.

It would be very important to have easy and accurate means of showing the temperature of locomotive smoke-boxes, but the appliances commonly employed are so inaccurate that the records are worthless. We are glad to see that Professor Austen, of England, who has been devoting much attention to the measurement of high temperatures, has devised a pyrometer which promises to be a great improvement on anything of the kind hitherto tried. It is a thermo-pneumometer of platinum and platinum alloyed with rhodium; this is attached to a galvanometer, and the spot of light from its mirror is received on a revolving drum covered with sensitized paper. The current of white light from a seven-foot burner produces the variations in the temperature of the blast supplied to furnaces smelting iron. It is thus possible to account for the variations in the working of these large structures, and by insuring regularity of work to avoid the occurrence of these variations, also to effect economy of fuel, which, it is anticipated, will attain very large proportions and will prove to be of great industrial importance in conducting this important branch of metallurgy. It is also certain to be used in showing the heat loss that passes through the smoke-boxes of locomotives.

If a good, practical and simple pyrometer was placed on the market, it would be highly valuable for locomotives as a fixed attachment. When it indicated an abnormal temperature, changes would be made which would reduce the waste of heat.

Development of the American Car.

The American railroad train is famous for steady, easy riding, the inventive ability and ingenuity of several generations of mechanics having been concentrated in the quest for the best conditions now reached by Miller platforms and coupler-pressure vestibules, and hydrostatic or heavy friction buffers. There are men, well advanced in life, brought up in this country, who think that the American car has always been the steady-riding car. It is found on all the best conditions following extract from "Railroad Accidents," by Charles F. Adams, will give many of our readers an insight into past imperfections that they little realize.

"The original idea of the railroad train was a succession of stage coaches chained together and hauled by a locomotive. The famous first train on the Mohawk Valley road was literally made up in this way, the bodies of the stage coaches having been placed on trucks, which were coupled together with chain links, leaving from two to three feet of slack. When the locomotive started to jerk the train, the links, by jerks, with sufficient force to jerk the passengers out from under their hats, and in stopping they came together with such a force as to send them flying from their seats. On this trip, the train came to a stop, when the passengers, with true American adaptability, set their wits at work to the work of devising some means of remedying the unpleasant jerk. A plan was soon hit upon and put in execution. The three links in the couplings of the cars were stretched to their utmost tension, a rail, from a fence in the neighborhood, was placed between each pair of cars and made fast to each end of the rail, one yard from the cylinders." Here was the incipient idea of couplers and buffers improvised by practical men, and for a third of a century it remained almost unimproved upon, except by the introduction of a spring upon which coupler and buffer acted alike. The only other improvement was made in the earlier days of car construction was by no means an improvement, inasmuch as it introduced the new and wholly unnecessary danger of telescoping.

"The original passenger cars, however frail and light they have been, were at least, when shackled together in a train, continuous in their beatings on each other—that is, their sills and floor timbers were all on a level and in line, so that, if the cars were suddenly pressed together, they met in such a way as to resist the pressure to the extent of their resisting power, and the floor of one did not buckle under the floor of another that of another. The bodies of these cars were about thirty-two inches from the rails. This was presently found to be too low. In raising the bodies of the cars, however, the mechanics of those days encountered a practical difficulty. The couplings of the cars built in the earlier model were higher than those of the old. They at once met, and, as they thought, not less ingeniously than successfully overcame this difficulty, by planing the couplings and draw-heads of their new cars below the line of the sills. This necessitated building the platform which made the coupling also beneath the sills, and in doing that they disregarded, without the most remote consciousness of the fact, a fundamental law of mechanics. With a possible pressure both sudden and heavy to be resisted, the line of resistance was no longer the line of greatest strength. In the first thirty years this stupid blunder remained uncorrected. It was, as if the builders during that period had from force of habit insisted upon always using as supports, pillars which were curved or bent instead of upright. At the close of those thirty years also, the railroad mechanics had become so thoroughly educated into their false methods that it took yet other years and a series of frightful disasters, the significance of which they seemed utterly unable to take in, before

they could be induced to abandon those methods.

"The two great dangers of telescoping and oscillation were directly due to this system of car construction, and of train coupling—and telescoping and oscillation were probably the cause of one-half at least of the loss of life and the injuries to persons incident to the first thirty years of American railroad experience. The badly built and loosely connected coaches of every train going at considerable rates of coupling—used to swing and roll about and hammer against each other after a fashion which made the infrequent occurrence of serious disaster the only fair subject for surprise. In case of a sudden stoppage or partial derailment, the train stopped or went on, not as a whole, but as a succession of parts, while the lost platform and slack couplings fearfully increased the danger—for if the train held together, the cars in stopping were likely to break off the platforms, making of what remained of them a sort of inclined plane over which the car bodies rode into each other at different angles, and the couplings, as well as the swaying and rolling of the train did not part, the propping and swinging of the loosely connected cars was almost sure to throw them from the track and break them in pieces.

"The invention through which this difficulty was at last overcome, simple and obvious as it was, and as far as the world of America at large is concerned, to be classed among the four or five really noticeable advances which have of late years been made in railroad appliances. It contributed unmistakably and essentially to the safety of every traveler. Known as the Miller platform and buffer, from the name of the inventor, it was a simple and intelligent reversion to correct mechanical principles. Miller went to work to construct cars in such a way as to cause them to come in contact with each other in the line of their greatest resisting power, while in coupling them together in such a way as to give them the compression that is, in plain language, brought—the ends of the heavy longitudinal floor timbers of the separate cars exactly on a line and directly bearing on each other, and then forced them against each other until the heavy spring buffers which played on those floor timbers were compressed, when the couplers sprung together and the train then stood practically one solid body from end to end. It could no more swing or crush than a single car could swing or crush. It then only remained to increase the weight and to perfect the construction of the vehicles to insure all the safety in this respect of which travel by rail admitted.

"Simple as these improvements were, and apparently obvious as the mechanical principles on which they were based now seem, the opposition for years offered to them by practical master car builders, and the railroad men who have been ludicrously hard to please, was hardly a railroad in the country whose officers did not insist that their method of construction was exceptional, it was true, but far better than Miller's. It was maintained that the slack couplings were necessary in order to enable the locomotives to haul the train, and that the men could not work without the slack, on Miller's plan, could not be set in motion, and that if it was set in motion, it must attack at every sharp curve, etc. The ingenuity displayed in thus inventing theoretical objections to the apparatus, which exceeded that required for inventing it, was such that no one who has not had official experience of what all realize the obtrusive capacity of the typical practical mechanic, whose conceit as a rule is measured by his ignorance, while his stupidity is unexcelled save by his obstinacy. When Miller's invention, for one reason or another, was not adopted, the principles upon which that invention was founded—the principles of tension, cohesion and direct resistance—at last forced their way into general ac-

ceptance. The long-urged objection that the way was practically impossible was slowly abandoned in face of the awkward but undeniable fact that it was done every day, and many times a day. Consequently, as the result of much patient arguing, duly emphasized by the regular recurrence of disaster, it is not too much to assert that for weight, resisting power, perfection of construction and equipment for protection when exposed to travelers, the standard American passenger coach is now far in advance of any other. As to comfort, convenience, taste in ornamentation, etc., these are so much matters of habit and education that it is unnecessary to discuss them. They do not affect the question of safety."

Uncle Sol's Ways.

"There is something strange about Uncle Sol's way of handling his engine and train," remarked the traveling engineer as he spread the aroma from one of the scribe's perfumes through the instruction car.

"What is there strange about Sol? I thought he was a first-class engineer."

"So he is; but he never appears to read a book or a paper, and yet he follows the pretties you book-making engineers lay down as the proper way to get the best work out of an engine, and there is no man handles brakes better, although I don't suppose he could tell a thing about the inside of an engine's valve or an air-pump."

"Perhaps he fired for an intelligent man who understood the principles of steam engineering and carried them into practice on the locomotive?"

"No," he tells me that most of his firing was done for a man who always ran throttling, preferred choked nozzles, and who used the smokestack for a gaugcock."

"How is he on noticing things? A man of keen, observing habits will get to the right way by learning step by step, letting performance be his guide, and free of prejudice. The principles given in books are merely the select teachings of experience."

"There you have him. Sol remembers more about how his engine worked at particular places than any man I know. He sees everything that happens and notes the cause of anything out of the ordinary. Another thing that helps Sol is that his attention is always upon his engine and train. Nothing takes his mind away from these, and his engine has the best share of his thoughts. The coal men call him cranky, but they can't cheat Sol out of a single dollar. He is careful of the tender before a new supply of coal is taken on, and by practice he can tell just how much has been delivered.

"Sol had for a long time a fireman named Jim Winter, who was the reverse of his engineer in every respect, but they got on well together. Jim was a great talker, and he used to talk to the engineer on a trip without having anybody to gas to. He tried talking to Sol, on the road at first, but was sternly repressed. When he was not firing, Jim was on the lookout for something that he would like to talk to, and Sol, used to say that his fireman passed the time of day with every horse and cow seen by the way of the road."

"When it came to be near Jim's time for promotion, the master mechanic asked Sol, if he would recommend his fireman for setting up, and was told 'No.'"

"What is the matter with him?" asked the master mechanic. "I understood he was a steady young fellow. Is he a poor fireman?"

"He is a pretty good fireman," said Sol, "but his mind is never upon his work. He reads books and papers about locomotives, but his mind is never upon what the engine is doing when we are on the road. You may set him up, but I will not be responsible for him."

"Jim was set up afterwards, and burned

a boiler the second week he was running. The boys say that it happened through a little care trouble. There was a girl in the dining-room at Springfield whom Jim was greatly stuck on, and this day he wanted to show himself off as a brand new engineer. Conductor Conway, the best looking and the most eligible on the road was at the table, and she did not spare a look or a word for poor Jim. He was all broken up with this treatment, and took it so much to heart that he forgot to start the injector, and only came to himself when the lagging took fire. He is running a switch engine now and will never go higher.

"Uncle Sol got into the way of running with very large nozzles. He said an engine did her work better when there was a big hole for the exhaust steam to escape by. Large nozzles were not common on the road and no other engineer could get her to steam if he had a fireman strange to the engine. They persisted in firing too heavy. The big exhaust would not pull through a thick fire."

"When Jim first went firing for Sol, he wanted smaller nozzles. Jim liked to hear the exhaust ring out clear. He had heard other engineers say it was a sign that the engine was working. He believed also that the '299' would steam better if the nozzles were bushed. He kept up the song about bushing nozzles so persistently, that one day they were in the shop. Sol agreed that he might take out the nozzles and have them bushed. After they were put back and Jim out of the way Sol opened the smokebox door and pinched out the copper bushings and put them in his seat-box.

"When they went out next morning and were pulling out through the yard Jim said, 'Isn't she a dandy! Don't you hear her speak?'"

"Yes," answered Sol, "there's eleven cars behind her."

"All through the trip the engine steamed splendidly, and Jim frequently mentioned that the bushings were doing well and he was burning less coal than he had ever done before. Two or three days after Jim was looking in Sol's seat box for a headlight chimney and found the nozzle bushings.

"What are these things?" he asked.

"These are the bushings you had put in the nozzles," said Sol.

"How did they come to be in your seat-box? When were they taken out?"

"I took them out the day you put them in. When they were making the engine speak out, and making her steam and saving coal they were in my box all the time. That's the right place for them."

"Jim looked speechless but said nothing.

"The engine," said Jim, "was running all right. There was never anything more said about bushing nozzles."

Want to Abolish Cab Seats.

The *Railway Age* has found a railroad man who objects to the use of seats in locomotive cabs, and wishes to compel the men to stand while on duty, so that they may direct closer attention to their duties. We are not surprised that a railroad man could be found who would express sentiments of this character when he could do so without his identity being revealed. It is not certain that a man holding a responsible position on a railroad is free enough to publicly father any such sentiment. Probably some people would like to see our engineers compelled to stand while on duty, because "it is English, you know," and there are asses among us who are ready to worship any sort of ass and wish to be made more or less oppressive if they can. The *Railway Age* submits the question of seats or no seats in locomotive cabs as worthy of consideration from different standpoints. We say that it is puerile and senseless to attempt finding excuses for taking away seats and after-wise making engineers as uncomfortable as possible. There have

never been any arguments advanced in favor of the barbarism of English practice in this respect. Those who say that a comfortable seat encourages the engineer to sleep on duty do not know what they are talking about. Men with sense do not sleep in the cab; but if a man has strong inclinations in this direction, he is free to sleep standing as well as the same class of men provided with a seat goes to sleep sitting, unamindful of the responsible duties intrusted to his care.

The mechanical engineers of England who designed the equipment of the early locomotives had no experience in the handling of the engine, of all kinds of wheels, and they had no sympathy with the hardships enginemen have to endure. They asserted that enginemen were no more exposed to the weather than stage coach drivers were, and no cabs or shelter were provided. The first locomotives had very small foot plates, and seats were not provided because room was scarce. This led to the practice of making the engine men stand. When engines became larger, and there was plenty of room for seats, the fashion of standing had been established, and a new mental dispensation for designers is required to change anything that has become a mechanical fashion, no matter how absurd it may be. When the British brutal treatment of enginemen was taken up by humanitarianism and discussed by the press more than thirty years ago, the men responsible invented the excuse that making enginemen comfortable would encourage them to sleep on duty or to neglect their duties. This has been the delusion of the practice ever since. There is nothing in it.

The writer passed seven years on the footplate of a British locomotive, and about the same time in the cabs of American locomotives. The teaching of this experience is, that a comfortably housed enginemen can attend much more closely to his duties than one standing exposed to the weather. The British engine driver is too often engaged trying to escape discomfort which detract from the efficiency of the working of the engine. An enginemen who is overcome—prostrated with fatigue—is a dangerous man to be in charge of an engine. In that condition it is physically impossible for him to devote close attention to the numerous duties devolving upon him. A man standing gets worn out much more quickly than one sitting, which is good and sufficient reason why good, comfortable seats should be provided.

A Roundhouse with an Educational Attachment.

Mr. Whalen, roundhouse foreman of the Chicago & Northwestern shops, at Chicago, has set up one of the stalls of the engine-house with a series of educational appliances which are greatly appreciated and used by the enginemen and ambitious machinists belonging to the road. The most prominent of the apparatus is one of the LOCOMOTIVE ENGINEERING valve motion diagram. This has been used so much that it broke down, but was promptly repaired. Some one appears always to be trying to find out something concerning valve motion by the use of this model. There are on all railroads men who pretend to profound knowledge of valve-motion, and as they are generally wanting changes made on their engines to conform to their ideas of what will secure improved distribution of steam. When any of these men belonging to the Northwestern wish to have their valve-motion changed, they are invited to come round and demonstrate on the model the improvements they propose to be effected on their engines. It is generally found that the grade showing which the model produces, leads those demanding changes to modify their views. After they wrestle with this tell-tale machine for an hour or two they conclude to call for no changes, or at least to wait until they have time to study up the matter a little more.

In addition to the valve-motion model, there are sections of injectors, engine valves, triple-valves, lubricators, and a variety of other things which are calculated to impart valuable practical information to the men handling or repairing the appliances. When the foreman sees any one who has caused any apparatus to become an object lesson, a model of the object lessons we found on the table were injector-tubes filled up with lime deposits, lubricator-feeders filled up with incrusting matter, bent reversing-rods of air-pumps, etc. Men examining these things quickly understand how they get out of order, and are able to report more intelligently about defects of their apparatus.

Mr. Whalen says that the educational effect of his museum has been of great benefit to the company. Men used to come in and report "air-pump to be examined, injector working badly, lubricator out of order," and so on. Very rarely was information given that would enable a man to be able to find a defect. This led to much useless labor searching for the wrong. Since they began studying the apparatus provided, the engineers nearly always report in a way that indicates what is the matter. They are very rarely mistaken. This provision for obtaining correct information leads to great discussions among the enginemen, and they arrive much more closely to the truth than they formerly did.

The Hobbs Island Transfer.

At the December meeting of the Engineering Association of the South, Mr. G. D. Hicks, division superintendent Nashville, Chattanooga & St. Louis Railroad, presented a paper on the Hobbs Island Transfer, from which the following is condensed.

"Hobbs Island and Guntersville, Ala., are twenty miles apart, on opposite banks of the Tennessee River, and on one of the lines of the Nashville, Chattanooga & St. Louis Railway. This gap is closed by the Hobbs Island Transfer. The transfer plant consists of two wheel steamboats, of 40 and 50 tons burden, and two double-track barges, one for four cars and the other for six cars; the lighter boat conveys the passengers, and the other, with the barges, the freight. Time, Guntersville to Hobbs Island, about two hours for the passenger boat and two and a half hours for the freight.

The transfer is an incline, at the foot of which is a cradle, movable along the incline, so that cars can be run upon the barges at all stages of the water. The river has a rise and fall of 40 feet at Hobbs Island and 47 feet at Guntersville. The grade of the incline is 3 1/2 per cent, and they are on earth fills, pile trestle, 75 ft. at each end, and on a bottom, where the nature of the river bed prevented driving piles. The incline at Guntersville is, in part, on a 10° curve. The crabs are built of 12 x 12-inch timbers, loaded with stone. The cradle at Guntersville is novel, in that it is constructed to run on the 10° curve as well as on tangent. It consists of eight sections on wheels and two sections on slides, the first section carrying a 20-foot apron and the last a feather rail. The sections are not rigidly connected, but by a ball, allowing about 5 inches play. The rails are laid with opposite joints, spiked only at the joints and laid together by tie rods. The rails slide on the curves, and the wheels are those on the inside; on tangent each opening thus formed between the shorter rails is closed by a short section of rail, inserted and held by a split key passing through its web and the splice plates. The bolt holes in the rails are slotted. The cradle at Guntersville is on a tangent. The crabs are moved along the incline by locomotives, or a boat.

"The connection between the apron and the barge is unusual. The ends of the rails on the apron are turned outward

about 30° at the junction, while the ends of the rails on the barge are beveled to the same angle. The rails are held by tie bars, one of which between the beveled ends has a turnbuckle. Just back of this rod a lever is arranged to lift the beveled rails clear of the apron, till the windlass has drawn the nose on the barge into the V on the apron, the gauge having been thus insured by the turnbuckle. Then the beveled ends are lowered to the place, and the gauge restored by the turnbuckle, making the rails continuous from the barge to the cradle.

"The cost of the steamboats and the barges was \$30,300, the cost of the crib and cradle at Hobbs Island \$4,343 and \$837, respectively, and at Guntersville \$3,245 and \$761, respectively."

In the days not long passed, when broken chilled wheels were keeping the ditches of certain railroads full of wrecks, the wheels that caused most of the damage were known as seven dollar wheels. Honest material could not be put into wheels, so it is not that figure, so it was well understood that the money paid represented the most dangerous wheel in the market. The seven dollar wheel has again come into favor with certain purchasers, and of course, the supply is equal to the demand. The agent of a maker of cheap wheels recently heard of a railroad company which was prepared to place an order for wheels to the lowest bidder, and he went to the purchasing agent with his seven dollar invitation to calamity. Imagine his surprise when he was told that his price was too high and that an offer was to in supply wheels at five dollars and twenty-five cents. They were bought for that sum, too. We believe this is the lowest point ever reached, even for the worst quality of wheels.

There is no line of invention receiving more attention at present than the producing of an angle-cock for the train-pipe, which will perform its simple functions and yet be of such form that it cannot be turned to cut off communication between the engine and the greater part of the train. Angle-cocks of special form are passing through the Patent Office in great numbers, but most of them have objectionable features. We believe that an invention has been perfected by Mr. A. M. Watt, superintendent of the car department of the Lake Shore & Michigan Southern, which will put an end to the inventing of improved angle-cocks, and will give us only simple manner he makes the common angle-cock perfect. By an attachment which can be put on for about fifteen cents, he provides means to notify the engineer if the angle-cock is turned. We are not at liberty to give particulars. This much-needed improvement was proposed by a car inspector and the details worked out by Mr. Watt.

A circular issued by President Ingalls, of the C., C. & St. L., says "The transportation department, through the general superintendent and superintendents of divisions, will have full control of all work and employees engaged thereon which is charged to conducting transportation. Master mechanics who report to the superintendents, instead of to the superintendent of motive power, in all matters charged to his account. This order is issued for the purpose of enabling the superintendents to have full and complete control of all matters and expenses charged to their account, and they are responsible for, and to relieve the superintendent of motive power of so much detail work. For convenience, storehouse supplies will be kept at Brightonwood, and employees engaged in handling same will be under the supervision of the superintendent of motive power, as heretofore."

We have recently received particulars of a peculiar wreck. The rear sleeper on U. P. train No. 1 was wrecked on January 9th, at Clark's, Neb., in the following

manner: The truss-rod of the sleeper ahead broke and caught the head rod of the switch, buckling it so that it pulled the point open, letting the car "San Antonio" off the rail and up the siding. Car ran about 150 feet, and tumbled over an embankment about a foot high. The car caught fire from the oil lamps, and before the trainmen could get action on the fire from the lamps, it had gained such headway as to be beyond control. The car was totally destroyed.

The *Railway Times* is the name of the new official organ of the American Railway Union. It is at present a six-column four-page paper, published every two weeks. The officers of the Association do not intend to publish a monthly magazine, but to gradually shorten the interval between publication days, until the *Times* becomes a daily. There seems to be some demand for a labor daily, and the *Times* proposes to fill that demand. The subscription price is at present \$1 per year. The Union seems to be gaining lodges and membership fast.

A most interesting paper on "Metal Under-framing for Freight Cars" was read before the New York Railroad Club at the January meeting, by Mr. G. R. Joughins, superintendent of motive power of the Norfolk & Southern road. They have in use there a car of their own design that carries 80,000 pounds with ease, and which shales that metal frames can be bolted together, and have no trouble in service, the car having run fourteen months without a bolt loosening, yet there are no check nuts nor are the bolts riveted down.

If we are to judge from the way railroads are managed in China, that country appears to be a perfect paradise for office-seekers. There is now in operation about 120 miles of railways in China, and about 500 miles of it is operated by the government. To do the work there are already in the head office about one hundred clerks, most of them forced into position by importunate politicians.

The English locomotive, "James Toleman," exhibited at the World's Fair, has been in use on the Chicago, Milwaukee & St. Paul for several weeks. The engine shales a good train so long as the steam lasts, and that is only for a very short time. The four cylinders in use very quickly empty the boiler, and then the engine has to stand until it has time to boil more water.

A new 8-wheel locomotive is under construction in the Union Pacific shops, at Armstrong, Kan., and the railroad men of the place are predicting that the engine will be a little better than anything of the kind ever by the company. The cylinders are 18 1/2 inches, driving-wheels 30 inches in diameter, boiler of steel, 3 1/2 inch thick, to carry 10 pounds pressure.

The engineers and firemen who struck on the Lehigh Valley Railroad are very much dissatisfied with the settlement made. Only about half of the old men have obtained jobs, and many of these have been put on inferior runs.

T. Hackworth Young, late assistant to the Chief of the Transportation Exhibits, World's Fair, has accepted a responsible position under Mr. E. W. Johnston, superintendent of motive power of the Central Mexican.

The *Locomotive Engineers' Journal* has a bright new cover and more illustrations than usual. Brother Hays deserves credit for the improved appearance of the journal.

We cannot change advertising after the 15th of the month. Advertising matter, except cover, goes to press on that date.

* Diseases of the Air Brake System;

By PAUL SYNNESTVEDT.

Governor.

Before considering the diseases to which the governor is subject let us get a word about the use to which it is designed. This will assist you materially in treating any difficult cases.

The necessity which was the mother of the invention of the governor arose from the large number of wheels that were flattened on many different roads as a result of an excessive pressure in the

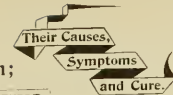

connection. Find out whether it is made to the train-pipe, main drum or some other place, as this has a great deal to do with its action. It cannot be expected that the governor will stop the pump when the main drum has accumulated 20 pounds pressure unless the air supply to the governor comes from the drum, and no governor can be blamed for irregularities in the train-pipe pressure unless it receives its supply of air from the train-pipe.

Referring now to the governor shown in Plate 5, which in general construction is a representative of all three shown, let us consider which parts are most liable to become deranged. First of all, the diaphragm valve 17 with its co-acting parts is the most sensitive, and should receive the most careful attention. The accumulation of dirt around the small seat of this valve is the only trouble with many governors reported defective.

This may produce either of two opposite effects. It may cause the pump to stop at too low a pressure from holding the valve open, so that the air constantly leaks through, or, if the dirt is gummy or sticky, it may accumulate in such a way as to gradually decrease the opening

train-pipe. This was the primary cause of other causes, there was of less importance, among them being the use of some device which would prevent, as far as possible, needless wear of the pump and waste of steam.

A governor is a throttle-valve for the pump, operated automatically by the air pressure. There are many different styles in use, but they all operate on the same general principle.

There is a steam-valve in one end which controls the flow of steam to the pump, and is attached to a piston in such a manner as to be operated by the piston in shutting off the steam to stop the pump. The other part of the governor is a kind of a safety-valve which controls the opening from the source of air supply to the piston which operates the steam-valve. This safety-valve is held shut by a spring under adjustable tension, and when the air pressure accumulates to a sufficient degree to open the safety-valve the pressure which escapes passes to the piston cavity, and forces the steam-valve shut stopping the pump. When the air pressure is reduced the safety-valve closes again, and the air which is holding the piston against the steam-valve leads by till the valve opens and allows the pump to start again.

DIAGNOSIS

The first thing to notice about a governor that is not working properly is the

* Copyrighted by Paul Synnestvedt, Chicago. All rights reserved. This article is contained in the January number.

or hit so that the pump will accumulate too much pressure.

Sometimes it has the effect of so reducing the sensitiveness of the governor that a reduction of several pounds may be necessary in letting the pump start.

sary in the air pressure before the pump will be permitted to go to work again. That it is necessary for a governor to work very sensitively is something that is not understood by many air-brakemen, and yet if a governor does not meet this requirement it will give a great deal of trouble in service from sticking of the brakes or loss of excess pressure where the connection is made to the train-pipe.

RELATION OF GOVERNOR TO EXCESS PRESSURE

Many men may want to know what the governor has to do with the excess pressure when the connection is made to the train-pipe and not to the drum. Let us consider a common difficulty in service that will help to make this point clear. Frequently on the road, when the engineer's valve handle is in the running position and the main drum has 20 pounds and the train-pipe 70 pounds pressure, with the pump stopped, the excess pressure will gradually begin to disappear, the red pointer or main drum pressure sometimes falling a little below the black one, till the black one begins to fall with it and the brakes set and drag before the pump can get to work and release them. Of course, it may be said that this trouble is due to leakage, and so it is, but the fact remains that if the governor were in proper shape it would not occur. Some leakage is unavoidable, such as will be lost through bell rings, sanding apparatus or other auxiliary devices attached to the air-brake system. The case described just above is most liable to

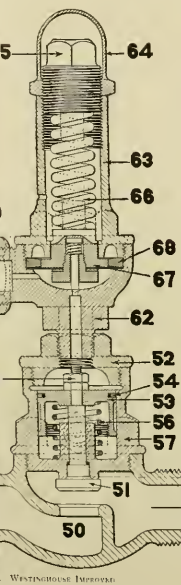

PLATE 6. WESTINGHOUSE IMPROVED.

occur on trains where there is little leak in the train-pipe for a heavy leak in the train-pipe would not permit the pump to stop.

Another part liable to get out of order is the soft metal diaphragm 29, which

sometimes gets loose at the edges, or "back-sets." In the experience of the writer, however, this is not of very frequent occurrence. Altering the length of the valve 17 is a very bad thing to do, as it may get so short as not to seat at all, causing the governor to throttle the pump all the time at about 40 pounds. It is better not to take the valve 17 out at all if it can be avoided, as a leak out of the vent-hole in the upper casing will be very apt to result if it not that holds this valve does not screw back to exactly the same position.

Splitting the stem 16 was done to prevent the buzzing or rattling noise the first governors made, and this practice is still followed, though it was afterward found that the cause of the noise was the lack of a packing ring in the piston 5, which was omitted in the earlier construction. The author thinks this split stem interferes a little with the sensitiveness of the governor if it is spread at the top, and would recommend that all such be straightened and trimmed, so as not to bind in the nut.

REASONS TO STOP IT.

If the governor is entirely inoperative, that is, does not stop the pump at all—the trouble may be found to be due to one of several different causes. Either the small vent hole in the side of the cap 13 may be stopped up, permitting the accumulation of back pressure above the diaphragm, the exhaust stud 3 may be stopped, or the piston 5 may be stuck in some manner, or the brass backing above the diaphragm 2 may be too thick, preventing the valve from raising.

FREEZING OF EXHAUST

Cases are not infrequent where, in very cold weather, the exhaust-pipe, leading down from the stud 3, has become frozen solid, the train-pipe pressure accumulating to over 20 pounds before the engineer discovered that the governor had ceased to act. This is a difficulty very hard to locate, as it thaws out when the engine is brought into the house, and then, of course, the governor works all right again.

LOCATION OF GAUGES

Many gauges are placed in such a position that they cannot be seen at night, and in such cases failure of the governor may slide many wheels before the engineer finds out that his governor has stopped working. No engineer can take time to get up every few minutes and light a match to see how his air pressure stands. He has other things to do.

BINDING

As to the lower part of the governor, set that the rod 7 and piston 5 fit well, and still work freely, and do not have the packing ring 24 too tight a fit, else the governor will not open promptly.

MAISON REGULATOR.

The Mason regulator is shown in Plate 7 (1). As its principle of operation is quite different from those previously described, we treat of it here under a separate head. The general distinction may be stated to be that in this one the operative fluid pressure (that which moves the piston to stop the pump) is *not* brought into play, of course, by pressure from the train-pipe, while in the train-pipe pressure itself acts directly to close the main valve. In examining one of these governors out of order, however, we have to begin with the same general diagnosis as was used in the other cases. That is, note whether the difficulty is too much or too little air pressure, or whether the pump is stopped entirely.

TOO MUCH AIR.

If our case is one in which the governor refuses to stop the pump when the desired

pressure has been reached, we can conclude that something is holding the main valve 21 open. This may be dirt under the seat of this valve, boiler scale perhaps, or what is much more probable, it may be steam pressure under the piston 19. If this be the case, it is very evident that the auxiliary valve 8 is not seating properly, for if it did no steam could then get under the piston 19.

This will generally be found to be the cause of this trouble, for this valve, being smaller and more delicate than the main valve 21, will naturally be more sensitive to dirt and need more frequent attention. To get the valve 8 out, proceed as follows:

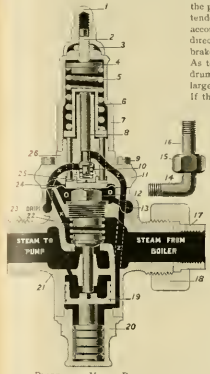

PLATE 7A. MASON REGULATOR.

Shut off both steam and air. Remove the cap 1, and unscrew the adjoining screw 2 until all tension is removed from the spring 3. Take out the screws 4 and remove the bonnet and diaphragm, when, by unscrewing the nut 25 and lifting on the small spring, the auxiliary valve 8 may be reached. This valve should work with considerable freedom, and have a good tight seat.

If the pump stops, and the regulator will not let it go to work again, it is very clear that for some reason or other the main valve 21 has failed to open, and some defect must be holding it, or rather the piston 19 which operates it, from moving. The piston is intended to be moved by steam pressure through an opening controlled by the auxiliary valve 8, and it is possible this valve is stuck shut, or, for some reason, refuses to let the steam pass. Corrosion, from standing long without use, might cause much trouble. Another thing which might interfere with the opening of the piston 19, or its dash-pot, sometimes wax from an expansion, from the heat of the steam will cause such trouble. Of course, the proper remedy for this is to take the piston out and reduce the size of it a very little, preferably with the use of emery cloth, so that it may work with perfect freedom when put back into place.

Main Drum.
The main drum is a very important although simple part of the apparatus, and one which seldom receives the consideration that it merits. It performs two separate and distinct uses. First, it acts as a storage reservoir for air to be used in releasing brakes or charging the train, and second, it is of great use as a drain-cup to

free the air from water, oil or other foreign substances, particularly care should be taken to have it located properly on the engine and to have the pipe connections properly arranged.

LOCATION

In order to get to the best advantage as a drain-cup it should be placed as low as possible, the best place where there is room enough, being under the forward end of the boiler. Sometimes it will fit better under the deck of the cab. Always avoid putting it on the tender, as such a location generally necessitates its being pretty high, and also requires the use of a hose connection in the pipe from the pump leading from the engine to the tender, and this will frequently rot out on account of the water and oil which come directly from the pump, rendering the brake entirely useless in case of a rupture. As to the storage capacity of the main drum, there is only one rule. Make it as large as possible. The larger the better. If there is not room anywhere for one big one, put two little ones on and connect them with a large pipe. Great care should be taken to see that they can be both readily and completely drained, and this should be done as often as possible. Twice a week is not too often by any means.

IMPORTANCE OF DRAINING.

Remember, there are two important reasons for this. First, the water, if allowed to accumulate in the drum, will get into the triple-valves and interfere with their action, freezing them up in cold weather, and, second, the more water there is in the drum, the less room there is for air, and, consequently, the less pressure will there be available to release the brakes or recharge the train.

More than one runaway on a grade has been caused by water in the main drum, there

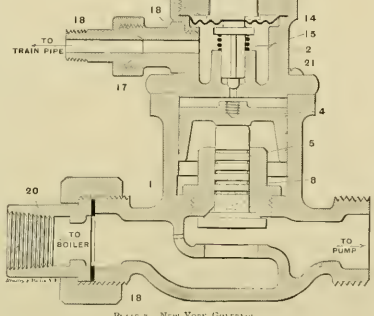

PLATE 7. NEW YORK GOVERNOR.

not being sufficient storage room for air to properly recharge the train after the brakes are released. There have been many cases of brakes sticking where there was no trouble at all with the apparatus itself, but simply too much water in the main drum.

It is hardly necessary to state that when a disease is as easy to cure or prevent as this one, there is very little excuse for its existence. Never stop to go through any brantacking argument as to whether there is water in the drum, but go right to work and let it out. There is now water in every drum, and even if it is only a few drops, it never hurts to let it out. A few

words as to where so much water comes from may not be amiss here. It is not, as many suppose, entirely the result of leakage past the piston-rod from the steam cylinder. In fact, comparatively very little of it is from that source. It is simply an unavoidable consequence of the compression of air.

SOURCE OF THE WATER.

All air contains moisture in suspension, and of course the more cubic feet of air we compress into one cubic foot the more moisture there will be in that one cubic foot, until, finally, it becomes so saturated that it will not absorb any more, and what surplus there may be is precipitated and collects in the bottom of the receptacle.

The pipe connections from the pump and engineer's valve should both be made near the top or highest side of the drum, so that any water that may collect in the bottom may not interfere with the flow of air through them. This is especially true of the pipe leading from the drum to the engineer's valve.

LEAKAGE.

Besides water, about the only other trouble to which the drum is subject is leakage. To test this, the engineer's valve handle should be placed on the lap when a falling of the red pointer on the gauge will be noticed almost immediately in case there is any leak.

* Railroad Coppermithing—VI.

By JOHN FULLER, SR.

CHIMNEY TOPS.

Chimney tops, or tops of smoke funnels, Fig. 73, are made of copper usually, on account of economy, and because of the difficulty in making or forming them of sheet iron. A chimney top, if properly formed, adds much to the beauty of the chimney or smoke funnel. The bell curve should be elliptical, as shown in C, Fig. 73, similar to a corset or trumpet, if it be made to a circular curve, it never looks well. I have heard many criticisms made by quite disinterested persons when new engines have been turned out of the shop or a new one brought from another factory, which has proved conclusively that where it is necessary to make curves or flourishes of a similar nature to that of a chimney top, those that please the practical eye the most are the ones made to or having elliptical curve. Let us suppose we have to make one of these chimney tops for a locomotive chimney, and let the bell or top diameter at A be 26 inches when complete, and have a half-inch iron ring for the crown plate, say on a half inch to turn over to fasten on the main plate, and let the funnel be 14 inches in diameter at B, as shown in Fig. 73. The pattern is the first thing in order, which is obtained in the following manner: First draw the outlines or diagram of the top as it is desired to be when finished and shown in D, Fig. 74, making it 28 inches from C to H, thus extending the curve of the bell an inch each side for the purpose of making the necessary edge for closing in the iron ring and crown. Now divide the curves G K and H N into four equal parts, and through the upper and lower divisions a, and draw the lines O F and O P, letting them meet in O, then on the line O F from R lay off the length of the curve H N towards F, and with O F as radius describe the arc F S T E, making it three times F P in length, join O R, and with O R as radius describe the arc R U, then R F S T E U is the pattern required. From a sheet of copper of about 16 gauge cut out the pattern and round up the edges outside and inside, make the joint and solder it together. Now form it up and make true as in Fig. 75, and take it to the mandrel block, Fig. 76. Now divide the depth of the top into four equal spaces with a racer. Fig. 75, then with a ball-faced mallet, work out on the mandrel a course at the small end, now turn it end for end, and from the inside work out a course at the large end, then hang it on the mandrel and work in a course from the end divisions on the outside towards the center, Fig. 77, which will complete the first course. Now anneal and proceed as before, first inside and then outside, until the proper curve has been given to the sides. Then put it on a former, that is, a cast-iron form made to the shape of the top, and about an inch thick, as in Fig. 78. The top is now needed, scoured clean and carefully dressed close to the former, and then planished smooth on the mandrel; after which the edge is turned up an inch at the large end to receive the iron ring and crown plate, and then handed over to the boiler-makers, who make and finish the funnel ready for the smokebox.

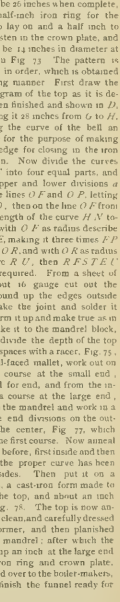

FINISH COPING.

In the manner of dress, locomotive engines have had to keep time, like other things, with surrounding circumstances or the fashion set by some leading road or manufacturer. Sometimes they have been copied, but in Fig. 75 the top is now needed, scoured clean and carefully dressed close to the former, and then planished smooth on the mandrel; after which the edge is turned up an inch at the large end to receive the iron ring and crown plate, and then handed over to the boiler-makers, who make and finish the funnel ready for the smokebox.

Copyrighted by John Fuller, Sr., Secaucus, N.J. All rights reserved. These articles commenced in September, 1893.

and ornamenting the lagging of locomotive engines is considered a first-class job, and only the leading workmen in a shop can safely be entrusted with the work, because if it be artistic and skillfully performed, instead of completing the symmetry of the lagging and adding to its beauty, it is a blemish instead of an adornment.

We shall first consider iron copings; because, while the two pieces of work when finished are very similar and for the exact same purpose, the manufacture of iron coping is performed quite differently to that of brass moldings. In England, for one, a greater part of the engines had three copings or moldings to complete and give finish to the lagging; one next the smokebox, one to connect the lagging of the boiler to that of the firebox, and the other to finish out and complete the lagging at the back of the firebox, but when iron coping was used, as we seldom made more than two, which were at each end of the firebox. These finishings are made of the best sheet iron that can be obtained, and are of about 16 gauge. Let us suppose we are making two of these iron copings to show the methods which have been used in preparing them, and we will take the one at the boiler end of the firebox first. The first thing in order is the pattern. Now, we will suppose the boiler with the lagging on it to measure 4 feet in diameter, and the firebox 4 feet 4 inches wide, with a 5-inch rise, that is, the crown of the firebox abut is set up three inches out of the center as shown in Fig. 79, at *a*. Let the coping at *A*, Fig. 80, have a curve from the firebox toward the boiler, equal to a 3-inch radius, and a lap over the firebox of three inches, so that the hand will grasp the coping well and bring it close, when finally drawn down by the bolt at the end of the strap shown at *C*. Let *a* and *b* represent the center of the coping equal to one-fourth of a 6-inch circle. The diameter of the firebox crown, including lagging, is 4 ft. 4 in. Divide the curve of the coping into two equal parts, as shown at *C*. Then through the points of division *a* and *b* draw the line *F, G*, and let it pass through the center of the boiler at *F*. Now measure the distance from *C* to the outside edge of the strap on the firebox and lay it off on *F, D* toward *d*, also from *a* to the outside edge of the strap on the boiler toward *d*, then *G, d* is the width of the pattern, which is found to be a little less than 11 inches, or to be accurate, $4 \times \frac{11}{16} = 2.7124$, and 3 inches for lap on firebox, 2 inches $\frac{1}{2}$ on boiler strap on boiler, thus $4.7124 + 3 + 2.4 = 10.1124$, now add $\frac{1}{4}$ inch for variation in working and trimming, and the width of the pattern *G, d* is 12 inches. The radius of the pattern from *F* to *G* is 45.4, and the length of the pattern in the middle is one-half of the circumference of the circle forming the crown of the firebox lagging, that is to say, $52 \times \frac{1}{2} = 26 = 81.616$. Cut out the pattern by making it a bright cherry-red lead and let it cool slowly. When cold, take out the rivets, Fig. 81, and open it out on a boiler-maker's slab until that which formed the small end of the cone lies flat on the slab, and that which formed the base stands perpendicular or at right angles with the slab on which it lies, Fig. 82. It will be found that the inner circle of the coping at *B* will now measure 18 inches or thereabouts, according to the degree of accuracy in the working. Draw the outer curved edge *C* will be 52 inches or the diameter of the firebox. Now round up to shape required, smooth and planish. This may be done with a suitable hammer, Fig. 83, from the inside in regular courses on a bottom stake or anvil, as in Fig. 86, or over a tee-stick, Fig. 82. When the planishing and smoothing is completed, lay out the saddle flange

which is to straddle the boiler and work it off to fit and trim it to the width of the strap, and the coping is complete ready for the lagging. If this work is performed skillfully the coping will add to the beauty and symmetry of the lagging and make a nice, clean finish. The coping at the back or feed end of the firebox is made in the same way, of a suitable width, and the addition of legs as shown in Fig. 87, which are riveted on after the arch of the coping has been once fitted to its place.

BRASS MOLDINGS.

Brass moldings made for the finishing of boiler lagging has and gives quite a different appearance to an engine, and make them more attractive if the moldings are well made. We will describe the

and from *B*, toward *F*, lay off the 2 inches for the band; and then the width of the pattern will be $4.7124 + 2 = 6.7124$ or 6 $\frac{1}{2}$ inches. Then with a radius *F, a*, which will equal 38.18 inches, describe the arc *A, C*, making it equal to 80, or one-third of the circumference of a 54-inch circle; then *A, C* will be one-third the pattern required.

The pattern for the middle molding, Fig. 89, is obtained in a similar manner to that of the smokebox, but it will be noted in Fig. 90 the *O, G* is both ends alike. To obtain this pattern, we proceed as before by taking a radius, *a, c* equal 3 inches, and drawing the curve *a, b* and *a* radius *b, d* also 3 inches; and drawing curve *a, d*; then through the points *a, c* and *d, F*, meeting the center of the boiler at *F*. Now, on *F, G*, from *a* and toward *G* lay off the length of the strap *a, s*, together with the width of the strap *a* or

$6 \times 3.1416 + 2 = 5.1416$, and from *n*, toward *F*, lay off the length of the curve *n, d* and the width of the boiler strap, *d*, also

$6 \times 3.1416 + 2 = 5.1416$, then adding these together, we have $5.1416 + 5.1416 = 10.2832$; add $\frac{1}{4}$ inch for variation in working and trimming, and our pattern is 10 $\frac{1}{2}$ inches wide. Now, with a radius, *F, G*, equal to 58 inches, describe the arc *G, H*, and with *F, B* equal to 17.5, describe the arc *B, S*, making the pattern one-fourth the circumference of a 54-inch circle in length, from *G* to *H*. Now add the piece *A*, to form the leg *N* shown in Fig. 86 (which turns the corner as far as and in line with the strap, and is held in position with set screws, as shown), and this half of the pattern is complete, ready for brazing together.

The pattern for molding at the back or feed end of the firebox, Fig. 91, is obtained in a similar manner to the other two which I have been here describing, and I leave this one to the learner, to exercise his perceptive ability, as well as to avoid repetition. We will now proceed to braze these pieces together and then work them up.

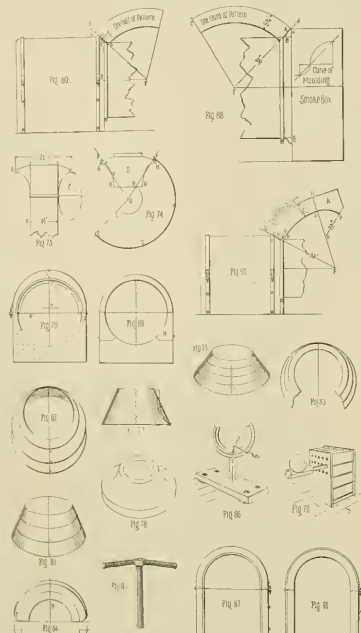

then adding these together, we have $5.1416 + 5.1416 = 10.2832$; add $\frac{1}{4}$ inch for variation in working and trimming, and our pattern is 10 $\frac{1}{2}$ inches wide. Now, with a radius, *F, G*, equal to 58 inches, describe the arc *G, H*, and with *F, B* equal to 17.5, describe the arc *B, S*, making the pattern one-fourth the circumference of a 54-inch circle in length, from *G* to *H*. Now add the piece *A*, to form the leg *N* shown in Fig. 86 (which turns the corner as far as and in line with the strap, and is held in position with set screws, as shown), and this half of the pattern is complete, ready for brazing together.

The pattern for molding at the back or feed end of the firebox, Fig. 91, is obtained in a similar manner to the other two which I have been here describing, and I leave this one to the learner, to exercise his perceptive ability, as well as to avoid repetition. We will now proceed to braze these pieces together and then work them up.

The Interstate Commerce Commission report for the year ending June, 1892, gives the following as the public service of the railroads of the United States:—The total number of passengers carried by the railways during the year was 560,958,211. Passenger mileage during the year was 13,302,896,299, and passenger train mileage 317,558,883. The average journey per passenger was 23.72 miles, and the average number of passengers per train for each mile run was 42. The number of tons of freight reported by the railways as carried during the year was 700,555,471. Ton mileage was 88,241,050,225. Accepting these figures, it appears that the average haul per ton was 124.89 miles. The freight train mileage during the year was 48,902,360, and the average number of tons per train for each mile run was 181.79 tons.

The Consolidated Car-Heating Co., of Albany, has begun suit in the United States Circuit Court against the Chicago & West Michigan Railway for infringement of the Sewall cooler patents. In January number, page 13, second column, second paragraph, sixth line, read "60 feet," instead of "69 feet"; in third column, second paragraph, twelfth line, read "friends of," instead of "friends with."

Several correspondents have asked lately, which of two engines, giving sizes and sometimes stating that one is a compound, the other not, will steam the best. No one can answer such questions from data. We have been swamped with subscriptions and calls for charts, but are on our feet again, now. Commence your orders with January if possible.

anneal by making it a bright cherry-red lead and let it cool slowly. When cold, take out the rivets, Fig. 81, and open it out on a boiler-maker's slab until that which formed the small end of the cone lies flat on the slab, and that which formed the base stands perpendicular or at right angles with the slab on which it lies, Fig. 82. It will be found that the inner circle of the coping at *B* will now measure 18 inches or thereabouts, according to the degree of accuracy in the working. Draw the outer curved edge *C* will be 52 inches or the diameter of the firebox. Now round up to shape required, smooth and planish. This may be done with a suitable hammer, Fig. 83, from the inside in regular courses on a bottom stake or anvil, as in Fig. 86, or over a tee-stick, Fig. 82. When the planishing and smoothing is completed, lay out the saddle flange

manipulate of a set, and suppose we are required to make the two front ones in *O, G* form by way of diversion, and give variety in method. Let it be required to make moldings to fit the boiler, as shown in Fig. 88, and to begin with the one at the smokebox end. Let the boiler with lagging be 4 $\frac{1}{2}$ in. in diameter, as before, and the molding made to cover the rivets and angle-iron, and let it stand out from the boiler 3 in., as shown at *E*. Then to obtain this pattern proceed as follows: Draw the curve at *A* with a radius of 2 inches, and the curve at *B* with a radius of 1 inch, and through the points *a* and *B* draw the line *F, G*, meeting the center of the boiler in *F*. Now lay off from *B* the length of the two curves, *a, B*, on the line *F, G*, toward *d*, which is equal to $2 \times 3.1416 + 1 \times 3.1416 = 4.7124$

Die for Punching Keyway in Tail-Bolts.

The attached sketch shows a good tool for punching holes in draw-bar tail-bolts with steam hammer, as designed and used by John H. Hughes, foreman smith of the Jacksonville Southeastern shops, Jacksonville, Ill.

The die, *D*, is in two parts as shown.

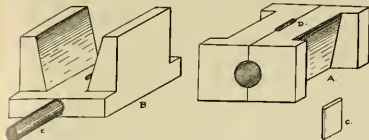

The holder, *B*, is tapered about 20 degrees, which prevents binding, and relieves itself readily, but holds the two pieces of the die firmly. *C* shows the kind of punch used. With this device no swaging or drifting of the hole is necessary, as the punch is kept perfectly straight and smooth. A piece of gas-pipe with a tee on the end in which a wooden handle is placed is attached at *E*, and swung to the hammer to facilitate handling.

The Indorser Was Not Good.

We have already mentioned that Mr. M. N. Forney, the well-known railroad journalist, has extended the field of his labors and undertaken the editing of *Aeronautics*, a journal devoted to ballooning, flying machines and kindred methods of transporting men and things through the aerial

realms of space. The reading and scientific world has not enthused to a remarkable extent over this new venture in journalism, but there have been exceptions. The other day Mr. Forney received a most enthusiastic letter from a gentleman in an inland city commending *Aeronautics*. Mr. Blank's son-in-law, who is an engineer, had seen the paper mentioned in *Locomotive Engineering*, so he advised the old gentleman to subscribe for it. On examining the first number, he wrote to Mr. Forney in the tone mentioned, adding that he intended advising all his neighbors and acquaintances to subscribe for the paper and read it. He considered it the most progressive paper of the day and deserved to be zealously encouraged. Anything that he could say or do for the paper would be a labor of love.

Only a Picture.

BY J. F. HOLLOWAY.

It was a little thing—simply a small picture of an old-style locomotive placed in the middle of a page of a technical journal. When I saw it I was impressed with the idea that there was something about it that seemed familiar, and I looked all over the page on which it was printed, as well as on several adjoining ones, for a description of the engine, some statement as to what it had accomplished, some story of the man who had built it, and of the shops in which it had been made; but there was nothing to be found anywhere, only the picture and a line below it which read as follows: "Old Cuyahoga Engine, Built at Cleveland, Ohio."

As I studied the picture from the foremost peak of the pilot to the step leading up into the cab, and from the truck wheels up to the top of the wood-burning stack, I thought came to me as to how many other eyes than mine had looked upon this little picture of the "Old Cuyahoga Engine," and I wondered if out of the thousands of readers of the paper wherein it was printed, there might not be one or

It was way back in the fifties that the engine was built, in what was then one of the neatest and prettiest towns on the banks of Lake Erie; and Billy and I were young chaps then, working in the "old Cuyahoga." Elisha Sterling was the agent and business manager; and W. B. Castle, afterwards mayor of Cleveland, was the accountant and secretary; and Ethan Rogers was the man who did the designing and made the drawings. Who the bosses in the various shops were, you well know, Billy.

The pictured engine might be the "Reindeer," "Antelope," "Leopard," or any other of the fleet engines designed by Rogers, but no matter which one it was, it was, in its day, a beauty and a runner. It looks light, the engineers of to-day will say. Well, it was light, and fortunately so, for the road on which it had to run was made of light iron rails, in many places spiked to slabs that lay on the top of the ground, with neither ballast under them or ditches beside them, and many a time did the engines come into the roundhouse after heavy rains clay-washed from track to top of smokestack. These new roads were not only unballasted, but they were so uneven that had not the engines been

An Abbreviated Pilot.

Mr. John Medway, superintendent of motive power of the Fitchburg road, has lately put what he calls an "abbreviated" pilot on some of his engines. We illustrate the design herewith.

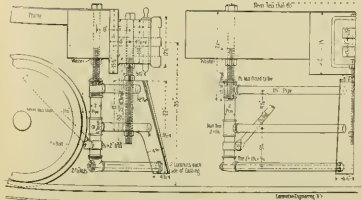
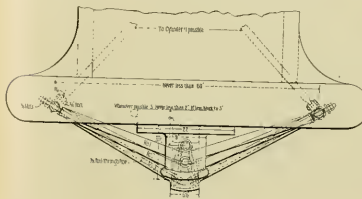

This pilot is very convenient on freight engines, as it requires no shackle-bar to couple to cars, and there is no danger to brake-beams when coupling. It is easily adjusted vertically, is safer than a pilot in case of collision—hardly enough of it to do much damage. The ordinary rear draw-bar for tenders is used, and the total cost for labor and material is only \$7.50. In a country where there is very little stock we see no reason why it won't do well.

Mr. Forney was delighted when he read Mr. Blank's letter, and, inspired by the true editorial spirit, determined to make use of it as an advertisement. Before doing so, however, he decided to find out the business followed by the gentleman who so heartily recommended *Aeronautics*. The letter is not lucky to pass through the typesetter's hands in a hurry, for to his disgust Mr. Forney learned that the man who was so anxious to encourage air navigating literature is an undertaker.

more like myself, to whom it was far more than a simple picture, picked up somewhere to fill a space in a page.

To the vast numbers who saw it, it was simply a picture of an "old Cuyahoga engine, built at Cleveland, O.," and nothing more, no interest would be awakened by it, no comment evoked except perhaps to say how old-fashioned it is, and what a big smokestack it has, and how light it looks. Almost, if not quite in the belief, and certainly in the hope that the sight of the picture brought back "old times," at least to some who had looked upon it, I am inclined to talk with them about the old engine, the shops in which it was built, and of the men who were in them; and if there are those to whom the story will be of little or no interest, this is the place for them to switch off and lay down the paper. I have at times seen on the streets of New York elderly, gray-haired gentlemen who now and then, and especially about Thanksgiving time, gave an extra erectness to their forms, and a quicker, firmer action to their feet as they walked, and talked about old Yale, or old Nassau, or Harvard. Brown owners of a famous institute from which they had graduated long ago, and of which the flying colors and the noisy parades of the day brought back old-time memories, and I honored them for their newly awakened enthusiasm.

That it was the little picture of the old locomotive that did the business for me, it was that which carried me back to the long ago, for I was a graduate from the "old Cuyahoga shops" years ago, and so was Billy Smith; and somehow it seemed to me that Billy must have seen the picture too, and although we have not seen each other for many years, I have a fancy that he will sometime or other see what I have written, and so it is to Billy, more than to any one else, I address myself.

"OLD CUYAHOGA ENGINE, BUILT AT CLEVELAND, OHIO." Republished from December Number

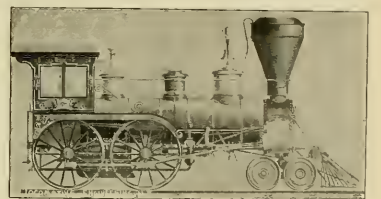

lightly built and of the best wrought iron, they would have wrenched themselves to pieces on the rough roads they had to travel on.

Those were pioneer days for railroads in Ohio, the few and newly-built roads were mostly through the woods and swamps, having a single track, with infrequent sidings, but with plenty of wet-wood stations in the winter and plenty of dry-water stations in the summer, and telegraph lines at no time; but the engines—they were classics, Billy, you would have known at that was a picture of a "Cuyahoga engine" if you had seen it in Timbuctoo, wouldn't you? That light, slender-looking frame was forged by Henry Trautman down in the old smith-shop, and you knew the fellow who blew the bellows, and the strikers that worked on the big fire; and you remember when they "pumped" the jaws on the frames, how all hands were ranged about Henry's fire to do something or other; and you know, too, that so well was the work done that never a frame was lost, or a wheel came apart, after leaving Henry's anvil.

I suppose if any of the engineers of to-day—the fellows who run the big moguls, or the consolidations, or the flyers on the Limited should happen to see the picture, they would wonder among themselves what that curved arm near the air-chamber of the pump was for, that is if they happened to know that piece was for one thing, they're not locomotives, and they would wonder why two valve stems came out of the steam-chest. But you and I know that the curved arm worked the independent cut-off valve that Rogers put in the "Cuyahoga engines," and which helped to make them famous in their day; for the vim with which they would start a heavy train, and the economy with which they used steam while en way, used to astonish the down-East en-

ginners who will in came out West with their heavier built engines.

Many and long were the disputes and discussions had between the men who used to run and swear by the "old Cuyahoga engines," as their superior merits as compared with engines brought from the East—iron shops, and run on the same or adjoining roads, and oddly enough didn't settle it. When differences now exist as to the superiority of one make of locomotives over another, the settlement of the question is left to scientific experts, who are usually professors of mechanical engineering at some college or technical school, who proceed to lash a student to the front of the engine, one on each side of the cow-catcher, furnishing them with levers, pulleys, strings, indicators, stop watches, etc., with instructions to take cards from the two steam cylinders under the varying conditions of load, speed and grade, and who come back from the trip with their hair full of dust and cinders, their faces marked with grime and their hats full of slips of paper covered with curved lines, all widely differing from Hogarth's line of beauty. Over these curious lines good professors would then solemnly ponder, accounting as best they might for their "instincts," and guessing at what they could not explain, after which, with the aid of planimeters, scales and logarithms, they figured out that one engine was better than the other.

Not so were settled the questions as to which locomotive could pull most, steam better, run faster or hang on the longest in the days in which flourished the "old Cuyahoga engines." There were good talkers among the runners of those days, who were not afraid to express in language often more expressive than polite their thoughts in favor of their own engines or in disparagement of others, and many a summer day was made warmer as a group of engineers on the shady side of the roundhouse whittled, bragged and bantered each other. Once after an unusual warm debate over the performance of a newly-arrived Eastern engine, as compared with a pet engine built at the "old Cuyahoga," it was decided to have a trial of the two engines in order to settle the matter.

The consent of the master mechanics having been obtained, a trial was arranged which in every respect differed from the trial trips as now made, and as before described. What they wanted to know was which of the two engines, having the same quantity of wood and water, could go the farther on the same day, and over the same track. So it was arranged that the "Cuyahoga engine" and the Eastern or Vankee engine, as it was called, should both start on an equal footing from Columbus, and run as far as they could towards Cleveland without replenishing. It may well be understood that each engine was put in the best possible trim, and each engineer and fireman in the best of their best. Along the line at every town were gathered the railroad men, from the wood-sawyer to the station agent, to greet and cheer their favorites as they rolled along northward, until, at last, the Eastern engine struck the descending grade several miles outside of Cleveland, and the latter managed to crawl into the depot, bereft of wood, water, and steam. Then the query was, where was the "Cuyahoga engine" of which so much was expected, had it gone dead and cold somewhere back in the woods, and would another engine have to be sent out to drag it in, helpless and disgraced?

For a while it looked blue for the Cleveland boys, but not long, for soon their pet engine was seen bowing down the grade, and as it neared the depot the crowd parted to clear the track, when the engineer motioned to open the switch leading to the Lake Shore track, then, with a defiant blast of victory, it dashed between the long line of spectators, turned its front towards Buffalo, and, climbing the heavy sward grade, the backwoods engine

rolled on and never stopped until it reached Painesville, thirty miles away, and, like Sheridan, won the day. Such a test would not at this time be deemed at all scientific, or perhaps satisfactory, but it settled the matter from Columbus to Cleveland.

The shops from which these engines came, were the first in which locomotives were built in the West, and they had few or none of the appliances with which the present locomotive works are so well supplied. They were situated on the banks of the Cuyahoga river, with no tracks near on which to place the engines after they were completed, and many a man would have shaken his head had he been asked to build engines in such a shop and with such tools, and then have been obliged to take them over a rickety pontoon bridge, but Ethan Rogers had the genius to manage it, and the pluck to dare it.

What a time it used to be, Billy, when it was noised about town that Rogers was going to take a new locomotive over the bridge, and what a job it was to get it up

triumphant. Then, as the cherris rung from a thousand throats die away, the shrill whistle of the engine answers back till all the valley rings with its echoes. But Billy, the man who designed, and the men who built the engine we saw pictured, are all dead and gone, the stalwart smith who forged its frames, the men who molded and cast its cylinders and wheels and bored and turned its various parts, and who fitted up its rods and set its valves, have passed away, and I doubt if even a single engine remains to show what they so well did back in the fifties, with but few tools to help them. And Billy, you and I, who looked upon the little picture and found in it so much of interest, can hardly expect that it will interest any one else who may by chance have looked upon it, for it will have no story for them, there will be no memories to be awakened by it, no recalling of youthful days or of the men you and I looked up to as being such great men, such famous engineers, and such skilled workmen. But, Billy, if the little picture and what I have written about it

into a popular barber shop yesterday morning and bring himself into the chair.

"I've known conductors who could make a night run for six months and never lay off a day," said he, "but I've been on one for a week now, and I'm dead—plumb dead."

"Do you know," asked the barber, as he passed with the lather brush in the air, "what it costs to shave a corpse?"

"Go on with your whitewashing," returned the conductor, "and I'll change the subject. Say, you ought to be the new-fangled engine the company has been trying at Missouri Valley this week. It is one of those things supposed to consume all the smoke, cinders and soot, and have nothing but a little white fog coming out of the stack. It looks like a muley cow. The smokestack tips back, and there are two big six-inch pipes, one on each side, running back to the firebox. These are supposed to carry the smoke and cinders, but to be burnt."

"Well, on the day of the trial they had the superintendent of construction on the cow-catcher, the superintendent of motive power up on top, and the general superintendent in the cab. At first Powers, the engineer, let her cut easy, and she worked all right. The general superintendent is a railroad man, and he says to Powers, 'Let her slip a little.' So Powers throws her



THE MULEY COW'S CINDER, SMOKE AND SOOT BURNER.

out of the yard onto the street and to turn it around there on an improvised turn-table. After this was accomplished, long timbers were laid across the old pontoon bridge and a short distance on the opposite bank, in the meantime steam had been raised in the boiler, and the crowd of spectators driven from off the bridge, and the street cleared for a run which might result in reaching the other side, or in sinking bridge and all to the bottom, just as luck or skill, and the coolness of Rogers at the throttle might decide. At last the decisive moment would come and with a shriek that might indicate defiance or despair, the throttle is opened and the engine makes a dash at the bridge which, feeling its weight, begins to sink deeper and deeper, as the spectators hold their breath and wonder why he don't go faster, but Rogers has done it before, and he will do it again. Nearing the opposite end of the bridge, with the water behind him awash on the pontoons, and the sinking track showing a sharp up-grade before him, he pulls the throttle valve to its widest notch, and a breath-taking engine, leaping as if for life, with a breath-taking exhaust that tells of the struggle it is making, chumps up from off the sinking bridge, landing on the bank safe and

has brought such memories back to you, if it has recalled incidents well-nigh forgotten, faces that had faded from your memory, or if it has brought back to many another gray-haired locomotive engineer the remembrance of the old engines he used to run, and of similar experiences in his past life, and if in such a retrospect he has found a pleasure, then I am not sorry that I happened to see the little picture of the "Old Cuyahoga engine, built at Cleveland, O.," and not sorry to have said what I could in grateful remembrance of my Alma Mater.

"The Muley Cow" Smoke Burner.

There is a queer looking engine switching around the Missouri Valley, Iowa, yards of the Freeman, Elkhorn & Missouri Valley road. She is known among the men as "The Muley Cow." She is one of the many attempts to return the smoke and cinders to the ash pan, through the grates and into the fire again.

A recent issue of the *St. Louis City Journal* has rather an amusing account of her performance on the road which we reproduce here.

"A well-known freight conductor came

wide open and let her slip a couple of revolutions, and the old girl coughed out about eight bushels of cinders, almost burning the overcoat off the superintendent of motive power. Of course, anybody can see that when she is thrown wide open it makes a double draft fog coming out of the stack. It looks like a muley cow, and she works all right."

"Wise guys," these railroad officials, they don't drive the men in the shops and on the sections, and spend from \$1,000 to \$8,000 to fit up an old engine to burn its own smoke. We've got three hands on each section now—the section boss, his wife and dog, and the dog is pretty near starved to death."

"If they want to stop the smoke nuisance, why don't they burn coal? They go down here on the Wabash and buy this mud at \$3 a ton, and try to burn that. No wonder they have smoke and cinders."

"By this time the railroad man had been shaved, and as the door closed behind him he could still be heard chucking over the operations of the muley cow smoke consumer."

We understood that the conductor who thus relieved himself was surprised by a call to "come up higher" — on the green carpet in the office—but our informant has not stated whether he was discharged or promoted.

Don't forget those prize designs. \$350 cash for an idea.

Practical Letters from Practical Men.

Write on one side of the paper, state your point plainly and briefly, and then quit. We supply the generalities. No letters noticed unless name and address accompany.

Locating Trouble in a Defective Brake.

An engineer reported that his tender-brake would not release and wanted the triple-valve examined. A plain triple-valve of the pattern of the brake mechanism would be liable to derangement. The brake-valve was of the latest Westinghouse design, plate D 3, and I had an idea that it was faulty instead of the triple-valve. I pumped up a little air, placed the brake-valve handle at service stop, and the regular preliminary exhaust occurred, but it was continuous, and the valve-reservoir would not empty its air. Neither would the brake apply. Pump still working. I turned the handle to emergency stop and the engine and tender brakes applied, but the exhaust was from both the train-pipe and main reservoir, the pump working with increased speed to supply the waste air. Moved the handle back to full release and there was no blow from the small warning port.

After pressure began to accumulate, the brakes released, the tender-brake last on account of short cylinder piston travel.

The engine was fired up to go out, and while I was experimenting, the engineer showed up. I explained to him that it was the defective brake-valve that caused his brake to stick, and advised him to not use his brake that trip except in case of an emergency. He said he knew there was something wrong with his brake-valve, it had been working bad for about two weeks.

After the engine had gone I studied this problem, but came to no conclusion until I took down my book containing cross-section engravings of the valve, and then I located the trouble, and when the engine returned I found that I was correct. The lower gasket, *B*, in brake-valve was completely worn out and in shreds, except at its outer rim under the seat casting, thus giving communication between chamber *D*, main reservoir and train-pipe. The small warning-port was closed when I started.

There are many expert air-brake men who have a supreme contempt for illustrations. There is no part of the brake apparatus which they have not dissected, and they understand it thoroughly. They won't look in a book. Books are for amateurs—not for masters. I know something about the air-brake, and when I find the symptoms of the disease, the easiest way to locate the trouble is to look in the book, and the whole thing is right there without the confusion of separating the parts. And to quote Synnott's: "Use your reason first, your hands afterward, and never take anything to pieces without having first your way for doing it."

Terre Haute, Ind.

Another Safety Angle-Cock—Not Patented.

Editors

"The air-brakes failed to work," is getting to be a too common excuse in railroad accidents. The air-brakes will work, unless handicapped by the carelessness or carelessness of some man. And great blame is laid to the angle-cock getting or being turned off so the engineer cannot handle the train. Now if the trouble is in the angle-cock, propose to stop it. Take the plug *A*, Figs. 1 and 2, and drill from the bottom up, two 1/4-inch holes, *D* and *C*, as shown in Figs. 1 and 2, and *D* and *E*, Figs. 1 and 2. The holes *D* and *E* must be drilled so as to open a commu-

nication with the train-pipe (both ways), when the plug is turned in the position shown in Fig. 2. This will allow air to escape through these holes down and out through the small stop-cock *F* (screwed into bottom of cap *G*) and set the brakes. The stop-cock *F* is supposed to be open on all the coaches except the last one.

Now, in this condition of things, we would lose all the air; but this must not be. We want a reserve, and to do this I put on the bottom of the plug *A* the two flat springs, *H*, *H*, Fig. 3. These springs keep a rubber valve over the holes *B* and *C*, which prevents air from escaping from the train-pipe, unless the pressure in train-pipe is in excess of what the springs will

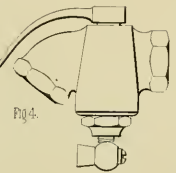
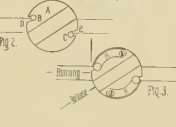
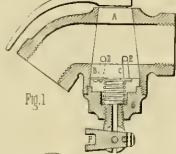

carry. The tension of the springs is optional—say 20 pounds for illustration. Therefore, by the time the service pressure has fallen to 20 pounds (at which pressure the springs will close), the brakes are hard and fast.

Now, it must be remembered that the hole through the engine is allowing air to escape and the pump is running to supply this leakage, but the other little valve is getting in its work on the brakes. The hole through the cock *F* should be equal to the two other holes. I have set 1/4 hole, but the size is optional. Now let us look after the angle-cock on rear coach. We shut it off and close the small stop-cock when the train pressure will force the valve next the pipe from its seat until the cavity below the plug fills with train pressure, when the valve will close of itself. This bottom pressure also forces the outside valve (on the one next the hose) tight against its seat, so the air cannot go down one hole and out the other and escape to the atmosphere. The angle-cock on tender calls for only one valve on the plug, and

that valve to be next the air-hose. As it is not advisable to cast a handle on the plug of small cock, there is a square hole cast in the plug, the train crew having keys that will fit the hole. In cutting off an engine, shut the small cock before shutting off the angle-cock, or if train is on a grade, leave the small cock open, and the brakes will set as soon as the angle-cock is shut off. Fig. 4 shows the angle-cock ready for use.

W. D. SANNO

Pain Handle Shop, Indianapolis

Charging Train with Any Form of Brake-Valve.

Editors

W. R. Scott, in his experience with the engineer's brake-valve of 1892, D 3, makes claims in favor of the old D 4 valve. I would say to release brakes under the conditions referred to, that it does not depend on the kind of brake-valve engine may have.

But it is necessary for engine-man and trainmen to work together to get good results.

To couple cars with high air-pressure to cars with no air, the first thing to do is to stretch the train to see if automatic coupler is fast, and then to place engine brake-valve on lap position. The trainman should couple hose and open angle-cock next to engine first, to test hose and coupling, and then to open into empty train, and open both angle-cocks slow, to get a service application of the brakes on high-pressure cars. The engine-man should note when train line pointer becomes good stationary, to show that train line is tight and angle-cock on rear end is closed.

You can then throw main reservoir pressure into train-pipe, and release one or twenty-five brakes if necessary. If you have a leaky train and have trouble getting air from the pump referred to, it is good practice to have every pound in sight put into train-pipe and auxiliary reservoirs—that is where you want it to stop first. Don't take chances with low air-pressure.

A very important advantage was brought up the new D 3 valve I have not seen brought up yet. That is, when running trains down heavy mountain grades, the engine-man can recharge in full release position and put main reservoir pressure, which is better than 70 pounds for such service. The warning port will not waste air while doing so.

J. R. ALEXANDER,
Pittsburgh, Pa.

A Kick from the Smithy—Better Shops Wanted.

Editors

Why is it that mechanical papers will furnish us with cuts of interior of machine shop, roundhouse, wood shop, and leave out blacksmith shop? Have they not got subscribers enough among blacksmiths, or would it be a detriment to the paper to furnish cuts of the average blacksmith shop?

Are the majority of master mechanics and superintendents of railroad shops and manufacturers ashamed of their own designs? If they are not, they ought to be. Railroad shops are a little further advanced than the rest of our manufacturing factories. But there is little sympathy in either place for the blacksmith—anything is good enough for him.

Here is a picture of the average blacksmith shop. A building with a flat roof of sheet iron or gravel, from 10 to 15 feet above the floor, with a single wall of masonry, common matched boards, 2 inches apart from floor to bottom of window, steam pipes, if any, next to the sheet-iron or gravel roof, for ventilation, skylights that cannot be raised; located between machine shop, wood shop and foundry. A hammer, placed from exhaust of steam boiler, for a clothes closet, a spike in the door. In the month of July the ther-

ometer will register from 100 to 115 in this building, and in January 20. For drinking water, the hydrant, and then we are told to be temperate men and take more interest in literature on our profession.

Now it would not do for a blacksmith to design or dictate the designing of a blacksmith shop, he has not studied chemistry, electricity or steam.

I know of a shop designed by a mechanical engineer who never worked in a blacksmith shop any more than a few hours now and then for instruction—but of course there are not any points in blacksmithing that he don't know. The designing of another one he would have the space between floor and bottom of window 6 feet 6 inches. Physicians tell us to keep feet warm and head cool, but the way this shop is designed the designer must believe in keeping head warm and feet cool. I believe he has brain enough to keep his head warm without some heating apparatus.

Madison, Wis.

W. G. LITTLE

If Education is Needed, What Kind?

Editors

I wish to make a few remarks suggested by Mr. W. R. Scott's article in November number. I will not discuss the mechanical aspect of the new valve, as it seems evident to me that a man can do anything with the new valve that he can with the old, and just as easily.

If I am not mistaken, Mr. Scott is traveling engineer on A., T. & S. F. R., and has been for some two or three years. The A., T. & S. F. was one of the first roads in the country to put air on its freight equipment, and for nine years passenger has handled nearly every train with air-brakes. With the exception of one or two short intervals, if I can believe men who claim to have worked there, the company has employed one or more air-brake instructors or traveling engineers. The Westinghouse Brake Co. has also, probably had some representatives on the road at times, and has probably endeavored to place their instruction book in the hands of every engineer and fireman on this road as on others.

Now, I would like to ask Mr. Scott if there are not in his jurisdiction a large number of right men, and even some passenger engineers, who never, on any train, attempt to use the excess pressure if he does not consider the process that has been going on on A., T. & S. F. for the past nine years a "campaign of education," and if not, what kind of one he would suggest. Does he not believe that a man who has been subjected to as long an educational process as the T. & S. men have, and still fails to use the brake-valve to the best advantage, is so built mentally as to be impervious to education?

Savre, Pa. J. CHARLES JENKINS

About Leaky Train Pipes—Why Engineers' Valves Cannot Always be Carried in Running Position.

Editors

In your December edition a Mr. J. D. Murphy tells us he thinks the only thing wrong in most cases with the equalizing charge valve is a lack of confidence on the part of the engine-man, and says "I find that when valve is in proper condition, 20 pounds excess pressure can be maintained, no matter how leaky your train-pipe. For example, have met with train, that, owing to leaks in train-pipe, pump would not supply more than 40 pounds train-pipe pressure. In this train, and equalizing discharge-valve in proper condition, has maintained 60 pounds reservoir pressure."

It is just possible that the train upon which Mr. Murphy made this interesting discovery was standing while this collection of data was going on, if so, very good, but if not, as Mr. Murphy means to tell the students' class of engineers in this

entry that a train—no matter how many cars—equipped with Westinghouse automatic air-brakes, with such prominent leaks in train-pipe that an ordinary first-class pump failed to accumulate over 40 pounds of pressure, will not "drag" (I use the word "drag" advisedly "stop" I should say under the circumstances) while handle is in running position, trying to gain the 20 pounds excess, *grating the valve in its perfect condition?* If he does, very few practical men will agree with him, I'm afraid.

If a "lack of confidence" was all that prevented the successful operation of this feature of the valve, it appears to me that railroad companies through their traveling engineers would have a standing "rule," or "bulletin," suspending engineers found carrying their valve handle in any other than running position while running, instead of equipping their new engines with Westinghouse's new valve, which is designed principally to make this feature a success.

As I noticed in the November edition, Mr. W. R. Scott's "campaign of education" no doubt would be a benefit all around, but in this particular feature mentioned above I fail to see where an intelligent engineer could do any more than an ignorant one while running—unless he stopped and walked up a few leeks.

G. A. ELLIS.

San Antonio, Tex.

Case of Imagination.

Some time ago one of our engineers, whom we will call Brown, was fitted with an engine on passenger service that was about used up for that work. She was put in freight service and another one of the same build just out of the shop given him in her place. She did not steam quite good enough to suit him, and he asked the stock man what dies that would raise her piston-rod pipe 3/4 in. This man did not know of the change of engines, and raised the pipe on the old engine. Brown made a trip, and on his return reported her as steaming fine, and raising the pipe just done the business, although it had not been touched. Fact?

W. J. STUART.

North Platte, Neb.

Pipkin's Brake Questions.

Editors.

As to your friend Pipkin's questions, he, in the first instance, probably had a plain D 3 brake-valve in which the feed valve No. 21 allows the main reservoir pressure to flow back into train-pipe. In that case grand valve. In the second one, description is not complete enough to locate, should think pump would lag or crawl from 30 to 70 pounds, and that is the reason for some other abstraction in governor or small-pipe leading from it to train-pipe. While the quick action might possibly be brought in to action on the rear cars spoken of by leaving the train-pipe open, it would not be reliable, and would probably freeze to work if only a reduction was made sufficient to stop the quick action on the live cars in front.

Roanoke, Va. — GEORGE HOLMES.

Electric Wires vs. Line Shafting.

Editors.

Many of our readers will remember the several articles I have written which called attention to some foibles, or worse, statements made by the too ardent advocates of this method of transmission, but it is good points are not to be overlooked, and it seems to have a special adaptation to the supplanting of line shafts in a great deal of shop work. It is safe to say that not one man in a hundred realizes the amount of power consumed in running the long lines of shafting which are so common as to attract no attention, and probably use one in this same number would believe

that at many times fully fifty per cent. of the power of the engine is used before it begins to do useful work at the machines, and the percentage often runs up above this. Suppose the shop is designed to supply 600-horse-power, and the shafting is calculated accordingly, the long lines of shafting, or numerous intermediate shafts with the attendant losses by belting, will consume a great deal of power whether the machine is doing work or not, in other words, the dead load on the engine is constant, and in a large shop is often fifty per cent. or more of the total power developed by the engine. When, as is often happens, particularly in railroad shops, we run a portion of the plant only by night, you perhaps, we must either run the entire shafting as well as all counter shafting which is connected to it, unless the main belts are thrown off beforehand, or if the portion wanted happens to be next to the engine we can unscrupulously shift coupling and proceed.

But when this happens to a portion of the shop farthest from the engine, there is no other way than to run the whole shafting, and it is very probable that the shafting consumes ten times the power that the useful work does, making it very expensive to run a portion of the shop, although this expense rarely ever seems to be taken into account. Now, it becomes necessary to enlarge the shop, and additions are made which necessitate 100 more horse-power at the further end of the shop, and nothing can be done except change the whole shafting, as the former sizes are too small to transmit the additional 100 horse-power, or else the shafting was larger than necessary in the first place, and has been consuming more power than necessary all the time.

So we must either enlarge our line shafting or else install an engine at the other end for the additional power, making two separate engine-rooms with the attendant loss of long steam piping and condensation, or the establishment of a new fire-room. Or, perhaps the engine may be moved to a more central location in the line shafting, and the power divided up in this way.

The running of long lines of shafting is a nice job and requires experience and care, and the alignment is affected by the belting and other causes, and should be attended to by a competent man in order to reduce the waste as much as possible. Even this is not done in too many shops.

Within the past year, or perhaps a little longer, there have been several plants installed in which the regulation line shafts, which for so long have been a fixture in every shop, were quietly dropped, and in their stead installed wires are run along the ceiling on porcelain supports, and small electric motors are placed with their motor itself or to drive a small countershaft from which power is taken for a group of machinery. The power can be led off at any point desired, and any portion of the entire shop can run quite independent of any other portion, and best of all, consuming only the actual power required at that section, plus the engine friction and the loss in the dynamo and motor, both of which need not exceed 15 per cent. to 20 per cent. of power being used.

By being generous in the amount of copper used in the line wires you can add considerable power with very little extra wire, the larger section of copper making the loss in transmission less, while the allowance in extra-sized shafting is consuming more power all the time. Or the additions can readily be made by running new lines beside the old for the additional power, and the old method of line shafting is much less in the case of shafting, with very little in the operating expenses. It has been demonstrated in several instances that even with ordinary running the electrical transmission is slightly cheaper than the old method of line shafting, despite the fact that the application of numerous

small motors must be less economical than a large motor of the same capacity, but the difference is more than made by the saving in shafting friction. Besides this, we have the independence of different departments, and there is no delaying the whole shop by any accident to a belt in one department.

Experiments have shown that with a plant of 1,000-horse-power capacity the efficiency at full load with electric motors in the subdivided power form was 79.4 per cent., and that of shafting in first-class condition about the same. With one half load the electrical efficiency has only dropped to 74.7 per cent., while the shafting has dropped to 58.8 per cent., and at quarter load the electricity has 57 per cent. against 47.6 per cent. of the shafting, and as the actual load in shops rarely exceeds one-half the total capacity that must be provided for, the comparative working efficiency can be readily seen.

Taking the case of a railroad shop, where it is often necessary to run the wheel lathe at night, it would be infinitely cheaper to run wires to the wheel lathe, put a motor direct on the lathe for use at night only, and run from the regular lighting dynamo, or else have one installed for power purposes.

While it would generally be cheaper to run from this motor all the time, it would be advantageous, if only used at times when the rest of the shop need not run, and there are other machines or groups of machines which could be similarly provided to advantage. The electric dynamo and motor have passed the experimental stage, and their capacities are now as well known as any other machine we have, and their liability to failure is not greater than any other machines.

They are much better than small steam engines, for it is far better to carry wires to different points than to carry steam-pipes the same distance, and there is no exhaust steam to get rid of after it has been used, and the small space for the power developed as well as the little attention required makes it better in many ways.

As hardly any shop of consequence thinks of operating their traveling cranes by any other power than electricity (or more properly any other means of transmission) so it will probably be in a few years that the power in shops will be subdivided by this same means, making a much more flexible arrangement than the shafting of the present. For portable drilling or similar work, it seems compares very favorably with compressed air, and is better than steam on account of the freedom from exhaust, and its ease of connection where wires are run for other power purposes makes it very useful. In this way much work that is done by hand can be power driven, and much hard work and unnecessary expense saved.

It would be useless to claim that this arrangement would be perfect, but it seems to possess more points of merit than any other to date, and with the precedents that have been set there should not be very much hesitation in adopting it wherever it seems advisable, as a reputable firm will undertake the contract and guarantee efficiencies, which is more than many millwrights are ready to do for shafting.

FRID. H. COLVIN.

Philadelphia, Pa.

Does the Machine Pay?

Editors.

Your January number contains an article on rolling files by power, which is not all so well explained and might have been overlooked by the article, it seems advisable, as a result of this process, or how long it requires to roll a set. He also fails to say that it requires two men to run the machine. I have seen this same machine tried in several places, and it took from two and a half to three hours to place it in position,

and from one to two hours to take it down, and five to six hours to roll a set, two men occupied all the time where one man can roll the largest set by hand in eight to ten hours; thus, in my opinion, there is nothing made by this process. I would like to hear more on this subject from different parties.

Des Moines, Iowa.

J. K. EVANS.

[So far as we can see the machine requires only two bolts to set it. Any boiler-maker who was more than an hour getting ready to use it, after front was off and steam pipes removed, would be a bigger leader than a navy yard apprentice.]

Machine for Tapping Holes in Smoke-boxes.

Editors.

It is often desired to tap holes in the smoke-box, when these are in the flue sheet it often becomes a hard matter to get them tapped straight on account of the double plate so commonly used. The job is not only hard to be out of true, but it is slow work and disagreeable.

Perhaps a little experience in this line may be of use to other men in the same line. I make flexible shafting do all such work that I can, and this is easily done.

I have some taps here that have a shank about 2 1/4 inches long, and they are all one size of square. I had a socket put on one

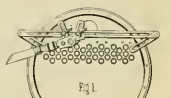

Fig. 1.



Fig. 2.

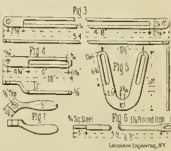

Fig. 3.

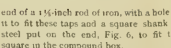

Fig. 4.

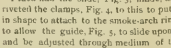

Fig. 5.

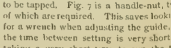

Fig. 6.

end of a 3/4-inch rod of iron, with a hole in it to fit these taps and a square shank of steel put on the end, Fig. 6, to fit the square in the compound box.

I then had the slide, Fig. 3, made, and riveted the clamps, Fig. 4, to this to put it in shape to attach to the smoke-arch, to allow the guide, Fig. 5, to slide upon it and be adjusted through medium of the slots to a perfect alignment with the hole to be tapped. Fig. 7 is a handle-nut, the use of which is required. This saves looking for a wrench when adjusting the guide, as the time between setting is very short, it taking a very short time to run the tap through a hole.

Dubuque, Iowa.

C. E. FERNES.

Danger in Applying Brakes From Rear of Train While Backing Out of Stations.

Editors:

There has been a number of criticisms lately in some of the railroad journals on who should handle the brakes on a passenger train, in making service stops, while backing up. In one particular there is, I believe, a gross account of the danger and habit of placing control of the brakes in the hands of the man at rear of train, when backing from yard to depot. That many accidents are due to this practice is certain, and that these lessons are often lost sight of will be apparent from the following:

On a yard being established at a well-known city, the capital of one of our most progressive States, I was sent to look up the air-brake part. I was warned before arriving that everybody was old hands from roads that might be said to have established systems, and that the methods employed by them were approved practically by all the air-brake experts who had anything to do with them. The brakes on the train I came in on did not seem to bear this out, but on coming into the depot my attention was attracted by a man who made up the passenger trains for the road. He was a hustler, and one of his duties was to act as a yard conductor, taking the train some two miles to and from the depot to the city. While riding up to the yard he told some very entertaining stories of how he backed trains into one of the largest depots in the country for years, and never had but one accident, when the brakes, after working well till they reached the depot, refused to take hold and he came near being killed in the smash-up, and at the investigation he could learn nothing of the matter might be, but was told that he did right in opening the backing whistle to set the brakes. He had one of this kind of hose with him, with a pipe and step-cock, but had not yet procured a whistle, but he would show me how he could handle a train just as well as the engineer when we came down again; but he wanted to know which made the brakes fail at the time of his accident. Telling him I would think it over, I got on the engine of the next train backing down, the hostler who took the engine looked very much disgusted with his job, but on getting the signal began backing with the brake-valve handle in release position. About every ten or fifteen rods the man at rear end would see a wagon near a crossing or have some reason for slackening up the train by letting air out of train-pipe with his whistle-hose, when the hostler would yell, "cussit," and the train-pipe conductor invariably answered. By the time the depot was in sight there was a swearing match between the front and rear representatives of the train, and only 30 pounds of air in the main reservoir. I found this was a regular thing, and on returning to the yard assembled the hostler, the air-inspector, who wanted the train tried as soon as they were coupled up, the yard conductor, and as many more as could be obtained, and having with me a brake and triple-valve cut in sections, I put a gauge on a car brake cylinder and one on the auxiliary reservoir, while the inspector and conductor timed while I was trying to get 70 pounds. I then went to the man with his backing hose and applied the brakes, till he was back got an idea of the action of them; then, having a man on the engine to work the brakes, I put the sectional valves in the position assuming that the valves in operation, pointing out the tread groove, graduating pump, proportion of air pressure to brake cylinder at 5, 10, 15, 20, 30, 40, 50, 60, 70, 80, 90, 100, pounds and emergency applications, and in the time it required to recharge after each application, and showed by the gauge how much air was lost by the giving time to recharge; then, with the entire party on the engine, the hos-

ter used the brakes and attention was called to the fact that the red hand re-quiring main reservoir pressure gauged while brakes were on, that this pressure was the same to the train-pipe as the boiler was to the steam chests.

Getting this plain, a man was sent to the rear of train to work the backing-hose as a service stop brake. After watching the air gauge a while, the yard conductor, who is more intelligent than the general run, broke out with: "Then, whenever I see the air from the big drum under that handle is on lap." Being told this was a fact, he said "Well, I'll never use it again only to whistle with or for an emergency." After the others had left, he came to me and said: "Then that was what was troubling you about. You bet I don't ever tell any one else what I done there." He could not be blamed for what he had not been inquired.

I made some lessons, and learn that it is not an uncommon occurrence to have the brakes fail to set while backing in this manner, and in a great many cases the reason for such failures are kept in the background. If the men who are so enthusiastic in trying to beat the engineer in handling his brakes would only investigate before they practice, they would soon find that the engineer's brake-valve is open to main reservoir in either release or running position, and when he applies the brake, it cuts out the main reservoir from the brake. In the case the brake is applied elsewhere, the main reservoir is robbed of its pressure, as well as the train-pipe, and a very few applications in a limited time would so reduce the braking power that it would be practically useless. Geo. Holmes.

Ronoke, Va.

A Hard Blow to Locate.

Editors:

Mr. C. E. Conger in November issue gave a batch of knicks that for the time "had the boys in the corner," but was easy enough when found out. It brings to mind a little "drama" that occurred on one of our southern roads a few years since, and the extent to which an interested party may be befuddled can be imagined from the condensed history of the case in question.

Sam B— was a quick tempered, positive, nervous kind of an old blunderbuss, who had been in the service a long while, and withal was a successful runner, but had, through force of habit, formed an unamiable practice and perseverance to an apparently fixed line of grievances, fell heir to the sobriquet of "Old Set-up Wedges."

A new train was to go on a little seventy-mile run, and a 15-in. engine, then in shop for general overhauling, was given to Sam for the "Jerkerwater" when she came out.

For a few trips Old Sam's rubicund, and not overly humorous, face was radiant with smiles at a young bride's car, but he came in one A. M. minus the smiles and reported:

"Engine Blow sometimes was than others, set up Wedges. No stock but Also look round." As he usually came down to wait to go to the A. M. the foreman was obliged to put the case a little more definitely from Sam by word of mouth, and on inquiry, he said: "She blows like hell'n' blazes sometimes, and then again she's all right." He thought a packing-ring had busted and fell down, and then again would get back in its place."

For a few days he was as radiant and O. K. Lids lifted and valves all right (old S. U. W. staying to see it well done), and when told by foreman "the blow was in cab on his side," the boys began to smile; old Sam got red in the face and went home. Next trip report amounted to "Oh rats," after which some one added "Oh rats."

The gang being a little larger that day, had read it, and were on the qui vive for

old Sam, who at the usual time put in and began by saying

"Boys, for twenty-three year I've been ridin' on the right hand side and '— Here Ed. Do— brought the book and asked why he didn't sign his name. He did so and read the report over: ' * * * and set up wedges. Oh, rats!'"

"Oh—! Now, gentlemen, I can just lick the dewd that writ 'em 'Rats,' or any other man who says that engine don't blow."

The M. M., passing through just then, he helped by and from the gestures he made him it was inferred his explanation was a forcible one.

The front was opened, pipes examined, and nozzles scraped out. When Sam went out on next trip road foreman went with him, 30 miles to meeting point; the blow falling to show up he turned back and Sam went on his way rejoicing, but next day when he got to the engine, it was open, old Sam seemed dazed, and with a bewildered look, scussed everything in sight in a plaintive tone that suggested he had sustained a sad loss or a heavy blow, and under the numerous casualties, remedies, and guys that were made him, he was influenced to believe his hearing was failing, and though he had the idea, on his way home consulted a physician, and confidentially told his fireman on next trip, "that he had left his tobacco behind, and didn't intend to drink any more coffee. That since the first day he took her,—when the boss ordered him to take his horseholes off the head-light brackets—he'd a hankering that something would happen, and d— and it hadn't, for at least part of it, and he hoped to live long enough to see what would the harvest be."

Well, next morning, old "S. U. W." came in about two hours late, and rode in the roundhouse with hostler, many anxious faces were watching old Sam, but he heeded them not, the sunny smile had flown, and a far-away look rested on his countenance. At last seeming to suddenly remember where he was, he washed up, put his towel in the grip, overalls under his arm, left his hat and made for the M. M. bareheaded, whose complacent smile intensified the wild look in Sam's eyes, to the extent that after saying, "That blow," he stopped short and was the picture of inquiry, suspicion and disconcert. As he asked, "What was I doing so long, that I asked, 'What was what of it?' continued, "I was—I want to get off a few days; something's wrong with me, or that old pitter of a '212' I ain't fit to go out (holding up a bandaged finger—poor excuse better than none) let some of these smart valve-setters try her."

Well, it "valve-setter" did try her, and found the trouble was as first supposed, but to let the boys guess at this awhile, but as that takes so long I'll give it away. The new runner found her all right until he tried to make a run for a bill, when the peculiar blow commenced and increased, the engine acting lame and making a strange noise, but just as soon as steam was cut off, it stopped, and did not commence again when throttle was opened out on the level. When he got in the valve-setter had the nozzle stand taken off and the passages "fished." They found a washer for an inch bolt in one of them, this was 2 1/2 inches outside, with an inch hole in it, and had been left in the passages by some one in the shop. When one of the pumps would pump pressure enough very hard it would come up and choke one of the nozzles.

Waycross, Ga. A. A. Brown.

Will This Tell How Many Brakes are Coupled Up?

Editors:

Having noticed several articles in your paper on trips and angle-cocks, perhaps this idea of mace supporting cocks and tanks will be permissible. Now, to remedy this troublesome cock, means probably, the changing of all angle-cocks in use. Now, why not do it another

Every engineer knows that the longer his train, the longer his equalizing-valve blows. It is this very principle, and very valuable I propose using.

Show a 2-inch hole in brake-valve as shown in sketch, then place nipple and 4-inch cock so that they will communicate with the brake-valve reservoir; also in the exhaust pipe of the brake-valve place a three-way cock.

The side outlet of three-way cock connects with a small drum, and on drum there is a gauge, properly connected and marked off, that is, marked cars instead of pounds.

If now, if the engineer wishes to ascertain how his train is all out in, puts his brake-valve on lap, closes three-way cock B and

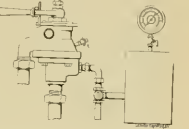

opens and closes cock A, about as quick as convenient. This will cause a small blow of the equalizing valve; yet enough to set the brakes, of course.

The pressure that escapes from the train-pipe into the small drum records on gauge the number of cars out on the train.

After ascertaining this fact, the engineer puts valve on running position, and moves three-way cock to its original position.

This device is very simple, and from tests I have made I have found out that it will work all right and be quite reliable. I would be pleased to know what your correspondents think of this simple idea.

Chicago, Ill. Geo. H. Cox.

Early Blowers.

Editors:

Forty-eight years ago the P. & Reading R. R. had a class of Baldwin engines with drop hoods, rock shaft under the furnace door, with sockets for starting-bars which acted as levers. When an engine failed for steam through leaky flues, bad wood, etc., the engineer threw his engine out of gear, put a starting-bar in a socket in the rock shaft, and moved the valve until it uncovered the exhaust-port a little, gave the engine steam, and a blower was the result. Was this the original blower? W. W. Adams, Jr., John Barstow.

[This was the usual way of "blowing up" before the advent of the independent blower.]

Had a "Choker" on It.

Editors:

One of our engines went out of the shop recently with general repairs, and after trial trip was sent to one of the branches. After a few days a request came for another pump, as the one on her would not supply the train. Another pump was sent, but with no better results. Then one of the pumps would pump pressure enough leaving out the element of time, but when "wind" was wanted in any quantity, there was a dead failure to get there. So fast and no faster. Having struck its gat, oil, copper hammer, all the persunations and blamingshames of man would make that pump pump another stroke faster. The train was one easily supplied by a 6-inch pump, so the fault did not lie there. After much trouble the difficulty was located.

The blower-pipe in front end had been put on the right side, and the closed end of the pipe would not let the steam get away from the pump fast enough. Doane, Ia. F. W. Peterson.

Around the World, to China, and Home.

Notes Taken by E. J. Lewis, an American Engineer Who Went to China with the First Air-Brakes.

Thinking that the readers of *LOCOMOTIVE ENGINEERING* would be interested in what I saw and felt and done in the service of the Imperial Railways of China, I send you herewith a photograph of one of the engines there, the first to get an air-brake, and some notes of my trip around the world.

This picture was taken near the wall of the city leading out of Tientsin, China, just south of the station. The engineer (called a driver there) is Mr. J. Buchanan. The two firemen on front end are natives, we call them *Mossy* and *Muldson*. The three standing at the side on the ground are Mr. W. S. Hamilton, next to the engine, the one in the middle myself, and the other Mr. Thomas Preston, an Englishman, track inspector. The house in front of the road, surrounded by a wall, is where we lived while in China, which was from August 17, 1892, till next March, 1893.

In the spring of '92 Mr. R. M. Brown was sent to America as an agent of the Imperial Chinese Railways to contract and arrange for a sufficient number of the W. A. B. apparatus for trial.

Two complete equipments, one for an

contestedly as though we were at home, and awakened the next morning just striking the ocean. There was an unusually strong wind for that part of the trip, causing her to rise and fall in an uncomfortable manner. Soon after rising I was called for breakfast, went up just because it is customary to eat at that time. Shortly after and for several days did not think much of ocean life. Eating up all the pies and cakes and smoking cigars while your parents are at church the first time is nothing. As I had to stand it for a few days I got better, but never entirely clear of it the whole trip. Would say to any one thinking they cannot live without her, just make a sea voyage. It will probably save his life.

The *Empress* line of boats keep in rather high latitude, just miss the Aleutian Islands; it is uncomfortably cold for July. I could not keep warm outside of being in bed, except going down below where the engines are. It was such a contrast, as it was very warm when we left home. About this time whales were seen occasionally and small birds from the islands. At times it was very foggy and would be very dangerous should there be any boats on the line or obstruction to the *Empress* rushing through the darkness, with her tons of death, given by the fog horn, to keep out of the way. It is remarkable how those birds, the albatross,

must be a many of the people lost at times when a storm springs up, which happens frequently. This is on the line of terrible typhoons that start down in the China Sea and sweep toward the north. These typhoons are storms similar to cyclones we have on land. A ship having lots of sea room, say fifty miles each way, and nothing happens to her power of controlling herself, will likely come out all right. Last fall the steamer *Hokara* became unmanageable by the water putting the fires out, allowing her to be carried over toward the Pescadore Islands, near Formosa, on the rocks, going down with nearly all on board being lost.

It was quite a pleasure to see land and the prospect of getting on it once more, even if it was a foreign one. We entered the Inland Sea, a narrow, rocky passage of water that divides Japan into two parts; Yokohama is situated about ten miles inland from the coast. It is just like going up a large river through this channel to the city. In all directions are seen small boats usually propelled by sculling at the sides and rear end.

This class of Japanese are a very dark color, and wear but little clothing; not an uncommon thing to see them with hardly anything on them but a large hat. The weather was very warm at that time. We dressed in light clothing, wore sun hats, carried umbrellas and rode as

much as possible, and were uncomfortably warm.

Many of them, with their straight black hair and shape of the nose, make a person think they are a part of our Indians or our Indians a branch of the Japs.

The Japs are about 50 cents per day if you want them that long, and \$10 to cents for short rides. I never met but one that did not ask for more. You soon learn what is right, and pay them and walk out. The Japs as a people are very pleasant and courteous to foreigners. If you do not know about what you should pay for an article they want to sell, you would be surprised how much cheaper it could be bought for rather than miss selling it. The shop-keepers do not have counters as we do for showing their goods, but sit down on the floor with them, giving you a mat to do the same. Most of the large cities have a store kept by a foreigner that asks fabulous prices for things in the pottery line. A fortune could soon be spent in that way.

We visited several temples of the Japanese religion, some of them very fine and rich in ornamentation. The one used by the Mikado has many old letters written in Sanscrit brought from India several hundred years ago. Considerable gold and copper is used in decorating the interior. The floor is made of lacquer-work with not a scratch on it, as all must take off their shoes before entering and put on soft slippers. The natives take advantage of the attraction of these places by establishing bazaars near the road to the temples. They have a large one that seems to be for



FINN ENGINE WITH THE AIR-BRAKE, IMPERIAL CHINESE RAILWAY.

8-wheel engine and for a 10-wheel engine, ten sets for passenger and twenty sets for freight cars, was considered sufficient.

Mr. E. W. Newell, a designing draughtsman of the W. A. B. Co., and two engineers of the C. & P. Division Penna Co. were engaged to go with the air-brake machinery to China and put it into use on the China railway. We got ready and started for Vancouver, B. C., July 15th, had a pleasant trip to the coast by the Northern Pacific Railway, stopping on the way several times, arriving at Vancouver July 17th, in time to take the Canadian steamship *Empress of China*, one of the three largest boats on the Pacific. Vancouver is a growing and interesting place, as it is the terminal of the Canadian Pacific Railway, but our stay was not as agreeable as it might be on account of the small-pox. On the 18th all was ready to let loose and sail away to the far East. Apparently nearly all the town came down to see the *Empress* leave.

It is an impressive sight, standing on deck watching the parting of friends, some never to return, and a possibility of none ever reaching the other side. But to look over a ship like this and see the precautions, and men of large experience in command, one does not have much fear of not reaching terra firma again. At 6 p. m. the *Empress* slowly drifted out into the Puget Sound, and soon the pulsation of her 10,000 horse-power machinery was felt moving her quietly down the Sound toward the Pacific. We went to be bound

as they are with such surroundings the most of the time and their associates limited to a few like themselves, and only hearing the news of the day while in port.

Soon only such questions and things pertaining to the people, as a nation, of their welfare that they become interested in. I was surprised how soon a person will, when surrounded by strange customs and people, soon forget their native land and be so taken up with things around them. Their former home would not be thought of much, only when hearing from friends by mail.

The trip around the world from California coast to China is where a day is lost. But few people understand this, nearly all that make the trip over do, upon a little reflection, as this is generally talked of about the time the line is crossed.

A strong current passes up past the Japanese coast and over towards Washington. The water is warm, which must be one reason why they have such nice weather in winter at that high latitude. A perceptible increase is necessary in the speed of the engines to make the time.

On July 30 we were going nearly south and sighted the mountains of northern Japan. That evening we had a beautiful sunset, said to be equal to any in the world.

All the next day was in sight of land the most of the time; everywhere could be seen small Japanese fishing boats. There

Every one must pass through the Custom House about the same as at New York.

All the Custom House men can talk some English, but not well enough to entertain an argument with them if you think anything you have should not be retained for duty.

I was somewhat angry when they refused to allow my typewriter to go through free, but when I thought of home, how we meet them when they come there, it made some difference. They are death on Kodaks; all must pay so much duty on them, as they have good photographers among their own people that want to take views of things to Japan.

You are besieged on all sides by professional guides; any one wishing to save time should employ one. The first thing they will notice the most first is the jini-

any one wishing to save time should employ one. The first thing they will notice the most first is the jini-

the public generally, as there was a constant stream of people going and coming from it.

No objection was offered to us going in and watching the performance. I was particularly struck by the attention given a red, monkish idol called Hindzum, that sits calmly on the right side of the person. A person who has any bodily infirmity rubs the affected part and the corresponding part of the idol alternately; the idol is believed to take the disease from the body to itself, and consequently the person is healed. It is patronized so much that its face is worn nearly smooth, and many flat places on different parts of its body. As it is made of wood, and polished so much, the former features are lost.

We went by the Emperor's grounds, which are guarded in all directions with soldiers. He has two styles of residences, one native, the other European. I am told foreign dress and customs are popular with the Japanese. The ladies are not what we would call beautiful, but are very pleasant and polite toward foreigners. I made the acquaintance of a Japanese gentleman at Kyoto, that took me out calling on some of his friends.

We were met at the door by the girls with slippers. I put mine on and followed the rest into a plain-looking but very neat room. I could see no furniture such as we have, but soon a servant came with several mats, scattering them around for us to sit on. I could not sit down on mine as my legs were so comfortable and gracefully as they did. Pitcher, ice and lemonade were brought in. The fruit was passed around with chopsticks. I did not have much success using mine, so just took out my knife, made one of them sharp like a fork, and used it the same as one. My failure to handle them as they did seemed to amuse them very much; I guess they had a good time. I did not know a word they said, only what my friend told me. I am not sure I enjoyed it much. When ready to leave, my shoes were gone, just as I expected might happen, but found one of the servants had put them in a closet. Their houses seem to be all sliding doors as regards the making of rooms.

When building a house the roof is put up first, the rest finished afterwards. The Japs seem to excel in woodwork more than anything they make. They are natural born imitators. Most anything they buy abroad, it is not long till they make it, they now make electric light machinery and telegraphs.

Foreign countries have no treaty with them yet that can prevent them from making our patented articles. Other countries cannot expect much profit from their sending anything new there, as they would soon make it. It is remarkable the work they can do in wood that requires time and patience, and at small pay. For instance, a man will build a Japanese miniature house, not over 8 inches square, complete, having mats on the floor made of bamboo, with the grain of the wood so arranged as to give the appearance of a mat. It will take a man's time to build and then sell it for \$1 Japanese money, about \$10 gold now.

We do not appreciate what a convenient money system we have in this country, nearly all those countries are changing from day to day. Silver (Mexican) is the currency generally used from China to India. It fell from 71 to 65 what time we were there (six months). Many business men that invested in China years ago can not now afford to leave there and go home, as they will lose so much in the exchange. A silver dollar is worth whatever the amount of silver it contains at the market price of silver at that time. At any port you stop and wish to get money in the native currency, the gold dollar is the basis of exchange. Mexican silver is the money mostly used in China, and the better class of Chinese, but a small copper coin called a cash is used by the coolie class. It takes 150 of them to make a gold dollar, 1,000 for a Mexican dollar. The natives,

buying in such small quantities and living means so small, is why such small money is necessary. China coins but very little silver, their principal business through the banks are rated in taels; there is no money coined by that name. Paper notes similar to our money are issued representing taels. A tael is nearly the same in value as a gold dollar and does not change much, usually traded about 98 cents. The Chinese are suspicious of silver money, as it is counterfeited so much. Experts are employed at the banks that soon detect one by the sound of it struck against one another. They prefer a dollar that is chipped or mutilated, one we would not take would suit them, as it shows it has been tested. They hesitate about taking a bright new one for fear it is not good.

Paper notes are issued representing the copper cash. This cash have square holes through them, so they can put them on a

siderable double track. On single tracks at the station they have double track quite a distance each side of the station, with the switches set for all trains to the left. (The practice is noticeable in Japan that everything meeting always turns to the left.)

The switches are set right, and the switch-lever holding switch in position is weighted, so that when a train leaves a station they can run through it, leaving it right for the train coming in opposite direction. Usually the switchman is there holding the switch closed, but does not go near it when a train is approaching the station, as the track is right. By this plan two trains approaching a station cannot have a collision unless they should run by quite a distance. They have nice clean-looking engines, of the eight-wheel and ten-wheel class, some of them tank engines and quite a number of them having

heating surface and grate area. She really would make more steam than she could use.

Foreign engines run with large nozzles on do not burn near the coal our engines do; but I doubt whether they would handle our trains as well as in this country.

The stations are nicely kept and passengers cannot cross from one side to the other only by an over-head bridge. Quite a number of coolies are kept about the place to do the work, such as loading freight and switching cars. Open cars with tarpaulins for covering are used extensively. At each station is placed a large clock, so that trainmen can see the time plainly when passing. I have known drivers in China to run for weeks without a watch.

Japanese railways have separate passenger and freight trains, with passengers first, second and third class. Passenger cars are similar in style to the English,

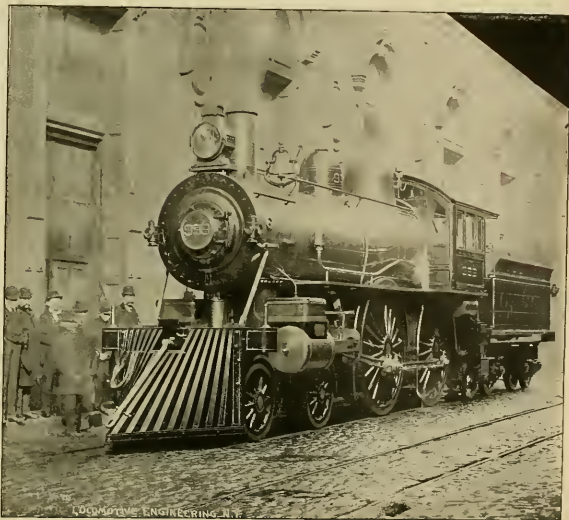

The "999" on her arrival in New York from the World's Fair.

string of 250 each, equal to 25 cents, but I never found the full number in a bunch—usually 245.

While at Yokohama we called on the general traffic manager for permission to examine their shops at Tokyo and railway system generally. He is an Englishman, being one of the few employed by the railways of Japan. He surprised us when ready to leave his office, by handing us transportation over the Japanese roads, at the same time saying he was pleased to do so, as the Pennsylvania Company did the same for him while in America not long ago.

The Japanese railways comprise about 1,500 miles of 3 ft. 6 in. track. They run their trains on the staff system, which can be done on account of labor being so plenty and cheap. All road crossings, bridges, and switches have men stationed at them. It appears as though they must see how many men they can employ. Considerable tunneling is done in hilly countries to avoid heavy grades. They have con-

siderable water motive. All that we saw with occasionally the improvement of the Baldwin, which is said to not do any more work than the English engine, and buras about twenty-five pounds more coal per mile. I saw the coal record for several months, and I think the record stood about fifty to seventy-five pounds per mile against the Baldwin. At first she would not steam until the netting and deflector was removed from the smoke-box. When that was done had no more trouble for steam.

This is something we noticed in about all foreign engines, they don't use netting and such arrangements, but have large nozzles, and pay attention to their dampers, and I do not see as they have any trouble with sparks. As we were strangers to the condition and fuel of the Japanese engines, we could not say anything as to why the Baldwin does not do better, or haul more cars than the other one, as she has an inch more cylinder. I heard one reason given why they thought she used so much coal, was she had so much

used with occasionally the improvement of the Baldwin, which is said to be a first-class car.

The vacuum automatic brake system is used on nearly all the cars. As their cars range from 10,000 to 20,000 lbs. in weight, this system of braking works very nicely. The cars are coupled by a screw and spring buffer arrangement; starting and stopping is smoothly done, similar to the trains run on the Elevated in New York. As trains are moved on the staff system, really only one train on the road at a time, and regular stopping places, their brake gives good satisfaction on their light cars.

It is thought when their new standard gauge railway, which will be necessary some time as they are their cars are too small now for their cavalry. It seems their horses are getting larger. It is very probable then the high-pressure brake system will be used.

While at Tokyo we visited the railway shops under the charge of Mr. McDonald, who showed us around very pleasantly. All the workmen in the shops are natives,

and also all the men on the railway trains are the same. Did not inquire into the wages of the men, but understood the drivers were paid about \$25 gold per month. That is probably the highest paid in the service outside the officials. The time is soon at hand when but very few foreigners will be employed. While we were there some lost their heads and Japs succeeded them. Some of the Japs are excellent workmen in iron, but their best is shown working in wood. It is true they do so many things opposite to other people. Their latest work was to make an operator, having the tool upside down, saws are filed to cut as it is drawn back, and planes the same way. All the cars are built there. Only import such things they cannot make conveniently. Car wheels all steel are used, as it is cheaper in the end to get the very best. Cast wheels, such as we use, to many souls become defective to use them.

After spending ten days around in Japan, started for Kobe by rail, which was a pleasant one through the country, showing how most of the Japs make their living—raising rice and tea. They appear like a very industrious kind of a people, but rather close about spending money for wearing apparel, investing the most to large-brim straw hats. Kobe is something like Yokohama, people of all countries assembled there. Witnessed a baseball game between the citizens and the crew of the warship *Marion*, 17 to 2 in favor of the marines. *Marion's* brass band furnished the music, making a fellow feel like he was at home seeing a game. Took passage for China on the Japanese steamer *Senku Maru*, a line of boats the same as the Empress Line, only smaller, of 1,250 tons capacity.

(Concluded next month.)

The Webb Engine and Her Train.

After the World's Fair the Webb compound and two cars came from Chicago to New York over the Lake Shore and New York Central in company with the "999" and her train of Wagners. A friend of this paper "got a shot" at them as they appeared in the Grand Central station, in this city.

It will be noticed that the "Queen-Empress" is carried in an American height on the front end and a bell set up on the tank, both of which were necessary while running on American railroads.

Following are a few of the principal dimensions of the engine:

Two high-pressure cylinders 15 in. in diameter by 24 in. stroke, and one low-pressure cylinder 30 in. in diameter by 24 in. stroke. The engine is carried on four pairs of wheels, the leading pair being 4 ft. 1 1/2 in. in diameter, fitted with Webb's radial axle-box with central controlling spring. Diameter of driving-wheels 7 ft. 1 in., trailing wheels 4 ft. 1 1/2 in. Driving-boxes having 1/2 in. side plates. Driving-wheels being in front of firebox necessitates having a long boiler, barrel of which is 18 ft. 6 in. long, made of 1/2-in. steel plates, having a mean diameter of 4 ft. 3 in., the firebox casing being 6 ft. 10 in. long. A combustion chamber is placed in a barrel of boiler, between firebox and smokebox tube-plates, so as to divide tubes into two lengths. Access is obtained to chamber by an opening at bottom, to which is attached a hopper for getting rid of ashes. To bottom of hopper is fixed a valve, which is air-tight and weighted, so that in its normal position it will be closed, it is also connected to the footplate with a rod, so that the "driver" can open it when necessary to let out the ashes. There are 150 tubes 2 1/2 in. diameter outside, length of tubes between firebox and combustion chamber, 5 ft. 10 in., between combustion chamber and smokebox, 10 ft. 1 in. Heating surface of tubes, 13,360 sq. ft. Combustion chamber, 39 1/2 sq. ft. Firebox, 120.656 sq. ft. Total heating surface, 15,097.84 sq. feet. Fire-grate area, 203.59

sq. ft. Weight of engine, working order, 52 tons 2 cwt.; 15 1/2 tons being on each pair of driving-wheels. Weight of tender, working order, 25 tons, carries 4 tons of coal, tank capacity 1,370 gallons. Wheel base, engine, 23 ft. 8 in. Engine and tender, 43 ft. 11 1/2 in. Total length, engine and tender over buffers, 54 ft., height, from rail level to center of boiler, 7 ft. 10 1/2 in. Steam pressure, 175 pounds per sq. ft. This engine took the highest award made for foreign engines at the World's Fair. The "999" has gone to California to the Mid-Winter Exposition, where she continues to be as she was at Chicago, the "belle of the ball."

The pictures of "999" and the "British Train," on pages 71 and 72, are from photos by Mr. F. W. Blauvelt, and as we have had considerable enquiry for photos, especially of "999," he has, at our request, con-

Not English Yet.

The following letter has been sent to the *English Engineer*, and is forwarded to us for publication, by Clement E. Stretton, C. E.

"The letter of Mr. F. L. Wanklyn is, in my opinion, calculated to mislead your English readers by causing them to suppose that the Pennsylvania Company had adopted a very English design of engine.

"A few years ago, when compounding first engaged attention in America, the Pennsylvania Railroad Company decided to very carefully test the question. A "Webb" three-cylinder engine was ordered from England, and is generally known as "Jack the Ripper," No. 1320.

"This has been followed by a Baldwin compound No. 1502, having six-coupled driving-wheels. No. 1503, a Schenectady

wheel-base of engine and tender right for turn-tables. The company's latest engines are all of the usual American pattern with the usual boge tenders."

Egotism of Inexperience.

We are all familiar with the saying that the young brakeman talks as if he knew more about railroading than the general manager. This display of egotism by the novice is seen in all departments of life. A young military officer mentioned as a curious fact that he wore a smaller cap than he did when attending the military school at West Point. That is a common experience, remarked an older officer.

The brakeman who pretends to know more than the old man, the apprentice who is anxious to give his foreman information, the fireman who looks down upon the ignorance of the engineer, and the brake



THE "QUEEN-EMPRESS" ON HER ARRIVAL IN NEW YORK FROM THE WORLD'S FAIR

sent to place on sale both of the above photos and those of engines "1515" and "Jack the Ripper," published in our December number. The size of these photos is 8 x 10, neatly mounted, and copies of either or all of them can now be procured there, for we shall never do any book business of that kind—too much brain tissue called for. The air-brake articles now being published will cover the ground and will appear in book form later on.

One of our correspondents suggests that a book compiled from the air-brake puzzles published in this paper would make a valuable book. Please make a scrap book of them, for we shall never do any book business of that kind—too much brain tissue called for. The air-brake articles now being published will cover the ground and will appear in book form later on.

We have no back numbers of anything except January, '94—no more bound volumes.

compound, having six-coupled driving-wheels, No. 1502, a Baldwin compound, having four-coupled wheels, and the Pennsylvania Company itself has built a compound at Altoona, No. 1515, which is the one to which Mr. Wanklyn refers. It will thus be seen that the company has five experimental compound engines running on trial, but not one of them has been decided upon as the design for the future. In fact, the company's latest design is the class "P," No. 1659, described in my letter of recent date, which is the usual American design. "Mr. Wanklyn speaks of the class "T" engine No. 1515 as "just turned out," implying that it is quite new, but this is not the case. In June last I went upon all the experimental compound engines at Altoona, including the one in question, No. 1515, and it had then been out a few months. I carefully examined the engine 1515, and have before me the official drawings I brought home, but fail to see anything of an English design in the engine. The six-wheeled tender has been adopted for this engine, so as to keep the total

inspector who despises God for knowing too little about train mechanism are all anxious in their conceit, and they have peers and equals in every calling. In an address to students by the president of a university it was said, that a young writer could always be detected by his repeated use of the positive adverbs, while the veteran in science, schooled by experience, acknowledged the universality of error, made frequent use of the modifying phrase and often introduced the element of uncertainty into statements.

A correspondent puts us straight, as follows: "In answer to R. C. Sedalia, Mo., you say the largest engine in the world works the Grand Trunk Business in St. Clair tunnel, near Detroit. Excuse me for the correction, but you will find that Detroit is about sixty miles from St. Clair tunnel, its terminals are Port Huron, Michigan and Sarnia, Ontario."

We cannot bind papers sent in. Pastors, please home industry.

What You Want to Know.

Don't ask questions that simply require a little figuring to determine. make each question separate. No notice taken of anonymous questions.

(15) Tinker, Portsmouth, Va., writes:

How can I ease-braden small iron screws and other small parts, none of them being more than half an inch thick? *A.*—Put them in a cast-iron box bedded and covered with animal charcoal. Line the cover of the box with clay and sand and keep it at a red heat for four or five hours.

(16) J. C. B., Des Moines, Ia., writes:

I have got up a very ingenious machine that would act as a brake to stop cars that would act on the power stored, to help in starting. Can you tell me how to get parties interested in the invention? *A.*—There have been hundreds of devices of that kind patented and none of them are of any value. We do not think any business man would care to put money in it.

(17) F. H. D., Walnut, Texas, asks:

How much more power would it require to lift the water from well 100 feet deep, the discharge-pipe being $3\frac{1}{2}$ inches, with pump-rods $1\frac{1}{2}$ inches square, working inside of the pipe which is only 2 inches and pump-rod of $\frac{1}{2}$ -inch pipe on same plunger. *A.*—The difference in power required would be the difference in the weight of water contained in the two sizes of pipe less the rods. Roughly speaking, in this case the larger pipe would contain about three times as much water as the smaller.

(18) Apprentice, Columbus, O., writes:

In reading mechanical papers, I have often seen a worm mentioned, which is some mechanical thing. I do not understand what it is, and I wish you would tell me. *A.*—There are several mechanical appliances called "worms." One is a double spiral used for drawing carriages from firearms. The best known worm is a short revolving screw, which drives a shaft by engaging in gearing. If there is a Sellers' planer within your reach, you will find that a worm is employed to drive the bed.

(19) R. A. C., Topeka, Kan., says:

We had a dispute here lately about the effect of a light and a heavy rail has upon the wear of a locomotive. I say that LOCOMOTIVE ENGINEERING had an article saying that the pulling capacity of locomotives had been increased on some road when eighty-pound rails were put down in place of light ones. He could not find the article, and I hold that the statement is absurd. What do you say? *A.*—We say that it is true.

We say that the losses we have received the statement about the locomotives pulling heavier trains over the stiff rails from a perfectly reliable source.

(20) Ed. Sams, Westbury, L. I., writes:

I wish to learn the machinist trade, and several advise me to take up electricity, in regard to it taking the place of steam, so would you please give your advice through your paper, as it may help others beside myself, and oblige. *A.*—It is entirely impossible to say what electricity may do for you, but whatever it does, it will not make any difference with the machinist's trade. Mechanics will have to make electric machinery just as they make steam engines, electric motors, sausage stuffers and sewer traps now. The machinist's trade, and keep your eye on electricity if you have a liking for it.

(21) W. H. S., Dennison, Ohio, asks:

1. In making an emergency application with the quick-action triple-valve the piston is relieved of its entire pressure. *A.*—Not necessarily; a quick reduction of twenty or thirty pounds will apply the quick-action emergency. 2. In bleeding the auxiliary reservoir, the brake-cylinder

is relieved of its pressure. I desire to know through what port the pressure leaves the brake-cylinder. *A.*—When the auxiliaries require bleeding it is because of the more pressure in the brake-cylinder and auxiliary drum than in the train-pipe; by "bleeding" the drum the pressure is reduced and the pressure in the train-pipe is allowed to move the piston of the triple-valve to release position.

(22) A. D. K., Colorado City, Col., writes:

1. Suppose you were waiting at a station for a train which does not stop, and this train passes 1 minute ahead of time, according to your watch, and your watch is 2 seconds slow; how much ahead of time is it? I say 13 seconds, a friend says 11 minute 22 seconds. Who is right? *A.*—Your friend. 2. Suppose you were building two boilers, both of the same kind of steel, one very small and the other very large in diameter, both to hold the same pressure; would it be right to use the same thickness of material? *A.*—No. It is a matter of tensile strength per square inch of area in the shell sheets, and how many square inches are exposed to pressure. The U. S. Law gives this rule to determine thickness of boiler shell: "Multiply pressure by radius of the shell, and divide by one-sixth of the tensile strength of metal."

(23) School Graduate, Louisville, Ky., writes:

I have heard it stated that locomotives operated by compressed air have been successfully used in places where smoke and gases were objectionable. Can you give me any information on the subject? It seems to me that locomotives of this kind would be cheaper and more reliable than electricity. Why not have several Westinghouse pumps on an engine of this kind, to keep up the pressure? *A.*—A pneumatic locomotive was tried on the elevated railroads of New York about twelve or thirteen years ago, and it did fairly well, but was more expensive than steam. We believe that the losses we have of this kind are greater than those of a good electric motor. The Westinghouse pump plant would not help any, unless there was some means of carrying power to work the pump. If air was taken from the tanks of the pneumatic engine, there would be loss instead of gain.

(24) E. W. D., Freeport, Ill., writes:

I have been reading the questions given on Educational Chat No. 1, 1894, and find some difficulty in satisfying myself as to the proper answer to question 25, first part. Does it mean piston rod, or crank pin? Does it mean loss of work resulting that it must stop to reverse its motion, and from the nature of the second part of question 25, I take it that this is correct, but it is not clear to me. I cannot yet see that it is correct, for the following reason: Let the crank-pin be a hair's breadth from the dead point, and a very slight dip of angularity exists in the main connecting rod, and the piston is a very slight distance from its position when crank-pin is on dead point. Now as the crank-pin does not come to rest on the dead point, in my opinion the piston does not come to rest at this point, not even the smallest portion of time. *A.*—The piston must stop before it starts in the opposite direction, of course it does not load around the end of the cylinder long, but it stops at each end.

(25) W. Meadville, Pa., writes:

Please answer this question in your paper: How does the oil from the lubricator get through the pipes into the chests against the steam pressure when engine is

working? There is a difference in opinion among some of us, some holding that the oil does not feed to cylinder and valve while engine is working. I say that either the force of the steam by force of lubricator, or the pipes fill full of water, the same as feed glasses. *A.*—The oil pipes from the lubricator to the chests are open all the time, and there is an opening from the lubricator above the feed glass that admits a little steam to this pipe, and this carries the oil down the pipe to the chests. If the pipe were with water, the oil would stay at the top until it filled the pipe full. There is no current of steam from the chests to the lubricator, but from the lubricator towards the chests the boiler pressure against the chest pressure if allowed time to equalize. When the engine is shut off there is a slight spray of steam flowing from the lubricator to the chests, carrying the oil with it.

The Fuel-Wasting Ash-Pan.

A part of the locomotive which has received too little attention from improvers is the ash-pan. If this humble part of the grand machine had received half the attention bestowed upon more ambitious features, much more efficient than it is would be made more efficient than they are, and more fuel would be saved than what is effected by expensive changes in mechanism. The ordinary household stove ought to furnish an edifying object lesson on what is good and what is bad about the ash-pan of a locomotive. When the stove is in good order and all the openings that admit air beneath the fire in such a condition that the flow of air can be easily regulated, the stove is efficient, and gives a maximum of heat with a minimum expenditure of coal. When the casings and damper slides become distorted by the turmoil of bare smoke, the stove falls into disrepair. Coal is thrown in without satisfactory results, the grate slakers, the regulators are tried in various shapes—all to no purpose. The stove burns twice the coal used at first, and does not appear to yield so much heat. All this disorder with the stove is due to the fact that the air cannot be regulated to suit the fire.

The locomotive furnace is merely a stove on a large scale. To get satisfactory results from the coal consumed, there ought to be means provided for regulating the supply of air to a locomotive furnace as accurately as to the fire of a stove. In the majority of locomotives, the appliances for controlling the admission of air to the grates are always in worse relative condition than the grate of a worst-out grate. When the engine is new, the ash-pan gives evidence that the maker never thought of making it air tight or of constructing the attachments so that the pan might be kept in shape and the dampers maintained in form, to be opened and closed readily. When wood was the prevailing fuel, our locomotives and the engines themselves were very small, an ash-pan made of sheet-iron was fairly satisfactory. With coal and heavy red-hot chinkers to be carried at times, with long grates to be spanned and irregular surfaces to be covered, the thin sheet-iron is still considered good enough for an ash-pan. The ash-pan in the shop is deemed fine enough to put the fittings of an ash-pan together. It is no wonder that locomotives standing at stations create a dangerous nuisance by pop valves roaring and constantly blowing off steam. It is merely what might be expected, the result of reasoning about as much coal when standing in idleness as they do when pulling trains. We heard a traveling engineer talking lately about the strict practice he follows of disciplining engineers and firemen for permitting safety-valves to pop when engines are standing at stations. He stated that the discipline was one-sided. It ought to be extended to those who are responsible for the ash-pans being no more air-tight than a market basket. That

is the thing to hold responsible for the danger of screaming pop-valves and for the waste of fuel at times when combustion should be checked.

Elements of a Good Shop Foreman.

"One Who Has Been There," writing about the shop foreman, says that too great care cannot be exercised in the selection of a foreman, for upon his ability depends the financial prosperity of his department and the comfort of those working in it. The first consideration of a good foreman is to know his business, but that is only the beginning of the list. Some of the men who have been the most conspicuous failures as foremen have been first-class workmen. It is not necessary that a man should be a particularly skillful mechanic to be an efficient foreman, if he only knows when work is well done, how it should be done, and the quantity that a good mechanic ought to turn out. A most important qualification for a foreman to have is the faculty of getting on well with workmen, keeping them in good humor while seeing that they all do a good day's work.

A shrewd foreman never discharges a workman for trivial causes, and always holds on to good workmen unless they have faulted likely to demoralize the shop. It is a peculiarity of many incapable foremen that they let good men go and keep the shop full of inferior hands. The weak foreman is always regarding particularly bright men with suspicion, and these are not likely to find the shop agreeable. The foreman, superintendent or manager who is jealous of able subordinates are expensive officers and ought to be discharged. There are many of them to be found tyrannizing over subordinates and ruining the business of their employers. The officer who understands the interests of his employers does all in his power to have his men do their best every day, and around him. By doing so he strengthens his own position.

A foreman should realize that his workmen are entitled to respect, and he should conduct himself in such a manner that when he moves about among his men they will in duty bound show him all the courtesy that is in their power. If workmen are treated with kind consideration, without harsh talk or profanity, they will acknowledge the foreman to be a gentleman, and act accordingly.

All operations in the shop should be carried on systematically, the material for machines under construction being ordered in time to prevent a moment's delay. The multitude of parts that make up a machine like a locomotive should be marshalled so that every piece is ready as required in erecting. Tools should never be seen lying on the floor or littering the benches. The tool-room is the place for them when not in use. Cleanliness and neatness are the first considerations. A place for everything and everything in its place, is the first principle of order, and order is an essential element of success in doing work.

When a job is given to a mechanic, he should be permitted to finish it. One of the most demoralizing things for workmen is to have their work interrupted. A man for everything and everything in its place, is the first principle of order, and order is an essential element of success in doing work.

One of the first steam brakes to be regularly used upon a locomotive in the United States was designed by George W. Cushing, when he was master mechanic of the standing on the Erie Railroad in 1856. He applied the brake to the locomotive "Michigan" in 1856, and it was the forerunner of that style of driving-wheel brake that shortly afterwards began to be seen on different roads.



A PERFECTLY CONSTRUCTED METAL BRAKE BEAM.
 The Cheapest, Lightest, and Most Durable.
 NOW STANDARD ON a MAJORITY OF ROADS THROUGHOUT THE COUNTRY.
 General Office and Works: 40th & Hopkins Sts., Chicago.
 CITY OFFICE: NEW YORK OFFICE:
 515 Phenix Building, Chicago. 49 Broadway, N. Y. Room 118.
 Correspondence solicited. FRANK G. EAT, Eastern Agent



CUYAHOGA FALLS, O.

ROLLED HOLLOW STAY BOLTS ARE STRONGER AND SAFER THAN DRILLED ONES.

Mandrel rolled from the finest charcoal iron. All sizes, from 3/4 to 1 1/2 inch, with any sized hole required from 1/4 to 7/8 inch. Let us send you a sample and quote prices. A set for one fire-box will convince you of their merits, safety and economy.

AGENTS IN CANADA: J. & H. TAYLOR, 751 Craig Street, Montreal, Canada.

LEONARD & ELLIS.



OILS FOR RAILROADS.

VALVOLINE OIL has long been used on many of the leading railroads in this country and abroad. It has no equal in quality and mileage.
W. A. BOYDEN, General Agent,
 157 Chambers Street, NEW YORK.

SIGNAL OIL WORKS, LIMITED.
 FRANKLIN, PA.

MANUFACTURERS OF
SIBLEY'S Perfection VALVE OIL.
 The only perfect Locomotive Valve Lubricant.
J. C. SIBLEY, Prest.

GALENA OIL WORKS, (LIMITED).
 Galena Engine, Coach and Car Oils,
 The Standard Lubricating Oils of America.

SAFETY, SPEED and ECONOMY are the results of the use of Galena oils on the leading railroads of the world. These oils do not freeze in the coldest weather, while they are adaptable for the hottest climates. In the use of Galena oils there is an entire freedom from hot spots, except when these are caused by a mechanical defect. The adoption of Galena oils on standard railway is certainly a large argument of their superiority, when the fact is considered that the oils are used in the coldest weather there more than 10 years ago, in an evidence of their adaptability from east to west and from sea to sea. Galena oils are an exclusive gas free lubricant, and upon one continuous line from the City of New York to New York, thus demonstrating their adaptability to all temperatures and climates. Being entirely free from gum, these oils are not affected by heat and sand as other oils are. We also furnish our customers SIBLEY'S PERFECTION VALVE OIL, which is also used on the leading railroads of the world.

GALENA OIL WORKS, Limited.
 CHARLES HERRICK, President,
 Chicago and New York.
 FRANKLIN, PA.
 PHOENIX BLDG. 117 Jackson St.

PATENTS FOR INVENTIONS.
GEORGE P. WHITTLESEY,
 ATTORNEY AT LAW, Washington, D. C.

EXPERT SEARCHES AND DRAWINGS.
RFP RAILROAD INVENTIONS A SPECIALTY.

THE Standard Steel Works,
 PHILADELPHIA.

STEEL TIRES

MANUFACTURED BY AN IMPROVED PROCESS INSURING SOLIDITY.

**Wrought Iron Centres.
 Steel Tired Wheels.**

REPRESENTATIVES:

Chicago, 1013 Monadnock Bldg., St. Louis, 616 North 3d St.,
 FITZ-HUGH & SPENCER, ANDREW WARREN.

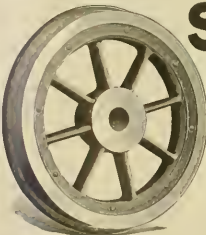

WROUGHT IRON WHEEL CENTRES.
 VAUCLAIR'S PATENT.

The Brotherhoods' Jeweler.



THE only substantial, moderate-priced clock on the market.
 Movement has escapement jeweled; case cast bronze; front screws on; side wind; 6-inch, porcelain dial. Very elegant and accurate.

The red hand, shown at VI o'clock is on the inside of the glass and is moved by a knurled nut on the outside. This is John Alexander's "Red Hand" device. When it is moved out of its regular position it is put at the time of the next meeting point, order station or wharf and serves to remind you that you must make a stopping point, get orders or sidetrack at that time. No extra charge for the "Red Hand." Clock furnished with or without it.

PRICE, \$12.

JOHN J. McGRANE,
 187 BROADWAY, NEW YORK.

WILLIAM F. HALL, President. **W. S. GILMORE, Treasurer.** **WELVILLE F. HALL, Secretary.**
S. HAINES 106 N. G. General Agent. **C. W. HERRICK, Sales Agent.**
HENRY BEZER, Mech. Eng. Factory. **A. J. WILSON, Supt. Electrical Contrs.**

Hall Signal Company,
 Principal Offices, 80 Broadway, New York.

115 The Ames Building, BOSTON. Equitable Building, BALTIMORE.
 Western Office, 927 The Rookery, CHICAGO.

The Hall Systems of Automatic Electric Signals are in operation and in process of erection
 ON A LARGE NUMBER OF PROMINENT ROADS.

Every Conceivable Form of Railway Signals.
 Wire Circuit and Rail Circuit Automatic Electric Signals.

We have added to our Automatic Electric Signal System

Mechanical and Auto-Manual Block Signaling

IN ALL ITS BRANCHES,
 Having obtained control of the BEZER LOCK AND BLOCK SYSTEM, BEZER & BURLEY INTER-LOCKING MACHINE, besides the best known forms of Semaphore, Compensator, Selector, etc.



THEIR SUPERIORITY IS PROVEN BY THEIR POPULARITY.

FINEST

Coach, Parlor Car, Sleeping Car, Street Car, Retton Elevated

SEATS.

IN USE ON ALL THE PRINCIPAL RAILROADS IN THE UNITED STATES



THE HALE & KILBURN MFG CO.,

Simplicity, Durability, Elegance, Comfort,

Combined.

IT IS SAFE TO SPECIFY THE **H. & K. SEATS**

PHILADELPHIA, NEW YORK, CHICAGO.



THE WASHBURN Car-Wheel Company,
HARTFORD, CONN.,
MANUFACTURERS OF
CRUCIBLE STEEL-TIRED WHEELS

For Parlor and Sleeping Cars, Passenger Coaches, Locomotive and Tender Trucks.



F. T. BIRD, H. M. BROWN

ROOD & BROWN, CAR WHEEL WORKS,
BUFFALO, N. Y.

Railroad, Car, Engine, Tender and Truck Wheels, Made from Best Charcoal Iron. Office and Works: HOWARD and THOMAS STS.

J. B. FAHRAE, JOHN TEFERS, C. E. ROOD

EAST BUFFALO IRON WORKS,
FAHRAE, TEFERS & ROOD, PROPRIETORS.

GREY IRON CASTINGS

of every description. Special Attention Given to Car and Locomotive Work. Office: N. Y. C. & H. R. B., Broadway Station, Best Line. (GREENE) 60 Perry St., Buffalo, N. Y.

C. E. ROOD, MALLEABLE IRON,
QUALITY GUARANTEED.

RAILROAD WORK A SPECIALTY.
Office and Works: LANCASTER, NEW YORK.



President, E. A. DEMOCK. Treasurer, J. L. OTIS. Established 1867. Capital \$100,000.

NORTHLIMPTON Emery Wheel Co.

MANUFACTURERS OF PATENT SOLID EMERY and CORUNDUM WHEELS and MACHINERY.

LEEDS, MASS. CHICAGO OFFICE, 26 South Canal St. Send for Catalogue.

RAMAPO IRON WORKS, Hillburn, N. Y.,

MANUFACTURERS OF

Brake Shoes for Steel Tired Wheels.

ROSS, for Steel Tired Car and Tender Wheels,
ROSS-MEEHAN, for Locomotive Drivers,
SHEPPARD, for Blind or Bald Tired Drivers.

NARROW GAUGE CARS, SWITCHES, AUTOMATIC STANDS.

YOKED, BOLTED and SPRING RAIL FROGS, CROSSINGS, TRACK EQUIPMENT,

RAILROAD AND MACHINERY. CASTINGS, HEAVY AND LIGHT.

Ready February 1st to 15th.

Locomotive Mechanism and Engineering,

BY H. C. REAGAN,
LOCOMOTIVE ENGINEER.

Over 100 Illustrations. 300 Pages. 12mo Cloth, \$2.00.

AGENTS WANTED.

JOHN WILEY & SONS, New York.



A MONTHLY JOURNAL devoted to Steam Engineering and Practical Work relative to the Economic Generation and Transmission of Power. 56 to 64 pages, size of this paper, profusely illustrated. Price, \$1.00 a year. Send for Sample Copy—FREE. Address:

THE POWER PUBLISHING CO.,
WORLD BUILDING, NEW YORK.

LUKENS IRON AND STEEL CO., Coatesville, Pa.

CHARLES WILSON, Pres't, A. F. HUTTON, Vice-Pres't.

CHARLES L. HEDDER, Gen'l M't.

ROBERT B. BAKER, Jr., Sec'y, JOSEPH H. REYNOLDS, Treas'r.

ESTABLISHED 1810.



ROBERT KELLY FOUNDRY

THE OLD MILL.

THE FIRST TO MAKE BOILER PLATES IN AMERICA, STEEL AND IRON PLATES. FIRE-BOX STEEL PLATES A SPECIALTY. We can roll plates up to 110 inches wide, and from 1/4 in. to 3/4 in. thick.

FINE DRAWING INSTRUMENTS.



Drawing and Blue Print Papers, DRAWING & MATERIALS OF EVERY KIND. **QUEEN & CO.** 1010 CHESTNUT STREET, PHILADELPHIA.

SEE CATALOGUE ON APPLICATION.

RAMAPO WHEEL AND FOUNDRY CO.

MANUFACTURERS OF

BOLTLESS STEEL-TIRED WHEELS

FOR PASSENGER AND LOCOMOTIVE SERVICE.



Tires with Annular Web and Hook, Best Charcoal Iron Double-Plate or Spoke Centers, Wedge-Shaped Retaining Ring.

Continuous Circumferential Fastening.



SAFE, + SIMPLE, + ECONOMICAL.

CHILLED IRON WHEELS

OF SUPERIOR QUALITY, Drawing Booms, Passengers and Freight Cars, Locomotives, Tenders, Plantation and Rice Cars.

CONGDON BRAKE SHOES

FOR CHILLED IRON WHEELS, Outwear from 4 to 6 ordinary shoes and enhance mileage.

CYLINDER PACKING RINGS.

Office and Works: RAMAPO, N. Y.

H. O. SETTLEME, President.

GEO. W. EVANS, Vice-President.

W. C. ARTHUR, Secy and Treas.

FRANK SNYDER, Supt.

Mt. Vernon Car

MANUFACTURERS OF
FREIGHT CARS OF EVERY DESCRIPTION, CAR-
BOOSE AND REFRIGERATOR CARS,
MT. VERNON,

**Manufacturing Co.**

CAR WHEELS CAR OASTINGS AND GENERAL
FOUNDRY WORK.

Capacity, 10 Cars and 500 Car Wheels,
ILLINOIS.

**MILLER'S ASBESTOS CAR ROOF.**

THE COMING ROOF

HEAVY, DURABLE AND STRONG.
WILL WEAR LONGER THAN ANY METAL ONE.

Costs from \$1.00 to \$1.75 Less per Car.
CAN BE PUT ON IN ONE-HALF THE TIME
OF THE CAR.

HEAR WHAT THEY SAY ABOUT IT:

Oct West. M. & T. N. Irons, East. Boston & Albany R.R.

1302 HAVEMEYER BUILDING, 26 Cortlandt Street, NEW YORK.

THE ALLISON MFG. CO.,

MANUFACTURERS OF

FREIGHT CARS AND
LOCOMOTIVE BOILER TUBES.

WROUGHT IRON PIPE OF SUPERIOR QUALITY.

PHILADELPHIA, PA.

DRAKE & WEIRS, Cleveland, Ohio.

ASPHALT CAR ROOFING

The Cheapest, Best and Most Durable Car Roof Known. In use by Seventy
Railroads. Twelve years successful use without a single failure. A new roof furnished free for
every one that fails to give notice.



WILLIAM C. BAKER,
Sole Proprietor and Manufacturer of

THE FIRE-PROOF BAKER CAR HEATER

MADE OF FLEXIBLE STEEL
ONE-QUARTER INCH THICK.
Firmly Welded into One Compact, Jointless, Seamless Whole.
FIRE WITHIN A SAFE OF SAFE MATERIAL
AS THE EXPRESS CAR SAFE.

The Only Alternative for the Deady Car Stove
and the EQUALLY VICIOUS AND EXPENSIVE STEAM HEAT.

NEARLY 1000 FIRE-PROOFS IN USE.

ALL OTHER STYLES OF "BAKER HEATERS."

143 LIBERTY STREET, NEW YORK.

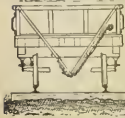
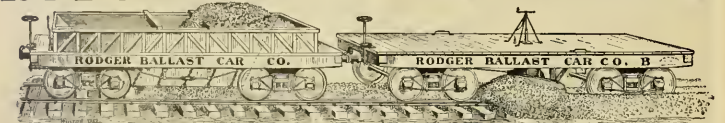
RODGER BALLAST CARS.

These cars are 34 feet long, and are built either 50,000 or 50,000 lb. capacity, M. C. B. Standard. They carry from 1 to 4 cubic yards of gravel or broken stone. In using them no ballast is thrown in the ditch, and none is wasted, as the precise amount of ballast needed is always determined. A train of 10 cars, carrying two yards of ballast each, can be unloaded and the ballast distributed, leaving the track perfectly cleared and damped, in less than 10 minutes. This is all done by the regular "train service" in unloading and two brakemen, no extra help being required. The track is perfectly cleaned by the apparatus, so that a train can immediately pass over it at any rate of speed, without detecting any obstruction. No spurs are needed, no wire cables are used. There is no shoveling of ballast from between the cars, and no cleaning the tracks with shovels. The ballast is left between the ties and on their ends, directly in position for tampering, while the cars are hauled, without being obstructed by from the ditch. The average saving per mile in material, labor, time, use of cars, saving in transportation, etc., is found to amount to \$50.

These cars are in use on the Great Northern Ry., the Illinois Central, the Gulf, Colorado & Santa Fe, the Chicago & Eastern Illinois, the Penn. Lines W. P., and other roads.

Detailed information will be furnished by circular by addressing the
**RODGER BALLAST CAR COMPANY, No. 1215 Monmouth Building,
CHICAGO, ILL.**

**PUT LEACH'S SAND FEEDING APPARATUS INTO SPECIFICATIONS WHEN ORDERING LOCOMOTIVES.**

H. L. LEACH, 55 Oliver Street, Boston, Mass.

MATCHLESS VALVE AND CYLINDER OIL.

Warranted not to corrode the iron or destroy packing, and to make more mileage than tallow or lard. Sold only to Railroad Companies direct or through our authorized agents. Matchless Cylinder Oil cannot be Bought of Dealers. In use on 60 Railways.

OILS FOR RAILROAD USE A SPECIALTY.

ECLIPSE LUBRICATING OIL COMPANY, Limited,

MANUFACTURERS OF EVERY PRODUCT OF PETROLEUM.

Sole Office: FRANKLIN, Pa.

Helmetsleeve FRANKLIN, Pa.

OLEAN, N. Y.

ERIE, Pa.

OIL CITY, Pa.



A. W. SOFER, Pres.

ROBT. ANDREWS, Vice-Pres.

C. H. HOWARD, Sec.

W. R. THOMAS, Treas.

R. M. DIXON, Engineer

THE SAFETY CAR HEATING AND LIGHTING CO.,

160 Broadway, New York.

HEATING SYSTEMS.—By hot water circulation and direct steam with regulating devices. Reliable and uniform heat. Economical and rapid circulation. Gibbs automatic coupler of Westinghouse type, absolutely steam-tight.

LIGHTING SYSTEM.—The celebrated Pintsch compressed oil gas method. In use on over 40,000 cars in Europe and America. Adopted by the U. S. Lighthouse Board for lighting Buoys. The best, most economical and only safe light for Railroad purposes. In brilliancy and cleanliness unsurpassed.

REQUIRES NO ATTENTION.

IN USE ON THREE HUNDRED RAILROADS.

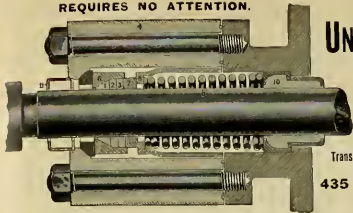

UNITED STATES METALLIC PACKING CO.

THE UNITED STATES METALLIC PACKINGS have stood the test of years, and are acknowledged to be superior to all. Renewal of packing rings made without disconnecting, by cutting them in halves and breaking joints. Swab and Oil Cups furnished with every packing.

Transportation Building, Section O. S., WORLD'S COLUMBIAN EXPOSITION, Bet. Columns 2 and 3.

435 NORTH BROAD ST., and 614 RIALTO BUILDING, PHILA. CHICAGO.

SEND FOR CATALOGUE AND SPECIFICATIONS.

OPEN HEARTH STEEL **CAMBRIA** COFFIN TOUGHENED

CAMBRIA IRON COMPANY,
OFFICE 218 SOUTH 4TH ST. PHILA. & CHICAGO, PA.

Driving, Truck, Passenger and Freight
Axles, Piston and Side Rods, Crank Pins.

WORKS AT JOHNSTOWN, PA.

COOLBAUGH & POMEROY
SPECIAL R.R. SALES AGENTS.
29 BROADWAY NEW YORK.

BENT & DRILLED

TOUGHENED BY COFFIN PROCESS, PATENTED

OPEN HEARTH COFFIN PROCESS TOUGHENED

CAMBRIA STEEL

THE TABOR MANUFACTURING CO.,

MANUFACTURERS OF

113 LIBERTY ST.,

NEW YORK.

Our Duplex molds both parts of flask at one operation of machine.

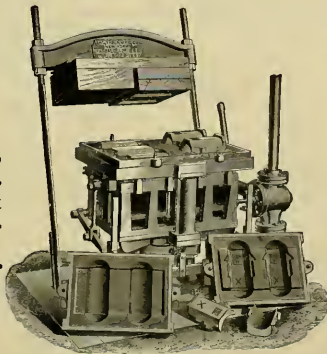

DUPLEX.

Our system produces better and cheaper castings than any other.

Automatic + Molding + Machines

Especially adapted for CAR BRASSES, BOXES and BRAKE SHOES.



VALENTINE & COMPANY, Manufacturers of High Grade
Railway Varnishes and Colors,
 57 BROADWAY, NEW YORK.

BRANCHES:

Chicago, . . . 300 Wabash Ave.
 Boston . . . 105 Parkside St.
 Paris, . . . 31 Rue de Lappe.

JOHN W. MASURY & SON, PAINTS AND VARNISHES.
 NEW YORK and CHICAGO.



THE CLEVELAND VARNISH CO.,
Mrs. RAILWAY VARNISHES.
 CLEVELAND, O.

JOHN J. BLOTT, President

HENRY LEAR, Secretary and Treasurer

JOHN Y. SMITH, General Manager



A—Air
 B—Steam
 C—Exhaust

SMITH'S TRIPLE-EXPANSION EXHAUST PIPE.

NOZZLE OPENING AS LARGE AS THE EXHAUST PORT.

This improved pipe will not clog up with any kind of fuel.

Reduces back pressure to a minimum.

Prevents spark throwing, they are left in the firebox where they belong.

Almost noiseless, and burns a fire as clear and strong as any nozzle can.



Requires no netting or other traps in the front end.

Keeps smokebox temperature down. Saves delays, repairs and expense.

We guarantee to prevent sparks, reduce back pressure, prevent clinkers and save coal—we are doing this on the Reading Road, where the pipe has been adopted, after a two years' trial.



A—Air
 B—Steam

WRITE FOR TERMS AND CATALOGUES TO THE SMITH EXHAUST PIPE CO., Doylestown, Pa.

THE JANNEY FREIGHT CAR COUPLER



THE MC CONWAY & TORLEY COMPANY

W. M. CONWAY—PRESIDENT.

48th ST. & A. V. RY.—PITTSBURGH, PA.

RAU MANUFACTURING CO.,

Manufacturers of
METAL SPECIALTIES, ENGINEERS' TORCHES & OILERS.

THE PERFECTION VALVE OILERS.

LABOR-
 SAVING
 AND
 ECONOMICAL.



SAVES
 BOTH
 OIL
 AND
 TIME.

We do a general contracting and jobbing business on orders, and would be pleased to figure on specifications for what you may use in our line.

Correspondence solicited.

122 to 128 MICHIGAN STREET, CHICAGO, ILL.

LOCOMOTIVE SPRINGS

WITH PATENT V SHAPE BANDS.

Gives more Elasticity to short Plates
 and Better Riding Qualities.

MANUFACTURED BY
A. FRENCH

SPRING CO.

A. FRENCH, Pres.
 J. E. FRENCH, Vice-Pres.

GEO. W. MORRIS, Gen. Mgr.

D. C. NORRIS, Sec. and Treas.
 P. N. FRENCH, Gen'l Supt.

A. FRENCH SPRING CO.

Manufacturers of
ELLIPTIC AND SPIRAL SPRINGS
 OF ALL DESCRIPTIONS.

THE MURPHY STEEL CAR ROOF.

HAS no surface nail or screw holes. It has no joints where cinders, rain or fine snow can get through. It allows for contraction and expansion, and has ample elasticity to provide for sagging, twisting, buckling and curving of the car body. It is as solid as the car frame itself. It has no soldered joints. It can be repaired readily, and without taking off more of the roof than is damaged. It is much cheaper than any other metallic roof now in use, and is cheaper than the double board roof, made of good lumber. It is unlike any other metallic roof for the reason that everything is furnished to make it complete; so that the parties buying it have no expense other than to apply it.

This ROOF can be applied on OLD LEAKY BOARD ROOF CARBS without making any changes in the board roof, thereby saving the expense of replacing the old boards with new, and thus utilizing material that must otherwise be thrown away.

Manufactured by the P. H. MURPHY MFG. CO., East St. Louis, Ill.

THE ROTARY.

For full
 Particulars,
 Address

The Leslie Bros. Mfg. Co.,
 Paterson, N. J.

THE Perfectest Arti-
 cular Leg is the
 best in the world. The lightest, most elastic
 most enduring and perfect in action. For
 special information address:
HENRY CAREY BAIRD & CO.,
 1011 1/2 GARDNER, 2300 Chestnut St., Phila., Pa.

HENRY CAREY BAIRD & CO.,
 Industrial Publishers, Booksellers
 and Importers,
 810 WALNUT ST., PHILADELPHIA.
 Having the most complete catalogue of Practical and
 Scientific books, it issues, via, and out other Cash
 orders and drawings, for which covering every branch
 of science applied to the Arts, sent Free and free of
 postage to any one in any part of the world who will
 return the address.



**BEATS THE MONKEY-
 WRENCH OUT OF SIGHT!**

OUR ROUND JAW NONSERRATED RATCHET No. 2 is the
 handiest tool for ratcheting requires that can be
 found. Its hardened steel jaws and hand adjust-
 ment make it keep hold when once set and you
 can get it on in one of the way places, and use of
 it not without taking jaws off, and where you
 wouldn't get in on right of a turn with the clumsy
 monkey-wrench it will take hold down up where
 the old wrench can't get. This prevents swarting
 fished nuts and parts around them. A thousand
 places for it avoid a locomotive where it can save
 time and money. We'll send a Catalogue Free.

THE KEYSTONE MFG. CO., 312 TERRACE,
 BUFFALO, N. Y.

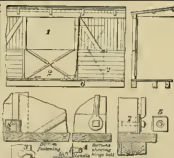

Steel Grain Door Come to Stay.

COMPARISON.
 Lots of Doors in Two Years:
 500 cars equipped with steel doors lost two doors.
 500 cars equipped with wooden doors lost 80 per cent. in the same time.

MICHIGAN RAILWAY SUPPLY CO.,
 DETROIT, MICH.

Books for Railroad Men.

- LOCOMOTIVE ENGINE RUNNING and MANAGEMENT. By ANGUS SINCLAIR. Price, \$2.00.
- INDICATOR PRACTICE. By FRANK F. HENNEY. Price, \$2.00.
- ELEMENTS OF MECHANICS. By T. M. GOODVEY. Price, \$2.50.
- PROGRESSIVE EXAMINATIONS FOR ENGINEERS and FIREMEN. By JOHN A. BILL. Price, 50 cents.
- AIR-BRAKE PRACTICE. By J. R. URELLAS. Price, \$1.00.
- COMPOUND LOCOMOTIVES. By A. T. WOOD. Price, \$2.00.
- CATERPILLER OF THE LOCOMOTIVE. By M. N. FOREY. Price, \$3.50.
- SIMPLE LESSONS IN DRAWING FOR THE SHOP. By O. H. REYNOLDS. Price, 50 cents.

Send price of any of these or of any other books of THE ENGINEERING LITERATURE COMPANY, East Orange, N. J., and they will be promptly mailed to any part of the world. Send for Catalogue.



29 BROADWAY, NEW YORK CITY.

THE CAMERON STEAM PUMP.

COMPLETE WITH BOILER.

THE A. S. CAMERON STEAM PUMP WORKS,
 Foot of E. Twenty-Third St.,
 NEW YORK.

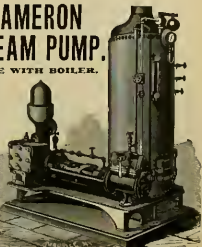

Send for Illustrated Catalogue.

BEMENT, MILES & CO., PHILADELPHIA, PA.

BUILDERS OF
METAL-WORKING MACHINE TOOLS,

For Railroad Shops, Locomotive and Car Builders, Machine Shops, Steam Forges,
Ship Yards, Boiler Shops, Bridge Works.

STEAM HAMMERS FOR WORKING IRON OR STEEL.

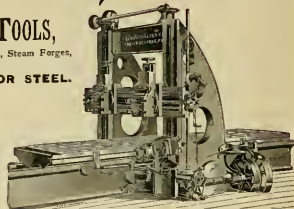
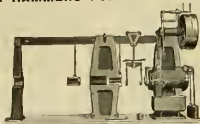

NEW YORK OFFICE: EQUITABLE BUILDING.

GEORGE PLACE, Agent.

PEDRICK & AYER,

Milling Machines. Cylinder Boring Machines.
Richards' Patent Open Side Planers.
Portable Valve Seat Planers.
Otto Patent Flue
Cleaners.

Universal Grinders.
Pneumatic Hoists. Tire Heaters.
Portable Crank Pin Machines.

SPECIAL TOOLS FOR RAILWAY REPAIR SHOPS

1001 & 1003 HAMILTON STREET,
PHILADELPHIA.



STEVENSON PATENT
IDEAL PENCIL DIVIDERS. FIRM
Number 69,
each only \$1.75

TOOLS.

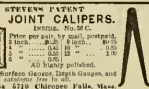

STEVENSON PATENT
JOINT LATHE. No. 50 C.
Price per pair, by mail, postpaid,
\$10.00. \$12.00. \$15.00.
All highly polished.

Ideal and London Spring Cutters and Dividers, Ideal Surface Gauge, Depth Gauges, and
Vine Scale-like "Tools." **ESTD** Household cutlery free to all.
J. STEVENSON ADW & TOOL CO., P. O. Box 5710 Chicago Falls, Mass.

BOSS SCREW PITCH GAUGE.

Price \$1.35, by Mail.

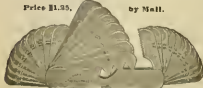

A FULL LINE OF
Machinists' Fine Tools.

SEND POSTAL CARD FOR OUR
NEW 1893 CATALOGUE.

STANDARD TOOL CO.,
Box G, ATBOL, MASS.

SHERBURNE'S AUTOMATIC TRACK-SANDING APPARATUS.

Three Ways Instead of One. Mind Your Steps.

On slippery rails sand the track automatically when brake is applied, avoiding rear collisions
In shunting, touch Lever and obtain jet of Sand and "get there."
The old rod and Lever retained as usual. For particulars apply to
SHERBURNE & CO., 53 Oliver Street, Boston.

Our Line Engravings are made by the
best process, a plan securing accuracy and
distinct lines on original copper plates
They are made by **BRADLEY & FOYER,**
251 William Street, New York City.



J.H. DIKLE CO.
TRADE MARK
GOLD'S
STREAM AND WATER FACTORY
Established 1848, 1, 1861
Specially adapted for Locomotives
(The Original Ring Packing)
Manufactured by **BRADLEY & FOYER**
of Boston and New York
New goods when the new
mark.

FLAT TURRET LATHE



STRAIGHT AND TAPER FRAME BOLTS, ETC.
SEND FOR A COPY OF
"RAPID LATHE WORK,"
By New Method - Harless System.
JONES & LAMSON MACHINE CO.,
SPRINGFIELD, VERMONT, U. S. A.



CATALOGUE ON APPLICATION.

THE NATIONAL MACHINERY CO.,
TIFFIN, OHIO.

**SPECIALISTS IN
Bolt and Nut Machinery.**

Bolt Cutters. Bolt Headers. Bolt Pointers.
Upsitters and Benders. Nut Tappers. Nut Machines.



THE ACME MACHINERY CO.
CLEVELAND, OHIO,

Manufacturers of
ACME BOLT & RIVET HEADERS
**ACME SINGLE AND DOUBLE
AUTOMATIC BOLT CUTTERS,**
Cutting from 1/4 to 2 1/2 inch diam
Also, SEPARATE HEADS and Dies.



THE PRATT & WHITNEY CO., Hartford, Conn., U. S. A.

SINGLE AND DOUBLE HEAD MILLING MACHINES used as Sub-
stitutes for Planers for Heavy and Rapid Cutting in Cast and
Wrought Iron and Steel.

TURRET-HEAD MACHINES AND TOOLS for Turning, Forming and
Threading Irregular Pieces of Circular Cross-section in Brass,
Iron and Steel.

METAL BAND SAWING MACHINES for Cutting Sprues from Brass
Castings.

MILLING CUTTERS, HOLDERS, with Inserted Cutters for Turning,
Shaping and Threading Metals. **SPIRAL SHEAR PUNCHES.**

CATALOGUE L SENT ON APPLICATION.

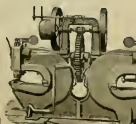

The Long & Allstatter Co.
HAMILTON, OHIO.

Double, Single, Angle-
Bar, Gang, Horizontal,
Twin, Boiler &
Spacing, Gate, Multi-
ple, Bolt, and Steam
Driven
Punches & Shears
OVER 300 SIZES.



Locomotive and Car Axles,
Coupling Links and Pins.

M. C. B. Passenger Coupler
Used in Place of Miller Hook
WITHOUT CHANGE IN PLATFORM.

M. C. B. STANDARD
Automatic Freight Car Coupler.

New York Office, . . . 120 Broadway,
Chicago Office, . . . 041 Rookery,
St. Louis Office, 019 Commercial Bld'g.

GOULD
Coupler Co.

BUFFALO OFFICE AND WORKS,
AUSTIN ST.

**Gould Continuous
Platform and Buffer.**

GOULD VESTIBULE.

Skilled mechanics prefer them Live dealers sell them

STARRETT'S

Best in workmanship
Finest in finish
Latest in improvements

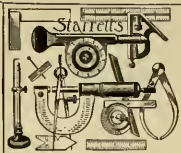

FINE TOOLS

Send for Catalogue L. S. Starrett, Athol, Mass.

For all workers in metal or wood Every tool warranted satisfactory

THE SMILLIE COUPLER is the Strongest and Simplest M. C. B. Coupler.
Only 4 Pieces.

Tensile Strength (Fairbank's Test) 139,640. Drop Test, 700 lbs.
hammer dropped 18 ft. 22 times failed to break the knuckle.

ALL LOCKING PARTS ARE THE BEST OF STEEL.

NEW YORK OFFICE, 52 BROADWAY.
Office and Works, 91 Clay St., Newark, N. J.



JOHNSTON CAR COUPLER COMPANY,
204 WALNUT PLACE,
PHILADELPHIA PA.

Strictly M.C.B. Lines. **JOHNSTON CAR COUPLER**

THE TROJAN CAR COUPLER CO., Troy, N. Y.
The knuckle may be thrown open for coupling by the hand rod at the side of the car, rendering it unnecessary for the trainmen to go between the cars to open the knuckle.
M. C. B. TYPE. THE STRONGEST AND THE ONLY SAFETY COUPLER. New York Office: 49 WALL ST.

STEEL ST. LOUIS COUPLER.

Stands M. C. B.
Tents, and complies with U. S. law, requiring use of Automatic Car Couplers on, and after January 1st, 1893.
Thousands of Cars already equipped. Capacity of Works, 200 Couplers per day.

ST. LOUIS CAR COUPLER CO., St. Louis, U. S. A.



THE POOLEY COUPLER.

POSITIVELY AUTOMATIC.

Made from the Best Material.
THE LONGER IN SERVICE THE BETTER IT OPERATES.

MANUFACTURED BY **PRATT & LETCHWORTH, Buffalo, N. Y.**

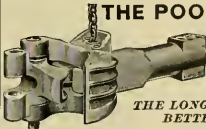

THE CHAPMAN JACK.
PATENTED.

THE screw being lubricated and protected, the Jack is always ready for instant service. Railroad men appreciate the importance of having Jacks always in good working condition. Serious delays frequently occur in getting common Jacks so that they can be worked when suddenly required in train service.
Common Jacks are frequently destroyed in efforts to make them work quickly after the screws are set with rust and dirt. This consideration alone makes the Chapman Jack the most economical one to purchase.

THE CHAPMAN JACK CO., CLEVELAND, OHIO.



OUR ENGRAVINGS.

Of late we have had a great many inquiries as to who made the fine half-tone plates shown each month in **LOCOMOTIVE ENGINEERING**. Credit is due the expert anywhere and we are glad to recommend the engravers of our plates to those wanting good work at reasonable prices. All the half-tones and reproductions we use are made by the **STAR ENGRAVING & PRINTING CO., 607 & 609 Sanson St., Philadelphia, Pa. SICOLA & HILL.**

CHARLES MURRAY
ENGRAVER ON WOOD
50 ANN ST. NEW YORK.

TANQY'S HYDRAULIC LIFTING JACK.
A good, reliable jack for lifting or pushing in any direction. The lever is for pumping it up, the key lever and stop it down point when it is again ready for lifting, saving time and trouble.
Various sizes made, from 4 tons to 200 tons.

Joseph F. McCoy Co.
26 Warren St., NEW YORK.



FIRE BOX STEEL.

Boiler, Locomotive AND Smoke Stack STEELS.
QUALITY UNSURPASSED
Plates up to 100 ins. in width.

SHOENBERGER & CO.,
PITTSBURGH, PA.

PURITY, DUCTILITY AND SOFTNESS.

RICHARD DUDGEON, 24 & 26 COLUMBIA ST., NEW YORK.

MAKER AND PATENTEES OF IMPROVED **HYDRAULIC JACKS**

Punches, Roller Tube Expanders, and Direct Acting Steam Hammer, and
1 1/2" Jacks for Pressing on Cross Pins or Cap Wrenches made to order. Communications by letter will receive prompt attention.



Cast Steel Works of FRIED. KRUPP, ESSEN, Germany.
 Represented by **THOMAS PROSSER & SON, 15 GOLD ST., NEW YORK.**

These works cover an area of 1,200 acres, employ about 18,000 men, have the most improved plant, and stand unique, from the fact that they have their own Ore and Coal Mines, Blast Furnaces, etc., and that every stage of manufacture is under their own supervision, and are not (like others) dependent on the open market for a miscellaneous assortment of crude material, which, in connection with 75 years' experience, enables them to turn out a product of a very superior quality, second to none, and at the same time the different grades of Steel are always of the same uniform quality.

Locomotive Tires, Crank Pins, Piston Rods, Spring Steel, Steel-Tired Wheels, Etc.

After a test of over 25 years the "KRUPP TIRE" has proved itself the best in the market. If a reliable article is wanted, which will give satisfaction, get KRUPP'S.

SCHENECTADY LOCOMOTIVE WORKS, SCHENECTADY, N. Y.

LOCOMOTIVES
 OF
STANDARD
DESIGN
 FOR ALL
CLASSES OF
SERVICE.

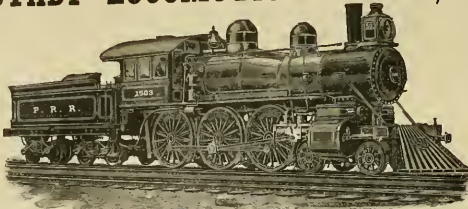

OR FROM
DESIGNS
FURNISHED
 BY
RAILROAD
COMPANIES.

EDWARD ELLIS,
 President.

WM. D. ELLIS,
 Vice-Prest. and Treas.

A. J. PITKIN,
 Superintendent.
 A. P. STRONG,
 Secretary.

COMPOUND LOCOMOTIVES, Showing an Economy of 15 to 30 per cent. in Fuel and Water. **Annual Capacity, 400.**

M. L. NEWMAN, Pres. and Treas. DAVID ROBBIE, Supt. H. TAYLOR, Asst. Supt.
 T. J. GIBSON, Vice-Pres. E. M. HARRISON, Secy.



Brooks Locomotive Works,
DUNKIRK, N. Y.

Builders of Locomotive Engines for any required service from our own designs or those of purchasers. Perfect interchangeability and all work fully guaranteed.

COMPOUND LOCOMOTIVES

FOR PASSENGER AND FREIGHT SERVICE.

ALBANY, N. Y.
 936 Broadway,
 New York City,
 115 BROADWAY.

STEAM COUPLERS
 AND
FIRE PROOF
HEATERS.

CONSOLIDATED
 McElroy, Sewall, Westinghouse and other Patents.
CATALOGUES UPON APPLICATION.
 Special Appliances and Extra Strong Fittings of Every Kind.
 AUTOMATIC CONTROL OF HEAT.
CAR-HEATING CO.

CHICAGO.
 200 Phenix Bldg.
 Canada,
 COATICOOK, P. Q.
COMMINGLER,
DRUM,
 AND
DIRECT STEAM
SYSTEMS.

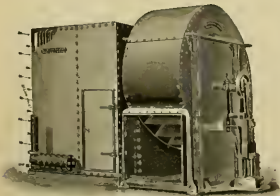

THE
STURTEVANT Heating Railroad Shops,
SYSTEM DRYING LUMBER, ETC.

Steel Plate Exhausters

FOR REMOVING SMOKE FROM FORGES AND REFUSE FROM WOODWORKING MACHINERY.

STEEL PRESSURE BLOWERS

FOR COPPLA FURNACES AND FORGE SHOPS.

B. F. STURTEVANT CO., Boston, Mass.

Branches: 91 Liberty St., New York.

16 So. Canal St., Chicago.

135 No. Third St., Philadelphia.

BALDWIN * LOCOMOTIVE * WORKS.

— ESTABLISHED 1831 —

ANNUAL CAPACITY 1,000 LOCOMOTIVE ENGINES.

Adapted to every variety of service, and built accurately to standard gauge and templete. Like parts of different engines of same class perfectly interchangeable.

COMPOUND LOCOMOTIVES.

Broad and Narrow-Gauge Locomotives; Mine Locomotives by Steam or Compressed Air; Plantation Locomotives; Noiseless Motors for Street Railways, etc.

BURNHAM, WILLIAMS & CO., Proprietors,
Philadelphia, Pa.



Pittsburgh Locomotive Works.

PITTSBURGH, PA.,

Manufacturers of

LOCOMOTIVE ENGINES

For Broad or Narrow Gauge Ponds

From standard designs or according to specifications in all particulars.

Tanks, Locomotive or Stationary Boilers

FURNISHED AT SHORT NOTICE.

WILSON MILLE, Jr. & Co. S. A. WIGHTMAN, Sup.



DICKSON MANUFACTURING CO.

SCRANTON, PENN.

Locomotives of every style and size, Standard and Narrow Gauge, made to Standard Gauge and Templete. Also for Plantations, Mines and Logging.

SPECIFICATIONS ON APPLICATION.

JAK P. DICKSON, President,
E. W. WETZEL, V. Pres. WM. S. PERKINS, Sec. & Treas.
JOHN SEVIER, Superintendent.

H. K. PORTER & Co.,

PITTSBURGH, PA.,

BUILDERS OF

LIGHT LOCOMOTIVES AND NOISELESS STEAM MOTORS.



CROSBY

POP SAFETY VALVES,

MUFFLED AND PLAIN.

IMPROVED

STEAM GAGES.

Single Belt CHIME WHISTLES.



A perfect equipment for a locomotive, giving maximum relief, accuracy and steadiness, agreeable tone. *Specify these goods when ordering locomotives.*

Crosby Steam Gage & Valve Co.,
BOSTON, MASS.
BRANCHES:
New York, Chicago and London, England.

ROGERS LOCOMOTIVE COMPANY

OF PATERSON, N. J.
New York Office, 44 Exchange Place.

MANUFACTURERS OF
LOCOMOTIVE ENGINES AND TENDERS,
And Other Railroad Machinery.
R. S. HUGHES, President.
G. E. HANNAH, Treas. G. H. LONGBOTTOM, Secy.
REUBEN WELLS, Superintendent.



PORTLAND CO. INCORPORATED 1846. LOCOMOTIVES OF ALL TYPES.

STANDARD OR NARROW GAUGE FOR ANY SERVICE FROM OUR OWN OR TO RAILROAD CO.'S SPECIFICATION.
Freight Cars, Derrick Cars, Push Cars and Car Wheels.
Boilers of Locomotive, Horizontal, Tubular and Vertical Type

FRANKLIN C. PAYSON, President. JAMES E. GREENSMITH, General Manager. BYRON D. VERELLI, Treasurer.



Richmond Locomotive AND MACHINE WORKS,

RICHMOND, VA.

Locomotives for Every Service.

ESTABLISHED 1865.

THE DETROIT No. 2 and 3

SIGHT-FEED CYLINDER LUBRICATORS

LUBRICATORS

FOR LOCOMOTIVES

ARE THE BEST.



This Lubricator discharges oil to cylinders accompanied by dry steam, consequently full effect of oil is obtained.
Cannot cross-feed.
No broken glasses by wear of steam and water.

DETROIT LUBRICATOR CO., Detroit, Mich.

Awarded Gold Medal and Highest Premium at the World's Columbian Exposition

COOKE LOCOMOTIVE AND MACHINE CO. PATERSON, N. J.

(Formerly Danforth Locomotive & Machine Co.)



JOHN S. COOKE, President & Gen. Man. PATERSON, N. J.
FRED W. COOKE, Vice-President.
W. M. BERDAN, Secy & Treas.

New York Office,
25 BROADWAY,
R. A. ALLEN, Agent.

Rhode Island Locomotive Works, PROVIDENCE, R. I.

CHARLES FELIX MASON, President. ARTHUR LIVINGSTON MASON, Secretary.
EARL PHILIP MASON, Vice-President. JOSEPH LYTTIGER, Agent and Supt.
WILLIAM P. CHAFIN, Treasurer. S. A. STURMIS, Traveling Agent.

NEW YORK OFFICE,

Nos. 31-33 Pine Street.

THE WESTINGHOUSE AIR-BRAKE CO.

Is now prepared to fill orders, at an hour's notice, for One or One Thousand Sets of

AIR-BRAKES FOR FREIGHT CARS,

having, at their New Works, an annual capacity for turning out Air-Brakes for 250,000 Freight Cars, 6,000 Passenger Cars, 10,000 Locomotives; besides repairs for the 350,000 Freight and Passenger Cars, and 26,000 Locomotives already equipped by

THE WESTINGHOUSE AIR-BRAKE CO.

Locomotive Engineering



A Practical Journal of Railway Motive Power and Rolling Stock.

COPYRIGHTED, 1914, BY ARDIE SINCLAIR AND JOHN A. FIFE.

VOL. VII, No. 3.

NEW YORK, MARCH, 1894.

30 Cts. Monthly
\$3.00 Per Year.

Unnecessary Reduction of Employees.

One of our contemporaries which has been devoting a great deal of space and labor lately to arguing that railroad men of all classes are in duty bound to accept reduction of pay without a murmur, inquires upon railroad officials the question: "If you had to pay the salaries of all the men employed out of your own individual income, do you think there would be as many employed?" An attempt is then made to answer the question in the negative. We believe that we have enjoyed an excellent opportunity for observing the conditions of employment on railroads and in private firms as any person connected with the *Railway Age*, and the result of our

ent upon them, and with the number of manufacturing establishments that are kept running with the expenses greater than the income. This is done for the purpose of providing a livelihood for the workmen under circumstances when it would be money in the pockets of the employers to close down the works.

We regret to say that we have seen very little of this benevolent spirit among railroad officers. They are hounded so with orders to reduce expenses that they appear to have no bowels of compassion. Those who perceive that they are losing valuable men who will be hard to replace when business revives, and understand that the policy will be costly in the end, perform the acts of harshness because they have no option

the most short-sighted kind of business policy, and ultimately causes increase in the expense necessary; but those who pursue it care for nothing but the present, and their acts exert disastrous influence upon the welfare of the whole country. There is certainly no reason to find fault with the men in charge of railroad operating for keeping at work men whose services might be dispensed with. The cause for regret is all in the opposite direction.

The Shoe Fitted.

We have had a rather amusing experience lately, which brings to mind some incidents connected with one of Dickens' novels. Readers of fiction will remember

of efforts made by various manufacturers of railroad supplies to make the purchaser the servant of the seller. The facts recorded were ingenious confessions of different men who were perfectly sincere in thinking that purchasers ought to do all in their power to accommodate the seller. Since the article was published, which is now two weeks ago, we have had complaints from three parties that we had been very unkind to make their business methods the subject of an article. None of the firms whence this complaint came had been in the mind of the writer when he was preparing the article. It looks as if the practices objected to were even more prevalent than we were aware of, and the indications are that the parties pursuing

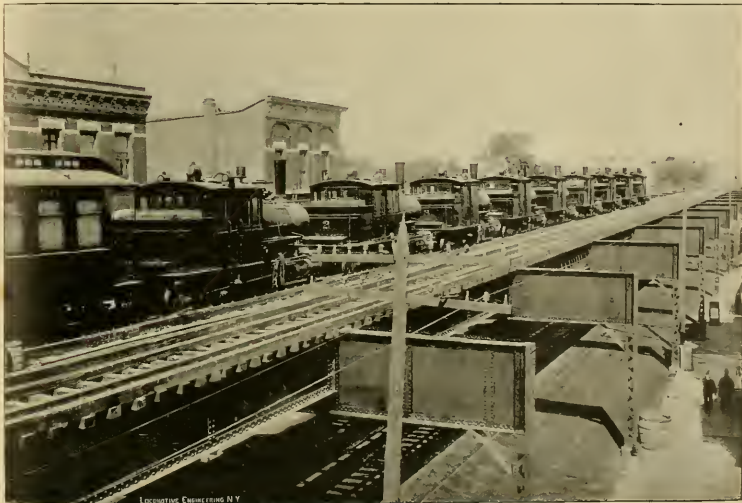

LOCOMOTIVE ENGINEERING N.Y.

READY FOR BUSINESS. LAKE STREET ELEVATED RAILROAD, CHICAGO.

observations is that we consider that railroad officers as a rule are less given to retaining superfluous help than any other kind of employer. A private employer, whose individual income suffers most severely in hard times, will often keep on old employees when there is little for them to do, partly through benevolent mistries and partly because it is good business policy to retain valuable men. In the course of numerous tours made during the last three months, we have been greatly impressed with the sympathy that private employers display towards those depend-

in the matter. To the manipulator of stocks, the individual employed is a mere machine. Supply and demand is his highest law, and he cares nothing for depriving men of employment. Men of this stamp give orders that operating expenses of railroads be reduced, and the executive officers have to obey or get out.

The present lamentable depression of business has been greatly intensified by that tendency of railroad stock owners and members to reduce operating expenses, and stop purchasing everything not absolutely required to keep trains going. It is

that in "Nicholas Nickleby," Dickens assailed the outrageous condition of the private schools by denouncing the educational methods of Mr. Whackford Squeers of Dotheboys' Hall. The pictures of the schools and schoolmasters of the day were so faithfully drawn, that the novelist was threatened with suits for damages by the proprietors of several different educational seminaries. We wish to tell how faithfully history repeats itself.

In our last issue we published an article headed, "Trying to Change the Methods of Railroad Purchasers," in which we told

them have an uncomfortable impression that they are on the losing side.

The Lehigh Valley Railroad Company have made a change in their method of charging meals in their dining cars. Instead of charging the hard and fast dollar for a meal, they supply eatables according to a bill of fare and charge accordingly. The patrons of the road talk very favorably about the change, and the indications are that this plan will become so popular that all railroad companies running dining cars will be compelled to adopt it.

The Elements of Boiler-Making.

By C. E. FOURNESS.*

In starting this series of articles on boiler-making, I will try and start at the bottom round by first defining circles, and its sections, also define cones, cubes, prisms, cylinders, spheres, etc.



1.—The radius of a circle is a straight line drawn from the center to the circumference, as $C D$.
 2.—The diameter of a circle is a straight line drawn through the center and terminating at the circumference, as $A C B$.
 3.—The circumference of a circle is a curved line, every point of which is equally distant from the center, as $A H K I L P Q R$.
 4.—A chord is a straight line joining any two parts of the circumference, but not passing through the center, as $H J J'$.
 5.—The versed sine of a circle is a perpendicular line joining the middle of the chord to the circumference, as $F K$.

6.—An arc of a circle is a portion of the circumference, as $B H$.
 7.—A semi-circumference is one-half the circumference cut off by the diameter, as $I L D B C A$.
 8.—A segment of a circle is any portion of a circle cut off by a chord, as $H J J' K H'$.
 9.—A sector is a part of a circle cut off by two radii, as $B C D$.
 10.—A tangent is a line that just touches a circle but does not cut it as $A T$.



The circle is a plane figure bounded by a curved line, every part of which is equally distant from the center.
 Rule.—Radius in relation to the circle.

1.—Multiply the diameter by 1.416, the product is the circumference.
 2.—Multiply the circumference by .705, the product is the diameter.

3.—Multiply the diameter by itself (square the diameter) and then multiply by .7854, the product is the area.
 4.—Multiply the square root of the area by 1.2732, the product is the diameter.
 5.—Multiply the diameter by .8502, the product is the side of a square of equal area.
 6.—Multiply the side of a square by 1.273, the product is the diameter of a circle of equal area.

Application of rules in relation to the circle

1.—Wishing to make a tank 38 inches in diameter, what would be the circumference required?
 $38 \times 3.1416 = 119.3808$ We now have 119 inches and 38.08 parts of an inch. As less than one-eighth of an inch does not amount to much in the circumference, we will reduce this decimal to one-eighths by multiplying by eight, $38 \times 8 = 304$, or three-eighths of an inch.

2.—The circumference of a circle 38 inches in diameter, equals 119.38 inches.
 3.—Having a sheet of iron 130 inches long, what diameter of shell will we make? First take off 2 inches for laps, we have then 128 inches, which multiplied by 3.1416 equals 40.247, or 40.247 inches in diameter.
 4.—Find the girth area of an upright boiler, the flrook being 3 feet in diameter, 3×3.1416 equals 7.06 square feet, the area.
 5.—The opening on top of the smokebox or breeching has 240 square inches. Find the diameter of smokestack which contains that area.

Extract the square root of 240, which equals 15.49, $15.49 \times 1.2732 = 19.747$ inches in diameter

5.—A man has a tank 36 inches in diameter, which he wishes replaced by a square

*Foreman Boiler-maker, C. M. & M. P. B., Dubuque, Iowa.

one of equal capacity. Find size of a square area in area, $36 \times 1.416 = 51$, length of side required.

6.—I want to replace a square tank by a round one of equal area. The old tank is 48 inches square. Find the diameter.
 $48 \times 3.1416 = 150.741$ inches in diameter.

1.—To find the area of a sector
 Rule.—Multiply the length of the arc, by half the length of the radius, the product equals the area.

Example.—Find the area of a sector, the arc being $9\frac{1}{2}$ inches long and the radius 7 inches long $7 \times 2 = 3.5 \times 9.5 = 33.25$ square inches, area.

2.—To find the area of a segment
 Rule.—Find the area of a sector whose arc is equal to that of the given segment. Then subtract the area of the triangle formed by the chord and radius, the remainder equals the area of the segment.
 Example.—Find the area of a segment, the length of the arc is $10\frac{1}{2}$ inches, the radius 7 inches, the chord 5.13 inches, and the perpendicular 3.75 10.375 $\times 7 = 72.72 - 14.25 = (8.332) \times 75 = 2$ 15.6.

CONCENTRIC CIRCLES
 Meaning one circle within another, and equally distant from each other at all points, or two circles with one common center

1.—To find the area of a segment
 Rule.—Find the area of a sector whose arc is equal to that of the given segment. Then subtract the area of the triangle formed by the chord and radius, the remainder equals the area of the segment.
 Example.—Find the area contained in the space between two circles, one 33 inches in diameter and another 28 inches in diameter

1.—To find the area of the space between two concentric circles.
 Rule.—Multiply the sum of the inside and the outside circles by their difference, then by .785, the product equals the area.
 Example.—Find the area contained in the space between two circles, one 33 inches in diameter and another 28 inches in diameter

$\frac{12+28}{2} \times 3.1416 = 16 \times 3.1416 = 50.264$

ELLIPSE
 An ellipse or oval is a curved line which returns into itself twice a circle, but has two diameters of unequal length, the longest of which is called the transverse, and the shorter the conjugate axis.
 1.—Find the circumference of an ellipse, or oval.
 Rule.—Multiply half the sum of the two diameters by 3.4416, the product will be the circumference.

Example.—An oval is 20 inches long by 15 inches wide. What is the circumference?
 $20+15 = 35 = 17.5 \times 3.4416 = 54.97$
 2.—Find the area of an ellipse or oval.
 Rule.—Multiply the two diameters together, and the product by .7854, the quotient equals the area.

Example.—An oval, 20x15 inches, require the area $20 \times 15 \times 7854 = 235.62$ square inches

TRIANGLE
 A triangle is a plane figure bounded by three sides and having three angles.
 Two sides of a triangle being given to find the third.

1.—Before raising a smokestack I wish to find the length of the guy-rods. The guy-band is 39 feet from the bottom of the stack, and the posts or anchors for guy-rods are 25 feet from the base of the smokestack.
 Rule.—Add the square of the base to the square of the perpendicular, and the square root of the sum is the hypotenuse or length required.

$39^2 = 1521$
 $25^2 = 625$
 $1521 + 625 = 2146$
 $\sqrt{2146} = 46.32$

length of guy-rod required.

3.—To another smokestack the guy-band is 39 feet from the bottom, and I have 16 feet of wire rope for guy-rods. How far must I set the anchors from the base of the smokestack?
 Rule.—Subtract the square of the perpendicular from the square of the hypotenuse, and the square root of the quotient equals the base.

Example.—I have 16 feet of wire rope, as there are four guy-rods in this case, I will have one-fourth of 16 feet, or 4 feet for each. As I will need about 1.5 feet for attaching to band and anchors, I will have 40 feet for hypotenuse or rod.
 $40^2 = 1600$
 $39^2 = 1521$
 $1600 - 1521 = 79$

DIAMETER
 3.—To find the area of a triangle
 Rule.—Multiply the base by one-half the altitude, the product equals the area.

Example.—Find the area of a triangle whose base is 14.5 inches long and the altitude is 6.5 inches long. $14.5 \times 6.5 = 94.25 - 94.25 = 47.125$
 4.—The above rule is very convenient for finding the area of any irregular figure formed by straight lines, as the example. Divide the figure into triangles and add the area of each; then add together.

CONES
 A cone is a body having a circular base and whose convex surface tapers uniformly to a point called the vertex.
 1.—To find the convex surface of a cone
 Rule.—Multiply the circumference of the base by the slant height and one-half the product equals the convex surface.
 Example.—Find the convex surface of a cone 6.5 inches in diameter at the base, and whose slant height is 18.5 inches. $6.28 \times 3.1416 = 19.635$ in the circumference of the base. $19.635 \times 18.5 = 363.2475 = 363.25$ square inches, the surface transferred.

2.—To find the solid contents of a cone.
 Rule.—Multiply the area of the base by the perpendicular height, and one-third of the product will equal the volume.
 Example.—To find the volume of a cone, the diameter at the base being 15 inches and the perpendicular height being 32.5 inches. $15^2 \times 3.1416 \times 32.5 = 1014$ cubic inches.

FRUSTUM OF A CONE
 The frustum of a cone is that part that remains after cutting off the top by a plane, parallel to the base.

1.—To find the convex surface of a frustum of a cone.
 Rule.—Add the two circumferences together, then multiply by one-half the slant height.

Example.—Find the convex surface of a frustum of a cone 25 inches in diameter at the bottom and 16 inches in diameter at the top and the slant height 10 inches.
 $25 \times 3.1416 = 78.5$, circumference of the base
 $16 \times 3.1416 = 50.264$, circumference of the top
 $78.5 + 50.264 = 128.764 \times 10 = 1287.64$

2.—To find the volume of a frustum of a cone
 Rule.—To the sum of the areas of both bases, add the square root of the product and multiply this sum by one-third of the altitude.

Example.—Find the solid contents or volume of a frustum of a cone, whose

altitude is 6 feet and the diameter of its base 4 feet and 3 feet.

$4 \times 4 \times 3.1416 \times 12 = 502.68$
 $3 \times 3 \times 3.1416 \times 12 = 351.68$
 $502.68 + 351.68 = 854.36 \div 6 = 142.39$

1.—To find the surface of a sphere.

Rule.—Multiply the square of the diameter by 3.1416, the product equals the surface.
 Example.—Find the surface of a globe 9 inches in diameter. $9 \times 9 \times 3.1416 = 254.47$ square inches, the surface.
 2.—To find the volume of a sphere.
 Rule.—Multiply the surface by one-sixth of the diameter.

Example.—Find the volume of a sphere 9 inches in diameter. $254.47 \times 3.1416 = 797.43$
 $797.43 \div 6 = 132.9$ cubic inches.
 A point has no dimensions, a line has length, a surface has length and breadth, a solid has length, breadth and thickness.

NO. 1. AREA
 A square is a plane figure, bounded by four straight equal and parallel lines, and has four right angles.
 1.—Find the surface or area of a square.
 Rule.—Multiply the length by the breadth, the product equals the surface

Example.—Find the area of a square 15 inches square. $15 \times 15 = 225$ square inches, the surface required.
 2.—To find the surface of a rectangle.
 Rule.—Multiply the length by the breadth, the product equals the surface

Example.—Find the surface of a rectangle 15 inches by 10 inches. $15 \times 10 = 150$ square inches, the surface required.

RECTANGLE
 A rectangle is a plane figure bounded by four straight parallel lines, and whose angles are right angles.

1.—Find the surface of a rectangle.
 Rule.—Multiply the length by the breadth, the product equals the surface

Example.—Find the surface of a rectangle 15 inches by 10 inches. $15 \times 10 = 150$ square inches, the surface required.

SQUARE
 A cube is a solid whose six faces are all equal squares.

1.—Find the surface of a cube.
 Rule.—Find the surface or area of one face, then multiply by the number of faces.
 Example.—Find the surface of a cube 9 inches long, 9 inches wide and 9 inches high. $9 \times 9 = 81$ square inches, the area of one face. $81 \times 6 = 486$ square inches, surface of the cube.

2.—To find the solidity of a cube.
 Rule.—Multiply the length by the breadth and thickness, the product equals the solidity.

Example.—Find the solidity of a cube 9 inches long, 9 inches wide and 9 inches high. $9 \times 9 \times 9 = 729$ cubic inches, the solidity.

PRISM
 A prism is a solid whose ends are equal and parallel, similar polygons, and whose sides are equal and parallel.

1.—Find the surface of a square prism.
 Rule.—Add the area or surface of the sides and ends together, the sum equals the surface.

Example.—Find the surface of a prism 6

inches wide, 6 inches thick and 16 inches long.

$A \times C = 36$, area of one end.
 $6 \times 16 = 96$, area of one side.
 $96 \times 4 = 384$, the number of ends = 384
 $36 \times 16 = 576$, the number of ends = 72

$\frac{384}{72} = 5\frac{1}{3}$
 square inches, the surface required.

Rule.—Multiply the solidity of a square prism. Rule.—Multiply the length by the breadth by the thickness, the product equals the solidity.

Example.—Find the solidity of a square prism, $10\frac{1}{2} \times 10 \times 24$ inches. $10\frac{1}{2} \times 10 \times 24 = 2520$ cubic inches solidity.

CYLINDER.

A cylinder is a solid bounded by a uniformly curved surface, its ends being equal and parallel.

1.—Find the convex surface of a cylinder. Rule.—Multiply the circumference by the length, the product equals the convex surface.

Example.—Find the convex surface of a cylinder 6 feet in diameter and 12 feet long. $3.1416 \times 6 \times 12 = 226.08$ square feet, the convex surface required.

2.—To find the solidity of a cylinder. Rule.—Multiply the area of the end by the length, the product equals the solidity. Example.—Find the solidity of a cylinder 6 feet in diameter and 12 feet long. $6 \times 6 \times 3.1416 \times 12 = 339.12$ cubic feet, the solidity.

That Angle-Cock.

We have received a flood of correspondence offering cars for that scapgoat—the angle-cock—that is always getting turned wrong. A great many of these are electric bells and wires, connections that have to be made beside coupling up the box. Improvers should not lay everything to the trap. There is no doubt whatever that in nine cases out of every ten where angle-cocks have been found turned, they have been left that way by careless or incompetent trammens. Surely if such a man has two connections to make under the car in place of one, he will make twice as many mistakes. The malicious person and the tramp may have done their worst, but we are inclined to think they are being overworked in this angle-cock business.

Some one will yet devise some simple improvement—like a hole or a valve—in the present apparatus that will give warning when any cock in the train is turned wrong, and this will be done without extra parts to handle. On passenger trains this is a simple problem of some connection between the brake-pipe and signal-pipe, but on freight trains it will probably be a valve that will set the brake when the cock is turned wrong. Anything that calls for making extra connections or turning extra cocks will be a source of more danger than safety, because men will depend on them to do something that they can't do.

The management of the East Tennessee, Virginia & Georgia have displayed good faith toward their employees and adhered to a verbal agreement, which is in strong contrast to the action of not a few other railroad managers. Four months ago, when times seemed to be at their worst, the management was compelled to reduce the wages of trainmen, and a protest was made that the old pay schedule would be restored on February 1st. When last month came round it was found that business was decidedly worse than it was when the cut took place, but the company kept the agreement, although they calculated to a certainty that the business of the road would be sufficiently improved to bear the increase of any roll without that harassment. We feel certain that the trainmen will show their appreciation by doing their best to reduce the consumption of supplies in every way possible, and thereby, in a measure, reduce the aggregate expenditure.

Duplex Compound Engines on Swiss Mountain Roads.

BY HENRY GREIFNER.

These engines are composed of two distinct groups of twin steam engines—a high and a low-pressure one—arranged under a common locomotive boiler. The high-pressure engine with its frame is made in a fixed connection to the boiler, while the low-pressure engine, placed at the front

ordinary engines. The reversing screw acts upon a lever, commanding the motions of the hind or high-pressure cylinders. From this lever, and by means of an intermediate lever and shaft, fixed in the prolonged main framings, also by an articulated tie-rod, the lever commanding the low-pressure cylinder motions is actuated upon.

The steam pressure in the receiver is limited to 70 pounds and safety-valves being provided to prevent the accumulation



of steam to swell under the boiler. Thus, the high-pressure steam pipes leading from the boiler to the respective cylinders are made a fixture, like in ordinary locomotives, and there is only a movable pipe, forming the receiver, connecting the two-cylinder systems; also a movable pipe leading from the low-pressure cylinders to the blast-pipe.

The two steam engines proper are built with outside cylinders and motions, and are mounted on an equal number of coupled

of a higher receiver pressure. If necessary, the starting of the engine can be facilitated at certain positions of the high-pressure pistons, by admitting live boiler steam to the receiver, and this can be done automatically by connecting the auxiliary steam-cock with the reversing gear.

It is claimed that, as compared with ordinary engines, the duplex locomotives have effected a saving of from 15 to 25 per cent. of coal by working the same trains and loads.

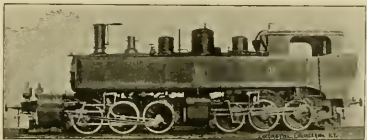

axles. As the front engine is made to swivel under the boiler, the framing of the locomotive is made of two distinct parts, in such a manner that the front framing is coupled or articulated to the hind framing by means of a strong vertical hinge. The hind or main framing, which carries the firebox, is curved upwards over the boiler engine, and supports likewise the boiler shell and water tanks, while the framing itself rests by means of suitable slides upon the front engine framing, which is thus en-

No. 151, of which a single engine has been built only, so far, runs on the Gotthardt Railroad. Its principal dimensions are: Boiler pressure, 177½ pounds (12 atm.); high-pressure cylinders, 15½ in. stroke, 25½ in.; tractive force, 19,320 pounds; heating surface of firebox, 100 square ft.; heating surface of tubes, 1,668.3 sq. ft.; total heating surface, 1,668.3 sq. ft.; grate surface, 23.7 sq. ft.; drivers, 41½ in. diam.; distance between buffers, 45 ft. 2½



abled to move freely in a horizontal direction. In order to prevent too great a mobility of the front engine, there are a pair of check springs put in, bearing against a support underneath the smoke-box.

The valve motions of both engines are made identically alike in all their parts. The stationary links are of the "Waltham" type, and as the volumes of the high and low-pressure cylinder systems are proportioned for an equal admission of steam, the reversing of the duplex locomotive is effected by a simple screw, as in

in, total wheel base, 25 ft. 7½ in. total weight, with full provisions, 187,200 pounds; weight, when empty, 147,577 pounds; water, 15,419 pounds; coal, 9,479 pounds. The engine is fitted with hand-brake and "Hardy" brake.

Of No. 180 there are six pieces running on the Central Railroad, built in 1891. The principal dimensions are: Boiler pressure, 177½ pounds; high-pressure cylinders, 14 in. diameter, low-pressure cylinders, 21½ in. stroke, 25½ in.; tractive power, 14,977 pounds; heating surface of firebox, 87.2 sq. ft.; tubes, 1,165.7 sq. ft.; total,

1,259.9 sq. ft.; grate surface, 19.6 sq. ft.; drivers, 4 ft. 2½ in.; distance between buffers, 37 ft. 6½ in.; total wheel base, 29 ft. 4 in.; total weight, with full provisions, 129,960 pounds; weight, empty, 105,760 pounds; water, 11,010 pounds; coal, 4,400 pounds.

Since these machines were put in service another order for ten more of the same type was placed about the same dimensions has been given by the company, and these are just now being delivered.

No. 6 is a narrow gauge engine, 3 ft. 3½ in. (1,000 mm) between the rails, and runs on the Landquart-Davos line. Two have been built of this kind, and their principal dimensions are: Boiler pressure, 171½ pounds; high-pressure cylinders, 19½ in.; low-pressure cylinders, 19½ in.; stroke, 21½ in.; tractive force, 13,200 pounds; heating surface of firebox, 65.7 sq. ft.; tubes, 797.6 sq. ft.; total, 863.3 sq. ft.; grate surface, 15.5 sq. ft.; drivers, 3 ft. 5¼ in.; distance between buffers, 33 ft. 2½ in.; total wheel base, 15 ft. ½ in.; total weight, with full provisions, 49,200 pounds; weight, empty, 41,500 pounds; water capacity, 7,710 pounds; coal, 2,200 pounds.

Besides the above-mentioned engines of the duplex type there are six more running on other roads in Switzerland, so that the total number in that country is now twenty-five, of which eight are narrow gauge (3 ft. 3½ in.). They have all been built by J. J. Maffei, in Munich. Zurich, Switzerland.

Curious Results of a Test of Metal Rope Fastening.

At the Seranton shops of the D. L. & W. they recently made some tests of wire rope and fastenings for it. One and a half inch steel cables are used in some of their mines, and these tests were made to determine whether or not the fastenings were as strong as the cable. Sockets with taper holes, known as rope cones, to receive the rope, and ending in a foot to fasten to the cage, are used. The rope is passed through the hole and the ends of the wires turned back, making a bushy head, into this mass of twisted and doubled wire they pour lead or babbit metal.

The pieces were tested in their regular wheel press. It was soon proved that the rope was amply strong, sustaining seventy tons with no other effect than a reduction of diameter owing to the compression of the soft center. Lead proved very soft for fastening the wires—they pulled through it a composition composed of three parts lead to one part iron, and broke far better. The forks sustained load enough to bend steel pins 2 inches in diameter before breaking, but when they did break a curious thing happened—one side of the fork broke in two places, and a piece about an inch long dropped on the floor; this happened when the load was about seventy tons.

The cross-section of metal was the same where each break occurred—but why should two occur?

Engine No. 19, on the Indiana & Illinois Southern R. R., was bought from the T. H. & I. R. R. in June, 1892. When she went there her valve-stems are packed with Kilmore packing. The left hand one chattered and did not work true, and the packing on that side would blow. It was taken out in about six months and packed with hemp; that stem has since been replaced with the right hand one. When she has never been touched, except to put in a little filler of hemp or rubber about three or four times since, and occasionally tighten the gland up a little—a period of over six and a half years. This engine has been on freight almost every day. If that packing is still made every day don't some one know it?

Michael Dune, formerly round-house foreman, has been appointed general foreman and road foreman of engines of the Cincinnati division, Penn. System, with headquarters at Cincinnati.

*** Diseases of the
Air Brake System;**

**Their Causes,
Symptoms
and Cure.**

By PAUL SYNNESTVEDT.

Engineer's Brake-Valve.

Before going into details as to the difficulties that arise in the use of the engineer's brake-valve, it will not be inappropriate to say a few words as to the different styles that have been and are now in most general use.

THREE-WAY COCK.

The first form used with the automatic brake was an ordinary three-way cock, the ones that had been used for straight air being made to do service by using the handle in the reverse position. The cock was simply a brass valve with three connections, one from the main drum, one to the train-pipe, and one an exhaust to the atmosphere. In one position of the handle, called the release position, there was communication between the main drum and the train-pipe, the exhaust being closed, in another position of the handle, called the application position, the exhaust from the train-pipe was open, the communication from the drum being shut, while the third position was midway between these two, and as it blanked all the ports, it was termed the "lap."

These three positions form the foundation for nearly all the engineer's valves, since designed to operate automatic compressed air brakes.

The main difficulty with the old three-way cock was that it had such a large port opening as to make too sudden a reduction when a service stop was desired. Another trouble was, that unless closed with very great care the stoppage of the opening was very apt to release the brake levers from the record of the train-pipe pressure.

Besides this there was no provision in the original three-way cock for storing any excess pressure in the main drum, and this made it difficult at times to properly release the brakes.

screwed together too tightly it was very hard to move, and if it was left loose it was constantly leaking.

BRASS ENGINEER'S VALVE.

The next valve to come into general use was a small brass valve with a rotary disk

stiff. The one which weakened the most was that which was placed just above the main or rotary valve, or more accurately, just within the head of the handle, and the result of this was to cause leakage in the train-pipe in the running position or on "lap." The excess pressure valve was the one which bothered by getting corroded, and this was because this was placed right in the center of the main body of the valve, and arranged in such a way as to be exposed to all the oil and water. Strange as it may seem, this small valve, the one requiring cleaning and repairs most frequently, was placed in the position most difficult to reach. To get it out required the taking apart of the whole valve

the valve-seat and reduce the size of the opening. **BLOW FROM EXHAUST.**
A constant blow out of the exhaust opening indicates dirt on the seat of this discharge-valve, and, if it does not blow out on a heavy reduction in the train-pipe,

EQUALIZING DISCHARGE-VALVE.

Following the second one came the equal-

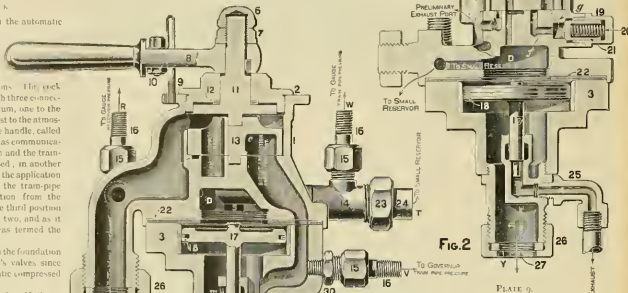

Fig. 1

Fig. 2

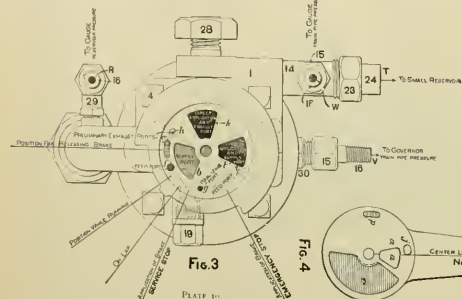

Fig. 3

Fig. 4

This old valve being in the shape of a plug-cock, was very liable to leak after a short period of service, as grit and dirt which got into the valves would cut grooves around the bearing. If it was

as the main operative part. This had an excess pressure valve and a spring device for cushioning the valve, which cut off the exhaust of air in applications of the brakes gave considerable trouble from weakening, and one which bothered considerably because of the corrosion making it brittle and

will necessitate the removal and cleaning of the piston.
An intermittent blow when the handle is on the lap indicates a leak somewhere around the cavity above piston 17, or the pipe connections to the small reservoir of train-pipe gauge.
A leak around any of these connections acts the same as a slight reduction in service stop position, causing the graduating piston to raise and open the train-pipe exhaust until train-pipe pressure is reduced below that in the cavity, when the valve will seat again.
A very small leak around any of the connections mentioned will cause quite a blow when the valve handle is on the "lap," because of the limited quantity of air contained in the small cavity and equalizing reservoir, and the fact that when the handle is on the "lap" all supply to this part is cut off. In the running position this blow will not show, because the equalizing port (c) from the train-pipe in the cavity (D) is open, so that the train-pipe loses pressure as rapidly as the cavity.

The parts of this valve most frequently requiring attention are: the rotary-valve 13, excess pressure valve 21, and equalizing piston 17. These should all be taken out frequently and cleaned.

OLLIN PISTON.
The relay and piston should be carefully cited before replacing, some oil which will not gum being the best to use. In se-

leaking an oil it must be remembered that when the valve stands near the boiler head it is subject to considerable heat, and any oil which dries rapidly is not suitable under such circumstances. The piston 17 seldom gives much trouble unless too much oil is being used in the air cylinder to the pump, in which case gum will collect around

LEAKS AROUND CAVITY.
Leaks from this cavity are very apt to occur around the joint of the gasket (22) between the two parts of the valve, especially if the valve stands very near to the boiler-head, as the heat dries the leather and makes it contract. Generally this can be remedied by tightening up the four nuts that hold the valve together, although sometimes it is necessary to put in a new gasket.

To become convinced of the importance of keeping all joints around this valve and the gauges tight, it is only necessary to experiment on a valve by making a leak (loosening the union connection to the small reservoir, for instance), and, with the handle on the "lap," examining the blow that will come out of the train-pipe exhaust.

This blow will, of course, be much heavier on a long train than a short one.

CLEANING ROTARY.
As stated above, it is necessary to fre-

Copyrighted by Paul Synnestvedt, Chicago, Ill. All rights reserved. This article commenced in January number.

quently take out the rotary-valve and clean it, and to do this it is necessary to let all the air out of the main drum, as that pressure bears against the top of the rotary-valve all the time. There are two convenient ways of doing this. One is to remove the valve handle so that the spring will not interfere, and then turn the handle

of little account for an emergency stop, and a serious wreck may be the result. In fact a number of serious wrecks have been attributed to this very cause, cases in which, as the papers say, "the air-brakes failed to work," simply because there was not sufficient air in the pipes to work them. The author has seen engineer's valves in operation in which the spring was broken or missing, and the engineer had to guess when his handle was in the running position. Of course, in examining the spring the quadrant should also be examined to see that the notches are sufficiently accurate and abrupt, and no one should alter these notches because the "excess pressure does not work right" unless perfectly sure that the ports do not register correctly.

EXCESS PRESSURE

Now that we have touched on the excess-pressure valve, let us say a few words more about it, and then consider the change that has been made in the latest valve by the substitution of the feed-valve in its place. The excess pressure valve shown on plate 9, No. 21, requires frequent removal and cleaning. If there is too much or too little excess the valve should be taken apart and

cleaned, after which it should be put in place and tried before anything further is done, as there may be no other trouble. To get at it most readily leave the handle in the service stop notch, with the train pipe shut off either under the valve or back of the tender, in case there is no stop-cock

where the trains are short, from 5 to 10 pounds is ample, while on long freight trains 20 is not too much. Where frequent stops are made, requiring considerable air, much excess will make it difficult to keep the train-pipe pressure up to the proper point on the valves we are now considering, which do not feed the train-pipe at all until the excess is pumped into the drum.

Under the head of Governor, will be found the explanation of the alternate in-

crease and decrease of excess pressure so often noticed after the train-pipe pressure has reached the limit at which the governor is set. This difficulty is not due to any defect in the excess pressure valve at all, and it is only a waste of time to take the engineer's valve apart in endeavoring to remedy it.

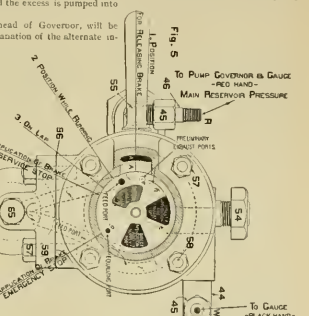

PLATE 13

crease and decrease of excess pressure so often noticed after the train-pipe pressure has reached the limit at which the governor is set. This difficulty is not due to any defect in the excess pressure valve at all, and it is only a waste of time to take the engineer's valve apart in endeavoring to remedy it.

TOO RAPID FALL OF GAUGE POINTER IN SERVICE STOPS.

If it is noticed on any valve that the gauge pressure reduces *very* rapidly when the handle is placed in the service stop position, it is a sure indication that there is some obstruction in the connection from the valve to the equalizing reservoir or that the reservoir is nearly full of water. Anything which will tend to decrease the capacity of the air in the cavity above the equalizing piston will produce this effect. To experiment on this, put a blind gasket in the union connection between the valve and little reservoir, when the handle can hardly be moved to the service stop position without losing all the gauge pressure at once.

TOO SLOW REDUCTION OF GAUGE PRESSURE IN SERVICE STOPS

If the pressure on the gauge reduces too slowly in service stop applications, it is generally an indication that the small equalizing discharge port is partially closed by gum or dirt and should be cleaned out. The same effect would be produced by having too large an equalizing reservoir, and the difficulty would be aggravated in direct proportion as the capacity of this reservoir was increased. The author once saw an engine on which a 12 x 33-inch reservoir had been placed because the small equalizing reservoir had not been sent with the valve. The engineer very justly complained that his brakes were very slow to set, until finally the proper drum was put in place. It should be understood that the discharge-port and little reservoir bear a certain proportion to each other, and any change in either will be pretty sure to result in trouble.

acted by a spring on one side and the train-pipe pressure on the other, and stays open until the train-pipe pressure has accumulated the limit of pressure, when it closes and allows the excess to be pumped into the main drum.

With this construction the governor, set at 90 pounds, is attached directly to the main reservoir, as the feed-valve prevents the train from accumulating over 70 pounds in the running position.

With the feed-valve it is impossible to have any excess pressure until the train has accumulated its 70 pounds, as, up to that time, there is an open passage from the drum to the train-pipe in the running position as well as the release, the only difference being that the port which is uncovered in the running position is smaller than that used in the release.

With a clear understanding of the principle of operation there ought to be very little difficulty in locating any defects that may arise in the operation of the device.

CARRIES TOO MUCH AIR.

If the train-pipe accumulates more than 70 pounds in the running position, it is very evident that air must be passing from the drum into the train, but the occlusion must not be hastily made that this is due to a defect in the feed-valve, for it may be, and not infrequently is, caused

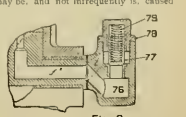

PLATE 14.

by an imperfect gasket between two of the main portions of the body of the valve. This is most apt to occur in gasket 61 just at the point to the right of the passage in which Fig. 6 stands in Plate 12, at which place it will be noticed there is a very narrow bearing.

Leakage by this gasket will be main-

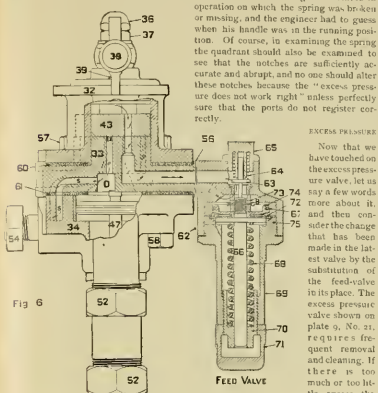

Fig. 6

upside down on the square and move it to a position about opposite the "lap," or, if there is not room for the handle to clear, use a wrench. Another is to leave the valve handle in the release position and go to the back of the tender and open the hose-cock

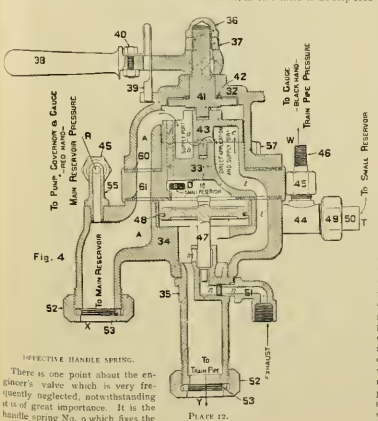

Fig. 4

ineffective handle spring. There is one point about the engineer's valve which is very frequently neglected, notwithstanding its of great importance. It is the handle spring, No. 9, which fixes the positions of the valve.

From violently striking the notch in release or emergency position this often gets bent or works loose, so that when apparently in the running position the ports may actually be lapped. When left in this position for some time the train-pipe pressure may reduce to such a degree as to be

in the train-pipe in the cab, when it will not be necessary to bleed the main drum. Twenty pounds is generally recommended as the proper amount of excess pressure to carry, and this is a good average.

The author prefers, however, to vary it according to the service in which the en-

PLATE 12.

tested in still another way much more troublesome than a mere increase in the train-pipe pressure.

NEGATIVE ACTION OF BRAKE IN SERVICE

It will prevent either partially or entirely the application of the brakes in service position. This is because the pressure in the cavity *D* will not reduce with sufficient rapidity through the small preliminary exhaust port if air is leaking from the main drum into the cavity at the same time.

To go back now to the increase of pressure in the train-pipe.

This may be due to trouble with the feed-valve. It is possible it may not be properly adjusted, or if it is all right in that respect it may be found to seat imperfectly. This may be due to some bend

in such a blow must be the natural result. This blow will stop more quickly if the handle be thrown immediately to full release position in letting off the brakes than if merely moved to running position as in the former case. The cavity (*D*) then has the benefit of an additional port(s) through which it may fill, while the release opening is not as much greater in proportion. If the piston refuses to close the exhaust in a reasonable time it should be taken out and thoroughly cleaned.

New York Engineer's Valve—Plates 15 and 16.

This valve, as well as the two of which we have previously treated, has the three principal positions of the old three-way cock "release" for letting the air from the drum back into the train "application," for shut-

tening, displacement or breaking of this spring would cause such defective action.

Boilers That Do Not Break Stay-Bolts.

"I read a report in LOCOMOTIVE ENGINEERING the other day," remarked Mr. William Buchanan, of the New York Central, "that the master mechanic of some road has large modern locomotive boilers in use that run for years and break no stay bolts. That is a kind of boiler that I would like to see the drawings of. I have been studying the designs of boilers for a great many years, and trying every rational thing suggested, to prevent the breaking of stay-bolts, but I am far from having found a perfect remedy. Good material and form arranged to provide as far as possible for the varying strains do much to make a boiler safe and durable, but I have never seen a large boiler subject to modern pressures that would run long without having broken stay-bolts. You newspaper men ought to enlighten people by publishing the drawings of the wonderful boilers that break no stay-bolts."

this subject. We are glad to see that the Traveling Engineers' Association are going to investigate it a little. Among the questions in a circular issued are the following: Have you tried the plan of paying premiums to the engine crew showing the most economy in coal? What is your opinion of the premium system? If premiums are paid, should they be given for greater mileage per ton in the month, or for greater improvement over previous months? Would the last plan encourage the poor or indifferent fireman to try to better his record? If you do not pay premiums, what course do you pursue to encourage your engineers and firemen to coal? Do you furnish your engineers and firemen with any literature bearing on the subject of combustion of coal in locomotive fireboxes?

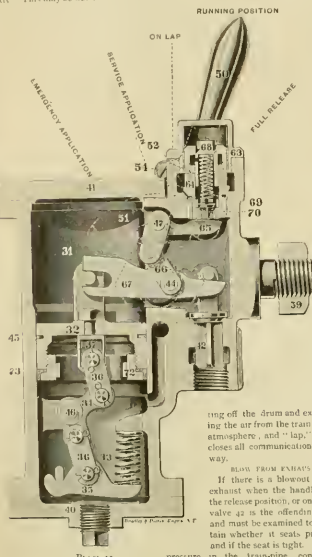

PLATE 15

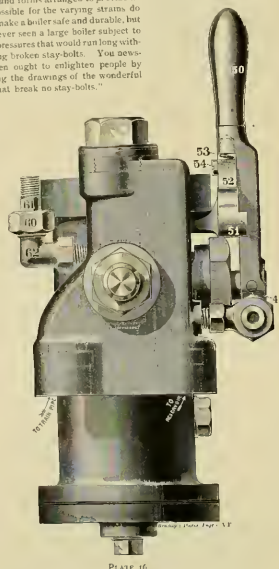

PLATE 16

ting off the drum and exhausting the air from the train to the atmosphere, and "lap," which closes all communication either way.

BLOW FROM EXHAUST.

If there is a blowout of the exhaust when the handle is in the release position, or on "lap," valve as is the offending part, and must be examined to ascertain whether it seats properly and if the seat is tight. If the pressure in the train-pipe constantly increases while the handle stands on "lap" the connections controlling communication from the drum to the train must be investigated. These are the piston 31 and the valves 44 and 70. The pressure is balanced between drum pressure below and train-pipe pressure above, and if the packing rings are not perfectly tight, the pressure in the train with the handle on the "lap" will soon show a gain on the gauge when the engine has no cars attached, or in other words, only a short pipe connected. This leakage can be reduced to a minimum by keeping the leather 73 soft and pliable.

RELEASE OF BRAKE.

Releasing of brakes on the lone engine will be apt to be one of the results of any leakage from the drum into the train, and an examination of the engineer's valve should be made before blame is laid on the triple.

In case of failure of the exhaust from the train to open fully when the handle is put to the emergency position, attention should be given immediately to the spring 33, as

or defect of a similar nature in the small section of the valve 61, or possibly merely dirt on the seat of this valve. In a case of this nature it is hard to determine which is the most promising field to investigate first. If in service application the reduction in cavity *D* is found to be slower than it should be the trouble is probably in the gasket, but if this symptom is not present at all it is a reasonable supposition that the gasket is all right, and something else must be examined instead.

BLOW FROM EXHAUST WHEN HANDLE IS PUT TO RUNNING OR RELEASE POSITION.

An excessive blowout of the train-pipe exhaust port on a lone engine or very short train (one or two cars) when the handle is moved to running or release position after applying the brakes, is no cause for alarm unless it is very extreme, as it is simply due to the fact that the train-pipe fills more quickly than the cavity *D* because the ports are larger, and on the pressure on top of the equalizing piston becomes greater than than breath-

We are looking round for the drawings, and will give them full publicity when we are certain that their stay-bolts do not break. It may be that the conditions of service—the uniform requirements of steam making, good feed-water and light service—may enable the boilers to run on one road without breakage of stay-bolts, while they would be no better than other boilers under more trying circumstances.

The Premium System.

The premium system introduced to induce engineers to use their best efforts to save coal and oil is doubtless a benefit to the railroad companies; but it is a source of constant heart-burning and jealousy among the men. There is some reason for believing, too, that the apparent saving is greater than it is in reality. Men well informed in the matter say that saving of coal and oil is sometimes effected by practices which increase the cost of maintenance and repairs. It would be a good thing to have all possible information on

Foreman J. C. Clarke, of the Woodward Oklahoma shops, of the A. T. & S. F., is rather proud of the record made by one of his engines, a 17 x 24-inch "Blood," with a 56-inch wheel. Two of these engines pull a mixed train between Woodward and Panhandle City, Texas, a distance of 143 miles, but one of them broke down in December, and the other one double, making in January 6,988 miles, pulling on an average six loads, a combination car, and a coach. This month's work was done on running repairs costing only \$16.20, and without the boiler being washed out—something unusual, as chain-gang engines only run with that water 2,000 miles between washings. This train allows a pint of valve oil for 73 miles run, and a pint of engine oil for 45 miles, yet the men on this engine run 86 miles to the pint of valve, and 60 miles to the pint of engine oil. Mr. Clarke gives all the credit of good work to the two engineers, John Scott and J. M. Bushwell, who took pains to blow the boiler out and get new rivets inserted themselves in keeping the old girl on her legs.

The Compartment Car Defended.

The numerous visitors from England who traveled on our trains last year appear to have gone home and told that traveling by rail in America is more comfortable than it is in the British Isles, and that our passenger cars are stronger and safer than the small compartment car used in England. This, coupled with object lessons of English cars going to pieces in wrecks, has stirred up an agitation in favor of hanging English passenger carriages to the American model. A correspondent

quently the carriage is more liable to oscillation, and, in fact, it rolls heavily, especially when striking points or entering a curve, when the tendency of this large and somewhat topheavy vehicle (in some modern cases seventy-six feet long and weighing nearly fifty tons) is to shoot forward at a tangent to the rails. It is, therefore, more than probable that many derailments are caused, and the serious consequences of accident intensified by the disposition of this vehicle to leave the rails and fall over on its side.

"This wide vehicle is attached to the two

thrown together in a confused heap at one end of the car, where in winter the lighted stove adds to the horror of the situation. In England the compartments localize the personal injuries.

"As a matter of comfort in traveling, the third-class passenger here is even better off than the first-class passenger in America, in each case settling aside the more wealthy passenger who travels in parlor cars or saloons, whilst the English vehicle offers considerable advantages, as already shown, in the direction of safety of the passengers generally."

the working of the sand-valves and pipes. When the lower reservoir is empty, we open the connecting cock between the two reservoirs and allow the sand to run into the lower one by the force of gravity until it falls. We then turn the air on just below where the pipe is cut, which throws the sand up into the sand bin. In filling the sand bin care should be taken not to quite empty the pipe of sand, for by so doing it is pretty hard to start it again. The cock on the loose end of the pipe is intended to be opened immediately if the supply is shut off, thus leaving a supply of



BOILER EXPLOSION OF A LOCOMOTIVE BOILER AT THE ERIE SHOPS, JERSEY CITY, IN 1884. FROM AN OLD PHOTOGRAPH IN THE POSSESSION OF W. L. BOWEN.

writing himself "Carriage Builder" has written to *Engineering* defending the English cars, and finding fault with those used on this side of the Atlantic. The correspondent evidently has never been in an American train, since he asserts that our car "rolls heavily," but he will no doubt convince many people that his views are worthy of consideration although they are the mere vaporing of ignorance. The letter reads:

"So much is heard in England regarding the superiority of the American railway carriages, and at the same time one reads of so many serious accidents (so numerous that in October one American paper had a column headed 'The Daily Smash'), that some remarks comparing the two types of carriages may not be without interest.

"The main difference is that the English carriage is on the 'compartment' system, one vehicle containing say six distinct compartments, not communicating one with the other. In the States the vehicle is on the 'corridor' system, and is practically one large open room with a passage down the center, each carriage communicating with its neighbor. The American vehicle, which is invariably larger than the English, is entered by a door at either end, instead of one door on each side for each compartment.

"The American condemns the English compartment because the passenger is at the mercy of any rogue or madman who may be his or her sole companion, and is, therefore, occasionally the victim of serious assault without being able to obtain assistance or move to another part of the train. Undoubtedly their system has the advantage over the English in that respect.

"They obtain the corridor by making their carriages some twenty inches wider than the English, and at the same time they gain head room by raising the height of the vehicle in the center. The rail gauge being the same in each case, it will be at once seen that in America the center of gravity is placed much higher, conse-

quently the carriage is more liable to oscillation, and, in fact, it rolls heavily, especially when striking points or entering a curve, when the tendency of this large and somewhat topheavy vehicle (in some modern cases seventy-six feet long and weighing nearly fifty tons) is to shoot forward at a tangent to the rails. It is, therefore, more than probable that many derailments are caused, and the serious consequences of accident intensified by the disposition of this vehicle to leave the rails and fall over on its side.

"This wide vehicle is attached to the two

thrown together in a confused heap at one end of the car, where in winter the lighted stove adds to the horror of the situation. In England the compartments localize the personal injuries.

"As a matter of comfort in traveling, the third-class passenger here is even better off than the first-class passenger in America, in each case settling aside the more wealthy passenger who travels in parlor cars or saloons, whilst the English vehicle offers considerable advantages, as already shown, in the direction of safety of the passengers generally."

starts immediately when the air is turned on whereas, if the sand is allowed to run into the lower one by the force of gravity until it falls. We then turn the air on just below where the pipe is cut, which throws the sand up into the sand bin. In filling the sand bin care should be taken not to quite empty the pipe of sand, for by so doing it is pretty hard to start it again. The cock on the loose end of the pipe is intended to be opened immediately if the supply is shut off, thus leaving a supply of

the working of the sand-valves and pipes. When the lower reservoir is empty, we open the connecting cock between the two reservoirs and allow the sand to run into the lower one by the force of gravity until it falls. We then turn the air on just below where the pipe is cut, which throws the sand up into the sand bin. In filling the sand bin care should be taken not to quite empty the pipe of sand, for by so doing it is pretty hard to start it again. The cock on the loose end of the pipe is intended to be opened immediately if the supply is shut off, thus leaving a supply of

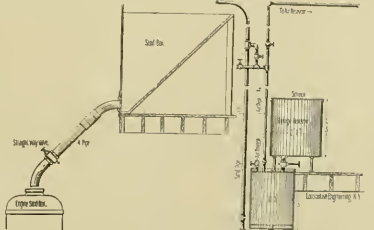

PNEUMATIC SAND ELEVATOR.

"Another feature of American coaches open to adverse criticism is the form of the seat, and the manner of attaching it to the vehicle. In England the seat is an integral part of the carriage, and, even in the third-class, is padded high enough to form a rest for the head. Across the water the seat is little more than a chair attached by screws to the floor of the carriage, and the back of the seat, which is reversible, only reaches to the shoulder, as shown by the diagrams. In the event of a sudden stoppage or jerk the American either falls forward with his face or chest against the back of the seat in front of him, or, having no support to his head, his neck is probably broken over the back of the seat he occupies. Take a very serious shock, say a collision or derailment, the seats in all probability give way, and, with the passengers (perhaps fifty in number), are

Mr William Smith, superintendent of motive power, writing to us about the host, says: "It is placed in the sand shed and this shed is dug out and walled up at the end of our coal shed. The building is about as high as the coal shed, and we run the sand cars up into it, the same as we do the coal in coal shed, and dump the sand from the cars into the sand shed underneath.

"We have two sand reservoirs down on the floor of the house, one of which is buried level with the floor, while the other stands above the floor. The upper one is what we term the storage reservoir, and is about the size of an ar-drum, as is also the under one. When the sand is dried it is thrown into the storage reservoir, and we keep this reservoir full, we have a screen in the top of this storage reservoir which allows nothing to pass that would obstruct

sand in the pipe. By so doing the sand starts immediately when the air is turned on whereas, if the sand is allowed to run into the lower one by the force of gravity until it falls. We then turn the air on just below where the pipe is cut, which throws the sand up into the sand bin. In filling the sand bin care should be taken not to quite empty the pipe of sand, for by so doing it is pretty hard to start it again. The cock on the loose end of the pipe is intended to be opened immediately if the supply is shut off, thus leaving a supply of

the working of the sand-valves and pipes. When the lower reservoir is empty, we open the connecting cock between the two reservoirs and allow the sand to run into the lower one by the force of gravity until it falls. We then turn the air on just below where the pipe is cut, which throws the sand up into the sand bin. In filling the sand bin care should be taken not to quite empty the pipe of sand, for by so doing it is pretty hard to start it again. The cock on the loose end of the pipe is intended to be opened immediately if the supply is shut off, thus leaving a supply of

They have commenced running dining-cars on some of the English railways, a peculiarity of the service being that there is a first-class and a third-class dining-car, with a kitchen-car between them. The trams having this greatly needed accommodation are vestibuled, and the passengers can pass through the train, a thing not practicable with the ordinary compartment car so much used. The vestibules are different from those used in America, being made of galvanized sheet-iron to form the gangways with "bellows" made of rubber sheeting. A novelty in connection with these dining-cars is that they are reported to pay the companies running them. We would suggest that some of the American railway companies which are constantly complaining about the loss incurred in running dining-cars try a third-class attachment to feed the people of small towns, who form the vast majority of travelers.

In September last the trainmen on the Nashville, Chattanooga & St. Louis accepted a reduction of pay of 10 per cent, and made no serious objection. President Thomas of the company has now displayed the spirit that he appreciates this helpful way by announcing that he is about to abrogate an agreement made with the men two years ago. If ever there was a railroad manager who deserves to have a fight on his hands it is General Thomas. He never was on any other railroad and has no idea of how white men ought to be treated.

Mr V B Lang has resigned the position of general foreman of the West Shore railroad shops at Newburgh, N. Y., and accepted the position of m. m. mechanic of the Louisville Southern Railroad at Louisville, Ky.

LOCOMOTIVE ENGINEERING

A PUBLISHED MONTHLY BY
ANGUS S. SINCLAIR, Editors and Prop.
JOHN A. HILL, Business Manager
GEO. W. WOLLASTON, Mgr. Adv. Dept.

3 Beekman Street, New York.

Subscription Price.

Five per year in advance for the mails, postage paid to any part of the world. Single copies, 5 cents. Sent by Express, Postage Extra. Draft, Postal Order or Registered Letter.

The editors reserve the right to use or discard matter for the reading column, entirely on their own merits. The reading column is not for sale.

Correspondents must give their names and addresses, but not necessarily their full names. Making address can be changed as often as necessary—always give old and new address, and you preferred to be published or not.

Please give prompt notice when your paper fails to reach you properly.

Entered as Second-Class Matter, New York, Second-Class Post Office.

Per Set by Newsdealers Everywhere.

NO BACK NUMBERS BEYOND THE CURRENT YEAR.

PUBLISHERS' AGENTS:
American News Company, New York, Boston.
W. Williams, 51 Park Bldg., Melbourne, Australia.

35,000 of this Issue Printed.

Notice to Correspondents.

Owing to the great number of letters received, answering all but a few, that are practically the same, many do not appear.

Let us suggest a few points for writers on this line. Don't ask solutions of puzzles, the answers string out over several months. State the trouble briefly and plainly, and then remedy you applied and the conditions of finding out the trouble. This is better than the puzzle, and thoughtful air-brake men will study the symptoms just as thoroughly, and those not so thoughtful will learn something—a month after they will have forgotten the case.

Don't send a letter without signature and address—of at least a post office. Don't mix up a letter for publication with something else, and please don't use up half your paper telling us what a good paper LOCOMOTIVE ENGINEERING IS—we know it is the best and that you appreciate it, if it takes time and also us to have to blue-print out so many kind words. The readers want plain, tersely-stated, interesting facts. These are the kind of letters we love to get.

SINCLAIR & HILL.

Judge or Dictator?

It appears nowadays to be the fashion with a railroad company does anything which is likely to be "made known" to the employes, for some influential person connected with the company to obtain an injunction from a judge of the United States Court, forbidding the aggrieved employes from striking. The most recent case of this kind was that of Judge Dundy, who issued an injunction restraining the employes of the Union Pacific from striking against a reduction of pay. The following paragraph gives the most important part of the order:

"Any employe who does not wish to continue his employment under these conditions (reduced pay) may, at any time and in any manner he sees fit, so as not to obstruct business; and it is unlawful for any employes to conspire, combine or confederate together while in the service of the receivers, or with, or through any labor or other organization, or the officers or committee thereof, with other person or persons whatsoever, for the purpose or with the intention of inducing a strike upon any of the railroad or telegraph lines operated by the said receivers under the direction of this Court, or to do any other thing, either directly or collectively, for the purpose of hindering, impeding, or in any way obstructing, embarrassing, or creating any undue pressure upon the receivers, in and about the business."

We believe that in all cases of this character, a much more sound principle is involved than that of putting in the hands of receivers or railroad managers the power to coerce their men into accepting reduced wages.

The violation of a principle of liberty of action is involved, which ought to appeal directly to every man who prides himself on living in a country where individual freedom is the heritage of all. If it is illegal for railroad men to combine for self-protection, when the property they are working for is in the hands of a receiver, common sense would say that it was never intended for them to combine or confederate under any circumstances. If the order of Judge Dundy is based on the laws of the United States, then the laws of this country are more unjust towards labor than the laws of any other country where large numbers of men are engaged in industrial pursuits. We understand that the laws of Mexico and of the South American States give the employer power to deal very summarily with "confederated" employes, but there is not a country in Europe where the order of Judge Dundy would not be considered an indefensible outrage on the liberties of the citizen.

An input United States judge may exert acts of tyranny exceeding the powers reposed in any other personage belonging to a country with a constitutional government, but, we believe that in his order to the Union Pacific employes, Judge Dundy exceeded his legal authority. The order forbidding the strikers from striking issued by Judge Jenkins to the employes of the Northern Pacific. We understand that those who obtained the injunction from Judge Jenkins regarded it as a bluff, and that they were very much afraid that the men would strike, and fall back upon the courts to decide the matter. The United States judge had authority to prevent them from combining for self-protection. We consider a strike of railroad men an unmitigated evil for the unfortunates who take part in it, but an order of a court restraining men from combining together so that they may be able to act as a unit, is striking at human freedom. The order issued by the letter and spirit of our system of government. A strike is a misfortune, but any man who has any sense of fairness and justice, ought to rejoice in seeing some case arise where there would be an opportunity of finding out whether a United States judge is a dictator or an administrator of the law of the country. A strike is an evil in the same sense that war and rebellions are evil, but cases sometimes arise where no other means are practicable in resisting tyranny. If the existing laws of the country make a man a criminal for combining to protect his own interests, the sooner a dictator or a tyrant is reached the better for all concerned.

Reproof for an Unjust Judge.

There are indications that the United States Circuit Judges, who have been a little lax in their view of striking against labor organizations, are about to be made to understand that they are the servants of the law and not dictators. A resolution has been introduced in the House of Representatives calling for the impeachment of Judge Jenkins for his action in the case of the Northern Pacific. This may not come to anything, but it intimates to Judge Jenkins and others holding similar sentiments that their masters, the people, are watching them.

Facts have lately been made public showing that the resolution taken by Judge Jenkins was dissipated by one of his associates. When he issued his order restraining the Northern Pacific employes from striking, it was sent to Judge Caldwell, asking for a similar order for the territory covering his jurisdiction. Judge Caldwell declined to do this, and in his opinion in regard to the matter in the following emphatic language:

"If the receivers should apply for leave

to reduce the present scale of wages, before acting on their petition I would require them to give notice of the application to the officers or representatives of the several labor organizations to be affected by the proposed change, of the time and place of hearing, and would also require them to grant such officers or representatives leave of absence and furnish them with transportation to the place of hearing and subsistence while both sides in person, or by attorneys. If they wanted attorneys to appear for them. The employes on a road in the hands of a receiver are the employes of the court, and as much to its service as the receivers themselves, and as much entitled to be heard upon any proposed order of the court which would affect the whole body of employes.

"If after a full hearing and consideration, I found that it was necessary, equitable and just to reduce the scale of wages, I would give the employes ample time to determine whether they would accept or reject the new scale. If by rejecting they would not be assisted from cutting the service of the court, either singly or in a body. In other words I would not enjoin them from striking, but if they made their election to strike I would make it plain to them that they must not, after quitting the service of the court, interfere with the property or the operation of the road or the men employed to take their road or the men employed to take their road. A United States Court can very readily find the means to effectually protect the property in its possession and the persons in its employ. I have in one or two instances pursued the policy I have indicated, and the differences were satisfactorily adjusted."

Subsequently, when a strike seemed about to break out on the road against a reduction of 10 per cent in wages, Judge Jenkins issued a second order of injunction against the proposed strike. When this order reached Judge Caldwell he ran his pen through that part arbitrarily enjoining the strike, leaving it only as a general restraining order against the employes of the road, and with the approval of the order by the successors of the strikers. This was not what the attorneys for the road wanted, and it was never recorded.

Improving the Valve-Motion of Locomotives.

Within the month we have received drawings of two forms of valve-motion designed to take the place of the link in operating locomotive valves. One is a modification and complication of a Corliss valve, the other is designed to operate a rotary valve of the slow-camper pattern by means of a vertical shaft secured to the cylinder, receiving motion from a shaft extending to the main crank-pin and engaging in a miter-gear attached to the pin. Both of the valve-motions in question display signs of great ingenuity and careful designing, but we do not believe that the experiment will ever operate the valves of a locomotive pulling a fast train.

The ambition to design and introduce into service a valve-motion which shall eliminate the reputed defects of the link-motion is still keeping inventors at work, but we have no expectation that they will ever accomplish an improvement on the present gear used for the distribution of steam in locomotives. There is a good reason for believing that all the labor, all the ingenuity, and all the money expended in trying to invent substitutes for the link-motion is so much misdirected effort. The modern method of valve-motion has been about sixty-five years, and it is doubtful if a year has passed in that period when some highly promising improvement was not offered to produce a better distribution of steam. For a few years before the link-motion was brought into use there were more inventions of valve-motion patented than of any other device. The link-motion was tried, and was considered of so little

propective value that it was not patented, yet within a very few years it monopolized the entire field, not only for locomotives, but for marine and every form of reversing-engine. As a reversing-gear it was unquestionably no equal, as a gear for distributing steam under constantly varying conditions of load, it has a better record for economy than anything else that the engineering world is familiar with.

What are popularly regarded as the faults of the link motion are readily perceived when engineers begin to study valve motion. More experience, however, very often convinces the same men that what they first consider to be the faults of the link motion are anything else in this type of valve gear. The student who looks at the motion with a critical eye becomes disgusted with the action of the motion when cutting off early, especially if he studies the subject by the aid of indicator cards. He starts out with the theory that steam ought to be admitted to the cylinders from the moment of the initial pressure close to that of the boiler. The supply of steam ought to be maintained to make a horizontal steam line up to the point of cut off, after which expansion should describe a hyperbolic curve, and then escape like an explosion at the end of the stroke. On the return stroke there should be back pressure, work retarding, and the valve should remain open long enough so that the compression which follows closure will be just sufficient to cushion the shock of the reciprocating parts. This is the ideal. The link motion has little of the theoretical ideal, but for making good use of the coal consumed it distributes the steam of a locomotive better than any of the perfected motions ever tried.

Among the numerous locomotive-valves gear tried as substitutes for the link, several have produced diagrams that closely resembled the well-known Corliss curve. They have made cards from which an important element of steam could be deduced, and which would compare with that of a locomotive doing similar work; but it was invariably found that the engine making the approach to the ideal card burned more fuel than the engine with the link motion, which made a card that looked like a jet of mutton. We do not believe that anyone ever gave the subject of valve motion more profound and intelligent study than William W. Clegg, superintendent of machinery of the Chicago & Alton; and we think he obtained a more thorough grasp of the subject than any other man we have ever met. He was ambitious to put on a locomotive a valve-gear that would make a Corliss card, and he succeeded. That is, he got the Corliss card, but the locomotive with the link motion doing similar work, was less engine card when the piston speed was less than 600 feet per minute; and what might be regarded as a greatly improved card up to the highest speeds necessary for express trains. But to the intense disgust and disappointment of the inventor, the locomotives having the improved Corliss valve motion did not run the engines with the link motion.

Others who have attempted to improve the link motion or the valve dimensions to approach as near as practicable to good stationary engine practice, have been disappointed with the results. An effort at improvement frequently tried has been applied to the valve gear in the form of passages, and giving unusually long valve travel. We have never known a locomotive with abnormally large ports and long valve travel that was not wasteful in the use of fuel. It is a little difficult to theorize on the true cause of this. What ought to be meant by long valve gear turns out to be practicable to be a source of loss. The evidence of this being the case is so overwhelming that we are compelled to admit that it is true. From the standpoint of a designer of high class stationary engines, the European locomotives, with their short steam ports and short valve travel, ought to be less efficient than American

locomotives in using steam; but American engineers do not compare in economy of fuel with those used abroad.

There are two causes which may account for the inferior economy of the locomotive built to approach the automatic engine ideal. Those who have attempted to dispense as far as possible with cylinder compression apparatus, have failed to resort to superheating and condensation. All engines run on steam with a wide range of temperature between the initial and the exhaust suffer more or less from the cooling of the cylinder to the temperature of the exhaust steam. When the hot steam enters from the boiler a portion of it is used in heating the cylinder walls, and the rest, which their cylinders so badly exposed to the cold atmosphere as locomotives, are very susceptible to the losses from condensation. When sufficient steam is left in the cylinder to be compressed to near boiler pressure at the beginning of the stroke, the mechanical heat generated by the compression passes partly to the cylinder and reduces the loss from condensation. Within proper limits the compressed steam also saves live steam, since it fills the clearance spaces close to boiler pressure. The attempts which Wilson and others made to run locomotives at high speed with the least possible compression in the cylinder lead to the same result, for live steam would fill the clearances and prevent shocks at the end of the stroke. It is easy to see how this would put a greater drain on the boiler than that required by the engine that was utilizing the blow of the reciprocating parts to compress steam to fill the passages and heat the cylinders.

Engines with very large ports have, necessarily, more clearance than those with small ports. The filling of the large ports may readily cause less of steam unless the necessary compression is obtained. When the valve travel is long the compression is likely to be restricted. The combination of long spaces and long valve travel may, therefore, tend to waste steam from the boiler that there is a constant tendency to entrain water with the steam, which has a most pernicious effect on automatic working. Again, the quick opening of the valve for release may intensify the exhaust action on the fire, causing quick, sharp exhausts instead of what approaches a continuous flow of steam through the nozzle.

These are merely theories. It seems certain, however, that large ports and long valve travel make an engine expensive in the consumption of fuel. There must be a reason for this, and that those we have offered give the only explanation we can think of after devoting careful study to the subject.

Piece-Work in Shops.

There is considerable prejudice among many skilled mechanics against the practice of piece-work in shops, which, we believe, to be based on a misconception of the true interests of the workman. The individual mechanics ought all to be favorable to a practice which would give first-class workmen, and to fully remunerate every man for the work performed. When payment is made on the basis of the amount of work finished, it has a stimulating effect to induce the young mechanic to help himself a first-class workman. Nearly all mechanics prefer to do a fair day's work without the assurance from foremen or gang bosses, but there are in every shop men who are mentally and physically opposed to doing more work than they can help. They will put themselves to greater exertion in working out schemes and covering up shoddy habits than would be necessary to do a fair day's work if their efforts were rightly directed. This class of man is violently opposed to piece-work, and being positive and aggressive

he carries others into supporting his views, whose real interests are all on the side of piece-work, since on that system they are not called upon to do the work of the loafer. Efficient superintendents and foremen have a pretty accurate idea of how much work ought to be turned out of a shop every week in proportion to the number of men employed. If there are many idlers in a shop who habitually avoid doing their own share of the work the industrious men have to work harder to keep up the average. Every man who has worked in a shop is familiar with the trifler who is always saying something and devoting his time to the amusement of his fellow-workers. We all know the man who makes believe that he is constantly busy and accomplishes nothing. Then there is the other type, who frequents hiding places and grins at the other fellows doing the work. The industrious workman is in the majority, and he ought to be the call of men employed. If there are idlers are paid for doing. In piece-work every man gets credit for his own performance.

Employers have been greatly to blame for the unpopularity of piece-work among mechanics. When, by industry or developed skill, workmen in any department begin making good wages under the piece-work system they have been cut down in prices until they could make little more than that received under day wages. This is not only an unjust but a stupid policy on the part of the employers, for they become the losers in the end. The first effect is to cause the best class of workmen to quit, and their places are taken by inferior men who are always accustomed to low pay. The next effect is to make the men careful not to do much more by piece-work than they would finish by the day. Men are sensible enough to understand the policy of the employers, and where they are likely to be fairly treated when they show how hard work they can do. Another objection from the employers' point of view to the cutting down practices is that it arouses the antipathy of the workmen, and they strive to get bad work passed. It is difficult for any method of inspection to detect bad work when the workman feels that he is justified in retarding upon his employer.

The system of piece-work, as it is carried on in many shops, greatly increases the productive capacity of tools and shop space and enables workmen to make exceptionally good pay without very hard work or long hours. There is no place for the idler in establishments of this character, and there are seldom openings for new men, because those employed know a good job when they find it and stick to it. Men working in these places, where employers take an equitable view of payment for piece-work, could not be driven back to the day-work system. That the piece-work system does not work well in some places is due almost entirely to the prejudicial tendencies of the employers. They rob the system of its chief merits, and then claim against workmen for being opposed to an arrangement which calls for payment according to merit.

Does Sympathy Help an Operator to Promotion?

A list of nearly 200 railroad officers, who have risen from the position of telegraph operator, has been published by the *Railroad Age*. The list finds more in the career of these men, which is: "Do not agitate for increase of pay, and you are likely to get it." Our contemporary puts the action to its soul and ribs in it, that none of the men who have risen to eminence from the operator's key was ever guilty of agitating for increase of pay. That is just where the *Age* is wrong. The energy which forces a man upward is likely to make him take an interest in the condition

of himself and fellow-men at the time he is at the bottom of the ladder, and cowardly fear of consequences is not likely to make his tongue mute. We know that some of the men who have risen highest from the operator's key were in former times the most energetic in advocating the interests of their class, and that they still retain the same spirit. It is the struggle for better remuneration of the men who remain in the lower ranks. It is a slander on the able men who have pushed their way upward, to say that their way was made easy by their turning their eyes up in holy horror at others who had the courage to say that they were miserably paid. Operators of the most prominent classes of workers in the railroad service, and the men who have come from that position fully recognize the fact.

The Uriah Heep who always "amble" is sometimes found in the position of telegraph operator, but the robust atmosphere of the United States does not agree with him. Operators of the most prominent classes of workers in the railroad service, and the men who have come from that position fully recognize the fact. The real test of his fitness for promotion is ability to perform the duties of a higher position satisfactorily. If he exhibits the qualifications required, his sympathy with or against his fellow-workers will exert very little influence.

Merciful Treatment Pays.

The policy of running a railroad in the manner described by Mr. G. R. Brown in his article on "Discipline without Punishment," in the last issue of *LOCOMOTIVE ENGINEERING* ought to appeal to the self-interest of railroad stockholders, for some figures based upon historical data indicate that the Fall Brook Railroad, of which Mr. Brown is superintendent, has enjoyed extraordinary immunity from serious accidents. The following facts may be accepted as correct:

"During thirty years not one passenger had been killed, and only six have been injured, two of those by fault entirely their own, the total number of passengers carried having been over six millions. The record for 1903 is in keeping with previous years: 461,000 passengers having been carried, and only one injured; that one forgot to leave the train when at his station, and was slightly injured in his attempt to get off the train after it had again started. As to casualties to employes engaged in the handling of cars and trains, one employe was killed and forty-three were injured during 1903, the number of trains handled being 27,843, running 2,059,064 miles, these trains being made up of 597,825 cars, running 42,267,931 miles."

The numerous railroad men who have been interested in the experimental work done in the laboratory of the Purdue University, will regret to learn that the engineering laboratory has been burned down. A feature of this laboratory, which was of special interest to the engineering world, was an apparatus on which a locomotive model could be run under conditions similar to those to which it would be subjected. It had a Schenectady locomotive which was experimented with a great deal, and much valuable information was obtained. They were about to begin a new series of tests when the building was burned, and the engine with much other engineering apparatus destroyed. It was in connection with this institution that the Railway Master Mechanics' Association voted to expend a large sum of money in carrying out tests. The proprietors of the University have determined to rebuild the laboratory, and equip it with even more elaborate apparatus than that destroyed. Professor Goss is the leading spirit in the work to be done, and he is actively at work making preparations for the equipment of the new building.

PERSONAL.

Mr. E. B. Gilbert has been appointed master mechanic of the Pittsburgh, Shenango & Lake Erie in place of Mr. E. Richardson, deceased.

Mr. J. D. Morehead has been promoted from round-house foreman of the Vandalia line, at Terre Haute, to be master mechanic at Paris, Ill., of the same road.

Mr. C. C. Richardson has been appointed chief clerk of the locomotive and car department of the Pittsburgh, Shenango & Lake Erie under Mr. E. B. Gilbert, master mechanic.

Mr. E. P. Mallinson has been appointed master mechanic of the Brooklyn Elevated Railroad, with headquarters at Brooklyn, N. Y. Mr. Mallinson was formerly in the Navy Department, and is a graduate of an engineering school.

Mr. E. J. Jardin has been appointed general inspector of rolling stock of the Brooklyn Elevated Railroad. Mr. Jardin is a locomotive engineer of long experience, and was for several years on the Long Island Railroad.

Mr. Ben. McKeen, Jr., son of President McKeen, has been promoted to be superintendent of the Peoria division of the Vandalia line, with headquarters at Terre Haute, Ind. A correspondent mentioning this appointment says: "Ben is a perfect little gentleman, and is well liked by everybody connected with the road."

A rumor has been lately current in New England that Mr. T. A. Mackinnon, general manager of the Concord & Montreal, has been appointed general manager of the Boston & Maine. There is some doubt about the news of the appointment being correct, but it seems certain that Mr. Mackinnon was offered the position if he cared to accept it.

One of our correspondents, Mr. J. M. Keith, who is master mechanic of the Western Railway of Guatemala, mentions a curious plan which he adopted to find the extent of back pressure in the cylinders of a locomotive. He drilled a hole in the base of the exhaust pipe and put in a 1/4-inch connection with the air-drum. The air-gauge then indicated the back pressure in the cylinders.

The Traveling Engineers' Association appears determined to go very thoroughly into the investigations they undertake, if we are to judge by a circular calling for information lately received from Secretary Thompson. The committee is composed of M. Mast, chairman; W. E. Chapman, W. H. Sheldon, Geo. H. Brown and P. A. Resstler. Their circular contains forty questions, all of a highly practical character.

A circular of inquiry concerning the use of sundry devices has been issued by Mr. O. S. Hart, chairman of the committee of the Master Mechanics' Association having that subject in charge. The aim of the circular is to find out what improved appliances are in use to apply sand to the rails for the purpose of preventing locomotives from slipping, and how efficient they are as compared with the common sandbox.

Mr. M. J. Redding, who for the past year has held the position of night general foreman for the St. L. I. M. & S. Ry., at Baring Cross, Ark., has been tendered the position of master mechanic of the White & Black River Ry., with headquarters at Brinkley, Ark. Mr. Redding had been connected with the Missouri Pacific system for several years, in charge of the air-brake department, and none knew the business better than he.

Mr. W. Lavery, master mechanic of the Erie at Susquehanna, Pa., has been appointed assistant superintendent of motive

power, with headquarters at Cleveland, O., succeeding Mr. Higgins, resigned. Mr. Lavery has been a long time on the Erie system, and has been noted for his success as a shop manager. There have been few men in the country who have approached him in the systematic manner in which he has conducted machine shops.

Mr. C. Youmans has been appointed general foreman of the New York Central shops at Depew, N. Y. Mr. Youmans was formerly with the R. & W. O. Railway, at Oswego, N. Y.

Mr. William E. Tew has been promoted from the position of assistant superintendent of the St. Cloud division of the Great Northern to be superintendent of the Cascade division or the same road, with headquarters at Leavenworth, Wash.

Mr. W. B. Stansifer has been appointed storekeeper and purchasing agent of the Butte Anaconda & Pacific, with headquarters at Anaconda, Mont. Mr. Stansifer has been for years connected with the supply department of the Great Northern.

Mr. C. B. Wilburn has been appointed superintendent and traffic manager of the Chattanooga, Rome & Columbus, with headquarters at Rome, Ga. Mr. Wilburn was formerly general freight and passenger agent of the Savannah, Americus & Montgomery.

Mr. Henry C. Ayer, intimates that he has severed his connection with the firm of Pedrick & Ayer, and with that of H. B. Underwood & Co. He has associated himself with Mr. Gleason, and under the name of Henry C. Ayer & Gleason Co., has commenced the manufacture of machine tools and engines.

Mr. V. B. Lang has been appointed master mechanic of the Louisville Southern, with headquarters at Youngstown, Ky. Mr. Lang was formerly general foreman of the West Shore shops at New Durham, N. J. While in that position, Mr. Lang was noted for the neat appearance of his shops, and for the systematic manner in which the work was done.

Mr. S. A. Sheppard, who has been for some time master mechanic of the Tavares & Gulf Railroad, has been appointed master mechanic of the Carabelle, Tallahassee & Georgia Railroad, with headquarters at Carabelle, Fla. Mr. Sheppard is a warm friend of *LOCOMOTIVE ENGINEERING*, and encourages men under him to profit by its educational facilities.

Mr. H. Dabbs, a very promising young mechanic, who has been working in the shops of the N. L. M. & S. Ry. at Burlington, Cross, Ark., has been appointed general night foreman, succeeding Mr. Reddy. Mr. Dabbs has been in the same position in these shops, and for several years connected with the Thomas Manufacturing Co., at Little Rock, Ark., in the position of foreman.

We have heard the remark made that the business of making aluminum brake shoes, which Mr. C. C. Jerome, the metallic packing maker, has entered upon, would not appear to amalgamate naturally with the manufacture of metallic packing. In answer we would say that the two lines of manufacture are kept entirely separate—they have no connection with each other, except in having the same lead, which is inventive enough and energetic enough to manage two shops.

Mr. S. Higgins has been appointed superintendent of motive power of the Lehigh Valley. Mr. Higgins has been for several years assistant superintendent of motive power of the Erie system, with headquarters at Cleveland, O. He rose through various steps to that position. He is a remarkably bright mechanical engineer, and has contributed valuable

papers to the different railroad clubs, and done valuable committee work for the Master Mechanics Association, of which he is an active member.

A new firm, Henry C. Ayer & Gleason Co., has been formed in Philadelphia for the manufacture of railroad specialties. Mr. Ayer's name is familiar to railroad men through his partnership in the firm of Pedrick & Ayer. They have started works at 2d and Diamond streets, where they are manufacturing machine tools, turning machines and the leading appliances required in railroad shops. The first-class first-class tools has been put into the works, and the intention is to make all the products of excellent finish and quality.

John J. McGrath, the well-known railroad jeweler of this city, made a neat stroke of business in getting complete control of the sale of the U. S. Waltham Co.'s new fine watch, named "The President." This movement is the latest, and has every known improvement up to date. It has been thoroughly tested, and the makers offer with it a written guarantee for its time-keeping qualities. It is sold on terms to guarantee the sale of a large number of fine movements per month to hold a monopoly on a brand of goods, but John has said and knows the watch will bear out all that can be said for it.

An effort has lately been made to turn out Captain Tyler from the management of the Atlanta & West Point R. R., with small prospects of moving him. Captain Tyler is a railroad man who began work at the first round of the ladder, and rose by native energy to his present position. He rose through the mechanical department, and was promoted to the position of chief engineer, and first-class has been his characteristic for every position he since he began railroading. He is exceedingly popular with high and low, and by his superior management operates the road under his charge at the lowest possible cost. Those interested in the Atlanta & West Point property will be glad to hear that Captain Tyler is retained in charge.

Mr. Isaac D. Barton has been appointed general superintendent of the Brooklyn Elevated Railroad, with headquarters at Brooklyn, N. Y. It is understood that Mr. Barton represents the interests of the Brooklyn Elevated road, which has been long associated with Mr. Corbin on the Long Island Railroad. For the last two years he has been general superintendent of the New York & New England, and is considered one of the most efficient expert railroad officers in the country. He has had quite a varied career in railroad service, having been station agent, conductor, train master, superintendent and general superintendent. He was for some time superintendent of the United States Rolling Stock Co., and had considerable experience in railroading in the West.

The Southern & Southwest Railway Club, which is a particularly active organization, of which Mr. P. Leeds, of the Louisville & Nashville, is president, will have their next meeting in April at Atlanta, Ga. The club will be introduced to Atlanta by road men from distant States. Mr. E. M. Roberts will present a report on "Construction of Ends of Box Cars," with special investigation into remedies for the bulging of car ends. "Is the Collar or Collarless Axle the Best Adapted to General Rolling Stock?" will be discussed by discussion by Mr. P. H. Shreber. Mr. McGee will present for discussion ideas on "The Relative Strength of Different Patterns of Metal-lic and Composite and Wooden Brake-brams under Service Strains." Mr. Philip Walle will report on "Soft Pliers for Stock" and "Influence of the Wash Pan and How to Keep Them Effective." W. H. Thomas will report on "Best Method of Keeping Locomotive Tubes Clean," and a variety of other interesting subjects will be brought up for discussion.

There has been a great deal of newspaper talk about contemplated changes on the Vanderbilt system of railroads. The Buffalo newspaper offices seem to take the lead in the manufacture of rumors of this kind. They have at definitely settled that the change is to be made by the New York Central, was about to retire, and that Mr. Webb would take his place. We confess that it would be in the interest of good business if this change took place, but there seems to have been no foundation for this rumor. Various other changes have been made by the New York Central, all of them originating in the fertile brain of the newspaper paragrapher. The Lake Shore was also the subject of contemplated changes, among them being the rumor that Mr. Canoff, general superintendent, was about to retire. President Newell, talking about this latter rumor, denounced it as very emphatically. He said that "these newspaper fellows are always telling that I am such a damned crank that I can get along with nobody. But even newspaper men must acknowledge that there is an exception to all rules, and the exception with me is that Canoff is one of the men whom I can get along with first rate."

The death of Mr. Gavio Campbell, whose last railroad position was that of general superintendent of the Wisconsin Central, takes away one of the most interesting personages in the railroad world among those who rose through the mechanical department. Mr. Campbell was a native of Glasgow, Scotland, and had considerable experience in marine engineering before he came to this country. Although while quite young he had made his mark as a marine engineer likely to rise to a good position in his own country, he was so impressed with the belief that America was the promised land for a man having to make his own way, that he gave up fair prospects, and came to America to begin at the bottom of the ladder. He began work on the Milwaukee Southern, and in a few years was promoted to the position of machine shop foreman. In 1871 he was appointed master mechanic of the Wisconsin Central, and seven years afterwards was promoted to be division superintendent. In 1885 the directors of the Green Bay, Wisconsin & St. Paul were looking for a man who could run their shops, and they got him. He succeeded Mr. Campbell to be general manager, a position which he held with great credit for four years. He left that to be general superintendent of the Wisconsin Central, a position which he held until nearly the close of his life.

Hall Signals for the Lackawanna.

The principal operating officers of the Delaware, Lackawanna & Western were ordered by President Sloan to make a thorough investigation into the merits of the various block signaling systems in use and to report. The result of the report submitted is an order to the Hall Signal Company, New York, to begin equipping the road with their most improved system. The contract calls for the immediate installation of signals for the M. & E. division, and the highest point, Merriestown, a distance of twenty-nine miles, and for the Montclair branch, which is five miles long. When this work is done the signal system will be extended in sections until the whole line is protected.

The signal system chosen is known as the West York system, and the highest development of the automatic electrical signals which the Hall people have been perfecting, step by step, for many years. By this system the Illinois Central tracks were protected that carried the immense passenger traffic to and from the World's Fair last year. The system was found not only perfect in protecting trains, but enabled them to be moved with practically no delay. The system is also in use on the Jersey Central and other roads. The Hall automatic block system of

signaling requires no personal attention in the setting and releasing of the signals. It is all done by ingeniously arranged electrical appliances, which are actuated by the wheels of approaching and passing trains. The signals in the latest system which will be put on the Delaware, Lackawanna & Western stand normally at danger, and are released by the approaching train if the block is clear. The mechanism for releasing the signal will not operate if anything is wrong or should be obstructed, a rail broken or a switch open. This arrangement of signals is one which not only secures absolute protection to trains, but is capable of controlling the heaviest species of train service without causing delay. Another attractive feature about it is that the indications of the track being clear are given under the eye of the engineer. As the train approaches a block the engineer sees the signal change from danger to clear. That intimates that not only the block is clear, but that there is an unobstructed track 1,000 feet beyond the succeeding signal, that margin being provided to protect a train for a reasonable distance beyond the signal. The apparatus for operating the signals appears to be perfect. Any breakage of mechanism or failure of the electric circuit merely results, in keeping the signals at danger.

Government Order for Lathes.

The Pond Machine Tool Company, of Plainfield, N. J., for whom Manning, Maxwell & Moore, 111-113 Liberty street, New York, are the sole sales agents, have just been awarded the contract by the Ordnance Department of the United States Army for the manufacture of gun lathes and other machine tools required in the construction of steel breech-loading rifle cannon of 12-inch to 16-inch caliber. The other bidders for this contract were the Niles Tool Works, of Hamilton, Ohio; Bement, Miles & Co., of Philadelphia, Pa.; Robert B. Miller & Son, of Philadelphia, Pa.; and the Builders' Iron Foundry, of Providence, R. I. The order consists of three lathes for turning and boring guns, one lathe for turning and finishing these guns, one machine for threading and slotting the guns and the rifling machine. This company have previously furnished the Ordnance Department with three lathes, one lathe and two rifling machines for the manufacture of breech-loading rifle cannon of 8-inch and 12-inch caliber. The lathes of 16-inch guns are very much larger and heavier in every particular, as the finished weight of three of these lathes will be 40,000 pounds each.

The present large contract awarded the Pond Machine Tool Company, is the first for completing the contract was four years, and they finished the contract to the satisfaction of the Ordnance Department, all the lathes having been fully tested and accepted nearly two years ahead of the time allowed them to complete the work, and it is not to be doubted that the same will be given by the execution of their previous contracts, both in regard to the quality of the work and time of delivery, favored them in the decision of the award of the present contract. The lathes are to be built from designs by the Ordnance Department, and the drawings, patterns and patterns will have to be made by the Pond Machine Tool Company, and when the lathes are built they are to be erected at the Army gun factory at Watervliet, West Troy, N. Y. They have eighteen months' time in which to complete the contract, and the amount of the contract is over \$200,000.

There is an impression among many engineers that a correctly balanced locomotive could be built with four cylinders and two rods, and that the rods, pistons and reciprocating parts of the inside cylinders acting as a counterpoise to the outside connections. A well-known English engineer, talking on this subject the other

day, expressed the belief that an engine of this character would be subject to disagreeable vibration, and that the shocks and strains now transmitted to the rail and frame would be sustained by the axle and would consequently make the axle much more liable to breakage.

Equipment Notes.

B. B. Hitchins, of Detroit, is in the market for 200 refrigerator cars.

It is rumored that the Monon route is in the market for 1,000 cars.

The Southern Pacific are said to be in the market for ten locomotives.

The Produce Dealers' Despatch Line, of Chicago, have ordered fifty cars.

The Baltimore & Southwestern are said to have ordered 200 box cars from Pullman.

It is said that the Cold Blast Refrigerator Co. of Kansas City are in the market for 100 cars.

It is reported that the Jacob Lule Packing Co. of Kansas City have ordered fifty refrigerator cars.

There was a rumor that the Baltimore & Ohio had ordered 200 freight cars, but it has been contradicted.

The New York, Susquehanna & Western have ordered 200 coal gondola cars from the Bloomsburg Car Co. It is reported that the Company are about to order several locomotives. They talk of having Wooten locomotives adapted for burning slack coal.

A bright ray through the clouded rail road situation in the West, is the news that General Superintendent Welby, of the Grand Central Western, has issued an order restoring the wages of all trainmen which was reduced to per cent. in October last.

E. Harrington, Son & Co., Philadelphia, are not complaining of hard times, although business is rather quiet. They have taken advantage of the lull to effect numerous improvements in their shops, with a view of being better prepared for the rush of business when it comes. Their new superintendent, Mr. McGregor, is busy making special tools, jigs and fixtures, with the view of improving the staple appliances made, and for securing uniformity at the lowest expense.

Special attention is called to the handsome educational chart accompanying this paper. The copper plate of this alone cost more than \$50, and is one of the finest pieces of work ever turned out. Every one of the 30,000 sent out deserves a frame. They are educational, and represent the highest development of the American locomotive up to March 1, 1894. Chart No. 3, the Triple Valve, will go out on May 1. It will be a working model of the valve and the best educator on brakes ever devised.

In January, 1893, we thought we did well when we were paid for and entered on our list 4,550 names. During the month of January, 1894, we were paid for and entered 7,250 names, new and old, and are correspondingly happy. We have now over 10,000 names on our mailing list, and the News Co. are taking over 4,000—and we are only just getting into the subscription business for the year. From February 1st to June first last year we entered more names for the year than we did in January, and this every reason to expect an increase this year. LOCOMOTIVE ENGINEERING now has far and away larger PAID circulation than the Railroad Gazette, Railway Age, Railway Review,

National Car Builders, American Engineer and Railway Journal, and Railway Review, combined. Our mailing lists and News Company orders are always on exhibition to anybody who cares to prove the above statement. More railroad officials pay for and read LOCOMOTIVE ENGINEERING than any other paper—we are loaded on this subject. This paper has a larger foreign circulation than any other American railroad paper, having more subscribers in Australia and New Zealand alone than any of the others send out of the United States altogether.

In a circular issued by the Traveling Engineers' Association, calling for information on the operating of locomotives, the question is asked, "What is the average time your engines are waiting for trains? This is a small question with a big tail to it. On some roads the engines are expected to be sent to the starting point for the train at the schedule time, and then they often stand for hours waiting. In this kind of waiting service, coal is burned sufficient to pull the train over a considerable part of the trip, and the telegraph system now in use there is no excuse for keeping engines waiting in steam for hours to take out trains that are late. It indicates bad management if the motive power department is not kept informed of the hours at which trains may be expected to arrive. This useless waiting for trains wastes more fuel than those responsible for it are aware, besides keeping crews on duty many extra hours. The expensive leak ought to be stopped, and the Traveling Engineers will do an important service to railroad companies if their investigation directs attention to the magnitude of this waste.

Hard times have come again and with them the old complaint that a mechanic has no future in these days of competition for the means of living. This complaint has been repeated to us until we are tired of hearing it. We acknowledge, sadly, that mechanics are having a hard time of it in these days of short hours and low pay, but we cannot see any other class which is more fortunate. There is fierce competition in every department of labor, and, naturally, every man who is suffering considers his own case the worst. High and low, men are finding their incomes decreased, but of course it presses hardest on those who earn little margin above a mere livelihood. When the broad field of labor is closely surveyed, and the condition of all the members noted, we do not think there is any reason for a mechanic to regret that he had not learned some other business, especially if he be a good mechanic.

On the bank of the clear flowing Delaware River, in a small valley in the suburbs of Easton, Pa., the Bessmer Manufacturing Co. have established fine new works for the manufacture of car seats. They have fine, light, airy shops, equipped with all the most modern appliances for facilitating the work. Mr. Bushnell says, that although business is dull, they have enjoyed a fair share of the few orders given, and that the street-car seat business has been better than they expected it would be. A visitor examining the work done in these shops, is struck with the ease exerted with the very smallest details, to render the production durable. They have lately effected some valuable improvements upon their passenger seats, and have also made some changes in the springing mechanism. This mechanism, which is independent of the arm rest, has always been popular and the new pattern is likely to make it more so.

We have received from Mr. William Kemp, of Boston, Mass., a description of a triple cylinder locomotive which he has designed and patented. The engine has three cylinders, two outside the frame

and one inside. The low-pressure cylinder is inside the frame and the intention is to keep hot by the smokebox gases. The steam passes from the boiler to the steam chest of the high pressure cylinder. After being used in that cylinder it passes to the intermediate cylinder on the other side, and from thence to the low-pressure cylinder. The drawings show indications of its invention and good designing ability. The inventor is willing to give the first railroad company which will adopt the engine the privilege of doing so without payment of royalty.

On the retirement of Mr. Edward Hedley from the position of master mechanic of the Brooklyn Elevated Railroad, on Feb. 18th, the men who worked under his direction made him a present of a magnificent set of drawing instruments. Mr. Hedley has only been at the head of the mechanical department of this road for a year and a half, but he made fast friends among the best men, because he treated them with justice and consideration. Had Mr. Hedley been less of a mechanic and more of a wall politician he might have gone higher in office over in the politician-ridden town of New York.

Under the heading, "Remarkable Angling," a new Brunswick paper contains detailed particulars of how Master Mechanic Haggerty raised a heavy locomotive out of the bottom of a deep lake, where it had gone while operating a heavy push snow plow. The fireman went down under the engine. This was another victim to the dangerous practice of attempting to clear off heavy snow with an obsolete machine. There is nothing more dangerous than rushing into deep snow drifts with push plows, and the practice ought to be prohibited, now that there are safe appliances for doing this work.

We were recently informed by a manufacturer of springs, in Philadelphia, that large orders for springs had recently been given out at a price for which good open-heat steel could not be bought. That means that the tendency towards cheapness was calling for the manufacture of Bessemer steel into railroad car springs. We think it bad enough that any railroad company should be short-sighted enough to use Bessemer steel axles, but to accept springs of that material is preparing the way to fill their repair tracks with disabled cars.

From railroad men everywhere, from general manager down to trainmen, come words of commendation for the plan of displacing men offered by Mr. G. R. Brown, general superintendent of the Fall Brook Railroad, in the last issue of this paper. We move that where this decent, manly, and honorable plan of dealing with men is adopted, it be called the "Brown Plan." It is the best of the man who originated it. Mr. Brown may have a monument in this that will eclipse anything that could be built of marble or bronze—and he deserves it.

When a railway accident happens in England, the daily papers are exceedingly free and frank in expressing their opinion of where the blame belongs. When a collision happens and is due to defective stopping or signal appliances, the papers never fail to tell that the true remedy is to pass a law requiring a director of the road to ride on the front platform of the locomotive, in the event of that kind of stoppage existing in the country we would hear fewer excuses for failure to equip railroads with signals and other safety appliances.

An engineer at Victoria, B. C., writes to say that for two years he has been using a device for releasing driving-brakes independently of the main brake. He has a 1 1/2-inch pipe tapped into the lower head of driving-brake cylinder, and leading up into cab with a common globe-valve on it, this is

located beside the engineer's valve. By its use he can stop the sliding of the drivers without letting brake off, and also finds it very convenient in switching, especially if in a hurry. It is just as effective with automatic as with straight air.

Mr. S. W. Johnson, locomotive superintendent of the Midland Railway of England, has lately designed a new passenger locomotive which has some peculiar features. The engine has a single pair of driving-wheels, 60 inches diameter, and is a four-wheel truck in front and a single pair of carrying wheels in the rear. The cylinders, which are inside the frames, are 19 x 25 inches, and are inclined upwards towards the driving-axle. Piston-valves are employed and they are set beneath the cylinders.

At the Middleton shops of the N. Y. O. & W. we recently took out a wrought iron back axle from an eight-wheeler that showed considerable wear. The axle was new just twenty months before, having been put in May 12, 1892, and taken out January 12, 1894. The bearings were originally 8 1/2 inches in diameter and 8 1/2 inches long, one of these was worn to 7 1/2 inches in diameter and the other to 6 1/2 inches. This engine has a weight of 72,000 pounds on her drivers, and made in the time given a distance of 128,660 miles.

The Pennsylvania Railroad Company are making careful experiments to test the value of the Harvey hardening process as applied to tires, crank pins, axles and other parts of the engine. It is said to be rapid wear. The indications of material reductions of wear are very promising. Many railroad men are watching these experiments with keen interest. If they prove as successful as expected, that process will prove of incalculable benefit to railroad companies.

One of the most idiotic fakes we have seen in print lately was a long article in a Cincinnati paper, saying that the Erie people were about to adopt a buffer brake for the whole of their rolling stock. The statement was made that the company named had had 100 cars equipped with the brake, and its working was so satisfactory that they were about to discard the air-brake. There is not a word of truth in the story.

In a paper, read before the German Society of Engineers, by Herr Lentz, a statement is made that there are 109,000 locomotives in use in the different countries of the world. There are said to be 63,000 in Europe, 40,000 in America, 3,500 in Asia, 2,000 in Australia, and 200 in Africa. Of those used in Europe, Great Britain and Ireland is credited with 17,000, Germany with 15,000, and France with 11,000.

On a North British railway they have in use a system of car heating, in which the exhaust steam from the engine is pumped into the cars to do the heating. We are afraid that this system would give very little comfort to passengers in cold weather.

The existing depression in business caused the Niles Tool Works, of Hamilton, Ohio, to greatly reduce their force, and to diminish their working hours to eight hours a day. They have now begun to work ten hours a day, and additional men have been given employment.

Something over 300 copies of our paper drawings have been asked for and sent out, this ought to mean some original ideas offered for the benefit of the railroad and the men who run locomotives on them.

The great miracle of modern engineering is the converting of the impossible of yesterday into the practical of to-day.

* Railroad Coppersmithing—VII.

By JOHN FULLER, SR.

ON SPINNING SHEET BRASS.

In both locomotive and marine applications there is sometimes considerable ornamentation of brass-work of various kinds, such as edgings for splashers, moldings, castings for domes, valve chimeys and covers, hand-rails, and a variety of other work, and I have often witnessed a great deal of annoyance and disappointment among workmen, myself included, on account of their want of attention in relation to the laws of expansion and contraction while attempting to brace joints for the completion of their work. Then, again, the many different kinds and qualities of brass made and sold often lead men into trouble, partly through the deception of the dealer or manufacturer, but mainly through their own ignorance of the nature of the material they are expected to work up. There are so many mixtures called brass that a workman may encounter a failure when least expected, unless he is quite familiar with them or on the alert and wary. After much unpleasant experience in this direction, it has been learned that when one is working on sheet brass of an unknown quality which it is required to solder together, before the work is begun it is best to take a small corner piece, and try its merits with such spelter as may be at hand. If the solder can be made to run with ease on the surface being tested, there will be no further trouble. But if it will not run on it, then it is desirable and necessary that some should be procured that will. After the work has been cut out, there are usually some scraps that cannot be used to any advantage for anything, take a portion of these scraps, if there are any of one, a portion of the sheet, say a pound, and having provided a small crucible, melt the scraps with some borax, and in the meantime have an ounce of zinc melted in a ladle. When they are both in a liquid state, mix the zinc and stir with a hard stick or chisel-rod, then pour it out, and when it has cooled enough so that it will only char the hand rod, break it up into small grains in an iron mortar, and then try its merits on another scrap of brass. If this new composition is not to be used, melt it again and add a little more zinc, until it will run with safety to the work in hand—that is, without fear of burning the parts adjacent to the joint, or having the scraps fall off from excessive heat. Brass made to have a silvery luster when polished is always difficult to work, and requires the utmost vigilance while being braced together, and much experience is necessary as well to the preparation of the work for this operation. In some instances it is necessary to add a little silver to the spelter in addition to the zinc, which will reduce the amount of heat necessary to run it, and add much to its malleability. The quantity required, however, is necessarily dependent upon the kind of brass, and must be left to the scrutiny of the operator. Having procured a spelter suited to the brass, let us suppose we have a job similar to that of the moldings shown in Figs. 58 and 59, requiring a strip of sheet brass 1/4 inches wide to be joined and braced together, then trim the edges of both ends to the work and cramp one with a chisel. The next step is to prepare a frame from a piece of 3/4-inch boiler plate, Fig. 92, in the shape of a horseshoe, some 4 or 5 inches wide, and about 15 inches long in the legs, also two screw clamps, C, and two pieces of bar iron, D, strong enough to hold the brass fast on the horseshoe frame when the clamps are applied. Bend the sheet in form shown, so that when the joint is brought together within the horseshoe frame it will hang in a curve or ramp between the legs of the frame. Now bring them together: open the clamps, and let

them screw the end of the other piece, and screw it fast to the plate with the clamps. Through the eyes of the screw-clamps pass an iron rod, and hook the two ends of a short chain to the rod, and then swing the whole thing to the traveling chain overhead. Take it now to an anvil and close down the joint, and be careful to take out all the spring from the parts about the joint before going to the fire. When at the forge apply two pair of tongs, and see that the work is slung so as to balance and hang level. Then chatter the joint and run some liquid borax through, charge it and dry slowly. Then with a low fire heat the parts within the frame gradually until the solder is all down; then with a gentle fire the joint may be chiseled successfully run down.

BRASS SOLDERS OR SPELTER.

The strongest spelter used by coppersmiths for heavy work is composed of 3 parts of copper and 1 of zinc. Another is made of 8 parts of old tubes or Bristol brass and 4 of zinc. Another, for copper of medium strength, is composed of 16

parts of copper and 1 of zinc. Another is made of 8 parts of old tubes or Bristol brass and 4 of zinc. Another, for copper of medium strength, is composed of 16

We will now form up and proceed to complete our brass moldings, supposing the directions given on brazing sheet brass has enabled us to successfully join together the pieces which make up and complete the pattern. Then we are now ready to go on. The pattern for the smokebox end, which has now been formed into a narrow or shallow frustum of a cone, is

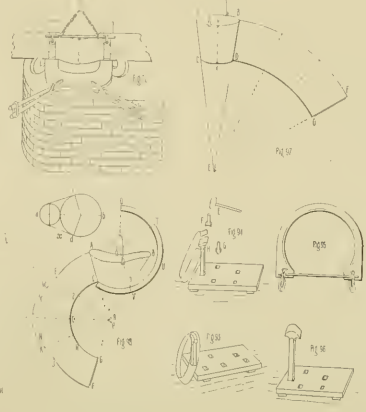

parts of copper and 12 of zinc. For the better kinds of brass equal parts of copper and zinc.

COMPOSITION OF BRASS.

It may be well to notice here some of the many alloys called brass, and their composition.

The following have been collected in a promiscuous way as opportunity offered, and are here presented for the benefit of the boys and those interested

	Copper, ounces.	Zinc, ounces.
Bristol Brass	16	6
Mintz Metal	16	12
Pale Yellow Brass	16	16
Muntz's Brass	16	16
Mosaic Gold	16	17
	Copper, parts.	Zinc, parts.
Brass, reddish yellow	86.6	11.4
Prince's Metal	83.0	17.0
Rolled Brass	79.6	20.4
English Brass	74.0	25.0
German Brass	62.2	33.8
Watchmakers' Brass	49.5	50.5
Pinchbeck	48.0	52.0
Tombak	44.5	55.5
Maiden Gold	30.0	70.0
Button Brass	30.4	69.6
Best Metal	32.0	68.0

There are many other compositions called brass. It will be readily seen that the workman who is ignorant of the many alloys commonly called brass, and incap-

able of judging or even forming an intelligent opinion as to the quality of the brass or the solder necessary for the particular kind he may be called upon to work up, can very easily and innocently fall into the position. I have found but little charity shown to workmen, or by them, when innocent failures of this kind have happened, and I have had my share. It is hoped the tables above given may be the means of assisting the young workman, and aiding him to avoid the chances of failure likely to occur in working of any of the poorer kinds of brass, if called on to do so.

WORKING UP BRASS MOLDINGS.

The first course is executed to give the curve to the large end of the frustum ring, and thus stiffen it enough so that it can be handled without fear of collapse. When this is finished it is turned the other side up and the arch flange for the band is laid off on a suitable mandrel, Fig. 76, then it is hung on a steak, Fig. 94, having the same curves as the O.G. of the molding is required to be, and carefully dressed with a smooth-faced mallet to the curve of the steak while the brass is soft, when it has been roughly formed to the shape required, it is scoured clean with the aid of muriatic acid and salt, washed thoroughly and dried, when two swages made of block or ingot tin, Fig. 94, are brought into use with the aid of a helper and a suitable maul, E, the molding is swaged on the cast-iron steak, H, Fig. 94—first the convex curve with the swage F, and then the concave curve with the swage G. If this work is carefully performed, a nice clean, smooth job will be the result, and no filing or sand-paper necessary to prepare the surface for polishing.

The middle molding is worked into shape in a similar way, except the two legs of the pattern V, Fig. 89, are put into shape and roughly fitted to their places before being

joined or brazed to the other part of the pattern. When the legs have been prepared sufficiently and the whole joined together, put it in its shape and fasten the legs in the right position with a light file bar about 1/4 x 5/8, and screw clamps, Fig. 95, then proceed as before directed by turning in the edge for the firebox and turning out the edge for the boiler; then on a steak having the same curve and O.G. the molding is wanted, draw it to the form desired, and then before and after the work is smooth, as shown in Fig. 96.

The molding at the front end of the firebox is formed up in a similar way to the other two, the arch being partly prepared before the legs are joined to it. When the legs have been brazed on, it is put into final shape and held there by a bar and screw clamps, as shown in Fig. 95, and swaged smooth on a steak, Fig. 96, of the same shape as the molding is designed to be.

FITTING MOLDINGS.

Fitting moldings and copings for lagging is rather a particular and trying job as a rule—at least it was when I first tried my hand at it—because the two that encircle the boiler were made in two halves and slipped into a joint at the top of the boiler, and then when the wooden lagging had shrunk and the hand got a little loose the halves would nearly always shake out of place, and because men would get impatient and get the stud holes wrong, and the fitters put in male studs instead of female bolts to receive a set screw, so that after a few months running the lagging being loose and out of place, the moldings, instead of adding to its beauty, would give it a disfigured appearance, as if the engine had been at work for years. We put these moldings on in two halves for quite a number of years, as it seemed there was no other way to do it, until one day after finishing a brass one for the smokebox end, and when about to saw it in two, my attention was called away and leaving one cut completed, the molding was hung up out of the way for several days. On my resuming the job again, while getting it down one end dropped, and I noticed the span made by the two ends when I dropped apart. I pulled it a little farther, and noticed it was apart enough to span the boiler, and instead of cutting the ring in two halves as usual, I tried the experiment of putting it on without cutting by pulling it apart like one coil of a worm and slipped it around the boiler, and was delighted with the success of my experiment, because I could now put the strap on, screw it up and scribe the edge of the molding to the smokebox plate, take it off once to trim, and then when put on again have it fit perfect to the smokebox plate. This was a great improvement on the old way, for while they would occasionally get loose there was no joint to fall apart, and it can be readily seen why it is a very superior job. The molding at that front end of the firebox, of course, had to follow suit, and was afterward put on in one piece, and the absence of the joint at the top added very much to the appearance of the work when completed. The fitting of molding at the end of the firebox suggests itself. All that is necessary is a little patience and to fit it around the various fittings attached to the end plate, and the proper kind of bolts and set-screws to hold it fast to its place.

WATER-PAILS AND COAL-HOODS.

On most railroads at this time of the year there is a heavy demand for coal-hoods and iron buckets, which are often made of the coppersmith, although they are more often made in the tinsmith or lamp shop. The South Eastern Railway in England manufactured most of their supplies of this kind. While in their employ I made a great many scoops for them, also water-pails or buckets, and I have seen many instances in which poor convenience in these articles has led to turn out this kind of work with anything like facility. They are, as a rule, made by hand, on purpose to fill up time that

might otherwise be used to less advantage. Now, there are boys, I presume, in most of our schools who would like to know how to cut out the patterns for pails and coal-buckets. Boys often pass by a thing that is familiar to their eye without enquiry, paying little heed until their attention is attracted by a request to make it, and then find themselves at once in a fog. To those who are willing to learn we are trying to clear away a little of the mist, and help them to become proficient and independent workmen. A water-pail, or fire-bucket as we used to call them, as shown by Fig. 97, which is the frustum of a cone; and a coal-bucket or coal bucket, as will be seen, is about the same thing with the addition of the lip, Fig. 98. Now, we will suppose we want to make some water-pails of the dimensions shown in Fig. 97. The first thing to do is to draw the pattern which we obtain as follows: Make *A B* 12 inches, *B D* 9 inches, and *C D* 8 inches. Produce *A C* and *B D*, and let them meet in *E*; then with *E B* as radius describe the arc *B F*, making *B F* equal to three times *A B*, then with *E D* describe the arc *D G*, and join *E G*. Now add enough to both ends, as shown, for the groove or seam, and *A F B D G* is the pattern required. Now notch the pattern, as shown at *G* and *A*, at both ends of the pattern, and if the ship is provided with proper machines from top to rollers, ream and wire; but if there are no machines, turn the edge and wire loosely before the pattern is turned or lamed up, when formed, round up true and put the bottom on. If a foot is required to the pail a ring made of suitable hoop-iron and fastened on with four rivets answers the purpose well.

Now, it happens sometimes that a vessel similar to this pail is required to hold a stated or definite quantity, and only the diameter of one end is given, with the height, or the two ends given and no other conditions have to be considered, which is a most unpleasant guesswork, and often causes disappointment, and I shall endeavor to make the solution of these two problems so plain that boys having a good common school education can easily solve them, because they bothered me for some years before I could solve them, although I was skilled in every mensuration I could lay my hands on. Let us suppose we have an order for pails to hold three gallons, the top diameter, *A B*, Fig. 97, to measure 12 inches, and the height, *X*, to measure 9 inches. Here you see the diameter, *C D*, is not given, and we are left to find out what the bottom diameter should be. Now, the way to find the solid contents of the frustum of a cone is to add the areas of the two ends to the square root of the two areas multiplied together, and then multiply this result by one-third the height, thus: $(AB^2 + CD^2 + \sqrt{AB \times CD}) \times \frac{H}{3} =$ the contents in cubic inches; then working this back to find the size of the end not given. Proceed thus: Three gallons = 231 cu. = 2184 in. = 693 cubic inches. If we divide 231 or the number of cubic inches in a gallon by .7854, we get 294.1 cubic inches, and to avoid using this decimal .7854 in the operation we will take the number of cubic inches in a gallon instead of cubic inches, thus: $294.1 \times .7854 = 882.3$ or the number of cubic inches in three gallons. Here, for the diameter of the end we are going to find we must substitute in its place some sign or letter; let it be *D*, then proceeding according to the rule, we shall have $12^2 + D^2 + \sqrt{12 \times D} \times \frac{9}{3} = 882.3$, or the cylindrical inches in three gallons. Now, $352.3 - 3 = 349.3$ is the value of $12^2 + D^2 + \sqrt{12 \times D} \times 3 = 294.1$. Deduct from each side $12^2 = 144$ we have $12D + \sqrt{12 \times D} = 150.1$. Adding the square of $\frac{1}{2}$, or one-half of 12, the coefficient of *D*, to complete the square again, we have $D^2 + 12D + 36 = 186.1$. That is $D^2 + 12D + 36 = 186.1$

Extracting the square root of each side, we have $D + 6 = 13.64 = 13 \frac{1}{2}$. Deducting 6 from each side, then $D = 7 \frac{1}{2}$. Here we find the water-pail or fire-bucket which will hold three gallons, whose top diameter is 12 inches, and whose perpendicular height is 9 inches, the bottom must be 7.64 or a little over $7 \frac{1}{2}$ inches. Again, to make this plainer to those who may not understand the last solution. Find the number of cylindrical inches in the pail or other similar vessel required and divide it by 3. From that subtract the square of the diameter of the end given; to the remainder add the square of one-half of the given end. Extract the square root of this sum, and from the root subtract one-half of the diameter of the given end, and the difference is the required end, thus:

EXAMPLE.
294.1—Cylinder in. in a gal.
—3—Number of gals. in a vessel.
352.3—Divide by 3.
117.4
294.1
144—Subtract 144 sq. dia. given.
150.1
36—Add 36, sq. of half dia. given.
186.1
136.1
1—7.64, sq. root of sum.
23186.1—6, subtracting 6, one-half of given dia.
69—7.64—dia. of end required.
2724 11400
10996
504

When I had discovered this rule and learned how to work it successfully, I found it of great service, and those who will take the time to learn it will also find it very useful.

We will now suppose we have the diameter of the two ends given, but no height, that is to say, a vessel to hold 4 gallons, whose top diameter is 12 inches, and the bottom diameter 9 inches. Here, as before, we must have a substitute for the number representing the height. Let it be *H*, then, as shown before.

$(12^2 + 9^2 + \sqrt{12 \times 9}) \times \frac{H}{3} =$ Contents of the pail in cylindrical inches.
Now 4 gallons = 294.1 x .7854 = 117.64, and proceeding in accordance with the rule, we have $144 + 81 + 36 \sqrt{3} \times \frac{H}{3} = 117.64$. That is $333 \times \frac{H}{3} = 117.64$. Clearing this fraction, we have $333 \times H = 1176.4 \times 3$. Or, $333 \times H = 3529.2$. Then, $H = 3529.2 \div 333$. Therefore, $H = 10.6$.

By this operation we find that the perpendicular height is 10.6, or ten and six-tenths inches, as was to be shown.

COAL-HODS
The sizes of coal-hods are designated by inches, thus, 15, 16, 18 inches; that is the rule is laid diagonally across from the top of the lip to the opposite side of the bottom, and this measure indicates the various sizes. It will be noticed by the reader that there are very many different patterns of coal-hods made to the various makers' taste; but the plainest and desirable to keep in view, is economy in cutting the sheet; that is, to cut with the least waste. Let us mark out the pattern of one taken at random from among the many styles, and work it up to measure 17 inches, as shown by Fig. 98. Thus you will see, is similar to the water-bucket, except that it is made with the addition of the lip. The plan of the mouth of the hod is indicated in *a* by parts of two circles *a* and *b*, *c*, and the tangents. The elevation is

shown by the outlines of the hod itself, Fig. 98. To develop this we proceed thus: Extend the lines *A C* and *D B* until they meet in *S*; then with *S A* as radius describe the arc *C O G*, and make it equal to the arc *C O*. Then describe the arc *C O G*, *M K A F*. Now divide the arc *C O G* into four equal parts, *G H, H O, O N, N C*. From *O*, with a radius equal to *D B*, describe the arc *N V*; continuing it from *V* to *K*, and from *V* to *M*. Then from the point *R* with *S A* as radius describe the arc *A E*, making *A C* an inch longer than *E N*, and from the point *F* with the radius *S A* describe the arc *A F*, an inch longer than *J H*, and each arc equal to *d* and *b* in *X*. Now, with the same radius *S A* on the lines *S L* and *S H*, and from the points *S and H*, describe the arcs *E M* and *J K*. Then *A M K F O P* will be the curve of the pattern for the mouth of our hod, and *C O G* equal the size of the bottom. Now add enough for seam to each end, and parallel with them, as shown at *F G*, and *A M K F G O P* will be the pattern for the body.

To mark out the foot proceed in a similar way as before. With *X Y* as radius, and from the point *X* describe the arc *V U T Q*, making it three times *C O*, and with *X D* describe the arc *D Z*, join *D Z* and *U T*, then *Q U T E* is the pattern for the foot. Having the pattern for the body and foot, notch the body as shown in *F* and *G*, and then fold and wire before forming if there are no machines at hand for wiring; if machines are provided, then form before wiring, after the wiring is completed, double-seam the bottom on. Now make the foot in a similar way, and rivet with six rivets, and complete the hod with a bail and back-handle. Hods made in this way are more durable than many others offered for sale on the open market.

There are some more complicated methods of obtaining this coal hod pattern; but we have endeavored to make this as simple as possible, and near the truth enough for all practical purposes, believing it will be more readily understood.

Around the World, to China, and Home.

Notes taken by E. J. Lewis, an American Engineer who Went to China with the First Arab-Brake.

(Continued.)
A part of the trip was through the latter end of the Inland Sea coming from Yokohama, Nakasaki being the first stop for coal, which is mostly done by Japanese men by placing ladders made of bamboo up against the side of the boat and having small baskets filled with coal, and pass them up from one to the other along the ladder till reaching the top. Ships taking hundreds of tons are loaded that way. Next stop was at Chemulpo, in Korea. The Koreans are a brave and hardy people, and contribute to the Chinese Empire, keeping them very poor by heavy taxations. Some of them are powerful men, but very low, degraded looking people, living in filthy mud houses. We visited a Korean village, and was met at the shore by a lot of naked children and dogs, who showed us nearly every where they were. The children were so small that when we would give them things, for relics, we would give them, say, 5 or 10 cents, they would seem in doubt as to whether it was good. Little stores, with a few cents' worth in them, resembling children playing at storekeepers, were to be seen. The money was to go aboard, came through the market place, where old women and men were assembled, offering small fish and green stuff for sale on a small scale, and with such fish-smelling surroundings that you would wonder why they did not die with the smell. A woman was standing in the crowd of women do not appear in public without having their faces covered similar to the Egyptians. Only the married men wear their hair curled up on top like a woman, and the women wear pants-like men. All these customs towns have a portion of them set apart for foreigners. When our American people go to realize the pleasure of being an American Consul at such places, their desire for honor must be very great, if they know anything of such places before going. While lying in the harbor, the tide went down so our boat was resting on the ground, and a typhoon ended its career, just the tail end of one, the captain said, which gave us an idea of what it was like at its best in the open sea. Small boats in the harbor were commonly blown about, and the loading or unloading could be done that day.

Left Chemulpo for Chefoo across the Yellow Sea, which took twenty-four hours. All the next day ran along the China coast, occasionally passing a wreck of some ship, some of which were stripped by pirates shortly after the accident.

At a small place, had to look upon, nearly void of vegetation and of red, burnt appearance, as if there had been considerable volcanic eruption at some time. Chefoo is the Atlantic City of China, where the foreigner spends the warm season, having good hotels and a nice sandy beach. We took our first dinner in China water as we could get ashore. It was an interesting sight, as we anchored at Chefoo, surrounded by hundreds of Chinamen, all screaming and scrambling on board, up the sides of the boat, anywhere they could catch hold of anything, reminding one of pictures of ships being attacked by pirates. Sometimes, just for sport, one of the sailors would pour a bucketful of water on a fellow just about make his way on board, but it did not seem to dampen his ambition the least to get on. While in port the passengers are advised to keep their cabins locked as some one might take possession of small things lying around.

Left Chefoo that night at 10 p. m. for Taikoo across the Peichai Gulf. The water was as smooth as a river, set at the bar next afternoon. As the tide was up, had no trouble in crossing the bar to the entrance to the Pei Ho River going up to Tientsin. A short distance up the river is a small place called Tong Ku, where they usually take the train when the river is not high enough to permit the ship to go up to the city (Tientsin).

Anchored over night to allow the ship to be lightened up to twelve feet to get to the river. Special pilots are required to take the boat up and down. After being nearly devoured by mosquitoes and sand flies, got away at 4 a. m. up surely, the crooked river in the world.

It is twenty-five miles, by rail, to Tientsin; it is about fifty miles by river. Frequently in the bends of the river the ship would take a run out on shore, sometimes into a Chinaman's garden, but does not seem to damage the ship any, as the shore is soft ground with no stones in it. The river is a narrow stream not over 300 feet wide at the most, with the surrounding land only a few feet above the river, so that a flood is a common thing. All along the river live Chinamen engaged in gardening, irrigating from the river by dipping buckets into the river into ditches running back to their farms. The money was really small boys would run along the river yelling at people on the boat, we were told by natives, "Foreign devils coming!" saying, "Mousa Lala." To see a boat across the country you could not say which way she is going, up or down, unless you ask the pilot, who is of the high class.

Arrived at Tientsin about noon, which presents a busy scene. This is as far as the boats run. Thousands of coolies are at work on Bund loading and unloading ships, singing from morning till night. A warehouse in that country is called a god-own.

The principal part of the city runs from the river and is occupied by foreigners. There is probably 500 persons living in Tientsin. On the Bund is noticed a high

pole with a cage-like box on top containing a Chinaman's head. It is put there for an example of their crime, this keeps it constantly before their eyes. Many people think, in China a fellow gets his head sheared off for most anything he does, which is not true. It is only for crimes such as the hanging of a man for he is given a trial, and executions must be approved by the Emperor. Firm and severe measures are necessary to govern these people. They do not seem to have any sympathy for one another, as other people could stand and see one of their number tortured and only hang their heads. They are in contact with foreigners that treat them right will be used the same, and a foreigner would have to misuse them very bad, and it become generally known among a large number of coolies before there would be any danger of being molested by them, which would be their taking the offender along with him in a bamboo basket, called by them the "bamboo-chow." This is why a man disposed to do right or wrong with them has no much influence. You will not find any people more appreciative than the Chinaman.

Soon after landing we engaged coolies to take our baggage to the Asher Hotel. Two of them wanted to carry the type-writer and got to quarreling over it, letting it fall in the scuffle. One threw the other down, swearing in plain English, I felt better among them at once, felt as if I was among civilized people. We reported at once to Mr. Wim, A. P. H. and the American director of the Imperial Chinese Railways, the first foreigner ever honored with such a position among the Chinese. Shortly afterwards went to the Postal Telegraph Office to say to our friends we had arrived, and found the one word, "arrived," worth about \$16.40. Our fellow-travelers and people in the street were so struck with our arrival, that on August 27th, just about fifty days going over. In a few days we were ready to get to work.

The Chinese railroads consist of about 150 miles in operation and something like 50 more under construction, to be added from time to time as the road is built. The division runs from Tientsin to Tong Ku south, and the other division runs from there toward the north to Tong Shan, where the shops and mines are located. It is twenty-five miles from Tientsin to Tong Ku. It was thought best to put the air-brakes on at Tong Ku junction, as the facilities were not sufficient, and this would allow us to stay over night at Tientsin. Mr. A. Sherriff is engine house foreman at Tong Ku. Mr. J. Buchanan, J. Fenwick and K. Terms foreign engine drivers, and Mr. Thomas Preston, track supervisor, gave us their assistance and advice, and were very kind among the natives. All the workmen given us were natives, many of them good ones. Mr. Hsieh was our interpreter, a native of remarkable patience, as he had to talk for us at every part of the work, which must have been very trying at times. Considerable credit is due to Mr. W. Newell for the various provisions he made in taking many tools and material he thought might be needed.

On September 30, 1892, engine No. 14, of the 8-wheel class, and a passenger car was ready for trial. That day Mr. Peacock and a few of the Chinese from the Tong Ku. I ran the engine the first trip to Tientsin, with Mr. G. Sherriff acting as pilot and Mr. W. S. Hamilton the return trip. Everything worked just as it should and was highly approved by all present. In the next thirty days the other engine, No. 16, of the 10-wheel class, and the balance of the cars were finished. In November Mr. Newell returned to America, going by the way of England, leaving us there during the winter to attend the care of air-brake apparatus and to see to anything that might take place during that time, and instead the play is in the use and care of it. The Chinese railroads are run almost entirely upon the English system in all its depart-

ments. The trains are moved by the staff system.

To any one accustomed to riding on trains, moved by such rights, would be nervous about riding on trains in America, and thought of the apparent safety of the staff system. It did seem dangerous, but when you stop to consider, with the staff system but little interest is needed by the men further than not forget the staff when leaving the station, the result is, a man is depended on after all for the safe and careful movement of the train. Only the best men are selected through years of training, and the rules and movements drilled into the men while they are young. The result is that a set of men are produced that fully make up the difference in the two systems. The increased responsibility resting on the men attention to their duties, while the other is so much the opposite. It is doubtful whether it is any safer than our system so long as a man is depended on. It is doubtful whether the heavy traffic in this country could be handled as safely by the staff system as they are now. Many have come to think that trains can be handled by any other system in China and Japan than that now practiced.

Railways in China are extending up toward Mongolia, apparently for military purposes, as the Russians are crowding down toward China at the time. One of the other branches is extending from St. Petersburg to the Pacific coast, near Manchuria. Should the Chinese railroads connect with this road a person could go by rail from Tientsin to Paris in twenty days. The principal trade of the railways in China is hauling coal from the mines at Tongshan to the stevedores at Tientsin. The south Chinese is estimated to haul more coal than any other country. Coal is worth about \$4.50 per ton at Tientsin. Something like 2,000 natives are employed at the Tongshan mines. This place is worth visiting, the whole thing is walled in, and all employes must pass out at one place, and all the things are walled in, and anything, such as tools and pieces of iron and steel, which they sell to blacksmiths, when successful. Some of the coal is down 1,000 feet deep, a few Englishmen have charge of the mining, very large pumping machinery is necessary to keep the water out of the mines.

But many of the things consumed by the natives, for they cannot afford to buy stores and fuel. But little fire is needed outside of cooking for them. They put on clothes enough if they have them to keep from freezing. Charcoal and weeds, raked off the fields in the fall and winter, is the fuel used on the stoves, and during the winter, when the ground is dry as powder, caused by not having any rain from September till next June, and the country being level, they have very heavy winds during the winter, making it so dusty you cannot see twenty yards at times. Last winter at one time the blue fire for six days and nights very hard. They rarely have any snow during the winter, but the sun shines brightly when the wind doesn't blow much. A great many poor people in Tientsin, during a cold spell, freeze to death. The wealthy class of Chinese are liberal toward the poor, and many would die if they were not so well off. This is the residence of the Viceroy, Lee Hang Chang, the most enlightened official China has ever had, who has done more than any other Chinaman toward the introduction of foreign ideas for the improvement of the people.

The native portion of the city is surrounded by a brick wall probably 20 feet high, having gates to shut at certain times at night. It is estimated there are 1,000,000 people living in the city. Some of the streets are 8 feet wide; but not see many roads over 50 feet wide. The streets and fares are crowded with people, and a person going through there in a jinriksha

for the first time doesn't feel safe among them, not understanding a word they say. It is exciting to meet a high mandarin at that time. A coolie runs along carrying some of the red umbrellas, following him are soldiers on horses, then comes the fat mandarin in his glass-windowed Sedan chair, lined with expensive furs, being carried by several coolies, and in the rear following a few soldiers on foot. Everyone gives this a wide berth. The mandarin is hardly ever seen to look at any one along the way.

The water supply of this monster collection of people is furnished from a river flowing past the city, by a line of coolies with wheelbarrows loaded with buckets of water, going from morning till night.

The language of the Chinese is not difficult to learn. I had a teacher for three months, and I think I could learn that time. I think in two years one could do without English altogether with the people. To any one staying in that country the spoken language is very important to know among them, as you are much more respected by them. The language consists of about 40,000 words, a person knowing 1,000 words will get along very well among them. But few of the native teachers know more than 20,000 words. The Pekinese is the proper Chinese language, but strange to say a Hong Kong man coming up the Tientsin cannot understand it, although the same characters are used in writing throughout the Empire.

Allow me to say here, that nowhere could I find a rat market or any that I knew of being eaten by Chinamen. On \$1 per month they live very well. If a fellow had to he could live on \$1 per month. There is this about the Chinaman, as soon as he has thought to keep him he works no more. A man having \$50 would be independent for life. A man having people rarely do not know what good servants and cooks they make of their world make use of them more, and then they would not be so hostile about them coming here. They are a harmless, inoffensive sort of people, very rarely drink, and not one-fifth the crime rate of the white and colored people. They are capable of high education, as several we met show. Take Mr. K. Yun, superintendent of telegraph, who is a graduate of Yale College, and the interpreter of the Chinese Minister at Washington, D. C., who was interpreter for the Railway Managing Directors while we were there. Several of the telegraph operators are under native management. The Yun Paper recording machines are used. The operator sending a message does not necessarily need to know what the message is. A clerk writes the message out in Morse characters, hands it over to the operator, who sends it as written. It is received on paper, and the clerk writes in English, then translated into Chinese. Mr. Yun thinks the teleautograph may be a great thing in China, as they can send a message in the Chinese characters.

The Chinese are a people that do not travel much and have few luxuries, and railroads will not build very rapidly as the people do not want them. They find great mineral deposits, such as iron, coal and silver, are lying idle, they seem to be satisfied to know they have them. Anything they can manufacture they do so regardless of cost. For instance, they make rifles at Shanghai for \$25 each, but for \$100,000 (Mexican) per case built for granite and steel. They live, broken, for about 12 cents per year. All the trains run in China are mixed trains, with only one foreigner, the driver. Occasionally a native fills the position of driver, and does very well as long as nothing serious happens to the engine. It looks very much as if they will try, if en-

couraged, till all such positions. The cars are run on to twenty-foot gauges. A train regarded as many as a train, regarding their contents. A train at times reaches as high as seventy cars, but when a heavy wind is blowing, and they cannot haul their train, must set off as many as the driver thinks necessary. It is remarkable how the capacity of the engines from time to time changes, and in different places. It is a good illustration of the evils of allowing work being left to the judgment of many persons. Very few people seem to realize the value of having systems of work being done under a fixed rule which is made through thorough trial and experience. Three men often go through the passenger trains taking up the tickets. The head guard who accompanies the train men and locks on, is the acknowledged authority. If a man has no ticket or money, they just take him by the neck, divest him of clothing or anything he may have in sight, and deliver him over to the station master at his destination till he pays for his ticket.

It is very little trouble is experienced under this practice. If a passenger knocks a window out, he must pay for it at once to the station master. A combination lantern for signaling the driver is a handy thing for the purpose. It has three colored glasses, so arranged that by simply pressing the handle any color wished could be shown. When stopping at a station, the gas is kept in sight of the driver, showing the white light. When desired to show a slow signal, green would be shown, and when the signal to stop was wanted, the red would be shown. A passenger is set on the rear end on the passenger cars; then the driver would complete the stop with the engine. Nearly all the employes can speak some English, and a foreigner is not entirely lost at any time.

The railway company furnish books for all their employes. At Tientsin, where the general office is located, part of it is set apart for a reading room, containing many valuable works on railroads and books on China. We arranged to have the locomotives and the employes sent to the United States, where it lay on the table, and other railway papers, in the reading room.

We made preparation for leaving China about the first of March, 1893. On March 12, we took passage for Shanghai by the China merchant steamer *Hsin Fung*. Shanghai is the finest city we saw in the East; sailed at 11 o'clock by the French mail steamer *Albatross* for Managua, arriving April 26th, thirty-two days on this trip, stopping in Cochin China, at Saigon, Hong Kong, Singapore, Colombo (a good place to stop rubies, if you know them, and you see them), Aden; while passing through the Red Sea, bored one of our engines, - through the canal to Port Said, Alexandria, and Managua. The voyage through the Mediterranean Sea, past Mount Athos to Marseilles; thence to Paris for a few days (there is only one Paris); thence to Calais, across the channel to Dover, once more again where we knew what people were saying, stayed in London ten days.

Took passage on American liner, *A. A. York* for America, arriving home May 10, less than a year from the time we left home. Saw enough in that time to think of for years, and had a good training in the practical application of air-brakes to engines and cars. I had no idea of saying anything about engineering, but I know it has been of interest. I am glad to

Warraton, O. E. J. Lewis
The only encouraging thing about the business of manufacturing articles for railroads at present is that numerous railroads are in circulation about roads that are thinking of new equipment. They are afraid that the thinking of new cases is going to be long drawn out, but it is something to know that there are a good many railroads that would like to order new machinery if they only saw their way clear to pay the bills.

The Coming Convention of Air-Brake Men.

Less than a year ago sixteen air-brake men assembled at Pittsburgh, Pa., and formed an association of their own. This has already grown to a membership of over seventy.

These air-brake men will hold their first annual convention at the Park Hotel, Columbus, O., on April 10th, and some very interesting papers have been prepared by the several committees. There is no doubt whatever that these men will devote the details of brake repairs, maintenance and handling more thoroughly than any other body of men. Why smaller they? It's their pet hobby. As they themselves write: "This will be a feast of air-brake 'cranks'."

It would particularly urge railroad officials to encourage this little association, and their air-brake inspectors and repair men attend, and extend courtesies to members from other roads. They are bringing safety in the interests of safety, and cheaper maintenance of apparatus for railroads. There is no possible gain to them, except to become experts in their line.

President C. C. Farmer has been particularly happy in his selection of men for committee work, each man is a wheelwright on the subject given, they are as follows:

- COMMITTEE ON INSTRUCTION.**
 H. M. Nellis, Westinghouse Air-Brake Co.
 Paul Symnstedt, Crane Air-Brake Co.
 H. H. Helendall, Union Pacific Ry.
 H. J. Cota, C. B. & Q. Ry.
 H. B. Shreve, Great North Air-Brake Co.
- COMMITTEE ON FREIGHT AND PASSENGER BRAKES.**
 J. J. Carney, Chicago & Northwestern Ry.
 H. M. Nellis, Westinghouse Air-Brake Co.
 H. W. Decker, Southern Pacific Ry.
 H. P. Rodman, Richmond & Danville Ry.
 J. J. Kudder, Westinghouse Air-Brake Co.
- COMMITTEE ON REPAIRS.**
 A. Sanders, Missouri Pacific Ry.
 W. B. Neal, N. C. & St. L. Ry.
 J. Montgomery, Pennsylvania Ry.
 W. H. Carr, P. C. C. & St. L. Ry.
 Robert Ward, St. L. I. M. & S. Ry.
 R. N. Martin, Pennsylvania Ry.
- COMMITTEE ON TRIPLE VALVES AND BRACKY CYLINDERS.**
 J. Burgess, Westinghouse Air-Brake Co.
 J. F. Houchlin, L. N. A. & C. Ry.
 H. F. Swan, P. C. C. & St. L. Ry.
 W. E. McKee, Great Northern Ry.
 W. A. Jessen, Louisville & Nashville Ry.
- COMMITTEE ON TRAINS WHOLLY OR PARTIALLY EQUIPPED WITH AIR.**
 S. D. Hutchins, Inland Empire
 J. Brown
 F. B. Farmer
- COMMITTEE ON FLAT WHEELS.**
 J. B. Farmer,
 J. L. Andrews,
 Geo. Holmes,
 C. B. Cugger,
 E. G. Desse
- COMMITTEE ON FREIGHT AND PASSENGER BRAKES.**
 P. J. Carney
 H. W. Decker
 W. J. Brodnax
 Ben Johnson
 F. M. Nellis.

There will also be short papers, as follows:

- COMMITTEE ON IMPROVING THE HANDLING OF PASSENGER TRAINS.**
 S. D. Hutchins
 Burgess
 Robert Burgess
- COMMITTEE ON FREIGHT BRAKES (GARS ONLY.)**
 L. P. Chase.
- SHORT PAPER—ON TROUBLE AND REPAIRS.**
 W. M. Carr

- MEMBER BRAKES.**
 J. L. Andrews.
- THE BEST METHOD OF CARING FOR REGULATING DISCHARGE VALVE.**
 Otto Best.
- AIR-TRIP GOVERNOR—ITS TROUBLES AND REPAIRS.**
 W. C. Walsh.
- HIGH BEST METHOD FOR PACKING STEERING TRUCKS TO AIR-PISHS.**
 Henry Montgomery.

Every man employed on air-brakes in any capacity ought to become a member of this association. They can learn all particulars by addressing the secretary, P. J. Carney, South Kaukauna, Wis.

Loss to Coal in Storage.

The management of every railroad that stores large quantities of coal are aware that there is considerable loss from heating and slaking, but the men on the engines know better how serious this loss is and what poor stuff they are often asked to burn.

Probably no man has paid more attention to this subject than Mr. H. G. Belcher, of Los Angeles, Cal., who for ten years has had charge of thousands of tons of stored coal in a country where coal is worth in the neighborhood of \$10 per ton.

Mr. Belcher has made many experiments with a view to saving coal and has succeeded admirably. His plan consists of means of ventilation at the night time and place. He has recently perfected a scheme of ventilating coal on shipboard that promises good results, but where coal is piled on the ground is where his improvements save the most money.

His plan consists principally of a large perforated sheet-iron pipe laid under the coal and filled with coke; this is connected with vertical piping, and for ships an interior and smaller pipe for removing heavy gases and forcing down carbolic acid gas to deprive fire of its life-giving qualities.

By using coke in the larger pipe a much lighter material can be used and the pipe is made to collapse for storage when not in use.

Leach's Improved Track-Sanding Apparatus for Locomotives.

The original form of this apparatus had no provision for sanding the track profusely in case of collision or other emergency.

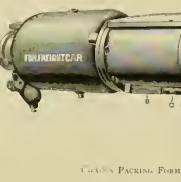

CHUCK PACKING FORMER AND SPRING COMPRESSOR

gency, and was generally condemned on that account. In the improved apparatus the usual sand-lever is retained, and may be used whenever desirable.

By reference to the sketch, which shows one form of the device, it will be seen that the trap is bolted to the outside of the sandbox, where it may be readily got at for inspection and repairs. The trap receives its supply of sand through the independent passage *B* directly from the sandbox. By means of the air-blast through the nozzle *J* the sand is blown out of the trap through the passage *D*, which connects with the sand-pipe at *I*. It will be seen that the direct sand-lever *V* may be operated by the sand-lever in the usual manner.

Another, and by far the most common form of trap, is bolted to the sandbox in

the same manner that the sand-pipe flange is usually attached. The lag is extended to provide two openings from the sandbox to the trap, one for direct sanding by means of the lever, and the other for the blast-feed. Either form of trap is applicable to old as well as new sandboxes.

The compressed air for operating the device is taken from the main reservoir connections, and is controlled by a feed-valve properly constructed for right feeding, placed in the only convenient location for the engineer. For ordinary feeding a very small amount of air causes the sand to "dow" upwardly through the passage *D*, and over the bridge of the trap. A plug *A*, *A* 1, is provided, so that the dow of sand from the box may be stopped by a bit of waste placed in the passage *D*. The plug *A* 2 may then be taken out and the trap thoroughly cleaned of stones or other foreign substances. The cap *C* 1 receives the wear of the sand-bank and may be cheaply replaced when worn out. By removing this cap, access is had to the blast-nozzle *A*, which may be taken out with a small socket wrench provided for the purpose. The simplicity of construction and operation, and convenience for inspection and repairs, has been the cause of its remarkable success, about 1,500 engines being now equipped. Its utility is demonstrated by the fact that its use saves more than one-half the amount of sand used by the ordinary sand-lever arrangement. "The waste of sand in itself is of little consequence. Pulling trains over an unnecessary quantity of sand on the rails is what wastes fuel, money, power, tires and rails."

The patent on this improvement was issued January 16, 1894, and is owned by Henry L. Leach, formerly M. M. of the Fitchburg, whose address is Room 45, Mason Building, 70 Kilby street, Boston, Mass.

Chain's Hydraulic Spring Compressor.

The annexed engraving illustrates an apparatus which will be found of great service in facilitating the work of examining, cleaning and oiling brake cylinders. The device is a packing former and cylinder spring compressor. The cut shows the apparatus so plainly that no description is necessary. It is a very simple appar-

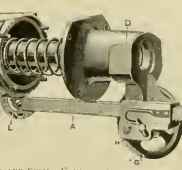

atus, and one that will be certain to improve the condition of brakes when it comes into general use. Brakes frequently work badly because the cylinder wears out of order. With existing tools it is a tedious and laborious job to take the cylinder head off and then replace it with the strong spring to be compressed. The invention shown will make this labor light, and consequently it is likely to be done more regularly. The apparatus is the invention of E. E. Chain, Boston, and is handled by F. A. Barbey & Co., 215 Franklin street, same city.

The second educational chart goes out with this paper. It's worth half the subscription price.

Where Piece-Work on Cars Was First Used.

The late John Stephenson, the noted car builder of New York, was one of the first manufacturers to introduce piece-work. He was fair and just in his dealings with workmen, and piece-work in his shops was always popular among the men.

The piece-work was first introduced through a curious circumstance. During an unusually busy time the glazing department was chronically behind and was delaying the other work. The room was small, and did not offer conveniences for more than two men and a boy working at one time. These were working all the hours

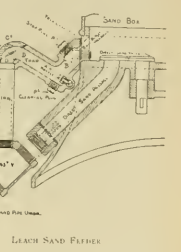

LEACH SAND FEEDER

that could be spared from eating and sleeping, but still the work was behind. Mr. Stephenson thought of making a larger glazing-room, but he was badly crowded for want of space, and it occurred to him that the men employed might turn out more work if he offered payment by the piece. He found out what the glazing of the various sashes cost, and offered to pay the men by piece-work on the same basis. This was accepted.

There was strong prejudice in the shop to the new innovation, but no active opposition was offered. After the new method was in use for a few weeks the head glazier discharged his assistant and did all the work himself with the assistance of the boy, and seldom worked any overtime while preparing the sashes as fast as they were needed.

This gave a good object lesson, which was applicable to other departments. The body painting room was badly in arrears with work, and interfered constantly with the prompt finish of cars. The men seemed to be working as hard as they could, and there was little prospect that piece-work would accelerate production. It was tried, however, and the force of men was found more than sufficient to do all the work promptly. One man who had learned his trade in the shop finished easily twice the work previously done. One of the men could never do better than his performance by the day.

The system was gradually extended to all other departments. It was found that on an average the men did about 30 per cent. more work under the piece system above what they did when working on day pay. In all departments men were found who could about double the average of the work done by the day, but others made very small increase of their own output, and were never up to the former average of the shop.

We have been obliged to scrap several communications because, for some cause or another, they have been long delayed—usually because they are not signed—until the matters they refer to are too old to reopen.

— Practical Letters —
from Practical Men.

Facts Wanted.
There's a glut
of Opinions.

Write on one side of the paper, state your point plainly and briefly, and then quit. We supply the generalities. No letters without names and address accompany.

An Air Jack for Car Shop Use.

Editors:

I send you herewith a blue print showing the construction of a car jack operated by air for service in freight car repair shops. Our shops are provided with air-pipes for the purpose of testing air-brakes

country where the running of a certain class of express engines was very much improved by raising their boilers 5 inches. Pending the scientific explanation, I will venture to offer this imperfect one: An engine is traveling on a perfectly horizontally level track, and eventually passes over a depression on the left hand rails.

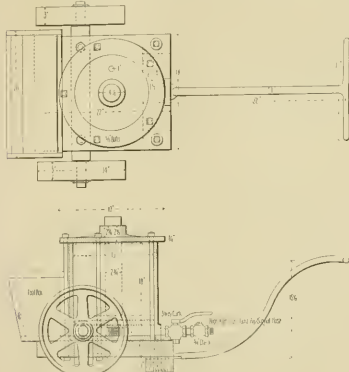

PORTABLE AIR JACK FOR CAR SHOP.

on all cars, with hose connections as feet apart, and a pressure of 10 lbs. is maintained in these pipes. The same hose that is used to test the brakes is also used in operating this jack. Sixty pounds of air will raise an ordinary box car, and two men will place a car on horses and remove the trucks in 20 minutes, average time. This jack is not our invention. We got the idea through the kindness of Mr. Westcott, Supt. Great Northern Shops at St. Cloud, Minn. We have improved on his jack, however, in some small matters.

As I have never seen any mention of a jack of this kind in print, I presume you can make use of it for the benefit of others in our line. It certainly will do its work a half quicker than any jack I have yet seen, and I presume nearly all repair shops are equipped with air-pipes for brake-testing, therefore this tool can be introduced cheaply.

S. L. BARN, M. M.

Brainerd, Minn.

The Steadiness of High Engines.

Editors:

The New York Central "909" class are acknowledged to be remarkably steady, although they are the highest engines at present running, I believe, with the exception of the new Pennsylvania "T" compounds, the center line of whose boilers is half an inch higher. It seems to be the general experience that high engines are steadier than low—on good tracks at any rate. Perhaps some of your readers can explain this apparent paradox.

Of course these high modern machines are very heavy, which would partially account for their superior steadiness, but I remember at least one instance in the old

it will oscillate to the right. It then—still oscillating to the right—meets with a high place on the same rails. The tendency will be to stop this right hand oscillation and produce a contrary one to the left. The higher the boiler is, however, the greater leverage it will exert to resist this lifting power on the right hand side caused by the now compressed springs. Given a sufficiently high boiler, instead of being thrown over to the right the whole machine will be merely restored to the perpendicular. Here another perfect piece of track intervenes and the engine remains perpendicular. I am supposing the boiler to be exactly the height, and the two irregularities in the track to be exactly sufficient to produce this result.)

Now suppose the boiler to be lower (and therefore exerting proportionately less leverage when out of the perpendicular), but all other conditions to remain the same. In this case, having tilted to the left at the depression, it meets the high place, the wheels rise, the springs are compressed and the power thus stored up in them is not only sufficient to restore the low boiler to the perpendicular but to throw it out of it and to the opposite side. Thus far, traveling over the same piece of track, the high engine has tilted to the right once and then become perpendicular, whilst the low engine has tilted to the right and left before becoming perpendicular. Repeat this performance *ad libitum*, and it is easy to see which would be the pleasantest foot-plate.

Abilene, Tex.

HUGH SHARP.

Doc's Puzzles.

Editors:

I got a letter from my friend Doc the other day, giving some puzzles in the

operation of the air-brake, copy of which is enclosed:

"FRIENDS COMES—You seem to enjoy roasting me about my way of doing things. As long as you are so good-natured about it I won't kick, as I keep on learning a little. Billy and I went out on a special train yesterday. Like to lost my job over it. The air-brake wouldn't hold anything. A funeral party got left on No. 9 going to St. Louis, so they made up a special with one of the 16-inch engines that nobody has regular, a pony baggage car—same as box car—with platforms, and one of our big chair cars. We were handy to call, so they sent us out, being in a big hurry. The driver-brake would let off just about as quick as you could set it. We could hear the air whistle out through the triple-valve exhaust, so we were sure about that. The first stop we made brakes didn't hold good, so I went back to look the train over.

"The little baggage car had about two inches slack on every brake-shoe, so I took it up till the shoes just cleared the wheels. The big chair-car held pretty good, but every one of the shoes rubbed

"Now if you can tell me what was the matter, and what I did to spoil the brake, I would like to hear from you right away. Our air-brake instructor says the triple leaked through the graduating-valve, but we did nothing to the triple-valve and the brake held all right after stopping the engine. The brake-valve and pump on brake was in good order. The brake seemed to leak off on the baggage car, but the piston did not travel very far, so I know it did not strike the head. Help me out quick."

Now, Mr. Editor, please have the readers of *Locomotive Engineering* crack these nuts. Why did the brakes refuse to hold—remember, he don't say they did not work—after he had adjusted the slack to his liking? And, why did making tight joints stop the driver-brakes from letting go, though triple-valve exhaust if a leaky graduating-valve is the trouble? I know let go that way when piston leather leaks, and when packing is made tight they hold all right.

Some months ago we had an engine with a 1 inch pump, on which it was impossible

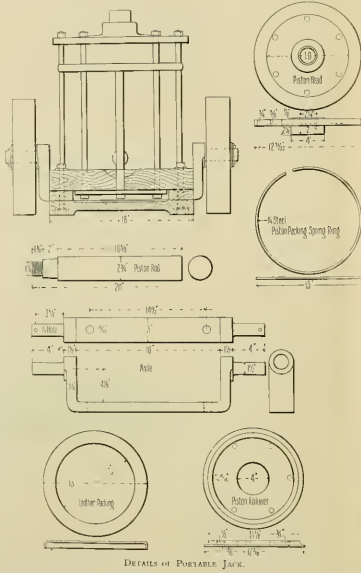

DETAILS OF PORTABLE JACK.

the wheels a little, so I let them out to about three-quarters of an inch all around, and thought it would help things, but next stop had to put her in back on sand for fifty or sixty car lengths. It was just that way all the way up. When we got there the car repairer let out the slack on the pony baggage car and took up the slack on the big coach; it held all right coming back. I watched him, and know nothing else was done to the cars. We made some new joints on the pipes to driver-brake cylinders, and that held all right coming back. When we got back to Indianapolis I had to walk on the carpet before the wiper. I expect he will give me thirty days for making poor stops.

to get over 60 pounds of air at any time while working the brake. The machinist —so he reported—took down all pipes and said none of them was obstructed at any point. Another pump was put on with no better results. Joints were all tested with soap suds for leaks and no leaks discovered. Then we put the painful of soap suds into the suction and ran it all through the pump into main reservoir, and air pressure went up to 90 pounds, because the dirt and wax was soaked up and blown out of delivery-pipe, which was 3/4-inch and had lots of short bends and elbows in it. In about a week the same trouble began, only it was only 10 pounds this time. Upon making a careful examination a small safety

valve was found in main reservoir, out of sight behind brackets on deck casting and other hindrances to a clear view, that no one suspected was there. It was blowing off very quietly but getting in its work out the same. It was very promptly taken out and a gas-pipe plug that don't blow off put in its place. This pump is all right.

Some of our equalizing discharge brake-valves fail to work as an equalizing valve, and D 17 hardly ever raises on a service application. When you examine them, look at the leather gasket first thing, and see if it is not leaking from train line into any over 17. The valve acts very queer when there is a small leak very near the good air-brakemen have decided if the rotary valve leaked—and got left of it.

The 1892 model with feed-valve attachment has two gaskets in it, one of them, it is defective, will let main reservoir pressure into this cavity and give the same trouble in the rotary valve does. In Doc's case, it is a fact that stack of brake-shoes cannot be just alike on very light and very heavy cars, if they are braked for 90 per cent. of their weight with pinch cylinders.

C B COMBER
Saw and Reports, Mich

Some Handy Shop Tools.

Editors

It is often the case that the mechanic, by the use of a little ingenuity is enabled to devise some special tool or method by which he can do his work more satisfactorily to himself and his employer. In many shops, however, there are no improved methods or appliances, partly because the workman thought it was not to his interest to improve on the methods of those before him, and partly, no doubt, the fault of those in authority. With a view of increasing the interest of mechanics in im-

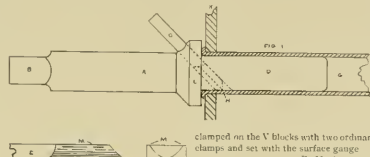

clamped on the V blocks with two ordinary clamps and set with the surface gauge

Savannah, Ga. F. M. AUBURN

proved methods, I will describe a few special tools that I have found to be of great value in locomotive repair shops.

It is a trying and tedious task to cut out a set of tubes in the ordinary manner, by chipping. By the use of the cutter shown in Fig. 1, it will be found the work can be done in one-half the time and with less labor. The construction is easily understood from the drawing. The shank, A,

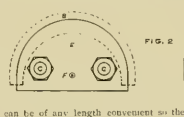

can be of any length convenient so the end will receive a wrench or ratchet. The portion that extends into the tube need not be over 6 inches long. The cutter is carried in the slot as shown. After the bar is in place the cutter is driven with a hand hammer through the tube and then revolved, the edges, M, cutting the tube, when the tool can be easily withdrawn. The shape of the tool is shown at E and F. This tool can only be used to advantage when there is some other opening as the dry-pipe hole, through which the tubes can be taken out, on account of the rough edge that is left on the tube

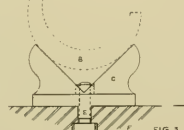

In fitting up driving-box brasses unscreamer is lost in chucking them. If a chuck similar to the one shown at Fig. 2 is used it will be found to expedite the work. It consists of two plates, holding the brass between them, securely clamped by the two bolts. The plates have centers drilled and countersunk to fit the centers of the lathe. It is driven by a left or L plate, secured to face plate. This chuck can be used on any lathe and is very convenient to clamp the brass. It will be found that two bolts will give better satisfaction than either three or one.

Who Made the First Blower?

Editors

It may be of interest to the readers of LOCOMOTIVE ENGINEERING to know who was the originator or inventor of the blower.

The first independent blower that was ever placed on a locomotive was placed on the "Elk," on the old Central Ohio—

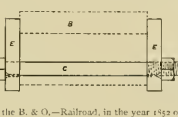

the B. & O.—Railroad, in the year 1828 or 1833.

This very simple but necessary attachment was placed on the "Elk" by Mr. P. H. Smith, engineer of the old mill, and to use Mr. Smith's own words or his own description

"I was running an old hook motion engine named the 'Elk.' She was built at New Castle, Pa., to be used as a passenger engine, but owing to faulty design, cylinders being too large for her boiler capacity, she would not make steam. She was placed in the Zanessville yards as a switcher. She was an eight-wheeler with

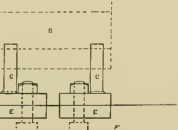

3 1/2 feet drivers, and was a wood burner with big ballion stack.

"When the old girl did not boil her juice fast enough, we used to throser her out of gear, and with the starting bar move the valve open so it would uncover the exhaust port, and by giving her a little throttle would give a good blast, which would soon run the steam pressure up. I put my thinking cap on one day, and thought why won't a jet of steam from a small pipe placed in the stack do the same thing. I went to Mr. Persay, who was master mechanic, and told him

my plan, and also to Mat Callahan, foreman of roadhouse at Zanessville.

"I told Mr. Callahan we could hunt up some old pipe which lay around the shop, and with the assistance of a helper I could put it in myself and save the company any expense. So after my day's switching was done I went down to the shop after supper and found the necessary pipe, I cut it to fit the boiler, but just used the pump water cock and connected my pipe to the heater cock on the boiler—had it run it out over the running board to the front end and up into the base of the stack, and it was done.

"The next morning when she was fired up for her day's work, the master mechanic and a number of the boys were down bright and early to see how the new blower worked. I can just see her now standing on the turn-table with the blower on, throwing the wood sparks out of that big ballion stack. I hardly need to say that it was a success. Soon after all the engines on the road were equipped with the blower."

Mr. Smith is now a resident of Columbus, O., having retired from railroad service after thirty-three years on a locomotive. He never had a collision nor was he ever called up on the carpet.

Columbus, O. E. H. HUMAN

[No doubt Mr. Smith's blower was original with him, but there is pretty good evidence that it was used before. Wilson Eddy built the "Addison Gilman" at Springfield, Mass., during the year 1850 and put her into service early in 1851, and she had an independent blower such as are used now. Does any of our readers know of its use at an earlier date?]

Learning Sizes of Parts from Engravings—High Pressure in Train Pipe.

Editors

I would like very much to shake hands with our friend Wood for the sentiments expressed in his contribution to the February number. Here is another who has gained more information from studying illustrations of the various air-brake parts and then endeavoring to make a practical use of the knowledge gained, than from any other method. I also find that I am not quite certain as to the manner in which some portions of the brake operate, it is a very great help to take the engraving representing that part and make a sketch of it, say as large again, or one-half size, and will keep the mind busy with measuring and transferring of sizes after this fashion will usually bring about the solution of the problem. Another point that is not, it seems, made use of as much as it should be, is that when a question arises, as sometimes it will, as to whether an standard size of a part has been cleared, or a part that has been made, there is no duplicate, the catalogue engraving is the last place to get sizes from when it should be the first. For instance, main valve stop No. 50, Plate D 6, is broken off in a pump; engine needed and no extra stop, or size not known—the majority of air-brake repair men have often heard this kind of a story—suppose he goes to his catalogue and measures, say, the stem cylinder of Plate D 6, it is almost two inches in diameter, or not quite one-fourth the real size of cylinder, he then measures the stop, small end 1/4 in., large end 3/4 in. in diameter, length of large end of stop is 3/4 in. in length, the multiplying these figures by = small end 1/4 inch, large end 3/4 inch, length 1/4 inch fall, and as the engraving is a little less than one-quarter size, the extra quantity will give the extra 1/4 inch for length of stop. By this means the stop could be nearly ready by the time the end of the pen was removed.

Every engraving of this sort should have its scale given.

Brother Alexander makes the point that with the new, or Plate D 5 brake-valve, 90 lbs. can be put in auxiliary reservoir, which is an advantage under heavy grades. It looks very much as though this was one

in the least of (rather) irregularly, the valves and one which is habitually liable to cause a great deal of trouble, and which a freight car loaded in only one direction with no central braking power, might ought to be readily practicable to risk sliding the drivers, and such other portions of the equipment as could not be saved for the coal-stand. While this case is I believe a loss in the right direction I have spent too much time trying to keep the main reservoir pressure from getting into train pipe when it was not wanted, not to resist against overcharging the same, and, therefore, the main reservoir is arranged in every car, equipped with air-brakes, along with a conductor's seat. This will not only educate the passengers by showing what effect the pressure in the train pipe have on the locomotive, but in case of accidents, the driver might find that wheel with no fluid pressure may engage to save an accident, and as it will point out the ones that actually overcharge their train pipe. While in very many cases, on account of faulty design in foundation plates, is insufficient attention from the inspector, the latter may not get their full share of the blame, but it is a trouble, the being got straightened along with other impediments of like nature, and to interference as a variation from the regular standard pressure is, according to the writer's ideas a long step backward.

Will not the accuracy of Mr. Haren's indicator depend very much on the condition of the operating pump?

To make, J. A. G. K. H. H. H. H.

An Air Problem.

Having applied a new pump to engine, I started pump to see if connections were all O. K. After pump had pumped up its reservoir pressure, stopped it to fix slight leak in steam pipe to pump. After pump had been stopped about one minute, air started blew, and continued to do so at intervals of about a minute, until air was gone. Examined signal line and connections and found it O. K. After having set in steam pipe restricted pump, and after attaching it, pumps pressure opened train cock to main reservoir. After draining reservoir, rechecked cock. Immediately after closing main tank brake release, the rechecked cock and brakes applied. Train releasing cock, breaks released. Pump still running. What was the cause?
 W. H. WOOD, JR.

A Rule that Won't Work on All Kinds of Trains.

Mr. Editor: I wish to refer an article in the W. G. Wallace on "How to Test an Air Supply," as his illustrations that by bringing the handle of the test valve from running position to full release the red hand will drop back about a pound for every car. This is all very good on short trains, but not on long ones. We all say that we are compelled to a train of forty cars and are carrying the handle of our engineer's valve in running position, and we have 20 pounds pressure on our train line and 30 pounds on our main drum. Now, according to W. G. W., if we bring our engineer's valve handle to full release the red hand should drop back about a pound for every car. Of course the red hand shows the main drum pressure, and the reduction of 20 pounds below 100-lb. line, according to instructions, would set the brake full force, and then we would set in lots of trouble. This rule will do up to about ten cars, but over that number it is a failure. This from experience and observation. SAM. M. DEEMAN, Seymour, Ind.

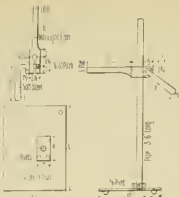

A Rod Rest and a Cellar Remover.

Editor: I wish to show two sketches of tools that we find very useful in our shops. The rod rest is entirely my own idea, and is very handy for the men when filing brasses, and can be used in a variety of other ways, also. It is simple, and can be cheaply made. The other tool will be appreciated by those who get underneath an engine and try to get down a tight driving-box cellar. The harder the pull the harder the little tool sticks into the cellar bolt holes. The idea did not originate with me, it was suggested to me several years ago by a machinist who had one in use. He read of it in some paper, probably yours. At all events, the tool is so admirable and easily made, I thought it should be brought out again for the benefit of the present army of Locomotive Engineers and readers. F. H. B. G., Ft. Collins, Co. C. C. LEACH.



Curing the Chatter of a Pump Governor.

Editor: IN DISCUSSING OF THE Air-Brake System, February number, Mr. Symonds mentions troubles with pump governors whose steam pistons are not fitted with packing rings, and gives as the remedy to put in packing rings. A few years ago five passenger engines came into service on the Vanhook Line and I fired one of them. Their pump governors could not regulate their action, and, when cutting off steam from the pump, would rattle and chatter so that the enginemen could not hear each other speak. The man I fired for screwed the regulating spring away down, and regulated his air pressure with the pump-throttle. He said that was best anyhow—had always done it that way. He never had a pump governor before, and didn't care whether it worked right or not. He wouldn't use it nor report it. Really, it wouldn't have done any good if he had, the air-brake engineers could not find anything wrong. And there was a man whose governors were just as their makers intended them to be. It was a faulty design. Finally, my engineer took a lay-off for the summer, and the runner in his place wanted to use that pump-governor. I asked the machinist at the other end of the road to fix it, and he said he would if I told him how, and I did.

The Westinghouse Plate D pump governor, is so arranged that the steam-piston when at rest seats against the cylinder-cap above it, and the steam-valve at the lower end of the piston-stem does not come up far enough to seat itself, therefore, if the piston-stem fits loosely steam will escape continually through the waste-pipe and carry a considerable amount of oil with it, resulting in the pump, groaning and working badly from lack of lubrication. The new governor is made so that the steam-valve seats both ways, above and below, so that but little steam is wasted but that is not the point.

With the older types of governor using the ringless steam piston, the piston was slightly tapered, its upper edge fitting closely in the cylinder and the lower edge narrower. When the piston was not cutting off steam from the pump it was seated against the cylinder-cap and slightly out of the level at the upper edge of the inside of cylinder. When running pressure accumulated in the train-pipe the diaphragm-valve would raise and the air pressure would push down the steam-piston, but not below the level in the cylinder. This made a large passage for the air around the edge of the piston and to the waste-pipe. The piston would immediately seat, and open seat, and so on, continuously wasting air and rattling the governor to pieces.

We shortened the piston-stem so that at rest the valve would seat instead of the piston and the piston would be pulled down in the cylinder far enough that the upper and wider edge of the piston would be below the bevel made the top end of cylinder. That was three years ago, and the governor has given no trouble since. Finest working governor on the road, and it has no packing ring either.

W. H. WOOD, JR.

A Planer Chuck.

Editor: IN DESIGNING SPECIAL TOOLS in the modern railroad machine shop, where there is a tendency to do as much work as possible without the assistance of skilled labor, the tools must be made simple, so as to be easily understood, and strong, so as to be able to withstand a good deal of muscular effort.

One of the worst jobs, if not the worst, on a planer to strap down is shoes and wedges to plane the face after they have been laid out. The advantage with which this is done is the saving of a great deal of time at the bench.

To secure this, the chuck here shown was designed. It consists of bed-plate, Fig. 1, 20x24 inches, into which three 1 1/2"x5 1/2" studs are screwed, and two holes are drilled in the bed-plate, and the studs are threaded to their full length, except 3/4 inch left in force shoulder to screw down on, and its nuts on each stud are faced on one side to a radius of three inches.

A plate, Fig. 2, with three holes to fit over the 3/4 inch holes, and concave to fit nuts on both sides. Drill and tap four holes to 1/2 inch tap 11 inches below center, lengthways and 3/4 inches side, set in six pieces 1 1/2"x1 1/2"x14 inches thick, that are drilled and tapped for set screws 3/8"x2 1/2" inch, cupped pointed. Get a wedge, and the chuck is ready for use.

To use it, lay the bed-plate on planer or stand, and bolt fast. Lay the plate, Fig. 2, on studs between nuts, then take shoe or wedge. If the face of shoe is thin, put between flanges two spread screws made from 1-inch hexagon iron, with 3/8-inch bolt through center to keep the shoe from springing. Now place shoe between set screws and tighten up. Shoe need not be so awful tight to carry a good heavy cut—then loosen top nuts, and with surface gauge on projecting part of bed-plate. Would say that this plate must be placed on both sides, and may be trued at any time when thought to be out. Seven

lower nuts up or down until work is level, with lines put there for that purpose, then tighten top nuts and try surface gauge again. The work is now ready to plane. After planing, the work can be taken off, trued on engine, and, if found not to be quite enough off, it can be put back in chuck and more taken off without resetting. Spot shoes and wedges top and bottom outside and at center inside, and put these marks opposite adjusting screws. I consider to be one of the handiest tools that we have in the shop—use two of them. Try one, and if you have more shoes and wedges than one planer can do, you will be sure to make another. To make chuck use old steam-chuck cover.

W. A. ROBERTSON, Cedar Rapids, Iowa.



How to Break a Water-Glass Tube.

Editor: I will give you something I have found very handy, which I do not think is generally known, for cutting water and lubricator glasses. Take a parlor-match, one of the kind with red end, wet the brimstone slightly and mark the glass on the inside where you want it to break. Hold it over a torch or lamp flame. It will break off even where it is marked on the inside with match. G. D. HENNINGSON, Ft. Madison, Iowa.

More About the Engineer's Valve with Reducing-Valve Attachment.

Editor: IN THE February number I note the different articles relative to new November, and my remarks on same in November number. Mr. Alexander evidently did not read my article correctly or he would have seen that I did not criticize the general construction of the new valve, only the reducing-valve attachment. In that article I stated, "Constructively, without the reducing-valve attachment, the new valve is a marked improvement over all the preceding ones." I am in favor of the valve with feed-valve instead of reducing-valve attachment. Mr. Alexander seems to think that what is needed is breakers in which will open angle-cocks slowly. I'm afraid he will have trouble getting the done as he describes, anyway it would not materially reduce the quantity of air required to charge the engine auxiliaries. He might release the brakes on twenty-five cars after picking up cars and then pick up three or four more and pick up fifteen or twenty. I think he would experience a little difficulty unless he had governor on main reservoir set to allow a very high pressure. In order to guard against delay in instances of this kind, with valve equipped with reducing device, I find it necessary to carry more excess pressure than is necessary to prompt release of the brakes. This in itself is a detriment, in that it causes pump to heat. The friction of the air on itself in compression at 100 pounds is such that no compressor will run cool that is not water-jacketed. Mr. Alexander also thinks, what I considered one of the bad features of the reducing-valve attachment, that it is possible to maintain reservoir pressure in train line. He is like the man taking medicine, who thought if a spoonful dose would do good, by taking the whole bottle down at a dose would cure him. I would like to know what pressure is calculated in adjustment of brake-levers, and if it would stand for his information in regard to handling trains on mountain grades, that we have lots of 3/4 and 1, and some 4 per cent grades, but have never found 10

expedient to use 50 pounds air pressure in train-line and I still maintain that any device that makes it possible to carry excessive train line pressure will result in increased number of shd wheels.

Mr. Jenkins also claims a man can do anything with valve equipped with reducing device that can be done with one equipped with feed-valve, but does not say how, and railroads seem to be making a great deal of that kind of knowledge possessed by Santa Fe engineers in general. In reply, I will state that we have had all the advantages he describes. We have had traveling engineers from time to time; all engineers and firemen have been supplied with Westinghouse Instruction Book, there is also a representative of the Santa F. Co., who spends a good deal of his time on the system, and we have a number of engineers who, as manipulators of the air-brake, are the equal of those possessed by any railroad on earth. I will also state that I find some engineers who claim excess pressure cannot be carried on freight train, but have generally been convinced by one that if can, though may not act as the suggestions afterward. There are several reasons for men insisting on running with brake-valve in release position. With a freight train they find they can maintain a releasing pressure of 50 or 60 pounds when, if valve was carried in running position, only about 40 pounds could be carried. Then, to their claim, and satisfactorily too, that their pump does not have the same tendency to heat as when carried in running position—this where governor is attached to train-pipe. On short trains, the excess pressure is not essential, and on any train with a careful manipulation of valve in service stops, no trouble will be experienced in releasing brakes, but excess pressure should always be carried on long trains to provide means for releasing brakes promptly in case of emergency application or train parting.

I do not think that any man is built naturally so as to be impervious to education, although that is what perhaps is said in connection with the manufacture of the steam engine, the form of new brakes, etc. The kind of education you get is what will explain the why of these different appliances, explain to the men who think that if train-pipe leaks bad that brakes will creep on when brake-valve is moved to running position after having been left in release long enough to equilibrate train-line and main reservoir pressure.

Building a brake-valve with an attachment ostensibly to enable the engineer to carry brake-valve hand in running position and excess pressure, no matter how train leaks, but in reality is nothing more than equal to brake-valve in full release position (a good portion of the time at least) is not educating anybody, and will not make a good air-brake man out of a poor one.

I would say a few words for the benefit of Mr. Ellis, who puts the argument a little strong. I will make the assertion, and am ready to demonstrate it by actual test any time, that unless a leak develops that will let air escape faster than pump can compress it, that will carry handle of brake-valve of old two-way cock, D or B or new valve without reducing valve attachment in running position, and won't stick or drag either, even though train-pipe leaks so cannot get over 20 pounds reservoir and maintain it there. Though I do not advocate starting with train in this condition, I will try and explain why this is possible. To begin with, you always have the same pressure on the train-line side of the valve as on the reservoir side with brake-valve in running position, and any leak in train-line will do the same on main reservoir. Say, for instance, feed-valve has sprung with tension of 20 pounds, and you have 50 pounds in train-line, you will have 50 pounds in main reservoir. Train-line is the same, 50 pounds air plus tension of

spring = 70 pounds, not all air but just the same pressure, and so soon as any leak starts in train-line feed-valve saves its seat a little further and air passes direct from main reservoir to supply it, and will maintain an equality of pressure between train-line and reservoir at all times. To convince yourself, put handle of brake-valve in running position, open stop-cock on rear end of tank and start your air-pump, and note that the same pressure you get on main reservoir that you get on train-line feed-valve spring. All intelligent engineers ought to understand this, whether those referred to in full face type do or not I am unable to state. If not, and they will investigate a little they will change their minds. The reason that brakes set when brakes are in moved to running position, after having equalized pressure in release position, is that pump is effectively shut off from train line until enough pressure has been accumulated in main reservoir to overcome tension of feed-valve spring. A little watchfulness in all that is necessary to overcome that. If brakes commence to drag, move handle to release position, not to through equalize pressure, but just to through brakes, then move to running position again. Except it is due to some defective triple, it takes a pretty bad leak to set any brakes, and sometimes when a man thinks brakes are dragging, if he will investigate he will find his imagination has got the best of him.

In my experience of over twenty years there is no part of the air-brake system that is so sadly neglected as the main drum. Every particle of air that is used in operating the brakes must pass through the main drum before any work can be done. This being the case, it is certain that the oil used in lubricating air end of air pump, dust and fine cinders pumped through valves, and the water accumulating must all be deposited in main drum. If these accumulations are not kept out of main drum they must pass through every part of the air-brake system on the train and interfere with their operation to a greater or less extent.

When air-brakes were not as well understood by those in charge as they are at the present time, I have known main drums to be neglected to the point where would blow out of the exhaust-port in engineer's valve and to-day, when air-brakes are fairly well understood, the neglect of the main drum on air-brakes on every railroad on this continent costs companies large sums of money yearly. Supposing every part of the air-brake system on a train of cars was cleaned and repaired, or put on new, excepting the main drum, which was one-third full of dirty oil and water, before one week's time the air-pump governor would be sticking, the equalizing-pressure piston in engineer's valve, the engineer's valve, and everything on the system would be affected more or less.

From my experience with air-brakes I have concluded to the satisfaction that all main drums should be fitted with a cock in the lowest part, so that it can be opened by the engineer with little trouble. If the cock be opened at both ends of the road, and the main drum blown out with full pressure of air while the pump is working, the repairs needed to the whole of the air-brake system will be greatly reduced. This is an improvement which costs very little and brings surprisingly good returns.

two leading wheels. They had two eccentrics, secured to the shaft by spiral keys. In reversing, the eccentrics were moved laterally on the shaft. The frames were made of two plates of iron, with a piece of English oak between them, all riveted through. It was of this wood that the cane was made.

"I will remember the presentation. The 'Whistler' was named for George W. Whistler, who was a prominent engineer, and had charge of a railroad building and operating in this section of the country. Later he went to Russia, where he died. He was father of the artist Whistler."

Give the Air-Drum Attention.

Editors.

After reading "Diseases of the Air-Brake System," by Paul Synnestvedt, the reader, if a practical man, must conclude that the author of the article must have been here and know where he talks. He describes the diseases minutely and applies the cures to bad every defect so completely that the practical reader will obtain valuable facts from Mr. Synnestvedt in his "Diseases and Cures of the Air-Brake System."

In my experience of over twenty years there is no part of the air-brake system that is so sadly neglected as the main drum. Every particle of air that is used in operating the brakes must pass through the main drum before any work can be done. This being the case, it is certain that the oil used in lubricating air end of air pump, dust and fine cinders pumped through valves, and the water accumulating must all be deposited in main drum. If these accumulations are not kept out of main drum they must pass through every part of the air-brake system on the train and interfere with their operation to a greater or less extent.

When air-brakes were not as well understood by those in charge as they are at the present time, I have known main drums to be neglected to the point where would blow out of the exhaust-port in engineer's valve and to-day, when air-brakes are fairly well understood, the neglect of the main drum on air-brakes on every railroad on this continent costs companies large sums of money yearly. Supposing every part of the air-brake system on a train of cars was cleaned and repaired, or put on new, excepting the main drum, which was one-third full of dirty oil and water, before one week's time the air-pump governor would be sticking, the equalizing-pressure piston in engineer's valve, the engineer's valve, and everything on the system would be affected more or less.

From my experience with air-brakes I have concluded to the satisfaction that all main drums should be fitted with a cock in the lowest part, so that it can be opened by the engineer with little trouble. If the cock be opened at both ends of the road, and the main drum blown out with full pressure of air while the pump is working, the repairs needed to the whole of the air-brake system will be greatly reduced. This is an improvement which costs very little and brings surprisingly good returns.

COLAR RESPON, Ia

How Much Pressure Should Be Carried with the New Brake-Valve?

Editors.

In the January number Mr. Holmes asks for opinions as to the pressure that should be carried in main reservoir when using the latest pattern of brake-valve, also refers to the preceding pattern of valve. The 20 pounds excess pressure carried when using the valve of 1893 (Plate D 5) is not sufficient to equally release all brakes on a lengthy train after an emergency application, and if there are any considerable leaks in train line, will cause brakes to stick. The excess pressure valve may be adjusted to carry more reservoir pressure,

but with the increased excess pressure some brakes on a long train will most certainly "stick" when the valve is drawn back to running position.

With the new valve of 1893 (Plate D 5) I think there may be no loss in the amount of main reservoir pressure carried. The feed of air through an inch opening from main reservoir to train-pipe is unrestricted until train-pipe pressure reaches 70 pounds, when the feed-valve closes. No healthy brakes will stick when train-pipe pressure is at 70 pounds. After the feed-valve closes, the air will continue to accumulate in main reservoir, and at the same time all waste or leakage from train line is automatically restored by the feed-valve, and as excess pressure will not accumulate until the normal pressure in train line is attained, there can be no sticking of brakes with this valve if enough pressure is carried in main reservoir. Now, what pressure should be carried? This is Mr. Holmes' question, and I can't understand why all the pressure the pump will make may not be carried to advantage.

Of course, if there is a high reservoir pressure and the valve is thrown into full release after a light application, there is danger of bursting a hose at head end of train, but it is unnecessary to use the full release position when the feed-valve has an inch opening.

Mr. Holmes calls attention to one of the extreme emergencies in air-brake service. Suppose you have thirty air brake cars; another section is following you closely with only a few cars in air, and you run so to a flag. The first thing is to throw the brake full on—emergency—and exhaust all train-pipe pressure, it's the correct thing to do; but the flagman gets on, tells you "all right, let her go." No 12 had a hot box—put in a brass—sent him back to flag and pulled out and left him. Your calluses are the cause, and the other fellows are coming in on you, get your brakes off and get out of their way? You have no time to spare for bleeding auxiliaries.

I don't think 90 pounds main reservoir pressure will do it. The Westinghouse people figure the contents of the train-pipe, hose-couplings, triple valve, etc., for the standard freight box car to be 319 cubic inches, and not counting the engine, the train-pipe of a thirty-car train would contain 24,570 cubic inches, while the main reservoir has a capacity of but 16,500 cubic inches of air. The head brakes would release and immediately begin to take air from train-pipe to recharge their auxiliaries, this lessening the releasing pressure as it flows back to the main reservoir.

It is only a matter of time when all freight cars will be equipped with air-brakes, and they will all have to be used. And it's an absurdity to think they can be operated successfully without an emergency reservoir pressure. The only reason why an air-reservoir may not hold as great pressure as a steam boiler, or even greater. Some day the pump-governor will be abandoned and the pump run with full open throttle, the air passing to train-pipe through a large feed-valve as at present, the full release position of the brake-valve will be taken away in order to prevent the high pressure from rupturing hoses or pipes, and a separate cock or valve attached to the brake-valve by which open communication may be obtained between the main reservoir and train-pipe in case of derangement of the feed-valve.

WILL W. WOOD

11111 Hunt, Ind

A Chip from the "Whistler."

Editors.

Several years ago my father, G. H. Griggs, gave me a gold-headed cane that was presented to his father, G. S. Griggs, by the employes of the Boston & Providence R. R. On the head of the cane is an engraving of an old-time locomotive, under the engraving is written, "A chip from the 'Whistler'."

My father told me that the body of the cane was a piece of oak that used to form part of the frame of an old locomotive called the "Whistler." The end is a part of a stay bolt from the same locomotive. The cane was presented to G. S. Griggs in 1857. Any information that you will give me about the "Whistler," and especially the most interesting part, LOCAL ENGINEERING, will be appreciated.

A. L. GREEN

Durango, Mexico

[Not knowing the history of the "Whistler" very well, we referred this letter to Mr. Geo. Richards, of Boston, Mass., who was fireman for G. S. Griggs, for many years, and succeeded him as master mechanic of the Boston & Providence road. Mr. Richards writes: "The locomotive 'Whistler' was one of the first three locomotives in New England. They were built by Robert Stephenson & Co., Newcastle, England, and received their names from the Boston & Providence, one by the Boston & Worcester, now a part of the B. & A., and the other by the Boston & Lowell. They had four wheels, two drivers on a crank axle, and

Clean Engines without Scouring—Some Road Talk by a Road Man.

The Drawing Engineers' Association, and the American Men's Association, are interested to see a great change in a wonderful improvement in the general care, handling, equipment and maintenance of locomotives, cars and air-brakes throughout the country. That a change in a good many of the railroads is needed, is more intelligent and progressive engine men and firemen will readily admit.

I believe that it more care would be taken in the selection and promotion of men to firemen, and of firemen to engineers, that where "strictly temperate" and intelligent men are employed and thoughtfully looked after by a traveling engineer, who knows how to handle men, "sternly, yet firmly—sternly yet tenderly." "Stern" might be the velvet scabbard before "soft" steel—that in the majority of cases these same engineers and firemen can save their wages every trip by being very careful in the handling of supplies. It is possible, by working engine and water as well as possible, by watching dampers to keep engine from popping, and by keeping everything in a neat and tidy condition.

That an engine with all joints tight and a nicely packed cab, with everything at least thoroughly wiped, neat and ship-shape is worth more than just the engine, no one will admit. Why then are there so many engines in a filthy condition, with steam leaking through nearly every joint, air-pump running forty miles per hour and still making no air, pipes blowing off steam when engine is standing or running still off, and when pulling a train making scarcely steam enough to get over the hill. Is it the fault of the men who run or fire them that so many engines are in just this condition? In some few cases yes, but in the majority of cases no. It is as a rule simply because they have never been trained or educated up in any standard of excellence, and have naturally grown careless.

The engineer says the fireman is dirty and don't clean, when he never knew how himself, and consequently never showed the fireman how to even wipe off anything *racar*, let alone clean. If the engineer could know how to do these things, how the fireman to learn? Only by employing men of first-class character and ability as "traveling engineers," to teach both how to do their work easily and promptly, and keep engines clean and *solid* without "living on them."

I fired a year and a half before I could wipe a lubricator off right (let alone scour brass), just because I was not shown properly, and I will guarantee that in that time I used more waste, more profanity, and worked harder than I did in the next four years, and with far less effect. I got up with a program in keeping engines clean, both by being neat himself and by doing it while helping him with his work. It is wonderful how much more interest a fireman will take in his work if the engineer will just encourage him once in a while by helping him clean up.

I have only been running six years, but I always help the fireman with his work, and in return, he assists me at anything I wish help at. I try to interest him in combustion, valve motion, air-brakes and time card, by short talks on the different subjects, and by actual experience by letting

him run an engine, handle the air and make his own meaning points. By the way, it is *not* good for a man's back to take the "slop" once in a while.

Orders should always be read aloud to firemen for mutual benefit—may save a bad wreck sometime.

Engine crews, to be efficient in every class of service, should be the best of friends, and when they can't be should ask for a change of once in the only way to render first-class service is to work for each other's interest and pull together.

When I speak of having engines neat and clean, I do not in all cases refer to "brass scouring," as there are a good many railroad systems that paint all brass moving engines. The Northern Pacific, generally conceded to be the best equipped road in the West, has all cab mountings and cocks on boiler head painted black, and a neat, tidy lot of engines would be hard to find, and the engineers and firemen as a rule are above the average in intelligence. That the Northern Pacific has always kept an able force of traveling engineers, and the general efficiency of the men is due in a large degree to their efforts.

I believe that many well-managed systems can be made to pay better than ever before, if first-class traveling engineers and air instructors are employed to teach the men general economy.

All engines should be equipped with *port cocks*, and when oil is fed carefully to cylinders they will seldom gum up, and if they do, it is better to clean them out occasionally than to have steam and water running as fast as the boiler, when taking them out of round-house. "An ounce of prevention is worth a pound of cure" is just as true on an engine as anywhere else.

There are two cocks in cab that should always be left with joints slightly broken, especially on engines with straight stacks, these are the throttles to blower and air-gauges. That is better to have them nicely ground in and then have a tiny steam-way cut in valves just enough to keep steam from condensing in pipes. The traveling engineers will improve engine service in all these and similar small details, as well as general ones.

The air-brake men are going to instruct engine men in the construction of air-brake apparatus and in the proper handling of the same, and will thereby vastly improve train service and prove the preventors of many a wreck, and will prove to companies yet in seeming ignorance, that it is poor policy to have a "thirteen-cylinder piston travel with a twelve-inch cylinder" to prevent brakes from wearing out. I am glad to see that there is a general awakening to the fact that better braking can be done with short piston travel, and say sixty or sixty-five pounds pressure, than with a long piston travel, and high pressure, besides it is easier on equipment.

I feel certain that as soon as this all-around change and improvement is made, the ignorant taught and instructed, and the hopelessly bad engineers and firemen put at something else, there will be less grievances, less "red" eyes, and more peace and harmony (beside a farther service between employers and employees than has ever been seen in the past).

L. D. SHAFER.

Amosonda, Mont.

Is Sixty Pounds of Air More than Sixty if Used on One Car?

Editors

The following notice is placed in the cab of all engines on this road.

E. A. RY.

SOLICITORS AT LAW.

You will be very particular and not carry over sixty-five pounds of air at any time, and when pulling but three cars you will not carry over sixty pounds of air, and when pulling but two or less cars you will not carry over fifty pounds of air.

Great care must be exercised at all times in handling air so as not to slide the wheels.

S. A. TRAIL, M. M.

Would like the air-brake experts' opinion in regard to this. Mr. Trail claims that 65 pounds of air, when handling one car, will slide the wheels quicker than when handling three or more cars.

I can't see how it is possible to get more power out of the same air pressure because there is only one car instead of several.

J. W. WITZ.

Missouri Valley, Ia.

About Oil Going from Lubricator to Chests.

Editors

Let me say the explanation generally given that the current of steam goes from the lubricator to the steam-chest is erroneous. The oil gets there simply and solely by gravitation.

The steam connection through the small tubes of the lubricator and the pipes leading to the steam-chest just causes the

the car is light. This is $\frac{1}{2}$ inch lower than the limit, and there is danger that the car will be too low when loaded. If a car comes out of the shop set to a height of 14 inches when the springs are new, there is likely to be settling which will soon lose half an inch. We should advise all concerned to put the empty car to the high limit, for the tendency is to settle downward. The law calling for this change is very important, for it makes the railroad companies clearly responsible for transportation to persons coupling cars with draw-bars above or below the limit of variation.

Gates Rock Crusher.

The annexed engraving illustrates a machine that is steadily becoming a necessity for the railroad companies which devote intelligent attention to their road-bed which is the foundation of the successful operation of a railroad. The machine is a rock crusher, and is employed for breaking the stone ballast that sustains the track better than anything else ever tried.

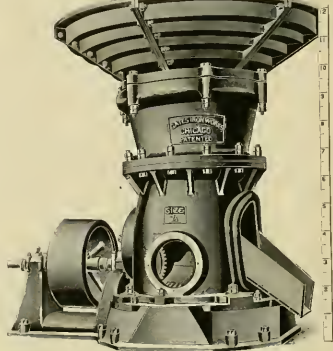

stone in that passage to equalize itself and there is no current, so the oil coming up out of the water finds but one outlet, and that is the oil-pipe to the cylinders, and that is carried down by its own weight. If you would place these same lubricators with the pipe slightly inclined upward, no oil would go to the place intended to be oiled until the pipe became filled with water. The oil is in just the same condition as if in the air. In air it would be surrounded by a pressure of 15 pounds per square inch at every point of its surface, and yet being pressed on all sides it follows the laws of gravity. The only difference is a larger amount of pressure.

C. O. MICKLE.

Huntington, W. Va.

Height of Drawbars.

At a meeting of the New York Railroad Club, attention was directed to the law concerning the height of drawbars for freight cars, and it appeared that those in charge of cars were not very clear about the provisions of the new law. An impression appears to prevail that the height now prescribed by the Interstate Commerce law is 33 inches, a variation of 1 1/2 inches above and below being permitted. This is, in fact, true, but the figures specified are that a car shall not have the center of drawbar more than 34 1/2 inches above the rail when the car is empty, nor less than 33 1/2 inches when the car is loaded. Some of the roads are changing the height of their cars to make the center of drawbar measure 34 inches from the rail when

Where fast, heavy trains are run by material short of stone ballast is satisfactory. It not only saves great expense in the maintenance of track, but makes traveling much pleasanter in summer owing to the absence of dust. The clean stone ballast employed has done much to enhance the popularity of the Pennsylvania Railroad as a passenger carrying route.

The machine shows the most powerful use, and crushes rock with surprising rapidity. It is a strong iron cylinder, which a cone of fluted lead is revolved in a heavy shaft. The rock passes down between the fluted lead and the walls of the cylinder and get crushed by the contact. This machine will crush one hundred and fifty yards of stone an hour. Those who are using machines of this kind speak enthusiastically about their power, efficiency and durability.

This machine presents a formidable appearance. It stands 12 feet high, weighs about 35 tons, and its immense receiving hopper is 11 feet in diameter. When operating to its full capacity it requires about 125 horse power. Great strength has been given the crushing parts to make them available for the hardest hematite ore, trap rock, porphyry, and other rock and ores of well known hardness. The makers fully guarantee this machine to handle successfully any rock or ore known.

The machine is made by the Gates Iron Works, Chicago, Ill.

In France they call a dining car a wagon restaurant, and a sleeping car a bed wagon.

? A. • — What You — • ? A.
Want to Know.

Don't ask questions that simply require a little figuring to determine; make each question separate. No notice taken of anonymous questions.

(26) M. J. R., Henning, Minn., says:
 Will you inform me how to solder copper wire to a zinc plate. A.—Good tinner's solder will do, with a flux of borax.

(27) W. L. C., Jacksonville, Fla., asks:
 Can a Westinghouse engineer's brake-valve be oiled whilst under pressure in case valve gets jammed and works hard? A.—No, not satisfactorily.

(28) J. T. B., Orion, Ill., asks:
 What kind of an engine is the West Side Elevated Railroad of Chicago going to use? A.—This is not yet settled. The likelihood is that the road will be operated by electricity.

(29) J. D. H., Somerville, Mass., writes:
 1. Does lead increase or decrease as lost motion grows? A.—The lead decreases. 2. Is lead beneficial or detrimental to a locomotive? A.—It is beneficial when used in moderation.

(30) Foreman, Hartford, Conn., says:
 Can you give me an easy rule for finding out the weight of steel and iron castings? A.—An approximation of the weight may be found by measuring the castings. The average weight per cubic foot is 450 pounds.

(31) R. M., Pittsburgh, Pa., asks:
 About what is the weight of a pair of cylinders and saddle complete for an 18-inch engine? A.—About 5,000 pounds. The weight of all the leading parts of a locomotive was given in our September number last year.

(32) W. Williams, Stuart, Ia., asks:
 Why is it that in speaking of vacuum the word inches is used instead of pounds? A.—Because measurements relating to the pressure of the atmosphere are recorded according to the number of inches of mercury that the pressure will balance.

(33) J. F. P., Chicago, asks:
 What is the proper size for stay-bolts for a locomotive boiler carrying 150 pounds pressure? A.—Opinions differ. Some prefer stays as large as 1 1/4 inches, others think 3/4-inch stays closer together are better. We believe the latter is preferable.

(34) F. C. L., Horton, Kan., writes:
 Were there any prizes awarded to locomotives at the World's Fair; and if there were, say on what particular points? A.—There were medals and certificates of merit awarded. The awards were based on various grounds—design, proportions, workmanship, etc.

(35) A Fireman, Fort Dodge, Ia., asks:
 Referring to your description of the "Detroit Lubricator No. 2," would like to ask if there is any valve regulating the flow of steam between the equalizing tubes and the steam chests? If not, what is to hinder steam from moving engine? A.—The amount of steam used is so small and the condensing surface so large, that it is mostly water that gets through pipes.

(36) Engineer, Milwaukee, Wis., says:
 The "James Toleman" has steamed badly and there is talk of sending to England for coal. Is the English coal better for steam-making than anything found in this country? A.—According to the tables in engineering books showing the constituents of different coals, some kinds of American coal are superior in heating qualities to anything found in Great Britain.

(37) R. H., Sherman, Texas, asks:
 Tell me what caused all four eccentric straps to break on a Rogers ten-wheeler? Lubricator was working, engine had just been hooked up to make a run for a hill, engine had been out of the shop about thirty days. I asked my engineer the cause, but he did not give me any answer. A.—We surmise that your engineer was

in something the same fix we are—we don't know.

(38) W. V., Detroit, Mich., writes:
 What effect does it have on the forward motion to move back-up eccentric back half an inch? A.—It will make the valve open more slowly when the engine is linked up in forward motion. Advancing the back-up eccentric is sometimes resorted to as a means of increasing the speed of valve opening when hooked up in forward motion. Under some circumstances the latter change will make an engine smarter.

(39) A. M., Muscatine, Iowa, asks:
 What was the fastest schedule of train known as the "Steamboat Train" between Boston and Fall River, and was there a sixty mile schedule anywhere in this country before 1894? A.—We have never heard of a faster schedule than one hour and twenty-five minutes for this run of 51 miles; the trains are very heavy, ten to fifteen cars. We know of no schedule time of sixty miles per hour, past or present.

(40) J. F. W., Terrel, Tex., writes:
 Will you give dimensions of a calliope whistle for a locomotive? A.—A calliope is a musical instrument made of a stand of steam whistles, each producing a different note. We do not think that exact dimensions could be given. The Crosby Steam Gage Co., Boston, have made musical whistles and they could probably supply information required. We think that the tube of each whistle has to be adjusted to the required note.

(41) S. H. W., Youngstown, O., writes:
 1. To settle a little argument, I wish to ask if the top of a locomotive wheel travels faster than the bottom? A.—Yes. If you examine the wheels of locomotives in photographs, taken while running, you will notice that the lower spokes are shown quite distinctly, while the top ones run into each other. 2. Is there any more weight on the rail when a locomotive is pulling hard than there is in pulling light? A.—No. The weight is constant.

(42) P. R., Rochester, N. Y., says:
 We have had a dispute about the expansion of copper patches on steel fireboxes and some of us believe that copper expands so much more than steel that the patch works itself loose. Can you give us any figures about the expansion of different metals? A.—In the difference of temperature from the freezing to the boiling point copper expands 1 1/2% of its length while steel expands 1/2% of its length. Zinc expands in the same range of temperature 3/4% of its length and platinum 1/4%.

(43) C. C. M., Beonett, Pa., asks:
 If the branch pipe be taken off an injector and another one put on which is much larger, will the injector throw water into the boiler? To show my meaning Suppose I procure a branch pipe 6 inches in diameter, and attach it by suitable reducing apparatus to an injector and check of the size commonly used, will or will not the injector work, and why? A.—Yes, the enlarging of the pipe won't make any difference after it is once full of water. The injector simply supplies a water pressure in the pipe.

(44) W. A. K., Dartford, Ont., writes:
 1. Suppose a traveler is able by the eye or ear to count the rail joints passed. If he counts the joints passed in twenty-one seconds will that indicate the number of miles per hour the train is running. A.—If the rails are 30 feet long, the number of joints passed in twenty-one seconds will give a close approximation to the speed in miles per hour. 2. What railroad in the United States has most mileage under

control? A.—The Atchison, Topeka & Santa Fe. The other questions are not suited for our columns.

(45) W. H. S., Danville, Ill., writes:
 I wish to know the best acids or composition to be used to write your name on tools; also the best covering to be used to protect the metal from the action of the acid. A.—The best corrosive compound for this purpose is a mixture of one ounce of nitric acid with one sixth of an ounce of hydrochloric acid. Cover the article to be marked with beeswax, write with a sharp steel scribe and apply the compound with a fine brush. Allow the compound to stand five minutes, then dip in water and clean thoroughly.

(46) Tool Room, Chicago, writes:
 Can you tell me where I can get drawings or engravings of a metallic gland packing which can be made without infringing any patents? A.—We do not know where such drawings can be found, and we are not looking for them. The various forms of metallic packing on the market are sold at reasonable prices, and these ought to be used. Home-made articles got out to avoid infringement of patents generally do infringe, and it is only through the forbearance of the proprietors that pirates are so rarely called upon to pay damages.

(47) W. H., Winnipeg, Man., writes:
 1. If you lengthen the back-up eccentric rod 1/8 inch, would it make any difference to travel of valve when engine is in forward gear two notches from the center? A.—It would affect the travel slightly. 2. Train was coming into station and engineer put engineer's valve to service stop and brakes would not work. Piston 17 was not stuck. Put handle to emergency position and the brakes worked all right. What was the trouble? A.—We are afraid that if piston 17 was not stuck it worked mighty hard; possibly the preliminary exhaust port was stopped up.

(48) Apprentice, Columbus, O., asks:
 What mechanical device is called a fusee, and what is it used for? A.—A fusee is a conical barrel round which a rope, chain or cord may be wound to equalize a pull of changing intensity. It was first employed for drawing water out of deep wells. When the whole weight of a long rope or chain was to be lifted, the coiling was done at the small end and consequently the work was slow. As the bucket rose the coiling got towards the thick part of the cone and the speed increased. The fusee is used in English watches and chronometers to regulate the pull as the mainspring gets run down. It is like a lever, constantly changing in length.

(49) R. C. B., Louisville, Ky., writes:
 Can you give me a recipe for making a mixture which can be used to fill blow-holes in castings and as a cement for rough joints? A.—There is a cement made by the Otley Mfg. Co., of Chicago, which is very good for this purpose. A home-made cement, which we have seen highly recommended, is composed of five parts, by weight, of Paris white, five parts yellow ochre, ten parts of litharge, five parts red lead and four parts of black oxide of manganese. These ingredients are very thoroughly mixed, and when wanted for use a small quantity of asbestos and boiled oil is mixed with it. This composition will set in from two to four hours and is very little subject to expansion or contraction.

(50) B. L., Chattanooga, Tenn., asks:
 1. What is the ordinary temperature of a locomotive smokebox and how is it found out? A.—The temperature varies from about 600° to 1,600° Fah. when the engine is working. The temperature is usually measured with a pyrometer which works by the expansion of metal. 2. In figuring heating surface, is it customary to take the inside or the outside surface of the flues? A.—The outside—that is, the side exposed to the water. 3. Is there any hard and fast rule for establishing the

radius of a link? A.—No, when a designer is laying out a link motion he uses the radius of link which will serve best to adjust the steam distribution. It is generally drawn from the center of the driving axle, but sometimes it is made longer or shorter.

(51) W. J. S., Morristown, N. J., writes:
 On page 36 of Auchincloss on "Link and Valve Motion," there is a travel scale in which the student is directed to extend a base line from *c* to some convenient point *a*, thus I am puzzled to know what determines the length of the *ac* base line. A.—The exact length of the base line is of no consequence. The triangle *aca* is to be divided into parts by lines at equal distances apart, to show the extent of the valve travel, etc. The line *ac* is of established length, so the dividing lines will be the same, no matter how long or how short the line *ca* may be made. This can easily be demonstrated by experiment.

(52) H. C. S., Glaston, N. J., asks:
 Why is it that in plate D 26 special quick action triple valve (for six-wheeled truck), the stem in emergency piston 8 is hollow the entire length, and what the horizontal port shown directly underneath the piston-head is for? Also, explain the purpose of middle port in valve-seat. A.—Six-wheel truck brakes have a 14-inch cylinder, and, in order to make this release in the same length of time taken by a 10 inch car cylinder, there had to be a larger exhaust port, this was done by boring holes through the stem of the emergency-valve piston (8) and from them to the top of piston, this provides enough extra area to make the release uniform. The stem of emergency-valve (10) seats against aul closes this top port, or hole, when the emergency piston is forced down.

(53) A. S. B., Toronto, Can., writes:
 We are taught that the work of a horse is equal to 33,000 pounds raised one foot per minute. What I want to know is, how the work done by a man compares with the work of a horse? A.—The unit of work, called a horse power, is greater than the work accomplished by ordinary horses. It is reckoned that 22,000 foot-pounds is about the real capacity of a horse. Experiments made in England indicated that an ordinary laborer could perform work equal to the raising of 3,300 pounds one foot per minute, which is one-tenth of the standard horse power and nearly one-seventh of the actual capacity of a horse. Strong men are capable of doing considerably more work. In a measured test of strength an Irishman once raised in two minutes a load equivalent to 27,562 foot-pounds per minute, and an Englishman was second, exerting 24,255 foot-pounds per minute.

(54) C. MeB., New York, asks:
 Would a mechanical device for supplying oil to the journals of cars, a simple appliance which dispenses with the use of waste packing, be of commercial value? Would railroad companies take hold of such a thing readily? Do you think there is a demand for an invention of this kind? A.—Cars are oiled in a very crude and wasteful manner, but we are afraid that it would be difficult to introduce a mechanical lubricator for this purpose. Several appliances have been tried which carried the oil to the journals, but they were always destroyed by oil men ramming waste into the box. When this class of artists look into a box and see no waste in it, they do not stop to consider that some better conveyor of oil may be employed. They jam the box full of dope, and if anything is encountered which obstructs the entrance of the mixture, they punch it to pieces with the end of a pinch bar.

(55) J. H. L., Port Jervis, N. Y., writes:
 1. Please explain which of the rails on a curve supports the most weight of a

train. *A*.—Generally the outside rail, but the centrifugal force of the speed throws the train to the outside of the curve. If the outside rail is high and the train passing the curve slow, the inside rail will bear the greater weight. *2*. In a dispute *A* claims that the peripheral speed of a wheel is uniform, and *B* claims that the top moves faster than the bottom. Who is right? *A*.—The peripheral speed of the wheel is uniform, but in relation to an object on the ground the upper part of the wheel moves faster than the lower part. The upper part is advancing while the lower part is turning backward. *3* is a silly question that a man with good sense ought to be ashamed to ask. Explain how pressure on governor connected to train line is reduced after placing handle of engineer's valve in running or in lap position. *A*.—We don't understand this question. At pressure on governor is same as train line; putting valve on lap will not change pressure on governor unless there is a leak in line.

166) P W, Dennison, Ohio, asks
 1. When an engine is running shut off, how does the air get to the cylinder behind the piston? This has reference to an old style engine, plain valve, and no relief valve. *A*.—When the piston starts back from the front head, the forward port is open and, as the piston recedes, it creates a partial vacuum in the front of cylinder, the port and the steam-chest. This is what causes the sucking action on tallow cups; at the same time the piston is forcing any air there may be back of it out through the exhaust port and nozzle. When the piston has very nearly completed its backward stroke, the valve has moved ahead enough to open the exhaust to the front end of cylinder, and if there be a partial vacuum, then air will rush in to fill it from the nozzle, this movement of air is not very considerable, this is with the lever in corner. *2*. In testing steam pipe and exhaust pipe joints, how does the water get into the exhaust? *A*.—We do not understand this question. If when testing with steam, the water that accumulates in the exhaust passages is meant, would say that it comes from condensation, and it is probable that the exhaust passages in the saddle are partly filled with water when engine is standing still, anyway.

A Mistake.

Last month a mistake was made in answering Question 22. This question was "Suppose you were waiting at a station for a train that does not stop, and the train passes one minute ahead of time by your watch, and your watch is 22 seconds slow, how much ahead of time is this train?" I say 18 seconds, my friend says 1 minute 22 seconds. Who is right? I said the train passed 1 minute 22 seconds ahead of time. My friend says my friend's thought will show that the train was one minute ahead *minus* 22 seconds, or 48 seconds ahead of time. We have received more than twenty letters about this question, some of them from general officers of railroads, all of which goes to show that this department is carefully read and thought of. We are obliged to our friends who thus help us out.

Starting Valve of Baldwin Compound.

Some time ago a correspondent asked us to publish description of starting valve gear of Baldwin compound. We misunderstood him, thinking he wanted the valve motion shown, and wrote him that we had already published it. He replied that he guessed the mechanics of the compound engine was too deep for some editors. We hasten to put ourselves straight with our correspondent—we got a boy to explain the starting valve to us.

We trust the following description will make matters plain
 The Baldwin combined starting valve and cylinder cock consists of a single casting, in which there are two taper plugs, one controlling the high-pressure cylinder cock and the steam for starting, the other controlling the low-pressure cylinder cock. The two plugs are held in place by springs and controlled by an arm operated by a lever in cab.
 The operation is as follows. In position 1, the starting valve is open to admit live steam to the low-pressure cylinder, the cylinder cocks at the same time being open to the atmosphere. In position 2,

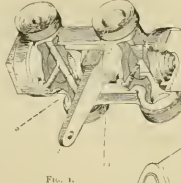

FIG. 1.

all passages are closed, and at the same time live steam admitted into the low-pressure cylinder when needed to start a train, or the cylinder cocks might be closed, the live steam cut off from the low-pressure cylinder, and the engine would be compounding in the most economical manner. The valve consisted of a cylinder having a connection to each end of the low-pressure cylinders, in which worked a plunger with three piston heads fitted with packing rings. These piston heads were so spaced that by a change of their position in the cylinders, the results described above were obtained.

Compounding by Use of a Lap-Valve.

American locomotive designers ought to take the lead in making compounding a success in locomotives, for the locomotive had hardly attracted attention as an element in transportation when an American began experimenting to make use of the exhaust steam in a second cylinder. It was in connection with this idea that lap was first used on a slide valve. This was done by Mr. William T. James, of New York, as early as 1852. It is now admitted that Mr. James invented and used the link motions on locomotives, which he built before Willoughby of England designed what is known as the Stephenson link motion. The link was designed by Mr. James entirely for the purpose of reversing the engine. It was an exceedingly simple form of reversing gear, and he appears to have had no conception of its capabilities as an expansion gear. He used a lap-valve to produce expansion, and tried to employ the lap to make a compound.

Mr. Dougherty, assistant to Mr. James, writing years ago about early locomotives, said "The lap-valve is older than the link by three or four years. It was one of Mr. James' hobbies to use steam twice over in all his engines—that is, each engine had two cylinders, both of the same size, and the exhaust steam from the first cylinder was used in the second, the first

cylinder having the lap-valve. By so using the steam there was a considerable saving over the single engine."

The principal thing which these views demonstrate is that any invention brought out to save steam or fuel is certain to appear to do so if it falls into the right hands. The information about steam engineering that has been acquired of late years proves that an engine using steam successively in two cylinders of the same size could not effect any economy, but this fact was not made clear in James' day, and he felt certain that his compound system had a great future. The same misapprehension has arisen about many new appliances offered for use in engineering.

Some Early Steam-Brakes.

Writing on the subject of steam-

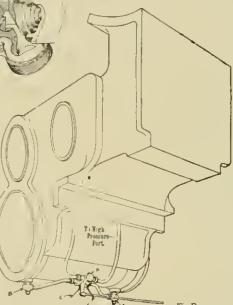

FIG. 2.

brakes, Mr. George Richards, formerly superintendent of motive power of the Boston & Providence, said "Mr. G. S. Griggs commenced building locomotives at the B & P shops in 1843. He built in all 20 engines—all eight-wheelers with crank-axes.

"His steam-brake was arranged as follows: A piston-cylinder was placed over the boiler, a upright-rod ran out at the top, a cross-bar was attached to this rod, and on each side was a lever with a middle fulcrum. One end of each lever was attached by a link to the cross-bar, the other end of each forced down a rod, to which was attached a brake-shoe which bore partly on top and partly between the drivers. This brake was on two locomotives and worked well. It was discarded because it was ahead of the times.

"One of these locomotives exploded its boiler in the winter of '46-'49. After the scientific people had given the subject a prayerful consideration, they decided that the explosion was caused by the steam-driver brake. A few of us, on the inside, however, knew that the safety-valves were screwed down solid. There were no steam-gauges in use at that time.

"Mr. Griggs also had a train-brake in use at that time, and applied the power to the wheels of the tender and all of the cars, and it was in use for a long time.
 "I cannot tell when the brake was first used, probably early in 1848.
 "In 1849, the time of the fastest train was one hour and fifteen minutes between Boston and Providence. Now it is one hour, showing a gain of fifteen minutes in forty-five years."

A Wonderfullly Good Car.

The Iron Car Co.'s style of iron car, made of iron tubing fastened to malleable iron castings, was popular with many railroad men a few years ago, but it appears now to have fallen from favor without having proved unworthy. In his paper before the New York Railroad Club, Mr. G. R. Joughins seems to have vindicated this car. He says

"I have been looking at these cars nearly every day for the last three and a half years, and feel compelled to say that it is very seldom indeed that I have come across a structure in which the details are so well designed as the details of these cars. It appears to me that the draftsman was an artist in metal; he showed a profound knowledge of the art of casting malleable iron castings. Every detail of the car has been formed on the most correct theory, by some one who possessed an artistic eye, competent to combine beauty and strength, and who instinctively cut away every ounce of superfluous metal. I feel that I cannot too much admire the cunning of the hand which molded these different details and adapted them so perfectly to the strains which they are called upon to withstand."

Where They Work Piece-work With No Inspector.

A mechanic on a railroad running into Jersey City, N. J., calls our attention to the beauties of piece-work without inspection as follows:

"Our paint shop turned out a caboose-to-day as finished, with one brake-wheel and staff, one draw-head, one hand-rail, one side-stringer, one brake-beam, three oil boxes, the ends of two body bolsters and one spring unpainted, this was just the outside, can not say if inside was finished the same or not."

A Reward for Brave Services.

The increasing number of train robberies, and the advantage tending to public security in any recognition by railroad officials of the bravery of their employees, seem to give more than a local interest to a recent action of the Illinois Central Railroad Company and the American Express Company, at Centralia, Ill. The railroad officials presented to each of seven men who on the night of September 20th repelled an attack on a train in Centralia, and captured the gang, a gold medal and three shares of the railroad stock. The express company bore an equal share in the expenses.

A New Valve Handle.

The cut shown herewith illustrates a steam-valve handle, just put on the market by W. F. Green, of Troy, N. Y. The



body of the handle is made of malleable iron and the edge is wound with a steel spring; this gives a good hold for a greasy hand or glove, one that cools quickly and one not broken or coming loose like the flimsy wooden devices that have become the standard handle on cab fittings in this country. Something more substantial is needed.

HONEST CHARCOAL-IRON BOLLER TUBES
 Manufactured by
 The Tyler Tube and Pipe Company, Washington, Pa.
 NEW YORK OFFICE:
 39 Cortlandt St.

Some Brains in Wheel Making.

By Camille Mazeaux.

NCE upon a time, long years ago, some foreign admirer of the ingenious Yankee made this statement

"If you want to make a machine that can't be made, take it to a Yankee; he will invent a way to make it, a machine to make it with, and put on several improve-



PILE OF SCRAP, READY FOR FURNACE.

ments before you think he understands just what you want."

This thought was brought home to me recently while visiting an American wheel works and noting the entirely original and unique way adopted to accomplish results, and produce what I unhesitatingly pronounce the very best and strongest wheel made for use under railway rolling stock.

In Europe we have from the first used nothing but wrought iron wheels, though our average load per wheel is far below that in America. Experiments and experience has proven that wrought iron is the strongest, most reliable, least liable to fracture, and the surest to yield to severe strains and recover itself again, of any of the metals used for wheels. Steel, though full of promises, has not been found any more honest, and is more deceitful than good cast-iron.

We use every known form of wrought wheel, the spoked form being the most



PAIR OF DISCS, AFTER FIRST FORGING.

generally used, but the ideal being the circumferentially corrugated web form, of which the No. 1, of the greatest German maker, is the best example.

As is, perhaps, well-known, this great maker winds up a strip of iron for his center, and, while he gets results, we Frenchmen never liked the idea, and have tried for years to make a web of single plate from picked scrap, but have always failed to get a center that showed perfect welding in the interior. If the German ideal wheel would break out of his hub under the testing machine, ours showed its weakness by laminations, that would virtually split the plate through the center, by repeated loads, in opposite directions, on the test press. So we contented ourselves with the spoked wheel and its thirty odd welds.

I naturally came to the conclusion that, as we have been experimenting for sixty years on wrought iron wheels, we should be in the van; and, as European railroad men always smile and say, "They use cast-

had thought of it in all their years of experience.

Great care is exercised in the selection



FRONT OF FORGED CENTER, BEFORE SURPLUS METAL WAS SHEARED OFF.

Here the Yankee comes in. His plates are nearly of a uniform thickness and will beat evenly, but there is little or no metal provided for the heavy hub, but he does the right thing at the right time, and around the center, and between the two discs, he places enough short pieces of faggot-bar to form the hub; these hold the two discs apart, the flames reach every part of each disc, and brings the two and the faggot bars up to the welding point at the same time—because all parts are of about the same size.

When they are at that beautiful white heat—not a dark spot in sight anywhere—a hand touches a hydraulic valve, the furnace door is lifted, a fork-hook is slipped under the almost melted pile, it is swung by an overhead trolley upon the die of the great hammer. Swish! and the giant smith of steam and steel has brought down his 20-ton sledge. There is a crash as if the head had struck a roll of baker's dough, but before you can think that mighty hammer descends again and again, and you knew without looking that there is a perfect weld

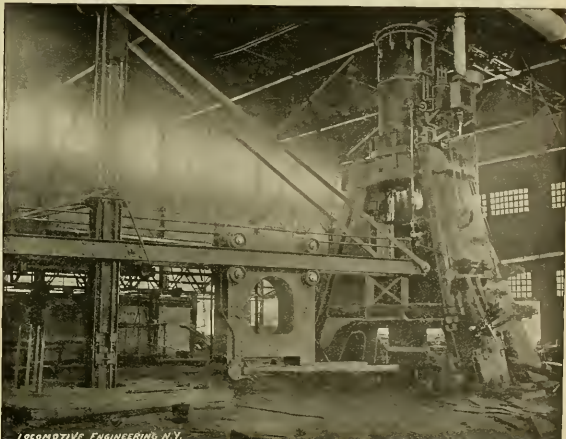

LOCOMOTIVE ENGINEERING N.Y.

FURNACE, HAMMER AND DIE CRANE OF THE BOIS STEEL WHEEL WORKS.

iron wheels under everything over there," when speaking of America, I was somewhat surprised to find at the great fair some American made, single plate wrought iron wheels, whose cut and etched sections showed perfect welding. I proposed then and there to find out how that was done—and I found out at the Bois Steel Wheel Works, in Scranton, in the province of Pennsylvania.

Our spoked wheels, with each weld made separately in an open fire, necessarily have many internal strains, and when put under the test machine invariably pull the spokes apart in the hub welds and not in the rim; this is undoubtedly due to the fact that the heavier parts are not brought to a welding heat through and through. How, then, could this American maker get a perfect weld of scrap in a hub six or seven inches long and eight or more in diameter?

At the Bois works the process was so short, direct and common-sense that I felt chagrined that none of my countrymen

of the scrap, the man who shears this is a blacksmith, and he keeps a careful lookout for steel pieces. The scrap is cut about 14 inches long, and, in a pile for half a wheel, of say, 36 inches diameter, the metal is crossed over thirty times.

They pile selected and sheared scrap, and weigh each pile; they interlace the fibers in every direction, they heat in a gas furnace to the dripping point and then form, under their 20-ton hammer, a blank or disc. For the whole center? No; for half the center.

These discs are allowed to cool and are then inspected, to be sure that no blisters or imperfect welds occur. Care is taken to put in enough metal to make more than a wheel.

This insures perfect welding in each of the two blanks, but as they are thin they would cool enough between the furnace and the die to prevent a weld if heated singly. If laid together the outside would melt before the center was hot enough to weld—that's what spoils ours.



BACK OF FORGED CENTER, AFTER SURPLUS METAL WAS SHEARED OFF.

and a perfect wheel center being made before your eyes—but why don't they stop that leaky steam pipe?

That steam has worked you, but the Yankee superintendent laughs as he shows you the two jets directed at the lower die—it's the way they get rid of the scale, such a smooth, clean face as it leaves. You can't help thinking of the water you have used, how it cooled the metal and increased

do, they hammer the fibers so close and firmly together that one of their centers could well have a ring, when struck with a hammer, similar to that of a cast-iron wheel.
A boy touches a valve, and a little hydraulic ram, whose presence you have never suspected, comes up through the center of the lower die, and your red hot center is posed between the two dies, a fork-hook again receives it and it is dropped into an annealing pit in the floor, there to cool off at its leisure and take time to get rid of any internal strains it may have.

They show you the special crane for taking on and off dies—cost thousands of dollars, but saves time. Ah! just think of the men, and the time, and the delay, and the expense of changing those 6,500-pound dies as anybody else but a Yankee would change them. It's a grand forge shop, with its special tool of every operation. You have never seen its like before. What have they got in the machine shop?

Here comes a rough blank *it* in the hammer shop. The first machine in its path is one simply and solely for drilling two 3/16-inch holes in the web near the rim, the wheel is self-centered on this machine and the two drills acting together get the holes through before you know it; these are to chuck and drive it in by turning the rim and boring the hub.

A special taper mill, of which there are several, all served by cranes, puts a true line through that hub without loss of time.



FINISHED FINISHED CENTER, READY FOR TIRE

the scale, and made a noise—and still left the peck-marks. Then the salt, and the brooms, and all the other disappointing experiments you've tried, and left it for the Yankee to think of steam, that is quick, tears off the scale, don't cool the plate so much, and keeps comparatively still about it.

While you look, the great smith raises his sledge aloft, throws it over his shoulder, as it were—that leaky steam pipe stops suddenly, a workman sets a steel ring on top of the red hot blank, the great hammer comes down with a smart rap, and the surplus metal in the wheel center, that has

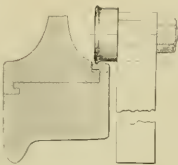

TOOL FOR ROLLING INTERNAL LOCK

is off, and on the mill that turns the rims. Carefully it's watched here, special gauges, that allow for the heat generated by the work, are being used by each workman, and as he finishes an operation he puts his private stamp on it.

Finally the rim is turned, that inside lip, like a Mansell retaining ring, is finished to a gauge and the wheel is placed on the floor, then the foreman tries his gauge out and places his mark of approval in the metal.

Every time they have bored a hole or turned a shaving you have looked for that black line that denotes a bad weld, but you haven't found it—it's not there.

Over in a corner is a great press capable of exerting a pressure of 300 tons. It used to be used in the manufacture of this maker's built-up wheel, but he, and you, and I all know that the day of the built-up wheel is on the wane.

On this press the wheel is placed, and from the tire shop comes a tire bored to gauge for this size and heated to expand it. Down it goes over the center and the ram comes down on it—just to be sure it's home solid and the lock is firmly embedded—a jet of water cools it down, and gauges will show you that the center has sprung and become smaller in receiving it, and then from the use of brakes the center will spring back and keep the tire tight even then.

While you were thinking, a crane has taken your wheel away and it is being

placed on a mandrel and centered on a wheel lathe. Here a tool with a roller on its side is placed on each side of the wheel, the machine having tool posts each side, and the first deliberate job you have seen is being done. These rollers savor home that lip on the tire that the maker calls an integral lock. The wheel is revolved with a rim speed of only 12 feet per minute, and the rollers are advanced but 1/16 of an inch per revolution; it takes an hour to set out this ring. This is done so as not to star the grain of the steel and thus separate and weaken it. That 200-ton press can't get one of these tires off with this one ring and the shrinkage holding it. By the way, the standard shrinkage used here as elsewhere in America is 1/16 of an inch per foot of diameter. Your wheel is now ready for paint—and service.

But you are interested in a lot of odd wheel centers—all kinds and sizes. They are old centers that have been tested in this great press, all of them have met their Waterloo except one, and that is one of these very centers that have been forged. It has a permanent set of 1/4 of an inch and when you are shown the record you wonder why it isn't 1/2 of a foot, for, supported at



CROSS SECTION OF BOIES WHEEL COMPLETE.

four points on the rim, it has stood thirty blows of two hundred tons each on that press. Then you stop wondering what kind of a wreck could injure that wheel!

Such wheel centers are a permanent investment for a railroad, they never wear out, they are immensely strong, they must be absolutely safe. How, with such magnificent equipment at hand, the American roads can afford to use cast iron or built-up wheels under their ponderous equipment is more than a French engineer can understand.

In our country, in case of accident, the courts would make it very, very interesting to the road that had a proven inferior device in use when a better could be had—and this will come in America.

This maker will put on Mansell retaining clips if you want, or the Gibson fastening, but after you see the integral lock you don't want any of them.

He has a perfect wheel with the smallest possible number of parts—two. A wheel of one metal throughout, tire and center, cannot be a success, the requirements of service being far different, and the wearing out of a tire would then mean the loss of an expensive center.

If the carriage superintendents and locomotive engineers of America could see all the different wheels made, I don't believe there's one that would leave the

Boies works without the same conviction that I had—that he had seen the best possible wheel made in the best known way.]

Safety from Wheel Accidents.

Wheels that have to be re-tired by taking out bolts and perhaps moving plates have inherent weaknesses that must

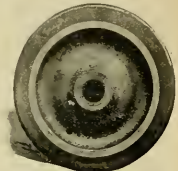

BACK OF TIED WHEEL

grow with age. Human ingenuity has not yet produced bolts and holes that can remain long perfect fits under such loads, and strains as a car wheel gets in service. Every extra piece in a wheel makes it that much more liable to derangement. The Boies wheel is composed of but two pieces, the center and the tire—the fewest possible. No bolts to work loose, shear or enlarge the holes. No wheel to take apart in re-tiring. A wheel that can be re-tired without touching the center—all fastening being done by the tire. A center stronger than required in any service—as permanent an investment as the right of way. Gives the mechanical department a chance to select any make of tires, and guarantees absolute safety against accidents from wheel failure of any possible kind. Can you afford to take chances on your passenger equipment with wheels that can, do, and have failed? In case of a fatal wreck from wheel failure could you hold yourself blameless?



THE BOIES WHEEL, READY FOR SERVICE

Deceptive Tire Fastenings.

Car repairers and others who inspect and have charge of passenger equipment should not forget to take into consideration the kind of fastening used on tires when noting their thickness.

Any wheel with Mansell retaining-rings has a thicker tire by half inch than appears—the rings cover up that much tire. This is also true of the Allen and Page wheels. The Boies No. 2 wheel having the integral lock appears to have an inch more tire than it really has—the outer lip coming down over the wheel center. This is true also in slighter degree of other wheels.



BACK OF FINISHED CENTER, READY FOR TIRE

of necessity flowed over at the edges, is cut off.

You understand now why they put in 25 or 30 pounds more of metal than they want; if there was just enough to fill the die, eight or ten blows would form the wheel center—they have struck between thirty and forty. No soft or spongy forging there. They have a simple standard for the amount of hammering they shall

REQUIRES NO ATTENTION.

IN USE ON THREE HUNDRED RAILROADS.

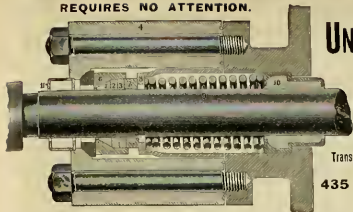

UNITED STATES METALLIC PACKING CO.

THE UNITED STATES METALLIC PACKINGS have stood the test of years, and are acknowledged to be superior to all. Renewal of packing rings made without disconnecting, by cutting them in halves and breaking joints. Swab and Oil Cups furnished with every packing.

Transportation Building, Section D. S., WORLD'S COLUMBIAN EXPOSITION, Bet. Columns 2 and 3.

435 NORTH BROAD ST., and 614 RIALTO BUILDING, PHILA. CHICAGO.

SEND FOR CATALOGUE AND SPECIFICATIONS.

OPEN HEARTH STEEL **CAMBRIA** COFFIN TOUGHENED

CAMBRIA IRON COMPANY,
Office 218 SOUTH 4TH ST. PHILADELPHIA PA.

Driving, Truck, Passenger and Freight
Axles, Piston and Side Rods, Crank Pins.

WORKS AT JOHNSTOWN, PA.

COOLBAUGH & POMEROY
SPECIAL R. R. SALE'S AGENTS.
29 BROADWAY NEW YORK.

SOFT STEEL BENT & DRILLED
ARCH BARS.

TOUGHENED BY COFFIN PROCESS, PATENTED

OPEN HEARTH COFFIN PROCESS TOUGHENED

CAMBRIA STEEL

THE HAYDEN & DERBY MFG. CO.,

Sole Manufacturers of

Metropolitan Double-Tube Locomotive Injectors

These Injectors work at all steam pressures from 25 pounds up to 250 pounds without any regulation or adjustment.

It is impossible for the water to run out of the overflow when Injector is working.

They are not affected by leaky steam or check valves.

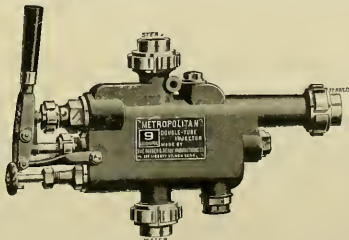

Owing to the peculiar form of nozzles used, repairs of these Injectors are reduced to a minimum. They are very slightly affected by bad water, there being no small relief holes or spills to wear or become clogged.

MADE INTERCHANGEABLE WITH STANDARD MAKES.

Office and Salerooms:

Nos. 111 and 113 LIBERTY STREET, NEW YORK.



A PERFECTLY CONSTRUCTED METAL BRAKE BEAM.
The Cheapest, Lightest, and Most Durable.
NOW STANDARD ON a MAJORITY OF RAILS THROUGHOUT the COUNTRY.
Second Office and Works: 40th & Hopkins Sts., Chicago.
CITY OFFICE: NEW YORK OFFICE:
218 Phenix Building, Chicago. 20 Broadway, - - Room 116
Farr's G. E. Bx, Eastern Agent.
Correspondence solicited.



Head Rest Seat.

THEIR SUPERIORITY
IS PROVEN BY
THEIR POPULARITY.

FINEST SEATS.
Coach, Parlor Car,
Sleeping Car,
Street Car,
Rattan Elevated

IN USE ON ALL THE
PRINCIPAL RAILROADS
IN THE UNITED STATES

Spring Edge Seat.



THE HALE & KILBURN MFG CO.,

Simolality,
Durability,
Elegance,
Comfort,
Combinad.

IT IS SAFE TO SPECIFY THE

H. & K. SEATS

PHILADELPHIA,
NEW YORK,
CHICAGO.

The Smith Triple Expansion Exhaust Pipe.



FRONT VIEW.

THIS Device is the invention of JOHN Y. SMITH, the originator of the Smith Vacuum Brake. In the cuts of the Front and Side Views shown herewith, "A A" represent Air Passages; "S S" Exhaust Steam Passages, and "B" an Annular Blower forming part of the Nozzle.

It is an entirely new departure in the construction of Exhaust Pipes for Locomotives.

Its distinguishing features are that the exhaust steam is NOT restricted after it leaves the cylinders, and the gases and heated air in the smoke arch are mingled with the exhaust steam in the exhaust pipe. The exhausted steam is thus superheated and expanded, and a powerful, prolonged, pulsating blast is created, which keeps the fuel in a constant state of agitation, and produces more perfect combustion.

Some of the beneficial results obtained are: Reduction of Back Pressure to a minimum (area of nozzle opening as large as the exhaust port); prevention of ejection of sparks from smoke stack; almost complete absence of noise from exhaust; prevention of formation of clinkers in fire-box; large saving of fuel.

By the elimination of Back Pressure we have demonstrated the fact that the power of engines has been increased to be able to pull from thirty to sixty tons more than with any other form of exhaust pipe. The pipe can be used with either straight or diamond stacks, in long or short front ends, and on locomotives burning hard or soft coal, wood or coke.

NEW YORK SALES OFFICE, Rooms 29 & 31, 115 BROADWAY.

GENERAL OFFICE DOYLESTON, PA.

FACTORY-READING, PA.



SIDE VIEW.

ALBANY, N. Y.

936 Broadway,
New York City,
115 BROADWAY.

STEAM COUPLERS

AND
FIRE PROOF
HEATERS.

CONSOLIDATED

McElroy, Sewall, Westinghouse and other Patents.

CATALOGUES UPON APPLICATION.

Special Appliances and Extra Strong Fittings of Every Kind.

AUTOMATIC CONTROL OF HEAT.

CAR-HEATING CO.

CHICAGO,

200 Phenix Bldg.
Canada,
COATICOOK, P. Q.

COMMUNAL,

DRUM,

AND
DIRECT STEAM
SYSTEMS.

A. W. SOFER, Pres.

ROBT. ANDREWS, Vice-Pres.

J. H. HOWARD, Sec.

W. R. THOMAS, Treas.

R. M. DIXON, Engineer

THE SAFETY CAR HEATING AND LIGHTING CO..

160 Broadway, New York.

HEATING SYSTEMS.—By hot water circulation and direct steam with regulating devices. Reliable and uniform heat. Economical and rapid circulation. Gibbs automatic coupler of Westinghouse type, absolutely steam-tight.

LIGHTING SYSTEM.—The celebrated Pintsch compressed oil gas method. In use on over 40,000 cars in Europe and America. Adopted by the U. S. Lighthouse Board for lighting Buoys. The best, most economical and only safe light for Railroad purposes. In brilliancy and cleanliness unsurpassed.

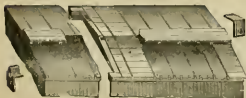

THE MURPHY STEEL CAR ROOF.

HAS no surface nails or screw holes. It has no joints where cinders, rain or fine snow can get through. It allows for contraction and expansion, and has ample elasticity to provide for sagging, twisting, buckling and curving of the car body. It is as solid as the car frame itself. It has no soldered joints. It can be repaired readily and without taking off more of the roof than is damaged. It is much cheaper than any other metallic roof now in use, and is cheaper than the double board roof, made of good lumber. It is better any other metallic roof for the reason that everything is furnished to make it complete; so that the parties buying it have no expense other than to rig it.

This ROOF can be applied on OLD LEAKY BOARD-ROOF CARS without making any change in the board roof; thereby saving the expense of replacing the old boards with new, and thus utilizing material that must otherwise be thrown away.

Manufactured by the P. H. MURPHY MFG. CO., East St. Louis, Ill.

JEROME METALLIC PACKING.

This is the Standard Metallic Packing all over the world, and is more generally adopted and in use on more locomotives than any metallic packing in use. Give the **JEROME** a trial and be convinced. Put it in competition with any other packing and be convinced of its superior merits.

Packing ring opened ready to apply without disconnecting the Piston from the crosshead. It runs longer and wears the rod less than any other packing in use.



Office and Works, Nos. 35 and 37 Canal St., Chicago, Ill.

C. C. JEROME, Inventor and Proprietor.

SEND FOR CATALOGUE.

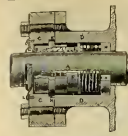

WROUGHT IRON WHEEL CENTRES.
VAUCLAN'S PATENT.



THE Standard Steel Works,

PHILADELPHIA.

STEEL TIRES

MANUFACTURED BY AN IMPROVED PROCESS INSURING SOLIDITY.

**Wrought Iron Centres.
Steel Tired Wheels.**

REPRESENTATIVES:

Chicago, 1013 Monadnock Bldg., St. Louis, 616 North 3d St.,

FITZ-HUGH & SPENCER.

ANDREW WARREN.

TANCY'S HYDRAULIC LIFTING JACK.



A good, reliable jack for lifting or pushing in any direction. The lever is for raising it up, the key-levers and stops it at any point, when it is again ready for lifting, saving time and trouble.

Various sizes made, from 4 tons to 200 tons.
**Joseph P. McCoy Co.
26 Warren St.,
NEW YORK.**

PATENTS
FOR INVENTIONS.
GEO. P. WHITTLESEY,
Atlantic Building, Washington, D. C.
EXPERT SEARCHES AND OPINIONS,
R.R. RAILROAD INVENTIONS A SPECIALTY.

The New "NATHAN"

(SEE ILLUSTRATION), AND
MONITOR INJECTORS
FOR
LOCOMOTIVES.

"NATHAN" SIGHT-FEED LUBRICATORS,
For Locomotive Cylinders and Air Brakes
STEAM FIRE EXTINGUISHERS.
For Switching and Tard Engines.
BOILER WASHERS,
Road and Guide Oil Cups, etc

Send for DESCRIPTIVE CATALOGUE.

**NATHAN MFG. CO., 92 & 94 Liberty St.,
NEW YORK.**

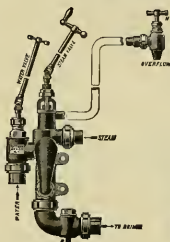

TAYLOR BEST YORKSHIRE STAYBOLT IRON

Axle, Piston Rods, Crank Pins and Forgings of all Descriptions, used by Leading Railroads.

R. MUSHET'S SPECIAL AND TITANIC STEELS

SOLE REPRESENTATIVES IN THE UNITED STATES,

B. M. JONES & CO.,

BOSTON, 11 and 13 Oliver Street. NEW YORK, 143 Liberty Street.

THE ONLY DOUBLE TRACK RAILWAY BETWEEN CHICAGO AND THE EAST.

Wagner Sleeping Cars, Dining Room and Private Compartment Cars between Chicago, Toledo, Cleveland, Buffalo, Rochester, Syracuse, Albany, New York, leaving and terminating points.
Route of the NEW YORK AND CHICAGO LIMITED, BOSTON AND CHICAGO SPECIAL, and the U. S. FAST MAILS.

W. E. CANNIFF, Gen'l Mgrt CLEVELAND, O. A. J. SMITH, G. P. & T. A.



A MONTHLY JOURNAL devoted to Steam Engineering and Practical Work relative to the Economic Generation and Transmission of Power. 56 to 64 pages, size of this paper, profusely illustrated. Price, \$1.00 a year. Send for Sample Copy—FREE. Address:
**THE POWER PUBLISHING CO.,
WORLD BUILDING, NEW YORK.**

**HOWARD IRON WORKS,
BUFFALO, N. Y.**

MANUFACTURERS OF

BOLT CUTTERS

-AND-

NUT TAPPERS.

Send For Price Lists.

MATCHLESS VALVE AND CYLINDER OIL.

Warranted not to corrode the iron or destroy packing, and to make more mileage than tallow or lard. Sold only to Railroad Companies direct or through our authorized agents. Matchless Cylinder Oil cannot be Bought of Dealers. In use on 80 Railways.

OILS FOR RAILROAD USE A SPECIALTY.

ECLIPSE LUBRICATING OIL COMPANY, Limited,

MANUFACTURERS OF EVERY PRODUCT OF PETROLEUM.

Main Office: FRANKLIN, Pa. Branches: FRANKLIN, Pa. OLEAN, N. Y. ERIE, Pa. OIL CITY, Pa.



J. G. HENDRICKSON, PRES.
F. I. CLAMER, Vice-PRES.
J. R. NEISON, Sec. and Treas.

"AJAX BEARINGS: RECORD 90 MILES AN HOUR."
"EMPIRE STATE EXPRESS, N. Y. C. & H. R. R. R."

**AJAX METAL CO.
INCORPORATED,
PHILADELPHIA, PA.**

SURE TO GIVE

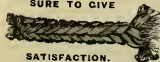

SATISFACTION.

DUVAL METALLIC PACKING

Send for Catalogues, Prices and detailed information to

**THORNTON N. MOTLEY & CO.,
SOLE AGENTS,**

43 John Street, NEW YORK.

SCHOEN MFG. CO.

PRESSED
STEEL MATERIAL
FOR CARS.

PITTSBURGH,
PA.

D. U. SETTLEMIRE, President.

GEO. W. EVANS, Vice-President.

W. C. ARTHURS, Secy. and Treas.

FRANK SNYDER, Supt.

Mt. Vernon Car

MANUFACTURERS OF
FREIGHT CARS OF EVERY DESCRIPTION, CAR-
BOUSES AND REFRIGERATOR CARS,
MT. VERNON,



Manufacturing Co.

OAK WHEELS, OAK CASTINGS, AND GENERAL
FOUNDRY WORK.
Capacity, 15 cars and 300 Car Wheels,
ILLINOIS.

MILLER'S ASBESTONE CAR ROOF.

THE COMING ROOF

HEAVY, DURABLE AND STRONG.
WILL WEAR LONGER THAN ANY METAL ONE.
WILL WEAR THE LIFE OF THE CAR.

Costs from \$10 to \$15 Less per Car.
CAN BE PUT ON IN ONE-HALF THE TIME.

HEAR WHAT THEY SAY ABOUT IT:
OUR WEST: M. K. & T. B. Downs East: Boston & Albany R. R.

1302 HAYMEYER BUILDING, 26 Cortlandt Street, NEW YORK.



THE

ALLISON MFG. CO.,

MANUFACTURERS OF

FREIGHT CARS AND
LOCOMOTIVE BOILER TUBES.

WROUGHT IRON PIPE OF SUPERIOR QUALITY.

PHILADELPHIA, PA.

DRAKE & WEIRS, Cleveland, Ohio.

ASPHALT CAR ROOFING

The Cheapest, Best and Most Durable Car Roof Known. In use by Seventy
Railroads. Twelve years successful use without a single failure. A roof now furnished free for
every one that fails in ten years.



WILLIAM C. BAKER,
Sole Proprietor and Manufacturer of

THE FIRE-PROOF BAKER CAR HEATER

MADE OF FLEXIBLE STEEL
ONE-QUARTER INCH THICK.
Firmly Welded into One Compact, Jointless, Seamless Whole.
FIRE WITHIN A SAFE OF SAFE MATERIAL
AS THE EXPRESS CAR SAFE.

The Only Alternative for the Deadly Car Stove
AND THE EQUALLY VICIOUS AND EXPENSIVE STEAM HEAT.

NEARLY 1000 FIRE-PROOFS IN USE.

ALL OTHER STYLES OF "BAKER HEATERS."
143 LIBERTY STREET, NEW YORK.

RODGER * BALLAST * CARS.

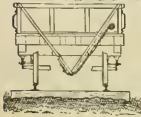
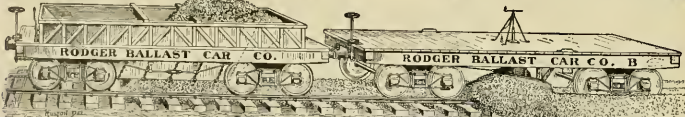

These cars are 34 feet long, and are built either 50,000 or 60,000 lb. capacity, M. C. B. Standard. They carry from 25 to 30 cubic yards of gravel or broken stone. In using them no ballast is thrown in the ditch, and none is wasted, as the greater amount of ballast proper can always be discharged. A train of 25 cars, carrying 500 yards of ballast can be unloaded and the ballast distributed, leaving the track perfectly cleared and dinged, as shown in the cuts, in from 15 to 18 minutes. This is all done by the regular "stra" system, i. e. coasting and two brakemen, no extra help being required. The track is perfectly cleared by this procedure, so that a ballast train can immediately pass over it at any rated speed, without needing any other train. (No aprons are needed.) No wire cables are used. There is no shoveling the track or wheels, without being shovelled in from the ditch. The average saving per mile, in the amount of ballast needed to make a "relief" of 10 or 12 inches, will average, in from \$200 to \$300, and in broken stone it often amounts to \$500.

These cars are in use on the Great Northern Ry., the Illinois Central, the Gulf, Colorado & Santa Fe, the Chicago & Eastern Illinois, the Penn. Lines West, and other roads.

Detailed information will be furnished by describing the
RODGER BALLAST CAR COMPANY, No. 1215 Monndock Building,
CHICAGO, ILL.

Books You Want.

- "Locomotive Running Repairs," by L. C. HILL in co., General Foreman "S. C. Shops." A practical treatise on running repairs, by a practical man. Numerous diagrams and illustrations. Just what is needed by men who handle and repair locomotives.
- "Simple Lessons in Drawing," by ORVILLE H. REYNOLDS (Chief Draughtsman Northern Pacific Railway). A splendid book Shows how to learn the elementary principles of mechanical drawing and sketching. Every student of locomotive engineering and every explorer in the field of mechanics should have it. Reduced from \$5.00.
- "Progressive Examinations of Locomotive Engineers and Firemen," by JOHN A. HILL, Editor Locomotive Engineering. A capital little book for new beginners. An excellent pocket companion. Three hundred questions, and the answers. Seventeen colored plates showing position and color of signals carried on engines and trains according to standard code. This plan of examination has been adopted on several roads. Twelve thousand of these books sold in less than two years.

Send 50c. for any of the above to
DEBS PUB. CO.,
TERRE HAUTE, IND.

PAUL S. REEVES, Philadelphia.
PHOSPHOR BRONZE IN INGOTS AND CASTINGS. * **LOCOMOTIVE AND CAR BEARINGS**
AND CASTINGS. A SPECIALTY.
BRASS AND PHOS. BRONZE CASTINGS from 1/4 lb. to 5000 lbs. in WEIGHT.

LEE-COMPOSITE-MANUFACTURING-CO.
ALL KINDS OF
STEEL
METALS
AND
SURFACES
PRESERVATIVE
1892-1904
TRADE MARK.
PERMANENCE

THE CAMERON STEAM PUMP.
COMPLETE WITH BOILER.
THE A. S. CAMERON STEAM PUMP WORKS,
Foot of E. Twenty-third St., NEW YORK.
Send for Illustrated Catalogue.

29 BROADWAY, NEW YORK CITY.

RAMAPO IRON WORKS, Hillburn, N. Y.,

MANUFACTURERS OF

Brake Shoes for Steel Tired Wheels.

ROSS, for Steel Tired Car and Tender Wheels,
ROSS-MEEHAN, for Locomotive Drivers,
SHEPPARD, for Blind or Bald Tired Drivers.

NARROW GAUGE CARS, SWITCHES, AUTOMATIC STANDS.

YOKED, BOLTED and SPRING RAIL FROGS,
CROSSINGS, TRACK EQUIPMENT,

RAILROAD AND MACHINERY. CASTINGS, HEAVY AND LIGHT.

C. E. ROOD. H. M. BROWN. ROOD & BROWN, CAR WHEEL WORKS, BUFFALO, N. Y.

Railroad, Car, Engine, Tender and Truck Wheels, Made from Best Charcoal Iron.
Office and Works: HOWARD and THOMAS STS.

C. M. FARRAR. JOHN TREFFTS. C. E. ROOD. EAST BUFFALO IRON WORKS, FARRAR, TREFFTS & ROOD, PROPRIETORS.

GREY IRON CASTINGS
of every description. Special Attention Given to Car and Locomotive Work.
Works: N. Y. C. & H. R. R., Broadway Station, 8th Ave. | CHICAGO: 60 Perry St., Buffalo, N. Y.

C. E. ROOD, MANUFACTURER OF MALLEABLE IRON, QUALITY GUARANTEED. RAILROAD WORK A SPECIALTY. Office and Works: LANCASTER, NEW YORK.

RAMAPO WHEEL AND FOUNDRY CO.

MANUFACTURERS OF



BOLTLESS STEEL-TIRED WHEELS

FOR PASSENGER AND LOCOMOTIVE SERVICE.
Tires with Annular Web and Hook,
Best Charcoal Iron Double-Plate or Spoke Centers,
Wedge-Shaped Retaining Ring.

Continuous Circumferential Fastening.



SIMPLE, SAFE, + ECONOMICAL.

CHILLED IRON WHEELS CONGDON BRAKE SHOES

OF SUPERIOR QUALITY, Drawing Room, Passenger and Freight Cars, Locomotives, Tenders, Flatstons and Blue Cars.
CYLINDER PACKING RINGS.
FOR CHILLED IRON WHEELS,
Outwear from 4 to 6 ordinary shoes and enhance mileage.

Office and Works: RAMAPO, N. Y.



President, ISA DIBBOCK. Treasurer, J. L. OTTE. Established 1867. Capital \$100,000.

NORTHAMPTON Emery Wheel Co.

MANUFACTURERS OF PATENT SOLID EMERY and CORUNDUM WHEELS and MACHINERY. LEEDS, MASS. CHICAGO OFFICE, 20 South Canal St. Send for Catalogue.

WILLIAM F. HALL, President. W. N. GILMORE, Treasurer. BELVILLE F. HALL, Secretary. S. MAESH YOUNG, General Agent. C. W. BREWSTER, Sales Agent. HENRY BEZER, Mech. Sg. Inspector. A. J. WILSON, Supt. Electrical Contr'n.

THE

Hall Signal Company,

Principal Offices, 80 Broadway, New York.

115 The Ames Building, BOSTON. Equitable Building, BALTIMORE. Western Office, 927 The Rookery, CHICAGO.

The Hall Systems of Automatic Electric Signals are in operation and in process of erection

ON A LARGE NUMBER OF PROMINENT ROADS.

Every Conceivable Form of Railway Signals.

Wire Circuit and Rail Circuit Automatic Electric Signals.

We have added to our Automatic Electric Signal System

Mechanical and Auto-Manual Block Signaling

IN ALL ITS BRANCHES,

Having obtained control of the BEZER LOCK AND BLOCK SYSTEM, BEZER & BURLEY INTER-LOCKING MACHINE, besides the best known forms of Semaphore, Compensator, Selector, etc.

HOW

Is the Locomotive Handled in Every-day Practice?
Do you Disconnect when Broken Down?
Do you Manage the Westinghouse and New York Air Brakes?
Do you Operate Steam Heat Regulators, and What is Their Construction?
Do you Run the different Compound Locomotives?
Do you Disconnect in case of an Accident to your Engine?

SEE

Locomotive Mechanism and Engineering.

By H. C. REAGAN.

145 Illustrations. 300 pages, 12mo. Cloth, \$2.00

JOHN WILEY & SONS, NEW YORK.

M. C. B. STANDARD
Automatic Freight Car Coupler.

New York Office, . . . 120 Broadway.
Chicago Office, . . . 941 Broadway.
St. Louis Office, 315 Commercial Build'g.

GOULD
Coupler Co.

BUFFALO OFFICE AND WORKS,
AUSTIN ST.

Gould Continuous Platform and Buffer.
GOULD VESTIBULE.

Locomotive and Car Axles,
Coupling Links and Pins.

M. C. B. Passenger Coupler
Used in Place of Miller Hook
WITHOUT CHANGE IN PLATFORM.

SEND FOR CATALOGUE.

STARRETT'S FINE TOOLS

ARE WARRANTED ACCURATE

J. S. STARRETT
ATHOL, MASS.

THE SMILLIE COUPLER is the Strongest and Simplest M. C. B. Coupler.
Only 4 Pieces.

Tensile Strength (Fairbank's Test) 139,640. Drop Test, 700 lbs.
hammer dropped 18 ft. 22 times failed to break the knuckle.

ALL LOCKING PARTS ARE THE BEST OF STEEL.
NEW YORK OFFICE, 52 BROADWAY.
Office and Works, 97 Clay St., Newark, N. J.

JOHNSTON CAR COUPLER COMPANY,
204 WALNUT PLACE,
PHILADELPHIA PA.

Strictly M.C.B. Lines.

JOHNSTON COUPLER

THE TROJAN CAR COUPLER Co., Troy, N. Y.
The knuckle may be thrown open for coupling by the hand rod at the side of the car, rendering it unnecessary for the trainmen to go between the cars to open the knuckle.
M. C. B. TYPE. THE STRONGEST AND THE ONLY SAFETY COUPLER. New York Office: 49 WALL ST.

ST. LOUIS COUPLER.

STANDS M. C. B.
Tests and complies with U. S. law, re-
quiring use of Automatic Car Couplers on and after January 1st, 1890.
Thousand of Cars already equipped. Capacity of Works, 200 Couplers per day.

ST. LOUIS CAR COUPLER CO., St. Louis, U. S. A.

INSPECTION!

Is the safeguard for boilers. Inspect your stay-bolts while boiler is under pressure.
Use hot water for hydraulic test—expands the joints in service. Our jet apparatus
washes out and dries boiler with hot water; no foundation required, no floor space.
One quarter the size and one-quarter the price of pump. Efficiency guaranteed.

RUE MANUFACTURING CO., 119 N. NINTH ST., PHILADELPHIA.

THE CHAPMAN JACK.
PATENTED.

The screw being lubricated and protected, the Jack is always ready for instant service. Railroad men appreciate the importance of having Jacks always in good working condition. Serious delays frequently occur in getting common Jacks so that they can be worked when suddenly required in train service. Common Jacks are frequently destroyed in efforts to make them work quickly after the screws are set with rust and dirt. This consideration alone makes the Chapman Jack the most economical one to purchase.

THE CHAPMAN JACK CO., CLEVELAND, OHIO.

RICHARD DUDGEON, 24 and 26 Columbia St., New York.
Maker and Patentee of
Improved Hydraulic JACKS,

Jacks for Pressing on Cross Pins of Car Wheels made to order. Communicate by letter and receive prompt attention.

Punches, Roller Tube Expanders and Direct Acting Steam Hammer

FIRE BOX STEEL.

QUALITY UNSURPASSED
Plates up to 100 ins. in width.

SHOENBERGER & CO.,
PITTSBURGH, PA.

PURITY AND DUCTILITY AND SOFTNESS.

SHERBURNE'S AUTOMATIC TRACK-SANDING APPARATUS.
Three Ways instead of One. Mind Your Steps.

On slippery rails sand the track automatically when brake is applied, avoiding rear collisions and derailment.
In starting, touch Lever and obtain jet of Sand and "get there."
The old Rod and Lever retained no sand.

For particulars apply to
SHERBURNE & CO., 53 Oliver Street, Boston.

FINE DRAWING INSTRUMENTS.
Drawing and Blue Print Papers.
DRAWING & MATERIALS
OF EVERY KIND.
QUEEN & CO.
1010 CHESTNUT STREET,
PHILADELPHIA.

SEE CATALOGUE ON APPLICATION.



VALENTINE & COMPANY,

Manufacturers of High Grade
Railway Varnishes and Colors,
57 BROADWAY, NEW YORK.

BRANCHES:
Chicago, 200 Wabash Ave.
Boston, . . . 104 Purchase St.
Paris, . . . 31 Rue de Lappe.

JOHN W. MASURY & SON, PAINTS AND VARNISHES.

NEW YORK and CHICAGO.

THE CLEVELAND VARNISH CO.'S Mfrs. RAILWAY VARNISHES. CLEVELAND, O.



The Sample Tells the Story.

A sample of Dixon's pure, flake lubricating Graphite, with interesting and instructive pamphlet,
Sent Free of Charge.

Every engineer and machinist should make himself better acquainted with Dixon's Pure Ticonderoga Flake Graphite. It will save both time and labor, and is infinitely superior to the common forms of plumbeago or black lead.

JOS. DIXON CRUCIBLE CO.,
JERSEY CITY, N. J.

LOCOMOTIVE ENGINEING, N.Y.

Is the most interesting historical paper published. Always ready with the latest news of the railway world. No. 79, we give large **EDUCATIONAL CHARTS.** One, "The Travelling Engine's Examination Chart," has enlarged valves and piston rods, cross-head, and to examination questions, with the answers. Another, "The Piston Rods," showing the placing of the valve and piston rod, every part of the engine in a few pictures of the engine in operation. You can see everything in size and color, and every place is named. A large colored paper, sent the quick action engine and having cast-iron plates and valves, and a few feet of track, little schoolhouses for a \$2.00. Address: **LOCOMOTIVE ENGINEING,** 2 Beekman St., New York.

THE BOYER Railway Speed Recorder

The only Recorder made that gives a chart of the run that can be carried at night, and has a dial indicator connected into the car so Engineer can see at a glance, any time, what speed he is running.

SIGNAL OIL WORKS, LIMITED, FRANKLIN, PA.

MANUFACTURERS OF **SIBLEY'S Perfection VALVE OIL,**
The only perfect Locomotive Valve Lubricant.
J. C. SIBLEY, Pres't.

GALENA OIL WORKS, LIMITED

Galena Engine, Coach and Car Oil, the Standard Lubricating Oil of America.

SAFETY, SPEED and ECONOMY are the results of the use of Galena Oils. COULD THEY, it is in Italy or Japan. These oils do not freeze in the coldest weather, will last any longer than any other oil, and will not burn or smoke. It is the only oil that will not burn or smoke. It is the only oil that will not burn or smoke. It is the only oil that will not burn or smoke.

Books for Railroad Men.

LOCOMOTIVE ENGINE RUNNING and MANAGEMENT. By AMOS SUGLAND. Price, \$2.00.
INDICATOR PRACTICE. By FRANK F. FENNER. Price, \$2.00.
ELEMENTS OF MECHANICS. By T. H. GOSNEY. Price, \$2.50.
PROGRESSIVE EXAMINATIONS FOR ENGINEERS AND FIREMEN. By JOHN A. HILL. Price, 50 cents.
AIR-BRAKE PRACTICE. By J. E. FRENCH. Price, \$1.00.
COMPOUND LOCOMOTIVES. By A. T. WOODS. Price, \$2.00.
CATECHISM OF THE LOCOMOTIVE. By M. N. FOSNEY. Price, \$3.50.
SIMPLE LESSONS IN DRAWING FOR THE SHOP. By O. H. REYNOLDS. Price, 50 cents.

Send price of any of these or of any other books of THE ENGINEERING LITERATURE COMPANY, East Orange, N. J., and they will be promptly mailed to any part of the world. Send for Catalogue.

TRACK SANDING APPARATUS FOR LOCOMOTIVES

HENRY L. LEACH,
(Inventor of the Apparatus)
BOSTON, MASS.,
Room 45, Mason Building, 70 N. City Street.

THE PERFECTED ART. The best in the world. The latest, most elastic, and most adapted for use in action. For special information address: **LEACH'S ADDRESS, 2101 Chestnut St., Phila., Pa.**

OUR ENGRAVINGS.

Of late we have had a great many inquiries as to who made the fine half-tone plates shown each month in LOCOMOTIVE ENGINEERING. Credit is due the expert anywhere and we are glad to recommend the engravers of our plates to those wanting good work at reasonable prices. All the half-tones and reproductions we use are made by the STEEL ENGRAVED & PRINTING CO., 607 & 609 SONNET ST., Philadelphia, Pa. **SINCLAIR & HILL.**

Boyer Railway Speed Recorder Co.

2-4 DICKSON ST.,
St. Louis, Mo., U. S. A.

TRADE MARK.

WATER AND STEAM RECORDING (Patented June 1, 1891)
Remotely adapted for Locomotives from \$10 to \$15.
The Original "Big Tank" is the only one that can be used in any part of the world. It is the only one that can be used in any part of the world. It is the only one that can be used in any part of the world.

THE GREAT PATENT CO.,
East Cambridge, Mass.

HENRY CAREY BAIRD & CO.,
Industrial Publishers, Bookellers and Importers,
810 WALNUT ST., PHILADELPHIA.

Get the New and Revised Catalogue of Practical and Scientific Books, of Maps, and our other valuable literature, sent free of charge to any part of the world. Write for it today.

GALENA OIL WORKS, Limited,

CLAREY BELLS, President,
CHICAGO BRANCH OFFICE, Franklin, Pa.
Florida Building, 129 JACKSON ST.

LEONARD & ELLIS.

VALVOLINE
TRADE MARK.

OILS FOR RAILROADS.

VALVOLINE OIL has long been used on many of the leading railroads in this country and abroad. It has no equal in quality and mileage.

W. A. BOYDEN, General Agent,
157 Chambers Street, NEW YORK.

New England Agents,
SHERBURNE & CO.,
No. 53 Oliver St., Boston.

CHICAGO SPlice BAR MILL.

Morris Sellers & Co.,

OFFICE,
216 PHENIX BUILDING,
CHICAGO.

Manufacturers of the new "GREER" Railroad Track Spike and the Celebrated "SAMSON" Bar.

Fourteen years' unexampled success has demonstrated the fact that under all varieties of Railroad Service they will prevent "low joints," battered rail ends, and in a remarkable degree withstand the test of breakage. More than 10,710,800 Bars in use on 175 different Railroads, equivalent to 16,213 miles of track.



The "Greer" Railroad Track Spike is the latest and best spike offered to the Railroad managements of this country and Great Britain. Indestructible. A leading power of from one to ten tons more per spike than any 5 1/2 x 9-16 spike. Automatically sharpened to chisel edge, it cuts; it does not tear the wood over. Hand picked 14 legs—every spike perfect. Particularly adapted for use on Bridges, Trestles, and on Switches.

SEND FOR TESTS AND PHOTOGRAPHS.

HENRY C. AYER,
General Manager

EDWARD D. GLEASON,

HENRY C. AYER & GLEASON Co.

MANUFACTURERS OF

Special Tools for Railway Repair Shops. Portable Cylinder Boring Machines.

SAFETY HOISTING MACHINERY. SPOKE AND HANDLE TURNING MACHINES.

OFFICE AND WORKS: N. E. corner of Second and Diamond Sts. — PHILADELPHIA. — CENTRAL OFFICE: No. 919 Betz Building.

THE ROTARY.

For full
Particulars,
Address

The Leslie Bros. Mfg. Co.,
Paterson, N. J.

LOCOMOTIVE SPRINGS

WITH PATENT V SHAPE BANDS.

Gives more Elasticity to short Plates
and Better Riding Qualities.



MANUFACTURED BY
A. FRENCH

SPRING CO.

A. FRENCH, Pres.
J. E. FRENCH, Vice-Pres.

GEO. W. MORRIS, Gen. Mgr

D. C. NOBLE, Sec. and Treas.
D. N. FRENCH, Gen'l. Supt.

A. FRENCH SPRING CO.

PITTSBURGH, PA.
Manufacturers of
ELLIPTIC AND SPIRAL SPRINGS
OF ALL DESCRIPTIONS.

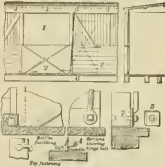

Steel Grain Door Come to Stay.

COMPARISON.

Loss of Doors in Two Years:
500 cars equipped with
steel doors lost
two doors.
1500 cars equipped with
wooden doors lost
80 per cent. in
the same time.

MICHIGAN RAILWAY SUPPLY CO.,
DETROIT, MICH.



CUYAHOGA FALLS, O.

ROLLED HOLLOW STAY BOLTS ARE STRONGER AND SAFER
THAN DRILLED ONES.

Mandrel rolled from the finest charcoal iron. All sizes, from 3/4 to 1 1/2 inch, with any sized
hole required from 1/4 to 3/4 inch. Let us send you a sample and quote prices.

A set for one fire-box will convince you of their merits, safety and economy.
AGENTS IN CANADA: J. & H. TAYLOR, 751 Craig Street, - - Montreal, Canada.

THE JANNEY FREIGHT CAR COUPLER

THE Mc CONWAY & TORLEY COMPANY

W. M. Mc CONWAY - PRESIDENT.

48th ST. & A. V. RY. - PITTSBURGH, PA.

BEMENT, MILES & CO., PHILADELPHIA, PA.

BUILDERS OF

METAL-WORKING MACHINE TOOLS,

FOR

Locomotive and Car Builders,
Railroad Shops, Machine Shops,
Steam Forges, Ship Yards,
Boiler Shops, Bridge Works.

STEAM HAMMERS

FOR WORKING IRON OR STEEL.

NEW YORK OFFICE: EQUITABLE BUILDING. GEORGE PLACE, Agent.

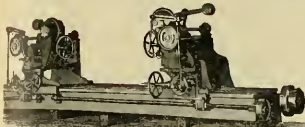
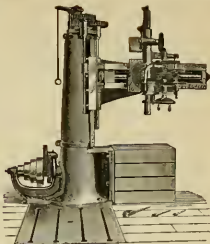

PEDRICK & AYER,

Milling Machines. Cylinder Boring Machines.
Richards' Patent Open Side Planers.
Portable Valve Seat Planers.
Otto Patent Flue
Cleaners.

Universal Grinders.
Pneumatic Hoists. Tire Heaters.
Portable Crank Pin Machines.

SPECIAL TOOLS FOR RAILWAY REPAIR SHOPS

1001 & 1003 HAMILTON STREET,
PHILADELPHIA.

STEVENS PATENT
SCRIBER. No. 80.

The best made for machinists. Sent by mail, postpaid, for \$1.00.
Other make. Ideal and Leader Spring Dividers and Calipers, Ideal Surface Gouge, Depth Gauge, and File Machine, etc., etc. Illustrated catalogue free on request.

STEVENS PATENT
Spring Inside Calipers.

Price, by mail, postpaid,
4 inch. No. 75 \$1.00
5 " " " " " " \$1.25

These goods exact for
uniform and true work, and
are made in Philadelphia, Pa.

TOOLS.



THE NATIONAL MACHINERY CO.,
TIFFIN, OHIO.

SPECIALISTS IN
Bolt and Nut Machinery.

Bolt Cutters. Bolt Headers. Bolt Pointers.
Upsetters and Benders. Nut Machines.
Nut Tappers.

BOSS SCREW PITCH GAUGE.



A FULL LINE OF
Machinists' Fine Tools.

SEND POSTAL CARD FOR OUR
NEW 1893 CATALOGUE.

STANDARD TOOL CO.,
Box G, ATHOL, MASS.



THE ACME MACHINERY CO.
CLEVELAND, OHIO.

Manufacturers of
ACME BOLT & RIVET HEADERS
ACME SINGLE AND DOUBLE
AUTOMATIC BOLT CUTTERS,
Cutting from 1/4 to 1 1/2 in. diam.
Also, REPAIRS HEADS AND NUTS.



THE PRATT & WHITNEY Co.,
HARTFORD, CONN., U. S. A.,
MANUFACTURERS OF

STANDARD CYLINDRICAL SIZE and U. S. STANDARD THREAD GAUGES.
Special Grades of every variety of interchangeable production
REAMERS, TAPS and DIES,
In all sizes styles for Machinists, Pipe Fitters and Boiler Makers

Ramshaw Ratchet Drills, Combination Lathes Chucks, Die Stocks, Bolt Cutters,
Lathes, Planers, Drilling, Milling, Pressing, Cutter Grinding, Die Sinking,
and Drop Forging Machines, Forging and Trimming Dies.

MONITOR MACHINES FITTED WITH TOOLS
For Sighting to Sample. Saws, Sticks, Locomotive Fittings, Timbers' and Gas Fitters' Brass Goods.
CATALOGUE SENT ON APPLICATION.

THE LONG & ALLSTATTER CO.,
HAMILTON, ONIO.



Double, Single, Angle-Bar, Drop, Direct
action, Twin, Roller, Spring, Gate,
Multiple, Bolt and Steam Drives

PUNCHES
AND
SHEARS.
Over 300 Sizes.



BEATS THE MONKEY-
WRENCH OUT OF SIGHT!
OUR ROUND Jaw KAMPFEL RATCHET No. 2 is the
best kind to hold for running repairs that can be
used on the hardest steel bars and heavy without
ever making it keep hold when once set and you
can set it on in one-of-they-way place, and take off
a nut without taking jaws off, and where you
couldn't get in an eighth of a turn with the
monkey—and it will take hold close up where
the old wrench can't get. This prevents getting
finished cuts and parts around shop. A thousand
times as fast as any other monkey wrench it can save
time and money. We'll send a Catalogue Free
upon request.

THE KEYSTONE MFG. CO., 812 TERRACE,
BUFFALO, N. Y.

CHARLES MURRAY
ENGRAVING WOOD
55 ANN ST. NEW YORK.

Our Lane Engravings are made by the
WAX process, a plan securing accuracy and
distinct lines on original copper plates.
They are made by BRADLET & PEARNE,
331 William Street, New York City

FLAT TURRET LATHE



STRAIGHT AND TAPER FRAME BOLTS, ETC.

"RAPID LATHE WORK,"
By New Method—Hartness System.
JONES & LAMSON MACHINE CO.,
SPRINGFIELD, VERMONT, U. S. A.

THE WESTINGHOUSE AIR-BRAKE CO.

Is now prepared to fill orders, at an hour's
notice, for One or One Thousand Sets of

AIR-BRAKES FOR FREIGHT CARS,

having, at their New Works, an annual capacity
for turning out Air-Brakes for 250,000 Freight
Cars, 6,000 Passenger Cars, 10,000 Locomo-
tives; besides repairs for the 350,000 Freight
and Passenger Cars, and 26,000 Locomotives
already equipped by

THE WESTINGHOUSE AIR-BRAKE CO.

World's Columbian Exposition Awards.

THE SAFETY CAR HEATING AND LIGHT- ING COMPANY OF NEW YORK.

❖ **Pintsch Gas System of Car Lighting.**—“For First-class Workmanship and Perfect and Effective Construction of all its parts.”

❖ **Steam Heating.**—“Awards for Excellence of Design, and Good Efficiency of their Direct Steam Heating System, the Combined Hot Water and Steam Heating System, and for the design of the Gibbs' Coupler.”

THE PINTSCH SYSTEM OF CAR LIGHTING, now applied to over 55,000 passenger cars in Europe, United States, South America, India and Australia, is recognized as the most efficient, safe and economical system of Car Lighting, and is adopted as the standard by many of the prominent railroads in the United States; also by the Pullman and Wagner Palace Car Companies.

THE HEATING SYSTEM of combined hot water and steam has been tested by five years of practical service on over 2,000 passenger cars in the United States. The simplicity of its construction and effectiveness of operation have been well recognized and endorsed by the railroads adopting it.

THE DIRECT STEAM HEATING SYSTEM provides abundant radiating surface to quickly heat cars in the coldest weather, and a positive means for regulating the temperature of the cars by a reduction of the radiating surface in a simple manner.

THE GIBBS' COUPLER, embodying recent improvements, maintains the principle of automatically uncoupling and closing more tightly as the steam pressure increases. They are absolutely interchangeable, whether old or new, and wear or repairs do not affect their interchangeability.

THOMAS PROSSER & SON,
15 GOLD STREET,
NEW YORK.



STEEL TIRES

ON LOCOMOTIVE DRIVING WHEELS
AND ON STEEL-TIRED WHEELS
GIVE THE BEST RESULTS
FOR EVERY VARIETY OF SERVICE.

The CAST-STEEL WORKS of FRIED. KRUPP, Essen, Germany, cover an area of 1,200 acres, employ about 25,000 men, have the most improved plant, and stand unique, from the fact that they have their own Ore and Coal Mines, Blast Furnaces, etc., and that every stage of manufacture is under their own supervision, and are not (like others) dependent on the open market for a miscellaneous assortment of crude material; which, in connection with 75 years' experience, enables them to turn out a product of a very superior quality, second to none, and at the same time the different grades of Steel are always of the same uniform quality.

Crank Pins, Piston Rods, Spring Steel, Steel-Tired Wheels, Etc.

After a test of over 35 years, the "KRUPP TIRE" has proved itself the best in the market. If a reliable article is wanted, which will give satisfaction, get KRUPP'S.

SCHENECTADY LOCOMOTIVE WORKS, SCHENECTADY, N. Y.

LOCOMOTIVES
OF
STANDARD
DESIGN
FOR ALL
CLASSES OF
SERVICE.

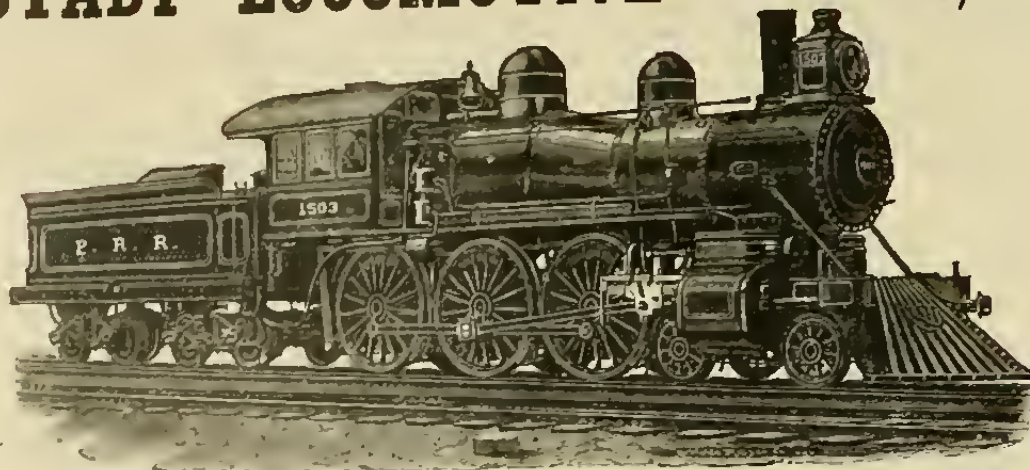

OR FROM
DESIGNS
FURNISHED
BY
RAILROAD
COMPANIES.

EDWARD ELLIS,
President.
WM. D. ELLIS,
Vice-Prest. and Treas.

A. J. PITKIN,
Superintendent.
A. P. STRONG,
Secretary.

COMPOUND LOCOMOTIVES, Showing an Economy of 15 to 30 per cent. in Fuel and Water. Annual Capacity, 400.

M. J. BENJAMIN, Pres. and Treas. DAVID BOWEN, Asst. to the Pres.
H. J. HARRIS, Asst. to the Pres.
T. M. HARRINGTON, Secretary

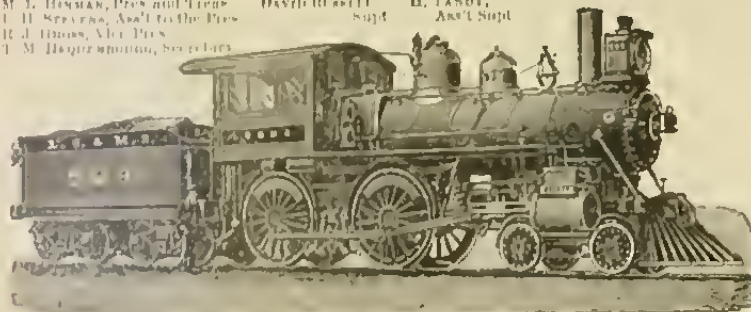

**Brooks Locomotive Works,
DUNKIRK, N. Y.**

Builders of Locomotive Engines for any required service from our own designs or those of purchasers.
Perfect interchangeability and all work fully guaranteed.

COMPOUND LOCOMOTIVES

FOR PASSENGER AND FREIGHT SERVICE.

William Sellers & Co. Incorp.
PHILADELPHIA, PA.

MACHINE TOOLS

For Railroad Shops, Car Builders, Etc.

HIGH SPEED
TRAVELING & SWING CRANES.
ALSO
TURNTABLES, INJECTORS,
SHAFTING,
ETC., ETC.



"LACKAWANNA"

Sight Feed Locomotive
Cylinder Lubricator.

ABSOLUTE UNIFORMITY OF FEED.

Perfect distribution of oil to both cylinders from one feed glass, and entire efficiency under all working conditions.

Only One Glass,

and that short and stout; almost unbreakable. Absolutely no use for any more. They are an unnecessary source of trouble and danger.

Write for full particulars.

LACKAWANNA LUBRICATING CO.,

1212 Capouse Avenue, Scranton, Pa.

BINDERS that will hold a years' numbers can be had by sending \$1.00 to
LOCOMOTIVE ENGINEERING,
5 BEEKMAN STREET NEW YORK.

Latrobe Steel Works
MANUFACTURERS OF

TIRES

FOR LOCOMOTIVE and CAR WHEELS.

Main Office and Works, Latrobe, Pa.
Branch Office, Bullitt Building, Philadelphia.
Chicago Office, Phoenix Building.
New York Office, Columbia Building.

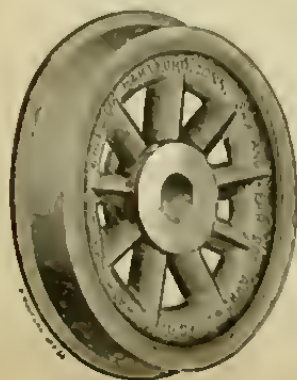

THE WASHBURN
Car-Wheel Company,
HARTFORD, CONN.,
MANUFACTURERS OF

**CRUCIBLE
STEEL-TIRED WHEELS**

For Factor and Sleeping Cars,
Passenger Coaches, Locomotive and Tender Trucks.



Locomotive Engineering



A Practical Journal of Railway Motive Power and Rolling Stock.

COPYRIGHTED, 1894, BY ANDREW BRIDGEMAN AND JOHN A. HILL.

VOL. VII, No. 4.

NEW YORK, APRIL, 1894.

10 Cts. Monthly
\$1.00 Per Year.

Mountain Climbing.

American locomotives were the first to gain reputation as hill climbers. The early English idea about a locomotive was that it must be run on a fairly level road to show favorable performance, and so immense labor was expended in cutting down hills and in filling up valleys to make a level road-bed. There was a belief that smooth wheel locomotives could not be employed in climbing steep grades, and so attempt appears to have been made to test how far this theory was correct until American engineers took it up.

In 1847 a Norris engine, designed by Mr. Joseph Harrison, was tried on the Colum-

Ministry of Agriculture, and a number of other engineers, went on the 17th inst. to Cachoeira to attend a trial of the new engine, made by the administration of the Cantagallo Railway, to test its fulfillment of the contract engagement to draw a 40-ton train up gradients of 8 3/4 per cent.

This was successfully effected, the locomotive, weighing 40 1/2 tons when ready for the trip, drawing a train of 40 tons, composed of three trucks, laden with sleepers, and a passenger car, drawing it from Cachoeira to Boca do Mato, 8 kilometers, at the speed of 24 kilometers an hour, and then easily up a rise of 8 3/4 per cent, with curve and counter-curve of 40 meters radius, a result superior to the contract

The Contributory Negligence Infamy.

In a published address by the Hon. L. S. Coffin, of Iowa, we find the following sensible remarks about an infamous law: "Here is an intended passenger. It is not absolutely necessary that he should take the train. He knows that accidents do happen to trains." He knows that the dispatcher in yonder office may make a mistake and send his train crashing into another. He knows all this, but still he takes the train; but does the court hold him as contributing to the results of the collision that cost him his life? Does it hold that he assumed the risk and therefore cannot recover? On the other hand

tributed by his own negligence to his death, and therefore the parents of the boy cannot recover.

"What, we common people ask, are our laws and our courts for? Are they for the strong or for the weak?"

"Let the courts hold the roads to as rigid responsibility for the life of the employe as for the passenger, and it would be the most effectual safety appliance possible. It would then be only a question of short time when every car would be equipped with automatic couplers and every train with power brakes. Then this dark, foul blot on this otherwise grandest achievement of this nineteenth century would be washed away."

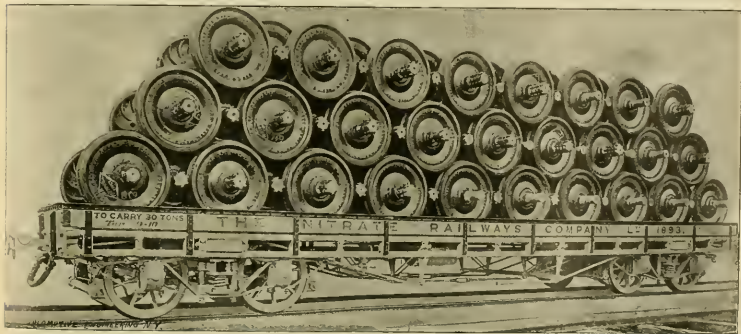

AMERICAN IRON CAR BUILT IN ENGLAND. CHURCH & ETTINGER'S PATENT TRUCKS. LENGTH, 34 FEET. LIGHT WEIGHT, 21,250 POUNDS. LOAD, 52,170 POUNDS. DEFLECTION UNDER LOAD, 1/4 INCH.

bia Railroad, now a part of the Pennsylvania Railroad, on a grade of 309 feet to the mile, and it pulled a little more than its own weight a distance of 2,800 feet at the rate of 15 miles an hour. Owing to the fame of this feat, a Norris engine was shortly afterwards imported to England to pull trains up steep grades on the Birmingham & Gloucester Railway, which English engines had failed to ascend without a load.

An account recently published in the *Angle-Braslian Times*, indicates that American locomotives are still attaining new triumphs in mountain climbing, and that abroad they are throwing in the shade the amazing performances of locomotives on some of the steep gradients on Rocky Mountain railroads. Think of an engine with smooth wheels climbing a grade that rises 9 feet in every hundred. We quote from the Brazilian paper:

"One of the three Baldwin locomotives recently obtained by the province of Rio de Janeiro for the serra section of the Cantagallo Railway having been set up and got ready for service, Dr. Honorio Bicalho, Director-General of Public Works, of the

engagement, and it is believed that when the driver has become familiar with the engine it will as easily ascend rises of 9 per cent.

"It has thus been satisfactorily proved that the serra section of the Cantagallo Railway can be worked with engines without special adherence, and that the Fell system adopted for it, and worked at such serious expense, can be completely dispensed with, as well as be as soon as the Barlow rails have been replaced by steel ones on the remainder of the serra section, and also on the first section, reducing the gauge of the latter to that of the rest of the railway. With these improvements it is expected that the working expense of the Cantagallo Railway will be so largely reduced that, instead of a burden, it will become a source of profit to the provincial treasury."

Brazilian engineers called the grades 8 3/4 per cent., but measurements were afterwards made by American engineers and it was found that the gradients were steeper than 9 per cent., and that curves of about 20 degrees twisted the trains on the heaviest part of the climb.

here is a green, simple boy, infatuated with a desire to be a trainman. You and I and all the great public and the court judges even wait him, green as he is, to become a railroad employe, because somebody must run the train. We want to ride, we want to send and receive our goods. It is absolutely necessary that this boy, unsophisticated and rustic as he is, having hardly the slightest idea of what railroading is, knowing nothing really of its perils, but desiring to follow this as his life work, and in so doing will be a great benefit to us all, to stockholders and to all, he goes, and in attempting to couple the first car perhaps is killed. Parents seek to recover something, but the judge whose library was in the car that killed the boy decides that as the boy was supposed to know all the dangers of railroading he assumed the risks, and by trying to do what we all wanted him to do; what the judge wanted him to do so he could get his package of law books; doing what the poor boy was in a sense compelled to do to earn his bread, doing his part in carrying on that which is now become a necessity of our civilization, because he did this he can-

Take another case. The company for some reason employs a dispatcher. He proves incompetent, he gets drunk, in his maddish stupidity he sends two trains together and lives of trainmen are sacrificed, and others are crippled for life. "Cannot recover because it was caused by negligence of fellow employe." Did the dead men have any voice in employing the incompetent dispatcher?

The Committee of the Master Car Builders' Association having in hand the investigation of brake beams has sent out a circular containing sixteen questions calling for information. The chairman of the committee is Mr. E. D. Nelson, superintendent of motive power of the Pennsylvania railroad at Williamsport.

The subject of "Wheel and Flange Gauges" is under investigation by Mr. J. N. Barr, chairman of a committee appointed by the Master Car Builders' Association. There is such a variety of gauges of this character in use that it is very desirable that the best ones should be selected and recommended.

* Diseases of the Air Brake System;

By PAUL SYNNESTVEDT.

Their Causes,
Symptoms
and Cure.

Train-Pipe.

In speaking of the train-pipe we include all the piping which serves to carry the air from the engineer's valve to the triple-valve throughout the train. And the pipe that carries the air from the triple-valve to the cylinder, as that must properly be regarded as a part of the cylinder. Of course, the hose connections form a part of the train-pipe, as do also the branch pipes leading from the train-pipe to the triple-valves, and on passenger trains the small length of pipe leading to the conductor's valve.

The two great difficulties that arise in the train-pipe are leakage and stoppage.



PLATE 16 A

which, but the latter particularly, may be positive of the most serious consequences.

LEAKAGE

Leakage may most readily be detected by a customer falling of the black pointer in the gauge when the engineer's valve is placed on the lap, and the rapidity of the reduction will show the extent of the leak.

A very heavy leak will make it difficult, or, in some cases impossible, to maintain sufficient pressure in the train to properly operate the brakes, while a slight leak will sometimes cause a sinking of the brakes, though serious trouble from this cause may be prevented on the road if the pump be in good condition and the brakes carefully handled, as the constant feeding of

reservoir or a triple-valve blowing from the cushion will also show a leak in the train-pipe (that is, by a reduction or falling of the black pointer on the gauge). These cases, however, are very easy to find, because they make a very decided and audible blow at one point.

The T connection where the conductor's valve branch pipe is connected to the main train-pipe, is particularly mentioned because this is a joint frequently broken by pulling cars apart without uncoupling the hose.

LEAKAGE IN COUPLINGS.

Perhaps the most frequent cause of leakage is to be found in the hose coup-

plings, generally from some defect in the rubber packing ring. A leak at this point should be treated as follows: First uncouple the hose, examine the packing rubber, straighten it if it seems bent or twisted, and couple up again. If this does not help and there is not time to replace the hose or packing rubber, take a little nail or wooden wedge and drive it in between the legs on the coupling in such a way as to force the packing rubbers closer together in the position indicated at 2 in plate 16 A. A very bad leak may sometimes be entirely stopped in this way. Never strike the legs on the coupling so as to make it go together more tightly, as this makes it difficult to couple to a coupling which has a new rubber in it, and

than a rotten gasket in one of these unions or a loosening of the nut because the pump had been insecurely fastened and rattles. Too much emphasis cannot be put upon the desirability of having all air-brake pipes very securely and firmly fixed in place. This will prevent a great deal of trouble.

LEAKAGE IN CONDUCTOR'S VALVES.

Conductor's valves sometimes get to leaking because of dirt lodging in them. Sometimes (and always with the new style) they do not close after having been opened, and although the blow from such a one be heavy it may be hard to find, because the location of the valve in the closet renders it rather inaccessible.

STOPPAGE, E. G. OBSTRUCTION

Now we come to the consideration of

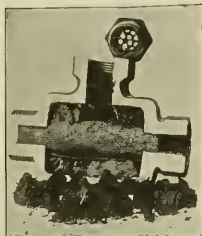

PLATE 16 B

the second part under this head - stoppage. By this we refer to any obstruction which interferes with the passage of air through the pipe. This difficulty is always manifested by a refusal of the brakes to set or release properly *back of a certain point* in the train, while all those forward of that point operate satisfactorily. Sometimes the stoppage is of such a nature as to allow the air to pass freely through the pipe in one direction but not in the other, the obstruction closing the pipe just like a valve.

in from the engine back while he is running, as well as when the train is at rest, without in any way interfering with the speed or momentum of his train, by simply moving his engineer's valve handle from the running to the release position after his main drum has accumulated 20 pounds of excess pressure (red pointer 20 pounds, higher than the black one), and carefully noting the number of pounds that the red pointer falls during the first couple of seconds. For ten average freight cars it will fall about 10 pounds. For twenty cars, or over it will fall from 15 to 18 pounds. If the train is cut out on one or two cars back of the engine the reduction will be but a couple of pounds. This result will, of course, vary slightly with leakage, the size of the drum, and the length of the cars, but a little practice will enable anyone to make a very close guess.

If the obstruction in the pipe is of such a nature that it permits the passage of air in one direction but not in the other, it is apt to be still more dangerous. This has been known to occur through curling up of the inside lining of the hose, the rubber rolling up into a ball, and, just like a valve, opening one way and closing the other. It might also be caused by the cylindrical screen in the car draft-cup collapsing or clogging up with the dirt. Plate 16 C, taken from the *Railway Age*, shows one that was in the possession of Mr. G. W. Rhodes. It is a fair sample of many that are now in service.

Cases are also recorded where, hose has formed in the coupling or been sufficient to obstruct the passage. This often results from allowing the hose to hang down and through the snow, and afterwards coupling it without examination.

Auxiliary Reservoir.

It is not generally supposed that anything ever goes wrong with the auxiliary reservoir, as it is nothing but a storage tank for air.

It plays a very important part, however, in the action of the triple-valve, and any leakage here, even though very slight, may seriously interfere with the function

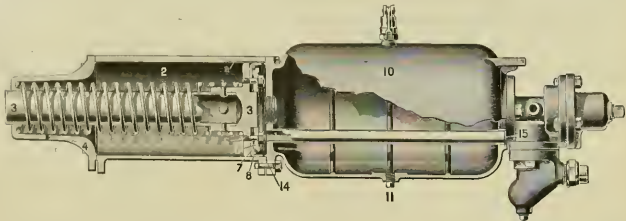

PLATE 16 A

pressure back from the engine will overcome the loss. Slight leakage on trains running on mountain grades is more serious, because it results in a constant increase of the braking force when it is not wanted.

HOSE LEAKS.

If the engine gauge shows a leak in the train-pipe a careful examination of the following points should be made, as they are the places where it is most likely to occur. Hose couplings, hose, pipe unions under the tender, conductor's valves, and the T at which the conductor's valve branch pipe is connected to the main pipe. A bleeding cock left open on any auxiliary

also increases the haulage of rupturing the hose in case the train pulls apart.

BURST HOSE.

About the only remedy for hose which are burst or leaking is to replace them with good ones. If no extra ones are to be had one can be taken off from a car near the rear of the train, say the last hose on the last car.

LEAKS UNDER TENDER.

The pipe unions under the tender are a frequent cause of leakage, probably because of the conditions surrounding them. Engineers should be very careful to thoroughly examine the equipment on their engines before commencing the train crew for not stopping leaks which may be both-ering them. It may be nothing more

very dangerous to see that this is a very dangerous disease and may result in the death of the patient (total failure of the brakes at a critical time), if it is not very promptly treated and cured.

Of course, the closing of a hose-cock somewhere in the train is the most frequent form of this trouble and great care must be taken at all times to see that this does not occur, or if it does happen, to have it immediately located and remedied. Hose-cocks will sometimes close while running if they stand in such a way as to strike against one of the timbers above the handle.

TESTING BRAKES.

The engineer can make a very close approximate test of the number of cars cut

of the most vital mechanism of the brake. Except in so far as any leakage will cause a slight drain on the pressure in the train pipe, any trouble with the auxiliary reservoir is purely local, however, and affects only the one car in the train.

Since the freight and passenger reservoirs are of different construction, we shall have to consider them separately.

PASSENGER "AUXILIARY"

The arrangement for quick-action brake on passenger cars is one which nearly all railroad men are familiar with.

There are only two points on this reservoir liable to leakage: the bleeding cock at the bottom and the pipe which leads from the triple-valve to the reservoir, for, as we said some time before, this pipe must be regarded as a part of the reservoir pipe.

being always open to reservoir pressure.

Any leak at these points makes the brake slow to act, especially in service or graduation applications.

Such a brake will be the last to set and the first to release.

The passenger cars equipped with the old automatic brake (triple-valve is suspended by a bracket from the reservoir, and this makes the nipple connecting the triple and the reservoir very liable to rupture at the thread.

FREIGHT "AUXILIARY"

The arrangement of freight brake is shown on Plate 18 A.

Leakage here is most liable to occur through the bleeding cock (release valve) shown on top of the reservoir, from the reservoir into the pipe (d) leading from the triple-valve to the cylinder, or most frequently of all, across the gasket joint between the reservoir and triple-valve (13) at the narrow bridge between the opening to the reservoir and the cylinder pipe.

BLOW FROM EXHAUST.

In the two last cases the leak will show as a blowout of the triple-valve exhaust, which should not always be attributed to some defect in the triple-valve itself.

Brake-Cylinder.

While there are several different styles of brake-cylinders, the arrangement of packing leather and piston head is practically the same in nearly all of them. For this reason we shall first consider that part and the peculiar ills to which it is heir. A section of a cylinder and piston is clearly shown in Plate 18 A.

CYLINDER LEAKS.

Leakage by the piston may occur through dry packing leather, Nos. 7, 8, a leather badly worn or imperfectly fitted, or some defect in the follower-plate (6), or the bolts (5) which hold it in place. If the leak is in any of these places it will produce a blowout of the vent hole *x*, in the back cylinder head while the brake is set.

Where the leather is to blame, plenty of good oil well distributed is the very best remedy. This softens the leather and keeps them tight. A thorough cleaning occasionally, also, has a very beneficial effect, though in most cases leather packing will remain tight in spite of dirt if it is kept well lubricated.

Sometimes, although rarely, a leak occurs at the joint between the cylinder and front cylinder head (that nearest the triple-valve), and this may require a renewal of the gasket or possibly nothing more than a tightening of the bolts (14).

The result of the above difficulties will be to cause the brake to come off *m-r-e* or slow slowly without any release or blow from the exhaust of the triple-valve.

"STICKING" OF BRAKES.

Sometimes a brake will remain "stuck" after the triple-valve has released, and can only be moved back with a bar. This may be due to the release spring (9) being weak or broken, or most frequently, on freight cars, at least, to a binding because of lack of oil. Sometimes the sleeve-piston (3) gets so corroded as to stick fast in the back head. Where brakes remain set after the triple-valve has released, a careful examination of the leather and rod should be made to see that they do not catch at any point.

For "sticking of brakes" when the triple-valve does not release, see the following chapter.

Steam Engine Running of a "High" Order.

The nearest thing to running a steam engine in the air is that on a drawbridge. A man in such a position is not bothered much by repairs, but he is worried much making meeting points, but for all that, we dare say he has his trials and his responsibilities the same as other men who start and stop steam engines.

Our pictures were made from amateur photographs taken by Mr. W. A. Eagles.

on the D. L. & W drawbridge over the Passaic river at Newark, N. J. One shows the bridge and the other the "cab" up on top of the big steel span.

Fellows who "bucked" slow last trip without supper and half frozen in a buffalo overcoat may envy the clean looking chap with his shippers on, who seems to be taking things easy.

He does his own firing, which is easy, and keeps things clean, making only a

of the Long Island Railroad, assisted by Mr. J. V. Davies, assistant consulting engineer. The test was essentially practical, one train having been used all the time, and the same division traversed in about the same time on each day of trial. The compound made a little better time than the simple engine, which would militate against it in coal consumption, and the compound also had the worst weather.

The following report on the test was

: The section of track between Hempstead Crossing and Ronkonkoma was used; and the train hauled the round trip twice each day, making a total daily run of 113 2/3 miles.

3. Two cars of Clearfield coal were set apart by the storekeeper as being from the same mine, and were used exclusively on the series of tests.

4. It was decided to run the test train three days with one engine, and then three days with the other, making a series of tests of three days each.

5. All coal was weighed on and off from point of start to return to that point, and the water consumption was measured with Thompson patent water meters attached to the injector or suction pipes.

It will be seen that with the same train over the same course, the work on each day was the same. On the first three days the compound engine was used, on the second three days the simple engine. On the first day's run with each engine the fire tubes and grates and front end were all perfectly clean, and on all succeeding days all conditions were similar, and the engines were in simple running order.

Each day's run for consumption was reckoned only from the time of starting with the train, and each day was concluded exactly at the point of origin, the fire being brought up to level as at starting, and the water in boiler being brought exactly up to the level of top cock. The same engineer and fireman being retained for the whole series.

All weather conditions were averse to the compound engine, as one day (November 21) was exceedingly wet, and on the succeeding day the coal was still soaking from the previous one. The resultant economy, it will be seen, is figured up as 37 1/2 per cent. in coal, and 17 1/2 per cent. in water, on the simple basis of per car per mile; but making allowance for the increased length of terminal stoppages with the simple engine, I have also entered up the economy per car per mile per hour as 32 1/2 per cent. in coal and 16 1/2 per cent. in water, each in favor of the compound engine.

What Causes the Sudden Disappearance of Oil in Sight-Feed Lubricators.

Since the appearance in February of our article on sight-feed lubricators, we have received a number of letters detailing experience in the sudden disappearance of oil from the cups—sometimes one kind, sometimes another.

In each case the writer states that this occurs only when steam-valve has been closed and water or condensing valve left open. This, of course, is bad practice, and open directly against instructions sent with all cups. All ask "Where did the oil go to?"

Take another look at the engravings in the February paper, and we will in a word explain the phenomenon.

Observant runners will notice that this will occur quickly and surely when backing up, this is because the condensing chamber of the cup is loaded off quicker.

When steam is shut off from the condensing chamber and the latter cooled off suddenly a partial vacuum is formed and it "sucks," the condensing valve is open and water and oil are drawn up out of the lower part of cup in the condensing chamber through this pipe, and when it reaches the equalizing tubes it is fed to the cylinders very fast, especially if engine is running with steam shut off, or as the suction of pistons helps draw the oil out of the cup. Probably this occurs rarely, if ever, when throttle is open.

It is already a simple—close condensing valve. Many think there is something mysterious about it as the feeds are closed and no oil goes through the glasses. There is no mystery about it, the oil simply goes up the water tube, through the neglected water-valve, and to the chests.

The steam-valve of any locomotive lubricator should never be entirely closed, except there is no accident to the cup.



NEWARK DRAWBRIDGE, D. L. & W.

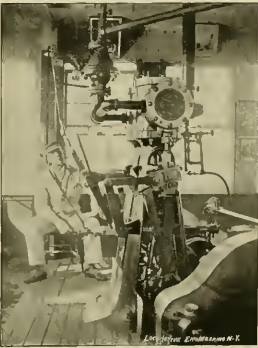

ENGINE HOUSE, NEWARK DRAWBRIDGE

"run" or two a day on an average, but sometimes he has to "go out" pretty often, and he must figure to do his work regard for the 100-passenger trains that pass under him every day.

It must be as lone some as batching on a ranch, and it seems to us would be a first-class job for a man who had a lot of steady thinking to do.

Locomotive Tests on the Long Island Railroad.

An extremely interesting and valuable test of simple and compound locomotives was recently made under the management of Mr. Chas. M. Jacobs, consulting engineer

made to Mr. E. R. Reynolds, general manager of the road.

The engine set apart for the test by Mr. Prince, superintendent M. P. were compound engine No. 143, and simple engine No. 138. These engines were built by Burnham, Williams & Co., 1861, and are precisely similar, except for the compounding of No. 143 on the Vaucoulan four-cylinder type.

They had both been in the shop for general repairs at a late date and were put on this service as being both in equally good running condition.

For the purpose of this test

1. A train of twenty loaded cars was set apart for the haul

How to Bore Flues with Air.

Mr. Jos. McDonald, of Monett, Mo., writes us that he has had good success in boring choked flues by using a smooth pipe long enough to reach nearly through the tube, on the end of it he puts a fitting that looks as if it might have been made by using a round file across the end of a piece of pipe—has two points. These loosen up the packed cinders when touched, and the pipe is so small there is plenty of room for them to get out. The firebox. He uses a small hose, but couples direct to trans-pipe coupling under deck, as he can then stop and start air jet by handling engineer's valve, says one engine in house with air will admit of the boring of any set of tubes in the house, but recommends that there be enough steam on engine to prevent dust and cinders from annoying operators.

Changed Conditions.

Speaking about stay-bolts that don't break and firebox sheets that don't crack, I remarked a foreman boiler-maker in Colorado, "there are railroads where this comfortable condition of affairs exists; but they are not situated west of the Mississippi River."

"It is all very well," he continued, "for men who never were out of the west desire to talk publicly about the best way to prevent stay-bolts from breaking and how to keep flues from leaking. If they had a little experience with the troubles we have to overcome daily, they would be a little more cautious about giving advice."

"Why, I went to see a foreman boiler-maker in a New England railroad shop the last time I was home, and he said to me that every two months was often enough to wash out a boiler, and if a firebox did not last ten years it had been badly used or neglected. He looked as if he would like to know how I was so accomplished in when I told him that we had places on the road where a boiler had to be washed out after running two miles, and that a firebox lasted only six months. It would be a good thing for lots of boiler-makers if they would read papers like LOCOMOTIVE ENGINEERING, so that we could keep posted on what is going on in their business. I would gamble that no regular reader of your paper would talk as if the conditions found in his small corner of the country applied to the whole continent."

"But a man must come out here to learn the hard lines of a boiler-maker's business. When I struck this place first my whole experience had been on roads in Pennsylvania. I went to Mr. Sample and asked for a job. He seemed willing to take me on, but first asked if I could set flues."

"Set flues," I said, "that is my best hold. I guess I can set flues with any man in the trade."

"Well, I was hired, and my first job was setting the flues of an engine that had got a new boiler."

"Take your time with them," Mr. Sample had said. "All we care for is a good job."

"I took my time and no flues were more carefully set. The engine went out on a trip shortly after, and on her return the report was put on the book, 'flues to be called.' I was amazed, but I went into the firebox, and sure enough, the flues were leaking. I believed that the engine had been badly used, but I made up my mind to fix these flues so that it would take pretty hard usage to make them leak again. I spent the greater part of the night toiling in that firebox, and made up my mind that there would be no more leaking for some time. When she got in the following night the report was again made, 'flues to be called.'"

"I talked them several nights, and then I got discouraged. I went to Mr. Sample

and said that I intended to quit. "What do you want to quit for?" was asked. "Well, the facts, that I have had some reputation as a boiler-maker, and I don't want to lose it all here. There is that engine, I did the best job I know how on her flues, and she comes in leaking every trip."

"But she's never lain down between stations, has she?" "No, it's not so bad as that, but when I can't do a job that will stand I want to give up."

"You look at it the wrong way," said Mr. Sample. "You are forgetting the effect of our water on flues. You have done as good work as any of our boiler-makers ever did. Go back to your work, and I shall make you foreman next month." I went back, and here I am."

New Plan of Suspending Links.

The engraving shown herewith illustrates a plan of link suspension being tried

smaller business until the clouds roll by. We publish below an answer from one of our largest spring makers to agents who had urged the manufacture of inferior material. The arguments used would apply equally well to many other lines of business.

"After an extended experience in the field, am fully convinced that our success in holding the business we have, and adding to it from trade that we have not been the recipients of, is to hold to the methods by which we secured our business and the reputation of manufacturing the best goods in our line that are offered to consumers of railway springs.

"There is no doubt that we have this reputation to-day, the proof of which is that in a large majority of cases we can secure the trade at equal or a slight increase in any prices quoted."

"The quality of our goods is unquestioned, the only obstacle is our higher price. In other words, we are desired to

purposes is not suitable to make a good quality of spring. Yet there are manufacturers, who, perhaps from a lack of knowledge of their business, or want of thought as to responsibility, do not hesitate to offer five year guarantees of service on such springs, and, strange as it may appear, there are many railway officials willing to be satisfied, provided the prices are the lowest in the market, evidently losing sight of quality or responsibility of parties making the guarantees.

"History repeats itself, and during and after the depression of 1873, it must be remembered that but three concerns in our line out of some dozen stood the financial crisis, and when the others were called upon to make good their guarantees, the railway officials were met with the reply that the old companies had gone out of existence, were in the hands of assignees, or reorganized, and the new organization or assignees could not or would not make good the guarantees of their predecessors. I remember very well the consternation

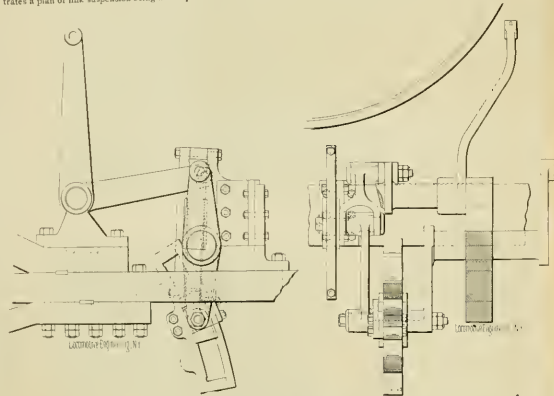

MANNING'S LINK HANGER GUIDE

at Omaha, it is the invention of Division Master Mechanic J. H. Manning.

He employs upright guides fastened to the back of the guide yoke, in these a block slides that carries the top of the hanger, and always at right angles to the center line of motion. The arc formed by the travel of the arms of tumbling-shaft do not affect the motion at all, and the tumbling-shaft can be located in any way without affecting the motion. Perhaps there are too many joints in this hanger arrangement, but the device has some merit no doubt.

Against Inferior Goods.

Railroad companies, as a rule, order material which is reliable in preference to that which merely has cheapness to recommend it. The hard times, are, however, seducing many roads, which have followed the sound policy of quality first, into the false practice of trying what is cheapest. They will pay for it in the end. The tendency in the direction of poor, cheap goods is hard on the more reputable manufacturers, and their business suffers, while the makers of inferior articles make inroads on the market. Much pressure has been put upon makers of first-class goods lately to produce inferior articles to meet the competition in their line. We are glad to find that most of the manufacturers refuse to do this, and are willing to put up with

such a first-class article at the price for which inferior goods are offered.

"This question of price is undoubtedly the cause of our failure to secure a share of what business is obtainable.

"To overcome this difficulty has been our study for the last decade. During this period our margins of profit have been reduced to a point below what should have been the minimum of a reasonable manufacturer's profit. One way to meet the hindrance would be to reduce the quality of the goods, as well as the labor necessary to produce first-class goods universally our product.

"The result of this plan would be to offer to the railway trade that we cannot now reach a cheap and inferior class of goods, that we have not only denounced, but always refused to make, and at the same time our reputation of retaining the anterior position we now occupy of the manufacturers in our line, and would lose the confidence of our patrons which we have merited by our policy of honest production, moderate prices, and fair treatment.

"The solution of the present disturbing situation will be rapidly and finally solved in the growing use of these cheap goods. The market is being largely supplied with all classes of springs, made, not of crucible or open hearth, but by the use of Bessemer steel, which all experienced manufacturers admit is characterized by an utter lack of uniformity, and while adapted to many

which these replies produced. How purchasing agents and others had to make explanations to their superiors, etc.; in fact, shoulder the blame of the losses to their companies.

"History is repeating itself at this time by the continued and now extensive sale of inferior goods at no margin of profit, and undoubtedly at a loss, as evinced by the failure of several of our competitors, now in the hands of receivers, assignees, trustees, and other legal guardians for these wrongdoers. Yet the sympathetic railway officials patronize them and accept their guarantees, which have no legal or other foundation, as against the responsible guarantees offered them by manufacturers of superior goods, but at a higher price.

"The result will be, as it was in 1873 and several years following, continued failures of manufacturers, extensive failure of goods, inquiries by general managers as to causes, reference to mechanical departments, reports from them, and explanations from purchasing departments that no recompense is obtainable for replacements and losses. This will be an accompanying requirement of the sun down on an improvement in business."

In a communication from Mr. S. L. Bean, in the last number, it was stated that twenty minutes was the time consumed in jacking up a car with their pneumatic jack this should have read three minutes.

Some Home-made Testing Devices.

Our illustration was made from a snap shot taken in a corner of the engine room at the Shoreham shops of the M. St. P. & S. N. Railway, and shows some little tricks of their own for testing air-brake hose, speed recorders, etc.

Between two wooden uprights can be seen two pieces of air hose. They are under the same pressure they must stand in road service, and a whistle signal is arranged to give warning when a leak ap-

pears. Another attribute is very manifest—humanity. This company has felt the pinch of hard times as severely as their neighbors, but they have followed a policy dictated by a spirit of fairness and founded on a basis of justice. They have posted no notices of a 10 per cent. reduction or of any other reduction. The workmen are, to a great extent, engaged on piece-work, and they receive as much for their labor, as the prices paid will warrant. When the depression due to the present condition of trade came, the manager, Mr. Williams, an

out loss. It is wonderful the skill developed by this premium system.

The engineering part of the establishment has been developed by Mr. Koepfer, the superintendent. He appears to be exceptionally successful in working out details. There is always considerable danger in metallurgical establishments of men getting burned through the accidents of chains giving way and permitting the vessels filled with molten metal to fall among the workmen. Some horrible accidents have happened in this way. In the Solid Steel Works no chain or hook that is used in supporting molten metal is employed longer than six months, and while in use it is subjected to daily inspection. No workman has ever been killed or burned in these works. Prevention is better than cure.

The popular railroad supply man, Mr. J. K. Bole, has large interests in these works.

Building Snow.

Our engraving on this page was made from a photo taken by W. J. Morrison, of Sacramento, Cal. It shows three Schneecady compound Hogs ahead of a freight train, and ready to pull out. This style of wedge plow with several large engines behind it represents the brute force plan of moving snow that was universal on the Western roads of this country ten years ago. It is a poor snow-mover, dangerous and a waste of power, yet there is something in it that is exciting to those who make the charge, and the Junior Philosopher acknowledges that there was a time not long ago when he "figured" to get a snow-plow engine.

The day of "showing" snow down the bank (and incidentally engines and men) is almost past. The modern machine plow is so efficient, so economical and so safe that no progressive management of a line at all hampered by snow in the winter months can afford to risk men and power with wedge plows. The rotary has shown

Meddling with the Railroad Mechanical Associations.

OFFICE OF THE RAILROAD GAZETTE, 1 CHICAGO, FEBRUARY, 1894.

MY DEAR SIR—I learn that the question of consolidating the Master Car Builders' and the Master Mechanics' Associations into one railroad association, having a new name, is being considered by some of the members, and I write to ask if you will kindly give me some advice about the proper position for the *Railroad Gazette* to take in the matter.

It is claimed that the higher officers of railroads would favor the consolidation, as it would give the men in charge of the mechanical departments a chance to attend both conventions without losing any more time than would be required for one, and that the result of the combination would be good for all concerned.

It is also claimed that the car and locomotive department properly belong in one department of rolling stock, and that this is shown by the universal tendency to combine these departments, instead of separating them, whenever there is a change of officers, and, therefore, there should be but one rolling stock association. Your reply will be considered strictly confidential, and the *Railroad Gazette* will be grateful for your opinion.

Very truly yours,

DAVID L. BARNES.

The above is the copy of a letter which has been sent to a number of the leading members of the Master Car Builders' and Master Mechanics' Associations. We have no doubt but they all duly appreciate the middleless spirit displayed by the *Railroad Gazette*. We are inclined to think that most of the members of the associations are competent to attend to their own business, and that any position taken by the *Railroad Gazette*, or any other publication, will not influence consolidation one way or the other. We doubt the truth of the assertion that "the higher officers of railroads would favor consolidation."

A correspondent in Butte, Montana, writes us some notes about the operating of the Montana Union. He gives a great

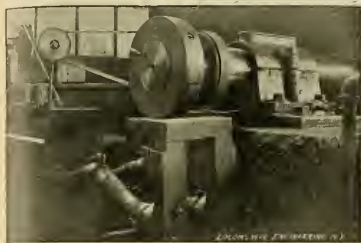

TESTING AIR-BRAKE HOSE.

pears. A crank is arranged below the hose, on which an upright pitman works. The upper end of this is forked so as to "wobble" two pieces of hose at the same time. The crank-shaft is driven by a belt from a wooden pulley on the end of the engine shaft, and is speeded up to 130 revolutions per minute.

(Of course, every rubber man has the "best" hose; but instead of taking his end of it, two kinds of hose are tested in this machine. In a recent test, a hose known as the C. P. Standard was tested with one of the N. Y. Belting Co.'s hose. They stood the "razzle-dazzle" for eighteen hours per day six days in the week for six weeks before either of them "hollered." Then the C. P. Standard gave in and up.

This device was gotten up by C. A. McClelland, general foreman, and the foreman of the back shop, whose name we have forgotten.

On the bench is shown a Boyer speed recorder with case removed. As can be seen, it is belted up, and this arrangement is used to test them before placing on engines. By the way, this road uses a "Boyer" on every road engine, and they are a good thing.

The Solid Steel Works.

One of the best managed metallurgical establishments which we have ever visited is the Solid Steel Company's works at Alliance, O. When the place is in full working order it employs about 600 men, but at present they are not working much more than one-half of their regular force. The works were started about eleven years ago, and were increased gradually to meet the demands of business, the policy of making a first-class product having raised a growing demand for steel castings of the kind made at these works.

Just before the panic came on, the company built a large new rolling mill, which has a capacity of 1,000 car couplers a day, but the sudden falling off of demand has prevented the company from putting it in operation. The mill, when finished, will be one of the best establishments ever devoted to the making of steel castings.

The company make an immense variety of steel castings for railroad machinery, and for every other line where combined strength and lightness is desired. An engineering visitor to these works cannot fail to be impressed with the intelligent care and skill displayed in carrying on the

local railroad train master and an essentially fair man, invited the men interested to come into his office and consult about how the company could compete for work on the prices quoted by competitors. The whole circumstances were laid before the men, and in every case they were ready to do the work for a price which would enable the company to bid on the contracts. This is the best kind of result from a prac-



LOCOMOTIVE ENGINEERING NY

SNOW-BREAKING.

tical application of the doctrine—"Let us reason together."

In most manufacturing establishments there are fines or marks of disapproval for men who fail on certain operations. Here the policy is followed of giving premiums for good results. A difficult operation in steel metallurgical establishments is making the plug which opens and shuts the opening at the bottom of the ladle, so that it will stop the flow of the metal when the various molds are filled. A badly made plug will frequently lose the greater part of the charge. Here the men are given a premium for each plug that works with-

out that it can cut and throw snow just as a wood matcher cuts and throws slavings, and is as much ahead of the wedge plow as the matcher is ahead of an axe.

Since writing the above a very serious accident has happened in California by a string of engines and a wedge plow going over an embankment.

A new form of continuous drawbar mechanism has been patented by Perry Brown, Sharoville, O. The connection between the two drawbars is made by two rods, one at each side, secured to the follower blocks.

deal of commendation to Mr. George Lindoff, master mechanic of the road, who, according to our correspondent, converted chaos into order and put the rolling stock of the road into a remarkably good shape at small expense. It appears that the completion of the Butte, Anaconda & Pacific Road is likely to win the business of the Montana Union, as parties who are interested in the establishments which supply most of the freight from Butte are interested in the new road. Some remarks are made about the Shay locomotive used on the road, and it is said to be remarkably efficient for slow, heavy pulls.

A Railroad Profile of Some Use.

All roads have profiles to show the grades, and might very few there be that show more, and some require another profile and a slide rule to explain them.

The best thing of the kind that has come to our attention of late is the profile and on the C, St. P. & K. C. Ry. We

way crossings or connections, the circles with black and white cross show water stations, the horizontal signs indicate stations with distances below from Chicago and St. Paul.

Each vertical line drawn from the undulating grade line to the horizontal datum line indicate the mile posts, the horizontal lines marked 650, 700, 750, etc., indi-

cate curve in feet right after the degree of curve. A 1 curve has a radius of 5730 feet, a 2 C, 2865 feet, a 3 C, 1910 feet, a 4 C, 1435 feet, a 5 C 1146 feet, a 6 C, 953 feet, etc.

The upper part shows the length of all sidings and the capacity of side tracks in number of freight cars, for meeting of trains this capacity should not be exceeded,

no more for repairs than other engines. Some time ago there was an agitation about the cost of fuel, and the record of all the engines on the divisions where the compound is running was looked up. The record for the compound was 3.27 pounds of coal per loaded car mile. The best record for any simple engine of the same class was 3.85 pounds, for the poorest, 6.32 pounds,

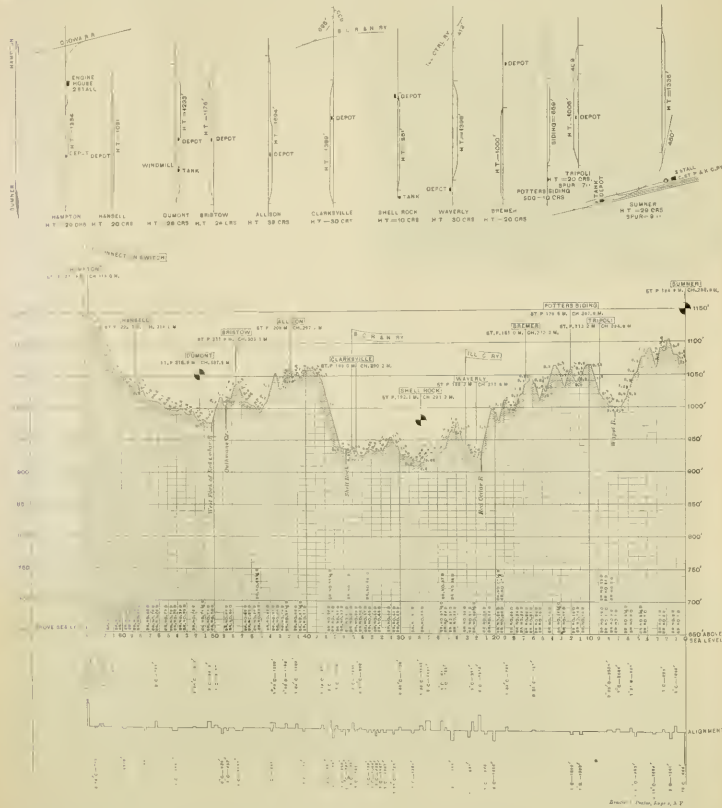

don't know who designed them, suggested the idea, or worked out the details, but it is all done well.

Our engraving shows the Weaverly branch of that road, and tells more than any profile we have yet seen. When furnished to a dispatcher, it seems to us it must be of some use to him—a question, when some profiles are sent.

We do not know of a more lucid explanation than that contained in a "note" on the blue print, which reads as follows:

The undulating line shows the rise and fall of the track, the flags show the rail

oste the height in feet above the level of the sea. The bridge numbers are put down just above the 650 horizontal line and are marked BR. No. 59, D. & C. Below the datum line the alignment of the road is shown. The offsets from the center line indicate curves right and left, the ones above the horizontal center line are curves to the left, and those below the same curves to the right going west. The longer the offset the sharper the curve, the wider the offset the longer the curve. The curvature is given and indicated thus 1° C, 2° C, 3° C, &c., the length of

The lower end of the siding is west. "P. T." means passing track, "H. T." house track."

The U. Compound Locomotive.

The two cylinder compound locomotive in use on the Chicago, Burlington & Quincy, built at the company's shops four years ago is giving good results in freight service. She is working on the chain gang, and is run by any crew that happens to fall to her, just the same as any other engine. She is reported to cost

for the average of forty engines, including the compound, 4 1/2. So that the saving made by the compound was as follows: Over the best record of any other engine in the same class, 15 per cent.; over the poorest record of a simple engine, 57 per cent.; over the average record of forty engines of the same class, 20 per cent. As this record of the compound is almost a duplicate of a similar record made when the engine was new, it seems to us there is no escape from the conclusion that the compound, at least, is saving at least 25 per cent.

Some Experiments in Hardening and Annealing Steel.

BY W. S. LITTLE.

It seems that one of the greatest difficulties in extraneous forging at the present time is the unequal strain that is caused by hammering, both in steel and in iron. This is, perhaps, not noticed so much in rough forgings as it is in those that have to be finished up in lathe or planer.

To illustrate this, take a thin piece of iron or steel and lay it on the anvil and strike it with a hammer. The piece is made in one place that another is increased. Blacksmiths very often do this at a very low heat, and forget to anneal it afterwards. Very often this piece is finished up and, if it is brought back for the smith to ease-harden, the result is that his piece warps so that he has to reheat it, and they try to straighten it, and by the time he gets through it is a poor job, if not worse.

Suppose the piece is thick instead of thin, and it receives the blow of a hammer as before. The effect of the blow extends only a little way in, the surface is made longer and broader, but extension of the inner part is resisted, and the material at the surface is put in compression and the inner portion in tension. If the piece is finished up at a red heat the material is soft and weak, and yields to the stresses caused by the hammering, and the stresses are equalized. This goes to show that internal stresses are generally the result of cold working.

Iron can be almost entirely relieved of these stresses by heating it to a red heat and letting it cool slowly—not as it does very often, through the doors when it is twenty below zero, or in a damp, cold floor.

In the manufacture of rough iron made from old scrap of different grades, the scrap is piled in bundles and put in a furnace, heated to a melting heat, then put under the hammer or rolls and drawn into rods. It is better to get rid of iron in this way than at all, because the poorer grade, and is not as soft when put under the hammer or rolls.

Now, it seems to me that this would cause tension, that is a very difficult matter to relieve by annealing. We find that when this iron is put in a lathe or planer the chips from the tool will break more readily in one place than another, and the piece will finish different in places, smooth in one while rough in another.

In steel these internal stresses, caused by hammering, are a more difficult thing to overcome than in iron, especially in tool steel, and are very often caused by the blow of a hand hammer while the steel is at a red heat, and the cause of this is the hammer blow so long as it only effects the steel on the outside and in small spots. Now, some men tell us that by annealing we can relieve all these internal stresses. I have experimented considerable for the last two years on this, and find that it is an easy matter to put internal stresses on a piece of steel with a hand hammer while the steel is at a red heat, but a very difficult matter to relieve the steel entirely of those stresses by annealing.

I have taken a piece of $\frac{3}{8}$ round steel to inches long, and pended with a ball-peen hammer in the center on one side while it was at red heat, then put it in an annealing box, where it took 24 hours for it to cool. It is then turned up, taking a cut off from each side, and when we came to harden it would warp right where I pended it every time. I have also had the same experience with thin pieces used for saws for milling machines.

As a rule, when a blacksmith warps a tap or reamer in hardening the cause is stress on the steel, or when one cracks a piece in hardening or a piece don't work as it ought to when it has gone through these processes of annealing. Here is where a large percentage of steel is ruined.

For illustration, I have tried to make some sketches showing the changes that the steel goes through from the time it is of an atmospheric temperature till raised to a white or melting heat.

We find that by heating the steel we change the hardening carbon to a non-hardening carbon, which is shown in Figure 1. Line *A* at *T* we have the atmospheric temperature. At *D R* we have it changing from a black heat to red at *B R* we have a bright red, and at *H* a white.

Suppose a piece of annealed steel be gradually heated from *T* to *H*, certain changes occur in the carbon and structure, as shown on line *A B C D E* represent carbon changes, and shows that the carbon does not become hardening carbon in line *A* until you get to the temperature of a bright red in a dark room, nor do we

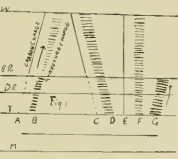

change the structure of the steel until we get to that heat, as shown in short horizontal lines *B*.

Line *C* shows a gradual temperature change of carbon downward. While the short horizontal line *B* shows the structure changes downward, and shows that if you heat a piece of steel above *B R*, or bright red, and then let it cool down to just above the temperature where the carbon changes from non-hardening carbon to non-hardening, and quench it at that heat, we do not refine the steel any. If it has been over-heated previous to this, it will not refine at any heat, and is what we call burned steel.

But we have got to heat steel to a great deal higher heat for forging than we do for hardening. Here is where a large percentage of blacksmiths make their mistakes. They get a tool to dress, it is put in the fire and heated up to a forging heat, and shaped and hardened at that same heat, and when the steel does not refine they curse the steel. There is no steel that will refine by putting it through the above process. If you take this piece of steel and let it cool off gradually to the atmospheric temperature, or quench it if there is no danger of cracking it, then reheat it to the lowest heat it will harden at, which is just to that heat where the non-hardening carbon has changed to hardening carbon, and your steel will refine and will not harden any more, as shown in Fig. 2) in water at a temperature of from 32 to 35 degrees, and there is very little danger of cracking it by quenching it in ice water.

F F shows a piece of steel overheated for annealing, and one way to restore it is to heat it to the lowest heat it will harden at, quench it, and reheat it to the same heat, as shown in Fig. 2) in water at a temperature of from 32 to 35 degrees, and there is very little danger of cracking it by quenching it in ice water.

I have taken a $\frac{3}{4}$ tap 6 inches long, Crescent special steel, and lached it fifteen

times in succession in salt water at a temperature of 35 degrees, and gave it this structure every time, and the tap was perfectly sound after hardening it the last time. But I shortened the tap about two one-thousandths of an inch every time I hardened it, one-thousandth in quenching it, and one-thousandth in softening it.

Now some may think that the shortening of the tap is due to a peculiar kind of steel. This is not true. All steel that will refine in hardening will contract, and in the shape of tap or reamer, it will contract in length and expand in diameter, which is due to the way the water cools the steel. Cooling the outside first, which you cannot prevent, and it is brought to its natural condition before the water has any effect on the inner portion of the steel, but when the outside is cooling, it carries the inner portion with it because it is hot and soft. But when the inner portion gets to the same temperature of the water, it must have its natural shrinkage. And if there is a great deal more of it, it will carry the outside of it, so that it will carry an awful strain on the inner portion of your tap.

Just as soon as you start drawing the temper of your tap you begin to relieve that strain. Yet you don't change the structure until you heat it to very near red heat. But the carbon seems to begin to change to non-hardening carbon from the time you heat your tap to a straw color till you get it to a red.

The tendency to change hardening carbon to non-hardening is probably strong at all temperatures below that of a dark red, and in the case of hardened steel it is held from being operative by the sudden cooling, because it renders the material more resistant to the tendency to change of carbon. If, however, a piece of steel which has been hardened be slowly heated, it is found that the tendency to change becomes operative at a temperature very much below a dark red. Thus, if it be heated to a temperature corresponding to the formation of a straw color oxide, the tendency to change of the steel. If the steel be heated to a bright red and cooled by quenching to a black heat and allowed to cool slowly the fine structure will be retained, and the hardening carbon will have had an opportunity to change back to non-hardening carbon, and the material will be soft and tough.

This method was applied with great success in the case of car axles by Mr. John Coffin, at the Cambria Iron and Steel Works, at Johnstown, Pa. It is claimed if steel be melted and quenched from the fluid state the carbon will be all hardening carbon, and the structure will be exceedingly fine, but if it be allowed to cool until it gets solid, and then to be cooled by quenching, the carbon will be non-hardening and the structure will be coarse.

These facts have been proved and apply to the annealing of steel castings. There has been a very general impression that very slow cooling of steel castings after being hard would result in toughening and softening.

The above facts, however, lead to the conclusion that heat treatment would result in softness and brittleness, and experience proves this conclusion. But if they be quickly cooled to a dark red, then allowed to cool slowly through the rest of the temperature range they will be soft, fine grained and tough.

In large castings this heat treatment was attained by Mr. John Coffin by allowing the casting to cool below a dark red, then placing it in a reheating furnace, where the temperature was raised to a bright red heat, the fires were then drawn, the furnace door was opened, and the castings were cooled as rapidly as possible by the admission of air till a black heat was reached, then the furnace was closed, and the castings were allowed to come slowly to the temperature of the air.

Madison, Wis.

Held On to the Right of the Road.

"That is a good letter you've got," remarked Master Mechanic Brown to a tall, earnest looking man with clear-cut features and keen gray eyes, who was in search of a job as engineer.

"You appear to be a man who would keep your wits about you and be ready for a change. What was the matter that you lost your job on the Prairie Midland?"

"To tell the truth, Mr. Brown, I got into a dreadful scrape, and I do not blame the superintendent for discharging me, but you may rest assured that I shall never get into a mess of the kind if I strike another job."

"What kind of a scrape was it?"

"It was nothing more or less than stopping the business of a division for five hours and delaying a fast stock train that length of time."

"How did it happen?"

"Well, I was pulling a stock train that the company were to pass through to Chicago, so the fastest possible time, and I had been given the right of the road against everything but passenger trains. All the crew were doubling back without any rest, and we had been over twenty-four hours on duty. It was away about midnight when we stopped at Elms, a small station without a telegraph operator. We saw-tracked there, because we could not make the next station, for passenger train No. 8."

"Now it happened that a farmer with a place close to this station was on our train with some cars of stock that he had bought further West, and he took the chance to run in and get something to eat. Very generously he sent a bountiful supply to the caboose for the trainmen, and Jim Forrest, the conductor, sent word for me and my fireman to come back and get a share. There seemed to be plenty of time, for there were no signs of No. 8, and we could see her headlight seven miles away."

"We sat all down in the caboose and had our lunch. Besides eatables there was a good supply of milk and a big jug of hard cider. Eatables and drinkables were finished, and still no signs of No. 8. Everybody made themselves comfortable to wait for the train. There were comfortable cushions to rest on and they felt good to men who had been tetefering in the hard riding seats for twenty-four hours. If you ever sat on an engine that rode like a dust-cart and felt as if your ribs were rattling apart, you will understand how nice it was to get ten minutes repose on a soft cushion."

"I imagined that I was still repeating that to myself for the third or fourth time when I vaguely heard a rich Miesawa voice shout."

"By Jussus, 'em self as found the chunder of the wood 'Luk at the sleepin' beauties'!"

"We all started up. The last one of us had been asleep for six hours, and it was broad daylight."

"The man who roused us was the track foreman, who had come from the telegraph station, eight miles distant, with his hand-car to get a report of the wreck. They supposed at headquarters that we were in the ditch, and were anxious to know the extent of the damage."

"The engine was solid, but there was plenty of water in the boiler, and a good supply of fuel rails soon steamed steam. When we got to the telegraph station we found several miles of trains waiting, as we had rights over them."

"We got the train through as quickly as we could, but we did not get the chance to go out again. The pipe and the good of the service demanded that the one of us should be discharged, and what he says goes."

"These are the exact facts, Mr. Brown. You may be sure that if you give me a job I'll keep away from the way when I happen to be worn out."

LOCOMOTIVE ENGINEERING

A PRACTICAL JOURNAL OF THE
STEAM ENGINEERING INDUSTRY
10 Beekman Street, New York.

PUBLISHED MONTHLY BY
ANDREW SINCLAIR, Editor and Proprietor,
JOHN A. HILL, Assistant Editor,
GEO. W. WOLLASTON, Rev. Advt. Dept.

Subscription Price.

\$5.00 per year, in advance. Postage paid by any part of the United States, single copies, 15 cents. Received by Express, by order of the Post Office Director of Registered Letters.

The editors reserve the right to use or discard matter for the reading columns, entirely on their merits. The reading columns are not for sale.

Correspondents must give their names and addresses, but not necessarily for publication. Address changes should be changed as often as necessary—always give old and new address, and who substituted in a case where one died or left.

Please give prompt notice when your paper fails to reach a proper office.

Entered as Second-Class, New York, on Second-class mail matter.

For Sale by Newsdealers Everywhere.

NO BACK NUMBERS BEYOND THE CURRENT YEAR.

PUBLISHERS' AGENTS.

American News Company, New York.
International News Company, Ltd., England.
W. Williams & Pilsbry, Inc., Melbourne, Australia.

25,000 of this Issue Printed.

Cylinder Condensation.

From the character of inquiries sent to this office during the last year, we would judge that a great many of that portion of our young readers who devote attention to steam engineering matters are interesting themselves in the subject of cylinder condensation. The subject is rather a difficult one to understand, and many of the books treating upon the subject are so charged with algebraic formulas that they repel the ordinary practical man. We shall therefore tell plainly and in simple words what we have learned about cylinder condensation and its effects upon the operation of the steam engine.

The first form of practical steam engine employed was called an atmospheric engine, because the principal power was derived from the pressure of the atmosphere acting upon an open piston, a vacuum having been created below the piston by the condensation of the steam. This was the Newcomen engine. James Watt, an instrument maker in Glasgow, Scotland, was asked to repair the model of an engine of this kind, which was used for educational purposes in the University. He knew a good deal about natural philosophy, and was keen enough to see that an enormous amount of heat was wasted by injecting cold water into the cylinder each stroke to condense the steam, for the metal had to be heated up to the temperature of the moving steam before the piston admitted steam to form a vacuum form. Watt conceived the idea of condensing the steam in a separate vessel (condenser), and that laid the foundation of his fame and fortune, giving at the same time the world an engine adapted for manufacturing purposes, an engine that did work with fair economy of fuel.

The steam engines developed by Watt and others were not long in use when it was discovered that there were serious losses of heat in the cylinders, and the practice attributed to railroads, was the use of jackets of jacking the cylinders with a non-conducting material. Others introduced steam jackets. In 1849, John Bourne, author of a famous book on the steam engine wrote, "A material advantage is derived from the use of the steam jacket, though on what principle or on what principle should result is not easily ascertained. The jacket presents a larger cooling surface than the cylinder itself, so that its use might reasonably be supposed to occasion an increased loss from condensation, nevertheless, of two engines, in every respect identical, but in one provided with a steam jacket and the other without it, the engine without the jacket has given considerably inferior results."

About the time the words quoted were written, D. Kinnear Clark was experimenting with locomotives to find the conditions of operating which were calculated to be most economical in the use of fuel. A celebrated deduction of his experiments was that beyond a very narrow limit "expansive working of steam was expensive working." This was at first stated as a fact without an attempt at explaining the cause, but further investigations of Clark, in Scotland, and of Isherwood, of the United States Navy, demonstrated that the condensing temperatures of the cylinders, the metal of the same being constantly inclined to get hot and cold according to the temperature of the steam passing through the cylinders. The use of the steam engine diagram as passing through the cylinders was much as beyond the volume of steam evaporated. The loss varied from 10 to 30 per cent. It was found that this loss was due to cylinder condensation.

Those who merely view the cylinder of an engine as an intensely hot vessel at all times when steam is passing through, do not readily realize how it could become so cold as to cause condensation of the steam after steady work has begun. But heat in a cylinder has degrees of comparison the same as the heat and cold of an October day. When steam enters at 150 pounds pressure the temperature is about 358 degrees Fahrenheit, the pressure is 150, and the temperature is 212 degrees Fahrenheit, a difference of 146 degrees. This is a wide difference, and the temperature of the metal in the cylinders naturally keeps changing with the temperature of the steam. The saturated steam which enters the cylinders is always at the pressure of the steam, and is hotter than what is necessary to keep it in a gaseous condition. On meeting with a colder body as it does when entering the cylinder, part of the heat is abstracted to raise the temperature of the metal, and a portion of the steam becomes water or water vapor, which has no power for doing work at the pressure of the steam, and is soon and exhaust, the surface of the metal forming the sides and ends of the cylinder and piston is undergoing a cooling process from the combined effects of radiation to the most steam, which is noted for its avidity in absorbing radiant heat, and conduction to the condensed steam which carries heat from the metal surface sufficient to convert the water vapor back into steam.

To put the case briefly. The steam in entering the cylinders goes into something like a condenser, and a portion is converted into water. As expansion proceeds and the pressure decreases, the condensed steam inclines to support, and takes heat from the walls of the cylinders to help the process. The re-evaporated steam is now about to pass out of the cylinder, so there is no gain from the return of the water to steam vitality at the end of the stroke. On the contrary, there is loss, for the re-energization has been brought about partly at the expense of heat drawn from the cylinder walls, and the augmenting pressure at the end of the stroke increases the back pressure against the piston on the return stroke. The real cycle of steam behavior is that the cylinder acts as a part of the beginning evaporator of the stroke, and as a steam evaporator or boiler at the end of the stroke. In this process the heat drawn from the cylinder metal toward the end of the stroke is cooling down the material to prepare it to perform its refrigerating action when the steam is admitted for the return stroke.

These conclusions were arrived at by Clark, Isherwood and other engineers by the aid of the steam engine indicator, but in the last few years more positive testimony has been furnished substantiating the testimony of the steam engine diagram. Many of the engineers who are conversant

with the experiments described by Professor Tyndall in his "Heat, a Mode of Motion," have tried to devise a thermometer such as the famous one used in hopes that the metal could make graphic record of the varying temperature of a steam engine's cylinders. The changes of temperature occur with such amazing rapidity, that for a long time the apparatus tried to make records failed to work; but within the last few years Prof. E. H. Hall of New York and Mr. Weyman Douglas of London, have devised perfect appliances which gave fairly accurate indications of cylinder temperature during the different parts of the piston stroke. These records agree with the calculations made by Clark, Isherwood and others, based on the indicator diagram and boiler evaporation. The test engine, in short, is that the cylinder condensation and re-evaporation is a real source of loss. The lesson of the testimony for locomotive men is: Do not attempt a wide range of steam expansion in simple cylinders, and use every practical means to protect the cylinders from the cold blasts of the atmosphere.

High Speed Locomotives.

A very interesting contribution to the literature of this age was made by a paper read at the Western Railway Club, by Mr. Queraen, engineer of tests of the Chicago, Burlington & Quincy. The paper contains an excellent summary of the advances made in locomotive engineering which have produced the high-speed locomotive of to-day. The limitations which control steam distribution, the functions of the different parts of the mechanism are clearly described, and an excellent plate is made for a more general use of the steam engine indicator. The paper is evidently the work of an expert in locomotive engineering, who has collected an immense amount of valuable data on which to form the conclusions arrived at. The paper is clear and logical, and although there are some points made which we think controvertible, as a whole it is well worthy of study and is a safe guide to those who have had limited opportunities of studying locomotive operating from the highest standards.

The paper opens by citing the requirements and demands upon high speed locomotives, and presents the conditions and narrow limits inside of which the designer must confine himself. It has been established that the resistance at high speeds is not equal to the resistance at the velocity, as formerly believed, but about equal to one-quarter the velocity in miles per hour, plus two, so that the resistance at sixty miles per hour is only so per cent greater than at thirty miles per hour, which demonstrates clearly that there is economy in increasing the speed. The conditions and great demands upon the motive power department as a given power is required to be furnished in a shorter time.

Some of the points discussed are larger boilers, higher steam pressures, larger driving wheels, the latter being desired to supply the required train velocity with a slower piston speed, that is, the steam more time to pass into and out of the cylinder. The paper very clearly illustrates this advantage by showing the higher steam line in the cards taken from engines after the diameter of drivers was increased. When drivers were increased from 60 to 66 inches there was a positive gain in piston speed, that is, the gain of 2.25 pounds per hour. The beneficial results of decreasing the lead was demonstrated to be well worthy of attention. There is a tendency on many roads to give much lead to tendies. Master mechanics who have a tendency in this direction should do well to carefully study the discoveries recorded in Mr. Queraen's paper. There has been an inclination in many quarters to believe that the use of the Allan port produced no economy in the steam distribution of locomotives. The paper referred to discusses this subject,

and finds that a decided gain is obtained in the use of the Allan valve, the mean efficient pressure being decidedly greater where it is employed. The subject of long and short travel is discussed, and again attributed to the lengthening of the travel from 3 to 5 1/4 inches. While we do not agree with the author on this point, he gives certain facts which seem to justify his conclusions as taken. We regret not having room for this paper as it is a very valuable one for those interested in economical operation of locomotives.

Hot Boxes.

The subject of hot journal boxes has been up for discussion again in the New England Railroad Club, and it gave rise to some interesting talk, in which practical railroad men and college professors vied with each other in demonstrating the causes which produce hot boxes. Hot boxes seem like the poor, always destined to be with us. The discussion of the subject seems always to be reasonable, for objects of this nature are a source of information to lots of men who are harassed with the trouble talked about. There are no doubt numerous causes that will reduce journals to run hot, but as a rule, there is no great mystery about this source of annoyance and delay. A man who travels a great deal soon finds that on some roads he may expect delays from hot boxes on nearly every trip, while on others this trouble is so rare that it is a matter of surprise when it happens. If the cases are looked into closely, it will be found that on the roads where a hot box is a rare occurrence the best of bearings are employed with well fitted trucks, and that first-class lubricants are held to the journals by elastic packing when the hot boxes are common, cheapness in first cost is the policy followed, and the account is balanced by delay, heartburnings, and all round annoyance.

If the men in charge of railroad rolling stock were permitted to have their own way about the selection of metal for bearings, and of the lubricants to be employed in keeping them in good order, hot boxes would be a little trouble with hot boxes. We notice that on most of the roads where hot boxes are chronic, varied by epidemics of the malady, the mechanical department have little influence in the character of the supplies purchased. A most unfair thing about this trouble is that the mechanical men are almost entirely blamed for the occurrence of hot boxes. No end of ingenuity is devoted to imagining fat-factories for the difficulty, when the real cause is on the surface. At the railroad club meeting referred to the causes for hot boxes talked of were: Too much weight on the bearings, bad fitting of brasses and cheeks are forms, improper packing, boxes that admit of too little oil to the bearing, unsuitable material and inferior lubricants. We feel safe in asserting that 90 per cent of the hot boxes arise from the two last-mentioned causes. If they are remedied the cause for complaint will be small. The seamy journals that are found on many roads are probably responsible for a good deal of the trouble, and neutralize the use of good material in bearings and good oil.

Passenger Car Construction.

A somewhat radical change on passenger cars has been recommended by Mr. Erwin Merton, a mechanical engineer, who was for some time superintendent of a department of the Pullman Works. He proposes abolishing the platform entirely and coupling up passenger cars in the same way that freight cars are coupled. He has patented a car design in which the ends of a few hot boxes, and a good reason why it should be adopted. Instead of using the platform as the approach to the end doors, doors are placed in the corners of the car, and appear to be as easily reached as those that

are placed at the ends. The platform was originally placed on a passenger car principally as a convenient place for reaching the brake. There is now a law on the present hand brakes occupying the prominent place they held when they called for a platform for themselves, and we believe it will enhance the safety of train operating if the platforms generally were abolished. With cars closely coupled together there would be much less danger of telescoping than there is with the platform. Many of our worst telescoping accidents have been caused directly by the platform forming a plane over which the adjoining car slid, and smashed up the other. Habit and custom are so strong that it will be very difficult to introduce Mr. Merrick's improvement, but we believe that it will eventually come around. In the car which Mr. Merrick has designed steel is very largely used in strengthening the ends and framing. This, of course, would be an advantage to any form of car, but it is especially desirable in the arrangement without platforms.

Relations of Railroads to Their Employees.

A very valuable and interesting report has been prepared by Mr. E. A. Moseley, Secretary of the Interstate Railroad Commission, on the Relations of Railway Companies and their Employees. It contains brief accounts of the various railroad labor organizations, and gives interesting particulars of the various benevolent associations connected with railroads. The extent to which railroad companies interest themselves in the welfare of their employes may be judged from the following extracts, giving the result of inquiries.

Out of 350 companies, 59 have an insurance or guarantee fund, or hospital fund, or relief association affording aid in various degrees and ways to employes. It is maintained either by the companies, or by the employes, or by both co-operating on some mutual plan. On the remaining 291 not a single one of them is claimed.

Fifty-two companies provide eating or lodging houses, or meals or lodgings at reduced rates for their employes, and 298 make no provision of this kind.

Seventy-eight companies provide reading-rooms, or some kind of place of resort for their employes, and 272 provide neither. Of these companies, many have established their reading-rooms in conjunction with the Young Men's Christian Association, by contribution to its fund.

Forty-eight companies provide in different forms and degrees for the technical education of their employes, and 302 make no such provisions.

Twelve companies make distinct provisions for their employes' superannuation in their service, and 337 do not. The Atlantic & West Point, and the Western Railway of Alabama, pension such employes, and allow them pay without work the same as given them in actual service.

One hundred and twenty-five companies employ disabled by accident employes given preference for the performance of other service for which they may be qualified, or that during disability they are provided for in divers ways and degrees at the expense of their respective companies. Two hundred and twenty-five companies make no claim of this sort in any way.

This makes on the whole a fair showing of the interest manifested by railroad companies in the welfare of their employes, but there is still room for improvement. Just thinking of there still being 225 companies that have a disabled employe is cast like a leaden car-wheel, and gives no preference to any company for which he is not qualified. We once knew of a case of a railroad manager in Scotland who charged the expense of a coffin for her husband out of the insurance money due the widow. The accident in which her husband was killed was due to the parsimony of the company. We scarcely think that any of

our railroad managers are as mean as this, but those who give a small dividend in their service no consideration do not stand on a much higher plane.

Locomotive Fire-Kinders.

In 1886 the writer made a tour which took in a large number of the most important engineering establishments in Great Britain. Improvements were noticeable in the conveniences provided for getting the locomotives ready promptly, but everywhere there were complaints heard of the danger, annoyance and inconvenience that resulted from the presence of piles of firewood kept for lighting the fires of the engines. In writing on this subject we remarked:

It appears to us that American ingenuity might devise a method of igniting coal on the grates of locomotives by means of gas or coal oil. On steamers used by the Central Pacific Company coal oil is used as fuel, and the combustible is thrown from jets upon a bed of fire-brick. By a modification of this plan, jets of oil could be injected upon a bed of green coal which would soon ignite from the heat generated by the burning oil. It would not take the exercise of great ingenuity to make jets of gas serve this purpose in places where gas could be readily obtained. We are persuaded that a simple way of starting fires by a safer and cheaper material than wood would fill a long-felt want and prove of great benefit to railroad companies and to the men responsible for getting locomotives steamed up.

This call was promptly responded to, and several patents were shortly afterwards obtained for methods of firing up locomotives by means of oil. The introduction of this improvement has been slow. The appliances first tried were not satisfactory, and they had to be changed and simplified to be suitable for use. There are now several practicable fire-kinding devices on the market, and railroad companies are displaying a disposition to adopt them. Already there are several railroad companies in Chicago which have equipped their engine-houses with a fire kinding plant, and a very satisfactory system has been in use in the Wisconsin Central engine-house at Waukesha, for several years. There are now good prospects that the piles of firewood will cease to be a feature of the roundhouse, and that neatness and order will prevail in the engine-house.

The fire-kinding is a simple device and easily imitated. Of course, there are railroad companies calling for imitations to save the small expense of royalty. We do not know how broad the patents are covering these devices, but we hope they are broad enough to exact royalty from the pirates who have learned the secret of the simple apparatus by studying the patented article.

Leaky Tubes.

At a recent meeting of the Central Railroad Club, a report was read on "Leaky Tubes—The Cause, and how to prevent it." The principal cause of leaky tubes, it was said, is bad water and defective circulation. Then was mentioned the prevailing practice of admitting air in a way which causes rapid contraction of the hot metal, and the irregular feeding of the boiler, which produces a similar effect to the unpropitious admission of air. Recommendations were made that a sufficient thickness of fuel should be maintained in the front of the firebox to prevent cold air entering, and that close-fitting dampers should be employed. The committee also expressed the opinion that workmanship was an important factor in the leak. We cordially second the expressions in this regard. One matter which the committee did not mention we consider of paramount importance. They said nothing about the character of the metal used for making the tubes employed. A discussion on leaky tubes without mention of this point was

like hearing the play of "Hamlet" with the Prince of Denmark silent. Some of the rods running into Buffalo, where this discussion took place, are using the worst tubes made in this country, and they are the native manufacture of the State. They are the poorest kind of Bessemer steel, and are sold as charcoal iron. The Central Railroad Club would do well to investigate the tube question a little further.

In an interesting discussion about hot boxes which took place at the New England Railroad Club, some curious information was elicited concerning so-called "habbit metal." A gentleman who is interested in bearings applied to a great many houses which were supposed to sell habbit metal, and he did not find the real metal in any of the specimens bought. It is well known that now-a-days any kind of alloy gets the name of habbit metal, and some of it is of most inferior quality and very badly adapted for any kind of bearing. It would be a good plan for those who are making alloys to find out exactly what habbit metal really is. There are a great many kinds of inferior metal not used because cheap mixtures are used, but we have noticed in not a few shops where habbit metal was made that the method of melting the ingredients had a good deal to do with the inferior quality produced. All the ingredients would be put in a crucible together and melted, although the melting point of some of the ingredients would be almost twice as high as that of the others. The consequence is that the metal which melts first evaporates and burns out, and a great measure before the other metals are melted. The proper way to do this work is to melt each constituent separately and then pour them together. When this is done, a metal of the kind required will be produced, but not otherwise.

The English syndicate which purchased the Otis Steel Works, appears determined to run the establishment according to English ideas. The representatives of the owners have taken charge, and the old manual forces which made Otis steel the most popular steel for railroad purposes are relegated to the rear. Mr. J. K. Bole resigned from the syndicate, and we are now informed that Mr. William Wilson of Chicago, who might have been the first, has also resigned. The latest news is that Mr. Charles Otis has sold his interests in the company. Our English friends evidently are doing their best to ruin the business. They are ignorant of how railroad supply business is managed in this country, or they would not under any circumstances permit the levellings of the business to go into other lines of industry.

At the last convention of the Brotherhood of Locomotive Engineers, a change was instituted making the conventional biennial—that is every two years. The first convention was held in 1884, and the next will be held at St. Paul, Minn., on May 9. An unusually large attendance is expected. Before the meeting of former conventions there have generally been rumors of war to be waged by one section or clique against others. The atmosphere appears to be surprisingly clear this time, and the industry and brotherly love which usually prevail unless unexpected firebrands are thrown into the midst of a somewhat explosive material.

The Traveling Engineers' Association are displaying a great deal of energy in investigating the subjects for which committees have been appointed. The last meeting was held on the 22d, and two circulars requiring answers, each of them being remarkably full. One is on "A Uniform Form of Examination of Firemen for Promotion and New Hire for Employment," the second is "How can Traveling Engineers Improve the Service when Engines are Double-Crewed or Pooled?"

PERSONAL.

Mr. Jesse Hall has been appointed train master of the South Western of Georgia, in place of Mr. C. L. Brunner, transferred.

Mr. F. E. Carey, of the Wisconsin Central, has been appointed chief dispatcher of the Butte, Anaconda & Pacific, at Anaconda, Mont.

Mr. H. M. Smith has been appointed general master mechanic of the St. Louis Bridge Terminal Railway, with charge of all machinery.

Mr. J. P. O'Brien, heretofore superintendent, has been appointed general superintendent of the Iowa Central, with headquarters at Marshalltown, Iowa.

Mr. F. H. Bleeker has been appointed division superintendent of the St. Louis, Keokuk & North Western, with jurisdiction from North St. Louis to Bellefontaine, Mo.

Mr. J. D. Morehead has been appointed master mechanic of the Vandalia Line at Paris, Ill. He was formerly foreman of the roundhouse at Terra Haute, Ind.

Mr. Rollin H. Wilbur, general superintendent of the Eastern division of the Lehigh Valley, has been transferred to the northern division, with headquarters at Bethlehem, Pa.

Mr. J. J. M. Laughlin has been appointed superintendent of the Butte, Anaconda & Pacific. He was formerly superintendent of the St. Paul division of the Chicago & Great Western.

Mr. E. E. Hudson, master mechanic of the Cleveland-Indianaapolis division of the Cleveland, Cincinnati, Chicago & St. Louis, has removed his headquarters from Cleveland to Bellefontaine, O.

Mr. A. J. Ball, who recently resigned as master mechanic of the Columbus, Sandusky & Hocking, has been appointed master mechanic of the Ohio Southern, with headquarters at Springfield, Ohio.

Mr. Robert Ross, who was murdered at Troy, N. Y., on last election day, was a bright mechanical engineer of much promise. He was one of the firm of the Ross Valve Company and held the position of secretary.

Mr. W. G. Busley, engineer of maintenance of way of the Cleveland, Cincinnati, Chicago & St. Louis, at Wabash, Ind., has been appointed superintendent of the Cairo division of that system, with headquarters at Mt. Carmel, Ill.

A lecture was given at Cornell University, Ithaca, N. Y., on March 10th, by Mr. George Sinclair. The subject was "The hard road of self-instruction in engineering." Professor Thurston introduced the lecturer to a large audience.

Mr. Arthur Crandall, the well-known railroad supply man, has lately associated himself with Mr. Johnson, a railroad man of many years' experience, and the firm has made arrangements to manufacture and sell a variety of articles required for railroad rolling stock.

Mr. J. H. Brown has been appointed to take charge of the Westinghouse air-brake manufacturing car of the Chesapeake & Ohio Railroad. Mr. Brown was formerly an engineer on the Baltimore & Ohio, and is thoroughly competent to perform the duties of air-brake instructor.

Mr. L. S. Randolph, who was for several years mechanical engineer of the Baltimore & Ohio, at Baltimore, is now pro-

lance in engineering of the Agricultural College, Blacksburg, Va. He writes that he will be a long time before he loses his interest in railroad matters.

Mr. T. T. Reed, superintendent of motive power and rolling stock of the Chicago Great Western, has tendered his resignation to accept of a similar position in an Eastern road. There is talk that he is going to the Canadian Pacific. He is merely a master mechanic on that road.

In a late issue we mentioned that Mr. W. J. Bule had been appointed master mechanic of the New York, Susquehanna and Maryland. This was a mistake. Mr. Bule has been appointed general foreman at Jersey City. On some roads the position of general master mechanic, hence our mistake.

Mr. L. P. Ligon has been transferred from East Radford, Va. to master mechanic of the Norfolk & Western, at Bluefield, Va. Mr. Ligon is one of the confidential friends that locomotive engineers have had in the South, and we are sorely grieved that he has made some unwise march upward.

We are pleased to note the steady and constant contribution to health of our old friend J. S. McCann, of the Kansas City, Cincinnati & Memphis road. There is little question to believe that it will no longer be a former position, and it will no longer be a pleasure to his old officers, and we are glad to see him back to his post.

Mr. H. H. Hous, Ransdell has resigned as superintendent of the Wisconsin Central, at Elmira, Pa., Wis., to accept a position of master mechanic at Topeka & Santa Fé, at St. Paul, Minn. Mr. Ransdell has had experience as pattern-maker, manager of a foundry and also as a mechanic, which gives him a good equipment for climbing the ladder higher.

Mr. L. D. Sweet, an old Denver & Rio Grande man, has been making a tour of inspection, exhibiting the Sims automatic car engine. The controller of the big and cap engine, exceedingly simple and perfectly automatic. Mr. Sweet has received much encouragement from numerous railroad men who have examined the engine. The talk is that the Santa Fé will adopt it as standard.

Among the pleasant incidents of the season was a banquet given to Mr. F. C. Davis, general manager of the Richmond Locomotive Works, by the men in the engineering and drawing-room departments. About forty men sat down to the feast, which was given to celebrate the successful completion of the new Virginia road, the Richmond & Hanover Railroad, the work having been done in shorter time than that allowed by the contract, which was unusually short.

A friend in Mexico writes us: "Mr. J. S. Turner, who has been acting as assistant master mechanic and road foreman on the Mexican International Railroad for the past eighteen months, has tendered his resignation, to take effect March 24, in order to accept the position of superintendent of motive power of the Mexico, Yucatan Central & Pittsburgh Railroad. Mr. Turner is a bright mechanic and a practical roadman, and he leaves Mexico with the best wishes of his many friends for his future success."

Mr. John A. Hill, the J. P., as he calls himself, of Louisville, ENGLAND, has gone away upon a Southern trip which will extend as far as the City of Mexico. He started out carrying two stachels, a photographic camera, two boxes of cigars and a load of native modesty. We commend our Junior to the tender mercies of his friends. He threatened to brush up his acquaintance with life in the cab, but

he will be better in a man car. Engineering is wearing on a chin who has been away for it for several years, and John has a 5,000-mile tour ahead of him.

Mr. L. B. Lawrence, who died at Patterson, N. J., last month, was an inventive genius of remarkable ability, whose talents were wasted for want of worldly-wise attributes. He was a Dane by birth, and in his youth was a lieutenant in the King's guards. He was brought to this country by the late Commodore Garrison, who was a great admirer of his inventive appliances for railroads, and to act as an advisor on engineering matters. Like many foreigners, he did not readily grasp the conditions of railroad operating in America, and the inventions he perfected were not appreciated.

Mr. W. H. Rosing has been appointed master of the Denver division of the Denver & Rio Grande, with charge of the shops at Burnham, Col. Mr. Rosing is a mechanical engineer of decided leading ability. He has been for several years a mechanical engineer at the Erie Central, and rose from the position of chief draughtsman. He was for a time mechanical engineer of the Grant Locomotive Works, at Chicago, and got those works in working order. He combines in a remarkable degree theoretical education with the dictates of a wide practical experience.

The following personal changes have been made on the Erie system, brought about by the promotion of Mr. W. Lavery to be assistant superintendent of motive power. Mr. B. Clark, who has been foreman of the car shops of the New York Lake Erie & Western, at Buffalo, N. Y., has been appointed mechanical engineer, with headquarters at Susquehanna, Pa. In place of Mr. F. N. Hibbits who has been appointed master mechanic at Rochester, N. Y. Mr. C. P. Weiss, heretofore master mechanic at Rochester, has been appointed master mechanic at Rochester, N. Y., to succeed Mr. I. Bond, transferred to Susquehanna, Pa.

Mr. Wm W. Adams, general storekeeper of the Fall Brook Railway Co., was, on the 10th of March, elected Mayor of the City of Curran, N. Y., over Harry H. Pratt, one of the editors of the *Corning Daily Journal*. The municipal contest was the most closely contested in the city's history, but the principles involved and the personal worthiness of the candidate brought Mr. Adams in a winner by the next majority of 22. Although comparatively young, Mr. Adams has been in the service of the Fall Brook for thirty years, and the position of honor to which he is now called is deserved and recognized, not only by his townsmen at large, but also by his railroad intimates and acquaintances.

Recent advices from Florida give us the gratifying intelligence that Mr. C. E. Smart, S. M. P. of the Mulhgan Central Ky. Co., who has been ill for some three months, is rapidly recovering and will, no doubt, be fully up to his health. The danger of this comes from a natural desire on his part to be at his post duty. The exceptionally fine treatment received by Mr. Smart from President Lydard and General Superintendent Robert Miller, in forcing upon him to devote care, fully gotten, to his health, and his transportation to wherever health could be found, and missing that he must go and stay until fully restored to health, is one of those striking and beautiful evidences of appreciation of service faithfully rendered.

Mr. Thomas Muldon, a well-known mechanical engineer and locomotive superintendent, died in New South Wales, in February last. He was for some years locomotive superintendent of the New South Wales Railroad, and was noted there for

the favor he showed to the American type of locomotive. In fact, he had made very close investigation of the relative merits of English and American locomotives' work in the colony, and although an Englishman himself, he decided that the American locomotive was the better suited for their work, and he designed a class of locomotives conforming very closely to American practice. This brought him many enemies in New South Wales and in England, and led to his discharge in four years ago. He was a member of the American Railway Master Mechanics' Association and took great interest in the proceedings.

An order has been issued by President Vreeland, of the Metropolitan Street Railway Co., New York, appointing Mr. Thomas Millen general master mechanic of the company. Mr. Millen resigned the position of superintendent and master mechanic of the New York & Northern to accept this place. Mr. Millen is one of the ablest of railroad engineers, and has been attending to their business early and late, and who make themselves a necessity with the company they serve. There is no fuss, no pretension, but when men like Fred Millen leave a job, it takes about three men to fill the opening they have left behind them. We have no idea what inducement has offered the company has offered to draw Mr. Millen from his surface railroad loves, but we feel disappointed that the latter interests have lost such a good man. But then, Vreeland has gone from our good stamping ground, and he appears to have no remorse of conscience in advising other good men to do likewise.

The following extracts from a letter written to us by S. P. George, W. McGourey, of Cleveland, will be worth reading to many of our friends. "I know you will rejoice with me when I tell you that George is going to come off victor in his battle with the grim tyrant, and that the doctor assures us that in a year's time, or may be less, he will be as well as ever was he before. It is truly marvellous the good he has made in some weeks in the hospital. The aneurism has already abated fully one half in size. . . . The doctor has arranged for him to see a gentleman friend once a week. He never utters a complaint, but is watching his own case and trying all he can to reduce his pulse down. I take him Locomotive Engineering, and after he reads it thoroughly, he sends it into the railroad ward of the hospital. The orderly says that one man will read aloud to the others and the paper is passed around. They have many discussions over its contents. George says could Mr. Sinclair and Mr. Hill hear the many complimentary remarks made they would feel highly pleased, for the praise is genuine."

A Tale Story with a Moral.

Any railroad man interested in the quality of boiler tubes could receive a good object lesson by calling at the office of Mr. A. E. Mitchell, superintendent of motive power of the Erie. The officers of this department follow a practice when they receive a delivery of five tubes of drawing the ends of some of them, then the work of course being done once in Mr. Mitchell's office is a piece of tube that had been treated in this way. The end is split so uniformly that the material looks like fine wire ends. The tube is steel and very fine steel at that. It is no wonder that the ends of some of these trouble bearing tubes when the material is of inferior quality. This was a cheap make of tube offered by the Erie as a means of reducing expense. The company are sensible enough to decline attempting to reduce expenses by employing inferior material in place where it would be likely to prove troublesome. We think it is a good idea, and boiler material generally should be among the last things for railroad companies to stint the cheapening process upon.

We have in mind the remembrance of

an instance where a purchasing agent cheapened an important part of a locomotive by the use of a less than a grade of steel with a moral and a bad tale. The company were using brick arch tubes supported by water tubes, and there had been great difficulty in getting the tubes to stand, as there was considerable impurity in the feed water. One day the maker of a remarkably good quality of boiler tube called on the master mechanic to make a collection. He was told that the boiler tubes which the road was using were satisfactory, but that the tubes used to support the brick arch did not last more than three or four months. The tube maker at once volunteered to supply tubes for this purpose, and said that he would make no charge if the tubes did not last two years. His offer was jumped at. When put in service the tubes proved as good as they had been represented to be; but they were high priced, the charge being about 15 cents a pound. They lasted so well, however, that they were very cheap compared to the tubes previously used when the service performed was considered.

It came out that the purchasing agent of the road died, and a successor was appointed who immediately began to try and make a record. One of his first discoveries was that the company had been paying a high price for brick arch tubes. This must be reformed instantly. He told the tube maker that his price was absurdly high, and that it must be cut to two or the company would buy no more of that kind of tube. Strained relations ensued, and the purchasing agent ordered tubes from a firm in New York State that undertook to make an article suitable for the purpose. A double steel flue was supplied. This had not been long in a firebox when one of them burst and scalded a fireman to death. This purchasing agent was morally certain that the cause of the death, but he was not put on trial. The company is again buying the first-class iron tube at an increased price. The moral is that nasty cheapness is expensive policy in the end.

An intimation has been sent us that Mr. George Richards, Sanfilippo House, Laurence Pountney Hill, London, England, has established an agency for introducing American patents and manufactures into England. Mr. Richards is a well-known mechanical and consulting engineer who went from this country to England to establish the manufacture of American iron in that country. He is thoroughly familiar with every way an persons who wish to introduce patented articles to the notice of English manufacturers can safely apply to Mr. Richards for assistance and information.

The Chicago & Northwestern mechanical department has some details connected to soften the feed water, and it is reported to give very satisfactory results. The mixture is similar to that employed by the Chicago, Milwaukee & St. Paul, the recipe for which was prepared by Mr. George Gibbs, the mechanical engineer. The use of this mixture appears to be a very profitable investment, if it keeps the heating surface fairly clean, reduces thereby the amount of boiler work to be done, keeps the engines longer in service between the periods of going in for repairs, and saves enough fuel to pay the expense of the compound.

In the course of a private letter from Mr. George Royal, Jr., he says: "In the March issue of LOCOMOTIVE ENGINEERING you speak of steam from air pump being counted as I might say that at Omaha, the Union Pacific men, had a very clever engineer fitted in this manner. The writer was at Omaha a week ago, and Mr. J. H. Manning, master mechanic, spoke favorably of the attachment, and I believe is fitting out other engines. It is arranged with a valve stem, on failure of the pump to supply steam, to let steam from the boiler can be used."

EQUIPMENT NOTES.

The Armour Refrigerator Co. have ordered fifty more refrigerator cars from Wells-French.

The Valley Road of Ohio have ordered ten-wheel locomotives from the Pittsburgh Locomotive Works.

A highly promising improvement in piston-rod packing has been patented by Thomas J. Hudders, St. Paul, Minn.

The Dakota Central & P. Co. have under advisement the purchase of some additional power and cars, for next winter's business.

The Jackson & Sharp Co. of Wilmington, Del., have an order for forty milk cars from a Philadelphia dairy company, to be ran on the Lehigh Valley road.

The Mason Regulator Co. of Boston, are sending out, as advertising, a neat set of dummies. They offer to send them to anyone who will send 12 cents for return postage.

The Fitchburg Railroad Company have given orders for 100 cars to be built at their shops at Fitchburg, for the purpose of giving employment to the men out of work in the town.

The Haskell & Barker Car Works are reported to have secured a contract for 1,000 cars, and the plant at Michigan City, Ind., will resume operations after six months of idleness.

A car-brake adjuster has been patented by James Howard, of New York, the well-known expert on train-brake mechanism. It is a ratchet arrangement and is of extremely simple design.

The Swartzschick & Sulzberger Packing Co. have ordered fifty refrigerator cars from the Missouri Car & Foundry Co. The cars are to be completed and delivered in Kansas City by May 1st.

The South Jersey Railroad Co. have awarded a contract to Harlan & Hollingsworth, of Wilmington, Del., for the construction of twenty-five passenger coaches, to be completed by May 15th.

The Schenectady Locomotive Works have just completed for the New York Central & Hudson River road a locomotive numbered 888, similar to the famous 999, and another will soon be built.

The shops of the Pennsylvania, at Columbus, O., have recently completed an order for passenger day cars for the Cincinnati & Muskingum Valley, to replace the old passenger equipment of that road.

A railroad in Japan has ordered four locomotives to be purchased from American makers. They will be six-wheel coupled tank engines, weighing about forty tons. There is a good deal of competition to fill the order.

The shops of the Southern Pacific, at Sacramento, Cal., are now building 150 refrigerator fruit cars. Oregon pine is to be used for the construction of the cars, and the work will be done by the piece-work system.

A disastrous explosion happened near Menace, Ind., last month to the boiler of the mogul locomotive belonging to the C., C. & St. L. The fireman was killed and the engineer and head brakeman severely injured.

The Vandalia Line has some engines with underslung driving-wheel springs, of the Pittsburgh Locomotive Works arrangement, which are reported to give better satisfaction than anything that has ever been tried upon the road.

The Sanford & St. Petersburg R. R., formerly the Orange Belt will build during the year at their Oakland shops some thirty box cars. They have recently purchased two engines—N G—from the Deaver & Rio Grande R R.

The Metropolitan Elevated Railroad of Chicago has decided to begin operating with locomotives. They talked of electricity, but no satisfactory guarantee could be obtained. They have ordered 100 passenger cars from Pullman.

The Mexico, Cuernavaca & Pacific R. R., of Mexico, is having four passenger cars built by the Jackson & Sharp Co., at Wilmington, Del. The company will also place an order for fifty freight cars and two large to wheel freight locomotives.

The order for locomotives which the New York, Susquehanna & Western has been considering for some time, has gone to Rogers. They consist of one passenger engine, two moguls and one consolidation. The freight engines will have Wooten fireboxes.

On the fifth day of May next the Antwerp International Exhibition will be opened. American manufacturers desiring orders of exhibiting at that place will lose no time in applying to Mr. T. A. Matthews, No. 46 Church Street, New York, for particulars about space, concessions, etc.

The Long Island Railroad Company have a firebox of Spang steel in one of their engines, and it is nearly ready for removal, although it has been in only about eighteen months. It is cracked badly from the stay-bolts, and it will be hard work getting it to stand out all summer. Good steel fireboxes stand on that road an average of five years.

Mr. Chas. F. Winby, inventor of the four-cylinder engine, "James Toleman," recently shown at the Fair, has been watching her performance on the C., M. & St. P. Her eccentrics ran hot, and Mr. Winby tried a pair of Bangs' oilers on them, these did so well that he ordered cups for the entire engine, and has secured the right to manufacture them in Great Britain.

Business on the Western R. R. of Ala. & West Point Road has an encouraging outlook. Few roads in the South are to be compared to it, and that may be expected. Road-bed and equipment is thoroughly first class, and the discipline of the men in all departments is of a highly satisfactory character. Capt Tyler has the fullest possible confidence in his men, which is well deserved.

The Orange Belt Railway of Florida appears to have a very efficient master mechanic in Mr. J. F. Sheahan. We have lately been looking over the performance sheets of the locomotives, and comparing them with other roads in the same vicinity. The expenses of repairs and renewals are well compared with other roads doing similar work. The total cost per mile run is below seven cents, the repairs being only about one cent per mile.

We are informed that the Gates Iron Works, of Chicago, manufacturers of the famous rock and iron casters, has recently purchased the entire plant of the Chicago Iron Works. This consists of buildings, tools, machinery, stock, patterns, drawings, etc. This will greatly add to the facilities of the Gates Iron Works Co., although they previously had the best facilities for constructing their own style of machinery that were to be found anywhere.

We have received from Henry C. Ayer & Gleason Co. of Philadelphia, a number of sheets showing illustrations of the tools used in tool making. Among these tools we find Gleason's instantaneous

positive vice, the same designer's automatic face-mill lathe and his original ratchet drill. Besides these there are several appliances, suitable for hoisting in road shops and similar places. Any persons needing tools of this kind would do well to send for circulars.

We are informed by Mr. F. H. Brackett, Brattleboro, Vt., that he is making a small screw jack for holding up the equalizer while a new spring is being put in. From a sketch of the jack which we have received we should conclude that it is a very useful tool and one likely to be very convenient on a locomotive. Tools of the kind are often made for the use of engineers and friendly machinists. Those who cannot get it made readily ought to send for this one, which can be bought for \$4.50.

A patent has been granted to Mr. James McNaughton, superintendent of motive power of the Wisconsin Central, for a locomotive fire-braking device which he had had in use in the engine house at Waukesha for about a year. It is a highly practical fire-kinder, is perfectly safe and does the work at very small expense. We understand that the cost of firing-up an engine with it is about six cents. Mr. J. S. Leslie, well known for his connection with the rotary snow plow, is handling McNaughton's fire-kinder.

The Long Island Railroad people are introducing brass eccentric straps and brass driving-boxes as a remedy for the breakage so common when these parts are made of cast iron. They make the driving-boxes in a mold, and do the work so accurately that the boxes are put under the engines without any machine work being done upon them. All the work found necessary is to clean the casting a little and sweat a soft lining upon the bearing. With this little care they start off and run perfectly cool.

The mechanical department of the Pennsylvania railroad at Altoona are getting out new drawings of the class P locomotive, with the intention of making radical changes on the P. They have taken a very sensible and practical way to obtain data for making the required changes. All the master mechanics were invited to criticize the old engine and note down what changes they would recommend as being likely to improve the engine. The opinions were expressed very freely, and the best of the changes suggested are embraced in the new design.

The Builders' Iron Foundry, Providence, R. I., have just published a new edition of their catalogue of globe special castings. These castings are of the great many railroad companies and are in high favor. The business policy of the makers of these castings may be judged from an introductory note to the catalogue. The ancient founder is heard to remark "We make specials as long as we can and as heavy as we can, our motto is 'iron first.' As a consequence of this the Builders' Iron Foundry state their policy to be: 'We make specials as compact as we can, as light as we can, we utilize every pound of metal. Our business is to sell globe specials.'"

After having the Fox pressed steel truck in use for several years the New York Central people are very highly pleased with its performance. The truck runs month after month without requiring any repairs. The criticism was made upon it that the rivets would soon get loose, and that would be more costly to keep in running order than the diamond truck. Experience has shown this fear to be groundless. There is no more reason why the rivets in a truck should work loose than those of a bridge should get in that condition, and there is no trouble with riveted bridges. There is good reason for believing that the New York Central will make the Fox truck their standard for freight cars.

The Mt. Vernon Car Mfg. Co. secured an order from the Mobile & Ohio Railroad for 100 of their standard improved wheel combination fruit and refrigerator cars. Cars to be 60,000 pounds capacity, equipped with air-brakes and Carson & Gurganus air-tight door. This is the combination fruit and refrigerator car that has attracted so much attention among railroad men in Ohio. The car is especially adapted for shipping bananas and oranges from southern points to the extreme North without transferring, and a car that can be used both in summer and winter. A representative of the company writing about this order says "Business is very dull at this time, and 100 cars look as big as 1,000 to many of our ordinary trade," say the builders. We have been very fortunate, however, having only been shut down for a couple of weeks. We have been running full time all summer and winter until about two weeks ago."

An improvement in car trucks, invented by Mr. William Voss, superintendent of the Markey & Smith Company's Works, has been patented. It is described as a car truck having one or more series of half elliptic springs rigidly secured at or near their centers, alternately to the car body and truck frame, the springs being linked together and their ends so connected with the car body or truck frame as to permit all the springs to yield freely to the inclination of the car body and truck. By means of this arrangement the weight is practically uniformly distributed over all the springs, imparting an easy movement to the car and securing a uniform distribution of the strains.

The Jacksonville, St. Augustine & Indian River R. R., with many others throughout the country, shares in the depression so generally prevailing. Their equipment, however, is maintained in that highly efficient condition which has accorded to it, most justly, the title "gilt edged" of the South. The little ornamental features which have marked this equipment in the past has been one of the best possible investments for the company in building a reputation for humane excellence and attracting travel, and furnishing its patrons comforts and enjoyments not given by other roads. The actual first cost and maintenance of these ornamental features is so insignificant that it is naturally a source of wonder why other roads do not attempt something in the line. To the traveler of experience in the railway field one is quickly impressed with a deficiency, in the operating department. Many little things in this department force themselves upon your attention. They cannot be specified in a convincing manner without the use of more space than we can well allow.

The Central Railroad of Georgia, under the general superintendency of Capt. V. D. Kline, is rapidly repairing its deficiencies. At one time seemingly hopelessly lost by wretched management under amateur managers—it being blessed or cursed with three successive regens of this class, each one of which seemed to sink it deeper in the condition from which it seemed impossible to raise it. Capt. Kline left the property some seven years since, when it was rated as one of the best of Southern roads. None stood higher in the North or the South. What a revelation it must have been to him to find it in a forlorn condition that can hardly be described. The task that confronts him is one that would have seemed the ordinary type of old time. It will cost him, or any man, to accomplish its restoration ten years of his life in money and hard work for which he can never be adequately compensated. His knowledge of the four departments and his all-around experience alone can bring about the ordinary type of old time. The specialists have wrecked it, as they have wrecked many other equally good properties.

Some "Don't's" for Young Engineers and Firemen.

An engineer, writing over the signature "Improvement," sends us this chapter of "don't's," dedicated to young men on the "ad. They are good.

Don't think, after you have fired or run a year, that there is no room for improvement—there is plenty of room, as you will find out.

Don't think because the M. M. or R. P. "nicks you up" that he "has it in for you" perhaps you are getting careless and need your "packing set out," we'll do once in a while. Keep up your rods and wedges, everything neat and clean, especially in the cab, always be punctual and your "packing won't blow."

Don't think because the boys on the "22" are lighter on coal, oil and supplies than you are that it is bound to be the fault of the "22"—it may be yours.

Don't forget to put your fire in before pulling out, and enough to last till he looks her up—she'll steam easier and be lighter on coal.

Don't forget to keep your front damper shut, especially if the coal is very coarse, and it lets in too much air, and you will have to fire heavier. There are exceptions to this rule.

Don't forget, if you are on a hard run and coal is lumpy, to call the "2" attention to it. It is easier broken by the men in the shed, and if you explain why, the R. F. will have it broken for you (?)

Don't forget, when oiling, to run oil can bar around shoes and wedges, you can then run them tighter than your neighbor who only oils "in sight," and your wedges get a tick.

Don't neglect to keep oil holes clean, and use a little headlight oil in these once in a while, it cuts the gum and she'll handle easier. Drop a little oil between boxes and hubs, and have less lateral motion.

Don't be sporadic or jerky with anything, be swift but sure, and un-deflected, your machinery will wear better and you will get a good name. Be at home.

Don't be afraid to ask your engineer questions, if he don't know, it is a good time to learn.

Don't be ashamed to read mechanical books and papers, especially Locomotive Engineering. Theory and practice are side-partners.

Don't lose your temper when you get delayed on the road, and curs the dispatcher, it is just as important for him to read to business as you, and—perhaps you don't realize.

Don't forget to be afraid to read your orders to the fireman and brakeman, they may save your job, your life, or a wreck. We are none of us infallible by any means.

Don't think because you work for a company that takes no interest in your work, that these "don't's" are a good. You may get on a good road some day.

Don't let her pop or slip, or work water, or pound, or get dirty, any more than you can possibly help. She will last longer, run cheaper, and give better service, if you are careful.

Don't talk across the boiler-head on a switch engine.

Don't get cross, ugly, or cranky because they did not reduce the "left back end" or because things don't go just right. It is the clouds and shadows of life that make us appreciate the sunshine. We all have our share of both.

Don't forget to be pleasant with the whole crew. Kind words don't cost anything, and the trip will be pleasanter.

Don't, when starting out late, try to make up all the time in ten miles. Make up a little all the way over the division, it will look better and be easier on the boy at the scope.

Don't turn your good air-pump water open, and depend on the governor to shut it off. Run it as slowly as possible always, let it work constantly, and use very little oil (except on swab), and it will last years.

Improvement of a Short Smokebox.

The diagram on this page was taken from a drawing sent to a committee of the Master Mechanics Association by Mr. F. W. Webb, mechanical superintendent of the London & Northwestern Railroad.

The front ends in use of Great Britain are universally short, and most of them are devoid of setting or deflector plates. The former practice on this road was a plain open stack with a very high single nozzle.

After the adoption of the extension of the smokestack in the arch—internal chimney

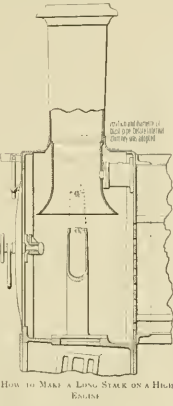

they, they call it—the nozzle was fully 12 inches and enlarged from 4 1/2 to 4 3/4 inches for 17-inch engines, with 80 other changes whatever.

The "internal chimney" virtually makes a stack two feet or more longer, and it would seem a very simple, cheap and easy way to accomplish an improvement.

In this country a great many roads use a short petticoat pipe, adjustable. The difference between this and the one shown being that the latter is tight at its junction with the stack and is a permanent fixture—a part of the stack.

Mr. Webb makes this extension of last iron.

It looks to us as if this would be an improvement on some of our big and high engines, where the smokestack looks as much like a plug hat as a chimney.

Long Island Shops.

The repair shops of the Long Island Railroad, at Morris Park, L. I., are the only railroad shops in the neighborhood of New York that have been working full time all winter. The origin of this highly satisfactory state of affairs is that the company are applying the Westinghouse air-brakes to the locomotives and cars and making numerous improvements on the passenger equipment. They are converting the passenger cars that had side doors and cross seats like summer street cars into platform cars with end doors and aisles.

This change was recommended by the Railroad Commissioners after the tunnel accident last summer when so many people were hanging on the outside of the cars were killed.

While applying the air-brake for the first

time to a great many of the cars, Mr. S. F. Prince, master mechanic, has been devoting close attention to the sliding of wheels, and he finds that with some shoes 90 per cent. of the light weight will cause sliding frequently, while with shoes of other material there is no sliding or even defective braking. His observations appear to show that one of the greatest needs of the day is a uniform mixture for brake shoes. The company has a large number of Lapham shoes, and they appear to be favorites beyond all others. Some of the divisions of this road are very sandy and particularly hard on brake shoes. A set of soft cast-iron shoes will be worn out to the end of the line and back.

The shops at Morris Park have been in use only about four years, but they are already too small for the work to be done. Important additions have been made to the machine tools, and the probability is that still more tools will be ordered soon. They have in use here a tool not often seen in railroad shops, which is very highly spoken of. This a Nicholson stay-bolt cutter, with six heads. It is much more efficient than the ordinary bolt cutter, and turns out a great many stay-bolts with the threads properly cut.

Where Bessemer steel is employed in the case of steel castings extraordinary care is exercised to make the product as nearly uniform as possible. During the blow an expert watches the varying color of the flame, and by the aid of a spectroscopic determines if the elementary gases are passing off in the manner desired. Experience has led to the curious discovery that it is desirable to prevent the silicon from passing out much before the carbon gases are burned by the blast. In case that the silicon is eliminated before the carbon the product will not differ materially in chemical analysis, and yet the steel will not be so good as it is when a fair percentage of the silicon is held till near the end of the blow. It is not very clear how this is so. It may be that the silicon prevents oxidation, but this is by no means certain. There are things in heaven and earth not known to our philosophy.

Harrington's Hoist and Traveler.

The annexed illustration shows a very simple and efficient form of hoisting and

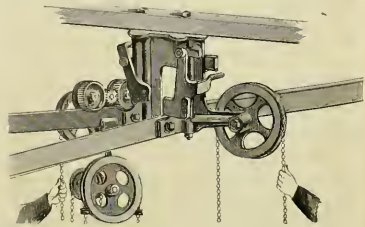

traveling arrangement, made by Edwin Harrington & Sons, of Philadelphia, for use in shops and factories. We have seen this form of appliance in use in different shops lately, and find that it was a great saver of time and delay in getting material to work, and in transporting it through different parts of the shops. These appliances can be put up at comparatively little cost, and will be found of very great service in places where overhead traveling cranes are not available. Parties wishing to equip their shops with this form of labor-saving device should apply to the manufacturers for particulars concerning it.

Efficiency of Ratchet and Pneumatic Jacks.

Mr. S. Bean, master mechanic of the Northern Pacific, sends us the following comparative statement of cost of putting freight cars upon horses and replacing same upon trucks with ratchet jacks and with the pneumatic jacks.

Five cars, after having outside brake beams removed, were put on horses by two men with ratchet jacks in one hour.

Cost of labor, 2 hours, at 20c per hour. \$40

Replacing cars upon trucks, 2 1/2 hours, at 20c per hour. 50

Cost of removing cars to horses and replacing upon trucks. \$50

Five cars, after having outside brake beams removed, were put on horses by two men with pneumatic jacks in fifteen minutes.

Cost of labor, 1/2 hour, at 20c per hour. \$10

Replacing cars upon trucks, 1 1/2 hour, at 20c per hour. 30

Cost of removing cars to horses and replacing upon trucks. 20

Amount saved upon five cars by using pneumatic jacks. \$60

Average cost per car to remove from trucks to horses and replace same with ratchet jacks. \$16

Average cost per car to remove from trucks to horses and replace same with pneumatic jacks. 04

Net saving of labor per car. 12

Amount of labor saved on 500 cars by using pneumatic jacks over ratchet jacks, \$600.00

A bad smash was reported to have been caused on the Pan Handle road last month through the engineer falling asleep. The *Railway Age*, with its usual love for railroad employes, asks if this accident would have happened had the easy cab seat been abolished? To us a much more pertinent question is, How long was the engineer on duty?

We have received the Seventh Annual Report of the Interstate Commerce Com-

mission, prepared by Mr. Edward A. Mosely, the able secretary. It contains in condensed form an account of the work done by the Commission in 1893. The principal part of the report is devoted to matters of traffic, and shows that the Commission is doing good work in promoting spirit of fairness between shippers and railroad companies. An account is given of the work done towards promoting the use of safety appliances. This part says that the most disastrous employment is that of trainmen. In the year under review, one out of every nine persons employed in this service was either killed or injured.

Crane for Handling Chest Covers.— A Tube-Hole Cutter.

BY F. M. ARTHUR.

For properly handling steam-chests and covers a rope hoist is very desirable. In some shops provision is made overhead, by means of timbers properly placed for the attachment of the hoist, but in many no such arrangement is made. In such cases and for use in the roundhouse a crane, similar to that shown in Fig. 1, is quite useful. Referring to the drawing, the hook on the upper end of the rod C

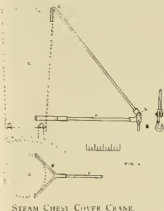

should be so shaped as to clear the ornamental head on the stack that is used on some roads. The lower rod F is made with a V-shaped end so as to give a good support against the stack, and where different sized stacks are used this arrangement will be found better than a circular bearing against the stack. The pin E is raised above the level of the rod F so as to allow the crane to be folded together, making it more convenient to handle. The arrangement of the hook for fastening the hoist too is fully shown in the drawing.

In Fig. 2 is shown a tube-hole cutter. The general rule regarding such cutters



has been to make them solid with two or three cutting edges. The great objection to that style of cutter is, that they can only be used for one size, and when one cutting edge breaks the tool must be annealed and refitted, making in fact an entire new tool except the taper fit for the drill press. Often too, the center bit cuts fast in the hole for want of oil, and breaks off. The tool shown in Fig. 2 will be found to be free from all the objections and possess some good points. It is not expensive, costing very little more than one of the solid tools, it can be used for different size holes by simply providing different sets of cutters. If a cutter breaks off it can be replaced at very little cost. The center bit A can be taken out and refitted or replaced by another size. In fitting up this tool it would be advisable to turn up a half dozen cutters, so that no delay would be occasioned should a breakage occur. The cutters are made of 3/4-inch square steel, and fit to the hole neatly, and secured by a setscrew F. The upper edge G of the cutter at H should be turned so it will nearly round off the edge of the hole and thus avoid going over the work with another tool. By throwing the cutting edges J either toward or from the center, the cutting circle of the tool can be decreased or increased.

The center bit B is fitted to the tool with the same taper as a lathe center, and can be removed with a small drift driven in the hole at the top, as shown. By using a bit as shown at B instead of a sharp center, better and more accurate work can be done. This will of course necessitate putting small holes, 3/4-in. or more in diameter, to the center of each tube hole to receive the bit which acts as a guide for the cutter. The taper fitted in the drill press should be secured with a setscrew through the spindle, so as to prevent the tool from dropping out and catching when it is just cutting through the sheet. The flat end usually made on the end of the taper fitted as on a twist drill will hardly be strong enough to drive this cutter.

Savannah, Ga.

A Deceptive Landmark.

A Western railroad man relates the particulars of a trying experience he had during a visit to New York City. He was stopping at a hotel up-town near the Sixth Avenue Elevator, and knew that he was about in the neighborhood of the hotel. It was necessary for him to go down town, and in leaving the railroad he looked about for some landmark which would tell him the station. A pair of huge pumpkins was seen at the door of a seed store, and these looked so familiar and homelike that they were naturally used to establish the landmark.

The Western man went about visiting the sights at the lower part of the city, and night was falling when he proceeded towards the street where the friendly pumpkins were to indicate the station he must start from. To his consternation the pumpkins had disappeared. He wandered up and down the street, cursing the store-keeper who would deceive rustic strangers by taking in the prominent landmarks, but at last he decided to take one of the elevated roads. In due time he came to a station on the street where his hotel was located and got off. But the surroundings were totally different. He was on the

An Early Promoter of Railroads.

One of the most persistent advocates of improved methods of transportation for New England in the pre-railroad days was Samuel Whitcomb, of Boston. In 1811 Mr. Whitcomb made a journey from New England through Pennsylvania and Ohio, and back through New York State, and his attention was greatly devoted to what other communities were doing to improve their means of intercommunication. He was greatly impressed with the advantages which New York was deriving from the Erie Canal, and endeavored to prevail upon the people of New England to construct a canal from Boston to the Hudson River near Albany. In articles which he wrote advocating this enterprise, he said that the earnings of the Erie Canal would soon be sufficient to pay the whole of the expenses for the government of New York State, and that all taxes would be abolished.

The project of building a canal from Boston harbor to the Connecticut River and thence to the West had taken active shape as early as 1792, but nothing had been done beyond a few preliminary surveys. The persistent efforts of Mr. Whitcomb put new life into this half-forgotten scheme, and there seemed prospects of the State of Massachusetts pushing it through. But money was hard to raise, and nothing was done. Then talk of the advantages of railroads came up. The people about Boston had an object lesson in the working of a short railway in connection with the Quincy quarries, and the most progressive men saw in that a means of transportation superior to canals, as a railroad would not freeze up in winter. Mr. Whitcomb was converted to the railroad idea and labored to have a railroad built over the route on which the canal was projected. He lived to see the first link in the chain which bound Boston to Albany by rail finished. This was the Boston & Worcester Railroad.

Mr. W. W. Whitcomb, President of the Safety-brake Shoe Company, of Boston, is a son of the man who took such an active part in improving the transportation facilities of New England.

An Enterprising Firm.

We are informed that Westinghouse, Church, Kerr & Co., have removed their New York office to the Havemeyer Building. This is one of the largest engineering concerns in the country, having built up a large and profitable business by doing things that had not been done before. To create new things, prove them, and make others appreciate them, involves a factor in progress which does not always meet proper reward, but this concern has seemed to combine the necessary engineering and business qualities to make it pay in the present time. All the members of the present firm are accomplished engineers and good business men, which is, no doubt, the secret of their substantial success. In the promotion of the interests of subdivided power they were the earliest and strongest advocates. Their success in this class of practice resulted chiefly from not overdoing it. In the revolution from simple to compound engines, this firm had hundreds of compound engines running before the engine-building class was fairly alive to the demand. They have taken the lead in supplying mechanical stock and other improved forms of firing. Their last special extension in engineering is in refrigeration and ice-making. Starting with an excellent and simple form of compressor and condenser, they have introduced various improvements in the methods of constructing refrigerating plants, and perfected a new, radical and almost revolutionary process of manufacturing artificial ice.

A new locomotive crane has been patented by William Sellers & Co., of Philadelphia. It consists of a boiler and engine with a hoisting and propelling apparatus. The crane runs upon a truck intended to move upon a track, the means being provided for self-propulsion. The crane looks as if it would be a highly convenient apparatus to have about a railroad shop where there are heavy weights to lift in places that cannot be reached by stationary cranes.



CARS THE MOBILE VERMONT CAR WORKS AND BULLOCK.

wrong avenue but did not know it. After wandering about for an hour, getting more and more puzzled, he met a polite stranger who offered to show him the way. The way shown led to an establishment where gambling was going on, and the innocent railroader was invited to try his luck. His answer was to knock down the polite stranger and make for the street. Luckily for him he got there without mishap, and happening to find a cab at the door drove to his hotel. He tells people visiting cities never to use a pumpkin for a landmark.

The first work of importance that has fallen upon Mr. S. Higgins as superintendent of motive power of the Lehigh Valley Railroad has been the classifying of the locomotives. It is said that he has found over 100 different kinds of engines among the 660 owned by the road. The work of reducing these to a few standards will be very great, but it will be a good thing for the company when the work is done. It would be an interesting operation to examine the multitude of patterns which must be carried to suit the diverse forms of the great variety of locomotives in use.

On the N. Y., O. & W. recently a freight car came into a terminal station minus one truck, the crew not knowing it was gone, one end of the car riding on the link alone. The car ran in this condition some ten miles. The truck was found, badly broken, down the bank, pieces of it being strung along the track for a long distance. The truck jumped the track at a switch some distance from where it was found, but it is not known what caused the jump, unless a brake-beam came down, a pair of shoes being found at this point that belonged to the company owning the car.

Great Northern Spokane Shops.

The railroad repair shops shown in the annexed engravings, have been erected by the Great Northern Railroad at Spokane, Wash. The shops are particularly well designed, the work having been done to carry out the views of Mr. J. O. Patter, superintendent of motive power.

Mr. Patter, in writing to us about the shops, says: "I send you blue prints which will show you the general design of the shops that we have erected at Spokane, and also the location, etc., of the tools in the machine and car repair shops."

The machinery is driven by a 170 h. p. live engine, steam for this engine and heating the shops and roundhouses being supplied by three 66-in. x 10-ft. upright boilers with return tubes. The engine drives the line shaft in the machine shop by a belt, and the car shop machinery is driven from a short shaft in the engine room connected to this line shaft by a tooth-clutch. There are two line shafts in the car shop which are driven from the engine room by means of a hemp rope

Babbitt Metal.

Nearly every person is familiar with the term, "babbitt metal," but few understand how important the alloy was considered when it was first brought out. At a meeting of the New England Railroad Club, Prof. Waldo said: "In looking up the subject of lubricants we found that a certain man, Mr. Isaac Babbitt, had received a gold medal from the Massachusetts Mechanics' Charitable Association in

1791, and asked them where they got genuine babbitt. They said it could not be bought, it had to be made according to specification. I sent out and bought forty samples of metal marked "Genuine Babbitt." It was bought in every part of the country, from New Orleans to Portland. Of the entire forty there was one single sample, which, by a stretch of courtesy, could be called genuine babbitt; I mean that described by Isaac Babbitt in 1791. I will, therefore, venture the opinion that

Lewis Valve Gear.

We have received from the Valve Gear Mfg. Co., St. Louis, a blue print giving an isometric projection of the Lewis valve gear, and a circular containing claims of the savings effected by the use of this gear. This gear is a reversible cut-off motion which dispenses with the radial links and eccentrics; it is a duplex movement, deriving its motion from the cross-heads, and is so constructed that the

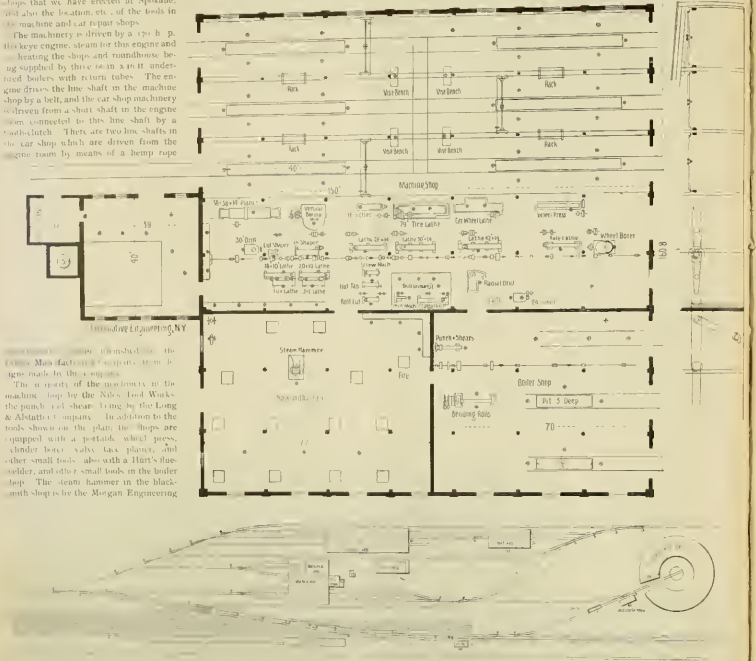

Providence Engineering, N.Y.

The machinery in the machine shop by the Niles Tool Works, the punch and shear being by the Long & Althoff's company. In addition to the tools shown on the plan, the shops are

equipped with a portable wheel press, cylinder valve tap punch, and other small tools, also with a Hart's die-solder, and other small tools in the boiler shop. The steam hammer in the blacksmith shop is for the Morgan Engineering

Company being their latest 1,000-pound hammer, and this shop is equipped with post cranes and all regular tools.

The machinery in the car shop is by Berry & Wilson, the fan for the shaving & sand system, and also for the blacksmith shop being furnished by the Starrvatt Blow-er Company.

It is the intention to use these shops for regular heavy repairing for the Western division of this road. As will be seen by the plan, they afford accommodation for six engines, the tools being capable of keeping the work well forward for this number. The engine pits are each supplied with a light over-head traveling crane and the entire buildings will be lighted on the incandescent system by electricity.

In the car shop heavy repairs and rebuilding as well as running repairs will be made, and the car wheel outfit is placed in the machine shop for both cast iron and steel wheels.

1791, and that the ground for the award of that metal, and the subsequent grant from Congress of \$25,000, was expressed in the letter from the master mechanic of the Boston & Providence Railroad Company, which was written from Roxbury in September, 1841. In this letter he says that for fourteen months a box of Mr. Babbitt's description has been used continually and has traveled nearly 31,000 miles. He cannot see that the box has received the slightest injury. They require one-half the usual quantity of oil and very little attention, and are at least 75 per cent cheaper than any he has ever used before.

If you follow the history of this distinguished inventor, you would know that subsequently he received a grant of \$25,000 from Congress in consideration of his having done a great thing for mankind.

It was told the other day that it was impossible to buy genuine babbitt metal. I went to the Baldwin Locomotive Works, with whom we have some professional re-

mechanical builders of this country are not familiar with genuine babbitt. There are some men who have the skill to make genuine babbitt, and who use it, but they are very few, because the making of good babbitt metal is a very difficult thing, much more difficult than is commonly supposed. But if you put in the boxes under your train, a babbitt metal which does not contain the weakening influence of lead at all, the full amount of block tin of the best quality, only antimony enough to harden it, you get a metal, first, that no amount of hammering will heat, and, second, which the ordinary works of lubricating oils will not affect, and the truck will run and keep perfectly cool. Mr. Isaac Babbitt himself, in his original patent, used fifty parts of tin, five of antimony, and one of copper. Of course, the very great disadvantage of introducing any lead in the metal itself has no compression strain to speak of.

lap and lead movement of one side is controlled from the crosshead of that side, while an increased travel to the valve is conveyed from the opposite crosshead, imparting to the valve a quick movement at the most advantageous points during the travel of the piston. The combination of these movements makes the travel of the valve a series of accelerations and retardations, and is identical both the forward and reverse motions. The principle advantages claimed for the motion are: 20 links, no eccentrics, constant lead, 4 to 10 per cent increased power and speed, 15 per cent economy in fuel and 50 per cent saving in oil and repairs. An engine equipped with this gear has been running for nineteen months on the Vandahla line.

An improvement in car seats has been patented by Anthony Sekyra, Dayton, O., whereby the seat can be converted into a bed. The invention would be useful on roads where sleeping cars are not run.

Practical Letters — from Practical Men.

Write on one side of the paper, state your point plainly and briefly, and then quit. We supply the generalities. No letters noticed unless name and address accompany.

High Pressure in Train Pipe on Mountain Grades.

Editors

The perfect control of freight trains on heavy grades by the air-brake has not been entirely satisfactory to railway people who are responsible for company property.

Messrs. Holmes and Scott must keep up with the procession, and note that the conditions found in passenger and freight service must be met by different methods and practice to insure success.

Let us reason together, to learn how we get into trouble when using the D 8 valve on heavy grades, and also if the pump-governor governs anything during such service, and then for the remedy by the use of the D 5 valve with same train in both cases. With the D 8 valve starting down the grade with 70 pounds train-line pressure, while the application is on, the air pump is working free and fairly fast, and a very high excess pressure, say 120 pounds, is gained in main reservoir.

When train-line pressure shows a reduction to 50 pounds, the handle is moved to full release to recharge. While waiting on 50 pounds pressure to equalize a difference of 70 pounds, you must depend on the retaining valves, and that means piston packing, to hold the train. And during this time, you have no effective brake pressure and the air-pump is stopped.

The trouble was, the next application had to be made before the pressure could equalize, making necessary a reduction of 15 to 25 pounds excess train-line pressure to apply the brake, the same as a 50 pound reduction will when equalizing.

That is what is hard on air-pumps, and why so many reports come in that brakes won't hold.

The worst of correct information about the feed-governor of the triple-valve is the cause of most all the failures of air-brakes.

When using the D 5 valve, the main reservoir pressure is regulated by air-pump governor and set at 90 or 100 pounds.

At top of grade, place handle in full release and equalize at 90 pounds. Make the same reduction as before, or to 70 pounds (in place of 50 pounds). Move handle to full release to recharge, and note you still have maximum pressure in auxiliary reservoir for brake power for any emergency, and the air pump is working.

Recharging with 70 pounds pressure in train-pipe, it will require no much less time to equalize that the retaining valves will hold train under control.

In this way speed of train will be regular, and is practicable to follow other train close and carefully.

Are we all one mind that it is not high pressure in auxiliary reservoirs that slides wheels on cars having 70 per cent brake power, but always resulting from carelessly making a 15 to 20 pound reduction from the train-pipe at one application. In fact, main reservoir pressure of 70 pounds is to take care of the automatic application of the brakes.

A good air-brakeman uses the graduating piston in triple-valve and the gauge pointer to do the work required, and knowing something of the proportions of auxiliary reservoirs and brake cylinders, and the weight and W of brake leverage, I would not criticize the following suggestions for mountain work.

Never run a train down a grade faster than you can haul the same train up the same grade.

Make the first reduction before maximum speed has been obtained.

Never let train-pipe pressure to get below 50 pounds. Better to be near 70 pounds

Recharge in full release. It is good practice to recharge as many times, as necessary, and about 20 pounds each time. Then but a few times, and perhaps 50 pounds at a time.

Use all retaining-valves. Never make use of air-brakes and handle valves on a train at the same time to regulate speed.

J. R. ALLEN, ALBONA, Pa.

How Air Gets Out of Brake-Cylinder When Auxiliary Reservoir is Fled.

Editors

Your second answer to W. H. S. Denison, O., in Vol. 7, No. 2, is all right, so far as it goes. But if there is no air in train-pipe when you bleed an auxiliary reservoir you reduce the pressure from top of slide-valve, when brakes/inter-pressure will force slide-valve from its seat, allowing air to escape to auxiliary reservoir and to atmosphere by way of release cock.

This is proven by your not bearing air from exhaust port of triple when there is no air in train-pipe.

Pittsburgh, Pa. R. B. McLEVEN.

If all the air is out of train-pipe and relief cocks are opened, there is a free passage from the brake-cylinder to the auxiliary, until such time as the check-spring moved the piston and valve back to a lap position; then there would be ten times as much area on top of valve as the port under it, besides, if the slide-valve did lift it would open communication to the exhaust port, and this would be the easiest and safest way for air from brake-cylinder to escape.

Arrangements of the Triple-Valve.

Editors

Some of the boys expecting to be examined on the air were talking one day to an engineer who had passed his examination. They were trying to find out some of the most important questions asked, and I heard this engineer say that with a fair understanding of the plain triple-valve anyone could get through his examination all right.

If one had a thorough knowledge of the construction and operation of the triple-valve, and knew nothing else about the brake apparatus, they are in possession of all the kind of an examination on the air, but the plain triple-valve is the keystone of the system, and anyone who thoroughly understands the triple can be depended on to know enough about the air-brake to enable him to pass a successful examination.

Engineers have not much to do with the triple-valve, they are of the car equipment. The triples on the engine are plain and require but little attention, yet there are few engineers that may not be tripped up on some points about the plain triple-valve.

A triple valve is the most faithful, requires the least care, and is the most important part of the air-brake mechanism, and when a plain triple-valve begins to need attention it usually shows it by a continuous blow from the exhaust port, and when this happens the service of the air-brake doctor is required. With the quick-acting triple, blowing is very true, and the emergency valve is set correctly, but sometimes the gasket between the triple body and cylinder-head is rotted through or torn between the openings to brake-cylinder and auxiliary reservoir, and the auxiliary air will pass through into brake cylinder and escape from the triple.

Plain triple-valves leak at the exhaust port more frequently than at the quick-

acting valves, and one cause for this leakage is a loose-fitting or dirty four-way cock—the cock at the triple-valve with handle attached. The air from train-pipe leaks around the four-way cock key and into pipe leading to brake cylinder, but the triple being in release position the air is discharged at the exhaust port.

A leak in the slide-valve head, if it becomes necessary to cut out the brake and the four-way cock leaks, it often sets the brake, and opening the release cock on auxiliary reservoir will not release it. I have seen this happen several times with the driver brakes cut out, and the shoes would bind and chatter against the wheels because the air leaked around one side of the four-way cock key and into the brake cylinders, while the other side of the key was tight and would not let the air pass back to the auxiliary reservoir and escape.

The slide-valve of the plain triple when in release position should nearly, not quite, touch the upper cup of the valve-case, and the margin is so slight that in some cases the slide-valve strikes the cap, and the area of the triple-piston being so much greater than the face of the slide-valve, the slide-valve is forced up squarely against the upper cap, and one end of the valve will be slightly drawn from its seat and allow air to pass the slide-valve and blow from the exhaust port. This may be remedied in a few minutes by filing the bottom end of the upper cap. Plate D 20.

Sometimes, when there is a blow from the exhaust port, you may take out the triple and find the slide-valve "cocked," the lower end pressed in toward the spindle so far that the graduating valve clamps the small pin that guides it. This holds the end of slide-valve away from its seat, causing the blow. Now loosen the slide-valve and carefully replace the triple. Turn the brake-valve into release position, and if there is no blow at the exhaust port the slide-valve does not strike the upper cap, but now make a sudden application of the brake, say 8 or 10 pounds, and on happening to the valve you can detect a blow which becomes louder after releasing the brake. If you take out and examine the triple-valve you will find that the slide-valve has "cocked" again.

When a quick train-pipe reduction of 5 or 10 pounds is made, the triple-valve pulls down far enough that, the air passes over the end of the slide-valve through the large port in the valve body and into the brake cylinder. This air pressure has great velocity, and when the triple-valve moves up again, the resistance is as though a stick were thrust through the port above the slide-valve, this opens the slide-valve and causes a blow, but the slide-valve instantly comes in its proper position in position, but if the graduating valve-pin is slightly bent or too snugly fits the hole in the graduating valve, then the graduating valve will bind on its pin when the slide-valve jumps from its seat and holds the valve "cocked." This small pin is liable to become scratched or ragged, and the edges of the graduating valve-pin are always a trifle rough and finny; but this is sometimes easy to repair, and I have done a pretty good job of the kind with a pocket knife with a file blade.

WELL W. WINSO, Terra Haute, Ind.

Who Made the First Blower?

Editors

In reply to your correspondent E. H. Harman's claim that Mr. P. H. Smith was the first originator of the blower, I beg to state that it was invented in England in 1837, the year in which the late Mr. Watson Eddy's application of it, that you mentioned last month.

In proof of this I quote from "Dempsey's Locomotive Engine," revised by D. K. Clark, C. E. On page 65 it says "It was necessary to adapt existing engines, as they were so small without smoke to simple means and independently of extensive structural alterations. Such

adaptation had been attempted by Messrs. Ryley & Charter in 1837, and again in 1839, on the Liverpool & Manchester Rail-way. They divided the firebox into two compartments—one for coal, the other for coke, they also admitted air in streams through tubes in the walls of the firebox, and they were the first who applied a jet of steam in the chimney (or smokestack) to maintain a draught when the blast was off."

ROBERTSON WATSON

Point St. Charles, Montreal.

That Cab Notice on the T. E. & M. V.

Editors

In answer to J. W. Wirtz letter in last issue, would explain that the notice referred to is a very old one, having been issued previous to our having air-governors or automatic brakes, and by an oversight has been allowed to remain in the calls of some of our engines. Our engineers, however, have long since lost sight of this card, and have kept almost of the times in the handling of air.

S. A. TEAL, M. M. T. E. & M. V. R. R. Missouri Valley, Ia.

Murphy's Whistle Puzzle.

Editors

In answer to J. D. Murphy's air brake problem in March number, would say an hose was coupled wrong between engine and tank signal to train-pipe and reversers. In this way a slight leak would start it. Whistle would blow, causing a reduction in train-pipe, which would cause brakes to set, then 20-pound pressure valve would fill pipe and release brake, causing a reduction to make up for reducing valve, which, of course, would cause whistle to blow again, setting brakes, and so on until all the air was gone.

JAN. DOWNING, Arkansas City, Kan.

The Answer.

Editors

Found feed-valve in engineer's equalizing discharge-valve turned around, with joint of valve in nut or cap and spring resting on valve seat, allowing direct passage between train-pipe and main reservoir, and angle cock on train-pipe at back of tank slightly open, which caused the blowing of whistle. When opened, drain cock on main reservoir of course reduced pressure, and as train-pipe was in direct communication with main reservoir, caused application of brakes, then upon closing as pump was still working it recharged pipe and caused release of brakes.

J. D. MISSEY, Wellington, Kan.

A Whistle Puzzle.

Editors

Here is a signal-whistle problem for some one to solve: At intervals of about 10 minutes the whistle squeals blow for about 10 seconds, then it stops. This would be as long as there was a pressure of 25 pounds or more. The pipes were looked over thoroughly and no leaks found. Pressure-reducing valve was thoroughly examined and found in perfect order, it was a new one. Then the signal valve, and the pipe were looked over, then it was found I could see nothing wrong with it, so I put it up again, and still the whistle would blow as before. Now, I knew there was no leak in any of the pipes, so I concluded the trouble must be in the signal-valve, and took it off again and put on another new one, that cured it. Then I went out the one I had taken off and found the trouble. What was it?

The chart is a great little joke. It is not only a good educator, but it is a "catcher" for those who know all about the angularity of the main rod—no, it is not, that little chart has brought out the very funny arguments. "W. H. I tell you, I have lots of fun with it."

Sydney A. J., W. F. KALSH

The Boy Was All Right.

You must have had a boy explain the fact to me that you published about a Vaudeville troupe starting in high-pressure doing all their work with the low-pressure being pistons of the high-pressure being "high pressure."

Was it the same boy who gave you the idea about the starting-valve?

Better look sharp, or some other paper will be after you with a sharp stick. Of course, I know it was one of the bulls among you, who are not Irish, even make one in a while.

So few find their way into the locomotive engineers, that we notice those that do.

In the way, what is the compression-valve, but in the Vaudeville man valve? You explain this yourself without the boy's help. JACK BOWERS.

The starting-valve admits the steam into the exhaust of the high-pressure cylinder—no other way to get it into the low. In doing this, the steam comes from both sides of the high-pressure pistons, therefore doing no useful work, or engine being started by live steam in the low-pressure cylinder.

The starting-valve shown in my last issue will give you a better idea of the Vaudeville man valve. They have used other designs, but these were designed to accomplish the same thing.

The valve in main valve of Vaudeville is a relief-valve, and is intended to answer the same purpose as relief-valves on steam chests—neither the boy or our correspondent know what they have to do with the compression.

Noisy Pump Governors.

In the last issue of your paper I wrote a complimentary notice by Mr. W. W. Wood of the interest I presided for noisy pump-governors in putting a packing ring in the piston.

Mr. Wood says that the steam piston then drifts back against the cylinder cap face, it, and that when in this position it does not get past the diaphragm-valve seals around the piston-head, because it is made slightly tapered and the large part projects into the counter-bore. This leakage causes vibration and noise.

I think that this is the correct explanation of the cause of the noise, and is done perfectly by Mr. Wood as far as that goes, but still think that my remedy (the packing ring) is better than the one he proposes (shortening the piston-stem) so that the piston-head stands at a lower position when at rest). Even if this stem is shortened the noise will continue unless the piston-head is a pretty snug fit, whereas, if a ring is put in, the fit is made tight enough to prevent vibration in any position. In my previous paper, I neglected to state that on account of the aforementioned counter-bore, or "bevel," it is necessary in putting a packing ring in to put it close to the lower edge of the piston-head.

When I first began to investigate this troublesome bore in the governors, it was suggested to me by Mr. Putnam, traveling engineer of the Iron Division of the C & G. W. Ry., that for the same reason consisted by Mr. Wood, the noise could possibly be stopped by preventing the piston from raising so far that the head would strike the cap. To accomplish this we had some small brass washers made and put around the piston-rod, just above the steam-ways, these washers being of sufficient thickness to arrest the upward movement of the piston before it reached the limit of its stroke. In one or two cases this was successful for a time, but after a while they began to buzz as badly as before, probably because of wear of the piston head. This plan we tried on quite a number, experimenting with many

different thicknesses of washer, until finally we became convinced that the use of a packing ring was more desirable, because more certain.

While on this point my remedy differs somewhat from that recommended by Mr. Wood. I wish to say that friendly criticism, be it favorable or unfavorable, is always welcome, and in addition to this may be very useful. PAUL SUNNENFELT.

Some Handy Tools Handled by Air.

With this I send you some "snap-shots" of air jack and pit for removing engine truck, tender and driving-wheels. They show a pair of 30-inch driving-wheels being removed from a consolidated engine, 2-foot drivers can be handled as easily as 20-inch tender wheels.

This jack has been used successfully for the past two and a half years at the East Buffalo shops of the West Shore Railroad, and entirely does away with jacking-up engines.

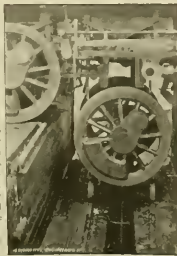
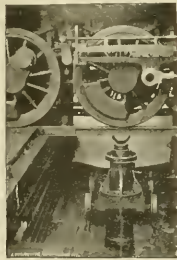

The pit runs under three tracks, on which engines are placed, and when not in use it is covered over.

In case of a loose driving-box brass of anything of that kind where it is necessary to remove a pair of drivers, it is much less work than raising the engine bodily, as the wheels can be left on the jack low enough to do the work, or they can be placed on the next track if desired until ready to be replaced.

There is a hose connection at each track to connect with jack. It can be operated from the pit or with a three-way cock above pit. The air passes through a check valve just before entering jack, this check has a pin-hole through valve, letting only air escape to lower driving-wheels steadily and safely, and in case of rupture to any pipe or hose from the pressure the

wheels cannot drop suddenly. On the lighter wheels this check is not required, as 30 pounds air will handle 23-inch cast wheels, about 100 pounds pressure is required for large driving-wheels.

The cylinder is 11 in diameter. On top of the piston is a double screw arrangement of the piston, when required. There is a 60-in horizontal cylinder in end of pit (not shown in picture) for drawing the truck, on which jack rests, with its load, from one track to the other. The piston in this cylinder is provided with a grab hook at the end, to which is fastened a chain which runs over four pulleys on floor of pit, to jack, drawing it in either direction as required.

It takes less than four hours for four men to do required stripping and remove drivers, a pair of 30-inch wheels is then placed under back pedestal brace, or frame, and engine put in shop. Having used this pit so long, we would hardly know how to get along without it now.

Along with the others, I enclose picture of air-press, 20-inch cylinder, 18-inch stroke, for driving-box-brasses, roller-brushes, etc., etc., which "knocks out" screw or



hydraulic presses for same kind of work. One hundred pounds air gives about 15 tons pressure on piston, this pressure we can increase to 120 pounds when necessary, and it will press in brasses as fast as they can be placed on the press.

We also have an arrangement for filling sand-boxes on engines, by compressed air, whereby both time and labor is saved. Sand put into the box in this way is clean enough to go through the pipes on engines, without the assistance of the coal pick. We placed a boiler, or sand tank, 4 feet in diameter by 12 feet long on end, 6 feet in a box, sunk in the ground, from the bottom of this tank two 3-inch pipes, are run up and out over the tracks, high enough to clear the stacks of engines. A sleeve is then dropped into sand-box, and box is filled in thirty seconds.

After sand is dried it is stored in box, being screened at same time directly over sand tank, and is then run into tank through a 3-inch hole, which is then plugged, and turned on, and it is ready for business. The sand does not get dirty, as it keeps going out from as fast as it is used. Fifty pounds of air does the work, and is taken from same large reservoir that supplies the drop pit. An air signal reducing-valve keeps the pressure right, and the sand flows in a solid stream into box without dust.

JOHN R. MACGREGG,
General Foreman.
East Buffalo, N. Y.

[Compressed air is getting to be the common laborer of the modern railroad shop, and in some instances seems to have learned something of the machinist trade as well. The jack here described is practically like the well-known Vreeland transfer jack, except that it is driven by air in place of hydraulic pressure.]

Who Has a Good One?

Editors—Will some of the readers of your valuable journal please send a cut of a good quality cutter for cutting gages for throttle-packing. J. J. JOHNS.
Hanover, Kan.

Economic Little Engines.

As it has been stated that the cost of operating street rail ways by electricity is 2.2 cents per car mile against 5 cents per car mile for direct steam power, I would like to produce a few figures as my experience in that line. For the past few years I have been running a little Baldwin dummy, with 16x12-inch cylinders on a short road running out of Brooklyn on the tracks of one of our car week days. The train consist of three cars, one of which are three eight-wheeled street cars, seating seventy passengers each, or more than twice that of the average trolley car. The day's work is seventy car miles. Fuel, hard coal at \$4.00 per ton on the engine. Cost of fuel per mile, pulling 1 car, \$1.12; and waste per mile, pulling 2 cars, .75.

Total cost per mile, pulling 1 car, \$1.87.
Cost per mile, pulling 3 cars—fuel, \$2.14; and waste, .75.

Total, \$2.89.
Cost per mile, each car, in 3-car train, 97 cents.

As each car has a carrying capacity of two "trolley cars," I would like to see it shown where electric cars are cheaper than steam motors. With power-brakes a quicker stop can be made, and in the case of barbush factor time can be made. The only objection I have yet seen to steam city streets is that in cold weather the exhaust steam is shown and will frighten some horses. E. W. GARDNER.
Brooklyn, N. Y.

Cooling off Hot Pumps.

Editors—In the March issue of LOCOMOTIVE ENGINEERING, I notice a criticism that Mr. Scott makes of some of my prescriptions. He desires to know, first, why I caution engineers against the use of water internally for hot pumps. In the statement referred to I did not intend to convey the impression that it would do any serious damage to let the water get into the inside of the cylinder in cooling it off, but simply meant to emphasize the fact, that when any such treatment is adopted it must be carefully administered, and to call attention to the fact that if any water gets into the cylinder it will be pumped into the steam chest. In such a case if it is drained off immediately no damage can result. Many of the most effective air-compressors made are cooled by a spray of water injected into the cylinder at every stroke, this water serving the additional purpose of reducing the dead or clearance space.

To test for leaks in the steam it is of course necessary to stop the pump. Some men might not think to do this if it is not specified, and so I have taken the liberty of inserting Mr. Scott's suggestion into my copy and hereby tender him my acknowledgments for the same. Chicago, Ill. PAUL SUNNENFELT.

We wish again to call attention to the fact that the correspondence must be addressed by the author's real name and address. Every man ought to be willing to father his own children—we have plenty of our own.

Don't send us any communications with the injunction, "Please don't mention my name," we shall ignore it—and the communication. Letters which writers refuse to endorse with their names are seldom worth publishing.

The Elements of Boiler-Making-II.

By C. E. Fourness.*

Geometry.

seven or eight places. This is to keep the foot in proper shape while working out the flow, which is done after the same fashion as the bell, in light cones with a mallet. The valve cover, Fig. 98, has no straight part. After the two bells *A* and *B*, Fig. 110, have been prepared, they are put together at the small ends, the flow at the lower end of the foot *A*, Fig. 111, is next worked out to fit the crown of the firebox, then the upper end of the foot *B*, as shown in Fig. 112, which is lower bell enough, as shown so, that the lower bell may be cramped in with ease, the joint is made and taken to the narrow fire, where it may be readily brazed, slung as shown in Fig. 112. After the joint is brazed and cleaned off the glazing is completed, \approx suitable heads, and a 1/2-in. bend formed around the edge of the foot, which is filled with rough solder. The final polishing is usually done in a lathe.

Directions for cutting the pattern of iron, in Fig. 110 will be given first. *A* and *B* will now turn to Fig. 98 and cut out the pattern for this foot. Let the crown of the firebox *A B*, Fig. 113, upon which the foot is to stand, have a radius of 2 ft., and the foot of our valve cover *D E F G* have a diameter of 18 in. at the top *E F*, with a flow of 1/4 in over the crown on each side, as shown at the bottom of the flow an elliptic curve as indicated by the ellipses on each side. Divide one-half the conjugate axes of the two ellipses which form the curves into four equal parts, and through the points of division, *M* and *N* draw the lines *P M* and *P N* parallel to the line *E F*, and from *A* and *B*, *E* and *F*, cutting the crown *A B* in *H* and *I* and *P* making the line *H I* 24 inches. Draw *H J K O* and produce it toward *K*. Through *P I* and *E* draw *P I e* and *E e e*, and let them meet in *O*. With the radius *O P* from the point *O* describe the arc *A' J' Y* and make it equal to the arc *A B*, now divide the arc *A' J' Y* into eight equal parts as shown. On the lines *Z O*, *I O* and *X O* from the points *Z*, *I*, *X*, lay off the distances *Z I*, *I X*, *X J* equal to *D P*. Through the points *N e* and *X* draw the lines *N I*, *N e*, and through the points *M* and *J* draw the lines *M I*, *M e*, letting them meet at *I* and *C*. Now with *I* as radius in the arcs *Z R I*, *I S R*, and *I X*. Then with *I* as radius, describe the arc *R T* and *C T* from the point *I*, *M I* *A*, lay off *A P*, the length of the curve *flow* *P*, and with *A P* as radius, from the point *A*, describe the arc *A P S*, then *Z I' X' Y' z'* is the pattern required for the foot, which is presented in Figs. 108 and 115.

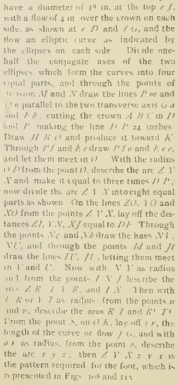

I will now give a few problems in geometry, enough to show how to draw lines at right angles to each other without a square, two methods of finding the center of a circle that will cut three points not in a straight line. This is needed by boiler-makers very often. Two methods of forming an ellipse or oval. And methods of forming polygons, which are figures formed of straight lines and having more than four sides. Geometry is the science which investigates and demonstrates the properties of lines on surfaces and solids; hence practical geometry is the method of applying the rules of the science to practical purposes.

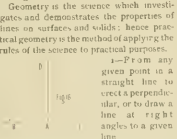

1.—From any given point *A* in a straight line to erect a perpendicular, or to draw a line at right angles to a given line.

On each side of the point *A*, from which the line is drawn, take equal distances, as *A H*, *A C*, and from *B* and *C* as centers, with any distance greater than *A C*, describe arcs cutting each other at *D*. Draw the line through *D* and *A*, and this line will be the perpendicular required.

2.—Where a perpendicular line is to be drawn at or near the end of a given line.

With any convenient radius, and with any distance from the given line *A B*, describe a portion of a circle, as *A B C*, cutting the given point at *A*, draw through the center of the circle *A C*, and a line from *A* cutting the intersection at *C* is the perpendicular required.

3.—To find the center of a circle with the dividers which will cut any three given points not in a straight line.

From the middle point *B* as a center with any radius, as *B C*, *B D*, describe a portion of a circle, *A B C D*, and from *A* as center, with an equal radius, cut the portion of the circle in *E* and *D*, draw lines through where arcs cut each other, and the intersection of the lines at *S* is the center required.

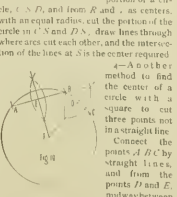

4.—Another method to find the center of a circle with a square to cut three points not in a straight line. Connect the points *A B C* by straight lines, and from the points *B* and *E* midway between *A B* and *B C*, draw lines at right angles *A H*, *B C*, and the point of intersection *F* will be the center of the circle required.

*Former Boiler-maker, C. M. & St. P. Ry., Dubuque, Iowa.

center with half the chord *R C A* describe the arc *C D*, from *O* as a center with the distance *O D* cut the diameters in *D R* *D T*, draw the lines *R S A S*, *T S C S*, then from *B* and *P* describe the arcs *S S S*, and from *D* and *D* describe the smaller arcs *S S S*, which completes the ellipse required.

6.—My own method of constructing an oval is to draw the arcs forming the ends *F A E* and *H G S*, as I think makes the best proportioned oval to suit my purpose; then I connect the points *E D H* and *F C G*, which forms the oval required.

7.—To describe any regular polygon in a given circle.

Divide the diameter of the circle into as many equal parts as the polygon has sides, from *A* and *B*, as centers, with a radius equal to the diameter, describe arcs cutting each other at *C*, draw the line *C D* through the second point of division on the diameter *E*, and the line *D B* is one side of the polygon required.

8.—The method given in No. 7 can be used to good advantage, but in forming a hexagon the sides equal the length of the radius, so if the circumference of a circle is spaced with the dividers set to the radius, it will divide the circle into six spaces or sides.

Also, lines drawn at an angle of sixty degrees to a horizontal line through the center of the circle divide a circle into six parts or sides.

9.—To form an octagon, divide the circle into eight parts, as shown by the light lines in Fig. 114.

To find the diameter of a circle by the angle of forty-five degrees, and one at ninety, to a horizontal diameter. Then connect the points where these diameters cut the circumference, and the sides thus formed will complete the octagon required.

I will now start on the laying out of sheet iron work, starting by finding the circumference of a square course, and ending in complex forms. I will begin by giving two tables, one the weight of one thickness, as it will be needed in approximating the weight of material used. The other table will contain the diameters, circumferences, areas, number of gallons contained in one foot of depth, and the side of a square equal in area to the circle. This latter table takes from 12 to 100 inches diameter and 1/2 inch.

There is one matter I wish to mention before going any further, that is regarding the decimals that are used to find the circumference, area, side of square etc. These decimals are used by a great many persons who do not know where they are derived from and should they be asked what the decimals represent and why they are used, a great many would say they did not know, but they would say they were

given in the arithmetic to find these required results. The decimal 3.1416 equals the circumference of a circle 1 inch in diameter. The decimal .7854 equals the area of a circle 1 inch in diameter. The decimal .3862 equals the side of a square, equal in area to a circle 1 inch in diameter.

Table No. 1.
WEIGHTS FOR IRON AND STEEL.
In pounds per square foot.

Thickness in inches.	Iron.		Steel.	
	in pounds.	in ounces.	in pounds.	in ounces.
1/8	2.556	2.75	37.89	38.50
1/4	5.095	5.35	75.11	76.42
3/8	7.578	7.95	112.50	114.50
1/2	10.160	10.60	150.00	152.50
5/8	12.643	13.50	187.50	190.00
3/4	15.160	16.00	225.00	228.00
7/8	17.688	18.50	262.50	266.00
1	20.215	21.00	300.00	304.00
1 1/8	22.742	23.50	337.50	342.00
1 1/4	25.270	26.00	375.00	380.00
1 3/8	27.797	28.50	412.50	418.00
1 1/2	30.325	31.00	450.00	456.00
1 5/8	32.852	33.50	487.50	494.00
1 3/4	35.380	36.00	525.00	532.00

WEIGHT OF SHEET IRON AND STEEL, B. W. U.

No. of gauge.	Iron in pounds.	Steel in pounds.	No. of gauge.	Iron in pounds.	Steel in pounds.
8	6.62	6.71	16	2.61	2.64
10	5.38	5.55	18	1.97	1.99
12	4.37	4.43	20	1.60	1.62
14	3.53	3.57	22	1.12	1.14

Table No. 2.
DIAMETERS, CIRCUMFERENCES, AREAS, IN TERMS IN GALLONS IN FOOT DEPTH AND SIDE OF SQUARE EQUAL IN AREA TO A CIRCLE.

Diameter in inches.	Cir. feet and inches.	Area, square inches.	No. of gallons deep 1 foot.	Side of square equal in area.
12	3 11/16	113.09	5.8735	10 1/8
14	3 7/8	153.93	7.9044	12 1/8
16	4 1/4	201.06	10.4413	15 1/8
18	4 8	254.46	13.2160	18 1/8
20	5 2/4	314.16	16.3418	21 7/8
22	5 9/16	380.13	19.7244	25 1/8
24	6 1/8	452.38	23.4040	29 1/8
26	6 9/16	530.92	27.2720	33 1/8
28	7 1/16	615.75	32.6070	37 1/8
30	7 1/2	706.85	38.7022	42 1/8
32	8 1/8	804.24	45.7608	47 1/8
34	8 11/16	908.61	53.7855	52 1/8
36	9 5/16	1021.57	62.8818	57 1/8
38	9 11/16	1142.11	73.0476	63 1/8
40	10 1/8	1270.64	84.2862	69 1/8
42	10 11/16	1407.44	96.6988	76 1/8
44	11 1/8	1552.44	110.2854	83 1/8
46	11 5/8	1705.66	125.0460	90 1/8
48	12 1/4	1867.09	140.9814	97 1/8
50	13 1/8	2036.82	158.1928	105 1/8
52	13 7/8	2214.95	176.6797	113 1/8
54	14 1/8	2401.58	196.4430	122 1/8
56	14 11/16	2596.80	217.4838	132 1/8
58	15 1/8	2800.61	239.8014	143 1/8
60	15 5/8	3013.02	263.4958	155 1/8
62	16 1/4	3234.04	288.5670	168 1/8
64	16 9/16	3463.66	315.0150	182 1/8
66	17 3/8	3701.89	342.9404	197 1/8
68	17 7/8	3948.72	372.3438	213 1/8
70	18 1/4	4204.15	403.3252	230 1/8
72	18 11/16	4468.18	435.8958	248 1/8
74	19 1/8	4740.80	470.0554	268 1/8
76	19 5/8	5022.01	505.8040	289 1/8
78	20 1/4	5311.82	543.1516	311 1/8
80	20 7/8	5610.23	582.0982	334 1/8
82	21 1/4	5917.24	622.6438	358 1/8
84	21 11/16	6232.85	664.7884	383 1/8
86	22 1/8	6557.06	708.5420	409 1/8
88	22 5/8	6889.87	753.9046	436 1/8
90	23 1/4	7231.28	800.8762	464 1/8
92	23 7/8	7581.29	849.4568	493 1/8
94	24 1/4	7939.90	900.6464	523 1/8
96	24 11/16	8307.21	953.4450	554 1/8
98	25 1/8	8683.22	1007.8526	586 1/8
100	25 5/8	9067.93	1063.8692	619 1/8

I hardly think it necessary to explain the use of the table, as that is apparent; but I will explain the use of the figures in the last each lines (the circumference of the fractions of an inch and of an inch), as they are to be used in connection with the table. For instance, I wish to find the circumference of a circle $1\frac{1}{2}$ inches in diameter, I refer to the table, and find the next size given is 14 inches, the circumference of which is 3 ft. 7 $\frac{1}{2}$ in. I now refer to this part mentioned for the circumference of one-half an inch $1\frac{1}{2}$ in., and of an inch $1\frac{1}{2}$ in. I now add the three together, 3 ft. 7 $\frac{1}{2}$ in. + $1\frac{1}{2}$ in. + $1\frac{1}{2}$ in. = 4 ft. 0 $\frac{1}{2}$ in. = the circumference required.

NO. 12.—In making most anything in a circular form, it is necessary to have the course of the required diameter either inside or outside. If the material you are using is very thin, there is no trouble, but when heavier metal is used, it is necessary to allow or deduct a certain amount. If once the thickness of metal be added to the diameter and the circumference found for this new diameter, the course will be that diameter inside, or if once the thickness be deducted, the course will be that diameter outside. The inside or outside diameter can also be secured by adding or subtracting three times the thickness to or from the circumference as required.

I have a smokestack to build 2 feet in diameter and 40 feet high, to be made of 30 iron. There will be one band at the top, another at the bottom, and one guy-band arranged for four guy-roads, also a damper in the bottom course; all these bands and the damper-rod to be made of $\frac{1}{2}$ -2-inch iron.

I will now find the amount of material needed, and I will use sheets of iron 4 feet wide. I divide the height of stack by the width of one sheet to ascertain the number of courses or lengths needed, $40 \div 4 = 10$, the number required, but as $\frac{1}{2}$ inches are taken off each sheet for laps, excepting at the top and bottom, this will make the stack come out 12 inches too short, or 39 feet long, so I will add another course, making eleven in all, and the stack will be 42 feet 11 $\frac{1}{2}$ inches in height.

I will now proceed to find the circumference or length of sheet required for one course: $3.1416 \times 24 \text{ in.} = 75\frac{3}{4}$ in., but this length would only give me 24 inches from inside to outside, and as I want the diameter inside, I will add three times the thickness of three-eighths. As No. 10 iron is one-eighth of an inch thick, this gives me $75\frac{3}{4}$ inches, the circumference required to let the sheet but, or length from center to the center of the rivet-holes. I now add 1 inch for laps, this gives me $76\frac{1}{2}$ inches full length, this divided by 12 equals 36 and thirty-nine one hundredths, the circumference in feet; this multiplied by 11 gives me 397 and two one-hundredths one hundredths, the number of feet of iron, 4 feet wide, required to make the stack. This length again divided by the length of one sheet (in this case 10 feet) gives seven and two one hundredths sheets required.

I will now find the weight of sheet iron in the stack by multiplying the sheet length in feet, seventy and two one-hundredths by four feet, the width of the sheets, this equals two hundred and eighty-one and sixteen one hundredths square feet, and by referring to Table No. 1, I find one square foot of No. 10 iron weighs one and thirty-eight one hundredths (5.38) pounds. Then, two hundred and eighty-one and sixteen one hundredths (281.16) multiplied by five and thirty-eight one hundredths (5.38) equals one thousand two hundred and eighty-two and forty-five one hundredths (1283.45) pounds, call it 1,284 pounds. The damper, 23 $\frac{1}{2}$ inches in diameter, will weigh 16 pounds, $1.284 + 16 = 1,300$ pounds.

I will now proceed to find the weight of iron in the bands and damper rod. As the large course is 24 $\frac{1}{2}$ inches in diameter inside it will be twice the thickness or 24 $\frac{1}{2}$

inches outside, this multiplied by 3 1416 equals $76\frac{1}{2}$ inches. These bands are $\frac{1}{2}$ inch thick, consequently in adding three times the thickness I will add $1\frac{1}{2}$ inches to the ends but. This gives a length of $77\frac{1}{2}$ inches (I will not allow anything for scarfing and welding) for top and bottom bands. For the guy-band, this will be made in halves and fastened together by two $\frac{1}{2}$ -inch bolts, these halves are left 1 inch apart on each side to allow the bands to be attached to the bolts in these spaces. I now take the same circumference used for the other bands, $77\frac{1}{2}$ inches, deduct 2 inches to allow the 1 inch opening on each side, then add 2 to each of the four ends or 8 inches, these are to be flanged to form the clamps to hold the bands together. I will require 6 inches more material of which to make the additional two eyes to rivet in for attaching the other two guy-roads. This makes a bar 89 $\frac{1}{2}$ inches long. Then the amount of bar iron needed will be

For top and bottom bands.	155 $\frac{1}{2}$ in.
" guy-bands.	89 $\frac{1}{2}$ "
" damper-rod.	27 "
	271 $\frac{1}{2}$ in.

This divided by 12 equals 22 ft. 7 $\frac{1}{2}$ in., this multiplied by 3.22, the weight per foot of bar iron, $\frac{1}{2} \times 2$ in., 22.056/3.22 = 75.27 pounds—call it 76 pounds.

I now want the number of rivets needed. The circumference, $75\frac{3}{4}$ in., divided by 3 in., the pitch or distance apart, equals 25.12 (I will say 25, and space slightly over 3 in.). I will have ten of these circular seams, consequently I will need 25 \times 10, or 250 rivets for these seams.

Now for the straight seams. The distance between the circular seams is 40 $\frac{1}{2}$ in., and this divided by 3 in., equals 13 $\frac{1}{2}$. I will call it 15 and space the rivets a little further apart. As each sheet will make one full course and part of another, I will have 3 with 1, and 6 courses with 2 seams; this makes a total of 37 seams, $17 \times 25 = 255$, the number of rivets required, $255 + 250 = 505$ rivets, total number.

The bands divide the circumference by 8 $\frac{1}{2}$ inches; the pitch, $75.375 \div 8.50 = 9$, the number of rivets needed for one band, and $2 \times 9 = 18$, the total number of rivets needed.

MATERIAL	POUNDS.
No. 10 iron	1,300
Bar iron, $\frac{1}{2}$ x 2 in.	76
" " $\frac{1}{2}$ x 2 1/2 in. (3/4 in. round for damper-handle)	1.5
12-pound rivets	6.25
$\frac{1}{2}$ x 1 in. bolts, for guy-band	1
3 " $\frac{1}{2}$ x $\frac{1}{2}$ in. for damper.	3
1 ball, cast-iron, 3 in. in diameter.	3.75

Weight of stack, 1,389.50

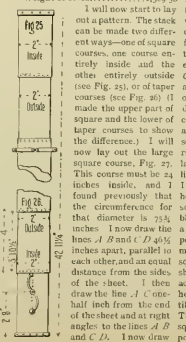

AB parallel to and $75\frac{1}{2}$ inches from *AD*. This completes the outline I will now proceed to space off with my dividers 25 points on each of the lines *A B* and *C D* for rivet-holes. Bear in mind in getting these points one corner hole should only be counted, as the corners lap and form one hole. Next I take the longitudinal (straight) seam *A C* and *B D*, space this into 15 points or holes, exclusive of the corner (lap) holes. This completes the large course. Allow one-half inch for lap outside of *BD*. Now for the small course. This will be 24 inches in diameter outside, $3.1416 \times 24 = 75\frac{3}{4}$, I now deduct $\frac{1}{2}$ inch, leaving 75 inches, the circumference of the small course. I now proceed in the same manner to lay out the small course as I did the

did at 1.1, 2.2, etc. This places the holes in the small end, so when the sheet is rolled up they will be on a line parallel to the base. To locate the holes in the other or large end, I take the trammels and set them to the length *A C*, or 40 $\frac{1}{2}$ inches, then set one point at the intersection of the short cross line with 1.1, 2.2, etc. (the center of the holes in the small end), I make a mark across the line 1.1 at 1.2, 2.2, at, etc. This mark I make on all the lines. These are the centers of the holes in the large end.

To lay out the holes for the bands it is not generally practiced, but can be accomplished very readily, as the bands are 2 inches wide and the holes will be placed in the center of the width. This will bring the holes 1 inch from the edge of the

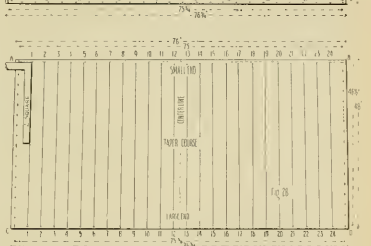

large, the only difference with the shorter circumference of 75 inches, instead of $75\frac{1}{2}$ inches.

The Taper Course. Fig. 28.—Draw the line *A D* one-half inch from the edge you make the small end of the course, and *C D*, 40 $\frac{1}{2}$ inches apart and parallel to *A B*. Locate the lap hole at *C* one-half inch from the end of the sheet on the line *C D*, *D* will then be located the length of the circumference of the large end $75\frac{1}{2}$ inches from *C*. I now find the center point *E* between *C* and *D*, and *E*, as center point *E*, I erect a center line *E F*, at right angles to *C D*. I then locate points or lap-holes *A* and *B*, the circumference of the small end, 75 inches apart, and one-half this distance, $37\frac{1}{2}$ inches, each side of the center *F*, then connect the lap-holes *A C* and *B D*. These lines form the straight seams, and must be spaced off at fifteen rivets. I then space off the holes on the large and small ends of the holes on the lines *A B* and *C D* for twenty-five holes. I then draw lines connecting the opposite holes, as 1.1, 2.2, 3.3, etc. I then lay a square along and to the line 1.1 and the blade of the square at point *A*. I draw a short line across the line 1.1, at this point the rivet-hole is to be punched. Next move the square to line 2.2, bring the blade of the square to the line and the blade to the short line across 1.1, then draw a line across 2.2; this is the center of that rivet-hole. Then move to lines 3.3, 4.4, etc., till line 12.12 is reached, the middle. Then start at the other end and lay the square along the line 24.24, the blade at point *D*, and proceed to line 13.13, as I

sheet. I now draw a line 1 inch from the bottom edge of Fig. 27 (if I were to lay them off on the taper course, Fig. 28) I would have to follow the curve formed with the holes), and space it off for nine rivets as shown in Fig. 27.

To lay out the holes for the damper-rod, I first draw a line 2 ft. 8 in. from the bottom, and then dividing the sheet into one-quarter by spacing or dividing the circumference by $4 \times 24\frac{1}{2} = 4 = 18\frac{1}{2}$ inches, the distance from the straight seams and the holes will be twice this distance or 37 $\frac{1}{2}$ inches apart.

A new illustrated catalogue has been published by the Taylor Electric Truck Co., Troy, N. Y. It shows by means of excellent wood cuts the designs and details of the various trucks made by this company for street railroad service. The catalogue is supplied free to those applying for it.

A form of metallic valve stem packing has been patented by John Olson, Two Harbors, Minn., which has rather novel features. It is described as a combination of two or more spaced packing rings with peripheral seal-channels and oblique steam-admission passages extending from the periphery to the back of the packing rings. These channels are in communication with an annular steam space which is between the valve stem and the packing gland. By means of the arrangement the first packing ring can be expanded by steam from the steam chest to take up the wear and prevent leakage.

? A. — What You — ? A. — Want to Know.

Don't ask questions that simply require a little figuring to determine, make each question separate. No note taken of anonymous questions.

(157) P. Wells, Orono, Me., asks—

What is the difference between a consolidated, a mogul and a decaop engine? *A*—A consolidated has eight drivers connected and a two-wheeled truck, a mogul, six wheels connected and two-wheeled truck, a decaop, ten wheels connected and two-wheeled truck.

(158) T. E. J., Albany, Ga., asks—

Will you please tell me what is meant by "clearance of valve." *A*—You probably mean valve clearance. This means that the exhaust cavity of the valve is wider than the exhaust port and both bridges by the amount named. Very few locomotives have valve clearance.

(159) A. B. C., St. Louis, Mo., asks—

1. What could happen that would cause you to disconnect without covering the ports? *A*—It would be of no use to cover ports of steam chest was broken—save the cover off. 2. What is preadmission? *A*—Admitting steam to cylinder before piston has completed its stroke.

(160) E. S. Westbury, I. I., asks—

How long does a person have to serve as an apprentice to learn the machinist trade in the repair shop, and how much does he get at the beginning? *A*—It depends where you are, how the business is, and how you work. Generally three to four years to learn the trade. Laborers' pay is big for apprentices.

(161) Apprentice, Toronto, Can., writes—

Please tell us how to set valves. I see some months ago you referred those who asked this question to your issue of January, 1893, but this is now out of print. *A*—We cannot very well repeat such a long article so soon. The writer should have Sinclair's work on locomotive running and management, which tells how to set valves.

(162) W. W. H., South Bay, Me., asks—

How many locomotives can Baldwin's turn out in thirty days, and how long does it take them to make a locomotive boiler? *A*—About ninety engines per month. Time required to build a boiler depends what is ready in the shape of material. If an odd boiler was asked for, it might take two or three weeks; if material was on hand—one might be completed, from start to finish, in five or six days.

(163) A. M. S., Fort Madison, Ia., writes—

In books on the locomotive we are always told to take down both side rods in case of one breaking. I don't see why this should always be done. One rod will keep the cranks of both wheels in the same relative position. *A*—It never safe to run with one side rod. If the engine slips on the crank the side rod is on or is on the center, the back crank is likely to be forced in the wrong direction, and in that event something must break.

(164) F. E. A., Little Rock, Ark., asks—

Does the cross-head move back when a locomotive is going ahead? *A*—In its relation to the engine, yes; or rather it stands still and the engine runs past it, in relation to ground, no, for the wheels are carrying cross-head, and guide and all, ahead all the time. When a engine is going out of the house place a stick or other marker on the ground and even with the cross-head when on forward center, and note what happens when engine moves.

(165) W. A. W., Cheyenne, Wyo., asks—

Will you please give me some good prescription for dope to scour brass. *A*—A good "dope" is made as follows: 6 sperm candles, 1 pint signal oil, 1 gum camphor (pulverized), 5 cc. arsenic, half a ball black (powdered), 1/2 pint ammonia. Melt the candles in the dish you use, then keep your dope in a small lead pan with

cover is handiest, then stir in the other ingredients, the black brick last. This makes a first-class polish for brass, especially if warm.

(166) Inquirer, Indianapolis, Ind., writes—

We have some passenger engines with cylinders 18 x 24 inches, drivers 60 inches diameter and carrying 160 pounds steam pressure. *A*—Do pipe the axles about the horse-power of the engines, and several of us would like to know what would be the horse-power when running at fifty miles an hour and the steam at the blowing-off point. *A*—That could not be answered without an indicator diagram to show the pressure in the cylinders. Figuring without that is mere guessing.

(167) V. F. Y., Lowell, Neb., asks—

Can you tell me about the locomotive "Duplex." I think it was got up something like seven or eight years ago. How did the differ from others of that date? *A*—She was talked about a good deal when first put out, but never heard of her any more. *A*—The "Duplex" was a 4-cylinder built by the Lehigh Valley Road. She had ten freight or corrugated tubes without stays, and a peculiar valve motion and steam-chest arrangement. Several of the class were built, but all were failures.

(168) A Reader, Montreal, Can., writes—

1. In what position should an engine be placed for keying up the big and little ends? (front and back ends of main rod, *A*—On the eight—that is between center and quarter. 2. Should the big end of the engine be in for keying up side-rods? *A*—In center. When the work is done in the shop and a train employed, the machinist often prefers to adjust the rods on the eighth. 3. Is there any book that gives information about the keying and care of rods. *A*—Sinclair's "Locomotive Engine Running" gives a chapter on that subject.

(169) J. S., Bradford Pa., writes—

At a popular report here, several questions arose about the difference between steam pressure in boiler and in the cylinders, and it was decided to refer the dispute for the decision of LOCOMOTIVE ENGINEERING.

(170) 1. Suppose an engine was working slowly on a grade and having 160 pounds pressure on boiler, would a gauge placed on cylinder indicate the same pressure as on boiler pressure gauge? *A*—No, it would vary from 15 to 20 per cent lower according to the size of the steam passages. 2. If an engine was standing still, and the throttle wide open, would there be a difference between the boiler gauge and a gauge placed on the cylinder? *A*—No.

(171) N. L. M., St. Louis, Mo., asks—

1. Do you think that a locomotive type of good for back head of locomotive type of boiler for model locomotive, size, 1 1/2 in. to 1 ft. thickness of heads, 3/8 in. *A*—Might do, sheet steel would be better. 2. Why is it that one out of every four exhausts at a locomotive is different from the others? *A*—Difference in volume of steam release or some other detail. 3. How is aluminum hardened or tempered? *A*—We don't know that it has ever been done. 4. Will a copper patch work itself loose from a steel firebox from difference in expansion of metals? *A*—Not if properly put on. 5. Do you think that injectors on a scale of 1 1/2 in. to 6 in. will work—style, Monitor No. 8. *A*—Yes. 6. What is the shrinkage of cast steel per foot. *A*—About one-quarter of an inch per foot.

(172) C. C. R., Cedar Rapids, Ia., writes—

Will you tell me what basic steel is, and in what way it differs from other steel? Is it better than common steel? *A*—Good

steel is usually made from iron which has been purified from the acids, phosphorus and sulphur, the great enemies of good iron, by puddling, or it is made from ores that contain very little impurities. This makes the steel rather expensive. The basic process was invented to eliminate the phosphorus and sulphur which the other two, and valve gear is adjusted correctly. Now, if I replace the long arm with a new one, and place it so on the shaft that center of top hole is two inches back of right angle with the other two arms, and I shorten reach-rod two inches, will that change affect the valve-gear and the working of the engine if it does not. *A*—We claim to do it. B. If it does not. What is right? *A*—Probably to practice this change would make very little difference, but it makes some, the difference increasing as the arm is shorter. The farther back the arm is carried, the more the reach-rod would have to be advanced to move the links a given amount. Take an extreme case and suppose the arm set almost at the horizontal, advancing the reach-rod two inches would move the tumbling-shaft ahead some, but the angle the reach-rod formed would shorten the distance between the lever and the tumbling-shaft arm. Beside this, the farther back the arm was inclined the harder the engine is to handle. 2. Why are some locomotive tumbling-shafts made so that the long arm sets back over right angle from the other two? *A*—Probably for convenience in most cases. Some are so arranged as to move the link in the forward motions while the arm is passing the horizontal position.

(173) I. H. L., Port Jervis, N. Y., asks—

1. Would like to know why coupling rods are more liable to breakage than main rods? *A*—At high speeds the coupling rods has to stand immense strain when it stops at the bottom of its downward throw and starts up, it must be stiff in the direction of its depth to resist this strain. One end of the main rod has no vertical throw, moving horizontally alone, and is therefore subject to less of the vertical strains. The probable reason for breakage of most side rods is the fact that they are coupled rigidly at each end, and the movement of the wheels in the jaws of the frame changes the distance between the centers. Most side rods are kept up too snug. The front end of the main rod can come and go, only one end is rigidly fixed—the back one. 2. Is a "fluted" or I section rod stronger than a plain rod? *A*—Of the same weight, yes. 3. Is there a current of steam in the oil pipes which convey oil to steam chests from lubricator? *A*—It is not possible. This steam in copper nipple being only about 1/4 of an inch in diameter.

(174) W. H., Winnipeg, Man., writes—

We have here an engine built at Kingston, Ont., that has her suspension stud above the center of the link. I looked up Sinclair, and he says it is to insure a better distribution of steam, but says it is not found practical for locomotives. Now, as this engine is a first-class one, I want to know why this arrangement has not been found practicable. *A*—Suspending the link from a point above the center was first practiced by Wm. Mason, his object being to prevent as much as possible the slip of the block. He designed his link motion so that when the engine was cutting off at about eight inches of the stroke angle the link block would be opposite the piston stud and the top of the hammer opposite the center of the rock shaft. As they both swing through, practically the same arc, there was no slip of the block except that due to the angle the link assumed. This slight movement was found to wear the link more than where the slip was greater, and besides it distorted somewhat the back-up motion. It is one of those little things that might be changed either way without making it.

(175) W. D., Blue Island, Ill., writes—

Referring to question No. 34, on your examination chart, "What is valve clearance?" I am in doubt as to the correct answer. I say the "up" may be termed "inade clearance," and "lead" "outside clearance," on account of their clearing the feed and exhaust ports accordingly. I have asked a dozen engineers here this question, and they all answered, "The distance between the piston and cylinder-head, except one, and he said, "The cavity in valve," being a first apprentice, and not wishing to dispute that one, I ask for advice. 1.—Inside clearance—the amount of opening between the inside edge of the valve cavity and the valve-seat bridge when the valve is upon the middle of its travel. 2.—Very few locomotives have inside clearance. They generally have a little inside lap which is measured by the distance the inside edge of the valve is on outside over the bridge when the valve is on

the middle of the seat. When a valve has neither inside clearance or inside lap, it is said to be made line and line. The distance between the piston and the cylinder head is called "piston clearance."

(176) N. A. S., Two Harbors, Minn., writes—

1.—On a locomotive, long arm of tumbling-shaft set back from the other two, and valve gear is adjusted correctly. Now, if I replace the long arm with a new one, and place it so on the shaft that center of top hole is two inches back of right angle with the other two arms, and I shorten reach-rod two inches, will that change affect the valve-gear and the working of the engine if it does not. *A*—We claim to do it. B. If it does not. What is right? *A*—Probably to practice this change would make very little difference, but it makes some, the difference increasing as the arm is shorter. The farther back the arm is carried, the more the reach-rod would have to be advanced to move the links a given amount. Take an extreme case and suppose the arm set almost at the horizontal, advancing the reach-rod two inches would move the tumbling-shaft ahead some, but the angle the reach-rod formed would shorten the distance between the lever and the tumbling-shaft arm. Beside this, the farther back the arm was inclined the harder the engine is to handle. 2. Why are some locomotive tumbling-shafts made so that the long arm sets back over right angle from the other two? *A*—Probably for convenience in most cases. Some are so arranged as to move the link in the forward motions while the arm is passing the horizontal position.

The Lake Shore & Michigan Southern people have specified cast-steel centers for the driving-wheels of the locomotives they are getting built at Brooks'. President Newall is said to entertain very decided views about the necessity for reducing the weight of the parts that impart blows directly to the axle. He is in favor of coil springs. The extremely heavy driving-wheels used on some roads must be very destructive to rails and rail joints. This subject has not received the attention it deserves, which is due, in a great measure, to the want of co-operation between the mechanical and the engineering departments of our railroads. If the men most interested in the track had been consulted in the early stages of rolling stock which affect the rails and bridges, there would be fewer heavy driving-wheels and fewer heavy trucks with all the weight beneath their springs.

Where there is very heavy traffic in switching yards and similar places it will be noticed that the heads of some of the rails are squeezed out in a way that makes one doubt if they are sufficient pressure as has been pointed out by the writer. If flow as it had been more so, say about 10,000 lbs. per square inch. This phenomenon made scientists believe that if sufficient pressure were applied every substance could be made to melt and flow like water. The Geological Department of the U. S. Government lately made some interesting experiments to determine what the was the rate of flow of the flow of solids. With an apparatus connected with the American Tool & Machine Co. of Boston, and the Emery testing machine at Watertown arsenal, they applied a pressure to various substances of 5,000 atmospheres, or 85,000 pounds to the square inch. Among the substances subjected to this pressure were antimony, bismuth, paraffin, lard, muth, lead, and silver. No indications were found of any of these substances inclining to liquify at the pressure named.

On an average of road in this country is the general average of engine supplies better than on the E. T. V. Co. superintendent of Motive Power W. H. Thomas and his master mechanics have somewhat interested the engineers, until there are few who do not have a pride in the appearance, performance and oil and coal record of their engines.

Wouldn't Carry Passengers' Baggage.

"I noticed," remarked the returned tourist, "that on the Rio Grande Western they have colored porters in the day coaches for attending to the comfort of passengers. A very good practice that is, and one which ought to be introduced everywhere."

"Do you know how that practice of having colored porters in ordinary trains was first started?" asked the car tracer. "Nobody knew just how the thing originated, but all thought the idea good one."

"I can tell you all about it," resumed the car tracer. "I was out in Denver hunting for some lost cars when the thing happened. There was an English lord or a nabob of some kind traveling out that way, and he came to the train with two heavy bags. When he got to the train he asked the brakeman to take his bags into the car."

"Go to blazes!" said the brakeman. "Do you take me for a blanked blank nigger?"

"The nabob was wroth at this treatment, and made a strong kick, with the outcome that the brakeman was suspended. The super, intimidated that the brakeman would learn better manners before he went out on a Rio Grande Western train again. But it was easier to threaten than to punish a brakeman in those days. The Brotherhood took up the case, and were ready for a fight to settle the question. 'Is it a brakeman's duty to be a lackey to all the passengers?' There were for a time prospects of a hot time, but a strike was averted by the company restoring the brakeman to duty without loss of pay, and the putting of colored porters on the trains to attend to the needs of passengers."

"I happen to know of a similar case on the Denver & Rio Grande," remarked Sam Short, "but it did not end so amicably in the same way. A mountain ranger who had two heavy bags and other traps arrived at a station close on train time, and called on a brakeman to help him to get the things into the car."

"You be blanked, carry your baggage yourself!" answered the brakeman, "I'll be a burro for no man, you son of a sea cowk."

"You won't, won't you," said the mountain man very quietly, taking out his w-thrower, "take up those things and carry them into the car, or I will shoot the stuffing out of you." The brakeman obeyed very meekly, and there was no call for the Brotherhood to interere in the settlement of that case."

A New Truck-Box Oiler.

On this page will be found a cut of a new truck-box oiler devised by Mr John M Smith, of Monroe, N. C., and in use on the G. C. & N. Division of the Seaboard Air Line. As can be seen the device is fastened to the inside end of oil collar, and is pulled out with it. The hinged piece

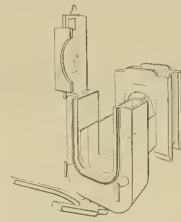

closes up tight to axle and prevents the escape of oil, and when down allows collar to be withdrawn where considerable collar has been worn on axle

It is practically dust and emder-proof, admits of packing collar without taking it out, and furnishes safe means of oiling collar packing on the road. The device is well spoken of by engineers who have run engines with it on.

Short of Material.

Mr. Thos. B. Purves, Jr., is not only a first-class master mechanic, but he obtained while in East Albany the reputation of being an excellent Sunday-school superintendent. Unlike many men who engage in this line of educational work, Mr Purves is of a general, fun-loving temperament, and he is even not beyond the practice of joking about incidents of his Sunday-school experience.

At a recent meeting of the Flat Wheel Club, some of the members were relating anecdotes of children, and it was not long before Mr. Purves thought of one.

"One time," he remarked, "I was putting my class through a course of Bible history, and the children were questioned not only about events in the reading, but they were asked for their opinion of the why and the wherefore of things done. The lesson was in Exodus, and was the

chapter where it is related that the Israelites gave up their earnings to make a golden calf.

"One question naturally was, 'Why did these people make a golden calf?'"

"No answer came for a time, boys and girls being equally bewildered, till one bright little girl looked up with a look of triumph and piped, 'Please, sir, it was because there were not earnings enough to make a cow.'"

Cleveland Twist Drill Co.'s Counter Bore.

The counter bore or facing bar illustrated is a new tool, gotten up by Cleveland Twist Drill Co., Cleveland, O., and was first shown to the public at their booth at the World's Fair, where it was very favorably commented upon by some of the best known mechanics of the country, and they



report many sales already. The blade or cutter is held centrally in the taper plug by a conically pointed set screw, shown in the illustration. This plug or holder, as it is called, is fitted into the ordinary twist drill socket of any convenient size, the end of the socket having a slot or notch milled across its open end to receive the top of blade or cutter. By this arrangement the whole strain comes on the larger socket or driver, and there is no twisting or other strain whatever on the smaller part. The end of the holder is turned down as small as consistent with the necessary strength, and hardened steel bushings of various sizes are furnished with each tool to act as leaders or pilots. Blades of the correct angle for countersinking for screw-driver headed machine screws can be furnished extra. These tools are no experiment, as they are already in use in some of the foremost shops in the country, from the smallest size up to blades 6 inches long. This tool is called by the manufacturers a common sense counter bore or facing bar.

The several parts are made to standard jigs, and are carried in stock, so that any piece can be duplicated with the certainty that it will fit into its place properly. Prices of the combined tool or any of its parts furnished on application to the manufacturers.

Easy Enough if You Only Know How.

The old timer from the M. K. & T. looked around the circle with a "oh, you are so young" look, and said, "The kids they're raisin' nowadays ain't no good 'cep'in' so long as the mill is all right, why how would enny of you fellers git in with a passenger train with the front bridge broke out, of the left side, lessin you was towed or went on one side?" All looked wise, but one kid asked how in thandler any one could get in that way and asked, "Have you done it?" "Done

it? Why, yasser; it's easy enough when you know how. That same happened to the old 'Chebrooke' one time when I was runnin' her, and I done same as any fore-sitted man would do, to run 'round the Y and backed her in, of course!"

He Knew Their Habits.

A friend on the L. & N. gives us a little tip on human nature as follows:

Recently, on one of the roads in this vicinity, an engineer pulled away from a station in such a lively manner that the "man who carries the bills" got left. This incident caused instructions to be issued that engineers must not disregard rule requiring the engineers to blow for signal from conductor and answer it when leaving a station. A new conductor was examined on time card. He was asked "What is necessary before a train can leave a station?" "A signal from the conductor," he replied. "And then what does the engineer do?" "Gets down and oils around."

An English writer describes a fast engine being built at Wolverhampton as having a stout wheels and a sharp-shoulder stroke. This is only equalled by the American engineer who equipped a bogey engine as having "a three months' lap."

RAU MANUFACTURING CO.,
Manufacturers of
METAL SPECIALTIES, ENGINEERS' TORCHES & OILERS.
THE PERFECTION VALVE OILERS.

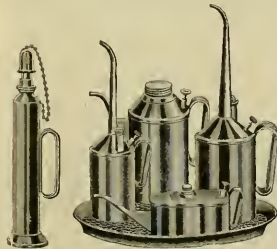

LABOR-
SAVING
AND
ECONOMICAL.



SAVES
BOTH
OIL
AND
TIME.

We do a general contracting and jobbing business on orders, and would be pleased to figure on specifications for what you may use to our list. Correspondence solicited.

122 to 128 MICHIGAN STREET, CHICAGO, ILL.

WE COMPETE
IN
QUALITY

NOT PRICE

WITH OUR CHARCOAL IRON
BOILER TUBES,
THE TYLER TUBE AND PIPE CO.,
Washington, Penn.
NEW YORK OFFICE: 39 Cortlandt Street.

THE WESTINGHOUSE AIR-BRAKE CO.

Is now prepared to fill orders, at an hour's
notice, for One or One Thousand Sets of

AIR-BRAKES FOR FREIGHT CARS,

having, at their New Works, an annual capacity
for turning out Air-Brakes for 250,000 Freight
Cars, 6,000 Passenger Cars, 10,000 Locomo-
tives; besides repairs for the 350,000 Freight
and Passenger Cars, and 26,000 Locomotives
already equipped by

THE WESTINGHOUSE AIR-BRAKE CO.

INSTRUCTION of MAIL

IN ARCHITECTURE, ARCHITECTURAL DRAWING, PLUMBING, HEATING & VENTILATION, MECHANICS, MECHANICAL DRAWING, BRIDGE ENGINEERING, ELECTRICAL ENGINEERING, SURVEYING AND MAPPING, MINING, ENGLISH BRANCHES, and

RAILROAD ENGINEERING.

Diplomas awarded. To begin students to only know how to read and write. Send for FREE Circular of Information stating the subject you think of studying to

The Correspondence School of Mechanics and Industrial Sciences, SCRANTON, PA.

4000 STUDENTS.

OUR ENGRAVINGS.

Of late we have had a great many inquiring as to who made the fine halftone plates shown each month in LOCOMOTIVE ENGINEERING. Credit is due the expert any where and we are glad to recommend the engravers of our plates to those wanting good work at reasonable prices. All the halftones and reproductions we use are made by the STRAUB ENGRAVING & PRINTING CO., 607 & 609 Sanson St., Philadelphia, Pa. SINCLAIR & HILL.

KEEP YOUR PAPERS CLEAN.

Binders that will hold a full year's numbers for sale.

PRICE, \$1.00, POSTPAID.

LOCOMOTIVE ENGINEERING, 2 Beekman Street, New York.

SIGNAL OIL WORKS, LIMITED, FRANKLIN, PA.

MANUFACTURERS OF SIBLEY'S Perfection VALVE OIL, The only perfect Locomotive Valve Lubricant. J. C. SIBLEY, Prest.

GALENA OIL WORKS, (LIMITED).

Galena Engine, Coach and Car Oils, the Standard Lubricating Oils of America.

SPEED, STRENGTH and ECONOMY are the results of the use of Galena Oil. OILS TESTED IN 25 miles while they are applicable to the hottest climates. The use of Galena Oil there is an absolute protection from hot boxes, except when these are caused by an original defect.

The adoption of Galena Oil as standard railway lubricant for a large number of the leading railways of this country is an evidence of their superiority, while the fact that the same grade was there used for the last ten years more than 20 years ago, is an evidence of their permanency from year to year and year to year. Galena Oil are in constant use upon three continents since they were first introduced in 1870. They are used from Boston and New York, to the Pacific Coast and the Gulf of Mexico. They are used by all the great lines of the world, thus demonstrating their adaptability to all temperatures and climates. Being entirely free from gum, these oils are not affected by dirt and sand as other oils are.

We also furnish our customers SIBLEY'S PERFECT VALVE OIL, which is also used exclusively upon a majority of the leading railways of America.

GALENA OIL WORKS, Limited, CHAS. ELLIS, President, Frankfort, Pa. CINCINNATI BRANCH OFFICE, Franklin St., Phoenix Building, the JACKSON ST.

LEONARD & ELLIS.



OILS FOR RAILROADS.

VALVOLINE OIL has long been used on many of the leading railroads in this country and abroad. It has no equal in quality and mileage.

W. A. BOYDEN, General Agent, 157 Chambers Street, NEW YORK.

THE BOYER Railway Speed Recorder



The only Recorder made that gives a chart of the run that can be read at sight, and has a DIAL INDICATOR carried into the CAB so Engineer can see at a glance, any time, what speed he is running.

Boyer Railway Speed Recorder Co. 244 DICKSON ST., St. Louis, Mo., U.S.A.

TRACK SANDING APPARATUS FOR LOCOMOTIVES HENRY L. LEACH.

(Inventor of Fireburg) BOSTON, MASS., Room 46, Nassau Building, 70 Kilby Street.



THE Perfected Anti-Sand Leg is the best in the world. This is the most elastic and perfect in action. For special information address EDWIN OSBORNE, 2100 Chestnut St., Phila., Pa.

The Sample Tells the Story.

A sample of Dixon's pure, alkali lubricating Graphite, with interesting and instructive pamphlet, Sent Free of Charge. Every engineer and machinist should make himself better acquainted with Dixon's Pure Fluorideroga Flake Graphite. It will save both time and labor, and is infinitely superior to the common forms of plumbeago or black lead. JOS. DIXON CRUCIBLE CO., JERSEY CITY, N. J.

Books for Railroad Men.

- LOCOMOTIVE ENGINE RUNNING and MANAGEMENT. By AMOS SINGULAR. Price, \$2.00.
 - INDICATOR PRACTICE. By FRANK F. HENSBY. Price, \$2.00.
 - ELEMENTS OF MECHANICS. By T. M. GOODRICH. Price, \$2.50.
 - PROGRESSIVE EXAMINATIONS FOR ENGINEERS AND FIREMEN. By JOHN A. HILL. Price, 50 cents.
 - WRE-GRAB PRACTICE. By J. E. FURMAN. Price, \$1.00.
 - COMPOUND LOCOMOTIVES. By A. T. WOODS. Price, \$2.00.
 - CATERPILLER OF THE LOCOMOTIVE. By H. S. FOSTER. Price, \$1.50.
 - SIMPLE LESSONS IN DRAWING FOR THE SHOP. By O. H. REYNOLDS. Price, 50 cents.
- Send price of any of these or of any other books of THE ENGINEERING LITERATURE COMPANY, East Orange, N. J., and they will be promptly mailed to any part of the world. Send for Catalogue.

THE HAYDEN & DERBY MFG. CO., Sole Manufacturers of

Metropolitan Double-Tube Locomotive Injectors

These Injectors work at all steam pressures from 25 pounds up to 250 pounds without any regulation or adjustment. It is impossible for the water to run out of the overflow when Injector is working. They are not affected by leaky steam or check valves.

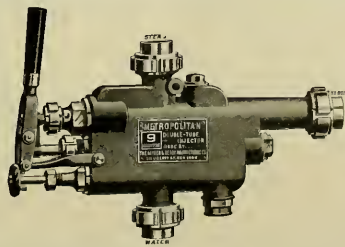

Owing to the peculiar form of nozzles used, repairs of these Injectors are reduced to a minimum. They are very slightly affected by bad water, there being no small relief holes or spills to wear or become clogged.

MADE INTERCHANGEABLE WITH STANDARD MAKES. Office and Salerooms: Nos. 111 and 113 LIBERTY STREET, NEW YORK.

M. C. B. STANDARD
Automatic Freight Car Coupler.

New York Office, . . . 120 Broadway,
Chicago Office, . . . 341 Rookery,
St. Louis Office, 319 Commercial Bld'g.

GOULD
Goupler Co.

BUFFALO OFFICE AND WORKS,
AUSTIN ST.

Gould Continuous
Platform and Buffer.

GOULD VESTIBULE.

Locomotive and Car Axles,
Coupling
Links and Pins.

M. C. B. Passenger Coupler
Used in Place of Miller Hook
WITHOUT CHANGE IN PLATFORM.

Skilled mechanics prefer them Live dealers sell them

STARRETT'S

Best
in
work-
manship
Finest
in
finish
Latest
in
improve-
ments

For
all
workers
in
metal
or wood
Every
tool
warranted
satisfac-
tory

FINE TOOLS

Send for Catalogue L. S. Starrett, Athol, Mass.

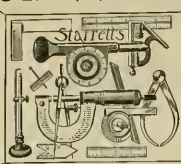

THE SMILLIE COUPLER is the Strongest and Simplest M. C. B. Coupler.
Only 4 Pieces.

Tensile Strength (Fairbank's Test) 130,640. Drop Test, 700 lbs.
hammer dropped 18 ft. 22 times failed to break the knuckle.

ALL LOCKING PARTS ARE THE BEST OF STEEL.
NEW YORK OFFICE, 34 BROADWAY.
Office and Works, 91 Clay St., Newark, N. J.



JOHNSTON CAR COUPLER COMPANY,
204 WALNUT PLACE,
PHILADELPHIA PA.

JOHNSTON CAR COUPLER

Strictly M.C.B. Lines.

THE TROJAN CAR COUPLER CO., Troy, N. Y.
The knuckle may be thrown open for coupling by the hand rod at the side of the car, rendering it unnecessary for the trainmen to go between the cars to open the knuckle.
M. C. B. TYPE. THE STRONGEST AND THE ONLY SAFETY COUPLER. New York Office: 49 WALL ST.

ST. LOUIS COUPLER.

STEEL

Sheds M. C. B. Tests and complies with U. S. law, requiring use of Automatic Car Couplers on and after January 1st, 1893. Thousand of Cars already equipped. Capacity of Works, 200 Couplers per day.

ST. LOUIS CAR COUPLER CO., St. Louis, U. S. A.



THE POOLEY COUPLER.

POSITIVELY
AUTOMATIC.

Made from the Best Material.
THE LONGER IN SERVICE THE BETTER IT OPERATES.

MANUFACTURED BY **PRATT & LETCHWORTH, Buffalo, N. Y.**



THE CHAPMAN JACK.

PATENTED.

The screw being lubricated and protected, the Jack lasts long ready for instant service. Railroad men appreciate the importance of having Jacks always in good working condition. Serious delays frequently occur in getting common Jacks so that they can be worked when suddenly required in train service. Common Jacks are frequently destroyed in efforts to make them work quickly after the screws are set with rust and dirt. This consideration alone makes the Chapman Jack the most economical one to purchase.

THE CHAPMAN JACK CO., CLEVELAND, OHIO.



INSPECTION!

Be the safeguard for boilers. Inspect your stay bolts while boiler is under pressure. Use hot water for hydraulic test—expands the parts as in service. Our jet apparatus, so when used and filled with hot water, no foundation required, no floor space. One-quarter the size and one-quarter the price of pump. Efficiency guaranteed.

RUE MANUFACTURING CO., 139 N. NINTH ST., PHILADELPHIA

FIRE BOX STEEL.

PURITY AND
DULCIFY AND
SOFTENES.

Boiler,
Locomotive
AND
Smoke Stack
STEELS.

QUALITY UNSURPASSED

Plates up to 100 ins. in width.

SHOENBERGER & CO.,
PITTSBURGH, PA.

THE ONLY DOUBLE TRACK RAILWAY
BETWEEN
CHICAGO AND THE EAST.

Wagner Sleeping Cars, Touring Room and Private Compartment Cars between Chicago, Toledo, Cleveland, Buffalo, Rochester, Syracuse, Albany, New York, Boston and intermediate points.

Route of the NEW YORK AND CHICAGO LIMITED, BOSTON AND CHICAGO SPECIAL, and the C. & N. EAST BAYLIS.

W. B. CANNIFF, Gen'l. Mgr. CLEVELAND, O. A. J. WHITE, C. P. & T. A.

FINE DRAWING INSTRUMENTS.

Drawing and Blue Print Papers.
DRAWING & MATERIALS
OF EVERY KIND.

QUEEN & CO.
1010 CHESTNUT STREET,
PHILADELPHIA.

SEE CATALOGUE ON APPLICATION.



JOHN W. MASURY & SON, PAINTS AND VARNISHES.

NEW YORK and CHICAGO.



THE CLEVELAND VARNISH CO.,
Mfrs. **RAILWAY VARNISHES.**
CLEVELAND, O.

RAMAPO IRON WORKS, Hillburn, N. Y.,

Brake Shoes for Steel Tired Wheels.

ROSS, for Steel Tired Car and Tender Wheels,
ROSS-MEEHAN, for Locomotive Drivers,
SHEPPARD, for Blind or Bald Tired Drivers.

NARROW GAUGE CARS, SWITCHES, AUTOMATIC STANDS.

VOKED, BOLTED and SPRING RAIL FROGS,
CROSSINGS, TRACK EQUIPMENT,

RAILROAD AND MACHINERY. CASTINGS, HEAVY AND LIGHT.



THE WASHBURN
Car-Wheel Company,
HARTFORD, CONN.,
MANUFACTURERS OF
CRUCIBLE
STEEL-TIRED WHEELS
For Parlor and Sleeping Cars,
Passenger Coaches, Locomotive
and Tender Trucks.

Patented, E. A. DIBOCK, Treasurer, J. L. OTT, Established 1867. Capital \$100,000.

NORTHAMPTON
Emery Wheel Co.
MANUFACTURERS OF
PATENT
SOLID EMERY and
CORUNDUM WHEELS
and MACHINERY.
LEEDS, MASS.
CHICAGO OFFICE,
20 South Canal St.
Send for Catalogue.

TAYLOR BEST YORKSHIRE STAYBOLT IRON

Axles, Piston Rods, Crank Pins and Forgings of all Descriptions, used by Leading Railroads.

R. MUSHET'S SPECIAL AND TITANIC STEELS

SOLE REPRESENTATIVE IN THE UNITED STATES,
B. M. JONES & CO.,
BOSTON, 11 and 13 Oliver Street. NEW YORK, 143 Liberty Street.



POWER
A MONTHLY JOURNAL devoted to Steam Engineering and Practical Work relative to the Economic Generation and Transmission of Power. 56 to 64 pages, size of this paper, profusely illustrated. Price, \$1.00 a year. Send for Sample Copy—FREE. Address:
THE POWER PUBLISHING CO.,
WORLD BUILDING, NEW YORK.

RAMAPO WHEEL AND FOUNDRY CO.



BOLTLESS STEEL-TIRED WHEELS
FOR PASSENGER and LOCOMOTIVE SERVICE.
Tires with Annular Web and Hook,
Best Charcoal Iron Double-Plate or Spoke Centers,
Wedge-Shaped Retaining Ring.

ESTIMATED BY
Continuous Circumferential Fastening.



SIMPLE, +
SAFE, +
ECONOMICAL.

CHILLED IRON WHEELS OF SUPERIOR QUALITY, Drivax Cars, Passenger and Freight Cars, Locomotives, Tenders, Plantation and Mine Cars.
CONDON BRAKE SHOES FOR CHILLED IRON WHEELS, Outwear from 4 to 6 ordinary Shoes and enhance mileage.
CYLINDER PACKING RINGS.

Office and Works: **RAMAPO, N. Y.**

C. E. ROOD, R. E. BROWN, CAR WHEEL WORKS, BUFFALO, N. Y.

Railroad, Car, Engine, Tender and Truck Wheels, Made from Best Charcoal Iron. Office and Works: HOWARD and THOMAS STS.

EAST BUFFALO IRON WORKS, GREY IRON CASTINGS

of every description. Special Attention Given to Car and Locomotive Work.

WORKS: N. Y., C. & N. R. R., Broadway Station, Belt Line. OFFICE: 60 Perry St., Buffalo, N. Y.

C. E. ROOD, MALLEABLE IRON, RAILROAD WORK A SPECIALTY.

Office and Works: LANCASTER, NEW YORK.

The New "NATHAN" MONITOR INJECTORS FOR LOCOMOTIVES.

"NATHAN" SIGHT-FEED LUBRICATORS, For Locomotive Cylinders and Air Brakes.
STEAM FIRE EXTINGUISHERS. For Switching and Yard Engines.
BOILER WASHERS. Road and Guide Oil Cups, etc.

Send for DESCRIPTIVE CATALOGUES.
NATHAN MFG. CO., 92 & 94 Liberty St., NEW YORK.

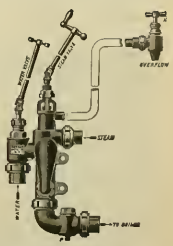

HOWARD IRON WORKS, BUFFALO, N. Y., MANUFACTURERS OF

BOLT CUTTERS -AND- NUT TAPPERS.

(Send For Price Lists.)

D. G. SETTLEMIRE, President.

GEO. W. EVANS, Vice-President.

W. G. ALTHUIS, Secy and Treas.

FRANK SNYDER, Supt.

Mt. Vernon Car

MANUFACTURERS OF
FREIGHT CARS OF EVERY DESCRIPTION, CAR-
BOOSE AND REFRIGERATOR CARS,

MT. VERNON,



Manufacturing Co.

CAR WHEELS, CAR CASTINGS, AND GENERAL
FOUNDRY WORK.

Capacity, 15 Cars and 300 Car Wheels,
ILLINOIS.

MILLER'S ASBESTOS CAR ROOF.

THE COMING ROOF!

HEAVY, DURABLE AND STRONG.
WILL WEAR LONGER THAN ANY METAL ONE.

Costs from \$10 to \$15 Less per Car.
CAN BE PUT ON IN ONE-HALF THE TIME.

HEAR WHAT THEY SAY ABOUT IT!
Down East: Boston & Albany R.R.

1302 HAVEMEYER BUILDING, 26 Cortlandt Street, NEW YORK.



THE ALLISON MFG. CO.,

MANUFACTURERS OF

FREIGHT CARS AND
LOCOMOTIVE BOILER TUBES.

WROUGHT IRON PIPE OF SUPERIOR QUALITY.

PHILADELPHIA, PA.

DRAKE & WEIRS, Cleveland, Ohio.

ASPHALT CAR ROOFING

The Cheapest, Heat and Frost Durable Car Roof Known. It will last for seventy
Railroads. Twelve years successful use without a single failure. A new roof furnished free for
every one that falls in its year.



WILLIAM C. BAKER,
Sole Proprietor and Manufacturer of

FIRE-PROOF BAKER CAR HEATER

MADE OF FLEXIBLE STEEL
ON CAST-IRON END THROUS.
Firmly Welded into One Compact, Jointless, Seamless Whole.
FIRE WITHIN A SAFE OF SAME MATERIAL
AS THE EXPRESS CAR SAFE.

The Only Alternative for the Deadly Car Stove
AND THE EQUALLY VICIOUS AND EXPENSIVE STEAM HEAT.

NEARLY 1000 FIRE-PROOFS IN USE.

ALL OTHER STYLES OF "BAKER HEATERS."
143 LIBERTY STREET, NEW YORK.

RODGER BALLAST CARS.

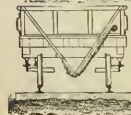
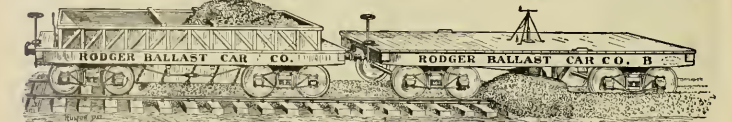

These cars are built long, and are built either 50,000 or 60,000 lb capacity, M. C. B. Standard. They carry from 16 to 20 cubic yards of gravel or broken stone. In using them on ballast is thrown in the ditch, and none is wasted, as the precise amount of ballast needed can always be discharged. A train of 20 cars, carrying 500 yards of ballast can be unloaded and the ballast distributed, leaving the track, perfectly cleared and damped, in about 12 to 15 minutes. This is all done by the regular "train service" in a conductor and two brakemen, no extra help being required. The track is perfectly cleared by the spreader, as that train can immediately pass over it at any regular speed, without moving any obstruction. No aprons are needed, no wire cables are used. There is no shoveling of ballast from between the cars, and no clearing the tracks with shovels. The ballast is left between the ties and on their ends, direct in position for tamping, when the track is raised, without being allowed to fall from the ditch. The average saving per mile, in the amount of ballast needed to make a "raise" of 10 or 12 inches, will amount, to from \$250 to \$400, and in broken stone it often amounts to \$500.

These cars are in use on the Great Northern, Ry. the Illinois Central, the Gulf, Colorado & Santa Fe, the Chicago & Eastern Illinois, the Penn. Lines West, and other roads.

Detailed information will be furnished by circular by addressing the
RODGER BALLAST CAR COMPANY, No. 1215 Monadnock Building,
CHICAGO, ILL.

LOCOMOTIVE ENGINEERING, N.Y.



Is the most interesting
technical journal published.
Always twenty
years ago of
the best of
the world.
No other journal
of
EDUCATIONAL
CHARTS FREE.
One of the
most interesting
technical journals
published in
any part of the
world. It is
the only one
of its kind
in the world.
It is the only
one of its kind
in the world.
It is the only
one of its kind
in the world.

stand with this. The price for you and those who
like to subscribe for a \$1.00. Address
LOCOMOTIVE ENGINEERING,
100 Broadway, New York.



29 BROADWAY, NEW YORK CITY.

THE CAMERON STEAM PUMP.

COMPLETE WITH BOILER.

THE A. S. CAMERON
STEAM PUMP WORKS,
Foot of St. Twenty-Ninth St.,
NEW YORK.

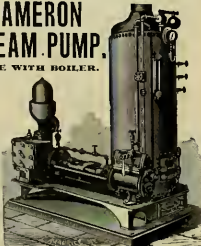

Send for Illustrated Catalogue.

SCHOEN MFG. CO.

PRESSED
STEEL MATERIAL
FOR CARS.

PITTSBURGH,
PA.

JEROME METALLIC PACKING.

This is the Standard Metallic Packing all over the world, and is more generally adopted and in use on more locomotives than any metallic packing in use. Give the **JEROME** a trial and be convinced. Put it in competition with any other packing and be convinced of its superior merits.

Office and Works, Nos. 35 and 37 Canal St., Chicago, Ill.

C. C. JEROME, Inventor and Proprietor.

Packing ring opened ready to apply without disconnecting the Piston from the crosshead. It runs longer and wears the rod less than any other packing in use.



SEND FOR CATALOGUE.



WROUGHT IRON WHEEL CENTRES. VACUUM'S PATENT.

THE **Standard Steel Works**
PHILADELPHIA.

STEEL TIRES

Manufactured by an Improved Process Insuring Solidity.

**Wrought Iron Centres.
Steel Tired Wheels.**

REPRESENTATIVES)
NEW YORK, 7 NASSAU STREET,
J. H. BELCHER.

CHICAGO, 1013 MONROCK BLDG.,
FITZ-HUGH & SPENCER.
ST. LOUIS, 816 NORTH THIRD ST.,
ANDREW WARREN.

BOOKS YOU WANT.

"LOCOMOTIVE RUNNING REPAIRS," by I. C. MITCHELL, General Foreman "Six" Shop. A practical treatise on running repairs, by a practical man. Numerous diagrams and illustrations. Best what is needed by men who handle and repair locomotives.

"SIMPLE LESSONS IN DRAWING," by ORVILLE H. BENTON, Chief Draftsman Northern Pacific Railway. A splendid book. Shows how to learn the elementary principles of mechanical drawing and machine.

"PROGRESSIVE EXAMINATIONS OF LOCOMOTIVE ENGINEERS AND FIREMEN," by JOHN A. HILL, Editor LOCOMOTIVE ENGINEERING. A capital little book for new learners. An excellent pocket companion. Three hundred questions and the answers. Numerous colored plates showing position and color of all signals carried on engines and trains according to standard code.

Send 50c. for any of the above to

DEBS PUB. CO.,
TERRE HAUTE, IND.

TANCY'S HYDRAULIC LIFTING JACK.



A good reliable jack for lifting or packing in any direction. The lever is for pumping it up, the key lowers and slips it at any point when it is again ready for lifting, saving time and trouble.

Various sizes made, from 4 tons to 300 tons.
Joseph F. McCoy Co.
26 Warren St.,
NEW YORK.

PATENTS FOR INVENTIONS.
GEO. P. WHITTLESEY,
Atlantic Building, Washington, D. C.
EXPERT SEARCHES AND OPINIONS.
BEST RAILROAD INVENTIONS A SPECIALTY.

MATCHLESS VALVE AND CYLINDER OIL.



Warranted not to corrode the iron or destroy packing, and to make more mileage than tallow or lard. Sold only to Railroad Companies direct or through our authorized agents. **Matchless Cylinder Oil cannot be Bought of Dealers.** In use on 60 Railways.

OILS FOR RAILROAD USE A SPECIALTY.

ECLIPSE LUBRICATING OIL COMPANY, Limited,
MANUFACTURERS OF EVERY PRODUCT OF PETROLEUM.

Main Office: FRANKLIN, Pa. Refineries: FRANKLIN, Pa. OLEAN, N. Y. ERIE, Pa. OIL CITY, Pa.

REQUIRES NO ATTENTION.

IN USE ON THREE HUNDRED RAILROADS.

UNITED STATES METALLIC PACKING CO.

THE UNITED STATES METALLIC PACKINGS have stood the test of years, and are acknowledged to be superior to all. Renewal of packing rings made without disconnecting, by cutting them in halves and breaking joints. Swab and Oil Cups furnished with every packing.

435 North Broad Street, Philadelphia. Rotunda, Grand Pacific Hotel, CHICAGO.
32 Laclode Street, ST. LOUIS. 130 Main Street, SAN FRANCISCO.

Send for Catalogue and Specifications.

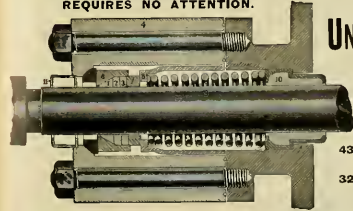

OPEN HEARTH STEEL **CAMBRIA** COFFIN TOUGHENED

CAMBRIA IRON COMPANY,
OFFICE 218 SOUTH 4TH ST. PHILADELPHIA PA.

WORKS AT JOHNSTOWN, PA.

COOLBAUGH & POMEROY
SPECIAL R. R. SALES AGENTS.
29 BROADWAY NEW YORK.

BENT & DRILLED

TOUGHENED BY COFFIN PROCESS, PATENTED

OPEN HEARTH COFFIN PROCESS TOUGHENED

CAMBRIA STEEL

HENRY C. AYER
General Manager.

EDWARD D. GLEASON.

HENRY C. AYER & GLEASON Co.

MANUFACTURERS OF

Special Tools for Railway Repair Shops. Portable Cylinder Boring Machines.

SAFETY HOISTING MACHINERY. SPOKE AND HANDLE TURNING MACHINES.

OFFICE AND WORKS: N. E. corner of Second and Diamond Sts. — PHILADELPHIA. — CENTRAL OFFICE: No. 919 Betz Building.

THE ROTARY.

For full
Particulars,
Address

The Leslie Bros. Mfg. Co.,
Paterson, N. J.

LOCOMOTIVE SPRINGS

WITH PATENT V SHAPE BANDS.

Gives more Elasticity to short Plates
and Better Riding Qualities.



MANUFACTURED BY
A. FRENCH

SPRING CO.

A. FRENCH, Pres.
J. E. FRENCH, Vice-Pres.

GEORGE W. MORRIS, Gen. Mgr.

D. C. NOBLE Sec. and Treas.
P. H. FRENCH, Gen'l Supt.

A. FRENCH SPRING CO.

PITTSBURGH, PA.
Manufacturers of
ELLIPTIC AND SPIRAL SPRINGS
OF ALL DESCRIPTIONS.

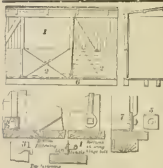

Steel Grain Door Come to Stay.

COMPARISON.

Loss of Doors in Two Years:

500 cars equipped with steel doors lost two doors.	500 cars equipped with wood doors lost 80 per cent. in the same time.
--	---

MICHIGAN RAILWAY SUPPLY CO.,
DETROIT, MICH.



CUYAHOGA FALLS, O.

ROLLED HOLLOW STAY BOLTS ARE STRONGER AND SAFER
THAN DRILLED ONES.

Made and rolled from the finest charcoal iron. All sizes, from 3/4 to 1 1/2 inch, with any need hole required from 3/4 to 2 1/2 inch. Let us send you a sample and quote prices. A set for one fire-box will convince you of their merits, safety and economy.

AGENTS IN CANADA: J. & H. TAYLOR, 751 Craig Street, - - Montreal, Canada.

THE JANNEY FREIGHT CAR COUPLER

THE MCCONWAY & TORLEY COMPANY

W. Mc CONWAY—PRESIDENT.

48th ST. & A.V.RY. - PITTSBURGH, PA.

BEMENT, MITES & CO. PHILADELPHIA, PA.

BUILDERS OF

METAL-WORKING MACHINE TOOLS,

FOR

Locomotive and Car Builders,
Railroad Shops, Machine Shops,
Steam Forges, Ship Yards,
Boiler Shops, Bridge Works.

STEAM HAMMERS

FOR WORKING IRON OR STEEL.

NEW YORK OFFICE: EQUITABLE BUILDING. GEORGE PLACE, Agent.

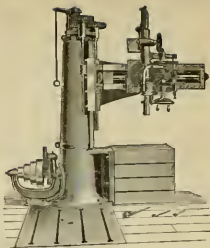

Portable Cylinder Boring Machine.

For boring in their special positions all makes and sizes of Steam Engine Cylinders, Pumps, Steam Boilers, Air Compressors, Mining and Hoisting Engines, Heavy Hoistings, Large Wheels, etc.

Machines made any size required. Recently adapted for Compound Engines.

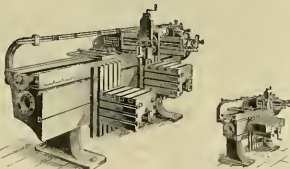

RICHARDS' PATENT OPEN SIDE PLANING AND SHAPING MACHINE.

CRANK-PIN MACHINE.

For turning off Crank Pin, in position, keeping the original centers of the Pin.

VALVE-SEAT PLANER.

Over 600 in use.

PEDRICK & AYER CO.

1001 & 1003 Hamilton St., PHILADELPHIA, PA.

SPECIAL TOOLS FOR RAILWAY REPAIR SHOPS.

Special Catalogue Mailed on Application Explaining Tools in Detail.

<p>STEVEN'S PATENT NIPPERS. Number 99. The best tool made for Taps, Drills, Locomotives and Machinery. Sent by mail post paid. 1/2 inch \$1.50 1 inch \$2.00</p>	<p>STEVEN'S Spring Calipers. Leader, No. 70. Price, by mail, postpaid. No. 70 \$1.00 No. 71 \$1.50 No. 72 \$2.00 No. 73 \$2.50 No. 74 \$3.00 No. 75 \$3.50 No. 76 \$4.00 No. 77 \$4.50 No. 78 \$5.00 No. 79 \$5.50 No. 80 \$6.00 No. 81 \$6.50 No. 82 \$7.00 No. 83 \$7.50 No. 84 \$8.00 No. 85 \$8.50 No. 86 \$9.00 No. 87 \$9.50 No. 88 \$10.00 No. 89 \$10.50 No. 90 \$11.00 No. 91 \$11.50 No. 92 \$12.00 No. 93 \$12.50 No. 94 \$13.00 No. 95 \$13.50 No. 96 \$14.00 No. 97 \$14.50 No. 98 \$15.00 No. 99 \$15.50 No. 100 \$16.00</p>
---	---

TOOLS.

Send for a complete list of tools, and prices, and catalogue free to you.
J. STEVEN'S ARM & TOOL CO., P. O. Box 219, Worcester Falls, Mass.

THE NATIONAL MACHINERY CO., TIFFIN, OHIO.

SPECIALISTS IN Bolt and Nut Machinery.

Bolt Cutters, Bolt Headers, Bolt Pointers, Upsetters and Benders, Nut Tappers, Nut Machines.

Illustration of a bolt cutting machine.

CATALOGUE ON APPLICATION.

THE PRATT & WHITNEY CO., Hartford, Conn., U. S. A.

SINGLE AND DOUBLE HEAD MILLING MACHINES used as Substitutes for Planers for Heavy and Rapid Cutting in Cast and Wrought Iron and Steel.

TURRET-HEAD MACHINES AND TOOLS for Turning, Forming and Threading Irregular Pieces of Circular Cross-section in Brass, Iron and Steel.

METAL BAND SAWING MACHINES for Cutting Spruces from Brass Castings.

MILLING CUTTERS, HOLDERS, with Inserted Cutters for Turning, Shaping and Threading Metals. **SPIRAL SHEAR PINNOCES.**

CATALOGUE L SENT ON APPLICATION

THE ACME MACHINERY CO. CLEVELAND, OHIO.

Manufacturers of **ACME BOLT & RIVET HEADERS**

ACME SINGLE AND DOUBLE AUTOMATIC BOLT CUTTERS.

Cutting from 1/4 in. to 6 in. diam.

Also, SEPARATE DEAD END DIE.

Illustration of a bolt header machine.

BOSS SCREW PITCH GAUGE.

Price \$1.25, by Mail.

A FULL LINE OF **Machinists' Fine Tools.**

SEND POSTAL CARD FOR OUR NEW 1893 CATALOGUE.

STANDARD TOOL CO.,
Box G, ATTOLU, MASS.

Illustration of a screw pitch gauge.

J.H. DIKKE CO.

Illustration of various tools and machinery.

FLAT TURRET LATHE

Illustration of a flat turret lathe.

SHERBURNE'S AUTOMATIC TRACK-SANDING APPARATUS.

Three Ways Instead of One. Mind Your Steps.

On slippery rails send the track automatically when brake is applied, avoiding rear collisions and derailments.

In starting, touch Lever and ahead it's Sand and "get there."

The old Rod and Lever retained as usual.

For particulars apply to **SHERBURNE & CO., 53 Oliver Street, Boston.**

BEATS THE MONKEY-WRENCH OUT OF SIGHT!

OUR ROUND JAW WRENCH, BATCH NO. 2 in the hand, is of tool for turning parts that can be made in any size and hardy material. It is not without looking down, and where you wouldn't get to an eighth of a turn with the monkey-wrench and it will take hold close up, where the old wrench can't get. This prevents marrowing and pulling and pulling. A thousand places for it around a locomotive here if you have time and money. We'll send a Catalogue Free.

THE KEYSTONE MFG. CO.,
512 TERRACE, BUFFALO, N. Y.

STRAIGHT AND TAPER FRAME BOLTS, ETC.

SEND FOR A COPY OF "RAMP LATHE WORK," by New Method, HORTON'S SYSTEM.

JONES & LAMSON MACHINE CO.,
SPRINGFIELD, VERMONT, U. S. A.

THOMAS PROSSER & SON,
15 GOLD STREET,
NEW YORK.



STEEL TIRES

ON LOCOMOTIVE DRIVING WHEELS
AND ON STEEL-TIRED WHEELS
GIVE THE BEST RESULTS
FOR EVERY VARIETY OF SERVICE.

The CAST-STEEL WORKS OF FRIED. KRUPP, Essen, Germany, cover an area of 1,200 acres, employ about 25,000 men, have the most improved plant, and stand unique, from the fact that they have their own Ore and Coal Mines, Blast Furnaces, etc.; and that every stage of manufacture is under their own supervision, and are not (like others) dependent on the open market for a miscellaneous assortment of crude material; which, in connection with 75 years' experience, enables them to turn out a product of a very superior quality, second to none, and at the same time the different grades of Steel are always of the same uniform quality.

Crank Pins, Piston Rods, Spring Steel, Steel-Tired Wheels, Etc.

After a test of over 35 years, the "KRUPP TIRE" has proved itself the best in the market. If a reliable article is wanted, which will give satisfaction, get KRUPP'S.

SCHENECTADY LOCOMOTIVE WORKS, SCHENECTADY, N. Y.

LOCOMOTIVES
OF
STANDARD
DESIGN
FOR ALL
CLASSES OF
SERVICE.



OR FROM
DESIGNS
FURNISHED
BY
RAILROAD
COMPANIES.

EDWARD ELLIS,
President.
WM. D. ELLIS,
Vice-Prest. and Treas.

A. J. PITKIN,
Superintendent.
A. P. STRONG,
Secretary.

COMPOUND LOCOMOTIVES, Showing an Economy of 15 to 30 per cent. in Fuel and Water. Annual Capacity, 400.

M. L. HENMAN, Pres. and Treas. DAVID BRADY, H. TANDER,
F. H. STEVENSON, Asst. to the Pres. ASST. Supt.
E. J. GIBSON, Vice Pres. Supt.
T. M. HUGHES, Sec. Supt.



Brooks Locomotive Works, DUNKIRK, N. Y.

Builders of Locomotive Engines for any required service from our own designs or those of purchasers.
Perfect interchangeability and all work fully guaranteed.

COMPOUND LOCOMOTIVES

FOR PASSENGER AND FREIGHT SERVICE.

Latrobe Steel Works
MANUFACTURERS OF

TIRES

FOR LOCOMOTIVE and CAR WHEELS.

Main Office and Works, Latrobe, Pa.
Branch Office, Bullitt Building, Philadelphia.
Chicago Office, Phoenix Building.
New York Office, Columbia Building.

William Sellers & Co., Inc.
PHILADELPHIA, PA.

MACHINE MODERN TOOLS

for Railroad Shops, Car Builders, Etc.

HIGH SPEED
TRAVELING & SWING CRANES.

ALSO
TURNABLES, INJECTORS,

SHAFTING,

ETC., ETC.

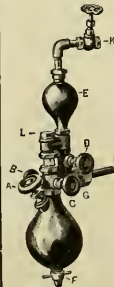

"LACKAWANNA"

Sight Feed Locomotive
Cylinder Lubricator.

ABSOLUTE UNIFORMITY OF FEED.

Perfect distribution of oil to both cylinders from one feed glass, and entire efficiency under all working conditions.

Only One Glass,

and that short and stout; almost unbreakable. Absolutely no use for any more. They are an unnecessary source of trouble and danger.

Write for full particulars.

LACKAWANNA LUBRICATING CO.,
1212 Capouse Avenue, Scranton, Pa.

The Long & Allstatter Co.
HAMILTON, OHIO.

Double, Single, Angle-
Bar, Gang, Horizontal,
Twin, Boiler
Spacing, Gate, Multiple, Belt, and Steam
Driven
Punches & Shears
OVER 300 SIZES.

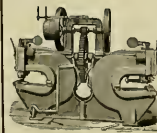

J. G. HENDRICKSON, Pres.
F. J. CLAMER, Vice-Pres.
J. R. NEISON, Sec. and Treas.

"AJAX BEARINGS; RECORD 90 MILES AN HOUR."

"EMPIRE STATE EXPRESS, N. Y. C. & H. R. R."

AJAX METAL CO
INCORPORATED
PHILADELPHIA, PA.

Baldwin - Locomotive - Works.

ESTABLISHED 1831.

ANNUAL CAPACITY:
1,000 LOCOMOTIVE ENGINES.

Adapted to every variety of service, and built accurately to standard gauges and templets. Like parts of different engines of same class perfectly interchangeable.

COMPOUND LOCOMOTIVES.

BROAD AND NARROW-GAUGE LOCOMOTIVES; MINE LOCOMOTIVES BY STEAM OR COMPRESSED AIR; PLANTATION LOCOMOTIVES; NOISELESS MOTORS FOR STREET RAILWAYS, ETC.

BURNHAM, WILLIAMS & CO., Proprietors,
PHILADELPHIA, PA.



Pittsburgh Locomotive Works.

PITTSBURGH, PA.,

Manufacturers of

LOCOMOTIVE ENGINES

For Broad or Narrow Gauge Roads
From standard designs, or according to specifications, to suit purchasers.

Tanks, Locomotive or Stationary Boilers
FURNISHED AT SHORT NOTICE.
WILCOX MILLER, P. & CO. S. A. WRIGHTMAN, Eng.



DICKSON MANUFACTURING CO.

SCRANTON, PENN.

Locomotives of every style and size, Standard and Narrow Gauge, made to standard gauges and Templets. Also for Plantations, Mines and Logging.

SPECIFICATIONS OF APPLICATION.

JAS. P. DICKSON, President.

17 W. WELLS, 7-Fas. Wm. E. ZELINSKY, Sec. & Treas.
JAMES DUNN, Superintendent.

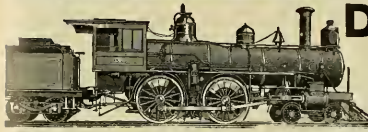

CROSBY



POP SAFETY VALVES,
MUFFLED AND PLAIN.
IMPROVED
STEAM GAGES.
Single Bell
CRIME WHISTLES.

A perfect supplement for a locomotive, giving the boiler water level, accuracy and steadiness, detecting leaks. Superior than any other ordinary locomotive.

Crosby Steam Gauge & Valve Co.
BOSTON, MASS.
Branches:
New York, Chicago and London, England

ROGERS LOCOMOTIVE COMPANY

OF PATERSON, N. J.
New York Office, 41 Exchange Place.

MANUFACTURERS OF
LOCOMOTIVE ENGINES AND TENDERS,
And Other Railroad Machinery.
R. S. HUGHES, President
G. B. HANNAF, Texas G. H. LONGFELLOW, Secy
REUBEN WELLS, Superintendent.



PORTLAND CO. LOCOMOTIVES OF ALL TYPES.

STANDARD OR NARROW GAUGE FOR ANY SERVICE FROM OUR OWN OR TO RAILROAD CO.'S SPECIFICATION.
Freight Cars, Derrick Cars, Push Cars and Car Wheels,
Boilers of Locomotive, Horizontal, Tubular and Vertical Type
FRANKLIN C. PATSON, President JAMES E. GREENSMITH, General Manager BYRON B. YERBILL, Treasurer



Richmond Locomotive AND MACHINE WORKS,

RICHMOND, VA.
Locomotives for Every Service.

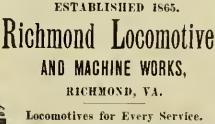

PAUL S. REEVES, Philadelphia. PHOSPHOR BRONZE IN INGOTS AND CASTINGS. LOCOMOTIVE AND CAR BEARINGS A SPECIALTY.

BRASS and PHOS. BRONZE CASTINGS from 1/4 lb. to 5,000 lbs. in WEIGHT.



COOKE LOCOMOTIVE AND MACHINE CO. PATERSON, N. J.
(Formerly Danforth Locomotive & Machine Co.)
JAMES E. COOKE, President & Gen. Mgr. | PATERSON, N. J.
Wm. BRIDAN, Secy & Treas. | 45 BROADWAY, N. Y.
New York Office: 45 BROADWAY, N. Y.

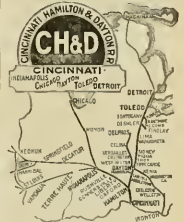

PULLMAN SLEEPERS on Night Trains.
ELEGANT PARLOR CARS on Day Trains.
DINING CARS between Cincinnati and Chicago.
Wm. H. GREENE, General Manager.
J. H. EDWARDS, Gen'l Pass. Agt., CINCINNATI, OHIO.

Trade Mark
GOLD'S STEAM AND WATER PACKING (Patented June 1, 1886).
The Original Ring Packing is the only one of its kind. It is made of the finest material and is the only one that will last. It is the only one that is made in the U.S.A.
A. CHAPMAN, Trade Mark

HENRY CAREY BAIRD & CO., Industrial Publishers, Bookellers and Importers,
810 WALNUT ST., PHILADELPHIA.
We sell the new and improved Catalogue of Practical and Scientific Books, if paper, iron, and our other Catalogues and Treatises. Our lists covering every branch of science, art, and industry are sent free to any part of the world who will send us a address.

Our Line Engravings are made by the wax process, a plan securing accuracy and distinct lines on original copper plates. They are made by BRADLEY & POATES, 251 William Street, New York City.

Rhode Island Locomotive Works, PROVIDENCE, R. I.

CHARLES FELIX MASON, President. ARTHUR LIVINGSTON MASON, Secretary.
EARL PHILIP MASON, Vice-President. JOSEPH LYTHGOE, Agent and Supt.
WILLIAM P. CHAFFIN, Treasurer. S. A. STEPHENS, Traveling Agent.

NEW YORK OFFICE,
Nos. 31-33 Pine Street.



A PERFECTLY CONSTRUCTED METAL BRAKE BEAM.

The Cheapest, Lightest, and Most Durable.
 NOW STANDARD on a MAJORITY of ROADS THROUGHOUT the COUNTRY.
 General Office and Works: 40th & Hopkins Sts., Chicago.
 CITY OFFICE: 317 TULLY STREET.
 514 Phenix Building, Chicago. 40 Broadway, New York. Room 118
 127 Corporation Street, London. Frazar's G. Ex. Eastern Agent.



THEIR SUPERIORITY IS PROVEN BY THEIR POPULARITY.

FINEST SEATS.

Coach, Parlor Car, Sleeping Car, Street Car, Rattan Elevated

IN USE ON ALL THE PRINCIPAL RAILROADS IN THE UNITED STATES



THE HALE & KILBURN MFG CO.,

Simplicity, Durability, Elegance, Comfort.

Combined

IT IS SAFE TO SPECIFY THE **H. & K. SEATS**

PHILADELPHIA, NEW YORK, CHICAGO.

The Smith Triple Expansion Exhaust Pipe.



FRONT VIEW.

THIS Device is the invention of JOHN Y. SMITH, the originator of the Smith Vacuum Brake. In the cuts of the Front and Side Views shown beneath, "A A" represent Air Passages; "S S" Exhaust Steam Passages, and "B" an Annular Blower forming part of the Nozzle.

It is an entirely new departure in the construction of Exhaust Pipes for Locomotives. Its distinguishing features are that the exhaust steam is not restricted after it leaves the cylinders, and the gases and heated air in the smoke arch are mingled with the exhaust steam in the exhaust pipe. The exhaust steam is thus superheated and expanded, and a powerful, prolonged, pulsating blast is created, which keeps the fuel in a constant state of agitation, and produces more perfect combustion.

Some of the beneficial results obtained are: *Reduction of Back Pressure to a minimum (area of nozzle opening as large as the exhaust port); prevention of ejection of sparks from smoke stack; almost complete absence of noise from exhaust; prevention of formation of clinkers in fire-box; large savings of fuel.*

By the elimination of Back Pressure we have demonstrated the fact that the power of engines has been increased to be able to pull from thirty to sixty tons more than with any other form of exhaust pipe.

The pipe can be used with either straight or diamond stacks, in long or short front ends, and on locomotives burning hard or soft coal, wood or coke.



SIDE VIEW.

NEW YORK SALES OFFICE, Rooms 29 & 31, 115 BROADWAY.
 GENERAL OFFICE—DOYLESTON, PA. FACTORY—READING, PA.

ALBANY, N. Y.
 936 Broadway,
 New York City,
 115 BROADWAY.

STEAM COUPLERS
 AND
FIRE PROOF
HEATERS.

CONSOLIDATED
 McElroy, Sewall, Westinghouse and other Patents.
CATALOGUES UPON APPLICATION.
 Special Appliances and Extra Strong Fittings of Every Kind.
 AUTOMATIC CONTROL OF HEAT.
CAR-HEATING CO.

CHICAGO.
 200 Phenix Bldg
 Canada,
 COATICOOK, P. Q.
COMMINGLER,
DRUM,
 AND
DIRECT STEAM
SYSTEMS.

A. W. SOFER, Pres.

HORT. ANDREWS, Vice-Pres.

C. H. HOWARD, Sec.

W. R. THOMAS, Treas.

R. M. HIXON, Engineer

THE SAFETY CAR HEATING AND LIGHTING CO.,
 160 Broadway, New York.

HEATING SYSTEMS.—By hot water circulation and direct steam with regulating devices. Reliable and uniform heat. Economical and rapid circulation. Gibbs automatic coupler of Westinghouse type, absolutely steam-tight.
LIGHTING SYSTEM.—The celebrated Pintsch compressed oil gas method. In use on over 40,000 cars in Europe and America. Adopted by the U. S. Lighthouse Board for lighting Buoys. The best, most economical and only safe light for Railroad purposes. In brilliancy and cleanliness unsurpassed.

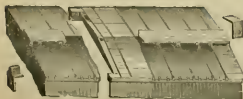

THE MURPHY STEEL CAR ROOF.

It is so built—mill or screw holes. It has no joints where chafers, rails or fire snow can get through. It allows for contraction and expansion, and has simple elasticity to provide for sagging, twisting, backing and covering of the car body. It is as solid as the old Iron Roof. It has no soldered joints. It can be repaired readily, and without taking off more of the roof than is damaged. It is much cheaper than any other metallic roof now in use, and is stronger than the double board roof, made of good lumber. It has no expense one other than to apply it.

This Roof can be applied on OLD LEADY BOARD-ROOF CARS without making any changes in the board roof; thereby saving the expense of replacing the old boards with new, and thus utilizing material that most otherwise be thrown away.

Manufactured by the P. H. MURPHY MFG. CO., East St. Louis, Ill.

Locomotive Engineering



A Practical Journal of Railway Motive Power and Rolling Stock.

COPYRIGHTED, 1901, BY ANGUS SINCLAIR AND JOHN A. HELL.

VOL. VII, No. 5.

NEW YORK, MAY, 1894.

30 Cts. Monthly
\$3.00 Per Year.

Extending the Use of Compressed Air.

In nearly every railroad shop in the country the men in charge are introducing methods of transmitting power by compressed air or extending the equipment already in use. No more convenient means of doing work in out-of-the-way places has ever been introduced. Every day new uses are discovered for this clean and reliable medium. Steam and electricity have both been thoroughly tried, and both have their advocates, but both these mediums are given to shortcomings of which compressed air is entirely free. A very good paper on the advantages of

vours to discharge into and to be drawn from, be placed at the points where it is to be used. By taking advantage of this system of long-distance piping, one of the greatest obstacles in organizing an air-brake plant, that of expense of operating, can be considerably reduced, but there are places where this cannot be done, and the establishing of a steam boiler, with an attendant, in addition to other parts of the plant, will be necessary."

In connection with the application of compressed air for the operation of tools or the transmission of power, there is one thing that it would be well for men in charge of shops to remember. They have

University there seemed to be no doubt whatever that the sum called for could easily be secured. The members had, however, scarcely all returned to their homes when the worst financial disturbance this continent has ever seen burst out like a thunder storm from a clear sky. Railroads were among the first business interests to feel the shock, and company after company went into the hands of receivers, while those that remained solvent entered upon a course of retrenchment and rigid economy that denied the expenditure of a dollar that was not absolutely necessary. This condition of affairs had become general when the secretary of the

engineering problems to be decided by the tests were strongly elucidated. Mr. G. W. Rhodes proposed that the General Managers' Association, of Chicago, should be appealed to for assistance in raising the required funds. This idea was broadened and recommendations made that the American Railway Association, which is composed of the leading railroad managers in the country, should be requested to co-operate in securing funds for the purpose of making tests at the Purdue University. This Association met in New York on April 11. Four members of the Committee on Standard Tests of Locomotives were present, viz.: Messrs. J. N.



LOCOMOTIVE ENGINEERING, N. Y.

GIANT AND DWARF—STANDARD PASSENGER ENGINE OF THE DELAWARE, SOUTHKILL & SPOTTYSVILLE, WITH CONY NO. 4 ADAMS.

using compressed air for shop and yard purposes was lately read at the Central Railroad Club by Mr. J. H. Chubb, of the Michigan Central. After dwelling on the importance of having air in yards for the inspection of cars, he said

"The distance to which air can be conveyed through pipes is almost unlimited. The Pennsylvania Railroad Company has carried air six miles to their interlocking system at Wilkensburg, near Pittsburgh, and in Chicago, at the present time, arrangements are being made to lay pipes of large dimensions extending several miles to different parts of the city, to carry and distribute compressed air for power manufacturing, the only requirements being that the compressors be located at the power point, and air reser-

voir right to apply air to tools that are patented to work by water steam. If they do so they must expect to pay royalty on the patents.

Prospects of Raising Funds to Test Locomotives.

This year has not been a good season for collecting money from railroad companies to defray the expense of locomotive tests. When the Railway Master Mechanics' Convention met last June there appeared to be no cloud in the business and financial atmosphere, and when the request was made by the committee in charge of locomotive tests for the Executive Committee to raise \$5,000 to defray the expenses of laboratory tests at Purdue

Master Mechanics' Association, representing the Executive Committee, began asking for contributions to pay for the locomotive tests. Many of the railroad presidents were interviewed and all others likely to contribute were appealed to by letter. All were sympathetic and commended the work proposed, but the general disposition about contributing money was well expressed by one railroad president who wrote "Wait till the clouds roll by." A few were willing to give the contribution asked for, but they were so few that the entire sum of money available was not sufficient to begin work with.

When the case seemed hopeless for this year, the Western Railroad Club took it up, and Mr. George Gibbs, one of the committee, read a paper in which the important

Lauder, R. H. Soule, Angus Sinclair and F. W. Dean, Col. Haines, president of the American Railway Association, gave cordial support to the committee, and through his good offices Mr. Lauder was permitted to address the convention and urge the importance of the work to be done. A petition was presented asking for assistance to the extent of \$5,000 annually until the more important tests should be carried out. The application was very favorably received, and a committee was appointed to take the matter into consideration. There now appears to be good prospects of the required funds being forthcoming, as the American Railway Association can assess the different railroad companies for the money in proportion to their mileage.

Getting to Mexico Wayside Notes.

EDITORIAL DEPARTMENT.

Americans who invade Mexico should not expect the capital or any highway and retreat over another thing seeing more of the country I am assuming that all Americans are like myself, inquisitive enough to want to see all they can for their money.

I resolved to reach the Mecca of the Astee republic via the "Laredo Route," and on a spring morning I left New York over the B. & O. for Cincinnati.

THE B. & O.

is not recommended at my hands. It is the first road of importance in America, and the only one of the originals that has grown improved and never changed in name, purpose and energy. It is rich in history, not only of the science of engineering, but the life of our country. From Washington west its banks, and cuts, its old stations, etc., some of the very old engines you see today say "only battles that the brothers of this road fought with the other."

There are old earthworks thrown up here and there, and notice cut in their bow at regular intervals tells where the mouths of some grim dogs of war stood and poured forth their hell of death and destruction in shells and canisters.

Old history that was here under "Old Glory," that of every shivertail lost to slavery emancipation and the Union forever? or is it Confederate shells spotted with British shell standing beneath the Stars and Bars, demanding respect to the doctrine of State Rights?

It is a magnificent road, and the brothers of this road freedom for the white and eternal night for the black man? You do not know. But you do know that peaceful green and spreading oaks are growing upon the old ramparts you know that the young life fed upon the blood and the iron of the war has made that a generation of winter wheat roasts the meadow below, where that desperate charge was made, and as the train whirs you may see a child ask up under the trees.

As you pass Harper's Ferry, don't deal in your imagination if you march on "John Brown's" and go marching on. Look quick as the train passes the old Army building, and you will see plainly the stone foundations where once stood the machine tools; yes, and there are the old bells mislaid in the masonry that once held them in place, and if you remember your history and shut your eyes you can see the soldiers in gray as they treat those machines away, load them upon the cars on the very track you are riding over, and send them away to make arms for the Confederacy. The heights above the town again are peopled with an army, now gray, under the Intrepid Stearns, or Jackson, now blue, under Pope or Burnside.

The bridge over the Potomac is historical. Can't you see it burn? Don't you see the pocket line of blue on one side and gray on the other? Your blind tangles, you are about ready to entice on one side or the other, when the owner of the bridge announces that "Drumh is now ready in de drum car."

You notice the new engines and trains, as fine as the finest, the great improvements in the roadbed, and say again that every American ought to ride over the B. & O. once in a lifetime anyway.

THE GREEN AERIAL.

I am not writing descriptions of roads or shops. I'm trying to get to Mexico, so I can't help dropping off now and then to see old friends or try to make new ones.

Perhaps you know that the Q. & C. road is made up of six smaller systems, its northern terminus being at Cincinnati and its southern at New Orleans, while a southwestern line extends across part of Ala-

bama all of Mississippi, and Louisiana to Shreveport on the Red river.

I visited an old friend in Geo. W. Cushing, at the Ludlow shops of this road, just across the river in Kentucky.

These shops are rather small, the force light, and only working forty hours a week, yet they are making good progress in putting the power in shape.

Like many other roads, they are doing the necessary work and leaving the frills for a more prosperous time. Running gear is put in good condition, boiler work well done, and plant painted up. They omit polish, but they do not omit oil.

This company is running quite a number of compounds, but it's utterly impossible to get any information about them here or anywhere else. The way to close the conversation with an official is to ask a pointed question about compounds, and he will shut up like a clam and remark that it looks like rain.

I noticed one improvement going on that is worthy of imitation. Most of the engines in the shop had loose tail-pieces across the frame. This is a common trouble, yet most shops they take them out, dress out the slots in frames, weld a piece on the tail-piece at each end to place it up and rest it just as it is in the first place.

Of course the tail-piece takes all the strains and shocks due to the engine's work or the handling of the train, and without a doubt they work themselves loose in the frames because they spring, and they sprang because they are tight. Mr. Leedes is increasing the thickness of the original signal between the frames, so that there is a possible spring to them makes a fit in the frames, and they stay put.

Here, as all over the South I noticed a great many New York air-pumps. I did not ride over the Q. & C. until I left Birmingham for Shreveport, but went south over the

DR. HALEY & SANBURY.

At Louisville I visited the prince of good railroad men in the person of Pulaski McCullough, president of motive power and machinery.

With him I visited the shops at Louisville, and interesting old shops they are.

CARS WITHOUT PLATFORMS.

The first thing of interest noted was the express and mail cars of this line, built without platforms. Mr. Leedes is a strong advocate of this style of equipment, and seems to have all the argument on his side.

Platforms do not earthly good on these cars, cost money to build and keep up, increase the length of train, are weaker than a non-platform car, furnish a place for tramps, endlers and train robbers to ride, and are of no use.

It shortens the head of the car and places the usual platform timber against the end of the car, does away with steps, platform and railings. By this construction, a very strong car can be built; it is less liable to break up in case of accident and is cheaper. When a railroad can get a cheaper, stronger and better thing, you'd think they would be suited to a queen's taste.

Is there any reason for keeping up platforms on mail, express or baggage cars?

NO DRAGGING MACHINES.

Mr. Leedes has prevented the dragging of air-hose on rear of tenders in a very simple and effective manner, he has taken off the angle-cock at rear of tank and put on a finished rubber coupling, that closes the hole when you come into hose-head. When an engine is cut off a train, the engineer blanks his valve and stays tight there until that hole is hung up—brake set till this duty is performed.

AN ADJUSTABLE FRONT END.

On one of the engines an experiment is being tried. A plate was fitted into the front end and held by four long screws passing through the smoke arch cross piece. Starting at the full size, this plate was

moved back an inch at a time, and the influence on steaming noted, not for a trip, but a week or so. It was tried back as far as 12 inches, but the best results was had when the plate was 5 inches back of the boiler. Further experiments has confirmed Mr. Leedes in this, and the intention is to shorten the fronts of this class of engine 6 inches. Surely this is a sensible, manageable way to "figure" out the proper length of smoke arch.

HEADER ARRANGEMENTS.

Improvements are noticeable in the tenders; wider coal space in front and inclined coal space, brake-staff on the right side, and no water necks. Both injectors are on the right-hand side of the engine, and both water-hoses on the right hand side of the tank. This arrangement will be shown in a future number of this paper.

The back side windows of the cabs let down, like a street car window, and the cabs have a free story and trailing sash to keep them cool.

AIR-PUMPS.

Mr. Leedes believes that there is the same necessity for two air-pumps that there is for two injectors, and he is fast putting two on each engine to supply air, but the left-hand one is not started by its governor until there is a main drum reduction of five pounds. Both have steam on them, and both are attending to business. All on the regular pump breaks down, the engineer don't care a straw; he don't have to do a thing but keep his head out of the window, with his eagle eye on the next signal, the "understory" is pumping in the "star's" place.

ROUNDHOUSE SHOPS.

In every roundhouse on the system they are putting in a shop on the shop, those where large shops are located as well. They build a neat little no-horse upright engine to drive them, and put in toolaches, a drill press, small planer or shaper and grindstone. These save lots of running to shops and taking regular work out there to do odd repair jobs. This looks like a very good idea, and will save lots of many miles apart. It will save lots of telegraphing, writing, and waiting for pieces that don't fit when they come.

LUBRICATING.

All through the roundhouses can be seen engines with heavy counterweights bolted into their wheels. They are weighing every diver on the system, and putting the proper weight in it, adding as high as 600 pounds to some wheels and finding a difference of many pounds in wheels on the same axle. I went out of Louisville on an engine—and a trim stogie, no-bleeder shag, as noted that while the four-bar guide was retained the two top guides had become one, about a foot wide, this keeps out dirt and gives the largest possible bearing where needed.

Mr. Leedes has recently commenced to trace the outside of his guide eyes to the side of boiler as was done long years ago. It was a practice that should not have been discarded.

NEW DETAIL.

IS one of the "boom" towns of North Alabama. It covers about half a county, and has a large building of some sort on almost every block (two-thirds of these are empty), and the rest of the block vacant.

There are miles of graded but unimproved streets, thirty three miles of water mains and over five hundred fire hydrants.

I enjoyed the exercise of walking a mile and a half alone to the "Tavern" through the mud at 10 a. M. This hotel is big enough for nine towns just the size of this. I ate breakfast with a real estate man who still hangs on.

"Pretty good here, now?" I ventured by way of opening conversation.

"Quiet" say, you art to see Sheffield. Well, sir, it's dead; my last fall a cow wandered into a \$10,000 house there. The

wind blew the door shut and the cow died at starvation. They never found it out till last week. Yes," he mused, "it ain't what it was. Why, sir, their lots right over their sold for \$500 a front foot—now well, what we want is Northern capital."

The shops of the L. & N. at this place is the only evidence of real life. Here are the finest shops in the system, and I doubt not in the South. Splendid buildings, good tools, and good men at work.

General Master Mechanic Heckert keeps a clean house, what a housekeeper he would have made! Every inch in that immense yard seems the same. Here are the finest shops in the system, and I doubt not in the South. Splendid buildings, good tools, and good men at work.

The car shops here are well equipped; they have built fifty freight cars in twenty-two days after receipt of order. Everything is in order, everything goes about as if a foreman was dead, "the old man keeps his eye on everything."

I rode on an engine again almost all the way to

BIRMINGHAM.

This is a brand new Pittsburgh, sleep Evidences of industries are everywhere. Almost every railroad in the South has a line to Birmingham. We stopped for not less than a dozen railroad crossings in entering the city. Steel works, furnaces, mills, foundries and smelters, rear their smokestacks everywhere. Very few of them was new lives are running. The town seems as if there was a big funeral going on and it was Sunday.

They, too, are waiting for Northern capital—or a lot up in the times. One man expressed a feeling I found pretty prevalent "If Congress would pretty die off or go home."

The hills around Birmingham are made of iron and coal, and a great manufacturing city must eventually flourish here. I wanted not for the boom or to see the railroad shops—I was headed for Mexico, and I took the night train for Shreveport.

I don't know what we passed in the night, but all the next day we rode through a low, flat country, much overgrown with water from the recent heavy rains, and peopled in a large majority with the sons of Ham.

The only let up on the trip is the boarding of the boat at Vicksburg and the ride across the river.

Here, again, war memories crowd the mind.

We rode, mile after mile, straight away through fertile country. It seems a pity that there is not more immigration of thirty white people to this section, but it will take years to drain the swamps and make it fit for farming; yet it's a thousand times better than the arid lands of the Dakotas, that have cost so much money of work and worlds of disappointment.

Shortly after dark we arrived at Shreveport, La., had time to eat, and climbed aboard a Texas & Pacific train for

MARSHALL, TEX.

the headquarters of the mechanical department of the T & P. road.

Here we found no evidence of hard times. The pay of road or shopmen had not been cut, and the force and the hours remained the same as before the panic. Business seems to be in a remarkable degree, there being considerable movement of live stock.

Superintendent of Motive Power J. W. Adolis has made many improvements in and around these shops since he took hold, less than two years ago. All about the place are evidences of former prosperity. Marshall is a town where the mechanical department ran full force full time, and still saved \$105,000 above the yearly expense of 1892.

Slowly tools are being relocated, the

terial placed where wanted and where the first move will put it upon the tools.

The buildings are large enough and good enough, but were very badly arranged.

It seems to have been the plan long ago to throw away things that did not just out. Some 17x24 eight-wheelers, with less than a year's credit to their service, were scrapped and stood outside of the shop for more than ten years; these have all been repaired but two—good engines being made of them.

I don't know of a road except the T. & P. where the under-side of the wheel covers is always wiped clean; it's done here simply because the under-side of wheel covers is painted a bright vermilion; you never have to tell a wiper to clean a spot that is painted bright red, just try it once on a track wheel, a wheel cover or a sand-pipe—anything that's always dirty.

The T. & P. have suffered two bad boiler explosions lately—new radial-stay boilers on a class of heavy engines. The officers of the road have been somewhat worried over the matter, have put some extra strays in the side sheets, and have doubted the strength of the single-riveted mud ring for large boilers carrying 100 pounds to the square inch. From what I could learn among "the boys" there are still some of the old devil-may-care sort of railroaders down in Texas, they imagine it's brave to have the reputation of "not being afraid of steam" and desirable to show that they are fine engineers because they can "take more cars without bubbling" than any one else. These men do not hesitate for a moment to screw down pops, falsify gauges and "get there." I am told the two unfortunate engineers who lost their lives in the two explosions spoken of were noted for carrying "a hundred-and-enough," and I have little doubt that excessive pressure caused the rupture of these boilers.

The T. & P. have lots of N. Y. brake equipment.

Mr. Addis is getting his passenger cars into first class condition, and they will show up well with the best. A new boiler-house and a new brass foundry are just being completed. A power plant attached to the transfer table and other improvements made. A new place to store parts of locomotives undergoing repairs is provided here. There being little room in the shop, parts have always been placed outside and between the stall doors opening on the transfer table. As there was no way to limit this space, the parts were often left in the way, and were liable to be carried off. This has been helped by building a neat little room between each pair of doors, covering same, and putting on a locked door. Parts are kept in order and safe, do not show, and are out of the shop. The little storerooms being nicely painted look all right.

Interwined with over the T. & P. to Longview and there took the

INTERNATIONAL & GREAT NORTHERN for Palestine, Tex., where the main shops of the road are located.

Met Mr. F. Huffsmith, who is mayor of the town as well as general manager of the company, busling up a subscription to feed a squad of sixty "Commonwealers" who had captured an I. & G. N. train the day before and rode into town. The I. & G. N. is the best equipped road in Texas. They have fine engines, fine machine tools and original ideas. Here you will find a large department for a tool room, and it's a good one. In it are first-class tools in the shape of lathes, millers, etc. and also a Brown & Sharp grinding machine, Pratt & Whitney center drill and countersinks, tools not often seen in railroad shops unless they pay to own, however.

All the other things, the tools in each shop being driven by independent engines. The locomotives cannot fail to attract attention at once, they are the finest looking engines anywhere, the frames are noticeable at once for their size, the boilers are

much larger than those in general use for the size of cylinders and are what Mr. Huffsmith calls his compounds. These engines have pulled light passenger trains and made eighty-one miles to the ton of coal.

The tender trucks are extra heavy, and every piece about the machine so heavy and solid that, now, after two years' continuous service, they show no signs of loose joints or other infirmities that mills are heir to beside the usual wear.

The jaws of the frames are some four inches long at the ends. They run over a rough road, and Mr. H. does not propose to have any boxes striking on the binders.

Bronze driving bolts are used. I saw a set that were taken out from under a passenger engine with over two years running to her credit, that did not need a single lot of work done on them. They will easily last until the engine is rebuilt again, and then the six will make five new ones. Bronze is so much stronger, and requires so much less work to fit up, that it's a wonder any road will try to get along with the old shell-brass cast-iron affair.

Krupp creosole steel is used for tires and rods throughout.

They use lead packing of their own for valve-stems, etc., that is poured into the gland, and it does remarkably well.

Mr. Huffsmith believes in every comfort for the engine crews—good seats, cushions, and arm-rests, are provided, and everything in the cab is made as handy as possible.

The Leach sand is used, as is also the Boyer speed-recorder.

They put a small nipple back of the rear drivers and connect to a small surface cock, these are used to clean off the rail after using sand heavily on a grade; the men claim that they can get two cars more over some of the hills by using this jet, it keeps the sand from getting under the train and the hot water lubricates the rail enough to prevent flame cutting.

No cut of wages has been made on this road. The men seem happy and contented, many of them having business interests in the town or along the road, appreciate their jobs and take care of them.

The lower end of the roads runs through some stretches of sage brush desert, and at last breaks up on the banks of the Rio Grande river at the hot, dusty, straggling, half Mexican town of Laredo, of which I shall tell you more in my next letter.

J. A. H

Improved Angle-Cock.

By E. F. BRIDGEMAN

The various accidents that have been attributed to the accidental or malicious closing of an angle-cock have attracted considerable attention to this valve and its weak points. That it stands in need of some strength of safe design, and only a short time ago one of the roads in this vicinity had a train leave a terminal with brakes cut off behind the tender. The cutting out of the brakes is too serious a matter to allow to go undetected until it is time to apply the brakes. To provide an indicator that will notify at once the engineer of the closing or even partial closing of an angle cock I have devised and applied for a patent on an improved angle-cock that will accomplish this purpose. I think fully, and I am pleased to see the criticisms of our air-brake friends upon it, for it is not any weak points I wish to know them.

Fig. 1 shows the angle-cock connected to signal-pipe by a short branch pipe. In the upper part of angle-cock there is located a valve whose stem extends out close to handle on angle-cock, but does not touch handle when angle cock is open. The closing of the stem on handle in contact with the valve stem of what I may term the signal-valve, forcing the valve from its seat and allowing air to escape from the signal-pipe.

This reduction of signal-pipe pressure blows the signal whistle, attracting at once the attention of the engineer. This alone would not be sufficient as it would be liable to confuse the conductor's signal.

In Fig. 2, the signal-pipe is tapped and a pipe run from it to a gauge on engine.

This gauge stands normally at signal-pipe pressure, but upon the closing of an angle-cock the gauge drops back to nothing, for the signal valve in angle-cock is so designed as to be able to exhaust pressure from the signal-pipe faster than the reducing valve can supply it. The branch pipe to signal-pipe, Fig. 1, is connected to signal-pipe outside of or to the rear of signal-pipe stop-cock. This method of making this connection is to provide for the rear end of train, for in that case the signal-valve, although raised from its seat is inoperative. Should the engineer be notified by the whistle and gauge that an angle-cock had been turned, he would then have some chance to provide for the safety of his train. A test of his brakes at once (by "feeling" of them) would tell him if he still had under his control

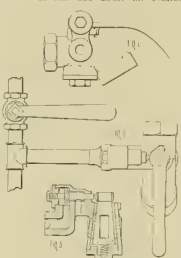

enough brakes to make the next stop safely. If he found that the safest course was to stop at once, he would "call for brakes." The conductor, upon hearing this signal, could at once get an idea as to what was wrong by simply pulling the signal cord in coach. If he did not get a blast of air from the signal-valve in coach he would know that the engineer had lost control of his brakes, and would also know that the brakes could still be applied by the use of the conductor's valve. By this means it will be seen that any disarrangement of the angle-cocks would be known almost instantly by the two men in charge of the train, and they would then be in a position to take some intelligent means to provide for its safety.

Incidentally, the placing of a gauge on the signal-pipe will also insure the reducing-valve being kept in good order, and not being allowed to overcharge the signal system until the engineer has to report. "Whistle blows when brake is released." This innovation would, at least, be appreciated by the man who at present is required to test the signal pressure with a gauge and section of hose hung to it.

Mr. P. Leeds, superintendent machinery of L. & N. R. R., has given orders to equip the Birmingham Decatur train and engine with this valve.

Uneven Wear of Tires.

By W. DE SAINO.

While Purdue University, of Lafayette, Ind., is wrestling with the problem of counterbalancing in locomotives, in a practical way, they are to be throwing some light upon the much vexed question, and it begins to dawn on the minds of skeptics that the "hammer-blow" man may be right after all.

The above remarks may not be pertinent to the subject matter of this article, but it

does prove that there are some things in connection with locomotive service that will stand considerable investigation. Broken straps, sheared rod bolts, broken and bent rods, and pins. These are only effects that follow close. Now, what is the cause of these breaks? While doing some work on the box lathes in a shop where I once worked, and in looking for the smallest wheels for the first turning, and noticing the great diversity in sizes, the writer put on his thinking cap, which resulted in the conclusion there must be a vigorous give and take, that the connections must resist, and this resistance in a heavy multiple-connected locomotive is very severe, and calls up some questions in traction and adhesion that might well be looked into.

By the use of a steel tape line around the badly worn tires of a consolidation engine, I found the following dimensions: No. 12, 12 1/2 in. No. 13, 12 1/2 in. No. 2, 12 ft. 7 1/2 in. No. 3 (main wheels), 12 ft. 7 1/2 in. No. 4, 12 ft. 7 1/2 in. being 1/2-inch larger than the largest and smallest wheel in circumference. We will put the wheel in the position shown in Fig. 1, with pins all in train on lower roller. Now let us take off the rods and roll the engine about five turns, when the pins will assume the position shown in Fig. 2. Wheel No. 2 will assume its normal position, while the pins of 1, 3 and 4 will be back of the center. We must now assume the main wheels to be the prime movers or driver, and the rest the driven when coupled together. Here we have the engine in service with the main wheels, 12 ft. 7 1/2 in. in girth than the front and back wheels, but 1/2 inch smaller than the No. 2.

It now follows that while the number of revolutions are the same, the rim speed must vary by virtue of a difference in size. Hence the main wheels, being larger than the front and back wheels, it has a greater rim speed, and if such is the case, the front and back wheels are not pulling, but slipping in such a way as to destroy the pulling qualities, unless it can be proven that the smaller wheels in this case are doing the pulling and the larger ones, doing the slipping. Again, the No. 2 wheels, being larger than the main wheels, have a still greater rim speed, but by virtue of the rod connections they must be slipping in two efforts to roll faster than the smaller wheels. The engine quoted as used at both ends.

Therefore it is not only the sand that

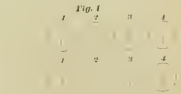

Fig. 2

wears the front and back wheels, but the constant slipping due to their reduced size. Those measurements were taken on the right side only. Why there should be a variation in the size of Nos. 2 and 3 I cannot explain, unless the main wheels being the heaviest. It would be much gained in the life of the engine if the wheels were turned often to keep them of a uniform size, even if the boxes, shoes and wedges were not touched. The defects mentioned in the above article is a strong argument for a case of solid end rods.

I wish to put this question to some of the readers of LOCOMOTIVE ENGINEERING. Suppose we had an engine with 10,000 pounds of iron to be placed above her frames or above her driver bearings. She will now pull a given load. Now let us remove this 10,000 pounds and make her drivers 15,000-pounds heavier, will the pull the same load as before? The engine has no track wheels.

Don't forget our new address, 250 Broadway.

Long Fast Run.

A correspondent in Galveston sends us the following:

A few weeks ago there was a special banana train left Galveston over the Gulf, Colorado & Santa Fe and Atchison, Topeka & Santa Fe Railways, for Chicago, making such fast time that it was generally commented on by the press, and pronounced by several railway officials as the result of an accident that could not be accomplished again. The run was considered the best on record, but we did not boast on the Santa Fe. We were not running against time, and I most certainly did not. The total number of hours consumed in making the run from Galveston to Chicago was fifty hours. On the Atchison they made fastest time. Comments were so numerous that the management desired to make a record next time.

The record-breaker left Galveston February 20th, Engine No. 5, 41 hours, 18.21 Engineer Wagner, Fireman Harris. The train weighed 314 tons. Some time was lost going through the yards and crossing the two-and-a-half-mile bridge over Galveston Bay. The distance from the west end of the bridge to Sealy is 99 miles. Time consumed, 2 hours and 27 minutes, speed, 37.5 miles per hour. The grade on this division is light.

At Sealy, Engine No. 82, an 1824 model, Engineer Haley, Fireman Stacy, took the train. The distance from Sealy to Temple is 124 miles, grade 1.5 per cent. Time consumed, 1 hour and 17 minutes, average speed, 31.5 miles per hour.

At Temple, Engine No. 420, 1824 8-wheel, Engineer Cowart, Fireman Rhine-smith, took the train to Cleburne. Distance, 99 miles, grade, 1.5 per cent. Time consumed, 1 hour and 6 minutes, speed, 31.25 miles per hour.

At Cleburne, Engine No. 44, a 1824 model, Engineer Anderson, Fireman Weeks, took the train. The tonnage was reduced at this point to 270 tons, two cars going over the "Pikes" to St. Louis. This division is 93 miles, grade, part 1.5 and part 1 per cent. Time consumed, 2 hours and 14 minutes, speed, 30.5 miles per hour.

From Gainesville to Purcell the train was hauled by Engineer Reedy, Fireman Combs, with Engine No. 187. Distance, 107 miles, grade, 1 per cent. Time consumed, 2 hours and 48 minutes, speed, 38.5 miles per hour.

The figures given are accurate. Mr. George A. Hancock, superintendent of machinery, rode on the engine or train the entire distance from Galveston to Purcell, and took the actual running time exclusive of delays. The distance is 3,375 miles. We feel proud of the record made, as it is said to be the fastest long-distance freight run ever made in the world.

For some years after the extension smoke-box for locomotives first appeared there were numerous patents obtained for combinations calculated to improve the box as a spark-arrester, or to perform some real or imaginary function which the common arrangement failed in. This line of invention led to the wasting of money by people ill able to afford squandering their means on patent office fees, and it fell into innocuous desuetude for a few years, but the impetus to improve smoke-boxes is spreading again. Half-a-dozen patents have been taken out within the last month for the improvement of the locomotive smoke-box. We only hope that the inventors will be more fortunate than their predecessors. Railroad companies are not ready to spend money on draught obstructions these days. They got too many lessons when the period of careful and wonderful smoke-stacks of the kind that tramped, for good cause, called see cream freeters was passing. The man who promises to save 50 per cent of fuel by an improved smoke-box is sure to get left. Superintendents and master mechanics will not listen to tales of that kind.

Circumference Indicator and Tire Gauge.

BY P. M. ALLEN.

In the Crosso shops of the Northern Pacific Railroad, there has been in use for about three years, an attachment to wheel lathes by which the size of wheels can be quickly and accurately determined. It is called a circumference indicator and tire gauge. Hitherto in turning down wheels retence has been placed upon an ordinary caliper to determine the size of the respective wheels. Calipers adapted to this use must necessarily be large, and as a result, the flexibility of the metal of which they are constructed renders them to a certain extent inexact and unreliable. In taking the circumference of a wheel during the process of turning the lathes must be stopp'd and opposite points marked on the head of the tire at equal distances from the face of the wheel, the points so marked to serve as a guide for the calipers. This process must be gone through with a view as measurements are necessary, which causes great loss of

This invention dispenses with this inconvenience, as will be readily seen from the accompanying drawings. The essential parts of the apparatus are, a scale provided with a small roller at its lower end for contact with the wheel, and a second piece of mechanism, consisting of an indicator wheel or disk supporting a suitable indicator by means of a small gearing. The whole is mounted upon a right support. The brackets are made of gas pipe and are slotted at their lower end over fixed projections. The scale, with the smaller roller at its point, is used for getting the size of the first cut on the wheel, and is placed in the groove made by the tool when it begins to cut. As the wheel is making its first revolution the dial is being started on the other wheel and the roller placed in the groove, as in the case of the first wheel. The operator at a glance can see when each wheel has made one revolution, the difference there

are finished and before they are removed from the lathes; or it can be used before they are finished, when the tool has traveled across the face of the tire sufficiently to allow the indicator disk to rest upon the part of the wheel that is being turned. Before beginning to take the circumference of the wheel, the pointers on the dial are brought to the zero mark and the circumference wheel or disk allowed to rest upon the wheel being turned. The

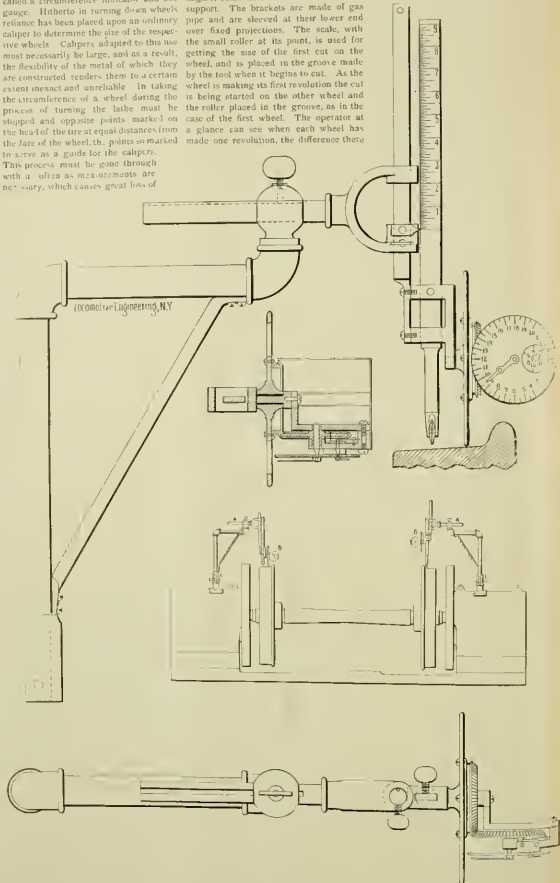

TIRE GAUGE.

time. To enable the lathe man to make accurate measurements, the assistance of another workman, who must be taken from his regular work, is required, making an additional expense.

may be in the size of each wheel, as the scales over both wheels read alike for equal diameters.

The circumference gauge is for taking the circumference of the wheels after they

lathes is then started, and any difference in diameters of wheels becomes evident before the revolution is completed, and the longer it runs the greater will be the difference between the dials. As can be

from from the accompanying drawings, the device can be swung around out of its position, thus giving the workmen a better chance to drive the wheel if it is necessary. The device is a great benefit also when the records are kept, as it shows the size of the wheel before and after turning. It is claimed for the gauge that it saves about 15 per cent in time of turning steel-

The Hard Road of Self-Instruction in Engineering.

It has been my privilege several times to listen to addresses made to students of engineering schools by self-educated engineers, but I have never before ventured to fill the position of speaker in a meeting of this kind. When listening to old en-

the vilest smelling mixture. This abominable stuff choked the bilge pumps every hour or two, and the wretched engineer on watch sometimes had a bath in this odorous bilge water before he got the pumps clean, so they would discharge the leakage which threatened to swamp the vessel.

My old shipmate is of the pessimist

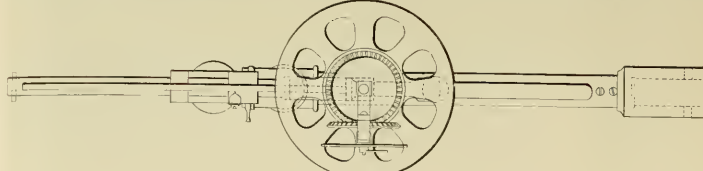

TIRE GAUGE.

guy wheels; that it gives the most correct size possible, is very easily handled, and is cheap and simple in its construction.

Swedish Compound Locomotives.

The locomotives hereby illustrated will interest our readers for several reasons. They have been built in Sweden for the government railroads of that country, and are notable from the fact that they so closely resemble the American type of locomotive. Both are compound engines with outside cylinders, one of them having tandem cylinders, and the other high-pressure on one side and low-pressure on the other. The 8-wheel engine has high-

engineers telling the rising generation about the methods they employed and the courses they followed to reach the higher planes of the profession, one peculiarity has struck me as being open to criticism. That is, the egotistical assumption, so often made, that a man who works his way upward from the vice bench or the anvil, from the fireman's soap or from the axe of the survey without the aids of college training must necessarily be a better engineer on that account. Self-made men are said to be peculiarly prone to worship their creator.

It is very natural that a man who has climbed to a high altitude by a certain road, and witnessed many failures by men apparently better equipped than himself,

class who see everything of to-day black as compared to the doings of yesterday. He believes himself opposed to modern marine practice and gapes lovingly on the doings of long ago.

We were recalling our old experiences on the *Helon*, of Glasgow. It was not a rosy period of my life. I spoke of the cracked steam-pipe which squirted steam every time the boilers moved. We all knew that if the pipe broke off every soul under the decks would be scalded to death instantly. I recalled the constant dread, the horror of seeing the crack gradually lengthen, and the grim jokes about how different members of the crew would look five minutes after the pipe parted.

McIntosh agreed that it was a little an-

acquire a great deal of accurate knowledge of various kinds. The first requisite towards obtaining this capital of professional lore is mental discipline. The next is guidance in acquiring the right kind of information. My own experience leads me to believe that the young mechanic who starts out determined to become an engineer, will waste no small part of his

energy in the wrong direction through want of the discipline and the training which the engineering school supplies.—*From lecture delivered by Angus Sinclair at Sibley College, Cornell University.*

Cleaning by Air.

The methods of cleaning cars by the use of compressed air have been extended greatly in the last year. It is found that the work cannot only be done much more expeditiously than by the brush and rod or fess-and-leathers way, but it is done more effectually. Those who interest themselves in sanitary questions say that cars cleaned by the compressed air process

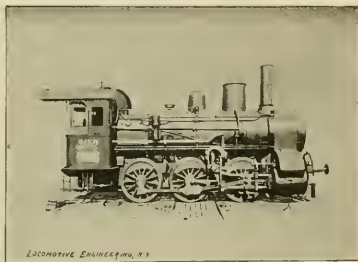
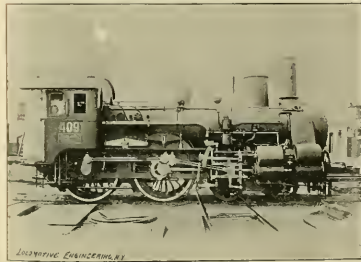

SWEDISH LOCOMOTIVES.

pressure cylinders 12 $\frac{1}{2}$, and low pressure cylinders 10 $\frac{1}{4}$ inches diameter. The stroke of both pistons is 21 $\frac{1}{2}$ inches. The driving wheels are 6 $\frac{1}{2}$ feet in diameter, and the truck wheels 32 inches diameter. The boiler is of steel $\frac{1}{2}$ -inch thick, the barrel being 51 $\frac{1}{2}$ inches diameter. There are 158 2-inch tubes, total heating surface of tubes and firebox is 1,452 square feet, the grate surface being 32.2 feet. The engine in working order weighs 59,96 tons.

The 6-wheel engine has a high-pressure cylinder 10 $\frac{1}{2}$ inches diameter, the low-pressure being 27 $\frac{1}{2}$ inches. The stroke is 21 $\frac{1}{2}$ inches. The wheels are 56 inches diameter. The boiler is nearly of the same dimensions as the other one. This engine weighs 46.35 tons.

All the valve motion connections are outside the frames, the Walschaert motion being employed. The engines do not appear to be models of simplicity.

should conclude that the path which he followed was the best route. After he has long rested on the summit, he forgets the roughness of the path traveled and the hard toil of the ascent. The obstacles which were surmounted by hard, tedious labor and the devious courses followed, in which precious time was wasted, are forgotten. The goal reached satisfies the aspirations of ambition, and the rocky roughness of the path remembered only as a picturesque route. It is wonderful to witness the capacity displayed by some people in forgetting the sting of hardships they have passed through.

I met an old marine engineer named McIntosh the other day who was once a shipmate of mine on a steamer which had the boilers so loose that they bumped on the side every time the vessel rolled, and she rolled often and frightfully. The bilges were filled with rotten grain, which made

comfortable. "But, man Angus," he said, "it was fine to go on deck at the end of a watch, and feel that you had finished another turn below without getting cooked."

I recalled the disgusting baths we got while cleaning the bilge pumps. "Yes," he admitted, "that was nasty, but it learned you to know what a good thing a change of clothes was. Then it was some pleasure to know that Fraser was having his turn." McIntosh hooked on Fraser as a top, and there was something incongruous about a top bathing in our peculiar bilge water.

I have never been able to convert past hardships into pleasant memories. Perhaps it is owing to this turn of mind that I always have seen envious of engineers who have enjoyed the good fortune of starting upon their life's work with a good scientific education. An engineer to be worthy of the name must in some way

be likely to be free from disease germs than others cleaned on the old plan. This idea has taken a hold on the popular taste, and we already find some agitation in favor of using compressed air for the cleaning of rooms. A writer in the *Chicago Dispatch* says:

"It is now in order for some home missionary to invent some simple device that will work an air-pump and current fan household use. Its introduction would revolutionize housekeeping and solve the heretofore hopeless problem of clean rooms, and will keep furniture covers and carpets. It would be economical, as it would render less service necessary and will save a large portion of the wear and tear of furnishing textiles. In houses where there is hydrant water it would not be at all difficult to attach an air-pumping apparatus to the kitchen or bathroom faucet and thus furnish power for every floor."

The Elements of Boiler-Making III.

By C. E. Fourness.*

Laying Out a Smokestack.

In constructing a smokestack it is necessary to make a bend or an offset to suit a condition. The stack is 35 inches in diameter and made of No. 1 iron. Fig. 30 is a side view looking south, and a small detail of the pipe joint is at the top, for illustration. Fig. 31 shows the location of the sheets at 20° incline apparatus, but it is not necessary to lay to scale the parts marked. This sheet is called a "lap" (Fig. 30).



Next in order comes laying out the sheets. Figs. 35, 36 and 37. I will first find the circumference and find it by a method I have not given as yet. I will reduce to a common fraction equals 34, consequently I multiply the diameter by 4, common fraction in place of a decimal. In performing this operation, I first multiply the diameter, 35 inches, by 3 inches, which equals 105 inches. I next divide the diameter, 35 inches, by 7 inches, which equals 5 inches. I now add 4 inches and 21 inches which equals 46, the circumference. As this is so little difference between it one-seventh of an inch, and one-eighth of an inch, I call this four-eighths, which reduced to its lowest term equals one-half of an inch. As No. 16 iron is one-sixteenth of an inch in thickness, I add three-sixteenths of an inch, which gives 36 1/2 inches, the circumference of the large end, and for the small I subtract three-sixteenths of an inch from 36 1/2, which equals 36 1/8 inches. I now outline all three sheets at once. To facilitate matters I draw two lines 10 inches apart. This brings them one-half inch from the sides of the sheet. I then making these curves of Figs. 35 and 36 and for Fig. 36, I draw the lines 47 inches apart. I next decide which end I intend to make the large end, and locate a lap hole one-half

I now draw the lines or ordinates between and just cutting the lines *I D E* and *K C F* through the points for rivet holes on the semicircle marked 1, 2, 3, 4. I next draw Fig. 32 complete. I next draw the ordinates in Fig. 34 through the points on the semicircle and just cutting the lines *J R G* and *I J H*. Next comes the ordinates in Fig. 33. I draw these lines through from where they cut the lines *K C F* and *J R G* in Figs. 32 and 34. I now draw the line marked center, midway between and at right angles to the center line *B C*. This completes the outline view.

Next in other comes laying out the sheets. Figs. 35, 36 and 37. I will first find the circumference and find it by a method I have not given as yet. I will reduce to a common fraction equals 34, consequently I multiply the diameter by 4, common fraction in place of a decimal. In performing this operation, I first multiply the diameter, 35 inches, by 3 inches, which equals 105 inches. I next divide the diameter, 35 inches, by 7 inches, which equals 5 inches. I now add 4 inches and 21 inches which equals 46, the circumference. As this is so little difference between it one-seventh of an inch, and one-eighth of an inch, I call this four-eighths, which reduced to its lowest term equals one-half of an inch. As No. 16 iron is one-sixteenth of an inch in thickness, I add three-sixteenths of an inch, which gives 36 1/2 inches, the circumference of the large end, and for the small I subtract three-sixteenths of an inch from 36 1/2, which equals 36 1/8 inches. I now outline all three sheets at once. To facilitate matters I draw two lines 10 inches apart. This brings them one-half inch from the sides of the sheet. I then making these curves of Figs. 35 and 36 and for Fig. 36, I draw the lines 47 inches apart. I next decide which end I intend to make the large end, and locate a lap hole one-half

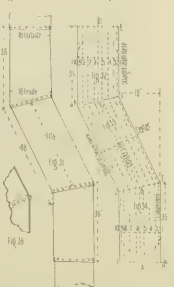

inch from the end of the sheet and the other lap hole 11 inches along the line. I now draw a center line midway between the lap holes and at right angles to the lines already drawn. I next locate the lap holes for the small end 36 1/8 inches apart, and one-half inch distance, or 36 3/8, each side of the center line on the small end. I now space off the large ends of the sheets for 18 holes, and the same for the small ends. You will notice I only require to set my dividers once for the large and once for the small ends of all the sheets. Next I draw the lines connecting the rivet holes, and in numbering the lines in Figs. 35 and 37 the center line will be No. 10 and run down to No. 1 at the straight seam. Fig. 36. As I do not wish to have all the straight seams in a line, I will start with

No. 1 at the center and end with No. 10 at the straight seam. This brings this straight seam opposite the others, and I find by referring to Fig. 31 that the small end of Fig. 35 and the large end of Fig. 37 is to be riveted directly to the stack. I will take a square and get the camber or curve

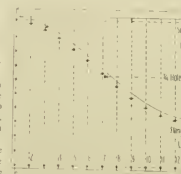
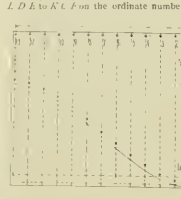
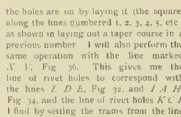

one this length I carry to Fig. 35, and setting one point at the center of the mark for the hole on number one line, I make a scratch across this line, at the other end this point just found is the center of the rivet hole wanted. As there is another number one line I also mark that,

I next find the length of the ordinate number two, Fig. 35, and mark that length on the line number two of Fig. 35. I follow along in a similar manner with numbers 3, 4, etc., to number 10. After this is completed I draw a line one-half inch outside of the holes for the lap. I then set the dividers to about 3 inches and space off the number one lines in the space between the lap holes of the straight seams for nine holes, exclusive of the lap holes. This completes Fig. 35.

I now start on Fig. 36. In this course both ends are beveled, so when the sheet is rolled up the ends conform to the angles at which the lines *K C F* and *J R G* stand. I set the trams on the ordinate number one from the line marked center to the line *K C F*. This length I carry to Fig. 36, on the line number one (which is also the center line). With one point at the line *A J*, I make a scratch with the other point across the line at the center of that rivet hole. By setting one point of the trams without having changed the setting at the center line, the other *A J*, Fig. 33, on the ordinate number ten, I now find it corresponds in length, so I set one point at the line *A J*, Fig. 36. On each of the two lines marked number ten I make scratches for holes. These are at the large end of the course. I again proceed to Fig. 33 and set the trams from the center line to the line *K C F* on the ordinate number two. I next try this length from the center line to the line *J R G* on the ordinate number nine and I find it corresponds in length. I next set one point of the trams at the line *A J* on both lines numbered two and make scratches to designate the center of the holes on the small end. Then I transfer this same length to both lines numbered nine on the other, the large end of this same sheet. I next set the trams again from the center line to the line *K C F* on the ordinate number three and try on the ordinate number eight from the center line to the line *J R G*, Fig. 33. This length I transfer to Fig. 36 on the two lines, number three on the small end, and the two lines number eight on the large end, measuring from the line *A J*. All these marks I make across the lines. I find by setting the trams from the line *L D E* to *K C F* on the ordinate number

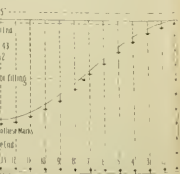
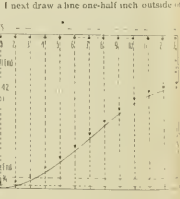

these centers as a line for shearing. I now set the dividers at about 3 inches and space off the straight seams for three holes exclusive of the lap holes. This completes this course, Fig. 36. Next in order comes Fig. 37. I will start by setting the trams from the lines *I J H*

*Formerly Boiler-Maker, U. S. A. St. P. M. Dubuque, Iowa.

Fig. 31, on the ordinate number 10. This length I transfer to the two lines number one, Fig. 37. I next find the length of the ordinate number two, Fig. 44, and transfer this to the lines number 10.

Fig. 37. I now find the lengths of Nos. 3, 4, 5, etc., and transfer them to the lines, after which I draw a line for the lap one-half inch out from the centers of these holes as a guide to shear by, and after spacing off the straight seams for ten holes all these sheets are ready to punch, roll and rivet up the straight seams. After these courses are completed, it will be necessary to flange out the long corner *G* and *K* in, and the short end *F* and *O* out; this is to make the seam on the lines *KCF* and *JBG* fit together all nice. It will not need much flanging, as the angle is slight, but give it a little round bend. See Fig. 38, which is an enlarged section at the lap. This completes the effect of elbow.

separate the laps. This locates them on opposite sides from each other. I notice, by referring to Fig. 39, that the small end of Fig. 41 and the large end of Fig. 43 must be left in shape to rivet to the other part of the stack. Consequently, I must give the rivets a certain number and have them shaped I find the center of the rivet on the line *J/K*, Fig. 40, by transferring the length between the lines *D/C* and *J/K*, on the ordinates 1, 2, 3, 4, 5, etc., Fig. 40, to the lines with the corresponding numbers on Fig. 42. Measuring these lengths from the center of the rivet holes on the small end of the cylinder and adding to each a one-half inch outside of these holes for the lap. I now space off the straight seams for three holes. This completes Fig. 42 ready for shearing and punching.

Now, for Fig. 43. I transfer the lengths of the ordinates 1, 2, 3, 4, etc., between the lines *G/A* and *H/B*, Fig. 41, to the correspondingly numbered lines in Fig. 43. Measuring from the center of the holes already found at the large end, I now mark these points with a center punch to prevent them becoming erased, and to be used as a guide for flanging. I now draw a line 1 inch out from these marks for the flange, then space off for ten holes in the straight seams, leaving the last side one-half inch from the center marks for flanging. I will next mark off the two holes in the center line *A/B* for fitting, and after the course is rolled and flanged set the two parts together and give drift pins lightly into these holes on each side, they will hold everything together nicely to work off the holes.

I will now explain how I lay out the holes for fitting in Fig. 43. Fig. 41 is a full size view of the part at B. Figs. 40 and 41, with *A, B, C* the center lines and the two diagonal lines are represented, one, *H, B, E*, the line of flanging; the other, *J, K*, the line of rivet holes. These latter lines are drawn parallel and one-half inch apart. The holes are on the ordinates or center lines *C, B* in Fig. 40. This brings them on a line at right angles to *A, B*, and measuring from one diagonal line to the other on the line *C, B*, it measures three-quarters of an inch; consequently on Fig. 43 I draw short lines at right angles to the lines *N, O* towards the center, and from the center mark on that line for flanging. I now locate the rivet holes three-quarters of an inch from the lines *N, O* on the short line.

I will now show a shorter method of making an outline view for getting the lengths of the ordinates for men who are more familiar with this work. I first draw a center line *A, B*. Fig. 45; next the lines *C, D* and *E, F*, 7 inches apart and 12 inches each side of the center line *A, B*. I now draw the diagonal line *C, B, F*, this line is at an angle of 45 degrees to the line *C, D*, the point at *F* being just the diameter of the course 24 inches from *G*, and *G* being on the line *C, B*, which is at right angles to *C, D*. I next draw two lines at right angles to *C, D*, one 12 inches from *C, D*, the other *D, A, E*, 34 inches apart and *C*. I next draw a semicircle, using the line 1-13 as a diameter. This semicircle I divide into thirteen points beginning with *N, O* at *D*. Through these points I draw the ordinates numbers 1, 2, 3 to *N, O*. Then the length on the ordinates between the lines *D, A, E* and *C, B, F* will correspond in length with the length of the correspondingly numbered ordinates in Fig. 40, which were transferred to Fig. 42 for the rivet holes, and the lengths of the ordinates between the lines 1-13 and *C, B, F* will equal the length of the ordinates between the lines *D, A, E* and the center mark for flanging in Fig. 43. These lengths were transferred to Fig. 43.

I expect the remark may be passed why I make this elbow of square courses and save the extra work of punching both the large and small ends, also the small ends 75 holes. I next space them off for twenty four holes and draw the lines across the sheet. Connecting these holes I number them 1, 2, 3, 4, 5, 6, etc., beginning in Fig. 42 with No. 1 at the center and ending with No. 30 at the straight seams. In Fig. 41 I begin with No. 1 at the straight seam end and with No. 30 at the center.

I will next take a square elbow 24 inches diameter, to be made of No. 10 iron. These elbows are very seldom used, it is not so important, principally of breaking the current of whatever passes through—like, steam, air, etc., striking against the end and having to seek a new path. Fig. 39 is a side elevation of the elbow complete. Notice that number one course is not flanged at all, consequently I will lay out all the holes in this course. In number two course I will only lay out two holes on each side on the quarter, or on the ordinate *C*; Fig. 40 I have on this marked holes for fitting. It is similarly marked

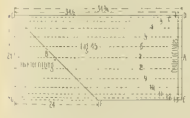

on Fig. 43. In drawing the outline view, Figs. 40 and 41, I first draw the center line *A, B*, then *B, C* at right angles to *A, B*. I next draw the lines *F, E, D* and *H, G*, 24 inches apart and 12 inches each side of the center line *A, B, C*. I next draw the line *D, A, E*, 35 1/2 inches from the corner *E*. This is the line of rivet holes for attaching to the next course (leaving one-half inch for lap as a 36-inch sheet 1/4 being used) and also the line to measure from, for the line of flanging. I now draw the lines *C, D*, 7 1/2 inches from *E*. This allows for 1/2 inch for the flange 2 1/2, and one-half inch for the lap at *F*. I next draw the diagonal line *H, B, E*, which is the edge of the lap of Fig. 40, and the line for flanging, Fig. 41. I now draw another line, *J, K*, one-half inch from *H, B, E* in Fig. 40 for the line of rivet holes. Using the lines *G, A* and *C, D* as diagonals and *A, B* and *C, B* as centers, I draw the semicircles which I divide into thirteen points for rivet holes. I next draw the ordinates and Nos. 1, 2, 3, 4, 5, etc., to 15, beginning at *F* and *D* with No. 1. I then lay out the two sheets, Figs. 42 and 43, the circumference of the large ends being 75 1/2 inches and the small ends 75 holes. I next space them off for twenty four holes and draw the lines across the sheet. Connecting these holes I number them 1, 2, 3, 4, 5, 6, etc., beginning in Fig. 42 with No. 1 at the center and ending with No. 30 at the straight seams. In Fig. 41 I begin with No. 1 at the straight seam end and with No. 30 at the center.

The reason for numbering this way is to

into the small one at the angle *H, B, E*. Necessarily when Fig. 41 is flanged it would require to be made four times the thickness or one-half inch smaller in diameter to have it enter into Fig. 40. This would take longer to flange, as the center marks for flanging would require to be flanged one more at *E*, and not over to the marks enough at *H* to accommodate the difference in the diameter. This would not make so nice a looking job when finished.

Most men, in laying out a cylinder, cut off by a plane at other than a right angle to the axis. Fig. 31. For instance here we lay out all the holes, and unless the work is performed correctly the holes will not

The Morris Exhaust-Pipe.

The exhaust-pipe here illustrated was designed by Mr W S Morris, superintendent of motive power of the Chesapeake & Ohio, and has been for some time in use on Engine No. 121. The pipe, in a general way, resembles that with which the Committee of the Master Mechanics' Association, which reported on "Draft Appliances" two years ago, obtained the most satisfactory results. It has made a remarkable good showing on the C & O engine. These engines were tested on the James River division to ascertain the relation value of the exhaust-pipe. En-

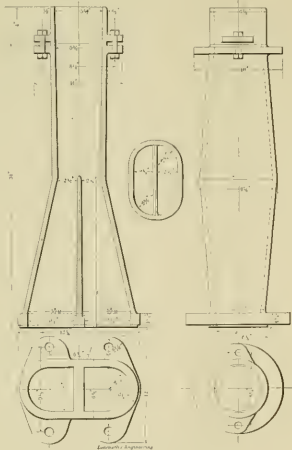

THE MORRIS EXHAUST PIPE.

come far. On this we cannot depend upon setting it in or out a little to suit, as is depended upon when the sheet is flanged and the holes not punched, but when the holes are punched, unless they are laid out and punched correctly the man who fits and rivets it together comes to the front with his gauge, reamer and profanity, especially if some one else does the laying out.

But, as before stated, most men in laying out this elbow would (as most teaching) do this by transferring the lengths of the ordinates to the correspondingly numbered lines on the sheets to be laid out, measure from a straight line used to outline and space off the holes on the end, or a straight line drawn at any other convenient point. This is the course proper for a square course. But, for a taper course you will readily recognize that the holes are placed on a curved line, so when the sheet is rolled up they are on a plane parallel to the base. Consequently, the lengths, as transferred from the ordinates, should be taken from the center of the holes at the end for attaching to the ordinary taper course to bring everything correct.

The definition of a plane in geometry is an even or level surface. The definition of an axis in geometry is a straight line in a plane figure about which it revolves to form a solid, the axis center from end to end, the axis of a cone is a straight line passing from the center of the base to the top or vertex.

Engine No. 112 had straight stack and oblique form of exhaust-pipe. No. 121 had tapered stack and new form of exhaust pipe. No. 120 is a compound locomotive. With equal duty Engine No. 125 burned 37 1/2 per cent less coal than No. 112, and 16 1/8 per cent less than the compound. This pipe combines the advantages of a single and double nozzle. At the junction of the passages the openings are reduced slightly below the nozzle opening.

A curious incident was related by Mr. Jacob Johann, superintendent of machinery of the Chicago & Alton, in remarks made at a Western Railway Club meeting. Mr. Johann said that for thirty years he had followed the practice of giving valves inside clearance instead of 1/4 inch lap with beneficial results. He went on "I took up that subject in 1863 with Mr. Hudson, superintendent of the Rogers Locomotive Works, and begged him to send me engines with inside clearance and be declined to do it. We corresponded about three months and he still persisted in having his 1/4-inch inside lap. The road I was with was not very solid financially, we were buying engines with paper, so I could not stand upon my dignity about having the engines just as we wanted them. I finally dropped the subject, and as fast as the engines arrived at the shop the valves were taken up and fixed as I wanted them. When changed they would take two more cars over the hills than they would when they had the inside lap."

LOCOMOTIVE ENGINEERING

Published Monthly by
 ANDRUS KING, Editor and Proprietor,
 JOHN A. HILL,
 GEO. W. WOLLASTON, Secy. Adv'g. Dept.

Subscription Price.

Five per year, \$10 for six months, postage paid to any part of the world. Single copies, 15 cents. Remitt by Express Money Order Draft, or by other Order or Registered Letter.

The editors reserve the right to use the material sent for the readers' use, unless otherwise stated. Correspondents must send their names and addresses, but not necessarily for publication. Mailing address can be changed without notice as necessary—always give old and new address, and if you prefer to be in a club state who get it up. Please give prompt notice when your paper fails to reach you subscribed.

Entered at Post Office, New York, as Second-class mail matter.

For Sale by Newsdealers Everywhere.

NO BACK NUMBERS BEYOND THE CURRENT YEAR.

PUBLISHERS' AGENTS.

American News Company, New York.
 International News Company, London.
 W. Williams & Pick's Bldg., Melbourne, Australia.

25,000 of this Issue Printed.

Uneven Performance of Locomotives.

The practice of running locomotives by different crews has done a great deal to dissipate the old fallacy that engines of the same general type, and of the same origin from the same templates, varied greatly in efficiency. This belief still lingers on some roads, but it is rapidly disappearing before the march of intelligence, and the conditions which assign all kinds of men to the handling of every class of engines. It used to be common to hear that certain engines were smart, while others were dummies, or one would have the reputation of steaming much better than others, and certain engines which would surpass others on a level would be called no good on a hill. It was said that they "ran into" the grade.

Trainmen are earnest propagators of the prejudices which give individuality to every engine. They repeat the increasing talk they have heard from others who ought to be better informed, and fallacies become established articles of faith.

There are the best of reasons for believing that the difference in performance would be due to prejudices respecting certain engines, was due to the man handling them and not to the machines. One man was always afraid to strain his engine. He would not open the throttle wide, for fear of putting too much pressure upon the slide-valve; he would not drop the reverse-lever a notch, for fear of hurting the piston connections. Another man, who is in decided contrast to the first, appreciates the fact that the locomotive is made strong enough to perform any work within its capacity, and he does not trouble himself with a fear of anything beyond what the engine can exert his best to make the engine do all the work within its parts. If his man works judiciously, the engine will run a game name for superior efficiency, and a name once obtained by machine or man on a railroad has nothing to do with its persistence. Between the man who in various ways coddling his engine to the best of his ability, and the man who believes in making the machine do its best, there are many gradations of personalities who put the influence of the engine obtained upon the character of the engine they handle.

When the wide variety of this personal equation is considered, it is not surprising that a firm belief took root that no two locomotives are alike in capacity, no matter if all the parts of the engines are duplications of those on all other engines in service.

Of course, there are sometimes minor defects or distortions which one or two lo-

comotives may suffer from that may make them less efficient than the others. We have known of one engine in a group that was noted as being a defective steamer and held that reputation for years, although all the others of the class were remarkable for making steam freely. A bright traveling engineer happened to reason that there must be some good cause for this, and a systematic investigation was instituted. This brought out the fact, that the exhaust pipe was out of line. When this defect was remedied the engine steamed as well as any of the others. It would be interesting to know how much fuel was wasted by this engine, because, if it was, it would not do us much good to know that something was radically wrong before she was running three months. The habit of thinking, as a matter of fact, that one engine was liable to work less efficiently than others of the same class blinded them to an imperative duty.

In another case that came under our notice, one engine never was able to do so much work as others of her class. It was the rule, rather than the exception, for freight engines on the road to be lame, and nothing was thought of this one ex- cepting as if she did not cut off evenly at both ends.

One day a traveling man who was a mechanical engineer happened to ride on the engine and he concluded that something was wrong with the steam distribution. He induced the master mechanic to let him take some indicator diagrams from the engine. It was found that the initial steam pressure on the sole was about 25 per cent. less than on the other. An examination then showed them that the steam passage in one side was more than half filled up with metal that had run in through a core collapsing.

Minor causes of certain engines are the class of valves, and that certain engines are valve setting and difference in cylinder clearance. Where there are not strict rules established about the setting of valves, those having whims on this subject sometimes get the eccentrics advanced or set back to give excessive lead or reverse. This is almost certain to have a pernicious effect.

We once encountered a curious cause which converted a free steamer into a very bad steaming engine. The engine had been in a collision, and had both cylinder heads broken. She went into the back shop for a general repair, and the foreman connected with the case, were senselessly that so he changed the pattern and made thinner ones. When she was put into service, it was difficult to get her over the road with a fast train for want of steam. The engine was also noted for rough riding and pounding in character. She was now phases in her behavior, and it was as if she had a burden and a torture to her in charge. Everything that experience and ingenuity could suggest was tried, with very little improvement. For several months she dragged through her runs, harassing everybody directly and indirectly connected with her, until one day the roundhouse foreman, who has taken the blame of many other people's mistakes, gloating in spirit, was contemplating this engine and cogitating upon the cause of her mysterious behavior. He had been running her not many years before, and taken several trips on her when she came out of the shop, and was convinced that the complaints of the engineer were well founded. As he looked at the engine he noticed that the crosshead was not traveling evenly in the guides. Thinking that the piston clearance was not evenly divided, he directed his attention to discover the crosshead and find the distorting points. When this was done, it was discovered that the piston had about 1/4-inch clearance. This was what thinned the cylinder heads had brought about. It did not require much penetration to

understand that 1/4 of an inch too much piston clearance would waste a good deal of steam, and plates were put on to fill up the superfluous space. The foreman was not absolutely sure that the large clearance was the cause of the engine's changed condition, so he did not say anything about what had been done to the engineer when he came to take out his engine. When the engine returned from the road trip, the engineer made direct for the roundhouse and asked "What have you been doing to the 317?" "Not much," was the reply, "we made some little adjustments." "What were they?" "Not much," he remarked, "but they are worth all more than my pay to the company. Why, she is her old self again, and steams better than she ever did, with half the coal she has been using lately."

Cases like those recorded are well worthy of being published, but they are really rare. In the vast majority of engines that are reputed to work better or worse than others of the same class, the man in charge is the cause of the difference. When it is considered desirable to investigate why any engine makes a strikingly good or bad record, it is always safe to begin by finding out how the man running her does his job.

The practical effect of the practice that some engineers have of coddling their engine was well demonstrated by a series of experiments carried out on a Western road a few years ago. There was a prevailing belief that certain small engines were superior in hauling capacity to some engines with smaller cylinders, and that certain engines were superior to others of the same class. A party of experts were sent out with a dynamometer car and all the equipment necessary to find out the truth about the engines. A first-class engineer and fireman were to handle all the engines. The results of the tests showed conclusively that the same was not true, and that precisely the same as another. It was also demonstrated that the tractive power developed agreed closely with the size of the cylinders. There was a popular belief that certain 17000-lb engines would pull more cars on a hill than other engines with cylinders 19000 lbs. The tests proved that the latter engines pulled more cars in a proportion close to the original superiority in power.

Getting trains up a grade depends very much on the way the engine is handled. On a long steep grade, a locomotive will take up only the weight of train she can haul on a steady pull. But on the numerous short steep grades to be found on so many railroads, the manner of approaching the same decides whether or not the engine will pull the train over. When the engine strikes the grade the speed may be thirty-five miles an hour, and with the best that skillful handling can do the speed may be reduced to three miles an hour before it has reached the grade. In a case of this kind the merit of the train when it reached the grade had helped the engine.

If the engineer, however, fails to make the engine perform its best, the speed will decrease so rapidly that an involuntary stop is made before the summit is reached. The man who does his best to take the train up the grade advances his reverse lever as fast as his judgment says is necessary after the hard pull is reached. The increased tractive effort holds up the speed to the full capacity of the engine, and the train goes over the top successfully. Another man, who is doing his best, is thinking about saving his engine, and he does not drop the lever a notch till he realizes that he is unable to get stalled. He is seldom mistaken in his fear. When the trainmen are blessing whatever has caused them the extra labor of doubling the hill, the engineer says that the train was too heavy for the hill and that the report is circulated that the 54 is not so good as the 55. It is of those who talk this way are capable of understanding the advantage gained by superior skill in handling.

Departing from Standards.

The tendency of some railroad men to depart from accurate dimensions of parts that are standard is also being brought to the attention of the average human being, to stray from the paths of rectitude. For years the engineering journals have been preaching the gospel of interchangeability, and seldom do two or three men stand up to talk in a club or convention without some allusion being made to the advantages of standard parts. It is a great pity that in such shape that one will take the place of another without fitting. The railroad mechanical air appears to be charged all the time with a sentiment advocating standard interchangeable parts, yet the vast volume of sentiment produces but a miserably small harvest of practice.

There has been so much done in the last two or three years to add those who desire to adhere to standards, that we supposed substantial progress was under way, but we were painfully undeceived in the course of visits made to manufacturing establishments within the last two months. In a brass foundry where car bearings are largely made we were shown nearly a dozen different patterns of the standard M. C. B bearings. In various establishments where they were making M. C. B standard couplers there were no efforts made to maintain the standard contour lines, without which couplers may not be expected to remain secure in tension with each other. On some roads there still appears to be great uncertainty about the exact size of standard wheels, rods, pins, taps and dies in use, merely approximate the standard dimensions. When their product is applied to the real standard article it will not go on without destructive strains, or it fits so loosely that it shakes loose on experiencing the least vibration. In many shops all the other so-called standards, in the same different dimensions, are made in the same slipshod manner, and interchangeability is incomplete. The real meaning of this condition of affairs is that there are many men in charge of railroad rolling stock who ought to be employed in less important occupations. Keeping the parts interchangeable is one of the very best means for maintaining the operating expenses low. It is not possible without any undue drain upon the sources of revenue. Where the operating expenses are made high by the mismanagement that results from multiplicity of patterns, attempts are made to effect saving in wages, and general demoralization of the service is the result.

Everal vigilance is said to be the price of liberty. This means that every man valuing his individual liberty ought to be constantly on the watch for the insidious impositions that would soon make liberty a mere by-word. The same principle applies to the performance of conscientious duty in every department of life. It is well worthy of the maintenance of the standard of interchangeability. There are many men always ready to say, "near the fit is good enough." This loose habit soon ruins the efforts towards interchangeability. To all those who favor this business-like way of having work done, but fall through depending upon subordinates, we would say eternal vigilance is your only safeguard. It is not enough to intend to exercise this vigilance, you ought not to be surprised or indignant if another man is suddenly appointed to fill your position.

There is a tendency among some of our most progressive master car builders to try and lead to an agreement on a standard size of box car designed to carry 60,000 pounds. Nearly one-half of the capacity of this capacity. The general dimensions vary very little, and there seems no good reason why an agreement should not be reached concerning the details of construction. Mr. Marden, of the Pittsburg, is very warmly in favor of this new standard, and his views are being advanced by the most men in the country. As a matter of fact, his direction Mr. Waitt, of the Lake Shore,

favor that the M. C. B. Association unite on standard timbers for a 60,000-pound car. Even this would be an important move in the right direction, for builders, and railroad companies could save their timber and keep the most important part in stock, which would insure the use of seasoned timber in new cars. Under the existing confined state of affairs new cars are nearly always built of indifferently seasoned timber, and the cars fall to pieces in a few years. Anything which would effect an improvement in this matter would be of benefit to railroads.

Short and Long Valve Travel.

In his paper on "Steam Distribution for High-speed Locomotives," Mr. C. H. (nearly) engineer of tests of the C., B. & Q., takes a decided stand in favor of long valve travel locomotives. He says that by the means of increased valve-cylinder-pressure may be obtained without raising the boiler pressure. If the valve travel is increased without increasing the outside lap, or the outside laps is not increased out of proportion, not only is the port opening increased for a given cut-off, but the ports open more quickly, the result being that the longer travel gives a higher steam-pressure in the cylinders. The longer valve travel gives also a later exhaust opening, later exhaust closure, and a larger exhaust opening, all necessary for high speeds and economy. He then proceeds to show, by diagrams worked out from actual practice, points which seem to substantiate his views. Some particulars are also given of a locomotive, noted as a coal eater, which was cured of her wicked characteristics by changing the valve travel from 5 to 5½ inches.

For years the writer entertained views about valve travel substantially the same as those advocated by Mr. Quereau, and as those are based on entirely the same reasons. Any one familiar with the movement of valves is aware that increasing the travel accelerates the velocity of the stroke, with the result that a better port opening is obtained, while protracting the periods of release and valve closure. It would produce a more efficient use of the steam, and that saving of fuel is inevitable. The trouble some thought about this improvement was that one very rarely found it put in practice, where complaints did not follow that the engines became noted as coal eaters. This is a result which seemed contrary to all reason, but we have heard of locomotives more efficient use of the steam, in such reliable authority that we have seen, to advocate long valve travel as a means of improving locomotives.

There was a series of experiments conducted on the C., B. & Q., by Mr. Philip W. Wallis, about seven years ago, to find out the effect of increasing the valve travel. The records made did not seem to corroborate the data given by Mr. Quereau. The trials were made with various engines on different kinds of service, but in each case the same engine was tested with short and long valve travel. They took an engine with 5-inch travel and tried it at certain speeds, then they changed the valve travel to 5½ inches and altered the cut-off, so that the cut-off could be adjusted. This engine was then put to perform the same service as it had done with the shorter valve travel and the performance recorded. One man handled the engines all the time, and every possible care was exercised to make the conditions of operation uniform. The test results compared with much thoroughness, and the deductions drawn from the records were that changing the travel did not make any perceptible difference in the working of the engines. We never regard the findings of tests made with locomotives as absolute proof, but they are of great value, and the conclusions of the tests made by Mr. Wallis may safely be put in the scale to bal-

ance the opposite conclusions arrived at by Mr. Quereau and others. The experience of men with engines in general service, and the performance sheets, seem to show that increasing the travel makes a locomotive more expensive on fuel.

Locomotive Laboratory for Cornell University.

The attention which the laboratory testing of locomotives has excited all over the country has induced the directors of Cornell University to consider favorably a proposal to build a locomotive testing laboratory at Ithaca, at a point where locomotives from three or four different railroads having lines touching could be run in and tested. The laboratory would, of course, be an adjunct of Cornell University. The work of testing the locomotives would give excellent educational training to the students, and might be made a commercial enterprise to earn enough money to defray all the expenses of the laboratory. The plan of establishing a testing laboratory on a commercial basis, we believe, originated with Dr. Thurston. The remarkable success achieved by this able professor of engineering, in all the enterprises he has advocated for developing the resources of instruction, is a good guarantee that the testing laboratory will prove a success in every respect.

Plans of the buildings required, details of the machinery and apparatus necessary are under consideration, and the intention is to establish a plant which will be complete in every particular. The experience with the locomotive testing laboratory at Purdue University will be of great service to the Cornell University people in working out their plans, but the intention is to make this laboratory much more complete and comprehensive than the other. Mechanical engineers with extensive experience in the testing of steam plants have been studying all possible methods of testing locomotives and their results as correct as the records of stationary engine tests, heavy apparatus that can be devised to make the test perfect will be introduced into this laboratory.

We believe that if railroad companies once began to send their locomotives to a laboratory where they could be accurately tested, that the practice would rapidly increase, and that the program of engines would derive much profit from having the engines started out in improved condition. The increasing introduction of the compound locomotive appears to have created a demand for more accurate methods of testing this form of engine, but we believe that the simple locomotive would derive sufficient benefits from laboratory tests to return a good profit on the cost incurred. When establishments of this character get into proper working order, many of the unsettled problems connected with locomotive operation will have light thrown upon them. Others that are little thought of will be discovered and remedied. The great advantage of knowledge has made very expensive. We anticipate that some of the most valuable work done by testing laboratories will be on old worn-down locomotives that are known on the road as scrap heaps.

It would be very edifying and instructive to see how much of the extra effort is lost in a locomotive that has all the troubles now so common that are all of different size. The figures would probably appall the men responsible for operating expenses, and would be the means of sending many engines to the back shop that otherwise would have remained for repair and returned to the road. The loss of, and wasting steam by internal friction. Disorders of valve-gear and of pistons that are endured because the cost is not counted, would probably be quickly cured if the exact resulting loss were known. There are scarcely any propositions of the locomotive that have not been settled as being productive of the best performance for different conditions.

Even the size of an engine best suited for certain trackage is a matter settled by personal preference, which is frequently against the interests of the company. Of late years there has been a tendency toward larger engines. The policy followed is, design the engine large enough and then add about 20 per cent. to its capacity. Accurate tests would demonstrate that this policy is largely for the work to be done, is one of the most expensive fallacies of the day. But these details merely begin to tell about the work that could be done to improve locomotives, were exact facts obtained as to the effect of disorders which are scarcely supposed to be serious blemishes.

Parts Which the Owners of Cars Ought to be Responsible For.

To judge from the discussions concerning changes necessary in the Rules of Interchange of Cars that have been going on lately, there is a desire that changes should be made holding the owners of cars responsible for oil-box lids, M. C. B. coupler knuckles, and air-hose burst or worn out. We consider that the changes mentioned would be entirely equitable. The change would be highly seasonable at this time because there is a strong tendency on the part of certain roads to purchase the cheapest kind of appliances for rolling stock. Knuckles are of inferior material are much more liable to break than those that are first-class. In addition to this there are certain knuckles that are peculiarly susceptible to breakage owing to weak forms. Railroad companies handling foreign cars ought not to be held responsible for the breakage of such knuckles. Similar reasoning applies to the loss of oil-box lids. Some box-lids are of bad shape and secured poorly. They are not designed properly, and therefore the owners ought to bear the expense of replacing them when lost. The cheapening process has exerted in many quarters a bad influence on the character of the hose used for air-brake purposes, and has no justice inflicted in holding the owners responsible for replacing all defective hose.

Amending the Rules of Interchange of Cars.

The various railroad clubs have lately been discussing the feasibility of making amendments to the rules of interchange of cars, with a view to reporting recommendations to the Master Car Builders' Association, for the purpose of discussing the proposed changes at the approaching convention. Not being the car representative of any railroad, we suppose it would be proper for us to recommend a general amendment to the rules. We will, however, venture to make it in a sort of free-lance fashion. Our amendment is that the parties subscribing to the rules try to live up to them. If this advice were followed, it would be the greatest reform carried out since the fashion of making rules for the interchange of cars was introduced. We believe that on the whole, the interchange rules patched, altered, squabbled over and amended at every meeting of the Master Car Builders' convention have been beneficial to railroads, because some officials would feel it their duty to adhere to the fashion, more or less conscientiously, to the rules they have helped to establish. But this duty has rested with astonishing levity upon the shoulders and consciences of most of the members of the Master Car Builders' Association. The common practice has been to establish the rules at the annual conventions for the establishment of certain rules, and then go home and pay no more attention to them.

In looking at the disputes which arise over the interchange rules, we find that those who have taken the most active part in establishing the rules, have not only not been the readiest to do things which led to appeals to the Arbitration Com-

mittee. What strikes an outsider, looking at these disputes from an equity standpoint, is the utter absence of fairness on the part of the officials who struggle to get the best of interchange roads. With this impression strong upon us, we would suggest that the members of the association form themselves into a conscientious Committee of the Whole, and direct impassioned appeals toward a general reformation. The most impressive text would be, "Obey the rules and adhere to them." The most radical changes are generally recommended by men who have never studied or tried to obey existing rules.

BOOK NOTICES.

LOCOMOTIVE MECHANISM AND ENGINEERING. By H. C. Rogbin, Jr. John Wiley & Sons, New York. Price \$2.

The ground covered by this work has been gone over in many different forms in the past. The author, a practical locomotive engineer, has put a new dress on the subject, and one that can be readily understood by the new beginner in locomotive service. Commencing with the boiler, a description of the locomotive has been divided into parts, and the clearness and technical language, a clear description of the part is given. Following, and while the description is fresh in the mind of the reader, a catechism is given that relates to the management of it. The same rule is followed in relation to the superheater, the cylinders, the pistons, the injectors, oil-cups, etc. The clearness in which the work is written should make it a good elementary book for beginners in locomotive service in the shop or on the road.

HEAT AND STEAM. By Charles H. Benjamin. Charles H. Holmes, Cleveland, Ohio.

This is a very compact little book, treating with various measurements of heat in an interesting fashion. It comprises chapters on heat, combustion and fire, chimneys, thermo-dynamics and steam. It contains nothing of a novel character, but the subjects are treated in very compact shape, and several very useful tables are given relating to steam, character of coal, etc.

ART OF COPPERSMITHING. By John Fuller, Sr. David Williams, New York. Price \$3.

This is a profusely illustrated, practical book on the art of copper-smithing, which will be found of great service to workmen engaged in this art. It is essentially a book of instruction, and covers a large field. It is written in a very simple and comprehensive manner, suitable to the requirements of people engaged in this trade.

The American Institute of Electrical Engineers has issued the tenth volume of the report of that institution. The report makes a handsome volume of 219 pages, and embodies all the transactions of the Institution for the year 1893. The reports of the committees, the reports of the committees allotted to them, the papers read, and the discussions on them are particularly interesting in this volume, and in this age of electricity, not only to the electrical engineer but to the mechanical engineer and the many interested in electrical matters. In addition to several annual committees and papers read, an appendix to the present volume gives a summary of the units, terms, symbols and definitions of terms, electrical congress, extracts from the recent report of the British Board of Trade, committee on electrical standards, and the report of the committee on power will make the volume of particular interest to mechanical engineers, but taken as a whole, the volume is one that should be on the shelves of every engineer and electrical student. The report is published by the Institute at its office, 10 West Thirty-fourth street, New York City.

PERSONAL.

Mr. H. L. Bucklen, president and holder of the Elkhart & West, has taken charge of the operation of the road.

Mr. N. E. Lyons has accepted the agency for the Vulcan Iron Works, Wilkes-Barre, Pa. He has moved his office to No. Liberty street New York.

Mr. Geo. O. Manchester, formerly of the A. T. & S. F. R. R. Co., has been elected vice-president and treasurer of the Saratoga Co., Chicago.

Mr. H. F. Parke has been appointed superintendent of car service of the Fort Worth & Denver City, with headquarters at Fort Worth, Tex.

Mr. William B. Page, road foreman of engines, has been appointed assistant master mechanic of the Pennsylvania Railroad shops at Jersey City.

Mr. R. W. Folger, formerly superintendent, has been appointed general manager of the Kingston & Pembroke, with headquarters at Kingston, Can.

Mr. G. Hays, division roadmaster of the Burlington, Cedar Rapids & Northern, has been appointed deputy engineer, with headquarters at Cedar Rapids, Ia.

Mr. C. H. Chappell, general manager of the Chicago & Alton, was on April 24 discharged as president of the road, succeeded by Mr. J. C. McMullin, resigned.

Mr. F. Hackworth Young, who has been some time in charge of the water service of the Mexican Central, has accepted a position with the Central Pacific.

Mr. William Byrd Page has been promoted from road foreman of engines, to be assistant master mechanic of the Jersey City Division of the Pennsylvania Railroad.

Mr. W. H. Taylor, formerly of the engineering department of the N. Y. S. & W., is now master mechanic of the Wilkes-Barre & Eastern R. R., located at Stroudsburg, Pa.

Mr. Ross Mackenzie, formerly assistant superintendent of the Eastern Division of the Canadian Pacific, has been appointed general manager of the Niagara Falls Electric road.

Mr. A. T. Hill, formerly superintendent of signals on the New York Central, has accepted the position of superintendent of the Atlantic City Railroad, with headquarters at Atlantic City, N. J.

A notice from Superintendent of Motive Power Hickey, of the Northern Pacific, intimates that the production of Mr. J. E. Pachen, master mechanic, has been extended over the Missouri division.

Mr. R. O. Cramback, formerly general foreman of the Illinois Central R. R., at Amboy, Ill., has been transferred from that place to the Clinton shops of the same road, and will continue to hold the same position.

Mr. F. T. Hatch, engineer of maintenance of way of the Pittsburgh division of the Pennsylvania lines, has been appointed superintendent of the Michigan division of the Vandalia line, to succeed Mr. N. K. Elliott, promoted.

Mr. George Collins has been appointed general superintendent of the Central Ontario, with headquarters at Trenton, Ont., to succeed Mr. J. D. Riddell, resigned. Mr. Collins has been elected as secretary and treasurer of the road.

Mr. W. E. Looney has resigned as master car builder of the Louisville, Evansville & St. Louis, and that office has been abolished. Mr. J. K. Lape, superintendent of motive power, will have charge of the motive power and car departments.

Mr. C. M. Mendenhall, who has been for several years assistant master mechanic of the Madison shops, of the Pennsylvania Railroad, near Jersey City, has been promoted to be assistant superintendent of motive power, at Jersey City.

Mr. Jas. McNaughton, superintendent of motive power of the Wisconsin Central, has had his jurisdiction extended over the car department. The headquarters of the car department have been moved from Stevens Point to Wauskeha, Wis.

Mr. J. M. Egan, the well-known president of the Chicago Great Western, has resigned. It is understood that the cause of his resignation is due to a difference of opinion with the directors in regard to the best policy for operating the road.

Mr. John Mackenzie, superintendent of motive power of the Nickel Plate, has been visiting in California and making a tour of the Western country, where he did some of his most exciting work as a railroad officer when the transcontinental lines were being organized.

Mr. John J. Bingley, who has been for the last eight years with the Eastern Vermont Brake Co., of Waterbury, N. Y., has resigned and removed to Hanover, Pa., where he previously had his home. Mr. Bingley has had thirty years' experience in the mechanical department of railroads.

Mr. John H. Parsons, who has been for the last eight years with the Eastern Vermont Brake Co., of Waterbury, N. Y., has resigned and removed to Hanover, Pa., where he previously had his home. Mr. Bingley has had thirty years' experience in the mechanical department of railroads.

Mr. W. H. Parsons has been promoted to be road foreman of engines of the Long Island Railroad. Mr. Parsons has been a good friend of LOCOMOTIVE ENGINEERING. One of his associates, writing about Mr. Parsons, speaks very highly of the appointment, and anticipates a bright career for him.

Mr. J. H. Moore, general foreman of the Erie shops, at Elmira, N. Y., has been promoted to be master mechanic of the Buffalo shops, succeeding Mr. Jas. P. Hubbard, deceased. This is another step in the policy introduced by the Erie people, of making all promotions from their own staff.

One of our correspondents is anxious to learn the whereabouts of Thomas D. Simpson, an old master mechanic, who left the Michigan Southern to go to Cuba. If any of our readers in Cuba or elsewhere know Mr. Simpson is still alive, and where he is located, they would confer a kindness by sending particulars to this office.

Mr. S. W. McMunn, the well-known railroad supply man, has been appointed sales agent for the Otis Steel Company, with headquarters at Chicago. Mr. McMunn is one of the best known representatives of railroad supplies. He was for years with the American Brake Company, and for the last six years has represented Carnegie, Phlips & Co., of Pittsburgh.

The necessity for reducing expenses has induced the Illinois Central people to close their machine shops at Amboy, Ill., and extend the jurisdiction of master mechanics to reduce the personnel. This has crowded out Mr. J. N. Santorum, master mechanic at Clinton, Ill., and Mr. McManis, takes his place. Mr. E. O. Dana, master mechanic at Freeport, has received charge of the mechanical department of the Amboy Division.

Mr. C. A. Hammond has accepted the position of eastern manager of the National Switch and Signal Company, with headquarters at New York. Mr. Hammond was for years superintendent of the Boston, Reverse Beach & Lynn Railroad, and is most of all available for such close management. He has for years made the theory and practice of signaling a special study, and is regarded as authority on the subject. He is secretary of the Superintendents' Association.

One of the funny spectacles of last month was the alleged portraits of the leading members of the Central Railroad Club, which appeared in a Buffalo paper. President Wait is the leading figure, and is standing up like a reformed pugilist, ready to fall back upon his former pugilistic career. Secretary Spear is seen calling the roll, and looking as if he had just swallowed the minutes and that he had not agreed with him. Fred Griffith is represented pushing an enormous cigar into the neck of Mr. A. E. Mitchell, who does not seem to enjoy the operation. Vice-President Higgins and Mr. E. D. Brommer are looking fiercely at each other, and no reason assigned why the relations should not seem cordial. We identify the personages in the same way that a juvenile artist indicated the character of his work, by saying "this is a horse," when others might have thought it was meant for a cow. If the names had not been appended, we never should have recognized our old friends.

Less than a month ago the writer spent a very pleasant hour with Mr. E. B. Wall, assistant general manager of the Western Pennsylvania lines. Mr. Wall seemed as bright, cheerful and in as good health as we had ever seen him, and it was a great shock a week afterward to learn that he was dead. He died from the result of the shock following an operation for appendicitis. Mr. Wall was a graduate of Stevens Institute of Technology, at Hoboken. On leaving the school he went as an apprentice to the Pennsylvania shops at Altoona, Pa., and remained there four years. He was then appointed chief draughtsman of the Pittsburgh, Cincinnati & St. Louis, and a year afterward was appointed to be assistant superintendent of motive power of the same road. He displayed so much ability in this position, that a few months afterward he was made superintendent of motive power. This position he held for about ten years. Before the opening of the World's Fair, last year, he was appointed to be assistant to the president to look after the unusually heavy train service. About the beginning of this year he was made assistant general manager, with supervision over the purchasing department. Mr. Wall was particularly familiar to mechanical railroad men, owing to the struggle which he carried on in the case of car builders' convention for years, to promote the Pennsylvania ideas, particularly the adoption of the Janney type of coupler. When the Master Car Builders' Association put itself on record as favoring a vertical plane coupler, it was due principally to the masterly efforts of Mr. Wall, who pushed through the resolution of a majority of the convention being against him. We do not think that any young railroad man of the present day had such a bright prospect as that enjoyed by Mr. Wall, and it seems very sad that he should be cut off in the prime of life and in the portals of his career. He was so good a kind of man who made friends everywhere, and his premature death will cause widespread regret.

The officers of the American Railway Association elected for the ensuing year are—President, H. S. Haimes, first vice-president, E. B. Thomas; second vice-president, W. F. Merrill. For members of the executive committee, C. W. Bradley, G. W. Steves.

A rather interesting improvement on angle-cocks has been developed by William Ogan, of Dayton, O. He bores about 3/16th holes around the top of the cock and then drills another, about 1/16th, down through the top so as to intersect all the others. This long hole is tapped and a small pet cock is put in.

When the handle is turned, the pet cock is slightly raised, and hence the holes to the pet cock are in a dense atmosphere, setting the brakes. To prevent setting the brakes on the angle-cock of the last car, the pet cock is kept closed.

Notice.

The three Educational Charts go with subscriptions for 1904. Any old subscriber renewing to the end of year or more will be entitled to them all. New subscribers must commence their subscriptions not later than March. Club raisers will govern themselves accordingly.

SINCLAIR & HILL.

Fast Run with a Ten-wheel Engine.

Nearly all the notable fast running done in this country of late years has been with eight-wheel engines, but a brilliant exception to this rule happened last month in a very fast run made by the Vanderbilt party passing over the Lake Shore road. The engine was a ten-wheel Brooks, of the kind employed on that road for heavy fast passenger service.

The run from Cleveland to Erie, a distance of 95 1/2 miles was made in 95 minutes, including a 4-minute stop at Ashtabula for water, and a 10-minute stop for the 5 1/2 miles, or 91 minutes. The next was an 88 miles run, which was made in 82 minutes, including another 4-minute stop. The remainder of the trip to Buffalo was made at about the rate of 70 miles an hour.

The Chicago, Rock Island & Pacific have made arrangements to put the McNaughton fire kindler into thirteen of their roundhouses. The Burlington, Cedar Rapids & Northern are putting it into their principal roundhouse at Cedar Rapids.

The engineering department of Cornell University have placed an order with Mr. A. L. Donnell, the artist, who made the drawing of our Chart No. 2, for one to be drawn sixteen times the size of our picture. This will be used for educational purposes in Sibley College. The picture has excited great admiration in all quarters, and thousands of them are framed and set up in railroad offices for the purpose of reference.

The management of the Rock Island road appear to consider it a good thing to encourage their trainmen to do all in their power to prevent robberies. In pursuance of this policy, they called Engineer J. D. McKinley, to Chicago, last month, and presented him with a handsome gold watch and chain, as a token of their appreciation for his bravery in preventing a robbery of his train near St. Joseph, Mo., in last March.

The Pittsburg Railroad Company have arranged to provide transportation to the Saratoga conventions for all members and their families who find it convenient to travel by that road. Colonel Ewing, a general superintendent, has displayed a warm interest in providing all conveniences for members going to the convention, and Mr. J. W. Marden, superintendent of the car department, and Mr. John Medway, superintendent of motive power, are both doing all they can for the accommodation of the members.

Three railroad men from New Orleans attending the last Mardi Gras, and they went into a hotel for dinner. A waiter who came to serve the party was a Mexican, and he made bad blunders in his English, and Col. Meahan began speaking to him in Spanish. The Colonel had spent several years in Cuba and speaks Spanish like a native. The waiter was emotional in his pleasure at finding a man to speak to in his own tongue, and the others looked on in amused admiration. After they talked for some time, filling the air with the rattling R's, Carroll exclaimed "Well! well! I never knew before that Meahan could talk like that in that style. Why he ought to be given a medal and made speeches to the Home Rulers in their own language."

EQUIPMENT NOTES.

The Florida Southern have ordered three passenger engines from Brooks.

The Savannah, Florida & Western are ordered in the market for ten first-class coaches.

All of the 300 cars built by the Locomotive Co. for the Fitchburg road have been delivered excepting five.

A full complement of twist drills and bits has been supplied to the United States Central Columbia, by the Cleveland Twist Drill Co.

The Newark Car Co. are building for the N. J. S. & S. coal ten special cars for heavy coal traffic. These cars are built to suit a special specification.

A correspondent in Buda, Ill., claims that a plumb-bob recently described in these pages by John Bourke, Kau., was invented by John Barrett, one of the pioneer railroad men of this country.

Hilles & Jones Company, Wilmington, Del., have sent out a neat illustrated catalogue, showing their punches and dies. The principal tools are shown in half-tone engravings and the punches by wood-cuts.

A rather ingenious switch-rod has been patented by Mr. John Wolter, yard-master of the Pittsburgh & Lake Erie, at Youngstown, O. The rod has a turnbuckle in the middle, which makes adjustment very easy.

We learn from the Leach Sanding Apparatus people that they have lately applied their sanding device to seven new road-ways and that they are putting it on at the rate of about thirty sets a month. Those who are using the device speak very highly about its efficiency.

The Wisconsin Central are prepared to fit up their entire trains with vestibules and electric lights. The intention is to use them on the limited between Chicago & St. Paul. A novelty in connection with these trains is that the vestibules will be applied to the tenders of the engines.

The Joseph Dixon Crucible Company, Jersey City, N. J., have lately issued an excellent interesting pamphlet on the subject of graphite for lubrication, in which they have embodied a generous amount of scientific and practical information. This pamphlet may be had for the asking by all who are interested in the matter of improvements in lubrication.

There was a convention of the Railway Abstracts Men's Association held at Columbus, O., last month. President Farmer presided and a very profitable convention was held. A notable feature about the discussions on air-brake matters was their practical character, all those taking part manifesting a desire to impart to all concerned a more accurate knowledge of the mechanism and proper way to handle air-brakes.

Rather a unique form of directing attention to the National Switch and Signal Co.'s equipment has been tried by Mr. Charles H. Hart, western manager of the company, with office in Monahan Building, Chicago. He sends out an annual free pass close imitating the railroad annual. This pass is between danger station and safety station, and the holder is politely invited to visit Mr. Hansel's office, to see how it is done.

A new concern, the Detroit Twist Drill Company, was organized on April 9, 1904, with four stockholders, who are the directors of the company. William Reed, president; Harry S. Hildreth, vice-president; Charles M. Swift, director; N. G. Williams, Jr., secretary, treasurer and general manager. Mr. Henry F. Hiller continues as

general superintendent, and the concern will be represented among the trade by Donald Churchill. They have installed facilities for turning out all kinds of drills and kindred tools.

From a Pittsburgh paper we learn that the Tyler Tube Works, of Washington, Pa., have purchased additional land for the purpose of extending the works. Notwithstanding the hard times, the Tyler Tube Works have not closed down, or very greatly reduced their output. It is said to be the only plant of the kind in the country which has been in steady operation during the past year. It is running one turn in the tail race, and double turn in the rolling mill at present, giving employment to 340 men.

We have recently received several catalogues from parties in the railway supply business which are not made according to the standard classed under the Master Car Builders' and Master Mechanics' Associations. We would like to suggest to parties making catalogues that they would serve their own interests by adhering to the standard sizes, because most of the heads of the mechanical departments are getting cases made to hold standard sizes of engines, and the tools they do not conform to these sizes are likely to find their way into the waste basket.

The Maine Central Railroad is known to be one of the best managed properties in this country, and it is noted for the fine work done by its inspectors. At the annual inspection last year, the Railroad Commissioners reported that the rolling stock of the Maine Central is in all respects first-class. None better can be found on any road, nor any kept in better condition. Large additions of the best to be procured, have been made in motive power and in cars during the year. The station buildings are models of design, comfort, convenience and general appearance.

In the course of a letter from Mr. E. C. Spaulding, general manager of the Southern Iron Car Line, he says that the iron car has been generally condemned on account of the trouble which it has experienced in ordering castings, and the delay to the cars until these castings were received. The mechanics did not have the time to analyze the trouble and see just what part of the car was faulty. From records covering four years, we find that 93 per cent. of all the castings ordered were required for repairs to our draft-rigging. We have overcome this source of weakness by the application of a heavy wooden sub sill under our cars, between the bolsters.

The Michigan Central Railroad Co. have been using a system of car heating which the Consolidated Car Heating Co. claimed to be an infringement of their patents. The railroad company contended this claim and the case went into court and was decided last month against the railroad company. The Michigan Central claim that many railroad companies do very unfairly towards patents of the appliances they put into use. Many of them are using patented articles, under the impression that the owners will not go to the great expense of upholding their rights in the courts. This is the case with the Michigan Central Co. is a vindication of justice and ought to be a lesson to many others.

Shortly after the Morris box lid was put on the market, a number of manufacturers and railroad companies began appropriating it without troubling themselves to pay royalty. The lid is very simple, durable and efficient, and naturally its good features appeal to that class of men who like to obtain things for nothing, and the other class who have a tendency to take the possession of their neighbors' goods. Unfortunately railroad rolling stock bears very strong traces of this unscrupulous

way of doing business by different companies, as manufacturers. The Morris Box Lid people bore the infliction for a few years, but at last they have turned, and have entered suits against the Drexel Railway Supply Co., of Chicago, Pennock Bros., of Cleveland, and others.

At the last meeting of the American Railway Association, a committee on train rules was formed in order to make a study of the number of changes in the code of train rules, which was adopted about five years ago. The changes recommended were framed with the view of making the rules more intelligible, and less open to misconstruction. When they came up for discussion, decided opposition was manifested towards making any changes. There appeared to be a hope and belief that no change should be made on established rules, unless the call for it was decidedly urgent. It was considered a good plan to let the members consider for six months the proposed changes, and then if they considered that changes were desirable they could take action to that effect.

In a report submitted to the American Railway Association it was shown that 236,814 freight cars have already been fitted up with air-brakes, and that there are yet 776,724 yet to be fitted. There are 242,983 cars fitted with automatic couplers and 720,355 yet to be fitted. There are 25,212 locomotives equipped with power-brakes, and 5,016 that are not so fitted. This represents cars and locomotives belonging to roads that are members of the American Railway Association. This shows that the application of power-brakes to locomotives has been exceedingly rapid within the last few years. The application of brakes and automatic couplers to freight cars proceeds very slowly, but nothing else could be expected at present with the small earnings that most of railroad companies report.

On the Long Island Railroad they have a good many cast steel driving-wheels which are in high favor and are likely to be steadily increased as the cast iron centers of other engines break and call for renewal. A rather curious thing in friction was discovered by the use of these driving-wheels. The driving axle-holes of many of the engines are weak, being rather small, and steel was tried on account of its superior strength. As usual when steel driving-boxes are introduced, there was immediately trouble from the boxes, cutting the wheel hubs, and brass liners had to be introduced. It is found, however, that cast steel wheel centers will run with cast-iron boxes without any more wear than there is when wheel-center and box are both cast iron. It is strange that the steel and iron rubbing together will cut in one case and not in the other.

At a meeting of the Railway Associations, held in New York City last month, President Himes, in his opening address, devoted attention to the question of how shall operating expenses be reduced? At least that was the subject of the address, but the real question discussed was, When will rate cutting cease? He holds that human ingenuity has done its utmost to give cheap transportation by rail, and that that which can be done in the way of reducing operating expenses. He made some very plain talk about the railroad officers who are always ready to cut rates to avoid business. He spoke of the readiness to reduce rates already ruinously low, and expressed the belief that the time has arrived in the management of this country's resources and of its railroad system, when such a policy in the management of competitive traffic cannot be persisted in without disastrous consequences.

We are informed by a correspondent in Montana that the Butte, Anaconda & Pacific, which was built by the great

Northern Railway Co., is already losing a flourishing business. The man here is twenty miles long, and parallels the Montana Union for twelve miles, and then proceeds on much better grades than the latter road. In the way of motive power the road has started out with one 3-wheel, three 4-wheels and five switching engines, all built at Brooks'. They are using Rodgers' trucks, and the road is very well equipped. The company have built a ten-stall round-house at Butte, also coal sheds, sand-house, water-tanks, etc., and it is expected that they will build machine shops in the early spring. The leading officers of the road are Mr. M. Donahue, general manager; Mr. J. H. Himes, superintendent; and Mr. George Henderfast, master mechanic. It is reported that Mr. Copeland is about to resign.

Accepting the Teaching of Reports.

A very good suggestion was made by Mr. G. W. Rhodes, of the C. B. & Q., in some remarks he made on a paper which has been read before the Western Railway Club. He said: "The important question is, How are we to derive the greatest benefit from the reports and statistics that so many of the members as can ought to get copies and present them to their master mechanics, and the suggestion made, Do not try to read it all at once. Take it, part by part, and read it three or four times, and then if you get it thoroughly mastered, put some of its teaching into practical application."

This is a line of instruction greatly needed concerning all the reports and statistics that take place at all our clubs and conventions. The records of experience, the confessions of mistakes, and the logic of experiments ought to carry valuable lessons, but in nearly all instances they are practically unappreciated and are quickly forgotten. In carefully watching the field of results we have been forced to the conclusion that no seed produces such a sterile harvest as the proceedings of clubs and conventions. The sentiment that the information brought out at technical meetings is intended for practical application is not only unappreciated but is usually practiced. Men who attend these meetings or read the proceedings have often a better way pointed out than the path they are following, but somehow they vaguely conclude that the better path is intended for some one else. A little self-examination would often show them that no one is needing the new way so much as themselves.

Wabash passenger engineers have been cut from \$5.50 to \$3.15 per hundred miles, through freight engineers, from \$4 to \$3.50, local freight engineers, from \$5 to \$4 per day, local freight firemen, from \$2.75 to \$2.25, passenger firemen, to \$1.75 per one hundred miles, and freight firemen to \$1.25 per one hundred miles. Conductors are cut in the same proportion.

We have at hand the fifth statistical report of the Interstate Commissioners on the Railroads of the United States. The information given and form used is the same as in previous reports, and needs no words of commendation at this time. Statistics are useful rather than entertaining reading, but to the railway man the reports are both when presented in the clear and comprehensive form that they have been by the complicity of this work.

The latest theme of talk among engineers in Chicago is the passing of the Engineers' Examining Board of the city by a young woman named De Barr, who has received a certificate of competency as an engineer. As a mild suggestion we would remark that skirts are not safe articles to wear among machinery. We have no doubt, however, that a young woman who has prepared herself to pass an examination as an engineer is equal to the sacrifice of abandoning flowing garments.

A Bit of Railroad Geometry.

BY JOHN H. JOYNER.

A few years ago there appeared in a Chicago newspaper a question in effect like this: "If a point be taken on the tread of a 5-foot locomotive driving wheel, what distance will that point travel through the air in going from Chicago to Milwaukee, supposing the distance between the two places named to be eighty-five miles?"

I took some pains in replying to this, turning extended mathematical detail, and sent the same abridged by post. To that I received reply after reply, each containing something about the facts of the case; it was simply an "ad." to call public attention particularly to their road and that it had the effect intended.

The effort brought out quite an array of geometrical data, which I believe will pay to reproduce and transmit for your readers, first promising that I will make the whole matter so plain that he who runs may read and understand.



I will, therefore, without further preliminaries, proceed to lay down the lines of it, explaining in simple language the course and value of each.

If a circle roll along a straight line, a point on the circumference of this circle describes a curve, which is called a cycloid (a Greek word which means *wreathlike*).

This curve is one of the most interesting we know, in respect both of its geometrical properties and of its application in mechanics.

In Fig. 1 we have shown such a curve, as well as the simplest, because most practical, way of producing it. If the curve desired is to be of a certain height, say $C D$, then we must take a circle plane of any convenient material at had having a diameter equal to $A B$.

To this circle plane a point or pencil must be placed at its edge, say at B , and locate the same on the straight surface $A B$. If now we roll this circle upon $A B$



from B to A without allowing its circumference to slip the point will describe a curve shown by $B D A$.

The terminal A , making the completion of the curve will also make the line $A B$ in length equal to the circumference of the circle which rolled over it. The height and middle of the cycloid will necessarily be at D .

This curve $B D A$ marks the path and distance traveled by the point on the locomotive wheel noted in the question, while the line $A B$ marks the path and distance made by the driving wheel and the train for every revolution of the driving wheel. Now, to obtain the distance traveled by each, the case is very plain for the wheel and train, as with a 5-foot driver, each revolution moves the wheel and train 15.7 ft., which is the circumference of the wheel (proving it don't slip, an infirmity of the tread). But how is it with the point on the inside of the wheel? What distance does it travel through the air while the wheel makes one turn?

Here is where the work of the geometer comes in. The length of the cycloid is found to be exactly four times the diameter of the circle that describes it, in this case it will be 50 ft.

Now, we have the two units of measure by which the question can be answered—

when the train travels 15.7 feet the spot on the driver travels 50 feet, and with the knowledge of this property of the cycloid other examples, including other diameters of wheels and road distances may be easily solved.

One of the most interesting properties of this curve is, the time required for a body to descend from rest from any point, as L , O , or N (Fig. 2, in the arc of an inverted cycloid), to the lowest point of the curve at M , is the same from whatever point of the curve the body begins to descend. This property is sometimes expressed by saying that the cycloid is the *tautochrone* curve, or the curve of equal time, and for this reason efforts have been made to cause the pendulum bob of a clock to move in a cycloidal path in order to vibrate in equal time whatever be the extent of the arc through which it moves.

Another property, the sequence of this is the body having reached the lowest point, will, through the impetus received in the fall, ascend the opposite branch of

the curve to the point L , in a vertical direction from a lower level. say at M , in a horizontal direction. The path of a cycloid is the curve and direction we should run our pipes to secure this advantage.

The area enclosed by the cycloid $A D B$ and its base $A B$ is equal to three times the area of the generating circle $D C$. If you wish to prove this statement in a practical way, do as Galileo did, who discovered this curve in the year 1615.

Take sheet metal of uniform thickness, cut out truly the generating circle, strike a cycloid with it, and then cut that out truly, weigh each, and you will find them 3 to 1, which solves the question of areas. Now, having a cycloidal plate, divide the axis of the curve $C D$, (Fig. 1, into eight equal parts; at the third part from C make a center and poise the plate on that point; it will balance and this is the location of its center of gravity.

Now, let us take any position of the generating circle, say $E H F$, (Fig. 1, and

tion of the water power was realized. H. Pung now you have seen several marvelous things brought out by the rolling of a circle on a straight line, I will end up with a story, the truth of which is vouched for in reliable history. I wish, also, to prove that difficult things can be made easy and the way to learning can be shortened if any one is only bold enough to show how to do it. Query! Did the Reading R. R. official who ordered clean shaven faces on its employees have in mind a great educational movement? But render further to find out how great minds run in like channels.

Put your mind to it, and try to arouse his subjects to the active life of business habits of the people of England and Prussia, he began by removing impediments.

He wished his people to become skillful workmen and mechanics, and it was evident that the Russian of his time, with his long flowing robes and his pendulous beard, could not work at the foot of a lathe. To remedy this, Peter stationed men at the city gates, each armed with a pair of shears, who cut off the long skirts and sacred beards of all those who passed through the city gates.

This was the first step in giving them a mechanical education, and the effect produced, in raising his people to the level of other European nations, has always been a subject of admiration.

A similar course was adopted later by the French, when the School Commissioners dismissed in a summary manner the teachers of the schools and colleges and flung after them, so to speak, all their traditional books and ancient methods of teaching, because a new era had arrived when practical knowledge had taken the place of speculative, and when it was of paramount importance that students should reach, by the shortest and plainest route, the wide range of learning now for the first time open to the human mind.

The object of mathematics is calculation, and while it is necessary to learn the definitions, yet many of them are more difficult than the things defined.

No wonder that the King asked of Euclid if there was no easier method than the elaborate systems then taught, which question brought out the famous reply: "There is, indeed, no royal road to geometry."

This may have a double meaning; there is a common-sense way, to which the highly educated and the luxurious do not always turn—but that way is open to the earnest, practical mind.

Drop Pit on M., K. & T.—Directions for Using.

The useful drop pit shown on next page is in use in the Missouri, Kansas & Texas shops at Demson, Tex. For the drawings and description we are indebted to Mr. F. T. McIlvaine, master mechanic of the shops, who writes:

I send you under separate cover blue print of a drop pit that we use here, and have gotten to feel that we cannot get along without. We put one in roundhouse about four years ago, and were so well pleased with it that we put one in the back shop and use it altogether, removing and applying wheels under cover.

An engine comes in for an overhauling, we put a force of four laborers under charge of a foreman, who take down rods and binders and remove wheels; they also put them under when fitted.

We have taken wheels out of a 10 x 24 mogul engine at a cost of \$5 35, and had engine off of drop pit and put on one of the other pits. For removing engine track-wheels we find it indispensable; can remove and replace wheels in a mogul truck with ease in thirty-five minutes, and in a four-wheel truck in from forty-five to fifty minutes.

Have taken front pair of drivers from under a mogul in roundhouse, and had them in wheel lathe in back shop in one



Narrow-Gauge Passenger Car, Built by BARNETT MFG. CO.

the curve towards P , to a height equal to that from which it fell losing velocity in its ascent, by the same degrees as those by which it acquired it in its descent, and it will employ precisely the same time ascending as it did in descending.

It is very clear now, accepting these facts as true, that if a surface could be procured that would be perfectly smooth and hard, the cycloid would thus present a means for the solution of the perpetual motion problem.

Another peculiar property is, that a body—a ball, for instance—will run from L to M , down the cycloid in less time than it will reach M by running the straight line $L M$. This does not seem possible, because we are used to believing that a straight line is the shortest distance between two points, and is therefore the way to reach a distant point in least time. For this reason the cycloid is called the curve of *quickest descent*.

Now, as these properties are sometimes true when considered in a reverse order, we may also call the cycloid the curve of

draw the line $E H$ from the points of contact E in the base and H in the curve, and then through H draw $H F$ at right angles to $H E$; this line $H F$ is a tangent to the curve; it would be perpendicular to $A B$ at A , and parallel to $A B$ at D . This property gives value to the teeth of cog-wheels, which are formed on the so-called epi-cycloidal principle. Furthermore, the line $A E$ is equal to the arc $H E$, plainly because the circle rolled that far to make it.

In hydraulic work the cycloid plays a most important part in the mouth-pieces of the suction and delivery pipes of pumps.

If water is to be received and delivered into pipes beneath the surface of water, these terminals of the pumping main should be formed trumpet-shaped, the curve of which should be a cycloid, if the least resistance to the flow of the water to and from them is desired.

This curve was applied to the surrounding rings, called *diffusers*, which were used by Mr. Boylen upon his turbine wheels at Lowell, Mass., several years ago, by which great gain in the utiliza-

If the fireman is indifferent as to how his coal record is, and only tries to keep the engine hot to be safe, he will keep up a heavy fire, and then hold the door open or let the engine pop. As some engineers keep the boiler full all the time, this keeps at every station, and in going over the division considerable coal is wasted.

But when the fireman does the pumping, then there is a great change. He becomes a better "boy" and takes more interest in his work. There is not so much to worry him. He can gradually raise the water to the proper condition, and when it is time to start the upstair he has but 50 lbs. to receive it, and has not wasted any coal.

The most successful thing I ever did was when the engineer allowed me to pump the engine on a local passenger train. The object of my sale would not be to supply the engine when working her hard, and the engineer would occasionally start his injector just before shutting off for a station and regain the water that was lost. But on level track the injector would not supply her, and it was a pleasure to let the engine steam so well. There is one more thing about the saving of coal that is not given the attention it deserves by some engineers, and that is about getting out of town. To show the difference that is practiced on the fireman and the engineer by some men, I will relate an incident that I will never be able to forget.

I was once informed enough to be sure that a man who had a bad habit of lagging an engine when leaving town he would pull the throttle wide open, and when going about fifteen miles an hour he would pull the lever about half way up the throat and leave it there until the speedometer 134, and then he would pull the lever to its normal position on the throttle, and when going to the next town and about to raise. This man took a lay-off, and the engineer who was put on in his stead was coal enough in a round trip to have been paid my wages, and in a run of variables against a strong wind he made 40 miles in 40 minutes.

Building of the Cuyahoga Engines.

Mr. A. J. Cole, of Los Angeles, Cal., a pioneer engineer, writes:

"I seen your February number in the 18th issue of *Locomotive Engineering*, and I have faint recollection of him. I do not know who this Billy Smith was to whom he alludes. I know Wm. F. Smith was master mechanic of the Cleveland, Columbus & Cincinnati Railroad, whether he had anything to do about designing the engine built at the Cuyahoga works or not, I do not know, I believe that he did. But that I do know, that Mr. Sterling worked in Detroit for Mr. Thomas L. Simpson to come to Cleveland and build the locomotive, as there were more there who knew anything about the proportions of engines, boilers, or anything else. Mr. Rogers was foreman of the shops while building many engines and such like work. T. L. Simpson was master mechanic of Michigan Central and had built some two or three locomotives while holding that position, and this was why Mr. Sterling wrote for him, and the same Mr. Holloway is very much mistaken about Mr. Rogers. As for the drawings, for I am positive that Mr. Simpson drew the plans of these 6-footers, also the 4 and 5-foot wheelers of the Cuyahoga build. I know this because I have seen the drawings at his house, and have seen him at work on them. As for Billy Smith, as he calls him, I know Wm. F. Smith. I will say that Mr. T. L. Simpson had forgotten more than Wm. F. Smith ever knew. Mr. Hamilton ignored Mr. Simpson altogether, and I think I know his reason for so doing.

"The rest of Mr. Holloway's communication, as far as I know, is correct, except the cut-off arm. I am not positive whether this was Mr. Rogers' or not. I know that Mr. Simpson was always advocating the

cut-off motion, and he and myself have had several talks about it, but I have found long since that my conception of the link that the steam could be managed as well by the throttle as by links the way they were then made. Mr. Simpson contended that an air for valve motion was the correct principle for cutting off steam, and I have since found him to be correct. I have the original lithograph of the "Reinforcer," and money would hardly buy it from me. The frame alone cost me \$16. Honor to whom honor is due."

A New Locomotive Lubricator.

We illustrate herewith a new form of locomotive lubricator that is just now attracting some attention on account of its simplicity and efficiency.

As will be seen, it is a single glass sight-feed instrument, one feed supplying both cylinder and chests. There is only one internal pipe, all passages and valves being in the body of the instrument itself. The oil reservoir is of the strongest possible form and contains nothing in the way of pipes, feed attachments or what-not, it is suspended below the frame of the instrument and its expansion and contraction can affect nothing. It is simply set into the frame, and has a haling plug and a drain cock tapped into it.

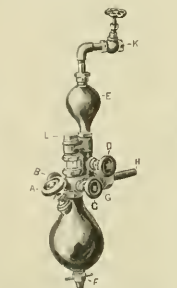

The condensing chamber is also globe-shaped and has no attachments except the steam pipe from the boiler, the equalizing tube standing up inside of it, but being attached to the frame pipe only.

When the oil chamber is filled and steam turned into the condensing chamber, water accumulates in the same until it flows over into equalizing tube 21. This fills passage 15, 14, and glass tube 13 at once, then when water-valve *H*, Fig. 5, is opened, enters the oil-chamber and displaces the oil, which rises to globe *C*, where the drop-feed is regulated.

When the oil leaves the feed-nipple it rises through the water in the glass and flows over into the pocket or depression 16, where it is caught by a jet of live steam from the equalizing tube 21 and forced through the passage 22, expansion-stud to the cylinders in the form of an oily vapor—experiments proving that it treats all parts of chests and cylinders in this condition.

In this oil passage 19, Fig. 1, there is a valve shown at 22 in Fig. 4 and at 11 in Fig. 5. This valve has a point on it to clean out passage and is used to restrict the opening until the pressure is equalized in the entire cup.

By closing this valve all operations of the cup are stopped, the glass tube is instantly filled with water, stops the feed and prevents oil from passing up the tube 21 to the condensing chamber. This latter fault is a grievous one with some lubricat-

ors, and is prevented in this one by simply dropping the lower end of tube 21 into the pocket 16, so that the end is sealed with water when valve 22 or *D* is closed, making a trap.

The eight-feed glass is very short and thick and is in plain view from all parts of the cab. It can be renewed by taking off the cap *L* and dropping in a new tube from the top.

The Lackawanna Lubricating Co. of Scranton, Pa., who make this instrument, have been experimenting for some years with lubricating cups and have over a hundred of these lubricators in successful use.

Large Saving on Coal Bills.

There has been a belief entertained among railroad men for years that the Wooten fireboxes used on the Philadelphia & Reading enabled the greater part of the locomotives on the road to be

Convention of Railroad Men.

There will be a great convention of the railroad employes of the United States, Canada and Mexico, held at the Lenox Lyceum, New York, commencing May 27th, under the auspices of the Order of Railway Conductors, and under the direction of New York Division 54 and Milwaukee Division 104 of Railway Conductors.

The following organizations—Order of Railway Conductors of America, Brotherhood of Locomotive Engineers, Brotherhood of Locomotive Firemen, Brotherhood of Railway Trainmen, Order of Railway Telegraphers and a Switchmen's Mutual Aid Association—wherever existing, are invited to attend and participate in the deliberations of the convention.

The purpose of the convention is to consider, and, if possible, to agree upon a line of action to be followed in the direction of securing such legislation as may be con-

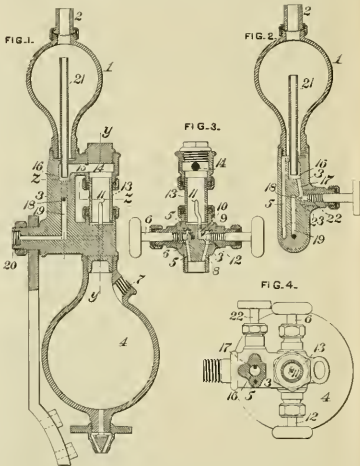

THE LACKAWANNA LUBRICATOR.

run with inferior coal, the culm and slack coal that had little market value. This was a delusion. There was reason to believe that the engines could make steam with very fine coal, and the fact was demonstrated by practice when there seemed to be special reasons for making a parade of the capabilities of the large fireboxes, but for every-day service the engines fall back upon the best qualities of coal to be found. There has been a change in the fuel burned lately. When Mr. Theodore Voorhes took charge as vice-president he got looking over the fuel bills, and was surprised to find the high quality of coal supplied to many of the engines. Having no interest in that particular type of engine beyond getting them to run at small cost for fuel, he naturally wanted to know why they did not burn the coal they were designed to burn. This was a very embarrassing line of inquiry and could not be answered satisfactorily. Peremptory orders were given to burn slack coal in every engine capable of making steam with it. On some of the divisions, where soft coal could be bought cheap, the freight engines were required to burn it. The result of these changes is that the company is saving about \$100,000 a month on the coal bills.

considered beneficial to the railway employes at the hands of State and National legislators, regardless of party politics, also to consider, and, if possible, outline a policy to be pursued in the matter of an arbitration law, and the formation of State organizations in all States of these United States, Canada and Mexico.

Each division or lodge of the respective organizations is requested to have as many of their members attended as possible; also to select a committee of five members to form a general committee in their particular States and sections.

An announcement has been made by Mr. F. W. Coolbaugh, chairman of the Supply Men's Association, to the effect that arrangements have been completed to have a line of shifting for the convenience of exhibitors at the Mechanical Conventions at Saratoga in June. The cost of power to individual exhibitors will be very small. Those requiring power should apply at once to Mr. R. C. Blackall, D. & H. C. Company, Albany, N. Y.

The average distance a passenger travels during a single journey in this country is twenty-three miles.

Practical Letters
from **Practical Men.**

Write on one side of the paper, state your point plainly and briefly, and then quit. We supply the generalities. No letters noticed unless name and address are annexed.

Set-Screws on Drill Presses.

I was interested in reading the account of the tube-hole cutter of Mr. Arthur, of Savannah, Ga., that I came to the set-screw to hold the tool from dropping out on twisting of the shank. I have seen men wad up by their clothes catching on that man-killer, and have forbidden one ever being put on a drill press under my care. I will give him a better idea than the set-screw. We use a great many Morse & Cleveland twist drills, and often have the flat ends twisted off. We then turn them down until they can be turned no farther but the flutes in the drill. So to remedy

Talking of valves, are they not getting to be an awful weight, not to speak of the weight of steam chest and covers, from what they used to be fifteen to twenty years ago? They are also getting to be so much higher up. Then a man and helper could lift off one; but what a job now if you do not have a traveling crane or a device as the one illustrated in Fig. 2, which is light and easily made. The yoke encircles the base of stack, and the outer end is 8 in. long x 1/2 x 2 in., the other end is 4 in. long x 1/2 in., with the upper slot to take a chain, and the lower end is 8 in. long, 1/2 x 2 in., two bars of 5/8 x 1/4-inch iron 6 ft. long are riveted with 2 or 3/4-inch rivets flush on lower side.

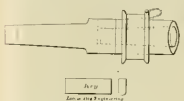

the matter and save turning, I take the Morse drill socket and cut a slot in it 1/4 x 1/4 inches, so as to be about half way up on the taper shank of the drill; a steel key to fit the slot in the socket and into a half round groove cut in the drill or outer shank cut with a mill or ball round chisel; then I have a collar with a key-way of the right taper which slips over the socket and on to the key. This keeps the key tight in the groove in drill shank, and if the groove is only cut the length of the key or a little over, the tool cannot fall out. (See illustration.) It is very simple, cannot get out of order; the old socket answers the purpose; new drills can be used, with or without this attachment. We have been using this for some time and it has never failed. The collar is turned out to make it tight.

Jno. J. BINGLEY.

Waters town, N. Y.

Minor Shop Tools.

One who is a reader of mechanical papers will notice that all devices and improvements in and on machinery are in the direction of having the machine do the work instead of the attendant, whose place is only to put the work in, wait until it is done, and then take it out and put in some more. This is the case with new machines, but old ones that do not have new tools, but old ones that long ago ought to have gone to the scrap heap, it is the place of the man in charge to see that he can get as many devices as possible to attain the desired end. He must also be able to take hold and work his device at first himself, or in some cases out of ten it will prove a failure. Most tools do not have new tools, but old ones that long ago ought to have gone to the scrap heap, it is the place of the man in charge to see that he can get as many devices as possible to attain the desired end. He must also be able to take hold and work his device at first himself, or in some cases out of ten it will prove a failure.

Fig. 1 is what might be called a chuck for holding valves on face or end out. The post and outside is made of iron 1/4 x 5 in., bent to the shape of a rectangle 7 x 18 in. On the inside the edges are planed and the end planed down as shown to 2 1/2 in. This is to accommodate clamps to hold the set-screw to the platen of planer. The set-screw to the end of the end through the set-screws on the sides should slant down on the inside so as to draw down the valve. With this device a surface gauge need not be used.

Timberies are also put between bars and riveted at intervals of 6 or 8 in. holes to be countersunk and riveted flush. A pulley with center gauge to run in groove and clevis to take block and fall. A piece of 1/4 inch round iron with fork on one end bent to go down in stack 3 in., with a ft. of chain on the other end. With this you have something that you will miss if you should forget to take it off and it goes out with an engine; for, as one of the engineers said, it would be locked up in his tank-box before it got back; another would know if they were not going to put one on every engine.

I would say to F. M. Arthur that the chuck (Fig. 1) for holding driving-brasses on slotter is one that we use, and the brass need not be squared. The base is 10 x 12 in. and the part that holds brass 12 in.

high, with two wells down the back to stiffen it. The face should be finished on slotter; it is 2 1/2 in. flat in the back, and 12 in. open in front, two holes for holding brass, one close to base and one side of the head of bolt taken off. On this bolt put a loose piece of iron flat brass to rest on. The other hole should be high enough to clear the brass. A piece of iron 1 1/2 in. will serve for strap. Now, to put in brass, remove top bolt, put in the brass, replace bolt, screw up tight, and go to work. No surface gauge needed. In another number I will show how we hold driving-brasses on lathe to turn and bore.

W. A. ROBERTSON

Cedar Rapids, Iowa.

Air-Brake Peculiarities.

DEFECTIVE BRAKES ON ENGINE AND TENDER. Has it ever occurred to our air-brake friends that engineers pulling trains entirely equipped with air-passenger trains, for instance—give but little attention to

as possible, but when all freight cars are air-equipped, will not freight engineers be as careless about their engine brakes as the passenger engineers are now?

A DRIVER-BRAKE DOES NOT HIT BY THE ENGINE. The theory of long ago that driver-brakes are hard on our engine seems to live yet in the minds of our old passenger runners and many of them don't know whether their engine brakes hold or not. When they get their engine out of the house to go out on their run they start their pump slowly and don't run up much pressure. Do their stopping with the reverse lever to work the water out of the cylinders until they couple on to train, and on the road the train-brakes make the stop.

WHEELS HULL BY DEFECTIVE BRAKE.

I was right holler for quite a while. A certain engine and engineer came in on the same run every night, one of the oldest runners on the road. One night he brought his engine in and left her by the roundhouse, shutting off his air-pump before he left her. As soon as he was off I moved the engine down to the ash-pit and stopped her with the brake. When I went to start, I found the brake stuck. The engine and tender brakes were actuated by a single triple-valve and auxiliary reservoir, but the tender brake was set so tightly that the wheels slid, while the driver brakes were in perfect release. By loosening the pipe fitting at different points, I found that air pressure from the tender brake only passed as far as the hose between the engine and tender. The tender had one of those forms of brake-tingering where the push-rod is attached nearest to the fixed center fulcrum of a dead lever, with the pull rods connected to the ends of the lever. There was but little slack in the rigging, and it allowed such a short piston travel that with the hose leading to driver-brakes stopped up, there was but little room for expansion of the auxiliary air, and with a bad leak in the pipe connecting the train-pipe with the triple-valve, it was easy to understand why the tender brake should stick and slide the wheels while the driver-brakes were unoperative. I looked at the engineer's report of repairs wanted, and found nothing as to his brake, and I concluded that he had put a blind gasket in the hose fitting to cut out his driver-brake. The engine came in in the same condition every night for a week, when she was taken off the run and laid in for a few days; she has her valves faced and has two new pairs of wheels put under the tender, etc. The morning she was laid up, I went down to the roundhouse, and the foreman, speaking of work laid out for that engine, incidentally remarked that there was work reported on nearly everything about the engine but the brake. He showed me how closely the tender and driver-brake shoes lugged the wheels, the pump had lately been overhauled, and so on. Then I told him about it, and he had the engine fired up immediately and put the air-brake men to work on her. They took a large piece of gummy waste out of the hose and they stopped the leak in the train-pipe, and the brake worked all right. It didn't take very long to do it. It looks like a matter of small importance, but it wasn't. I don't know, of course, what two new pairs of wheels cost, or the price paid for repairing the engine, but I think it is odd that the engineer ran his engine in such condition so long without noticing the disorder.

REAL CASE OF TENDING AND LOCKER.

I once fired a passenger engine whose brakes, independent driver and tender, were always in such poor condition that it was almost impossible to stop the train without breaking the Janney on the tender or the one it coupled with. We were on the same run every day, and on Saturday nights some young "toughs" would climb on the front end of the limited mail car next to the engine at our last stopping place on

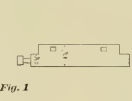
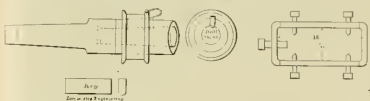

Fig. 1

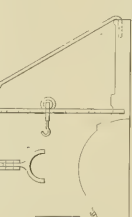
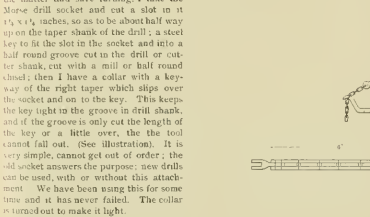

Fig. 2

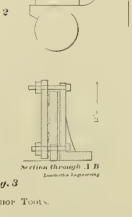
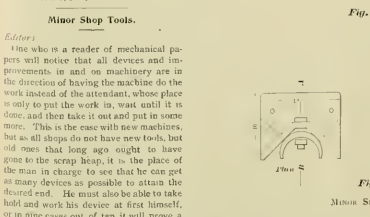

Fig. 3

MINOR SHOP TOOLS.

the road, ran about four miles to the village where they lived and then pull the air signal. Of course we would forget that it was Saturday night and about those fellows and would stop, when the boys would jump off and take to their heels. But one night we saw them go on, and the engineer and "the three fellows" followed by "the Hauler to-night." At the usual place, the moss, began. The air-brake played a regular tune. It was a heavy down-grade and the old Man shut off and let her roll. At the foot of the grade the track was well run-in and lined, but he intended to go over as fast as he dared, and with all confidence in the train brakes, he set the train fall down that bill P. D. Q. The air-gauge showed a train-pipe pressure of 75 pounds before he applied the brakes, and when he got pretty close to the engine track he jammed the brake on loose or after he intended. There was some little trouble at first from the three-way valve. At the black hand of the gauge was 70 pounds. Those fellows on the front end of the mail car, finding that the air-pressure hadn't the usual effect, began to complain about the angle-cock and they applied the brakes by turning the angle-cock on end of train and thought they had set the train by turning the angle-cock. The engineer whistled for brakes, and the train responded by going after the road again, thinking the air had failed, and he had to pull the train to the valve, but he couldn't find track again to force the engine to stop much. They might as well have been on the brake on the engine and made for all the good it did. We went over that piece of track with the engine working in the locomotion on the road and was the roughest ride I ever experienced, the engine leaving the rails, striking the track at that place probably causing a collision a little later. When we got to the top we opened the angle-cock and the train had stopped, tried the brakes, but they all right and started. It is fairly common for the front end of the train to stop, but they got stopped by going on the engine's air track.

One day in a yard there was a railroad engine approached by a curve, and the front end of the cars in the side tracks obstructed a view of the crossing, which had a red light.

As the train went through the yards, the brake was applied until we reached the curve, and one night there was a train on the crossing. Having to slow up for that bad track undoubtedly prevented a wreck.

WHY BRAKES ON FREIGHT ENGINES ARE KEPT IN ORDER.

Now, even passenger trains should not have an always being able to apply the brake on every car in their train, although the brakes may be in perfect condition before leaving. There is the "deadly angle-cock." Of course, trouble from that source is magnified, but the danger exists. A powerful brake on an old modern heavy passenger engine goes a long way toward stopping a train. Freight engineers know the effect of a good engine brake on a train of thirty or forty cars not equipped with air-brakes. While a hostler, I had the opportunity to notice the difference in the efficiency of the brakes on passenger and freight engines, and found but few passenger engines, with really powerful brakes, while it was a rare thing to find a freight engine with a brake that did not hold good, and where there was such a one, there was certainly a report left a brake work.

WHY PASSENGER TRIPPER BRAKES SHOULD BE KEPT IN ORDER.

The round-house foreman asked me once why it was that the trip in eight-wheeled engines, push-down driver brakes, were better than the pull-ups. Such really is the case here, and my idea is that nearly all the pull-up brakes are supplied with air from the tender triple and auxiliary, and

the air expands in the three-brake cylinder to a lower pressure than it does with the push-down brakes, which have their own triples and auxiliary reservoirs and hank. Of course, with the pull-up brake, the tender auxiliary is calculated to be of sufficient capacity to supply the three cylinders with the required pressure, but don't seem to do it. It is often placed under the tender where it is inconvenient for the engineer to drain it, and its air capacity is lessened by water collecting, while the driver-brake auxiliary may be drained without trouble. Will W. Wood.

Improved Reverse-Lever Quadrant.

On many locomotives the reverse-lever quadrant notches are spaced considerably too far apart. One will notice that in hooking the latch from one notch to the succeeding one, a variation of three inches

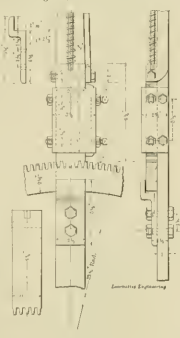

and often more will be found in the cut-off. In these days, every point that denotes economy in fuel consumption is eagerly sought and profited by. It is true there are some very good reverse-lever levers and quadrants in use, but there are also some objections found with them. In designing the latch and quadrant herewith, the writer considered four very important elements. First, a close adjustment in the variation of the cut-off; second, increased bearing surface of the teeth and dog (with the teeth it five times as much as on a common single toothed latch), third, its simplicity and cheapness of construction and future repairs; fourth, the quadrant can be turned end for end in case it becomes worn. It will be noticed that the levers are spaced one-half inch, that is, the lever will move one-half inch at quadrant to engage the succeeding tooth in the quadrant. The quadrant is a single bar one inch or more wide, and the reverse-lever travels on one side of it. A bracket key is bolted on the quadrant side of the lever to form a guide. The teeth in the quadrant and dog are cut in a milling machine, and when cut accurately the dog will mesh with quadrant, so that there will be no danger of the teeth breaking out by violent or careless handling, there being five teeth in contact.

One of these levers and quadrants complete was constructed at a labor cost of \$12.21, and put on an engine that had previously been cutting off at 8 1/2 inches. Now, the engine, doing the same service as formerly, cuts off at 7 inches, and does the work equally well in freight service. The first week, all other conditions being equal, this engine showed a gain of about six miles per ton of coal. We find a variation

of one inch in the cut-off by hooking the dog in each succeeding notch in quadrant. This permits a wide open throttle and the steam can be controlled by the reverse-lever to a point where economy is best obtained. The merits of a close adjustment of the cut-off are conceded, and I will advise you later on what the gain will be in a longer space of time.

J. MILLER,
G. F. C. M. & St. P. Shops,
Dubuque, Iowa.

Top of Wheel Traveling Fastest.

Editors

A question has been raised in *LOCOMOTIVE ENGINEERING* as to a wheel traveling faster at the top than at the bottom. I was asked by several men if I could explain why this occurred; so I concluded to send you the sketch I made showing the wheel through one revolution. As an illustration, this circumference or revolution I have divided into one-fourths.

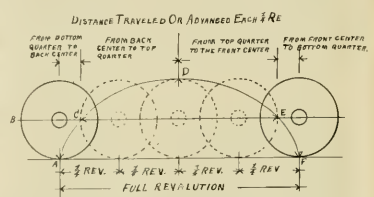

The cycle above shows the path the mark or dart at the bottom of the wheel at A will travel in this revolution. Notice, the wheel will not travel backward at all, but upward and forward in traveling from the bottom quarter to the back center, but will travel the short distance from A to C. The distance this mark will travel directly forward is shown above. Now, from C to D this marked part of the wheel will travel rapidly forward and gradually upward to C, and it will travel ahead the distance shown above. Then, from D to E it will move rapidly forward and gradually downward to E, and will travel ahead the same distance as from C to D, as shown above. Then, from E to F the part moves slowly forward and downward to F at the bottom of the wheel and at the bottom quarter, and advances the short distance shown above.

A person can readily see from this illustration that the top of the wheel travels decidedly faster than the bottom.

Dubuque, Ia. CHAS. E. FOLBRESS.

Hard and Easy Means of Removing Hard Bolts.

Editors

Did I ever strike you as any of your readers how amusing it is to see the way frame, cylinder and other large bolts are generally taken out in railroad shops? The operation is an amusing spectacle to a man with an eye to the ridiculous phases of mechanics.

In most shops there are two or three men at a time are considered extra good strikers with a sledge, and whenever there is a set of frame or other bolts to be backed out the machinist who has the job takes a trip through shop, roundhouse and probably the boiler and blacksmith shops, and hunts up three or four sledges weighing from fifty to forty pounds each.

The shop sledge, by the way, is of unknown quantity, and always of very poor quality, generally of one or two that have been discarded by the blacksmiths as useless and weighing about sixteen pounds. A couple of cast iron mauls, twenty-five or thirty pounds each, and a sledge that was originally made for the foundry to break

up old car wheels, etc., with weighing anywhere in the neighborhood of forty pounds. The probability is that not more than one of this assortment has a whole handle in, and the chances are that it is loose.

The shop sledge should weigh from fifteen to twenty pounds. It should be double faced, with eye in the center. Spike driving is a section man's trade, so don't have your sledge drawn down to a point on the ends to resemble a spike maul, but have it made the same size at the ends as in the middle, with the exception of the corners, which should be taken off from near the center to the ends. Have a straight handle put in, and you who sees it will come down to the shop at night and steal, and then you can use the one previously described, for nobody will ever steal them.

After the machinist has collected the sledges, two or three flatters and all the punches, with and without handles, that

can be found, he goes after one of the heavy hitters and asks him to come down and strike a few blows for him.

The first strike the heavy man does is to look at the array of sledges. Of course his favorite one is not there, and so off he goes to find it, coming back in the course of half an hour with the information that "that d—n Dutchman has got it and won't loan it." As the machinist knows who's meant by "d—n Dutchman," he goes and interviews him, and after much persuasion and many promises to return it unimpaired, he succeeds in obtaining the much prized instrument and returns with it triumphantly.

Now the fun commences. The striker, after carefully examining the bolt, picks up the sledge and hits it just once, then everybody examines it to see if it came any. Alas! no; so he goes to work in earnest.

By this time a crowd of spectators has gathered, consisting of machinists, boiler-makers, helpers and possibly a foreman or two, all of whom render assistance by offering a word of encouragement and advice now and then, and also by helping to examine the bolt-head to see if it shows any signs of starting.

After twenty or thirty blows are struck, the welcome words are heard: "That's the half she come." After driving it about half an inch, the striker rests while the end of the bolt is chipped off, for if it is not already broken off it is up-till it is about four sizes too big to go through the hole.

When the end is chipped, the sledge is brought into use again, and the bolt finally driven out.

The next one proves too much for the heavy man; and after every one on the job, and two or three ambitious spectators, have tried their hand at it, it is given up; the head is knocked off and it is left to be drilled. This process is gone through with each bolt, until all of them are either out or waiting to be drilled.

As a result of this method the holes are in such a shape that they need a great deal of reaming before they are ready for new bolts to be fitted.

If instead of main strength and awkwardness, the one doing the job will take

the nuts off, put a little oil on the thread of the *h*, and also on the face of the nut, screw it back on again, and get a wrench that fits, and take a good pull (put a piece of pipe on the end of the wrench if necessary), he will find that the bolt can be stretched enough to loosen it, and then be driven out very easily, and the holes will be left in condition to require very little if any reaming. This is called stretching bolts out.

N. B.—Don't use the old bolts again.

F. C. CHARLES.

Cedar Rapids, Iowa.

Other Diseases of Air-Brake.

Editors:—In article "Diseases of the Air-Brake System," by Paul Synnestvedt, in March number, I noticed that Fig. 6 Plate II, shows handle *h* in position for releasing brake, while feed port *f f* is open and feed valve in operation. Since the latter is only possible when handle is in running position, will you kindly explain this seeming distortion in your paper.

I recently found a defect in a feed-valve, which was rather troublesome to locate. It was impossible to adjust this valve with any accuracy, and train-pipe pressure constantly crept up to reservoir pressure. I found that spring 64 bound slightly in adjusting nut 70, and reversing spring 65 remedied the difficulty completely.

In the air-pump puzzle I sent you in February nuts—holding pistons on main valve stem—were loose, allowing pistons about *A* play, causing pump to hammer. Hyde Park, Mass. Geo. Lynch.

Admitting Air to Steam Chest.

Editors:—In question No. 56 in March number you gave a fair explanation of how air got in the cylinders, but as the ports are covered, you do not explain how air gets in the steam chests. As there is no way for air to get in the steam chests except by the valves raising off the seats by the vacuum acting in the steam chests, caused by the pumping action of the piston, what is the reason I use a valve in the leakage holes of balance slide-valves to get a tight vacuum on top of the main valve.

Brooklyn, N. Y. D. KILEY.

To Tell the Number of Air Cars in Train.

Editors:—In your March issue I notice an article from Sam M. Huffman criticizing the veracity of W. G. Wallace, how to tell if your air is coupled up, which he states that by bringing the handle of engineer's valve from running position to full release the red band will drop back one pound for each car. S. M. H. says this will do very well on short trains but not on long ones. S. M. H. is mistaken in this. It was in August, 1893, that I first commenced this practice. I have kept silent on the subject for fear some one would give me the laurel, but nevertheless it is true. I have practiced this every day and have proved it to my own satisfaction. I have the brakemen ascertain the number of air cars in the train, and after train line and auxiliary pressure is pumped up can tell within two cars of the full number in train. Twenty two air cars is the most that I have had in a train. Do have from ten to twenty in all of our trains, and I can tell up to that number; and I do think that I can tell up to twenty-six or twenty-eight. I carry thirty pounds excess pressure. There are several of our men, both firemen, brakemen and conductors who will testify to these facts, also our trainmaster will bear me out in this. He is well posted on air himself, and he goes into the details, and I have proven it to his satisfaction. On one of my trips I had eight cars of air in the train. At this station we picked up and set out quite a number of cars, and took into train eight air, filling the number to eighteen.

I did not see how many air cars there was picked up. The trainmaster, after the air was coupled up, came on to engine and asked if I could tell how many cars of air was then in train. I told him, and he said that he was satisfied that I could tell quite close. I have had the conductor ride on the engine with me, while his brakeman would cut off, and have me tell him how many. He had his brake-cock on one occasion to partly close the angle-cock. They claimed that the angle-cock was almost closed. He then asked how many cars were cut out. After making the test, I told him that there was none of them cut out. He was well satisfied as to the results.

Now I think that this is proof enough to show S. M. H. that W. G. W. is correct. St. Paul, Minn. P. K. SULLIVAN.

Tire Handling Tools—An Eccentric Blade Bending Device.

Editors:—How often when tires are to be put on locomotive driving wheels do we see six or eight men taking the tire from the fire (where an outside fire is used), all confusion and excitement in an endeavor to get

the tire on the wheel center to the proper distance, the clamps acting as a guide and support.

When gas is used these clamps will be found still more useful. When a tire is to be removed two clamps are placed on the center as before stated, the iron pipe through which the gas is conducted is placed in position on the tire, which when sufficiently heated, without removing the pipe heater, is pulled off the wheel center on to the clamps, the pipe is then removed and the tire taken off by means of a hoist furnished with a plain L hook.

In putting tires on, the tire is hung on the clamps, the gas-pipe heater put in place, and when the tire is heated it is pushed on the wheel center the proper distance.

Where gas is used, the device shown at Fig. 3 will be found quite an advantage. Often the pipe heater is put on the wheel and a nut or loose blocks placed under it to keep it the proper distance from the tire. After a few minutes the pipe will be found to need a little adjusting, and it is pushed into proper position when one or more of these pieces will drop out of place, and it will be necessary to take it up with tongs and replace it. Again the pipe itself must be removed after the tire is heated.

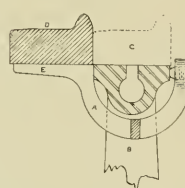

the tire on its wheel center before it cools off too much, so as to leave it with so little shrinkage as to make it almost impossible to get it on in time to properly set it. By the use of the device shown at Fig. 1 a great deal of this anxiety will be overcome. Referring to the drawing, *B* is the section of wheel center, *A* is a clamp secured as shown, *E* is a projection on the clamp long

This must be done with tongs, as the pipe is too hot to be handled otherwise. By the use of the small cast-iron block shown at *H*, Fig. 3, the handling and adjusting of the pipe is made an easy matter. This block is secured to the pipe with a cheese-head bolt. One block is placed so as to rest on the top of the tire, and one on each side, in the upper half circle just above the

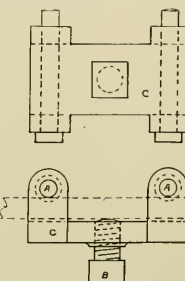

enough to furnish a proper support to the tire. When a tire is to be shrunk on, two of these clamps are put on the upper half of the wheel center, about 2 feet or 3 inches apart, with the top of the projection *E* in line with the outer edge of the center. As the tires become sufficiently heated, presuming them to be heated in a wood fire near by, they are taken up and hung on these two clamps and then simply pushed

which the time required for valve setting will be shortened in every shop in which it is used. It is intended for setting or straightening eccentric rods. It is often found that the rods have more lateral play on one side of the link than on the other, and it then becomes necessary to remove the rods and have the blocksmith set them. By the use of this tool this work can be done under the engine and without removing the rod. Referring to the drawing, *A A* are pins which are taken out and *C* clamp put over the rod *E*, the pins then being replaced, and the screw *B* set against the rod *E* sufficiently hard to give the required set. F. M. ARLING.

Reading, Pa.

Using Air with the Vreeland Jack.

Editors:—We wish to emphasize somewhat the final lines of your P. S. regarding "Some Handy Tools Handled by Air," page 136 of the April copy of your paper just received. The tool is covered by the patents of Mr. Vreeland, and the railroad company will be notified of this. We wish to give notice that it is covered by a patent that there may not be unnecessary trouble. We stand ready to furnish a tool driven by compressed air, if the roads desire it in that shape, at the same prices that we would get for the other.

THE W. & S. HYD. MACH. WORKS, Pet Watson & Stillman.

Malone's Water-Glass Attachments.

Editors:—I send you a print of an improvement in water-glasses or cocks patented to me. You will see by a glance at the print that this cock has no threads on stem or rod, so the seat cannot be injured by being screwed in against scale or other hard substance by inexperienced handlers. In fact, the more it is turned the better the seat, as turning will grind it in. When the cocks are open and water and steam in

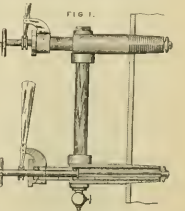

them, the pressure is the same to the square inch in cocks and glass as in boiler, thereby creating a balance and rendering the action of cocks automatic.

The barrels of cocks extend into and beyond the sheet a sufficient distance that, if broken off outside of sheet, there will remain enough of the barrel and rod inside of boiler to insure valve coming to seat evenly, rendering the cocks automatic if broken off. The rod running through the barrel is a three-cornered or three-edged one, and is designed to be turned to cut the scale and lime out of the cocks, and it may then be blown out through valve. I. M. MALONE.

Raton, New Mexico

The contributions to our correspondence columns are becoming embarrassingly voluminous. We have been doing rigid selecting lately and condensing all the letters that could be put into smaller space, but we still find ourselves compelled to leave several good letters over.

The Queen-Le Châtelier Pyrometer.

Modern investigation and many of our modern industries demand an instrument for the accurate measurement of very high temperatures.

A vast amount of experimental work in this line has been done by physicists and metallurgists in the past, their most noteworthy results having been achieved by the employment of the air or gas thermometer, which depends for its action upon the expansion of air instead of mercury, as in the ordinary form of thermometers. The bulbs of these thermometers are constructed of materials like glass or platinum, whose melting points are very high. In the more recent experiments, however, porcelain bulbs were used.

measured on the galvanometer scale, from which the temperature is readily deduced.

The pyrometer has the following advantages:

1st. It is adapted for a very large range of temperature, *i. e.*, from 200 to 3,000 Fahr., but it is intended more especially for high temperatures such as are met with in the manufacture of metals, chemicals, porcelain ware, etc.

2d. It is almost instantaneous in its indications, few seconds being sufficient time to subject the couple to any stationary temperature, or the couple may, if desired, be left permanently in the furnace or oven, indicating at all times the temperature, and thus enabling the operator to keep an hourly record of same.

3d. The metals which compose the couple are not affected by gases, and

New Method of Driving Drills.

Every mechanic knows that the weakest point about the ordinary taper shank twist drill is the flattened end of the shank, which frequently twists off long before the drill is worn out, or if it does not, it will often cut or ream out the flat recess in the socket. In either event the drill or the socket are forever after useless, until considerable expense has been put on them in the way of repairs. The Cleveland Twist Drill Company, fully alive to the demands of the times, have gotten up what they call a grip socket that entirely overcomes this, the only weak point in the modern system of taper shanks. This grip socket is fully shown in the illustrations. A steel key is let into one side of the ordinary socket and its inner side engages in a groove or flattened place prepared for it on the shank of the drill. A slight turn of the eccentrically counterbored sleeve or collar fastens or locks the key securely in its seat, and then the drill cannot be turned in its socket or pulled out. The key is so located in the body of the socket that the

constructed for that purpose on application at a very trifling expense. They have put in special machinery for making these "grips," and at all parts will be made to "jigs or standards," they can furnish duplicate parts at any time. Patent applied for and all rights reserved by Cleveland Twist Drill Company, Cleveland, O.

The Most Economical Load for a Locomotive.

A very valuable, practical and interesting discussion was started in the New York Railroad Club, by a paper from Mr. Gen. W. West, superintendent of motive power of the New York, Ontario & Western, on "What is the Most Economical Load for the Locomotive from the Standpoint of the Motive Power and the Transportation Departments?"

Mr. West contended that the necessity for the means of starting abnormally heavy trains and the power to surmount steep grades is leading to the over-cylindering of locomotives. "Have you ever thought," he continued, "that in the severest, a

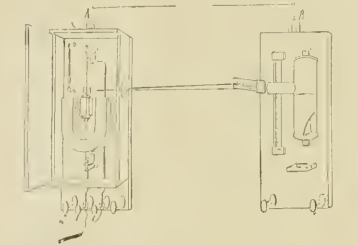

hence will not become oxidized or react chemically on each other at high temperatures, nor are they affected on their thermo-electric properties by rough usage or bends.

From the above statements it will be readily seen that the instrument is of great accuracy and durability.

The measurement of the temperature is made by means of a D'Arsonval galvanometer, contained in two wooden boxes, which are screwed against a central wall or slab, with handle for portability as shown in Fig. 1.

Fig. 2 shows the two boxes unscrewed from the central slab and placed in their respective positions against the wall.

Box A contains the galvanometer proper, and is also provided with set screws and a small plumb-line, so that it may be set vertically.

Box B contains the lamp, having a lens and window with cross-hairs for throwing an image upon the galvanometer mirror in Box A, which, in turn, reflects it back upon the scale in Box B. Box B has also two sets of screws for adjusting it vertically. The two boxes are set one meter apart.

The current set up by the thermo electric couple (no battery is used) enters the galvanometer through the two binding posts, Box A, and the deflection caused by it is shown upon the scale. Box B. This scale is graduated in millimeters, and it is necessary, therefore, that a curve be made reducing these millimeters to degrees Fahrenheit or Centigrade. This curve is very simply made from known melting points given herewith: Water boils, 212 F.; lead melts, 617 F.; zinc melts, 779 F.; gold melts, 1013 F.; platinum melts, 2232 F.

This instrument is fully described in a pamphlet on pyrometers published by Queen & Co., Incorporated, of Philadelphia. We strongly advise those who are interested in heat measurements to obtain the pamphlet. The subject of heat measurement is an interesting one, which does not receive the attention it deserves. The pamphlet referred to gives valuable information on the subject.

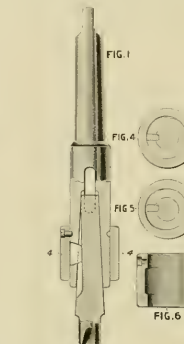

18-inch cylinder was counted big, and for it taxed the designers of locomotives to get boilers large enough to furnish steam for them. Now 20-inch and 21-inch are common, and still boilers are built that supply them. But how? Not worked as men used to work the engines with 16-inch cylinders at nearly full stroke.

"This, in my opinion, is the stumbling block, or whatever you may call it, that leads to a difference of opinion as to what is a load for a locomotive, for anything that is an overload cannot be economical. I have been on engines with division superintendents when they would say to an engineer, climbing a heavy grade, and noticed the engine slacking yet holding up full boiler pressure. 'Why don't you drop her down a notch or two?' And the engineer would reply 'If I do I must put on the second injector, and if that is done she will go back in steam.' I have seen men most on the lever being dropped down, with the result as predicted—out of steam. Now, if there is anything that grinds a master mechanic or superintendent of motive power, it is to examine the morning reports and see half a dozen or more engines reported losing time up Onondaga Hill or Rock Tavern Grade on account of 'no steam,' he knowing the engine is in good order, and the only reason in his mind for being shy on steam is that the yardmaster has just measured off a mile or less of cars, without any regard to their capacity, and in his opinion it should not be reported as 'no steam,' but as 'overload'."

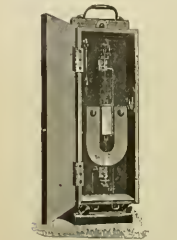

M. Le Châtelier in constructing his pyrometer has made use of these known melting points.

It is based upon the principle of measuring the electric current generated by the heating of a thermo-electric junction. As modified by Queen & Co., it consists of a thermo-electric couple and a D'Arsonval galvanometer. The wires which compose the couple are one of pure platinum, and the other platinum alloyed with ten per cent, rhodium, both of which are perfectly homogeneous.

For use, the couple, which has been first connected with the galvanometer, is inserted into the furnace or oven, when immediately a current is produced and

tang on the drill will fit into the usual slot or recess prepared for it, and in this way the socket has a double driving-power. The advantages arising from the fact that the drill cannot be pulled out till the collar is turned back and the key released are many, as heavy tools have a provoking way of dropping out of their sockets at most inopportune times, and many drills are dulled or spoiled by tapping them into place by a hammer.

If this simple drilling device is put directly on to the drilling machine spindle, heavy undercutting can be done with boring bars and the labor necessary to turn over heavy castings entirely avoided. These grip sockets will hold just as perfectly and securely straight shank drills, and can be furnished with 1/8, 3/8, 1/2, 5/8 and 1-inch holes for straight shank drills. The company propose to put this necessary groove in the shanks of all their drills so that they can be used in these grip sockets, just as the purchaser may prefer. A drill that has had the tang twisted off, can be made as good as new for use in this grip socket by milling a half-round groove in the shank, or if it is not convenient to mill it, a flat piece can be filed or ground in the shank, care being taken that such groove or flat place has a taper the reverse of that on the outside of shank, as shown in the section drawing of the illustration. The small cut illustrates the reducer or shell sockets used with the "grip." The Twist Drill Company have applied the gripping device directly to several drill press spindles, and will furnish collars properly con-

On the other hand, the superintendent will say to the yardmaster "I notice, by the speed-recorder tapes, that Smith, last night, on his engine '172,' ran over the division with forty cars at passenger train speed, you had better add a car or two to the train."

Next night Smith starts out with another train of forty cars, and lays down, as they call it, for steam. Dispatcher asks the conductor what's the matter with the engine and conductor calls it into office and receives the reply, "no steam." The conductor and engineer called into office next day and asked to explain, their explanation is that the night they made the good run they had forty cars of merchandise freight and good rail, and the night they failed had a train of sugar or oil, wet rail used all the sand they had, had to work Carey's grade, and everything else possible.

certain grade got to pulling eighteen. At the end of the contract the purchasing agent insisted that they were paying too much money, so a new contract was made with a cheap man, and the haulage of cars soon dropped back to fourteen cars again.

Mr. Mendenhall believed in the trains being regulated by weight, but he did not think that the ordinary yardmaster was discriminating enough in assigning loads.

Mr. Bradley gave an item from his experience when he was a conductor. He had an engineer named Howard. They were pulling a great load of flour and leather. When he wanted to make a good run he told Howard that all the cars were loaded, with leather, and they got there promptly, no matter if flour filled most of the cars.

Mr. Mitchell mentioned a case where they were trying the capacity of a new

make it impossible, I think, to determine with accuracy what a locomotive ought to haul, and I hardly think it is practicable to weigh each car before we apply it to the train.

Mr. Colvin—On the Erie road, years ago, when it was a broad-gauge road, and when they had no foreign cars, it was quite easy to load their cars very nicely. Almost every man here believes I am sure, that one engine can pull one car with thirty tons easier than three cars with ten tons each. There is hardly any road but what the hill that limits the weights of trains is located within one mile on the road, and it seems to me that the economical load to put on a locomotive is the train that it is possible for it to get over that particular grade. Such a train would be so much more economical on 99 per cent. of the road as to much more than counter-

balance during the construction of the building. It is expected the new building will be completed in June. With the completion of this building, these works will be the most modern in buildings and equipment in this country, if not in the world, the entire plant having been practically rebuilt and equipped with new tools during the past ten or twelve years. The works are also about to receive a large hydraulic fanning plant, for flanging boiler work, which is about completed by the Morgan Engineering Company, Alliance, Ohio. This is the largest and most modern plant of its kind ever constructed for this purpose.

Anaconda Engine and Tender Hose Connection.

This hose illustrated was made at the suggestion of one of the leading superintendents of motive power in this country, who has equipped his engines with this hose. It is certainly filling a long-felt want for engine and tender connections, owing to the fact that it will not collapse and kink under any conditions, consequently it will never break or shut off injectors, the importance of which every railroad man fully understands.

This hose is made in the exact lengths required, and the ends for a distance of



about 2 1/2 inches are plain—the same as on the ordinary plain hose. This is so that the fittings, clamps, etc., will fit this hose, same as the ordinary 3 or 4-ply hose.

This hose is made of good quality material, the duck on the outside will prevent grease and other substances disintegrating it. It should wear in service several years.

Improved Connelly Boiler.

We have received from Mr. J. T. Connelly a set of drawings of a modification of his well-known locomotive boiler. The boiler is straight and is rather notable for the short distance between the crown sheet of the firebox and the outside shell. The form of design adopted has been taken for the purpose of giving a large heating surface as possible. Writing on this point Mr. Connelly says as the common opinion is that a large space for steam is indispensable to the efficiency of the locomotive boiler. Assuming that belief to be correct, why not increase its present size and make it agree with the dimensions of the engine? Lack of steam is what prevents our engines from doing the work successfully. The boiler is likened to a store-house upon which we may draw for supplies. Unless there is a good storage when approaching a heavy grade the steam is likely to fall twenty or thirty pounds, and the engine fails to take the train.

The fact is, there is generally too much space for steam without the steam, and too little heating surface. The design of this boiler obviates this short-coming.

In the northern district of Manitoba dog trains are still in use, and very satisfactory is the time made by the animals, who skim over the frozen snow at a rapid rate. A train arriving at Stanley covered 350 miles in four days—well on to ninety miles a day. The railway has opened up communication with the settled districts in southern Manitoba, but the dog continues to supply the best means of transit for passengers and mails in the sparsely settled regions.



BEING DOWN AN OLD-TIME LOCOMOTIVE SHOP.

The men in charge of motive power are naturally interested these times, when their reputation is at stake, in making the most of a mile run between stopping. In other words, the most miles at least possible, regardless whether the company is earning any money from that class of traffic. On the other hand, the heads of transportation departments of to-day, in order to keep up the standard of other men or even of their own records of three or four years ago, are compelled to overload the engine on account of the greater number of large capacity cars coming into use."

Mr. Bradley, West Shore, favored loading engines according to tonnage and not by the number of cars.

Mr. A. E. Archell, Erie, believed that the condition of rail and weather ought to be considered in loading a locomotive. He did not think that a locomotive could be strained by hard pulling.

Mr. Watson, West Shore, intimated that on the road the way-bills were in the hands of the yardmaster when he was making up a train, and that the weight of the cars regulated the number assigned to the engine.

Mr. Geo. Fowler mentioned a case where a man took a contract to keep a car full in brass, oil and waste. To make money he put in the best material to be found. The result was that engines which formerly hauled only fourteen cars over a

mile and had loaded it by the stenciled weight of empty cars. The engine did not seem to be equal to the work and he had some of the cars weighed. Those stenciled for 30,000 light weight weighed about 35,000 pounds.

Mr. Joughins believed that the speed required was not taken sufficiently into account when loading locomotives. A locomotive with one car will consume a great deal of fuel going at twenty miles an hour, whereas, if you put thirty or forty cars on that locomotive it will consume, of course, more fuel, but the economy obtained in moving those cars is very marked indeed. We make out a rather elaborate performance sheet on our road, and in looking at that performance sheet from month to month I can, with a great deal of certainty, tell by merely looking at the amount of coal consumed per car per mile whether we are doing a large business on these trains or not. If the amount of coal consumed per car mile is small I know that we are hauling big trains. We have a road which is not much troubled with grades, and therefore we do not hesitate to put sixty or seventy cars on the engine, and we find that as the load increases the cost per car mile decreases, until we get at such a load that we cannot make time. Then we have to stop increasing the load. Of course, it is a very difficult matter to say what a locomotive ought to haul from day to day. The season of the year, the condition of the rail and other variables

balance any non-economical point in working over that grade. I am not speaking in the interests of the motive power or the transportation departments, but of the company, that pays all the bills.

Changes in Schemedaly Locomotive Works.

The Schemedaly Locomotive Works are improving the opportunity of the fall times by replacing their old machine shop with a new two story modern structure built of steel frame work and brick filling. The new building will be 50 feet in width by 308 feet in length.

The first floor will have two Sellers' electric cranes, traveling the entire length of the building, and covering all the heavy tools used on locomotives and driving-wheels.

The Phoenix Iron Company of Philadelphia have the contract for the steel frame-work of the building, while the masonry is being done by a local builder. The B. F. Sturtevant Company, of Boston, are furnishing their blower system of steam heating, which is used with success in a number of other departments of the works.

The old machine shop, now demolished, was built in 1866, replacing a structure which at that time was destroyed by fire. The machine tools have been temporarily transferred to other buildings and set up, so no delay in filling orders will be experi-

? A. What You Want to Know. ? A.

Don't ask questions that simply require a little figuring to determine. make each question separate. No notice taken of anonymous questions.

174 F. E. W. Menomonee, Wis., writes - Will you give me a mixture of some kind for painting brass in the cab so that it will not scale off. A.-Try asphaltum varnish.

177 J. G. M., Chicago, writes From what point of the valve-face would you measure in order to ascertain the amount of the inside lap? A.-This is answered in Answer No. 78, of April.

178 J. H. H., Concord, N. H., writes Will you give me a good method of soldering two pieces of brass together by using common solder. A.-Clean the surfaces thoroughly, to them over and use borax as a flux.

179 A. J. Dallas, Tex., writes Will you tell me if a narrow gauge locomotive of the same tonnage will pull as much as a standard gauge engine, everything else being equal? A.-Yes. The power will be the same.

184 J. W. B., Winnepeg, Man., writes Is it possible by exact mathematical methods to square any given circle, and, what method should be followed? A.-If the question relates to the size of a square which any circle will make it can be done by taking the square root of the area. If the question relates to the old method of finding a circle, we do not care to say anything about it.

185 E. B. H., Belle Centre, O., writes 1. Will an engine exhaust earlier in the stroke when hooked up than when running at full speed? A.-Yes. 2. Will the load of a perfect engine be decreased when it is hooked up? A.-We do not know what you mean by a perfect engine, but ordinary locomotives and with ordinary sliding link motion the load is increased as the engine is hooked up.

187 Apprentice, Louisville, Ky., asks What is the Walschaert valve motion, and in what respect is it better than the link motion? A.-The Walschaert motion actuates the valve by means of a single eccentric and a connection with the cross-head. The only claim we ever heard advanced for its being superior to the link is in its producing a constant lead. We do not consider this feature of any advantage.

188 A. R. M., Philadelphia, Pa., writes What is a regular advance of eccentrics? A.-If a valve had no lap the eccentric would be set with the full part at right angles to the crank. The lap and lead require that the eccentric be advanced sufficiently to cause the valve to admit steam at the beginning of the stroke. The number of degrees the eccentric has to be advanced for this purpose is called the "angular advance."

189 A. S. B., Spokane, Wash., writes Is there any way that I could obtain a general knowledge of chemistry without much study? A.-A king once asked Euclid, the famous mathematician, if there was not some easy way to learning the problems which Euclid had given to the world, and was informed that "There is no royal road to geometry." It is a great secret he said about chemistry. It is a great science, which can be mastered only by hard and persistent effort. Any one merely wishing to know what chemistry is can get a fair idea by going through Rowce's Science Primer on the subject.

189 Engineer, Buffalo, N. Y., writes In connection with the discussions going on about the hammer blow due to uncounterbalance, I have heard the suggestion that the reciprocating parts be made of aluminum. Do you think this is practicable, and that it would pay railroad companies? A.-An alloy of aluminum

might be used in pistons and crossheads that would reduce the weight. Pure aluminum is the most promising material that steel is the most promising material that is to be employed in reducing the weight of reciprocating parts. For a given weight it has strength far beyond any other metal.

186 C. W. H., Sayre, Pa., writes 1. Please state which is the best way to fasten a valve-stem when covering parts on an engine with metallic packing, where there is no arrangement for the purpose? A.-This might be accomplished in different ways, but an engineer with metallic packing has no right to be found on the road without a clamp for holding the valve stem in position. 2. What part does the lower chamber to a Westinghouse triple-valve perform, and what is the spring in this chamber for? A.-The chamber acts as a dip reservoir, and the spring cushions the blow from the triple valve.

187 B. N. Y. L., New York City, writes I want to know the difference weight of a pound of steam and a pound of water, and the amount of space occupied by each of them. A.-There is about the same difference in weight between a pound of steam and a pound of water as there is between a pound of chalk and a pound of cheese. A pound of water at its greatest density has a volume of 27 7/8 cubic inches. When converted into steam at atmospheric pressure its volume is increased 1,644 times, steam at 100 pounds pressure has 273 times the volume of the water; at 300 pounds pressure the steam occupies only 97 times the volume of the water.

188 J. P., Ludlow, Ky., writes Will you give for the benefit of several of your readers a clear definition of the word "stress" as we find it used in engineering books and papers? A.-"Stress" is an abbreviation of the word "distress" and Rankin explains it as, "Force exerted in any direction or manner between contiguous bodies or parts of bodies, and taking specific names according to its direction or mode of action." There is the tensile stress, caused by pulling, the compressive stress, such as that borne by a rack under a load, the shearing or tangential stress, that boiler rivets are subjected to, and the volumetric stress, which a body is subjected to entirely inside of a boiler or of a hydrostatic press.

189 Student, Brooklyn, N. Y., writes We have been talking about your article on cylinder condensation, and several remedies have been suggested. We understand that English locomotive builders use inside cylinders because the heat from the smoke-box helps to keep the cylinders warm, and prevents the losses from condensation. Now, why can't American builders make a casing round the cylinders, and cause the gases from the tubes to flow through the casing and keep the cylinders hot? Is this plan feasible? Is there any practical objection to it? The plan has been tried repeatedly with American locomotives without the proof being made of any apparent saving. Tests of improvements on locomotives have, however, been carried out so unsatisfactorily that the effect of keeping the cylinders warm is in doubt. We believe that material saving would be effected.

A railroad man in Utah sends us a paper with a description of an improvement to the Westinghouse air-brake which has been patented by a Utah inventor. Its purpose is to give a better hold of the train on a steep grade. The engineer is recharging the auxiliary reservoirs.

Moving the Angle-cock by Vibration.

Mr. George Holmes, of Roanoke, Va., writes.

"In the December number of the LOCOMOTIVE ENGINEERING I mentioned the fact that I was experimenting with angle-cocks, but in order to learn, if possible, why they do not order to lears, I stated that right or left hand-wound springs would open or close them. I am now led to believe that this was not the greatest factor in the results obtained, but were acted upon by something else that I can not as yet satisfactorily explain. At any rate, other experiments go to show that with the axis of the angle-cock key perpendicular and the springs bearing properly at the ends, the tendency of the handle on being struck appears to be to move a short distance toward the side from which it was last moved, and then, other things being equal, to remain practically stationary."

Instantaneous Positive Vice.

The appended illustrations show a decided improvement in that useful shop tool, the bench vice for wood-workers. Hitherto the wood-worker's vice has received little attention from inventors, the consequence being that many of the tools in use hold the work so loosely and are so clumsy to handle that much time is wasted over it.

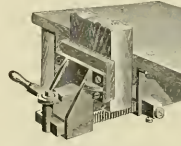

The peculiarities of this vice are that it takes work in instantly and holds it firmly and parallel, two very important features.

The mode of action is as follows: The work is put between the jaws and the construction of the vice being such the work



will not fall off, unlike other vices where you have to hold the work while you fasten it; you then take hold of handle and push up to the face of the bench, and by giving the handle a slight turn the work is instantly held tight and firm, the harder you push on handle the tighter it holds.

To release the work the handle is slightly pulled toward you, and when standing in front of the bench is entirely out of the way.

The vice is made by Henry C. Ayer & Gleason Co., Philadelphia, Pa. They will send a vice on trial to any responsible firm.

How Firemen Should be Selected.

At the New York Railroad Club, Mr. W. C. Watson, superintendent of the West Shore Railroad, read a paper on "From What Class of Railroad Employes Should Firemen be Selected?" After a few introductory remarks, he said:

"In considering this subject we should practically have the locomotive engineer, rather than the fireman, in view, because probably 99 per cent. of the men who become locomotive engineers in this country are now advanced from the ranks of the firemen, and probably 75 per cent. of the locomotive firemen ultimately become engineers. Therefore, upon the selection of firemen, depends the character of the

engineer. And upon the character of the engineer depends more largely than on any other class of employes the safe operation of our roads. Also, that the demands upon the engineer of the engine are being gradually increased, both with reference to him as a factor of safety and of economical administration.

"The title of my subject implies that the locomotive fireman should be selected from among the employes on the road and I believe that to be the best practice.

"First proposition-Loocomotive fireman should be gradually selected with reference to their fitness as firemen, and that while they are filling the position of head brakeman they will be on probation or trial for the purpose of ascertaining, as nearly as possible, whether they are the right kind of timber to grow up to be engineers or not.

"Third proposition-In selecting firemen the main purpose of the engine runner should be the controlling consideration, and that everything else should be subordinate to this essential requisite.

"Fourth proposition-As a general rule, the fireman who has the least promise of becoming a satisfactory engineer is the one who is selected from the ranks of the engine runners.

In the discussion that followed of the reading of this paper, the transportation men favored selecting the firemen from brakemen, and the mechanical men expressed a preference for the promotion of wipers. The general sentiment was that much more are no longer needed as engines and members objected to firemen being selected from any single class. They preferred the best young men they could find, no matter what their previous occupation may have been.

A Conductor Who Defended His Money. Tom Robinson is a hitch-hick freight conductor on a run that takes him through the verdant New Jersey meadows, and accords him the distinction of living in the lively regions where Jersey City ends and Hoboken begins. Tom is something of a joker, and says his home is the liveliest place on the mainland, for there are no longer needed as engines and members objected to firemen being selected from any single class. They preferred the best young men they could find, no matter what their previous occupation may have been.

A Conductor Who Defended His Money.

Tom Robinson is a hitch-hick freight conductor on a run that takes him through the verdant New Jersey meadows, and accords him the distinction of living in the lively regions where Jersey City ends and Hoboken begins. Tom is something of a joker, and says his home is the liveliest place on the mainland, for there are no longer needed as engines and members objected to firemen being selected from any single class. They preferred the best young men they could find, no matter what their previous occupation may have been.

No man in the service is more attentive to rules than Tom, but the rule against going into saloons while off duty he has considered an infringement of his personal liberty. Not that he is a drinking man, but he had a habit of looking into the little saloons in a corner while on his way home and indulging in a glass of beer. This saloon was the resort principally of men of low degree, and Tom considered the most aristocratic patron The habitués of the place naturally envied Tom, and coveted the wealth a railroad conductor must necessarily possess.

One night, as Tom was crossing some vacant lots between the saloon and his mansion, two enterprising voters of the region jumped upon him and demanded that he empty his pockets into their hands. Instead of doing that he smote them from head to heel with all the weapons that nature had provided. After a violent struggle he was left with a few scratches and a few bruises, and the ruffians were victorious. They carefully examined the pockets of the prostrate conductor, and all they found was a dime and two cents. They were the most disgusted brace of ruffians in Jersey. They had a hard time of it, but no worth of blows and gathered in only a few cents. "Be Jaws," groaned one of them, "I'm almost dead away. 'If a fellow had had the dollar in his pocket he wd' a' kill us both."

Important Car-Heating Patent Decision.

At a session of the Circuit Court of the United States for the Eastern District of Michigan, continued and held pursuant to adjournment, at the District Court Room, in the City of Detroit, on Tuesday, the tenth day of April, in the year one thousand eight hundred and ninety-four.

Present—The Hon. HENRY H. SWAN, District Judge.

CONSOLIDATED CAR-HEATING COMPANY, vs. No. 3265. MICHIGAN CENTRAL RAILROAD COMPANY.

This cause came on to be heard and was argued by counsel for complainant and defendant, and thereupon upon due consideration thereof it is ordered, adjudged and decreed as follows, viz:

1. That the Letters Patent No. 329,047, granted on the 27th day of October, 1885, to Elmore D. Gody and John W. Hayes, assignee for a one-half interest therein for a new and useful improvement in steam car-heaters are a good and valid Letters Patent, and are now owned by complainant.

2. That the defendant has infringed the rights secured to the owners of said patent.

3. That the said Elmore D. Gody was the first and true inventor of the improvements in car-heating described and claimed therein, and especially those claimed in the second claim thereof.

4. And it is further ordered, adjudged and decreed that the said defendant, The Michigan Central Railroad Company, its officers, agents, servants, workmen and attorneys be, and the same are each and every one of them hereby perpetually enjoined and ordered to desist from making, using or selling in any manner or form whatever, any car-heating system or apparatus described and claimed in said Letters Patent, and especially any form of continuous car-heating apparatus employing or taking steam from the locomotive through a continuous train-pipe, in combination with the upper and lower courses of side coils within the cars, with intermediate connections near the center of the car, between the upper courses of the said coils and the supply-pipe, and with an automatic steam-trap under the central

portion of the car and intermediate connections between the lower courses of the side coils and said trap; and that the usual writ of permanent injunction issue out of this Court directed to the Michigan Central Railroad Company, its officers, agents, servants, workmen or attorneys, ordering them and each of them to desist from making, using or selling the inventions described in said Letters Patent, and especially those claimed in the second claim thereof.

5. And it is further ordered that the complainant do recover from the defendant all damages which it has sustained by reason of said infringement, and all profits which the defendant has made by and due to said infringement and the employment wrongfully of the said invention, and that said complainant have an accounting therefor, and that it be referred to Walter S. Harsha, who is hereby, at the request of parties appointed Special Master for that purpose, to take an accounting thereon and to report to this Court with all convenient speed the amount of damages suffered thereby by complainant and the amount of profits earned thereby by the defendant. And that said Master be empowered to examine such witnesses as may be summoned or produced before him, and to require the production of such books, accounts or papers as shall be competent evidence thereon.

HENRY H. SWAN, District Judge.

Detroit, April 10, 1894.

United States of America.

IN THE CIRCUIT COURT OF THE UNITED STATES.

FOR THE EASTERN DISTRICT OF MICHIGAN. IN EQUITY.

CONSOLIDATED CAR-HEATING COMPANY, vs. No. 3265. MICHIGAN CENTRAL RAILROAD COMPANY.

EASTERN DISTRICT OF MICHIGAN, JJ.

I, WALTER S. HARSHA, Clerk of the Circuit Court of the United States, for the Eastern District of Michigan, do hereby certify, that the above and foregoing is a true copy of the decree in the above entitled cause, as the same appears on record in my office, that I have compared the same with the original entry, and it is a

true and correct transcript therefrom and of the whole thereof.

In testimony whereof, I have hereunto set my hand and affixed the seal of said Court, at Detroit, in said District, this Tenth day of April, in the year of our Lord, one thousand eight hundred and ninety-four, and of the Independence of the United States of America, the one hundred and eighteenth.

Clerk.

This issue of the paper is gotten out slightly ahead of time to give us more days to get into our new offices at 256 Broadway. LOCOMOTIVE ENGINEERING has grown so fast that the old offices at 912 Temple Court have been far too small for the past year. All friends of the paper are expected to call when in the city. Visitors furnishing their own cigars will be treated to Croton water gratis.

The Sample Tells the Story.

A sample of Dixon's pure, flake lubricating Graphite, with interesting and instructive pamphlet,

Sent Free of Charge.

Every engineer and machinist should make himself better acquainted with Dixon's Pure Ticonderoga Flake Graphite. It will save both time and labor, and is infinitely superior to the common forms of plumbago or black lead.

JOS. DIXON CRUCIBLE CO., JERSEY CITY, N. J.

THE HALL SIGNAL CO.

Leads the World in the manufacture and installation of

Automatic Block Signals

Operated by either Track or Wire Circuits.

The ONLY Automatic Signal Systems in which the signals can be operated on the "Normal Danger" principle. Believed by many to be the best and safest plan.

HIGHWAY CROSSING SIGNALS, STREET RAILWAY CROSSING SIGNALS, ETC.

OFFICES:

- 80 Broadway, New York.
- 927 The Rookery, Chicago.
- 115 The Ames Building, Boston.
- Equitable Building, Baltimore.

FINE DRAWING INSTRUMENTS.



Drawing and Blue Print Papers. DRAWING MATERIALS OF EVERY KIND.

QUEEN & CO. 1010 CHESTNUT STREET, PHILADELPHIA.

CATALOGUE ON APPLICATION.

RAU MANUFACTURING CO.,

Manufacturers of

METAL SPECIALTIES, ENGINEERS' TORCHES & OILERS.

THE PERFECTION VALVE OILERS.

LABOR-SAVING AND ECONOMICAL.



SAVES BOTH OIL AND TIME.

We do a general contracting and jobbing business on orders, and would be pleased to figure on specifications for what you may use in our line. Correspondence solicited.

122 to 128 MICHIGAN STREET, CHICAGO, ILL.

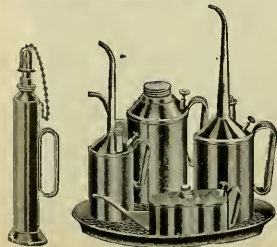

THE WESTINGHOUSE AIR-BRAKE CO.

Is now prepared to fill orders, at an hour's notice, for One or One Thousand Sets of

AIR-BRAKES FOR FREIGHT CARS,

having, at their New Works, an annual capacity for turning out Air-Brakes for 250,000 Freight Cars, 6,000 Passenger Cars, 10,000 Locomotives; besides repairs for the 350,000 Freight and Passenger Cars, and 26,000 Locomotives already equipped by

THE WESTINGHOUSE AIR-BRAKE CO.

REQUIRES NO ATTENTION.

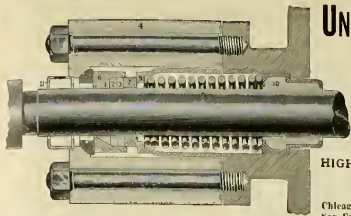

Swab and Oil Cups Furnished with every Packing.

IN USE ON THREE HUNDRED AND FIFTY RAILROADS.

UNITED STATES METALLIC PACKING CO.

For Locomotives, Stationary and Marine Engines.

The United States Metallic Packings

HAVE STOOD THE TEST OF YEARS AND ARE ACKNOWLEDGED TO BE SUPERIOR TO ALL.

Renewal of Packing Rings made without disconnecting, by cutting them in halves and breaking joints.

HIGHEST AWARDS COLUMBIAN AND PARIS EXPOSITIONS.

General Office, Bullitt Building; Works, 427 N. 13th St., Philadelphia, Pa.
Chicago, Rotunda, Grand Pacific Hotel. St. Louis, 32 Laeude Building.
San Francisco, 130 Main Street. Montreal, Canada, 751 Craig Street.

SEND FOR CATALOGUE AND SPECIFICATIONS.

JEROME METALLIC PACKING.

This is the Standard Metallic Packing all over the world, and is more generally adopted and in use on more locomotives than any metallic packing in use. Give the JEROME a trial and be convinced. Put it in competition with any other packing and be convinced of its superior merits.

Office and Works, Nos. 35 and 37 Canal St., Chicago, Ill.

C. C. JEROME, Inventor and Proprietor.

Packing ring opened ready to apply without disconnecting the Piston from the crosshead. It runs longer and wears the rod less than any other packing in use.



SEND FOR CATALOGUE.

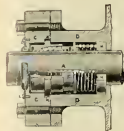

Graham's Patent Groove Shank Twist Drills and Chucks.



DETROIT TWIST DRILL CO., Detroit, Mich., U. S. A.

PATENTS
FOR INVENTIONS.
GEO. P. WHITTLESEY,
Atlantic Building, Washington, D. C.
EXPERT SEARCHES AND OPINIONS,
ESPECIALLY IN RAILROAD INVENTIONS A SPECIALTY.

SCHOEN MFG. CO.

PRESSED
STEEL MATERIAL
FOR CARS.

PITTSBURGH,
— PA. —

MATCHLESS VALVE AND CYLINDER OIL.

Warranted not to corrode the iron or destroy packing, and to make more mileage than tallow or lard. Sold only to Railroad Companies direct or through our authorized agents. Matchless Cylinder Oil cannot be Bought of Dealers. In use on 60 Railways.

OILS FOR RAILROAD USE A SPECIALTY.

ECLIPSE LUBRICATING OIL COMPANY, Limited,
MANUFACTURERS OF EVERY PRODUCT OF PETROLEUM.

Head Office: FRANKLIN, Pa. Home Office: FRANKLIN, Pa. OLEAN, N. Y. SHIP, Pa. OIL CITY, Pa.



OPEN HEARTH STEEL **CAMBRIA** COFFIN TOUGHENED

CAMBRIA IRON COMPANY,
Office 218 SOUTH 4TH ST. PHILADELPHIA, PA.
WORKS AT JOHNSTOWN, PA.

Driving, Truck, Passenger and Freight
Axles, Piston and Slide Rods, Crank Pins.

COOLBAUGH & POMEROY
SPECIAL R. R. SALES AGENTS.
29 BROADWAY NEW YORK.

STEEL BEFORE TOUCHENING TOUCHENING STEEL AFTER TOUCHENING

TOUGHENED BY COFFIN PROCESS, PATENTED

OPEN HEARTH COFFIN PROCESS TOUCHENED

CAMBRIA STEEL

INSTRUCTION BY MAIL

IN ARCHITECTURE, ARCHITECTURAL DRAWING, PLUMBING, HEATING & VENTILATION, MECHANICS, MECHANICAL DRAWING, BRIDGE ENGINEERING, ELECTRICAL ENGINEERING, SURVEYING AND MAPPING, MINING, ENGLISH BRANCHES, and

RAILROAD ENGINEERING.

Diplomas awarded. To begin students we only know how to read and write. Send for FREE Circular of Information stating the subject you think of studying to:

The Correspondence School of Mechanics and Industrial Sciences, SCRANTON, PA.

4000 STUDENTS.

OUR ENGRAVINGS.

Of late we have had a great many inquires as to who made the fine half-stone plates shown each month in *LOCOMOTIVE ENGINEERING*. Credit is due the expert any where and we are glad to recommend the engravers of our plates in those wanting good work at reasonable prices. All the half-tones and reproductions we use are made by the STAR ENGRAVING & PRINTING Co., 607 & 609 Sanson St., Philadelphia, Pa. SICHLAR & HILL.

KEEP YOUR PAPERS CLEAN.

Hinders that will hold a full year's numbers for sale.

PRICE, \$1.00, POSTPAID.

LOCOMOTIVE ENGINEERING, 8 Beekman Street, New York.

SIGNAL OIL WORKS, LIMITED, FRANKLIN, PA.

MANUFACTURERS OF SIBLEY'S Perfection VALVE OIL, The only perfect Locomotive Valve Lubricant. J. C. SIBLEY, Prest.

GALENA OIL WORKS, (LIMITED)

Galena Engine, Gravel and Car Oils, The Standard Lubricating Oils of America.

SAFETY SEERED and REWORKED are the results of the use of Galena Oils. LARD TEST IS IN IT BELOW 250°. These oils are refined to the extent as when while they are adaptable to the heaviest conditions. On the use of Galena Oil there is no extra freedom from dirt, because it is so refined by our standard before.

The attention of engine men on standard railways is attracted by a large majority of the leading railways of this country are in evidence of their superior quality. While the fact that the same roads use these oils as they that used them more than 20 years ago, is an evidence of their superiority from year to year and year to end our leaders are sure to continue to use them because of their fine flow from below and New York to the Pacific coast, and upon our machines are being their durability to all temperatures and climates. Being collected from foreign lands oils are not affected by dirt and sand as other oils are.

We also furnish our customers SIBLEY'S PERFECTION VALVE OIL, which is also used extensively upon a majority of the leading railways of America.

GALENA OIL WORKS, Limited, CHARLES MILLER, President, CHICAGO BRANCH OFFICE, Franklin, Pa., FRANKLIN BUILDING, 10 JACKSON ST.

LEONARD & ELLIS.



OILS FOR RAILROADS.

VALVOLINE OIL has long been used on many of the leading railroads in this country and abroad. It has no equal in quality and longevity.

W. A. BOYDEN, General Agent, 137 Chambers Street, NEW YORK.

THE BOYER Railway Speed Recorder



The only Recorder made that gives a chart of the run that can be read at sight, and has a DIAL INDICATOR carried into the cab so Engineer can see at a glance, any time, what speed he is running.

Boyer Railway Speed Recorder Co.

244 DICKSON ST., St. Louis, Mo., U. S. A.

TRACK SANDING APPARATUS FOR LOCOMOTIVES

HENRY L. LEACH, (formerly of Boston), BOSTON, MASS., Room 45, Mason Building, 70 Kilby Street.

HENRY CAREY BAIRD & CO., Industrial Publishers, Booksellers and Importers.

810 WALNUT ST., PHILADELPHIA, Pa. Our New and Revised Catalogues of Practical and Scientific Books, of Journals, etc., and our entire Catalogues and Circulars, for whole covering every branch of science applied to the Arts, sent free and free of postage to any one in any part of the world who will forward his address.

BOOKS YOU WANT.

"LOCOMOTIVE RUNNING REPAIRS," by I. C. BIRCHHEAD, General Foreman "800" Shops. A practical treatise on running repairs, by a practical man. Numerous Engravings and Illustrations. Just what is needed by men who handle and repair locomotives.

"SIMPLE LESSONS IN DRAWING," by GAYLIE H. BIRCHHEAD Chief Draftsman Northern Pacific Railway. A splendid book shows how to learn the elementary principles of mechanical drawing and sketching.

"PROGRESSIVE EXAMINATIONS OF LOCOMOTIVE ENGINEERS AND FIREMEN," by JOHN A. BILL, Editor *LOCOMOTIVE ENGINEERING*. A capital little book for new locomotives. An excellent pocket companion. Three hundred questions and the answers. Seventeen colored plates showing position and color of all signals carried on engines and trains according to standard code.

Send 50c. for any of the above to DEBS PUB. CO., TERRE HAUTE, IND.

Books for Railroad Men.

LOCOMOTIVE ENGINE RUNNING AND MANAGEMENT, By ANGELO SICHLAR. Price, \$2.00.

INDICATOR PRACTICE, By FRANK F. HEIKENWAY. Price, \$2.00.

ELEMENTS OF MECHANICS, By T. H. MOORE. Price, \$2.50.

PROGRESSIVE EXAMINATIONS FOR ENGINEERS AND FIREMEN, By JOHN A. BILL. Price, 50 cents.

AIR-BRAKE PRACTICE, By J. E. FUSLAR. Price, \$1.00.

COMPOUND LOCOMOTIVES, By A. T. WOODS. Price, \$2.00.

CATECHISM OF THE LOCOMOTIVE, By M. N. FORSTER. Price, \$3.50.

SIMPLE LESSONS IN DRAWING FOR THE SHOP, By O. H. KARNSTADT. Price, 50 cents.

Send price of any of these or of any other books of THE ENGINEERING LITERATURE COMPANY, East Orange, N. J., and they will be promptly mailed to any part of the world. Send for Catalogue.

THE

HAYDEN & DERBY MFG. CO.,

Sole Manufacturers of

Metropolitan Dowel-Tube Locomotive Injectors

These Injectors work at all steam pressures from 25 pounds up to 250 pounds without any regulation or adjustment.

It is impossible for the water to run out of the overflow when Injector is working.

They are not affected by leaky steam or check valves.

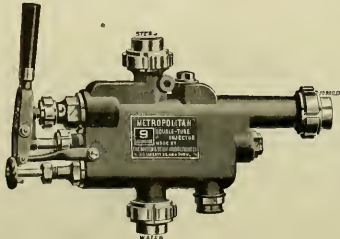

Owing to the peculiar form of nozzles used, repairs of these Injectors are reduced to a minimum. They are very slightly affected by bad water, there being no small relief holes or spills to wear or become clogged.

MADE INTERCHANGEABLE WITH STANDARD MAKES.

Office and Salerooms:

Nos. 111 and 113 LIBERTY STREET, NEW YORK.

M. C. B. STANDARD
Automatic Freight Car Coupler.

New York Office, . . . 120 Broadway,
Chicago Office, . . . 941 Rookery,
St. Louis Office, 319 Commercial Bld'g.

GOULD
Coupler Co.

BUFFALO OFFICE AND WORKS,
AUSTIN ST.

Gould Continuous
Platform and Buffer.
GOULD VESTIBULE.

M. C. B. Passenger Coupler
Used in Place of Miller Hook
WITHOUT CHANGE IN PLATFORM.

Locomotive and Car Axles,
Coupling
Links and Pins.

STARRETT'S FINE TOOLS
SEND FOR CATALOGUE.

Starrett's

ARE WARRANTED ACCURATE

L. S. STARRETT, MASS.
ATHOL, MASS.

THE SMILLIE COUPLER is the Strongest and Simplest M. C. B. Coupler.
Only 4 Pieces.

Tensile Strength (Fairbank's Test) 139,640. Drop Test, 700 lbs.
Hammer dropped 18 ft. 22 times failed to break the knuckle.

ALL LOCKING PARTS ARE THE BEST OF STEEL.

NEW YORK OFFICE, 52 BROADWAY,
Office and Works, 91 Clay St., Newark, N. J.

JOHNSTON CAR COUPLER COMPANY,
204 WALNUT PLACE,
PHILADELPHIA PA.

JOHNSTON CAR COUPLER

Strictly M.C.B. Lines.

THE TROJAN CAR COUPLER Co., Troy, N. Y.

The knuckle may be thrown open for coupling by the hand rod at the side of the car, rendering it unnecessary for the trainmen to go between the cars to open the knuckle.

M. C. B. TYPE. THE STRONGEST AND THE ONLY SAFETY COUPLER. New York Office: 49 WALL ST.

ST. LOUIS CAR COUPLER CO., St. Louis, U. S. A.

STEEL ST. LOUIS COUPLER.

Stands M. C. B.
Tests, and complies with U. S. law, requiring use of Automatic Car Couplers on and after January 1st, 1893.
Thousand of Cars already equipped. Capacity of Works, 200 Couplers per day.

THE CHAPMAN JACK. PATENTED.

THE screw being lubricated and protected, the Jack is always ready for instant service. Railroad men appreciate the importance of having Jacks always in good working condition. Serious delays frequently occur in getting common Jacks so that they can be worked when suddenly required in train service.
Common Jacks are frequently destroyed in efforts to make them work quickly after the screws are set with rust and dirt. This consideration alone makes the Chapman Jack the most economical one to purchase.

THE CHAPMAN JACK CO., CLEVELAND, OHIO.

O. K. BRAKE ADJUSTER.
Insert the Maximum pressure on the Brake shoes at all times.

Manufactured by PRATT & LETCHWORTH,
BUFFALO, N. Y.

FIRE BOX STEEL.

QUALITY UNSURPASSED

Plates up to 100 ins. in width.

SHOENBERGER & CO.,
PITTSBURGH, PA.

SWIFT, DURABILITY AND SOFTNESS.

Boiler, Locomotive AND Smoke Stack STEELS.

POWER

A MONTHLY JOURNAL devoted to Steam Engineering and Practical Work relative to the Economic Generation and Transmission of Power. 66 to 64 pages, size of this paper, profusely illustrated. Price, \$1.00 a year. Send for Sample Copy FREE. Address: THE POWER PUBLISHING CO., WORLD BUILDING, NEW YORK.

THE ONLY DOUBLE TRACK RAILWAY BETWEEN CHICAGO AND THE EAST.

Wagner Sleeping Cars, Drawing Rooms and Private Comforted Cars between Chicago, Toledo, Cleveland, Buffalo, Indianapolis, St. Louis, Albany, New York, Boston and intermediate points.

Route of the NEW YORK AND CHICAGO LIMITED, BOSTON AND CHICAGO SPECIAL, and the U. S. FAST MAIL.

W. B. CANNIFF, Gen'l Mgr. CLEVELAND, O. A. J. SMITH, G. P. & A.

New York. Boston. Chicago.

HOWE, BROWN & CO., (Limited) PITTSBURGH, PA.

STEEL.

HOWE'S SPECIAL TOOL CAST STEEL for Taps, Dies, Reamers, Cutters, Planes, Chisels, Drills, Shear Blades, Lathe Tools, etc., etc. Crucible Spring Cast Steel, Crucible and Open Hearth Firebox and Sheet Cast Steel, Forgings, etc.

D. O. SETTLEMIRE, President.

GEO. W. EVANS, Vice-President.

W. C. ARTHURS, Secy and Treas.

FRANK BENDER, Asst.

Mt. Vernon Car

MANUFACTURERS OF
FREIGHT CARS OF EVERY DESCRIPTION, CAR-
BOOSE AND REFRIGERATOR CARS,
MT. VERNON.



Manufacturing Co.
CAR WHEELS, CAR CASTINGS, AND GENERAL
FOUNDRY WORK.
Capacity, 15 Cars and 500 Car Wheels,
ILLINOIS.



MILLER'S ASBESTOS CAR ROOF.

HEAVY, DURABLE AND STRONG.
WILL WEAR LONGER THAN ANY METAL ONE.
WILL WEAR THE LIFE OF THE CAR.

Costs from \$10 to \$15 Less per Car.
CAN BE PUT ON IN ONE-HALF THE TIME.

HEAR WHAT THEY SAY ABOUT IT!
Get Test M. A. 1 1/2. Don't List Boston & Albany R.R.

1302 HAVEMEYER BUILDING, 26 Cortland Street, NEW YORK.

THE ALLISON MFG. CO.,

MANUFACTURERS OF
FREIGHT CARS AND
LOCOMOTIVE BOILER TUBES.

WROUGHT IRON PIPE OF SUPERIOR QUALITY.

PHILADELPHIA, PA.

DRAKE & WEIRS, Cleveland, Ohio.

ASPHALT CAR ROOFING

The Cheapest, Best and Most Durable Car Roof Known. In use by Seventy
Railroads. 7 cent's extra on roof as without a single failure. A new roof furnished free for
every one that falls in ten years.



WILLIAM C. BAKER,
Sole Proprietor and Manufacturer of

FIRE-PROOF BAKER CAR HEATER

MADE OF FLEXIBLE STEEL
ONE-QUARTER INCH THICK.
Firmly Welded into One Compact, Jointless, Seamless-Whole.
FIRE WITHIN A SAFE OF SAFE MATERIAL
AS THE EXPRESS CAR SAFE.

The Only Alternative for the Deadly Car Stove
and the EQUALLY VICIOUS and EXPENSIVE STEAM HEAT.

NEARLY 1000 FIRE-PROOFS IN USE,
ALL OTHER STYLES OF "BAKER HEATERS."
143 LIBERTY STREET, NEW YORK.

RODGER * BALLAST * CARS.

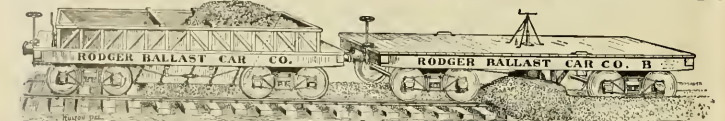

These cars are 34 feet long, and are built either 50,000 or 60,000 lb capacity, M. C. S. Standard. They carry from 10 to 20 cubic yards of gravel or broken stone
in using them to haul to throw in the ditch, and some is used, as the precise amount of ballast needed can always be discharged. A load of 25 cars, carrying
100 cubic yards of ballast, can be unloaded and the ballast distributed, leaving the track perfectly cleaned and leveled, in from 12 to 15 minutes. The
cars are built with a "triple service" (a coupler and two brackets), no extra help being required. The track is perfectly cleaned by the scraper, so that a
ballast from between the cars, and so cleaning the tracks with wheels. The valves is left between the cars, and no wire cables are used. There is no shoving
the track's wheels, without being obstructed by from track. The average saving per mile, in the amount of ballast needed to make a "raise" of 10 or 12 inches,
will be about \$90 yards and often far exceeds this. The total saving per mile, in material, labor, time, use of cars, saving in transportation, etc., is found to amount to
\$1000 per mile.

These cars are in use on the Great Northern Ry., the Illinois Central, the Gulf, Colorado &
Santa Fe, the Chicago & Eastern Illinois, the Penn. Lines West, and other roads.

Detailed information will be furnished by circular by addressing the
RODGER BALLAST CAR COMPANY, No. 1215 Monahan Building,
CHICAGO, ILL.

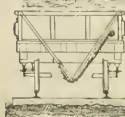

SURE TO CIVE

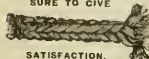

SATISFACTION.

DUVAL METALLIC PACKING

Send for Catalogues, Prices and detailed information to

THORNTON N. MOTLEY & CO.,

SOLE AGENTS,

43 John Street, NEW YORK.

LOCOMOTIVE ENGINEERING, N.Y.



Is the most interesting
feature of the
present day
locomotive
industry.
It is the only
book of the kind
published.
It is the only
book of the kind
published.
It is the only
book of the kind
published.

Send with title. The power for you and those like
you who are interested in a 40 page. Address
LOCOMOTIVE ENGINEERING,
8 Beekman St., New York.



29 BROADWAY, NEW YORK CITY.

THE CAMERON STEAM PUMP.

COMPLETE WITH BOILER.

THE A. S. CAMERON
STEAM PUMP WORKS,
Foot of E. Twenty-third St.,
NEW YORK.

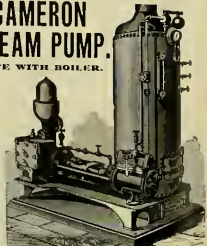

Send for Illustrated Catalogue.

Charcoal Iron
Boiler Flues

THAT DO NOT PIT

ARE MANUFACTURED BY
THE TYLER TUBE AND PIPE CO.
WASHINGTON, PA.
New York Office, 39 Cortland St.



THE CLEVELAND VARNISH CO., Mfrs. RAILWAY VARNISHES. CLEVELAND, O.

RAMAPO IRON WORKS, Hillburn, N. Y.,

MANUFACTURE

Brake Shoes for Steel Tired Wheels:

ROSS, for Steel Tired Car and Tender Wheels,
ROSS-MEEHAN, for Locomotive Drivers,
SHEPPARD, for Blind or Bald Tired Drivers.

NARROW GAUGE CARS, SWITCHES, AUTOMATIC STANDS.

YOKED, BOLTED and SPRING RAIL FROGS,
CROSSINGS, TRACK EQUIPMENT,

RAILROAD AND MACHINERY. CASTINGS, HEAVY AND LIGHT.

RAMAPO WHEEL AND FOUNDRY CO.

MANUFACTURED OF

BOLTLESS STEEL-TIRED WHEELS

FOR PASSENGER AND LOCOMOTIVE SERVICE.

Tires with Annular Web and Hook,
Best Charcoal Iron Double-Plate or Spoke Centers,
Wedge-Shaped Retaining Ring.



SECTION OF BOLTLESS TIRE-TIRE

Continuous
Circumferential
Fastening.



SIMPLE, +
SAFE, +
ECONOMICAL.

CHILLED IRON WHEELS

OF SUPERIOR QUALITY,
Drum or Room, Passenger and Freight Cars,
Locomotives, Tenders, Flatcars,
and Blue Cars.

CONDONGON BRAKE SHOES

FOR CHILLED IRON WHEELS,
Outwear from 4 to 6 ordinary
shoes and enhance
mileage.

Office and Works: **RAMAPO, N. Y.**

C. B. HOOD.

D. M. BROWN.

ROOD & BROWN, CAR WHEEL WORKS, BUFFALO, N. Y.

Railroad, Car, Engine, Tender and Truck Wheels, Made from Best Charcoal Iron.
Office and Works: HOWARD and THOMAS STS.

C. M. PARRAR.

JOHN TRETTA

C. E. ROOD

EAST BUFFALO IRON WORKS,

PARRAR, TRETTA & ROOD, PROPRIETORS.

GREY IRON CASTINGS

of every description. Special Attention Given to Car and Locomotive Work.

Works: N. Y. C. & H. R. R., Broadway Station, Belt Line. | General Office: 60 Perry St., Buffalo, N. Y.



**THE WASHBURN
Car-Wheel Company,**
HARTFORD, CONN.,

MANUFACTURERS OF

CRUCIBLE STEEL-TIRED WHEELS

For Parlor and Sleeping Cars,
Passenger Coaches, Locomotive
and Tender Trucks.



President, H. A. DRISCOLL. Treasurer, J. L. OTIS.
Established 1907. Capital \$100,000.

NORTHAMPTON Emery Wheel Co.

MANUFACTURERS OF
PATENT
SOLID EMERY and
CORUNDUM WHEELS
and MACHINERY.

LEEDS, MASS.
CHICAGO OFFICE,
20 South Canal St.
Send for Catalogue.



TAYLOR BEST YORKSHIRE STAYBOLT IRON

Axles, Piston Rods, Crank Pins and Forgings of all
Descriptions, used by Leading Railroads.

R. MUSHET'S SPECIAL AND STEELS TITANIC

SOLE REPRESENTATIVES IN THE UNITED STATES,

B. M. JONES & CO.,

BOSTON, 11 and 13 Oliver Street. NEW YORK, 143 Liberty Street.

Manufacturers of BEARINGS FOR LOCOMOTIVES,
CARS, AND MACHINERY CASTINGS OF ALL KINDS.

DAMASCUS BRONZE A SPECIALTY.

WILL NOT HEAT TO CUT JOURNAL. FURNISHED IN INGOT OR CASTING.

J. & H. TAYLOR, F. F. VOLLIER, EDWARD PAGE & CO.
71 Craig Street, Montreal. 448 The Hookery, Chicago, Ill. 17 Battery Street, Boston, Mass.

The New "NATHAN"

(SEE ILLUSTRATION), AND

MONITOR INJECTORS FOR LOCOMOTIVES.

"NATHAN" SIGHT-FEED LUBRICATORS,
For Locomotive Cylinders and Air Brakes

STEAM FIRE EXTINGUISHERS,
For Switching and Yard Engines

BOILER WASHERS,
Road and Guide Oil Cups, etc.

Send for DESCRIPTIVE CATALOGUES.

NATHAN MFG. CO., 92 & 94 Liberty St.,
NEW YORK.

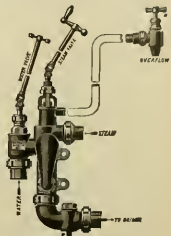

HOWARD IRON WORKS, BUFFALO, N. Y.

MANUFACTURERS OF

BOLT CUTTERS

-AND-

NUT TAPPERS.

Send For Price Lists.

HENRY C. AYER,
General Manager.

EDWARD D. GLEASON,

HENRY C. AYER & GLEASON Co.

MANUFACTURERS OF

Special Tools for Railway Repair Shops. Portable Cylinder Boring Machines.

SAFETY HOISTING MACHINERY. SPOKE AND HANDLE TURNING MACHINES.

OFFICE AND WORKS: N. E. corner of Second and Diamond Sts. — PHILADELPHIA. — CENTRAL OFFICE: No. 919 Betz Building.

THE ROTARY.

For full
Particulars,
Address

The Leslie Bros. Mfg. Co.,
Paterson, N. J.

LOCOMOTIVE SPRINGS

WITH PATENT V SHAPE BANDS.

Gives more Elasticity to short Plates
and Better Riding Qualities.



MANUFACTURED BY
A. FRENCH

SPRING CO.

RICHARD DUDGEON, 24 and 26 Columbia St., New York.

Made and Patented of
Improved Hydraulic
JACKS,

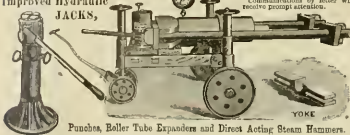

Punches, Roller Tube Expanders and Direct Acting Steam Hammers.

EP Jacks for Pressing on Crank
Pin of Cast Iron make to drive
Combinations by letter will
receive prompt attention.

YOKE

A. FRENCH, Pres.
J. E. FRENCH, Vice-Pres.

GEO. W. MORRIS, Gen. Mgr.

D. C. NOBLE, Sec. and Treas.
P. N. FRENCH, Gen'l Supt.

A. FRENCH SPRING CO.

PITTSBURGH, PA.
Manufacturers of
ELLIPTIC AND SPIRAL SPRINGS
OF ALL DESCRIPTIONS.



CUYAHOGA FALLS, O.

ROLLED HOLLOW STAY BOLTS ARE STRONGER AND SAFER
THAN DRILLED ONES.

Mandrel rolled from the finest charcoal iron. All sizes, from 7/8 to 1 1/2 inch, with any sized
hole required from 3/4 to 1/2 inch. Let us send you a sample and quote prices.

A set for one fire-box will convince you of their merits, safety and economy.

AGENTS IN CANADA: J. & H. TAYLOR, 751 Craig Street, - - Montreal, Canada.

THE JANNEY FREIGHT CAR COUPLER



THE MCCONWAY & TORLEY COMPANY

W. M. CONWAY - PRESIDENT.

48th ST. & A.V.RY. - PITTSBURGH, PA.

BEMENT, MILES & CO. PHILADELPHIA, PA.

BUILDERS OF

METAL-WORKING MACHINE TOOLS,



FOR
 Locomotive and Car Builders,
 Railroad Shops, Machine Shops,
 Steam Forges, Ship Yards,
 Boiler Shops, Bridge Works.

STEAM HAMMERS
 FOR WORKING IRON OR STEEL.

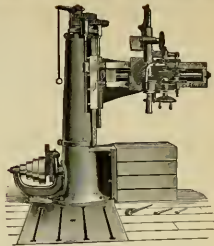

NEW YORK OFFICE: EQUITABLE BUILDING. GEORGE PLACE, Agent.



Portable Cylinder Boring Machine.

For boring in their present positions all makes and sizes of Steam Engine Cylinders, Pumps, Steam Hammer, Air Compressors, Mining and Hoisting Engines, Heavy Hoists, Large Wheels, etc.

Machines made any size required. Recently adapted for Compound Engines.

PEDRICK & AYER CO.

1001 & 1003 Hamilton St.,
 PHILADELPHIA, PA.

SPECIAL TOOLS FOR RAILWAY REPAIR SHOPS.



STEVENS' PATENT IDEAL COMBINED DIVID.-R & CALIPER SPRING SCREW THREAD CALIPERS
 No. 62.
 Price, per set. \$4.00
 All nickled. \$5.00
 Packed for transmission by mail.
 Ideal Surface Gauges, Depth Gauges, Ideal and Leader Spring Dividers and Callipers, and Fine Machinists' Tools. For illustrated catalogue for 1894, send 3c. to J. Stevens Arms & Tool Co., P. O. Box 578, Chicago, Ill., Ill.



STEVENS' PATENT LEADER, No. 71.
 Price, per pair, graduated. \$4.00
 \$5.00 10 inch. \$5.00 12 inch.
 These Tools for iron work, especially for shafts, have no equal in the world.

THE PRATT & WHITNEY CO., HARTFORD, CONN., U. S. A.

MANUFACTURERS OF
STANDARD CYLINDRICAL SIZE AND U. S. STANDARD THREAD GAUGES.
 Special Gauges of every variety of interchangeable production
REAMERS, TAPS AND DIES.
 In all usual styles for Machinists, Pipe Fitters and Boiler Makers
 Renshaw Batchet Drills, Combination Lathes, Chucks, Die Stocks, Bolt Cutters, Lathes, Planers, Drilling, Milling, Profiling, Outer Grinding, Die Sinking, and Drop Forging Machines, Forging and Trimming Dies.

MONITOR MACHINES FITTED WITH TOOLS
 For Batching to Sample: Screws, Studs, Locomotive Fittings, Plumbers' and Gas Fitters' Brass Goods.
 CATALOGUE L SENT ON APPLICATION.

BOSS SCREW PITCH GAUGE.



A FULL LINE OF
Machinists' Fine Tools.
 SEND POSTAL CARD FOR OUR NEW 1893 CATALOGUE.

STANDARD TOOL CO.,
 Box G, ATHOL, MASS.

SHERBURNE'S AUTOMATIC TRACK-SANDING APPARATUS.

Three Ways Instead of One. Mind Your Steps.
 On slippery rails sand the track automatically when brake is applied, avoiding rear collisions and derailment.
 In starting, touch Lever and obtain Jet of Sand and "go there."
 The old Rod and Lever retained as usual. For particulars apply to
SHERBURNE & CO., 53 Oliver Street, Boston.

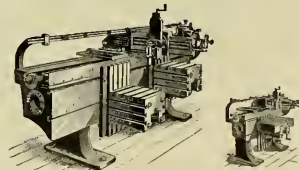

RICHARDS' PATENT OPEN SIDE PLANING AND SHAPING MACHINE.

Special Catalogue Mailed on Application Explaining Tools in Detail.

CRANK-PIN MACHINE.



For turning of Crank-Pins, in position, require the efficient features of the Pin.

VALVE-SEAT PLANER.



Over 600 in use.

THE LONG & ALLSTATTER CO., HAMILTON, OHIO.



Horizontal Punch. Made in 5 Sizes.

Double Die, Angle-Bar, Saws, Horizontal Twist, Boiler, Spacing, Gate, Multiple, Bolt and Hexagon Drives
PUNCHES AND SHEARS.
 Over 300 Sizes.



Horizontal Rivet Header.



Die Cutting Machine.

THE ACME MACHINERY CO., CLEVELAND, OHIO.
 Manufacturers of
ACME BOLT & RIVET HEADERS
ACME SINGLE AND DOUBLE AUTOMATIC BOLT CUTTERS.
 Cutting from 1/16 in to 6 in diam.
 Also, Repairing Brass and Dies.



J.H. DRAKE CO.
 BUFFALO, N. Y.



BEATS THE MONKEY-WRENCH OUT OF SIGHT!

OUR ROUND END NON-REVERSE RATCHET No. 2 in the form of the horizontal steel jaws and heavy adjuster, most make it keep hold when closed and you can get it on one of the lower jaws, and take off a nut without taking jaws off, and where you would get it on an eighth of an inch with the ordinary monkey-wrench it will take hold close up where the old wrench can't get. This prevents wearing splined bolts and parts around them. A thousand times for it around a hex-headed where it runs sure time and money. We'll send a Catalogue Free.

FLAT TURRET LATHE

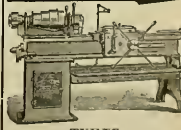

TURNS STRAIGHT AND TAPER FRAME BOLTS, ETC.
 SEND FOR A COPY OF "RAPID LATHE WORK."
 By New Method-Martens System.
JONES & LAMSON MACHINE CO.,
 SPRINGFIELD, VERMONT, U. S. A.

THE KEYSTONE MFG. CO., BUFFALO, N. Y.

THOMAS PROSSER & SON,
15 GOLD STREET,
NEW YORK.

K R U P P

STEEL TIRES

ON LOCOMOTIVE DRIVING WHEELS
AND ON STEEL-TIRED WHEELS
GIVE THE BEST RESULTS
FOR EVERY VARIETY OF SERVICE.

The CAST-STEEL WORKS OF FRIED. KRUPP, Essen, Germany, cover an area of 1,200 acres, employ about 25,000 men, have the most improved plant, and stand unique, from the fact that they have their own Ore and Coal Mines, Blast Furnaces, etc., and that every stage of manufacture is under their own supervision, and are not (like others) dependent on the open market for a miscellaneous assortment of crude material; which, in connection with 75 years' experience, enables them to turn out a product of a very superior quality, second to none, and at the same time the finest grades of Steel are always of the same uniform quality.

Crank Pins, Piston Rods, Spring Steel, Steel-Tired Wheels, Etc.

After a test of over 35 years, the "KRUPP TIRE" has proved itself the best in the market. If a reliable article is wanted, which will give satisfaction, get KRUPP'S.

SCHENECTADY LOCOMOTIVE WORKS, SCHENECTADY, N. Y.

LOCOMOTIVES
OF
STANDARD
DESIGN
FOR ALL
CLASSES OF
SERVICE.



OR FROM
DESIGNS
FURNISHED
BY
RAILROAD
COMPANIES.

EDWARD ELLIS,
President.

WM. D. ELLIS,
Vice-Prest. and Treas.

A. J. PITKIN,
Superintendent.
A. P. STRONG,
Secretary.

COMPOUND LOCOMOTIVES, Showing an Economy of 15 to 30 per cent. in Fuel and Water.
Annual Capacity, 400.

M. L. BRIDGER, Pres. and Treas. David Bussell, Secy. H. TANTY, Asst. Secy.
J. H. WATSON, Asst. Mgr. and Gen'l. Supt. J. A. LINDSEY, Asst. Supt.
T. M. HERRINGTON, Asst. Supt.



Brooks Locomotive Works, DUNKIRK, N. Y.

Builders of Locomotive Engines for any required service from our own designs or those of purchasers.
Perfect interchangeability and all work fully guaranteed.

COMPOUND LOCOMOTIVES

FOR PASSENGER AND FREIGHT SERVICE.

Latrobe Steel Works
MANUFACTURERS OF

TIRES

FOR LOCOMOTIVE and CAR WHEELS.

Main Office and Works, Latrobe, Pa.
Branch Office, Holtsville Building, Philadelphia.
Chicago Office, Western Union Building.
New York Office, Home Insurance Building.

William Sellers & Co., Incorp.
PHILADELPHIA, PA.

MACHINE MODERN TOOLS

for Railroad Shops, Car Builders, etc.

HIGH SPEED
TRAVELING & SWING CRANES.

ALSO
TURNTABLES, INJECTORS,

SHAFTING,

ETC., ETC.



"LACKAWANNA"

Sight Feed Locomotive
Cylinder Lubricator.

ABSOLUTE UNIFORMITY OF FEED.

Perfect distribution of oil to both cylinders
from one feed glass, and entire efficiency
under all working conditions.

Only One Class,

and that short and stout; almost unbreakable. Absolutely no use for any more. They are an unnecessary source of trouble and danger.

Write for full particulars.

LACKAWANNA LUBRICATING CO.,
1212 Capouse Avenue, Scranton, Pa.



INSPECTION!

Is the safeguard for boilers. Inspect your stay-bolts while boiler is under pressure. Test hot water for hydraulic test—expands the parts as in service. Our jet apparatus washes out and fills boiler with hot water; no foundation required; no floor space one-quarter the size and one-quarter the price of pump. Efficiency guaranteed.

HUE MANUFACTURING CO., 115 N. NINTH ST., PHILADELPHIA.

J. G. HENDRICKSON, PRES.
F. J. CLAMER, VICE-PRES.
J. R. NELSON, SEC. AND TREAS.

"AJAX BEARINGS: RECORD 90 MILES AN HOUR."
"EMPIRE STATE EXPRESS, N. Y. C. & H. R. R. R."

AJAX METAL CO.
INCORPORATED,
PHILADELPHIA, PA.

Baldwin - Locomotive - Works.

ESTABLISHED 1831.

ANNUAL CAPACITY:
1,000 LOCOMOTIVE ENGINES.

Adapted to every variety of service, and built accurately to standard gauges and templets. Like parts of different engines of same class perfectly interchangeable.

COMPOUND LOCOMOTIVES.

BROAD AND NARROW-GAUGE LOCOMOTIVES; MINE LOCOMOTIVES BY STEAM OR COMPRESSED AIR; PLANTATION LOCOMOTIVES; NOISELESS MOTORS FOR STREET RAILWAYS, ETC.

BURNHAM, WILLIAMS & CO., Proprietors,
PHILADELPHIA, PA.



Pittsburgh Locomotive Works.

PITTSBURGH, PA.

Manufacturers of LOCOMOTIVE ENGINES

For Broad or Narrow Gauge Ponds
From standard designs or according to specifications, to suit particular cases.

Tanks, Locomotives or Stationary Boilers
FURNISHED AT SHORT NOTICE.
WILSON WILDER, P. & TR. 3 A. WHEATMAN, Mgr.



DICKSON MANUFACTURING CO.

SCRANTON, PENN.

Locomotives of every style and size, Standard and Narrow Gauge, made to Standard Gauges and Templets. Also for Plantations, Mines and Logging.

SPECIFICATIONS OF APPLICATION:
JAN. F. DICKEY, President,
E. W. WELSH, V. Pres. WM. B. FEELECK, Sec. & Treas.
JOSH. DEWINE, Superintendant.



ROGERS LOCOMOTIVE COMPANY

OF PATERSON, N. J.

New York Office, 44 Exchange Place.

MANUFACTURERS OF
LOCOMOTIVE ENGINES AND TENDERS,
And Other Railroad Machinery,
R. S. HUGHES, President
G. E. HANNAN, Treas. G. H. LINSBROTTON, Supt.
REUBEN WELLS, Superintendent



PORTLAND CO. LOCOMOTIVES OF ALL TYPES.

INCORPORATED 1846.

STANDARD OR NARROW GAUGE FOR ANY SERVICE FROM OUR OWN OR TO RAILROAD CO'S SPECIFICATIONS.

Freight Cars, Derrick Cars, Push Cars and Car Wheels,
Boilers of Locomotive, Horizontal, Tubular and Vertical Type

FRANKLIN C. PAYSON, President JAMES F. GREENSMITH, General Manager HYDIN D. SMITH, Treasurer



ESTABLISHED 1865.
**Richmond Locomotive
AND MACHINE WORKS,**
RICHMOND, VA.

Locomotives for Every Service.

CROSBY



POP STEAM VALVES,
MUFFLED AND PLAIN
IMPROVED
STEAM GAGES.
Single Bell
CHIME WHISTLES.

A perfect equipment for a locomotive, giving the best results in economy and durability, and the most reliable and longest lasting. These goods are made under the supervision of Crosby Steam Gage & Valve Co., Boston, Mass. New York, Chicago, and London, England.



PULLMAN SLEEPERS on Night Trains.
ELEGANT PARLOR CARS on Day Trains.
DINING CARS between Cincinnati and Chicago.
W. H. STEPHEN, General Manager
P. O. BOX 4000, NEW YORK

GULL LOGS
ESTABLISHED 1865
The Original Gull Log
The Gull Log is the best in the world for its purpose. It is made of the finest material and is perfectly adapted for use in all climates. It is the only log that will not burn out.

PAUL S. REEVES, Philadelphia.
PHOSPHOR BRONZE IN GUNDS AND CASTINGS. **LOCOMOTIVE AND CAR BEARINGS**
A SPECIALTY.
BRASS and PHOS. BRONZE CASTINGS from 1/4 lb. to 5,000 lbs. in WEIGHT.

COOKE LOCOMOTIVE AND MACHINE CO. PATERSON, N. J.



JOHN S. FROBER, President & Gen. Mgr. PATERSON, N. J.
FRYD. W. COOKE, Vice-President.
W. W. BIRDAN, Supt. & Treas.

Rhode Island Locomotive Works, PROVIDENCE, R. I.

CHARLES FELIX MASON, President. ARTHUR LIVINGSTON MASON, Secretary.
EARL PHILIP MASON, Vice-President. JOSEPH LYTHGOE, Agent and Supt.
WILLIAM P. CHAPIN, Treasurer. S. A. STEPHENS, Traveling Agent.

NEW YORK OFFICE,
Nos. 31-33 Pine Street.



A PERFECTLY CONSTRUCTED METAL BRAKE BEAM.

The Cheapest, Lightest, and Most Durable.
NOW STANDARD ON A MAJORITY OF RAILROADS THROUGHOUT THE COUNTRY.
General Office and Works: 40th & Hopkins Sts., Chicago.
CITY OFFICE: 314 Phenix Building, Chicago. NEW YORK OFFICE: 39 Broadway, - - Room 118
Correspondence solicited. Frazz's G. Est. Eastern Agent.

ALBANY, N. Y.
936 Broadway,
New York City,
115 BROADWAY.

STEAM COUPLERS

AND
FIRE PROOF
HEATERS.

CONSOLIDATED

McElroy, Sewall, Westinghouse and other Patents.
CATALOGUES UPON APPLICATION.
Special Appliances and Extra Strong Fittings of Every Kind.

AUTOMATIC CONTROL OF HEAT.
CAR-HEATING CO.

CHICAGO,
200 Phenix Bldg.
Canada,
COATICOOK, P. Q.

COMMUNGER,
DRUM,

AND
DIRECT STEAM
SYSTEMS.



THEIR SUPERIORITY
IS PROVEN BY
THEIR POPULARITY.

FINEST Coach, Parlor Car,
Sleeping Car,
Street Car,
Rattan Elevated SEATS.

IN USE ON ALL THE
PRINCIPAL RAILROADS
IN THE UNITED STATES



THE HALE & KILBURN MFG CO.,

Simplicity,
Durability,
Elegance,
Comfort,

IT IS SAFE TO SPECIFY THE
H. & K. SEATS

PHILADELPHIA,
NEW YORK,
CHICAGO.

A. W. SOFER, Pres.

ROBT. ANDREWS, Vice-Pres.

C. H. HOWARD, Sec.

W. R. THOMAS, Treas.

R. M. DIXON, Engineer

THE SAFETY CAR HEATING AND LIGHTING CO.,

160 Broadway, New York.

HEATING SYSTEMS.—By hot water circulation and direct steam with regulating devices. Reliable and uniform heat. Economical and rapid circulation. Gibbs automatic coupler of Westinghouse type, absolutely steam-tight.

LIGHTING SYSTEM.—The celebrated Pintsch compressed oil gas method. In use on over 40,000 cars in Europe and America. Adopted by the U. S. Lighthouse Board for lighting Buoys. The best, most economical and only safe light for Railroad purposes. In brilliancy and cleanliness unsurpassed.

The Smith Triple Expansion Exhaust Pipe.



FRONT VIEW.

THIS Device is the invention of JOHN Y. SMITH, the originator of the Smith Vacuum Brake. In the cuts of the Front and Side Views shown herewith, "A A" represent Air Passages; "S S" Exhaust Steam Passages, and "B" an Annular Blower forming part of the Nozzle.

It is an entirely new departure in the construction of Exhaust Pipes for Locomotives. Its distinguishing features are that the exhaust steam is not restricted after it leaves the cylinders, and the gases and heated air in the smoke arch are mingled with the exhaust steam in the exhaust pipe. The exhaust steam is thus superheated and expanded, and a powerful, prolonged, pulsating blast is created, which keeps the fuel in a constant state of agitation, and produces more perfect combustion.

Some of the beneficial results obtained are: *Reduction of Back Pressure to a minimum (area of nozzle opening as large as the exhaust port); prevention of ejection of sparks from smoke stack; almost complete absence of noise from exhaust; prevention of formation of clinkers in fire-box; large saving of fuel.*

By the elimination of Back Pressure we have demonstrated the fact that the power of engines has been increased to be able to pull from thirty to sixty tons more than with any other form of exhaust pipe. The pipe can be used with either straight or diamond stacks, in long or short front ends, and on locomotives burning hard or soft coal, wood or coke.

NEW YORK SALES OFFICE, Rooms 29 & 31, 115 BROADWAY.
GENERAL OFFICE - OOLEYESTON, PA.

FACTORY - READING, PA.



SIDE VIEW.



THE MURPHY STEEL CAR ROOF.

Has an surface nail or screw holes. It has no joints where cinders, rails or fine snow can get through. It allows for contraction and expansion, and has ample elasticity to provide for sagging, twisting, buckling and corrugating of the car body. It is so well damaged! It is much cheaper than any other metallic roof now in use, and is cheaper than the double board roof, made of good lumber. It is unlike any other metallic roof for the reason that everything is furnished to make it complete; so that the parties buying it have no expense other than to apply it.

This ROOF can be applied on OLD LEAKY BOARD-ROOF CARS without making any changes in the board roof, thereby saving the expense of replacing the old boards with new, and thus utilizing material that must otherwise be thrown away.

Manufactured by the P. H. MURPHY MFG. CO., East St. Louis, Ill.

Locomotive Engineering



A Practical Journal of Railway Motive Power and Rolling Stock.

CONFERRED BY THE SOCIETY OF ENGINEERS AND ARCHITECTS.

VOL. VII, No. 6.

NEW YORK, JUNE, 1894.

20 Cts. Monthly
\$3.00 Per Year.

A Trip in Old Mexico.

[EDITORIAL CORRESPONDENCE.]

SOME GENERALITIES.

I am afraid that I went to Mexico with all the usual ignorance of the size, importance, interest and climate of the country, and of the habits and customs of the people that I was going to see.

Most people living under the glorious Stars and Stripes are willing to know

office, in the fifteenth story of a great building, I found myself thinking that it was about nine times as high as that old school-house.

I can't give you an idea of the size of the Republic of Mexico by comparison with my established standard—the school-house—but perhaps I can get at it in another way, by another comparison.

Suppose we select States from the Union, say along the Atlantic seaboard, to make up a country equal in area to

People who have never been to Mexico know a lot of things about the country that are not so. In the first place they think it's a hot country. The coast sections are hot, but three-fourths of the area of Mexico consists of great plateaus, formed by the expansion, or flattening out, of the upper end of the Corderillas, the chain of mountains reaching up from Central America. These plateaus lay from six to eight thousand feet above the level of the Gulf of Mexico, and the climate is cool, varying

and covered by irrigating ditches, aqueducts, etc.

Our people also think that Mexico is a republic like our own, where the men all vote, and the women want to—this is because they have never been to Mexico.

The republic part of it is much like the "hot meat pie" that the boy was lustily calling out on the station platform. A tourist invested in one, took a bite, and called to the boy: "Here, boy, this here ain't no meat pie!" "Well, I know it ain't," an-

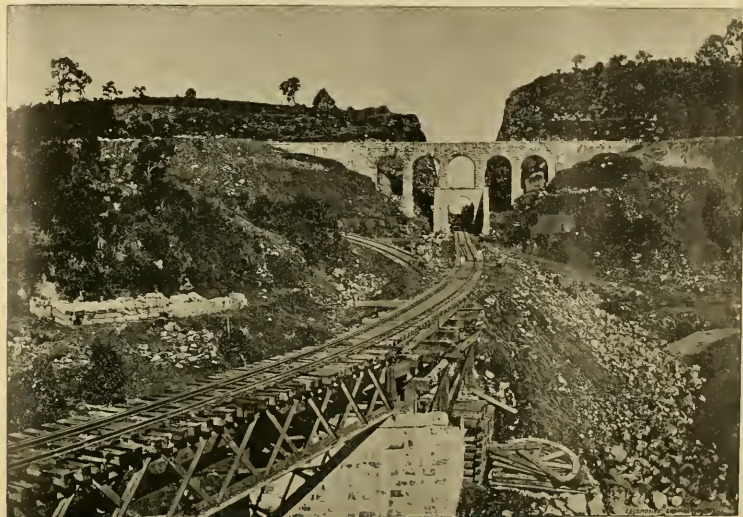

THE BRIDGE AT JAJALPA, STATE OF MEXICO. NATIONAL RAILWAY BUILDING CO.

that the United States is the biggest thing in North America, and mentally add, "All of which I know and part of which I am."

Few of us remember much about Mexico except as a red strip of map in the old Geography. I recall that in my brief school days, with half shut eyes and wandering thoughts, I have looked at the map of North America, when it seemed for all the world like a great big tadpole—with Mexico for the tail.

As we grow older, we come more and more to measure things by comparisons—by others with which we are familiar. Years and years ago, when I was young, I used to measure every building by the old, white, country school-house at home, and that habit clings to me still. Just now, as I looked out of the window of my

Mexico's 750,000 square miles. Commencing away up at Maine, we will take in all the New England States, Maine, New Hampshire, Vermont, Massachusetts, Rhode Island and Connecticut, then we will add New York, Pennsylvania, Delaware, New Jersey, Maryland, Virginia, West Virginia, Ohio, Michigan, Indiana, Kentucky, Tennessee, Alabama, Georgia, North Carolina, South Carolina and Florida, and the total area is less than that of Mexico. When I figured this out I came to the conclusion that my North American tadpole had an abnormally large tail.

Mexico has a population of between ten and twelve millions (some of the people move around too fast to be counted), of these between three and four millions are Indians.

very little the year round, always being warm in the sun and cool in the shade, and requiring the use of blankets at night, and an overcoat in the evening the year round.

For hundreds of miles the northern end of the Republic is a great, dusty, sage brush desert, even a little worse than the lower fringe of the United States, represented by Texas, New Mexico and Arizona.

The soil on these plains and in these valleys is rich, but there is no water. It has not rained enough to speak of along the northern line of the Mexican National for over three years, and there is a water famine threatened. All over these lands, especially well south, are evidences that once, long ages ago, they were under cul-

tered the boy. "Tain't hot, neither." "Know that, too?" "But, didn't you call out 'Hot meat pie'?" "asked the victim." "Course I did, but that's just the name of 'em!" A republic is just the name of Mexico. The Czar of Russia rules with no more autocratic power, there is as little voting in Mexico as in Russia, and the bayonet holds the people in subjection just as strictly. And after you have been there a few days, you do not wonder at it, and you are rather glad to see the six white uniformed soldiers that sit in the third-class car of every passenger train, and the well-trained, well-armed dare-devils that stand like statues just twenty feet apart in a line across every station platform as the train rolls in. These are the *Rurales*—President Diaz's ex-bandit soldiers. When they go

after a man they get lost, but they never bring in any prisoners.

Ignorance and superstition have been the curse of the people. The wealth of these people has been piled up in churches and cathedrals for three hundred years, and they simply worked for enough to eat. I see had on her winter suit compared to some of these people. They have today down to cover their nakedness. I actually saw a large gang of men at work killing in a

Of course, as the altitude varies the climate varies, so that Mexico can and does raise a greater variety of products than any country in the world. In the neighborhood of Mexico City they raise wheat equal to that of Minnesota, but within eight hours' ride by rail you reach a climate hot enough to raise coffee, bananas, vanilla bean and a thousand other tropical fruits.

Mexico has many rich mines of almost

Vera Cruz from Wales, and the price at that city ranges from \$4.50 to \$11 per ton. The railroads would be about the only buyers, however, as the people never use fires in their houses for heat, and cook with charcoal. Most of the roads are burning wood.

But I started to write off the railroads, and here I am wandering off on another trail. I'll follow up the roads just as I saw them, and try and stick to the subject.

not let their cars go off their line for some reason or other.

There is quite a system of narrow-gauge roads in the country. The National reaching to the city, the Interoceanic from there to Vera Cruz, and the Southern from Pueblo south into the hot country at Oaxaca.

This road was built under a concession granted by the government, and after 99 years will be Federal property. It is 1,200 miles long, counting in the 162 miles of the Texas-Mexican, which is in Texas.

For some reason unknown to the writer the main shops were located at Laredo, Texas, which makes many complications. The Mexican officials will not allow engines to be taken across the International bridge, except at certain hours, and the regular road engines, both freight and passenger, are hauled from Nuevo (new) Laredo, Mex., across to the shop for repairs, wiping, wash-out, etc., and back again down Laredo, Tex., in a straggling half-Mexican towed, hot and dusty to desperation. The shops are pretty well out, and the electric car line runs only one car—it's quicker to walk.

There are very good shops here. The buildings are of brick and stone, fairly well supplied with tools, and in decent order, but it is awfully dull, and men are starving in the shops.

Mr. Tom Milan, the superintendent of motive power, spent the best part of a day with me in these shops. Mr. Milan has four big wrinkles on his brow caused by wondering what they are going to do about water. The drought has caused the surface pools, etc., to become especially vile, and leaky firebricks and flues are the order of the day.

Out back of the shop there are a dozen more firebricks, out after because of ground-

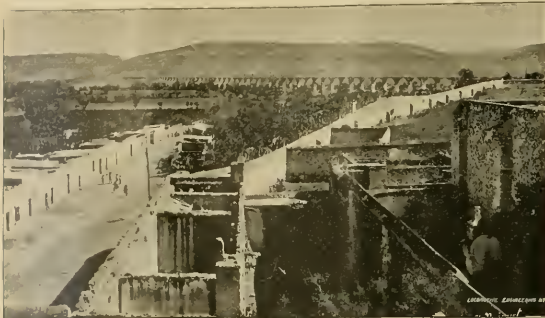

TEHUACAN MOUNTAINS, NEAR ROAD AND VERTICALLY ABOVE, AT QUEVEDO WHERE MAMMOTH WAS SHOT.

ledge, by carrying sacks of earth on their backs and heads, not one of whom had on enough clothes to flag a train if they had all been red.

The Indian population differs from ours in that they all work men and women do, and work hard. On the highlands about the City of Mexico the useful land is all owned by a few rich men; a "hacienda" being a farm from 15 to 150 miles square. On this there are houses and churches and people, and they all belong to the owner. The peons are "free," but they cannot leave a place until their debts are paid, and their children must stay until they are debt-free. As they eat it every day, and have to take at the owner's store, and support families, they remain slaves forever. When a few own the land, the many are slaves to them in any country. Land is as necessary to the life of every individual as air, and a monopoly of one is as big a "crime" as the other.

The Indian people of Mexico are very industrious and ingenious; they make many artistic articles that in any country but theirs would bring very high prices.

There is no "season" in the country except the "rainy" and the "dry." It rains every day in the high lands from June until September. But crops are put in any time the ground is ready. It is no uncommon thing to see ripe grain in one field and plowing in the next.

The country people are as primitive as they were three hundred years ago. They plow with oxen and Arrowsmith's stick. They use carbide mainly instead of wood, not even a nail in them. They cut grain with sickles, and thresh it out by driving oxen or mules over it. Everywhere you can see "threshing machines." A brick wall about 4 feet high, in the form of a circle, with an opening for entrance and a brick floor. In this they place a layer of grain and drive in their animals. When threshed out they pitch out the straw, removing the grain by passing a bar back and forth in the wind.

In some ranches you can see American plows; but the peons always saw off one handle to make them like the old wooden ones.



NATIONAL RAILWAY ENTRANCE TO THE BARANCA OF TRES PINOS (THREE PINES).

everything except gold and silver—two things she most needs. They coin nothing but has more intrinsic value than ours; yet down a Yankee silver dollar and he will give you two of his "doble" dollars, and make seven cents out of it. This is because ours has a gold backing, and theirs stand on its own bottom. The rate of exchange is very low for travelers. I got my breakfast, and had down a United States \$10 bill receiving \$10 in change. But it is hard for Americans working there who have to send money home, as they must pay two for one for it. This also prevents the roads from buying supplies of us.

A first class coal mine would be worth millions in Mexico. Coal is brought to

OF NATIONAL HEADQUARTERS is the shortest route between the States and the capital of Mexico, it is only 424 miles via this line, while from El Paso to the city via the Central it is 1,724. This difference is not in a more direct line, but because it starts farther down.

The National is a three-foot gauge road, built much on the plan of the Denver & Rio Grande. It is in pretty good physical condition, but its gauge, it seems to me, is against it, certainly the tourist business would be better if "Raymond" and other special cars could be taken over it, while an interchanging traffic would be possible. Yet freight has to be handled at the line, anyway, on account of the customs, and the Central and the Mexican roads will

ing and piling, and they had run hardly long enough to get used to the job. They have a small independent shop devoted entirely to the work, a new set lasting from 99 to 150 days.

Some brand new compounds run out of here, and every stay bolt in their sole shafts was leaking, but I opine this was not all water, however that may be, the water is certainly villainous.

Mr. Jas. Farrell is division master mechanic here, but was away at the time of my visit. Mr. R. B. Small (a brother of the Sup'ts of M. P. of the Southern Pacific and of the N. Y. R. & P.) is general foreman.

They have quite extensive car shops, and dual of work. The climate is particularly

and on soft wood and on paint; they have been trying an oil paint on coaches about varnishing, but it was not a success. They are now trying a rubber paint for the same purpose.

First, second and third-class cars are used, the majority of well-to-do people belonging second class. Men, women and children smoke in all cars—and everywhere else. The body of a Pullman car is usually placed in Mexico where you can get no more.

They always have a wood-passer, who they hire themselves for a very small sum; these boys sooner or later make firemen, and they are not bad ones. The firemen almost always do the pumping, and will shut off the injector whenever they put in a fire, as they have the door open some time. This done they jump for the squirt. They keep a good level in the glass, and take great pains to do it right.

The native fireman (if he is not hungry) is very independent, and discharging en-

gine repairs to keep it from being charged up to their engines, and also take care of oil and fuel. When the plan was first introduced, the running expenses fell down on an average of \$1,500 a division.

In Sept. J. N. Galbraith I found an old Rio Grande dispatcher who was at the key and remembered the time the South Park got on my time and got it, way back in '52.

Here, also, I fell in with Traveling Engineer I. M. Hutchinson, who acted as guide and interpreter for me from Laredo south

city is a desert, and one constantly wonders how anybody ever got across it.

Monterrey lays on the eastern slope of a little range of mountains, has a very nice climate, is fairly clean, and was for many years the chief city of the north, being the supply point (before the days of railroads) of the mining States west of it. The bishop's palace is a striking edifice on a high hill. It was here that Gen. Taylor's troops won the first victory of the Mexican war in 1846. One keeps wondering how in the world they ever marched from Matamoros across that 200-mile desert and got there in fighting trim.

The National have no shops here, but do the work out of doors. They have wash-out facilities and a few hand tools. Foreman Bartlett was in charge.

THE MONTERREY & MEXICAN GULF

Shops and headquarters are here; they have a fine depot and yards, pretty good shops are under construction, but at present the work is all done in a roundhouse. Mr. Frank Harrow is master mechanic.

The road has pretty good looking power—all Baldwin and Roger ten-wheelers—these look as engines do that run some time without general repairs and without out of doors.

Great attention is paid here, as on every other Mexican road, to blow-off cocks. There are always three of them, and they must be so built as to admit of handling while running. It's the first thing a master mechanic notices, and they have a different kind on each road.



LAKE PALOVEDO, STATE OF MICHIGAN. HEAVY TRUCKS AND BRIDGES TIMBER FOR NATIONAL ROAD ON MEXICAN CALIFORNIA.

The later build of freight cars are usually 40,000-pound cars, having M. C. B. coupler, straight air, and journals 147½ inches, and an exceptionally heavy truck.

They like the M. C. B. coupler, because the natives can not steal anything from it. When a car is left at a station on this road, they take off the links and pins and the hose from each end, else there would be trouble when they came for it. This requires the carrying of a lot of links and pins on all freight trains and a pile of hose. This is stinky and short-righted about the hose, as only enough to equip ten cars is allowed to a freight train, and they often take from twenty to forty cars down a hill, run too fast and flatten lots of wheels so it would not be hurt if all wheels were getting their share of the baking.

Labor is very cheap, and hands can be had for fifty cents a day—and that's all they are worth. This allows some things to be done well, however, as there is little chance for not wiping engines when labor is so cheap.

This road has a very large number of classes of engines for a road so young. There are classes down to 17-horsepower kinks is a good many.

They have a class of consolidation engines with the firebox back of the frames that make an excellent narrow gauge model, especially where there is bad water.

The box is nearly square, can be made deeper, has a free ashpan, the mud-ring can be calked, and the firebox be removed without disturbing the head or shell of the boiler. Their only fault is that there is nothing but the long draw-bar between the engine and tank and unless the holes in the bar are kept very well up to gauge the tank rocks very hard. Another class have the same boiler, but a long draw-bar, but a light slab frame extends back under the firebox, and a wedge can be used between the engine and tank.

Mr. Milan has a very good plan in that he has one shop repair and overhaul, as much as possible, one class of engines. They rebuild most of the freight consolidations at Laredo, while the shops at San Luis Potosi rebuild nothing but ten-wheelers.

They burn wood here, mostly mesquite, and not very good wood either.

Engines are paid by the day. They use the best two exceptions, American.

The treatment are all natives, they get \$2 per day here and \$2.50 out of the

has no effect whatever on the others. When they "get funny" or neglect their business, they are laid off anywhere from six to eight months. They don't care at first, until their money is gone, then they go hungry until their time is up, and will usually saw wood and keep clean engines for a year.

Fuel and supplies are very expensive, and a close account is kept of everything. For some time they have given a monthly premium on each division of \$25 for the engineer and \$10 for the fireman who show the best performance, but have run the most miles for the least money, counting everything, fuel, oil, supplies and repairs. The crews do a great deal of run-

to San Miguel, some 66 miles, and it's well he did, for alone I should have missed many interesting points, and perhaps gone hungry, for I could not talk the language of the country to any alarming extent.

One thing that fouls you at first is the mile-post; they are so close together. They use kilometers (about 1/3 of a mile). The first post I noticed after leaving Laredo was marked 1,330 and scared me for a minute; it's 1,351.4 kilos from Laredo to Mexico City, but its only 80.4 miles in English.

Our first stop was at Monterey, 167 miles south, the country between U. S. territory and this quaint, historical old

This is one of the newest roads in Mexico, and is yet in the "grub-stake" period of its existence. The mee for the most part claim to be only staying until something else shows up, or until they get in a month's pay, business is dull, I did not go over the road, as I expected to see the Gulf further south. The main line runs through Monterey, from Germaine Trevino, on the Mexican International, south-east to Tampico, the only good harbor on the Gulf coast. It would do a big business if it were not that the Mexican Central has a line from Tampico to their main line, striking all the important points in the country that formerly sought an outlet through Monterey.



OSHON, STATE OF MICHIGAN. NATIONAL RAILWAY, AN INDIAN TOWN NEAR TULSA.

But let's get back to

THE SATHON VALLEY.

It's sixty-eight miles from Monterrey to Saltillo, our next stop. This is a city of something like 20,000 people, has the regulation plaza, cathedral, and a dozen or so of churches.

The road has a roundhouse, or running shed, and a few hand tools. Jas. Tobin, the M. M., takes life as comfortably as he can, and does all the work he can. The cut-

on a board and covered with flowers, the whole earned on the head of a man. There are many gardens and many flowers around the city.

The National has a fine stone depot here and nice little shops. All the power is ten wheeled, freight and passenger. Mr. Fred Schneider is M. M. here and has the shops in very nice shape. Here, it seems to me, would have been the proper location for the man shop.

I met more men here that I had known

are surrounded by a stone wall and one side is lined with quarters for employes and their families.

Against this wall is piled about 200 tons of scrap—there is no market for scrap in this country, it's too far to mills.

At San Miguel, 120 miles further south, Mr. Hutchinson's duties required that he head north again, and it was with a very lone-some feeling and a due appreciation of his help and kindness that I bid him good-bye and got on the train again, but

intended to stay right where they were for a few hundred years longer.

For more than a hundred miles south the road travels over a mountainous country, full of broad arid plateaus that bear evidence of former cultivation, past some rich and well cultivated valleys, and at last enters the thriving city of Toluca, capital of the little State of Mexico. Toluca, like Milwaukee, is famous for its beer. Ed. Knapp said so, and Knapp a general foreman and takes subscriptions for the LOCOMOTIVE ENGINEERING, and ought to know. The city is on the edge of a beautiful, well cultivated valley, the prettiest sight I had yet seen. The train was crowded from here into the city.

At Toluca I met Dick Bolby. Dick and I fired together in '80; Dick fired the "31," the first engine that went into Leadville. I fired the "30." If he had not left the road about this time and gone to Mexico, I am sure I should have left and gone on a ranch—for we were rivals.

I had a record as an all-round bar when I came there, but Dick wore the Rio Grande belt, and it was neck-and-neck with us for awhile. Dick is Grand Past Master of the Ananias Club now, and to prove his claim, I'll tell you a bear story of his (in another part of the paper) that will forever settle all disputes in his favor.

From Toluca to Mexico the scenery is magnificent. We cross a beautiful valley and then a mountain, grades of 211 feet,



SHRINE REFUSED TO NOT RUNNING GRAMMED TIME. NO-LE WEA OF HANDBES, DRIVERS, ETC

ing-hill here is kept by a Chinaman, as are most of them in Northern Mexico, but a very pleasant change was made to Mr. Tobin's house, where I tried my best to put away enough to last me just the next Chinaman. We stayed over night here and took an early start the next morning. Seven miles out the train runs across the old battle-field of Buena Vista, where Taylor's handful of men, with a loss of 700, killed 2,000 Mexicans and put the kishou on Mr. Santa Anna. Some of the old earthworks are still standing. The train climbs all the time over a barren, dusty waste of country, sparsely peopled, and looking as dry as a prohibition town.

We got dinner at Calabre. The station is on a desolate plain, but a little mining road runs some twenty miles up the mountains, away up at the top of which, above timber line, can be seen the famous mining town of Calabre, where they have mined silver in paying quantity since the days of Montezuma.

Not far from Calabre, the line crosses the tropic of Cancer. A ball is made here just to let people know where they are, a large monument with a hand pointing east and another west marks the spot. The monument was erected by Supt. of M. P. Milan when he was superintendent of this division.

It's 225 miles from Saltillo to the interesting old city of

SAN JUAN TERESE

If I had not started in to talk railroad alone, I'd be tempted to tell you something about this city, its fine churches, new theater and other buildings, which show what wild ruffians these people are, the wells in the plaza, with odd-fashioned sweeps, from which a crowd of sandaled peons are carrying water, etc. It was here that the church bells got so numerous and noisy that I could not sleep, though there is an ordinance against ringing some of them and one to prevent certain ringings altogether. I'm sure that they ring all the time before that.

It was here that I first noticed little red lanterns hanging out of the graded windows to keep away pneumonia and other diseases. It was here I saw the first funeral—that of a babe, the little red coffin covered with flowers, was carried on the head of the father, a dozen people followed him. The cover was tied on, which called for an explanation—the little coffin was rented. I afterwards saw children's funerals, where the corpse was simply laid



OWNER'S CAR, LEWIS VALLEY RAILROAD.

"away back yonder," and had a very pleasant stay of twenty-four hours.

Here also are the shops of the Central for their Tampico division. Master Mechanic Haynes was away when I called, but I wandered through the shops for awhile. They have good buildings, and a great many good tools. Out under a shed two natives were firing a large boiler for all they were worth. I noticed it was a water-tube affair and stopped to look at it. The steam-gauge was so black you could not see the hand, and one of the men explained that it was "no wano" (no good), it was out of order, and had been for a long time.

In the roundhouse, one of Mr. Johnston's double enders was all torn to pieces. They have been breaking the side levers, and new ones of cast steel are being built for them.

These shops are good stone ones, they

the minute the conductor opened the door I was at home—it was Bill Law, and didn't I pull Bill Law out of Leadville twelve years ago? Bill and I gossiped until we reached

AN ANBAR

This is a division terminal, and Master Mechanic Jacobs was waiting for me. Mr. Jacobs was for twelve years master mechanic of the Arroyo road in Peru, he has been in Mexico several years, and has a Spanish better than a native, and has a large fund of reminiscences. I slept well, and in the morning visited the shops—they are all alike, more or less, and I'm not going to describe any more of them. We walked through the queer old town, visited the magnificent old stone bridge, built by the Spaniards, how long ago no one seems to know within a hundred years, the bridge is a splendid piece of stonework, and its solid arches look as if they

where you look down on that valley as on a map. On the bill engines I ran on to more old friends in Tabor, King and Zimmerman, J. F. Roberts was a Denver man, and from his engine I saw the wonderful cultivated slopes of the mountain on the southern side, from the summit to the city it's one terraced field after another of maguery plant (century plant) from which the great national drink, "pulque," is made.

Just out of the city we passed an engine, Ed. Rinckel, a first-class, broad-gauge fellow on a narrow-gauge road. I got acquainted with Rinckel at the B. I. E. Convention, at Atlanta two years ago. "Say," said he, "I'll be in by 11 o'clock, and I'll lay off a week and go around with you"—and he did.

To him I owe much of the pleasure and interest of the trip south of the city and

in and around it. If he ever comes to New York I shall take an afternoon off and show him the rattle-dazzle at Coney Island.

Hold still, now, till I just say that the National has another shop, a little better than the average, at the City of Mexico, on the burg of Slater, Mechanic I. If Sherman, that the passenger trains are handled by Baldwin compound consolidation engines; that they do better than any compounds I know of, the service being slow and hard, and that they are having trouble to make their injectors take up the overflow after two-thirds of the water (about 100 lbs) tank pressure is on, and I must say a word about the city or any other road until next month—ho-ho!

J. A. H.

Dick Bolby's Bear Story.

The American colony gathered on the sunny side of the Mexican roundhouse and told tales about fast runs they had made and what they had told the superintendent and the general manager, until Dick Bolby dropped in with a happy smile on his classic features—just such a smile as a fellow always has when he comes in from a successful trout fishing or tiger hunt. Dick had been hunting jack rabbits up on the divide.

Well, Dick, old socks," said Grimsby, "how many John rabbits did ye get?"

"Thirty-two jacks," said Dick, loading his cob pipe, "four mountain sheep and a cinnamon bear."

"Bear, hey? Well, that's more like 'em, but make a fight?"

Well, considerin'," said Dick, thoughtfully, "he did—not as I let him get to me, but a better study o' bearology and bear temper I never had."

"You see, I'd herd lots about bears and that they could and would do when I wanted, but I didn't believe much of it. I was thinkin' o' bear when I come out of a little sage brush patch into an opening, and there was a big be cinnamon."

Well, sir, he wasn't long in risin' to his business. He stood up on his hind legs and got himself into a John L. position. I jest thought to myself, 'Old man, I'll see if you fellers kin perform as they say when you're hurt and not killed.' So I pulls up my Winchester, and jest clipped off three toes of his front paw."

"Well, sir, it was his sort o' terrifying the way that criered did. He let one big yell out at himself, jumped clear out into that opening, kicked his hurt paw, and jest natcherly lashed his tail with his tail!"

Nose of the boys had killed bear, nor even seen 'em, so Dick was a hero for two months, until a dago come to town with a dancing bear and told "Zim" and "Biondy Rinckel" that "barra navava gotta-tala, verra shorta holds." Then they went and made fun of Bolby, pretending they knew it all the time.

Something of a Flat Spot.

General Superintendent Bradley, of the Western, tells an amusing story of his early railroad life.

It was out in Western New York, and in the days of iron tire.

Old Judd Morell was running an old peltier that had been shimmed and flattened until she rode like a tin peddler's wagon on a corduroy road. The superintendent, who is now vice-president of the C. & E. I., got on the engine one day and sat down on the cushion seat for a ride.

When they got to going pretty lively the engineer stood on top-toe to lessen the jar, the fireman went out in the tank and the superintendent's hat danced around on his head like a green boy on a trotting horse, finally, he leaped over toward old Judd and said:

"Jutson, isn't this track pretty rough, or has she got a flat spot in her tire? I don't seem as if her wheels was bound?"

"Round," yelled Morell, "Why, sir, her wheel, ain't no nearer round than the State of New Hampshire!"

An Expert in the Business.

"A good many summers ago," remarked McGlance, "when I was firing between Troy and Albany, there was a fireman on the road noted for his expert acquisitive-ness of other people's property."

"If there was anything in sight that he wanted it seemed to kinder come to him."

"Complaints had reached the office time and again that articles had been missed just after the train had left on which this fireman was employed."

"They changed conductors, brakemen, engineers and everybody else, until the trouble was finally laid to the door of the fireman, but he was so good-natured and tree-hearted that the only punishment was a reprimand."

"Cases occurred several times, until the reputation of this particular fireman for

mandrel by a circulating pipe, and by its use pieces as short as 2½ inches can be welded. The furnace is constructed of firebrick, and its fuel is fed in from the side. The swaging apparatus is operated by compressed air, and the dies can be adjusted to suit any size of tubes used in locomotives.

Is this an Intelligence Office to Furnish Help in Case of a Strike?

Something like a year ago we received a letter from a young man anxious to go firing, he wanted pointers about how and where to get on the road.

We receive a large number of letters of this character, and always answer by telling the applicant to seek employment on a home road.

Our correspondent tried to get on firing,

good thing for men and railroads to let alone.

National Railway Employees' Exchange, Secretary's Office, 39 West Congress Street, Chicago, Ill., Feb. 22, 1914.

DEAR SIR—In reply to yours of 11th inst., enclosed please find blank application for position as locomotive fireman, which please fill out in detail and return to this office at once, together with fifty cents for membership, when your application will be filed and placed at the disposal of the proper official of any railroad company in the United States needing or about to need men.

During the past six months a large number of companies have greatly reduced the number of engine and train crews in service on account of slack business, so that even a slight increase in business calls for the re-employment of former employees or of new ones, and other engineers are likely to occur any day, when one or perhaps several of the larger companies may require the services of a large number of experienced railroad men

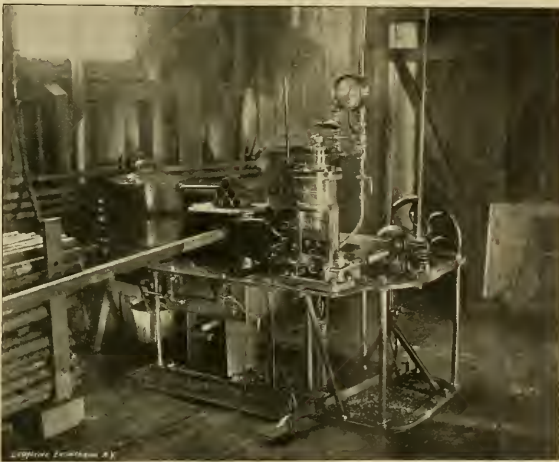

VAIL & CUMMINGS' FLUX WELDING MACHINE

honesty was at low ebb at headquarters. One morning the superintendent, who was in Pennsylvania, called the boarding-house lady, that the fireman of '93' had stolen a large, red, rocking-chair of her porch, when a conductor came in.

"Thecon, was an old-timer, and had been saving up his money to buy a farm. He and the super had 'broke' together way back in the '40's, and he had great faith in the old man's judgment."

"Well, Jim," says he, "I've got \$1,000 together now, I want that farm, where do you think I could get one that would suit?"

"Well, lemme see," said the super, thoughtfully, "ah yes, I have it—you go to that d—n fireman on the '93' and he'll steal you one."

Vail & Cummings' Welding Machine.

The apparatus shown herewith is in use in the shops of the Western New York & Pennsylvania. Mr. Vail, writing about the apparatus, says:

"I attach photograph showing Vail & Cummings' combined boiler tube welding and swaging apparatus. With this machine 2½- to 2-inch or 2½-inch boiler tubes can be welded and swaged in ten hours without burring. The water tank shown in the left of the print is connected to a water

but the times being hard he failed, and kept to work at his trade, that of carpenter.

He recently wrote us, stating his experience and inclosing a circular letter from the National Railway Employees' Exchange (whatever that may be) which we reproduce below.

We have been hearing for some time that there was a bureau in Chicago that made a business of hiring men for the purpose of supplying men to roads in case of a strike. Perhaps this is the concern.

They seem willing to take (at regular rates) firemen without any experience whatever, and put them to work, if they are as particular about engineers, the men furnished by the Exchange must be very reliable (?)

Of course, all the rif-riff and no-account engineers in the country will be "on the list." God help the passengers on the road equipped with these ready-made men.

Too little care is exercised now by railroad officers in the selection of men for positions of trust and responsibility on engines and trains, and we should be afraid to ride on the road whose men were gathered from the four corners of the earth by an exchange for a commission. We have not investigated this new supply depot, but just on the face of it it looks like a mighty

in a short space of time. All this you will get the direct advantage of through the Exchange being in communication with, and having the sanction of general managers, superintendents, master mechanics and train masters throughout the country.

Your application, together with our recommendation, will thus be on file and receive attention in advance of those who depend upon newspapers or letters to officials for their information.

If you feel yourself to be deficient in any way on machinery, air-line or other time card—if there are any little quirks you want straightened out—let us know at once, and our examiner will send you our blank forms of examination, covering all the points called for by the leading railroads.

When satisfied as to your ability, character and habits, we will do all in our power to obtain for you a permanent position and advancement as you merit it, and will send you a certificate entitling you to all the benefits and privileges of the National Railway Employees' Exchange, which we know will be of great benefit to you with railroad companies.

Expecting in return for our services—in addition to membership fee, which hardly covers the expense of placing your application properly—a sum equal to 3¢ (three per cent) of your second month's salary. All applications will receive complete attention in the order of receipt, and you will be kept fully advised.

Yours, very respectfully,

H. C. CASS,

Secretary.

Reforming the Counterbalance Practice of a Big Road.

Most roads have had more to do with the counterbalance question, but few of them have devised a plan to remedy defects—and put it into operation.

On the Louisville & Nashville a decided

of reciprocating parts. Take two-thirds ($\frac{2}{3}$) of the second, and divide it by the number of drivers on a side, and add the quotient to the weight on each pin. This will give the revolving weight on the pins to be balanced in the counterweights.

To get the proper weight in the counterbalance we must know the center

as shown, the overhanging weight of the counterbalance can be determined by using a prop as shown, this should be placed under the straight edge at a distance three times the distance of the center of crank-pin from center of axle. Then the weight on scales multiplied by three will give the weight acting against the weight on the pin at an equal distance from the center of axle.

This is the weight which should equal the weight on the pin after adding its share of the weight of the reciprocating parts.

To find the actual weight of metal to be added to or deducted from the counterbalance, multiply the difference between the crank-pin weight and the counterbalance weight, as found at crank-pin line, by the distance of the crank from center of axle, and divide the product by the distance of the center of gravity from the center of axle. This will give the actual weight of metal necessary to add to or deduct from the counterbalance. This weight must then be distributed equally over the surface of the counterbalance, or if deducted from it by counterboring from inside of counterweights, due allowance should be made to retain center of gravity.

Figs 7 and 8 show preferable mode of applying extra plates.

Fig. 9 shows mode of riveting extra plates on to wheel by passing rivet through countersink lug on plate.

Fig. 10 shows tool head for finishing lugs on plate.

Fig. 11 shows tool for countersinking recess in wheel for lug.

Order all counterbalances through the office of superintendent of machinery, giving outline of blocks needed, weights desired and thickness that can be applied, always allowing at least seven-sixths

Back end front side rod	140
Weight of side rods on main pin	125
Back end back side rod	125
WEIGHT OF REPLICATING PARTS	
Piston and rod	339
Crosshead	339
Front end main rod	152
Total	862

Two-thirds of reciprocating weight = 574 lbs. 574 ÷ number of drivers on a side (3) = 191 lbs. This to be added to weight of rods on each pin.

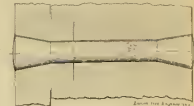
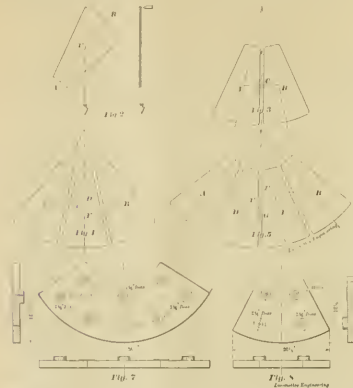

Fig. 6

Distance of center of gravity from center of axle would be 21 inches

MAIN WHEEL	
Weight of back end main rod	140
Weight of side rods on main pin	125
Total	265
Weight of reciprocating parts per pin	191
Weight to be balanced	594
Weight on scales at 30 inches	24
Equivalent weight at 12 inches	72
Weight on pin to be balanced	67
Value of counterweight at 12 inches	72
Deficit	5



plan has been made, and every engine that goes into the shops has every wheel and rod and piston and crosshead weighed and the counterbalances re-adjusted to give the best results.

A difference of over 20 pounds per wheel has been found between what counterweight was used and what ought to be used and a difference in counterweight of 10 pounds has been found on wheels on the same axle.

Fig. 1 shows the method employed to weigh rods. The connections are held up on the edge of square iron bars, supported on cast-iron standards as shown, each connection is weighed and the weight noted.

The method of weighing the wheels is shown in Fig. 6. The axle is supported on level horses, a straight edge is clamped across the wheel as shown, and an adjustable standard placed between it and the scale platform. The method of figuring is explained below (taken from notations on the blue print).

In almost every case it has been found necessary to add weight and the way this is done is shown in Figs. 2, 8 and 9. A plate is fastened on the front of the counterbalance weights, and this is done in such a way as to relieve the rivets or bolts employed of the load. The extra weights have bosses cast on them and these enter and fit holes bored in the old counterweights, the rivet merely holds the two parts together, the bosses carrying the weights.

Fig. 10 shows a special tool employed to form and finish the lugs, and Fig. 11 a tool to bore the holes in the wheel.

The following directions and example show the mode of procedure in testing and adjusting counterbalances:

TO DETERMINE THE WEIGHT TO BE BALANCED.

Weigh side rods and main rod as indicated in Fig. 1, noting the weight due to rods for each separate pin. To the weight thus found for the main pin add the weight of back end of main rod, weight piston and crosshead completely, and add to this weight add the weight of front end of main rod; this will give complete weight

of gravity of these counterbalances. To find this cut a thin wooden template the exact size of the counterbalance, and scribe a center line as *A B* in Fig. 2, then hang it by one corner so that it will swing freely, and drop a plumb line from the point of support, where this line crosses the center line will be the center of gravity sought, as in Fig. 2. If the counterbalances are solid, this method will apply for any sized template. If separate find the center of gravity for one section. The center of gravity for the group will then depend upon the number in the group.

If two sections, describe a circle from the center of the axle through the center of gravity of each, as *A B* in Fig. 3, then connect the two centers of gravity by a chord, and where this chord crosses the center line between the two sections, as at *c*, Fig. 3, will be the center of gravity of the group.

If three sections, describe a circle from the center of the axle through the center of gravity of each, as *A B C* in Fig. 4, connect *A* and *B* by a chord crossing the center line of the middle section at *D*, lay off one-third of *D E*, and the point *C*, found will be the center of gravity of the group. If four sections, describe a circle from the center of the axle through the center of gravity of each segment, connect the extreme centers by a straight line, as *A B*, Fig. 5, then connect the remaining centers by another line, as *D E*. These will cut the center line of the group at *b* and *c*, then one-half the distance, *B C*, will give the center of gravity *c*, of the group.

To test a pair of wheels as to their balance proceed as follows.

A pair of trestles are provided, on the top of each of which is placed a smooth iron surface, such as a pair of old engine guides, these trestles are made so that they can be leveled in both directions. The pair of wheels are then placed upon these trestles and leveled up in both directions, and are then ready to weigh. Get the side which is to be weighed, in the position as shown in Fig. 6, so that the line through the centers of the pin and axle shall be perfectly horizontal or level, and by means of the straight edge clamped to the wheel

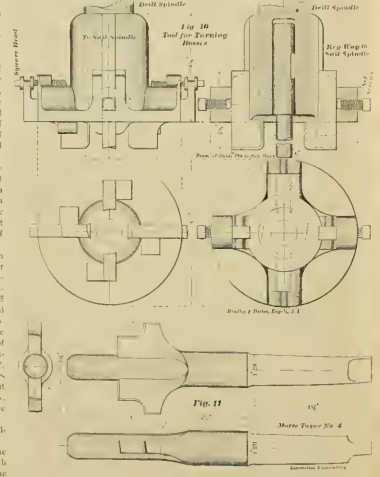

WEIGHT OF RODS.	
Front end main rod	125
Back end main rod	152
Total	277

BACK AND FRONT WHEELS.	
(In this case weight on both front and back pins was the same.)	
Weight of rods on pin	12
Weight of reciprocating parts per pin	191
Weight to be balanced	203
Weight on scales at 30 inches	22
Equivalent weight at 12 inches	67

EXAMPLE Correcting Counterbalance of 20-ton Wheeler - Diameter of Drivers to inches (Dimensions and Weights are for one side only.)

Value of counterweight at 12 inches 675
 Weight on pin to be balanced 316
 Surplus 359

The actual weight of material to be deducted from counterbalance to be equivalent to 359 lbs., at 12 inches from center of axis, is found by multiplying the 359 by 12 and dividing by the distance of the center of gravity from the center of axle, which distance has been found to be 21 inches.

$359 \times 12 \div 21 = 205$ lbs.

We find the area to be 390 square inches, and as one-quarter of the area will give the weight per inch of thickness, we have $390 \div 4 = 97\frac{1}{2}$ lbs. per inch of thickness, then $205 \div 97\frac{1}{2} = 2.1$ inches to be deducted.

Jim Blinkers' Failing.

BY R. E. MARKS.

Jim Blinkers was a peculiar chap, a cantankerous fellow as ever lived, and was always willing to help a friend out of a

wasn't in sight. "Tomkins got a great scheme for a blowing engine or air pump, making it compounded, and making one valve and a piston valve at that, do all the work of steam distribution, cutting the air into proper sized chunks and firing it into the receivers, and sometimes, though this wasn't intended, it had to chew up cylinders which found their way into it.

"You can imagine what kind of a valve this would make, big as a barrel, and openings enough in the ports or shell to make it do for a collender such as your wife uses, or a coal screen for pea coal, and naturally nothing this gave trouble sometimes.

"But the first blower that was turned out was 'perfect', gave cards like a Corliss engine, saved 67.35 of fuel, 73.45 of oil (for lubrication), and added 43.15 to the compressibility of the air, or about those figures, tested by H. G. Nopants, M. E. But somehow or other things didn't go right; the crank disk either wasn't balanced or else it was balanced too much,

came to me and told me of the trouble he had, I was 'surprised,' couldn't understand it at all, and told them that they had better not, either, and to say air was steam, and steam air if Tomkins wanted them to, and he generally did. But when the blowers would be back for overhauling the questions would come in, and the most skillful lar in America couldn't answer them all without making a fool of himself, but it was either be a fool or lose the job—and I kept the job.

"Men would say 'Blinkers, what ails this blower, why should she be sent back from Kalamazoo?' I'd like to have what the freight cost." Main-bearing thumps and crosshead went lining up, and they didn't have any tools. "Better buy a machine shop than pay freight, I should think," they would say, and then I would laugh at them and tell them 'They ought to study machine shop economy,' but every apprentice in the shop knew I was lying. Send a 40-ton blower 2,000 miles to have a main-bearing fixed or crank disk balanced, or crosshead lined up—did ever a man try to

the wrong oil, forgot to cross himself and tip his hat as he came in the room, or some other good 'mechanical' excuse, designed by Tomkins, or on lines and formulas laid down in the drawing-room. Well, the last one that came back to be 'doctored' caused the same talk, and one of my boys asked me 'what ailed the beauty?' and after mentally thinking which part of her would be least likely to be seen, I said, 'the frame cracked between the valve and the cylinders,' and gave him a job at the other end of the shop—he is too inquisitive and investigating when there is something you don't want him to know.

"Next day I was sent out to see another, and I'll be whipped if they didn't put that boy of mine to taking her apart, and 'twas too late to mend matters when I got back. He began to quote to me about Solomon's saying regarding the truthfulness of men, which was, to say the least, applicable to the case, but then I couldn't tell him so. But I have led so much since Tomkins sprung his scheme on us

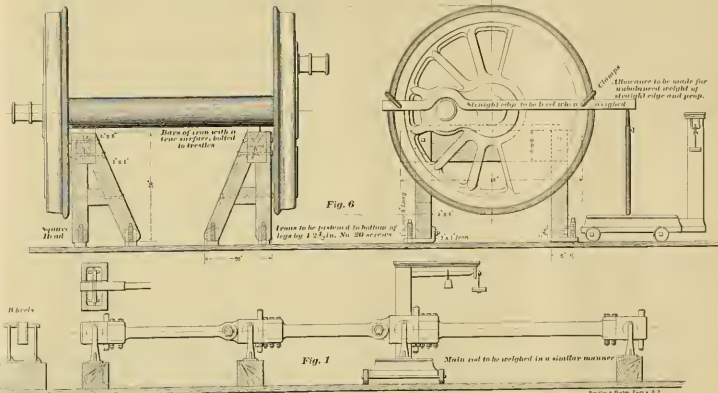

L. & N. METHOD OF CORRECTING COUNTERBALANCE WEIGHTS

shape, but he had one great failing, at least so the men all said, for Blinkers would be like a trooper at times, but he had his reasons. He had been foreman for years, had seen as many as eight superintendents over him, and Blinkers said, on the quiet to his few bosom friends, that every one had his pet scheme which cost the company more than his salary every year, and this was the real reason of Blinkers' rivalry with Ananias—that chap with corrugated teeth which twisted the truth into a lie before his mouth shot off.

If Blinkers had told the solemn, bald-headed truth on every occasion he wouldn't have held his job six months, and Blinkers knew it. And knowing that he would never get the super's place offered to him, on account of lacking the "x y z cosine angle" in his education, he just froze to his job like an icicle on an iceberg, and the cement used to stick was telling just what the super wanted to know.

But the last man gave him the hardest task of any, and Blinkers hadn't told the truth to his knowledge for three years at the time he unfolded his tale to me, his father confessor, begged forgiveness, and promised to reform just as soon as the super got fired and a new one came. "You see?" said Blinkers, as he glanced around to see that Tomkins (the super)

nobody knew which, but Tomkins knew that could be fixed all right, and went on building more of 'em. But blower No. 1 didn't quite suit, even if it was 'perfect,' the foundations wouldn't stand the shake, and something had to be done, and as of her in a little over a year's trial, the owners took her in hand, put on ordinary compressor cylinders and valves, and the first 'perfect' blower ceased to be, but newspapers and medals of award kept the success booming, and orders kept coming in.

When first one asked Tomkins about the first one being altered, he said 'Prejudice, looked wise, and walked off, and I had to say 'prejudice' so many times that my wife used to wake me up nights and ask me what 'I was talkin' about,' said I 'I kept talkin' about 'prejudice' and 'doe,' asking if I had gone mad or taken to gambling. Flowers kept being sent out, men with them, and the men often staid as long as the blowers did, trying to get them to run steady, and keep in the record of the first one; but once in a while a fellow would manage to steal away to the night and come home, hoping to be sent to China before complaints came from the last blower he set up. Some a chap

lie under worse conditions? Shades of Castor, I'd rather make up a good, decent, respectable lie, than have every boy in the shop think me a ——— fool besides.

"We built over a thousand of the grand 'economizers,' saved everything (but lying and profanity) from coal to air, before Tomkins would believe anything ailed the internal arrangement of the animal, and, of course, he didn't hear me say that anything was wrong with the digestive organs. Not that they were diseased, unless it might have been a tapeworm, but they seemed to be too healthy, if food taken but not digested, can be called healthy. The thump and uneven running became too much of a nuisance to be tolerated, and something must be done. But balancing the crank-disk didn't cure the pound, although it helped it somewhat, and after many an attempt to lie to the blowers themselves and make them think they were running all right, Tomkins set to work to improve his 'perfect' blower—valve of three years before.

"We would go to a place and under pretense of balancing the cranks or lifting the guides, we would change the ports in the valve seat, chip them off, put on there, according to the latest 'diagram,' and then swear the trouble was in the main bearing, engineer hadn't kept it lined up, had used

that I like to talk plain facts to you, just for a change. Seems almost like going to bed with his job five months, and Blinkers knew it. And knowing that he would never get the super's place offered to him, on account of lacking the "x y z cosine angle" in his education, he just froze to his job like an icicle on an iceberg, and the cement used to stick was telling just what the super wanted to know.

But the last man gave him the hardest task of any, and Blinkers hadn't told the truth to his knowledge for three years at the time he unfolded his tale to me, his father confessor, begged forgiveness, and promised to reform just as soon as the super got fired and a new one came. "You see?" said Blinkers, as he glanced around to see that Tomkins (the super)

that Jim Blinkers stopped, he had faired, and I worked over him twenty minutes before he came to. He hadn't told the truth for so long that the strain was too much for him, and for his family's sake I warned him not to do it again, or at least to begin gradually, and he said he would.

Now, you who think this story may be exaggerated, just stop and think if you don't know or haven't met 'Jim Blinkers' somewhere on your travels, and if you have, just be easy in your judgment of his shortcomings. For, if a job depended on it, "Jim Blinkers" are numerous.



PUBLISHED MONTHLY BY
ANGELO SIRC, A. I. R. E., Editor and Prop.
J. H. A. BIRD, Editor and Prop.
GEN. W. WOLLASTON, Mgr. Adm'g Dept.

Subscription Price.
 \$5.00 per year, \$2.00 for six months, postage paid to any part of the world. Single copies, 15c. Remittances in Advance. M. O. Order. Drafts on all cities. Money or Registered Letters.

The editor reserves the right to use or discard matter for the reading columns, entirely at his own will. The reading columns are not for advertisement, but not necessarily for publication.

Mailing address can be changed at will, as long as necessary—always give old and new address, and if you published in an old issue give it up. Please give prompt notice when your paper fails to reach you properly.

Entered at Post Office, New York, as Second-Class Matter.

For Sale by Newsdealers Everywhere.

NO BACK NUMBERS BEYOND THE CURRENT YEAR.

PRINTER'S AGENTS.
 American News Company, New York.
 International News Co., London, England.
 W. Williams, 11 Princes' Bldg., Melbourne, Australia.

75,000 of this Issue Printed.

Keeping Air-Brakes in Working Order.

Anyone who has good opportunities for observing the automatic air-brake on freight cars, cannot fail to strike the same essential portions of the mechanism in performing its functions under varying loads, and under conditions that strongly invite failures to operate. These air-brakes should occasionally be found in a defective condition is a matter of course, due to reckless neglect, but the great majority of them should be subjected to a thorough and satisfactory for years without the least attention, is one of the most surprising things developed in the mechanical world. We have frequently met with instances illustrating the wonderful power of air-brakes in operating when subjected to all other conditions, subjected to such conditions would have been useless. We know of a case where air-brakes had been in use on a small road for five years, but absolutely nothing had ever been done to them. Not a cylinder had been oiled, or an air-pump examined, and yet the brakes worked fairly well, but this usage is nothing but a gross neglect. An accident occurred to air-brakes on many of our freight cars. They go into service, and nothing is done to them until they fail to work. In the meantime, the hose is half the time trailing loose, accumulating all sorts of objectionable matter and the cylinder piston is allowed to get under a great part of the time. The triple-valve is often working in water, and lubricants very rarely reach any of the moving parts. It is phenomenal that air-brakes should perform their functions under this treatment. That they do so, is not an unaccounted for, or a secret, but it is essential to give them more attention, neglect would not be so commonly afforded.

Railroad companies are not equipping their freight cars so fast as they might be expected to do, considering the approach all the time when the use of those brakes will be compulsory for interstate traffic, but most of the roads have applied their brakes faster than they have provided facilities for inspecting the brakes and keeping them in order. The leading roads, which depend upon the air-brakes regularly for controlling the freight trains, have been forced by grim necessity to organize an air-brake inspecting and repairing force, but many roads that have a smaller proportion of air-brakes applied to the cars, have made little or no provision for keeping them in good working order. They depend in a great measure on connecting roads to do the inspecting and repairing. Cars that have to go east of Chicago seldom encounter a yard where testing facilities are provided for air-

brakes, and on many of the roads no attention whatever is paid by trammens to cars with brakes out of order. On Western roads, conductors are required to report cars that have brakes "out of working condition." This duty is performed as faithfully as any other duties connected with train operating, and brakes in bad order by this means identified and repairs are effected as soon as possible. Were a system of this kind in operation on all railroads, there would be less cause for complaint, and it would do a working course in the matter of keeping air-brakes in working order, but there are very few railroad companies which display any practical interest in the matter. There is a prevailing objection to do anything which is to increase the working force in the smallest degree, and on this account the air-brakes which have been applied so much cost are permitted to lose their real value.

At several of the railroad club meetings, where the care of air-brakes was under discussion suggestions were made to introduce defect cards for air-brakes, which would be filled out by the conductors. This would be a move in the right direction, and it is disseminating the understanding that it was the conductor's business to watch the air-brakes closely, and systematically report defects found. It will take a long time to spread this kind of practice over all the roads in the country, and an authoritative beginning cannot be made too soon.

The real cause of the prevailing neglect lies in the higher railroad officials. They become prevailed upon to equip a certain portion of their rolling stock with air-brakes, and then their sense of responsibility ceases. They do not reflect that the introduction of this complex mechanism entails new duties. The cars are placed in service, and the business calls for the men handling the trains are given no instruction about them, and the same set of car repairers, whose skill and knowledge goeth not beyond the changing of an oil-box, are expected to do any repairs required by devices whose interior construction they have no conception of. The only class of men in the business who have the knowledge that they are expected to report on the condition of air-brakes will be of great service in the maintenance of brakes, but still greater efforts are needed in several directions. The trammens ought to be carefully instructed concerning air-brakes, and examined at intervals to testify to the condition of the device. It is a common thing to find air-brakes on cars cut out on the ground that they are inoperative, when all that is wrong is that the slack has been taken up so tightly that sufficient air does not get in on an ordinary application to move the piston.

But increasing the knowledge and responsibility of trammens concerning air-brakes is only a beginning of the reform necessary. The crying need of the time is the establishing all interchange points of apparatus for testing the brakes, of men trained to inspect the brakes intelligently, and of others competent to repair the repairs with skill and accuracy. When a suggestion of this kind is made, it is immediately rejected on account of the great expense it would involve. We believe that the expense is much less formidable than many railroad men think it is who have not figured upon the cost of the repairs required consists mostly of piping, which is cheap enough these days. When all they have to inspect are air-brakes, one or two men can go over a great many cars in the course of a day, and their wages are easily saved by the damage they are prevented. The cost of the inspection of a triple-valve is that, except in the presence of dirt, it will not act in making a service stop. It is quick-action or nothing. This quick-action on a single car causes destructive shocks and will, in the course of a run, joint the draft timbers and damage more coupling than it would pay the wages of trained inspectors for a month. This troublesome defect of the

triple-valve is one which trammens are not likely to detect, but it would be readily found out by a trained inspector. The New York Central has an excellent air-brake inspection plant at Buffalo, which is well worthy of examination by those who are freighted at the cost of establishing and maintaining plants of the kind. The men in charge inspect and repair the air-brakes, and the expense entailed is trifling considering the value of the cars. The men in charge of the triple-valve is the principal member of the air-brake family which calls for repairs, they keep a supply of perfect triples on hand, and when one on a car is found defective it is taken off and one in good order put in its place. When the inspectors are not engaged examining brakes on cars they devote their time to repairing the triple-valves and other parts which have been found defective.

As has been frequently remarked, the air-brake for freight cars has come to stay. Many roads act as if the putting on of the apparatus was a temporary craze that would soon pass away. Those who act in this way had better put themselves into a discommodious and unprofitable position. Then they will be in a proper frame of mind to admit that apparatus and persons of higher quality than those needed for the repairs of draft rigging must be provided to keep air-brakes in good working order.

The M. C. B. & M. M. Conventions.

The railroad mechanical conventions, which will be held at Saratoga, N. Y., this month promise to be among the most interesting and useful meetings that have been held in the history of the Master Car Builders' and Master Mechanics' Associations. It might be supposed that men in charge of railroad traffic who are accustomed every year of year, in a short time, exhaust the subjects suitable for investigation and discussion, but the progress and changes in this department of the mechanical arts are so great, that new phases are constantly appearing and improved methods coming up which require study, research and discussion. The many changes that have come from the conventions for a year or two ago pays no attention to the work done is likely to fall so far behind in the march of progress that it becomes an unprofitable officer to his employees. The investigations, reports and discussions contain information that is of great importance to railroad companies and the men. The digest thoroughly the facts presented are likely to put them to good practical use. While we estimate at their full value the educational importance of reports and discussions, we have always considered that the semi-social intercourse for which the conventions provide opportunities is of great benefit to all concerned. A great many master car builders and master mechanics who attend the conventions find this the only time during the year that they can meet with men engaged in the same occupation, and they avail themselves of this event to exchange personal experiences and the methods of these social accounts are given with facilities encountered and the methods followed to overcome them.

But the most amusing part of these experience meetings is the account of mistakes made. Many a man who was considered a competent and successful mechanic who he supposed to be improvements were exploded fallacies. When conversing with some brother master mechanic he revealed his purpose, and received in return an account of how wittily worthless the improvements had found the things to be. The information is of sufficient value to pay the expense of attending these conventions.

The Master Car Builders' Conventions have to deal with an extraordinarily wide range of topics, no less than fifteen subjects being given out for committees to report

upon. They embrace all the most important points concerning the construction and operation of cars, several of them being reports of tests conducted to demonstrate the comparative value of different material. One of the most important of these is the report on "Laboratory Tests of Metal for Brake Shoes." Railroad companies are badly in want of accurate information on this subject. The higher speed of trains in every year putting harder duty upon brake-shoes, and the prevailing cast-iron shoe is entirely inefficient for the work to be done. There is an impression that more durable material is made to last longer at the expense of the wheel tread. There are good reasons for believing that the wear of rails under the action of hard tough brake shoes is not so serious as it is reported to be, and it is to be hoped that the report of the committee will settle this important question.

The only subject of urgent importance which will not be discussed at the Master Car Builders' Convention is the necessity for a standard box-car body. The sentiment in favor of a standard of this kind has been growing so rapidly during the past year that we may expect the subject to be taken up in the near future.

There are ten subjects to be reported upon by the committees of the Master Mechanics' Association, which will, no doubt more than occupy all the time at the disposal of the convention. It is much better and more profitable to have a few subjects thoroughly discussed than to have a great many which must be hurried through for want of time.

Several of the reports are of a kind likely to excite earnest discussion. First among these may be mentioned the report on "Cracking of Back Tube Sheets." This refers to a defect in boiler construction which greatly increases the cost of maintaining boiler bodies. It has already been recommended they will be certainly deferred adoption, but it is likely that conflicting views may be heard about the disease of its cure. The subject of "Boiler and Fire-box Steel" will be reported on again, and recommendations made for standard specifications and tests. Material for boilers and fire-boxes is a subject which always comes up in this convention it is to be hoped that there will be more facts and fewer prejudices aired than there have been in previous discussions. What may be regarded as the final report on "Standard Tests of Locomotives" will be reported on. The subject is in able hands, and will go down in establishing standard methods. A new and important subject, the "Cost of Maintaining Locomotives," will be reported on, which will discuss the comparative cost for repairs of locomotives built in contract shops and those built in railroad shops. This is a subject charged with explosive material, and will be sure to excite controversy. Builders of course consider their work the best, and nearly all master mechanics who build engines in their own shops are prepared to show that their own product is far superior to the purchased article. It will do no harm to bring out facts relating to the subject.

For several years there has been agitation in favor of Saratoga or some other central point as a permanent place of meeting for the associations, and we thought the idea was a very good one. At a recent town, when the writer had the opportunity of talking with a great many of the members of both associations, he was surprised to find decided opposition to holding the conventions at one or two places. The members say that attending the meetings is the only time in the year they are given a holiday, and they consider it only fair that they should be given the opportunity to visit different sections of the country. They will ought to be the law in a matter of this kind.

Weak Car Bolsters.

There is no part of the railroad car so badly in want of improvement as the body bolster. We recently spent the greater part of a day in a very large yard where hundreds of cars belonging to a great diversity of roads were stored. We were searching for the defects which involved the most expense for repairs. At first we were inclined to put defective draft appliances at the head, but after prolonged examination, assisted by a highly intelligent car interchange inspector, we concluded to place the inferior body bolster at the head of the causes which keep the car repairer busy.

A peculiarity about a defective body bolster is that it performs its destructive actions in secret. When a badly constructed truck is holding the wheels so that they grind their flanges on the rail, or when a draft rigging is constantly sending a car to the repair tracks, the men in charge have their attention constantly directed to the cause of delay and expense, but the average body bolster hunches up its back as soon as a heavy load is put upon it, and transfers the major part of the weight to the trucks by the side bearings. Trucks are not designed to carry the load on the side bearings. When the weight rests there it makes the truck unsymmetrical, that the twist given to a car remains after the load is reached, and the truck drags along sideways, damaging wheels and increasing the resistance.

In the prevailing tendency towards steel for cars we think that a good beginning could be made by using this material for body bolsters. There is also every reason why the truck bolster should be strengthened in the same way. With the present weak combination, the weight and shocks of service soon forces the center of the body bolster up and that of the truck bolster down, aggravating the tendency to carry the weight on the side bearings. Steel could be made rigid enough to resist distortion.

The Great Northern Strike.

The new railroad employes' association—the American Railway Union—have scored a signal victory in their first strike, that on the Great Northern road. This is the first successful strike by railroad men in twenty years. When men combine to resist a reduction of wages below the average of the country, the public are on their side, and railroad officials themselves are glad to see them maintain their pay. Only the fact that all employes went out and tied up the road from the Mississippi to the Pacific saved the day—and the pay—and goes a long way toward proving what President Debs has so stoutly maintained, that there was strength and safety in their combination. Had any one man ordered struck on the G. N. for the same thing the A. R. U. did, the strikers would have lost their jobs and others would have taken their place at the reduced pay. It has been the hope and ambition of President Debs to keep out of strikes and avoid differences by agreements, but he has shown his action that he is generally in the field as well as on the recruiting board. We miss our guess of Mr. Hill, or any other manager of his kind, will not go quite a way to arbitrate with the A. R. U. before they bluff them into a strike.

Let the officers and members of this new order keep cool, and be as well as usual, ask for only what is right and demand only justice—quit for the other side as well as their own—they will do much to elevate and help their own members, and railroad workmen everywhere, and still have the respect of the railroad officers and the public. That there is strength in a union of all classes of railroad men has been proven. Let us hope, then, there will be no excesses on either side that will call for another clash to prove it over again.

A writer signing himself "Div. 31" in the *Locomotive Engineer's Monthly Journal* takes us to task for saying that it would make no difference with the work of an injector if the feed pipe were enlarged to six inches in diameter, the writer in question claiming that the momentum, rather than the pressure or weight, of the water is what opens check-valves. "Div. 31" will take the time and trouble to connect up an injector so that it will deliver water into the boiler of another locomotive, and then from that to the one he wants to get water into, that the instrument will get there with the water just as soon as it gets the water into the boiler. "Div. 31"—this is enlarging the feed pipe with a caution, but it will prove something. The writer's assertion that " * * * the present injector will not permit of such a radical change as the substitution of a 6-inch discharge pipe * * *" is merely his opinion—for a simple trial will show him that it will, or a few feet one either.

The diversity of locations for the marker and tally marks (the two being combined), has naturally led us to speculating as to why one road should locate them on the corner posts and another, perhaps a parallel road, should carry them on the hood, while still another will place them on the rear platform. This, too, by roads supposedly members of the Association. The location, we presume, has been defined, and if so, why it should not be adhered to is the natural query. Crowded platforms of excursion trains make any other position than the hood a dangerous one for these important signals, and why the experience of the Pennsylvania road in this regard has not taught all roads this lesson, seems strange to us.

There is to be seen in the office of Pratt & Letchworth, Buffalo, a list of about 150 names of the older employes of the establishment, all of them having been employed before 1870. Some of the men have been in the works since 1869. This firm is celebrated in the neighborhood of Buffalo for the generous treatment accorded to employes. There are numerous stories to be heard which illustrate the benevolent tendencies of the firm. The members evidently have the welfare of their people at heart, and their sentiment finds many kindly expressions. If all firms and companies were like this one we would hear less about the doings of wicked unions.

Our Chart No. 2, the transparent locomotive picture, will undoubtedly become the best selling locomotive picture in the world. The demand for it for the purpose of framing has been unprecedented, more than 30,000 copies having been issued. The names of parts have been translated into Spanish, and it will become the official "Dictionary of the Locomotive" for the Spanish speaking countries south of us. It is being printed in large quantities, to frame for the offices of train dispatchers, etc., etc. It was the "hit" of the season.

We are almost daily in receipt of letters intimating that the writers have had an offer to go to the Annual or other South American Convention, and asking our advice about going there to run engines. From all we can learn it's a poor place to go to, wages are no better there than here, money of the country depreciated and climate undesirable. We do not believe that any reasonable firm are contracting with men to go to those countries.

Some one signing "J. S. D." writes "What have you done with my piece about machinists' firemen engineers?" It was sent a long time ago. If the original material was not simply signed "J. S. D." it's safe to bet that it has gone to some paper mill, via our waste basket. Don't send anything here that you are ashamed to sign—we've got just as much pride as you have.

The coal strike threw about as many railroad and other machinists out of work as if there had been a general stop. Coal is the stream that turns the mill of mechanical industry, and when that dries up the wheel is liable to stand still and rust away. If the coal miners and the operators don't go to work pretty soon there will be a coal famine in the country.

Some of our contemporaries are standing up on their hind legs and howling about the Coxeyites. It seems to us that the Coxeyites are very much like the green bottle fly, not so awful bad in themselves, but indicating the presence of a carion somewhere—where? That's the question the American people must answer.

BOOK NOTICES.

TWENTY-THIRD ANNUAL REPORT OF THE RAILROAD AND WAREHOUSE COMMISSION OF ILLINOIS. Published by the State, at Springfield, Ill. Distributed free.

This is the usual railroad commissioners' report, and is filled with interesting statistics. The work only covers the year ending June 30, 1893, but we notice that the railroads in Illinois carried 9,300,000 more passengers that year than it did the year before.

The commission are strong in their recommendation of block signals as safety devices, and speak in the very highest terms of the work and the record of the Hall system employed on the sixteen miles of the Illinois Central out of Chicago.

The report shows that out of a total railroad mileage of 34,347.51 but 696 of 6.7 per cent of the total miles of receivers, while the percentage of roads in the hands of receivers in the whole country is 12.7 per cent.

The commission ask for legislation that will allow them to compel railroads to put their tracks and bridges in better order, rather than recommend that they do so.

ENGINEERING EDUCATORS: Being the Proceedings of the Section of the World's Engineering Congress. Edited by De Volson Wood, Ira O. Baker and J. B. Johnson. Published by J. B. Johnson, Secretary, Washington University, St. Louis. Price \$2 50.

This book contains a number of papers on engineering education, principally by professors engaged in this kind of work. It contains a great deal of valuable information for those interested in the education of young men for engineering pursuits. Among some of the subjects treated are: Requirements in Mathematics for Engineering Education, Comparison between American and European Methods in Engineering Education, Field Practice and Field Equipment, Training of Students in Technical Literary Work, Original Research by Students, and a variety of other subjects of minor consequence.

THE MAGNETIC HAND TELEPHONE. Its Construction, Fitting up and Adaptability to Field Work. By Norman Hughes, Spool & Chamberlain, New York. Price \$1.

This little work explains how to make and use magnetic telephones. It will be found a very useful guide to those who wish to fit up local telephone lines of five miles or less, which can now be done without infringing patents. The principles of magnetic telephones are explained in simple language and directions given for every detail of the work.

ENGINEERS' HAND BOOK OF MEXICO. By Philip G. Reeder, Cleveland, O. Price \$2.00.

This is a small volume containing a page or two of abbreviations used in commercial business in Mexico, some general shipping hints and a list of business houses of the country. It is intended as a guide to houses selling goods in Mexico.

Those Charts.

Remember that all whose time expires in June, July or August, who renew, are entitled to charts Nos. 1 and 3. No. 2 was sent to all in the March number.

PERSONAL.

Mr. James Roosevelt was, on May 15th, chosen vice-president of the Delaware & Hudson.

Mr. Day Mills has been promoted from the key to be chief train dispatcher of the St. Louis Southwestern.

Mr. J. F. Scott has resigned as master car builder of the Evansville & Terre Haute, and that office has been abolished.

Mr. E. W. Knapp, general foreman of the Mexican National road at Tolima, has been transferred to Monterey, several hundred miles further north.

Mr. A. C. Barstow, Jr., heretofore second vice-president of the Cleveland, Canton & Southern, has been chosen first vice-president of that road.

Mr. George A. Black has been appointed superintendent of the White Mountain division of the Maine Central, with headquarters at Lancaster, N. H.

Mr. E. Richards, chief train dispatcher of the Arkansas division of the St. Louis Southwestern, has been appointed trainmaster, with office at Pine Bluff, Ark.

Mr. Jeff N. Miller, heretofore general superintendent of the Pecos Valley Road, has been appointed general manager of that road. Headquarters, Eddy, N. Mex.

Mr. F. A. Starnard, a member of the Master Mechanics' Association, formerly on the Erie, has made an engagement with Magnolia Anti-Friction Metal Co. of New York.

Mr. Samuel J. McEwen has been appointed trainmaster of the Rome, Watertown & Ogdensburg, in charge of the Utica & Black River division, in place of Mr. Huggins, resigned.

Mr. E. M. Seebree has been appointed trainmaster of the Chicago, Rock Island & Pacific from Chicago to Terrell Tex., both inclusive, and for the Chicago, Rock Island & Texas Railway.

Mr. A. R. Perry, for many years identified with the malleable iron business of the country, has recently accepted the position of traveling representative of the Dayton Malleable Iron Co. of Dayton, O.

Mr. J. P. Reeves, for two years past private secretary to the president of the Chicago & Eastern Illinois, has been appointed cashier and paymaster of that road, with headquarters at Chicago.

Mr. Edward F. Luce has been appointed general agent of the Detroit, Lufkin & Chicago, with headquarters at Chicago, and the Chicago office removed from the Western Union Building to No. 541 the Rowley.

The management of the Evansville & Terre Haute has extended the supervision of Mr. John Terrance over the car department, and his title has been changed from that of master mechanic to superintendent of motive power and rolling stock.

Mr. Wm. Rutherford has been appointed superintendent of motive power of the Savannah, Florida & Western, with headquarters at Savannah, Ga. He was formerly master mechanic of the Jacksonville, Tampa & Key West, and before that was on the Florida Southern.

Mr. W. B. Coffin, heretofore superintendent of the Jacksonville, Tampa & Key West, with headquarters at Jacksonville, Florida. He was formerly superintendent of the western division of the New York, Lake Erie & Western.

When Engineer William H. Howland drew his month's wages from the Michigan Central pay car, he received a trip

to call, together with a letter from W. H. Vanderbilt complimenting him on the truck run he made from Jackson to Michigan City with the Vanderbilt special recently.

Mr. G. W. Rhodes, superintendent of motive power of the C. & B. Q., has been very sick, and it was feared for a time that he was suffering from appendicitis. The complaint which carried away Mr. E. B. White. The trouble was, however, found to be less serious, and Mr. Rhodes is able to be about again.

Mr. R. T. McKeever, superintendent of the Florida, Jacksonville & Gulfville, writes: "Will you kindly insert paragraphs to the effect that Mr. Lawten Van Meter had his connection with this company (Nov. 1, 1903), and all matters pertaining to purchasing should be addressed to me at Gulfville, N. Y."

Mr. Thomas R. Freeman, the well-known school supply man, has accepted the general agency for The Hale & Kilburn Mfg. Co. of Philadelphia. He is now doing also in the Western Union Building, Chicago. He handles his railroad freight car and is coming to the fine specimens of work he has in exhibition.

Postal paper recently published a portrait of Mr. W. T. Reed, lately superintendent of motive power of the Great Northern, and gave a long account of a struggle upon him by a large number of men who belong to the road which he had just left. They presented him with a number of valuable presents, testifying to his merit.

Mr. H. H. Chanamoy M. Dewey, president of the New York Central, has promised to deliver an address of welcome at the opening of the Master Mechanics' Convention, at Saratoga, on June 17th. The name of Mr. Dewey as orator is new to the world over. The members would like to be there in force, for the opening would be worth traveling a long way to attend.

Mr. William H. Tanny has been appointed master mechanic of the Florida Central, with headquarters at Palatka. Mr. Tanny has been for several years master mechanic of the Lake Shore, in charge of the shops at Buffalo. It is understood that some locomotives built by the Brook Locomotive Works lately for the Florida Southern were designed after Mr. Tanny's ideas.

Mr. L. T. Myers has resigned as general superintendent of the Seaboard Air Line to accept a position with the Richmond, Fredericksburg & Potomac, with which he was formerly connected for eight years. He has been general superintendent of the Seaboard Air Line since May, 1900, and before that date was for two years superintendent of transportation of the Seaboard & Roanoke.

The Fox Solid Press (Steel) Co. announces that their New York office has been moved to the Havermeyer Building, on Cortlandt street. That is now where Mr. James B. Brady holds forth, and where he is anxious to have his numerous friends call. We were there to-day, and can testify that his cigars are as sweet as ever. There are two things Jim brings himself in having the best of champagne and cigars.

Mr. Edward M. Neill, general manager of the Iowa Central, has been offered the position of general manager of the Great Northern and declined. The Great Northern is a fine road, but there are too much of a hill on it to make the life of a general manager endurable. A life incumbent of the position said that he liked dealing with boys occasionally, but it stimulated one by his lessening tendencies, but to be bossed by a bear all the time was irritating.

The title of Mr. E. W. Graves, of the Baltimore & Ohio, has been changed from

master car builder to that of superintendent of car department. He will report direct to the general manager. This is a genuine compliment to an able man and particularly efficient officer. It will honor all the members of the Master Car Builders' Association. To learn that their president has been thus honored by the management of a great railroad system.

Mr. W. S. Morris, superintendent of motive power of the Chesapeake and Ohio, was elected president of the Central Railroad Association of Cincinnati at the last meeting. This association is composed of the officers of the operative departments of roads running into Cincinnati, and its principal purpose has been to discuss matters pertaining to car interchange. The election of Mr. Morris is quite a compliment, for he is one of the youngest members.

Mr. L. B. La Rue, the well-known railroad supply man, has been appointed general manager of the Auto Pneumatic Signal Co., of Rochester, N. Y. This company has a plant on the D., L. & W. at Buffalo, which has been in use eight months and has accomplished 8,000 movements without a single accident, at a cost of repair of eight dollars and six cents per movement. Eight signals and six derailing points are moved by a single lever, which is so easily worked that a girl could handle it.

Mr. A. Dolbeer has been appointed general foreman of the Florida Central, with headquarters at Tallahassee, Fla. The numerous friends of Mr. Dolbeer will be glad to see him in railroad service again. He is known to be one of the ablest mechanical men in the country, and the Florida Central people are fortunate in securing his services. He can make more out of nothing in a machine shop than any man we have ever known. There are good opportunities for displaying this creative faculty on most southern railroads these days.

Mr. Theodore Voorhees has resigned as general manager of the Lehigh Valley, and the duties he performed will be attended to by President Wilbur. Mr. Voorhees reorganized the whole operating department of the Lehigh Valley, and introduced modern methods which will ultimately be of great benefit to the property, which are adhered to. The mechanical department received the greatest attention, and a reorganization was effected which reduced the machinery to standards. Before this was done, some of the shops were still using odd sized screw threads, and the locomotives on most divisions were built without any regard to uniformity with those of other divisions.

It is understood that Mr. H. H. Burrows, superintendent of the New York Central, has been on leave of absence for the last six or eight months, but will not again resume active duties. This news will be a great relief to many persons connected with the New York Central. Mr. Burrows was a good representative of the railroad officers who made tyranny a pleasure, and never failed to say the hardest word and perform the cruelest act when men came up for discipline. With this class of superiors, to be accused of a mistake or a failure of judgment was equivalent to a crime, which must be punished to the limit of vindictiveness. It is safe to say that no officer in railroad service was ever hated so cordially and so generally as Mr. G. H. Burrows. His hand was against everyone and everyone's hand was against him, including all the subordinate officers who were subjected to his cutting lash of his tongue, and to the exasperating scourge of his disapprobation. His policy as an officer was to constantly exasperate those whom he considered less zealous and less competent than himself. His policy, which ever generated hatred and scattered seed of revenge, must have been an expensive harvest to the New York Central Rail-

road. It is one of the mysteries of railroad business that such a man should have been so long permitted to cast the shadow of his injustice over the principal limb of a great system. Happily, the end of the tyrant as a railroad officer is on the wane.

As we go to press we learn by a dispatch to the morning papers that Col. R. E. Ricker, late general superintendent of the St. Louis, Iron Mountain & Southern, had died suddenly of heart disease. Col. Ricker had been in railroad service for about fifty years, and was one of the best representatives of the class of managers who liked to supervise every detail. Unlike many members of this class, Col. Ricker was always a gentleman, and his heart was always with the hardships passed through by the men who had to carry out his orders. He was a warm friend of *LOCOMOTIVE ENGINEERING*, and a letter from him lately published in our columns, on railroad management, excited wide spread attention. His letter showed, without question, that roads managed by such men as Marvin Hughton and others of similar stamp, who devoted all their personal attention to the interests of the roads they looked after were prosperous, while competing lines with greater financial influence, managed by amateurs, settled gradually toward the goal of receivership. Col. Ricker had a highly varied career as a railroad man. He began as assistant engineer on a railroad in Maine, and gradually worked up to be division superintendent. During the war he was in charge as superintendent of the railroads in Indiana for the War Department. Then he was appointed superintendent of motive power of the Pennsylvania Railroad, a position he held for nine years. During this time he devised the system which is now in use in the department of transportation, and in charge of the mechanical department. Later on he held the position of general superintendent of the Jersey Central. Then he went to various Western roads, and toward the end drifted upon the Gould roads. He was a man of strong individuality and did not tolerate interference with his duties by high or low. He resigned from the Iron Mountain a few months ago, worn out by that which was indifferently appreciated. He did not long survive being out of harness.

EQUIPMENT NOTES.

The Savannah, Florida & Western placed orders with Pullman for twenty passenger cars.

The locomotives for the M., K. & T road have not yet been placed. Bids, however, are all in.

Armour & Co., of Chicago, have let a contract to Wells & French Car Co. for 100 provision cars.

The N. Y. N. H. & H. are reported to have placed orders with the Rhode Island Co. for ten gasolines.

Baldwin's people are building three engines for Brazil and two for the United Verde Copper Co. of Arizona.

The Hot Springs & Little Rock are in the market for 500 freight cars. They will have M. C. B. couplers and air-brakes.

The Florida Central & Peninsular road will in all probability be in the market for additional power for their winter's business.

The Richmond & Danville have placed an order with the Richmond Locomotive Works for two 100-wheelers, and it may be increased to ten.

The Cuddey Packing Co., of Milwaukee, are asking bids for fifty refrigerators cars. These cars are to be built under the Armour Packing Co.'s specifications.

The C. & B. Q. people are experimenting with petri leas as fuel for their loco-

motives. They are very short of coal, and wish to be prepared for present and future scarcities.

The Rogers Locomotive Works are working on ten 10-wheel engines for export. They have finished the five engines ordered for the New York, Susquehanna & Western.

The Canda Car Co. are busy at their new shops at Cartaret, N. J. They are about completing an order for two cars for Cuba, thirty of which are tank cars for carrying molasses.

The Detroit Twist Drill Co. have received a large order for Graham chucks and drills to be sent to Africa. This company reports the business keeps up remarkably well. They advertise.

The Westinghouse Air Brake people have received orders within the month for brake equipment for the Northern Railroad of Guatemala. They have also received orders from several railroads in Brazil.

Orders for two hundred and fifty locomotives and several thousand railway carriages have been given by the Russian government to Austrian and Belgian firms, particularly required for the trans-Siberian railway.

In order to avoid setting fire to the pampas by sparks from its locomotives the Buenos Ayres Great Southern Railroad has been experimenting successfully with petroleum as a locomotive fuel, the intention being to substitute petroleum for coal.

A practical man, writing about the Cleveland Twist Drill Co.'s drills, says "The drills you have furnished us are the best I know of. I have drilled two holes in a 66 pound steel rail with two men in exactly four minutes. They very often have drilled 100 holes without being sharpened, and I have one instance of 120 holes by accurate count, without sharpening the drills."

The Santa Fe Railway Company has placed an order for a large compressed air plant at Argonne, Kan. It is for the cleaning of coaches, but will be used for many other purposes. Pipes are being laid all through the yards, and the air will soon be in use with new patent jacks to boost cars and engines. Oil will be transferred to all parts of the yards by means of the pipe system, and the sand-boxes on the engines will be filled in a very few seconds by simply turning on an air faucet.

An all-steel box car has been designed by Mr. W. Buchanan, of the New York Central, and full working drawings have been prepared. Mr. Buchanan has had considerable experience with iron cars, and has carefully watched their strong and weak points. The car designed is likely to draw strength from the lessons of a well-worked out. Every detail has been carefully worked out, and the likelihood is that this car when built will be a success. Many iron cars have been made weak by the aim of designers to hang patents on them. There is no patent on this one.

On another page we have seen a striking picture of springs that had been raised by rubbing against the driving-wheels of the locomotives they were applied to. The thing seems incredible, yet these springs were returned to the maker to have others supplied free of charge, on the ground that they had not worn up to the guarantee. It is amazing to find an officer in charge of railroad rolling stock would advertise his own incompetency by an action of this kind. If the manager had happened to see those springs, and reflected on the amount of power wasted in grinding them to pieces, questions might have been raised which would place the motive power department in an awkward position.

Haskell's Brake Leverage Plan.

The annexed illustration shows the method followed by Mr. B. Haskell, superintendent of motive power of the Chicago & West Michigan, for keeping the brake leverages the proper length to suit the weight of car. The wheel sliding that destroys wheels on so many roads is due in a great measure to mistakes in leverage. The selecting of levers is often left to men who are not able to calculate the correct dimensions, and frequently they have not sufficient data to figure on. Mr. Haskell's plan leaves no loophole for making mistakes. One set of levers is used for the whole passenger car equip-

ment, and a cylinder lever is painted on the bottom of each car, with an arrow pointing to the hole to be used. This hole, of course, is suited for the weight of car. It would effect a great saving of wheels if all railroad companies would adopt this plain way of finding the right leverage.

any other position being to their own detriment. The Master Car Builders' Association now, with its rules of interchange and the adoption of standards, has become invaluable in the interstate commerce of the country, and anything tending to interfere with the distinctive work of the Association could not but result in injury to traffic. One could scarcely imagine the utter confusion that would result were the rules of interchange to be suddenly abol-

ished. But while this has not been suggested, no advantage could accrue to either association by a consolidation. The interests of the Master Car Builders' Association take in the whole United States and Canada, while the work of the Master Mechanics' Association is necessarily of limited scope. Engines are usually built to meet the requirements of service in a certain territory, and therefore the construction and maintenance of locomotives does not become a general question, in the sense that the interchange of cars does.

The work of the two conventions, as now conducted, is on an economical basis, utilizing three or four days in the latter part of one week for the Master Car Builders' Convention, and the first portion of

the following week for the Master Mechanics' Convention, so that very little more than a week is taken up, if certain officers have to attend both conventions. There could hardly be any saving in time if the discussions on both cars and engines were to be fully carried out.

I cannot see the wisdom there would be in any change, and do not believe the sentiment is in favor of it.

A Beamless Brake with Automatic Adjustment.

The beamless brake here shown is the simplest form of device yet offered to do away with the heavy and somewhat dan-

gerous levers acting as dead-lever, as shown.

This brake has been patented by Mr. A. Hendee, of the City of Mexico, who represents the Westinghouse Air-Brake Co. in that section of North America.

Roller Bearings.

The subject of roller bearings for cars is one which the average railroad man would rather not discuss. He has seen and heard of so many failures with roller bearings that he naturally thinks the attempts to change the methods of imposing the load on a journal so that rubbing friction is changed for rolling friction to

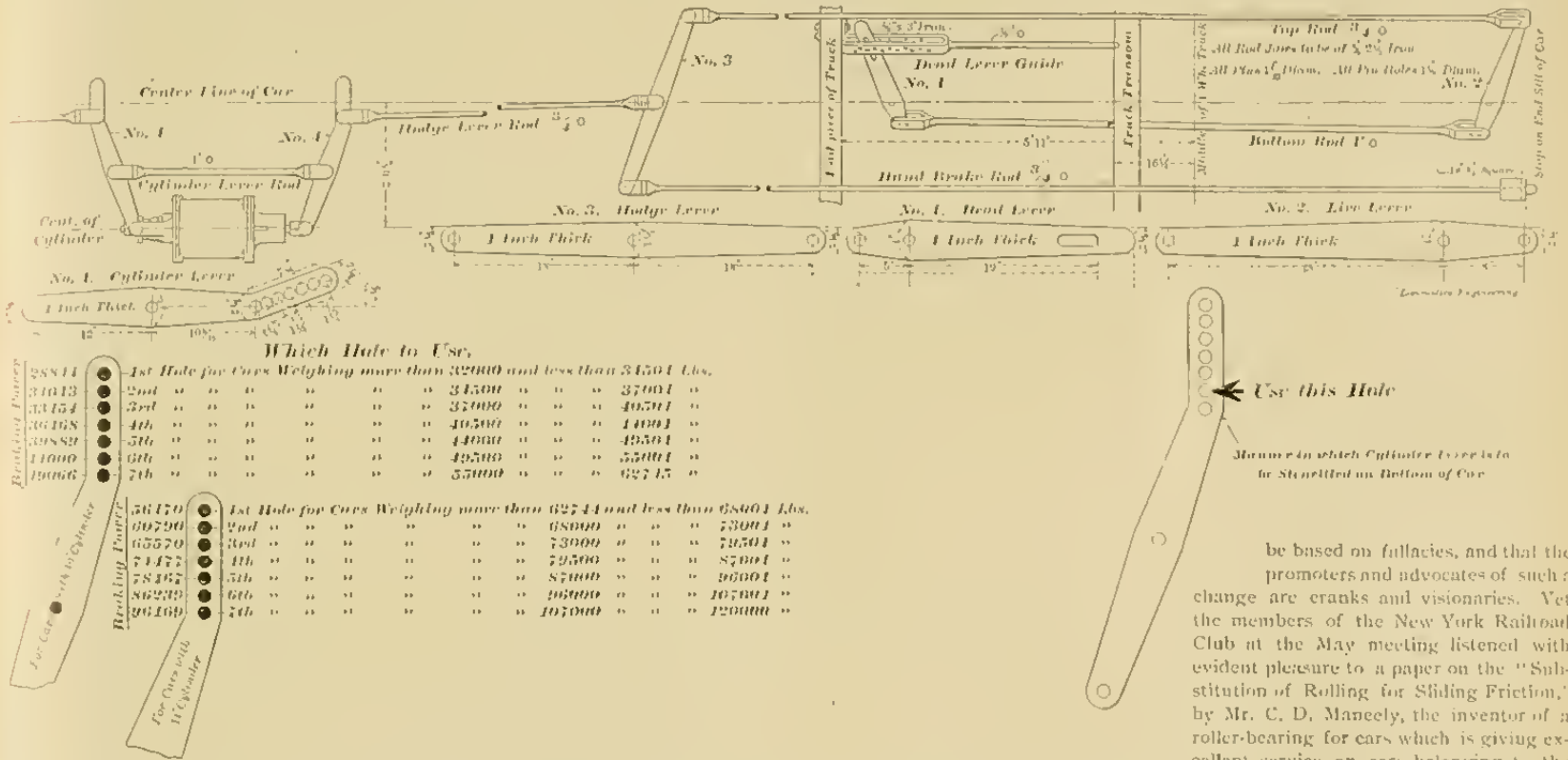

Which Hole to Use.

Braking Power	Hole	Weight Range
28811	1st	For Cars Weighing more than 32000 and less than 34501 lbs.
31013	2nd	34501 " " " 37001 "
33154	3rd	37000 " " " 40501 "
36168	4th	40500 " " " 44001 "
39882	5th	44000 " " " 47501 "
44000	6th	47500 " " " 51001 "
49066	7th	51000 " " " 54501 "
50170	1st	For Cars Weighing more than 62744 and less than 68001 lbs.
60790	2nd	68000 " " " 73001 "
65570	3rd	73000 " " " 78501 "
71172	4th	78500 " " " 84001 "
78192	5th	84000 " " " 90001 "
86239	6th	90000 " " " 96501 "
96169	7th	107000 " " " 120000 "

be based on fallacies, and that the promoters and advocates of such a change are cranks and visionaries. Yet the members of the New York Railroad Club at the May meeting listened with evident pleasure to a paper on the "Substitution of Rolling for Sliding Friction," by Mr. C. D. Maneely, the inventor of a roller-bearing for cars which is giving excellent service on cars belonging to the Delaware & Hudson Canal Co.

The paper gave a good resumé of the attempts made to introduce roller bearings into service, and drawings were shown illustrating the forms of bearings tried. Roller bearings can be divided into two general classes: Those in which the axes of the rollers are fixed and those in which the axes of the rollers move in the direction of the journal rotation. The first is well known as the grindstone bearing and has been successfully applied to various purposes, but is unsuitable for car journals. The greatest success with cars and all kinds of vehicles has been attained with the second form of roller bearing which includes ball bearings so largely employed in bicycles and light carriages. Mr. Maneely gave detailed particulars of the difficulties encountered with various forms of roller bearings, and outlined the line of improvement which he had followed to produce a bearing that is reliable and durable enough to justify adoption by steam railroad companies.

This bearing is composed of steel tubes, uniform in section, which are grouped closely though not in contact with each other, around and in alignment with the journal, and enclosed within a steel-lined cylindrical housing. The tubes are arranged longitudinally in three series, the center series being of double length. Each short tube is in axial alignment with the corresponding tube of the opposite end series, while exactly intermediate to these end lines are arranged the axes of the center series, thus making the lines of bearing equal.

Bearings of this kind have been in use on a Delaware & Hudson Canal car for two and a half years, and has run 138,000 miles without showing any traces of wear. A train of four coaches equipped with these bearings has been running two years, making 117 regular stops daily, and there is every reason to believe that

That Old Chestnut Wheel Question.

That old, old chestnut, about the top of a wheel traveling faster than the bottom, got a hearing in the paper somehow or other, and now we are buried under an avalanche of explanations, good, bad and indifferent, of how it can and cannot be true. We are not going to open up this old chestnut mine again, and don't publish them for that reason. It has been and can be proven that the top does move faster than the bottom; there is no longer any dispute about it among scientific men, and wouldn't help matters a bit if it were or were not proven true over again.

Photographs have been taken of fast-moving locomotive wheels which show the lower ends of the lower spokes very distinctly, while those at the top are lost in a whirl. This only goes to show that those scientists who have contended that the bottom was momentarily at rest when it touched the rail were correct.

It's one of those things that's so, even if we can't understand it—like love at first sight.

The Associations to Manage their own Business.

Mr. E. W. Grieses, superintendent of the car department of the Baltimore & Ohio and president of the Master Car Builders' Association, writes us that he has sent the following letter to the *Railroad Gazette*. We believe that the views expressed by President Grieses are endorsed by 95 per cent. of the members of both associations.

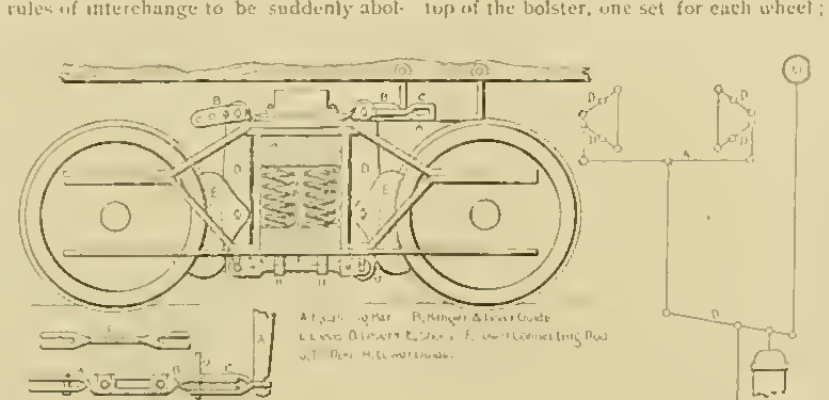

When the car is empty the springs raise up the bolster, carrying the levers with it, and the leverage of the brake is decreased, the short end of the levers, *D*, being lengthened. When the car is heavily loaded, the bolster springs are depressed, and the short arm of the levers, *D*, are shortened, and the braking power proportionately increased. The slack is taken up by the usual dead-lever arrangement; one of the

four levers for a truck being moved by an equalizing bar running across and hung to the frame of car body.

The fulcrum of these levers is a rod supported in hangers on the bottom of truck frame, as shown at *F*. The lower ends of the brake levers are slotted.

When the car is empty the springs raise up the bolster, carrying the levers with it, and the leverage of the brake is decreased, the short end of the levers, *D*, being lengthened.

When the car is heavily loaded, the bolster springs are depressed, and the short arm of the levers, *D*, are shortened, and the braking power proportionately increased.

The slack is taken up by the usual dead-lever arrangement; one of the

four levers for a truck being moved by an equalizing bar running across and hung to the frame of car body.

The fulcrum of these levers is a rod supported in hangers on the bottom of truck frame, as shown at *F*. The lower ends of the brake levers are slotted.

the cars will run full years before the bearings need any repairs.

The claims made for the bearing are: A saving of over 50 per cent in power required to start, a saving of 25 per cent in engine fuel, a saving of 50 per cent in lubricants, absolute prevention of hot journals.

There appears to be good reason for believing that these claims are well founded. The bearings originally used

track can be packed up and torn to shreds

by over-repair men will use at a glance

how convenient this would be. For loading wheels, on or off the axle tracks, or any such material, the trolley roller is most convenient.

Pit Jacks for Car Repair Shops.

The Lake Shore, Rock Island Illinois Central, and other roads have recently

He Turned the Angle-Cock Handle.

Two young men were sitting in the smoking car talking locomotives. They belonged to the lines west of Pittsburgh, and were members of that class of students which some great railroad corporations appoint as road foremen of engines to instruct engineers and firemen how to perform their duties scientifically.

The younger man whose piken brow

station: "You see I had shut off the air behind the baggage car."

"But do the trainmen on your division not try the brakes when they take on a car at a way station?" asked an inquisitive passenger.

"Perhaps they do sometimes, but I never heard of any rule that required them to do so," answered the scientific road foreman of engines.

"You must be a valuable instructor for trainmen about how to care of air-brakes," remarked another smoker.

"Well, you see that it is by experience that a man learns things," was the reply. "You bet I can tell them to be careful about how they turn angle cocks after this."

"What would have been said if your mistake had led to a disastrous accident?" asked the smoker again.

"That would have been bad, but mistakes are always happening."

And we sadly reflected that the policy of some railroad companies of putting in experienced youths into important positions prepares the way for serious accidents.

There was a discussion going on in a meeting of railroad managers on the question: "In what way can an automatic system of signals be superior to a manual system?" The manual system advocates were apparently having the best of the argument, when Mr. Robert Fitzcarrin, of the Pennsylvania Railroad, who is very familiar with all sorts of signals, proceeded to make himself heard. He expressed great admiration for the best of the manual systems, and said they had been exceedingly useful in their day, just as other methods and appliances, now obsolete, had been valuable when nothing better was to be found. But for modern use, he was in favor of a strictly automatic system, which by reliable apparatus indicated without fail when the block was not clear. The leading advantage of an automatic system he declared, was that the controlling system never went to sleep, never left its post, to have a chat with a friend and never got drunk.

A correspondent in Rockhampton, Australia, who sends in a list of thirty-seven

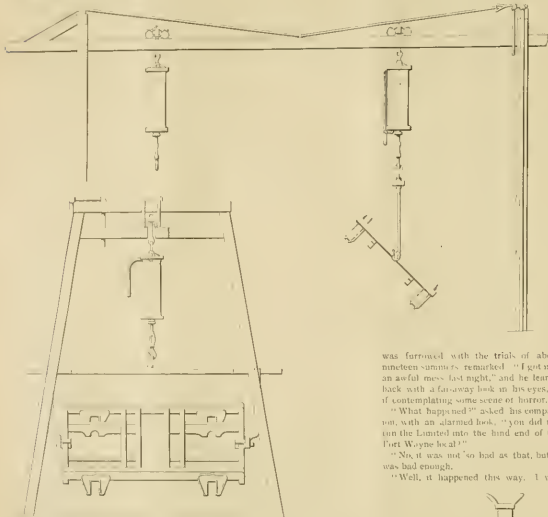

was furnished with the trial of about nineteen summers, remarked: "I got into an awful mess last night," and he leaned back with a far-away look in his eyes, as if contemplating some scene of horror.

"What happened?" asked his companion, with an alarmed look. "You did not run the Limited into the hand end of the Fort Wayne box, did you?"

"No, it was not so bad as that, but it was bad enough."

"Well, it happened this way. I was

used to test cars, and are no longer an experiment. The invention deserves investigation in railroad men. Because many roller bearings have failed is no conclusive evidence that they cannot be made a question were failures for years. It has been on the ruins of many failures that numerous successful devices have been built up. Those who have no patience with roller bearings should remember these facts, and approach the question with unclouded judgment.

put in extensive passenger car cars with means of cleaning and repairing cars.

Air for testing brakes and cleaning the interiors is brought in under ground pipes and air hydrants located where handless. A cast pit for removing wheels is a feature, and one of these used on the Lake Shore, is illustrated herewith.

This device is used, as shown, to remove wheels from trucks.

A permanent cylinder is located in a pit,

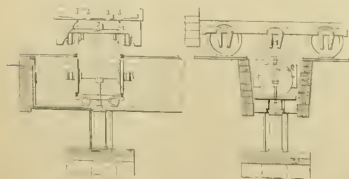

Truck Shop Jack.

The accompanying cut shows an overhead trolley jack used in the Lake Shore shops for handling trucks and loading cars. A 12-inch cylinder with a 4-foot lift is used to do the work. A special rig is used to handle trucks, so arranged that a coach

and the pair of wheels, lowered by it upon a small track as shown.

Another pit jack is shown herewith. It is a telescopic jack and is itself located on a wheel pit track and air connection made to it by hose. A pair of wheels can be lowered with it, moved to another track and raised up again.

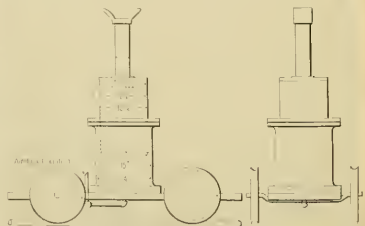

running on the engine of No. 4, and we had to take on a car at Alliance. It was put on behind the baggage car. When we pulled the train up to the station the engineer said to me that he thought there was something wrong with the brakes. Would I go back and see if they were coupled up all right.

"Of course I went back, and I thought that one of the angle-cock handles was wrong, and so I turned it. They have no right to have angle-cock handles that sometimes set one way and sometimes the other."

"We pulled out as soon as I went back to the engine, and I never dreamt that anything was wrong till the engineer tried to stop at the next station. He applied the brakes and they did not hold. Then he whistled for brakes and pulled the engine over but we ran two train lengths past the

great satisfaction here. Its success has led to the establishing of a debating class in connection with railroad men to discuss matters of mutual interest. The first meeting was devoted to the discussion of your Educational Chart No. 1, and it was a great success. The other charts will be eagerly looked for."

Engineer Cooper, of the Michigan Central, made a fast run on May 3d with the Vanderbilt pilot. Engine No. 447, a ten wheeler, left St. Thomas, Can., at 4:20 a.m., and at 7:21 was in Fort Erie, 119 1/2 miles away. This distance in 145 minutes with a stop for water and slow tops and bridges and switches, is not bad running. This division is particularly favorable to high speed, it's straight and level and the track first-class.

Shop Truck for Lifting Ends of Empty Cars.

The combined truck and air jack shown herewith is a very handy device and made with the fewest possible parts.

The truck is the ordinary hand-truck and the cylinders a pair of ordinary Westinghouse passenger car cylinders, the manner of connecting them, the controlling cock and hose connection is shown.

They are very useful around a repair shop, as they will lift the end of an empty car without trouble, and do it quickly.

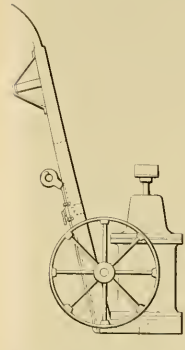

These trucks were designed and built at repair shops of the Lake Shore road, under the direction of Mr. A. M. Wait, B. I. B.

High Train Speeds.

The popular appreciation of high train speed is altogether comparative. For a few years past there has been an ambition among some railroad men to have a clear record of 100 miles an hour. Although there is no authentic record of that speed having been reached, the nearest possible approach to it is used as the subject of boasting, and stretching the figures in the one sure direction is the most innocent and popular subject of lying.

The reckless destruction of truth over train speed has hitherto been confined almost exclusively to this continent and to the British Isles. We are pained to notice that this infection of pride and mendacity is spreading. The Dutch are agitating to have the express trains speeded up away above the velocity of their canal boats, and even sleepy Spain has wakened up, and trains with schedules based on the oxen pace are no longer popular. The agitation in favor of higher train speeds in Spain has not been barren of results, for the papers lately have been full of sensational accounts of a train that for two hours kept up a speed of twenty-five miles an hour. We are afraid that some of the newspaper reporters from Buffalo have gone to Spain—the fellows who made out that a certain train was running at the rate of 112 miles an hour.

"A Wimm'in's Riteser."

"Speakin' o' wimm'in's rights," said the old timer, "reminds me o' Barney Butz and his wife—she's a 'Wimm'in's Riteser'."

"Barney had allus lived 'round boardin' houses, where the wimm'in folks allus do the work and a man kinder loafs around on the age o' circumstances.

"At the boardin' house the wimm'in

allus built the fires, and on the kindlin', too, and Barney concluded in his heart that after he'd been married a month or two, Kate should do like the other wimm'in he knew.

"He was awful good at first, but after awhile he uster stay down to the roundhouse when he o't to have got up the coal and kindlin'."

"Kate made a bargain with him, right on the start, he was to git up and build a fire if he'd been in bed a full night, same as she had. If he come in late, why she'd git up."

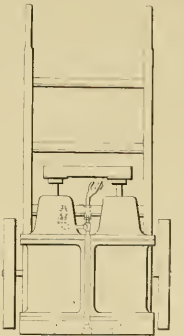

Locomotive Engineering, N. Y.

"But they disagreed on eatin' the kindlin', Kate said 'twain't no woman's work to chop kindlin', and Barney told her every railroad man's wife in town cut her own kindlin'—which wa'n't all true.

"There wa'n't no jawin' o' cryin' in it. Jest a sorter good-natured determination to be boss on that put was evident on both sides.

"Barney went to the roundhouse, leavin' Kate without kindlin', she gin in and cut some for dinner and then informed him that she waddent never do the like aguin'—'cause, she pretty near cut her foot; accident bit straight.

"Barney, he laughed, and 'lowed he'd tamed her at last.



"That night he went out on a hard, long run, and long 'bout 12 '90 got out his lunch pail to get even with the w'orld.

"Meby you think he wa'n't took down when he opened that air pail. There was flour—raw, peraters—raw, beefsteak—raw, egg—jest like it was burned—soda, pepper, salt, coffee, shugger, and everything to make a lunch ov'—but not a bite to eat.

"Barney was hungry mad, and told me all about it up at the end of the round—l was married ten years, and was supposed to know how to handle wimm'in.

"I took the young man round behind

my tank and talked to him for a few minutes, and—well, the next day when I went home I heerd Barney cuttin' kindlin', and he's cut all they used in that house ever since.

"If Barney Butz ever gits off an engine it will be because his wife Kate's gone to Congress or sumpin'." She knows

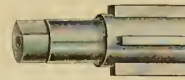

how to arrange a case with a railroad man, I kin tell ye, say, wouldn't she be a kuter on the general grievance committee?"

Car Box Packing Mixer.

On the Lake Shore they use a device of special construction for mixing, sifting and draining waste used to pack car boxes. The illustration will make clear this device. As can be seen, the lower part of the box has two compartments of equal size, these are 24 inches square and 25 inches deep, 17 1/2 inches from the bottom there is a strip on each side of the box running across them both, the partition only reaching to the strips; on these strips slides a single box, 24 inches square and 2 1/2 inches deep, the bottom of which is a copper screen of 1/4-inch mesh. The main box is lined throughout with galvanized iron.

In one end of this box is kept plenty of oil, into which the waste is put to soak. When thoroughly saturated, it is taken out with hooks and placed on the screen, the top box shoved over the oil compartment, and the waste allowed to drip. This waste is used for packing, it is saturated with oil, but not dripping with it, and a great deal of oil now wasted in handling is saved for future use. One end of the box is used

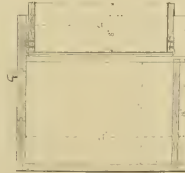
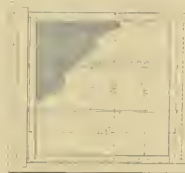

for old waste that is fit for further use when properly packed and oiled.

These boxes are located in shops and at points, where; much packing is done, and it is chimed save lots of trouble—and oil.

On May 5th a freight train on the New England road struck a carriage containing a family, throwing some of them here and there. A young lady and an infant child held in her arms were thrown upon the pilot of the engine. The fireman went out over the running board and held them on until the train was stopped. None of the party were seriously hurt.

Nicholson's Expanding Lathe Mandrel.

Every railroad mechanic fully appreciates the benefit to be derived from any substitute for the old form of solid mandrel. The Nicholson expanding lathe mandrel, as illustrated, possesses many excellent features.

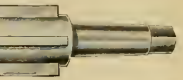

It is claimed to be absolutely accurate and labor-saving, the latter claim being apparent from the fact that it is not necessary, at any time, to make a mandrel suited to the work to be done, or spend any time hunting for one from the "mandrel pile," if the shop is equipped with a standard set, which consists of nine mandrels covering expansion from one to seven inches inclusive.

The mandrel consists of a taper arbor, four taper jaws, and a slotted sleeve to receive the jaws, holding them in their relative position, so that all bind at the same time. The arbor and jaws are made of the best tool steel, hardened and ground, the sleeve is cold drawn steel tubing. The operation to hold work on the mandrel is the same as for solid mandrels, requiring only a blow to set or loosen the jaws. For working it is especially valuable, as the force is fastened to project over the jaws, which prevents injury to the mandrel, and is done in less time than chucking.

This tool has been on the market for some time, and has received the highest endorsements, but it has only recently been offered to the railroad trade, and is already in use on a number of roads. It is sold by Geo. L. Weiss, 137 English avenue, Cleveland, O.

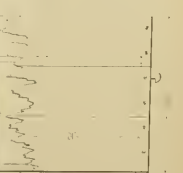

The first successful power brake applied to the west of Chicago was designed by Mr. George W. Cushing, when he was on the Chicago & Northwestern. The brake was applied to the locomotive "Mine," and was used for many years.

Some antiquarians claim that here is proof that the locomotive engine was known in China two hundred years ago.

The Metropolitan Elevated Road in Chicago has decided to use electricity in stead of steam.

Cracking of End Sheets of Fire-Box.

In looking over an accumulation of fire-boxes that had been removed from the locomotive boilers of a prominent railroad lately, we noticed that in nearly every case there lateral stay-bolts had been used the tube-plate fire sheet and had become cracked, and were more or less fractured. When we suggested that this premature destruction of the fire sheets was due to strains, set up by the uneven expansion of the outside and inside sheets when the fire sheet is first lighted, a smile of incredulity responded to the attempt to impart to them any importance. We must not believe anything which we do not see with our eyes, and cannot measure with a 2-foot rule. They class all those who believe in the existence of forces which cannot be stirred with a spoon as dreamers, with amusing views that should not be put to earth quite yet, and ignored, stating in nothing more correct than that the fire sheet when a fire is first started in a locomotive fire sheet and back expands from the bottom of the heat and moves upward. If these sheets are tested by the fire, so that no movement can take place, the fire strains are put upon the fire sheet. This fact has been repeatedly proved by those who have given considerable expensive boilers the most imprudent care, and the practice of putting them in the fire, which will compensate for the strain, is becoming general. It is true that all railroad men in charge of the locomotives, what has been done to the fire sheet, is to secure it.

The cause that the fire is uneven movement, and the fire sheet is not in a uniform position, and the practice of putting them in the fire, which will compensate for the strain, is becoming general. It is true that all railroad men in charge of the locomotives, what has been done to the fire sheet, is to secure it. The cause that the fire is uneven movement, and the fire sheet is not in a uniform position, and the practice of putting them in the fire, which will compensate for the strain, is becoming general. It is true that all railroad men in charge of the locomotives, what has been done to the fire sheet, is to secure it.

A Tool for Forming Collars and Squaring Up Rocker Arms Under Steam Hammer.

The accompanying sketches show a very handy blacksmith shop tool designed and used by foreman blacksmith F. Bidlauer, of the N. Y. Central shops at West Albany, N. Y.

The plan of the tool is shown plainly in Fig. 1. The tool fits into the anvil block under a steam hammer having a long

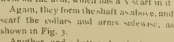
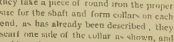
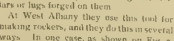
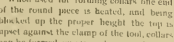
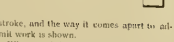
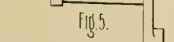
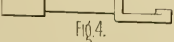
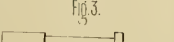
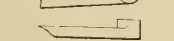
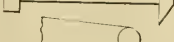
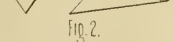
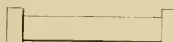
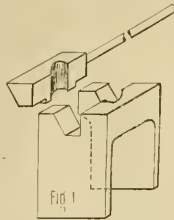

Figs. 4 and 5, where a shaft and both arms are formed without welds. In this case the shaft is forged down from larger material and one arm formed in the shape shown in Fig. 4, the tool being used to bend the arms only. After the first arm is properly bent the second is forged as shown in Fig. 5, and then bent and squared up in the tool described.

A Question of Calipers.

We are frequently asked questions by shopmen and others relating to calipers and small tools. A recent inquiry of this kind is from an apprentice, who says that one man will tell him to buy calipers as light as possible, while another will say that the weight has nothing to do with the tool. The answer which we have given this communication will apply to other inquiries.

Much depends on the size of calipers you wish to make or buy. Calipers for small work should be spring calipers with screw adjustment. For larger sizes the screw may be handy, but we prefer the plain calipers with firm legs, that will not spring. We have one word of advice to you, and that is that you analyze well the work you have to do, and when you have done so you will readily see what tool is best answer your purpose. The tool is but incidental to the work. Understand that, and you will have no difficulty in selecting proper tools. This mental training is the first training an apprentice should have. Your shop training should help you in this, but do not let your shopmates to select tools for you.

Knew He Was Color Blind.

He had marks of ancient paint about his garments. There was an anxious, uncertain look on his face as he inquired of the motive power clerk if Mr. Thompson was in.

"No," replied the clerk, "but there he is, coming along the hall."

The marked man walked along to meet the superintendent of motive power, and cheerfully exclaimed, "Good morning," Mr. Thompson.

"Good morning," was the reply, "but you have the advantage of me."

"Why, Mr. Thompson, don't you remember me? I'm Tom Grimshaw. I worked for you ten years ago."

"What do you want now?"

"I want a job painting."

"I don't believe you are capable of mixing paint properly. You would be sure to spoil lots of material."

"Why, Mr. Thompson," answered the son of the brush, "you know I was a good hand when I worked for you before, and never spoiled any material."

"I can't help that, but all the same I know that you are color-blind. Last time I saw you, you told me that I was an old white-headed son-of-a-gun, and I had not a white hair in my head at that time."

Cure for "Freshness."

We spent a half day in a roundhouse lately and observed a few things. For instance

One fireman was explaining to another how the injector worked—and a very good explanation it was.

The engineer was packing, and, seeing a stranger with a bored shou interested in the explanation, put in his ear; he first reminded the fireman that he was "runners" when they were born, and then commenced to explain the injector for our especial benefit the old vacuum-in-the-feed-pipe explanation.

The whole proceeding was comical in the extreme, and reminded us of the section foreman's rebuke.

Put down that the man, Jerry Casady, and kept away from that push-kay. Go get your shovel, there, do be soldier mud on the job than youse—what the devil do ye know about machinery, anyway?

Device for Centering Line Through Cylinders.

A very important piece of work is to set a line parallel with the bore of a cylinder, and especially in locomotive work. When it is necessary to do so it is always well to be prepared to do it promptly and well.

The old method of doing this was by bolting a piece of wood on the studs in cylinder, or with a wooden brace driven into the cylinder and a large hole drilled therein to admit changing line. The line was usually set with a small piece of wood with a pin in one end, the pin was adjusted to suit the bore of the cylinder. Both of the above methods have been relegated to the past, and there is now in use on the E. T., V. & G. Ry. system, at the Selma shops, a couple of handy and convenient tools that are hard to beat for the purpose of setting lines and holding them in position, without danger of miring.

These tools are the product of the brain of Mr. George Pierce, foreman of the

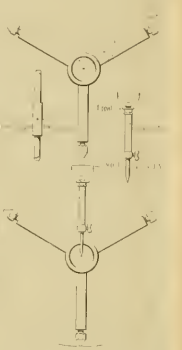

machine shops. The first consists of a tripod of solid brass, as per sketch, the center is dished to hold nut on the end of line, which passes through a small hole that is bored only large enough to allow line to pass through.

The arms at each end are bored and tapped for any length set screw desired. The set screws have four square heads and sharp point, which is hardened, and when set, imbeds itself into the iron and cannot be moved without a wrench.

The advantages of this tool are that you can set the center with hermaphrodite calipers. Tighten it up and you are done. You need not trouble yourself any further about the front end.

The next, in connection with the above, is a tool that goes with it, consists of a handy little tapered extension gauge, and can be made to use in cylinder of any size. It is made of $\frac{1}{2}$ -inch brass pipe, with a forked end, as per sketch. Pipe tapped at this end and fork screwed into it and held in place and adjusted by thumb screw, as per sketch. A boss on the other end for thumb screw to hold a $\frac{1}{8}$ -inch steel rod that can be extended and retracted as desired. It can be used longitudinally or transversely.

They are both handy tools and one used they are generally continued and adopted.

A circular has been issued by the Leach Sanding Apparatus Co. in which intimating that the litigation concerning rights in the patents is ended. Henry L. Leach now controls the whole business.

The Elements of Boiler-Making—IV.

SHEET-IRON WORK.

By C. E. Fourness.*

Laying Out a Smokestack.

(Continued.)

I now have 2 taper connection to make between two smokestacks that stand parallel to each other, and 2 feet 6 inches, or 30 inches, apart center to center; one, the upper stack, is 24 inches, the lower 18 inches in diameter. The upper one being made larger on account of making connections with another boiler higher up, and thereby requiring a larger cross sectional area to accommodate it; the whole to be made of No. 30 iron or steel, most likely steel, as it is cheaper than iron and works better. (A section or sectional view means to show some part of the inside that cannot be seen without removing some of



the outside part, as, for instance, if a working drawing of a boiler is made, the interior details like crown-bars, braces, etc., are shown by cutting the boiler crosswise and lengthwise into as many parts as there are important points to show; for if the boiler-maker is merely shown where he is to locate the seams and the kind of seams wanted, that is all he needs of the outside view or elevation—except for the boiler fixtures—and the matter regarding the seams can be shown in a sectional view or given in a note on the drawing. But remember a sectional view can be shown at any point where there is something important to show, and a longitudinal section means lengthwise, a cross section across the boiler; other points are designated as section at *A B* or *C D*, etc., Fig. 45 is a side elevation. This shows the location of the seams and the appearances of the connection when finished; the straight seams I have on opposite sides in adjoining courses, as a boiler-maker always tries to avoid having two laps come to-

draw *B C*, this is 56 inches long, next draw the lines *E F* and *K L*, 24 inches apart and 12 inches each side of the center line *C D*; next *G H* and *J I*, 18 inches apart and 9 inches each side of the center line *A B*; next measure and mark the points 9 inches each side of *B*, on a line at right angles to *B C*. I perform the same operation at *C*, only that I measure 12 inches instead of 9. I now draw the lines *F G* and *J K* through these marks; next draw the lines *K' C' F'* and *J' B' G'* through where the lines cross each other at these points; then draw the lines *H' A' I'* and *L' D' E'* 35 inches from *A'* and *G'*, and the line *M' N'* midway between and at right angles to *B' C'*. This will be the center line of rivet holes if the connection (Figs. 47 and 48) is made of two courses, or the center line to measure from if made of one. Next draw a semicircle 18 inches in diameter, having *A' H'* for the diameter and *I'* for the center of the circle. Next divide this semicircle into 13 points and number them 1, 2, 3, 4, etc., to 13, beginning with No. 1 at *H'*, and then draw the ordinates through these points and just cutting the lines *H' A' I'* and *J' B' G'*. Next draw a semicircle 24 inches in diameter, having *L' D' E'* for the diameter and *D'* as the center, divide this semicircle into 13 points and mark them 1, 2, 3, 4, etc., to 13, beginning with No. 1 at *E'*, now draw the ordinates through these points and terminate them at the lines *L' D' E'* and *K' C' F'*. Next draw the ordinates 1, 2, 3, 4, etc., in Figs. 47 and 48 between the lines *K' C' F'* and *J' B' G'*, starting from where the ordinates in Figs. 46 and 49 cut the lines *K' C' F'* and *J' B' G'*. This completes the outline.

Next in order comes the sheets, and I start with Fig. 50 by first drawing two lines, *A' H'* and *C' D'*, along each side of the sheet, 35 inches apart, and an equal distance from each side of the sheet; next lay off the circumference of the large end, 78 1/2 inches, starting at *C'*, one-half inch from the end of the sheet and terminating at *D'*. Next erect a center line midway between and at right angles to *C' D'*, then on the line *A' B'* lay off the circumference of the small end 75 inches, an equal distance, or 37 1/2 inches each side of the center line. Next divide or space the lines into 24 points for rivet holes, and connect the opposite points with lines and number them 1, 2, 3, 4, etc., beginning with No. 1 at the laps and ending at the center with No. 13. This will bring the straight seam on the right side, as marked in Fig. 45. Next find the camber on the small end, as that end attaches to an ordinary taper course. After this is found set the trams or mark on a stick or strip of iron—that is

outside of these marks for shearing. This allows the lap and completes the course. Next in order comes Fig. 51. This is Fig. 47, in the outline view, and you will notice this sheet is 25 inches wide between the hole at *C* and the hole at the intersection of the line *M' N'* with the line number 7, consequently I draw two lines, *A' B'*

line *G' H'*. At the intersection of that line with lines numbered 1, 2, 3, 4, etc., mark across the latter lines for the path of the line *E' F'*, and draw a curved line (*E' F'*) along this path or through these points of intersection. Now space off the line *G' H'*, beginning at the center with the dividers set the same as when the line *A' B'* was

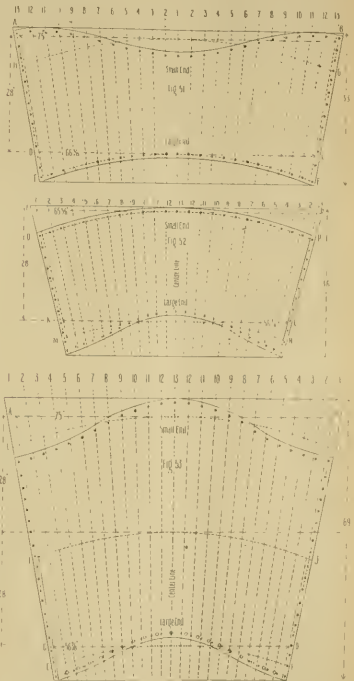

and *C' D'*, 25 inches apart parallel, and *A' B'* one inch from the side of the sheet. Next, by referring to Fig. 45, I find that this course is 24 inches in diameter outside at the top end; so I lay off this circumference, which I have found previously is 75 inches on the line *A' B'*. The middle seam of the connection is 21 inches in diameter, and the circumference, 21 x 3 1/2, equals 66 1/2 inches plus three times the thickness of the sheet, or 3/8 of an inch, equals 66 3/8 inches, the circumference required. As this course must be 21 inches inside diameter, this length I lay off on the line *D' C'*, an equal distance each side of a center line drawn at right angles and midway between the lap holes *A' B'* and *D' C'*. Next divide the lines into twenty-four points, using two pair of dividers, and being careful not to change them after spacing. Next draw lines through these points and number them from 1 to 13, beginning with No. 1 at the center, and ending with 13 at the straight seams. Next lay the square along the lines 1, 2, 3, 4, etc., to get the camber *L' D'*. Next find the line *E' F'* by using the trams set to 25 inches and measuring from the

space, and the line *E' F'*, with the dividers set same as used to space *C' D'*. I find these points overrun the lines drawn through the points of division on the straight line *A' B'* and *C' D'*. Next I center mark these latter points for holes on

*Foreman Boiler-maker, C. M. & St. P. R. Ry. Dubuque, Iowa

Measuring from the center of the holes

on the line *EF*, next *spice off* the straight seams for ten holes, and after drawing a line half-inch outside of the center of the rivet holes for the lap the course is ready to shear and punch. Next in order comes Fig. 52. Trace the line *I, J* half-inch from the side of the sheet of which the seam is to be made, then draw another line *A, I*, 25 inches from and parallel to *A, J*, as that is the distance apart of the holes on the line *M, A* and the hole at *B* from the center line, *B, C*, the diameter at the line *M, A* is 21 inches, but this end requires to be 23 inches outside, and the circumference I found was 66 inches for a hole 21 inches in diameter, so after subtracting three times the thickness, or $3 \times \frac{1}{8}$ inch, I have 64 inches, the circumference required, which I lay off on the line *I, J*, keeping these points on a line half-inch from the end of the sheet and draw a center line midway between the right angles to *I, J*, then find the diameter of the end, *E*, the diameter being 15 inches, $15 \times \frac{1}{8}$, or $1\frac{5}{8}$, or 1.625 inches in diameter inside and $1\frac{5}{8} \times 3$, or 4.875 inches equals $4\frac{7}{8}$ inches, the circumference required. This length lay off on the line *I, J* making each side of the center of the line *A, I* next *spice off* for the rivet holes and lay away the dividers, then draw lines through the points at *B* and number them from 1 to 13, beginning with No. 1 at the rivet hole and ending with No. 13 at the center. Next find the number with the *B* and *C* diameters and the taper of the rivet, then the lines *O, P* and *M, A*, and transfer to *P*, space this off with the dividers the same as when the *M, A* was done. These points are the center of the rivet holes next space off the line *M, A* the same as the *B, C* diameters. This space was spaced, in fact draw lines through the points just found on the lines *M, A* and *A, P*. Now transfer the lengths of *M, A* to *A, P* and on the lines *M, A* and *A, P*, the correspondingly numbered lines in Fig. 52, and after spacing off the straight seams for ten holes and drawing a line half-inch all around outside of the rivet holes the sheet is ready to shear and punch.

Fig. 53 and 54 is the connection made of the two courses. Fig. 53 is where it is made of one, but it requires an extra width-sheet, as it is 10 inches wide. I will now proceed to lay out this sheet by tracing the line *I, J* $\frac{1}{2}$ inch from one side of the sheet. Next draw the line *A, B* 46 inches from, and parallel to, *A, C*, as that is the distance apart of the holes *B* and *C*, Figs. 47 and 48. Next lay off the circumference of the top end, 75 inches, on the line *I, B*, and draw a center line midway between and at right angles to *I, B*. Next lay off the circumference of the bottom end, 66 inches, on the line *I, C*, and draw an equal distance each side of the center line just drawn. Next space off the circumference between the lap holes *A, B* and *C, D* for twenty-four holes, and when these are found draw lines through these points and number them 1, 2, 3, 4, etc., beginning with number 1 at the lap, after which find the center *G, H* and *E, F*, also *I, J*. This is located midway between *B* and *C*. Next space off the line *G, H* with the dividers. Set same as used to space *I, B*, and now space off *E, F* same length as *I, B*. Next draw lines through the new points just found, and on these last lines transfer the lengths of the ordinates between the lines *M, A* and *K, C, E*, Fig. 47, to the corresponding numbered lines at the side end of the sheet, Fig. 53, measuring for that end from the line *I, J*. These points are the center of the rivet holes at that end. Next space off the straight seams for eighteen holes, after allowing $\frac{1}{8}$ inch for lap all around the sheet is complete.

Next Fig. 54. First draw the lines *A, B* and *C, D* 35 inches apart and parallel to each other, and *C, D* half-inch from the side of the sheet. Next lay off the circumference of the large end $66\frac{1}{2}$ inches on the end of the sheet, and draw a center line midway between and at right angles to *C, D*, then lay off the circumference of the small end $60\frac{1}{2}$ inches on the line *I, B*, locating one-half this amount, $29\frac{1}{4}$ inches, each side of the center line. Next space the sheet at each end between *A, B* and *C, D* for twenty-four holes. Draw lines across the sheet connecting these points, the centers of the rivet holes, and number them from 1 to 13, beginning with No. 1 at the center and ending with No. 13 at the straight seams, as they will be located on the left side. See Fig. 45. Next find the center for the holes at the large end, as that end will rivet to an ordinary taper course, and then transfer the lengths of the ordinates between the lines *I, A, H* and *J, B, G*, Fig. 46, to the correspondingly numbered lines in Fig. 54, these points just found are the center of the rivet holes. Next space off the straight seams for eight holes, and after allowing half-inch for lap all around the sheet is complete.

But, as I wrote this word, it flashed through my mind "What a word, how often it is used and how much it expresses." How very often, when a job is finished and the person who did the work is asked if it is all right, he will say "Yes, but some little detail is not just right to suit." The *but* in this case is a saving of labor, rivets, and the job will look better. Note Fig. 54 has the same number of rivet holes in the circular seams as Fig. 50, although the latter is 6 inches larger in diameter. I draw a line through the center of the rivet holes on both ends of Fig. 54 and the narrow end of Fig. 53 where it will not touch Fig. 52, as it would require the same treatment as Fig. 51, I set the dividers at about 3 inches and space the ends off for twenty holes, by spacing for this number of holes it locates one at each quarter on the lines 1, 1, 7, 7, and 13. I show these latter holes by a circle, also on the taper connecting sheets I have them marked small end and large end, which seems to be out of place, as the end marked large is the smallest and the end marked small is the largest. I call them large or small same as on an ordinary taper course, the end that fits inside is called the small end the other the large end, or the male end is the small and the female the large end.

A Cutter that Cuts.

The diagram published herewith shows the form and construction of a boring cutter, used principally for boring out the wheels, that does wonderful work. As will be seen, there are eight cutters, adjustable to enable it to draw a hole from 4 to 5 inches with one set of knives.

This cutter lures on a wheel in a first-class manner with a half reel feed—which is so fine feed. This tool was designed and used by Mr. Wm. A. Foster, superintendent of the Fall Brook Road, who has since patented it, and it is now being made by the Putnam Machine Co., of Fitchburg, Mass.

Houghtaling's Reducing Motion for the Tabor Indicator.

A troublesome thing connected with the application of the steam engine indicator has always been the appliances employed to reduce the motion of the cross-head to suit the movement of the drum. A great variety of appliances have been employed for this purpose, all at them more or less

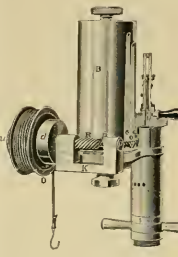

objectionable, and all entailing the use of awkward mechanism. The invention illustrated in the annexed engraving, as an attachment to the Tabor indicator seems destined to put an end to the difficulties experienced with reducing motions. The motion is taken direct from the cross-head of the engine to a small pulley mounted on a shaft, on which is cut a worm which engages in a toothed spur at the base of the drum. This produces the required revolving motion. The size pulley is selected to suit the stroke of the engine, and the circumference ought to be from $\frac{1}{4}$ to $\frac{1}{2}$ the length of the engine stroke, so that it will revolve four or five times during each stroke. The general arrangement of the invention is so simple that no detailed description is necessary. The details have been worked out with remarkable care and skill. The invention has been put upon the market as an attachment to the Tabor indicator by the Ashcroft Mfg. Co., Liberty street, New York

passages are in communication with the dry pipe or the high-pressure steam-chest, and are open all the time. When the engine is working in full gear the valve moves over the openings sufficiently far to admit steam for starting. When the reverse lever is hooked up, it reduces the travel of the valve and thereby keeps the admission holes covered. A rib crossing the inside cavity of the valve prevents the starting passage from admitting steam through the exhaust. The thing is exceedingly simple, and demands no extra attention from the engineer.

The first compound locomotive constructed after the Goldsford patents was built about two years ago for the Royal Austrian State Railways, and completely fulfilled the expectations entertained, the engine having been noted for promptness and certainly in starting. Those in charge were so well satisfied with the working of the engine that eight more were immediately ordered, and now there are nineteen of them running on the road named. The Nathan people are preparing to push the invention upon the attention of American railroad companies. The simplicity of the engine will certainly appeal to those who favor compound locomotives.

Hale & Kilburn, of Philadelphia, have made a radical improvement in

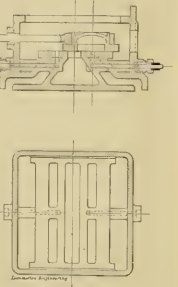

Compound Locomotives Without Starting Mechanism.

The Nathan Mfg. Co., of New York, have obtained control of the patents of the Goldsford compound locomotive. This is an Austrian invention, and has the peculiarity that no starting mechanism is

the mechanism for turning their car seats. The usual well-known plan is to employ jointed levers that reverse the seat and hold the back in position. These levers are objectionable for several reasons. In their new seat Hale & Kilburn place a toothed rack under the bottom part of the end

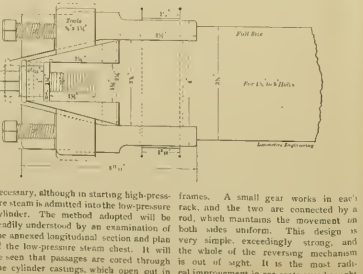

frames. A small gear works in each rack, and the two are connected by a rod, which maintains the movement on both sides uniform. This design is very simple, exceedingly strong, and the whole of the reversing mechanism is out of sight. It is the most radical improvement in car seats ever brought out.

Practical Letters
from Practical Men.

Facts Wanted.
There's a glut
of Opinions.

Write on one side of the paper, state your point plainly and briefly, and then quit. We supply the generalities. No letters noticed unless name and address are annexed.

A Tool for Tapering Driving-Box Flanges.

The flanges of all driving-boxes should be, and, as a rule, are, planed taper on the inside, both top and bottom, in order to allow the box to roll laterally in the pedestal jaws of the locomotive frame when one driving-wheel strikes an elevation or depression in the track.

To plane these flanges taper in the old way has been an expensive operation, as it was necessary to chuck the driving-boxes four extra times, and take eight extra cuts down the sides of flanges.

The writer and Mr. F. H. Dersch, our machine shop foreman, designed the new and simple planer attachment shown here, whereby we finish the inside of driving-box flanges with one rough and one finishing cut, thereby saving four extra chucks and eight extra cuts down the flanges of each driving-box.

This cheap and simple arrangement can be put on any planer for doing this or a similar kind of work. This attachment is composed of a cam bar *A*, Figs. 3 and 4, clamped to the planer bed. An upright box frame *B* clamped to cross bar of planer, in

the attachment is one side, can be loosened up and shoved to one side, or be removed entirely in a very few minutes. The at-

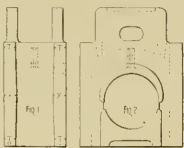

tachment can be used on either side of planer as desired. Possibly some one may be benefited by the above, as I have benefited by the experience of others.

J. C. MILLER,
Dubuque, Ia. General Foreman.

Flat Wheels and the Air-Gauge.

Editors

Reading over a statement of slid flat wheels of a system operating over 3,500 miles, for a period of nine months, in

done and done regularly is when a man commences to brake by a system. In all my observations I have found but few who did their braking in this manner, and their work was noticeable by the regularity and ease with which their trains were stopped. I have been unable in a day's ride to find a man that could make two stops in succession with the same reduction when braking by ear or guess, or whatever you may please to call it. Neither have I been able to find the man who would acknowledge to flattening a pair of wheels when found under his train. It was the other fellow. He don't brake hard enough.

Under ordinary circumstances, a given reduction will produce a like braking force every time, if the auxiliaries are given time to recharge. Any runner should be able to tell in two or three stops just how much of a reduction is necessary to handle his train. Now, let him make his reduction, be it 7, 9, or 10 pounds, as the working of his train demonstrated to be necessary, and he will have time to look at the block, or any other matter that requires his attention. He don't have to devote it all to his brake. It is doing its work all the while, and he don't have to worry after he has started whether he sees the block changed or not. I speak from experience. I've been there. I am aware that this means to many that they would have to educate themselves over again to brake. It means that they will have to educate themselves as to speed, distance and location of road, up to that point that at the required time they can apply their brake

in near line of vision when looking ahead. On the contrary, it is placed where, to get a view of it, one must turn his head at right angles with his point of view, and on our modern engines, if they keep running them up it will require a telescope to get a glimpse at it. This, coupled with a poor cab lamp, renders it well useless after dark. Place the gauge near the front window as possible, so the eye is continually on it, so it cannot escape attention, brake it straight, and the flat-wheel problem will solve itself.

R. S. GOSW.
Pittsburgh, Pa.

Past and Present.

Editors

Nearly all the recent innovations on standard locomotive practice are but revivals of venerable equipment. The oval boiler of the "James Toleman," for instance, was anticipated by the English designer Gray, of the London & Brighton Railway, as far back as 1845. Gray's barrel was a simple oval, and, therefore, differs slightly from Wimby's, but it was essentially of the smallest diameter, and was practically a similar solution of the problem to get a large barrel between the wheels. Corrugated firebrass are not new by half a century either, for they were made in England, to the order of the late Sir Daniel Gooch, in 1814. Gooch, however, adopted corrugated plates, not for their greater strength, but because at equal sizes boxes made of thin gage greater heating surface than those made with plain sheets. Even the latest idea of Harveiny steel tires recalls Gooch's analogous but not identical process of case-hardening wrought-iron tires. The piston-valve is again with us and seems likely to stay, though when such valves were first introduced, in 1853, they found little favor, compositioning is a time-honored institution founded in the early '40's", but the peculiarity about the old compounds was that their cylinders were the same or nearly the same size. The only novelty about pressures of 200 pounds, and thereabouts, to the square inch that boilers are now built to stand them, whereas the old boilers burst under them sooner or later—generally sooner. Probably every known variety of valve gear has at one time or another been inflicted on the locomotive, and so we find the complicated mechanism grouped round the cylinders of the Belgian engines shown at Chicago last year is but a form of Corliss gear, and that an engine was fitted with the genuine article in this country by Corliss himself in 1851. Perpetual motion has not yet been successfully applied to the locomotive, and there would seem to be a chance of absolute novelty for the inventor in that direction.

Andrus, Tex. H. H. SHAW.

Points on Good Firing.

Editors

As a fireman with over eight years' experience, I will give the method I use in firing soft coal, and if other firemen will give it a fair trial they will agree with me that this method will give the best result.

A great many firemen, when putting in coal, distribute it evenly all over the fire-box, being sure to cover up all the white spots.

This practice, I claim, is not right, as too much of the gas goes out of the place in the middle of the fire-box. The way I put in coal after the engine is working, is to distribute it evenly in a strip about a foot wide, along the side sheets on each side and in the corners, being careful that there are no holes along side sheets and in the corners. This leaves a strip across the fire-box from one fire-door to the fire-sheet, that I do not put any coal on. You will ask how will coal come in the center, if the fireman does not put it there?

I claim that the engine will do for you. How? When coal is put into the fire-box

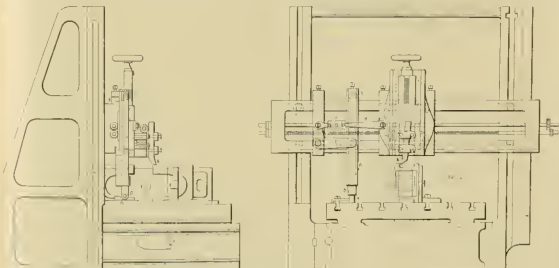

TOOL FOR TAPERING DRIVING-BOX FLANGES.

which holds the bar *C*, with roller *D* in its bottom end, resting on cam bar *A*. From sliding-bar *C* a right angled rocker, or bell crank, *E*, receives a motion equal to the rise and fall of cam bar *A*. Rocker *E* is pivoted on another frame *F*, also clamped to cross bar of planer. The upper arm of rocker *E* is connected to crosshead or tool head *G* with a connecting bar *H*, on which is a right and left nut *P* for adjusting the planer tool *K*, all connected in such a manner that when the planer tool *K* stands at the proper place on the driving-box flange, the cam *A* produces such a motion to the planer tool *K* that it will plane the driving-box flanges, taper at each end of driving-box, or, in other words, the driving-box flanges will be $\frac{1}{8}$ inch (more or less) thicker at the middle *X*, *Y*, *Z*, than at the ends *T*, *T*. This permits the driving-box to roll laterally in pedestal jaws of frame, as above mentioned. Any variation in thickness of flanges, can be produced, providing the cam bar is properly proportioned.

Cam *T*, Fig. 4, is used to provide for less motion than may occur; also to keep roller *D* down on cam bar *A*.

This attachment has been in use at the Denver shops of the C. & M. St. P. Railway for several months, and is proving a success for the purpose set forth. When

which time 5,470 wheels were removed, at an expense of \$22,500, over 50 per cent of which were taken from passenger cars, it struck me that there was a text for a sermon on our economy worthy the pen of some of our economists.

It is a significant fact that all roads have been straining every economy during the past year, and that for a purpose. Every employe could, and should, contribute his mite toward assisting them through this, the winter of their distress. A thoughtful use of the oil-can will show quite a saving at the end of the trip, as will also the coal shovel. It may appear insignificant to many, but if practiced by all entrusted with the care and use of material and stores, it would aggregate a sum that would materially assist in reducing expenses.

No doubt but many other roads have their share of the flat wheel affliction, and where is there a broader field for the engineman to display his skill and prove his interest in his employers' welfare? In seeking for a remedy for the evil I am compelled to fall back on an old hobby for relief, and that is simply—brake by the gauge. I know that I am touching the institution of the Westinghouse people, don't claim originality. But when that is

with the determined reduction, and bring their train to a stop at the required point. This, I venture to say, any man can do in two weeks' careful practice, just as can be taught himself to tell by the way his train checks whether it is necessary to make a further reduction or not. When a man is able to do this, and does it regularly, then he is in a position to assert he did not flatten the wheels under his train, but until he is, he is in the dark, for he don't know what he is doing.

Then, again, the method will prove a great factor of safety, inasmuch as the gauge will get that attention that it will demonstrate when the pump has stopped, which would not be noticed until a stop was attempted, only to find there was no air enough to do it. Could all the facts be gotten at in some of these disastrous brake gotten at, it would show that the pump had stopped, and the man in charge had not discovered it. A good reliable pump will naturally lead to carelessness as to the gauge, and that will lead to trouble—only a question of time. But what has led us into this habit, and will keep us there until the gauge is changed? The position of the air gauge is, above all, most directly responsible. I have yet to find an air gauge placed so that it would

the heat soon drives the gas and other matter out converting it into coke, and coke being very light the draft will carry it to center of firebox. The corners and along the sides being a little higher after coal has been put in also aids the draft.

It can readily be seen what a valuable aid to combustion this strip of incandescent fire is. The fuel furnished to this strip being coke, it takes very little air to burn it, and the draft drawing the gas from the sides to center of box gives more chance for air and keeps the heat constant and uniform. It will surprise you how soon you will have an incandescent fire all over the box after putting in coal, and how level your fire will be when it is time to put in more coal, and how much lighter fire it is possible to carry with this method.

Another good feature of this method is it is impossible for large clinkers to form in the center of firebox, and every fireman knows to his sorrow what detriment they are when formed there.

Another feature of importance is, before a fireman opens the door to put in coal he knows just where it is to go, this will greatly aid him in keeping the door open as short a time as possible, as he can put the coal along the sides more easily than all over the box. A little effort on the part of the fireman to put a fire in quickly will greatly repay him, as it is much better to keep the steam at a uniform pressure than to let it drop back, to be regained at the expense of the coal pile.

With this method of firing the fireman cannot fire by the stack, as the black smoke soon disappears, but will have to watch the steam-gauge to tell when to put on a fire.

If the many fireman who will read this article and will give it a fair trial, I will refer you to Foreney, who says that intelligent firing will reduce the amount of coal used as much as any of the improved draft appliances now in use.

I claim that if engineers and firemen will give this method close attention it will reflect a saving of 10 per cent. over the other way.

H. E. CRAIK.

Hebron, Kan.

Metallic Packing Molds.

Editor:

The use of metallic packing is becoming so extensive that it is comparatively an expensive item to keep up the renewals. While it is true this style of packing has proved to be far superior and a great deal less expensive than the old styles of hemp, cotton, etc. the present method of turning the rings on the lathe is both a slow and expensive one, and except where gauges are used, there is a possibility of failing to have duplicate sets of packing. The method described below, of making the packing-rings has been found both economical and accurate. Any size of packing can be duplicated at will. If one ring in a set should break it can be replaced in a few minutes from stock with the assurance that it will fit.

By a reference to the drawing of the packing-ring mold, it will be seen it is designed for the "United States Metallic Packing." It can, however, be designed to produce any of the different patterns in use. The plate or mold consists properly of three principal parts, the base, or mold proper *B*, the top *J*, and mandrel *A*. The space *V* Fig. 1, and *W* Fig. 2 is the mold for the rings. The mandrel *A* is to form the inside diameter of the ring, and is so fitted to the base plate *B* that they can be easily removed. The diameters of these mandrels should be adjusted to conform to the size of the piston or valve rods to which they are intended. It will be found gives the best satisfaction to measure the diameter by $\frac{1}{16}$ inch. The small studs *R* and *S* shown at *O*, Figs. 2 and 4 is for the purpose of cutting the ring, thereby avoiding the necessity of sawing the rings, and also making it possible to get them off the mandrels with no difficulty.

These mandrels should be well fitted to

the base plate, both in the hole which acts as a holder and guide for them, and also on the bottom of the recess cut into the base plate the depth the packing desired. The counter-bore holes *Z* in the top plate *A* are intended for the double purpose of pouring holes, and after the metal is sufficiently cooled to cut off the gates. The screws *H* hold the top plate against the base plate, producing a ring of uniform thickness. The holes *P* are so arranged as to allow a sliding movement of the top plate. This movement is required to cut off the gates after the rings are poured, and is caused by inserting a small lever in the hole *K* in the base plate and pressing it against the top plate, causing it to cut off the gates and allow the top plate to be lifted off and the rings taken out by knocking the mandrels out with a wooden mallet.

By a reference to Fig. 2 a small section

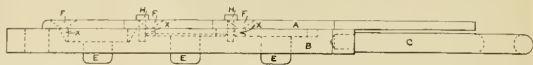

FIG. 1



FIG. 2

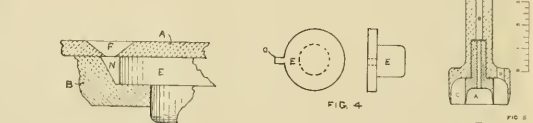

FIG. 3

of the mold will be found on a larger scale. Before using the mold, it should be thoroughly warmed so as not to chill the metal when pouring, as, if it is not thoroughly warmed the first few rings will be imperfect. If desired, three or four pins can be screwed on the bottom of the base plate to serve as legs to rest it upon.

After the rings are poured it will be found that the flat surface is not perfect. To remedy this, so as to form a perfect joint between the rings in a set, take a sheet of emery cloth and run it over the rings in inches in diameter, with a hole in the center large enough to go over the mandrel of a small emery wheel, and secure the emery cloth against the emery wheel, by a small emery wheel can be utilized, fit a center on a small lathe, and fasten a piece of metal on it to act as support for the emery cloth. By placing the rings against this wheel a perfectly true surface is produced in a very short time. The emery cloth can be easily renewed as required.

As Fig. 4 shows a washer-cutter. On many trials gear washers are used for packing the throttle stem, and it is a very unsatisfactory job to cut them with the double adjustable cutter usually furnished. By the use of the cutter shown, these washers can be cut and kept in stock. Repairing the hole in the washer.

This part to be so it can be removed and replaced by a smaller cutter, sometimes necessary when it is desired to trace up and use the old stem. This inner cutter is secured by a pin through the body

or it can be screwed in. The holes *H* are for the double purpose of allowing the escape of air and also to allow a wire to be used to push the washer and center disc out should they stick to the cutter. The cutter should be kept thoroughly oiled, and used on a block of wood. If desired, the center piece *J* can be made solid with the rest of the tool. One or two sizes of these cutters will be found to repay their cost many times.

Reading, Pa.

F. M. ARTHUR.

A Suggestion to Card Air-Brake Details.

Editors:

In the discussion going on in regard to the merits and demerits of the 1892 valve or the reducing valve feature of it, I think Mr. Scott has the best of it. If all engineers would handle it as Mr. Alexander

Such a plan would save time and trouble when crews change, and would help inspectors. In the article by Paul Synnstedt, April number, under the head, "Locating Leaks," it is all right with the old 1880 valve, but not so with the 1890 or 1892 valves, they have gauge connected to equalizing discharge reservoir. In the catechism on air brakes in back of printed proceedings of the Joint Mechanics Convention, I see they have left out that lap-valve test for train-leaks.

Orange Point,

Right and Wrong Ways of Fitting.

Editors:

"The eyes and the day of small things." With the view that this may fall upon the eyes of some, who, like a certain sheep for a number of years had been in the habit of tramping up the ends of tumbler

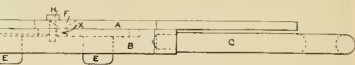

FIG. 4



FIG. 5

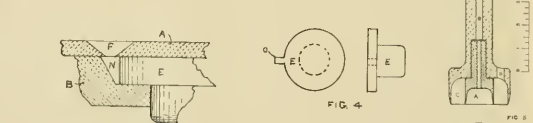

FIG. 6

does it might do, but a good master will carry it in release to enable them to make "fly" stops—and it will make lots of flat wheels. Some may say there is a defect here to keep engineers from carrying valve in release. So there is in the old 1880 valve, but most engineers carry them in release. There is a good deal of nonsense in the usual excuse given for carrying the 1892 valve in release position. There is need of a "campaign of education," and it should reach far enough to take in the conductor and his crew. If they knew more about air-brakes they would not coo to you a lot of empty air cars, and as soon as angled cut tender is opened ask you to try the brakes, they should also be compelled to hang up hose. Go where you may, all over the country, and you will find more hose hanging down than you will find up in dummy.

It seems to me that there should be some system adopted that would hold good for all roads for the inspection and repair of air-brakes. We have cars here from nearly all roads in the Union, and nearly one-half of them have something the matter with the brakes. Mr. Holmes suggested a good plan several months ago, but his cars run all the way to California and Mexico. I would suggest a plan for something like this. Have the conductor or one of his crew carry air defect cards something like common shipping tags, and when they find any defect in brakes state what it is and tie tag to crossover pipe near cut-out cock. The reason why I think that the best plan is because that way they look first if car is cut out,

shatts, with a file—not that the men were unable to execute a good job—but from methods which had become unalterably fixed, through the serious error of "not taking the papers," and a decided objection to new men (of the family), temerarious clinging to the inheritance that had been handed down to justify. He, who through a recognition of progress of Divite gift, dared advocate a deviation from the established ways, was not long in receiving the fellowship of disfavor and the decision of being "off his base." But, like Rome in all its pomp and splendor, while music by the above note was being ground out, it fell—not the shop, but the band-master and drum-major—and unlike the sepulcher of Moses, the places where they hit are known even unto this day.

"When red brass castings, after being 'stewed together,' are to be finished, it is by no means an uncommon occurrence to use the operator clamp or chuck not spending much time to avoid a burr, and in shimming up to make it 'solid.' He starts up and strikes off one side, turns over and gets his fit in length of pm. By way of comment we've sent from A to B, in about, but where this line is delegated to certain men it is usually uniform and correct. Now for the strap and nut. After planning one edge he is careful to fit his square as he goes round, well satisfied that "all things worketh together for good," which perhaps they do, (if those brasses have to be "took up," when, if the

in being done. The cutting teeth in reamers to cutting teeth in bevel gears. There are no sizes given, as different tools would require different sizes, and when you know what is wanted it does not take long to get sizes.

W. A. ROBERTSON

Editor Rapids, Ia.

Running an Engine Underground.

Some time ago I was employed by a large railroad and mining corporation on what was called the chain gang. There was a number of students on M. M. and his assistant, who had charge of all the machinery including several locomotives. One day our M. M. ordered me to go up to the engine and watch over No. 2, giving me a slip with instructions. She was a saddle tank and I was to take off everything that was 24 inches above the top of the tank, and when completed she was to be lowered into the boxes of the shaft to take the place of a number of "hay burners" in heating coal. I had for my assistant a young fellow who could play ball some, and who was usually first and ran best extra. We placed new wheels and driving boxes under her, also overbanded the running gear. We took off the cab, saved off the stack and sandbox to clear the top of the tunnel. We were working at the end of the shaft, when our M. M. appeared on the day and said: "Hurry now, and get her in one kind of shape, the Superintendent says we must take her down this evening before he is ready for duty by ten o'clock tomorrow morning," and I was to stay until the student as well as myself were better. For a couple of days until he graduated, for a couple of weeks he was more than I could get out of. I was given that tunnel as a matter of fact, but had much to do. I also know the circulating superintendent the mines would not be completed in several days, yet also a few things were not yet in order would make the engineer's instructions to the student very unpleasant. We lowered the 72 ton engine and had her ready, except for the boiler, by ten o'clock next morning. This was an experience that I hope I may never have to go through again. Our M. M. and assistant was on hand to see that everything went according to schedule. Everything being ready, we backed out on an empty tank and started for our mine terminal. I sat in the engine, the other boys and student on a metal powder-box. We arrived without anything special occurring, coupled to our loaded tank, and as we got to the tunnel we reached a siding and ran in the tunnel, where we ran around and got to be held the train to push into the tunnel. Instead of reaching the mine terminal there was a very big grade and at the foot of this grade, for about two or three lengths, there was about four inches of muddy and greasy mine water covering the floor, and here also was a door completely closing the tunnel, its part of the ventilation system. A small boy was placed at this door to open it. I sat in the engine and close it immediately after we got through. In approaching this door the first time I pulled the whistle as a signal for the boy to let us through, and great Scott's fire that sounded went through our ears. The boy opened the door and I then discovered that it did not lead to the tunnel down in the corner I would never reach the top of that grade, so I dropped her down and shut my eyes, and when we reached that water at the foot of the grade the old "2" made about five hundred revolutions per second, as she had no spark-arrister or grate in her. She was a big chunk of coal as large as hens' eggs up against the roof of the tunnel and spreading them all over us, setting us on fire in about twenty different places. Several jumps off with his metal seat and fills it with ice as cold, muddy ditch water and gives me a dose to spend a couple of days on my back, and kept dancing around until I could respicate. "Put plenty

thing was stripped off from her. Sol Tuttle, now an engineer on the C. M. & St. P., the fireman of the forward engine, was back in the tank throwing forward wood. This was all that saved his life. I believe he was somewhat hurt. Colton, of back engine, was blown from the foot-board some three or four rods, his pants ripped up from washboard down. We saw some four others of those engines blown up, and a number of others besides, but I never saw such a perfect wreck as this was. Bryant died within four or five days after from inhaling steam; had it not been for this, the doctors said they could have saved his life.

I had been to work all night, had washed up and got to the roundhouse doors, when I heard the report of an explosion. She must have been some four or five miles from the roundhouse at the time. Of the

other engines that make which exploded, one was just ahead of the wagon top, the other part in the center of boxes and the other near front end or just back of smokestack. The last of those engines built at the Cuyahoga shops were all better stayed than the first ones were, and better iron put in the boilers. It was all iron from beginning to end, boilers, fire sheets and fireboxes were all iron.



DEVELOPMENT OF THE GREAT LOSS FOR THE PURCHASE OF THE WINTER FAIR, CALIFORNIA.

live another minute longer, just stuck your finger down your throat, throw up, and you will be as fresh as a daisy."

We did the best we could the balance of that day. I went home that evening and went to bed. I did not get up next morning, nor the next, but student did, however, and about eleven o'clock that day No. 2 was put in her stall and student was carried home.

J. B. WOOD

Shawmut, Pa.

Explosions of Cuyahoga Engines.

Editors:

There was an explosion of one of the Cuyahoga engines while I was working on the C. M. & St. P. Railroad for Wm. P. Smith, that I have never seen the parts of rails of iron that I have never seen in all my railroad life anything like it, although I have seen a great many exploded boilers. After crossing the Cuyahoga River going toward Columbus, was a forty-four foot grade. On this morning the train was so heavy that they coupled the wood engine ahead of the train engine. The engine attached to the freight was run by a man from the New York Central road, by the name of James Bryant, his fireman's name was Edward Colton, now on the St. Paul road. It was the back engine that blew up, or her cross-boiler blew out through the fire-box. She went up in the air, they said, about forty feet, turned a complete somersault and landed on the engine's tank ahead of her, with her firebox close to the tank, the smokebox going through the cab of forward engine and killing the engineer instantly. There was nothing left on her when she struck, but of her frame on the right hand side of firebox. Every-

thing was stripped off from her. Sol Tuttle, now an engineer on the C. M. & St. P., the fireman of the forward engine, was back in the tank throwing forward wood. This was all that saved his life. I believe he was somewhat hurt. Colton, of back engine, was blown from the foot-board some three or four rods, his pants ripped up from washboard down. We saw some four others of those engines blown up, and a number of others besides, but I never saw such a perfect wreck as this was. Bryant died within four or five days after from inhaling steam; had it not been for this, the doctors said they could have saved his life.

I had been to work all night, had washed up and got to the roundhouse doors, when I heard the report of an explosion. She must have been some four or five miles from the roundhouse at the time. Of the

other engines that make which exploded, one was just ahead of the wagon top, the other part in the center of boxes and the other near front end or just back of smokestack. The last of those engines built at the Cuyahoga shops were all better stayed than the first ones were, and better iron put in the boilers. It was all iron from beginning to end, boilers, fire sheets and fireboxes were all iron.

ANDREW J. COLE

Los Angeles, Cal.

Some Lessons of Experience.

Editors:

It was because I did not know much that I came to be plugging a flue that drove through the sheet. Have since been told of old boiler-maker that I had let water down below he flue it would not have driven through. Another time I plugged one with wooden plugs and had no trouble taking train in. I have also tried the plan of plugging a blow-off cock hole with a split plug and wedge on inside, and found it worked well.

Then, again, my engine sprang a leak in the mud-ring, and upon examination I found a crack two inches long in outside sheet. The leak I succeeded in stopping very nicely with a little white lead and cast-iron borings. But I would not advise putting this in where you do not want it to stay, as the boiler-washer says it is just as solid as rock. Another good scheme I have found for a frozen pipe is a bucket of water from the overflow of the injector. Beats fire all out, and does not burn any thing. Furthermore, you can tell just how far pipe is open, as steam will dry water as far as it can get to the pipe.

The way I take up lost motion between engine and tank is with some levers I have, with notches in them that just fit over drawbar, and are just long enough to come up to apron. They do not come out, and a man can rein an engine as tight as he wants to; but wouldn't advise putting in many, unless he knows how much stock there is outside of holes in the end of drawbar.

This scheme has always worked nicely with us, and why more engineers don't use these liners is a mystery to me, as some go along with so much lost motion one would think nothing but check chains were connected.

For the benefit of some other juveniles who may make the same mistake, let me say that the other night I was coming along nicely, and the engine was working as nice as one would want an engine to work. I shut off for a station, and the fireman went to oil valves, but could not, as oil flew out of both sides. When I stopped at station, engine blowing through on right side. Being unable to stop blow by jarring stem and working (as in case of cocked valve), I took up steam-chest cover (there being no air-valve on chest) and found yoke broken off stem. About this time a pusher engine came along, and they had orders to take my train to terminal, which was fourteen miles.

It being a bitter cold night, I did not fancy the job of blocking valve and putting up cover again, so I just broke in with them, thinking I would not take her down for so short a distance, as I could give her plenty of oil and thereby get in without any trouble. But here was where I made a mistake, as I could get oil into neither side, but as engine had steam I gave her a little to keep cylinders moist, and got in without any damage to cylinders. But the next time I will not put on giving an engine lots of oil with partial open on one side.

B. HEAD

Humbolt, Mo.

Another Kick From Doc.

Editors:

While on the way home from the Air-Brake Men's Convention, at Columbus, Ohio, I met Doc. After expressing surprise at seeing me so far away from home, finding out where I had been, what far, etc., in true Yankee style, he opened up on me.

I have got it for these air-brake fellows. We have got one of them they call an instructor who can't make a good stop at half a dozen stations on the road, I don't believe, for he has never run an engine a foot. He has a car full fitted up with a set of brakes of different kinds, mostly freight, pumps, hand-valves, signals, etc., all in working order. When he sees the brakes they all work elegant, but what does he know about the condition of the rail, how many long drawbrakes we have in the train, or how the brakes are going to hold? His set of brakes don't show any greasy rail to stop on or any down grades, it don't show a jump-up by grading on tight just as you get stopped, you have to make his word for that. Of course, it is all very nice to see how all these things are made, and look at the various parts of which the air-brake system is composed, when it has a section cut out so you can see all the openings, when and how they open and close. You get a better understanding of it. But it makes me tired when he examines you and asks what you would do if something breaks or they don't work just right, and some young fellow that never made a stop with a passenger train in his life jumps up and tells all about it. You get a better understanding of these things, I will admit, but the fellow who has the ready tongue gets the best of it. Here is the card I got from him after the examination was over. It says I am rated fourth in a general understanding of the principles and operation of the air-brake. "Lots of things he asked the boys I

can't answer, but as luck would have it he but me with questions I was at home on except one, that was about finding leaks in the brake-valve. I told him I always reported the valve to be examined when it did not work just to suit me, and let the fellow to the shop, whose business it was, find out and fix it. He said that was a sure way if I got to the shop *in time*. He says to me, 'Does it take any longer for the brake to take hold after you have set it tight once, let it off, and want to set it again in a few seconds?' I says, 'Yes, it does.' 'But I don't know just why,' some-how it works so slow you will run by, and when it catches on everything goes with a jerk.' He showed me all about it. By watching the gauges, I learned that part of it quick. What good are all these meetings and conventions they are having? Every few days you hear of one, and every railroad paper is full of them. I suppose the call-boys' turn will come next. Everybody else attends some kind of a convention. What did you fellows do at the air-brake men's meeting? I suppose our man was there, he has not been on exhibition this week."

In reply, I told "Doc" he must take into consideration that there were lots of leaks in the handling of the air-brake that he had not got on to yet because it had never been his bad luck to run across them, but when he did it would save him trouble in finding out the how and why of getting out of it if he knew how all the parts were expected to operate. It used to be the practice to brake by hand when the least little thing went wrong with the brake on the train. Now it has to be fixed or another engine secured that is all right. Nobody dare trust a passenger crew to hold the train with hand brakes if the time is fast and train heavy, it can't be done. Everybody don't know how; some of them have trouble in switching their own train at terminals. It is not the fault of the train crew, because it is getting to be none of their business.

The engineer is in the place where he finds out first if the brake don't work, and he is pretty well fixed if he knows *what* it don't. I saw your instructor. He is a quiet good-natured young man, who not only knows his business, but knows how to tell you about it, as you admit. Never mind the fact that some of the young fellows can answer up so quick, they learn easy when they are young. Probably, if you had learned to adjust the brake-shoe slack by the piston travel, instead of by having the shoes just the right distance from the wheel, you would not get called on the carpet—see page 100 *LOCOMOTIVE ENGINEERING*.

Now, as to why these conventions are held. Railroad men have found out that they will learn more at one meeting of this kind than by working along on their own road for six months. They meet other men in their special branch of business, who tell of their difficulties and how they have overcome, of their failures, and what caused them. So it is better to learn how to know how to meet them when they come up. Associated effort in learning how is better than the "go-as-you-please" style. Now that it is recognized as a fact, every one engaged in a special line of work on a railroad wants to meet the others, and take advantage of what they know about it. There are a few members who air their views without being sure they are right, but somebody shows them their mistake right off, that widens out their observation and increases their experience, and none of us are too narrow-minded to profit by the experience of others.

Papers are read on various subjects, and a number of comments from the members on the ideas advanced, so all around the subject is thoroughly discussed and better understood. Some of them aim high and seem to shoot over the subject, but they have an object in it. You know, Doc, that you hate to give up the old way of doing things, and don't like to tell the young fellows coming up around you about lots of things you ought to. You

think they ought to learn it as you have done, by hard knocks and sad experience. If you don't want to show the young men how, don't get in the way of those who are trying to. Every instructor needs the help of the old heads on the road.

Mr. Editor, the air-brake men's meeting was a success. There were some able papers; the various committees got right down to business, there were no hitches in the proceedings, all questions were discussed intelligently, a good programme for the next meeting laid out, and I hope to see some of our old friends like Doc sitting on the back seats as spectators. They will be welcome.

CLINTON B. CONGER,
Grand Rapids, Mich.

On Bishop's Angle-Cock.

Editors:
Would like to make a criticism on E. P. Bishop's new angle-cock as illustrated in the May number of your paper. As it

Durable Packing.

Editors:
We have an 8-inch Westinghouse air pump on engine 289, which has been running, making an average of 3,000 miles per month, since January 5, 1891, and has never had the air end pumped. It is still in service and has never leaked any and we don't know why it doesn't leak. We would like some of your air-brake experts to explain why this pump runs so long without leaking.

C. E. SHREWOOD,
Livingston, Mon.

That Defective Cut.

Editors:
In the May issue, Mr. Geo. Lynch asks a question about the relative position of the feed ports and handle shown in the March chapter of my article on the engineer's valve, Fig. 6, Plate 11. The cut is the same as that in the latest Westinghouse

Movement of Cross-Head.

Editors:
I have noticed a number of pieces in the paper in regard to the movement of the cross-heads on a locomotive. A cross-head with a 24-inch stroke will, from any stationary point, move in the backward stroke 24 inches less than one-half the circumference of the wheel, and in the forward stroke it will move 24 inches more than one-half the circumference of the wheel when engine is running ahead.

Chicago, Ill. B. H. HAWKINS.

Air-Brake Questions.

Editors:
WHAT MIGHT CAUSE THE SIGNAL WHISTLE TO BLOW.
In the March number of *LOCOMOTIVE ENGINEERING*, Brother Relyea gives us a whistle valve. There are now two styles of signal valves used by the Westinghouse



RED WOOD L. CO. SEEN IN HAMBURG, CONN., CAT

stands, one can cut out train-pipe without notifying any one by simply closing signal stop-cock first, then closing train pipe cock. Would suggest that to make his device effective and proof against accident or malice, he should use the same pattern of angle-cock on signal-pipe that he uses on train-pipe. Then connect its relief or safety-valve with another cross-pipe having its inlet in the train-pipe angle-cock back or outside of the plug. Then, if the signal-cock was turned, it would set the brakes; and if the train-pipe cock was turned, it would notify the engineer by means of the gauge and whistle.

The back end of train needs no extra attachments, as, when both cocks are closed, both pipes are sealed. Both cocks might be combined in a single casting, which would make less joints. With this construction, in cutting out an engine or car, you would lose all air from signal-pipe. Signal stop-cock would only be turned in rear of last car. If it were not for the serious loss of time and air every time a train is uncoupled, the best plan would be to take all angle-cocks off, and couple each hose of rear end into a dummy coupler.

ERIC PA. PORTER STAFFORD.

Company, one shown in the 1890 catalogue and the other in 1895 catalogue. He does not state what kind it was, but if it was the kind shown in 1896 catalogue, the trouble would be caused by the diaphragm. I often find the holes in these diaphragms stretched so wide that they do not fit the little flat tube. The flat bearing on the inside next the center of the valve is so narrow that when the hole in diaphragm becomes enlarged, the casing does not hold the gum tight and the air will leak around it so that you can cause the whistle to blow by rapping the signal-valve with your hand.

Chicago, Ill. PAUL SYNENSTVEDT

How to Stop Noise in Pump Governor.

Editors:
Reading what others have to say about the noise and remedy of pump governors, just reminds me that the first governors put on engines here were very noisy affairs, and as a consequence very unpopular with the engineers. We soon found out, though, that the noise was not caused by any defect of the governor, but the position in which it was placed, that is, it was put on the steam-pipe inside of cab and above small lubricator, so that it was perfectly dry. They were afterwards changed to the pipe outside of cab, so that the oil from the lubricator passed through it, which put a stop to the noise entirely.

North Platte, Neb. W. W. WOOD.

LOOSE WAY OF MAKING REPAIRS.
I was amused when I read the little article on page 158 of March number, describing the way of a fresh individual examining triple valves on cars. It reminded me of another case of a man fitting air valves. The engineer of the engine asked him how he got the lift, when he replied "Oh, I just make him shake around."
I suppose he filed some off the stem or tit, then he would hold the discharge valve on its seat and shake the receiving valve. The instruction book of the W. A. B. Co.

will tell the proper lift for the air valves in the 6-inch, 3-inch and $\frac{3}{4}$ -inch pumps—the air-brake doctor will only take the trouble to look it up. I will give you

2-inch pump—receiving valve, $\frac{1}{2}$ inch, discharge valve, $\frac{1}{2}$ inch
6-inch pump—receiving valve, $\frac{1}{4}$ inch discharge valve, $\frac{1}{4}$ inch
 $\frac{3}{4}$ -inch pump (all four valves same)—receiving valve, $\frac{1}{4}$ inch, discharge valve, $\frac{1}{4}$ inch.

There are certainly some quick air-pump doctors touring around loose that it seems to me should be made to resign for the benefit of the traveling public. I have taken new valves out of air-pumps repeatedly that had no lift, only what would be made by wear in coming from Jersey City to Camden. I recently had to take an engineer's brake-valve off on account of a groove cut in face of air-valve, around the pin or post in the center of the valve. A groove about $\frac{1}{4}$ inch wide and $\frac{1}{4}$ inch deep is recommended by some air-brake men, but in the case referred to the groove was about four times as wide as it should have been—so wide that the engineer could not use it on lap at all. When he wanted to apply the brake he would have to let all the air out of train

An Interesting Experiment with a Locomotive.

The accompanying drawing shows the valve-lifting device recently placed on a locomotive belonging to the Fall Brook Railroad.

As can be seen, the valve is balanced, but in the top of it are tapped three bolts holding a strip that slides in a T-slot in a heavy central standard that extends up through the chest cover with a suitable packing gland.

This central plug can be raised and lowered $\frac{1}{4}$ of an inch by the piston of a small air cylinder above the chest.

This allows the air to flow back and forth from one end of the cylinder to the other without offering much resistance to the piston.

This rig is fitted only to one

in dealing with other railroad companies. The principle advocated is recognized as just in all other lines of litigation, so there is no reason why it should not apply to disputes in the interchange of cars.

We are informed by Professor Goss, of Purdue University, that the locomotive testing laboratory which was destroyed by fire some months ago has been rebuilt, and a greatly improved plant introduced. They have a track connection with the Lake Erie & Western entirely finished, for the

The New York Iron Car Co. have about 8,000 of their cars in service. The framing of these cars is made of tubing, a feature which attracts attention when any of these cars are seen on a train. How seldom one of that 8,000 cars are seen in trains is a good illustration of the vast number of cars that are in use on our railroads. Since Mr. Joughins read his paper at the New York Railroad Club on iron cars, the New York Iron Car Company's design has been growing in grace. Other roads that have looked askant at the iron car have sud-

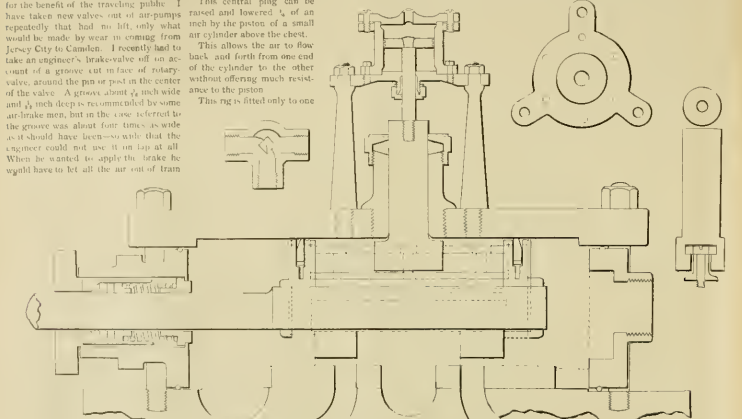

INTERESTING EXPERIMENT WITH A LOCOMOTIVE.

If he made an ordinary screw stop application, and placed it on lay, the brake would go off right away. The engineer got from Jersey City to Camden with it. The valve had to be faced off down level with the bottom of the groove. Result, no more trouble with it.

I sometimes find the upper valve chamber bush put in and made oblong by the chamber bush set screw being screwed up hard against it, so that the air from reservoir or discharge pipe leaked just the upper discharge valve on two sides and held the upper receiving valve down so that it would not draw the air in on the down stroke. The chamber bush should have a hole in its side for the point of screw to go in. The screw should be screwed up tight so that the head of it jams against the pump and the point of screw should fit loose in the hole in valve bush, the object of the screw being to keep the bush from turning around in the chamber, so that the port in pump and the hole on side of bush will be in line when the chamber cap is screwed down. The cap should fit tight on top and of bush and tight under its own flange against the pump at the same time. The bush should be ground in so that the two shoulders of it will both be air-tight.

I think that all engineers should read the letter in March number, page 132, on the "Sudden Disappearance of Oil in Sight Feed Lubricators."

FRANK B. ARNOLDING

Camden, N. J.

In order to compete for prizes your drawings should reach this office by June 30th at the latest.

side of the engine mentioned, and in addition there is a plug valve in the steam pipe. The intention is to see if there would be economy in employing only one cylinder where the work is so light as to require cutting off at less than half stroke. The results of the experiment will be very interesting.

Make the Loner in a Dispute Pay Costs.

A very sensible amendment to the M. C. B. rule of interchanging of cars has been suggested by H. B. Hall, of the Delaware & Hudson. Those who are familiar with the decisions by the Arbitration Committee of disputes arising under the rules, are aware that some rounds display no spirit of fairness when a dispute arises and efforts toward settlement are futile. The case may have been decided repeatedly under analogous forms, and this may be laid before the attention of the disputant, but he will not be satisfied. If he cannot hully or wear the other side into compliance with his desires, the Arbitration Committee is appealed to in the meager hope that they will help out the man who is trying to impose upon his neighbor. It has repeatedly happened that disputes, involving a dollar or two have been forced upon the attention of the Arbitration Committee, when every man familiar with the previous decisions was aware that the parties pushing them had no case whatever.

The change of rule to be proposed is that parties ruled against in a dispute shall be required to pay 75 per cent. of the expenses incurred. Those who are inclined to act fairly cannot object to this arrangement, and it will exert a highly salutary influence on those who have no conscience

purpose of taking in and out locomotives that are sent to be tested. Several improvements have been effected in the supporting wheel mechanism, and William Sellers & Co. have furnished a splendid kinemata dynamometer. The locomotive which was damaged by the fire has been rebuilt and is ready for use again. The authorities of the University are anxious to have a deputation from the Master Mechanics' Convention come and examine the workings of the plant. We are afraid the distance from Saratoga is too great for this to be managed, but it would be of great interest to the association if only a committee could go and make a report on what is to be seen there.

A correspondent in St. Petersburg informs us that the Alexandroff Mechanical Works in that city have just turned out a masterpiece of rolling stock in the form of a new train of eleven bogie corridor (vestibule) cars for the Emperor. They are lighted with electricity, heated by steam, and supplied with three complete systems of brakes, and furnished with the most luxury, nothing being spared to enhance the comfort of the travelers. The four-wheeled trucks which carry the cars are so made that they can be changed from the continental standard gauge to that of Russia, which is 62 inches.

Engineering (London), says, and truly, that of the 45,768,000 bushels of wheat exported from New York during 1893, not one bushel was carried in an American vessel.

California has a railroad in Sonoma county graded through a forest, the ties being laid on stumps.

denly been inspired to find out exactly how it behaved in service, and are astonished to discover that it has done its work year in and year out with almost no repairs. In connection with this car they are also finding out that the objection raised to iron cars on account of the expensive plant necessary to repair them is also fallacy. The work of repairing can be done with tools that cost very little. Nearly all the calls for repairs of these cars is due to accidents, such as collisions.

Pratt & Letcher, Buffalo, makers of the Posley car coupler, have been making drop tests of the coupler, which showed extraordinary results. The coupler, which is of the M. C. B. standard type, is made of a special kind of malleable iron, which has a very close, dense texture when set in a fracture. In the tests a coupler was set up vertically, and the standard block of 1460 pounds allowed to drop on the knuckle just as the latter would receive a blow in service from any of the destructive link couplers that play such havoc with the M. C. B. type. In the first test three drops were made from 10 feet and six drops from 15 feet before any distortion took place. In the next test three blows were given from 10 feet, two from 15 feet, six from 20 feet, two from 15 feet, and one from 20 feet before the bar bent. The knuckle connections remained intact throughout this severe hammering.

The Long Island Railroad mechanical department have begun securing the smokestacks of locomotives to the smoke-box sheet, a flange drawn out from the smoke-box sheet. It makes a neat-looking job, and is said to be less expensive than the cast-iron base.

* Diseases of the Air Brake System;

By PAUL SYNNESTVEDT.

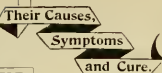

The Triple-Valve.

(Plates 17, 18, 19, 20 and 21.)

There is probably no complaint more common amongst trainmen and engineers than "The triple-valve sticks." It is safe to say that in nine out of ten cases where this complaint is made the triple-valve is not to blame at all. It is merely a *red herring*, which shows a defect somewhere

completely stopped with dirt. Strainers in this condition are shown on Plate 18*b*. They were taken from actual service.

They may be in such condition that they will permit sufficient air to filter through to partially fill the reservoir after a considerable length of time, and yet not allow the pressure to escape fast enough from the train-pipe side of the triple-valve to cause the brake to set. If there be plenty

main piston itself is "stuck, and that should then be taken out and cleaned.

and cylinder passage in the gasket between the triple-valve and the part of the apparatus to which it is attached, it being

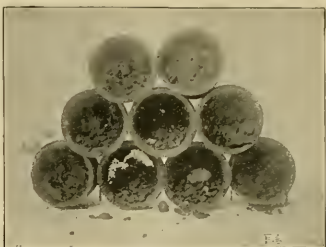

PLATE 18*a*

FROZEN TRIPLES.

In very cold weather there is always the possibility that the valve may be frozen, especially if it is on a car near the head of the train and the main drum on the engine has much water in it. The author has located more than one negligent engineer, by discovering an excess of moisture in the triple-valve under the baggage car which he pulled regularly.

BLOW FROM EXHAUST.

If there is a constant blow-out of the exhaust of the triple-valve (or the pressure-retaining valve which is connected to the triple-valve exhaust) the first thing to determine is whether it comes from the *train-pipe* or *auxiliary reservoir*. This can be very easily done by cutting out the valve with the cut-out cock.

If the blow does not stop for some time and then grows fainter gradually, there is little question but that it comes from the reservoir, but if it stops immediately and the brake sets, it is a clear indication of a leak from the train-pipe, between the triple-valve piston and the cut-out cock, the reduction on the train-pipe side of the piston causing the application of the brakes. If the leak is found to be from the reservoir, it must come either from an

fastened to the *valve* head on passenger cars and directly to the *reservoir* on freight equipments.

If the blow be from the train-pipe it is nearly always due to an imperfect seating of the emergency-valve (Plate 17, No. 10), the bearing face of which being rubber will sometimes rot out from the action of oil. In many cases a little dirt under this emergency-valve will cause a sharp blow out of the exhaust, and this can frequently be dislodged by a number of emergency applications of the brake, the rush of air into the cylinder blowing the dirt along with it.

Sometimes the blow can be stopped, simply by cutting out the car bleeding the reservoir, and then opening the cut-out cock suddenly.

BLOW FROM EXHAUST—FOAM AND LINGER TRIPLE.

In the triple shown in Plate 18 a blow from the exhaust is generally caused by a leak around the plug of the cut-out cock, and it can sometimes be stopped by simply turning the handle down and then up again. If this does not help, the plug must be ground in.

STICKING AFTER EMERGENCY.

Brakes sometimes refuse to release promptly after an emergency application. If this "sticking" is accompanied by a violent blow from the exhaust, when an attempt to release is made, it is a sure indication that the emergency-valve (Plate 17, No. 10) did not go back to its seat prop-

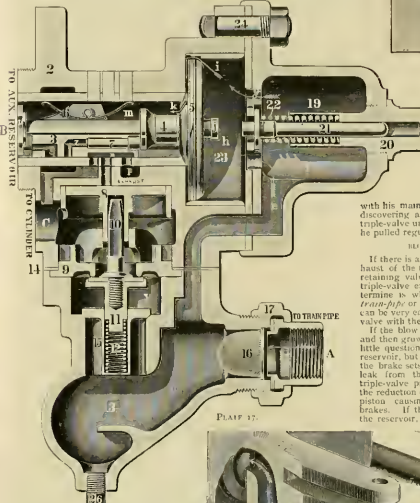

PLATE 17.

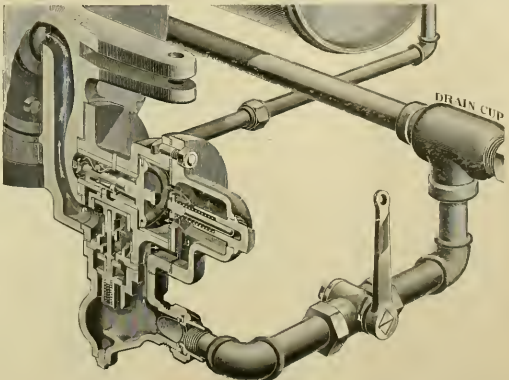

PLATE 18.

else in the apparatus, for the triple-valve being the automatic part of the brake, the foundation of the whole system, is the first part to be affected when anything else gets out of order. In quite an extended experience with air-brakes the author does not remember more than a few cases where triple-valves were so defective as to be absolutely inoperative. They must be in very bad shape indeed if they will not work at all.

BRAKE WILL NOT SET.

In case the triple-valve refuses to act, the first thing to examine is the auxiliary reservoir, as that may not have its full supply of air and, of course, as it is the air in the auxiliary reservoir that moves the triple-valve piston, a deficiency of pressure there will prevent the valve from acting. Sometimes the bleeding cock will be found left open or leaking, and sometimes there is a leak somewhere else about the reservoir of sufficient extent to prevent the proper accumulation of pressure. All the pipe connections about the reservoir should be very carefully examined.

In case the reservoir contains considerable pressure it is of course useless to look for leaks, and the attention must be turned elsewhere.

DIRT IN STRAINER.

The strainer (plate 17, No. 10) where the train-pipe connection is made should not be examined, as it sometimes becomes

of air in the reservoir, and all the passages are found to be free and open, the only remaining inference is that the

imperfect fit of the seat of the slide-valve, or more probably from leakage past the narrow bridge that divides the reservoir

only after the application, and something must be done to make it do so. Dirt lodging on the seat as described just above

Copyrighted by Paul Synnestvedt, Chicago. All rights reserved. These articles commenced in January number.

BRAKES SETTING WHILE RUNNING. This is almost invariably an indication of a reduction of the pressure in the train-pipe, either through leakage equalization (air flowing from a car having a less pressure to one having a less

pressure, the separation of the train into two or more parts, or the bursting of a hose. I say *almost* invariably, because there are cases in which the brakes may set while running, without any reduction of the train-pipe pressure. For example, this sometimes occurs on a driver or tender brake as a result of leakage past the four-way cock plug (No. 13, Plate 19).

pipe would cause the same action, such as the opening of a conductor's valve or the blowing out of a plug, gasket or pipe fitting. ACCIDENTAL SERVICE APPLICATION, OR "BRACING OF BRAKES." This is one of the most frequent troubles that arise in the use of the automatic brake, and, as was stated before, is seldom the fault of the triple-valve. When it is once clearly understood that the brake is dragging, as a result of some reduction of pressure somewhere in the train-pipe, and that the triple-valve would not be doing its duty if it did not respond to this reduction, then a long step has been made towards locating the difficulty and remedying it. The first thing to do is to find out whether the reduction is due to equalization or leakage. If it is the former, a part of the train only will be affected, but if the latter, the trouble will be general throughout the train. In either case, the handling of the engineer's valve will generally prevent any trouble or delay of a serious nature, as the brakes will cease to drag if the air is fed into the train-pipe as rapidly as it is leaking out, and if the head cars are not charged with a higher pressure than the rear ones when the brakes are released

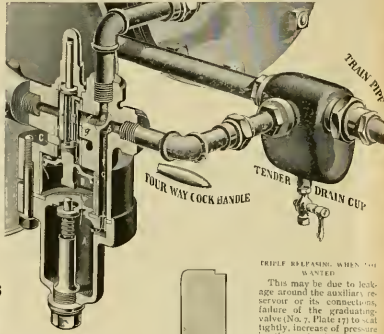
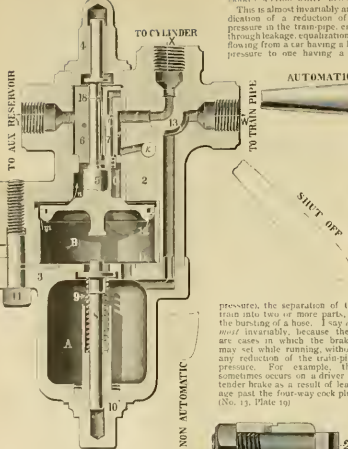

pressures, the separation of the train into two or more parts, or the bursting of a hose. I say *almost* invariably, because there are cases in which the brakes may set while running, without any reduction of the train-pipe pressure. For example, this sometimes occurs on a driver or tender brake as a result of leakage past the four-way cock plug (No. 13, Plate 19).

may be the cause, or it may be some defect in the apparatus itself, such as the spring (No. 12, Plate 17) being broken or very weak, or some binding of the piston (9). The author has a very distinct recollection of one case, in which such trouble was caused by a piece of wax from the casting being above the piston (9), just large enough when it stood on edge to block the piston so low that the valve could not seat. Hard tapping on the valve case would shake it down flat and stop the flow, but the next emergency action would set it up again, causing it to stick as before. A careful examination on taking the valve apart revealed the cause of the disturbance.

If the brake sticks after emergency, but does not blow from the exhaust when the excess pressure is thrown against it, it is an indication that the main piston (No. 5, Plate 17) refuses to be forced back to normal position. This may be from frost or dirt, but in the great majority of cases will be found to be simply because the pressure put into the train-pipe is not yet high enough to overcome that in the reservoir. Bleeding the reservoir slightly should release it, but if it does not, then the blame may fairly be laid on the valve. It must be taken apart, thoroughly cleaned, and then put together again.

TRIPPLE VALVE WHEN NOT WANTED. This may result from a very weak graduating-spring (Plate 12, No. 21, or a failure of graduating-valve (7) to unseat properly, either because the pin which controls it is loose, or else because it is surrounded with gum and dirt. It might also result in case the main piston (9) should stick just enough to require a very heavy reduction to move it. This is a very annoying and difficult trouble to locate. The first thing to do is, of course, to find out which triple-valve it is that is giving the trouble. This can best be done by obtaining men along the train to watch the action of the brakes under the cars, while the engineer makes an application. If the train is too long to be conveniently watched in this way, begin with the first half. If this by itself does not give the defective action complained of, it is a manifest fact that the offending triple-valve must be in the latter half of the train. A few careful tests of this nature will soon locate the car on which is the defective valve, and when so located it can be cut out until the repairer can fix it. The exact operation of a valve such as the one just above described is as follows. On the first light reduction in the train-pipe it will be the last to apply, and when it does set it will go on very violently, this quick action causing a full application of all the other brakes in the train.

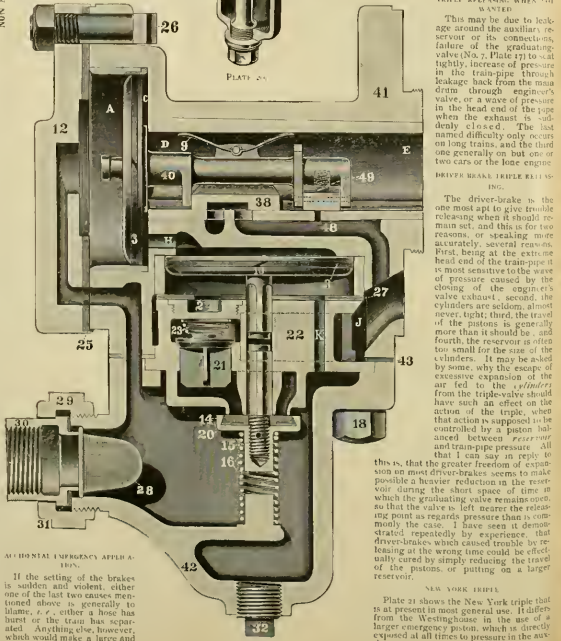

ACCIDENTAL EMERGENCY APPLICATION. If the setting of the brakes is sudden and violent, either one of the last two causes mentioned above is generally to blame, *i. e.*, either a hose has burst or the train has separated. Anything else, however, which would make a large and sudden reduction in the train-

TRIPLE BRAKING WHEN NOT WANTED. This may be due to leakage around the auxiliary reservoir or its connection, failure of the graduating-valve (No. 7, Plate 17) to seat tightly, increase of pressure in the train-pipe through leakage back from the main drain through engineer's valve, or a wave of pressure in the head end of the pipe when the exhaust is suddenly closed. The last named difficulty only occurs on long trains, and the third one generally on but one or two cars or the lone engine.

DRIVER BRAKE TRIPLE RELIEF. The driver-brake is the one most apt to give trouble releasing when it should remain set, and this is for two reasons, or, speaking more accurately, several reasons. First, being at the extreme head end of the train-pipe it is most sensitive to the wave of pressure caused by the slowing of the engine's valve exhaust; second, the cylinders are seldom, almost never, tight; third, the travel of the pistons is generally more than it should be, and fourth, the reservoir is often too small for the size of the cylinders. It may be asked by some, why the escape of excessive expansion of the air fed to the cylinders from the triple-valve should have such an effect on the action of the triple, when that action is supposed to be controlled by a piston balanced between reservoir and train-pipe pressure. All this is, that I can say in reply to this is, that the great freedom of expansion on most driver-brakes seems to make possible a heavier reduction in the reservoir during the short space of time in which the graduating valve remains open, so that the valve is left nearer the releasing point as regards pressure than is commonly the case. I have seen it demonstrated repeatedly by experience that driver-brakes which caused trouble by releasing at the wrong time could be effectually cured by simply reducing the travel of the pistons, or putting on a larger reservoir.

NEW YORK TRIPLE. Plate 21 shows the New York triple that is at present in most general use. It differs from the Westinghouse in the use of a larger emergency piston, which is directly exposed at all times to pressure in the auxiliary-reservoir on one side and train-pipe on the other, and, further, in the use of a

PLATE 21.

small slide-valve for a graduating-valve in place of the poppet-valve in the main slide-valve found in the Westinghouse. The general principle of operation is so similar as to permit of the use of the same general method of treatment as that given just above. Where the brake sticks after an emergency application, it is generally because the emergency-valve (20) and its piston (13) has not gone back to its seat after the emergency. In this case, heavy blow from the exhaust will show itself as soon as the train-pipe pressure is increased above that of the main reservoirs, because the emergency-valve being open the train-pipe pressure has direct communication with the cylinder, and as soon as the main pressure and valve are moved to release position this pressure will find an escape through the exhaust. This action of the valve may be the other to the emergency piston being dirty or the spring (16) being broken or weak.

If there is a constant blow from the exhaust port of this valve (or through the pressure retaining-valve, which amounts to the same thing), and still the brakes set and release properly, the first thing to do to locate the trouble is to determine in the manner previously described whether this blow comes from the train-pipe or auxiliary reservoir.

If the brake sets immediately on being cut out, indicating that it is train-pipe pressure that is escaping, the valve must be examined to see whether it is from dirt on the seat of the emergency valve (20) or an imperfect bearing of the gasket which fits into the joint at (27).

If, on the contrary, the brake does not set when cut out, but the blow grows gradually fainter and finally dies out entirely, the bearing of the small slide valve (13) must be examined as also the gasket between the main valve and reservoir, as these two points are the one at which the reservoir pressure is most apt to escape.

Edison's Railroad Career.

All railroad men are more or less familiar with the name of the great electrician, Thomas Edison, but few of them are aware that he started out in life as a train-boy, and that he was a railroad operator for several years. The story of Edison's boyhood is very attractively told by Linda Rose McCabe in *N. Nicholas* for February.

He was born at Milan, on the Huron River, and his first work was that of train-boy on the Grand Trunk. In this humble position he was noted for his energy and ingenuity in devising means to advance his business. The first original enterprise he undertook was to wire the most startle-

nication with Sarnia on the other side, but there seemed no possibility of making any connection in this emergency. Edison went to one of the switching locomotives and with the whistle blew calling Sarnia by the telegraph code. After a time he was answered. The whistle has often been used to sound the telegraph signals since that time, but Edison first showed the way.

He drifted about for several years, working as an operator. When stationed at a station on the Great Western as night operator, he devised a rig which automatically reported his office signal at the required times, even when he was indulging in a nap. The train dispatcher was struck with Edison's regularity in reporting, but one night, needing to send a holding order the particularly punctual operator could not be roused, and his trick was discovered and the author was promptly discharged.

After that he found employment where his scientific attainments and inventive ability could be employed for useful purposes.

Don't Get Funny.

J. A. M. WELLS.

Old Tom Bowen had seen a good many of his firemen set up, and always looked forward to that end with pleasure. He was in the habit of giving the young fellows plenty of advice, which they usually took with good grace, though sometimes Tom wasn't so choice of his language as he might have been. He was proud of his "boys," as he called them, and always took credit to himself for all their advancement and "good luck," but laid all their mistakes to "the cussedness that was born in 'em, that he couldn't educate out of 'em."

Old Tom was "Old Tom" to everybody, and no one intended disrespect to him by its use; in fact Tom himself considered it a compliment to his age and experience on the road.

He always contended that you couldn't transform a fireman into an engineer by just putting him over on the right side, and that if you wanted a young fellow to do reasonably well when he was set up you must give him practice while he had a man to oversee his work, and show him

harmful for. When Tom cooled down he told John the story of a fireman he had had years ago, whose sad experience had been a lesson to many a man.

Says old Tom: "Do you remember that flagman at the A street crossing in Arlington who has both legs cut off below the knees?" John recalled him and Tom said: "Well, he was one of the brightest fellows that ever lived for me. He hadn't a lay bone in his body. He was always on time and eager to work; kept the engine as bright as the day she left the shop, and the cab as clean as a parlor. I felt my pride in him grow every day. I felt my pride he'd make a first-class man when they gave him an engine. The master mechanic thought so too, and gave him a job of hostling. For some time he seemed to remember all I had told him, and ran as any careful man would. But after a while his independence, and an irresistible desire he had to see the wheels go fast changed things, and the way he flew around the yard was a caution to the slower fellows, who were sure the switches were right before going ahead, but this fellow seemed to go on the plan that everybody knew he was coming and would get out of his way. If there was an engine to be turned back on short time, he was sent to catch her, and I guess his success in this line turned his head. Anyhow, his luck left him, for he had an experience one day that put him where he is now. He caught No. 3's engine, and although there was no hurry, he started for the roundhouse as if he was pulling the flyer out of town, and he failed to see a freight car coming toward him with a switch-engine behind it until it was too late, when he reversed his engine and jumped. He fell across the next track, and before he could get up, a

and he silently resolved that his car's ends should never bring sorrow upon his loved ones.

After a long silence old T's face began to brighten, and soon with a smile he said: "But you should have seen that engine when she was cleared of the car, which was loaded with bananas. If ever you saw a sight to make Dagoes weep, it was the waste of those bananas. She was simply plastered with them from pilot to cab. The headlight, smokestack and sandbox were gone, and there was nothing to be seen but bananas, bananas, bananas."

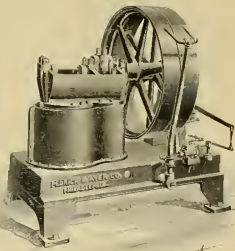

COMPOUND AIR-COMPRESSOR.

A New Compound Air-Compressor for Shops.

The Poltrek & Ayer Co., of Philadelphia, Pa., have just put on the market a new belt-compressor for shops, shown in the accompanying illustration.

The machine is very compact, and has an automatic bell-shifter that keeps the pressure up within a fixed limit, when no air is being used, the compressor is at rest and not wearing itself out.

The large cylinder is 11 inches in diameter and delivers its air to the smaller cylinder, 6 inches in diameter. The cranks are set opposite each other, which insures quiet running.

The air-valves are the usual gravity variety, and the cylinders are water-jacketed, this keeps them cool, but, of course, the jacket need not be used.

The machine can be run with good results up to as high as 70 revolutions per minute.

Strangely enough, the first of these compressors went to a railroad shop at Trondheim, Norway, where it is reputed as very satisfactory.

It has a capacity of about 32 cubic feet free air per minute.

A Self-Feeding Tube Expander.

We illustrate herewith a flue expander that has been in use for some three years at the D. L. & W. shop at Kingston, Pa., and is being put on the market by the Henry C. Ayer & Gleason Co., of Philadelphia.

The cuts make the construction plain. There are no end pivots, no casing nor screws. The rollers are loosely held in the ring by ball heads and a coil spring band. The project out from the ring without a case, and are entered in a tube at an angle to the line of the taper plug, by turning which they are forced into the flue tighter. When desired to release, the drift pin is turned backward. The drift pin is never hammered to get it in or out. This is a big improvement, as often as much damage was done to saturated flue by hammering this wedge as the rolling did good to the leaky one.

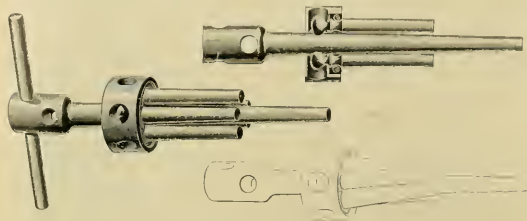

SELF-FEEDING TUBE EXPANDER.

"tricks an old Jack." When Tom thought his fireman was far enough advanced in his education to be allowed to run the engine a little, he always read him a lecture, telling him, among other things, to be careful-not to be in a hurry-to be satisfied to see the wheels turn slowly at the first, and to be sure of what he could do, and then do it, and he always ended his lecture by saying, forcibly: "Above all things, boy, don't get funny."

Just before Tom's fireman, John O'Brien, was put to hostling, old Tom was letting him do some switching, when John forgot the "funny" part of the lecture he had heard, and broke a truckbar. Old Tom's watty broke beam, and John got another lecture and a job lot of epithets, he hadn't

string of ex-cran over his setting off both legs below the knees."

Here Tom stopped speaking and as he recalled the picture of his old fireman picked up from the track, a bleeding wreck, and remembered the pitiful grief of the poor wife and children when he was taken home, and thought of their scanty home comforts, now his eyes filled with tears. The sight of Tom's emotion told John that there was a part of the sad history Tom had not told him, but his mind instinctively took up the same train of thought Tom was following, and he saw the grief and woe of the poor man's family, and realized, for the first time in his life, that a man's duty is not only to himself but to those dependent on him,

ing headlines of the morning papers to the way-stations and get them posted in advance to induce people to buy papers. Then he started a small weekly paper called *The Grand Trunk Herald*, which he set up and printed in the baggage car. As far as we know, this was the first and only paper printed on a train.

The boys was fond of reading scientific books and was greatly attracted to natural science. His bent in this direction induced him to quit the position of train butcher and editor and turn telegraph operator. When he was still a boy and operated at Fort Huron, Mich., an ice man broke the telegraph cable in the river, and there was so much floating ice that no boat could cross. It was important to obtain commu-

? A. — What You — ? A. — Want to Know.

Don't ask questions of simply require a little figuring to determine; make each question separate. No notice taken of anonymous questions.

(69) E. S. H., Mineral Point, O., asks: If an engine is running down grade and you reverse it and open the throttle, will the pistons pump air into the boiler against steam pressure or not? *A.*—Yes, if engine has sufficient momentum to keep running after there is pressure on her pistons equal to her boiler pressure.

(71) W. B. A., Norwich, Conn., asks:—
1. What disposition has been made of the Boston & Providence engine "Daniel Nason" and the Baldwin express locomotive "Columbia," exhibited at the World's Fair, Chicago? *A.*—They are now in the hands of their owners. 2. Is it true, as reported in the papers, that the latter made two miles in a minute in a recent trial on the Baltimore & Ohio? *A.*—It is not true.

(72) E. R. M., Minneapolis, Minn., writes:—
In answer to B. N. Y. L. No. 87, you state that steam at 100 pounds pressure has 273 times the volume of water. Is this a typographical error, or are Hawley and Roper both wrong? They give 246, a difference of 27 volumes. *A.*—The figures given were taken from Northcutt's tables. The best steam tables ever worked out were by Charles T. Porter, the eminent steam engineer, who gives the specific volume of steam at 100 pounds absolute pressure which would be 147 more than gauge pressure at 26.9, which, reckoned from gauge pressure of 100 pounds, would give 35 volumes.

(73) G. S. H., Windsor, Ont., asks:—
1. In Educational Chart No. 2, what is the object of running one pipe from pump to drum and another line from drum to engine's valve, and so on to train line? Would not one pipe from pump extending both ways from T, one end to drum after end to engine's valve and so through it to train line, do equally well if suitably framed, and save pipe? *A.*—When connected as you suggest, the engine's valve receives a great deal of water, oil and dirt collected by the pump, the pulsations of the pump make the handling of the valve very uneven and affects the action of the governor. The extra pipe amounts to nothing, and insures a cleaner valve and better braking.

(74) J. J. Jones, Hamovet, Kan., writes:—
1. Why can a person skate over ice so thin that it would break almost instantly if the same person were to stand still on it? *A.*—This ice may be crushed quickly because it is supported by the water, which is quite dense, and moves from under the ice and the skater's foot. The ice and water do not have time to get out from under him. 2. How can you get a 75-ton engine over a bridge constructed to carry only a 50-ton engine? *A.*—Strengthen the bridge. These questions are doubtless raised by one who believes the common notion that an engine running very fast upon the structure due to the weight of the engine. Exact engineering measurements have proved that there is nothing in this theory.

(75) J. R., Grand Rapids, Mich., writes:—
In running different gauges 1 notice that injectors placed about on a level with the top of tank run with less noise, have greater range, start quicker, and do not break as those high up on boiler. Does it not the velocity greater when the level is a foot than it is at 25 feet? If velocity, vacuum and steam pressure are the main points in a successful working injector, why place it so high up? It takes all the power to raise water say twenty feet, what's left to force it in boiler? And that climbing up and down every time to start or stop it is not pleasant. *A.*—A whole

chapter might well be written on the outrageously unhandy location of injectors; they ought to be so located that a runner could handle them without even taking his head inside the window, let alone getting off his seat. Every inch of extra lift decreases the capacity of any injector, and adds a straw to the load of possible failure, affects the range, and causes the instrument to make more noise.

(76) S. G. F. Fall River, Mass., writes:—
What is the answer to questions 44, 21, 23 and 25, Chart No. 1? *A.*—Question 44 reads: "How would you place piston and valve if disconnecting a moqul or two-wheeler, where side rod pin would strike cross-head key if it was locked in center of guides?" This was put in to call attention to an often forgotten point. The answer is obvious. If the front side rod pin struck the key when cross head was in the center, it would be necessary to block the cross-head forward or back, and if forward move the valve forward, and *vice versa*, the pin might strike the key if it was forward or back, this point should always be observed. Question 23 reads: "What could happen that would cause you to disconnect without covering the ports?" We will give you a clue by asking another: What good would it do to cover the ports if the steam chest cover was broken? Question 25 reads: "Does it (the piston) stop at each stroke? When?" Yes, the piston stops at each end of the stroke.

(77) M. T. Port, Jersey, N. Y., writes:—
There is a difference of opinion as to the construction of a deck engine and a foot-board engine. Please advise in your next issue how a foot-board engine is constructed, and also how a deck engine is constructed. *A.*—We do not know that there is an established rule in this matter. In Europe the platform behind the boiler-head in this country called a "deck" is called a foot-plate, in this country the word "foot-board" was once used to designate the same thing, and some still call the "running-board" ahead of the cab, foot-boards. If we were the cart of last resort in this case (which we are not) we should say that an engine having the boiler extending through the cab and where the engineer and fireman stand on an extension of the running-board, which engine is the boiler, was a "foot-board" engine, and one with a short boiler-head and an open deck between the men and back of the boiler-head (like the ordinary soft coal-tender, etc.), a "deck" engine.

(78) S. G. F. Fall River, Mass., writes:—
1. Am running a moqul, drivers are equalized to front track by usual long equalizer with a hanger coming from back front driver spring. Should I break this up to a cross-bar between the ends of the long equalizer or center-pin of my truck, how should I block up? *A.*—Raise engine in front and block between the cross-equalizer and the boiler, or between the long-equalizer to truck and the cylinder saddle. 2. If truck wheels are solid cast wheels or a piece of flange, how many truck wheel to a shoe? *A.*—This is a case for horse sense and judgment. Probably by breaking a piece of wood or iron between the broken piece and the frame, or some other satisfactory part of the truck, 3. How to mend a chump would you recommend? metal packing is used? *A.*—A strip of iron 1 1/2 inches wide, 1/4 inch thick, with a slot in it for the key, and curved back and punched to go over one or both right hand of the gland studs. It must be the right length to hold the valve in the center of the face of the seat.

The Air-Brake Situation.

A circular has been issued by the Westinghouse Air-Brake Co. on "The Air-Brake Situation." The circular deals principally with the renewed efforts of the New York Air-Brake Co. to place an air brake upon the market after being defeated in the courts for infringement of the Westinghouse patents. The Westinghouse Air-Brake Co. claim that it is entitled to the exclusive manufacture and sale of quick-acting automatic air-brakes and brake material, and that it is advantageous to the railway companies to purchase exclusively from them in order that there may be only one class of apparatus to maintain. The company further believes that if brakes and repair parts were to be made indiscriminately by a number of manufacturers, there would be increased risk of accident, and that the money heretofore expended for air-brake equipment would be greatly jeopardized.

To the Railway Supply Fraternity.

GENTLEMEN—As your Standing Committee, we feel called upon to direct your attention to a matter of great importance in connection with the coming convention. You have already been fully advised in connection with the Committees of the Master Car Builders' and Master Mechanics' Associations, your Committee has secured a rate of three dollars (\$3) per day each, at Congress Hall. It being obligatory to all that Mr. Clements, the proprietor of Congress Hall, must open his hotel in advance of the regular season to accommodate us. He consented to do this with the full understanding that he was to have the entire patronage of those attending the convention, and we think it very desirable that all our fraternity should contribute their part toward carrying out our part of the agreement. Unless we are faithful to these pledges, it will be difficult in the future to effect such favorable arrangements, or induce desirable hotels to open for our special accommodation. We beg, therefore, that you will promptly secure your rooms.

W. D. DRAKE,
H. H. SULLIVAN,
T. R. FICHAMON,
A. G. REICHARDT, Standing
F. W. COLLIER, Chairman.

We Saved His Life.

One of our subscribers away in California puts the following bill Nyc P. S. to a letter.

"If you can't send me that chart please let me know and I will commit suicide, because life is not worth living without that chart and LOCOMOTIVE ENGINEERING. I came near dying while I was waiting for the answer to my subscription."

William C. Baker, of New York, the well-known Baker heater manufacturer, has issued a new illustrated catalogue showing the most recent form of heater now used for marine cars. An important feature about this catalogue is that it gives very detailed directions about how to erect the heaters, how to prevent them from freezing and how to manage them after they are in use. The book contains a great deal of valuable information which trainmen in charge of car heating ought to learn. It would be a good plan for railroad companies to copy the most important parts of this catalogue and put it in the form of a book of instructions for their trainmen.

The Water Circulating Grate Co., of Philadelphia, is reported to be meeting with great success with the grate they have recently put on the market. Its use has principally been confined to stationary boilers, but a modification has been adopted suitable for locomotives, and the expectation is that it will soon be tried in locomotive fire-boxes.

The many friends of Mr. G. S. Woolman, so many years engaged in the scientific instrument business at 116 Fulton street, New York, will be interested to learn of a very important change in his affairs. The firm of Queen & Co., of Philadelphia, with whom he was connected earlier in life, having found it necessary, owing to the great volume of their business in the vicinity of New York, to establish a branch there, have purchased Mr. Woolman's entire business and have secured his services as their New York manager. From the Philadelphia staff of the railway companies, Mr. G. T. Loomis, formerly in charge of resistance standardization in Queen & Co.'s laboratory at Ardmore, has been detached and stationed at the New York office. The establishment of this New York branch will be a great convenience to the many customers of Queen & Co. in New York and will undoubtedly be largely increasing their already extensive business in that vicinity.

We cannot understand why the M. C. B. Association does not repeal the clauses added to No. 8 of the Interchange Rules which are responsible for making owners of cars and bearings renewed while the cars are away from home. Keeping account of these renewals causes more extra clerical labor than the parts are worth. It worked quite equitably for every railroad company to put in brake shoes and brasses when necessary on any car passing over their lines. Why the practice should have been changed is hard to understand. The existing practice gives the unscrupulous man a steady advantage over those who are trying to act fairly towards connecting lines.

A new illustrated catalogue has been issued by the Rue Manufacturing Co. of Philadelphia, showing their well-known "Little Giant" injector, their boiler-washers and other boiler-feeding appliances made by the company. Besides showing very clearly the different forms of apparatus manufactured, the catalogue gives a great deal of valuable information about injectors and boiler connections. The catalogue will be found convenient and reference when anything is the matter with an injector, or it is necessary to order any particular part.

Watson & Stillman, makers of hydraulic machinery, New York, have issued a new catalogue, showing the latest forms of apparatus which they make. Their products are by no means confined to hydraulic machinery, as they appear to make everything required for lifting or moving heavy articles. Among the things illustrated are an electric motor lift, a portable double screw hoist, traversing jack, three-roll adjustable tube expander, and various other articles used in machine shops.

A new illustrated catalogue of their air-brake, air-signals, and other appliances, has been issued by the Westinghouse Air-Brake Co. It is got out in admirable form, the engravings being of the highest class, all parts being named and numbered as they have been in previous catalogues. This catalogue is much fuller than any of the previous ones and appears to contain illustrations of every detail of brakes and air-signals.

The Hall Signal and Circuit Co. of the United States Circuit Court of Western Pennsylvania against the Union Switch & Signal Co. of Swissvale, Pa., for alleged infringement of their United States patent covering their improved Auto-Lighting relay and circuit.

The committees of the M. C. B. and M. M. Associations request that members attending the Saratoga meeting bring their button badges.

RAU MANUFACTURING CO.,
 Manufacturers of
METAL SPECIALTIES, ENGINEERS' TORCHES & OILERS.
 THE PERFECTION VALVE OILERS.

LABOR-
 SAVING
 AND
 ECONOMICAL.



SAVES
 BOTH
 OIL
 AND
 TIME.

We do a general contracting and jobbing business on orders, and would be pleased to figure on specifications for what you may use in our line. Correspondence solicited.

122 to 128 MICHIGAN STREET, CHICAGO, ILL.

Carbon Steel Company, Pittsburgh, Pa.

MANUFACTURERS OF

OPEN HEARTH STEEL PLATES FOR ALL PURPOSES.

SPECIALLY SUITED FOR **LOCOMOTIVE** FIREBOXES AND BOILERS.
 PARTICULARS SENT ON APPLICATION.

Railroad Agents:

J. B. BRADY, 909 Havemeyer Building, New York.

W. M. WILSON, Western Union Building, Chicago.

FLEXIBLE STEEL RULES.

Watch Spring Tempered Steel.
 Graduated in 32nds and 64ths on one side only.

SEND FOR CIRCULAR.



VALLEINE TOOL CO.,
 Hartford, Conn.

ON MAY 21st, 1894, THE P. H. MURPHY MANUFACTURING COMPANY, East St. Louis, Ill., by their attorney, PAUL BAKERWELL, brought suit in the United States Circuit Court at St. Louis, Missouri, against the EXCELSIOR CAR ROOF COMPANY, C. M. JENNINGS, President, claiming infringement of the Murphy Car Roof patent and asking for an injunction and an accounting of damages and profits.

SHERBURNE'S AUTOMATIC TRACK-SANDING APPARATUS.

Three Ways Instead of One. Mind Your Stops.

On slippery rails sand the track automatically when brake is applied, avoiding rear collisions and derailment.
 In starting, touch Lever and obtain lot of sand and "get there."
 The old Rod and Lever retained as usual. For particulars apply to

SHERBURNE & CO., 53 Oliver Street, Boston.

EDWIN S. JACKMAN COMPANY,

STEEL AND COPPER, RAILWAY SPECIALTIES.

Refined Cast Steel for Shop and Track Tools,
 Railway Spring Steel, Firebox and Boiler Steel of Extra Quality.

Warehouse: West Water St., near Randolph. General Office: 901 Rockway Building, CHICAGO.



THE
 "Southwestern
 Limited"
 RUNS DAILY
 Between
 NEW YORK
 BOSTON
 Cincinnati,
 Indianapolis,
 St. Louis,
 via
**BIG 4
 ROUTE.**

E. W. McHEMIS, D. B. MARTIN,
 Passenger Traffic Mgrs., 400-1 Passenger & Ticket Agt.
 CHICAGO, ILL.

THE BOYER

Railway Speed Recorder



The only Recorder made that gives a chart of the run that can be read at sight, and has a dial indicator carried into the case so Engineer can see at a glance, any time, what speed he is running.

Boyer Railway Speed Recorder Co.

244 DICKSON ST.,
 St. Louis, Mo., U. S. A.

**THE CAMERON
 STEAM PUMP.**

COMPLETE WITH BOILER.

THE A. S. CAMERON
 STEAM PUMP WORKS,
 Foot of St. Twenty-third St.,
 NEW YORK.

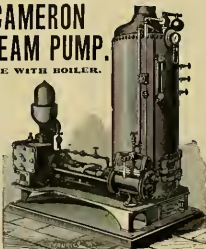

Send for Illustrated Catalogue.



ATHOL, MASS. U.S.A.
 Catalogue Free.

WHEN I AM AT I MUST CAREFULLY THE Tyler Tube and Pipe Company's
Saratoga EXAMINE CHARCOAL IRON BOILER FLUES.



HERE WE ARE!

Locomotive Engineering



HAS MOVED TO

256 BROADWAY,

15th FLOOR.

To Subscribers!

LOCOMOTIVE ENGINEERING is now "At Home" in her new offices, where there is always a welcome, and the smell of tobacco, for those that read and are wise. Come in!

To Advertisers!

While you are as welcome as anybody else, we want to say a word to you about a chance to send out some drummers for business. You can get out 25,000 drummers that work nights and Sundays—and don't send in bills for "sundries"—by renting a little wall-space in what a Railroad Manager said was "The Most Interesting Railroad Paper Published." If you and your business are alive, advertise them—the dead advertise not!

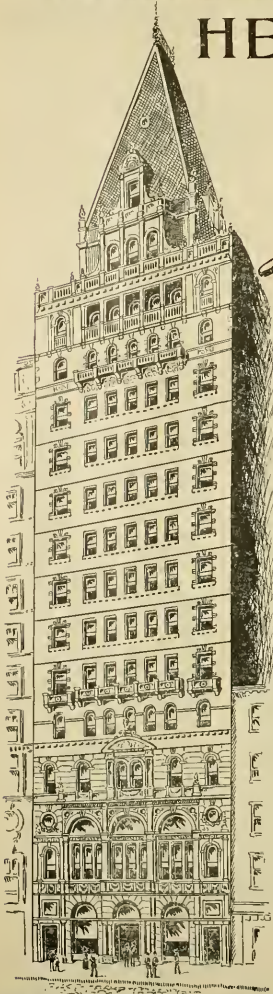

THE WESTINGHOUSE AIR-BRAKE CO.

Is now prepared to fill orders, at an hour's
notice, for One or One Thousand Sets of

AIR-BRAKES FOR FREIGHT CARS,

having, at their New Works, an annual capacity
for turning out Air-Brakes for 250,000 Freight
Cars, 6,000 Passenger Cars, 10,000 Locomo-
tives; besides repairs for the 350,000 Freight
and Passenger Cars, and 26,000 Locomotives
already equipped by

THE WESTINGHOUSE AIR-BRAKE CO.

Have you any Janney Couplers or Knuckles?

If you have,
this will interest you.

JANNEY FREIGHT COUPLERS and JANNEY WROUGHT IRON KNUCKLES sold by us are, until further notice, covered by the following

Guarantee:

We will replace all broken JANNEY FREIGHT COUPLER Castings (knuckle not included) returned to us, with New Castings, for \$4.00 each.

We will remake and replace all broken or worn-out JANNEY Wrought Iron KNUCKLES returned to us, for \$1.00 each.

Respectfully, **THE McCONWAY & TORLEY CO.**

To prevent, and to some extent correct misunderstanding in regard to the guarantee on Janney Freight Couplers and Janney Wrought Iron Knuckles, we beg to say that our guarantee (see copy above) applies to all broken Janney Freight Couplers and broken or worn-out Janney Wrought Iron Knuckles, wherever and by whomsoever held. It makes no difference whether the railroad company removing a broken Janney Freight Coupler or Janney Wrought Iron Knuckle is a customer of ours or not; we extend the privilege of our guarantee to everyone, and will replace broken material under the terms of the guarantee to anyone who sends to us such broken material.

In sending to us broken Janney Freight Couplers or broken or worn-out Janney Wrought Iron Knuckles for replacement under our guarantee, we respectfully request the observance of the following routine in each transaction:

- I. Ship to us by freight, to reach us via Pennsylvania Lines when possible, our only track connection being with them.
- II. Send us bill of lading, with letter giving number of broken Couplers and Knuckles separately.
- III. Await our report of inspection of material before sending Purchasing Agent's order.
- IV. When our report is received by you, send us Purchasing Agent's order, marked "Replacement."

In explanation of the above, we would say that foreign material, not of our manufacture, and steel knuckles, are frequently sent to us in error, and, as we do not guarantee or replace such material, it leads to confusing and unnecessary correspondence when Purchasing Agent's order is received in advance of our report of material received.

As we keep a sketch of each piece returned to us, you may depend absolutely on the correctness of our reports.

We cannot undertake to combine credits for replacement shipments with charges for new material, and each replacement transaction must be complete in itself on the above outlined system.

Respectfully, **THE McCONWAY & TORLEY CO.**

The JANNEY COUPLERS for Passenger and Freight Cars,
Locomotives and Tenders, are manufactured only by

THE McCONWAY & TORLEY CO.,
PITTSBURGH, PA.

Locomotive and Car Axles,
Coupling
Links and Pins.

M. C. B. Passenger Coupler
Used in Place of Miller Hook
WITHOUT CHANGE IN PLATFORM.

M. C. B. STANDARD
Automatic Freight Car Coupler.

New York Office, . . . 120 Broadway,
Chicago Office, . . . 941 Rookery,
St. Louis Office, 319 Commercial Build'g.

GOULD
Coupler Co.

BUFFALO OFFICE AND WORKS,
AUSTIN ST.

**Gould Continuous
Platform and Buffer,
GOULD VESTIBULE.**



STEEL **ST. LOUIS COUPLER.**

Stands M. C. B. Tests and complies with U. S. law, requiring use of Automatic Car Couplers on and after January 1st, 1895. Thousand of Cars already equipped. Capacity of Works, 200 Couplers per day.

ST. LOUIS CAR COUPLER CO., St. Louis, U. S. A.

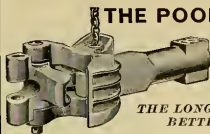

THE POOLEY COUPLER.

**POSITIVELY
AUTOMATIC.**

Made from the Best Material.

*THE LONGER IN SERVICE THE
BETTER IT OPERATES.*

MANUFACTURED BY **PRATT & LETCHWORTH, Buffalo, N. Y.**

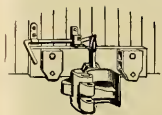

**THE SMILLIE COUPLER is the Strongest and Simplest M. C. B. Coupler.
Only 4 Pieces.**

Tensile Strength (Fairbank's Test) 139,640. Drop Test, 700 lbs. hammer dropped 18 ft. 22 times failed to break the knuckle.

ALL LOCKING PARTS ARE THE BEST OF STEEL.

NEW YORK OFFICE, 39 CORTLAND ST.
Office and Works, 91 Clay St., Newark, N. J.



Strictly
M.C.B.
Lines.

JOHNSTON COUPLER

JOHNSTON CAR COUPLER COMPANY,

204 WALNUT PLACE,

PHILADELPHIA PA.

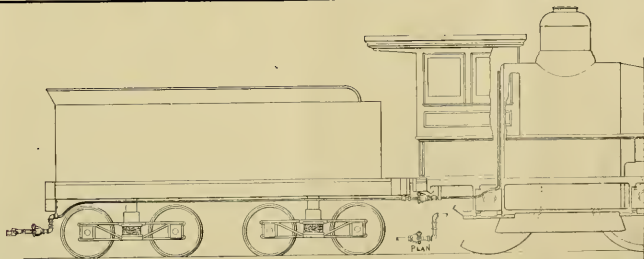

THE HAMPSON FLEXIBLE STEAM JOINT

**Does away entirely with Rubber Hose for
Steam Heating.**

HAS NO GROUND JOINTS.

WESTERN AGENT,
GEO. H. BRYANT,
702 BORT BUILDING,
CHICAGO, ILL.

F. A. BARBEY & CO.,
215 FRANKLIN STREET, BOSTON.



A PERFECTLY CONSTRUCTED METAL BRAKE BEAM.
 The Cheapest, Lightest, and Most Durable.
 NOW STANDARD ON A MAJORITY OF ROADS THROUGHOUT THE COUNTRY.
 General Office and Works: **40th & Hopkins Sts., Chicago.**
 DIST. OFFICE: **NEW TEE OFFICE,**
 314 Phenix Building, Chicago. 39 Broadway, - - - Room 114
 Correspondence solicited. Frazz's G. Exr, Eastern Agent.

ALBANY, N. Y.
 936 Broadway,
 New York City,
 115 BROADWAY.

STEAM COUPLERS
 AND
FIRE PROOF
HEATERS.

CONSOLIDATED
 McElroy, Sewall, Westinghouse and other Patents.
CATALOGUES UPON APPLICATION.
 Special Appliances and Extra Strong Fittings of Every Kind.
 AUTOMATIC CONTROL OF HEAT.
CAR-HEATING CO.

CHICAGO,
 200 Phenix Bldg.,
 Canada,
 COATIDOOK, P. Q.

COMMINGLER,
DRUM,
 AND
DIRECT STEAM
SYSTEMS.



THEIR SUPERIORITY
 IS PROVEN BY
 THEIR POPULARITY.

FINEST SEATS.
 Couch, Parlor Car,
 Sleeping Car,
 Street Car,
 Rattan Elevated

IN USE ON ALL THE
 PRINCIPAL RAILROADS
 IN THE UNITED STATES



THE HALE & KILBURN MFG CO.,

Simplicity,
 Durability,
 Elegance,
 Comfort,
 } Com-
 bined.

IT IS SAFE TO SPECIFY THE
H. & K. SEATS

PHILADELPHIA,
NEW YORK,
CHICAGO.

A. W. ROOPER, Treas. ROBT. ANDREWS, Vice-Pres. A. H. DOWARD, Sec. W. R. THOMAS, Treas. R. M. DIXON, Engineer

THE SAFETY CAR HEATING AND LIGHTING CO..
160 Broadway, New York.

HEATING SYSTEMS.—By hot water circulation and direct steam with regulating devices. Reliable and uniform heat. Economical and rapid circulation. Gibbs automatic coupler of Westinghouse type, absolutely steam-tight.
LIGHTING SYSTEM.—The celebrated Pintsch compressed oil gas method. In use on over 40,000 cars in Europe and America. Adopted by the U. S. Lighthouse Board for lighting Buoys. The best, most economical and only safe light for Railroad purposes. In brilliancy and cleanliness unsurpassed.

The Smith Triple Expansion Exhaust Pipe.



THIS Device is the invention of JOMY Y. SMITH, the originator of the Smith Vacuum Brake. In the cuts of the Front and Side Views shown herewith, "A A" represent Air Passages; "S S" Exhaust Steam Passages, and "B" an Annular Blower forming part of the Nozzle.

It is an entirely new departure in the construction of Exhaust Pipes for Locomotives. Its distinguishing features are that the exhaust steam is not restricted after it leaves the cylinders, and the gases and heated air in the smoke arch are mingled with the exhaust steam in the exhaust pipe. The exhaust steam is thus superheated and expanded, and a powerful, prolonged, pulsating blast is created, which keeps the fuel in a constant state of agitation, and produces more perfect combustion.

Some of the beneficial results obtained are: Reduction of Back Pressure to a minimum (area of nozzle opening as large as the exhaust port); prevention of ejection of sparks from smoke stack; almost complete absence of noise from exhaust; prevention of formation of clinkers in fire-box; large saving of fuel.

By the elimination of Back Pressure we have demonstrated the fact that the power of engines has been increased to be able to pull from thirty to sixty tons more than with any other form of exhaust pipe. The pipe can be used with either straight or diamond stacks, in long or short front ends, and on locomotives burning hard or soft coal, wood or coke.

NEW YORK SALES OFFICE, Rooms 29 & 31, 113 BROADWAY.
GENERAL OFFICE OOYLESTON, PA. **FACTORY—READING, PA.**



THE MURPHY STEEL CAR ROOF.
HAS no surface nail or screw holes. It has no joints where eiders, rails or fire show can get through. It allows for contraction and expansion, and has ample elasticity to provide for sagging, twisting, backing and cornering of the car body. It is as solid as the car frame itself. It has no solder joints. It can be repaired readily, and without taking off more of the roof than is damaged. It is much cheaper than any other metallic roof now in use, and is cheaper than the double board roof, made of good lumber. It is unlike any other metallic roof for the reason that everything is furnished to make it complete; so that the parties for it have no expense other than to apply it.
 This ROOF can be applied on OLD LEAKY BOARD-ROOF CARS without making any changes in the board roof, thereby saving the expense of replacing the old boards with new, and thus utilizing material that most others see thrown away.

Manufactured by the P. H. MURPHY MFG. CO., East St. Louis, Ill.

Skilled mechanics prefer them Live dealers sell them

STARRETT'S

Best in workmanship Finest in finish Latest in improvements

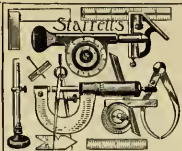

For all workers in metal or wood Every tool warranted satisfactory

FINE TOOLS

Send for Catalogue L. S. Starrett, Athol, Mass.

THE HALL SIGNAL CO.

Leads the World in the manufacture and Installation of

Automatic Block Signals

Operated by either Track or Wire Circuits.

The ONLY Automatic Signal Systems in which the signals can be operated on the "Normal Danger" principle. Believed by many to be the best and safest plan.

HIGHWAY CROSSING SIGNALS,
STREET RAILWAY CROSSING SIGNALS, ETC.

OFFICES:

- 80 Broadway, New York.
- 927 The Rookery, Chicago.
- 115 The Ames Building, Boston.
- Equitable Building, Baltimore.

The New "NATHAN" MONITOR INJECTORS FOR LOCOMOTIVES.

"NATHAN" SIGHT-FEED LUBRICATORS, For Locomotive Cylinders and Air Brakes
STEAM FIRE EXTINGUISHERS. For Switching and Yard Engines

BOILER WASHERS. Road and Guide Oil Cups, etc.

Send for DESCRIPTIVE CATALOGUES.

NATHAN MFG. CO., 92 & 94 Liberty St., NEW YORK.

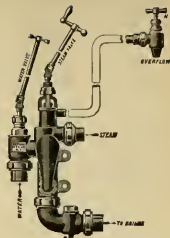

TAYLOR BEST YORKSHIRE STAYBOLT IRON

Axles, Piston Rods, Crank Pins and Forgings of all Descriptions, used by Leading Railroads.

R. MUSHET'S SPECIAL AND TITANIC STEELS

SOLE REPRESENTATIVES IN THE UNITED STATES,

B. M. JONES & CO.,

BOSTON, 11 and 13 Oliver Street. NEW YORK, 143 Liberty Street.

Boiler, Locomotive AND Smoke Stack STEELS.

FIRE BOX STEEL.

PURITY, DUCTILITY AND SOFTNESS.

QUALITY UNSURPASSED

STEEL.

Plates up to 100 ins. in width.

SHOENBERGER & CO., PITTSBURGH, PA.

HOWARD IRON WORKS, BUFFALO, N. Y. MANUFACTURERS OF

BOLT CUTTERS

-AND- NUT TAPPERS.

Send For Price Lists.

New York. Boston. Chicago.

HOWE, BROWN & CO., (Limited) PITTSBURGH, PA.

STEEL.

HOWE'S SPECIAL TOOL CAST STEEL for Taps, Dies, Reamers, Cutters, Fanches, Chisels, Drills, Shear Blades, Lathe Tools, etc., etc. Crucible Spring Cast Steel, Crucible and Open Hearth Firebox and Sheet Cast Steel, Forgings, etc.

POWER

A MONTHLY JOURNAL devoted to Steam Engineering and Practical Work relative to the Economic Generation and Transmission of Power. 32 to 64 pages, size of this paper, profusely illustrated. Price, \$1.00 a year. Send for Sample Copy—FREE. Address: THE POWER PUBLISHING CO., WORLD BUILDING, NEW YORK.

LOCOMOTIVE ENGINEERING, N.Y.



Is the most interesting and profitable publication. Always interesting, always practical, and containing the best of illustrations. For \$2.00 you get three.

EDUCATIONAL CHARTS FREE.

One of the Traveling Engineers' Examination Charts, has explained valve and piston and crank mechanism in various positions and is answered by sliding the plates and pins in proper position. Another is a picture of the "in" inspection—you see and everything in size and motion, and every part is explained the quick before slide valve, leading to the piston and valve gear and the injector.

stand with this. The price for you and those three this subscription for a \$2.00. Address: LOCOMOTIVE ENGINEERING, 5 Lockman St., New York.

The Sample Tells the Story.

A sample of Dixon's pure, flake lubricating Graphite, with interesting and instructive pamphlet.

Send Free of Charge.

Every engineer and machinist should make himself better acquainted with Dixon's Pure Ticonderoga Flake Graphite. It will save both time and labor, and is infinitely superior to the common forms of plumbo or black lead.

JOS. DIXON CRUCIBLE CO., JERSEY CITY, N. J.

THOMAS PROSSER & SON,
15 GOLD STREET,
NEW YORK.



STEEL TIRES

ON LOCOMOTIVE DRIVING WHEELS
AND ON STEEL-TIRED WHEELS
GIVE THE BEST RESULTS
FOR EVERY VARIETY OF SERVICE.

The CAST-STEEL WORKS of FRIED. KRUPP, Essen, Germany, cover an area of 1,200 acres, employ about 25,000 men, have the most improved plant, and stand unique, from the fact that they have their own Ore and Coal Mines, Blast Furnaces, etc., and that every stage of manufacture is under their own supervision, and are not (like others) dependent on the open market for a miscellaneous assortment of crude material: which, in connection with 75 years' experience, enables them to turn out a product of a very superior quality, second to none, and at the same time the different grades of Steel are always of the same uniform quality.

Crank Pins, Piston Rods, Spring Steel, Steel-Tired Wheels, Etc.

After a test of over 35 years, the "KRUPP TIRE" has proved itself the best in the market. If a reliable article is wanted, which will give satisfaction, get KRUPP'S.

SCHENECTADY LOCOMOTIVE WORKS, SCHENECTADY, N. Y.

LOCOMOTIVES
OF
STANDARD
DESIGN
FOR ALL
CLASSES OF
SERVICE.



OR FROM
DESIGNS
FURNISHED
BY
RAILROAD
COMPANIES.

EDWARD ELLIS,
President.
WM. D. ELLIS,
Vice-President and Treas.

A. J. PITKIN,
Superintendent.
A. P. STRONG,
Secretary.

COMPOUND LOCOMOTIVES, Showing an Economy of 15 to 30 per cent. in Fuel and Water, Annual Capacity, 400.

M. L. HUNMAN, Pres. and Treas. DAVID ROSSER, H. TAYLOR,
J. H. REYNOLDS, Asst. to the Pres. Mgr. Asst. Supt.
E. J. GIBSON, Vice-Pres. W. M. HANCOCK, Secretary.



Brooks Locomotive Works, DUNKIRK, N. Y.

Builders of Locomotive Engines for any required service from our own designs or those of purchasers.
Perfect interchangeability and all work fully guaranteed.

COMPOUND LOCOMOTIVES

FOR PASSENGER AND FREIGHT SERVICE.

Latrobe Steel Works MANUFACTURERS OF

TIRES

FOR LOCOMOTIVE and CAR WHEELS.

Main Office and Works, Latrobe, Pa.
Branch Office, Rollit Building, Philadelphia.
Chicago Office, Western Union Building.
New York Office, Home Insurance Building.

William Sellers & Co. Incorp.
PHILADELPHIA, PA.

MACHINE MODERN TOOLS

for Railroad Shops, Car Builders, Etc.

HIGH SPEED
TRAVELING & SWING CRANES.

ALSO
TURNTABLES, INJECTORS,

SHAFTING,

ETC., ETC.



"LACKAWANNA"

Sight Feed Locomotive
Cylinder Lubricator.

ABSOLUTE UNIFORMITY OF FEED.

Perfect distribution of oil to both cylinders from one feed glass, and entire efficiency under all working conditions.

Only One Glass,

and that short and stout; almost unbreakable. Absolutely no use for any more. They are an unnecessary source of trouble and danger.

Write for full particulars.

LACKAWANNA LUBRICATING CO.,
1212 Capouse Avenue, Scranton, Pa.



INSPECTION!

Is the safeguard for boilers. Inspect your stay bolts while boiler is under pressure. Use hot water for hydraulic test—expands the parts as in service. One jet application washes out and fills boiler with hot water, no foundation required, no floor space. One-quarter the size and one-quarter the price of pump. Efficiency guaranteed.

RUE MANUFACTURING CO., 119 N. NINTH ST., PHILADELPHIA

J. S. HENDRICKSON, PRES.
F. J. CLAMER, VICE-PRES.
W. R. NEISON, SEC. AND TREAS.

"AJAX BEARINGS: RECORD 90 MILES AN HOUR."

"EMPIRE STATE EXPRESS. N.Y.C. & H.R.R.R."

AJAX METAL CO.
INCORPORATED.
PHILADELPHIA, PA.

BALDWIN LOCOMOTIVE WORKS' Standard-Gauge Locomotive FOR IMMEDIATE DELIVERY.



Cylinders, 17" x 31"; driving-wheels, 60" diameter; tires, steel, 3" thick; total wheel-base, 22' 2"; driving-wheel-base, 8' 3"; weight in working order, 84,000 pounds; weight on driving-wheels, 58,000 pounds; boiler, 52" in diameter; fire-box, 69 1/2" x 34 1/2"; flues, 188 in number, 2" diameter, 10' 11" long; chilled cast-iron truck wheels, 38" diameter; tender of 3,000 gallons capacity; 33' chafed cast-iron wheels; driving journals, 7" x 8"; truck journals, 4 1/2" x 7 1/2"; tender journals, 3 1/2" x 7". Engine is fitted with Nathan sight-feed lubricator; balanced slide-valves; two No. 7 Friedman-Monitor injectors; height-light; Westinghouse automatic air-brakes on driving and tender-wheels; Jauncey coupler, and all necessary tools.

For Price and Particulars, address, **BURNHAM, WILLIAMS & CO., PHILADELPHIA.**



Pittsburgh Locomotive Works.

PITTSBURGH, PA.,

Manufacturers of LOCOMOTIVE ENGINES

For Broad or Narrow Gauge Ponds

From standard designs, or according to specifications, to suit purchasers.

Tanks, Locomotives or Stationary Boilers

FURNISHED AT SHORTEST NOTICE.

WILSON MILLER, Jr. & T. A. WIDEMAN, Supt.

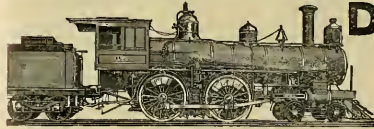

DICKSON MANUFACTURING CO.

SCRANTON, PENN.

Locomotives of every style and size, Standard and Narrow Gauge, made to Standard Gauges and Templates Also for Electricians, Miner and Engineer.

SPECIFICATIONS ON APPLICATION.

JAS. P. DICKSON, President.

R. W. WESTON, 7-9th, Wm. H. PERKINS, Sec. & Treas.

JOHN DODDING, Superintendent.

ROGERS LOCOMOTIVE COMPANY

OF PATERSON, N. J.

New York Office, 44 Exchange Place.

MANUFACTURERS OF

LOCOMOTIVE ENGINES AND TENDERS,

And Other Railroad Machinery.

R. S. HUGHES, President.

G. B. HANNAH, Treas. G. B. LONGFOTTON, Sec'y.

REUBEN WELLS, Superintendent.

PORTLAND CO. PORTLAND, ME. LOCOMOTIVES OF ALL TYPES.

INCORPORATED 1846.

STANDARD OR NARROW GAUGE FOR ANY SERVICE FROM OUR OWN OR TO RAILROAD CO.'S SPECIFICATION.

Freight Cars, Derrick Cars, Push Cars and Car Wheels, Boilers of Locomotive, Horizontal, Tubular and Vertical Type

FRANKLIN C. PAYSON, President JAMES E. GREENSMITH, General Manager BYRON D. YERRILL, Treasurer.



Richmond Locomotive AND MACHINE WORKS,

RICHMOND, VA.

Locomotives for Every Service.

ESTABLISHED 1865.

PAUL S. REEVES, Philadelphia. PHOSPHOR BRONZE IN INGOTS AND CASTINGS. LOCOMOTIVE AND CAR BEARINGS. A SPECIALTY. BRASS and PHOS. BRONZE CASTINGS from 1/4 lb. to 5,000 lbs. in WEIGHT.

COOKE LOCOMOTIVE AND MACHINE CO. PATERSON, N. J. (Formerly Danforth Locomotive & Machine Co.)



JAMES S. COOKE, President & Gen. Mgr. PATERSON, N. J. JOHN W. COOKE & Vice-President. WM. BRIDAN, Sec'y & Treas.

New York Office, 45 HERRADEN AV. H. A. ALLEN, Agent.

CROSBY POP SAFETY VALVES,

MUFFLED AND PLAIN. IMPROVED STEAM GAGES. Single Bell CRIME WHISTLES.



A perfect equipment for a locomotive, give the following details: Economy and standard accuracy under all operating conditions.

Crosby Steam Gage & Valve Co. BOSTON, MASS. BRANCHES: New York, Chicago, and London, England.



FULLMAN SLEEPERS on Night Trains. ELEGANT PARLOR CARS on Day Trains. DINING CARS between Cincinnati and Chicago. Wm. H. GREENE, General Manager. E. G. EDWARDS, Gen'l Pass. Agt., CINCINNATI, OHIO.

TRACK SANDING APPARATUS FOR LOCOMOTIVES

HENRY L. LEACH, (Successor of PROSSER) BOSTON, MASS., Room 46, Mason Building, 70 Kibby Street.

Our Lath Engravings are made by the wax process, a plan securing accuracy and distinct lines on original copper plates. They are made by BRADLEY & POATES, 251 William Street, New York City.

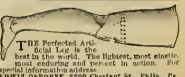

THE Perfect Art. Best in the world. The lightest, most elastic, most enduring and best in action. For special information address: EDWIN OSBORNE, 7508 Chestnut St., Phila., Pa.

Rhode Island Locomotive Works, PROVIDENCE, R. I.

CHARLES FELIX MASON, President. EARL PHILIP MASON, Vice-President. WILLIAM P. CHAPIN, Treasurer. ARTHUR LEVINGSTON MASON, Secretary. JOSEPH LYTHGOE, Agent and Supt. S. A. STEPHENS, Traveling Agent.

NEW YORK OFFICE, Nos. 31-33 Pine Street.

D. O. SETTLEMIRE, President.

GEO. W. EVANS, Vice-President.

W. C. ARTHURS, Secy. and Treas.

FRANK SUTHER, Supt.

Mt. Vernon Car

MANUFACTURERS OF
FREIGHT CARS OF EVERY DESCRIPTION, GAR-
BOOSE AND REFRIGERATOR CARS,
M. T. VERNON,



Manufacturing Co.

CAR WHEELS, CAR CASTINGS, AND GENERAL
FOUNDRY WORK.

Capacity, 15 Cars and 300 Car Wheels,
ILLINOIS.



MILLER'S ASBESTONE CAR ROOF.

HEAVY, DURABLE AND STRONG. **THE COMING ROOF.**
WILL WEAR LONGER THAN ANY METAL ONE. **WILL WEAR THE LIFE OF THE CAR.**
Costs from \$10 to \$15 Less per Car.
CAN BE PUT ON IN ONE-HALF THE TIME.

HEAR WHAT THEY SAY ABOUT IT:
Genl Warr - N. E. & T. Ry. Down East - Boston & Albany R.R.

1302 HAVEMEYER BUILDING, 28 Cortlandt Street, NEW YORK.

THE ALLISON MFG. CO.,
MANUFACTURERS OF
**FREIGHT CARS AND
LOCOMOTIVE BOILER TUBES.**

WROUGHT IRON PIPE OF SUPERIOR QUALITY.

PHILADELPHIA, PA.

DRAKE & WEIRS, Cleveland, Ohio.

ASPHALT CAR ROOFING

The Cheapest, Heat and Frost Durable Car Roof Known. In use by Seventy
Railroads. Twelve years successful use without a single failure. A new roof furnished free for
every one that falls in ten years.



WILLIAM C. BAKER,

Sole Proprietor and Manufacturer of

THE FIRE-PROOF BAKER CAR HEATER

MADE OF FLEXIBLE STEEL
ONE-QUARTER INCH THICK.

Firmly Welded into One Compact, Jointless, Seamless Whole.

FIRE WITHIN A SAFE OF SAFE MATERIAL
AS THE EXPRESS CAR SAFE.

The Only Alternative for the Deadly Car Stove
AND THE EQUALLY VICIOUS AND EXPENSIVE STEAM HEAT.

NEARLY 1000 FIRE-PROOFS IN USE.
ALL OTHER STYLES OF "BAKER HEATERS."

143 LIBERTY STREET, NEW YORK.

JEROME METALLIC PACKING.

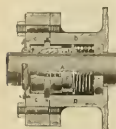

This is the Standard Metallic Packing all over the world, and is more generally
adapted and in use on more locomotives than any metallic packing in use. Give the
JEROME a trial and be convinced. Put it in competition with any other packing
and be convinced of its superior merits.

Office and Works, Nos. 35 and 37 Canal St., Chicago, Ill.

C. C. JEROME, Inventor and Proprietor.

Packing ring opened
ready to apply without
disconnecting the Piston
from the crosshead. It
runs longer and wears the
rod less than any other
packing in use.



SEND FOR CATALOGUE.

THE TROJAN CAR COUPLER CO., Troy, N. Y.

M. C. H. TYPE.

THE STRONGEST AND THE ONLY SAFETY COUPLER.

New York Office: 49 WALL ST.

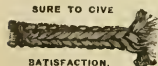

SURE TO GIVE

SATISFACTION.

DUVAL METALLIC PACKING

Send for Catalogues, Prices and detailed information to

THORNTON N. MOTLEY & CO.,

SOLE AGENTS,

43 John Street, NEW YORK.

Graham's Patent Groove Shank Twist Drills and Chucks.



DETROIT TWIST DRILL CO., Detroit, Mich., U. S. A.

KEEP YOUR PAPERS CLEAN.

Binders that will hold a full year's
numbers for sale.
PRICE, \$1.00, POSTPAID.

LOCOMOTIVE ENGINEERING,
5 Beaman Street, New York.



THE CHAPMAN JACK.

PATENTED.
THE screw being fabricated and protected, the Jack is always
ready for instant service. Railroad men appreciate the im-
portance of having Jacks always in good working condition.
Serious delays frequently occur in getting common Jacks so this
type can be worked when suddenly required in train service.

Common Jacks are frequently destroyed in efforts to sink
them work quickly after the screws are set with rust and dirt.
This consideration alone makes the Chapman Jack the most
economical one to purchase.

THE CHAPMAN JACK CO., CLEVELAND, OHIO.



THE ONLY DOUBLE TRACK RAILWAY

BETWEEN

CHICAGO AND THE EAST.

Warmer Sleeping Cars, Drawing Room and Private Compartment Cars between Chicago
Tulsa, Cleveland, Buffalo, Rochester, Syracuse, Albany, New York, Boston
and intermediate points.

Route of the NEW YORK AND CHICAGO LIMITED, BOSTON AND CHICAGO
SPECIAL, and the U. S. FANT MAILS.

W. D. CASPARY, Gen'l Supt.

CLEVELAND, O.

A. J. SMITH, G. P. & T. A.

Charcoal Iron
Boiler Flues

THAT DO NOT PIT

ARE MANUFACTURED BY
THE TYLER TUBE AND PIPE CO.
WASHINGTON, PA.

New York Office, 39 Cortlandt St.

REQUIRES NO ATTENTION.

IN USE ON THREE HUNDRED AND FIFTY RAILROADS.

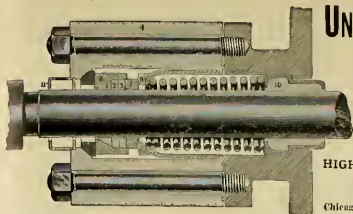

UNITED STATES METALLIC PACKING CO.

For Locomotives, Stationary and Marine Engines,

The United States Metallic Packings

HAVE STOOD THE TEST OF YEARS AND ARE ACKNOWLEDGED TO BE SUPERIOR TO ALL.

Renewal of Packing Rings made without disconnecting, by cutting them in halves and breaking joints.

HIGHEST AWARDS COLUMBIAN AND PARIS EXPOSITIONS.

General Office, Bullitt Building; Works, 427 N. 13th St., Philadelphia, Pa.

Chicago, Rotunda, Grand Pacific Hotel.
San Francisco, 130 Main Street.

St. Louis, 32 Laeche Building.
Montreal, Canada, 751 Craig Street.

Swab and Oil Caps Furnished with every Packing.

SEND FOR CATALOGUE AND SPECIFICATIONS.

RODGER BALLAST CARS.

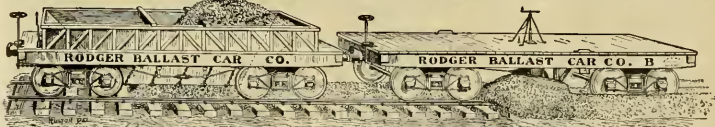

These cars are 14 feet long, and are built either 30,000 or 50,000 lb. capacity, N. C. B. standard. They carry from 10 to 20 cubic yards of gravel or broken stone in using them no ballast is thrown in the ditch, and none is wasted, as the precise amount of ballast needed can always be discharged. A train of 20 cars, carrying 500 yards of ballast can be unloaded and the ball set distributed, leaving the track perfectly cleared and leveled, as shown in the cuts, in from 12 to 15 minutes. This is all done by the regular "train service" (a conductor and two brakemen) no extra help being required. The track is perfectly cleaned by the spreader, so that a train can immediately pass over it at any raised speed, without meeting any obstruction. No aprons are needed, no wire cables are used. There is no shoveling ballast from between the cars, and no cleaning the track with shovels. The ballast is left to travel the ties and on their ends, directly in position for tampling, when the track is raised, without being shoveled in from the ditch. The average saving per mile, in the amount of ballast needed to make a "mile" of 10 or 12 feet, will be about 200 yards, and often far exceeds this. The total saving per mile in material, labor, time, use of cars, saving in transportation, etc., is found to amount, in gravel, to from \$20 to \$40, and in broken stone it often amounts to \$50.

These cars are in use on the Great Northern Ry., the Illinois Central, the Gulf, Colorado & Santa Fe, the Chicago & Eastern Illinois, the Penn. Lines West, and other roads.

Detailed information will be furnished by circular by addressing the

RODGER BALLAST CAR COMPANY, No. 1215 Monadnock Building, CHICAGO, ILL.



SCHOEN MFG. CO.

PRESSED
STEEL MATERIAL
FOR CARS.

PITTSBURGH,
PA.

MATCHLESS VALVE AND CYLINDER OIL.

Warranted not to corrode the iron or destroy packing, and to make more mileage than tallow or lard. Sold only to Railroad Companies direct or through our authorized agents. Matchless Cylinder Oil cannot be Bought of Dealers. In use on 60 Railways.



OILS FOR RAILROAD USE A SPECIALTY.

ECLIPSE LUBRICATING OIL COMPANY, Limited,

MANUFACTURERS OF EVERY PRODUCT OF PETROLEUM.

Head Office: FRANKLIN, Pa.

Refiners: FRANKLIN, Pa.

OLEAN, N. Y.

ERIE, Pa.

OIL CITY, Pa.

OPEN HEARTH STEEL **CAMBRIA** COFFIN TOUGHENED

CAMBRIA IRON COMPANY,
Office 218 SOUTH 4TH ST. PHILADELPHIA, PA.

Driving, Truck, Passenger and Freight
Axles, Piston and Side Rods, Crank Pins.

WORKS AT JOHNSTOWN, PA.

STEEL BEFORE TOUGHENING

COOLBAUGH & POMEROY
SPECIAL R. R. SALES AGENTS.
29 BROADWAY
NEW YORK.

STEEL AFTER TOUGHENING

TOUGHENED BY COFFIN PROCESS, PATENTED

OPEN HEARTH COFFIN PROCESS TOUGHENED

CAMBRIA STEEL



PORTABLE CYLINDER BORING MACHINE.

For boring IN THEIR PRESENT POSITIONS all makes and sizes of Steam Engine Cylinders, LARGEST SIZE OF LOCOMOTIVE CYLINDERS, Compound Locomotives, Pumps, Steam Hammers, Air Compressors, Mining and Hoisting Engines, Heavy Housings, Large Wheels, etc. Machines made any size required. Circulars with full description on application.

HENRY C. AYER & GLEASON CO.,

Office and Works, N. E. cor. 2d and Diamond Sts., Philadelphia, Pa.

Central Office, No. 919 Betz Building, Philadelphia, Pa.

THE ROTARY.

For full Particulars, Address

The Leslie Bros. Mfg. Co., Paterson, N. J.

LOCOMOTIVE SPRINGS

WITH PATENT V SHAPE BANDS.

Gives more Elasticity to short Plates and Better Riding Qualities.



MANUFACTURED BY
A. FRENCH

SPRING CO.

A. FRENCH, Pres.
J. E. FRENCH, Vice-Pres.

GEO. W. MORRIS, Gen. Mgr.

D. C. NOBLE, Sec. and Treas.
P. N. FRENCH, Gen'l Supt.

A. FRENCH SPRING CO.
PITTSBURGH, PA.
Manufacturers of
ELLIPTIC AND SPIRAL SPRINGS
OF ALL DESCRIPTIONS.

PEERLESS ENGINE AND TENDER HOSE CONNECTION.

Air Brake Hose Guaranteed for 3 years.

Steam Hose for Car Heating.
Wonderful Steam Resisting Qualities.

E. L. PERRY, Pres. W. G. WINANS, Treas.



C. H. DALE, General Manager.

THIS HOSE is known as our ANACONDA brand. It is corrugated, made of three and four plies of duck, with a wire inserted to prevent it from collapsing or kinking, thereby making it impossible to break or shut off injectors when rounding a curve or striking a low joint. It is made any shape or length required. The outside is covered with a canvas jacket or covering to prevent oil, grease, etc., from destroying the hose. This hose is thought by many of the master mechanics of our large railroads to be the ideal hose for engine and tender connections.

MANUFACTURED EXCLUSIVELY BY

THE PEERLESS RUBBER MFG. CO.,

No. 16 WARREN STREET, NEW YORK.

THE

HAYDEN & DERBY MFG. CO.,

Sole Manufacturers of

Metropolitan Double-Tube Locomotive Injectors

These Injectors work at all steam pressures from 25 pounds up to 250 pounds without any regulation or adjustment.

It is impossible for the water to run out of the overflow when Injector is working.

They are not affected by leaky steam or check valves.

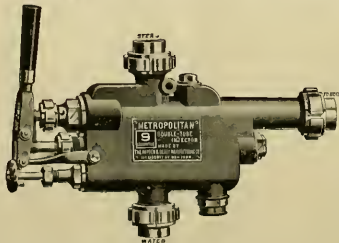

Owing to the peculiar form of nozzles used, repairs of these Injectors are reduced to a minimum. They are very slightly affected by bad water, there being no small relief holes or spills to wear or become clogged.

MADE INTERCHANGEABLE WITH STANDARD MAKES.

Office and Salerooms:

Nos. 111 and 113 LIBERTY STREET, NEW YORK.

BEMENT, MILES & CO., PHILADELPHIA, PA.

BUILDERS OF

METAL-WORKING MACHINE TOOLS,

For Railroad Shops, Locomotive and Car Builders, Machine Shops, Steam Forges, Ship Yards, Boiler Shops, Bridge Works.

STEAM HAMMERS FOR WORKING IRON OR STEEL.

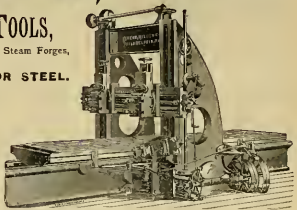
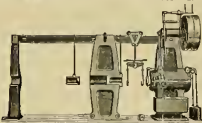

NEW YORK OFFICE: EQUITABLE BUILDING.

GEORGE PLACE, Agent.

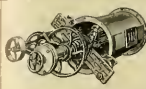

Portable Cylinder Boring Machine.

For boring in their present positions all kinds of steam Engines, Cylinders, Pumps, Steam Hammer, Air Compressor, Mangle and Hoisting Engines, Heavy Housings, Large Wheels, etc.

Machines made any size required. Recently adapted for Compound Engines.

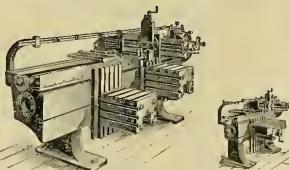

RICHARDS' PATENT OPEN SIDE PLANING AND SHAPING MACHINE.

CRANK-PIN MACHINE.

For turning of Crank-Pins, in position, to replace the original centers of the Piston.



VALVE-SEAT PLANER.

Over 600 in use.



PEDRICK & AYER CO.

1001 & 1003 Hamilton St., PHILADELPHIA, PA.

SPECIAL TOOLS FOR RAILWAY REPAIR SHOPS.

Special Catalogue Mailed on Application Explaining Tools in Detail.

Nicholson's Expanding Lathe Mandrels.

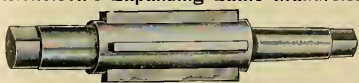

Set of 9 takes from 1 in. to 7 in. Set of six from 1 in. to 4 in.

Either Set sent subject to Thirty Days Trial, and Guaranteed Absolutely Accurate and Labor Saving. Send for catalogue for full description and references.

GEORGE L. WEISS, General Agent, 130 INGLESDALE AVENUE, CLEVELAND, OHIO.

THE PRATT & WHITNEY CO., Hartford, Conn., U. S. A.

SINGLE AND DOUBLE HEAD MILLING MACHINES used as Substitutes for Planers for Heavy and Rapid Cutting in Cast and Wrought Iron and Steel.

TURRET-HEAD MACHINES AND TOOLS for Turning, Forming and Threading Irregular Pieces of Circular Cross-section in Brass, Iron and Steel.

METAL HAND SAWING MACHINES for Cutting Spruces from Brass Castings.

MILLING CUTTERS, HOLDERS, with Inserted Cutters for Turning, Shaping and Threading Metals. SPIRAL SHEAR PUNCHES.

CATALOGUE L SENT ON APPLICATION.

THE INEVITABLE RESULT OF USING INFERIOR STAYBOLT IRON IN THE CONSTRUCTION OF THE MODERN, HIGH PRESSURE LOCOMOTIVE BOILER.



To AVOID EXPLOSIONS and consequent GREAT LOSS OF LIFE AND PROPERTY, use the

SAFETY HOLLOW STAYBOLT,

MANUFACTURED BY THE CALLS HOLLOW STAYBOLT CO., CINCINNATI, O.

Patented in all states from 1/4 to 2 in., outside diam with any size hole required from 1/4 to 3/4 in.

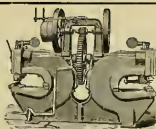

The Long & Allstatter Co. HAMILTON, OHIO.

Double, Single, Angle-Bar, Gang, Horizontal, Twin, Boiler, Spacing, Gate, Multiple, Belt, and Steam Driven Punches & Shears OVER 300 SIZES.



THE ACME MACHINERY CO. CLEVELAND, OHIO.

Manufacturers of ACME BOLT & RIVET HEADERS ACME SINGLE AND DOUBLE AUTOMATIC BOLT CUTTERS, Cutting from 1/4 in. to 6 in. diam. Also, SPANISH HEADS and DISKS.



BEATS THE MONKEY-WRENCH OUT OF SIGHT!

OUR ROUND END MONKEY-WRENCH, PATENT No. 2 is the best found. Its broadened steel jaws and handy adjuster prevent slipping & keep hold when once set and you can get it on in one-half-way places, and take off in any without making jaws slip, and when you can't get it on an eighth of a turn with the ordinary monkey-wrench it will take hold close up where the old wrench can't get. This prevents gnawing, fibrous ends and parts ground down. A thousand places for it around a locomotive where it can save time and money. Will send a Catalogue Free.

THE KEYSTONE MFG. CO., 312 TERRACE, BUFFALO, N. Y.

FLAT TURRET LATHE



TURNS STRAIGHT AND TAPER FRAME BOLTS, ETC.

SEND FOR A COPY OF "RAPID LATHES WORK."

By New Method - Harless System. JONES & LAMSON MACHINE CO., SPRINGFIELD, VERMONT, U. S. A.



THE CLEVELAND VARNISH CO. Mfrs. RAILWAY VARNISHES. CLEVELAND, O.

RAMAPO WHEEL AND FOUNDRY CO.



BOLTLESS STEEL-TIRED WHEELS

FOR PASSENGER AND LOCOMOTIVE SERVICE.

Tires with Annular Web and Hook,
Best Charcoal Iron Double-Plate or Spoke Centers,
Wedge-Shaped Retaining Ring.

Continuous
Circumferential
Fastenings.



SIMPLE, +
SAFE, +
ECONOMICAL.

CHILLED IRON WHEELS

OF SUPERIOR QUALITY,
Driving Boilers, Passenger and Freight Cars,
Locomotives, Tenders, Flatcars,
and Hvy Cars.
CINDER PARKING RINGS.

CONDONG BRAKE SHOES

FOR CHILLED IRON WHEELS.
Outwear from 4 to 6 ordinary
shoes and enhance
mileage.

Office and Works: RAMAPO, N. Y.

RAMAPO IRON WORKS, Hillburn, N. Y.,

Brake Shoes for Steel Tired Wheels.

ROSS, for Steel Tired Car and Tender Wheels,
ROSS-MEEHAN, for Locomotive Drivers,
SHEPPARD, for Blind or Bald Tired Drivers.

NARROW GAUGE CARS, SWITCHES, AUTOMATIC STANDS,

YOKED, BOLTED and SPRING RAIL FROGS,
CROSSINGS, TRACK EQUIPMENT,

RAILROAD AND MACHINERY. CASTINGS, HEAVY AND LIGHT.

C. E. ROOD. ROOD & BROWN, H. M. BROWN,
CAR WHEEL WORKS,
BUFFALO, N. Y.

Railroad, Car, Engine, Tender and Track Wheels, Made from Best Charcoal Iron.
Office and Works: HOWARD and THOMAS STS.

C. M. FARRAR. JOHN TRUETT, C. E. ROOD,
EAST BUFFALO IRON WORKS,
FARRAR, TRUETT & ROOD, PROPRIETORS.

GREY IRON CASTINGS
of every description. Special Attention Given to Car and Locomotive Work.
Works: N. Y. City, 4th Ave. Broadway; Chicago, 160 Perry St., Buffalo, N. Y.

C. E. ROOD, MANUFACTURER OF
MALLEABLE IRON,
QUALITY GUARANTEED.
RAILROAD WORK A SPECIALTY.
Office and Works: LANCASTER, NEW YORK.

INSTRUCTION & MAIL GALENA OIL WORKS,

IN ARCHITECTURE, ARCHITECTURAL DRAWING, PLUMBING, HEATING & VENTILATION, MECHANICS, MECHANICAL DRAWING, BRIDGE ENGINEERING, ELECTRICAL ENGINEERING, SURVEYING AND MAPPING, MINING, ENGLISH BRANCHES, and

Galena Engine, Coach and Car Oils, the Standard Lubricating Oils of America.
SAFETY, SPEED and ECONOMY are the results of the use of Galena Oils. COLA TEST is in full effect. These oils do not freeze in the coldest weather, will last for an indefinite time, and are made from the use of carbon oils that is an entire freedom from bad acids, except those that are removed by the application of Galena Oils as standard railway oil. The fact that the same tests have shown oils to last that would have lasted for years ago, is an evidence of their superiority. These oils are sold and addressed by mail and Galena Oils are in exclusive use upon three leading lines from New York, thus demonstrating their superior merit, and upon one continuous line from the City of New York to New York, thus demonstrating their superior merit, and upon one continuous line from the City of New York to New York, thus demonstrating their superior merit. We also furnish our customers SIBLEY'S PERFECT VALVE OIL, which is also used exclusively upon a majority of the leading railways of America.

RAILROAD ENGINEERING.

Diplomas awarded. To begin students need only know how to read and write. Send for FREE Circular of Information stating the subject you think of studying to

The Correspondence School of Mechanics and Industrial Sciences, SCRANTON, PA.

4000 STUDENTS.

OUR ENGRAVINGS.
Of late we have had a great many inquiries as to who made the fine half-toner plates shown each month in LOCOMOTIVE ENGINEERING. Credit is due the expert engraver and we are glad to recommend the engravers of our plates to those wanting good work at reasonable prices. All are half-toner and reproductions we use are made by the STRAUB ENGRAVING & FINISHING CO., 607 & 609 Sanson St., Philadelphia, Pa. STICKLER & HILL,

GALENA OIL WORKS, Limited.
CHARLES MILLER, President,
Chicago Branch Office, Franklin, Pa.
Phoenix Building, 18 Jackson St.

SIGNAL OIL WORKS, LIMITED, FRANKLIN, PA.

MANUFACTURERS OF
SIBLEY'S Perfection VALVE OIL,
The only perfect Locomotive Valve Lubricant.
J. C. SIBLEY, Prest.

HENRY CAREY BAIRD & CO., Industrial Publishers, Bookseellers and Importers.
810 WALNUT ST., PHILADELPHIA.
For the name and Revised Catalogue of Practical and Scientific Books, or for the name and price of any book of Science applied to the Arts, writing or printing, send the name of the book and the name of the publisher to the nearest branch office.

THE WASHBURN Car-Wheel Company, HARTFORD, CONN., MANUFACTURERS OF CRUCIBLE STEEL-TIRED WHEELS

For Parlor and Sleeping Cars, Passenger Coaches, Locomotive and Tender Tracks.

President, IRA DIBCOCK. Treasurer, J. L. OTIS.
Established 1867. Capital \$100,000.

NORTHAMPTON Emery Wheel Co.

MANUFACTURERS OF PATENT SOLID EMERY and CORUNDUM WHEELS and MACHINERY.

LEEDS, MASS., CHICAGO OFFICE, 20 South Canal St. Send for Catalogue.

Books for Railroad Men.

LOCOMOTIVE ENGINE RUNNING and MANAGEMENT. By ARTHUR NICHOLAS. Price, \$2.00.
INDICATOR PRACTICE. By FRANK P. HERMANN. Price, \$2.00.
ELEMENTS OF MECHANICS. By T. H. GARDNER. Price, \$2.50.
PROGRESSIVE EXAMINATIONS FOR ENGINEERS AND FIREMEN. By JOHN A. HILL. Price, 50 cents.
AIR-BRAKE PRACTICE. By J. K. PURLES. Price \$1.00.
COMPOUND LOCOMOTIVES. By A. T. WOOD. Price, \$2.00.
CATECHISM OF THE LOCOMOTIVE. By M. N. FORDY. Price, \$2.50.
SIMPLE LESSONS IN DRAWING FOR THE SHOP. By O. H. REYNOLDS. Price, 50 cents.

Send price of any of these or of any other books of THE ENGINEERING LITERATURE COMPANY, East Orange, N. J., and they will be promptly mailed to any part of the world. Send for Catalogue.

Books You Want.

"LOCOMOTIVE RUNNING REPAIRS." by L. C. HERR, Chief Mechanical Foreman "New" Shops. A practical treatise on running repairs, by a practical man. Numerous diagrams and illustrations. Work which is needed by men who handle and repair locomotives.

"SIMPLE LESSONS IN DRAWING," by ORVILLE H. BIRNBAUM, Chief Draftsman Northern Pacific Railway. A splendid book shows how to learn the elementary principles of mechanical drawing and sketching.

"PROGRESSIVE EXAMINATIONS OF LOCOMOTIVE ENGINEERS AND FIREMEN," by JOHN A. HILL, Editor LOCOMOTIVE ENGINEERING. An excellent little book for new engineers. An excellent text-book. Three hundred questions and the answers. Seventeen colored plates showing position and color of all signals carried on engines and trains according to standard code.

Send 50c. for any of the above to
DEBS PUB. CO., TERRE HAUTE, IND.

Locomotive Engineering



A Practical Journal of Railway Motive Power and Rolling Stock.

PUBLISHED BY ARTHUR HILLMAN AND JOHN A. HILL.

VOL. VII, No. 7.

NEW YORK, JULY, 1894.

120 Cts. Monthly
\$2.00 Per Year.

A Trip in Old Mexico.

EDITORIAL CORRESPONDENT 1

NOTES ON THE MEXICAN RAILWAY

I hit the City of Mexico "in edge of the dark," as the natives describe the twilight, and as the National station is a mile or more from the hotels, I arranged with the conductor to bargain with a hack driver to

In no Mexican hotel will you find a parlor or waiting-room. They are hollow, square structures, with a covered court or open garden in the center, with interior porches on all four of the inside walls.

The City of Mexico is built in a pocket or low spot in the mountains—the worst place to drain they could possibly have found within a hundred miles. A large lake a couple of miles away on the south

streets are well paved, and there is fairly good water.

Splendid little parks are located all through the city, and the suburbs are full of nice resorts, gardens, etc.

The street cars are hauled by mules, and when a suburban car gets out of a crowded part of the city, the driver blows on a brass horn, lights his cigarette, and setting his mules at a run, makes electric car time to

and the road is the oldest in the republic.

It was commenced in 1858, but the ups and downs of Mexican politics kept it back, and it was not completed through from the seaport to the city until in January, 1873, when it was opened by the then President.

It's a curious fact that none of the rails ever built "in" to the City of Mexico—every last one of them hauled iron, loco-

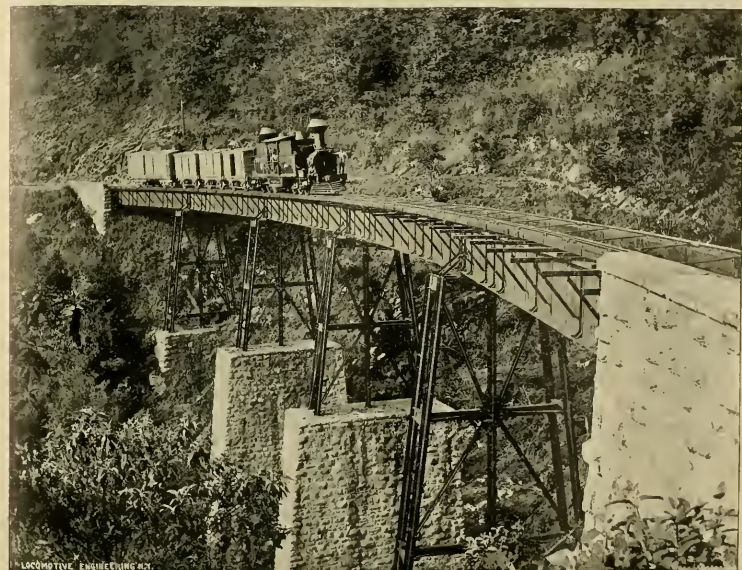

VIAVIDO OF WATER, MEXICAN RAILWAY. PORTABLE ENGINE, FOR HEAVY GRADE.

get me safe into a hotel where they could talk English. I landed all right at the Guardiola (pronounced "Ward-e-ola"), a pleasant hotel, as Mexican hotels go, no place to eat, but fairly nice rooms with single beds and good attendance. There is no temptation to a weak soul in a Mexican hotel, no bar, and all the chambermaids in Mexico are "he" ones and they are not overly attractive in dress or appearance. You rustle grub wherever you stay, and have the choice of American, Chinese, French or Mexican restaurants. The French are high-priced and pretty good, of the ordinary ones the Chinaman is in the lead,

is some six feet higher than the city. It is a very shallow body of water, the shores being acres and acres of mud, so impregnated with salts, alkali, soda, etc., that nothing will grow on them.

Sewage goes through upon canals, or rather goes into them, there appears to be no "go" in it, these canals being full of green slime. Nothing but the heavenly climate of this altitude prevents the maintenance here of a perpetual pestilence.

The city is on nearly level ground, the streets as a rule are narrow, and all have churches, great and small.

Stone is the principal building material,

the destination; it's the liveliest mule and the liveliest move you will find in Mexico.

Every railroad running out of the city has a depot of its own, and they are all located at a considerable distance from the center of the city. A union depot is badly needed.

Of course, there is no rail of interesting things to see in the capital—the Museum, the Cathedral, the Castle of Chapultepec, National Pawnshop and the plazas—but the most of all, the people. But we are after railroads, and will take a trip south to Vera Cruz over the

MEXICAN RAILWAYS, popularly known as the Vera Cruz road. This is an English company (limited),

motives and cars in and built out. I was told that this was a law, it is at least an established custom.

As the coast country is hot and the upper end of the line very dusty, Rinkie and I prepared for it. He appeared at the Mexican Railway depot in a linen duster and a smile, and I hauled aside my hard-boiled shirt for what the native merchant assured me was the proper thing—a French "traveling shirt." This was a gorgeous-figured affair of soft goods something on the order of an outing shirt. As it was intended to sleep in as well as to ride in, it was cut very long for a shirt and a trifle short for a tunic—when I got it on I looked just like

the plaster figure of St John that stood on a building across from my room. But everything goes in Mexico.

We ate a pair of hot doughnuts of some kind and poured down a couple of cups of coffee, just about hot enough to scald hogs, and then procuring two seats in an American coach with our grips, we went up ahead to see what kind of a "mecanica" was going to pull us.

The line constantly approaches the base of the great snow-clad peak of Orizaba, the highest in the country, 17,500 feet, until we reach Esperanza, where we traded our eight-wheeler for a Fairlie double-ender, and start down the mountain over a grade of a per cent, with curves of 350 feet radii.

For ten miles the scenery is simply magnificent, the like does not exist any-

where quite extensive, the machinery being about half English and half American.

The service calls for some modifications in machinery, and all men we talked to, on this or any other road, spoke in the highest terms of the big double-ender Fairlies employed on the hill, especially after General Master Mechanic Mantie has overhauled and "Americanized" them. Mr. Mantie is a Pennsylvanian

the "Ponte Infendiblo"—Bridge of the Little Hell.

Below, the line falls steadily, and tropical vegetation, tropical dress and tropical houses are seen. This is the coffee, mango, banana and coconut country.

I noticed that the fireman and all the other, and used plenty of it. The drops in the Nathan lubricator were changing each other through the tubes, and when I spoke about it the engineer hurried them a little more.

This company, as well as the Inter-oceanic and the Southern, believe that oil is the cheapest and best thing they can use for many purposes, and would rather buy ten quarts of oil a trip for one pin than have it cut. They fine an engineer \$20 for burning and breaking an eccentric strap, \$10 for cutting a main pin or a set of guides, \$5 for burning off an eccentric, blade pin or other small pins of the motion work. For this division of eighty-two miles the runners are allowed thirty pounds of lubricating oil, and can draw all of it in valve oil if they wish—and no questions asked—the only time a row is raised is when there is something hot.

Colombia is a great coffee, tobacco and fruit place. In June and July you can buy mango manillas for \$1.50 a gross, and pineapples at one cent each at wholesale.

From here on the country is purely tropical, and near the coast line sand is abundant—around Vera Cruz it drifts like snow.

The conductor of our train was a native, educated in the United States. He was very kind and attentive, pointing out places of interest, etc.

All the switches are common ground switches with weighted lever, and there is a man on every one of them. If a yard has thirty switches, there are thirty switch-tenders. Men are cheap, watchmen in the mountain section are almost in sight of each other. These poor switch-tenders wear blankets, most of them being as cool as flint it's red, and until one becomes accustomed to it it should call for many unnecessary stops.

Here, as on most other roads in the



STATION OF MEXICAN RAILWAY, CITY OF MEXICO.

We found a large, road connected, eight-wheeler, built by Dubs & Co., of Glasgow, Scotland. She had 17,500 inch cylinders and 16-foot drivers, a typical English machine.

The "mecanica" was a native, and was busy slopping oil on the bearings, and adjusting and lube of it.

There are some English cars in existence on this road, but not many. There is an officer's private car on the rear of the train, this was an English carriage with side doors, etc., but all in one room, such as they call a saloon car in Europe.

On the regular service the road uses American cars, everything being equipped with the Westinghouse brake.

The line is pretty straight and nearly level out of the city, and on 1-foot wheel got a fifty-mile an-hour swing on its road stop—where we killed ten or fifteen minutes. This is typical of all the Mexican roads, long time at stations, time to get a drink, see a friend, roll a cigarette or buy "pulque" coffee of some of the many liver jacks made of red peppers and cornmeal that the poor women offer at every station.

The road runs north and out of the city, passing the church and shrine of Guadalupe, the patron saint of Mexico, and passing between the lakes Texcoco and San Cristobal, across the great canal that is being built to drain the valley, the ground is nearly level for miles, the road passing through miles of agave plantations.

All through the country you will notice crosses and crucifixes on straw-stacks, posts, buildings, etc. The average Mexican will steal a red-hot stove under any and all circumstances save one—if it has a cross on it.

On the plains of Amatlan the road turns to the southeast, passing well to the east of the extinct volcanoes Popocatepetl and Estacaballal. At Apizaco we got a good meal, here the branch runs to Puebla, the second city of importance in the republic. On this branch is the town of Tlaxcala, where the first Christian church on the American continent was built. The grade is slightly up now, the hills more abrupt, and at a point a few miles south of Apizaco the altitude reaches 8,333 feet above the mid-tide of the Gulf.

where. The train is on a shelf above up on the mountain side, and 2,000 feet below and almost under it is a perfect map, a green valley with fields, river, towns and farms, one almost feels like trying to throw a stone at the church in the little Indian town of Maltrata below.

As the train stops, women crowd around to sell fruit, such as one has never seen

has been a long time in Mexico, and knows the needs of the line. It is hampered more or less as is every other master mechanic in Mexico who works for an English corporation—by some "consulting engineer" in England, to whom the officers of the company refer everything, and as the said consulting engineer has never had any experience out

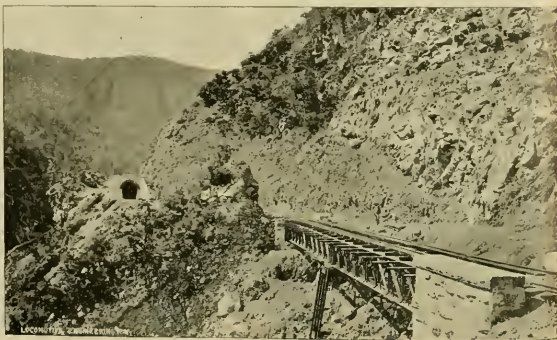

BRIDGE AND TUNNEL OF THE LITTLE HELL, MEXICAN RAILWAY.

or factored before. When the train starts, so do the fruit vendors, across and direct to the station below, and when the train emerges from the last tunnel and stops at the station, six and a half miles below, in the valley, there are your self-same fruit vendors.

At Orizaba we leave the double-ender and take a half-ton ten-wheeler. There are twenty minutes to spare, and we take a harnessed run through the shops. These

of Great Britain, and must show his ability somehow, he "designs" things for the customer—don't forget it.

I did not see Mr. Mantie, he was out on the road, but my guide knew the engineer, and we were invited to ride ahead.

Out of Orizaba the road follows the river Blanco and, a short distance below the town, goes through a wild cañon, crossing a bridge 140 feet high and known as

country, they have tried to do something with their old rails, there being absolutely no market for them. The station grounds are fenced with old rails. Freight platform forms are made of them. Good bridges are also constructed of rails. Wood racks, skids, hitching posts and many other things are constructed of this material, and it answers the purpose very well indeed.

One of the queerest practices is that every station platform is built on a side

track instead of the main line, and all passenger trains go into and out of a siding at each station.
Trains are not numerous, and are run by the block system, without blocks. This is

The Elementary Electric Battery.

Some time ago Mr. James W. See, the author of "Chordal's Letters," the most interesting mechanical book ever written,

author is famous. His elementary battery is thus described:
"Imagine a ditch reaching from St. Louis to Boston, filled with a mixture of acid and water. Into the Boston end, we drop one

also to Cincinnati. We have one end of a zinc and one end of a copper wire, which we tie together. Such an arrangement constitutes an electric current. The trench is a simple galvanic battery. When we tie our wires we developed that indescribable something called electricity. Something is going on over the whole length of our wire, and through the whole length of our ditch. The mysterious electric current is passing over the wire from St. Louis to Boston, and through the liquid in the ditch from Boston to St. Louis. We feel nothing in the wire and see nothing in the ditch; but we can make the current appreciable to our senses. We untie the wires, and the current instantly ceases. We bring the ends near each other, and an electric spark flashes from the copper to the zinc wire. Electricity leaped the space between the wires and we saw it. We place a finger between the ends of the wire, the passing current produces sharp, stinging, nervous shocks of pain—we have felt it. * * * * *

"You understand that our ditch, which we must never let out of our minds, is a battery. You will understand that the ditch, instead of being 1,000 miles long, might be 18 inches and still produce the same effect."

After describing a great many of the wonderful uses this electric current is applied to, Mr. See continues: "We take our copper and zinc wires, and dip them in a vessel of water. The current passes from the zinc to the copper through the water, for water is a conductor of electricity. Instead of water, we put acid into the vessel and then we drop in a gold dollar. The acid dissolves the gold and we have a clear colored gold solution. We drop in our wires, and we find that the current not only passes from the zinc to the copper wire, but that in its passage it picks up all our dissolved gold and deposits it upon the zinc wire in a perfectly uniform skin. Lifting out our zinc wire, we find it beautifully electro-plated. If



STATION OF ORIZABA. ENGINE RUNNING SHED ON LEFT.

known as the telegraph block system and resembles a telegraph system where clearances only are given. The "orders" are little blanks (one color for trains going north, another color for south-bound). These are given from station to station, sometimes on passenger trains a clearance ticket is given to a point several stations away. When a train is to be met, they write in the margin "X train to at —" they use the word "Cross" for meet or pass and abbreviate it by a simple X.

The engineers get \$155 per month, work on pay. Some of the English runners, who came out under contract ten years ago, get ten pounds (\$50) of this in English gold, making their pay about \$200 per month.

The road is unfenced and many cattle are killed, and once in a while a peon, by some of the Mexican roads it's a jail job to kill a man, but this road stands well with the government, and its men are never molested for peking up a drunken man, and they don't pay for stock—or stop for it, either.

The Mexican Road is a standard-gauge road, the roadbed is excellent, many steel ties being used. The bridges are exceptionally massive and solid, and there are lots of them. A trip over this line should never be missed by anyone who ever goes to Mexico.

We arrived at the Gulf just after dark and walked to the Hotel de las Diligencias, opposite the Plaza and the Cathedral, and there we slept.

In the next issue I shall tell you of my trip over the Interoceanic from Vera Cruz to Mexico City, and thence to El Paso over the Central, thus bringing to a close these already long drawn out notes on the land of Montezuma. J. A. H.

The Benjamin Altha & Hlinaworth Co., Newark, N. J., are making a specialty of the manufacture of steel casting for knuckles of M. C. B. couplers.



CANTON BRIDGE, BARRANCA DE METU, CURVE OF 325 FEET RADIUS, MEXICAN RAILWAY

delivered a lecture on "The Application of Electricity to the Arts," which contains much information related in the elementary, comprehensible manner for which the

end of a zinc wire, which we stretch overland till the other end is within our reach in Cincinnati. Into the St. Louis end, we drop the end of a copper wire leading

we tie a tin tea kettle on the end of the zinc wire and drop it into our vessel, we can deposit the gold upon the kettle instead of upon the zinc wire. This consi-

tutes the general art of electro-plating. Any metal may be deposited the same as gold.

Table services of hard nickel composition, heavily electro-plated with pure silver are stronger and more serviceable than solid ware and vastly cheaper. This art permits strength to be combined with beauty, and allows us to use two metals for more facility than the molten metals. Nickel-plating on brass gives us an exterior surface unaltered by most acids, and at the same time of such hardness as to

engines, and the work done formed a very valuable beginning for the more comprehensive work done this year.

The great difficulty in coming to accurate conclusions, based on investigations made with road engines, is due to the variables that come up caused by the ever-changing conditions of road service. It has been customary for investigators of draft appliances to collect all the facts they could obtain and finish up by guessing at the others. The last committee appeared to understand very well the usual process, for they began by saying: "No satisfac-

wheels. Nearly all the other parts employed in the plant were drawn from the company's store or the scrap heap.

The means for running an engine at full speed on rollers being provided, a variety of special apparatus was prepared to use in the tests. Foremost among these was a special form of exhaust pipe which has a partition that can be raised or lowered while the engine is working. In connection with this was a highly ingenious device for measuring the angle of the exhaust steam. The engine experimented with has an extension front end. The

meat." The party was taken by special train from Corning to Williamsport and back in one day, and the following day from Corning to Lyons and return, the latter trip including a run over a branch which leads through a most romantic lake region.

The Fall Brook Railroad is devoted principally to the transportation of coal, and it is remarkably well equipped for doing the work efficiently at low cost. The permanent structure is excellent; heavy rails and rock ballast being used for the greater part of the main line. The numerous bridges are of steel, built on solid masonry, and there are numerous stone culverts and solid stone walls for the protection of the track from freshets and floods. Station houses are all substantial-looking buildings, and the siding accommodation is unusually good. Every place where trains stop is protected by signals, that are operated by men who seem to be strictly ruled by the discipline for which the road is noted.

From Corning south the track follows the bed of rivers that run into the Susquehanna, and it passes through scenery of the most striking mountain scenery to be found in Pennsylvania. For the greater part of the way huge pine-covered mountains rise from each side of the ravines followed by the track, and some times a part of a mountain slides down and pushes the track into a line of curvature not designed by the engineers. An active lumbering business is carried on at each side of the track, and the operation of getting the logs down to the river sometimes makes it exciting for the railroad men. They slide the logs down the mountain sides, which vary from the perpendicular to an angle of about 45 degrees. When a log travels three or four thousand feet on a grade of this kind it is apt to have its own way, even railroad trams receiving scant respect. One day an errant log rolled the box car of a passing train in its way, but it did not stop. It went right through the car and kept churning along, and so did the train, for the car seemed hardly to feel the shock.

There are several logging railroads that branch off from the Fall Brook line and climb up to the mountain tops by grades



STATION OF ATHENS, MICHIGAN RAILWAY.

rejoice its brilliancy. In the printer's art the electro-plating operations are of great value. The engraver draws and cuts his picture upon leadwood blocks. The process is slow and very expensive. If the block is used to print from it soon wears out, and new ones would have to be made at the same expense. Instead of using these blocks, the electro-typer is called into service and he takes the finished block and makes a wax mold from it. This mold he dusts with black lead so as to make it a conductor of electricity. He then hangs it upon his zinc wire in a solution of copper. He soon has a thin coating of copper which he removes. This shell is filled with type metal and it becomes the electrotype from which most pictures are printed.

Draft Appliances.

One of the most valuable reports ever submitted to an engineering society was that presented to the Railway Master Mechanics' Association on "Exhaust Pipes and Steam Passages," by the committee of which Robert Quayle was chairman. The report is not of so much consequence in itself as it is for the evidence given that the committee had labored with the device apparatus of an original character which can be employed in obtaining information of a highly important character. Nothing about the design of a locomotive exerts influence on the economical operation of the engine to the same extent as the draft appliances, and yet the last form of exhaust, smokestack arrangement, and form and size of smokestack, have been regulated more by whimsical preferences than by accurate demonstration of what was calculated to produce the requisite draft with the lowest exhaust steam pressure. This has been the chief form of indifference regarding the importance of the subject, but to the almost insuperable difficulties encountered by those who attempted to investigate the relative value of different arrangements of draft appliances by experiments on road engines.

Three years ago, an admirable report on "Draft Appliances," prepared by Mr. C. P. Thomas and Mr. A. W. Gibbs, was presented to the Master Mechanics' Convention. That report gave the records of careful original investigations with road

tory conclusions can be arrived at on this important subject by obtaining one good result from the many important factors connected with it, and guess at the rest. The man who thinks this subject is one easy of solution will, by a short time of wrestling with it, convince himself that the variables are legion, and that the obstacles presented are not much unlike the man who falls over a wheelbarrow—it presents a new and different obstacle every time it turns over."

In order to put themselves in a position to control the variables, the committee pro-

committee tested the value of this arrangement by applying a partition which provided the means of cutting out part of the extension front. By moving this partition, they found that the best results could be obtained with a short smokebox, or at least one much shorter than the style which is now the prevailing fashion. Various tests were made with different sizes of exhaust nozzles set in different positions, with different forms and sizes of smokestacks, and with varied arrangements of the whole draft-regulating appliances. The results were very edifying, but want of



WORKS IN BIRMINGHAM, CITY OF MICHIGAN.

evolved to arrange the carrying out of tests that would be no more subject to variables than the tests of a stationary engine plant. They made arrangements to carry out tests on the experimental locomotive plant at Purdue University, and when that was burned down Mr. Quayle, chairman of the committee, courageously set about erecting an experimental plant at his own expense. He demonstrated that a plant, with supporting rollers, on which a locomotive could be run at ordinary train speeds, could be created at small expense. We believe that the outcome of this plant will be the erecting of similar apparatus in connection with all large railroad shops. Mr. Quayle made excellent carrying rollers by turning the flange off worn out steel tread

plates. The report from being complete, the work will be continued for another year, when we can safely predict that a report will be presented which will do much to settle the best proportions and arrangement of draft appliances.

Watching the Working of "Discipline Without Punishment."

Last month a party of railroad officers and other friends of Superintendent Brown of the Fall Brook Railroad, went on a trip over the line to examine the practical working of the system made famous through the article published in our February issue on "Discipline Without Punish-

worthy of the Rocky Mountains. The party went up one end of these roads, the Oregon & Texas, on a flat car pushed by a Shay locomotive. All the logging roads are operated by Shay locomotives and they are said to be remarkably efficient. It may be mentioned that a Shay locomotive has three cylinders set vertically at the side of the firebox, with connections that turn a shaft running lengthwise of the engine at the level of the axle. This shaft carries cog wheels which engage with gearing on the engine and tender wheels, and thus transmit the power. A Shay engine does not look as if it would make much of a record on speed, but the machine that pushed us along rattled down that mountain side at a gait which made

the ears of one of the party turn white. This engine has been at work for four years, and has received no repairs beyond the work done by the engineer. The trees look as good as when they were put on.

The mountain part of this road is devoted strictly to business. There are numerous industries engaged converting

and the manner in which the men did their work. All acknowledged that the performances were perfect, and all admiration was expressed for the discipline which brought forth such good results. The remark was made by a Western superintendent "You have a better class of men than we can hire." This may be the

master car painter under Mr. W. H. Lewis, superintendent of motive power, makes very successful use of oxalic acid for cleaning locomotive tenders and cars. This acid has been used for years by locomotive firemen for cleaning smoke stains and tarnish from cab fittings, but we are not aware of its being used for cleaning on a large scale except on the road mentioned. Mr. J. K. Lowry, foreman of the paint department, writing about cleaning with oxalic acid, says "I have used the acid for several years, and cannot see that it has any injurious effects by continued use any more than water alone, and for this and other reasons I consider it the cheapest and best preparation I know of for cleaning purposes. I cannot explain the cause of the chemical action that the acid has upon the smoke and dirt, but it seems to decompose the

puissance will facilitate the work. After it is cleaned, rinse off with water, and for nice work it should be rubbed dry with a chamouis skin.

As to the quantity of the acid necessary to a given amount of water, will say about a pound to a gallon; however, the amount should be about all the water will dissolve. There is no danger of getting it too strong.

The members of the railroad mechanical conventions have remarkably good memories for injuries inflicted. When suggestions were in order to indicate the preference of members for the next place of meeting, nearly every available place in the country received mention except Cape May, which is really one of the pleasantest resorts in the country, except that its principal hotel is run by a man who made him-



BRIDGE OF THE AHOVAL. NATIONAL HIGHWAY BRIDGE BEYOND.

wood into various marketable products, which give, with the raw lumber, a good business to the road, and the freight rates are not subject to the slashing of competitors. A great part of the region is a wilderness. In one district where the railroad runs, there is not a country road for eighteen miles. Yet there are people

living, but we are inclined to think that the treatment accorded works out the process of natural selection. When Mr. Brown's system of "discipline without punishment" becomes more general, we feel certain that the results will be the same wherever it is applied. Its vital principle is the treating of men as men. A. S.



CHICAGO BRIDGE, MAIN IN RAILWAY.

combined accumulation of dirt without having the well-known injurious effects consequent to the use of all leys or lime preparations, and to demonstrate the difference in the action of the acid and soap, try it on a freight car or any oil painted surface, and it will be seen that the soap acts immediately upon the paint, which can be seen by the coloring of the water, while the acid will clean equally as well without affecting the paint in the least.

In order to obtain the best results from the use of the acid, it will require some

self exceptionally obnoxious to his guests. There is a very decided desire that the next convention be held west of Chicago, and the members of the Master Mechanics' Association were strongly in favor of Manitou, Col. That is a delightful health resort at the foot of the Rocky Mountains, and we feel certain that it would be an enjoyable place to meet in.

One of the handsomest little catalogues that we have seen has just been issued by the Griffith, Axtell & Cady Co., of Holy-



CASINO OF CHAPULTEPEC, THE WHITE HOUSE OF MEXICO.

living there. There are numerous clear mountain streams that swarm with trout. But no visitors try to catch them. We commend the attractions of this region to scribblers and others in want of a quiet rest.

The part of the road north of Corning is of a different character. It passes through some of the most fertile country in New York State, and permits passengers to look upon some of the finest sylvan scenes for which the Empire State is famous. Shortly after leaving Corning, we cross the famous Watkins Glen on a bridge three hundred feet high, then we run for forty miles along the shore of Lake Geneva, the finest lake east of Erie. Branching off on an exploring trip, we see two many lakes for enumeration, and find them fringed with varieties of verdure that make up scenes wonderfully attractive.

While the party appeared on pleasure bent, business was not neglected, and the railroad men of the party were watching keenly the way that trains were handled,

Cleaning Cars with Oxalic Acid.

Although the practice of cleaning the outside of passenger cars has been followed ever since railroad trains began to run, there continues still to be great diversity in the methods employed to keep the paint clean. All sorts of cleaning material has been tried, but the objection to many of the compounds that would readily remove dirt is that they take off the varnish and paint as well. Of late years most of the roads have adhered to soap and water. The finest looking cars we have lately seen, that have stood the brunt of smoke and dust for months without being marred in appearance, are on the Chesapeake & Ohio. They are cleaned by a special kind of soap mixture prepared by an intelligent foreman. It removes the dirt, and yet leaves that glossy appearance of the varnish seldom seen except when a car is newly out of the shop.

On the Chicago, Burlington & Northern



THE ALAMEDA, AVENUE OF PALMS, VERA CRUZ.

economy in its use. It can be used economically, and cost no more than soap, but it used profusely, as water usually is, it will necessarily be wasted. It is not necessary to use more of the acid water than enough to thoroughly wet the surface, rubbing it the same as with soap, and if very dirty, the use of a little ground

elke Mass. It is a sample lot of fine embossed catalogue covers gotten up by this firm for advertisers and is entitled "A Mint of Hints." Any firm contemplating the issue of a good catalogue will find that one of these covers will add about 50 per cent. to the appearance of the work.

The Leslie Device for Kindling Locomotive Fires with Crude Oil. Instead of Wood.

The complete success of this device has been fully established in the kindling of thousands and thousands of fires on several of our important railroads, on whose lines it has been adopted and put into general use. It has attracted wide-spread attention and created much enthusiasm on account of its cheapness, convenience, and the enormous saving which has been effected through its use.

It consists of a suitable storage tank for the storing of the desired supply of oil for the different sized round-houses, a small tank or auxiliary reservoir is fed from the storage tank, suitable globe and check-valves being located between them—the former to shut the supply from the storage tank, if necessary, and the latter to automatically feed the required oil to the auxiliary reservoir. An ordinary air pump which supplies air to a storage reservoir at a pressure of four to six pounds for shop purposes, can be utilized to supply sufficient air for the kindler, through a pipe connected with said storage reservoir and entering a locker suitably located in the round-house. In this locker an air-pressure regulator reduces the pressure to about 20 pounds, and the main air-pressure pipe extends from there round the house over each stall, a smaller air-service pipe enters the auxiliary reservoir, and passing through the locker extends, in close proximity to the main air-pressure pipe, round the house, and is connected with the latter by suitable branch pipes and the intermiscibility of a lock combination valve over each stall. An oil service-pipe emerges from the auxiliary reservoir, and passing also through the locker, follows the same course as the two former

automatically, making it impossible to injure the firebox sheets, either through carelessness or otherwise.

When the fire has been kindled, by the closing of the lock combination valve the supply of air and oil is cut off simultaneously, and the oil remaining in the pipe is automatically returned to the auxiliary tank, after which the burner is disconnected.

The complete success of this kindler does not consist only in a device which will kindle locomotive fires with the least amount of oil and air possible to do the work efficiently, and with absolute safety from fire, but a series of years of actual experience has enabled its promoters to produce a kindler in which every detail has been worked out in the simplest, cheapest, most efficient, and most economical manner possible.

The storage and auxiliary tanks are buried in the ground outside of the buildings and below the first line, fully protecting the oil, not only from fire but also from all kinds of weather, and at the same time economizing space. The location of the pipes over the stalls, where they are entirely out of the way, the means of controlling the whole system, by having the controlling valves, including those which are placed out of reach over the stalls, securely locked, so that persons passing through the round-house cannot interfere or tamper with them, even the safety and accuracy in kindling fires with this device

They have a gauge on the cylinder that with a little computation shows the weight of any article lifted by the crane. This feature, it seems to us, is worth imitating on any hoist or crane around the shops of any road.

At the Dennison shops, they use six Westinghouse pumps, compounded, so that they get an air pressure of 120 pounds per square inch.

In his inaugural address to the Master Mechanics' Convention, at Saratoga, President Hickey expressed himself as favoring the consolidation of the Railway Master Mechanics and of the Master Car Builders' Associations. We are aware that Mr. Hickey has advocated this consolidation for several years, but we believe that he is mistaken in calculating on the benefits which would result from the change. The work done by the two associations is so distinct, that very little time would be gained unless they narrowed the scope of the investigations now carried on from

The Official Railway Equipment Guide has changed managers, and is now published at 113 Nassau street, New York, and Mr. John A. Chater is manager. The *Guide* has been enlarged and greatly improved, and is now a most valuable work of reference for railroad men and others interested in rolling stock. Besides giving all particulars about the various kinds of cars and locomotives owned by all railroad companies and private lines, it contains exceptionally correct lists of the general and operating officers of all the railroads on this continent. In this respect it is superior to any of the lists published specially to give the names and addresses of railroad officers, for corrections are made every month, keeping the information up to date.

The Consolidated Car Heating Co., Albany, N. Y., announce that they have acquired the ownership of the Pope system of car heating, and have decided to put it upon the market. This system is

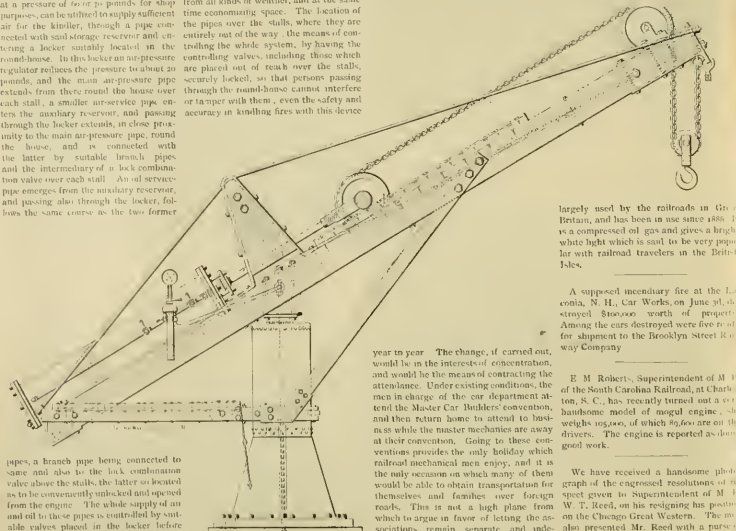

pipes, a branch pipe being connected to same and also to the lock combination valve above the stalls, the latter so located as to be conveniently un-locked and opened from the engine. The whole supply of air and oil to these pipes is controlled by suitable valves placed in the locker before mentioned, in which also are located the gauges, all being placed under lock and key, in this way the absolute control of the whole system is in the charge of one person, and when the system is started, the control of the supply to each stall is governed by its respective lock combination or regulating valve. When a fire is to be kindled, sufficient coal is thrown into the firebox to cover the grate thoroughly, a light and easily handled burner, with two small holes attached for air and oil, is connected by suitable hose couplings to the lock combination valve, after the burner has been connected, by unhooking and opening the combination valve, the oil is brought into the house automatically and the air and oil simultaneously admitted to the burner. A small quantity of greasy water is then lighted and thrown into the firebox on top of the coal, the air and oil are then turned on to the burner by their respective valves, the necessary quantity of oil only being fed

are not dependent upon the operator, but are due to the fact that those parts, which have to be manipulated by him, are so arranged that they are either automatically adjusted, or it is compulsory for him to adjust them properly to enable him to do the work, in this way protecting the property from all risks through carelessness or otherwise.

This apparatus is in use on over 200 stalls on the C. B. & P., and on the C. B. & N., Wisconsin Central and other roads. It is controlled by Mr. J. S. Leshe, of Paterson, N. J.

A Load-Wheeling Pneumatic Crane.

The illustration shown herewith gives all the particulars that a mechanic wants of an ingenious crane made and used at the Dennison, Tex., shops of the M. K. & T., in charge of C. T. McElvaney, master mechanic.

year to year. The change, if carried out, would be in the interests of concentration, and would be the means of contracting the attendance. Under existing conditions, the men in charge of the car department attend the Master Car Builders' convention, and then return home to attend to business as while the master mechanics are away at their convention. Going to these conventions provides the only holiday which railroad mechanical men enjoy, and it is the only occasion on which many of them would be able to obtain transportation for themselves and families over foreign roads. This is not a high plane from which to argue in favor of letting the associations remain separate and independent, but the personal deprivations ought not to be overlooked in taking action towards a change.

In the shops of the Western New York & Pennsylvania, presided over by Mr. Allan Vail, general master mechanic, they have in use a simple form of air injector for drawing whitening out of a bucket or barrel and squirting it upon the walls of shops that need a whitening application. This arrangement is more portable than that in which a closed drum is used to hold the whitening mixture. We understand that they are experimenting to find out how this system will work in the report of freight cars and buildings. It is said that when a man uses the whitening jet for a short time, that he becomes so skillful in applying the mixture that very little is wasted. The time may come when all rough painting will be done by compressed air.

largely used by the railroads in Great Britain, and has been in use since 1886. It is a compressed oil gas and gives a bright white light which is said to be very popular with railroad travelers in the British Isles.

A supposed incendiary fire at the Leveaux, N. H., Car Works on June 10, destroyed \$700,000 worth of property. Among the cars destroyed were five road for shipment to the Brooklyn Street Railway Company.

E. M. Roberts, Superintendent of M. P. of the South Carolina Railroad, at Charleston, S. C., has recently turned out a very handsome model of model engine, which weighs 105,000 lbs, of which 80,000 are on the drivers. The engine is reported as doing good work.

We have received a handsome photograph of the engrossed resolutions of the W. T. Reed, on his resignation, has published on the Boston Great Western. The motion also presented Mr. Reed with a purse of \$150.

A circular has been issued by the authorities of Purdue University, intimating that the locomotive testing plant, which was destroyed by fire a few months ago, has been rebuilt and is now ready for work. The locomotive "Schenectady," which was damaged in the fire, has been thoroughly repaired and is in place ready for work. Any railroad company having locomotives that they want tested can have the work done now without delay.

Manning, Maxwell & Moore, New York report that they have received an order from the Frank Knechtel Machine Co. of Pittsburg, for one of their large three-motor electric cranes, with an auxiliary motor, being the second crane ordered by that firm. There are numerous inquiries for these cranes and this department of the Pond machine works is busy.

Pittsburgh Ten-Wheelers.

The annexed engravings illustrate a class of fine ten wheel locomotives built by the Pittsburgh Locomotive Works for the Carno & Indianapolis, and reported to be performing remarkably good work. The engine is a fine representative of careful designing, every detail being worked out with close care and engineering skill. It will be noted that the engine has a straight boiler, which is a favorite form with the

necessary for convenience in operating and durability in service. All castings and the front end are made of pressed steel. The following are a few of the leading dimensions:
Weight on drivers, 110,000 lbs.
Weight on truck wheels, 28,000 lbs.
Weight, total, 138,000 lbs.
Wheel base, total of engine, 23 ft. 8 in.
Wheel base, driving, 13 ft. 4 in.
Wheel base, total (engine and tender), 57 ft. 7½ in.

Steam ports, width, 1¾ in.
Exhaust ports, length, 18.
Exhaust ports, width, 3 in.

VALVES.

Valves, greatest travel, 5 in.
Valves, outside lap, ¾ in.
Valves, inside clearance, ¼ in.
Valves, lead in full gear, ¼ in.

BOILER.

Type of boiler, reduced shell.
Boiler, working steam pressure, 180 lbs.

Firebox, width, 3 ft. 4½ in.
Firebox, brick arch.
Firebox, water space, width, front 4 in., sides, 4 in.; back, 4 in.
Grate, cast iron, rocking.

OTHER PARTS.

Exhaust nozzle, diameter (four sizes), 4½ in., 5¼ in., 5 in., 5¼ in.
Stack, straight, with pressed steel base.

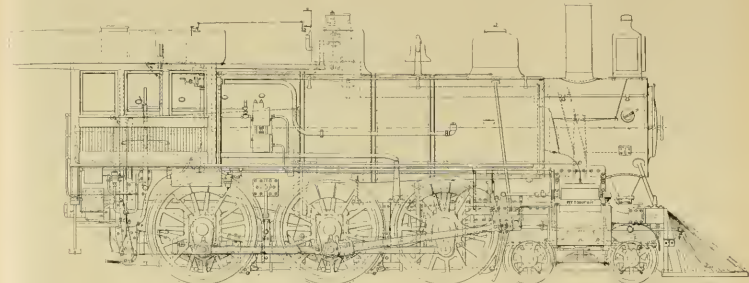

Pittsburgh people. We have frequently heard the objection raised against straight boilers that they do not carry water well (the same number of tubes are put in that can be used in a wagon-top boiler; but this boiler has 300 tubes in a 6¼-inch shell, and the engines are said to carry the

Length over all, total (engine and tender), 61 ft. 6½ in.
Height of stack above rails, 15 ft. 5¾ in.
Heating surface, firebox, 188 sq. ft.
Heating surface, tubes, 2,278 sq. ft.
Heating surface, total, 2,466 sq. ft.
Grate area, 32 sq. ft.

Boiler, material in barrel, homogeneous steel.
Boiler, thickness of material in barrel, ½ in.
Boiler, diameter of barrel, 64 and 70 in.
Seams, horizontal—butt joints, double welded, 82 staple riveted.

Stack, least diameter, 15½ in.

TENDER.

Weight of tender, empty, 29,300 lbs.
Weight of tender, with fuel and water, 76,600 lbs.
Kind of tender frame, oak

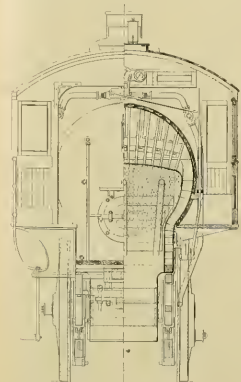

water remarkably well. Throughout the boiler is a remarkably fine one, and well calculated to bear without distress the working pressure of 180 pounds. It is made of homogeneous steel, the shell being ¾-inch thick. The horizontal seams are butt-jointed, with double welds, sextuple riveted; the circumferential seams are double riveted. The engine is equipped with the American brake, Westinghouse train signal, Manton injectors, Nathan lubricators, Richardson balanced valves, solid rod cups, Laird guides, Ross brake shoes, and with every modern appliance

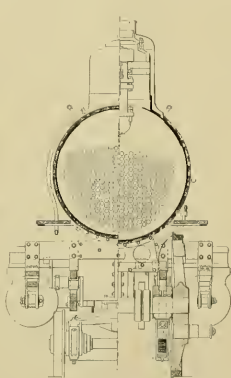

WHEELS AND JOURNALS.

Drivers, number, 6.
Drivers, diameter, 72 in.
Journals, driving axle, 20C, 8 × 10 in.
Journals, truck axle, 22C, 5½ × 10 in.
Main crank-pin, journal, 5¼ × 6 in.

CYLINDERS.

Cylinders, diameter, 30 in.
Piston, stroke, 26 in.
Piston rod, diameter 1½ in.
Main rod, length, center to center, 9 ft. 6½ in.
Steam ports, length, 18 in.

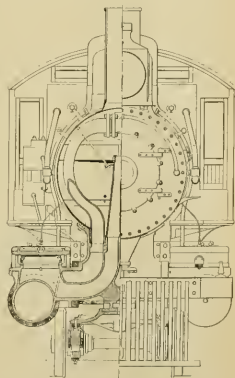

Seams, circumferential—double riveted.
Thickness of tube sheets, ½ in.
Thickness of crown sheet, ¼ in.
Crown sheet stayed with radial stays, 1½ in. diam.
Dome, diameter, 30 in.

TUBES.

Tubes, number, 305.
Tubes, outside diameter, 2 in.
Tubes, length over sheets, 13 ft. 2 in.

FIREBOX.

Firebox, length, 9 ft. 6 in.

Type of tender truck, diamond.
Wheels, chilled iron, 36 in.
Size of journals, 4 × 8 in.
Capacity of tank, 4,000 galls.

Night men in the Lake Shore yards at Elkhart missed lunch from their pals and one of them placed croton oil on a piece of pie. A fellow workman ate the pie and almost died.

The Merrill-Stevens Manufacturing Co. have erected a plant in Niles, Mich., for the manufacture of metallic cattle guards.

LOCOMOTIVE ENGINEERING

A PRACTICAL JOURNAL OF
RAILROAD ENGINEERING

325 Broadway, New York.

PUBLISHED MONTHLY BY
ANGUS SINCLAIR, Editors and Proprietors,
JOHN W. HILL,
GEO. W. WOLLASTON, Secy. Adv'ty Dept.

Subscription Price.

\$1.00 per year, \$2.00 for six months, postage paid to any part of the United States, Canada, Cuba, Porto Rico, Mexico, by Express. Money Order, Draft, Postal Note preferred. Letters and notices to the Editor.

The Editor reserves the right to use of all matter for the leading columns entirely on his own terms. The reading columns will not be published unless accompanied by three names and addresses, but not necessarily for publication. Material should be sent to the Editor as soon as possible. Address always give old and new address, and if you subscribe in a club state name your paper falls to reach you properly.

Entered at Post Office, New York, as Second-class mail matter.

No Sale by Newsdealer Every Year.

FOR BACK NUMBERS BEFORE THE CURRENT YEAR.

PUBLISHERS' AGENTS.

American News Company, New York
Herald and News Co., London, England.
W. Williams, at Flak's Bldg., Melbourne, Australia.

\$4.50 of this Issue Printed.

Award of the Prize Designs.

There were sixty-four designs offered for our cash prizes for the best design of the boiler fittings for eight-wheeled and consolidation locomotives.

The committee on the award of all were unanimous in their opinion. A greater safety for the live of the engine crew under any and all circumstances, especially in wrecks.

Convenience in handling the locomotive, comfort of crew consistent with best construction.

Economy of time and money in keeping the running gear in repair.

On the whole the designs submitted were rather disappointing, there was nothing new of value offered, but the combination of good devices and the arrangement of them were admirable in many cases.

We have no time to prepare the details of these designs for the issue of the journal, but will submit one or all of them in the next issue.

The awarding committee were as follows: John McConnell, superintendent motive power, Union Pacific Ry., St. M. Vanehan, superintendent, Baldwin Locomotive Works, W. F. Ivins, chief draughtsman, Rogers Locomotive Works, Chas. Hogan, traveling engineer, New York Central Railroad, Samuel Hutchins, engineer, C. C. & St. L. Ry. All were present except Mr. Hogan.

Drawings, good, but and indifferent were looked over patiently and sorted down to a dozen of each kind, these were discussed in every detail and one by one dropped out for defects, until there only remained three of each kind. The committee did not especially recommend these designs, but decided they were the best advance on practical lines made, and most of the features were desirable.

LID WINNERS.

John S. Payne, of Wortendyke, N. J., won both first prizes; Fred. M. Woodcut, of Toledo, O., won second prize on eight-wheeler; W. A. Eagles, of Newark, N. J., won third prize on eight-wheeler; W. B. Holloway, of McKees Rocks, Pa., won second prize on consolidation; G. A. Averil, of Rock Island, Ill., won third prize on consolidation.

The prizes are \$100 for each first prize, \$50 for the second and \$25 for the third. The Committee destroyed all other designs and descriptions and the envelopes containing names of competitors. The winners have been sent their money as promised for the Fourth.

Personal mention will be made of the winners in the next issue.

Block Signaling.

Although America is entitled to the proud boast of having the finest net-work of railroads in the world, the splendid system of transportation is far from being so well equipped as ordinary prudence would dictate. Railroad extensions have been too often pushed into the wilderness to stretch out a long mileage that could be bonded and stocked at fictitious values. Where this policy was followed, the track and equipment were constructed with regard merely to cheapness.

The failure of the railroad was as a few years ago the enormous and unnecessary applications for protecting the safe movement of trains as if nothing of the kind had been invented, and the train equipment itself was no better off. Year after year an army of human beings was killed through the want of means to stop trains promptly. Slowly the public conscience was aroused to the enormous and unnecessary sacrifice of life, and measures have now been taken to compel the general use of power brakes. This has been a grand victory in the interest of humanity.

The equipping of all trains with air-brakes will serve greatly to decrease the carnage of train operating, but the consummation of this victory may be delayed the field for action in another conflict. The battle of the brakes has been fought and won, although it lasted for many years; a battle for the general introduction of block signaling has now begun. It may be a stubborn fight, with the forces of diminishing cost-money on the one side, and the friends of humanity on the other, but there is no doubt as to the final outcome.

The railroads in this country as in all others, were first put in operation without any mechanical means being provided to keep the trains apart. The enterprising engineers in charge of the building and equipping some of the earliest railroads saw the necessity for some kind of visible signal to protect trains standing at stations, and several crude appliances were brought into use. The operating officers, however, preferred the use of rules in train movement that seemed to render few signals unnecessary, and within a few years after the opening of the Baltimore & Ohio, it became the recognized practice to place the responsibility for the safe movement of trains upon the train crew. This practice exists without change on most of our railroads to-day. As long as care, vigilance and intelligence can succeed in operating the trains without serious accidents, so long as the trainmen load with the heavy responsibility of doing the work without the aid of signals. It is only when a link in the human chain of vigilance fails and a disaster results that a willingness is manifested to adopt modern appliances. It is amusing, the persistent opposition which railroad managers as a class, have shown to the introduction of fixed signals. They could perceive in the system merely an addition to the operating expenses. They blinded themselves to the saving that would result through prevention of accidents. When crowded times have been tormented by the weight and volume of public opinion to adopt block signals, the value of the system has frequently been neutralized by carelessness in the manner of operating the same.

The purpose for which displayed stationary signals were really useful was in the protection of draw-bridges. A ball that could be raised to the top of a pole was the favorite means of indicating safety or danger. Many railroad men, however, considered that it was much safer for all trains to stop on approaching draw-bridges in the same way as they still do with level crossings. No real progress was made towards signals was arranging for some means to show the time at which the presence of a train had passed. This practice gained wide application, and is still re-

garded by many railroad men as being of great utility. Much ingenuity has been expended in inventing signals which would remain at danger for a certain time after a train had passed. The fatal defect of the system is that the locomotive may fail or something may happen to the train requiring a stop to be made on rounding the first curve after a signal is passed. Unless the flagman is vigilant a collision is likely to happen, and the fact that the engineer of the next train has been in danger of collision is clear, makes an accident all the more likely. Hundreds of accidents have happened under the circumstances described. The principle of establishing a time interval between trains has been tried in a great variety of ways without success. It is a form of retarded protection which does not protect, and the failures thereof have led to a great many people to believe that signals are worthless for the prevention of accidents. This is merely true of a vicious system. The time system of signals may have been useful in its day, just as the straight air-brake was infinitely superior to the Armstrong, but it is a deception where trains move at high speeds as in our case.

In England, where the cause of every railroad accident is thoroughly investigated by government experts, it was settled forty years ago that the only safe system of train operating was to put a certain space between each train. This was arranged by establishing a system of sections called blocks, each being protected by signals. No train is permitted to enter a block until the preceding train has passed off. This is called the absolute block system. In some form it is destined to be applied to all our railroads, for public opinion is getting rapidly educated to its advantages and the demand is growing for its introduction. Several of our leading railroads are operating under the block system, and others have it modified to what is called the permissive block system. Under the latter, two or more trains may be upon the same block at one time, their entrance to a block not clear being regulated by a cautionary signal. This is often done to facilitate the movement of trains when under the operation of the permissive block system has most of the vicious features of a time signal system. With a certain class of men a system which divides the responsibility is an invitation to be careless. Many an engineer who might be depended on to avoid running into trains under the most trying circumstances when his own vigilance and judgment were his entire reliance, has failed utterly when the responsibility was divided between himself and a fallible signal system. From the records we have seen of operating under time signals and permissive block signals we are inclined to believe that it is safer to rely entirely upon the care of a well-trained and experienced train crew.

A variety of automatic block systems of signaling are now in use, and a variety of others with wonderfully developed mechanisms are candidates for the patronage of railroad companies. The systems may be divided into three kinds—the manual, the auto-manual, and the automatic. The manual is the simplest system of block signaling and dependently upon human care and judgment to be operated successfully. A man is stationed in the tower at the entrance to each block, provided with all the apparatus for operating the signal, and being in communication with the signalman in the towers in front and behind, when a train enters the block the signalman turns the signal to danger and keeps it in that position until he receives notice from the tower ahead that the train has passed off the block. This system has worked remarkably well in Europe and on some of the railroads in this country, but it has the defect that the signalman may make a mistake, or show a red signal when the train is still on the block. It is a great improvement over the flagman, but it contains large

loop-holes through which accidents have happened. A disastrous collision on the Long Island railroad in 1898, and another on the Pennsylvania Railroad in Jersey Meadows, testify to the necessity for improvement upon the plain manual block system. The tone of railroad managers in public discussions of the various block systems, indicates that the plain manual is falling into disrepute. It is a decidedly expensive system to maintain and operate; it does not give absolute security in return.

A decided improvement upon the manual, is the auto-manual system, which contains ingenious mechanism that tends to prevent the signalman from making mistakes. If the signal mechanism is not tampered with, and is handled with ordinary care, the auto-manual system is practically perfect as a block system. When a train enters a block and the signalman puts the signal to danger, the apparatus is automatically locked. It cannot be opened so that the signal may be set to safety until the lock is released by the signalman at the other end of the block. The stupid practice which is in charge of these signal towers will sometimes take it upon itself the fact that means have often been taken to prevent the lock acting which prevent a signalman from clearing his signal before it is released. When it is found that practices of this kind prevail it tends to show that human agency ought to be eliminated from the operating of signals.

This desirable end is accomplished in the automatic systems. There are a variety of automatic block-signaling systems, the most valuable of which not only indicate that a block is not clear, but show danger if a rail is broken or any other serious defect of track exists. Most of the automatic systems are operated by electricity, and the auto-manual system consists in electricity connecting all the ends of adjacent rails in a block and insulating the rails that separate the blocks. The signal-operating mechanism forms a part of the circuit which embraces the whole of the track on a block, and the signal-show safety when the block is clear. When a train enters upon the block its wheels break the circuit and the signal goes to danger. Some automatic signals are operated by compressed air, the actuating appliances being started by electricity. The only drawback to the electric auto-manual system is that the electrical appliances require a great deal of attention, and when they fail delays occur. But failure of the current leaves the signal at danger so that the worst which happens is delay of trains. The improvements in electrical mechanism are rapidly eliminating the failures of electric signals, and it may be expected that within a few years there will be no more failures from electricity than there is with water or compressed air.

An incident connected with the working of an automatic system may be given as a finish to this article. A company supplying an automatic signaling apparatus invited a party of railroad officials to witness the working of the system upon a road to which it had been applied. The party started out in a specially arranged train that did not go far when they reached a signal which obstinately refused to go clear although the party was well aware that no train was in the block. The experts went down and examined the signal, but they could see nothing wrong with it, and they could not find why it refused to act. After a consultation of the manufacturers the signal had to be passed at danger and a bad impression was given of the system which the perfect working of following signals did not dissipate. The exhibition was acknowledged to be a failure and a black eye to the promoters. Next day when the railroad company's engineers were investigating the cause of that signal failing to act, they discovered that a broken rail had cut the circuit.

To Make Owners Responsible for Defects of Cars.

Several years ago an addition was made to Rule 8 of the Master Car Builders' instructions, which made the owners of freight cars responsible for brake-shoes and journals renewed when a car was away from home. The working of this arrangement greatly increased the clerical labor in Master Car Builders' offices, and widespread opposition was excited. At every succeeding convention attempts were made to repeal the rule, and from the talk in advance it seemed certain that it would not remain in force more than one year, but when the time for voting came, it was always found that those who favored the holding of owners responsible for the renewal of brake-shoes and brasses were in the majority, and the rule was kept in force.

The old plan of each railroad company renewing the brake shoes and journal brasses, when necessary, to foreign cars passing over its road seemed quite equitable, for its cars would be treated in a similar manner when they were away from home. Why a change should be insisted upon that added to the burdens of the M. C. B. officers and called for increased clerical labor, is somewhat a mystery, for there appeared to be no one reaping real benefit, and many railroad men had their measure of annoyance greatly increased by the disputes which arose concerning the rule. Events transpired at the last convention which created considerable new light upon the rule. It appears that there are owners of certain classes of private cars who have habitually and systematically contrived to make railroad companies do the greater part of repairs to these line cars without any compensation. A bill might be sent to a private line under the old rule for cost of renewing brake shoes and brasses, but it was rarely done when it was not the general practice to charge the owners for these parts.

Under the new rule, however, a car and a sentiment has been spreading, especially in the West, that it would be a good plan to hold the owners responsible for the renewal of several other parts now exempted when cars are repaired away from home.

Several superintendents of motive power in the West met on a train on their way to Saratoga, and they got talking about the impositions their roads had suffered under the inflictions of a few owners of private cars. Numerous instances were cited of railroad companies being compelled by sharp practice on the part of the owners, to effect expensive repairs on private cars that were worn out in service. Various remedies were suggested as remedies for this wrong, and it was finally decided to make additions to Rule 8, holding owners responsible practically for the whole parts of the car when renewals were made on foreign roads, and were not rendered necessary by accidents. It was felt that the principle of holding owners responsible for the renewal of broken parts would not only protect railroad companies from petty exactions, but it would do much to facilitate the movement of cars. A motion was made to add an article holding owners responsible for "drawbars or couplers, drawbar timbers, drawbar springs and sills cracked or broken." To this was subsequently added center plates, and the parts relating to drawbars was changed so as to include only link and pin couplers.

The arguments used in support of that motion were that the change would tend to reduce the endless disputes and delayous delays now so common in car interchange. It was also interchanged points would have no inducement to delay cars unless the defects were of a dangerous character, and there would be less scheming to put the cost of repairs upon companies that had no right to pay them. The move was so radical in character that the representatives of

several large roads refused to support the change without consulting with their managers. On the motion being put to the meeting, it was lost by 386 yeas to 405 nays. It is confidently expected that the change will be made next year, and there is every probability that it will accrue to the benefit of every railroad company which is inclined to act fairly towards others whose cars they handle.

We received visits last month from a gentleman from railroad town, who came to New York after attending the mechanical conventions, and they were all delighted with the wonderful views of New York and its vicinity to be seen from our office windows. We had the pleasure of escorting some of them to look over the splendid ocean rappers lying in the harbor, and were surprised to find the intense interest manifested in the machinery to be seen in these huge steamers. It never occurred to us before that examining steamboat machinery would give so much pleasure to railroad men. We intend in future to invite all our mechanical visitors to go and see the steamers. Don't fail to call when you are in New York. Our office is a Mount Pisgah.

At a meeting of the Central Association of Railway Officers held in Cincinnati, the article "Discipline Under Punishment," which appeared in the February number of *LOCOMOTIVE ENGINEERING* was read and discussed. The method of managing the men there described is exciting much attention all over the country, and several roads have already adopted it, while others are considering the advisability of doing so. Officers are inclined to try Mr. Brown's plan with modifications to suit their own conditions. Mr. Darlington, superintendent of the Indianapolis division of the C. C. & St. L., had the article read at his staff meeting, and it aroused a lively discussion which resulted in a decision to try that plan of discipline.

A curious statement was made in a report submitted to the M. C. B. convention on safety chains for freight cars, to the effect that twelve roads, representing 226,351 cars favored the use of safety chains. It would be interesting to find out how many of the roads in question follow the practice of putting link-locks on freight cars. Safety chains were never of any practical value, and the growing introduction of automatic couplers leaves very little excuse for their being applied. Besides being useless they are a source of danger to the men coupling cars when switching is going on.

An iron manufacturer remarked, in this office the other day, that he would be willing to give \$50 for the best explanation of the well-known fact that it takes more heat to melt charcoal iron than common iron. Perhaps some of our readers who know can make a claim for that offer.

BOOK NOTICES.

THE ENCYCLOPEDIA OF FOUNDRYING, and Dictionary of Foundry Terms used in the practice of molding. By Simpson Holland. John Wiley & Sons, New York.

This is a dictionary and encyclopedia of everything and every term used in molding, and it seems to us would be almost as necessary to a progressive molder as the best tool in his kit.

The work contains some 335 pages, the subjects arranged in alphabetical form and gotten up in the plainest and simplest language. It is the only work of the kind extant, and will doubtless meet with a ready sale in its own field.

There are numerous rumors flying round about railroad equipment to be ordered in the near future, but the real contracts given out are frightfully few. Everybody who has any assurance in finding the address of the most tangible person to blame for the protracted depression.

PERSONAL.

Mr. F. E. Talbot has been made master mechanic of the Jacksonville, Tampa & Key West, at Palatka, Fla.

Mr. R. G. Ward has resigned as road-master of the South Carolina road, and Mr. Littlefield, a New Englander, has taken his place.

Mr. George H. Hansel has been elected secretary and treasurer of the National Switch & Signal Co., with offices at the works, Easton, Pa.

Mr. A. M. Pichel has been appointed traveling engineer of the Michigan Southern division of the Lake Shore, in place of Mr. D. A. Fleming, transferred.

Mr. John Poak has been appointed general foreman of rolling stock of the Jacksonville, Louisville & St. Louis, with headquarters at Jacksonville, Ill.

Mr. F. M. Stevens, late of the Baldwin Locomotive Works, has been appointed master mechanic of the Hoosac Tunnel & Wilmington Railroad, with headquarters at Readsboro, Vt.

Mr. M. A. Kimmel, who has been connected with the Central of New Jersey for many years, has been appointed superintendent of the company's car works at Mauch Chunk, Pa.

Mr. W. S. Jones, lately superintendent of the Central division of the N. Y. & N. E., has been appointed general superintendent of the South Carolina Railroad, in place of Mr. J. M. Turner, resigned.

Mr. R. G. Matthews, superintendent of the Buffalo and Rochester divisions of the Buffalo, Rochester & Pittsburgh, has been appointed general superintendent of that road, with headquarters at Buffalo, N. Y.

J. F. Sechler has been appointed master mechanic of the Elgin, Joliet & Eastern Railway, in charge of motive power and rolling stock, vice T. Downing, resigned. Mr. Sechler's headquarters will be at Joliet.

Mr. J. H. Barrett, lately general superintendent of the Buffalo, Rochester & Pittsburgh, has been appointed general superintendent of the Cleveland, Akron & Columbus, and Ohio Southern roads, with headquarters at Cleveland, O.

Mr. Charles Hansel, C. E., at present Western manager of the N. S. & S. Co. of Eastern Pa., has been elected vice-president and general manager of the company, with offices at 35 Liberty street, New York, commencing June 1st.

Mr. E. S. Cannon, the well-known railroad supply man, has accepted the position of manager of the railway department of Pettier & Symes, New York. That firm is about to place a fine car sent upon the market, and the business will be in Mr. Cannon's hands.

Mr. N. Monarral, who has been appointed receiver of the Valley Railway in the place of Mr. J. K. Bole, deceased, is well known in railroad circles from his long connection with the Cleveland, Akron & Columbus, with which he has only recently severed his connection.

Mr. H. M. Sperry, who for some years has been connected with the Johnson Signal Company, as general representative, has tendered his resignation, to take effect June 1st. Mr. Sperry has been appointed as Western agent of the N. S. & S. Co., with office rooms 1236-78, The Monadnock, Chicago.

Mr. H. G. Peters, Long Beach, Cal., who has our assurance in finding the address of her brother, Richard Houston, who was running an engine out of Mason City, Ia., the last time he was heard from.

If any of our readers know the whereabouts of the man, and will send it, they will do a kind favor to a dangerously sick woman.

A model of the McIntosh improved automatic oil collar and sight-feed oil cup, which was exhibited at the Saratoga Convention, excited much favorable comment among railroad men. The device is so simple and inexpensive, and is such a thorough preventative of hot boxes, that it ought to be applied to every locomotive in the country.

Mr. E. T. D. Myers, president of the Richmond, Fredericksburg & Potomac, issued the following touching circular: "It is with great distress that the death of W. H. Trainham, for many years the master car builder of this company, was announced. He was a thorough workman and an exemplary man whose record is unimpaired. His death is a great loss to us."

Messrs. R. J. Gross and H. Tandy, of the Brooks Locomotive Works, have gone to Brazil for the purpose of investigating matters connected with the operating of locomotives in that country. The journey has been considered necessary in connection with the order which the Brooks' people received for sixty locomotives for the Central Railroad of Brazil.

Mr. C. A. Moore, the well-known member of the firm of Manning, Maxwell & Moore, New York, has been favorably mentioned as a candidate for Governor of the State of New York. Mr. Moore is president of the Montauk Club of Brooklyn, and was in the chair at the dinner given at the Pacific club in New York, which directed the necessity for municipal reform in the city of Brooklyn.

In the election of Mr. W. H. Truesdale, receiver of the Minneapolis & St. Paul, to be third vice-president of the Chicago, St. Paul & Pacific, an able and popular railroad officer takes a step upwards. Mr. Truesdale has managed an unimpaired road with much skill, vigilance and care, and he will be a valuable acquisition to the Rock Island management. He is a most genial gentleman, highly popular alike with patrons and brickmen—the latter are the most penetrating critics of all railroad men.

Mr. J. D. McIlwain has resigned from the Harvey Steel Car Works, of Chicago, and accepted the position of superintendent of the Union Car Co., Depew, N. Y. Mr. McIlwain is one of the best known and ablest master car builders in the country, and we feel certain that he will prove a valuable acquisition to the Union Car Co. He writes that he is now in charge of "the finest plant for building cars on earth." With such advantages we feel certain that Mr. McIlwain will beat all records in car building.

When Mr. David Clark, the well-known master mechanic of the Lehigh Valley, at Hazelton, Pa., walked up to pay his dues at the last Master Mechanics' Convention, the treasurer noticed that the \$5 bill handed in had Mr. Clark's signature on the face. Inquiry brought out the fact that Mr. Clark is president of the bank. We believe that this is the only case in the United States where a master mechanic is a bank president. There are several master mechanics who are mayors, and others enjoying honorable civic positions, but their distinction is faint beside a bank president.

Mr. J. H. McConnell, superintendent of motive power of the Union Pacific, made his mark as a speaker at the mechanical convention. He makes no pretensions to oratory but talks in a modest style that means business. His power as a speaker is in the facts which he strings off in rapid succession, his head being brimful of

figures giving particulars of the points he is making. Mr. McCannell did not speak often but he never rose without having something to say that was worth listening to, and the members indicated by their attention that they appreciated what was said.

In the new reorganization of the Richmond & Danville, East Tennessee & Virginia & Georgia and Queen & Crescent systems, we are pleased to note that Mr. W. H. Baldwin, Jr., general manager of the Plant & Pipe Manufacturing Co., is named as third vice-president, with charge of the operating department. Mr. Baldwin has achieved great success under discouraging conditions, on a small road badly run down and with very limited resources. By careful and intelligent management this road was put on a sound footing and the service was thereby greatly improved at less expense than was formerly incurred in letting it run down. We shall be greatly disappointed if Mr. Baldwin does not make a splendid record in his new position.

Mr. P. P. Swan, of Chicago, a manufacturer of lubricants much used by railroad companies, was shot with most disastrous results last month. He had formerly labored in Mr. Swan's employ, and was nursing some grievance which led to the visit at Mt. Henry. Vaughan was for about fifteen years on the Burlington, Cedar Rapids & Northern Astoria and engineer. He was highly popular with the men, and in about twenty years that of the dress of the Locomotive Engineers' Brotherhood, and was sent to several conventions as delegate. Later, he fell into drinking habits, and that got him into trouble. We know of no railroad workman who had a more promising career before him than Henry Vaughan last ten years ago. And now.

One of the surprises of the Master Mechanics' Convention was the large vote cast on the first ballot to Mr. R. H. Soule for second vice-president. Mr. Soule has been in the railroad business for many years, much, but he has taken a very active part in the Master Car Builders' Convention, and was several times a favor to the president of that association. He is one of the most accomplished mechanical engineers in railroad service, is an excellent traveling officer, and a pleasant and genial gentleman. It is not surprising to know that he is superintendent of the machinery of the Norfolk & Western. It is not so well known that in the few years he has been on that road the rolling stock has been greatly improved and the train service made much more punctual, while the operating expenses have been reduced.

Mr. J. K. Bole, receiver of the Valley Railroad, and president of the American Steel Castings Co., died suddenly of apoplexy last month. Mr. Bole was one of the most popular men in the country. His services brought into intimate contact with many railroad men, and many thousands of warm friends among them. In fact, he possessed the happy faculty of making many friends and no enemies. We know of no man taken away of late whose death came like a personal loss to so many friends. He was well known to railroad men in almost every connection with the Ohio Steel Works. Lately he has been working hard in connection with the American Steel Castings Co., and his untimely loss means much regret, and his untimely loss means much regret, and his untimely loss means much regret.

We are informed that the United States Health-Care Co., Utica, N. Y., has purchased of M. M. Buck & Co., the Dayton Manufacturing Co., Kelly Lamp Co., Steam Gauge & Lantern Co., L. A. Wallens & Co., and The Adams & Westlake Co., the

machinery, tools, patterns, etc., constituting their head-light business, together with thirty-two letters-patent and a number of applications for patents, covering all of the standard devices for illuminated numbers and signals in head-lights and other desirable improvements therein. It is the intention of the United States Health-Care Company to unite with the patents and facilities thus acquired, the result of over forty years' experience in manufacturing head-lights, for the purpose of embodying in them the latest improved devices which will add to the design, convenience and durability, farm-shining and other purposes, superior to any heretofore supplied, at the lowest possible price consistent with first-class material and workmanship.

Reports say that the Williams Palace Car Company, capitalized at \$1,000,000, will begin the construction of cars in St. Joseph, Mo., to compete with the Pullman and Wagner companies. There is a saving of weight in the Williams car of 5,000 pounds. The berths will be a little longer than those in the Pullman and Wagner cars and about the same width. They will be arranged in about the same manner with upper and lower tiers. The Kirk upon which the mattresses will rest will be made of aluminum inclosed in a case of wood and will fold up in the same manner that an accordion does, and will be deposited in the wall of the car in a space of one and seven-eighths of an inch thickness. Upon these frames will rest mattresses made of cloth and rubber, which will be inflated with air immediately before being put in use. In the summer heated air and in the winter warmed air will be used. These mattresses, together with the heating system, will be stored underneath the seats when they are not in use.

A motion was made at the Master Mechanics' Convention to put Mr. Charles Graham upon the list of honorary members, and it was carried by an enthusiastic vote, which indicates that many personal friends of this veteran mechanic were present at the meeting. Mr. Graham was one of the organizers of the Master Mechanics' Association, and always took a warm active interest in the meetings. Twenty years ago he was considered one of the ablest mechanical men in America, and almost any railroad company would have been glad to employ his services. About that time he was offered the position of superintendent of one of the largest locomotive works, but Mr. Sloan, then general manager of the Delaware, Lackawanna & Western, would not let him go. Mr. Graham is not a very old man, but he is supposed to be from some experience in injuries which he received by being struck by a locomotive. His lower limbs are a defective working order, which prostrate his powers of locomotion. Otherwise he is well. He spends a great part of his involuntary leisure reading engineering literature. He says that Locomotive Engineers' Association does not count often enough.

Alphand-Thomas Tarsney, of Colorado, who has come prominently into public notice through being forcibly taken out of a hotel in Colorado Springs and carried to a federal prison for non-payment of an engineer on the Denver & Rio Grande, and the J. P. of Locomotive Engineers, did a little extra thing for him. Mr. Tarsney was trained as a lawyer, and his feebility of speech recommended him for success in that profession, but as a locomotive engineer he found it being to be of little use. He got discharged from the service, and his work was general superintendent, and he went about telling that he intended to kick Mr. Cushing. One day the latter gentleman stopped off at Pueblo, and Tarsney went up and asked what he was discharged for, and before an answer could be given he knocked off Mr. Cushing, and he ran like a deer for the nearest shelter. For the next few days he went around telling that he knocked the general superin-

tendent down. Tom went off with the Populists and got to be a "general." In this connection it might be mentioned that the S. P. of Locomotive Engineering did his first journalistic work in this country for Governor Waite of Colorado, when the latter was proprietor of the Jamestown Journal. Some time afterwards the S. P. was offered a permanent position on the editorial staff of that paper, but declined the honor.

A very graceful testimony of appreciation of the services of old members was made by the Master Car Builders' Convention in electing five of the oldest members to be life members. The men thus honored were Messrs. John Kirby, F. D. Adams, C. A. Smith, George Hackett and Robert McKenna. Mr. Kirby was aided to be the father of the Association. In 1864 there was a little meeting of master car builders held in his office, and plans were talked over for more intimate co-operation among railroad car builders in the handling of foreign cars. This resulted in the call for a meeting of master car builders at Springfield, Mass., where the National Association was organized. The Kirby took an active part in starting the association, and he was long its treasurer and for one year was president. Mr. Adams was one of the few present at the preliminary meeting, and he has always been an active and earnest worker. Mr. C. A. Smith was secretary of the association for several years, and he has done more than any one man to keep it alive in times when apathy and senseless opposition were threatening its dissolution. Mr. Smith never misses a convention, although his voice is not loud on the floor he is an active worker. Messrs. Hackett and McKenna are old members still in active railroad service, and ever ready to give assistance and co-operation in any way work to promote the interests of the association.

A notable thing about the Master Mechanics' Convention, held at Saratoga, N. Y., last month, was the number of old faces to be seen in the meetings. There were fifty or sixty men who had never been at one of the conventions before, but there were several of the old veterans present who are known to very few master mechanics' now in active service. First among these might be mentioned Mr. G. A. Coudage, from Chicago, who was the honorary member who was long master mechanic of the Fitchburg Railroad. He is a venerable-looking old gentleman, and displayed warm interest in the proceedings but had nothing to say in the meeting. Railroading of to-day has drawn away from the pastimes of his time and new problems have come up for him to keep it that were never heard of in his day. Twenty years ago one of the best known master mechanics in New England was Mr. John Thompson, of the Eastern Railroad. He was the inventor of the extension smokebox and first made that form of spark-arrester a success. Mr. Thompson attended the convention, and his general face attracted new friends and acquaintances, but few of the new men who grasped his hand had any idea of the prominent feature he had put upon the locomotive. At a convention in the early seventies a most interesting and amusing party of old fellows was held by George Wheeler, an associate mechanic who was an engine builder in Worcester, Mass. Mr. Wheeler was present at the Saratoga meeting, and most of the members took him for an Episcopal clergyman of engineering tastes. He is full of years, and of engineering reminiscences, but he changed his dress on the subject of railroad valvies.

It is curious the events that sometimes exert powerful influence upon a person's life. The late John Sawyer, superintendent of motive power of the Atchafalaya, Topoka & Santa Fe, at a few weeks' work exchanging reminiscences on the piazza of

Congress Hall, Saratoga, during the convention time. "Do you know," he enquired, "that I got my first real start by having a fight with another boy?" It happened the other way. When I was about thirteen years old, I went to work in the Washburn Arsenal, doing odd jobs in the office and for the foreman. The best position for a boy was to enter the machine shop as an apprentice, but that privilege was greatly sought after, and my parents had not enough influence to get me entered as an apprentice. One day I was going round the shop behind checks to the men, and another boy hit me in the face with a lump of wet greasy waste. I did not for a moment reflect upon the august rules of the great Government establishment, but jumped upon the boy and began to thrash him. I knocked him down upon a revolving grindstone which was set level with the floor and it carried him round and sent him sprawling along the shop. Just at that moment the superintendent happened upon the scene, and promptly locked me out of the place. A week or two after, I met the assistant superintendent on the street, and he asked me why I was not at work. I told him the story and he told me to be careful in the machine-shop next day, but to be careful to keep out of sight when the superintendent came round. So I went to work as an apprentice, but he indulged out of sight for a year or two every time the superintendent came round. I believe, however, that he knew all the time that I was there, but the rules of the place had to be upheld. He was one of my best friends after I grew up."

EQUIPMENT NOTES.

The Lehigh Valley have ordered three locomotives from Schenectady, and they are reported to be in the market for 2,000 coal cars.

Baldwin's people have received orders from the Missouri, Kansas & Texas for five consolidation locomotives, and from the Cincinnati, Lebanon & Northern for some eight-wheelers.

The Star Head-light Co. of Rochester, N. Y., of which Mr. S. H. Wheeler is a railroad representative, has closed a contract with the People's Traction Co. of Philadelphia, for 300 head-lights.

The firm of Ralsdale & Lewis, 39 Cortland street, New York, have put on the market the Daval metal packing for locomotives. This packing is made entirely of metal woven in any desired shape, and is handled as easily as fibrous packing, while giving the same effects as sectional metallic packing. A 30-II P. 10-key engine had the pistons packed with this packing four years ago, and it has not been touched since.

The Pyrotechnic Railway Signal Co., New York, have a device which is calculated to be a good protection for trains on roads not protected by block signals. It consists of a small iron carriage, weighing only a few pounds, and containing a rocket on one end, and it is propelled along by a rocket attached to the carriage. When the rocket is lighted, the thing shoots along at a high rate of speed burning a bright red light. An exhibition of the invention was given at Saratoga during the convention, and it worked to perfection.

New repair shops for the Buffalo & Squawhamo roads are to be erected at Glastonbury, Pa. The shops are expected to employ 150 men, and to have a capacity of 30 locomotives and 1,000 cars a year when fully equipped. Some of the contracts have already been let, and the work of building is to be begun in thirty days and is to be finished in six months. The dimensions of the buildings are: Paint shop, 50 x 125; roundhouse, 70 x 100, containing seventeen stalls, of which six will be at once built; machine shop, 100 x 100; car shop, 75 x 125; and a planing and exchanging reminiscences on the piazza of

The Elements of Boiler-Making—IV.

SHEET-IRON WORK.

By C. E. Fourness.*

A man wishes a square elbow built of No. 13 steel to connect two pipes, one 21 inches in diameter outside, the other 14 inches in diameter inside, this necessitates the elbow being tapered as shown in the side elevation, Fig. 55.

In laying this out, first in order comes the outline view, Figs. 56, 57, and 57A. First draw the center line $A B$, then draw $A F$ at right angles to $A B$, C , 21 inches long and 17 inches each side of A . By referring to Fig. 15, the distance from the center of one pipe to the center of the rivet holes in the other is 28 inches, consequently locate O 28 inches from A and B and N 28 inches from O , A being on the line $O P N$, A at right angles to $A B$, C . At B draw $D B G$ at right angles to $A B$, D 18 inches long and 8 inches each side of B . Draw $L N M$ at right angles to $A P$, N P , O , 16 inches long and 8 inches each side of N . Draw the lines $E D C$, and $F G C$ from O as a center with the distance $O P$ (the radius at that point). Mark the points R and S , set the straight edge to the points M and S , and draw the line $I S M$. Set the straight edge again to the points R and L , and draw the line $H L$, then from the points I and H , where the line I cuts $E D$, and where $H L$ cuts $F G$, draw the diagonal line $I H$, and draw $J K$ one-half (1/2) inch from and parallel to $I H$, this latter line is for the rivet holes. From A , as a center, with the distance $A E$ for a radius, draw a semi-circle. The arc $E F$ will be the diameter. Space off this semicircle for thirteen points or holes and number them 1, 2, 3, 4, etc., beginning with No. 1 at E , and ending with 13 at F . Set the straight edge at each of the points successively to draw the ordinates through these points of division on the circumference of the semi-circle at the large end, and at C the vertex of the angle, and at D the vertex of the angle, for the other end, the ordinates are to be drawn between the lines or diameters $D B G$ and $E A F$.

Next in order comes the sheets. First, take the sheet to form the cone (Fig. 56), set the trams to the length $C O$ to F (Fig. 56), and draw the line or arc $A B$, (Fig. 56). A and B to be located five (5) inches from the side of the sheet. This is the number for the holes on that, the large end. Preserve the center K , from which this arc was drawn, then set the trams again from C to P (Fig. 56) and draw another arc, $C D$ (Fig. 56), using the point K as a center. These are the lines $A B$ and $C D$ to lay off the circumference upon.

The end $E A F$ (Fig. 57) is 24 inches in diameter inside, and 17 inches the circumference. I will use a somewhat different method, by adding one the thickness of the material, $\frac{1}{8}$ of an inch, to the diameter for a new diameter, which equals 24.125, this multiplied by 31 equals 753, inches, this length lay off on the line $A P$ (Fig. 56), and from the point midway between A and P , draw $A B$ as a center line, and from the center K , cutting the line $C D$. To find the diameter at this point, I add the diameters of the ends together, and divide the seven by two for the average diameter or the diameter midway between the two ends which equals 20 inches. By referring to Fig. 55 I find the cones must be 30 inches outside, $30 \times \frac{1}{2} = 15$, inches, and equals two times thickness, or 8, or 4 inches less, equals 104 inches. This length lay off on the line $C D$, an equal distance each side of the center line. Space off the lines $A B$ and $C D$ each into twenty-four points, this will be the center of the rivet holes on the line $A B$. Draw lines through each of the correspondingly numbered points on the lines $A B$ and $C D$, and number them

1, 2, 3, 4, etc., beginning with No. 1 at the ends or straight seams, and ending with No. 13 at the center. Transfer the lengths of the ordinates between the lines $A E F$ and $H I$ (Fig. 56) to the correspondingly numbered lines in Fig. 59, measuring from the center of the holes on the line $A B$. Center these points just found, as after the sheet is rolled it must be flanged here to fit into the other course. Allow a 1/16 inch outside of these marks for the flange, space off the straight seams for thirteen holes, leaving the last at least $\frac{1}{8}$ of an inch from the center marks for flanging, allow one-half (1/2) inch outside of the holes for the lap, and the course is complete.

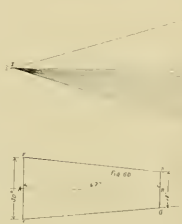
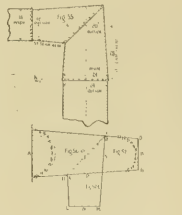

Now for the other course, Fig. 57A. The straight seam comes on the line or side, $L H$, suppose this part, bounded by $M N$ $L H I H$, is given a one-half (1/2) revolution on the plane $H I$, it would then be in the same position that Fig. 57 occupies. By doing this, one set of ordinates, answer for Figs. 56 and 57, but number them differently by starting with No. 1 at G and ending with No. 13 at H . Set the trams to the distance $C G$ (Fig. 57) and draw the line $G H$ (Fig. 57), the points G and H to be one-half (1/2) inch from the side of the sheet. Set the trams again from C to P (Fig. 57), and draw the line $E F$ (Fig. 57) from the same center axel to draw $G H$. Referring to Fig. 55, the diameter is 20 inches inside at the point O (P in Fig. 57), and the circumference of a diameter of 20 inches as found is 62.8 inches. As it is to be this diameter, 20 inches inside, add three times the thickness, or $\frac{3}{8}$ of an inch, this equals 63.4 inches, which length or circumference lay off on the line $E F$. Set one end of the straight edge to the center from which the arcs were drawn, the other at a point midway between A and F , and draw a line for a center line a little distance across each

arc $E F$ and $G H$. Referring again to Fig. 55, the diameter at the small end is 16 inches outside, $16 \times \frac{1}{2} = 8$, inches, less three times the thickness or $\frac{3}{8}$ inch equals 49.7 inches. Lay off this length on the line $G H$, one-half on each side of the center line. Space off the lines $G H$ and $E F$ into twenty-four spaces, and number the points found from 1 to 13, beginning with No. 1 at the center and ending with No. 13 at the ends or straight seams. Draw lines through the correspondingly numbered points or marks on both lines, and transfer the lengths of the ordinates between the lines $D B G$ and $J A$ (Fig. 57) to the similarly numbered lines in Fig. 58, measuring from where the lines last drawn cut the arc $G H$. These marks just found will be the center of the rivet holes in the diagonal seam, and the holes can be punched, as this course will require no flanging. Space off the line $G H$ for twenty holes, as the twenty-four holes

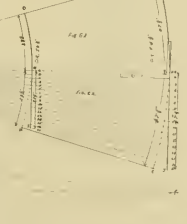
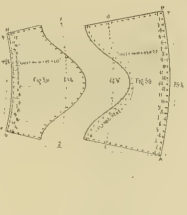

would bring them too close together. Then space off the straight seams for five holes, and after allowing one-half (1/2) inch outside of the rivet holes for lap, the sheet is ready to shear and punch. In our next I will endeavor to give in a plain manner, the method of finding the curve or curve that sheets must be cut to in order to form the envelope of cones or frustrums of cones. There are several approximate methods for finding this curve or curve where the difference in the two diameters is but very little, but for my part I believe in the old reliable, and in making use of this method (radial line and a square), there are no exact number of lines to be used, but generally it (the circumference) is spaced into as many points as there are holes, as this saves spacing again, but in case of a rush job use a less number of lines say four lines each side of the center, but the greater the number of lines used (the closer together) the more accurate the result. I, for quite some time, supposed that the method of using lines and a square was only approximate as I had not understood the principle of it, but in Figs. 60 and 62 both methods are shown, one

half the sheet is laid out with the trams, the other half with a square, and as you can see for yourself, the results are the same.

I want to lay out an envelope or sheet to form a frustum of a cone, 30 inches in diameter at the bottom, 16 inches in diameter at the top and 67 inches high, as shown in Fig. 60, and will proceed to lay it out by first drawing the center line $A B C$, next $E A F$, 16 inches long, 15 inches each side of A , and at right angles to $A B$, C , 67 inches from A . At D draw $D H G$, 18 inches long and 9 inches each side of D , then draw the sides $E D$, and $F G$. Draw the center line $H I$, 16 inches long and 15 inches each side of H , then lay out the arcs $A B$, $C D$, and $E F$, as shown in Fig. 60.

Draw the center line $H I$, 16 inches long and 15 inches each side of H , then lay out the arcs $A B$, $C D$, and $E F$, as shown in Fig. 60. Next set one end at H , the other at I , Fig. 61, set the trams at the arc $A B$, set the trams again to the arc $C D$, Fig. 60, and carry to P and Q , and a line drawn from P will just cut through the point I , conversely, it is only necessary to find the circumference at one end, as a line drawn to the center will give the other. Thus, as you will notice, is a very convenient method of accomplishing this result, but when you have a taper course or frustum of a cone where the difference in the diameter at the top and bottom is very little, just the thickness of the iron, perhaps, then it will require trams of extraordinary length, and another system or method must be adopted. There is another method, Fig. 62, by using radial lines and a square, which I will proceed to explain. Draw the line $H I$, Fig. 62, at right angles to $H N$, I , and one-half the circumference of the large end, 47.1 inches long, draw $N A$, 17 inches from and parallel to $H I$. Make $N A$ one-half the circumference of the small end, or 28.9 inches in length, space $H I$ into 17 points, and number them from 1 to 17, calling H No. 1 and I No. 17. Space $N A$ into 17 points, numbering them from 1 to 17, calling N No. 1 and A No. 17. Draw lines through points I , correspondingly numbered, as 2, 3, 3, 4, 4, etc. In this case they are drawn to the center I merely to show how nearly the lines draw to the same center from which the arcs in the other one-half were drawn. Take a square and lay it along $N A$, the line 2, the blade just up to the point I on the center line, or line 1, make a short mark across the line 2. Move the square to the line 3, with the blade at the short mark across the line 2, make a short mark across 3.3, move the square again to the line 4, the blade to the short mark across the line 3, 3, and make a mark across 4.4. Proceed in the same manner until the line 17 has been treated, and if the work has been performed accurately, the arcs $H I$ will be similar to $H P$. Set the trams to the length $H N$, or 17 inches, and place one point at the intersection of the small mark with the line 2, and 2, and make a small mark across 2.2 on the center line at the same one point of the trams at the intersection of the short mark with the line 3, at 3, and make a mark across the same line at 3. Proceed in a similar manner to 17, and the arcs $H N$ will be exactly the same as $N D$. Measure off on the arc $H I$ 17.5 inches, one-half the circumference of the large end, notice the difference on the line 17.7. Next measure off on the arc $A M$ 28.9 inches, one-half the circumference at that end, this also overruns. Draw a line from M to N , this will be the edge of the sheet or envelope, and if the line $A J$ were continued it would cut the center I .

Before taking up a new subject, perhaps

*From Boiler-Maker, C. M. & S. P. By Dubuque, Iowa.

it would not be amiss to take on a little matter pertaining to smokestacks. A man came to me, he had bought two second-hand boilers, he wanted a smokestack. But first he wanted to know if these boilers had the proper sized openings in the smokebox or breeching. He said one boiler, 48 inches in diameter, had 2 1/2 inch flues 3 inches in diameter, and the opening for the smokestack was 27 1/2 inches in diameter. The inside area of a 3-inch flue is 6 square inches, and this boiler has 48 such flues, and this boiler has 288 square inches of flue area. The area of a circle 27 1/2 inches in diameter is 597.6 square inches. From this, subtract the area of the 48 square inches, this gives a difference of 495 square inches, divide 48 by 49.6, the answer will be 7, and shows that the opening in the breeching is 7 greater than in the flues, and is about the right proportion, as the openings are made from 1/2 to 1 larger than the flue area.

The other boiler was 36 inches in diameter and had 24 flues 3 inches in diameter, and had an opening of 31 inches in diameter in the smokebox for the stack. The area of one flue is 31 square inches, and 24 flues is 744 square inches. The area of a circle 31 inches in diameter is 754.76 square inches, the difference is 100.76 square inches, and 100.76 divided by 24 is 4.198, showing that the area in the opening to the stack is about 4 1/2 greater than the area of the flues, and is all right. This latter opening is slightly greater than that, but I call it 4 1/2, as it is quite close to that figure.

The man said he wanted a smokestack for the two boilers. But he wanted the proper size of the openings of the boiler to come to a boiler. The opening of the boiler is 4 1/2 greater than the area of the flues, and I think they should be 4 1/2 more than the area of the flues, and the opening of a circle to contain that area is 4 1/2 greater than the area of the flues, and it will be 27 1/2 inches, call it 28 inches.

The man had a stack of brick that contains the above the 28 and 31 inch flues.

There are four (4) different methods of finding the area of a circle. First and the most accurate method, then find the diameter of a circle that contains this area.

$$D = \sqrt{\frac{4A}{\pi}}$$

24 x 24 = 576, 576 divided by 3.1416 = 183.23, and the square root of 183.23 = 13.537, 13.537 multiplied by 2 = 27.074, 27.074 is the diameter of the circle that contains the area of 576 square inches.

The second method, if you will notice in the first example, I multiply first by the decimal .7854 to find the area, then I divide again with the same decimal to find the new larger diameter. This overcomes the effect of the multiplication, and in the second method I will get the same result by just merely squaring the diameters.

$$24 \times 24 = 576, \text{ and } 576 \div 3.1416 = 183.23$$

$$13.537 \times 13.537 = 183.23$$

The third method is to find this in a practical manner. Draw two lines at right angles to each other (Fig. 63), make the base A B equal in length to one of the diameters as 24 inches, and the perpendicular C D equal in length to the other diameter, or 31 inches long, then the hypotenuse or length from B to C will be the diameter of a circle equal to the area of the two smaller circles.

The fourth method is to figure or find the length of the hypotenuse. By figuring

the square of the base plus the square of altitude equals the square of the hypotenuse, and the square root of this equals the diameter required.

$$24^2 + 31^2 = 576 + 961 = 1537$$

$$\sqrt{1537} = 39.20$$

Find the size smokestack required for a boiler having 24 flues 3 inches in diameter. Rule—Square the diameter of the flue and multiply by the number of flues, and the square root of the result is the diameter required.

$$3 \times 3 \times 24 = 9 \times 216 = 1944$$

The cut herewith shows a device for injecting kerosene oil into boilers to prevent and remove scale.

It has come to be a pretty well recognized fact that kerosene will prevent scale, but the question of how to introduce it into the boiler in regular quantities has been left unsolved to a great extent.

This cup is attached to the injector branch pipe, as shown, and feeds by displacement of the oil by drops of water. The

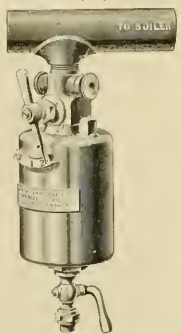

feed is regulated by the lever shown, and the drops can be seen through the glasses on each side.

As there are 2,000 drops of oil in one pint, it is an easy matter for the engineer to set his feed to supply a given amount of oil per hour.

Some thirty of these cups are in existence and doing regular work satisfactorily. They are neat, placed out of the way and require little attention. They are made and sold by the Chixmas Injector Co., of Springfield, Ohio.

Science of Railroad.

By J. F. PHILAN.

The following are a few extracts from an excellent lecture recently delivered by Mr. J. E. Pichon, master mechanic of the Northern Pacific at Fargo. We regret not having room to publish the whole address.

"The intelligent consideration of any subject must be broad enough to encompass the known field of nature, and the natural development of railroads, if successful, must continue along lines of endeavor as indicated by the wants and destroyer necessities of cosmopolitan population. This is a study as interesting as 'Darwin's Origin of Species,' or 'Descent of Man,' and fraught with vital consequences in the struggle for existence, for the magnificent and powerful development created by man as existing in railroad property, strengthens mankind in proportion to its well-directed and consummate motion and activity. In further consideration of the cause and governing influence

In the railroad's existence and prosperity, we can view the activity in railroad building in the United States, dating in its approximating 1827, and at present approximating 175,000 miles.

"Great Britain at about the same time has acquired about 30,000 miles, while France equals Great Britain, and the German Empire exceeds Great Britain about 5,000 miles.

"The Russian Empire in Europe has about 20,000 miles of railroad, with about 30 per cent. more population, it has about 50 per cent. less railroads than the United States.

"For the past five years railroad building in the United States has averaged about 5,000 miles per year, or 1,000 miles per year more than for the seven years preceding the panic of 1873, but this will not seem so remarkable when we find for five years prior to 1852, 40,000 miles of railroad were constructed in the United States, or 8,000 miles per year. For five years following the panic of 1873 this country constructed 2,800 miles per year. We have seen considerable complaint in the newspapers for several years back about the depressing influence of Canadian railway lines, especially on transcontinental traffic, but not very much about the depressing influence of home competition, struggling for revenue from sources of supply expanded and stimulated to a successful extent. While this remarkable railway building within the United States progressed and stimulated the cultivation of immense areas of new land and the development of mines and mining, all tending to an enormous output of material products, the most important field in contemporaneous history to view, in my mind, embraces other new countries. The development of railroads and new country in Canada, while important, is but a small factor when viewing other new fields. Canada, with an area of about 1 1/2 million miles, has less than 15,000 miles of railroad, while the Argentine Republic with only about one-third the area and about three-quarters of a million less inhabitants has over 6,000 miles of railroad. Chili and Peru have developed railways to a remarkable extent, considering population. Brazil and Mexico have been fairly active, and each has over 5,000 miles, while Cape Colony, Victoria, New South Wales, Queensland, South Australia and New Zealand, considering the location and conditions, have shown activity in railroad building corresponding in degree with other new countries. Railroad building in India has been active in recent years, and now has railroad mileage exceeding that of Russia or the United Kingdom. Compare the products of all new countries or of territory where railroad building has been most active, and you will find such products corresponding to those produced in the United States to a remarkable degree. Can you wonder at the low price of wheat and other products of new countries and corresponding depression of railroad securities in the light of such circumstances?"

"Is not overproduction most natural under such a stimulant, and can that portion of the population who dig their revenue out of the ground, continue to purchase manufactured articles where profitable revenue is not realized from their labor?"

"While the products of new countries are forced on consuming markets, every effort is made by the older countries to favor home industry, and shut out the constantly cheapening products from the newer countries. We are now at a stage where the fish must eat the little ones and the smallest of the world's organizations. You may recall the weaker Lord Bacon on the entrance to the Transportation Building, at Chicago: 'There are three things which make a nation great and prosperous—a fertile soil, busy workshops and easy conveyance for men and goods to place to place.' We must not respect the past, but the 175,000 miles of railroad in the United States may play in sustaining the activity and great-

ness of the nation, and I do not en in saying that the railroads of the United States must be powerful or popular enough to invoke the aid of government for the common good, or ultimately become an adjunct to the work of the general government of the nation.

"In this respect it must be understood the government is by and for the people. Herein we must recognize the great advantage of a general education, both technical and practical for the enlightenment of government and railroad employees for the common good. So long as railroad progress is in advance of government employees in point of technical or practical training, or *education*, so long it remains one with the other will seem meddlesome and abortive. So rapid has been the development of railroad mileage, that general education in the details of railroad, has marched on the flank of railroad progress, as it were, in the van, for location and operation. In fact, the well-organized presented an animated aspect of Kindergarten principles as applied both to engineers and operators. Construction of railroads in the United States not only advanced into new territory inland, but has also paralleled canals and watercourses in successful competition with navigation, and is a useful and profitable mode of transportation. The railroads build with grades corresponding to the surface levels of navigable waters, affording the least resistance and requiring a minimum force or energy to propel the loads, can be depended on to exist and gain compensation in competition with the cheapest method known for conducting transportation.

"The railroads build under the stimulating advantages pertaining to a new country, with steep grades and sharp curves must modify the resistance in every possible direction within limits to insure compensation for traffic, under a tariff fair to producers and successfully maintained against the efforts of competitors. Able men in railroad management have provided, within recent years, powerful locomotives to successfully overcome the resistance of steep grades, and at the same time propel tonnage sufficient to insure profitable returns, while at the same time the weight and capacity of cars have been increased in the same ratio. In turn, roadbeds and bridges have necessarily increased in strength and cost to sustain increasing weights of rolling stock. Thus, the tendency had been to overcome resistance by main force, and while eminently successful at an apparent reduction of cost in operation, yet the obstacles in form of steep grades, sharp curves, and unnecessary distance in many cases, remain to worry and absorb money and revenue without compensating returns.

"While development has been successfully carried on, other able men in management have successfully carried out the principles of removing resistance by revision and reduction of grades, curves and unnecessary distance. By such methods they not only remove the excessive resistance, but, in proportion to the measure of resistance removed, you increase the efficiency of motive power. The most progressive civil engineers have demonstrated this principle to a satisfactory conclusion. I cannot follow this branch of analysis, but will only say by saying that the engineers who view the matter of location for the most economical results in operation, favor the location of railroads, when practicable, on a grade as water may flow evenly and when coming to a point of rapids or necessary to climb a divide or to cross the mountains, grade, accomplish the ascent in the shortest distance. The same would continue a canal by the introduction of locks introducing at the railroad locks, or short distance grades, helper engines. This principle insures maximum tonnage being hauled for the greatest distance being necessary to overcome unavoidable resistance. It can be done in the shortest space of time at minimum cost."

Practical Letters

from Practical Men.

Write on one side of the paper, state your point plainly and briefly, and then quit. We accept the generalities. No letters noticed unless name and address are annexed.

Leaks in Train-Pipe Showing on Gauge.

Editor

Mr Orange Pommel, in an article in the June issue of your paper, questions the correctness of a statement of mine, which appeared in the April issue, to the effect that, with the handle of the engine valve in "lay" a leak in the train-pipe will show on the gauge by a falling of the black pointer. He says, "This is all right with the 1850 valve, but not so with the 1850 or 1902 valves," they have gauge connected to equalizing discharge reservoir.

He evidently lost sight of the fact that the packing ring in the equalizing valve is never a tight fit, and that on account of the small capacity of the equalizing reservoir leakage past this ring will be sufficiently rapid to indicate on the gauge any ordinary reduction in train-pipe pressure in spite of the fact that the equalizing port is closed. To substantiate my assertions I have just made some tests on one of the latest Westinghouse valves, and found the packing rings fit better than those with the handle in "lay" and a few sized leak in the train-pipe on a train composed of an engine and one car, the black pointer on the gauge will fall from 70 to 20 pounds in a little over 20 seconds, and if all the air be exhausted from the train-pipe suddenly the black pointer will fall from 70 to 60 pounds in about 5 seconds.

Other valves which I have tested are found in which the packing rings fit better than the one tested above, but no ring was ever made to fit so closely that, under the conditions mentioned, it would not permit sufficient leakage to indicate every appreciable reduction in train-pipe pressure on the gauge.

PAUL S. SNEDECOR.

Chicago, Ill.

A Pound Hard to Locate.

Editors:

Maybe the readers of LOCOMOTIVE ENGINEERING will be interested in a curious trouble we had with one of our 1852 McQueen passenger engines that puzzled several of the smart ones. She went in the back shop to have a little flat spot turned out of her tire and a few lines pulled; very little other work was done on her. When she came out again she rode so hard that it was an awful task to run her, she just jumped right up and down when running fast and pounded horribly on her left side. Like, our traveling, one of the men had some much lead on the left side, but the man who set her valves when she came out said they were exactly square; the eccentrics which were keyed on the shaft were not moved. She had two heavy exhausts on the left side, two light ones on the right side, but they were just a quarter of a turn apart, so then I checked the valves. The left three-way valve had more port opening on the left side than right. Two different men run valves over by the punch marks on the valve-stem. They said she was square as a die. All this time she had a pound on left side when working steam in short out. They trimmed her, she was square in the valves and eccentrics, the pins were quartered right and not sprung any, she took right length. They tried her every where outside her steam chest without getting on to the trouble, but when they took up the steam chest cover it showed up mighty quick. She had an Allen valve on one of the corners on front side had a piece of brass on it, which hung over into the Allen port which goes up over the back of the valve, so there was live steam in this port all the time. That gave her

Facts Wanted. There's a glut of Opinions.

N-inch lead on that side more than right side. Of course the port closed that much later, too, so she was working steam on left side against the piston, which made her thump bad, and took steam for a longer part of the stroke, so her exhaust was stronger, although her exhaust port opened for the same length of stroke on both sides. The old man put a new valve on the left side, and she's a pretty slick engine to ride on now. We will be on to her track next time.

I used to think lots of lead was a good thing, it made an engine smart, and they had to have it to get a train away from a station, but I am converted now, for she pulled better, run faster and rode better when she was set line and line a full year ago.

How does the D5 or D3 brake valve? Nothing from the train-line can get up there, as the reservoir pressure is always on top of valve. We find bits of sand in some of them.

JOHN W. TAYLOR

Indianapolis, Ind.

Two Kinds of Air-Brake Standards.

Editors:

The air brake is of greatest interest to those who make it, buy it, use it and repair it, and the interested parties understand it, more or less, usually as classified above. The manufacturers know what is required in buying and using, and they try to conform to the appliances to do it with. They experiment continually, note results, make alterations, and finally establish a standard design, to be again changed and changed again, but the latest design is always their standard, and always better than the preceding one.

There are some folks who think that the people who make air-brakes don't understand their business. The roundhouse running repair men think so as a rule, and so do a great many locomotive engineers. I saw an old passenger runner step out of the instruction car once, and I heard him address a "brother" this way: "Say, that feller in there said he had twenty-five twenty-five rats." He let his three-way cocks couple up. It's a fella. He has cocks and sets of brakes, though, and when he set 'em kinder easy like, with that new-fashioned brake valve, every one of them pistons slid out at the same time, and they all let off the same way, but he can't take twenty-five cars out on the road and do with them what he did in that car. "Twenty-five rats." Rats? You mean he had to be b'd off every time I make a stop. It's just a scheme to sell that new brake valve, they get more money for it. You bet they can't influence me. If the Old Man lets me keep my three-way cock, I'll get over the road all right with all the air-brake cocks and sets for the engineer quoted as much pay as any of the "smart Alex's."

Younger runners are not so positive that an equalizing discharge and excess-pressure valve is not a requirement of the times. An extra engineer, who was lately promoted from yard service and who, by the way, used to set for the engineer quoted above, said to me the other day: "Had a special freight train the last trip, twenty-two loaded cars, all equipped with air-brake and coupled up, finest set of brakes I ever handled, but I couldn't control them. That engine has a three-way cock, and I run by every stopping place except when making emergency applications." If the engineer had one of those new improved brake-valves I could have handled the train myself. Anyone who says he can handle twenty or two cars of air success-

fully with a three-way cock is talking through his hat. Can't keep your eye on the air-gauge the time when stopping at a water crane, and the train-pipe pressure fluctuates so with a three-way cock that it is really no use to look at the gauge, and as for bearing the exhaust, if light, you can't. The governor is connected with train-pipe, of course, and as soon as the cock goes on lap, the pump starts up, the engine starts popping, and with the handle of the train-pipe so near the engine, you can't tell what kind of an application you are making until you feel the brakes. If you set it strong enough the head brakes will 'kick off' or the emergency go on. With an equalizing discharge valve one can tell almost the exact measure of air he is drawing from the train-pipe, and he has time to allow his valve handle to stay in the service stop position, whether with one or with fifty cars, and in the darkness as well as in the light."

Every railroad company purchases air-brake equipment, but I venture the assertion that not one road in the country keeps its equipment up to the Westinghouse standard. Every road has certain things in the brake line that they refer to as their standard, but it is usually something that the brake company discarded for something better years ago. It may be a brake valve, a triple-valve, an air pump or a form of brake rigging, but master mechanics are left to believe that their old standard is better than anything later. I say "to believe," because I know that many master mechanics are influenced by the arguments and suggestions of running repair men, roundhouse foremen and locomotive engineers to a certain degree, and, also, the first cost of an ancient piece of mechanism is always a factor in coming never and better. Running repair men would rather attend to a three-way cock than to a new brake-valve, naturally enough. And having no road experience, they are honest in their convictions that the brake-valve is an unnecessary complication needing constant attention. And the engineers—they are usually the old-timers, who have rail-sailed the longest and take the least interest in modern improvements. If they get something new they must use it, and to use it rightly, they must understand it, but realizing that "it is hard to teach an old dog new tricks," and that the remaining years of their rail-reading will be few, they condemn anything that is new and different to taking a train over the road in the old-time way.

The prejudiced opinions of some roundhouse foremen and running repair men are of great weight with most master mechanics, and it is the oldest engineers who are consulted by the M. M. or Supt. of M. P. and M. when anything new is to be adopted, and the oldest engineers are usually the ones who try the newest appliances. If it lessens their work without requiring any increased mental exertion it is adopted, otherwise rejected. How seldom it is that young runners are approached by their superiors for "pointers."

There is but one *best* way to do anything, and certain the matters of air-brakes have found, through experiment and experience, the best way to brake an engine and train with air, and they make to sell appliances to do it with. Using brake apparatus not standard with the manufacturers is a source of embarrassment to the air-brake companies, for if any accident occurs through the use of something they had condemned years ago, the daily papers tell the public that the accident was caused by a "failure of the air-brakes."

In the issue of this paper for August, 1922, Mr. Symmesdell illustrated a design of a "test" apparatus which had come across, which he regarded as a "freak," and so would anyone else that did not know there were so many of them in use. I commented on it in the following number and the editors called attention to our

letters. Last summer, however, this "badly designed brake gear"—which is putting it mildly—was exhibited at the World Fair under the banner of an engine that attracted attention on account of its immense proportions and modern design, a part of the engine appeared in LOCOMOTIVE ENGINEERING last summer. She had all the latest improvements—chime whistle, etc. By the way, I have never seen an engine built by the same firm that did the World Fair under the banner of an engine under the tender. This engine had one of the new Westinghouse brake-valves placed beneath the running board and under the cab, with a rod from it to the engineer's handle in the cab. The original handle of the valve was cut off, enough being left to hold the handle spring, and the handle in the cab also worked with a spring in a notched quadrant just like the one shown on the valve, the two springs making the handle hard to operate. When the engine was running, the engineer could not hear the preliminary exhaust or the flow of air from the train-pipe, and he would not know what he was doing but for the gauge, and he can't always see that. The whole engine went into road service, the engineer who ran her, condemned the brake-valve.

The handle of those rotary valves should be attached directly to the valve. From the position of lap to that of service stop is a very short distance, and as some of the ports in the valve and seat are in register line and line, it is of great importance that there should be absolutely no lost motion between the handle and the valve. There was no cut-out cock under the brake-valve on this engine, it was set so close to the T connection with train-pipe that there was no room for it. This way of applying air-brake apparatus to an engine and tender was probably a "standard" idea in some one's mind, but it is surely not anyone connected with the Westinghouse Air-Brake Co. If railroad officials, repair men and engineers would concede that the air-brake companies know more in their own particular line than they do, and bring themselves to conform to the standards of the brake people, there would be fewer air-brake failures reported on paper and fewer air-brake failures in practice.

WILL W. WOOD

Terre Haute, Ind.

Uniform Air Pressure.

Editors:

I have been writing for some one who was in the "process" to take up the question of purposely increasing the train-pipe pressure on mountain grades, but I suppose they are too busy just now to get into this subject, and not being convinced by Brother Alexander's argument, will add a few words to keep the ball rolling, and in such fashion that you may criticize my methods also. As we are to reason together in this matter, let us see if there are not some reasons why the auxiliary reservoir should not be overcharged indiscriminately as advised. Is there not danger in such cases of imposing a great load on the axle, and in this manner being provoked for, and in this manner punishing the innocent to correct the guilty? In the first place, train-pipe pressure has usually been accepted as a standard from which basis the braking power is calculated. It is understood that with a service application, with a freight car brake and a coach piston, travel in the pressure will be about 30 lbs. in brake cylinder and auxiliary reservoir when they are equalized, and while not absolutely correct, my plan in explaining these matters is to assume that the space in brake-cylinder should be equal to one-fourth of the total piston travel, in accordance to the tests made near Karner, N. Y., in September of 1902, the auxiliary contains a trifle over 1,000 cubic inches, while the brake-cylinder space is $8 \times 8 \times 14 = 784 = 59.25$ square inches $\times 14$ inch

the first travel. It is also to be noted that this reservoir releases about 20 per cent of its pressure, when the space has been enlarged one-fourth, and that about two and one-half times the reduction with a service application will be the amount in brake-cylinders, where, say 50 lbs. or more has been pumped out from the reservoir, and this pressure will be increased one-fifth under the conditions in an emergency application. Whenever the piston travel has been shortened to less than six inches the pressure will be nearly 70 lbs. for every inch taken off, and when two inch piston travel is had, or only 2 inches per inch will be lost for all that pressure. In the air-brake and signal instructions of 1902, as approved by M. C. H. and A. R. M. H. is the limit allowed in piston travel, making a variation of nearly 8 lbs., so that with 70 lbs. train-pipe pressure, and 5-inch piston travel made up of four-fifths of train-pipe pressure, and one-fifth in service stop, or 60 lbs. of air retained in service stop, and 10 lbs. of emergency pressure, the piston travel would be increased by the added pressure, for some adjustments, in retaining 15 lbs. in brake-cylinder when released, as with pressure-retaining valves, it was found that with correct piston travel from 4 to 5 lbs. was gained in pressure in service stop on the second application with auxiliary release charged to 70 lbs. This is an increase in pressure of from one-twelfth to one-tenth. It seems evident, then, that with 5-inch piston travel and pressure-retaining valves, 50 lbs. could be put in brake-cylinders in service stop and 20 per cent of the total pressure for service stop for quick action. A 10 lbs. pressure, was on account of having to overcome the 4 lbs. in brake-cylinder. Now, with 40 lbs. in train-pipe, and 5-inch piston travel, the pressure in cylinder after service stop would be 40 lbs. only 15 lbs., while with each piston travel of 100 lbs. train-pipe pressure would be 100 lbs., or 72 lbs. if the 5 lbs. added for pressure-retaining valves, making 77 lbs. in brake-cylinder for a service stop. If 10 lbs. is not intended, and if 50 lbs. in brake-cylinder gives 70 per cent braking power, then an increase of one-fourth in cylinder pressure should increase the percentage one-fourth, which is 17, or 87 per cent in service stop, while the emergency would give the full pressure, of 72 lbs. in brake-cylinder, nearly half more than was intended in the beginning, and making this cut brake at 90 per cent. This, of course, would be an extreme case in 70 per cent cars. But what of the freight cars that are now running on some roads, braking at 10 per cent with a 5-inch piston travel and 70 lbs. train-pipe pressure? With 5-inch piston travel and 87 lbs. in their brake-cylinders they would be braking at about 130 per cent.

There is also another side to this question, of more importance, perhaps, than the one just presented, that of not carrying sufficient main reservoir pressure to promptly release the brakes. There is a tendency to do so, but that on long freight trains there should be ample pressure or volume held in reserve to attain this object. While using maximum main reservoir pressure as maximum auxiliary pressure, it is not in freight trains that there is a tendency for some brakes to be so much longer than others, so that some may release at once and others, perhaps, not until it is almost time to apply again? With the pressure-retaining valves working, the cut-brake releases would have lost all but about 17 lbs., and it has been shown the amount they should have in the auxiliary if the brakes are used as soon as the

trains are recharged, to avoid this difficulty there should be a local sufficient excess pressure to promptly overcome the auxiliary pressure, so that as near as possible all brakes would be given the same time in which to recharge. I once heard a traveling engineer from one of the worst roads in the Rocky Mountains say "their air governors were sealed, because while the engineers did not they could let a train down with 70 lbs. of air just as well with 90, they wanted 20 lbs. in case anything happened," and this logic would probably apply to the case now in hand. In fact, it seems to be the same old plea used by the man who used to screw his pop valves down when he had a hard pull, male that excess pressure of 120 lbs. will not charge auxiliary reservoirs through train-pipe from 50 to 70 lbs., as quickly as 70 lbs. constant pressure will recharge from 70 to 70 lbs. With a heavy train-pipe in a freight train (which seems to occur quite as often as heavy piston packing) with the handle in running position and plenty of excess, the Plate 18 valve would be in charge, in release position would prefer the Plate 18 valve, because when the time came to release there would be some excess.

There are no doubt plenty of runners who, if there were no occasion to use the emergency-brake, and there were no leaks, and the main reservoir possessed volume enough to release the brakes, would have no difficulty in handling their trains with the brake valve handle in release position and all the air the pump could make, but this combination cannot be counted on always. Another point in this debate is a little subtle, it is the amount of main reservoir pressure to be carried. It is as up to be 95 or even 100 lbs., as it is to be 90, at least such is my experience. It seems to be a most opportune circumstance that, at a time when there is apparently a general awakening on the subject of percentage and the condition of foundation brakes, this method of overcharging train-pipes should be brought up, as it is probably those who are on the point of increasing their freight-braking-power to 100 per cent, will, when this practice is brought to their notice, take the necessary steps to protect themselves. It may be a little hard on the valve on the start, but I believe when the question is finally settled, the final valve adjustment will be accepted and carried in running position and with all the main reservoir volume needed. At the present time about the only foundation on which we can build to get the most efficient and uniform service from the air-brake is that of a fixed train-pipe pressure.

There can be nothing substituted which will so easily adjust different conditions, and handle rolling stock in amon. I wish also to call attention to the fact that a great many of the driving-brakes of to-day do not equalize at 50 lbs. as between their brake-cylinders and auxiliaries, but at nearly 40 lbs., and that it is useless to insist on an engineer that he has got the full benefit of his braking service, his reduction when he can see his driving brakes going out and his one made even 25 lbs. reduction. After, however, my suggestion. Probably when the present pressure-retaining valve was adopted 15 lbs. was enough when the condition of affairs was taken into consideration, and it is possible, though a little more could be added in this line. Referring to the statement made as to retaining 15 lbs. of air, and then recharging, it will be seen that from 4 to 5 lbs. was gained on second application after 70 lbs. had been regained in auxiliary pressure. If the retaining-pressure was increased to something more than 15 lbs., so that with correct piston travel, say 50 lbs. would be gained on the second application after recharging to 70 lbs. Of course, in this case the auxiliary would then only reduce to about 60 lbs. This, as has been shown, is a service application would be likely to damage anything, but

the time saved in recharging might be valuable. It takes very near the same time to charge from 50 to 70 lbs. as it does to charge from 0 to 50 lbs., that is, say five sevenths of the pressure would be obtained in the first half of the time required for the whole space to charge. Now, say we had made one application, reduced the train-pipe pressure to 50 lbs. and had to recharge while triple-valves were released, the train would not make much headway on account of the 50 lbs. in brake-cylinders, and if it was necessary to apply again 50 or soon as 90 lbs. could be obtained it would take but 50 lbs. in auxiliary, reduced five-sevenths, which is so added to the 10 lbs. gained from pressure-retaining valves to get the quantity required. Lack of opportunity has prevented practical experiments in this line, but it seems at present to solve the difficulty experienced in keeping brake-cylinders charged on long steep grades. I can see but two objections to this plan that concerning quick action, which could not be of much service, but which would hardly be necessary when there was 10 lbs. in brake-cylinders; and leaking apparatus, which should be kept in order any way. While I do not claim that 30 lbs. should be used as a standard, I would like to learn what others think of a plan. This could be tested by turning up the long pressure-retaining valve case, No. 2, Fig. 11, Plate E 34, of the '01 catalogue, and putting in a spring of sufficient strength to make up to 30 lbs. Also, what would be required to prevent trains from breaking in two when brakes were released and a number of such cars were latched behind those with the standard retaining-valve, or would it be necessary to employ at the start a double valve which in one position would retain 15 lbs. and in another 30 lbs.

ROBERT H. BISHOP

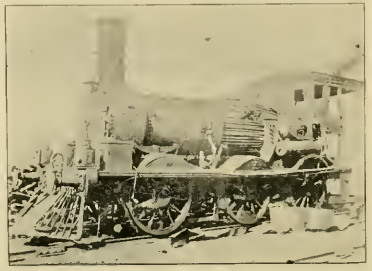

ENLARGED BOILER, GOVERNMENT RAILROAD, OF NEW SOUTH WALES

* Railroad Coppersmithing—IX.

BY JOHN FULLEN, SR.

REGULAR FORMS

The covers for the regular domes have been made in a great many different styles, but I shall only be very similar in all except two, as work only notice these, and let them answer as a guide to all the others. In Fig. 114 is represented one of the prettiest dome covers ever made. In the construction of this cover one is made to encounter some of the most difficult though common geometrical figures, and as they are usually made by hand with poor and scant appliances, it requires skill of a high order to produce them in proper shape. It should be noted this cover is Fuscan in design. The skirt and plinth or foot is after the fashion of a Fuscan column, the capital being crowned with half a sphere pierced with a trumpet.

*Copyrighted by John Fuller, Sr., NEWARK, N. J. All rights reserved. This article communicated to September, 1913.

We will suppose that we have one of these beautiful domes to make. It will be seen in Fig. 115. There are seven pieces or sections in the make-up of this dome—namely The bell or trumpet, the dome 6 or half sphere, a ring r for the dome to rest in the oval l , the foot or barrel c , the torus f , and the plinth or foot e . The first piece in order is the plinth or foot. This should be made of brass of No. 12 wire gauge, and may be made in three ways to accommodate the size of the sheet at hand. If a sheet can be had large enough, the square base may be worked up in one piece by cutting out the corners, and turning up the sides similar to a straight square pan and soft-soldering the corners with cleats or bracing them; but there was no sheet made large enough twenty-five years ago, and so we made them in pieces. I have seen the plinth or foot made in five, and again in three pieces.

We will make the one under consideration in three pieces. Mark out the pattern of the side size required, as shown in Fig. 116, which explains itself. Then cramp and fold the two pieces and make them fast with two pairs of dogs, as shown in Fig. 103. Braze them together and trim the joint. We now form it up square, and put a stiff from cross, Fig. 117, in the diagonals to hold it in position, making it fast with four screw clamps, while we lay off the saddle ledge two inches wide, with the flange at the two sides. Now fill in the corners, and sling the work by the iron cross in the center over a narrow saddle force. Fig. 112, and braze them in. The corners are now finally laid up square, the sides planished, and the upper edge turned about $\frac{1}{4}$ inch on the inside ready for the bottom b . Cut out the lower b , Fig. 116, making it $\frac{1}{2}$ of an inch larger all

round than the square of the foot. When planished and smoothed, tin the edge of this all round about $\frac{1}{4}$ inch inside ready for soldering. Now make four cleats of this copper the length of the foot, that is, take four pieces of tin copper an inch wide and bend them at right angles $\frac{1}{4}$ inch each way to lay in the corners, and tack them in pieces A and B together, and bring them in a sufficient number of places to hold it properly, while the cleats are being soldered in the corners. Then lay a body of solder in the corner, enough to cover the outer edge of the cleats. When the soldering is completed, examine the joint on the outside for any faulty places, which must be made good, if the joint is sound, the $\frac{1}{4}$ inch we laid on may now be trimmed off level with the side. Now make a head o , Fig. 117, and slip it on the edge of the foot all round and soft-solder it to its place on the under side of the flange. We are now ready for the torus or ring f . This will be seen, is the outer half of a cylindrical ring, and may be roughed out nearly to its final shape by following a ring of brass in

a suitable hole in a block, as shown in *Fig. 11*. *Fig. 21*, at *J*. When he desires the shape is obtained, it may be planed and smoothed on a suitable T-*scab*, *Fig. 22*, or it may be swaged smooth with a swage as shown in *Fig. 24*.

We are now ready for the shaft or barrel. The barrel is braced together, and when rubbed up true, is taken to an anvil or a similar anvil, and the cavetto and the fillet is worked out, the cavetto a good inch deep, and the fillet an inch and a quarter wide, then the barrel is planed and smoothed, and the fillet at each end swaged smooth with a suitable swage, *Fig. 18*, or it may be smoothed up in a beading machine between two suitable blocks, *Fig. 19*, similar to a turner's sleeve lathe, in which the fillet at each end is beaded about $\frac{1}{2}$ inch, outside is ready for the torus and oval. The pattern of oval or outer part of capital is shown in *D*, *Fig. 20*, and is a flat disk ring in which the cone rests. These two parts *c* and *d*, which make up the capital, are put into dogs, planed, smoothed and soldered together, as shown by *c* and *d*, *Fig. 15*, and for the dome *b*, and for which we are now prepared.

To describe the pattern for this dome, proceed as follows: Let *a g f*, *Fig. 12*, represent the dome or half sphere *b*, *Fig. 10*. From the edge of the hole *g* draw the line *g f*, also draw the versed sine *a* and divide it at the center, through which draw the line *h e*. With the line *h e* as radius, describe the arc *a c e* and measure off on its circumference six times the radius *h e*, then *a d e* will be the pattern for the half sphere or dome required. Now make the joint, being careful in the folding, and brace it, round up into shape and anneal, when it is ready for the first course. Cramp or wrinkle the sheet carefully at the bottom and take it to a mandrel block, *Fig. 122*, and with a good shop mallet raise in a course, beginning a fourth the distance up the side on the outside, then raise down a course at the top. Now work out a course on the inside toward the center of the side and anneal. Repeat the operation, taking first a course outside and then inside until the spherical curve is obtained, then planish and smooth and in the upper edge inside about $\frac{1}{2}$ inch and the lower edge outside about $\frac{1}{4}$ inch ready for soldering. We are now ready on the bell.

The bell may be made in the same way as that described for *Fig. 99*, but with the addition of the bead at the lower end, which is worked in with a suitable swage similar to *Fig. 18*. When the bell is completed the straight part under the bead is fitted ready for soldering to the dome. We are now ready to put the several parts *a, b, c, d, e, f, g*, together, proceeding as follows: First fit the bell tight into the dome and solder, leaving a fall $\frac{1}{2}$ inch of solder around the joint. Next put *c* and *d* together, leaving a fall of solder in the corner of the joint, then fit the fillet of the shaft or barrel tight into the oval *a* of $\frac{1}{2}$ of an inch, and solder it in the same way, leaving the solder level with the edge of the fillet. We now fit the dome into the capital made up of *c* and *d*, *Fig. 15*, and be careful that the bell and dome stand perpendicular and in a line with the center of the shaft, and solder it in. Next make a cleat, *A*, *Fig. 120*, of light copper $\frac{1}{4}$ inches wide—that is, so that it will lap $\frac{1}{2}$ inch on the plinth and $\frac{1}{4}$ inch between the torus—and fit it tight into the hole in the plinth *g* and solder it fast, then fit the torus *f* and solder it to the back edge of the torus, using the fillet on the inside to fill tight into the torus and solder in the same way, leaving the solder level with the edge of the fillet. When all is completed clean up and polish. If this work is performed skillfully, and the parts put together true, I believe there is nothing in a range of engineering shops which can give to the workman a greater satisfaction for the labor bestowed than one of this kind of domes.

We will now proceed with the other cover of which I have spoken, and let us say that, while in a measure the first is a good job and requires a good mechanic to execute it, the cover represented in *Fig. 123* requires the greatest skill attainable in this line of work as the cover is brazed together complete, the brazed joint around the crown has always been considered the

the lines 1, 2, 3, 4 of the circle *a b d* draw the lines 11, 22, 33, 44 parallel to *d*. Through the points of intersection draw the curved line *b d p q*, which will fit a boiler when formed into a cylinder. Round up the edges and thin the ends, cramp one and double the sheet, being careful, as before directed, that all spring caused by doubling is taken out before going to the fire, then sling it, jar some borax and

will answer for the pattern of the foot *g*, *Fig. 110*. In working out the foot, as previously observed, the most pleasing curve is that of the ellipse, which may be made of any length desired. Having the pattern or template of the curve, which will be one-fourth of an ellipse, commence raising out the foot or flow by a light course with a half-faced mallet, represented by *Fig. 126*, using a thick swollen block (*B*) hollowed out to nearly fit the curve of the cylinder, and sloping off at one end, being rounded nearly to the curve it is desired the foot should be. The block is dogged down to the bench *t*, as shown. Let each course taken to raise the foot be light and the blows regular, annealing at the conclusion of each course.

The top, or crown, of *Fig. 124* may be worked with the foot, after mate speaks, as they are cooling, and this economizes time. When the writer first began making these covers the crown was made exactly half sphere, the same as *b* in *Fig. 115*, but while in the act of drawing the outlines it was noticed that much time could be saved by taking a wider sheet and tucking in the top end, and hammering a part of the crown from the barrel, and making the crown smaller, which method was adopted, and the work being much easier performed with less time spent at the fire, and very much less trying to the operator. The difference is illustrated at *c* in *Fig. 123*, where it is shown that two-thirds of the circle is taken for the crown and the other sixth left on the cylinder, which economized the labor, and made the work required at the fire, not only less, but much easier than when the crown was one-half a sphere. I will now form the top or crown, first cutting the pattern and forming it into shape, and then complete the job. Let *a g f*, *Fig. 127*, represent the crown for the dome cover, which is similar to two-thirds of one-half of a hollow sphere whose diameter is the same as the cylinder part of the dome cover. Draw the line *g e* from the edge of the hole *g*, also draw the versed sine *a*, dividing it in the center, through which draw the line *h e*. With the radius *h e* describe the arc *a c e* and measure off on its circumference six times the radius *h e*, and draw *b e*, then *a c e f* will be the pattern for the segment of a hollow sphere *a, c, e, f*, of the crown of the dome cover, *Fig. 123*. Now make the joint and brace it, round up to shape and anneal, when it is ready for the first course. Cramp the edge regularly at the bottom as before directed, and take it to the mandrel block, *Fig. 122*, with a mallet take in a course on the bead, beginning one-third the distance up the side, then the same at the top, and anneal.

The next course should be enough to bring in the edge at the bottom and also at the top, then take a course out each way to the middle from the inside, which should complete the spherical curve. It may now be smoothed up true, after which the crown is ready to put in. Before proceeding to do this see that the edges are true across their diameter, then thin them with a thinning hammer, after which anneal and clean them either by filing or scraping. Cramp the base part with a chisel, then open the outside cramps regularly with a tweezer, and bring the crown to fit, and with a cross piece of boiler iron, or two pieces laid across each other, pass a rod through the crown, upon which lay another short piece, the bolt passing through it also. Now screw it up tight, starting the bolt from the inside, all round to assist the bolt in bringing the joint up close. Turn it now with the foot up, and in at four opposite places, close down four cramps and drill four small holes, putting four brass rivets, enough to hold it while the joint is being closed down smoothly, starting the rivets from the inside with a helper holding a lead inside or by putting it on a head, as in *Fig. 125*, and balancing it with a weight as shown.

When the joint is ready, take it to the fire and sling it in an endless chain with

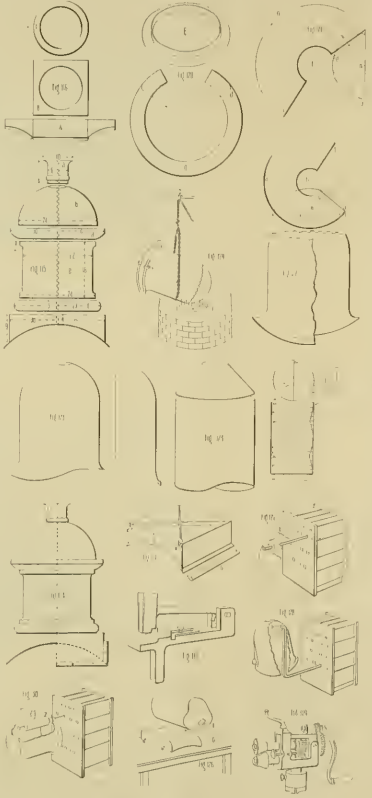

very center of the brazer's skull. This cover is about 27 inches in diameter and 3 feet high, made of brass of No. 12 wire gauge in thickness. To mark out the curve which will fit the boiler when the sheet is turned round, as in *Fig. 124*, proceed as follows: Let *a b d* of *Fig. 125* equal the diameter of the boiler, and *c d* equal the diameter of the dome cover. Divide *c d* describe the circle *a b d*, and divide the circle into sixteen equal parts, draw the lines parallel with *b k* to *a*, then from

water through the cramps, and with a reel, charge the joint, laying the spelter in a zigzag line following the edge of the cover, which should not exceed an inch in length. Now, be patient, and slowly heat the sheet, each side, on a clean fire, being careful that there is no lead, or salt, or any foreign matter in the coke should be clean and about an inch square) when heated enough to bring the borax all down, then with a gentle blast slowly run the joint down, and when cool, clean off and round up on a suitable mandrel. It will be noticed that the method here given for laying out the pattern, can be adopted

pulley wheel Fig 125, hooking it to the traveler over head. As some liquid borax through the joint and sprinkle some powdered borax outside, then charge it with spelter all around, warming it gradually as you proceed, and tack it in four places between the rivets and then at the rivets. By this time it will be fairly hot, so once more around slowly, and when at the place of starting again begin to run the joint with a gentle fire, one cramp at a time. A little help is necessary here to attend to the blast and sprinkle borax on the joint as required. As a hand-hole to use at the fire, two screw clamps are fastened to the foot as shown. When the joint has been brazed and had time to cool, if found to be perfect, it may be cleaned off. The whole job is now finally turned up to shape and planished, first the body, as in Fig 126, the mandrel curve being rather smaller than that of the dome cover next the foot, and then the crown, as in Fig 127. You work in the dome round the foot if required and fill with coarse solder. The cleaning and polishing can and usually is done in a lathe.

The tables below are given for the benefit of the learner and are the latest issued by the manufacturer.

TABLE I. TABLE ADOPTED BY THE ASSOCIATION OF COPPER MANUFACTURERS OF THE UNITED STATES.

Boiled copper has specific gravity of 8.9. One cubic foot weighs 354.1 lbs. One square foot of 1 inch thick, weighs 28.67 lbs.

No.	SHEET COPPER		BRASS		SHEET COPPER	SHEET BRASS	SHEET IRON	SHEET STEEL
	Weight in lbs. per sq. ft.	Thickness in in.	Weight in lbs. per sq. ft.	Thickness in in.				
1	1.12	.015	1.12	.015	1.12	1.12	1.12	1.12
2	1.12	.015	1.12	.015	1.12	1.12	1.12	1.12
3	1.12	.015	1.12	.015	1.12	1.12	1.12	1.12
4	1.12	.015	1.12	.015	1.12	1.12	1.12	1.12
5	1.12	.015	1.12	.015	1.12	1.12	1.12	1.12
6	1.12	.015	1.12	.015	1.12	1.12	1.12	1.12
7	1.12	.015	1.12	.015	1.12	1.12	1.12	1.12
8	1.12	.015	1.12	.015	1.12	1.12	1.12	1.12
9	1.12	.015	1.12	.015	1.12	1.12	1.12	1.12
10	1.12	.015	1.12	.015	1.12	1.12	1.12	1.12

WEIGHT OF COPPER AND BRASS SHEET AND PLATE BY AMERICAN LATH.

No.	Weight of Sheet in lbs. per sq. ft.	Weight of Plates per square ft. of Area.	
		Brass Lbs.	Copper Lbs.
1	1.12	1.12	1.12
2	1.12	1.12	1.12
3	1.12	1.12	1.12
4	1.12	1.12	1.12
5	1.12	1.12	1.12
6	1.12	1.12	1.12
7	1.12	1.12	1.12
8	1.12	1.12	1.12
9	1.12	1.12	1.12
10	1.12	1.12	1.12

WEIGHT OF SHEET AND BAR BRASS FINISH, IN INCHES AND PARTS OF AN INCH.

Thickness	Weight of Sheet per sq. ft.	Weight of Bar per sq. ft.
1/16	1.12	1.12
1/8	1.12	1.12
3/16	1.12	1.12
1/4	1.12	1.12
5/16	1.12	1.12
3/8	1.12	1.12
7/16	1.12	1.12
1/2	1.12	1.12
5/8	1.12	1.12
3/4	1.12	1.12
7/8	1.12	1.12
1	1.12	1.12

NUMBER OF COPPER BRAZERS' BISSETS IN ONE POUND.

No.	1	2	3	4	5	6	7	8	9	10
1	1	2	3	4	5	6	7	8	9	10
2	2	4	6	8	10	12	14	16	18	20
3	3	6	9	12	15	18	21	24	27	30
4	4	8	12	16	20	24	28	32	36	40
5	5	10	15	20	25	30	35	40	45	50
6	6	12	18	24	30	36	42	48	54	60
7	7	14	21	28	35	42	49	56	63	70
8	8	16	24	32	40	48	56	64	72	80
9	9	18	27	36	45	54	63	72	81	90
10	10	20	30	40	50	60	70	80	90	100

WEIGHT OF ROUND BOLT COPPER, PER FOOT.

Diameter in inch	Weight per foot in length	
	Brass	Copper
1/4	1.12	1.12
3/8	1.12	1.12
1/2	1.12	1.12
5/8	1.12	1.12
3/4	1.12	1.12
7/8	1.12	1.12
1	1.12	1.12
1 1/8	1.12	1.12
1 1/4	1.12	1.12
1 3/8	1.12	1.12
1 1/2	1.12	1.12
1 5/8	1.12	1.12
1 3/4	1.12	1.12
1 7/8	1.12	1.12
2	1.12	1.12

LIST OF STANDARD SIZES, WEIGHTS, ETC., OF STANDARD DRAWN IRONING.

No.	Imperial outside diameter	Length feet	Imperial gauge	Weights per foot	
				Brass Lbs.	Copper Lbs.
1	1/4	12	18	11	11
2	1/4	12	18	19	19
3	1/4	12	18	25	26
4	1/4	12	18	31	33
5	1/4	12	17	46	49
6	1/4	12	17	54	57
7	1/4	12	16	79	84
8	1/4	12	15	97	103
9	1/4	12	14	114	121
10	1/4	12	13	131	139
11	1/4	12	12	148	157
12	1/4	12	11	165	174
13	1/4	12	10	182	192
14	1/4	12	9	200	210
15	1/4	12	8	217	228
16	1/4	12	7	235	245
17	1/4	12	6	252	264
18	1/4	12	5	270	282
19	1/4	12	4	287	301
20	1/4	12	3	305	319
21	1/4	12	2	322	338
22	1/4	12	1	340	356
23	1/4	12	1/2	357	375
24	1/4	12	1/4	375	393
25	1/4	12	1/8	392	412
26	1/4	12	3/16	410	430
27	1/4	12	1/4	427	449
28	1/4	12	1/8	445	467
29	1/4	12	3/16	462	486
30	1/4	12	1/4	480	504
31	1/4	12	3/16	497	523
32	1/4	12	1/4	515	541
33	1/4	12	3/16	532	560
34	1/4	12	1/4	550	578
35	1/4	12	3/16	567	597
36	1/4	12	1/4	585	615
37	1/4	12	3/16	602	634
38	1/4	12	1/4	620	652
39	1/4	12	3/16	637	671
40	1/4	12	1/4	655	689
41	1/4	12	3/16	672	708
42	1/4	12	1/4	690	726
43	1/4	12	3/16	707	745
44	1/4	12	1/4	725	763
45	1/4	12	3/16	742	782
46	1/4	12	1/4	760	800
47	1/4	12	3/16	777	819
48	1/4	12	1/4	795	837
49	1/4	12	3/16	812	856
50	1/4	12	1/4	830	874

IRON PIPE SIZES, List of Sizes, Lengths, etc.

No.	Outside diameter	Thickness	Length	Weights per foot	
				Brass Lbs.	Copper Lbs.
1	1 1/2	1/4	15	12	12
2	1 1/2	1/4	15	12	12
3	1 1/2	1/4	15	12	12
4	1 1/2	1/4	15	12	12
5	1 1/2	1/4	15	12	12
6	1 1/2	1/4	15	12	12
7	1 1/2	1/4	15	12	12
8	1 1/2	1/4	15	12	12
9	1 1/2	1/4	15	12	12
10	1 1/2	1/4	15	12	12

An Engine on Fire.

An intensely painful accident happened on the Chicago, Burlington & Quincy last month through the bursting of a cap that was used for feeding kerosene into the boiler. The kerosene ran down the boiler head and was ignited instantly, filling the cab with flames. The train was running at a high rate of speed at the time.



FOOT BRIDGE AT NEW CASTLE, NEW SOUTH WALES, BUILT OF OLD RAILS.

The fireman, Edward Martin, was standing in front of the boiler-head at the time the cap broke, and his clothes were saturated with oil, which was quickly ablaze. He rolled on the cab floor trying to extinguish the flames, and Engineer V. E. Giddings thrust one arm and leg and his body from the cab window, and with the other foot set the brake and brought the train to a standstill. Martin, before the train

stopped, jumped from the floor, and, with flames streaming from his clothes, rushed to the water tank, raised the cover and dumped in, extinguishing the flames. Giddings jumped from his engine and rolled around in the wet grass.



BUILDING WORK IN THE STATE OF WASHINGTON.

Martin put up on a freight train and seat home. His clothes, save his undershirt, had been destroyed by the fire. He was horribly burned and is in a precarious condition. Giddings' left hand was badly burned, and the flames devoured his overalls and trousers, only his drawers saving him from serious injury.

helped to carry a few car loads from the Union Pacific. The first engine that got a supply of the fuel started out with a freight train and set the cars on fire six times before she got over the division.

It will be remembered that Mr. M. N. Furney, by some objection to the use of the steam engine indicator, roused a vigorous discussion on the subject at the Master Mechanics' Convention two years ago. Mr. Furney appears to have been only partly convinced by the advocates of the indicator, for during a recent gossip he declared that the instrument was like chewing gum, it has too many limitations.

There must be something more common about the powers exercised by the coal strikers who have lately been tearing up railroad tracks, destroying bridges and playing havoc generally with railroad property. A morning paper dispatch lately went on to tell that a band of strikers blew up a coal road frolic with dynamite and with fresh deliberation burned up the fragments.

A railway station indicator, which is worked automatically by means of a lever projecting underneath the carriage in position to strike an inclined plane upon the track upon approaching a station, has recently been put into service upon an English railway. The indication is by means of a ball bearing the name of the station, and a small bell to call attention to the change.

There must be something more common about the powers exercised by the coal strikers who have lately been tearing up railroad tracks, destroying bridges and playing havoc generally with railroad property. A morning paper dispatch lately went on to tell that a band of strikers blew up a coal road frolic with dynamite and with fresh deliberation burned up the fragments.

Diseases of the Air Brake System;

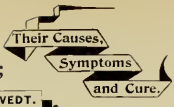

By PAUL SYNNESTVEDT.

Pressure Retaining Valve.

A valve this is one of the smallest pieces of apparatus used with the air-brake, it is, on mountain roads, one of the most important. While it is one of the simplest devices it is one of the least understood. Hence, so simple it is not very liable to get out of order. This is not really a part of

endeavor to get them loose while on the car. The average life of these rubber gaskets is considerably shortened by the pernicious habit many trainmen have formed, of hooking up the hose with the point of the dummy coupling right in the port opening. This destructive practice cannot be too strongly condemned.

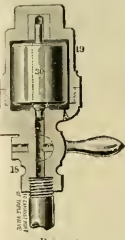

the valve proper, but is in a certain sense an interference with the normal action of the brake. When the handle is not in operative position it has no effect any more than if it did not exist, but when in operative position (that is when the handle stands at right angles to the pipe) it prevents the entire release of the brakes, by about 15 or 20 pounds in the cylinder after the triple-valve has released so as to prevent the train from gaining too much headway while the reservoirs are being recharged.

Any dirt on the seat of this valve will, of course, destroy its function entirely, and, cleaning is all that is necessary to retain it.

Blow from Retainer.

If the air is blowing out of it when the valve is not set, the trouble is in the triple-valve, and not in the retainer at all. If the retainer be missing entirely there is no interference with the primary functions of the brakes, and if a blow is detected at the end of the broken pipe it must not be rattled up, as this will entirely prevent the release of the brakes. This pipe is nothing more than the exhaust from the triple valve, and if a brake blows hard from the exhaust it should be cut out until the triple valve can receive proper attention. For instructions in such a case, see the chapter on "Triple-Valve."

Hose Coupling.

Before taking up the subject of foundation brakes, let us now give a little attention to the hose coupling. The care required by this part is mainly necessitated by wear or destruction of the packing rubber or gasket, which must be occasionally renewed.

With the designs in most common use (shown in Plate 23, Figs. 1 and 2) this removal can most readily be effected by taking the hose off from the car to some place where the cap on the back can be fastened in a vice and a nut inserted in the nipple as a lever to turn the coupling-body. These caps are generally screwed down so firmly that it is up to useless to

connection, while on the road, see the chapter on the train-pipe.

Foundation Brakes.

Under this head are included all the levers, rods, beams, shoes, etc., that are used in conjunction with the air-brake proper. This is a subject so vast that anything like full consideration of it would require a special treatise, therefore we shall touch on it here only in a very general way. For convenience, let us divide the question into the following heads: Car-Brakes, Tender-Brakes and Driver-Brakes.

Car-Brakes.

Probably the most troublesome disease under this head is improper

ADJUSTMENT OF LEVERS.

Even when the piston travel is right the



FIG. 1.

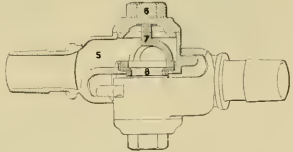

FIG. 2.

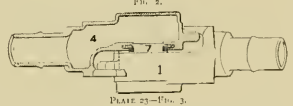

PLATE 23—FIG. 3.

Westinghouse's Improved Coupling.

This, the latest form introduced, is shown in Plate 23, Fig. 3.

In this, the gasket 7 is simply inserted in a taper groove around the port opening, the idea being to permit of the renewal of the gasket without the necessity of removing the coupling from the car. The main trouble with this design arises from hardening of the gasket in the groove or rusting of the inner surface, making it

angle of the levers is frequently wrong. All levers should stand as nearly at right angles to the rods as is possible. Any other position interferes with a proper distribution of the braking power, to a greater or less extent, according as the position of the levers is more or less oblique.

The proper

PISTON TRAVEL is, for passenger cars, about 6 inches, and

cylinder will escape through the leakage groove, and the brake thereby be rendered useless entirely.

Let us repeat, too much stress cannot be laid upon the necessity of keeping the foundation brakes properly adjusted. Care in this respect will reduce both the number of wrecks and flat wheels. This applies not only to car-brakes, but to driver and tender-brakes as well.

If levers bend they should be made stronger. If rods break they should be made thicker.

If beams collapse better ones should be substituted.

What sense is there in spending thousands of dollars for the latest improvements in triples, engineer's valves, or pumps if the braking force developed by them is lost through the breaking of beams, rods or levers? What does it profit a road to put expensive driver-brakes on an engine if they are not kept in operative condition?

No one should remain satisfied with a brake that simply takes hold, it should be made to take hold just as hard as is possible without slipping wheels. It is a good rule not to let a single wheel run without a brake if there is room to put a brake on it, but it is even more important after it is on to take proper care of it.

The author has seen a number of instances where two trains, to all appearances exactly similar as to brake equipment, were stopped on the same track, but showed remarkable differences as to the length of stop, one sometimes running nearly twice as far as the other.

Investigation invariably revealed the fact that the difference was largely due to the condition of the foundation brakes.

Tender-Brake Levers.

Many, if not most of the designs of lever arrangement under tenders are exceedingly poor. In many cases the whole construction may be called one great disease. Such can only be cured by complete reorganization.

About all the engineer can do with this brace is to see that the cylinder is properly oiled, the slack adjusted, and the water frequently emptied from the drain cup. A tender should have about the same piston travel as a freight car (6 or 7 inches).

The modified form of the Stevens' system, illustrated in Plate 24, is about the best lever arrangement for tenders. It is simple, compact and easily adjusted, three points of advantage of particularly great importance where the available space is as limited as it is under most tenders.

Driver-Brakes.

A good driver-brake is a great boon to an engineer, and if properly proportioned

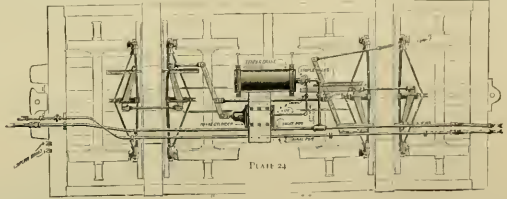

difficult at times to clean out the groove, or get a new gasket in so as to make a tight joint.

If, on attempting to extract the old gasket, it breaks in pieces and sticks obstinately, it is best to put on a new hose and take the old coupling to some place where the gasket can be scraped out with a tool.

For instructions as to the best thing to do when a leak is detected in a coupling

for freight cars about 6 inches. A constant struggle should be maintained to keep this as nearly uniform as possible, and any great variation either way will be sure to show itself in the performance of the brakes in service. With too long a travel the brakes will not hold properly, and with too short a travel they will stick.

If the travel be reduced to an extremely small amount all the air admitted to the

is of greater assistance in stopping a train than the reverse-lever. It therefore behooves the engineer to take good care of it, and in order to be able to do this properly he must make a careful study of the peculiar eccentricities of that driver-brake which comes under his immediate charge. Of all classes of driver-brakes there has to run many engines. In the latter case it is of course considerable of a

Published by Paul Synnestvedt, Chicago, Ill. All rights reserved. These articles copyright January number

LOCOMOTIVE ENGINEING.

task, and better results can be expected where an engineer always has the same engine.

Every driver-brake has its own peculiarities, due to differences in location, and the proportion and arrangement of parts. Some push-down brakes have very long cams, and such generally require frequent

proper proportionate expansion or equalized pressure, but it must be remembered that this calculation is based on a moderate travel of the pistons and not by any means on the full capacity of the cylinders.

These cylinders are generally of the pull-up type, the same as shown in the cut, with a stuffing-box around the piston-rod.

cock plug in such a position that when the brake was cut out, this channel would connect the cylinder with the atmosphere, and the brake would come off. As soon as it was cut in again, however, it would reset, and so it would continue. When cut it would release, when cut in again it would set, when cut out again it would

reset travel to pull the slide-valve entirely past the opening to the cylinder.

BRAKE EFFECTS ON SET.

As a result of the above-mentioned condition, this triple becomes entirely inoperative when the graduating pin breaks, because the air-pressure closes the gradu-

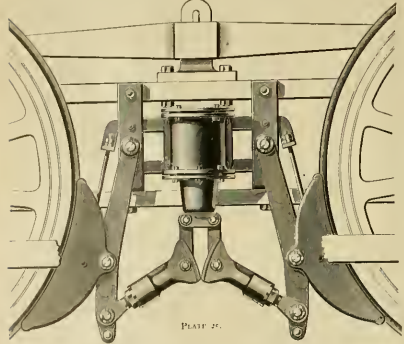

PLATE 25.

adjustment, for if they are allowed to get a little too much slack they will soon take load too violently and grind or lock the wheels. Some have very short cams, and these will generally run much longer without adjustment. In some the cylinder is closer to the wheels than in others, and as a consequence the packing leather dries out more rapidly, to counteract which it must be very frequently oiled.

Push-Down Brake.

Plate 25 illustrates the most common form of push-down driver-brake. The angle of the cams, when the brake is released, should always be about the same as that shown. The shoe in air should be so adjusted that the shoes will bang with their faces about parallel with the tread of the wheel, except in winter, when difficulty is experienced from ice collecting around and on the face of the shoe, when the head should be so adjusted that the end of the shoe inward which the tread of the wheel moves, shall hang nearer to the wheel than the other end. This will serve better to scrape off the snow and ice. The idea will be more clearly understood by reference to Plate 26. This rule cannot, of course, be applied to engines which run backward as much as forwards. It applies equally, however, to the style of brake shown in Plate 26, which is now used very extensively on heavy engines.

This requires constant watching to prevent loss through leakage, because the packing around these rods is so liable to fail. The author has never seen a cup leather-packing around a rod which did not give more or less trouble, and thinks almost any other form of packing would be most satisfactory.

Special Cases.

They are forms of apparatus, which, while not at this day recognized as standard on any road, are still in use to a greater or less extent. For instance

TRAIN FREIGHT TRIPLE

Plate 27 illustrates the third of these special cases. A large number of these valves were put into service prior to the



PLATE 27.

introduction of the quick-action triple, most of them having been applied to cars used in fast freight runs. As far as general construction is concerned it was simply a plain triple with a four-way cock, but because of a couple of weak points in design it has given more trouble to trainmen than, perhaps, any other form of triple ever brought into general use.

again release, and if the handle was turned down to "straight air" position it would set again. Finally the trainman in disgust would abandon all attempts to make it work, leaving it cut out when it might have been used had he understood how to fix it. All this trouble arose from the fact that the groove in the four-way cock (through which the brake released when cut out) bled the cylinder but not the reservoir. As long as the pressure in the reservoir was greater than that in the train-pipe, the main piston was held in application position, while the opening to the cylinder could be shut and the exhaust from the cylinder opened by turning the four-way cock to cut out position.

This would not reduce the pressure in the reservoir, and so, as soon as the valve was cut in again, the brake would reset.

In most of these cases the reservoir pressure could have been reduced simply

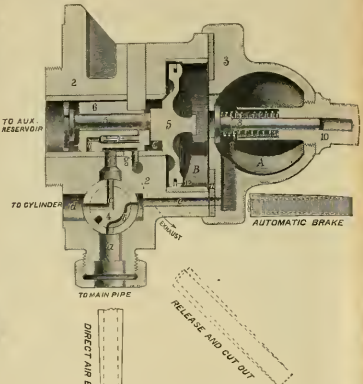

PLATE 27.

atmosphere, thus shutting off the passage through which air might have reached the cylinder.

There are at the present day many of these valves, which, though in good condition, are allowed to run cut out simply because of the lack of a proper understanding of them by the trainmen.

Appendix.

The plates shown under this head are from photographs of various parts of the air-brake apparatus in a disassembled condition. Most of them were obtained through the kindness of Mr. G. W. Rhodes, superintendent motive power, C. B. & Q. R. R., but the author's thanks are also due to a number of others, who generously assisted him in making the collection.

PLATE 28.

The first of the set, Plate 28, shows an upper valve chamber backing, taken from an 8-inch pump, together with a number of disabled air-valves. No. 1 is broken in a manner not at all uncommon, and yet one which, when it occurs in a lower discharge-valve of a 6-inch pump, is very apt to deceive the "doctor," for when he touches it underneath it feels all right, has the proper lift, etc. No. 2 has the broad broken ledge from the wings and forming a kind of collar around the stem or projection above. Nos. 3 and 4, as will be readily seen, are each broken in two pieces, the projecting knob on top of No. 3 being missing entirely. This knob when broken off frequently wears round, like a little ball, and sometimes causes trouble by getting stuck somewhere in some pipe or port. No. 5, like No. 1, is but very little worn, and serves particularly to emphasize the importance of having these valves made of the very best material. No. 6 speaks for itself.

PLATE 29.

No. 1 (Plate 29) shows a main piston-rod taken from a pump, broken at the upper end where the head was screwed on. No. 2 is a main valve rod and lower piston-valve, with an adjustable set attached. It is evidently "home-made." If this adjustable stop should happen to be made a

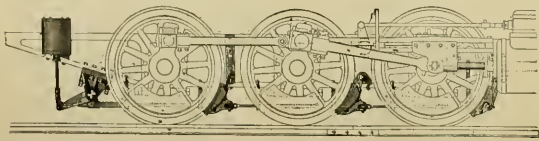

PLATE 26.

Outside Equalized Brake.

In connection with this design, very large cylinders are generally used, and this makes it very important to guard against allowing the pistons too much travel, for this weakens the braking force very materially.

To be sure the auxiliary reservoirs are supposed to be enough larger to obtain the

BRAKE STICKING.

When one of these brakes refused to release, the trouble would begin. With an ordinary triple this could be easily remedied by letting a little air out of the bleeding-cock. These brakes were not provided with bleeding-cocks. In place of them a groove (shown just to the left of Fig. 4 in the cut) was made in the four-way

by moving the handle clear around beyond the straight air position as far as it would go, for this would bring the exhaust groove opposite the port from the reservoir, and allow the reservoir pressure to escape until the piston and slide-valve move back to cut off the opening.

Another defective point about this design was that the piston was not allowed suffi-

little too short, the main valve would travel too far down, the lower small packing-ring expand below the bushing, and the remainder of the trip have to be made with hand-brakes.

Beware of adjustable stops.



PLATE 28.

What an interesting trio we have in Plate 30. Nos. 1 and 2 are evidently the result of the coupling being caught and



PLATE 29.

washed between two cars. No. 3, it will be noticed, has the upper lug bent downward, a condition not infrequently result-



PLATE 30.

ing from a blow from a link or pin in the hooks of some brakeman, in an attempt to stop a leak.



PLATE 31.

No. 1 (Plate 31) shows the body of a N. Y. triple valve, which has evidently received some "hard knocks." No. 2 is a



PLATE 32.

striking object lesson for the men who clean and repair triple-valves. The marks of the hammer clearly show the cause of



PLATE 33.

the crack. When a gasket joint sticks, persuasion generally works better than force in getting it loose.

Nos. 1 and 2 (Plate 33) are two triple-valve pistons, on which the gum and dirt



PLATE 34.

are "beautifully" shown. The smaller one, No. 2, was taken out of a freight triple on a car, which came in with a 4-inch flat spots on eight wheels, because the brake "stuck."



PLATE 35.

The lot of engine-valve gaskets, marked 3, show the effect of neglect and carelessness (particularly in the use of too much oil in the brake cylinder) and graphically illustrate a frequent cause of the



PLATE 36.

"blow from the triple-valve exhaust" about which we hear so much complaint.



PLATE 37.

The sections of train-pipe shown, were taken from under a refrigerator car, the pile of dirt numbered 2, being the accumulation shaken out of a pipe only 8 feet long. Like No. 1, was shaken out of a 16-foot length of *new* pipe, and most impressively



PLATE 38.

teaches the need of blowing out all pipe thoroughly, in setting up new work, before connecting the valves.

The triple screens shown in Plate 34 are fair samples of hundreds that are running at the present day. They are shown just as they were found. The two large, tin, funnel-shaped extensions shown at one side were put on to hold the dirt found in the pipe next to the screen; the screens not being large enough to hold it all. The accumulations are mostly a mixture of pipe scale, cinders, sand, sponge, corn, etc.

"The effect of such a condition of affairs can be better appreciated when we reflect that all the air to operate the triple must pass through such a mass of dirt. With some of the samples shown a service application is still possible, but not an emergency stop.

Plate 35 illustrates something similar to Plate 34, except that the case is a little more aggravated. No. 1 shows the check-valve case of a No. 1 New York triple-valve. No. 2, a pile of dirt taken from the train-pipe at the union connection, with the screen lying on top.

To get some approximate idea of just how rapidly dirt will collect at the triple-valve screens, a dirt collector, in the form of a drain cup, with a strainer like the strainer in the supply-pipe to an injector, was placed on a number of cars just at the triple connection, and the accumulations put in small bottles, which are shown in Plate 36. The amount in the ones numbered 2 and 3 does not show very clearly, so a short line has been drawn to one side of each to indicate the quantity."

The attention of trainmen is particularly called to the exhibits shown in Plate 37. No. 1 is a retaining-valve with the exhaust hole plugged, and No. 2 a retaining-valve pipe, which, because the valve was missing, was plugged with a piece of wood. Both of these were taken from cars on which the brake was reported "stuck," and had to be bled off after every application or else remained stuck all the time.

From some imperfection in the quick-action part of the triple-valve there was a constant blow from the retaining-valve or pipe, which some uneducated brakeman stopped in the manner shown.

The most striking curiosity in the air-brake line the author has ever seen is illustrated in Plate 38. It is a car drain-pipe, broken open to show the interior, into which some one has stuffed a heavy wooden club and pine stick, crushing the screen all to pieces, and almost completely filling the whole of the cavity. It was found just in the condition shown, when the brake came to be overhauled under a general order to examine all the drain-pipes, and how it got into such a remarkable condition is a mystery. It is possible some one tried to clean out the cylindrical screen by forcing the wooden rag through with the stick, and that the stick became caught, and not being able to get it out, the pipe was coupled up in a hurry and nothing said about it.

THE END.

An Old, Old Man.

They were lounging in the smoking-room of the club, with no better subject for conversation than the vile character of the cigars provided, when Barnard put new life into the crowd by telling that Baggins had got a new job.

"What is it this time?" demanded Montgomery, "is it superintendent of a sewing-machine factory or teller of a bank?"

"Guess again," said Barnard.

All sorts of surmises were expressed as to the nature of Baggins' latest venture. The guesses varied from locomotive en-

gineer to general superintendent, from stone clerk to coal mine manager.

"You're all out," said Barnard. "Baggins has accepted the position of manager of a large cattle ranch in Montana. He declares that he has left railroading in all its branches for ever."

An emotional feeling swept over the party. In far Montana the imaginative accomplishments of Baggins would be wasted upon mountain air. No longer would he sit in this smoking-room and tell of experiences in shops, offices, mines and ships that extended beyond two hundred years.

"It's too bad that we are going to lose Baggins," remarked Benson, "let's pass some resolutions. Say something about his versatility of his genius and wonderful turn for catching on to different kinds of jobs."

"This suggestion met with no response. After a few minutes of reflective silence Redding remarked, "Baggins must be about 40 years old, yet one evening I took a note of the experience he told about in different positions and it totaled 120 years. Baggins was not in much of a reminiscence mood that evening, either."

"The man's greatest peculiarity," remarked Millen, "was in being in several places at the same time. One night some one spoke of an incident of the war time and that started Baggins off. He said that he joined the army shortly after the breaking out of the war, and was in most of the principal battles. Incidentally, he mentioned that he was running an engine most of the time, but the remark of some member the next evening brought out the assertion from Baggins that he was in charge of a gun-boat on the Mississippi for several years before Lee surrendered.

"One evening we were talking about Russia, and Baggins remarked, with a pensive look in his eyes, 'Great country. Only wants push and capital. Plenty of people. I went there the year before the war. Took out fifty locomotives from Baldwin's. Remained there ten years. Based the construction of 500 miles of new track.'

"Something was said about Brazil, and Baggins remarked, 'Ah, that's the country to make money in. I went there in '63 and took charge of an ore reducing plant. Had yellow fever twice. Stopped seven years, though.'

"One evening A. W. Wright, of Chicago, was at the club, and got talking about the exciting times they had on the first Atlantic Pacific survey 'I can back every word you say about that, chimed in Baggins. 'I went to California in '65 and the first work I did was pulling a chain on the Central Pacific survey. Exciting times! I should not care at all to thought that I have my own hair. No you see that mark on my hand? That was a wound from an Indian arrow.'

"On another evening Baggins had said that the mark on his hand was made by the splinter of a shell, and was put when he was helping General Scott to take the City of Mexico."

"After all," remarked the man with a pen for a scarf-pin, "I like Baggins. He is always amusing, is always ready to corroborate another man's lies. The trouble with him is that he is too sympathetic when he hears an Annias artist distinguishing himself. Baggins always wants to associate himself with every man's experience. If any member were to come in and say he had been in hell, Baggins would remark at once that he was well acquainted in those parts, had in fact been master mechanic of the Hell Central Railroad for ten years."

Several anecdotes were told illustrating the mental slowness of Baggins, and then it was moved that the man with the pen pin should write expressing the hope of the club that Baggins might meet with appreciative Estenes in Montana, and that he might never be steered into regions less containing than the carpet of the Flat Wheel Club Room.

What You Want to Know.

Don't ask questions that simply require a little figuring to determine. make each question separate. No notice taken of anonymous questions.

Q. M. C. Panama, Cal. asks: What was the first built, and by whom? By the New York Central & Hudson River Railway at their shops at Manhattan, N. Y.

Q. I. M. D. Wayne, Ind. asks: Why is automatic action packing rings used in steam engines (rather than automatic valves) and is there a tendency for them to become loose and set the piston, packing rings, and so on, in the center of the cylinder?

Q. W. W. Magdon, Va. asks: Why do the rods of a reciprocating engine have a hole in the stem of the piston, also a hole in the main crank pin, for counterbalancing purposes? Why do the rods of a reciprocating engine have a hole in the stem of the piston, also a hole in the main crank pin, for counterbalancing purposes?

Q. J. P. B. Steamship, Minn. asks: Why do the rods of a reciprocating engine have a hole in the stem of the piston, also a hole in the main crank pin, for counterbalancing purposes?

Q. J. P. B. Steamship, Minn. asks: Why do the rods of a reciprocating engine have a hole in the stem of the piston, also a hole in the main crank pin, for counterbalancing purposes?

Q. J. P. B. Steamship, Minn. asks: Why do the rods of a reciprocating engine have a hole in the stem of the piston, also a hole in the main crank pin, for counterbalancing purposes?

Q. J. P. B. Steamship, Minn. asks: Why do the rods of a reciprocating engine have a hole in the stem of the piston, also a hole in the main crank pin, for counterbalancing purposes?

Q. E. E. M. D. Delaware, O. writes: An engine came in with the following defect: The Westinghouse air-pump stuck and the discharge-valve heated so much that the pump leading to main reservoir became red-hot. Please explain the cause of this? The pump piston is churning a small volume of air, and the work done by the piston was converted into heat. Compressing air in any other gas always generates heat, but its effects are not perceptible when the compressed medium passes away with small resistance.

Q. J. P. B. Steamship, Minn. asks: Why do the rods of a reciprocating engine have a hole in the stem of the piston, also a hole in the main crank pin, for counterbalancing purposes?

The pile is made up of pieces of metal having different magnetic properties, such as bismuth and antimony.

Q. I. B. V., Savannah, Ga. writes: What is the difference between permissive and absolute block systems, and which system is best for the safety of train movement? Under the block system of signaling a railroad is divided up into separate sections called 'blocks.' Each section is protected by signals. Under the absolute block system no train is permitted to enter a block until the preceding train has passed it. Under the permissive system two engines may travel on one block at the same time, certain directions being given to the trainmen to be careful. The absolute block system is the safest one.

Q. G. R., Chicago, writes: Firebox side sheets are generally 1/2 inch thick for all kinds of locomotives. We have engines carrying 150 pounds of steam and others carrying 200 pounds, all with the same thickness of side sheets. Now what I want to know is if 1/2 inch is thick for 150 pounds pressure, is it not wrong for 200 pounds pressure? The thickness of sheet metal has been found to be about right for water that contains scaling ingredients. A thicker sheet is more liable to crack. When the pressure is raised the same strength can be secured by putting the staybolts closer.

Q. W. D. S., Bluefield, W. Va. writes: Is there any rule in the standard code which will not allow a train to pick up its schedule time, at the first point after 12 o'clock, after a new time-table goes into force? There is no rule bearing directly on such a case. When a train starts under an old time card the train dispatcher uses his own judgment whether to let it take up its time on the new time card or to let it run as extra. Where control is given a train dispatcher's order. The train dispatcher's order is the order of Standard Train Rules, which may be obtained from the Engineering Literature Co., East Orange, N. J.

Q. A. F., Santa Rosa, Cal. writes: Not long ago I was asked: Does putting a dome on a boiler increase its capacity? My answer was, that if firing rather heavy and taking steam direct from boiler, steam would be more or less saturated according as water was high or low, and considerable water carried over into engine, while, if a dome were used steam would be dry, thus getting the full benefit of the expansive quality of the steam. Was I right or wrong? A dome tends to prevent water from passing out with the steam, but it cannot be said to increase the capacity of the boiler. There are many locomotives running without a dome.

Q. J. A. P., Vevoh, Ill. asks: In what position should an engine be to test the blowing of valves with the lever in the center? 1. Top or bottom quarter. 2. With engine on her quarter and lever in center, will steam go through cylinder cocks or through exhaust, if valve is blowing? To exhaust, and possibly to cylinder cocks if blow is strong. With the lever in center, an engine will be placed in any position where steam will come out of one cylinder cock on each side. 1. With a right-hand lead engine, the lever in the center will blow the ahead of the axle, it is possible for the valve on each side to open the port the amount of the lead.

Q. A. S., Denison, Ohio, writes: I was hauling a freight train of twenty-one loads with a Class K consolidation engine, the engine blew I with Richardson valve, with relief cock in steam chest

When running down a grade, at a speed of 35 or 40 miles per hour, the driving-wheels revolving only at the rate of about 15 miles per hour. I had to use steam two or three times to keep the engine from locking her wheels. The engine was in the forward motion, and full stroke, brakes and everything free. We cannot account for this, unless there was so much friction somewhere that the engine could not keep it up. Might it be possible that you were mistaken—namely, impossible to get axle with any known laws.

Q. P. S., Wheaton, Minn. asks: 1. Where would the valve be when compression commenced on forward stroke? 2. In what part of the piston travel the greatest pressure exerted on the crank pins? 3. At what part of the piston travel the greatest pressure is exerted on the angle of the main rod? 4. In what part of the piston travel the greatest pressure is exerted on the angle of the main rod? 5. What is the difference between back pressure and compression? 6. They are the same. 7. When the valve is closed, where does the steam go? 8. To the exhaust.

Q. J. P. B. Steamship, Minn. writes: I have a steel screw 2 1/2 inches diam-

eter trunk out of iron. All these cases must be taken into consideration and the real cause of the defect judged accordingly.

An Improved Combination, or Water-Filling Cock for the Baker Car Heater.

The accompanying cut shows recent improvements in this important attachment to the Baker car heater.

The improvements consist mainly in a simple substitute for the old style threaded joint of a single thread cut on the neck of the funnel. The entire funnel is cast whole, of brass, as is also the body of the cock, thus making the entire cock most durable, and to consist of three simple parts—the funnel, body and plug. Hereafter the expense of renewing the iron or sheet-iron funnel has been considered.

Its special advantages over the old style are the funnel having a horizontal screw-threaded connection with the cock, whereby the funnel is allowed to hang down when partially unscrowed, and is held firmly in the friction merely, when turned up for use. This makes a tight joint, preventing the leaking so prevalent with the old union coupling.

The simple act of opening the cock also opens the air vent. In order to prevent the water from the drum being spilled on the car roof, there is a drip-pipe from the vent from which the water can be caught in the dipper used for lifting. Of the

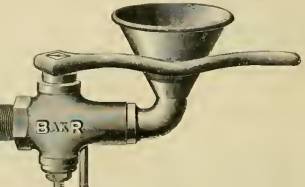

water from the drum being spilled on the car roof, there is a drip-pipe from the vent from which the water can be caught in the dipper used for lifting. Of the

step-pipe, it may be extended down into the heater chest, so the water will run under the car. This new combination cock is fast taking the place of the old. Pullman has ordered it for all of his car heaters, and many other companies are doing likewise. The inventor and manufacturer of the device is Mr. William C. Baker, of 123 Liberty street, New York.

How to Tell Steel from Iron.

In many shops a question often comes up about the nature of a piece of metal—whether it is steel or iron. This is especially true where scrap is used. There is a simple sure way to tell steel from iron long in use by practical men. Put a drop of nitric acid on the metal, allow it to stand one minute, and then wipe off with water. If the metal is iron, a grayish-brown stain will be left, a black one if it is steel.

A peculiar improvement on the link motion has been patented by Mr. William R. Warren, of Ill. It consists of placing the eccentric rod-pins at different sides of the link. The forward eccentric rod is pinned at the back of the link in the usual way and the back-up eccentric is pinned to the fore-end side. The pins are so located that a straight line connecting their centers passes through the center of the longer pin.

WANTED.

Wanted—An position as draughtman or clerk on locomotive work by one who has had ten years' experience. Stable salary and class of work. Address, N. LOCOMOTIVE ENGINEERING, N. Y.

You see them everywhere.

Columbia Bicycles

Their sales attest their popularity.

For sale by all our agencies,
or mail-order for two 2-cent stamps.

POPE MFG. CO.,
Boston, New York, Chicago, Hartford

The New "NATHAN"

(SEE ILLUSTRATION), AND

MONITOR INJECTORS FOR LOCOMOTIVES.

"NATHAN" SIGHT-FEED LUBRICATORS,
For Locomotive Cylinders and Air Brakes

STEAM FIRE EXTINGUISHERS,
For Switching and Yard Engines

BOILER WASHERS,
Road and Guide Oil Cups, etc.

Send for DESCRIPTIVE CATALOGUES.

NATHAN MFG. CO., 92 & 94 Liberty St.,
NEW YORK.

SHERBURNE'S AUTOMATIC TRACK-SANDING APPARATUS.

Three Ways Instead of One. Mind Your Stops.

On slippery rails sand the track automatically when brake is applied, avoiding rear collisions and derailment and preventing
In starting, touch Lever and obtain jet of Sand and "get there"
The old Rod and Lever retained as usual For particulars apply to

SHERBURNE & CO., 53 Oliver Street, Boston.

THE HALL SIGNAL CO.

Leads the World in the manufacture and installation of

Automatic Block Signals

Operated by either Track or Wire Circuits.

The ONLY Automatic Signal Systems in which the signals can be operated on the "Normal Danger" principle. Believed by many to be the best and safest plan.

HIGHWAY CROSSING SIGNALS,
STREET RAILWAY CROSSING SIGNALS, ETC.

OFFICES:

80 Broadway, New York.
927 The Rookery, Chicago.
115 The Ames Building, Boston.
Equitable Building, Baltimore.

PERFECT PUMP PACKING

AN ABSORBENT OIL CUSHION—INSURES PERFECT LUBRICATION

WEDGE-SHAPED WEARING PIECES THAT MOVE ON EACH OTHER—INSURE A TIGHT JOINT, WITHOUT UNDUE PRESSURE FROM GLAND

DOES NOT GET HARD OR BAKED—NONE WASTED—YOU KEEP PUTTING IN RINGS, NEVER TAKE ANY OUT

THIS PACKING IS GUARANTEED TO KEEP TIGHT WITH STEAM, WATER, AIR OR AMMONIA

PERFECT FOR AIR PUMPS.

A TRIAL SOLICITED

All kinds of Packing—the P. P. P. is best.

C. A. DANIEL,
313 Market St.,
PHILADELPHIA, PA.

THE WASHBURN Car-Wheel Company, HARTFORD, CONN.

MANUFACTURERS OF

CRUCIBLE STEEL-TIRED WHEELS

For Parlor and Sleeping Cars, Passenger Coaches, Locomotive and Tender Trucks.

TAYLOR BEST YORKSHIRE STAYBOLT IRON

Also, Piston Rods, Crank Pins and Forgings of all Descriptions, used by Leading Railroads.

R. MUSHET'S SPECIAL AND TITANIC STEELS

SOLE REPRESENTATIVE IN THE UNITED STATES,
B. M. JONES & CO.,
BOSTON, 11 and 13 Oliver Street. NEW YORK, 143 Liberty Street.

THE ROTARY.

For full
Particulars,
Address

The Leslie Bros. Mfg. Co.,
Paterson, N. J.

ALBANY, N. Y.
936 Broadway,
New York City,
115 BROADWAY.

STEAM COUPLERS
AND
FIRE PROOF
HEATERS.

CONSOLIDATED
McElroy, Sewall, Westinghouse and other Patents.
CATALOGUES UPON APPLICATION.
Special Appliances and Extra Strong Fittings of Every Kind.
AUTOMATIC CONTROL OF HEAT.
CAR-HEATING CO.

CHICAGO,
200 Phenix Bldg.
Canada,
COATICOOK, P. Q.

COMMINGLER,
DRUM,
AND
DIRECT STEAM
SYSTEMS.



THEIR SUPERIORITY
IS PROVEN BY
THEIR POPULARITY.

FINEST SEATS.

Coach, Parlor Car,
Sleeping Car,
Street Car,
Rattan Elevated

IN USE ON ALL THE
PRINCIPAL RAILROADS
IN THE UNITED STATES



THE HALE & KILBURN MFG CO.,

Simplicity,
Durability,
Elegance,
Comfort,

IT IS SAFE TO SPECIFY THE
H. & K. SEATS

PHILADELPHIA,
NEW YORK,
CHICAGO.

A. W. SOFER, Pres.

ROBT. ANDREWS, Vice-Pres.

C. H. HOWARD, Sec.

W. E. THOMAS, Treas.

R. M. DIXON, Engineer

THE SAFETY CAR HEATING AND LIGHTING CO.

160 Broadway, New York.

HEATING SYSTEMS.—By hot water circulation and direct steam with regulating devices. Reliable and uniform heat. Economical and rapid circulation. Gibbs automatic coupler of Westinghouse type, absolutely steam-tight.

LIGHTING SYSTEM.—The celebrated Pintsch compressed oil gas method. In use on over 40,000 cars in Europe and America. Adopted by the U. S. Lighthouse Board for lighting Buoys. The best, most economical and only safe light for Railroad purposes. In brilliancy and cleanliness unsurpassed.

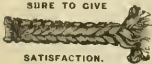

DUVAL METALLIC PACKING

Send for Catalogues, Prices and detailed information to

THORNTON N. MOTLEY & CO.,
SOLE AGENTS,

43 John Street, NEW YORK.

O. K. BRAKE ADJUSTER.
Insures the Maximum Pressure on the Brake Shoes at all Times.



Manufactured by **PRATT & LETCHWORTH,**
BUFFALO, N. Y.

NIAGARA FALLS EXCURSION.

VIA THE C. H. & D. R. R.

Under agreement of the Trunk Lines, it was decided that no Niagara Falls cheap excursions would be run this year until after the first of August. The Cincinnati, Hamilton & Dayton Railroad will run one of their famous excursions to Niagara Falls at the usual low rate sometime about the first or second week in August. These excursions were discontinued last year owing to the World's Fair, and it is expected that they will be larger than ever this year. Look out for the announcement of them in this paper.

LEONARD & FLLIS.



OILS FOR RAILROADS.

VALVOLINE OIL has long been used on many of the leading railroads in this country and abroad. It has no equal in quality and mileage.

W. A. BOYDEN, General Agent,
157 Chambers Street, NEW YORK.



THE MURPHY STEEL CAR ROOF.

It is no surface nail or screw holes. It has no joints where rain or fine snow can get through. It allows for contraction and expansion, and has ample stiffness to provide for sagging, twisting, buckling and covering of the car body. It is as solid as the car frame itself. It has no soldered joints. It can be repaired readily, and without taking off more of the roof than is damaged. It is much cheaper than any other metallic roof now in use, and is cheaper than the double board roof, made of good lumber, though it does not require any other than to apply it.

This ROOF can be applied on OLD LEAKY BOARD-ROOF CARS without making any changes in the board roof, thereby saving the expense of replacing the old boards with new, and thus utilizing material that most otherwise be thrown away.

Manufactured by the **P. H. MURPHY MFG. CO.,** East St. Louis, Ill.

THE CLEVELAND VARNISH CO.

Mfrs. RAILWAY VARNISHES.

CLEVELAND, O.

RAMAPO WHEEL AND FOUNDRY CO.

MANUFACTURERS OF

BOLTLESS STEEL-TIRED WHEELS

FOR PASSENGER AND LOCOMOTIVE SERVICE.

Tires with Annular Web and Hook,
Best Charcoal Iron Double-Plate or Spoke Centers,
Wedge-Shaped Retaining Ring.

SIMPLE, + SAFE, + ECONOMICAL.

CHILLED IRON WHEELS

CONGDON BRAKE SHOES FOR CHILLED IRON WHEELS,

Outwear from 4 to 6 ordinary shoes and enhance mileage.

Cylinder Packing Rings.

Office and Works: RAMAPO, N. Y.

THE HAMPSON Flexible Steam Joint

DOES AWAY ENTIRELY WITH RUBBER HOSE FOR STEAM HEATING

HAS NO GROUND JOINTS.

F. A. BARBEY & Co.

215 FRANKLIN ST. BOSTON.

START A LIBRARY

WITH

Sinclair's Locomotive Running.

12mo, Cloth, \$2.00.

Reagan's Locomotive Mechanism.

12mo, Cloth, \$2.00.

Meyer's Modern Locomotive Construction

4to, Cloth, \$10.00.

JOHN WILEY & SONS, NEW YORK.

Books for Railroad Men. Books You Want.

LOCOMOTIVE ENGINE RUNNING and MANAGEMENT. BY ANSON SINCLAIR. Price, \$2.00.

INDICATOR PRACTICE. BY FRANK F. HERBAY. Price, \$2.00.

ELEMENTS OF MECHANICS. BY T. M. COONEY. Price, \$2.50.

PROGRESSIVE EXAMINATIONS FOR ENGINEERS AND FIREMEN. BY JOHN A. HILL. Price, 50 cents.

AIR-BRAKE PRACTICE. BY J. E. FELKS. Price, \$1.00.

COMPOUND LOCOMOTIVES. BY A. T. WOODS. Price, \$2.00.

CATERPILLER OF THE LOCOMOTIVE. BY M. N. POSEY. Price, \$3.50.

SIMPLE LESSONS IN DRAWING FOR THE SHOP. BY O. H. RETZELER. Price, 50 cents.

Send price of any of these or of any other books of THE ENGINEERING LITERATURE COMPANY, EAST ORANGE, N. J., and they will be promptly mailed to any part of the world. Send for Catalogue.

"LOCOMOTIVE RUNNING REPAIRS," by L. C. BIRDSON, General Foreman "Six" Shops. A practical treatise on running repairs, by a general mechanic. Numerous diagrams and illustrations just what is needed by men who handle and repair locomotives.

"SIMPLE LESSONS IN DRAWING," by CHARLES E. KEEFE, Chief Draughtsman Northern Pacific Railway. A splendid book shows how to learn the elementary principles of mechanical drawing and sketching.

"PROGRESSIVE EXAMINATIONS OF LOCOMOTIVE ENGINEERS AND FIREMEN," by JOHN A. HILL. A full and complete two-volume, a capital little book for new locomotives. An excellent pocket companion. Five hundred questions and the answers. Seventeen colored plates showing position and order of all significant engine and train according to standard code.

Send 50c. for any of the above to

DEBS PUB. CO., TERRE HAUTE, IND.

RAMAPO IRON WORKS, Hillburn, N. Y., MANUFACTURERS

Brake Shoes for Steel Tired Wheels.

ROSS, for Steel Tired Car and Tender Wheels,
ROSS-MEEHAN, for Locomotive Drivers,
SHEPPARD, for Blind or Bald Tired Drivers.

NARROW GAUGE CARS, SWITCHES, AUTOMATIC STANDS.

YOKED, BOLTED and SPRING RAIL FROGS, CROSSINGS, TRACK EQUIPMENT.

RAILROAD AND MACHINERY. CASTINGS, HEAVY AND LIGHT.

C. E. ROOD, D. M. BROWN,
ROOD & BROWN,
CAR WHEEL WORKS,
BUFFALO, N. Y.
Railroad, Car, Engine, Tender and Truck Wheels, Made from Best Charcoal Iron.
Office and Works: HOWARD and THOMAS STS.

C. M. FARRAR, JOHN TREETS, C. E. ROOD
EAST BUFFALO IRON WORKS,
FARRAR, TREETS & ROOD, Proprietors.

GREY IRON CASTINGS

of every description. Special Attention Given to Central Engine Works.
Works: N. Y. C. & N. H. R., Broadway Station, East Line. Offices: 60 Perry St., Buffalo, N. Y.

C. E. ROOD, MANUFACTURER OF

MALLEABLE IRON,

QUALITY GUARANTEED

RAILROAD WORK A SPECIALTY.

Office and Works: LANCASTER, NEW YORK.

INSTRUCTION OF MAIL

IN ARCHITECTURE, ARCHITECTURAL DRAWING, PLUMBING, HEATING & VENTILATION, MECHANICS, MECHANICAL DRAWING, BRIDGE ENGINEERING, ELECTRICAL ENGINEERING, SURVEYING AND MAPPING, MINING, ENGLISH BRANCHES, and

RAILROAD ENGINEERING.

Diplomas awarded. To begin students need only know how to read and write. Send for FREE Circular of Information stating the subject you think of studying to

The Correspondence School of Mechanics and Industrial Sciences, SCRANTON, PA.

4000 STUDENTS.

OUR ENGRAVINGS.

Of late we have had a great many inquiries as to who made the fine half-tone plates seen each month in LOCOMOTIVE ENGINEERING. Credit is due the expert anywhere and we are glad to recommend the engravers of our plates to those wanting good work at reasonable prices. All the half-tones and reproductions we use are made by the STAR ENGRAVING & PRINTING CO., 607 & 609 SHAWAN ST., Philadelphia, Pa. SOUZA & HILL.

GALENA OIL WORKS, LIMITED

Galena Engine, Coach and Car Oils, the Standard Lubricating Oils of America.

SAFETY, SPEED and ECONOMY are the results of the use of Galena Oil. THE BEST TEST, to be 15 MILES PER HOUR, cannot be made for the student or other. In the use of Galena Oil there is no extra friction, and the engine runs smoothly and without any unusual defects.

The principal of Galena Oil as a standard railway lubricant is by a large majority of the leading railways of this country has evidence of their preference, while the fact that the same is used on those lines to-day that used kerosene more than 25 years ago, is an evidence of their uniformly freedom of year and year to suit and maintain it in the fact that the same is used on the coast, and upon our continent from the City of New York to the West, has determined its great superiority to all other grades and climates, being entirely free from gum, being not subjected by heat and cold as other oils are.

GALENA OIL WORKS, Limited, CHAS. MERRILL, President, CHICAGO BRANCH OFFICE, 100 Franklin, Pa. Branch Building, 301 Jackson St.

SIGNAL OIL WORKS, LIMITED.

FRANKLIN, PA.

SIBLEY'S Perfection VALVE OIL,

The only perfect Locomotive Valve Lubricant.

J. C. SIBLEY, Preset.

HENRY GARY DAIRD & CO., Industrial Publishers, Booksters and Importers.

810 WALNUT ST., PHILADELPHIA.

Engine New and Revised Catalogue of Practical and Scientific Information, the value of which is beyond price, and the only value which every branch of Science and Art can derive from the study and use of, to any one in any part of the world who will furnish his address.

REQUIRES NO ATTENTION.

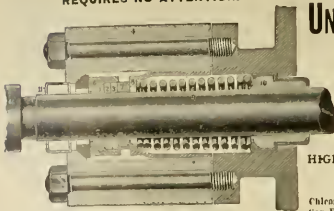

Seals and Oil Cups Furnished with every Packing.

IN USE ON THREE HUNDRED AND FIFTY RAILROADS.

UNITED STATES METALLIC PACKING CO.

For Locomotives, Stationary and Marine Engines.

The United States Metallic Packings

HAVE STOOD THE TEST OF YEARS AND ARE ACKNOWLEDGED TO BE SUPERIOR TO ALL

Renewal of Packing Rings made without disconnecting, by cutting them in halves and breaking joints.

HIGHEST AWARDS COLUMBIAN AND PARIS EXPOSITIONS.

General Office, Bullitt Building; Works, 427 N. 13th St., Philadelphia, Pa.
St. Louis, 32 Laclede Building.
Chicago, Rotundo, Grand Pacific Hotel.
San Francisco, 130 Main Street.

SEND FOR CATALOGUE AND SPECIFICATIONS.

RODGER BALLAST CARS.



These cars are 30 feet long, and are built either 50,000 or 60,000 lb. capacity, M. C. B. Standard. They carry from 15 to 25 cubic yards of gravel or broken stone, or using them as ballast is thrown in the ditch, and none is wasted, as the precise amount of ballast needed can always be discharged. A train of 25 cars, carrying 1500 cubic yards of ballast may be unloaded and the ballast distributed, having the track perfectly cleared and leveled, in 12 to 15 minutes. The cars are all done by the regular "train service" (no conductor and two brakemen), no extra help being required. The track is perfectly cleaned by the unloading, as that is immediately done over it at any rated speed, without needing any extra work. No drivers are needed; no wire cables are used. There is no shoving of ballast from between the cars, and no coupling the trucks with shovels. The ballast is left between the ties and on their ends, directly in position for dumping, when the truck is raised, without being elevated in front of the ditch. The average run per mile, in the amount of ballast needed to make a "raise" of 10 or 15 inches, will be about six yards and 400 for 60,000 lbs. The total saving per mile in material, labor, time, use of cars, saving in transportation, etc., is found to amount, in gravel, to from \$250 to \$400, and in broken stone it often amounts to \$500.

These cars are in use on the Great Northern Ry., the Illinois Central, the Gulf, Colorado & Santa Fe, the Chicago & Eastern Illinois, the Penn. Lines West, and other roads.

Detailed information will be furnished by circular by addressing the

RODGER BALLAST CAR COMPANY, No. 1215 Mononock Building, CHICAGO, ILL.

MATCHLESS VALVE AND CYLINDER OIL.

Warranted not to corrode the iron or destroy packing, and to make more mileage than tallow or lard. Sold only to Railroad Companies direct or through our authorized agents. Matchless Cylinder Oil cannot be Bought of Dealers. In use on 60 Railways.

OILS FOR RAILROAD USE A SPECIALTY.

ECLIPSE LUBRICATING OIL COMPANY, Limited,

MANUFACTURERS OF EVERY PRODUCT OF PETROLEUM.

Main Office: FRANKLIN, Pa.

Holmesport: FRANKLIN, Pa.

OLEAN, N. Y.

ERIE, Pa.

OIL CITY, Pa.



OPEN HEARTH STEEL **CAMBRIA** COFFIN TOUGHENED

CAMBRIA IRON COMPANY,
Office: 218 SOUTH 4TH ST. PHILADELPHIA, PA.
WORKS AT JOHNSTOWN, PA.

OPEN HEARTH STEEL

TOUGHENED

COFFIN PROCESS

Driving, Truck, Passenger and Freight
Axles, Piston and Side Rods, Crank Pins.

SOFT STEEL ARCH BARS.

COOLBAUGH & POMEROY
SPECIAL R. R. SALES AGENTS,
236 BROADWAY,
NEW YORK.

BENT & DRILLED

TOUGHENED BY COFFIN PROCESS, PATENTED

OPEN HEARTH

COFFIN PROCESS

TOUGHENED

CAMBRIA STEEL

SCHOEN MFG. CO.

PRESSED STEEL MATERIAL FOR CARS.

PITTSBURGH, PA.

Locomotive and Car Axles, Coupling Links and Pins.

M. C. B. Passenger Coupler Used in Place of Miller Hook WITHOUT CHANGE IN PLATFORM.

M. C. B. STANDARD
Automatic Freight Car Coupler.

New York Office, . . . 66 Broadway.
Chicago Office, . . . 941 Rookery.
St. Louis Office, 319 Commercial Build'g.

GOULD
Coupler Co.

WORKS: DEPEW, N. Y.
BUFFALO, N. Y.

Gould Continuous Platform and Buffer.
GOULD VESTIBULE.



STEEL **ST. LOUIS COUPLER.**

Stands M. C. B. Tests, and complies with U. S. law, requiring use of Automatic Car Couplers on and after January 1st, 1890. Thousands of Cars already equipped. Capacity of Works, 200 Couplers per day.

ST. LOUIS CAR COUPLER CO., St. Louis, U. S. A.

New York. Boston. Chicago.

HOWE, BROWN & CO., (Limited) PITTSBURGH, PA.

STEEL. HOWE'S SPECIAL TOOL CAST STEEL for Taps, Dies, Reamers, Cutters, Punches, Chisels, Drills, Shear Blades, Lathe Tools, etc., etc. Crucible Spring Cast Steel, Crucible and Open Hearth Firebox and Sheet Cast Steel, Forgings, etc.



A MONTHLY JOURNAL devoted to Steam Engineering and Practical Work relative to the Economic Generation and Transmission of Power. 56 to 64 pages, size of this paper, profusely illustrated. Price, \$1.00 a year. Send for Sample Copy—FREE. Address:

THE POWER PUBLISHING CO.,
WORLD BUILDING, NEW YORK.

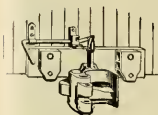

THE SMILLIE COUPLER is the Strongest and Simplest M. C. B. Coupler.
Only 4 Pieces.

Tensile Strength (Fairbank's Test) 139,640. Drop Test, 700 lbs. hammer dropped 18 ft. 22 times failed to break the knuckle.

ALL LOCKING PARTS ARE THE BEST OF STEEL.

NEW YORK OFFICE, 39 CORTLAND ST.

Office and Works, 92 Clay St., Newark, N. J.



THE TROJAN CAR COUPLER CO., Troy, N. Y.

The Trojan is made by throwing open for coupling the head end of the side of the car, and the H emergency for the tramway runs between the two heads of the two cars.

M. C. B. TYPE.

THE STRONGEST AND THE ONLY SAFETY COUPLER.

New York Office: 49 WALL ST.

THE JANNEY FREIGHT CAR COUPLER

THE MCCONWAY & TORLEY COMPANY

W. MC CONWAY—PRESIDENT.

48th ST. & A. V. RY.—PITTSBURGH, PA.

D. O. SETTLEMIER, President.

GEO. W. EVANS, Vice-President.

W. C. ARTHURS, Secy and Treas.

FRANK SUTYER, Supt.

Mt. Vernon Car

MANUFACTURERS OF
FREIGHT CARS OF EVERY DESCRIPTION, CAR-
BOOSE AND REFRIGERATOR CARS,
MT. VERNON.



Manufacturing Co.

OAK WHEELS, OAK CASTINGS, AND GENERAL
FOUNDRY WORK.
Capacity, 15 Cars and 200 Car Wheels.
ILLINOIS.

MILLER'S ASBESTONE CAR ROOF.



THE COILING ROOF!

HEAVY, DURABLE AND STRONG.
WILL WEAR LONGER THAN ANY METAL ONE.
WILL WEAR THE LIFE OF THE CAR.

Costs from \$10 to \$15 Less per Car.
CAN BE PUT ON IN ONE-HALF THE TIME.

HEAR WHAT THEY SAY ABOUT IT!
Our Warr. M. & T. B. Doves East: Boston & Albany R. R.

1302 HAYEMEYER BUILDING, 26 Cortlandt Street, NEW YORK.

THE ALLISON MFG. CO.,
MANUFACTURERS OF
FREIGHT CARS AND
LOCOMOTIVE BOILER TUBES.
WROUGHT IRON PIPE OF SUPERIOR QUALITY.

PHILADELPHIA, PA.

DRAKE & WEIRS, Cleveland, Ohio.
ASPHALT CAR ROOFING

The Cheapest, Best and Most Durable for Roof Known. In use by Seventy
Hundred. Fully insured against use without a single failure. A new roof furnished free for
every one that falls in its path.



THE Fire-Proof Baker Car Heater

MADE OF FLEXIBLE STEEL
ONE-QUARTER INCH THICK.

Firmly Welded into One Compact, Jointless, Seamless Whole.

FIRE WITHIN A SAFE OF SAME MATERIAL
AS THE EXPRESS CAR SAFE.

NEARLY 1000 FIRE-PROOFS IN USE.
ALL OTHER STYLES OF "BAKER HEATERS."

WILLIAM C. BAKER,

Sole Proprietor and Manufacturer.

143 LIBERTY STREET, NEW YORK.

Carbon Steel Company, Pittsburgh, Pa.

MANUFACTURERS OF

OPEN HEARTH STEEL PLATES FOR ALL PURPOSES.

SPECIALLY SUITED FOR LOCOMOTIVE FIREBOXES AND BOILERS.
PARTICULARS SENT ON APPLICATION.

Railroad Agents:

J. B. BRADY, 909 Havemeyer Building, New York.

W. M. WILSON, Western Union Building, Chicago.

Strictly
M.C.B.
Lines.

JOHNSTON COUPLER

JOHNSTON CAR COUPLER COMPANY,

204 WALNUT PLACE,

PHILADELPHIA PA.

PEERLESS

**ENGINE AND TENDER
HOSE CONNECTION.**

Air Brake Hose Guaranteed for 3 Years.

Steam Hose for Car Hoisting.
Wonderful Steam Resisting Qualities.

E. L. PERRY, Pres. W. C. WINANS, Treas.



C. H. DALE, General Manager.

THIS HOSE is known as our ANACONDA brand. It is corrugated, made
of three and four plies of duck, with a wire inserted to prevent it from
collapsing or kinking, thereby making it impossible to break or shut off
injection when handling a curve or striking a low joint. It is made any
shape or length required. The outside is covered with a canvas jacket or
covering to prevent oil, grease, etc., from destroying the hose. This
hoop is thought by many of the master mechanics of our large railroads
to be the ideal hose for engine and tender connections.

MANUFACTURED EXCLUSIVELY BY

THE PEERLESS RUBBER MFG. CO.,

No. 16 WARREN STREET, NEW YORK.



THE CHAPMAN JACK.

PATENTED.

THE screw being lubricated and protected, the Jack is always
ready for instant service. Railroad men appreciate the im-
portance of having Jacks always in good working condition.
Serious delays frequently occur in getting common Jacks so that
they can be worked when suddenly required in train service.

Common Jacks are frequently destroyed in efforts to make
them work quickly after the screws are set with rust and dirt.
This consideration alone makes the Chapman Jack the most
economical one to purchase.

THE CHAPMAN JACK CO., CLEVELAND, OHIO.



**THE ONLY DOUBLE TRACK RAILWAY
BETWEEN
CHICAGO AND THE EAST.**

Number Sleeping Cars, Drawing Rooms and Private Compartment Cars between CHICAGO,
Trenton, Philadelphia, Buffalo, Rochester, Syracuse, Albany, New York, Boston
and intermediate points.

Agents of the NEW YORK AND CHICAGO LIMITED, BOSTON AND CHICAGO
SPECIAL, and the U. S. FAST MAILS.

W. H. CANNIFF, Gen'l. Mgr.

CLEVELAND, O.

A. J. SMITH, G. P. & T. A.

NO PLUGGING NEEDED IF I USE

Knobbed Charcoal Iron Flues

MANUFACTURED BY

THE TYLER TUBE AND PIPE CO., Washington, Pa.
NEW YORK OFFICE, 35 CORTLANDT ST.

JEROME METALLIC PACKING.

This is the Standard Metallic Packing all over the world, and is more generally adopted and in use on more locomotives than any metallic packing in use. Give the **JEROME** a trial and be convinced. Put it in competition with any other packing and be convinced of its superior merits.

Office and Works, Nos. 35 and 37 Canal St., Chicago, Ill.

C. C. JEROME, Inventor and Proprietor.

Packing ring opened ready to apply without disconnecting the Piston from the crosshead. It runs longer and wears the rod less than any other packing in use.



SEND FOR CATALOGUE.

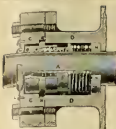

Graham's Patent Groove Shank Twist Drills and Chucks.



DETROIT TWIST DRILL CO., Detroit, Mich., U.S.A.

KEEP YOUR PAPERS CLEAN.

Binders that will hold a full year's numbers for sale.

PRICE, \$1.00, POSTPAID.

LOCOMOTIVE ENGINEERING,
256 Broadway, New York.

The Smith Triple Expansion Exhaust Pipe.

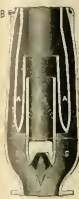

THIS Device is the invention of **JOHN Y. SMITH**, the originator of the Smith Vacuum Brake. In the cuts of the Front and Side Views shown herewith, "A A" represent Air Passages, "S S" an Exhaust Steam Passages, and "B" an Annular Blower forming part of the Nozzle.

It is an entirely new departure in the construction of Exhaust Pipes for Locomotives.

Its distinguishing features are that the exhaust steam is not restricted after it leaves the cylinders, and the gases and heated air in the smoke arch are mingled with the exhaust steam in the exhaust pipe. The exhaust steam is thus superheated and expanded, and a powerful, prolonged, pulsating blast is created, which keeps the fuel in a constant state of agitation, and produces more perfect combustion.

Some of the beneficial results obtained are: *Reduction of Back Pressure to a minimum (area of nozzle opening as large as the exhaust port); prevention of ejection of sparks from smoke stack; almost complete absence of noise from exhaust; prevention of formation of clinkers in fire-box; large saving of fuel.*

By the elimination of Back Pressure we have demonstrated the fact that the power of engines has been increased to be able to pull from thirty to sixty tons more than with any other form of exhaust pipe.

The pipe can be used with either straight or diamond stacks, in long or short front ends, and on locomotives burning hard or soft coal, wood or coke.

NEW YORK SALES OFFICE, Rooms 29 & 31, 115 BROADWAY.
GENERAL OFFICE DOYLESTON, PA. FACTORY-READING, PA.



THE LESLIE PATENT

Locomotive Fire Kindler

FOR

Cheapness, Simplicity, Cleanliness, Convenience, Absolute Safety, Durability and Economy,

STANDS UNRIVALED.

IT IS THE ONLY SYSTEM OF KINDLING LOCOMOTIVE FIRES WITH CRUDE OIL WHICH HAS EVER BEEN PUT INTO GENERAL USE BY ANY RAILROAD COMPANY.

THOUSANDS OF FIRES Have been Kindled for Less than **4 CENTS PER ENGINE.**

During the past Winter ONE car tank of Crude Oil kindled more fires than 500 Cords of Wood.

Its adoption in all round-houses over their Entire System by the Roads, which had tested it in all kinds of weather, furnishes absolute proof of its Complete Success.

For particulars, address **J. S. LESLIE, Paterson, N. J.**

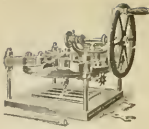

Portable Valve Seat Rotary Planing Machine.

Will Face off the Valve Seats of Locomotives and other Engines in a rapid and accurate manner. No lost time; no breaking of the edges; the only machine requiring no use of files or scrapers after machine has faced off the seat. HUNDREDS OF THESE MACHINES IN USE.

HENRY C. AYER & GLEASON CO.,
PHILADELPHIA, PA.

Office and Works,
N. E. cor. 2d & Diamond Sts.

Central Office,
No. 619 Betz Building.

Boiler,
Locomotive
AND
Smoke Stack
STEELS.

**FIRE
BOX
STEEL.**

PURITY AND
DUCTILITY AND
SOFTNESS.

QUALITY UNSURPASSED

Plates up to 100 ins. in width

SHOENBERGER & CO.,
PITTSBURGH, PA.

HOWARD IRON WORKS,
BUFFALO, N. Y.
MANUFACTURERS OF

BOLT CUTTERS

-AND-
NUT TAPPERS.

Send For Price Lists.

STEVENS PATENT FIRM JOINT
HERMAPHRODITE CALIPERS

No. 36 E.			
Price List sent by mail			
Length	Weight	Price	Price
6 in.	1 lb.	\$1.00	\$1.00
8 in.	1 1/2 lb.	\$1.50	\$1.50
10 in.	2 lb.	\$2.00	\$2.00
12 in.	2 1/2 lb.	\$2.50	\$2.50
14 in.	3 lb.	\$3.00	\$3.00
16 in.	3 1/2 lb.	\$3.50	\$3.50
18 in.	4 lb.	\$4.00	\$4.00
20 in.	4 1/2 lb.	\$4.50	\$4.50
22 in.	5 lb.	\$5.00	\$5.00
24 in.	5 1/2 lb.	\$5.50	\$5.50
26 in.	6 lb.	\$6.00	\$6.00
28 in.	6 1/2 lb.	\$6.50	\$6.50
30 in.	7 lb.	\$7.00	\$7.00
32 in.	7 1/2 lb.	\$7.50	\$7.50
34 in.	8 lb.	\$8.00	\$8.00
36 in.	8 1/2 lb.	\$8.50	\$8.50
38 in.	9 lb.	\$9.00	\$9.00
40 in.	9 1/2 lb.	\$9.50	\$9.50
42 in.	10 lb.	\$10.00	\$10.00
44 in.	10 1/2 lb.	\$10.50	\$10.50
46 in.	11 lb.	\$11.00	\$11.00
48 in.	11 1/2 lb.	\$11.50	\$11.50
50 in.	12 lb.	\$12.00	\$12.00
52 in.	12 1/2 lb.	\$12.50	\$12.50
54 in.	13 lb.	\$13.00	\$13.00
56 in.	13 1/2 lb.	\$13.50	\$13.50
58 in.	14 lb.	\$14.00	\$14.00
60 in.	14 1/2 lb.	\$14.50	\$14.50
62 in.	15 lb.	\$15.00	\$15.00
64 in.	15 1/2 lb.	\$15.50	\$15.50
66 in.	16 lb.	\$16.00	\$16.00
68 in.	16 1/2 lb.	\$16.50	\$16.50
70 in.	17 lb.	\$17.00	\$17.00
72 in.	17 1/2 lb.	\$17.50	\$17.50
74 in.	18 lb.	\$18.00	\$18.00
76 in.	18 1/2 lb.	\$18.50	\$18.50
78 in.	19 lb.	\$19.00	\$19.00
80 in.	19 1/2 lb.	\$19.50	\$19.50
82 in.	20 lb.	\$20.00	\$20.00
84 in.	20 1/2 lb.	\$20.50	\$20.50
86 in.	21 lb.	\$21.00	\$21.00
88 in.	21 1/2 lb.	\$21.50	\$21.50
90 in.	22 lb.	\$22.00	\$22.00
92 in.	22 1/2 lb.	\$22.50	\$22.50
94 in.	23 lb.	\$23.00	\$23.00
96 in.	23 1/2 lb.	\$23.50	\$23.50
98 in.	24 lb.	\$24.00	\$24.00
100 in.	24 1/2 lb.	\$24.50	\$24.50

STEVENS UNIVERSAL
THREADING TOOL

TOOLS.

No. 95. Price \$4.00
With Square Thread Cutter, \$5.00.
With Square Thread Cutter, Die, Gauge, and File
\$10.00.
No. 97. Illustrated catalogue free by mail.
J. STEVENS ARMS & TOOL CO., P. O. B-1 5719 Chicopee Falls, Mass.

LOCOMOTIVE SPRINGS

WITH PATENT V SHAPE BANDS.
Gives more Elasticity to short Plates
and Better Riding Qualities.

MADE AT TURKEY BY
A. FRENCH

SPRING CO.

A. FRENCH, Pres.
J. H. FRENCH, Vice-Pres.

GEORGE W. MORRIS, Gen. Mgr.

D. C. NOBLE, Sec. and Treas.
F. N. FRENCH, Gen'l Supt.

A. FRENCH SPRING CO.

PITTSBURGH, PA.
Manufacturers of
ELLIPTIC AND SPIRAL SPRINGS
OF ALL DESCRIPTIONS.

THE

HAYDEN & DERBY MFG. CO.,

Sole Manufacturers of

Metropolitan Double-Tube Locomotive Injectors

These Injectors work at all steam pressures from 25 pounds up to 250 pounds without any regulation or adjustment.

It is impossible for the water to run out of the overflow when Injector is working.

They are not affected by leaky steam or check valves.

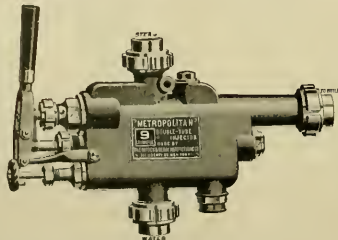

Owing to the peculiar form of nozzles used, repairs of these Injectors are reduced to a minimum. They are very slightly affected by bad water, there being no small relief holes or spills to wear or become clogged.

MADE INTERCHANGEABLE WITH STANDARD MAKES.

Office and Salerooms:

Nos. 111 and 113 LIBERTY STREET, NEW YORK.

BEMENT, MILES & CO.,

PHILADELPHIA, PA.

MANUFACTURERS OF

Metal Working Machine Tools

FOR

Railroad Shops, Locomotive and Car Builders,

Machine Shops, Rolling Mills, Steam Forges, Ship Yards, Boiler Shops,

Bridge Works, etc., etc.



STEAM HAMMERS, Steam and Hydraulic RIVETING MACHINES.

Special Air Tools for R. R. Shops.

Automatic Compound Belt Compressor. - -

Only runs when air is used, requires no attention except oiling, delivers 35 cubic feet of free air per minute—great economy over steam air pumps.

Air Hoists of all sizes, — saves more labor and time than any other shop tool, speed of hoist being entirely at will of operator. Will save ten times their cost per year over a wheel lathe.

Let us quote you on above tools.

PEDRICK & AYER CO.,

1001 Hamilton Street,

PHILADELPHIA, PA.

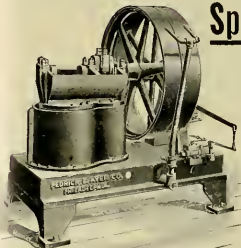

Nicholson's Expanding Lathe Mandrels.



Set of 9 taken from 1 in. to 7 in. Set of six from 1 in. to 4 in.

Either Set sent subject to Thirty Days Trial, and Guaranteed Absolutely Accurate and Labor Saving.

Send for catalogue for full description and references.

GEORGE L. WEISS, General Agent, 139 INGLESIDE AVENUE, CLEVELAND, OHIO.

THE PRATT & WHITNEY CO., HARTFORD, CONN., U. S. A.

MANUFACTURERS OF

STANDARD CYLINDRICAL SIZE AND U. S. STANDARD THREAD GAUGES.

Special Cutters of every variety of interchangeable production.

REAMERS, TAPS AND DIES.

In all usual styles for Machinists, Pipe Fitters and Boiler Makers

Benshaw Ratchet Drills, Combination Lathe Chucks, Die Stocks, Bolt Cutters, Lathes, Planers, Drilling, Milling, Profiling, Cutter Grinding, Die Sinking, and Drop Forging Machines, Forging and Trimming Dies.

MONITOR MACHINES FITTED WITH TOOLS

For Building to Sample. Screws, Studs, Locomotive Fittings, Plumbers' and Gas Fitters' Brass Goods. CATALOGUE SENT ON APPLICATION.

THE LONG & ALLSTATTER CO.,

HAMILTON, OHIO

Double, Single, Angle Bar, Gang, Bar, Central Trunk, Roller, Spacing, Gate, Multiple, Fall and Beam Drives

PUNCHES

AND

SHEARS.

Over 300 Sizes.



Horizontal Punch. Made in 5 Sizes.

THE ACME MACHINERY CO. CLEVELAND, OHIO,

Manufacturers of

ACME BOLT & RIVET HEADS

ACME SINGLE AND DOUBLE

AUTOMATIC BOLT CUTTERS,

Cutting from 1/2 to 1 1/2 in. diam

Also, SEPARATE HEADS AND DIES.



pat. Apr. 2, '90
pat. Nov. 2, '90
pat. Aug. 25, '90

FLAT TURRET LATHE

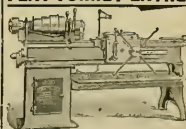

TURNING

STRAIGHT AND TAPER FRAME BOLTS, ETC.

SEND FOR A COPY OF

"RAPID LATHE WORK."

By New Method—Hartness System.

JONES & LAMSON MACHINE CO.,

SPRINGFIELD, VERMONT, U. S. A.



BEATS THE MONKEY-WRENCH OUT OF SIGHT!

OUR ROUND LAW NONPAREIL, BATCH No. 2 to the Institute used for running repairs. That can be found! He has found about how and how to make monkey wrench it keeps hold when monkey set and you are not it on the end-of-the-way, save, and when you need it you can take it off at once and where you monkey and it will make hold close up where the end of the an eating of a hole with the monkey wrench can't get. This prevents getting detailed notes and parts around shop. A horizontal plate for it around a locomotive where it can save time and money. We'll send a Catalogue Free.

THE KEYSTONE MFG. CO., 312 TERRACE, BUFFALO, N. Y.

THE Inevitable result of using INFERIOR STAYBOLT IRON in the construction of the MODERN, HIGH PRESSURE LOCOMOTIVE BOILER.

TO AVOID EXPLOSIONS AND CONSEQUENT GREAT LOSS OF LIFE AND PROPERTY, USE THE

Safety Hollow Staybolt.

MANUFACTURED BY THE **FALLS HOLLOW STAYBOLT CO. CUYAHOGA FALLS, O.**

Purported to all sizes from 1/2 to 1 1/2 in. outside diam., with any size hole required from 1/4 to 3/4 in.



THOMAS PROSSER & SON,
15 GOLD STREET,
NEW YORK.



STEEL TIRES

ON LOCOMOTIVE DRIVING WHEELS
AND ON STEEL-TIRED WHEELS
GIVE THE BEST RESULTS
FOR EVERY VARIETY OF SERVICE.

The CAST-STEEL WORKS of FRIED. KRUPP, Essen, Germany, cover an area of 7,200 acres, employ about 25,000 men, have the most improved plant, and stand unique from the fact that they have their own Ore and Coal Mines, Blast Furnaces, etc., and that every stage of manufacture is under their own supervision, and are not (like others) dependent on the open market for a miscellaneous assortment of crude material; which, in connection with 75 years' experience, enables them to turn out a product of a very superior quality, second to none, and at the same time the different grades of Steel are always of the same uniform quality.

Crank Pins, Piston Rods, Spring Steel, Steel-Tired Wheels, Etc.

After a test of over 35 years, the "KRUPP TIRE" has proved itself the best in the market. If a reliable article is wanted, which will give satisfaction, get KRUPP'S.

SCHENECTADY LOCOMOTIVE WORKS, SCHENECTADY, N. Y.

LOCOMOTIVES
OF
STANDARD
DESIGN
FOR ALL
CLASSES OF
SERVICE.



OR FROM
DESIGNS
FURNISHED
BY
RAILROAD
COMPANIES.

EDWARD ELLIS,
President.
WM. D. ELLIS,
Vice-President and Treas.

A. J. PITKIN,
Superintendent.
A. P. STRONG,
Secretary.

COMPOUND LOCOMOTIVES, Showing an Economy of 15 to 30 per cent. in Fuel and Water. Annual Capacity, 400.

M. L. HILMAN, Pres. and Treas.
F. H. HERRICK, Asst. to the Pres.
H. J. HARRISON, Vice Pres.
T. M. HERRINGTON, Sec. to the Pres.

DAVID BRIDGEMAN, 202 1/2
E. TARTY, Asst. 202 1/2



Brooks Locomotive Works, DUNKIRK, N. Y.

Builders of Locomotive Engines for any required service from our own designs or those of purchasers. Perfect interchangeability and all work fully guaranteed.

COMPOUND LOCOMOTIVES

FOR PASSENGER AND FREIGHT SERVICE.

Latrobe Steel Works
MANUFACTURERS OF

TIRES

FOR LOCOMOTIVE and CAR WHEELS.

Main Office and Works, Latrobe, Pa.
Branch Office, Hollis Building, Philadelphia.
Chicago Office, Western Union Building.
New York Office, Home Insurance Building.

William Sellers & Co. Incorp.
PHILADELPHIA, PA.

MACHINE MODERN TOOLS

for Railroad Shops, Car Builders, etc.

HIGH SPEED
TRAVELING & SWING CRANES,
ALSO
TURNABLES, INJECTORS,

SHAFTING,
ETC., ETC.



"LACKAWANNA"

Sight Feed Locomotive
Cylinder Lubricator.

ABSOLUTE UNIFORMITY OF FEED.

Perfect distribution of oil to both cylinders from one feed glass, and entire efficiency under all working conditions.

Only One Glass,

and that short and stout; almost unbreakable. Absolutely no use for any more. They are an unnecessary source of trouble and danger.

Write for full particulars.

LACKAWANNA LUBRICATING CO.,
1212 Capouse Avenue, Scranton, Pa.



INSPECTION!

Is the safeguard for boilers. Inspect your stay bolts while boiler is under pressure. Use hot water for hydraulic test—expands the parts as in service. One day exposure washes out and fills boiler with hot water; no foundation required, no flow space. One-quarter the size and one-quarter the price of pump. Efficiency guaranteed.

RUE MANUFACTURING CO., 119 N. NINTH ST., PHILADELPHIA

J. G. HENDRICKSON, PRES.
F. J. CLAMER, Vice-PRES.
J. R. NEISON, Sec. and Treas.

"AJAX BEARINGS: RECORD 90 MILES AN HOUR."
"EMPIRE STATE EXPRESS. N.Y.C. & H.R.R.R."

AJAX METAL CO.
INCORPORATED
PHILADELPHIA, PA.

BALDWIN LOCOMOTIVE WORKS' Standard-Gauge Locomotives FOR IMMEDIATE DELIVERY.



DESIGN AS CUT.

Cylinders, 18" x 24"; driving-wheels, 50" diameter; tires, steel, 3" thick; wheel-base, 11' 0", weight in working order, 87,000 pounds; boiler, 52" diameter; fire-box, 30 1/2' x 34'; flues of iron, 1 1/2" in number, 2" diameter, 11' 3/4" long; tender of 2,800 gallons capacity, 33" chilled wheel; driving journals 7 1/2" x 8 1/2"; tender journals, 3 1/2" x 7". M. C. B. standard. Engine is fitted with Nathan No. 8 -light-feed lubricator; balanced slide-valve; two No. 8 Friedman-Monitor injectors; and all necessary tools.

For Price and Particulars, address, BURNHAM, WILLIAMS & CO., PHILADELPHIA.



Pittsburgh Locomotive Works.

PITTSBURGH, PA.,

Manufacturers of
LOCOMOTIVE ENGINES

For Broad or Narrow Gauge Roads

From standard designs or according to specifications furnished at short notice.

Tanks, Locomotive or Stationary Boilers
WELDON MILLER, Jr. & Co. C. A. WHEATMAN, Supt.



DICKSON MANUFACTURING CO.

SCRANTON, PENN.

Locomotives of every style and size, Standard and Narrow Gauge, made to Standard Gauges and Templates Also for Plantations, Mines and Logging.

DESCRIPTIONS OF APPLICATION.

JAS. P. DICKSON, President.
E. W. WESTON, V. Pres. WM. E. PERLINS, Sec. & Treas.
JOHN DETHLE, Superintendent.

CROSBY POP SAFETY VALVES,

MUFFLED AND PLAIN, IMPROVED STEAM GAGES. Single Bell CHIME WHISTLES.



A perfect equipment for a locomotive, giving full range of relief, accuracy and steadiness, applicable to all cases. Supply these goods when ordering locomotives.

Crosby Steam Gage & Valve Co., BOSTON, MASS.

Branches: New York, Chicago, and London, England.

ROGERS LOCOMOTIVE COMPANY

OF PATERSON, N. J. New York Office, 43 Exchange Place.

MANUFACTURERS OF LOCOMOTIVE ENGINES AND TENDERS, And Other Railroad Machinery. R. S. HUGHES, President. G. H. HANNAH, Treas. G. H. LONGBOTTOM, Sec'y. REUBEN WELLS, Superintendent.



PORTLAND CO. PORTLAND, ME. LOGOMOTIVES OF ALL TYPES.

STANDARD OR NARROW GAUGE FOR ANY SERVICE FROM OUR OWN OR TO RAILROAD CO.'S SPECIFICATION. Freight Cars, Derrick Cars, Push Cars and Car Wheels. Boilers of Locomotive, Horizontal, Tubular and Vertical Type.

FRANKLIN C. PAYSON, President. JAMES E. GREENSMITH, General Manager. BYRON D. VERBELL, Treasurer.



ESTABLISHED 1865.
Richmond Locomotive AND MACHINE WORKS,
RICHMOND, VA.
Locomotives for Every Service.

PAUL S. REEVES, Philadelphia. PHOSPHOR BRONZE IN INGOTS AND CASTINGS. LOCOMOTIVE AND CAR BEARINGS. A SPECIALTY. BRASS and PHOS. BRONZE CASTINGS from 1/4 lb. to 5,000 lbs. in WEIGHT.

COOKE LOCOMOTIVE AND MACHINE CO. PATERSON, N. J. (Formerly Danforth Locomotive & Machine Co.)



JOHN S. COOKE, President & Gen. Mgr. FRED W. COOKE, Vice-President. W. M. BRIDMAN, Sec'y & Treas. Paterson, N. J. New York Office, 45 BROADWAY, E. A. ALLEN, Agent.

Rhode Island Locomotive Works, PROVIDENCE, R. I.

CHARLES FRANK MASON, President. ARTHUR LIVINGSTON MASON, Secretary. EARL PHILIP MASON, Vice-President. JOSEPH LYTHGOE, Agent and Supt. WILLIAM P. CHAPIN, Treasurer. S. A. STEPHENS, Traveling Agent.

NEW YORK OFFICE, Nos. 31-33 Pine Street.

STANDARD TOOL CO. Mechanics' Fine Tools. ATHOL, MASS. U.S.A. Catalogue Free.

FLEXIBLE STEEL RULES. Watch Spring Tempered Steel. Graduated in 32nds and eighths on one side only. SEND FOR CIRCULAR. VALLENTINE TOOL CO., Hartford, Conn.

THE Perfectoid Art-Steel Log is the best in the world. The lightest, most elastic, most enduring and present in action. For special information address: EDWIN HOBBS, 2200 Chestnut St., Phila., Pa.

THE WESTINGHOUSE AIR-BRAKE CO.

Is now prepared to fill orders, at an hour's notice, for One or One Thousand Sets of

AIR-BRAKES FOR FREIGHT CARS,

having, at their New Works, an annual capacity for turning out Air-Brakes for 250,000 Freight Cars, 6,000 Passenger Cars, 10,000 Locomotives; besides repairs for the 350,000 Freight and Passenger Cars, and 26,000 Locomotives already equipped by

THE WESTINGHOUSE AIR-BRAKE CO.

Locomotive Engineering



A Practical Journal of Railway Motive Power and Rolling Stock.

COPYRIGHTED, 1911, BY ANDREW SARGENT AND JOHN A. HILL.

VOL. VII, No. 8.

NEW YORK, AUGUST, 1914.

10 Cts. Monthly
\$1.00 Per Year.

A Trip in Old Mexico.

(EDITORIAL CORRESPONDENCE.)

FROM VERA CRUZ TO EL PASO.

Vera Cruz one, of necessity, continually thinks of Cortez and his little band of plundering conquerors who came here in 1519, and with less than 400 men, put an empire under the rule of Spain.

Vera Cruz is credited with founding the city of El Paso, Vera Cruz, and I remember that I was taught that in the little, old, white school-house up in Wisconsin—but it is not true. I once sailed up the river Tabasco, which

been building a breakwater on the north of the town to form a harbor, this extends out in a semicircle for something like a mile, and is built up of huge blocks of concrete made on shore.

Ranckle and I hired a Greek boatman (the town is made up of people from every quarter of the globe) to row us over to the castle. He showed us, by putting down his oar, how shallow the waters were, the only effect the breakwater has had being the filling of the harbor with sand—they were busy cutting an opening in it hoping thereby to form a current that would again clear the harbor,

or 400 of them hover around it, the driver paying no more attention to them than if they were flies. He throws in a barrel of garbage and in a minute the amount is reduced to a peck—they won't eat bottles or hoop-skirts. The Americans there call them the "Sacred Birds" or the "Great Mexican Eagles."

The climate is hot, and yellow fever is never absent, but is worst from May till November.

There are some twenty churches, mostly built in the Moorish style, the Cathedral being quite an imposing structure, it has a large collection of bells—it would be like

especially where to get good baths. Everybody bathes daily, and some of the bath houses are very extensive and unique, reminding one of the pictures of old Roman baths.

All around Vera Cruz are shifting dunes of sand that drift and change with every wind, large hills moving themselves considerable distances in a few weeks.

It is almost impossible to keep from losing material piled on the ground, any obstruction to the wind causing a drift of sand. Piles of rails are elevated several feet above the level of the ground, yet many a pile of sand shows the ends of



TYPICAL SCENE ON INTEROCEANIC RAILWAY, BETWEEN PUERTO AND CITY OF MEXICO. INDIAN CULTIVATION OF AGAVE, OR CENTURY PLANT.

flows into the Gulf a few miles (three Spanish leagues) above the present city, here he burned his ships and founded a town which he named Villa Nueva de Vera Cruz (the New City of the Real Cross). It is now a small village, the city having been really located further south.

There are only two available seaports on the Gulf side of Mexico—Vera Cruz and Tampico. The first place has no real harbor, but an open roadstead in front of the city, vessels anchor between the town and the fortress of San Juan de Ulloa, which is on an island about 3,000 feet from shore. All around the Gulf approach can be seen the teeth of the coral reefs as the waves alternately cover and expose them. It is a very dangerous harbor when there is a "norther" blowing. For some years the Government have

The town is built right down to the water's edge, and the level of the streets only three feet above high tide. Sewage flows through open trenches in the center of the streets, and on account of these there are no continuous sidewalks on the streets running parallel with the shore—when you come to a corner of a block you have to go up the side street about twenty feet where there is a little bridge across the sewer.

There are more stinks and stenches in Vera Cruz than the average man supposes to exist in the known world. Turkey buzzards will eat anything that's nasty enough and are considered here as scavengers. There is a fine of \$5 for killing one, and the buzzards know that better than anyone; they are to be seen everywhere, especially do they swarm on the garbage wagons, 30

to call them a chime, for the Mexicans simply make all the noise they can with the bells. This seems strange, for they are a musical people, every town, great and small, having one or more plazas, and every plaza has a band, and a good one.

Most of the houses are in the old Spanish style, and are built of grout or rubble plastered over and stained and painted in many colors.

The Mexican road only has a small terminal here.

The Interoceanic has a small shop under the charge of Mr. Antonio Sarria, a Cuban, who has been many years in Mexico. Mr. Sarria learned his trade at the Portland Locomotive and Machine Works, in Portland, Me., where he put in seven years' apprenticeship. He was very cordial, and gave us many points about the city,

rails, pipes, pumps or some other supplies.

Superintendent of Motive Power W. R. Barclay had kindly sent us transportation to come back to the City of Mexico by the Interoceanic, the narrow-gauge road of the southern part of the country.

We left Vera Cruz about one o'clock in the afternoon with a five-car train pulled by a Baldwin consolidation, and were soon in the sand hills and then among the scraggy growth of tropical vegetation that fringe the desert of sand. Here were growing several varieties of the cocon tree—those with the huge nut so familiar, and others with great clusters of smaller nuts, coffee, mango and many other strange plants also abound.

The conductor, a young native, was introduced by the American engineer. He

was educated at Poughkeepsie, N. Y., and took particular pains to point out all objects of interest.

One of the first of these was at a little station where the track crosses the river Iason. Right here below this bridge, was the spot where the intrepid Cortez landed his ships, thus saving his little band of cutthroats. "There is no remnant of a compass or journal." Natives yet come out of the *barcas* behind of these ships

JALAPA (pronounced Halapa), the prettiest town that I saw in Mexico.

From the depot uptown we rode on an open car drawn by six mules, the grade being about 70 feet per mile. The whole town lies on the steep side of a mountain. Two sides of their plaza have high stone walls and steps, the other two being on a level with the streets.

There are only two or three churches,

above it in the mountains can be seen the white spires of churches and glimpses of little towns. Jalapa is 4,333 feet above the Gulf.

We left early in the morning, and had a delightful ride up that mountain, twisting and turning, but never going down grade; for some forty miles.

Off to the left, or west, the great Coffee die Perote stood out against the sky. This is a mountain peak nearly 14,000 feet high

big turtles. These were placed under each rail, and a light tie-rod was supposed to keep them from spreading. They made an awful mess when anything got off the track.

After traversing a long stretch of territory, mostly given up to the cultivation of the agave or pulque plant, we arrived at

TEHUACA.

the second city of importance in the Republic and the headquarters of this road and the Ferrocarril del Sur (Mexican Southern).

Puebla was founded by the Spaniards in 1519, it has always been the church stronghold. When President Juarez confiscated the church property after the French occupation, there were at Puebla then a city of only 75,000—seventy-two churches, nine monasteries, eleven convents and twenty theological colleges. The Cathedral has the finest and most expensive interior on this continent, if not in the world. Puebla has now over 100,000 people, large manufacturing interests still support six-hundred churches—monasteries or nunneries are allowed in the country. This is the place where onyx and fine marble goods are made. It is a very interesting city. Almost within the city are the two fortresses. They were taken by General Scott and then were taken and retaken between the French and Mexican forces.

Eight miles away, at Cholula, are the famous Aztec pyramids, made of clay and brick. On top of the largest one stands a church, built by the Spaniards. The pyramid is 177 feet high—quite irregular, now and grass-covered—and the base is 1,440 feet across.

It seems strange that the Spaniards found here the church-town of the Aztec Empire—and established theirs so near. At that time Cholula had 20,000 houses and 400 temples. It was here that M



GUADALUPE BRIDGE, INTER-OCEANIC RAILROAD, STATE OF MEXICO.

The physician said was to the rear of a train, and is very interested in the work of the mine. My best warning is to make haste to get a tall, straight, blue-eyed fellow, a couple that made you think I was a doctor. It is always glad to find an Englishman in a foreign country, they are always being so made, you feel at

and they are good ones. It is said to be the most Protestant town in the Republic. The people are well dressed, and everything looks prosperous, nice stores and fine hotels. We had the best meal here that I got in the country, and ate it in a house of flowers that reminded me of the pictures of fairyland.

crowded by an immense square rock. Soon we emerged into a little plateau, dry and dusty, in the center of which stands the now abandoned castle of Perote, once the strongest fortress in Mexico; it is a very large fort with high and strong walls, inside of which many American soldiers died during the Mexican war. The Interoceanic

Mr. Hill, the engineer, "let me introduce you to our paymaster, Mr. Murphy." Mr. Murphy gave me a hearty handshake and looked at me from his eyes.

He said nothing. I said, "I don't shame that an Irishman can't talk United States?" He said, "He is an engineer. But Mr. Murphy insisted in his car and we pulled out. His wife came to Mexico in the 50's, married a native woman and died there. Mr. Murphy was educated in Spanish, never learned his father's tongue, and spent his young life as a conductor on the old Jalapa tramway. I must tell you about that.

Many years ago an English company built a standard-gauge tramway from Vera Cruz to Jalapa, a distance of 74 miles, this was usually laid along the Federal highway, there was no grading whatever, it went up hill and down hill same as the wagon road. This line was operated by mule-power and carried freight and passengers, people sleeping on the cars and stopping at stations to eat. It did a large business in taking the natural products of the country to market. It finally fell into the hands of the Mexican Railroad which used part of its lower end for main line, but a great part of the way it was paralleled by the new Interoceanic, and its glory has departed they were taking up part of it when it was there.

The Interoceanic has a good road-bed most of the way, and follows from Vera Cruz to Mexico the old highway across the mountains. It climbs, climbs all the way. Ruckle and I tried the front of the locomotive, but the extension front end was too hot for comfort and there were bull-running horses.

The scene changes constantly one place a plain, the next a gorge, churches everywhere. Tropical vegetation tank and strange. It would worry some of our osteopaths to see the way orchids waste themselves on the trees here.

Just at twilight we reached the mountain town of



PANORAMIC VIEW OF CITY OF MEXICO FROM ROOF OF CATHEDRAL. GOVERNMENT HOUSE IS THE PROMINENT BUILDING ON THE RIGHT.

They are cotton and wooden mills here, and a large business is done in fruits and other products. It is from this vicinity that the root known in medicine as *jalap* from which the well-known purgative medicine is made, commonly called *j. slip* in our country.

The view from the city down the mountain is beautiful, and thousands of feet

people tried to buy it from the government for their general shops, but the deal fell through.

A large part of the road-bed has pressed steel ties. They are used on all curves and make a very permanent track, but it seems not easy to keep in alignment. When the road was first built they employed cast-iron sleepers that looked like

Cortez massacred some of the people, but couldn't get out of the city.

Part of one of the old Aztec temples is built into the front of a new abandoned convent. Some 10,000 miserable people live here now, and pigs run the streets. But I'm off the track—it's time I got out

LOCOMOTIVE ENGINEERING, N. Y.

INTER-OCEANIC SHOPS.

The shops are new, and the buildings in the Republic, built of brick, and fairly well equipped with tools. This is an English combination of shops are laid out on the plan, a transfer table between the shops, a round roundhouse, etc.

through the pans and under the tanks of both engines, the throttles were connected by a ball-and-socket-levee-combination that worked both by handling one.

Mr. Barclay and all his men protested that the long drawbar would never hold, but the Englishman who came with them said it would—the bar got hot, pulled in

little cylinders with piping and a small three-way cock in the cab, and the engineer can open any valve he pleases, by simply turning a handle in the cab. This can be done running or standing, thus taking advantage of wind, or a fill, to blow out without getting engine or train dirty. Air can be used, but they use steam there because it requires a smaller piston and is always there if wanted.

This device is worth a United States patent.

General Foreman Eberts has charge of the main shop, and L. Dunbar of the roundhouse. Mr. Dunbar has but recently returned from Peru, where he was for a long time running an oil-burning engine. E. M. Ruth has charge of the car shops, and that reminds me.

The day I was there Mr. Ruth caused the arrest of the native who was running the stationary engine in the car shops. Some one had stolen one of the large belts the night before. This man was under suspicion, his place searched and the belt found. Natives are born thieves. They were going to make an example of this one.

Here, as on the Mexican, the men draw all the oil they want, and are fined for getting anything but Welsh coal which is burned out of Vera Cruz and wood out of Puebla.

Mr. Barclay does one thing worthy of being imitated, especially on crooked roads. He connects both goose necks with a cross-pipe with a T in the center, the combination opening being larger than

get off the track and out in the country, the hose will stay there until the drawbar breaks. It requires less hose, fewer joints and the injector works better.

Americans are employed in these shops only as foremen, the natives are pretty far workmen when intelligently directed. In Mr. Barclay's office I met Lon Hendee, the representative of the Westinghouse Air-Brake Co. in Mexico. He was one of the old-time engineers on the Central who came down and helped build the road out of the city.

Everyone was so cordial here and treated me so well that I wished to go away, as we got on board the train for Mexico City Mr. Barclay handed me a package, and on opening it I found two boxes of the finest cigars I ever put a lip over—that is, the country for good cigars, anyway. I shall always remember that visit with pleasure. I only regretted one thing, and that was that I got no chance to get Mr. Barclay to talking of personal reminiscences; he has been in Mexico for 30 years, and through a great deal of war and revolution—as interesting to me as hot bran mash to a kuan ssw.

THE LOS ANGELES

is another narrow-gauge road, English company, and is much like its neighbor. I did not go over it, as it reaches south toward the Pacific into the hot country.

They use an English engine much like the Inter-oceanic's ten-wheeler, but make by Kitson at Leeds, instead of Dubs, they are much the better engine, and do very good work.

Their gubnats are, if anything, a little worse.

Superintendent of Motive Power H. E. Walker, kindly opened the front end to let me see the arrangement, the steam pipes were 2 1/2 inches outside and the exhaust pipe runs nearly straight across from one cylinder to the other with an opening in the center for exhaust, nothing to prevent the exhaust from one side going over to play horse on the wrong side of the opposite piston.

Mr. Walker has some American engines and is in love with them, though he is an English mechanic sent there from England, he says, the American engine is adapted to the work, the English is not.

He is not very enthusiastic over painted jackets, as one would expect, in the hot water and hot climate it is very difficult to make varnish stand on them.

Mr. Walker is also disgusted with the combination check and injector on the boiler head, and rather laughed at me for advocating an internal feed-pipe. He is taking theirs out and running an outside



REMAINS OF BUILDING DESTROYED BY FIRE, BEFORE OLD RAILROAD.

of the tools are of English make, though there are some Yankees. I found some tools that were particularly awkward; for instance, a large set of dies for bending boiler plate, with no provision for lowering the thickness of the metal on tilting the roll. If a complete circle was rolled up on this machine the top roll and sheet would have to be hoisted out of the frame. It was evidently intended for a ship builder's roll, one for making slight curves. Many of the other tools are of this kind, but the majority of them do fairly well.

The shops are pretty well equipped as a rule. The road was originally operated with English locomotives, and they have some shops outside, in the graveyard, that are carefully and wonderfully made.

They have a class of 10-wheeled passenger engines, with cylinders 18 x 22, that will pull 10,000 pounds, as against 12,000 for the Baldwin ten-wheeler of the same size. The American consolidations weigh 100 or 134,500 pounds.

These engines have not been very satisfactory, don't curve well or stay on the track. They were converting one of them into an eight-wheeler by taking out a pair of wheels, thinking this would lighten her

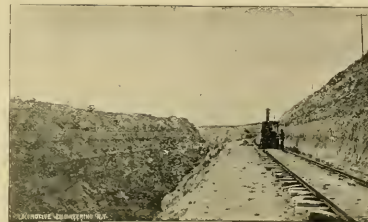

CONSTRUCTION OF CENTRAL RAILWAY. TRACK IS ON A SHELF ON SIDE OF GREAT CUT, CAUSED BY THE CAVING IN OF THE OLD SPANISH DRAINAGE TUNNEL.

two, and one-half the locomotive ran away the first day. They welded axles into the long drawbars, but it was no good, they finally had to cut them in two and use the ends separate as switch engines.

The covers of their tender hoses were cast on, and there was no possible way to pack a box or renew a brass on the road.

A spring hanger could not be put in without taking off the side tank, and it was impossible to get the side rods off without jacking engine up. There are more trapdoors and subterranean passages around these engines than I have seen in my brief experience. The Southern has some of the same kind and use them for the same purpose—to rest back of the shop.

The boss blacksmith here, Jas. Smith, has devised a special steam hammer die for bending and welding car links, the best thing of the kind I have seen. He promised our reporter a sketch of it, and this is to remind him of that promise.

As I said in one of my former letters, every master mechanic in Mexico has a blow-off cock, and J. W. Preston, in charge here, is no exception to the rule, he has one. I was in one of my former letters, every master mechanic in Mexico has a blow-off cock, and J. W. Preston, in charge here, is no exception to the rule, he has one. I was in one of my former letters, every master mechanic in Mexico has a blow-off cock, and J. W. Preston, in charge here, is no exception to the rule, he has one.

It's a plain inside opening valve operated by a piston. He makes two shapes, one for the sides of the firebox and one for the belly of the boiler. He connects their



PANORAMIC VIEW OF ZACATECAS, FROM THE CENTRAL MEXICAN TRACK.

the cross-pipe, then he connects the feed-pipes of injectors the same way, and puts in one large hose right under the drawbar. The crookedest track hardly moves this hose, it never kinks, and an engine can

feed-pipe to a check on the side of the boiler head, and rather laughed at me for advocating an internal feed-pipe. He is taking theirs out and running an outside feed-pipe to a check on the side of the boiler head, and rather laughed at me for advocating an internal feed-pipe. He is taking theirs out and running an outside

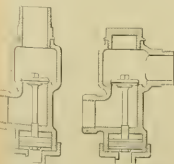

PRESTON'S BLOW-OFF COCK.

and give her a chance to let her truck gilder her a little. The most outrageous contraption to be built a locomotive is a class they have known to the men as "gunboats." They are six-wheel coupled mills with water tanks on their backs and sides, and coal spaces at the rear on a short tank. When they came here two of them were coupled together, making a double-ender, a round drawbar some twenty-five feet long went from a cross-piece ahead of the ash pan,

many Mexicans there. But you go into the bank and exchange your "dobie" dollars for Uncle Sam's promise to pay—giving two for one. People answer in plain English. The policeman carries a club, instead of a sword, shot-stopper and a lantern. You smell the morning air and remember something—you are hungry—a gentle breeze brings you a breath of home—yes, it's ham and eggs frying somewhere, you follow that scent.

At a turn of the street the lazy wind stops the old flag, she lazily reaches out to you as if for a friendly shake, you take your hat back and—well, you are real glad you are back in God's country again.

J. A. H.

Strange Destruction of Flues in a Collision.

Photographic reproductions are here given of the side and end views of some flues that failed under peculiar circumstances.

December 20, 1890, engine "95" on the East Tennessee, Virginia & Georgia Railroad had a rear end collision. She was not taken into the shop for almost a year, Dec. 14, 1891, and was turned out on Feb. 11, 1892.

A portion of Division Master Mechanic Sullivan's letter to his superintendent of motive power will best tell the story.

"I send you herewith a few pieces of burned flues taken out of engine '95' * * * The flues in the boiler looked so good at both ends I thought at first I would not take any of them out, but afterwards thought best to take part of them out, from center to bottom of boiler, to get the end out, if there was any in the boiler, and commenced to take out the center flues first, and found that they would not drive out. Only one end would start, and flue would drive into boiler and would not start the other end. After trying a few of them and they all drove alike, I knew there was something wrong, and ordered the steam pipes and dry pipe taken out, also all the flues, to find out what was the matter, and found something I had never seen or heard of before.

"Forty-five of the flues were burned and melted nearly all away in the center of the boiler, leaving about three feet on each end of the flue perfect, and the flues in sheets in both firebox and smokebox in good condition, and neither of the flue sheets damaged, or any of the other sheets in firebox. There were five rows of flues all around the outside, next to shell of the boiler, in good condition and not damaged.

"The fire was extinguished in firebox as soon as it could be after the collision, and there was no fire around the engine to damage anything, as the shell of the boiler was found, after testing it, to be all right, seams tight and none of the rivets loose, and the paint was not burned off the sandbox, bell frame, dome casing or hand rail, and part of the lagging still remained on the boiler. The engine did not turn over, but stood on her wheels and on the rail all right after the collision.

"The only cause I can give is that gases became ignited and burned and melted the flues. I would like very much to have your opinion of it, as I never heard of a parallel case.

"The general condition of flues taken out was good. Very little mud was in the boiler, and no water between the flues in the center of boiler where the flues were burned.

"The distance from center to center of flues is 12½ inches, space between them, up, down and sideways, ½ inch. The flues were slightly scalded on the outside,

and I send you three pieces of the scale that came off the outside of the flues, so that you can see the thickness of scale on the flues."

We have shown these tubes to many men of large experience, but have received no satisfactory explanation of how this could occur. It will be noticed in the end views the flues are nearly full of metal that ran in when the melting took place.

The long piece of tube has thin parts of other tubes welded on to it, and is itself as thin as paper at the edges.

The tubes used on this road are iron, and mostly of the National make.

We should like some expert opinions on this subject.

Long vs. Short Valve Travel.

The following highly fair criticism of our article on "Short and Long Valve Travel" is made by Mr. C. H. Quereau, engineer of tests of the Chicago, Burlington & Quincy Railroad:

In the editorial on "Short and Long Valve Travel," it is argued that because Mr. Phillip Wallis' test showed no superiority for 5½-inch valve travel over 5-inch, it is fair to assume that long valve travel has no advantage over short in service, though it is admitted that theoretically the long travel should be more economical, and quite sure that all the conditions of Mr. Wallis' tests were not known, or such a broad conclusion would not have been

drawn. The tests were made in freight service. No average speed is given, but it is probably safe to assume that it was not over twenty miles an hour. It is very doubtful if the editor were willing to accept as conclusive, the argument that because 5½-inch valve travel showed no economy over 5 inch travel in a test made in freight service with an average speed approximating twenty miles an hour, it therefore follows that the longer travel will show no economy in passenger service at an average speed of forty miles an hour. This is practically the conclusion drawn, as the paper criticised for advocating long travel treats of "Steam Distribution for High Speed Locomotives."

In the report of Mr. Wallis' tests, to which reference is made, attention is called to the fact that the shorter travel gave a practically perfect steam distribution; that the admission line showed a pressure approximating 75 per cent. of that in the boiler, and that there was almost no back pressure. Under these circumstances even "theory" would hardly expect any advantage in increasing the valve travel. But rather the contrary, as it must be admitted that the longer travel absorbs more power than the shorter. This report was made in November, 1886, and did not include dynamometer or fuel records. In September,

1887, a report was made by his successor, which gave the results of a comparative test of 5-inch and 5½-inch valve travel, made in freight service with a dynamometer car, and included the amount of coal burned. It showed that the 5½-inch travel produced a dynamometer horse power hour for 5.71 pounds of coal, while the 5-inch travel required 6.09 pounds to produce the same power.

It certainly would be unwise to claim that more economical steam distribution could be obtained by increasing the valve travel, when the valve gear in service gave practically perfect results. It would seem to be equally unwise to conclude that, when the existing distribution was considerably less than perfect, an increased valve travel would not produce economical results in service, when theoretical considerations admittedly point to the conclusion that it would. An intelligent use of the indicator would materially help in deciding whether a given valve gear would be improved by increasing the travel or not.

FROM PHOTOGRAPH OF A FLEW MELTED DOWN IN SERVICE.

Union of the Mechanical Associations.

The recommendation which President Hickey made, at the last Master Mechanics' convention, favoring the consolidation of the Master Mechanics' and the Master Car Builders' Associations, and some newspaper writing in the same line, have led to considerable discussion of the subject among the individual members of the two associations. There appears to be

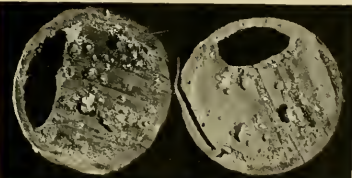

SECTIONS OF FLUES JUST BACK OF WHEEL MELTED, NADLY FLEW OF METAL.

considerable feeling upon the question, and we have yet to find a half dozen of the persons immediately interested who would be generally known that the movement of this sort was started several years ago, and led to some action in 1882. A committee of the Master Mechanics' Association, consisting of F. M. Wilder, James Seigley and Wm. Woodcock, was appointed to confer with a committee of the Master Car Builders' Association, to see if something could not be done to consolidate the two associations, or to arrange for joint meetings. The Master Mechanics' committee was quite favorable to drawing the two associations closer together, but the Master Car Builders' representatives firmly opposed the change, and nothing came of it.

The consolidation of the two associations is very much like the joining of two people in marriage. It cannot be done without the consent of both parties. There are a number of matrimonial agents very anxious to bring about this union, but the principal parties to the contract are sternly opposed to these relations. So long as this sentiment continues, it will be wasted effort for people to argue forward consolidation. Even if one party to the contract was willing, and the other kept aloof, the union would be no other than consummation

than it was before. Barks' was willing. This is a case where Peggotty's sentiment cannot be ignored.

Conflicting Opinions on Common Devices.

As we were sauntering along the porch of the hotel where the last Master Mechanics' convention was held, we found one of the members sitting in deep reflection. Rousing slightly on our approach, he started us by the question, "Is it Shakespeare or Burns, or what writer is it who says that 'all men are liars'?" We named another authority for the broad expression about mankind, and then ventured to ask what had suggested that line of thought. Had he been listening to the tales of the veranda?

"Well, no," he answered. "The discussion which I have been listening to in the convention on spark arresters has convinced me that there must be some prodigious lying going on. One man is all

for the extension smokebox, and attempts to prove that it saves cost, prevents sparks, makes the engines steam better, and is, in short, an all-round benefit to railroad companies. Another man has no use for extension fronts; says he has tried them and has proved that they are no good, but that all the merits claimed for them are to be found in the short front and open stack. A third man finds that the old rejected diamond stack has been rejected without cause, and that nothing better can be found as a spark arrester and aid to unrestricted combustion of fuel. Then there are a lot of others who have had notions about engine smokestacks, odd baffles, plates, and I don't know what. Now these fellows cannot all be telling the truth. Where is safety to be found among the conflict of statements?"

This is a species of talk that is to be heard at the close of every meeting where mechanical men discuss subjects and express views that do not harmonize. We think, however, that a little charitable reflection will lead to the conclusion that different results may be caused by a difference in conditions. In the matter of spark arresters, almost the diversity of experience may be attributed to the different circumstances under which the appliances are used. The difference in fuel alone may account for all the diversity of experience with various spark arresters. It is never safe or sensible to maintain that a man is a liar or a fool, because he tells of experience different from that which has come to his neighbors. Perhaps the results he has found have been due to exceptional attention and good management. Devices that are put on and run in the melow, give very different performance from those that are watched and cared for with intelligent vigilance.

Railroads in the Wrong Places.

When you see the world, Boston & Albany you naturally think of the road from the Hub to the Hudson, but there is a Boston & Albany of Georgia.

Who'd suppose that the Bangor & Portland was anywhere but in Maine. It's up in the interior of Pennsylvania.

The Oregon & Texas Legions on the line of the Fall Brook road and runs up to a tie camp. The only two stations on the road are named Texas and Oregon.

The Secretary of the Railway Master Mechanics' Association has received enough M. M. badge buttons to supply all those who did not get them at last convention. Application should be made for them by those who did not receive buttons.

Encouraging Engineers and Firemen to Practice Economy in Engine Supplies.

Superintendent of Motive Power Haskell of the Chicago & West Michigan, has an efficient traveling engineer, C. B. Conger, who is going about the subject of engine economy in the right way—intersecting the lines.

They have encouraged the engineers and firemen to try to improve the service without fixing arbitrary limits, and results are following.

Just as quick as the men who run and fix engines get interested in seeing how well they can do their work and take a personal interest in the little economies, the saving amounts to something—far more than is usually imagined.

On the first of last March Mr Haskell issued a neat little folder on manilla cardboard, suitable for the vest pocket, and gave it out to the men. It shows what results are obtained by a little oil economy, and is so brief and plain and interesting that it is reproduced in complete below.

MILEAGE IN USE OF OILS	EQUIVALENT OIL		VALVE POINTS ON ENGINE OIL	
	Miles per Ton	Cost per 100 Miles	Miles per Point	Cost per 100 Miles
CHICAGO & WEST MICHIGAN RY.				
1000 LBS. VALVE & NORTH BURNER R. R.				
And Locomotive				
	20	17.00	55	11.35
	21	17.80	60	10.40
	22	17.00	65	9.60
	23	16.10	70	8.90
	24	15.60	75	8.30
	25	15.00	80	7.80
	26	14.50	85	7.30
	27	13.80	90	6.90
	28	13.30	95	6.50
	29	12.90	100	6.20
	30	12.50	105	5.90
	31	12.00	110	5.60
	32	11.70	115	5.40
	33	11.30	120	5.20
	34	11.00	125	5.00
	35	10.70	130	4.80
	36	10.40	135	4.60
	37	10.10	140	4.40
	38	9.80	145	4.30
	39	9.60	150	4.20
	40	9.30	155	4.00
	41	9.10	160	3.90
	42	8.90	165	3.70
	43	8.70	170	3.60
	44	8.50	175	3.50
	45	8.30	180	3.40
	46	8.10	185	3.30
	47	7.90	190	3.20
	48	7.70	195	3.10
	49	7.50	200	3.00
	50	7.50	205	3.00

LIST OF LUBRICATING AN ENGINE

From 20 to 35 miles out of Engine Oil, and from 35 to 50 miles per gallon of Valve Oil.

THE COMPARISON OF ENGINEERS AND FIREMEN

Chicago & West Michigan R.R. Co. 1893-4. Report, March, 1894.

This was so useful, and pointed out so plainly the results to be obtained, that a circular one on the subject of fuel was issued on May 1st. This is also reproduced below.

MILEAGE IN USE OF OILS	EQUIVALENT OIL		VALVE POINTS ON ENGINE OIL	
	Miles per Ton	Cost per 100 Miles	Miles per Point	Cost per 100 Miles
CHICAGO & WEST MICHIGAN RY.				
1000 LBS. VALVE & NORTH BURNER R. R.				
And Locomotive				
	15	814.46	38	85.28
	16	13.75	39	84.40
	17	12.83	40	83.50
	18	12.44	41	82.60
	19	11.57	42	81.70
	20	11.00	43	80.80
	21	10.47	44	80.00
	22	10.00	45	79.20
	23	9.56	46	78.40
	24	9.10	47	77.60
	25	8.70	48	76.80
	26	8.40	49	76.00
	27	8.10	50	75.20
	28	7.85	51	74.30
	29	7.58	52	73.40
	30	7.33	53	72.50
	31	7.09	54	71.60
	32	6.87	55	70.70
	33	6.66	56	69.80
	34	6.47	57	68.90
	35	6.28	58	68.00
	36	6.11	59	67.10
	37	5.94	60	66.20

FOR ENGINEERS AND FIREMEN

Chicago & West Michigan R.R. Co. 1893-4. Report, May 1, 1894.

Mr. Haskell has under his care 123 locomotives, and it's easy for a thoughtful man to see how much could be saved by an extra mile of service to a ton of coal or a pint of oil for a year. When the total amount of fuel for a year is figured up, the amount is interesting.

That the engineers and firemen are do-

ing their share in the matter is proven by the May performance sheets, which shows that they are making 130 81 miles to a pint of valve oil 32 93 miles to a pint of engine oil, and 35 45 miles per ton of coal, this on a total mileage of 170,623 miles.

Specimen of Welding Cast Steel.

The photographic reproduction shown herewith will give a good idea of a specimen of welding now in this office. It was made by W. W. McLelland, foreman black-

smith of welded cast steel that will, I think, show quite clearly that a high tempered steel can 'weld' with a suitable flux 'be safely heated' so that you can weld it easily and as solidly as the specimen I send you, without injury to the steel. Our flux is homemade and contains no borax. Show the specimen to any of your blacksmith friends who may call at your office, perhaps they may send you something better.

"I have been experimenting for eighteen months, am almost tempted to think I have something that may be valuable."



SPECIMEN OF WELDING CAST STEEL

The specimen was made of five old taps and lathe tools welded together, and the bar formed of them, when pushed, showed no sign at the welds and appears a solid bar.

Device for Holding Couplers While Riveting on Yokes.

Among the many other ingenious shop tools to be found in the shops of the Western New York & Pennsylvania, of which

NOTE: Points on Engine Oil
An increase from 20 to 40 miles per part of Engine Oil means a saving of 54 cents per 1,000 miles. If 4,000 miles per month is made it means a saving of \$24.00 per month, and for twelve months at same rate, \$288.00 for one engine. Ten engines, as per above, would save in one year, \$2,880.00.

NOTE: Points on Valve Oil
An increase from 55 to 100 miles per part of Valve Oil means a saving of 51 cents per 1,000 miles. If 4,000 miles per month is made, it means a saving of \$24.00 per month, and for twelve months \$288.00 for one engine. For ten engines, it would amount to \$2,880.00.

Thus the engines making an increase from 30 to 40 miles per part of Engine Oil and from 45 to 100 miles per part of Valve Oil, would save about \$666.00. This amount would pay for 29 barrels Engine Oil and 40 barrels of Valve Oil. These points are worthy of your consideration. A good Engineer is an economical one.

B. HASKELL.
Sept. 1894.



DEVICE FOR HOLDING DRAWBAR WHILE YOKES ARE BEING RIVETED ON

Mr. Allen Vail is superintendent of motive power, can be seen the above handy device.

The cuts show so plainly just how it is constructed, that after description seems unnecessary.

The yoke simply unkeys under the round part or stem of the drawbar, and the other end has a lip that enters the knuckle in the knuckle, and is held there by a pin through the lip and pin hole of the knuckle, this lip has a shaft on one end which turns it, a box on the back end of the yoke and has a handle on it, with this handle the coupler can be turned over as wanted. The yoke is hung near the center to a support, from a trolley track above. Means of raising, lowering and bolting are provided by the crank, pawls and ratchet wheels.

One helper cut up a conpler and carry it to level of screw hammer, hold and turn it while tail yoke is being riveted and deliver it at the other side of shop very easy and expeditiously.

B. HASKELL.
Sept. 1894.

McIntosh's Improved Blow-off Cock.

The engraving shown herewith represents the form of blow-off valve used on that part of the Northwest-west, where

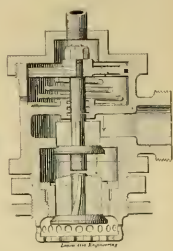

the motive power is in charge of Mr. Wm. McIntosh, at Winston, Minn.

This valve is handled from the cab by compressed air, and is doing good service in the road.

As will be seen, there are two valves between the water in the boiler and the

atmosphere, one of them acts as a safety check, in case the valve is lifted out.

The spring shown insures the closing of the second valve upon the release of the pressure from over the piston, the inner valve is closed by the boiler pressure alone. This valve has twisted wings, or cones, that causes it to revolve when moving, thus seating in a new place. A strainer is used as shown.

There is no packing used about the cock, and it is opened and closed by use of a small valve in the cab. Another hard and dirty job neatly done by compressed air.

The practice of putting out a blue flag at a station to indicate that a car-repairer is at work on the train was first introduced by Mr. H. C. Stone, when he was general superintendent of the C., B. & Q. The practice was found to be so much in the interests of safety that other companies soon adopted it, and the blue flag is now a recognized workman's signal.

Mr. Haskell has under his care 123 locomotives, and it's easy for a thoughtful man to see how much could be saved by an extra mile of service to a ton of coal or a pint of oil for a year. When the total amount of fuel for a year is figured up, the amount is interesting.

That the engineers and firemen are do-

ing their share in the matter is proven by the May performance sheets, which shows that they are making 130 81 miles to a pint of valve oil 32 93 miles to a pint of engine oil, and 35 45 miles per ton of coal, this on a total mileage of 170,623 miles.

Specimen of Welding Cast Steel.

The photographic reproduction shown herewith will give a good idea of a specimen of welding now in this office. It was made by W. W. McLelland, foreman black-

smith of welded cast steel that will, I think, show quite clearly that a high tempered steel can 'weld' with a suitable flux 'be safely heated' so that you can weld it easily and as solidly as the specimen I send you, without injury to the steel. Our flux is homemade and contains no borax. Show the specimen to any of your blacksmith friends who may call at your office, perhaps they may send you something better.

"I have been experimenting for eighteen months, am almost tempted to think I have something that may be valuable."

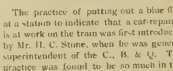

SPECIMEN OF WELDING CAST STEEL

The specimen was made of five old taps and lathe tools welded together, and the bar formed of them, when pushed, showed no sign at the welds and appears a solid bar.

Device for Holding Couplers While Riveting on Yokes.

Among the many other ingenious shop tools to be found in the shops of the Western New York & Pennsylvania, of which

an *engineer*, and railroad workmen *are* *engineers*, and still hold the respect of the railroad officers of the country. That there is strength in a union of all (save of railroad men has been proven. Let us hope, then, there will be no excess on either side that will call for another clash to prove it over again."

"That piece of advice would have defeated the purpose for which the ship was sent out—to hurt the reputation of the papers and railroad officials. The strikers did not do that."

"This paper has always been a mechanical one, it has an aim, and that is to "increase the efficiency of the motive power and rolling stock of American railroads." We believe the best way to do this is to make better mechanics and engineers out of our workers."

"We have never carried water on both shoulders, and we won't. We have often condemned abuses on both sides of the same question, and have always given the best advice we knew how."

"The Great Northern strike we believed the men were right—and said so. In the great sympathetic strike and boycott we thought they were wrong, and say so now. There never has been any doubt as to where we would be found—on the side of justice and right as we saw it. We have and do try to avoid all subjects except mechanical and engineering ones—but we cannot ignore the pages of history being made around us daily."

"We do object to half truth—they are ten times as dangerous as full-fledged lies. It is that's why we are making this kick. That dip was sent out by a business man, and it will be a boomerang, for it is a well-known axiom that "To mention a rival is to advertise him, to slander him is to degrade yourself."

"We had a notion that writing this would please us and make us feel better, but it does not do good does it, to a grown man to step on a pismire."

"The members of the Association of Railroad Air-Brake Men should be proud of their first annual report. It is gotten up in a way that other associations can only strive to imitate. The editors of *LOCOMOTIVE ENGINEERING* cannot endorse too strongly such associations of railroad men as this one. They meet with one object in view—self education—but this object means much to the railroads and the public. Our railroads have become of as much importance and their service is as much depended on as the mail service or any other function of the government. Railroad engineering is made up of many details, any one of which is as important to the public as are streets or highways—they are part of our necessities. The air-brake is the most important of railroad detail, and a knowledge of it is as much a trade as any mechanical pursuit can be. It is comparatively new business—the maintenance of air-brakes—and the men who form this association have no West Point or Annapolis to graduate from, they must instruct themselves, and this they are doing in the best way possible—by an exchange of ideas and experience. Every encouragement possible should be extended to this association and the society of our Travelling Engineers. Their meetings are only fraught with good to themselves, their employers, and the public."

"We do not know of any railroad company in the country that has been carrying on business that is directly to be of so much permanent value as those carried out within the last three years by the Lake Shore & Michigan Southern. There has been very little public mention of the work done, and we were surprised during a recent trip over the road to find so many improvements on the tumb and rail track. All the great work done in the last year at a maximum of about sixteen feet to the mile, and very heavy work has been done in straightening out curves. It has been, in a great measure, owing to these im-

provements that the Lake Shore people are able to run their exceptionally heavy passenger trains with unusually light locomotives. President Newall, it is well known, is a strong advocate of first-class track and track equipment, and he does not favor the use of heavy locomotives that are calculated to hammer the track to pieces prematurely. From what we have seen of the train running on this road, we believe that President Newall's policy is likely to result in decided and permanent reduction of operating expenses."

"It is sad to reflect that railroads with an air of permanence about them are subject to the same transient misadventure as the Prairie Midland and the Mountain Central to fame. About two years ago we gave illustrations of locomotives from the Baldwin Locomotive Works being unloaded at Jaffa for the Jaffa & Jerusalem Railway. The engines were duly put in service and the road opened. The population of Jerusalem has greatly increased of late years, and it is now about 50,000. It was expected that the railway would gradually bring the ancient city and that adjacent territory would begin to have fewer beggars and more laborers. These improvements may be on the way, but they did not come soon enough to give the railway a paying business. The tourists who were to crowd the trains did not appear in the expected numbers, and the consequence is that the company has defaulted in the interest of its bonds, and the road is in the hands of its enemy—a receiver, or his Assa Miran equivalent."

The courts are evidently accorded great precedence to the conclusions of the Patent Office, and giving more consideration to the right of inventors. Six important suits, decided within a few months in United States courts in various parts of the country, awarded damages for infringement, and sustain patents for air-brakes, for the incombustible lamp, for locomotive brake shoes, for water filters, for lay hands, for certain systems of cable-laying. The more careful system of examining patent applications at Washington in the first instance, seems to be bearing good fruit in making such patents as are drawn by competent attorneys and finally issued, of actual value."

The Society of Locomotive and Carriage Superintendents of India have adopted a very compact way of showing the leading particulars of locomotives. It looks like an algebraic formula, thus $W = \frac{4.25}{4.25}$. That means $W =$ class of engine, 15—diameter of cylinders, 2—number of coupled wheels, 25—diameter of drivers in inches.

BOOK REVIEW.

AMERICAN STREET RAILWAY SYSTEMS. Published annually by the office of Bankers, Brokers, Capitalists, Investors and Street Railway Companies. The Street Railway of Philadelphia, No. 27, 10th Street, New York. 216 pages, including 24 maps. Cloth. Price, \$5 00.

This is a large work, giving a great deal of information to those interested in street railway securities, etc. It gives a brief description and some statistics of every city having street roads, tells the mileage, power, etc., and gives a list of the stocks and bonds, including them. We should think it would be invaluable to street railway officers and investors.

While the Rules of Interchange of Cars were under discussion at the M. C. B. Convention, Mr. R. H. Jones of the Norfolk & Western proposed the highly desirable amendment that handbills and steps for cars be made only of wrought iron or steel. It is an outrage that these parts, in which a human life often hangs, should in many cases be made of the porous and brittle material of cast iron. Some of the Chicago & Northwestern raised the curious objection that his car-makers could not tell the difference between steel and cast iron.

PERSONAL.

Mr. R. T. Rundlett has been appointed general manager of the Wisconsin & Quebec Railway, with headquarters at Wisconsin, Me.

Mr. G. Gunby Jordan, general manager of the Georgia Midland & Gulf Railroad, has been appointed State Railroad Commissioner of Georgia.

Mr. Frank D. Jones, heretofore chief engineer, has been appointed superintendent of the Glendon & Gulf railroad, with headquarters at Glendon, N. C.

Mr. Jacob Martin recently died at Charleston, S. C. He had run a locomotive for over fifty years on the S. C. R. R. The last forty-five without an accident.

Mr. Wm T. Harding, late of the Baldwin Locomotive Works, has been appointed chief draughtsman for the Seaboard Air Line, with office at Raleigh, N. C.

Mr. L. M. Martin has been appointed general manager of the Iowa Central, with headquarters at Marshalltown, Ia. He was formerly with the Des Moines & Western.

Mr. Jas. Maglelen, heretofore master mechanic, has been appointed general superintendent of motive power of the Seaboard Air Line, with headquarters at Raleigh, N. C.

Mr. B. S. Shaw, master mechanic of the Georgia, Carolina & Northern Ry., has been promoted to the office of master of machinery of the Seaboard Air Line, at Raleigh, N. C.

Mr. James A. Eagan has been appointed general foreman of locomotive repairs of the Santiago shops of the Mexican National Ry., City of Mexico. He was formerly yardhouse foreman.

John W. Dickinson has been appointed division superintendent of the Southern Railway of the Gulf, Colorado & Santa Fe Ry. Co., with headquarters at Temple, Tex., vice C. S. Haylen, resigned.

Mr. H. E. Palsom, superintendent of the Passumpsic division of the Boston & Maine, has also been appointed superintendent of the Connecticut River division of that road, in place of Mr. H. E. Howard. The headquarters remain at Lyndonville, Vt.

Mr. George Preston, master mechanic of the Canadian Pacific shops, at Toronto Junction, has been appointed master mechanic of the lines east of Montreal, with headquarters at Farnham, Que., in place of Mr. George MacKinnon, who succeeds Mr. Preston as master mechanic at Toronto Junction.

Mr. David Ramsdell, foreman pattern-maker, for the Iowa Central, at Marshalltown, Ia., dropped dead on the streets of Chicago last month. Mr. Ramsdell had been engaged on railroad work for many years and was long pattern maker of the Burlington, Cedar Rapids & Northern, at Cedar Rapids, Ia.

Mr. Henry F. Sampson has been appointed assistant superintendent of the Connecticut River and Passumpsic divisions of the Boston & Maine, with headquarters at Springfield, Mass. Mr. Sampson was superintendent of the Connecticut River road before it was leased by the Boston & Maine in April, 1893.

Mr. W. S. Jones has been appointed general superintendent of the South Carolina & Georgia Railroad, with headquarters at Charleston, S. C. He was formerly a division superintendent of the Long Island Railroad, and has been closely associated with President Barton of the South Carolina & Georgia road.

Mr. Stanford T. Crapo has been appointed acting general manager of the

Flint & Pure Marquette Railroad in place of Mr. W. H. Baldwin. Mr. Crapo is a young man, only twenty-two years old, but has worked his way upward in ten years to be assistant general manager. He is a son of the president of the road.

Mr. A. M. McCracken, heretofore superintendent, has been appointed general superintendent of the Louisville, St. Louis & Texas, with full charge, under the receiver, of all departments of the company's business, and all duties heretofore performed by the general manager and superintendent will be performed by him. Headquarters, Louisville, Ky.

Mr. A. L. Mohler has been appointed general manager of the Almonacook, St. Louis, with headquarters at Minneapolis, Minn. Mr. Mohler was for several years general manager of the Great Northern, and before that held the same position on the St. Paul & Duluth. He is a pleasant gentleman and an excellent railroad man, and his appointment will give much satisfaction to hosts of friends in the Northwest.

Some important improvements have lately been made by Mr. William C. Baker on his well-known car-beater, which promise to make it even more popular than it is. It is necessary for Mr. Baker to leave the Master Car Builders' Convention before the meeting ended in order to supervise some of the changes being made on the beater. He reports business to be remarkably good, considering the prevailing depression on railroads.

Mr. J. E. Hogan, foreman boiler-maker on the A. T. & S. F., at La Junta, Colorado, has a record board for keeping track of his boiler working, which is an item of importance in his line. The board is laid out in 16 squares, the lines on a square numbered from 1 to 31 to represent the days of the month, on the lines the other way, are the numbers of the engines running into La Junta. When an engine is thoroughly washed when an X is placed in her line in the square under the proper date, if only the water is changed they number the square. The number of work, takes only a few seconds to record the day's work, and shows just what engines need washing as well as those washed.

Those who met Mr. J. N. Lauder, superintendent of motive power of the Old Dominion division of the New York, New Haven & Hartford, at the last Master Mechanics' Convention and note how he looked will not be surprised to learn that he has been prostrated with a most severe illness, and is lying very low at his home at Concord. Mr. Lauder is one of our best known master mechanics, and few men handle their work so easily and so well as he. He is a man of strong convictions, Mr. Lauder seldom gives offence in the expression of his opinions, and few men in the country have such a large circle of warm friends. We earnestly hope that his great will-power and iron constitution will pull Mr. Lauder safely out of the affliction he is now enduring.

To the casual observer there were no persons attending the last Master Mechanics' Convention, who enjoyed themselves more than William F. Small, and no person in the company had a more cheerful demeanor. The courage and sustaining fortitude of the man may be appreciated, when it is known that the cloud of a fatal disease was upon him, which closed his life some days after the meeting at Saratoga. Mr. Small underwent an operation a year ago for appendicitis, and it led to complications which proved fatal. He was one of our best known master mechanics, having been in various prominent positions, that of superintendent of motive power of the New York, New Haven & Hartford, making him best known. At the time of his death he was superintendent of motive power of the Buffalo, Rochester & Pittsburgh.

On the 21st of July Angus Sinclair sailed away for France on *La Touraine*. Angus will visit his old mother up among the Highland heather of bonnie Scotland, and then hunt something worth writing about on the Continent. He has several pressing invitations to visit some motive power officials in Russia, who were here to the Fair last year, but the cholera may keep him away from St. Petersburg and Moscow. It is really comical to notice with what care some men, who swear they never are seasick, will hunt up all the patent remedies for that disease and smuggle them into their baggage "unknownst" to their friends. The J. P. sincerely hopes that the Senior Philosopher will have a good time and come back refreshed, ready and willing as he has always been to take the big end of the lead, while his partner does the grunting.

He Held the Fort.

"Do you know that little fellow?" asked in old-timer, as the scribe shook hands with the Dowdell, of the Gould Compler Co., on the porch at Saratoga.

"Yes, he's with Gould."

"Oh, I know, I know, my boy—but do you know his history?"

The scribe took out his note book and put down a mark—it was one of the few things left that he had not found out—and answered "No."

"Well, sir, that boy was a telegraph operator on the Pennsylvania road at Pittsburg during the Centennial, and the great strike of '77 found him there. He stayed at his post to the last. When the old Union depot was ablaze, he cried: 'The depot is on fire now,' and half an hour later: 'The room is too hot to stay in any longer, good bye.' Then he took the screws out of his key, tore it off the table, set it under his coat and left."

When old Tom Scott heard of it, he sent for the boy, and gave him a good job, took him to Europe with him the next year and the year following sent him over alone, he said, he gave him a pass for life on the P. R. R. system. "Gus is a brick, you bet!"

Small but Firm.

It was in the smoking car on the New York Central. There was one chap who was blustering a great deal and telling how many duels he had fought, and he had him at a small man reading a magazine.

"Sir!" said the big man, as he wheeled around, "what would you do if challenged?"

"Refuse," was the quiet reply.

"Ah! I thought as much. Refuse and be branded as a coward! What if a gentleman offered you the choice of a duel at a public house-whipping—then what?"

"I'd take the whipping."

"Ah! I thought so, thought so from the looks of you. Suppose, sir, you had foully slundered me?"

"I never slander."

"Then, sir, suppose I had coolly and deliberately insulted you. What would you do?"

"I'd rise up this way, put down my book this way, and reach over like this, and take you by the nose like this, and give it a three-quarter twist—just so!"

When the little man let go of the big man's nose, the man with the white hat began to crouch down to get away from bullets, but there was no shooting. The big man turned red, then pale, then looked the little man over and remarked:

"Certainly—of course—that's it exactly!"

The little man, whose name is Twombly, had resumed reading his magazine. When the others found that the case was settled they returned to their talk about the strikes.

EQUIPMENT NOTES.

Murray, Dongal & Co. have orders for 400 freight cars for the N. Y., S. & W.

The Rogers Locomotive Co. are building eight freight locomotives for the N. Y., S. & W. R. R.

The Southern Pacific have under advisement the ordering of some 35 locomotives, 15 of them will probably be let soon.

The Jackson & Woodin Mfg. Co. have orders for 150 hopper-bottom coal cars and six stock cars for the Delaware & Hudson; they will have Westinghouse air-brakes, M. C. B. couplers and standards.

The Lehigh Valley order for 2,000 coal cars was divided between the Buffalo Car Mfg. Co. and the Lebanon Mfg. Co., 1,000 each. The cars will have Westinghouse brakes, Fox pressed steel tracks and the King hopper doors.

The Schenectady Works are building two heavy 8-wheeled passenger locomotives for the Boston & Albany; they will be used on the heavy grade between Springfield and Albany. They are also rebuilding two engines for the same company.

The Juniata shops of the P. R. R. have just turned out three of the sixteen new class "D" eight-wheelers recently ordered. They have 19x24-inch cylinders, 50-inch wheels, a 57-inch boiler (Belpare), outputting 175 pounds of steam. They weigh 125,000 pounds.

The Schenectady Locomotive Works have an order for twenty locomotives for the Main Central. Twelve will be mogul freight engines, five 8-wheeled passenger engines, and three will be 6-wheeled switchers. The road engines will all have Westinghouse air-brakes.

Rapid Evaporation in Locomotive Boilers.

Considering the tremendous rapidity with which locomotive boilers convert water into steam, it is surprising that the accident of burned crown-plates is so exceedingly rare. We know of nothing which forms a better testimony to the care and vigilance of the average locomotive engineer. Everybody who has had experience in the cab of a locomotive is well aware how rapidly the water disappears if anything happens to prevent the injectors working, but very few people have seen actual figures of the tremendous evaporation going on. Mr. Sanderson, of the Norfolk & Western, speaking on this subject some time ago, gives figures that will be interesting to most of our readers. He said: "Several years ago, when they had some engines burned owing to the carelessness of engineers, they made experiments with one of their engines, which has a boiler 60 inches in diameter, has 1,774 square feet of heating surface, and it square feet of grate area. The quantity of water evaporated when one safety-valve was blowing off was twelve gallons per minute—when both safety-valves were blowing off the rate is doubled. When the engine is working moderately, the feed water is used up at the rate of about forty-four gallons per minute. When the engine was working hard on a hill, the evaporation rose to seventy-seven gallons of water per minute. The last figures represent measurements taken when the safety-valves are closed, so that if the engine is working hard on a hill, and both safety-valves blowing off, the water would be going away at the rate of eighty-nine gallons per minute. This represents nearly 1 inch in the water gauge per minute, so it can readily be seen how little time there is for a crown-sheet to get exposed when anything has happened to stop the feed-water supply.

An Inscrutable Traveler.

J. R. L. MOHAN.

He was a little, old, dried-up Yankee from Maine, the top of his bald head glistened in the light like the top of a newly varnished sandbox dome, while two faded little watery eyes peered through an antiquated pair of gold-rimmed spectacles.

His legs deformed description, though to an unprejudiced person, these members would certainly not look more homely than bent side rails, and barring a distinct wobble in his gait, which suggested a section of shafting out of line, it must be admitted that his legs performed nobly the duty for which they were appended to his short, thick body, even though he was exceedingly nervous and pettish, the result of rheumatic gout, with which, so he informed me, he suffered continually.

My first meeting with him was in the smoking room of a Mann boudoir car, en route from Fort Worth, Texas, and the manner in which I became acquainted with him might be considered novel, when I say that our acquaintance grew out of a volume of sincere, though seemingly reluctant apologies, occasioned by his having made a mistake and dropped a five minutes' accumulation of tobacco "spit" into my traveling cap, which had fallen from my head to the floor while I was taking an afternoon snooze; it is needless to say that his apology was readily accepted, since I knew that those eyes of his could not distinguish between my nubby cap and a cuspidor.

While the train was standing at a station, after dark, he sat fidgeting in his seat, nervously chewing the end of a "Newsboy's delight," and it was only by exercising my keenest powers of smelling that I was able to distinguish between the exhalations of his "onion" and the disagreeable odors occasioned by a hot box in our car; anyway I congratulated myself upon the fact that my nasal organs were above the average, to be able to detect such a difference, if any.

While I sat thus congratulating myself, he suddenly jumped up, calling vociferously for the porter, whom he intoned in terms more emphatic than polite, that the railroad company had no respect for the lives of its passengers, and ordered him to pull down all the curtains in the car at once, lest some one should throw rocks through the windows.

After having abused everybody and everything connected with the company, he looked somewhat appeased, and started down the aisle to his berth. On his way down he tripped over a pair of shoes, but said nothing until he came to another pair, sticking out from under the curtains. This vision so irritated him, that he stood still in silent contemplation for a moment, then gave them a mighty kick, calculated to drive them through the door at the end; but, strange to relate, these shoes had feet in them, and it was only by bringing all my powers of persuasion into play, that I prevailed upon the owner of these feet to forego his intention of spoiling the beauty of my erratic friend, who seemed very grateful to me by not uttering a word, but casting at me a look, which, for a moment, lost its usual suggestion of disgust. This, on account of its rarity, spoke more eloquently than words, and just before he stepped upon the face of the man in the lower berth, in his attempt to scramble into his upper berth, he informed me that he would stop over a day at New Orleans with me, in order to be able to travel with me to Fort Worth.

At the St. Charles Hotel a scratching pen annoyed him and excited his ire, while registering. This he promptly threw upon the floor with all the force he could command, and proceeded to deliver his opinion of any first-class hotel that would hand such a pen to a man, with which to register. This opinion was much in the nature of a Frenchman's oration, with the exception that many of the words

could not be found in the dictionary. The well-trained clerk did not vouchsafe a reply, but I observed that he took from the desk an old pewter spoon with one end chewed off, and retired to the private office until we were shown to our rooms.

Upon our arrival in Marshall, Texas, we stopped at the first hotel we found, and were assigned to a table in the dining-room that had accommodations for six persons. As we sat down three other guests took seats at the same table. One of these was evidently "troubled with 'choked nozzles,' as his 'exhausts' could be heard all over the room, or perhaps, as his appearance would seem to indicate, these 'exhausts' were occasioned by the excitement which is generally attendant upon the first visit of a man to a town. The second guest I concluded must surely have been a professional sword-swallower from some dime museum, at least he would not have done discredit to one of that profession, judging from the reckless manner with which he handled his knife while devouring a large dish of cabbage; but, owing to his profession this could hardly be attributed to bad breeding, but rather to the force of habit. I noticed while these operations were in progress, that my Yankee friend was growing even more nervous and irritated than usual, though he held his own counsel until the third guest, after having eaten a yard of fat spare ribs, began to gag and cough. He jumped up and left the table, with the remark that he supposed the next course would be chopped hay and oats; the three guests "shut off" and looked up for a moment, but resumed work without comment, evidently thinking that the remark was not intended for them.

The sleeper from Marshall to Fort Worth was a compartment car, and all the lower berths but one were sold. I happened to know the conductor of the car, and gave him an outline of my experience with my friend. He seemed to be much amused at my recital, and remarked that he had another just such character aboard, and would put my friend in the upper berth over him; giving me the lower in the same compartment.

We accordingly fixed up a little plot to break the monotony of the trip, I telling my friend that the man who was to occupy the berth under him had just been discharged by an asylum, cured, having been a dangerous maniac, and that it would be well to watch him.

The conductor told the other erratic individual that my friend was suffering from periodical insanity, and that I was taking him to Fort Worth to be treated.

My friend sat out in the aisle, on a camp chair, glaring through the little opening at the end of the compartment at the supposed maniac inside, while the other man, who was a little, dried-up individual, with a glass eye and a flat wheel, sat up against the window and glared back at my friend, both conjuring up in their minds terrible scenes of a midnight encounter with a maniac.

While the berths were being made up, I sat in the smoking-room, smoking a cigar with the conductor, and forgot for the time being what must be the feelings of my friend. As I entered the compartment the first thing that caught my eye was the man with the glass eye sitting up in his berth, dressed in a suit of white linen "pajamas," while his head was amply protected by a white linen night-cap with draw-strings to it; thus he sat, disagreeable expectancy written in every line of his wrinkled face, staring like a great owl through an opening in the curtains.

My friend would not allow the porter to turn down the gas, preferring to suffer with the heat and the light slaming in his face, rather than run any chance of being attacked unawares. There he was, lying half on his side, with his neck craned over, watching for any suspicious move on the part of his neighbor, and irritation, revenge, anger and fear struggling which should make themselves more prominent

his eyes, which looked more to be in the line of sanctity. I do not know how long this lasted, but I do know that I was truly awakened in the night by a loud crash and springing through the curtains to the floor, beheld a horrible sight. It seems to me that through accident or a malicious stroke of the porter to retaliate upon his superior of the tier, the upper bed, that had not been fastened up securely, had fallen from its mooring from the constant vibration occasioned by the nervous restlessness of its occupant, and had come down with a crash.

These were bent "side rails" of flat iron, "spectacles" and night caps mixed in a terrible confusion for a few moments, while the two supposed maniacs, clinched in a death grip, each afraid to relax his hold on the other, and both struggling vociferously for the porter.

After much trouble and force we got them separated, and neither of them would again for the balance of the night. I got off the car in the morning, at a private house, the man with the glass eye walking down the platform with his "flat head" catching on the raised planks, and falling in upside down.

Upon our arrival at the Arlington Inn, a friend discovered that in the excitement of the night he had put on the other's shoes, and beginning to suspect a trick, had me a not very allusive crowd.

Special Shop Tools.

There is so much pressure placed on men in charge of railway machinery at the present day to lay to rest the everlasting stock in operation at the least possible expense, that every method in use for keeping down this expense is living interest to all the master mechanics and foremen in the country. On this account the report submitted to the Railway Master Mechanics' Convention on "Special Shop Tools" was of great practical value. There are two features about this admirable report which are especially worthy of note. One is the great ingenuity displayed in railway shops in the invention and perfecting of special tools for finishing the work more expeditiously and accurately.

The other is the readiness displayed by men in charge of nearly all railway shops to take advantage of the devices invented and perfected in other places. There is no class of men having charge of work that is not more keenly for information respecting the business than master mechanics and master car builders, and a new invention is rarely perfected long before it is adopted in use all over the country. The illustrated railway journals give great assistance in disseminating this kind of valuable information, and railroad companies are much more inclined to afford outlets for keeping down expense of repairs than they are aware of or are willing to admit.

Mr. T. W. Gentry, who had the principal part in preparing this report, was exceptionally equipped for the work on hand, as the shops of the Richmond & Danville, at Richmond, which he had charge of for the last eight or ten years, is better provided with special tools than any establishment that we are aware of. The principal work of designing and selecting had been most

done by Mr. Gentry himself. Having special facilities in special shop tools, he naturally came to know what shops were noted for getting out these tools for facilitating work, and he was able to prepare a long list of the information of members. We do not know of anything that can be studied to more advantage than those interested in improving their shop facilities that the five pages, at the report referred to, giving names of special appliances in use at various railroad shops.

The Baldwin Locomotive Works have just shipped six locomotives to Japan

Some Blacksmith Shop Tools that Save Time and Money.

After the first annual meeting of the Foreman Blacksmiths' Association, last fall, Mr. W. W. McLellan, of the D. & R. R. road, sent out the following circular letter to the other members of the association:

Dear Sir:—Since returning from the meeting at Chicago I have asked myself, how can we achieve the greatest success for our association? And to the question, only one answer comes, viz. Show the

and our work, don't want to get the reputation of fancy drawing. We have in our shop a steam hammer, hold-down, shear's hold machine and Bradley belt hammer, and you too have which may add to the value of either, or a simple tool which may be used on an anvil—anything that will save money for our employers will be appreciated. Should the opportunity occur, I will gladly reciprocate.

This letter brought a shower of "kinks" of all kinds, shapes and sizes, and a lot of them have been placed at the disposal of LOCOMOTIVE ENGINEERS, and will be illustrated.

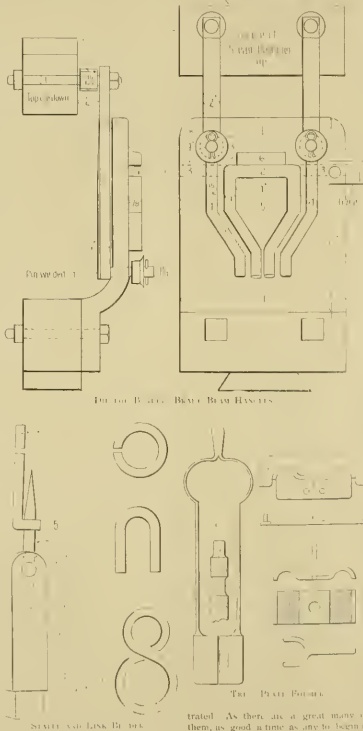

officers of the corporations that employ us, that it pays, and has a real money value to them. At no time in my recollection would this be more appreciated than now, when every official is forced by the financial stringency to adopt measures (sometimes disagreeable to them), to save a cent. It is not our duty as shop foremen to show them that we can help them save. I believe every foreman has in his shop some tool that is looked upon as his personal "kink," easily made and cheap, that will save many times its cost each month. An old friend once told me that one thing worth having was work saving for. Therefore ask you to send me a sketch, or description, of any tool or labor-saving machine you have, no matter if it is only to bend a staple, providing you look upon it as a special labor-saver on locomotives

and one piece bent in duplicate by a copying machine, to long hangers from the top of a couple of rollers that come down on top of the straight piece of iron, bending it clean square, and are then guided through curved slots to close the lower ends together. This tool cost \$50, and it will undoubtedly save that over hand work every ten hours.

The same mechanic suggests a simple device for bending staples, tail bolts, key lings and chain links as shown below.

Another tool of his is used to make true plates for iron cars. The complete device is shown in 2. It represents one-half of the die that forms the outside of the plate *B*; the other half forming the inside. After the plate is bent to the proper shape *B* is removed and a flat plate, shown at *C*, is dropped on the dovels in the end insuring its going in the right place; then punch *D* is placed in the hole in *C* and driven through the work by a blow of the hammer, thus forming the pier or cutting drill. *E* represents the finished product, the fork shown below is used for bending the block *B*.

A larger number of these blacksmith kinks will be shown next month.

One for the Railroad Chemist.

There was a very suggestive remark made by Mr. S. M. Vaudeman, of the Baldwin Locomotive Works, who it is well known is the specifications for boiler and fire-box steel. While talking about mistakes made by steel makers in delivering plates of inferior quality to the kind paid for, he said: "It costs very little to analyze a sample from each pile. You can hire a chemist for a great deal less than you can hire a good mechanic at the present time, and you do not have him long before you're willing to pay him the best wages paid about your establishment, after you have once found out the value of such a man. I would suggest that after this report is adopted each and every master mechanic who can possibly do it hire a chemist and start a laboratory of his own. He can hire him as a mechanic. He will make a first-class machine, and he can help his employer to come to conclusions that will be of the utmost value in his shop."

We commend these remarks to the railroad managers who are inclined to top out chemists and laboratory help as the first step in reducing expenses. Mr. Vaudeman knows what he is talking about, and his advice is well worth following.

A Safety Ash-Pan Damper.

Mr. E. H. Marshall, of Fort Madison, Iowa, has recently applied for a patent on a double ash-pan damper, one that allows the damper to be open to admit air and



closed with the top of the pan and at the same time admits of removing the backing instantly and opening both ends of the pan, on a level with the bottom, to admit of quick and efficient cleaning.

The form of his damper and its operation can be seen from the cut. On the left end of the pan is the cover or the netting is open for the admission of air only, on the right the whole arrangement is swung up to admit of clearing quickly.

The pictures of locomotives shown in our May number and called "Swedish Locomotives," were made at Hinkley, by the Royal Hungarian State Works. This correction should have been made in our June number, but was overlooked.

Those Prize Designs.

THE EIGHT-WHEELERS.

As we remarked last month these were quite as very new in the designs offered in competition for our prizes.

It is seen, that the brake valve is handy, and everything is simple and direct, no extra parts being introduced.

THE WINNER.

John Shields Payne was born on the 21st of October, 1868, near Islip, L. I. His

mirable, the fewest possible parts being used.

A steam bell ringer is used and inside closing cocks as shown in detail drawings.

The designer's description says: "All connections for conveying steam

"The valves and air pump are oiled by a No. 3 triple lubricator.

"The engine has steam bell ringer and chime whistle. The steam pipe to bell ringer is under jacket, and it exhausts into front end.

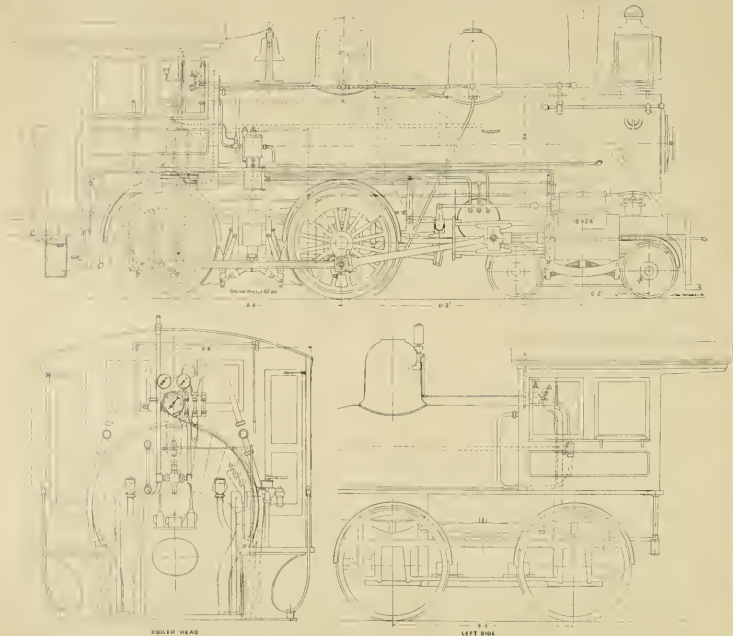

FIRST PRIZE FOR EIGHT-WHEELERS. WORK BY JOHN S. PAYNE, WORTENDYKE, N. J.

The engine is of that wheel taking first prize, and all things are extremely simple, but the details that it was hoped to have were carefully thought out.

There is nothing on the side of the boiler to get knocked off. The checks are located on the boiler-head, and an open pipe carries the water in toward the front of the boiler.

All the steam is taken from a turret, detail drawings shown herewith.

The designer furnished a very brief description, as follows:

"The checks placed on back head of boiler, where they are less liable to be broken off in case of wreck.

"One triple sight-feed lubricator placed in cab.

"All steam cocks and valves in cab to be screwed into a turret having an unusually light neck, which is likely to be broken in a collision or wreck, at the same time allowing the valve to close to prevent the escape of steam.

"Hand brake placed on right side of tender.

"For further particulars consult drawing.

It will be noticed that the air pump is lowered to get it out of line of engineer's

parents moved to Wortendyke, N. J., when he was three years of age. He received only a common school education, it being necessary for him to start to work at an early age. He claims the foundation of his mechanical education was obtained from an old Patent Office report and several trade catalogues that he got hold of. He was always especially interested in locomotives, and whenever possible spent his spare time around the railroad shops and on the yard engine. At the age of fifteen he went to work for the Automatic Truck Works, at Midland Park, and when he was seventeen procured a situation in the drawing room of Rogers L. & M. Works, where he learned his trade and has ever since been employed.

THIS DESIGNER.

was awarded a designer who would have come in first but for two things—doubts about the inside closing check and locating the air pump too high.

The drawing submitted was by long odds the nicest piece of work of all those offered and was highly complimented by the committee.

The turret used by this designer is placed outside of the cab and only the handles of the valves extend into it. The cab arrangement of piping is ad-

justed from boiler to injectors, steam heater, blower, air pump, water glass and bell ringer are attached to a steam chamber, which is connected to boiler by a flange joint, and has a valve inside of boiler which closes automatically in case the chamber is broken off. This valve is kept open by a rod, which extends to the outside of chamber, and can be used to close connection from chamber to boiler at any time.

The pipe which runs from chamber to cab is also provided with an automatic valve.

The gauge cocks, check valves and water glass cock all have their valves located inside of boiler, so that in case of breakage they will remain closed.

The water glass is connected at the top with steam chamber by 1/2-inch pipe.

The pipe to whistle has a guard valve inside of dome.

The blow-off cock is located on the back end of firebox, and a rod extends from it up through deck.

The engine is equipped with the Westinghouse automatic air-brake, and compressed air-train signal.

The air pump is a 1/2-inch improved, and the brake-valve is a model 1869 with feed-valve. The boiler is supplied by two No. 9 injectors.

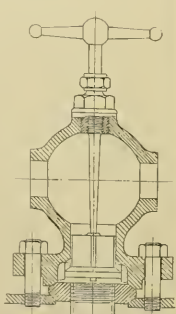

EMERGENCY VALVE FOR TEREFF, USED IN FIRST PRIZE DESIGN.

"All studs screwed into boiler have a weakening groove cut outside, so that they will break off instead of pulling out."
 "Branch pipes are made of seamless brass, and all other piping to be copper, except pipes for air, which are iron."
 "The Brotherhood spring seats are used. The seat boxes are alike on both sides of engine."

The designer says
 "A small steam dome is placed on boiler in front of cab, from which all steam connections are made, with the valve handles running through the cab (to be handy)."
 "This dome being placed behind the main dome would be protected in case of a collision."
 "The throttle is run to the left side of the

The throttle arrangement was considered good, and some of the committee were strongly in favor of placing air pumps on the left side on all engines.

THE WINNER.

W. A. Eagles, is a resident of Newark, N. J., and is 22 years of age. He served his time in the D., L. & W. shops at East

"Hunted for a B'ar."

By HUGH SHARP.

Lum Prentiss, who had been reading the editorial bear story in the June number of LOCOMOTIVE ENGINEERING, volunteered a bear story on his own account. Lum, before this story, had the reputation of lying

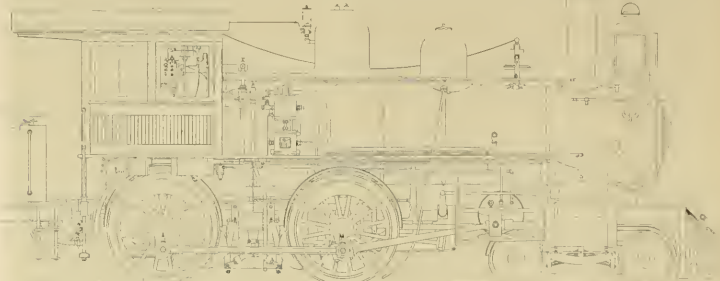

Right Side
Scale 1/4" = 1"

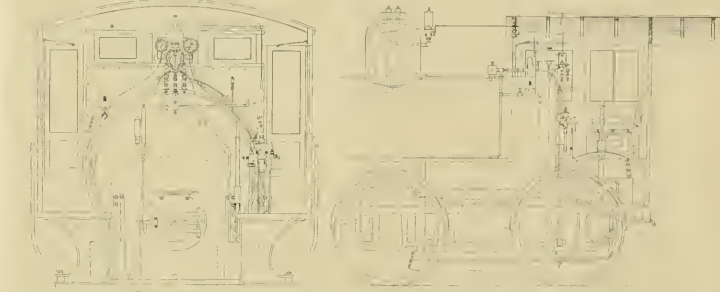

SECOND PRIZE FOR FRONT-WHEELERS. WON BY FRED. M. WESCOTT, OF TOLEDO, O.

"The upper part of steam-gauge bracket is left blank for mirror, clock, or additional gauges, if wanted."
 "The front windows are held open in any desired position by a slide and thumb screw, the back windows lower down like street car windows."
 "The tank hand-brake is on right side and has automatic dog. The opening in deck for grate shake lever is covered by a hinged plate."
 "The steps on engine and tank are the same distance from rail, 14 1/2 inches. The other step on tank is half way from bottom step to deck of tank. The back driving springs where they protrude into cab are covered by iron boxes."

and arranged with bell cranes to lift the valve. With this arrangement very little packing would have to be done, and the lever would pull very easy.

Buffalo, N. Y., under F. B. Griffith, M. N., and is now employed as a draughtsman by

"The air pump is placed on left side, out of the way of engineer."
 "The boiler check is similar to that used on the Pennsylvania Railroad, and made so as to grind in with steam on. Auxiliary reservoir for front truck brake to be placed on top of truck frame, with rubber connections. The brake wheel on tank to



less than any I & I runner between Texas kana and El Paso."
 "For b'ar stories, I commenced Lum, 'men mostly hunt the b'ars, sometimes the b'ars hunt the men. But, say, hev any you fellers ever bin hunted ter a b'ar No? Wal, I hev."

"In 1874, before the T. & P. went further than Fort Worth, I was out in Callahan county after wolf scalps. The X and Y ranches paid \$2.00 for coyotes and \$5 for leafer. I trapped, shot and hunted, and generally made good money. One mornin' in January I concluded to go round my traps. I'd bin down with grip—'breakbone fever', as we called it then—and put on a long buffalo overcoat and a cow-man cap, against gettin' chilled. Them days I turned my whiskers loose, and between the coon cap and the buffalo coat, and bein' nat'rally hairy about the face, I came mighty high gettin' into trouble that same mornin'."

THE WINNER
 Fred. M. Wescott, a native of Toledo, O., twenty-three years of age. He attended the Toledo High School, and went to the Manual Training School for two years, where he learned all he knows about drawing. He is employed as a fireman on the Wheeling & Lake Erie Railroad.
 THE THIRD PRIZE
 was awarded to a design with more changes from the ordinary than either of the other two.



SAFETY GAUGE COCK.

hang in an upright position, to be more out of the way of fireman."
 "The steam-beat regulator is placed under cab on left side, and to have the handle run in cab."

the Meyer-Saiffen Co., of New York, manufacturers of plumbing supplies.
 We will show the design of the consolidation engines next month.
 We can furnish all back numbers for 1894—40 more.

Practical Letters

from Practical Men.

Write on one side of the paper, state your point plainly and briefly, and then quit. We supply the generalities. No letters noticed unless name and address are annexed.

From the Rajputana-Malwa Railway of India.

I AM writing a subscriber to your LOCOMOTIVE ENGINEERING. I have taken the liberty of sending you a photograph of one of our passenger train engines, with a brief description of the class of engine, which you may find a corner in your paper for the same when convenient. The engine shown is our class "M" 100-horsepower, 20-inch diameter gauge, or 20 1/2 inches, and is an our mail and passenger service. These engines were built by Dubs & Co., Glasgow, in 1850, and were put to work in the latter end of that year. They are inside cylinder engines, with living and leading wheels 4 feet 6 inches diameter, crossed the leading rod of

line and the narrow gauge is not adapted to fast running.

Coal consumption per train mile with country coal is 10 7/8, with English coal, 13 3/4 per mile.

The engines are much liked by the drivers, their average day's work being 135 miles. We have a hot, trying climate for seven months in the year, and 135 miles is considered a good day's work.

The photo was taken by Mr. Joseph Sheffield, one of the "drivers," who runs one of this class of engines. "Engineers" you call them in America.

Locomotives do not always stay on the line in India, as will be shown by the snap shot accompanying.

ALEXANDER WALKER,
Locomotive Foreman.

Pandit's Junction, India.

with a powerful induction coil would do the work quite effectually and very cheaply, the "juice" from one such being warranted to tie a hand in a double lock-out and put him far beyond any idea of dollars or gold brick.

Or, again, the platform irons might be insulated and arranged to place his highness in circuit when he plants his regulation boots on the step and grasps the handles, and so teach him to do a backward vault, after which he would not be in a hurry to run away, but might be a fit subject for the nearest coroner, who might return a verdict of "didn't know 'twas loaded."

SAM. H. LIBBY.

Scheme, N. Y.

[This device could be depended upon to kill traumen regularly, and to insure the use of dynamite before a robber would look at a car.]

Back Pressure and Compression.

Editors

In your July issue, "P. S." of Wheaton, Minn., asks the difference between back pressure and compression, and you answer, "They are the same." I do not under-

stand it, about an engine being the same left while running as while standing still.

Take for instance a ball thrown through the air. While it is under swift enough motion it will not come to the ground at all, but as soon as the speed begins to slacken, the force of gravitation begins to draw it to the ground. Now, is this not on the same principle as the locomotive case, and if not, why? R. V. FRANK.

Holden, Mo.

[The speed of the cannon ball makes no difference with its weight, nor does it change the force of gravitation—the ball commences to fall the instant it leaves the cannon. If your theory were correct, we would only need to run fast enough to enable our heaviest trains to run over hoop-iron rails and constrict bridges with safety.]

A Sand Remover.

Editors

I have recently piped a ten-wheel engine so that a jet of steam can be thrown on the rail behind each back driver. In pulling heavy trains, where much sand is used, this little jet prevents its getting under the wheels of the train and causing it to pull hard. The steam and water seems to lubricate the flanges just enough to make train pull easier on curves and seems to cause a saving of wear on rails and wheels. Why is not this a good thing on any engine? G. M. TOWER.

Foreman Loco. Dept.
Fitchburg, Mass.

[These jets have been used with good results in many places, and it seems to us would be a simple and cheap improvement on any road locomotive.]

Proposed Plan to Load the Locomotive on the Gross Weight of Train.

Editors

It was an interesting discussion in the May issue of LOCOMOTIVE ENGINEERING, started in the New York Railroad Club by

CLASS "M" LOCOMOTIVE, RAJPUTANA-MALWA RAILWAY OF INDIA.

the boiler being on an Adams bogie. The boiler is flat topped with vertical stays. They are fitted with Allan's straight link motion which wears less, and is much easier to reverse than Stephenson's common shifting convex curved link or 6-inch stationary concave curved link. It is found that the lead with Allan's motion is not exactly constant for all grades of expansion, as in Gouche's, but it is far less variable than is the case with Stephenson's, besides the link and die block being straight is much easier repaired than curved ones; the steam chests of these engines are on the old system, between the cylinders, the latter are 14 inches in diameter, with a 20-inch stroke. The big ends are of the ordinary marine type, with a cap and long bolts, for holding the brasses together, straps and cutters being dispensed with. The webs of the steel crank-axles are strengthened by iron straps which have been shrank on, the crank-axles are 6 1/2 inches in diameter. There is a compensating beam between the driving and trailing wheels, and the weight being carefully distributed, the engines run remarkably easy, the bogie in front enabling it to round curves without any loss whatever. The engines are fitted with a good steam-brake in addition to the ordinary brakes, they are capable of running at high speed, and hauling heavy loads, the boilers carry a pressure of 140 pounds to the square inch.

These engines have done excellent work the load for mail being twenty carriages, and on ordinary passenger trains, twenty-four, the average speed for the former trains being thirty miles, the latter twenty-eight miles an hour. The road is heavy on some sections, grades of 1 in 150 being common. The writer has ridden on these engines when they were running forty-eight miles an hour with a light special train, of course. The construction of our

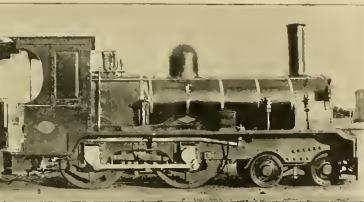

WORK ON A STATE ROAD IN INDIA.

They Might Wear Lightning Rods.

Editors

I would suggest that a good way to effectually dispose of train robbers would be to give them a good dose of "lightning." This could be carried in the express car bottled up in the shape of a storage battery, at a high potential, say a thousand volts.

The car floor could be made of sheet-iron, having the express box insulated from it, and then connecting the box to one side of the battery and the car floor to the other side, everything is ready for the reception of the "Dime Novel Heroes."

When called upon to deliver his treasure, the messenger could invite the heroes aboard and to help themselves, then throwing a switch, stand back and watch them dance for his edification as they make futile attempts to lay hands on the box.

In place of the storage battery, a battery

stand it so. Back pressure is a resistance on the exhaust side of the piston, caused by the friction of the escaping steam while the exhaust is still open. Compression does not begin till the exhaust is closed. Back pressure is an evil, but compression, within certain limits, is a benefit to any engine, and absolutely necessary to an engine running at high speed and having large clearances, as it brings the heavy reciprocating parts to rest without shock, and reheats the cylinders and steam passages.

TOMASINO POGGI.

Scranton, Pa.

[Compression and back pressure are both resistance to the piston, but the distinction noted by our correspondent as above is correct.]

The Cannon Ball Theory of Speed.

Editors

I differ somewhat with your answer to the last part of question 94 in last month's

paper from Mr. Geo. W. West, Superintendent of Motive Power of the New York, Ontario & Western, on "What is the Most Economical Load for the Locomotive from the Standpoint of the Motive Power and the Transportation Departments."

It is the first time I have ever seen in print any mention made of this long-neglected problem, and just why we make a study of almost every minute detail in every department of the service and have neglected this most important subject, and continue to load the locomotive in the same primitive fashion of fifty years ago, making no effort to adopt a better system, is in my opinion, past understanding.

Just how the "average yardmaster" is to load the locomotive properly, when every official from the general manager down makes no distinction between the gross weight of one car weighing 90,000 and another weighing 45,000 (either one representing a car), except the accounting

department must amount per ton-per-
sided.

When it is taken into consideration what
the railroad companies lose daily, espe-
cially some of the trunk lines having
sixty to eighty trains per day, each way,
on account of power not being loaded to
the maximum limit, and on account of
power being overloaded, causing delay,
waste of fuel etc., has not the time ar-
rived for the inauguration of a better
system to load the locomotive?

Mr. West implies that the officers of the
 motive power department are at the pres-
ent time very anxious to change the
method that the engines under their supervision
take, the greatest number of miles at
the least expense and do this in order
to keep up their reputation to the same
standard as men on other roads, regardless
of the fact that the companies may or
may not earn any money from this kind
of service.

Also, that the officers of the transporta-
tion department are equally as anxious to
load that their engines and rail has not
been loaded, and that this is hauling as many
cars at the present time, with less power
than they did several years ago, even if
it is shown economically to load.

Mr. West says with the "122" says
"that the engines under their supervision
take, the greatest number of miles at
the least expense and do this in order
to keep up their reputation to the same
standard as men on other roads, regardless
of the fact that the companies may or
may not earn any money from this kind
of service."

Mr. Watson intimates that on the West
side of the yardmaster has the way-bills,
and the weights on the way bills regulated
the number of cars assigned to the engine.
I am not familiar with the amount of
weight done on the West Shore, but if
all the yardmasters had the same trans-
portation bill frequently, when he gets finished,
and the yardmaster of adding up the
weights, and just measure off a mile of
road, more or less. If Mr. Watson will
just take the trouble to copy the weights
of about forty way-bills and add them up,
he will readily see that his yardmasters on
the West Shore on the road at large, do
not have sufficient time to inspect any such
plan to load power by.

Even where it would be possible to do
this, we still would have another difficulty
to overcome. The weight of the cars also
an important factor in the case. At the
present time we have cars of the following
weights, 40,000, 50,000 and 60,000 lbs, capacity,
the average weight, 17,000, 22,000, 26,000 and
31,000 lbs, respectively, the standard car
of the mines doubling the weight of the
car of the seavents.

It will be readily seen, with such a vari-
ation in weight cars, that in order to
adopt a loading basis to load the loco-
motive, we will have to include the weight
of not only the freight in the car, but the
car itself.

To inaugurate a new system for loading
the locomotive in the manner proposed,
and at first appear very difficult, but not
so easily accomplished, but with such a
terminated effort in the proper direction,
it can be so simplified that any yardmaster
can quickly assign to the locomotive a
train exactly rated in per thousand pound.

To do this the motive power department
and the transportation department should
require the accounting department to fur-

nish, with every car load they offer for
movement, a way-bill with the gross weight
entered on it. Where the loading consists
of light merchandise the lading should be
estimated, and, with the light weight of
the car, should constitute the gross weight,
with every way-bill thus showing the gross
weight. We next need a piece of mech-
anism, called an adder, so we can quickly
determine the number of cars needed to
load the engine of a train by gross weight.
With this mechanical device, we can not
only load the locomotive on the per gross
weight of train loads, but can do it with
accuracy, speed and precision, not over the
limit or under the limit, not in the interest
of the men of the motive power depart-
ment, or in the interest of the men of the
transportation department, but in the
interest of the company, "that pays the
bill," and I might add, in the interest
of Engineer Smith, Conductor Jones and
the "122."
J. L. HOLLIS.

Derry Roads, Pittsburgh, Pa.

A Proposed Angle-Cock Improvement.

Seeing the numerous devices adapted
for preventing the closing of angle-cocks
I beg leave to submit the enclosed design

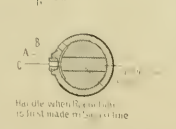
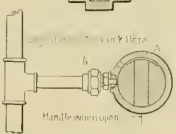
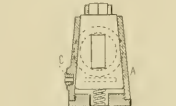

Handle when open.
Handle when closed.

All that is required of any plan angle-
cock is to drill two holes in casing, as
shown in drawing, one for a branch to
signal pipe and another for an exhaust
port, also an exhaust cavity in plug, which
can be milled, or can be coed-out when
made new, this must be hollow enough to
make connection with train pipe. The
object of cavity in plug is to connect
signal line to exhaust port when angle-
cock is closed or half closed, which causes
reduction and noises engine.
The ports and cavity should be made
sufficiently large so as to make a very
noticeable reduction, which may be in-
duced on a gauge in cab, so as not to
lose the turning of a cock with conductor's
signal.

J. E. MURPHY
St. Wayne, Ind.

A Point or Two on Firing.

There has just read a letter in your June
issue of LOCOMOTIVE ENGINEERING, written
by H. L. Clark, Alton, Kansas, giving
his experience as a locomotive fireman.

I thought I could give some advice to
firemen who read your valuable journal
as to soft-coal firing. Mr. Clark's idea may
be all right on one engine, but there are many
different kinds of fireboxes. You may
have an engine built just able to let the
water, and still have to fire both differ-
ently. I claim there is just as much
science in handling a soft-coal fire of a
locomotive as any trade a man may go at.

To become a practical soft-coal fireman
a man must first "get his hand of her."
He must learn to see his fire just as soon
as he opens the furnace door, and to feed
it as needed, not too fast or too heavy,
then again he should watch the engineer,
and learn how he is working the engine.
It takes some men a long time to learn
that point, and it's the most important of
all.

An engine may be working an engine
comparatively easy with his fireman throwing
coal, but the result of this softness is
his fire is burned over and the steam is
going back on him. He then has a hard
time to get back to full pressure and there
is a waste of coal.

Again, the fireman should know the
shutting-off places and never use his look
on the fire just before an engineer shuts
off. Wait until he leaves the station and
gets his engine "out back," then use the
look as necessary. This will save labor
and coal.

Another point in the economy of coal
and labor is to keep the coal wet down,
and around stations to keep the damper
down. This will apply to fireboxes with
stack brack.

In regard to the long fireboxes—say
the twelve-foot turnouts—are handled
very differently. As this class of engines
will pull their fire ahead, you will find it
won't burn your coal ahead, that you will
soon have your fire sheet covered. Bad
coal will make chinks in any furnace.

I think that these facts in regard to soft
coal firing, if practical will give good re-
sults. I have stood on the foreboard of
a heavy fast train for over twenty years
and have always had plenty of steam,
which I got easily and with an economical
use of coal.

H. W. A. 109, P. 1
E. J. JOYCE.

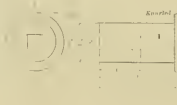

Tapping out Staybolts.

Here is with the drawing of a staybolt
with spring attachment to a flexible shaft
I use here. The only limitation to the
speed with this is what the taps will stand.
Here we are not supposed to exceed 175
revolutions per minute. This will advance
the tap 1/16, inches per minute, but with
good iron oil, and two or three taps, 30 to
40 times a day in changing, and the taps have
a chance to cool both in times, they can
be run considerably faster.

With hard oil and two taps, 1/16-inch,
we tapped 122 holes in 50 minutes. That
would be at the rate of 140 revolutions per
minute if kept going continuously. For
the thread sheet I have the compound box
used, illustrated in January issue of this
issue, for tapping all the holes in a great
many shops, and use the fastest speed for
the shaft, 175 revolutions per minute,
and as this box is geared 1/4 to 1, the tap

will advance 4 1/2 inches per minute—quite
a difference. I think the drawing is plain
enough to be understood, but I will explain
it one to hold the tap, the other end is
turned down to 3/4 inches in diameter and
3/4 inches long for the loose sleeve B. On
the end of this again, it is turned down to
3/4 inches in diameter and 1 1/2 inches long
with a right hand thread cut on it to hold
the clutch C. B is a sleeve with a ring
turned on one end. This ring is knurled
so the pin can hold it, and is loose so it
is free to turn when the clutch engages.
D is the pin to hold the clutch in working
contact. E is an oil hole. L is the clutch,
and must be made to suit the shaft. It is
tapped with a 1/4-inch tap, right hand
thread, and screws on after B is in posi-
tion, and is practically a part of A.

In your February issue, a gentleman
questions the use of the machine for rolling
flues by power on account of the cost.
As he asked the opinion of others, I waited
to hear them before telling just what I
will do. We rolled a large set of flues in
three hours and forty minutes, altogether
I allow four hours for the work. This with
two men, the operator at 17 1/2 cents, and
the man rolling at 25 cents, equals 12 1/2 cents
per hour, this comes to \$1 70, the operator
with a boy at 10 cents per hour, can
put up and take down the machine in 40
and one-half hours comfortably, cost 12
cents, total cost rolling flues, \$2.12. By
hand, nine hours, at 25 cents, equals \$2.25.

Exclusive of the cost, I think makes a
fair better job, and is easier on the men
as the rollers run continuously with a
nice even motion, and having the pin draw
away in and the man jerking to turn it
down. There are also other matters to be
considered, as to less time in the front end
and using the man on other jobs, etc.

Regarding the machine illustrated in
your February issue, we tap those holes
now for 35 cents, while they never cost
less than \$3 by hand.

On a boiler requiring a new firebox, we
drilled 28 staybolts (heads on this require
a depth of one inch), these were 5/16 inch
holes, and were drilled previous to break-
ing, fifty countersunk rivet heads, drilled.
So the bolts would drop off in backing out
the rivets, and the corner plugs in the
mand ring drilled clear out and twenty
six holes, 1/2 inches in diameter, on the
wagon-top for new cross-feed for cross-
bar braces. This drilling was done with
a drill frame that required a support like
a rat-hat. This drilling cost \$16.75, this
includes bringing setting, and taking a

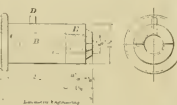

Tapping out Staybolts.

tools, etc., away to place. On the sam-
ple we broke 28 staybolts, average 1 1/2
inches, on the side sheets, the back head
was removed, cost, \$4.95, this includes
handling the tools, and the men had a
snap that day.

Bingham, Iowa. J. C. MILLER

Studying Air-Brake Problems — Are Standards Sacred?

Editor:—One of two things could be im-
posed on a little, without contradicting or criticizing
in a carping spirit the writer, who
is furnishing you with precisely the information
needed on this subject, and in much
better shape probably than any other who
might attempt to perform the task under-
taken, still, it does not seem to be just
right to remain silent in such a case. It will
endeavor to point out the mistakes.

Referring to piston ring No. 48, Plate

of the 1891 catalogue, the statement is made that these rings do not fit right. I have not yet found one of these valves which were tight, with handle on lap and train-pipe exhausted, but a few years ago there was a number of engines here on the Plate 183 valve which, if the engine No. 17 were oiled with a heavy oil, would when the handle was on lap and train-pipe empty retain the air so that the back hand would remain stationary for a reasonable time when the engine was standing, but while running, owing to vibration, would not do so well.

The other point which it appears necessary to take up is the tender-brake rigging illustrated on page 211, Plate 24. Suppose an apprentice seeking after knowledge on the air-brake subject, when he goes home at night, study up the plan presented that might have a better understanding of the subject. We have all been there, and this is about the way it goes: After supper I take up my riders, rule and paper, and try to find what the brake cylinder is proportional by measuring the length of reservoir and comparing it with the length of brake cylinder, suppose he decides the reservoir to be 12 x 31 in. and the brake cylinder to be 10 in. which his W. A. B. instructor's book, page 14, tells him will give about 4,000 lbs. on the piston end of cylinder lever. He pulls down the short end of the lever or the one next to the cylinder in 1/2 in. long and the long end about 11 in. long, to find the power on the long end of the lever he multiplies 4,000, which is power in cylinder, by 7, cylinder end of long end, and divides by 14 or the truck lever end getting 2,000 lbs. pull on the rod leading to top end of rear live truck lever, which measures about 10 in. short end and 11 in. long end, or 11 in. all in, to find the power on brake beam he divides the short end into total length, which gives him a proportion of 6 to 1 or 12,000 lbs. on each pair of wheels; then looking at the cylinder rod he sees the lever for the front trucks is fastened to the hand-brake rod instead of the front head and the cylinder rod connects very near the center; to find the pull here he adds the pull at both ends of the cylinder lever or the one connected to piston, which gives him 4,000 + 2,000 = 6,000 lbs. pull on cylinder rod, and as the hole for the hand-brake rod and front live truck lever are at the same distance from the center or cylinder-rod hole, it follows that the power is divided equally and each end gets 3,000 lbs. brought to a standstill. Perhaps the inventors to figure this out, as equipped with an air-brake cylinder and 10 x 24 in. reservoir; from page 53 of his instruction book he finds 2,500 lbs. is the pressure, then 2,500 x 7 + 14 = 1,750 x 6, proportion of truck lever = 7,500 lbs. on each pair of wheels on rear truck, for the front truck gets pull on cylinder rod as before, which is 3,000 + 2,500 = 5,500 lbs. pull on center of lever at the front end of cylinder rod, this divided by 2, proportion of hand-brake rod and truck lever, lever = 1,775 lbs. pull on the top end of front live truck lever or 625 lbs. more than the pull on the top end of rear live truck lever. It is evident then that the end of lever connecting to front live truck lever should be twice as long as the end connecting to hand-brake rod, to be in proportion with the lever at the rear end of cylinder rod, and if the boy is not sure of his plan, he is liable to go wrong.

It is pretty odd, too. Some of these boys have their friend Wood, page 237. I cannot agree with him when he infers that we should strictly follow in all cases the recommendations of different companies, no man or company is infallible, and I frequently catch points from those who have

not the slightest idea of the operation of the part they are commenting upon. When lacking positive information on a subject, whether it be air-brake or anything else, it is best to go by the instructions offered by those who are best posted, which in this case would be the makers. The tender-brake rigging herein discussed, however, emphasizes the importance of not blindly taking for granted anything, but to carefully examine, and if it differs from what you believe it should be, to post yourself on the subject. You will detect an error in the work, or have added to your store of knowledge, usually the latter, and in either case will be the gainer.

Roanoke, Va. GEORGE HOLMES.

On the Travel of the Crosshead.

Editors: In the June number of LOCOMOTIVE ENGINEERING, Mr. B. H. Hawkins comments upon the travel of "crosshead" in forward and back stroke while making a revolution of wheel, but gives no explanation of how he gets at the result.

Mr. H. says a crosshead will travel 21 inches less than half the circumference of the wheel in the back stroke, and will gain 21 inches more than half the circumference of the wheel in the front stroke, which I think is right.

I have drawn a rough sketch representing the path of crank-pin. (No. 1.) This sketch represents a wheel 2 inches in diameter and 1-inch stroke. The circumference of this wheel is about 6 1/4 inches.

I start the wheel revolving with the pin on front center A, and move her to the back center C, which is the back stroke,

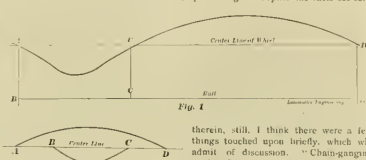

and the curved line from A to C represents the path of crank-pin in traveling from front to back center when engine is going ahead, or the back stroke. I find that the crank-pin has traveled 25 inches, which is 1 inch less than one-half the circumference of the wheel, and in moving wheel from back center C to front center D, pin has described the long curve and I find the pin travels 24 1/2 inches, which is 1 inch more than half the circumference of the wheel. This is caused by top part of wheel traveling further than the part on the rail. The crank-pin travels the same in proportion to its height from the rail. The crank-pin in the bottom stroke is traveling in the part of the wheel that is moving the shortest distance. This is shown in sketch No. 2, which shows two crank-pins, one pin on the back center A, the other on front center B. By making one-half stroke the back pin will travel from A to D and the front pin will travel from B to C. This will show you that the pin on the top stroke travels twice the distance that the pin on the bottom stroke travels and illustrates Mr. Hawkins' idea.

W. W. McVIEHAND.

Marquette, Mich.

A Blade Straightener.

The blade straightener shown by Mr. Arthur in the May number is, as he says, a very convenient and useful tool. I use it, and a very economical one for the company who owns it. The convenience of the tool would be much greater if there were no pins to lose, and I send you a sketch of one which has been in use on

this road for some years, the idea of which, if I mistake not, emanated from the fertile brain of Mr. Geo. Gollmar, of the Gollmar Bell Ringing Co., who is at that time gang boss in the Baraboo shops of this company. The ends are turned as shown, only from opposite edges, so that no matter what the width of the blade, the set-screws come in the middle.

I have often puzzled my brain, without practical result, over some plan for twisting the blades on ten-wheel and consolidation engines where it is almost impossible



to get the ordinary forked arrangement on without taking down the forward brake rigging, and then the blade is to be clear forward. If some one has been more fortunate in results than I, let us hear from him:

Roanoke, Va.

Difficulties in Engines.

Editors:

In your May issue, in editorial columns, you give considerable space to the discussion of the "Uneven Performances of Locomotives" With all due respect to such an authority as LOCOMOTIVE ENGINEERING is conceded to be, and without presuming to dispute the facts set forth

therein, still, I think there were a few things touched upon briefly, which will admit of discussion. "Chain-ganging engines," you say, "has dissipated the belief that engines built from the same templates and general dimensions varied in efficiency." This subject I have often heard brought up by men handling engines, and it is remarkable how many men will agree as to certain engines being "good" and certain others N. G. There may be, as you say, some defects that would lead to such verdicts, but allowing that an engine that handles easy cuts off square, with neatly fitting rod brasses, boxes that do not knock or pound, and above all an easy rider, generally earns a good reputation, still the fact remains, that no matter how well kept up some engines are they do not "appear" to haul trains as easily as others, built apparently precisely the same and under the same conditions. I could name a dozen engines here that the boys, if they had their choice, would never peek out to make a day on, though they may be good steamers. One thing noticeable about some engines is, that an injector, when working half capacity, will feel the boiler when hauling an average train, and on other engines it is partly choked or tank valve out of order. These injectors, like the others, were made from the same templates, possibly by the same person, yet even when speed is taken into consideration, apparently there is great difference in

action. While on this subject I will say a few words about an editorial opinion published some time ago in LOCOMOTIVE ENGINEERING, referring to an engine hauling a given load, regardless of distribution of weight. The opinion expressed was that an engine would haul a train composed of equal engines and loads just as easily with empty next to engine as next to caboose. I am not prepared to say, mind you, that an engine will haul a train easier with loads next to engine, but it certainly does "appear" to me to do so, especially up grade and around curves, and in conversation with many railroad men, I am able to be certain of it. However, it is taken for granted that the resources of LOCOMOTIVE ENGINEERING would enable it to prove, by means of the dynamometer, the pulling powers of engines under any and all circumstances, and, of course, to be able to back up its assertions by actual figures, if necessary. In my own mind I had about reached the conclusion that chain-ganging engines, and the like, dissipated the belief, etc., instead of dissuading it, though common sense would seem to teach a person that with the same forces we should be able to produce like results. As stated in your article, if all things were considered, and the actions of different engines analyzed, possibly some reason would be found for their behavior, and in the case of injectors, some scale formation or sediment might reduce standard ports or passages by which the supply could be changed in volume.

Assertions like the above made in the editorial columns sometimes stir up a little adverse criticism among the boys when it is first sprung on them, but it sets 'em all thinking, anyhow, and incites them to further investigation.

Pittsburgh, Pa. JIMMY BOST.

[There is a reason for everything, and when two locomotives "actually alike" are found in practice to do different work, careful investigation will always prove that they are quite different in some important particular. We know of a case where one engineer claimed he could not pull a full train without working his injector, and the man on the opposite run ran his injector half shut off the engines were sisters, and discussion was idle. Careful measurements were made in the tank, when it was found that both injectors were throwing the same amount of water. A long train of cars, the head half empty, will pull harder on curves and uneven track than a full train, and the same friction, etc., but on a straight, dead level there will be no difference. LOCOMOTIVE ENGINEERING is a good long way from being infallible, and when it gets men to think about and discuss practical questions it has filled part of its mission.]

Is This an Improvement?

Editors:

Inclosed please find blue print of arrangement of pump governor Charles Brown, a young machinist, and myself have rigged up on the engine I am running on the N. & S. Ry. As you will notice, it is the Westinghouse pattern, using a new double center piece and two complete tops. One controls train pipe, the other main reservoir pressure. As you well know, should the steam valve to pump be well open, when handle is pulled around and main reservoir made, the pump will stop to accumulate considerable pressure in main tank, depending on length of time handle is left on lap, now, when release is made by throwing high drum pressure into comparatively low train pipe pressure, distortion of diaphragm in and trouble with pump governor results.

This happens on long grades quite often, and there have been cases of the engineman going to dinner and leaving handle on lap without easing off steam to pump. Some men claim it to be an advantage to be able to accumulate a high drum pres-

Taking into consideration the somewhat greater average train resistance of the Empire express, it will be seen that both designers agree as to the amount of tractive force that their respective engines should have. But there is a very great discrepancy in the amounts of the tractive force—the Great Western engine, with 20,000 pounds on its driving-wheels, having less than half that of the "999," which has 84,000 pounds. The older authorities give the adhesion as one-fifth of the weight on the drivers, under ordinary favorable conditions. If this rule is correct, the English engine with adhesion of 8,000 pounds could slip during its tractive effort of 8,000 pounds, unless sand were used, but sanding is not found necessary except in a greasy rail. Other authorities maintain that a greater proportion of the weight on the driving-wheels than one-fifth can be depended on for adhesion, and ascertain that the performance of this and many other English "single" engines, as actually obtained in dynamometer experiments, prove the soundness of their views. The adhesion of the "999," unlike that of the Great Western engine, is considerably in excess of its tractive force, as under the old rule, one-fifth of 24,000 being 4,800 pounds. It appears, therefore, that this celebrated engine is either extremely heavy or is under-cylindered. It weighs 12,000 pounds, and it is not sufficient why, with abundant heating surface, the cylinders were not 21 x 24 inches, which would have given it a tractive force slightly in excess of its adhesion.

$$21 \times 24 \times 142 = 71,256 \text{ lbs.}$$

The English engine is lighter than the American by 24,000 pounds. As it is also as powerful, this great difference is noticeable. It may be attributed to three causes:—slab frames in place of bars, single pair of leading wheels instead of two heavy four-wheel truck, and the much lighter casting required for inside cylinders. I estimate that there is here a saving of 18,000 pounds, and that the remaining 6,000 pounds is accounted for by the smaller boiler. Looking at these figures, it is worth inquiring if we are not too much wedded to outside cylinders, bar frames and trucks, and if inside connection slab frames and the absence of a truck would not be an improvement on the present practice of roads where the conditions are practically the same as those obtaining in England. For many years English designers have had the benefit of the inner road-beds, and the typical English express engine is a survival of the fittest. Half a century ago, when rails were light and halflasting only nominal, bar frames and outside cylinders were very common in the old country, but with improved tracks bar frames disappeared naturally, and outside cylinders at the present day are quite the exception. Here the New York Central and some other systems that might be named wish it, the trucks have been improved to such an extent that they are now ahead of anything in England, yet the finest engines are, with few exceptions, simply developments of types that were originally designed to work under conditions which have now passed away forever. Steel rails of 50 pounds to the yard and upwards, and rock ballasting are comparatively things of yesterday with us, but they have been common in England any time during the last thirty years, therefore the improved, box-end-rod English locomotive, the only one of long experience, should be—and is, I believe—better adapted for such tracks than the types we are familiar with.

This criticism will be unwelcome to those who have the mistaken notion that the value of engineering facts is, in some way, dependent upon patent or local prejudice. Nor do I wish to suggest that the English design is superior to our own, except in the arrangement of cylinders and in the form of the frames. Their low

running-boards, for instance, are altogether bad, and their cabs, and the foot-plate arrangements generally, are inferior to our own. The groundless fear of raising the center of gravity too high is the cause of their fireboxes always being sunk between the driving axles, and, as a consequence, coupling rods, even with boxes of moderate dimensions, are extravagantly long. Thus, the new Northeastern express engines, whose boxes are only 6 feet inside, have rods 111 inches long. Whilst the use of trucks is not increasing in England, probably more than half the passenger engines have them. Webb, of the Northwestern, prefers a leading radial axle. These axles are lighter, give equal flexibility, and permit larger centers being used if carried well ahead of the cylinders, as in the Baldwin P. & R. compounds and the same firm's "special high speed" type. A single pair of axles is not too heavily loaded at 20,000 pounds, the weight on trucks seldom exceeds this, and in such cases there seems no good reason for employing four wheels with an independent frame where two would do the work. Inside cylinders gives these advantages over outside—first, the great saving in weight, secondly, losses from condensation are much reduced, as cylinders and steam chests are included in the smokebox, which is brought down below the barrel for this purpose, thirdly, inside connected engines are stender, laterally, and are consequently easier on the track. Where accessibility is not of the first importance there is everything to be said in their favor. Slab frames are cheaper than bars, they are lighter, the material is better distributed, and by their use the width of the firebox can be increased from 4 to 6 inches. Single driving-wheels are still largely used in England, but they are not seen in any other part of Europe. It is claimed that these engines run easier and are lighter on repairs than when coupled. Most engines of this class are fitted with Gresham's steam sand-saddle, which is kept in use constantly, the G. W. "single," referred to in this paper, works without this artificial increase of adhesion.

Intercepting Valve of the Richmond Two-Cylinder Compound.

The two-cylinder compounds recently built at the Richmond Locomotive Works, and in service on the C. & O. and C. & C.

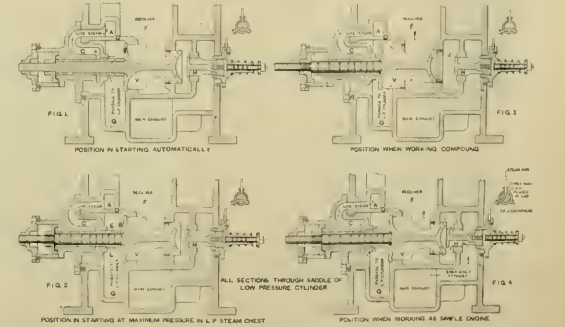

& St. L., have an intercepting valve designed by Mr. C. J. Mellin, the chief draftsman, illustrations of which are here presented. The drawings show sections through the low-pressure cylinder saddle, with the valves in their various relative positions.

What You Want to Know.

Don't ask questions that simply require a little figuring to determine; make each question separate. No notice taken of anonymous questions.

(117) S. B., Buchanan, Iowa, asks Who should a person apply to for position as fireman on a coal? A.—The master mechanic or roundhouse foreman.

(118) R. W. M., Charlestown, Mass., asks Does the valve travel any faster when an engine is hooked up in six inches than it does when traveling its full throw—engine running at the same speed? A.—No. As the valve makes one complete movement back and forth to every revolution of the wheel, it stands to reason that it must travel fastest when it moves the longer distance. Moving six inches and back in a second, say, it must travel faster than it would if it traveled two inches and back in the same time.

(119) J. S. G., Frankfort, N. Y., writes In the shop in which I am employed the dead centers are caught on two points on the side rail. The first point is about 25 inches back of the crank-pin and the other point is 24 inches for the length of the stroke) back of the first point. Now,

The high-pressure cylinder exhausts into the receiver, which is placed inside the smokebox, and opens into the chamber E. The intercepting valve, as shown at I in the several views, has a piston on its forward end, which acts in its cylinder as an air dash-pot, to prevent any slamming of the valve. Around the stem of this valve is a sleeve L, which has an axial movement on the stem, and acts as an admission and reducing valve to the low-pressure cylinder when starting and when working simple. Valve H is a plain winged valve with a piston on its rear end, and is called the emergency valve, as by its use the engineer can, at will, operate as a simple engine. When starting, steam from the boiler goes to the high-pressure cylinder in the ordinary way, and also to the port C, through a 2-inch steam-pipe connected to the dry pipe. There is then no pressure in the receiver B, and the pressure on the shoulder A of the sleeve L, Fig. 2, moves the sleeve and valve I to the right, closing the receiver, and letting steam pass the shoulder E into the low-pressure valve chest G.

to the left, carrying the sleeve with it, when the steam being permanently cut off at C, then a straight connection between the two cylinders. In starting on grades, or when exerting maximum power, the engineer can move the three-way cock in the cab, letting boiler steam behind the piston on the emergency valve H, and holding it open against its spring. This expands the small cavity I, in which the pressure is equalized with the receiver through holes in the valve I, and then the valves F and L move instantly to the right, assisted by steam pressure on the shoulder L. The high-pressure cylinder has now a separate exhaust, and the low-pressure cylinder gets its steam direct from the boiler through the port A and reducing valve L. Except when working simple, the valves F and L move instantly. The lubricator to the low-pressure cylinder enters port A and this insures constant lubrication to the intercepting and reducing valves. Owing to the small area of port C, and the contracted exhaust through H, the engine develops less power as a simple engine than as a compound, at a speed of over, say, five miles an hour, and thus the

the motion of a crank-pin through the air when running is somewhat like a wave, or a number of connected semicircles, and I claim that owing to the peculiar motion of the side rods that the dead centers cannot so be accurately obtained what you mean. A.—We do not understand what you mean.

(120) G. A., Princeton, Ill., writes

I notice in railroad papers that experience in increasing the travel of locomotive valves and adding lap makes a smart engine, but wasteful of fuel—that is for a 6 or 6½-inch valve travel, while a 4 or 4½-inch travels to make an engine both economical of fuel. I notice this opinion was given by the S. M. P. of the Old Colony road and others. If this is so, there is a reason for it. What is the reason? Please explain why should merely increasing the travel of valve tend to burn more coal. A.—The only explanation we have heard of the above is that long travel gives quick opening and closing of a valve, creating a jerking or uneven draft in the fire that was detrimental.

When working as a compound, at a speed of over, say, five miles an hour, and thus the

runner is compelled to work compound. Should either side break down, the emergency valves can be opened and the engine brought in on one side like an ordinary engine. We are indebted to our neighbor, the American Engineer and Railway Journal, for the use of this engraving.

THE POOLEY COUPLER.

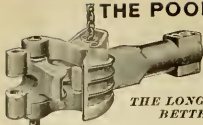

**POSITIVELY
AUTOMATIC.**

Made from the Best Material.

**THE LONGER IN SERVICE THE
BETTER IT OPERATES.**

MANUFACTURED BY **PRATT & LETCHWORTH, Buffalo, N. Y.**

New York. Boston. Chicago.

HOWE, BROWN & CO., (Limited) PITTSBURGH, PA.

HOWE SPECIAL TOOL CAST STEEL for
Taps, Dies, Reamers, Cutters, Punches,
Chisels, Drills, Shear Blades, Lathe Tools,
etc., etc. Crucible Spring Cast Steel, Crucible
and Open Hearth Firebox and Sheet Cast Steel, Forgings, etc.

STEEL.

The New "NATHAN"

(SEE ILLUSTRATION) AND

**MONITOR INJECTORS
FOR
LOCOMOTIVES.**

"NATHAN" SIGHT-FEED LUBRICATORS,
For Locomotive Cylinders and Air Brakes
STEAM FIRE EXTINGUISHERS.
For switch and Tard Engines.
BOYLE & WEAVER'S
Road and Guide Oil Cups, etc.

Send for DESCRIPTIVE CATALOGUE.

**NATHAN MFG. CO., 92 & 94 Liberty St.,
NEW YORK.**

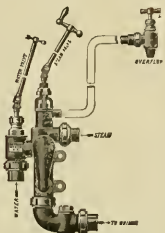

COLUMBIA BICYCLES

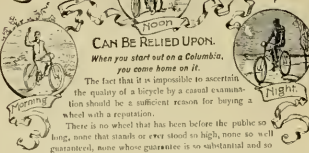

CAN BE RELIED UPON.

When you start out on a Columbia,
you come home on it.

The fact that it is impossible to ascertain
the quality of a bicycle by a casual examina-
tion should be a sufficient reason for buying a
wheel with a reputation.

There is no wheel that has been before the public so
long, none that stands or ever stood so high, none so well
guaranteed, none whose guarantee is so substantial and so
liberally interpreted, none so safe to buy as a Columbia.
With Columbias listed at \$105, few riders will be so unwise as to invest in lower grade bicycles.

POPE MFG. CO.,
Boston, New York, Chicago, Hartford.

C. E. ROOD. H. M. BROWN.

**ROOD & BROWN,
CAR WHEEL WORKS,
BUFFALO, N. Y.**

Railroad, Car, Engine, Tender and Truck Wheels, Made from Best Charcoal Iron.
Office and Works: HOWARD and THOMAS STS.

C. E. ROOD. JOHN GREFFS.
EAST BUFFALO IRON WORKS,
FARMER, TREETS & ROOD, PROPRIETORS.

GREY IRON CASTINGS
of every description. Special Attention Given to Car and Locomotive Work.
Works: N. Y. C. & H. R. R., Broadway Station, Belt Line. Office: 60 Perry St., Buffalo, N. Y.

**C. E. ROOD,
MANUFACTURER OF
MALLEABLE IRON,
QUALITY GUARANTEED.**

RAILROAD WORK A SPECIALTY.
Office and Works: LANCASTER, NEW YORK.

THE BOYER

Railway Speed Recorder



The only Recorder made that gives a
chart of the run that can be read at
sight, and has a dial indicator carried
in the car so Engineer can see at a
glance, any time, what speed he is running.

Boyer Railway Speed Recorder Co.
244 DICKSON ST.,
St. Louis, Mo., U.S.A.

The Hickory Bicycle

CONTAINS EVERYTHING DESIRABLE

The 1894 HICKORY has many
improvements, and embodies
special features not found in
any other machine.

Simple machines can be found
at our agencies in all the principal
cities and towns, and it will
pay you to examine them.

If we have no agent in your
place, write for terms and cat-
alogue.

Hickory Wheel Co.,

So, Framingham, Mass.

**KEEP YOUR
PAPERS CLEAN.**

Binders that will hold a full year's
numbers for sale.

PRICE, \$1.00, POSTPAID.
LOCOMOTIVE ENGINEERING,
256 Broadway, New York.

**GALENA OIL WORKS,
(LIMITED).**

Galena Engine, Coach and Car Oils,
The Standard Lubricating Oils
of America.

SAFETY TESTED AND PROVED AS THE RESULT OF
the use of Galena Oils. GOLD TEST, as so called, is
EXAMINED THROUGHOUT THE WORLD, and the results
while they are adaptable to the boiler engine,
in the case of Galena Oils there is no other reason
from hot blow, except when those are caused by me-
chanical defects.
The adoption of Galena Oils as standard railway oil
is due to a large majority of the leading railways of
this country is an evidence of their superiority, while
the fact that the same oils are used on the boats that
travel between New York and New York is another
evidence of their superiority. It is an evidence of
Galena Oils are used on the boats that travel between
New York and New York is another evidence of their
superiority. It is an evidence of their superiority.
The fact that the same oils are used on the boats that
travel between New York and New York is another
evidence of their superiority. It is an evidence of their
superiority. It is an evidence of their superiority.

GALENA OIL WORKS, Limited,
CHICAGO BRANCH, Franklin, Pa.
PHOENIX Building, 10 Jackson St.



**Diseases
of the
Air Brake System**

Causes - Symptoms - Cure

by
PAUL SYNNESTVEDT.
Profusely Illustrated.

ONLY ONE DOLLAR
Send Orders to
W. F. HALL PRINTING COMPLY.
21 to 25 1/2 month Place,
CHICAGO.

TAYLOR BEST YORKSHIRE STAYBOLT IRON

Also, Flange Heads, Crank Pins and Forgings of all
Descriptions, used by Leading Railroads.

R. MUSHET'S SPECIAL AND TITANIC STEELS

BEST REPRESENTATIVES IN THE UNITED STATES.

B. M. JONES & CO.,

BOSTON, 11 and 13 Oliver Street. NEW YORK, 143 Liberty Street.

**SIGNAL OIL WORKS,
LIMITED,
FRANKLIN, PA.**

MANUFACTURERS OF
SIBLEY'S Perfection VALVE OIL,
The only Perfect Locomotive Valve Lubricant.
J. C. SIBLEY, Pres't.

**TRACK SANDING
APPARATUS
FOR LOCOMOTIVES**

HENRY L. LEACH,
(Inventor of Pittsburgh)
BOSTON, MASS.
Room 45, Mason Building, 10 Kilby Street.

D. O. SETTLEWIRE, President.

GEO. W. EVANS, Vice-President.

W. C. ARTHURS, Secy and Treas.

FRANK BENTLER, Supt.

Mt. Vernon Car

MANUFACTURERS OF
FREIGHT CARS OF EVERY DESCRIPTION, CA-
BOOSE AND REFRIGERATOR CARS,
MT. VERNON,



Manufacturing Co.

OAK WHEELS, OAK CASTINGS, AND GENERAL
FOUNDRY WORK.

Capacity, 15 Cars and 300 Car Wheels,
ILLINOIS.



MILLER'S ASBESTONE CAR ROOF.

THE COMING ROOF!

HEAVY, DURABLE AND STRONG.
WILL WEAR LONGER THAN ANY METAL ONE.

Costs from \$10 to \$15 Less per Car.
CAN BE PUT ON IN ONE-HALF THE TIME.
WILL WEAR THE LIFE OF THE CAR.

HEAR WHAT THEY SAY ABOUT IT!
GUT WEST: M. K. & T. B. Down East: Boston & Albany R.R.

1302 HAYEMEYER BUILDING, 26 Cortlandt Street, NEW YORK.

THE ALLISON MFG. CO.,

MANUFACTURERS OF

FREIGHT CARS AND
LOCOMOTIVE BOILER TUBES.

WROUGHT IRON PIPE OF SUPERIOR QUALITY.

PHILADELPHIA, PA.

DRAKE & WEIRS, Cleveland, Ohio.

ASPHALT CAR ROOFING

The Cheapest, Best and Most Durable Car Roof Known. In use by Seventy
Railroads. Twelve years successful use without a single failure. A new roof furnished free for
every car that falls in ten years.



THE Fire-Proof Baker Car Heater

MADE OF FLEXIBLE STEEL
ONE-QUARTER INCH THICK.

Firmly Welded into One Compact, Jointless, Seamless Whole.

FIRE WITHIN A SAFE OF SAME MATERIAL
AS THE EXPRESS CAR SAFE.

NEARLY 1000 FIRE-PROOFS IN USE.
ALL OTHER STYLES OF "BAKER HEATERS."

WILLIAM C. BAKER,

Sole Proprietor and Manufacturer,

143 LIBERTY STREET,

NEW YORK.

Carbon Steel Company, Pittsburgh, Pa.

MANUFACTURERS OF

OPEN HEARTH **STEEL** PLATES FOR ALL PURPOSES.

SPECIALLY SUITED FOR LOCOMOTIVE FIREBOXES AND BOILERS.
PARTICULARS SENT ON APPLICATION.

Railroad Agents:

J. B. BRADY, 909 Havemeyer Building, New York.

W. M. WILSON, Western Union Building, Chicago.

WROUGHT IRON WHEEL CENTRES. VAUGHLIN'S PATENT.



THE Standard Steel Works
PHILADELPHIA.

STEEL TIRES

Manufactured by an Improved Process
Insuring Safety.

Wrought Iron Centres,
Steel Tired Wheels.

REPRESENTATIVES:

CHICAGO, 1013 MONAGNOCK BLDG.
PITZ-HIGH & SPENCER.

ST. LOUIS, 516 NORTH THIRD ST.
ANDREW WARREN.



THE WASHBURN
Car-Wheel Company,
HARTFORD, CONN.,
MANUFACTURERS OF

CRUCIBLE STEEL-TIRED WHEELS

For Parlor and Sleeping Cars,
Passenger Coaches, Locomo-
tive and Tender Tracks.



THE CAMERON STEAM PUMP.

COMPLETE WITH BOILER.

THE A. S. CAMERON
STEAM PUMP WORKS,
Foot of E. Twenty-Third St.,
NEW YORK.

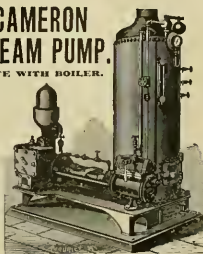

Send for illustrated Catalogue.

MILLS ESTABLISHED IN 1844.

Ewald Iron Company,

OWNERS AND OPERATORS

Tennessee Rolling Works, Tennessee Rolling Mills,
CUMBERLAND RIVER, LOUISVILLE, KY.

Tennessee Charcoal Bloom and Laurel Stay Bolt,
"E. I. C." and "BOONE" IRON.

Also, Tank, Flange, Fire Box and Boiler Steel and Iron.

PRINCIPAL OFFICE AND WAREHOUSE:

939, 941, and 923, 925, 927 N. Second Street, St. Louis.



THE CLEVELAND VARNISH CO., Mfrs. RAILWAY VARNISHES. CLEVELAND, O.

RAMAPO WHEEL AND FOUNDRY CO.

MANUFACTURERS OF

BOLTLESS STEEL-TIRED WHEELS

FOR PASSENGER AND LOCOMOTIVE SERVICE.

Tires with Annular Web and Hook,
Best Charcoal Iron Double-Plate or Spoke Centers,
Wedge-Shaped Retaining Ring.



SECTION OF BOLTLESS FASTENING

Continuous
Circumferential
Fastening.



SIMPLE, +
SAFE, +
ECONOMICAL.

CHILLED IRON WHEELS

OF SUPERIOR QUALITY,
Handling Heavy, Passenger and Freight Cars,
Locomotives, Tenders, Flatcars
and Box Cars.

CYLINDER PACKING RINGS.

CONGDON BRAKE WHEELS

FOR CHILLED IRON WHEELS,
outwear from 4 to 6 ordinary
Shoes and enhance
mileage.

Office and Works: RAMAPO, N. Y.

RAMAPO IRON WORKS, Hillburn, N. Y.,

MANUFACTURE

Brake Shoes for Steel Tired Wheels.

ROSS, for Steel Tired Car and Tender Wheels,
ROSS-MEEHAN, for Locomotive Drivers,
SHEPPARD, for Blind or Bald Tired Drivers.

NARROW GAUGE CARS, SWITCHES, AUTOMATIC STANDS.

YOKED, BOLTED and SPRING RAIL FROGS,
CROSSINGS, TRACK EQUIPMENT,

RAILROAD AND MACHINERY. **CASTINGS,** HEAVY AND LIGHT.

THE HALL SIGNAL CO.

Leads the World in the manufacture and installation of

Automatic Block Signals

Operated by either Track or Wire Circuits.

The ONLY Automatic Signal Systems in which the
signal can be operated on the "Normal Danger"
principle. Believed by many to be the best and safest
plan.

HIGHWAY CROSSING SIGNALS,
STREET RAILWAY CROSSING SIGNALS, ETC.

OFFICES:

80 Broadway, New York.

927 The Rookery, Chicago.

115 The Ames Building, Boston.

Equitable Building, Baltimore.

PERFECT



PUMP PACKING

AN ABSORBENT OIL CUSHION—INSURES PERFECT
LUBRICATION.

WEDGE-SHAPED WEARING PIECES THAT MOVE ON
EACH OTHER—INSURE A TIGHT JOINT, WITHOUT
UNDUE PRESSURE FROM GLAND.

DOES NOT GET HARD OR BAKED, NONE WASTED—
YOU KEEP PUTTING IN RINGS, NEVER TAKE
ANY OUT.

THIS PACKING IS GUARANTEED TO KEEP TIGHT
WITH STEAM, WATER, AIR OR AMMONIA

PERFECT FOR AIR PUMPS.

A TRIAL SOLICITED

All kinds
of Packing
—the P.P.P.
is best.

C. A. DANIEL,
313 Market St,
PHILADELPHIA, PA.

HOWARD IRON WORKS.

BUFFALO, N. Y.

MANUFACTURERS OF

BOLT CUTTERS

-AND-

NUT TAPPERS.

Send For Price Lists.



STEEL

ST. LOUIS COUPLER.

Stands M. C. B.

Tells and complies with U. S. law, re-
quiring use of Automatic Car Couplers on and after January 1st, 1900.
Thousand of Cars already equipped. Capacity of Works, 200 Couplers per day.

ST. LOUIS CAR COUPLER CO., St. Louis, U. S. A.

THE ROTARY.

For full
Particulars,
Address

The Leslie Bros. Mfg. Co.,
Paterson, N. J.

ALBANY, N. Y.

936 Broadway,

New York City,

115 BROADWAY.

STEAM COUPLERS

AND

FIRE PROOF

HEATERS.

CONSOLIDATED

McElroy, Sewall, Westinghouse and other Patents.

CATALOGUES UPON APPLICATION.

Special Appliances and Extra Strong Fittings of Every Kind.

AUTOMATIC CONTROL OF HEAT.

CAR-HEATING CO.

CHICAGO

200 Phenix Bldg.

Canada,

COATCOOK, P. Q.

COMMINGLER,

DRUM,

AND

DIRECT STEAM

SYSTEMS.



Hend Roll Seat.

THEIR SUPERIORITY IS PROVEN BY THEIR POPULARITY.

FINEST SEATS. Coach, Parlor Car, Sleeping Car, Street Car, Rattan Elevated

IN USE ON ALL THE PRINCIPAL RAILROADS IN THE UNITED STATES



Spring Sige Seat.

THE HALE & KILBURN MFG CO.,

Simplicity, Durability, Elegance, Comfort,

Combined

IT IS SAFE TO SPECIFY THE

H. & K. SEATS

PHILADELPHIA, NEW YORK, CHICAGO.

A. W. SOFER, Pres.

ROBT. ANDREWS, Vice-Pres.

C. H. HOWARD, Sec.

W. R. THOMAS, Treas.

R. M. DIXON, Engineer

THE SAFETY CAR HEATING AND LIGHTING CO.,

160 Broadway, New York.

HEATING SYSTEMS.—By hot water circulation and direct steam with regulating devices. Reliable and uniform heat. Economical and rapid circulation. Gibbs automatic coupler of Westinghouse type, absolutely steam-tight.

LIGHTING SYSTEM.—The celebrated Pintsch compressed oil gas method. In use on over 40,000 cars in Europe and America. Adopted by the U. S. Lighthouse Board for lighting Buoys. The best, most economical and only safe light for Railroad purposes. In brilliancy and cleanliness unsurpassed.

SURE TO GIVE

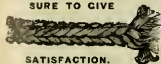

SATISFACTION.

DUVAL METALLIC PACKING

Send for Catalogues, Prices and detailed information to

THORNTON N. MOTLEY & CO.,

SOLE AGENTS,

43 John Street, NEW YORK.

PEERLESS

ENGINE AND TENDER HOSE CONNECTION.

Air Brake Hose Guaranteed for 3 years.

Steam Hose for Car Heating. Wonderful Steam Realizing Qualities.

E. L. PERRY, Pres. W. G. WINANS, Treas.



C. H. DALE, General Manager.

THIS HOSE is known as our ANACONDA brand. It is corrugated, made of three and four plies of duck, with a wire inserted to prevent it from collapsing or kinking, thereby making it impossible to break or shut-off injectors when rounding a curve or striking a low joint. It is made any shape or length upon order. The outside is covered with a canvas jacket or covering to prevent oil, grease, etc., from destroying the hose. This hose is thought by many of the master mechanics of our large railroads to be the ideal hose for engines and tender connections.

MANUFACTURED EXCLUSIVELY BY

THE PEERLESS RUBBER MFG. CO.,

No. 16 WARREN STREET, NEW YORK.

THE MURPHY STEEL CAR ROOF.

It is a surface wall or screw holes. It has no joints where chisels, rips or the snow can get through. It allows for contraction and expansion, and has ample elasticity to provide for sagging, twisting, buckling and warping of the car body. It is as solid as the car frame itself. It has no soldered joints. It can be repaired readily, and without taking off more of the roof than is damaged. It is much cheaper than any other metallic roof known to us, and is cheaper than the double board roof, made of good lumber. It is unlike any other metallic roof for the reason that everything is furnished to make it complete, so that the parties hiring it have no expense other than to apply it.

This ROOF can be applied on OLD LEAKY BOARD-ROOF CARS without making any change in the board roof, thereby saving the expense of replacing the old boards with new, and thus utilizing material that most otherwise be thrown away.

Manufactured by the P. H. MURPHY MFG. CO., East St. Louis, Ill.

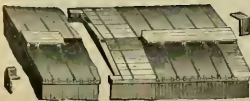

REQUIRES NO ATTENTION.

IN USE ON THREE HUNDRED AND FIFTY RAILROADS.

UNITED STATES METALLIC PACKING CO.

For Locomotives, Stationary and Marine Engines.

The United States Metallic Packings

HAVE STOOD THE TEST OF YEARS AND ARE ACKNOWLEDGED TO BE SUPERIOR TO ALL.

Renewal of Packing Rings made without disconnecting, by cutting them in halves and breaking joints.

HIGHEST AWARDS COLUMBIAN AND PARIS EXPOSITIONS

General Office, Bullitt Building; Works, 427 N. 13th St., Philadelphia, Pa.

Chicago, Rotunda, Grand Pacific Hotel.
San Francisco, 130 Main Street.

St. Louis, 32 LaCade Building.
Montreal, Canada, 751 King Street.

Swab and Oil Cups Furnished with every Packing.

SEND FOR CATALOGUE AND SPECIFICATIONS.

RODGER BALLAST CARS.

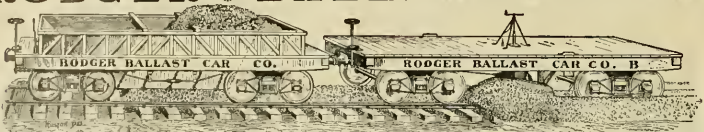

These cars are 34 feet long, and are built either 50,000 or 60,000 lb. capacity, M. C. B. Standard. They carry from 18 to 20 cubic yards of gravel or broken stone in using them as haulers in the open, and more is wanted, as the precise amount of ballast needed can always be discharged. A train of 25 cars, carrying 500 yards of ballast can be unloaded and the ballast distributed, leaving the track perfectly cleared and straight, as shown in the view, in from 15 to 18 minutes. This is all done by the regular "trab" surface" in unloading and two brakemen, no extra help being required. The track is perfectly cleaned by the spreader, so that the train can immediately pass over it at any rated speed, without meeting any obstruction. No spurs are needed; no wire cables are used. There is no shoveling of ballast from between the cars, and no cleaning the tracks with shovels. The ballast is left between the cars and on their ends, directly in position for tampering, so the track is cleaned, without being shovelled in from the ditch. The average saving per mile, in the amount of ballast needed to make a "plate" of 19 or 24 inches, will be about 400 yards and often far exceeds this. The total saving per mile in material, labor, time, use of cars, saving in transportation, etc., is found in amount to be from \$20 to \$40, and in broken stone it flows amount to \$60.

These cars are in use on the Great Northern Ry., the Illinois Central, the Gulf, Colorado & Santa Fe, the Chicago & Eastern Illinois, the Penn. Lines West, and other roads.

Detailed information will be furnished by circular by addressing the

RODGER BALLAST CAR COMPANY, No. 1215 Monadnock Building, CHICAGO, ILL.

MATCHLESS VALVE AND CYLINDER OIL.

Warranted not to corrode the iron or destroy packing, and to make more mileage than tallow or lard. Sold only to Railroad Companies direct or through our authorized agents. Matchless Cylinder Oil cannot be Bought of Dealers. In use on 60 Railways.

OILS FOR RAILROAD USE A SPECIALTY.

ECLIPSE LUBRICATING OIL COMPANY, Limited,

MANUFACTURERS OF EVERY PRODUCT OF PETROLEUM.

Main Office: FRANKLIN, Pa.

Reburrinet: FRANKLIN, Pa.

OLEAN, N. Y.

ERIE, Pa.

OIL CITY, Pa.



OPEN HEARTH STEEL CAMBRIA COFFIN TOUGHENED

CAMBRIA IRON COMPANY,
OFFICE 218 SOUTH 4TH ST. PHILADELPHIA, PA.

WORKS AT JOHNSTOWN, PA.

SOFT STEEL, ARCH BARS. COOLBAUGH & POMEROY, SPECIAL R. R. SALES AGENTS, 255 BROADWAY, NEW YORK. BENT & DRILLED

TOUGHENED BY COFFIN PROCESS, PATENTED

OPEN HEARTH COFFIN PROCESS TOUGHENED

CAMBRIA STEEL

Driving, Truck, Passenger and Freight
Axles, Piston and Side Rods, Crank Pins.

NEW YORK OFFICE FOR RAILS AND FASTENINGS—33 WALL STREET.

SCHOEN MFG. CO.

PRESSED STEEL MATERIAL FOR CARS.

PITTSBURGH, PA.

Locomotive and Car Axles,
Coupling
Links and Pins.

M. C. B. Passenger Coupler
Used in Place of Miller Hook
WITHOUT CHANGE IN PLATFORM.

M. C. B. STANDARD
Automatic Freight Car Coupler.

New York Office, . . . 46 Broadway,
Chicago Office, . . . 941 Rookery,
St. Louis Office, 319 Commercial Build'g.

GOULD
Coupler Co.

WORKS: (DEPEW, N. Y.
BUFFALO, N. Y.)

**Gould Continuous
Platform and Buffer.**
GOULD VESTIBULE.

Skilled mechanics prefer them Live dealers sell them

STARRETT'S

Best in work-manship
Finest in finish
LATEST in improve-ments



For all workers in metal or wood Every tool warranted satisfactory

FINE TOOLS

Send for Catalogue L. S. Starrett, Athol, Mass.

THE SMILLIE COUPLER is the Strongest and Simplest M. C. B. Coupler.
Only 4 Pieces.



Tensile Strength (Fairbank's Test) 139,640. Drop Test, 700 lbs. hammer dropped 18 ft. 22 times failed to break the knuckle.

ALL LOCKING PARTS ARE THE BEST OF STEEL.

NEW YORK OFFICE, 39 CORTLAND ST.
Office and Works, 91 Clay St., Newark, N. J.



THE TROJAN CAR COUPLER Co., Troy, N. Y.

The knuckle may be thrown open for coupling by the hand rod at the side of the car rendering it unnecessary for the trainmen to go between the cars to open the knuckle.

M. C. B. TYPE. THE STRONGEST AND THE ONLY SAFETY COUPLER. New York Office: 49 WALL ST.

THE JANNEY FREIGHT CAR COUPLER



THE McONWAY & TORLEY COMPANY

W. M. CONWAY - PRESIDENT.

48th ST. & A. V. RY. - PITTSBURGH, PA.

THE WESTINGHOUSE AIR-BRAKE CO.

Is now prepared to fill orders, at an hour's
notice, for One or One Thousand Sets of

AIR-BRAKES FOR FREIGHT CARS,

having, at their New Works, an annual capacity
for turning out Air-Brakes for 250,000 Freight
Cars, 6,000 Passenger Cars, 10,000 Locomo-
tives; besides repairs for the 350,000 Freight
and Passenger Cars, and 26,000 Locomotives
already equipped by

THE WESTINGHOUSE AIR-BRAKE CO.

A "Business" Map, showing location of Paid Subscriptions of LOCOMOTIVE ENGINEERING.

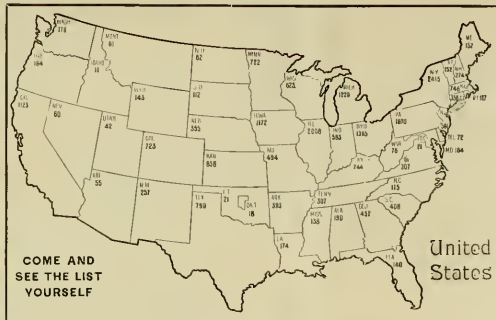

COME AND SEE THE LIST YOURSELF

Foreign Paid Subscriptions.

ARGENTINE REPUBLIC, -	2
AUSTRALIA, - - - - -	78
AUSTRIA, - - - - -	3
BRAZIL, - - - - -	2
CANADA, - - - - -	748
CENTRAL AMERICA, -	6
CUBA, - - - - -	1
CHILI, - - - - -	2
ECYPT, - - - - -	2
ENGLAND, - - - - -	26
FRANCE, - - - - -	1
HAWAIIAN ISLANDS, -	1
HOLLAND, - - - - -	12
HUNGARY, - - - - -	2
INDIA, - - - - -	11
IRELAND, - - - - -	4
ITALY, - - - - -	2
JAMAICA, - - - - -	3
JAPAN, - - - - -	1
MEXICO, - - - - -	160
NEW FOUNDLAND, - -	4
NEW ZEALAND, - - -	25
NORWAY, - - - - -	1
RUSSIA, - - - - -	4
SCOTLAND, - - - -	14
SPAIN, - - - - -	2
SWEDEN, - - - - -	1
SWITZERLAND, - - -	2

Total, = 1,128

Total in the United States, - - - - -	23,093
Grand Total, Paid Subscribers, - - - - -	24,210

PROSPECTIVE ADVERTISERS

OFTEN ASK:

Where does your Paper go to, anyway ?

THIS happens so often, when we expect a signed contract instead, that we have, at times, been tempted to copy the reply of an esteemed contemporary in the wild and woolly West, "It goes to Europe, Asia and Africa, and it's all we can do to keep it from going to h—l." But we have thought better of it, and on May 22, 1894, counted our mailing list, and we give here with a graphic idea of where LOCOMOTIVE ENGINEERING goes to in the United States.

19,093 copies are sent direct by mail from this office, 4,000 are taken by the American News Co., and this amount was apportioned to the States in percentages of the mail list, making a total of 23,093 paid subscribers in the United States. Beside this, the appended list shows that 1,128 copies go to foreign countries. Making a grand total of 24,210 papers sold every month. The 781 over are used for binding at the end of the year, and with the returns of the News Co., to supply special calls during the year. There are no back numbers beyond the current year for sale! Every copy printed goes out, and hustles.

ADVERTISING RATES are from seven to ten times as cheap as other railroad papers, on a circulation basis. An inch ad. at yearly rates only costing to cents per thousand copies issued!

(LET US QUOTE YOU RATES)

Of course such a list is subject to constant change. Within the past few months the list has increased heavily in California, Ohio, Illinois and New York, while Australia and New Zealand have gone down: one man in Melbourne had a list of 240, and now has only 10 hard times hit Australia first, "an' she hasn't done anything since."

But LOCOMOTIVE ENGINEERING hustles while she waits for the clouds to roll by, and grows in favor every-day.

It is a valuable advertising medium because: it is paid for and read, and if you fail to consider its "get-there-ness," you make a mistake.

EVERYBODY SAYS SO!



SINCLAIR & HILL,
256 BROADWAY, NEW YORK.



JOINTER FOR FACING LOCOMOTIVE BRASSES.

Will hold any size brass same as held by strap when in use. No more time required to place brass than screw up an ordinary vise. Any desired thickness of cut can be taken, jointing the faces perfectly true. No files required.

HENRY C. AYER & GLEASON CO.,
PHILADELPHIA, PA.

OFFICE and WORKS,
N. E. Corner 2d and Diamond Streets.

CENTRAL OFFICE,
No. 919 Betz Building.

Boiler,
Locomotive
and
Smoke Stack
STEELS.

**FIRE
BOX
STEEL.**

PURITY AND
DUCTILITY
SOFTNESS.

QUALITY UNSURPASSED

Plates up to 100 ins. in width

SHOENBERGER & CO.,
PITTSBURGH, PA.



THE CHAPMAN JACK. PATENTED.

THIS screw being lubricated and protected, the Jack is always ready for instant service. Railroad men appreciate the importance of having Jacks always in good working condition. Serious delays frequently occur in getting common Jacks so that they can be worked when suddenly required in Train service. Common Jacks are frequently destroyed in efforts to make them work quickly after the screws are set with rust and dirt. This consideration alone makes the Chapman Jack the most economical one to purchase.

THE CHAPMAN JACK CO., CLEVELAND, OHIO.



STEVENS' PATENT
IDEAL PENCIL DIVIDERS, FIRM
Number 59.

Price per pair, postpaid,
ditch only \$1.15

Our goods exact, for penknives
and the best, any other make

and the best, any other make

and the best, any other make

and the best, any other make

STEVENS' PATENT
FIRM JOINT CALIPERS.
INSIDE, No. 50-C.

Price per pair, by mail, postpaid,
3 inch..... \$0.75 4 inch..... \$0.75
5 inch..... \$0.75 6 inch..... \$0.75
7 inch..... \$0.75 8 inch..... \$0.75
9 inch..... \$0.75 10 inch..... \$0.75

Our goods exact, for penknives
and the best, any other make

and the best, any other make

and the best, any other make

and the best, any other make

TOOLS.

All highly polished.

and the best, any other make

and the best, any other make

LOCOMOTIVE SPRINGS

WITH PATENT V SHAPE BANDS.

Gives more Elasticity to short Plates
and Better Riding Qualities.



MANUFACTURED BY
A. FRENCH

SPRING CO.

A. FRENCH, Pres.
J. E. FRENCH, Vice-Pres.

GEO. W. MORRIS, Gen. Mgr.

O. C. NOBLE, Sec. and Treas.
P. H. FRENCH, Gen'l Supt.

A. FRENCH SPRING CO.
Manufacturers of
ELLIPTIC AND SPIRAL SPRINGS
OF ALL DESCRIPTIONS.

THE

HAYDEN & DERBY MFG. CO.,

Sole Manufacturers of

Metropolitan Double-Tube Locomotive Injectors

These Injectors work at all steam pressures from 25 pounds up to 250 pounds without any regulation or adjustment.

It is impossible for the water to run out of the overflow when Injector is working.

They are not affected by leaky steam or check valves.

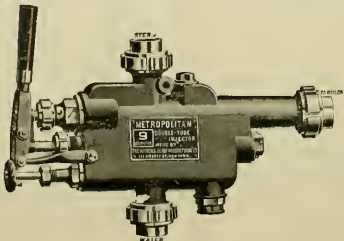

Owing to the peculiar form of nozzles used, repairs of these Injectors are reduced to a minimum. They are very slightly affected by bad water, there being no small relief holes or spills to wear or become clogged.

MADE INTERCHANGEABLE WITH STANDARD MAKES.

Office and Salerooms:

Nos. 111 and 113 LIBERTY STREET, NEW YORK.

BEMENT, MILES & CO.,

MANUFACTURERS OF
METAL WORKING MACHINE TOOLS

FOR
Railroad Shops, Locomotive and Car Builders,
Machine Shops, Rolling Mills, Steam Forges,
Ship Yards, Boiler Shops, Bridge Works,
ETC., ETC.

STEAM HAMMERS
STEAM AND HYDRAULIC RIVETING MACHINES

Philadelphia, PA.

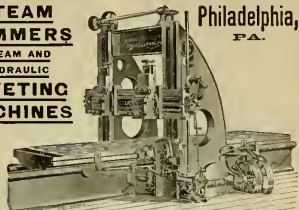

Special Air Tools for R. R. Shops.

Automatic Compound Belt Compressor. - -

Only runs when air is used, requires no attention except oiling, delivers 35 cubic feet of free air per minute—great economy over steam air pumps.

Air Hoists of all sizes, —saves more labor and time than any other shop tool, speed of hoist being entirely at will of operator. Will save ten times their cost per year over a wheel lathe.

Let us quote you on above tools.

PEDRICK & AYER CO.,

1001 Hamilton Street,

PHILADELPHIA, PA.

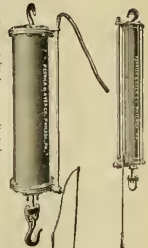
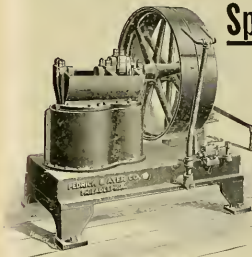

Nicholson's Expanding Lathe Mandrels.



Set of 9 takes from 1 in. to 7 in. Set of six from 1 in. to 4 in.

Either set sent subject to Thirty Days Trial, and Guaranteed Absolutely Accurate and Labor Saving.

Send for catalogue for full description and references.

GEORGE L. WEISS, General Agent, 130 INGLESIDGE AVENUE, CLEVELAND, OHIO.

THE PRATT & WHITNEY CO., Hartford, Conn., U. S. A.

SINGLE AND DOUBLE HEAD MILLING MACHINES used as Substitutes for Planers for Heavy and Rapid Cutting in Cast and Wrought Iron and Steel

TURRET-HEAD MACHINES AND TOOLS for Turning, Forming and Threading Irregular Pieces of Circular Cross-section in Brass, Iron and Steel.

METAL BAND SAWING MACHINES for Cutting Sprues from Brass Castings.

MILLING CUTTERS, HOLDERS, with Inserted Cutters for Turning, Shaping and Threading Metals. **SPHAL SHEAR PUNCHES.**

CATALOGUE L SENT ON APPLICATION.

THE INEVITABLE RESULT OF USING INFERIOR STAYBOLT IRON IN THE CONSTRUCTION OF THE MODERN, HIGH PRESSURE LOCOMOTIVE BOILERS.



To AVOID EXPLOSIONS and consequent GREAT LOSS OF LIFE AND PROPERTY, use the

SAFETY HOLLOW STAYBOLT, MANUFACTURED BY THE **FALLS HOLLOW STAYBOLT CO.,** CUYAHOGA FALLS, O.

Furnished in all sizes from $\frac{3}{4}$ to 2 inch, outside diameter, with any size hole required from $\frac{1}{8}$ to $\frac{3}{4}$ inch.

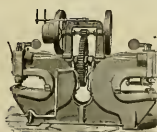

The Long & Allstatter Co. HAMILTON, OHIO.

Double, Single, Angle-Bar, Gang, Horizontal, Twin, Boiler, Spacing, Gate, Multiple, Belt, and Steam Driven
Punches & Shears
OVER 300 SIZES.



THE ACME MACHINERY CO. CLEVELAND, OHIO.

ACME BOLT & RIVET HEADERS MANUFACTURERS OF **ACME SINGLE AND DOUBLE AUTOMATIC BOLT CUTTERS,** Cutting from $\frac{1}{2}$ to 6 in. diam. Also, STRAIGHT HEADS AND TOOLS.



THE DETROIT No. 2 and 3

SIGHT-FEED CYLINDER LUBRICATORS FOR LOCOMOTIVES ARE THE BEST.



This Lubricator discharges oil to cylinders accompanied only by dry steam, and requires full effect of oil is obtained. Cannot cross-feed. No broken glass by wear of steam and water.

DETROIT LUBRICATOR CO., Detroit, Mich.

Awarded Gold Medal and Highest Premium at the World's Columbian Exposition.

FLAT TURRET LATHE



TURNS STRAIGHT AND TAPER FRAME BOLTS, ETC. SEND FOR A COPY OF "RAPID LATHE WORK,"

By New Method—Horseshoe System. **JONES & LAMSON MACHINE CO.,** SPRINGFIELD, VERMONT, U. S. A.

THOMAS PROSSER & SON,
15 GOLD STREET,
NEW YORK.



STEEL TIRES

ON LOCOMOTIVE DRIVING WHEELS
AND ON STEEL-TIRED WHEELS
GIVE THE BEST RESULTS
FOR EVERY VARIETY OF SERVICE.

The CAST-STEEL WORKS OF FRIED. KRUPP, Essen, Germany, cover an area of 1,200 acres, employ about 25,000 men, have the most improved plant, and stand unique from the fact that they have their own Ore and Coal Mines, Blast Furnaces, etc., and that every stage of manufacture is under their own supervision, and are not (like others) dependent on the open market for a miscellaneous assortment of crude material; which, in connection with 75 years' experience, enables them to turn out a product of a very superior quality, second to none, and at the same time the different grades of Steel are always of the same uniform quality.

Crank Pins, Piston Rods, Spring Steel, Steel-Tired Wheels, Etc.

After a test of over 35 years, the "KRUPP TIRE" has proved itself the best in the market. If a reliable article is wanted, which will give satisfaction, get KRUPP'S.

SCHENECTADY LOCOMOTIVE WORKS, SCHENECTADY, N. Y.

LOCOMOTIVES
OF
STANDARD
DESIGN
FOR ALL
CLASSES OF
SERVICE.

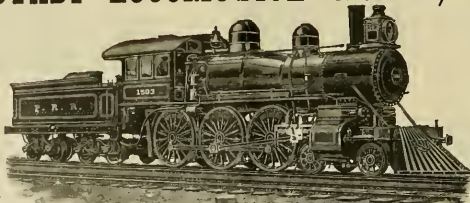

OR FROM
DESIGNS
FURNISHED
BY
RAILROAD
COMPANIES.

EDWARD ELLIS,
President.
WM. D. ELLIS,
Vice-President and Treas.

A. J. PITKIN,
Superintendent.
A. P. STRONG,
Secretary.

COMPOUND LOCOMOTIVES, Showing an Economy of 15 to 30 per cent. in Fuel and Water.
Annual Capacity, 400.

M. L. BISHOP, Pres. and Treas.
P. H. STORAN, Asst. Treas. and
H. J. SIMON, Vice Pres.
W. H. HERRINGTON, Sec. and Treas.

DAVID BRADLEY, Supt.
H. TAYLOR,
Asst. Supt.



Brooks Locomotive Works, DUNKIRK, N. Y.

Builders of Locomotive Engines for any required service from our own designs or those of purchasers.
Perfect interchangeability and all work fully guaranteed.

COMPOUND LOCOMOTIVES

FOR PASSENGER AND FREIGHT SERVICE.

J. B. HENDERICKSON, Pres.
F. J. CLAMER, Vice-Pres.
J. R. NELSON, Sec. and Treas.

"AJAX BEARINGS: RECORD 90 MILES AN HOUR"
"EMPIRE STATE EXPRESS, N. Y. C. & H. R. R."

AJAX METAL CO.
INCORPORATED.
PHILADELPHIA, PA.

Latrobe Steel Works

MANUFACTURERS OF

TIRES

FOR LOCOMOTIVE and CAR WHEELS.

Main Office and Works, Latrobe, Pa.
Branch Office, Hubert Building, Philadelphia.
Chicago Office, Western Union Building.
New York Office, Home Insurance Building.

William Sellers & Co. Incorp.
PHILADELPHIA, PA.

MACHINE MODERN TOOLS

For Railroad Shops, Car Builders, Etc.

HIGH SPEED

TRAVELING & SWING CRANES.

ALSO

TURNTABLES, INJECTORS,

SHAFTING,

ETC., ETC.



"LACKAWANNA"

Sight Feed Locomotive
Cylinder Lubricator.

ABSOLUTE UNIFORMITY OF FEED.

Perfect distribution of oil to both cylinders from one feed glass, and entire efficiency under all working conditions.

Only One Glass,

and that short and stout; almost unbreakable. Absolutely no use for any more. They are an unnecessary source of trouble and danger.

Write for full particulars.

LACKAWANNA LUBRICATING CO.,

1212 Capoue Avenue, Scranton, Pa.

Rhode Island Locomotive Works.

PROVIDENCE, R. I.

CHARLES FELIX MASON, President. ARTHUR LIVINGSTON MASON, Secretary.
EARL PHILIP MASON, Vice-President. JOSEPH LYTIDGE, Agent and Supt.
W. CLAW P. CHAPIN, Treasurer. S. A. STEPHENS, Traveling Agent.

NEW YORK OFFICE.

Nos. 31-33 Pine Street.



This is the Standard Metallic Packing all over the world, and is more generally adopted and in use on more locomotives than any metallic packing in use. Give the **JEROME** a trial and be convinced. Put it in competition with any other packing and be convinced of its superior merits.

Office and Works, Nos. 35 and 37 Canal St., Chicago, Ill.

C. C. JEROME, Inventor and Proprietor.

Packing ring opened ready to apply without disconnecting the Piston from the crosshead. It runs longer and wears the rod less than any other packing in use.



SEND FOR CATALOGUE.

Graham's Patent Groove Shank Twist Drills and Chucks.



DETROIT TWIST DRILL CO., Detroit, Mich., U.S.A.

OUR ENGRAVINGS.

Of late we have had a great many inquiries as to who made the fine half-tonne plates shown each month in *LOCOMOTIVE ENGINEERING*. Credit is due the expert engraver, and we are glad to recommend the engravers of our plates to those wanting good work at reasonable prices. All the half-tonnes and reproductions we use are made by the **STAR ENGRAVING & PRINTING CO., 637 & 639 Sanson St., Philadelphia, Pa.** **SHULZ & HILL.**

The Smith Triple Expansion Exhaust Pipe.



FRONT VIEW.

THIS Device is the invention of **JOHN Y. SMITH**, the originator of the Smith Vacuum Brake. In the cuts of the Front and Side Views shown herewith, "A A" represent Air Passages; "SS" Exhaust Steam Passages, and "B" an Annular Blower forming part of the Nozzle.

It is an entirely new departure in the construction of Exhaust Pipes for Locomotives.

Its distinguishing features are that the exhaust steam is not restricted after it leaves the cylinders, and the gases and heated air in the smoke arch are mingled with the exhaust steam in the exhaust pipe. The exhaust steam is thus superheated and expanded, and a powerful, prolonged, pulsating blast is created, which keeps the fuel in a constant state of agitation, and produces more perfect combustion.

Some of the beneficial results obtained are: *Reduction of Back Pressure to a minimum (area of nozzle opening as large as the exhaust port); prevention of ejection of sparks from smoke stack; almost complete absence of noise from exhaust; prevention of formation of clinkers in fire-box; large saving of fuel.*

By the elimination of Back Pressure we have demonstrated the fact that the power of engines has been increased to the able to pull from thirty to sixty tons more than with any other form of exhaust pipe.

The pipe can be used with either straight or diamond stacks, in long or short front ends, and on locomotives burning hard or soft coal, wood or coke.

NEW YORK SALES OFFICE, Rooms 29 & 31, 115 BROADWAY.

GENERAL OFFICE DOYLESTON, PA.

FACTORY-READING, PA.



SIDE VIEW.

THE LESLIE PATENT

Locomotive Fire Kindler

FOR

Cheapness, Simplicity, Cleanliness, Convenience, Absolute Safety, Durability and Economy,

**STANDS
UNRIVALED.**

IT IS THE ONLY SYSTEM OF KINDLING LOCOMOTIVE FIRES WITH CRUDE OIL WHICH HAS EVER BEEN PUT INTO GENERAL USE BY ANY RAILROAD COMPANY.

THOUSANDS OF FIRES

Have been Kindled for Less than

4 CENTS PER ENGINE.

During the past Winter ONE car tank of Crude Oil kindled more fires than 500 Cords of Wood.

Its adoption in all round-houses over their Entire System by the Roads, which had tested it in all kinds of weather, furnishes absolute proof of its Complete Success.

For particulars, address

J. S. LESLIE, Paterson, N. J.

Locomotive Engineering



A Practical Journal of Railway Motive Power and Rolling Stock.

ESTABLISHED, 1881, BY ANDREW SINCLAIR AND JOHN A. HILL.

VOL. VII, No. 9.

NEW YORK, SEPTEMBER, 1894.

130 Cts. Monthly
\$2.00 Per Year.

The Largest Mogul Locomotive in the World.

We present herewith an engraving of the largest mogul in service anywhere—some of ten recently built by the Baldwin Works for the Delaware, Susquehanna & Maryland Road.

The engine was designed by Daniel Cox, Jr., superintendent of the road, and is a fine example of a modern freight locomotive, embodying, as it does, all the latest improvements, and having every convenience for the safe and expeditious handling of very heavy freight trains.

Firebox, 132 1/2 in. long, 42 in. wide inside, 3-in. water space on sides, 4-in. back and front.

All short stays in boiler drilled. Crown supported by radial stays 1 in. diameter, 4 1/2 in. between centers.

Rocking grates in three sections. Short extension smoke arch.

Two-wheeled engine truck has 36-in. steel tired wrought iron wheels, with journals 6 in. diameter and 12 in. long.

Nathan triple sight feed lubricators. Jerome metallic packing. Cast steel crossheads. Ajax metal bearings.

Crosby safety valves (3).

Air bell ringer. Four gauge cocks. Westinghouse air brakes, with American outside equalized driver brakes, 9 1/2-in. pump.

Tender, 6-wheeled, wrought iron, steel tired wheels 42 in. diameter, brakes on all wheels. Janney coupler on tank. National hollow brake beams.

Capacity of tank 4,500 gallons. Tender axles, steel, journals 6 1/2 in. diameter, 16 in. long.

The P. R. R. standard (3 bars) connection between engine and tender is used.

springs on top of each box, the center and back pair equalized.

The materials selected for these engines has been the best to be had, the design presenting some new features, and the size and weight going beyond any precedent. They were intended to pull coal trains from Roan, the central point on this road, to Perth Amboy, N. J., over the Lehigh Valley road. There was a misunderstanding about this arrangement, as the bridges of the L. V. were not ready to stand such heavy engines, and the L. V. R. R. bought six of the engines and have them in heavy freight service on the northern division of

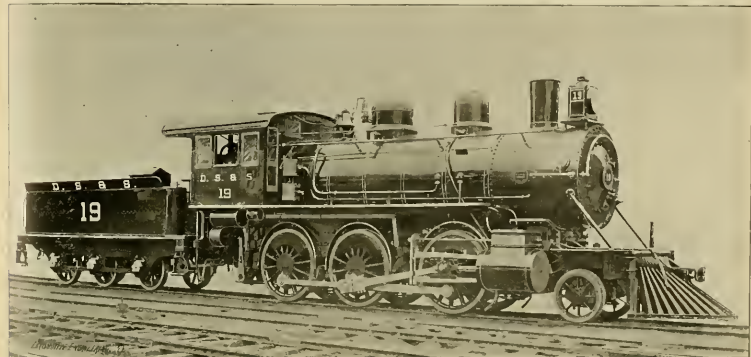

THE LARGEST MOGUL LOCOMOTIVE IN THE WORLD, D. S. & S. RAILWAY.

It may not be generally known that the D. S. & S. is owned by the Cox Brothers, & Co., a coal mining concern, and there are some sixty odd miles of main line, all on their own land.

The general dimensions of the engine are as follows:

- Cylinders, 22 x 28 in.
- Drivers, 62 in. diameter, all flanged.
- Gauge of track, 4 ft. 9 in.
- Fuel, lump anthracite.
- Wheel base, engine, 22 ft. 5 in.
- Driving wheel base, 14 ft.
- Wheel base of tender, 11 ft. 6 in.
- Total length of engine and tender, 62 ft. 7 in.

- Weight, total, 151,000 pounds.
- Weight on drivers, 136,000 pounds.
- Weight of tender (loaded), 90,000 pounds.
- Boiler, made throughout of flange plates, homogeneous cast steel 1/2-in. thick; 72 in. diameter at smallest ring, straight, longitudinal seams butt jointed with double welt strips, all rivets hand driven, button set, dome placed in center, pressure 160 pounds per square in.
- Tubes, 270, of iron 13 wire gauge, 12 feet long, 2 1/2 in. diameter.

Slide valves, Richardson balanced.

All drivers are flanged with 5 1/2-in. tread Krupp crucible steel tires 3 inch thick.

Axles, steel, with journals 9 in. diameter and 12 in. long.

Driving boxes of steered cast iron, with Ajax bearings.

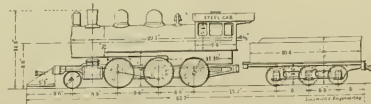

Side rods of steel, oil cups forged on. Crank pins, steel. Coffin toughened process.

Injectors, Little Giants, No. 10, 18 1/2 g. pattern, both on right side.

Cab of steel with ventilator, ceiled and insulated with ash. Leach air blast sander. Fenna, R. K. standard whistle.

The jacket, outside of cab, is painted, like the rest of the engine and tender, Brunswick green.

It will be noticed that all the latest improvements are to be found on these engines.

The throttle lever stands up behind the reverse lever, the pair of them looking

like a man and a ten-year-old boy, the throttle stem is outside the boiler connecting to the operating lever on side of dome as plainly shown.

The frames are remarkably heavy, especially in front of and around the cylinders, they do a great deal of heavy pushing.

The 6-wheeled tender has long elliptic

the road. The four in service on the D. S. & S. are each handling two of the trains formerly hauled by the old 10 x 24 moguls.

Some anxiety was felt as to their effect on the track, as the rails are only 60 pounds per yard, but the road department say they can see no difference.

Mr. Cox is very enthusiastic about the 6-wheeled tanks, they ride splendidly, have never had a hot box, and are simpler and cheaper than the double truck tender.

The Traveling Engineers' Association will meet in Denver, September 12th. This meeting promises to be well attended, and, the subjects up for consideration being particularly interesting, it is bound to be a great success in a mechanical way.

We hope every superintendent of motive power will insist on his traveling engineer going, as he is bound to pick up information enough on the trip to pay his year's salary in money saved to the company.

The J. P. just aches to go to Denver to be with the boys, but the S. P. still lingers on the "banks" to handle Duane and Denver is out of the question—we can't even go to Coney Island.

Reminiscences on Locomotive Smoke-boxes, Exhaust Nozzles and Stacks.

BY W. D. THOMAS.*

One of the difficulties met by the early locomotive builders was in getting the

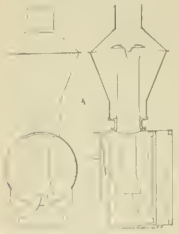

size of fireboxes increased this difference became apparent, and means had to be taken to overcome the difficulty, and the origin of the "lift or petticoat pipe" is explained.

This raised or lowered would increase the draft through the lower flues, and decrease it through the upper flues, or the reverse, and thus enable its manipulator to equalize the strength of the draft at front and back end of the firebox.

This lift-pipe was made in a variety of shapes, as is shown by various sketches, but all intended to reach the same end

size of the draft for the area it being found that a draft was applied to blow the fire from the front. But the arrangement in question had not been used in all factories. When exhausted the stack was tried and found to be a good one at which answered the purpose and has been used in many cases. It is to be noted that the exhaust pipe was first made probably not quite certain, but the drawings of Stephenson's engine seem to indicate that the pipe entered the back or chimney near the top of the boiler, at the side, and probably turned up by the exhaust shot upward in the form of a jet.

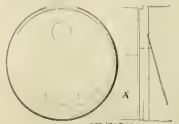

With the forced draft the engines violently threw sparks, for in 1817 we find a cone used with a "carleflower" edge to deflect the sparks, the smoke-stack being wide and having a wire net or funnel over it—the cone also being expected to keep the wire funnel from being cut out by the sparks.

Probably with the small engines there was little or no trouble because of one part

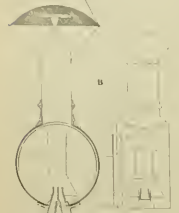

of the fire getting a greater effect from the forced draft than did some other. As the

* Superintendent of Mable Power, Southern Railway Co. E. T. V. A. G., Knoxville, Tenn.

size of fireboxes increased this difference became apparent, and means had to be taken to overcome the difficulty, and the origin of the "lift or petticoat pipe" is explained. This raised or lowered would increase the draft through the lower flues, and decrease it through the upper flues, or the reverse, and thus enable its manipulator to equalize the strength of the draft at front and back end of the firebox.

This lift-pipe was made in a variety of shapes, as is shown by various sketches, but all intended to reach the same end

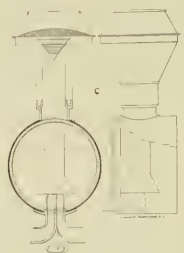

The smokebox was about the same size as the boiler in diameter, and long enough to take the stack base at the top, and to hold the cylinders, which were, and still are, fastened to it.

The sparks arrested by the cone and netting were supposed to be caught, and very many of them were, in the wide topped stack, which was built in many shapes, some very fantastic, and many with ingenious details.

As early as 1810 an engine was built with a slightly extended front end, as shown in Fig. A, and with it a deflector

plate covering the top rows of flues—the top of the nozzles being just above the lower flues. Just what was intended to be

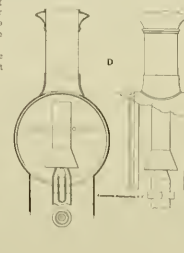

gained by this extension is not explained. The deflecting plate was then extended down, and as shown in Fig. A, with an adjustable pin at its lower edge.

An adjustable or telescopic lift or petticoat pipe was tried, Fig. B. In some cases, the petticoat pipe was dispensed with, the plate being evidently intended to take its place in effect. The nozzles are still low, as shown in the sketches.

Figs. C, D, E, F, G, and H show a variety of forms of the lift pipe, perhaps the extreme being Fig. H, when five flues are shown.

Other Figures I, J, K, L, M, N and O, show cases where the lift-pipe was done away with and other means of equalizing the draft substituted.

It will be noticed in Fig. L that a deflector or "half" plate is placed in front of the flues, while the exhaust pipes have been raised up to about the level of the top flue. A netting was placed from the de-

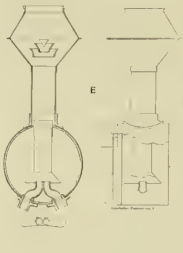

deflector just below the top of the nozzles, extending in front of the nozzle, level to about where the front of the smokebox formerly was, and then curving to top of the smokebox, which was extended as shown.

Fig. K shows another form, where the nozzles are lower and are in a "basket" or perforated casting extending from the netting about half way from it to the bottom of the smokebox. There is no deflector here.

Fig. F shows a case where, inside the lift pipe, which extended very low, was an inverted perforated steel cone which was attached to the top of the nozzle and extended up the stack nearly half way to its top, and was expected

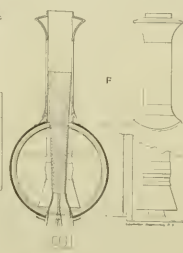

to act as a netting and prevent throwing fire.

Figs. I and J are cases where there was no deflector and no lift-pipe. How well they worked we cannot say. Fig. O shows a case with the deflector in front of the exhaust nozzle, which extended above the top of the flues, a steel plate perforated with 1/2 inch holes extending from the flue sheet to the exhaust

nozzle, while in front of the nozzle is a wire netting extending to the front and up to the top of the smokebox. This deflector will be noticed to have its lower part adjustable.

The forms of the stacks are various. Just why would be hard to tell, though doubtless the makers may have had rea-

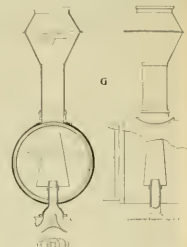

sons of greater or less value to them in the form.

Form or material alone would seem to be of little value so far as consumption of fuel is concerned, and yet in the annual report of one road, some years since, its managing officer said to his stockholders that they had adopted a new cast iron stack which would insure to per cent economy in fuel.

Form, in connection with other items, may have its influence. There has been much question as to sizes both of stack and lift pipes, opinions varying greatly. Views on forms and sizes of both stack and petticoat pipes varied, and the construction

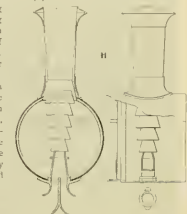

were almost as varied as the master mechanics. It is quite possible that frequently opinions were formed and then experiments were made to prove their correctness. We find cases of this kind not infrequent in this world.

Again character of fuel has much to do with particular devices. What might be



called successful with good fuel and under one train of conditions, under other circumstances and with poor fuel would quite likely be less successful.

It was the fortune of the writer to have to deal with poor fuel some years ago, and he was placed that a study of cause and effect in locomotive work was possible. As to the sizes of petticoat pipes, a mean between the two extremes, of very large and very small, was found under all circumstances to give quite as good results as either extreme.



The telescopic device for adjusting the petticoat pipe to produce the best result was successfully used, enabling a control of the fire on all parts of the grates. Not all engines, however, could be worked with the parts in the same position. Each had to be tried, its fire watched and the parts adjusted until the fire burned with equal brightness in all places.

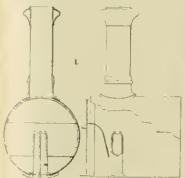

By the adjustments resulting from these studies and trials the steaming qualities of the engines in use were materially improved.

Examinations of a lot of engines in which the sparks used to pile up in the smokebox and against the front, frequently taking fire and burning it out, showed an unequal draft through the flues—that through the lower ones always being deficient. The knowledge gained by former observations applied here remedied the

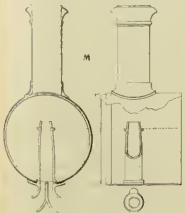

trouble, and much reduced the quantity of sparks gathered in the smokebox.

In later years the deflector plate has taken the place of the left or petticoat pipe, to a great extent, and by it, especially when it is adjustable, as shown in Figs. A, L, M, N and O.

In some cases the writer has used two plates—the one controlling the lower half of the flues and the other the upper. The adjustable parts have been handled in the

cab by levers, so that the draft could be regulated at will, but it is questionable if as good average results were reached as when the plates were carefully adjusted and then bolted in place.

Whatever may have been the reason for extending the smokebox, as was done in 1859, it was after a time extended to have a place to catch sparks. It became fashionable, and very many roads used it for a while, then thinking it useless cut it off.

The writer's observations led him to conclude that the extended front end had another use, and a more important one than as a catcher of sparks. It was believed to act much as does an air chamber in connection with a pump and a column of water, viz.: Make possible a continuous movement of the water, notwithstanding the intermittent action of the pump

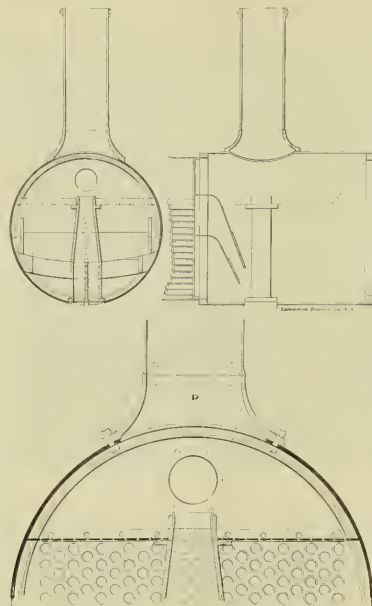

So the smokebox (as an air chamber) equalized the draft through the flues, and made it softer and more uniform than it would otherwise have been.

Its uses enabled other changes which seemed to be in the right direction—softening and equalizing the draft and still making plenty of steam.

Now as to the nozzles. It will be noticed that all the earlier ones, especially the low ones, were double, as were some of the high ones. We also find that the parallel and intended to be vertical as in Fig. E, or they converged toward the top, as second figure on Figs. B, C, P, G, H, T, J and K, the convergence nearly always reducing the areas, and consequently causing a sharper or stronger jet (for it was a jet, and intended to be a jet), and

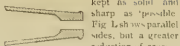

kept as solid and sharp as possible. Fig. L shows parallel sides, but a greater reduction of areas.

It is true that to throw a solid stream of water a nozzle with parallel sides is required, and that the sharper the edges the better. So it may be presumed that a solid stream of steam was wanted, and the sides should be parallel in the same way. Just why the converging sides were used it may be difficult to say, but probably to contract the nozzle and possibly hoping to further solidify the stream. At any rate, the effect seemed to be to produce a jet, and pass it up as nearly as possible in the middle of the stack, and that it was done was shown by the way the cones were worn. The direction of the axis of the

As the variable exhausts have never come into anything like general use it may be presumed that their practical value was small.

The earlier uses of tall exhaust pipes would hardly be deemed a success, though after many trials it became so. The earlier of the American experimenters probably tried to follow English practices, with



conviction conditions. The writer became convinced that they should succeed, and endeavored to ascertain why and how they failed.

He tried them with straight sides, with partitions, when single nozzles were used, very nearly to the top, and with practically no divisions, and finally settled down to a division about one-third the height. He



also tried the effect of various shapes, from the straight sides to quite large shells in the pipes, but finally found the best results from a shape practically shown by Fig. O, though in the course of his experiments he applied the principle to an old engine with exhaust openings at the sides of the smokebox, as shown in Fig. N.

He believed it was a mistake to contract the nozzles and attempt to use a jet, but was convinced that a better result could be reached by making his exhaust stream fill the stack and form a piston. To this end he flared the top of the noz-



zles, as shown in Figs. M, N and O, and more perfectly shown in the large Fig. P.

With a wider, a nozzle shaped like this spreads the steam, and it was found to do the same with steam. The dotted lines from top of nozzle to bottom of stack show how it was intended to spread the steam and fill the stack. It will be noticed that the base of the stack is flared, is smooth and wide at bottom, the shell of smokebox being cut away to fit it.

This varies much from other practices, in which the stack base was square (see Figs. B, C, E, F, K, L, M), or extended

nozzle was intended to be central, but not infrequently it hit the cones on one side, and sometimes, even one side of the stack.

Variable nozzles have been used—intended to put into the hands of the engineers the power to increase the force of the exhaust and consequently of the draft. One case of this is shown in Fig. D, where the horn-shaped plug in the nozzle under the lat-pipe could be raised or lowered by the engineer, and thus reduce or enlarge the size of the exhaust opening. Another case was where the nozzle was in two parts, hinged at lower side or edge, and arranged so the engineer could open or close it at will.

Dampers have been put in base of stack, to lessen the draft on the fire by opening when desired.

down (see Fig. F), or shall not cut away (see Fig. J).

The chamber formed by the swelling of the exhaust-pipe, and the filling of the stack at its base, and the use of the steam as a piston has been found to render possible a reduction in size of stack, and an enlarging of the nozzles, until on a 2 x 2 1/2 consolidation engine the writer uses a 6-in. diameter nozzle, and the engines steam well and are economical in fuel.

The draft is so softened that there have been engines run for months, without any setting in, and they did not throw fire.

A great deal has been written about back-pressure with single nozzles, and undoubtedly truthfully with the engines considered in the papers written, for the nozzles were on the jet principle and very well compared with what is possible to-day. The single nozzle was condemned,

Comparative statement of average coal per car mile, several years, used by engines the writer refers to

Freight (writer's engines)	4.54
Other roads	7.4
Improvement	7.89
Passenger (writer's engines)	12.00
Other roads	24.00
Improvement	23.00

This sustains the writer in the belief that the exhaust-pipe with swelled body, and curved line in nozzles, that fill the stack and give piston action, are superior not only to the double nozzle, but also to the exhausts as in common use, and shown in most of the sketches.

It should be borne in mind that the writer's experiments with the swelled body nozzles commenced in 1893, prior to which time it is believed that no one had used the nozzle with curved lines, thus giving

lant matters been considered at the same time, their value would have been increased.

The form from which they seem to have gotten the best results was not unlike those selected by the writer, and from which their investigations seem originally to have started. It will be noticed, however, that the nozzles which they used all had either parallel or converging sides, and in one of the nozzles tried the areas were reduced substantially as shown in Fig. L.

The committee evidently used and wished to use the jet system and solid central stream, and they gave it in their report as their opinion "that when a pipe is of such shape us to insure *central and solid* (the italics are mine) discharge the best results will be had," etc. They say, also, "where care is not taken to insure a *straight discharge*, part of it impinges against the sides of the stack (italics mine) with injurious results to the steaming"



COMPLIMENT OF THE SEASONS. CORLIAN RIVER BRIDGE, E. & N. RAILWAY, BRITISH COLUMBIA, RISEK SPAN 275 FEET LONG.

and the condemnation was broad and covered all single nozzles. Nevertheless, it still exists, and the author of the articles referred to is now using them, notwithstanding his former condemnation.

The writer's examination showed that a smooth stack (but the inside) is very desirable, and that even a rivet head on the side is an obstruction and should be avoided. The cylinder of the stack may be of cast-iron or sheet steel. The latter is lighter, but if used rivets should be counter-sunk. The base should flare as shown in Fig. P, and barrel of snakebox should be cut out as large as possible. Then, with a nozzle that fills the pipe, and with steam forming a piston, you have, with the proper adjustment of the deflector, as good a device as is now in use—permitting, as it does, the use of a very large nozzle (6 inches diameter for a 2-inch engine), giving a very soft exhaust and still steaming freely.

A comparison of the work of the engines so treated, when made with those of other kinds of like character, as to engines, loads and business, but with better coal, shows markedly in favor of the engines described.

the piston principle, or had used the swelled body of the exhaust pipes, or had in any way succeeded in using so large nozzles, and thus softening and equalizing the draft upon the fire.

It has been the writer's pleasure for a number of years to explain his experiences to many of his brother mechanical officers, and in the last five or six years he has sent drawings of his pipes, or the pipes themselves, to quite a number of them, and was glad to know that considerable interest was taken upon the subject.

In the discussions of the Master Mechanics' Association it evidently had taken a place, for in 1892 a special committee was appointed to consider the matter. In the report of the meeting of 1891 we find quite an elaborate report from this special committee upon the subject of exhaust-pipes. The examinations, however, seem notwithstanding the fact that one member of the committee had served under the writer, and was to some extent familiar with his experiences.

Their observations seem to have been centered upon the form of exhaust-pipes, and their experiments on this line are of value but had other and quite as impor-

The inference you may draw from this last remark is that the steam aim was to get the "jet" through the stack, practically without touching the sides.

They conclude by showing a preference to the taper stack.

It is the experience of the writer that using the piston principle with the large nozzles and straight stack, as he used it, better results have been obtained.

The committee used no nozzle in their experiments on consolidation engines larger than 5 inches in diameter, which has an area of 19.4 square inches, while the writer is using nozzles 6 inches in diameter, with an area of 28.27 square inches, or 45 per cent greater than the 5-inch nozzle.

In these days of progress it is questionable, or perhaps the better word would be probable, that some better arrangement will be found in the near future, and when presented, the writer will gladly welcome it—be it up to the present, his best results have been obtained with the swelled exhaust pipes, flared or curved mouth, and straight parallel-sided snakebox, giving piston action, and with the bottom of stack flared and smooth, substantially as shown in Fig. P.

A Vermonter of the Good Old Time.

In a letter to his old home in Vermont, nearly a year ago, Mr. Benjamin Garvon, of Pond du Lac, Wis., said:—
"I recall with interest an account of old time-tables of the Vermont Central. I was an engineer on the road and ran the first train to Northfield and Windsor in the fall of 1848. I to Montpelier in June, 1849. The road was opened to Winooski in the fall of 1849. When the road was opened to Waterbury we made the run from White River, or rather from Ferrisburgh, Lebanon, N. H., about 77 miles, inside of eighty minutes, and made two stops, with engine "Ethan Allen," which had a 3 ft. 6 in. wheel. John Danforth and I ran it in the fall of 1850. We ran to Rouse's Point in the fall of 1852 and I ran from Essex Junction to the Ogdensburg depot and boat house, across the lake, think it is 47 1/2 miles, making nine stops, in 45 minutes. Left Essex Junction at 5:15, stopped in Ogdensburg boat house at 7:20. Danforth ran from Northfield to Essex Junction, going into Montpelier and backing out, making 47 miles, with nine stops, in fifty-two minutes. H. Campbell was superintendent, and he timed him and told me that he did it in fifty-two minutes. We commenced running express trains from Ogdensburg and Montreal May 1, 1853. I saw Marvin Brown in Chicago last week. He was the first engineer on the Ogdensburg line running from Ogdensburg to Rouse's Point 115 miles, with four stops, took wood and water twice, and did it in 1 1/2 minutes. I made the run from Rouse's Point to Burlington, making five stops, in seventy minutes, from Essex Junction to Northfield, 44 miles, in fifty-three minutes, and from White River Junction to Northfield, 40 miles, in sixty-five minutes, making six stops. Do they beat it now on a good track? I guess not. I would like one of the old time-tables. I was seventy years old October 2, 1893, and am hearty and well. I came to Chicago in April, 1852, and helped build the C. & N. W. Railroad from Chicago to Lake Superior. I am not on the road now, but am as well as ever. Marvin Brown is running on the St. Paul road out of Chicago."

Sheep and Wolves.

We have received a number of letters from engineers, especially in the South, inclosing glowing circulars from a Wall Street firm of brokers, so called, soliciting the use of \$50,000 or \$100,000, in "contingents" for stock gambling. Some of our readers ask us to find out if they are "all right." Boys, use a little of the hard old common sense in your heads. If these fellows can double up your money 50 fold, they can double up their own and could become rich in a very short time on "the street." Wall Street sharks do not cat one another, they feed on the poor in the rural districts—don't be a lamb. The longer you live the more you will see the truth of the old saying, "you can't get something for nothing." In the long run a man gets just about what he pays for, and no more. The Wall Street philanthropists, who advertise to give away fortunes, great or small, to unknown rail-riders up in Wisconsin or down in Alabama, and who don't care for any such snaps for themselves, are good people to keep away from.

Two Railroad Views in British Columbia.

We are indebted to Mr. Toney Silvine, an engineer on the terminal at Nimmo Railroad, on Vancouver Island, B. C., for the photos reproduced here.

One view shows Mr. Silvine's engine with a k. of P excursion train on a very high and crooked trestle bridge—225 feet above the stream. This road has many of these. The other view shows how a little melted snow breaks on a 275-foot trestle bridge when it starts out to make spring calls.

A Few Yards of Red Tape.

The whole general official force of a well known road were out on a tour of inspection. At each division they would pick up the division officers, and take them over their own part of the line.

The special was on the siding waiting for No. 6. A section gang were at work near by, and No. 6 was late.

The crowd stood on the track waiting and talking.

The general manager squinted down the main line, and said to the general superintendent, "John, ain't there a low place in the track there?"

"John squinted.

"Smith," said he to the division superintendent, "there's a low joint there at that switch."

"Smith squinted.

"Hogan," said he to the roadmaster, "there's a bad joint there, better have it wiced."

"Hogan squinted.

"Sullivan," said he to the section foreman, "there's a dam bad joint there; raise it up."

"Sullivan squinted.

"Jerry," said he to one of his gang, "I've in the devil don't ye do phwat ye'r doin'! get ye now and tamp that low joint."

"Jerry squinted—but he got his hat first.

"Mike," said he to the youngest man in the job, "dom you're lazy sowl, do you come and tamp this toic phwile O' boald upp the ind."

"Mike" failed to squint.

"And, lo, the low "joint" was raised.

They Did Go Around.

"A long time ago," remarked Fred Coxey, of the Ashton Valve Co., "when I was running on the Lake Shore, the trumps were pretty thick, and got to be something of a nuisance.

"One chilly night I put one fellow off the job, and then off the back of the tank, but at the next water station the fireman told me he was on the front end of the baggage car.

"We had a small hose, connected to the pump pipe, for wetting down the deck, and I laid its nozzle on the clothes box, put a stick of wood on it, and turned the jet on—it just threw a nice steady spray of cold water over the rear of the tank.

"We had a piece of pretty crooked track around and among some little lakes, the time was lively, and I forgot all about my tramp.

"I got down to oil at the next station, and the wettest looking mortal I ever saw came up to me and said in the driest way 'Say, pardner, I alius thought this road went around that lake—damme if ever I knowed before that it went through it!'"

"I told the poor coos to get right up by the firebox and get dry—and I carried him to the end of the car."

A Rusty Fortune.

Those of our readers who remember their history lessons will perhaps recall that long years ago early in the eighteenth century, probably about 1715, the French Government built a great fortress on the island of Cape Breton, now the extreme eastern part of New Scotia.

This fortress was the strongest in the New World, and was called the Gibraltar of America. It was the stronghold of the French, then chronically at war with Great Britain and the colonies, and was the refuge of several hundred privateer vessels that continually ravaged the American fisheries.

"The colony of Massachusetts proposed to reduce it, and being joined by other colonies, 3,500 men were sent against it, sailing from Boston in 1745, and shortly afterwards captured the fortress. It was afterwards in the hands of the French by treaty, and was again reduced in 1758. But to our story.

On this fortress were mounted thirty

large cannon and many mortars, and on a sixty-four-gun ship in the harbor, also captured, were many more heavy guns. Before the surrender the French spiked many of these guns and threw them into the sea.

Along about 1876 some enterprising man put there conserved the idea of raising those guns for the old metal in them, and some fifty or sixty rusty old cannon were soon lying on the dock awaiting a purchaser.

But the rust on the guns commenced to bulge out and scale off inches deep, and a hammer or hatchet could be used to cut the corroded metal as if it were green cheese, and the junkmen refused to make an offer.

It was finally decided to sell the whole at auction, and it so happened that on the day of the sale Mr. William P. Tyler, now president of the Tyler Tube and Pipe Company, at Washington, Pa., and then a

Mechanics were sent for with chisels and hammers and ordered to cut that gun in two, just back of the shot.

It was the work of a few moments to cut through two or three inches of rust, it crumbled out like red brick, and was eagerly gobbled up for keepsakes by the bystanders. It was not long, however, before the workmen came down to good iron, and the chipping was hard work, but in time the muzzle of the gun was knocked off by a blow, and there was the gold—in the old lady's mind.

Back of the shot was a dark cake of rust, the base of which had probably once been powder, and that was all.

About this time one of the curiosity-hunters came to Mr. Tyler and said his specimen was hot, and so it was. All the chips of rusty iron were hot, the action of the air on the oxidized iron was causing some change that produced heat.

But none of these things, however in-

The gas which has thus been burned is then forced against the boiler and its heating power is utilized to the last possibility. The great advantages of this process are plain. Besides effecting a great saving of heating materials—estimated as 10 to 25 per cent.—it enables a railway company to do away with the disagreeable and unhealthy smoke, cinders, and gas which are emitted by locomotives of the usual type. For the locomotives provided with the Langer smoke-consuming device give out only the pure steam necessary to operate them. . . . This device has been applied on thirty-five locomotives (most of them in the express train service) of the Northwest Railway, and after trials extending over two years has been found in every way satisfactory. More locomotives are provided with it by the Northwest company almost every month. Other companies which have tested the invention report equally good results.

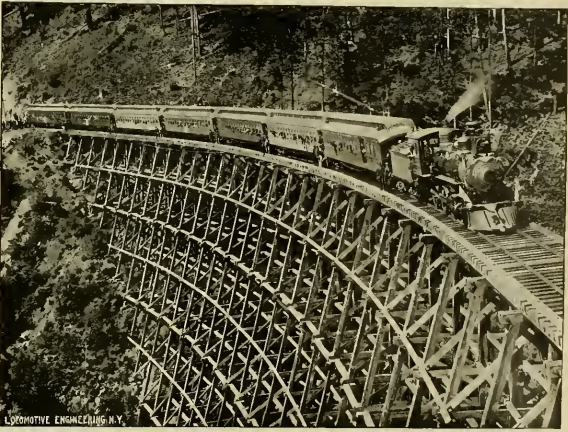

IN ARDUS CASON, BRITISH COLUMBIA—BRIDGE 225 FEET HIGH, ON ENGLISH & NANAIMO RAILWAY.

buyers of iron, old and new, dropped into town.

When Mr. Tyler showed up at the sale, the auctioneer, whom he knew, spotted him and asked him to bid, but Mr. Tyler looked at the rust scales and declined.

"Being pressed to 'start 'em at something," he offered two dollars each for the guns, and, after the usual harangue and "last calls," "going, going, gone!" was shouted. Mr. Tyler owned several car loads of rusty cast-iron guns that he did not want.

Shortly after the purchase, an old lady in the crowd came to Mr. Tyler and asked him if he was the man that bought the guns, and when the victim acknowledged that he was, she exclaimed

"Why, sir, your fortune is made. It's a tradition here, and I know it from my own family, that when the French officers found that they must surrender, they collected all their watches, diamonds, jewelry, etc., put them into one or more of these guns, rammed a solid shot on top and dumped it overboard."

It seemed like a not altogether improbable story, and Mr. Tyler commenced to look for a gun with a shot in it. One was soon found with a rusty ball not far from the muzzle—which lent color to the story.

interesting, made the bargain any better except the fact that there was some iron left in the guns. They were shipped to Boston anyway, and an analysis showed that the iron left was the quintessence of refined charcoal iron, finer than anything on the market—refined by some process of nature in 130 years' of immersion under the sea.

Mr. Tyler sold these guns for \$60 per ton, and realized a profit of more than \$6,000 on the deal.

A New Smoke Consumer.

A smoke preventing locomotive designed by Mr. Theodor Langer, a German engineer, has been giving very good service on the Northwestern Railway of Prussia. A newspaper notice of the invention says "After years of observation Mr. Langer succeeded in explaining with theoretical correctness the complicated processes of heat power and the law of the composition of smoke. In harmony with this law he placed outside the boiler an automatic device which supplies the fire with just enough air to make possible the consumption of the smoke and gas. In the space over the fire a small well operates in such a manner that the air and the gas are whirled together and thoroughly mixed.

Searching for the Best Metal for Brake-Shoes.

A number of railroad companies are making systematic tests of brake-shoes to find out what material combines the highest frictional resistance with the greatest durability. It is a question badly in need of settlement. The first requisite of a brake-shoe, of course, is good holding qualities. Soft cast iron appears best to fill this requirement, but shoes of this character wear so rapidly that they will not last over a single long-trip where much braking has to be done.

If the tests which the railroads are engaged in will lead to the selection of a metal which gives fair holding power with durability, it will render the brakes much more efficient, for the common soft shoe frequently causes the brakes to be impetative toward the end of a journey.

In the tests in operation, thirteen special brake-shoes are under trial. One track is equipped with soft cast iron shoes, made at Altoona, of a known hardness, and the other track is supplied with a set of special shoes. Close records are being taken, and conclusive information will soon be forthcoming.

Broken Stay-Bolts Cause and Effect.

It is a subject upon which a great deal has been written. *Cause and effect.* The effects are very easy to comprehend, as, for instance, broken or corroded stay-bolts are found, that is the effect—find the cause, that is the effect—find the cause. The principal cause or reason for stay-bolts breaking is on account of the difference in the expansion of the firebox and the sheet enclosing it. And most of the broken bolts are found in the top rows,

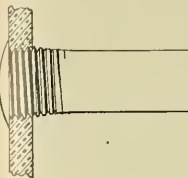

although a great many are found at the joints on the side sheets. 1, to one case, removed over over twenty bolts, along with the effect on the one side of an engine in the shop, although the stay-bolts are tested on all the engines every three months. Also, at times many are found at Mandator corners. These are not found unless so often as the upper ones, as the lower starts to expand from the mud hole, and so does not bend the bolts so much. I must say it is the exception of one than the rule to find any number broken here. When the fire is first started at the firebox to get up steam, in particular when the fire is forced, when steam is wanted in a hurry, I know of cases where a pipe was ran from another engine into steam up, and put up in the jack at the top of the smokestack to use as a blow-off. Steam can be raised in a very short time that way, but how about the boiler and the stay-bolts? Just imagine how that firebox must expand, as the outside is comparatively cold, perhaps dead cold, besides the firebox being so much cooler. And certainly when the fire-box expands more than the outside the bolts swell, and when they have been bent to the limit of their endurance they break, and the better the quality of the material in the bolts the longer they will last under the bending action. These bolts do not break clear off at once, of course, as any number are found partly broken. And the engines that carry the highest pressures have the most broken. In one case in particular, on a 160-pound engine when gruing by a new firebox was found

Thirty-six stay-bolts partly broken off on the back sheet

Twenty-eight stay-bolts partly broken off on the throat sheet.

Seventy-one stay-bolts partly broken off on the back right side-sheet.

Thirty-two stay-bolts partly broken off on the left side sheet.

This will give 167 stay-bolts partly broken that we noticed, and we also found three bolts broken clear off on the right side and two broken clear off on the left side sheet. At the offsets, this short arc of a circle which changes the circle to the flat sides on the outside sheet, this is exposed to the pressure on its convex surface which tends to straighten out. Here the stay-bolts must be exposed to considerable of a strain if the stay-bolts are placed to pull straight, as they should.

When the firebox expands it pulls up on the stay-bolts in its endeavor to pull in the outside sheet, which it is unable to do to any extent. The bolts on the straight part of the sides are free from this, as they are only subject to the bending action, and the longer the bolt the less the bend. I

once read a letter in a mechanical paper. This letter was written by a master mechanic on broken stay-bolts, and he claimed that they were caused mostly by the stay-bolts being put in too loose, that if they were put in a nice snug fit they seldom broke. I claim he is altogether wrong.

A stay-bolt, if it is a nice fit and can be screwed in with the hand, is tight enough, and never tighter than to require a 6-inch wrench it will give the best service. I have known bolts to be put in that could be shook around in the holes and never gave any trouble after being

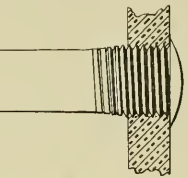

well hammered up. I fail to see why a stay-bolt is screwed tight in the hole, as it is the hammering and they hammered up, that it does not produce such a heavy strain on the sheet as to cause the sheet to crack out from the holes. But to the point as to the greater liability of a loose bolt to break over a tight one. Every one with any experience in this matter knows that the stay-bolts invariably break on the outside close to the sheet. I have never known of but one to break next to the firebox, the reason they break on the outside is on account of the outside sheet being heavier, it being at least one-half inch thick, while the firebox is usually but five-sixteenths. When the firebox expands and bends the bolts they are held like a vise in the outside sheet, especially when a tight fit, and they bend close to that sheet causing them to break at that point, while the firebox being lighter the bolt is stiffer than the sheet and the sheet springs. I have noted in some cases, after the stay-bolts were removed from the outside sheet that the sediment (it just showed white) had formed between the stay-bolt and the sheet in the hole to within about three-sixteenths of an inch of the outside, showing that that was the distance lack the stay-bolt was upset. Why would that not be easier on the bolt when subject to the bending strain, as the bolt has little play in the hole on the inside, while on the outside the bolt would be held firm for three-sixteenths of an inch. The bolt, being next to the sheets and weakest between the sheets and the sheets, is not in excess of the strength required, they can be reduced without any loss or increase in the size of the bolts. A great many will hesitate at the cost of turning, but where in the neighborhood of 70 broken bolts are found each day, I think it would pay.

Some time ago I had orders to prepare some samples to test and see what, if any, difference there would be between a stay-bolt screwed tight and a bolt screwed quite loose in the hole. The results of these tests were as follows:

STAY-BOLT TESTS.

Sample	Tons	Sample	Tons	Sample	Tons	Sample	Tons	Sample	Tons	Sample	Tons	Sample	Tons	Sample	Tons
1/4-inch bolt screwed tight in 1/4-inch firebox steel.	145	12	20	9 1/2	10	10 1/2	10 1/2	10 1/2	10 1/2	10 1/2	10 1/2	10 1/2	10 1/2	10 1/2	10 1/2
1/4-inch bolt screwed loose in 1/4-inch firebox steel.	145	12	20	9 1/2	10	10 1/2	10 1/2	10 1/2	10 1/2	10 1/2	10 1/2	10 1/2	10 1/2	10 1/2	10 1/2
1/4-inch bolt screwed loose in 1/4-inch firebox steel.	145	12	20	9 1/2	10	10 1/2	10 1/2	10 1/2	10 1/2	10 1/2	10 1/2	10 1/2	10 1/2	10 1/2	10 1/2
1/4-inch bolt screwed tight in 1/4-inch firebox steel (this bolt hammered).	145	12	20	9 1/2	10	10 1/2	10 1/2	10 1/2	10 1/2	10 1/2	10 1/2	10 1/2	10 1/2	10 1/2	10 1/2
1/4-inch bolt screwed tight in 1/4-inch firebox steel (this bolt hammered).	145	12	20	9 1/2	10	10 1/2	10 1/2	10 1/2	10 1/2	10 1/2	10 1/2	10 1/2	10 1/2	10 1/2	10 1/2
1/4-inch bolt screwed loose in 1/4-inch firebox steel (this bolt hammered).	145	12	20	9 1/2	10	10 1/2	10 1/2	10 1/2	10 1/2	10 1/2	10 1/2	10 1/2	10 1/2	10 1/2	10 1/2

By this you will notice that while the average of the loose bolt unhammered was lower, the loose bolt hammered gave the best average.

CORRODED STAY-BOLTS.

Corroded stay-bolts are seldom found, they are caused principally by the boiler lying idle with water in it, and, of course, some waters have impurities in them, the use of which causes corrosion. I have some samples here of stay-bolts removed from a stationary boiler that had been in an elevator, and the stay-bolts were reduced from three quarter inches in diameter to one-half inch in thickness. This



AUTOMATIC LOAD-STAINING AIR HOIST.

boiler had been out of a great deal and the water left standing in it.

Water Flashing into Steam.

In the course of a discussion at the Southern and Southern Railway Club on "Useful Plugs for Fireboxes," Mr R. P. L. Sanderson, of the Norfolk & Western, mentioned a fact in connection with the law which keeps water liquid under certain pressures, which has very rarely been seen in practice. It is well known, for instance, that while water turns into

steam at a temperature of 212 degrees under atmospheric pressure, it will stand a temperature of 350 degrees before turning into steam when the pressure is 120 pounds to the square inch. These figures are a matter of calculation, and are rarely seen in operation except in laboratory experiments. In the remarks made by Mr. Sanderson he said: "I never appreciated the fact as to water flashing into steam until I watched it, when trying to wash the grease off engines with hot water, and I found we had nothing but steam a few inches from the nozzle, and we had to get pressure down below 100 pounds before there was any hot water when the jet struck the grease."

In connection with this engineers understand how much more disastrous a boiler explosion is when a large quantity of water has been in the boiler than where the boiler supply was short. Those who have given the subject most attention are well aware that a boiler carrying a large volume of water is much more liable to disaster, in case of anything happening, to suddenly reduce the pressure on the boiler, such as the fracture of a sheet or the sudden opening of a very large safety valve. When the sudden reduction of pressure takes place the water flashes into steam, and there is no doubt being many cases where this has caused violent boiler explosions.

Application of Air to Chain Hoist.

The accompanying illustration shows the ingenious method of applying a pneumatic cylinder to a differential chain hoist, recently patented by Mr. Howard Pedrick, general foreman of the Peirick & Ayer Co.'s shops, at Philadelphia.

As will be seen, the cylinder is the usual arrangement, except that the lower part of the piston rod is a heavy rack. This rack engages with the teeth of a forged gear wheel on each end of the gear wheel shaft there is a sprocket wheel carrying the usual chain.

The difference between the gear wheel and sprockets governs the length of hoist for a given movement of piston.

This hoist automatically retains the load and is desired height, regardless of the air pressure, this is done by a pawl that engages the rack on the piston. This pawl can be operated only by the air-valve cock

is disengaged when the pressure is on, or the valve is open, but once closed it is locked into engagement and can not be released except by opening the valve again. It will be readily seen that should all the air leak off, the load would be secure.

This hoist is particularly applicable to job arms, and other places where it is desirable to get considerable lift in short space. The crane shown lifts 5 feet where there is but 3 feet head room.

There are no stuffing boxes to keep up and no ropes to tie or wheels to block.

LOCOMOTIVE ENGINEERING

A BROADLY INTERESTING PAPER

325 Broadway, New York.

PUBLISHED MONTHLY BY
ANGUS S. AIR, Editor and Prop.
JOHN W. HILL,
Geo. W. WOLLASTON, Mgr. Advs. Dept.

Subscription Price.

\$5.00 per year, \$5.00 for six months, postage paid to any part of the world. Single copies, 15 cents. Remitt. by Express Money Order, Draft, Post Office Order or Registered Letter.

The editors reserve the right to use the material furnished for the reading columns, not entirely on a non-exclusive basis, but to be used in any of our departments, but not necessarily for publication. Making address care as changed as you wish, and we will promptly give you a new address, and if you are subscribed in a club state who got it and how you give prompt notice when your paper fails to reach you properly.

Entered at Post Office, New York, as Second-Class Matter.

For Sale by Newsdealers Everywhere.

NO BACK NUMBERS BEYOND THE CURRENT YEAR.

PUBLISHERS' AGENTS.

American News Company, New York
International News Co., London, England
W. Williams & Pick's Bldg., Melbourne, Australia.

The Difference Between Wholesale and Retail Train Robbers and Railroad Wreckers.

In most of the States there are laws meting out severe punishment to train robbers and railroad wreckers, and law on law, public opinion against the excessive fine and heavy jail sentences are caught red handed. But all this is for the cheap, poor, miserable robber or wrecker who only rucksles one train at a time, him of the triple, the mask and the six-shooter.

There are stringent laws against the retail robber and wrecker, the *wholesale* robber is protected by his law and his money and gets away with his fellow men is only governed by the measure of his success—the size of his bag of plunder.

The press and the public have been incensing blood, and many good citizens have predicted the destruction of the Republic, because the man who rucksled a few hundred cars during the recent disastrous strikes. The mobs destroyed, perhaps, a million dollars' worth of property. On one railroad alone, at the same time, a president and his officers suffered the amount of over \$2,000,000 and was at the time a receiver of the property, under the protection of the United States army.

Our laws favor dishonest management of railroad properties—else how could such men as McLean put his presidential hand into the Reading Railroad treasury to the tune of \$1,000,000, without suffering the punishment of other robbers.

The president of the Erie Co., Mr. Kleinhart, a receiver of the company, caused a loss of millions to appear as something else to deceive investors. His only punishment has been the necessity of resigning his position.

The facts of the matter are that most train robbers are some exceptions, of course are managed by men who have no ownership interests in the matter, and are often paid, usually—the enemies of the property, treating it just as a privateer does a captured prize, to be looted at leisure.

It is to the interest of every American citizen, more especially those employed by railroad companies, that the railroads should be well and honestly managed, that there should be constant development of the systems, and that the hampering legislation known as Granger laws, be stopped, and those already on the statute books be repealed. The people mistake the railroad company for the management—they are two distinct and separate things.

Laws like those in Texas, for instance, check railroad development (just what Texas needs), and increases the chances of gambling in Texas railroad securities. It is just as easy to make money on the "short" side of stock as on the "long" side. Let that pending legislation will make stock

cheaper, as to let that the building of new lines will make it more valuable.

A bill has recently been introduced in Congress that is intended to reduce these worthless rubbers from the ranks of arch-angels to common criminals, and if adopted as now worded, looks as if it might do something for the benefit of railroad security holders, railroad property and railroad employes.

Among other things, it declares criminal all violations of trusts in the management of railroad properties engaged in interstate traffic, such as selling securities "short," or the purchase in sale of substantial property for the benefit of railroad managers. Many a railroad has paid its own officers ten times the value of a "feeder" that it would did not need of want.

The bill seeks to insure honest elections of railroad officers by crushing out the "proxy" fraud—requiring every voter to meet on oath that he or she is the bona fide owner of the stock. It is customary now for officials in power to put their hands into the treasury and put up "margins" on stock, so as to get temporary possession of it to vote themselves into power again.

Every thinking citizen has before this recognized that the railroads are not private corporations, but public ones, whose operation affects all classes of people just the same as the functions of the postal system does, only on a greater scale. They perform public service on franchises granted by the public. This bill provides that there shall be government inspectors and accounts—just as there are government inspectors of banks, who shall make public, correct reports of conditions, resources, etc., of all railroads. This for the security of investors and the public.

The bill also makes a wise provision that prevents its own courts from appointing as receivers the men whose management have caused the receivership.

Not the least important provision of the bill is that one which requires the initiative in the prosecution of wrong-doers in railroad management to be taken by the public prosecuting authorities, just as it now does, for those who commit crimes against National defense. These defenseless stockholders attempt to draw the law's attention to the official criminal who has robbed them, they have their trouble and expense for their pay. When the Grand Jury and the prosecuting attorney have to take up these cases and the punishment is fixed, as the bill does, by it, at not less than \$1,000 and not more than \$20,000 fine, or term not less than one year nor more than five in the penitentiary, or both fine and imprisonment, it will be different. Criminally dishonest managers will be less bold, and there may come a time when railroad stocks will be good and safe property to own.

The bill seeks to fix one essential point, and that is to in-crease the responsibility of directors. In the Reading, Atchison and Northern Pacific scandals many directors have assumed that their skirts were cleared when they announced that they knew nothing of the acts of the operating officers. If true, it would be direct, and a provision should be made in the new law fixing their responsibility. Hundreds of thousands of dollars are yearly invested in railroad securities, because investors know this, or that director to be a good man.

Many interested parties will object to this bill becoming a law, offering as an excuse that it interferes with private rights, but it does not, it only seeks to enforce honest methods in handling the greatest and best investment of money in the country, wrecking. The honest railroad manager has no more to fear from this law than the law against robbing hen roosts. Only those who fear the light of day to shine on their methods will fit up their voices and smite upon their breasts.

Half of the reductions of wages of

the operatives of our roads has been the last squabble of such managements, or their successors, and an attempt to take out of the necessary expense of operation money to cover the shortage caused by manipulation.

With a ten thousand dollar-a-year freight agent in every city "making a rate" on every crate of eggs, every box of goods, paying rebates, and inviting bankruptcy, there is little show for the owners of the railroads.

The present disclosures of criminal mismanagement of railroads, has made the idea of governmental control of railroads, but sure it is, that in the hands of private enterprise our lines will be developed much faster than if they were in the hands of the general government, and anything that develops the railroads, develops the country—and that is a great necessity. Men who work for railroads should be as much interested in the prosperity of the roads as in their own fortunes—for one controls the other—and there should be no distinction between the employe on a train and the employe in the president's chair.

If the press who bewail the destruction of railroad property by mobs will but investigate more, they will find that the cash value of all the railroad property ever destroyed by mobs and strikers would not pay the legal rate of interest on the value of railroad property looted by its managers in the last year.

Honest men court honest, open, above-board methods—and God knows American railroad management needs some of this kind of sunshine. Only poisonous weeds grow in the dark. Let there be light.

Dangerous Improvements.

The above title was suggested to the writer while examining some coaches on a large New England railroad last week. The most dangerous improvement consisted of a small chain, one end of which was fastened to the handle of the angle-valve of the air-brake train-pipe, running diagonally to the rear of the steps, the other end was secured there.

This device was evidently intended to allow the trainmen to close the angle-cocks without getting under the cars—at first sight a handy little thing.

There are more reasons than one why this is a dangerous improvement.

In the first place, it increases the danger of the cock being accidentally closed a hundred per cent. It was found that the old, plain straight-way cock, with the handle standing at right angles to the pipe, would cock and did get shut accidentally by flying pieces of ballast, coal, etc., and the new angle-cock with the handle on top of the pipe and parallel with it was a better protection. Now this chain increases the closing of the cock if any thing strikes the center of the car and the rear of the steps, a stick, a loose track rod or what not may close that cock—and when the train refuses to stop, those responsible will say it was a "failure of the air-brakes," and honestly believe it.

In the second place, it is dangerous to equipment, because the temptation is great for the well-meaning brakeman to "pull the string and let the engine go" to "pull the hose in two" without uncoupling by hand.

In the third place, it don't do any good in coupling up, and the supposed good in uncoupling is dangerous. If there is any one thing that passenger brakemen and switchmen ought to do, it is to unhook the platforms, close the cocks and uncouple and hang up the hose *Ar hard*, take it down and couple it up.

We have had a great deal to trumpet that should have been charged up to carelessness in coupling hose and turning the wheels, and ought to regret to test the brakes before starting on a trip.

That little chain running back to the steps, where it can be easily reached by

boys and other curious persons to pull it, see what it does—it apparently does nothing, but in fact it does everything, and all looking in possible disaster, never to be safely forgotten.

It should be made more difficult, rather than less difficult, to close these cocks than to open them, or else opening one should set the brake train and there is.

The power to stop a train is of as much or more importance than the power to start it, and the means to that end should be the best in the world, the most carefully inspected and most jealously guarded. If your brakeman wanted to carry kegs of gunpowder in the smoking car or your children wanted to play with your revolver, you wouldn't listen to it—because you know either practice to be simply fooling with human life. Don't let any one juggle with your air-brake apparatus—it's loaded.

Diverse Experience with Draft Appliances.

There is no theme connected with locomotive operating that keeps itself so persistently before railroad men as the cause, which affect the free steaming of the engines. Given two locomotives of a boiler suited to the size of cylinders, fairly good fuel to burn in the firebox, and we are certain to have a free steaming engine, if the draft appliances are so arranged that the gases of combustion flow freely and evenly through the flues. This "if" however, is very important, for greatly diverse results are obtained on different roads with the same size of draft appliances.

We have repeatedly heard it said that accurately conducted shop tests of locomotives would demonstrate with precision what form of draft appliances were calculated to give the best draft with the least obstruction to the exhaust steam, and from that it would be an easy matter to establish a standard for all draft appliances. Standard draft appliances would be practicable only with equal of perfectly uniform quality, and all the conditions of train operating the same. Where train are light and run at moderate speed, draft appliances can be employed which would lead to delays for want of steam on roads where the trains and speed were kept up to the full capacity of the locomotives.

Mr. George Gibbs, mechanical engineer of the Chicago, Milwaukee & St. Paul, who has been employed a great deal making tests of draft appliances, while discussing the subject, asserted that there is a certain arrangement which is best for a given service, but it must not be inferred that all others are bad. The probabilities is that each road has for years experimented with and discussed the draft appliances which are standard on its own locomotives, and made changes until it has a fairly satisfactory arrangement for each class of service, fuel, etc. Discussion of draft appliances must not upon details. There are two main principles in which we are discussing the subject—the first being to obtain requisite steaming capacity for the locomotive under all conditions of service, the second to obtain maximum fuel economy. Steaming is the essential requisite.

The two requisites may not work out in one design. In the different elements which go to make up a successful draft arrangement, there are at least a dozen different conditions, any one of which has an enormous effect upon the efficiency of the device. If you change any one of these, you are going to injure or improve the steaming capacity of the locomotive.

There are some successful combinations of draft arrangements, but it is not surprising that experience has evolved a multiplicity of designs. Turning to personal experiences, Mr. Gibbs related particulars which appear very forcibly to every engineer who has experimented with draft appliances. He said: "Some years ago I was engaged in a great enthusiasm to figure out the best possible arrangement for draft appliances

locomotives, and it took me several months to come to the conclusion that I knew less than when I began." The remedy which he proposed for the inconclusive experience of draft appliance tests on the road was a series of shop tests.

A curious illustration of draft appliances that were successful in one place failing there in another was given by Mr. C. H. Trueman, engineer of tests of the C. & E. Road that Herr Von Borries, of the Hanover State Railway, interested the C. & E. in the draft appliances used in Germany. Drawings were obtained and an engine equipped with the German device. There was no haffle plate, and the nozzle was set high, reaching almost to the base of the stack. The best man to be found was assigned to the engine, but it could not be made to haul on a through train, even when the boiler was reduced. After a thorough test they had to abandon the arrangement. They put on a smaller stack, 13 inches at the choke, applied the standard haffle plate, lowered the nozzle so that the tip was only 3 inches above the center line of a boiler, and enlarged the nozzle from 42 to 44 inches. These changes enabled the engine to steam freely. Why, if the German railway people would not materially improve the working of their box motives if they made similar changes on their draft appliances.

The results of several years' experience are shown in another part of this issue, in the article by Mr. W. H. Thomas, the well-known superintendent of motive power of the E. V. & G. Co. at St. Louis. Mr. Thomas has undoubtedly found the best device extant for the conditions on his road but this does not necessarily follow that the arrangement would be equally successful under different conditions. The road under this writer's charge covers a large territory, however, and the fact that he is using the largest nozzle in the country has been noted for a long time, looks as if he might have struck a pretty good general average of a device.

Who Has the Best Cinder Pit?

Mr. Walter Berg, principal assistant engineer of the L. V. Ry., chairman of the Committee of the Association of Railway Supts. of Bridges and Buildings is sending out inquiries about cinder and ash pits, the substance of which is as follows:—
 "What system for dumping and removing ashes from locomotives is in use on your road? Give general description and the location, whether in a main track, side track or special track.
 "If a pit is used, give depth, clear width at length, and describe in general the kind of foundation, material in side walls and bottom of pit, coping, rail fastenings or supports, drainages, and the methods used to protect against heat.

"If a conveyor system, elevated platform with dumping trestle, or other method is used, describe same, giving principal dimensions, materials and details.

"What is the arrangement, location and height of ash-car track in relation to the pit or dumping track?

"What kind of coal is used? Does the choice or dimensions of a cinder pit system depend, to a certain extent, on the kind of coal used, and, if so, in what respect?

"It is particularly desired to obtain first cost of cinder pits and other systems for removing ashes, also the unit cost of operation (i. e., handling the ashes from pits to cars), and the output capacity of a pit or plant of given size.

We are especially desirous of obtaining prints of cinder pit systems in actual use on any railroad, with such remarks as you may wish to make as to the efficiency of the design, the reasons for its adoption, and any possible improvements you might have to suggest or general views to offer on the subject of the best system to recommend under stated conditions.

Of all the ingenious plans devised at our different roundhouses this committee ought to find something worth recommending; then if they could only make railroads that clean ash pans on the ground, and require their firemen to keep clean engines, adopt something decent in the pit line they will confer a real boon. Many and many a fine engine has been ruined by cutting driving brasses and motion work caused by the want of decent facilities for cleaning ash pans.

Mr. Eddy, Commissioner of Railroads for the Government of New South Wales, Australia, cabled that the picture of exploded locomotive boiler, shown in our July issue, was not a New South Wales locomotive, and that they had not suffered an explosion for two years. "The editors will have to take the blame of mislocating this engine," the photograph was sent us by a reader in New South Wales, with the simple notation "Just to show you how boilers sometimes 'let go' in the Colonies." We assumed that the "let go" occurred in New South Wales. It evidently did occur—the camera tells us we are, but it is doubtful over the fence in Victoria, Queensland or South Australia. We shall try to find out, as we have no desire to state anything but the truth.

BOOK NOTICES.

DISPOSAL OF THE AIR-BRAKE SYSTEM, THEIR CAUSE, SYMPTOMS AND CURE. By Paul Synnestrud. THE W. T. HALL PRINTING CO., CHICAGO, PRICE \$1.

This work needs no recommend at our hands, it has appeared in this paper in serial form during the past year. The book is most conveniently gotten up for ready reference, but not being independent and occupying no more than a page, thus avoiding folders and insets. The work is intended for those having repairs to make to air-brake apparatus, and illustrates and treats of old devices as well as new ones, and of all makes in common use. The ground covered in this work is different from that covered by any other publication, and ought to be in the hands of the author approved. It is well worth the price of any man's money who is interested in air-brake work. This work should be in the hands of every progressive engineer and fireman.

POCKET PRIMER OF AIR BRAKE INSTRUCTION. By W. S. ROGERS, M. E. Published by the author, Buffalo, N. Y. Price, 50c.

This little work was compiled by Mr. Rogers, while he was employed as air brake instructor of the Delaware & Hudson Railway, and is something odd in the instruction book line, following in no beaten track, and, therefore, very new. The author says several of what he calls charts to illustrate his ideas of instruction, but instead of being pictures they are composed of lists of essential parts of the brake apparatus so arranged that the relative parts shall be connected in the student's mind. For instance, the first one is as follows:

Compressed air	1. Source of	1. Pump capacity?
		2. Pump joint?
	2. Storage	1. Main reservoirs?
		2. Train line?
		3. Brake reservoir?
		4. Brake cylinder?
	3. Valves	1. Pressure?
		2. Quantity of volume?
		3. Quality?
		4. Position?
4. Time	1. Charging main reservoir?	
	2. Charging train line?	
	3. Charging auxiliary?	
5. Waste?		

He makes a question of every item and the subject matter in the book is intended to get the student's mind in a condition to intelligently understand the relations these parts bear to each other. The book contains some plates of engineers' valves and triples, and has special instructions to trainmen, inspectors, and others, each in his particular line. The book is worth its price to any man whose living is earned by working with air brakes in any capacity.

PERSONAL.

Mr. W. H. Harding has been appointed mechanical engineer of the Seaboard Air Line.

Mr. D. C. Frederick has been appointed car service agent of the St. L., C. & P., in place of Mr. B. L. Babb, deceased.

Mr. C. A. Swinegar has been appointed superintendent of the Route, Anconita & Pacific, vice J. J. McLaughlin, resigned.

Mr. H. W. Gays has been appointed traffic manager of the St. L., C. & St. P. R. R., with headquarters at St. Louis, Mo.

Announcement is made of the death of Mr. Morleau W. Jackson, founder of the Jackson & Woodin Manufacturing Co., of Berwick, Pa.

George Potter, master mechanic of the New York Central at Rochester, recently celebrated his sixty-fourth birthday. He was given a handsome clock by the men.

Mr. G. W. Conklin, master mechanic and trainmaster of the Bradford division of the Erie, has resigned and taken a better position on the Tonawanda Valley road.

W. A. Simsrett, the defaulting secretary and treasurer of the Switchmen's Mutual Aid Association, is believed to be insane. The association have denounced him as a defaulter.

George J. Loomis, an engineer and machinist, who helped to build the first locomotive made by the Michigan Central road, died at Ann Arbor, Mich., on the 28th of July.

Owing to the resignation of Master Mechanic Cahill, the jurisdiction of Master Mechanic Wenzel, of the Western division of the Erie, has been extended over the Bradford division.

We will be under personal obligations for life to every correspondent who keeps his letter within the length of one column. You can say an awful lot in a column if you dig out the unnecessary.

Mr. D. G. Mott, M. N. of the Panama railroad, at Astinwall, Col., has been spending a three months' vacation at and around his old home in Campbellton, Pa. Bunsawick. Mr. Mott learned his trade in Boston.

Mr. F. D. Adams, the well known M. C. B. of the Boston & Albany, favors our correspondents' column with a little light on the first inception of the M. C. B. Association, and places credit where it belongs.

Mr. Charles E. Turner, for some years past master mechanic of the Western New York & Pennsylvania, at Olean, N. Y., has been appointed superintendent of motive power of the Buffalo, Rochester & Pittsburgh, in place of W. T. Small, deceased.

Col. Edward H. Castle, who during the civil war was appointed by Gen. Fremont to be general superintendent of all western railway lines confiscated by the government for military purposes, and did very efficient service, died in Chicago on July 25, aged eighty-three years.

Engineer C. W. Kemp has run one engine—the "13"—on the Toledo, St. Louis & Kansas City road for 30,601 miles, without having her main rod brasses filed or out of the strap, and they were not "pounding" when she went into the shop. An engineer who can let his rod brasses alone for two years deserves a medal.

Mr. P. C. McNiven, formerly a draftsman at the Canadian Locomotive Works,

at Kingston, Ontario, died last April in South Africa, where he had been for over two years. Mr. McNiven was a Scotchman, and came to Canada from Dubs' works, in Glasgow. He was a member of the American Railway Master Mechanics' Association.

President Cleveland appointed as commissioners to investigate the recent railroad strike at Chicago—Messrs. Carroll D. Wright (U. S. Commissioner of Labor), John D. Kernan, of New York, and N. E. Worthington, of Illinois. This commission is in session as we go to press and is taking testimony from the men, railroad officers and outsiders.

Mr. H. O. Nourse, at one time the Chicago representative of the Standard Car Chair & Seat company of St. Louis, has again taken a position with that company in the railway and street railway department, and will have his office at No. 943 Rookery, Chicago. Mr. Nourse will retain his connection with Smith's Locomotive Fire Knifing company as manager.

Mr. Henry Deane, engineer-in-charge of construction of the government railways of New South Wales, Australia, called on us last month. Mr. Deane came to America via the Pacific, and has been looking over American railroad construction. He sailed for Europe on the 15th. While here he saw much of the great strike and was long delayed in the West by it.

Very few railroad men ever live to celebrate their golden wedding, either railroad work or marriage wears most of them out long before the fifteenth anniversary of the glad day. Mr. and Mrs. F. D. Adams, of New York, Mass. are therefore to be congratulated upon their celebration, which occurs on September 27, 1904. Mr. Adams celebrated his fifteenth anniversary as a car builder a long time ago.

Mr. Luther C. Challis, who died in Atchison, Kan., last month, was a western pioneer, a member of the first Territorial Council of Kansas. He built the first road west of the Missouri river—the Atchison & Pike's Peak, now the Central Branch of the U. P. He was instrumental, if not the chief factor, in starting the A. T. & S. P., and was at one time worth over a million. He was killed on Wall street, and died in poverty.

The car and locomotive departments of the Houston & Texas Central road have been consolidated, and Master Car Builder James McGee has been placed in charge as acting superintendent of motive power. This is one of the few instances on record where a man, whose experience has been entirely in the car department, has been given charge of the motive power. The M. M. swallows up the M. C. B. pretty often, and "turn about is fair play."

An engineer on the C. St. P. & M. T., sends us bulletin blue prints of their performance sheet that shows good service for a road in the West. We notice that for the whole system the engines average 30.7 miles per ton of coal, 32.0 miles for a pint of engine oil and 74.7 miles for a pint of cylinder oil. This is good service, and is doubtless due to the interest taken in the men and their work by the man in charge, Mr. John J. Ellis, superintendent of motive power of the system.

Mr. Timothy Hackworth Young died of consumption, at Sacramento, Cal., on July 21st. Mr. Young was an English mechanic of ability and a grand-son of the pioneer locomotive builder, Timothy Hackworth. Mr. Young came to America about 1850, and soon after took the position of master mechanic of a road in Costa Rica, S. A., but his health failed steadily and he

retired to the United States. He was division master mechanic of the C. & M. St. P. at Chicago until 1892, when he was selected as assistant to the chief of the transportation exhibits of the World's Fair. While in this position he engaged to go to Mexico with Mr. Johnstone, on the Central. While the writer was in Mexico this spring he met Mr. Young at San Luis Potosi, where he had charge of the machinery of the water service. He was not satisfied there, and had just engaged to go to California to take a better position under H. J. Small, of the S. P. For a man in such precarious physical condition Mr. Young was particularly hopeful and courageous.

The necessity for "doing as the Romans do while in Rome," was the cause of two seasons' accidents to engineers on the National Mexican road recently. Everywhere in Mexico "packs-guns," and out on the road the mickel-packed handle of a six-footer sticking out of the hip pockets of the trainmen causes great deal of respect for persons and property. With very few exceptions the men carry revolvers. One day Engineer J. Cabell Smith arrived at the station at San Miguel, and backed his engine into the roundhouse track. He was looking out of the side window when he noticed that at the same time taking a walk on the platform of his seat box, a man's revolver was accidentally discharged. The ball struck him in the chest, and he was not out of the car until he was taken to the hospital. Engineer Dick Smith also had a narrow escape from the same fate when he stepped in his revolver in a box car, and, as he was in a very bad state of nerves, he was not stating anything to his friends.

Mr. J. R. Andrews has been appointed superintendent of the Atlantic Avenue Railway, in Brooklyn. This is the oldest street car line in the world, having been in operation for thirty years, and was one of the first steam roads to change to electricity. Mr. Andrews, though a young man, has been employed on several lines of electric railways, from fireman up to assistant superintendent.

Jeffrey's Years on One Locomotive.

Engineer Jefferson B. Clark, "Jeff," as the boys call him, recently delivered his engine to the Depue shops of the New York Central to be cut up. The engine, "the '94," was built in 1870 and was named "Burrows," after the well-known division superintendent of the Western division, who has recently retired from service. Mr. Clark took her in 1880, and ran her steadily until now to be exact, thirty-five years, two months and twenty-five days. Of course the old engine is not in the best of health, but she has been running for many times, but she and Uncle "Jeff" stuck together like lovers.

Everybody on the Auburn road between Buffalo and Syracuse knew Clark and his engine.

The officials offered the old-time engine on the old man, but he had been laying off since he lost the '90, and must feel something like a widow.

This is the longest case of "keeping his own engine" we have ever heard of.

At the last meeting of the M. C. B. and M. C. Associations, the land gave a Sunday concert in the Park, at which a collection was taken up for the Fresh Air Funds of the Chicago Daily News and the New York Tribune. Each of these funds received the sum of \$374, for which the chairman, Mr. F. W. Coulter, held receipts.

The relief of sick children by these two funds is a worthy charity and helps, every summer, something like 300,000 children and mothers in each city.

All the general offices of the Pennsylvania Railroad have been moved to the new station building on Broad St., Philadelphia. This is now one of the best, if not the very best, terminal stations in America.

A Successful Rival.

There was once upon a time, and that time was not so very long ago, a general supervision look on the East Tennessee, Virginia & Georgia Railroad, who was famous in those parts, and even in adjoining states as a snorer. Local gossip said that this railroad superintendent was compelled to choose a residence in a thinly settled part of the city, because he was afraid that the neighbors might raise a riot as a slight protest against the uncharitably noises which he created while engaged in his nightly slumbers.

We do not know whether it was that he is not in an atmosphere of other noises or not, but this superintendent was much given to traveling at night in his disposition, he liked to have a social disposition, he liked to have division superintendents, paymasters, master mechanics, car builders and other officials to hear him company. His accomplishments as a night warbler being well understood, there was general consternation among the night men. The porter in charge, who understood the situation, looked in at a spirit similar to the Moguls of India, at state dinners.

Madras, in the early days of British-occupied India, was terribly infested with mosquitoes, and it was almost torturous to sit through an evening at one of the prolonged state dinners. The porter who understood the situation, looked in at a spirit similar to the Moguls of India, at state dinners. Madras, in the early days of British-occupied India, was terribly infested with mosquitoes, and it was almost torturous to sit through an evening at one of the prolonged state dinners. The porter who understood the situation, looked in at a spirit similar to the Moguls of India, at state dinners.

Now, the card says that Mr. E. M. Roberts was appointed master mechanic of the road at Atlanta. The sardes of his new office had scarcely touched his head when he was invited to go out with the general superintendent on a tour of inspection. There was a very pleasant party out of it. They spent a very pleasant social evening at Mr. Roberts' story telling qualities went with great appreciation from his fellow officers. But the best of good things must come to an end. Stories were banished, anecdotes laughed over, and reminiscences ended by a call that it was time to go to bed.

Mr. Roberts was gently ushered into the general superintendent's stateroom, with the information that the extra berth was for his accommodation. Not a word was said about the snoring accomplishments that he was about to be introduced to. Everybody retired to rest, after a brief session, the usual noises proceeded from the general superintendent's room, and the others were wakened about five o'clock by the new superintendent of motive power was having.

In the morning the general superintendent walked out into the observation room, and no one had ever before seen him in such a d-d-tion condition. "What's the matter?" inquired the stateroomer, with anxiety portrayed on his face. "Are you sick, Mr. General Superintendent?"

"Sicks! No, I am worried out. Haven't had a wink of sleep all night."

"What was the matter?" inquired several. "We thought we heard you sleeping."

"Matter? I couldn't get to sleep for that master mechanic's snoring."

"You kept from sleep by anyone snoring, Mr. Superintendent. We always thought you could look after anybody in a case of that kind."

"So I could, generally, but Roberts took a mean advantage of me. He got to sleep first."

Those English Engines in Mexico.

Mr. Henry E. Walker, superintendent of motive power of the Mexican Southern, says the J. P. mangled the truth in some of his statements about his engines, and after a perusal of his very fair and good-natured letter the J. P. owns up that he must have been mistaken. Mr. Walker did not say that the majority of the American engines were broken, and the writer remembers that he had been talking about repairs before, and on this subject Mr. Walker wishes to be quoted correctly, and says: "You say that I think the American engine is adapted to the work and that the English is not. I must emphatically deny every word of such a statement. An engine better adapted to the work they have to do than our Kison Class A engine it would be difficult to find. A photograph of this engine was given in your issue of September, 1893. The American locomotive is certainly the handier to do repairs on, but as a piece of machinery she is not out of the world with the English make. My locomotive performance sheet shows that during the past year the cost of ordinary running repairs was for three Baldwin locomotives 3.35 cents per kilometre, and for fourteen English locomotives 2.06 cents per kilometre (Mexican currency). One of the gunboats which you deery has been working continuously for the past nine months after a general overhaul, and her running repairs during that period have cost only 1.27 cents (Mexican currency) per kilometre. I may say that the total cost of repairs last year including all back-shop work, averaged for the seventeen engines 5.04 cents (Mexican currency) per kilometre, equal to 8.40 cents per mile (1.05 cents gold)."

Mr. Walker also says those steam pipes on the "gunboats" are 3/8 in., and that the exhaust pipe does not go nearly straight across. The J. P. evidently had all the faults found on the system to the "gunboats"—and the half were never told—but the aforesaid J. P. will hold up his head to find and swear that there are engines there or thereabouts with the exhaust pipes that do "go nearly straight across."

We had no desire to misstate, and honestly tried to be accurate (and easy) about those "gunboats"—they are awful examples. We agree now, as we did in the article, that those little Kison ten-wheelers are all wool and a yard wide.

Report of the Proceedings of the American Railway Master Mechanics' Association, in its twenty-seventh annual convention, held June 18th, 19th and 20th was sent out July 25th. It was issued one month after the close of the meeting, and it is very quiet work, especially when it is known that, owing to a mistake in joining cuts to the Railway Age, they were sent to Chicago and lost in the strike riots—every one had to be made a second time. Angus Sinclair, the secretary, worked night and day in compiling the report, and the printers got into a similar hustle themselves. The report contains 116 pages besides numerous insets. The subject matter is very interesting and the typographical set-up about the average.

The fourth biennial convention of the Grand Lodge, Brotherhood of Locomotive Firemen, will meet at Harrisburg, Pa., on September 14th. Something over five hundred delegates meet at these conventions, and a good time is always had. The present convention will have plenty of work before it. The order has done a world of good—and it is not through yet.

There are considerable many inquiries about locomotives and rolling stock gone out, and quite a number of roads are on a still hunt for "rock bottom" prices, etc. Almost everybody says, and if those who say so, think so and act so, better times will have.

EQUIPMENT NOTES.

The Calumet & Blue Island is in the market for engines.

The Seaboard Air Line is in the market for ten locomotives.

The Reading shops of the P. & R. are running double time.

The Erie is having one hundred cars built at the Buffalo Car Works.

The Cooke Locomotive Works are working on some Government orders.

It is said that the Wisconsin Central will buy two complete vestibular trains.

Baldwin's have an order for three locomotives from the Elgin, Joliet & Eastern.

The Indiana, Illinois & Iowa are reported to be in the market for two or three freight engines.

Robert Hardie is building a compressed air locomotive at the Rome Works street car service.

The Illinois Central are in the market for six new cars—fruit, refrigerator, box, stock and coal cars.

The Atlantic Avenue Electric road in Brooklyn, now runs mail cars to the suburban towns on its line.

The Falls-Hollow Stay Bolt Co. writes us that their mill is running full time all year, and that they are therefore ready to deliver at once any order.

Mr. Webb, of the London & North-Western, has just turned out eight new three-cylinder compound engines of the same class as the "Queen-Empress" shown at the Fair last year.

Locomotive building is on the pick-up. The Brooks Works, at Dunkirk, have completed two for the Toledo & Ohio Central. Eight engines will be begun at once at Altoona for the Pennsylvania road. The Y will be of the "Class R" type.

The Rogers Locomotive Company are at work on fourteen engines for Cuba—ten having just been shipped on a previous order. They are also building one engine for a private concern in Brazil.

The East & West Texas railroad which has just been widened from narrow to standard gauge, has received six passenger coaches, two baggage-cars, and four express cars from the Hatney & Smith Co. Company, of Dayton, Ohio.

The Ajax Metal Co., of Philadelphia, Pa. have rechristened their anti-friction metal, formerly known as Ajax White Metal Alloy, the new name being, "Ajax Metal." They publish the proper formula for mixing their metals for different purposes.

During the war there were many men employed as engineers and machinists on the military railroads of the United States. There is an attempt being made now by a few of these old-timers to get together, talk over old times, etc. Who are they? Write to this office.

Maxim's steam flying machine recently broke the track above that he held it down, being a passenger with, and a foot in the air with three men on it. They were not ready for business, and the machine came to grief. This machine has a 30-horse power engine, and has proved that it can hit itself into the air. Humanity will navigate the air yet.

Practical Letters

from Practical Men.

Write on one side of the paper, state your point plainly and briefly, and then quit. We supply the generalities. No letters noticed unless name and address are annexed.

Facts Wanted.
There's a glut
of Opinions.

Who First Suggested the M. C. B. Association?

I am extremely sensitive, and very much like to see justice done in all cases, and I am well aware that comparatively few of the present membership of the M. C. B. Association have any definite knowledge of the real origin or who was the first man to suggest the idea of a national organization. While Mr. Kirby is certainly entitled to great credit in the early work of the association, and Mr. King and myself are the only living members who were at the meeting mentioned in your article on page 234, July number, excepting Mr. J. H. Van Houton and John P. Lavan, of the Penn. R. R. They were sent there to Adrian, by their representative, Dr. Williams, to see and meet our acquaintance and learn what the objects were that called us together. The idea of anything beyond our own line, viz., New York and Boston to Chicago, had not entered the mind of any of us until after listening to our discussion as to the needs of Red Line cars, which then was the only through line organized. Mr. Van Houton asked the liberty to speak, and of course we were pleased to hear him. He talked at some length, expressing himself pleased with the discussion and object, etc., and said that while listening to our discussion the idea came to his mind that it would be a grand thing to call together the car masters of the United States and Canada to form themselves into a national association. He said he hoped before we adjourned we would take some action in this direction, and further suggested that we instruct our chairman (Mr. Kirby) to issue a call to all the M. C. B. to meet at some time and place, we might agree upon. This was done unanimously, and I claim that to Mr. J. H. Van Houton, now in charge of the Penn. shops in West Philadelphia, belongs the honor of first suggesting and organizing the M. C. B. Association. Let doing be given to whom it belongs. One other mistake I see. Mr. Kirby held the office of president two years instead of one.

I write this, thinking you, as well as many others, are not fully posted as to all the early experiences of the association. The present members would hardly recognize it in its early days.

H. D. ADAMS.

"One of the Handy Tools."

Editors:

Inclosed please find sketch of one of the handy tools for shop and household use. Which I think you will not be generally known for its merits of usefulness to many.

Fig. 1 shows side view of screw clamp *A* with key *B*, and gib *C*, with section of eccentric rod *D*, or piece to be bent, straightened or twisted, as the case may be.

Fig. 2 shows top view and method of application to eccentric rod.

Fig. 3 shows end view of screw clamp and side view of eccentric rod, etc., and the several positions that gib *C* can be applied to straighten, bend or twist eccentric rod *D*, or other work.

Fig. 4 shows perspective view of screw clamp and method of application.

Fig. 5 shows how an eccentric rod or any other rod should be offset by two leads.

Fig. 6 shows screw clamp *A* without key *B* and gib *C*, and used as a spring puller that will pull.

For hanging links and putting up eccentric rods on locomotives, this device is in-

valuable. There are many ways and customs of doing this work, and they are all attended with the usual awkward, unhandy and time-killing ways of getting at them, such as taking down and into the blacksmith shop to have an offset put in them of an inch and a half or so. Also taken down and peened on the rail also a sledge held on one side and maulled on the other side with a sledge, and more likely than not break off the head on the eccentric strap by so doing, all of which is unnecessary and unmechanical, and in these exciting times we might say un-American. With this device the eccentric rods can be offset, straightened or twisted in a very short time very easily without taking them off the eccentric straps. I have seen eccentric rods bent and twisted in the middle to

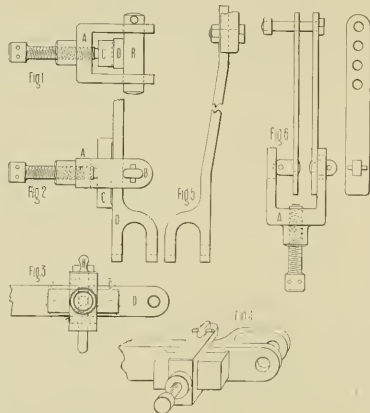

A HANDY SHOP TOOL.

get them into position. This should never be done under any circumstances, as it spoils the rigidity of the rod and will cause it to spring, and the eccentric or link will run hot. Any such rod, where tension or rigid resistance is required, should be offset or bent only at the extreme ends (see sketch, Fig. 5), and the middle of the rod maintained as straight as possible.

If the jaw of an eccentric rod should be twisted, and not come up square to the link, place the clamp on close to the jaw, as Fig. 2, and put gib *C* on a slant, as Fig. 3, dotted lines, and tighten the screw by the end of a small steel bar, and the twist can be thrown at will.

Fig. 4 shows as throwing the jaw from the point of jaw to you, put the gib *C* the other side of the rod against the key *B*, and leaving the clamp in the same position, turn the screw against the rod *D*, and if any twist is desired, slant the gib *C* up or down, as the case may be (see Fig. 3 at *C*), and proceed with screw and bar and throw point to, and the twist, as desired, is out at the top at the same time.

We will now suppose that a jaw is cramped rigid on the link sufficient to stand alone in its place without the bolt,

now put a 1/4-round stick of brass or copper in the bolt hole, to keep it from falling, put on the clamp the way you think is necessary to relieve it. Now, as soon as the rod tension is given in the right place, the jaw will fall free on the brass, and be free on the link, and this is the quickest possible way to find what it wants. Now give the screw a little more tension, as the rod will spring back some, and you have it, O. K.

The clamp can be used on many parts of an engine, such as rocker arms, tumbling-shaft arms, reach rod, valve rods, hand rails, pilot brackets, run-board brackets, etc., without taking them off the engine; it also can be used as a spring puller, but should have another and longer screw for this purpose. Take two pieces of 3/4 x 2 1/2 spring steel, any length necessary, anneal it, and punch a series of 7/8 holes in one end, and one hole in the other, to rivet in log (see Fig. 6), to fit key way hole in clamp, and you have a spring puller that will pull.

It can also be used to clamp dies for bolt machines, to drill and plane small boxes to be drilled, etc., keys, etc., numbers of small pieces of the same size to be drilled,

the difference. The pressure reduced slowly, but the gauge did not show it except when the engine was running, when the vibration caused it to register more accurately.

I confess I am somewhat at a loss to answer the criticism on the tender brake, because it seems to be based on a peculiar misapprehension of the purpose for which the cut-off valve was inserted. It also appears that Mr. Helmes does not read the drawing correctly.

Throughout his calculation is based on the incorrect assumption that the end to which the hand brake rod is attached is the fixed fulcrum of the front cylinder lever. More careful examination of the cut-off valve shows that the angle next, which supports this lever (the angle next the triple valve), has a long slot in it for the purpose of allowing a pin to travel forward when the hand brake is applied, and it is this pin which is the fulcrum in applications by air pressure. The distance from this pin to the point at which the cylinder tie rod is connected is equal to the distance that corresponds to it on the other cylinder lever, thus equalizing the power on both trucks. As to the calculation in regard to the brake beam levers, it is to be noted that the cut indicates clearly that they are shown at an angle, or as it were in projection, in view of which they cannot properly be used as he suggests, nor was that the intention; the purpose of the illustration being only to show the general arrangement or disposition of the parts, and not the proportion of levers, as that must or should be figured out in each individual case, the same as is done in equipping cars.

PAUL SVENNERUD.

Chicago, Ill.

Critical Comments of the Prize Designs—Their Faults.

Editors:

Permit me to say that in the prize designs shown in your August issue, one of your conditions appears to me to have been only partially complied with—the safety of engine crew and of the traveling public in case of accident. In your prospectus (if I may call it so) mention was made of the wreck on the Colorado Midland, where a boiler check was knocked off and passengers were scalded to death. The story of a fireman was also related, found with steam pouring from mouth and nose, caused by the penetration into his body of the broken end of a steam gauge pipe.

Prize Design No. 1, excellent as it no doubt is, shows checks outside the boiler, and though not quite so liable to be knocked off as if placed on the side of the boiler, still they are liable to be cracked down or broken off in a rear collision. Their protective value over the same kind of check on the side is only slightly greater. The turret from which steam is drawn has a thin neck, and would presumably break at the thinnest part. The scaling of the fireman mentioned above still quite possible, because the turret did not break off, the steam gauge pipe, if broken, would continue to pour out live steam. For the matter of that, so might the injector steam pipes, blow pipe, air-pump pipe, lubricator pipe and steam-heater pipe, bell ringer and any other pipe that has its origin in the boiler. The turret was broken off at the thinnest part, it would still leave the wings of the protecting valve exposed, and though it might hold the steam in the boiler, yet a blow from an falling piece of debris, occasional while extrating passengers from a wrecked coach, might easily open and cut through the wings of the protecting valve, so permit the escape of steam and water.

Prize Design No. 2. The same objections appear to me to apply here also. Unless the turret is actually broken off the safety appliance would not come into play at all, and the chances of the most useful action of the valve are still further min-

Tupelo, Kan.

A. P. GOODRICK.

Figure Wrong.

Editors:

In reply to Mr. Helmes' article, in your August issue, permit me to say a few words. He agrees with a statement I made in a former number, that the rings of the equalizing piston in the latest engineer's valve are seldom tight it is not necessary to have them so, but says he has seen valves which, with the handle on lap, would not indicate train pipe reductions on the gauge to any appreciable extent while the engine was standing still, but did better while running. I have also seen valves which were tighter than the one the test of which I cited, but none as tight as he seems to have found, and I am inclined to the belief that the gauge, more than the valve ring, was accountable for

isal is protected piston selected for the turret. If the turret was broken off and the protecting valve closed the steam passage, still the exposed wings of the valve are liable to accidental contact with debris and wreckage with the same fatal result as is now possible in ordinary American locomotives.

Prize Design No. 3 would be quite as desirable in an evolution as are the ordinary unprotected engines in use to-day, because if any of the globe valves which are attached to the auxiliary door were broken off, say by a passenger coach being thrown upon the locomotive, the steam and water would escape as readily as it can now from the unprotected engine in common use. The throat arrangement might be an additional source of danger in case of collision. Even if the engineer had shut the throttle at the first approach of danger, it could be opened by the upright arm striking some projecting obstacle and so turning live steam into the steam chest and perhaps into the boiler as well, through the broken opening of air-valve, broken cylinder cocks, or perhaps broken cylinder cover, steam chest, or cylinder.

In none of the designs have the safety valves been protected externally by a strong shield, in case the engine turned over in a wreck, and an explosion took place, as so fearful a menace to life as any other of these deadly openings. I have called attention to these matters, because there is one fact that must strike the careful observer, not only of these designs but of your Educational Chart No. 2—one of the finest, if not the finest, American locomotives of today. It stands there unscathed, surrounded with the least improvements for the protection of life and limb. We placed switch or a moment of forethought might convert this useful machine into the most fearful messenger for announcing death for locomotive runters, engineers and travelers. Halt the fatalities of railroad wrecks, and more than half the fatalities can be prevented if the steam can be kept in the boiler. Mr. Editor, will these designs do it?
(Hudson, Ont.) G. S. HORGAN

We have received many letters about the prize designs, serious, sarcastic and funny, and as we can not publish them all, we select this one as being the best. It is not our intention to fill these columns with arguments and opinions about these designs. We offered quite a large sum of money, \$50, for a prize to induce men with ideas to bring them out, left the matter to a committee, who did their work, we are sure conscientiously, and we paid the money without a quibble, and if not an and. We do not think any of the designs offered were of any particular value to railroads. Few of them presented original ideas that came within the bounds of reasonable possibility. The winners were common-place designs departing very little from the ordinary practice of the country. As pointed out by our correspondent, any turret affair with a so-called self-closing cock is a delusion and a snare. The self-closing cock is never shut except in an accident, and then won't close tight, and as we can't get the valve to close in the turret, or in any pipe may break and let us try to get to close the valve, doing all the damage that is possibly to be done. There is a chance for a good invention in the turret line, one that will close in an accident, *whether broken or not*. Checks should be taken off the side of the boiler, and we believe they can do less damage if placed on the boiler head, but inside checks are full of grave disadvantages. Safety valves and globe oil cocks are a source of great danger and need greater protection. To those who are disappointed, let us say: Don't write letters, but send in details of suggested improvements of our designs, and we will judge ourselves, and if of benefit to the germ of an idea in them we will gladly publish them. The contest has had one

good effect, it has started a lot of bright men to thinking on this line, and in time a great improvement will come out of it.]

Tool for Finishing Solid Rod Cups.

Editors

The question of securing oil cups to the rods of locomotives in such a manner as to prevent their loss has been a perplexing one to many. In the ordinary manner they are secured either by an independent keeper on the inside of the cup, or the cup

This tool will be found useful for other purposes. For link hangers, where no lathe is at hand large enough to swing them or milling machine to shape them up, and for many other purposes that a wide-awake mechanic will be apt to find. To those who desire a cheaper tool, it can be had by making the sleeve $\frac{1}{2}$ stationary and feeding with the ordinary feed of the drill press. This method will require more adjusting of the tools and will be found less satisfactory.

If for any reason it should be desired to finish the outside of the oil cup first it can be done by simply drilling a small hole, say $\frac{1}{8}$ inch, in the top of the oil cup to receive the fit K , which will act as a guide and support for the tool. This tool can be secured to the spindle of the drill press by a set screw, or by the device suggested by Mr. Bingley in May issue. I can say the device is an excellent one, as I used one similar to it a number of years ago on some six-spindle out-tapping machines, in that case I had a spring to release the key when the collar or sleeve was raised, and a stop to prevent the sleeve being raised too far, this arrangement being necessary from the fact that the spindles were not sloped.

Reading, Pa. F. M. ARTHUR

Cutting Quadrants.

Editors

Almost every part of the modern locomotive is a development of something similar, a steady growth, an evolution.

A few years ago the average quadrant for locomotives had six or eight notches in front of the center and three or four back of it. Now most of them are filled as full of $\frac{1}{2}$ -inch notches as they can be from end to end.

It has taxed the ingenuity of more than one mechanic to devise ways of cutting these quadrants, so the latches—which necessarily wear fast—can be kept in stock and be sure to fit any quadrant out.

The following is the way that we took to accomplish it. I would say that it does the work well and quick. We have no lathe, so we used a turret lathe for the milling machine, so we curved to the slotter, but that has a table with only $\frac{1}{8}$ -inch radius; our quadrant with smallest radius is 24 inches and largest $24\frac{1}{2}$ inches, and we could not get the center of the table far enough away from the tool by 14 inches for smallest, to say nothing of the largest. What we did was to have a

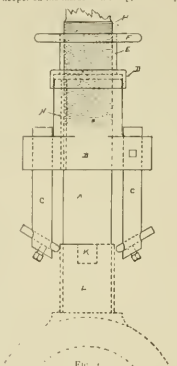

FIG. 1.

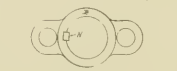
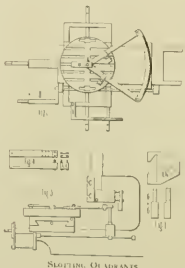

FIG. 2.

is made with a stud in the bottom to screw into the rod. The difficulty has been to so secure the cup that the engineer in screwing it on, or unscrewing the top, often with a wrench, will not loosen the cup, and consequently lose it; by jarring out after a short run, or in cup where the oil is supplied without removing the top the cups often get loose and are lost. On some roads this continual loss has been partially remedied by forging the cups on all new rods. The use of solid cups would no doubt be extended were it not for the expense in fitting them up. As some suggestions in this line would doubtless be acceptable to many, I submit the drawing of a tool I have found to be very convenient for this purpose.

Referring to the drawings, Figs. 1 and 2, the cup is a flat rod forced on the rod. This is first drilled the diameter and depth desired. The tool consists of a spindle A of the diameter of the hole in oil cup (if more than one size is used, bushings to fit on the spindle will be found convenient), on which is a movable sleeve carrying two steel rods to which are attached the cutters. The spindle A has on its upper end a left hand thread, and on this a bush to which is secured a star wheel, too turned by a pin secured to the drill press in such a manner as to turn the star wheel one point each revolution of the spindle. The bush to which the star wheel is secured is fitted to the left hand thread, and on its lower end has a collar bearing on the sleeve B , to which it is secured by the nut D , then, as will be seen a movement of the bush E will cause a corresponding movement of the sleeve B , carrying the cutters. The key N prevents the sleeve B from turning.



SLIDING QUADRANT.

block forged, and shape shown in Fig. 1, and fitted to cutting bar and held with one bolt and turned inward throat of machine. There are three 2-inch holes through it, with set screws on one side. The post for holding the tool is $2\frac{1}{4}$ inches in diameter outside the block and fits in the 2-inch hole, filed flat on the side where the set post of the way. We then made an angle piece to put on screw, so as to get the feed gear out past where the table would come. We also had to change the nut on

screw. This was easily done by drilling two new holes for the bolts that held it on. We now have the center of the table back far enough for all purposes to hold the quadrant, which has all been planned to thickness. We take two bars of iron, $1\frac{1}{2} \times 2\frac{1}{2}$ inches, the length of radius. Through one end drill $\frac{1}{8}$ -inch hole, to fit on pin that has been put in center of table. One of the bars will have to be bent so that they will both be on the pin and level at other end, in which holes have been drilled same size as ones in firm on the table.

Take an old binder, plane one side level, put a block on the end to be planned to the same level as the ways, through center drill $\frac{1}{8}$ -inch hole, turn a piece of iron to fit and cut off just long enough to touch quadrant, as in *J*, Fig. 3. Work on two quadrants at one time, the first move will be to trim off the outside in the exact radius.

To space the teeth take a gear from one of the tables in the mill, take its shaft with it, that resolves matter, if you find it, make a sleeve so that it will. Make piece as in *H*, Fig. 2, this is to set gear by. Now, by knowing how many teeth it will take on the gear to one on the quadrant you will be ready to go to work.

Find out how many revolutions of gear to turn the table one: multiply by number of teeth in gear. This will be the number of teeth in one revolution of table. Find exact length of circle with radius of your quadrant. If the quadrant teeth are to be $\frac{1}{8}$ inch, get it in eighths, divide by three and you have the number of teeth. Divide the number of gear teeth by this, and you will know how many teeth your gear will have to be moved.

We have turned four and cut fifty teeth in two quadrants in ten hours.

To cut latches take bar $1\frac{1}{2} \times 6$ inches, long enough to put block on one end to hold the latches, the same as they would be on the reverse lever, Fig. 4. One plate will do for all lengths.

W. A. ROBERTSON.

Cedar Rapids, Iowa.

Air Brake Instruction Kinks.

Editors

An air brake instruction card is a good thing to have, in fact it is necessary on any system that has over two engines. But we can't all have one, they cost lots of money, first and last, some of us without any facilities at all except sectional valves and instruction books can have a temporary one that can be used in fire, whether using material already on hand.

First get the consent of the M. M. Then secure a good double-hand gauge, and a small size single-hand one with $\frac{1}{4}$ -inch fittings for pipe connections. Get four or five elbows, three or four nipples or short pieces of pipe about 2 inches long, one quarter—all $\frac{1}{4}$ -inch gas pipe size—some bushings to fit cups, $\frac{1}{4}$ -inch pipe into $\frac{1}{2}$ -inch holes and one $\frac{1}{4}$ -inch pipe into $\frac{1}{2}$ -inch hole and one $\frac{1}{4}$ -inch rubber hose 12 inches long, and ten pieces of $\frac{1}{4}$ -inch pipe 6 and 8 inches long. Take out the plug in the front head of 10-inch brake cylinder on opposite side from where $\frac{1}{4}$ -inch pipe leading to auxiliary is coupled, and couple one connection to the double-hand gauge into this casting which has one $\frac{1}{4}$ -inch hole bolted to, using piece of pipe 8 inches long, one elbow and suitable bushings—gauge will stand right side up. This will show pressure in auxiliary and above triple piston. Use the piece of hose, two nipples and union to couple the other connection of the gauge to hole in check-valve case No. 13, then draw plug, connect valve case No. 13, show the pressure in train line or below triple piston, both pressures showing on the one gauge. Then couple the small gauge to the brake cylinder at the double-hand gauge hole, this will take two $\frac{1}{4}$ -inch pipe, one 6-inch piece of pipe, one nipple and suitable bushings. The next is to bring the small gauge just over the double-hand one, so both can be seen at

once and right side up. This rig described is for a quick-action passenger equipment, the same gauges and connections can be used on a freight car, only it will have to be coupled to draw-pling in bottom of auxiliary reservoir, as that is the only place handy to get auxiliary pressure. With this rig, of course, you will have to use an air-brake engine for an hour or two while "showing how she works." That don't cost much, and the "old man" won't kick very hard when he finds out what you want to use it for. To make it still more handy put a spare hose on each end of a piece of 1/2" pipe, so the car can man along, and with call window opposite gauges so that the man at brake-value on engine can see gauges on triple, that way he can see what's going on as well as in an instruction car working one brake—the piece of pipe and spare hose breaks from tender, has one track to car-hose on track alongside.

Very you have tried this rig on a coach east or twice, and found how handy it is, you will get on to other ways to couple it up, and couple other cars to be one with gauges, but the double hand gauge should be used to show the pressure on each side of the triple piston. With this arrangement, a great many accidents can be proved, or shown to be mistakes, for the gauges show just what is going on all the time. All the connections can be made with hose instead of pipes, but it don't seem to work as well if you get the gauges very many inches from the triple.

One thing will surprise you, that is, most times some of the brakes take to lock off who the car-regular pronounce them O K and holding good. With this rig the operation of the quick-action part of the triple-valve can be shown very plain.

Draw the train line pressure down suddenly about to pounds, put the brake (back on lap, you will first see the hand on the train line pressure at triple come down moderately fast. When emergency piston gets its work in, and opens valve on the hand will take a second drop, and as a flash, showing the reduction of train line pressure by air going into brake cylinder, and the small gauge attached to brake cylinder will fly up to full pressure quicker than the eye can follow all of them at once.

You can also show the loss of auxiliary, and consequently brake piston, pressure after setting and releasing brake three or four times (or one station stop).

About the third time it is set, you have only 35 pounds out of 70 to begin on, it will show that a reduction of 30 pounds out of 70 will generally set all the brakes on good order, with proper piston travel, to full pressure, and also show what to do to hold a leaky brake up to its work till the repairer can get it fixed.

To be sure the men that have instruction cars all fitted out in good shape will turn up their noses and brag up "our car," but that don't give you any chance to learn how-bearing them tell of their advantages.

Get at it yourself, put on the gauges some day, when you are laying out at the end of the division for the four or five hours that you have to yourself, and you will be surprised at how much this temporary instruction car will show you.

It will show you what some instruction cars won't; just how brakes work that are in actual service stopping trains, and how they work when pushing out against levers and brake beams, instead of the steel springs in cylinders set in trucks. This kind is not a new one, by any means, but it may be new to some of the readers. Try it—"seeing is believing."

CLINTON B. CONGER,
Grand Rapids, Mich.

Simple Device for Putting on Hose Fittings.

Editors:

The fittings of air and steam hose will outwear the hose to which they are attached, and it is necessary to force the hose on them when re-coupling. This is not a very easy matter unless some device is at hand to

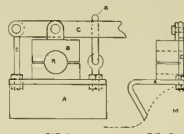

FIG. 1

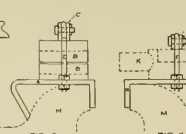

FIG. 2

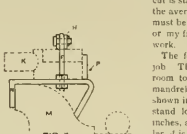

FIG. 3

SIMPLE DEVICE FOR PUTTING ON HOSE FITTINGS.

hold the hose and fitting while they are being forced together. While there is no doubt a number of useful devices for this purpose, the one shown at Figs. 1, 2 and 3 has proved to be very satisfactory work. This device is used in connection with a vise, which is the means used to force the hose on the fitting, the rest of the mechanism merely holding the hose and fitting in position. The plates A and A' are made of 1/4" or 5/8" boiler plate bent to shape, as shown, so that the upper surface is level. The clamps B are of wood, of sufficient size to allow a hole through them large enough to take in the hose. The top piece is secured to the lever C by means of an iron yaw and pin. The lever is secured to the fulcrum D by a pin, so it can be thrown back or ranted to allow the hose to be placed in position between the blocks. The coupling is held in position on the plate A by means of the lever H, connected to a block and fulcrum I, manner similar to the lever C on plate A'. The pins P act as a stop for the coupling. The levers C and H are held secure on the hose and coupling respectively, by means of the hooks S so as to leave the hands free. After securing the hose and coupling, as shown, all that is necessary is to screw the vise up, keeping the coupling well oiled where it enters the hose. The plate A can be easily arranged so as to take in the second fitting used on the end of the hose secured to the train pipe.

Reading, Pa. F. M. ARTHUR.

Information Wanted.

Editors:

I notice a great many ten-wheel engines that have their eccentrics on lead driving-axle, and I want to know how such an engine could be run in case a strap, or pin was broken on front end of side rod? There is one opposite rod taken down there would be no connection with the eccentric axle. I have put this question to a number of engineers but have failed to receive a satisfactory answer.

The above slip was cut from the *Locomotive Fireman's Magazine*. Will you please answer the question, and if there are any ten-wheel engines constructed with their eccentrics on the lead driving-axle, please say what make they are?

W. A. RHEIMAN.

Hampden Junction, Ohio.

[Years ago Mason built ten-wheel engines by simply adding on a pair of drivers behind his eight-wheeler, this, of course, meant that the forward axle had the eccentrics on it, but it was the main driver. We know of no ten-wheelers built with eccentrics on forward axle with main rod connections on center part of wheel. There are many engines in use where the eccentrics are not on the main axle, the Elevated engines being all built that way. With such an engine, when side rods are taken down, be towed in, don't run with one side rod.]

Stretching Bolts that are Too Tight to Drive Out.

Editors:

I was somewhat amused to read that article of Mr. Charles' some months ago on "stretching" bolts that are to be driven out, thus making them smaller.

Suppose we take cylinder bolts in the

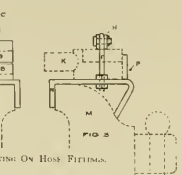

frame fastening, one-inch bolts, and they are tight. We wish to drive them out. I find that a one-inch bolt is 1 1/8 inch at the bottom of the thread. How much power would be required to stretch that bolt in the 1/8" and not stretch in the threaded part? St. Louis, Mo. JOHN ATKINS.

Driving Brass Chuck and Boring Bar.

Editors:

How me it must be to work in or have charge of a shop where they have all new, improved tools, when the work can be got out quick, and, as you would think, with-

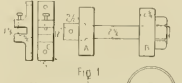

Fig. 1



Fig. 2



Fig. 3



BORING BAR AND CHUCK FOR DRIVING BOX BRASSES.

out having to make any measurements, the machine doing all that simple operation. I have no doubt but this can all be done in a shop where all new work is put up and enough of it to pay for making a set of tools for each part of the job, but when it comes to repairing them all your standard sizes go, that is, in the average shop, if it is not in all shops that they keep standard sizes.

One night, after quitting time, I was walking down through the shop with a friend, and passed a 30-inch lathe with a

driving box strapped to the face plate. He remarked "Is that the way that you bore driving boxes? Why don't you have a vertical boring mill? Then you could bore them while you are now getting them set."

This rather staggered me, as we think that in the matter of driving boxes we are pretty well up in the air. From the time that a driving box is on the floor until the cut is started will never exceed five, and the average will be not two minutes, there must be some fast work done elsewhere, or my friend did not know how fast we work.

The following is a way of doing the job. The brasses are brought from store-room to the lathe, 10-inch Pond. The mandrel, or chuck, for holding them is shown in Fig. 1. It is good and heavy, to stand lots of strain. The shaft is 2 1/4 inches, and enlarged at the head, and collar A is shrunk on. Collar B is a nice fit, the outside diameter is 1/4 inch less than the size of brass, so that the brass can be set without raising the lathe. C is the driver, bolted to face plate, the dog is made on purpose for this job, and just fits shaft, and point of set screw is let 1/2 inch, so there is no slipping. D is a section of the thread. By making thread of this style you get the strength just where you want it. Make good big centers, almost size of lathe centers, then put in a brass.

Tighten up by letting the handle of the wrench come over on the carriage with the lathe just moving, then put in a tool and see if you can pull out the brass. You will find that the lathe will stop first.

The brasses are next marked and slotted, this being done on slotter held in chuck (described in May issue). We press our brasses in at five to seven tons weight, and then pin them, then plane the brasses and they are ready for boring.

The boring bar is 31 inches long, 1 inch at one end is 1/2 inch smaller to take the handle. The centers are good and large and "out," so that the bar is even to 1/4 inch. The handle is a good fit and has a projection at back to take a screw bolt so as to clamp it tight. This should be changed often, so that the centers will not wear out of place. In the handle is a slot 1/4 inch by 1/4 inch to go over a standard that is bolted to ways E, Fig. 2. The upper part of this is same radius as slot in handle on bar, the thumb screw is to hold it in any desired position. The sleeve G is of cast iron, with a collar of wrought iron on each end. The one marked H is to have holders to clamp in tool post and the hole should be slotted about 1/4 inch and should have 1/2-inch rivet through it. This is for the purpose of carrying sleeve G along on bar E. The collar A is for holding in tool and is 1 1/2 inches wide, shrunk on, and is made as thin as possible on the back so as to fit in a small brass, for by putting the eccentric towards back of lathe the tool will clear in a smaller hole than when it is set in front. The slot for the tool is 1/4 inch by 1/4 inch and a plate over the outside bolted tight. The tool is held by a set screw, one thing the center wants to be big so as to avoid all chance of pulling them out.

It may be thought and said that these bars are heavy and clumsy, and that you would have to have a crane to get them in and out of the lathe, but that is not so. This they are heavy is true, but not so much so but that one man can handle them quite easy, lifting them out and in alone, and there is no cut too heavy for them. While 1/4-inch feed and 1/4-inch depth of cut will suit an ordinary bar, this bar will go along just as lively with 1/4-inch feed and 1/4-inch depth of cut. If, after having set the tool, it is found that the cut is too deep, or that you could take more, just loosen thumb screw on standard G, and raise or lower handle, as the case requires. This is the object of the eccentric bar, and two or more cuts can be taken out without loosening the tool. We think that this is

a good bar, but would like to hear from some one who thinks they have a better, as mechanics ought never to be satisfied with what they have if there is a better.

W. A. ROBERTSON.

Colfax Rapids, Ia.

Getting Out of the Rut in Air Brake Practice.

Editor:

Air brake men working on engine equipment do not seem to make it a rule to give the new brake valve of 1892 more excess pressure than the valve of 1899.

When the brake is applied with the old

pressure, and no more air can accumulate in the main reservoir than the pressure at which the main reservoir is adjusted, while with an excess pressure valve and the governor connected with train pipe, when I draw my valve handle from running position to service stop, the pump will start up and increase the main reservoir pressure. With an old three-way cock, the pump governor set at 70 pounds and connected with train pipe, an 8-inch pump, and 165 pounds of steam, I have seen main reservoir pressure increased to 83 pounds before releasing the brake, after making a "hurry up" stop for a railroad crossing.

While standing at a water crane or coal

gines and jump off, leaving the brake set and pump working. After a while the brake leaks off, and the engine runs down against the one on the pit, causing great excitement in the neighborhood of the ash pit, and sometimes cracking an outside hanging brake beam and scraping the pilot bars. Then the boys give the engines a "roundhouse overhauling"—paint the scars with lamp black on oily waste.

This new Westinghouse brake valve seems to be just what is required in handling the air brake on long trains, but its efficiency is increased or decreased by the amount of reserve pressure carried,

rapidly. I have seen a portion of the pipe between the air pump and main reservoir *red hot* and tender gauge pointer reach 70 pounds, with a leaky train pipe, frequent stops and a heavy train; but it is not necessary to overheat anything.

If high excess pressure is carried, an 8-inch pump will give as good service as a 9½-inch pump, but with little or no excess. The pump is the main factor in releasing brakes on a long train after an emergency application, and the air must be compressed rapidly, necessitating a large pump and causing heating.

After 70 pounds of pressure is attained and the feed valve closes, it will not take

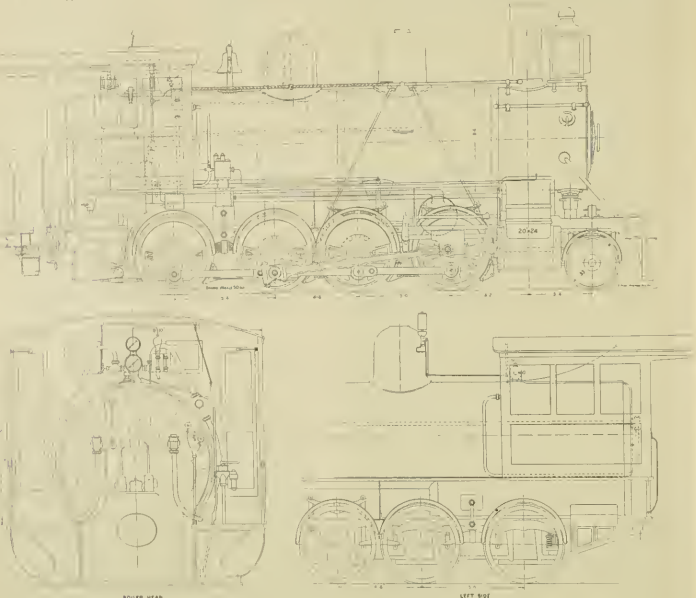

FIRST PRIZE 1894 FOR CONSIDERATIONS, WON BY JOHN S. PAYNE, WORTENBAKI, N. J.

valve, Plate D 5, the pump will continue increasing main reservoir pressure after the regular amount of excess pressure is gained, and if the governor is set to carry 20 pounds excess, there will often be 25 or 30 pounds excess pressure in the main reservoir when the brake is to be released, the exact amount depending on the length of time between applying and releasing the brake, the kind of pump used, and the area of throttle opening.

This feature of the old valve has its advantages as well as disadvantages, and if the new brake valve with feed attachment is not allowed to carry at least 30 pounds of excess pressure, I would prefer that the feed valve be removed and replaced by an "excess pressure valve" made to fit the new brake valve, and let the governor be controlled by train pipe pressure. In this way I could have more pressure to release my brakes with, because, with a "feed valve" the action of the pump is limited by the main reservoir

chute, the engineer oiling around, and the Bremen busy on the tender, the train may move off if the grade is not level, and in such cases the air brake is not released after making the stop until the train is ready to start. One bad feature of the old valve is that an extremely high pressure may accumulate in the main reservoir in a case of this kind, and burst hose or start leaks in the train pipe when the brake is released. Of course we are instructed that the automatic brake is not expected to hold a train after stopping it, and if the train will not stand, hand brakes must be set and the air brake released and recharged immediately, but engineers know that hand brakes are not used on the train equipped with air.

Down here, by the roundhouse, the track descends to the ash pit, and when there is an engine on the pit, the boiler is set a couple of engines behind her on the pit track ready to have their fires dumped in turn. The boys frequently stop their en-

My theory of high pressure has been unfavorably criticised, and a larger volume proposed instead. But there is no place about an engine where another or a considerably larger main reservoir may be placed without being in the way, and so why not compress the larger volume into smaller space? This may be easily accomplished by carrying a higher pressure of air in the main reservoir, and I would like to have some one give one good and sufficient reason why it should not be done.

When the automatic air brake does not release as promptly as it applies, it is an instrument of danger instead of a safety appliance, and when every car used in interstate traffic is equipped with air and all brakes used, it will be apparent that an ordinary main reservoir carrying but 20 pounds excess pressure is away short of the requirements.

Some say that the main reservoir and piping will heat under high pressure, so it may if the pressure is pumped up too

very long to work up a high excess pressure, and it is not necessary to crowd the pump and generate heat either; give it time enough, and the atmosphere will absorb the heat from compression, then when you need air to release a lot of brakes with, you "hold it all the time," don't have to run your pump to pieces or overheat anything, and you get your brakes off, too.

Fifty pounds excess pressure is about the right amount to carry with the new D 5 brake valve. Set the feed valve at 70 and the pump governor at 120 pounds. I would suggest making a threaded hole in the path of the brake-valve handle spring just to the left of running position into this hole screw a stud that will prevent the handle spring from passing it, thus cutting off the full release position. In case of derangement of the feed valve, the stud may be easily removed and the handle carried in full release.

As the equipment of freight cars with air brakes increases, apparently new

conditions arise, and the new brake valve is intended to meet those conditions. Its operation should not be restricted. But it is as fully hard for human nature to "get out of the rat."

Several years ago I fired for an old-time engineer, who laid off one summer and went down East to visit the home of his youth. When he came back, he told me a story that I shall never forget and never believe, but it has a "moral." He said that when he lived down there with the old folk, there was a big tree stump-standing in the road and passing teams were obliged to turn out and drive around it, he remembered the exact place by the big

Those Prize Designs—Consolidations.

The first prize for best arrangement of cab and boiler fittings for consolidation locomotives was won by John S. Payne, of Wortendyke, N. J., who also won the first prize for eight-wheeler. Out of this design is shown herewith, its specifications are identical with those of the eight-wheeler illustrated last month, except in necessary detail. The arrangement of throttle stem and lever in this design was especially recommended.

SECOND PRIZE

There were far fewer designs to choose from for the consolidation engines than for

Kees' Rocks, Pa. This young man is the son of a locomotive engineer, but states that he got no pointers about this design from his father. He has picked up what little he knows about drawing without instruction, and writes us that he graduated from one of the public schools in Pittsburgh on the day he got our check.

His ideas seem to run in lines pretty well accepted as good, and if he keeps on, may accomplish the aim of his life—to be a mechanical engineer.

THIRD PRIZE

The design herewith submitted exhibits more originality than any of the others.

The winner of this prize is Mr. G. A. Akerlund, now employed in the drafting rooms of the Brooks Locomotive Works. He was born in Sweden 38 years ago, learned the machinist trade and worked at it until 1879, when he entered of the Technical S. S. school at Stockholm, where he studied for four years, and was then employed as draftsman until 1887, when he came to America. He worked as draftsman in several shops, including the Brooks works, the P. R. R., Erie, Big 4 and the Rock Island, and has recently returned to the Brooks drawing office.

The drawings will furnish any other detail that is required to be known.

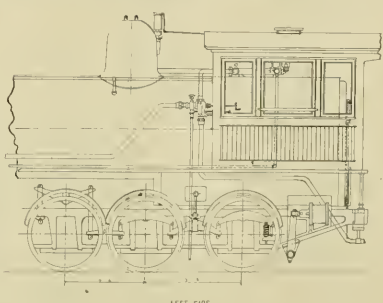
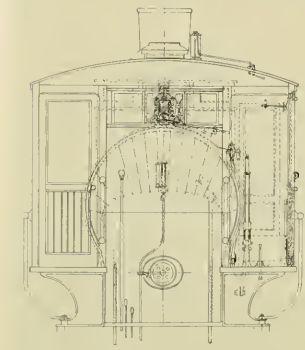
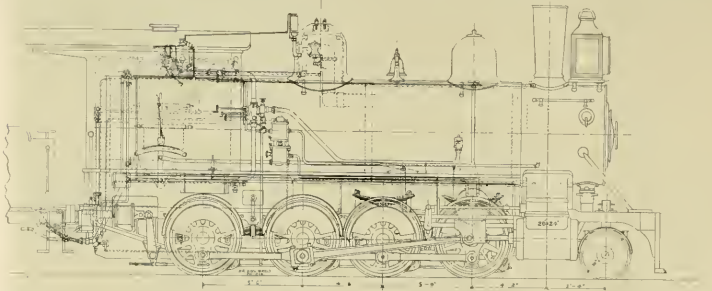

SECOND PRIZE (\$9.00 FOR CONSOLIDATIONS, WON BY WILLIS E. HOLLOWAY, OF KEES' ROCKS, PA.

truck over in the pasture. And he said it was actually the fact, that, although the stump had disappeared, the grass was growing over the spot nearly to the center of the "right of way," and teams were still turning out and following the ruts of thirty years ago. WILL W. WOOD, Terre Haute, Ind.

We have received a small, pocket-sized manual-covered book known as the *Car Interchange Manual*, being an abstract of the decisions of the Arbitration Committee of the M. C. E. Association, and including cases from 1 to 237. This little work was compiled by Mr. J. D. McAlpine, of Cleveland, O., and is issued by the *Railroad Car Journal*, of this city, at 20 cents each. It is a very useful little work for car inspectors at interchange points.

the eight-wheelers, and there was very little that was new offered. The arrangement of cab fittings in this design were commended for the absence of cocks and pipes in the cab. The cocks are all located in a turret between the steam gauge stand and dome, and the pipes lead from them directly ahead and out of the cab—for instance, the steam pipe to injectors.

A double check is used, an inside and an outside one.

The center window of the cab lets down, like a street car window, and the arm rest is carried on brackets far enough outside to avoid any movement of the windows. The arrangement of levers and handles in cab are very handy for the engineer, and the air pump is out of the line of vision.

This design was made by Willis E. Holloway, (18 ho is but 17 years of age) of Mc-

and only for the location of the air pump directly in the line of vision, the design would have taken second money.

Every opening in the boiler is protected by a safety device, the checks are double—having an outside and inside opening valve.

All the steam cocks, even the whistle, are tapped into a turret of special design, with a self-closing valve of peculiar construction. All the glass in ventilators, side windows and back doors is opaque, with wire mesh in it—to prevent breakage.

The engineer's valve is located on side of cab, and there are a good many special fittings of the designer's own ideas. The handholds on corner of cab, where they can be seen and reached from deck of the ground were highly commended.

Munning, Maxwell & Moore, of this city, have received orders for a 12-ton Shaw electric crane for the Pittsburgh Tin Plate Works, a 30-ton crane for the Worthington Pump Works, Brooklyn, and a 40-ton crane for the Midvale Steel Works, at Philadelphia. The makers of the Shaw crane can feel proud of these orders, and especially of the Midvale crane, as those works already have an 80-ton, two 4-ton, and two 20-ton Shaw cranes at work. It is only in the last ten years that good manufacturers have found out what a large part of the cost of production could be charged up to handling material, and the best of them are hunting for the most economical means of doing this work. Who would build even a moderate sized shop now without a crane?

Committees for Conducting Discusstion for the American Railway Master Mechanics' Association for Meeting of 1895.

No. 1. *Exhaust Nozzles and Steam Passages*—Continued—Robert Quayle, William Forsyth, James McNaughton, W. S. Morris, D. L. Barnes.

No. 2. *Locomotive Fire Kindlers*—Continued—John Hickey, J. O. Patten, Geo. B. Brook, W. T. Reed, John A. Hill.

No. 3. *Shop Tests of Locomotives*—William Forsyth, A. S. Vogt, George Gibbs, D. L. Barnes, W. H. Marshall.

No. 4. *Gauges for Sheet Metal, Tubes and Wires*—Committee to confer with manufacturers and others, and to submit a practical system for adoption by the association—Geo. R. Henderson, T. W. Gentry, C. F. Thomas, A. W. Gibbs, Alex. Gordon.

No. 5. *Utilization of Railroad Scrap Material*—Report on best method of

port on relative merits of pneumatic and electric transmission of power in railway shops—T. B. Purves, Jr., John Medway, F. M. Twombly, C. E. Fuller, J. T. Gordon.

To Confer with American Railway Association—J. N. Lauder, W. A. Smith, R. C. Blackall.

Arrangements for the Meeting of the Traveling Engineers' Association.

The Committee of Arrangements has issued the following circular, which explains itself.

The Committee of Arrangements for the second annual convention, to be held at Denver, Colo., commencing Tuesday, September 11, at 9 A. M., desire to submit the following information.

Our headquarters will be at the Albany Hotel, corner of Seventeenth and Stout streets. Rates, \$2 per day (American plan). All trains arrive at Union Depot, foot of Seventeenth street. Cable cars

buy your tickets both ways, taking a receipt for the same each way. Upon your return home inclose your receipts, together with your credentials, to J. A. Spoor, general manager Wagner Palace Car Company, 423 to 429 The Temple, Chicago, Ill., and one-half the money paid by you will be refunded. The Wagner cars are treated as Pullman west of Council Bluffs, which feature please look out for, and take separate receipts to Council Bluffs and beyond. The credentials necessary for members to have to secure the reduced rates in sleeping cars, hotel, etc., to their membership certificates, reading good until September 1, 1894.

W. O. THOMPSON, Chairman.

R. A. HEDENBARK,

T. A. McVICAR,

MARIN MONROE,

F. P. WILSON,

Geo. Royal, Sr.,

P. H. SLACK,

Committee of Arrangements.

After Fifty Years on the Footboard.

There now lives, at Daytona, Fla., Mr. John G. Eckman, who has put in fifty straight years running a locomotive. Mr. Eckman was born in Philadelphia in 1839, became an apprentice to the P. W. & B. road in 1857, and in 1849 took out his first locomotive—the "Nicholas Biddle." He ran on Southern roads mostly until 1890, when he quit the Florida Southern on account of rheumatism, but is still employed by the company. In these fifty years Mr. Eckman has seen every improvement made in locomotives, and it is claimed, was himself the inventor of the cab, the pilot, cylinder cock rigging, and other devices.

Mr. Eckman knows just what he has done, as he is one of the kind of men who "set things down." Since 1849 he has been the regular engineer of 118 locomotives from ten different builders, on 21 different roads, and has made 1,750,000 miles.

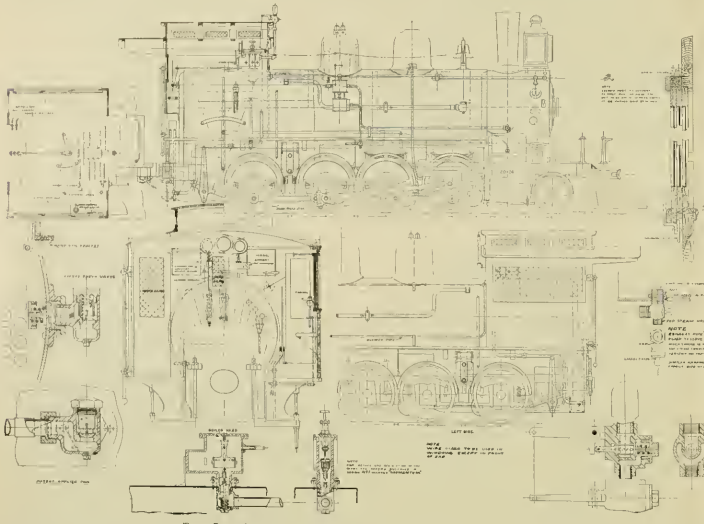

THIRD PRIZE (\$25) FOR CONSOLIDATION, WON BY G. A. ARTHUR, DENVER, N. Y.

handling the same. H. J. Small, H. Meekhouse, Henry Schlacks, Geo. W. Smith, H. P. Robinson.

No. 6. *Causes of Bulging of Firebox Shells*—P. Leeds, John Hickey, John Ellis, A. E. Manchester, G. H. Baker.

No. 7. *Best Material for Boiler Tubes and Specifications for Same*—T. A. Lawes, W. L. Gilmore, R. B. Reading, P. H. Peck, M. N. Forney.

No. 8. *Pistons and Piston-rod Fastenings*—With special reference to pistons of large diameter and light weight—R. H. Soule, W. H. Thomas, William Swanson, J. D. Barnett, C. Graham, Jr.

No. 9. *Riveted Joints*—To submit a set of proportions for riveted joints, representing most approved practice—A. E. Mitchell, S. Higgins, Geo. W. West, H. D. Gordon, L. R. Pomeroy.

No. 10. *Wear of Driving Wheel Tires*—As affected by weight upon same—W. H. Lewis, J. N. Barr, E. M. Herr, J. H. McConnell, Geo. F. Wilson.

No. 11. *Transmission of Power*—Re-

opposite depot pass the Albany Hotel entrance. Members desiring to stay at headquarters should engage their rooms in advance. The meetings of the convention will be held at the Elks Hall, 1515 Lawrence street. The general managers of all the principal railroads in the country were very thoroughly canvassed last year, and we do not think there will be any trouble about securing transportation for members and their families desiring to go to the convention if asked for in the usual manner. The Pullman and Wagner Palace Car Companies will make a one-half fare to members and their families to and from the convention. When traveling in Pullman or Wagner cars please note the following: If traveling in a Pullman car buy a ticket to Denver, take a receipt from the agent that you purchased ticket of, and when you arrive at Denver take your receipt, together with your credentials, to the district superintendent located there, and you will receive a free pass for the return trip. If you travel in Wagner cars,

The Meeting of the Master Blacksmiths.

The next annual convention of the National Railroad Master Blacksmiths' Association will open in Pittsburgh, Pa., on Tuesday, September 4, 1894, and the sessions will continue Wednesday and Thursday. The indications are that the meeting will be exceptionally well attended and present many features of mechanical and social interest. Thus far there have been planned visits and tours of inspection to the various works in and about Pittsburgh. Among the papers contributed several give promise of unusual interest.

The Home Hotel, Duquesne Way, between Eighth and Ninth streets, has been designated as the official headquarters during the session.

Geo. F. HINKEN,

J. J. THORNTON, Secretary.

President.

Mr. Eckman is now 73 years of age. There should be a pension fund for such as he, they deserve it.

Something Near.

The officials of the Western R. R. of Guatemala, C. A., gave their American employees a holiday on July 14th—with full pay.

Thirty-four of the exiles got together in Retalhuleu, had a parade with band, visited the U. S. Consul, the Government officials, and then partook of a fine dinner, tendered by an American hotel keeper. A vote of thanks was given Superintendent A. Traft and Director-General A. Mover of the Compania del Ferro Carril Occidental de Guatemala.

We notice quite a number of railroad men who carry copies of the code of rules of car interchange that are a year or more out of date. This is bad policy, as the rules are modified and changed every year and new one are to be had at five cent each, and much cheaper in quantities.

Railroad Coppermithing—X.

By JOHN FULLER, Sr.

PLANNISHING AND SMOOTHING

We have been talking about planishing and smoothing, and it strikes me that there may be many of the boys who would like to have an explanation of what we mean by that, so they may be helped to fully understand the last two chapters. Planishing, as understood by brassiers or coppermithers, is the art of first molding smoothly, or shaping the metal when first formed; second, hardening or closing the grain after the form is completed, and third, giving it, by the aid of a bright hammer, a finishing gloss or a kind of case-hardening sufficient to receive the fine polish with tripoli, which is a very fine powder having a purple hue.

To planish or finish the numerous articles made by brassiers and coppermithers, it is necessary to have quite a variety of hammers as near their curves as possible, and the square shank of the head should be tapered so to make it fit tight into the upper or upright shank of the mallet, as in Fig. 131, the ten-kettle hammer, Fig. 132, and the gibbet shank, Fig. 133, which receive it, the convex curves of the round heads may run from four inches to two feet or more, the long heads used for cylinders, about the same, and these are usually made twice their width in length or thereabout. It is also necessary to have a few light mallet heads for such work as requires them. We had no bright mandrels, but later experience has taught me that they would have been better adapted to our use for many things than the little short heads we had. Our hammers were various: some with round and some with square flat faces, Fig. 134 for they were commonly called so, though none were very flat, and ranged from twelve ounces to three pounds or more. The convex hammers, Figs. 135—14, those with flat faces—ranged from an erde of four or five inches to fifteen inches or more, and were used for spherical or ball-shaped work. The saddle hammer, Fig. 136, and those with long faces were used for such work as has been under consideration, such as balls, bodies, crowns, feet of domes, valve covers and chimneys. It is also necessary to have a number of bright bullet or convex-shaped hammers for special purposes, together with a bright anvil, Fig. 131, and a bottom stake, Fig. 141. Now let us suppose we have heads, hammers and other tools suitable for a valve cover, Fig. 107, and we have the cover covered with muscic acid and salt clean and bright. We first take it to a mandrel or suitable long head, and smooth down all the irregularities with a clean smooth-faced mallet. Then take a flat-faced hammer, weighing, say about one and a half pounds, and commence at the beginning of the curve of the crown. Develop the metal in successive strokes in a straight line, perpendicular to the top curve and the bottom flow, and then proceed in the same way, letting the blows lap each other a little at their edges as they are delivered until the course is completed.

It is around. Now take it to a bullet stake, Fig. 131, and repeat the process as far as the straight line, then take it to a head of an upright shank *B*, Fig. 131, finish up to meet the planishing previously completed on the bell or crown. Next give it a good rubbing down with a clean rag, so that the blows of the next course may be delivered between or on the edges of the last course, which may be readily seen. If the article is to be planished in a lathe two courses properly done are sufficient, but if it is to be finished complete under the hammer and then polished by hand, then, with a flannel wip scour with sweet oil and tripoli, and after cleaning off carefully all oil and dust, look over the work and

examine it well to find omitted spots and touch them up. Now take a spring-faced hammer, Fig. 138, or muffle the head with a piece of shalloon or a piece of skin parchment drawn tight over it, and go over the work lightly to finish. The spring-face may be changed from hammer to head according to the ingenuity of the workman and the necessity of the work in hand. The shalloon supplies the place of a spring-face, as also does the skin, their purpose being to take off or counteract the effect of the impact of the hammer, the impinging of which on a naked head causes a sharp ridge all around the blow, and this can only be obtained by the muffle inside or the spring-face outside. The convex and all other hammers may be fitted with false faces, according to the work for which they are to be used.

The planishing described in the foregoing is for the best kind of bright work. The next grade is for common or brown work. This grade is carefully cleaned, and then before the planishing is commenced the article is covered with good Spanish brown, sometimes it is applied with a brush like paint, being mixed with clean water, at others it is put on with a dry towisp, well rubbed into the grain and ap-

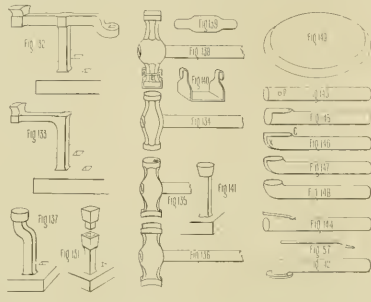

plied so that plenty bangs on, but uniformly all over; it is then hammered into the grain the first course, and then smoothed and finished in the second. Another style of planishing is executed in a way that every blow may be seen distinctly and in regular succession, and is adopted in that kind of goods where closing the grain to stiffer or harden is the principal object in view, while in the rough kinds of brassery, such as carbony, sugar molds, pump bodies, air vessels and various kinds of boilers, the hammering is done in a promiscuous way so long as the surface is covered and the work hardened sufficient to maintain its shape. The large pipes in ocean steamers are also planished in this way.

SPRING-FACE HAMMER

A spring-face hammer is used in the constructing and substituting of false face for special smooth work, and is made and fitted to the hammer, as shown in Fig. 138. A piece of sheet steel of a suitable thickness for hammers, about 20 gauge, is cut as shown in Fig. 139, the two ends are then turned up as in Fig. 140 to fit the hammer face, the lugs being placed in a line with the handle. When fitted properly, harden and draw down to a good spring temper. Now lay between the hammer face and the spring face two or three layers of good French shalloon, which answers as a cushion, then bind the lugs with a stout piece of binding wire to the hammer, and turn the lugs up, so the wire in such a way that they will tend to draw the spring face close up and tight to the hammer face. After testing and polishing it is ready for

use, and will be found a valuable and effective tool where a nice smooth job is necessary.

SHORT BENDS.

In both locomotive and marine work it has often been found necessary to make a short bend of a special kind or to turn the end of pipes, when it is required to get the shortest possible turn that can be made so that a flange will set right down close on the straight part of the pipe, as in Fig. 142. In some shops I have seen this particular problem block the progress of work until some other means could be devised to accomplish the end in view, when perhaps, if all the workmen had been consulted, the way out of the difficulty would have been made clear, for among a gathering of a dozen men engaged in the copper trade there is almost always a stray brazier to be found who, if apt in the application of or in turning to account the methods acquired in youth, is usually the leader of the class. The principle upon which this bend is made, are, among braziers, almost the first lesson to be learned, while among railroad coppermithers it is about the last. I make this statement to call attention a little closer to the lesson, because this is an example where one



means is adopted to obtain different though similar ends.

To make or turn this bend, Fig. 142, we proceed as follows: First, measure along the pipe a length equal to one-half the circumference of the pipe on which it is required to make the turn, Fig. 143, at the point *P* make a small hole large enough to admit the point of the burring pin easy, and with a round file round up the edge all around the hole carefully. Now take the steel burring pin, Fig. 57, having the point bent as shown, and make the pipe red hot about the hole, insert the point of the bar and jar it out with a hammer, as shown in Fig. 144, until there is a burr or turn *T* worked out as high as the flange is thick on the long parts; then slit the pipe down from the hole to the end, as in Fig. 145, and run out the seam at the back the same distance if it is a brazed pipe. If it is a solid drawn pipe make a hole at the back, or opposite side (without burning), and cut the pipe down as far as the hole and open it out, as in Fig. 146. Now flatten out the flaps, then with a radius equal to one-half the circumference of the pipe describe the curve at *A* and cut the pipe at *B*, as shown in Fig. 146, and draw the line at *C*, where the burr or bend begins to turn, take $78\frac{1}{2}^\circ$ of the circle as described in the formulae and shown in Chap. III, Fig. 27) of which *A* is a part. Now this the back edges of the flaps of the turn, Fig. 147, and work them over on a rod or some suitable bullet stake, and if large enough to need it, cramp it, then close the seam, as in Fig. 148, and finish by brazing. The method here described,

as hinted above, is an adaptation or application in part of the brazier's manner of making the lower turn of a tea-kettle spout, and is among the first lessons to be learned by him; and while it is often necessary to make a short turn of this kind in both locomotive and marine work, the method is not general, and when it happens that the workmen do not know how to make this turn, a casting for a special piece at a much greater cost and perhaps inconvenience.

BRAZING FLANGES.

The brazing on of flanges, large and small, has caused as many or more objectionable language to be uttered than almost any other operation usually performed in a coppermith's shop, owing principally to the want of a little knowledge, or the possession of an inquiring mind, sometimes, too, owing to the greed of a manufacturer, who wishes to palm off his flanges for pure copper, or to get enough heat to run the spelter. This necessarily entails much trouble and annoyance to the workman, and not a little loss to themselves, because the extra time spent and habit of failure, together with the extra material consumed with the failures, more than balances the advantage to be gained by the use of spurious metal. In speaking thus, I do not wish it understood that pure copper is the best material from which flanges can be made, for the best flanges the writer ever operated on were cast from a mixture composed of one pound of old copper and one pound of old brass tubes—which reduced to its elements would make the flange about sixteen parts copper and three of zinc—this makes the flange stiff and close grained, and much better for general purposes than pure copper. Having a good flange provided, the next thing is to have it properly prepared while at the lathe, the only thing, however, that concerns the coppermith is the hole into which the pipe is to fit. This should be tapered one-eighth inch so that it will drive on tight, the end of the pipe being reduced that much. On the face side a one-eighth countersink should extend into the hole one-fourth of its thickness. When the flange is eased on the end of the pipe, and the pipe is through a short distance, drive it back with a blunt-pointed hammer down into the countersink, turning it over a little toward the face of the flange. It is now ready so far for brazing, but before taking it to the fire, if the pipe is small, it is sufficient to stop the opposite end of the pipe with a ball of waste or a wooden plug, so that the heat cannot run up through the pipe. Around the countersink of the pipe, which is through the flange, rub some soft fire clay that is about the consistency of tooth cream, and brush a little on up the seam if it is brazed pipe. It is now ready for charging with solder and the fire. Flanges for large pipes are bored in the same way as small ones, but it is also necessary to take some precautions in preparing for the fire, so that the heat does not run up the pipe. In this case take a disk of light sheet iron about three or four inches larger than the diameter of the pipe, and clip this disk all around with the shears, at intervals of one inch each; now turn the edge of the iron flange up, and the shears, in places dipping up as a spring to hold it fast in position. The pan is crowded into the end of the pipe about four or five inches from the flange, and some soft fire-clay is plastered in the cracks of the pan all around the edge, and also in the space between the countersink of the flange. The edge of the clay should be an inch or two above the flange, or above the thickness of it, and arranged so that no flame can go up the pipe. See that the seams of the pipe are well covered with clay far enough beyond the upper edge of the flange where the solder is to lay. Now heat the pipe so that the flange hangs level, and it is ready for charging and the fire. If the flanges

appear to be of doubtful metal, try the quality before putting them on the pipe, by trying to run a portion of the spelter you have on the flange first. If it proves, as was suspected, that the solder will not run on the flange, it should be reran—that is, remade. To do this, take one pound of the spelter and melt it and add one ounce of zinc while it is in a state of fusion, stir, and when cool enough to char a barrel stick, place it in an iron mortar, previously made about the same heat, and break it up again. Try it on the flange as before. If it still takes too much heat or more than it is thought the flange will bear, lower it again with zinc, until it runs at a low enough temperature to preserve the flange and there appears no danger of failure. Never use what is called black solder or spelter, it is only employed by those wanting a sufficient knowledge concerning spelters or solder suitable for their work, they are tempted to add tin under any circumstances if good work is desired.

The Elements of Boiler-Making—VI.

SHEET-IRON WORK.

By C. E. Fourness.*

How to Build a Snow Plow.

As the time of the year is approaching that snow plows must be prepared for business, I think it will be to the point to treat some on that subject. But judging by the tone of our Editors in regard to short, but boiler-makers will be called upon to make a great many still, especially for lines that only have an occasional bad winter, as under those circumstances a company would hesitate to tie up so much money in a machine plow. I consider it a very nice job to lay out a plow right, especially when the sweep is different at the back than at the front. Although this first plow given will be

bad, after which he tries it again, marks and cuts off a little more. He, perhaps, repeats this operation three or four times before it goes back to place, and then, if it fails to fit properly, he will, perhaps, jack up the helper for not getting it back equal when he marked it off.

By laying this all out on the straight sheet, it takes but very little longer for the layer-out, and then after it is fitted together all that is required is to shove the plow back to place and fit the braces. Fig. 73 is a side and Fig. 74 is a front elevation of a pilot, with a snow plow attached. These views show the appearance when ready for use and are, with the top view or plan (Fig. 75), the views that would be given

required under each corner of the latter to bring it into the required position. That attained, it is necessary to find the length and angle of the bottom line or edge of the plow, this is found by setting the sweep up to the pilot into the position the plow will occupy when in place, as shown in Fig. 79. The sweep is full lines, being the back end and the bottom is 3 inches from the base of the pilot, at which point make a mark. The sweep in position at the front is shown in dotted lines, and the bottom is 4 inches from the base, at which point also make a mark.

In order to find where these marks are located along the side, see Fig. 75 (of course, in working at the pilot, looking at the side of the sweep is Fig. 79, and looking down at the sweep is Fig. 75), and through these marks draw a line which will represent the bottom edge of the plow and give the angle required, next draw the center line *A B*, Fig. 75, then *C D*, one-half the width of the plow apart

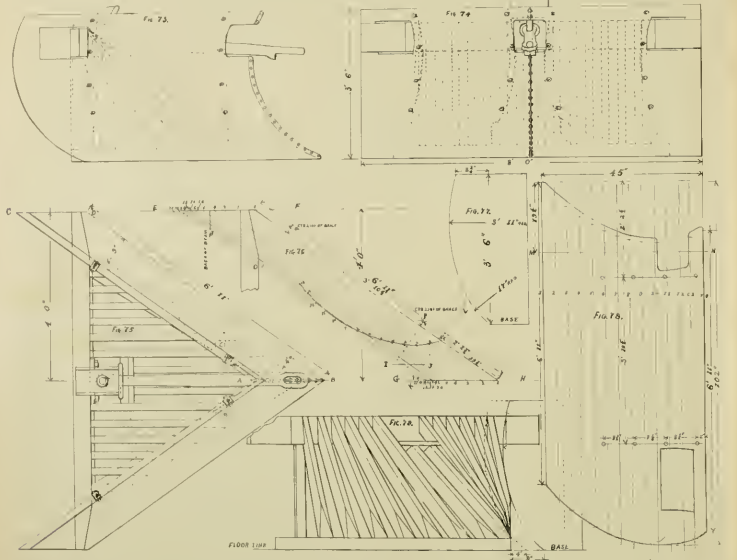

HOW TO MAKE A PILOT SNOW PLOW

An engineer on a big freight road writes that his engine has made over 100,000 miles, and is good for 25 or 30,000 more in heavy freight service. He says his mill and one or two others have a great reputation for pulling trains and for economy of supplies, but says it is all due to the fact that he, with one or two others, buy and use Dixon's graphite. He puts the black lead into the tallow pot and mixes it on valves and pistons, polishing them like mirrors. This engineer claims to be afraid to own up to the facts, as stated, in his market mechanic, and wants his name kept out of print. Is it the M. M. that he is really afraid of? If it is—what for?

In the testing department of Sibley College, Illinois, they have recently broken steel wire which showed the enormous tensile strength of 180,000 lbs. to the sq. inch.

made the same sweep the whole length, and it will be a pilot plow, layed out so it can be cut to fit the beam of the pilot, and the hole for the draw-bar to work through, also the holes for the braces (that is the difficult braces) to get at, after they are to be all cut and punched while the sheet is straight, before rolling, as steel can be handled so much more conveniently.

Generally in building a pilot plow, if any thing is laid out it is the hole for the draw-bar beside the front and back, so after it is belted together it is placed as near as possible in position, then the man on the job marks off what he thinks will be necessary to cut off to clear the beam of the pilot.

He then takes it apart and punches it if he can, but generally cuts out the piece by *Fourness Boiler-maker, C., M. & St. P. Ry., Dubuque, Iowa.

most likely in a blue-print to build the plow by.

In starting on this job, the first thing necessary is the sweep (it is sometimes given on the drawing, but generally the boiler maker must decide that, and it must pose matter). Fig. 77 is the sweep used, and notice the top lacks 9/4 inches of being perpendicular to the bottom. Cut this sweep out of wood or iron and cut the bottom at right angles to a line drawn from the bottom to the point 9/4 inches from the top, this will cause the sweep to stand in the correct position when set upon the base, as shown in Fig. 77. When the sweep is ready, set the pilot on a level part of the floor, if the bottom of the pilot is to be level with the bottom of the plow. Some prefer to have the pilot project below the pilot, if that is desired, place strips of wood the thickness

(in this case, 4 feet), and parallel to each other, this gives the length of the sweep 6 feet 11 inches. On a sheet of iron, or any convenient place, proceed to construct Fig. 76, by first drawing the center line *G H*, then *E F*, parallel and one-half the width of the plow, 4 feet apart. Draw the line *I J*, to represent the bottom, 6 feet 11 inches long, and at any convenient distance from the point (in this case it is 1 1/2 inches) draw a line *A L*, at right angles to *I J*, and upon this line set the sweep. Fig. 77, the base resting upon this line and the bottom point to the line *I J*, draw the curved line to represent the sweep and space this into fourteen points, number them from 1 to 14. (Remember, as stated, it is immaterial how many points a line is divided into, the only thing the closer together the greater the accuracy.) Draw ordinates through these points, keep's

them parallel to the line *L*; number these ordinates 1, 2, 3, 4, 5, etc. to *L*, being very careful in numbering, as the *L* is drawn with a back among the others after getting over the highest point in the curved line or sweep.

Notice, an opening must be cut on each side of the plow to allow the beam to pass through to let the plow go back to place upon the pilot, consequently find the distance that the beam is back from the point and draw an arc of six and no. shown in Fig. 76, draw also the line *J*, Fig. 76, in parallel with and parallel to the center line, this is the width of the opening on this side and one-half of the opening required to allow the business end of the draw-bar to protrude.

Now for the sheets. Fig. 73 represents one side of the two sides, this will require two sheets, 42 inches by 102 inches—the distance is optional, generally $\frac{1}{2}$ inches. First draw line *M, N*, Fig. 78, $19\frac{1}{2}$ inches from the end of the sheet, at right angles to the side of the sheet intended for the bottom, space off this line into fourteen points, with the dividers set same as used to space the curved line in Fig. 76, beginning at the bottom, and number them 1, 2, 3, 4, to *N*, 14, draw lines through these points the full length of the sheet and parallel to the bottom, or line *L*. Set the dividers from the center line *G* to the line *L* on the ordinate No. 2, Fig. 76, and convey this length to the line No. 2, Fig. 78, measuring from the line *M, N*. Set the trams again to the distance between the lines *G* and *L*, Fig. 76, on the ordinate No. 3, this length convey to the line No. 3, Fig. 78, measuring from the line *M, N*. Convey the lengths of all the ordinates in Fig. 76 to the corresponding numbered lines in Fig. 78, being very careful when transferring the lengths of the ordinates Nos. 12, 13 and 14, or the ordinates for the top, that the right angles are taken. Now center punch marks at each of these points of intersection, as the sheet will flange to these marks, and after flanging $1\frac{1}{2}$ inches outside of these marks for the flange, that end is finished. For the back end, measure the full length from 1 to 1 on *L* ordinate, Fig. 76, in this case it is 6 feet 11 inches. As the sheets of this plow are formed of one sweep the whole length, each one of these ordinates are the same length; all that will be necessary will be to convey this length to the lines Nos. 1, 2, 3, 4, etc. to No. 14, Fig. 79, measuring from the center marks for flanging on the front end and making a mark at the back end to correspond with the length of the ordinates, then a line drawn through these points of intersection will be the line for shearing at the back end. This completes the outline.

To find the opening required for the pilot and bumper beams. When the sweep is placed in position at the back of the pilot, mark the width of the beam and the height from the floor on the sweep as shown by the darts in Fig. 79, leaving at least one point of clearance above and below the beam. I then find by laying the sweep on Fig. 76, in the position it occupies when drawing the curved line, that the width of the opening is from one inch above the line No. 10 to the line No. 13, inclusive, consequently set the trams to the distance between the line *K, L* and the line turning the front of the pilot beam, Fig. 76, on ordinate No. 10, having this length, convey it to Fig. 78 and make a mark that distance from the line *M, N*, on line No. 10, convey the length of the ordinates Nos. 11, 12 and 13 in a similar manner to Fig. 78, and a line drawn through the points of intersection will be the line to cut along the beam. For the back find the distance in Fig. 76, from *O*, the front, to *P*, the back of the beam; this will be the distance that the front and back lines for cutting will be apart, as the front and back of the beams are parallel. Now draw a line one inch above and parallel to the line No. 10, and between the front and back lines, for cutting, as the

bottom of the opening comes one inch above the No. 10 line.

For the draw-bar hole find the standard height of draw-bars on the cars, and measure and mark this length on the sweep, Fig. 77, measuring from the base after deducting the height the pilot stands from the rails, this will be the height of the center part of the hole, and as the hole in this case is 9 inches square, measure and mark $4\frac{1}{2}$ inches above and the same below the center part found, and find that the bottom comes one-half inch above the No. 10

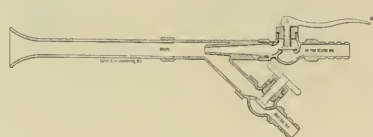

FAIR AND SAND DISTRIBUTOR.

point, and the top one-quarter inch below the No. 13 mark at which points draw lines parallel to No. 10, and No. 13 lines. Set the dividers from the lines *G* and *H* and *I* on ordinate No. 10, Fig. 76, this length measure off on the lines Nos. 10, 11, 12 and 13 (as all these ordinates are the same length), measuring from the center marks through these marks just found, and the corners rounded out a little for appearances principally, that part is finished.

The holes for the braces are on two lines, at right angles to the bottom, the front one is 2 feet 2 $\frac{1}{2}$ inches from the point, the back one is 3 feet 10 $\frac{1}{2}$ inches from the front brace. The holes are placed—the first hole 2 inches from the top, the others 3 $\frac{1}{2}$ inches apart respectively. This completes one side ready to shear and punch. After this is accomplished use this sheet for a pattern for the other side by just turning it over when marking off the other sheet. After the sheets are ruled, the front end requires to be flanged and I always found it better to start at the bottom, at the long point, and to heat the sheet just to the center marks and no farther, as when heated properly, I always found, it was much more difficult to work, and to ascertain when it was flanged enough, sight over the end from the top, as notice in the plan or top view, Fig. 75, looking down on top of the plow it is possible to see when the flange presents a plane surface. In fitting the ends of points together I usually mark off the holes on the right side and punch them, then set the two sides together at the point beginning at the long end at the bottom, which when set nice and even, hold *W* tongs while punching a hole with a screw punch at the point of intersection, which hole put a temporary bolt to hold this part and change the tongs higher up, then set about 10 inches of the flange nice and even and punch a hole two more for bolts, punch these holes same distance apart, move the bolts and set some distance more of the flange, punch more holes and put bolts in the holes to hold the point in place, and proceed in the same manner until the top is reached, then go back over it and punch all the holes; then the plow is ready to set in place on the pilot, to fit the braces, etc.

There are a great many methods in vogue of attaching the plow to pilots. I will leave the braces to the judgment of the builders, but the plow shown will require more braces before going to work at a snow bank, although what makes an excellent brace is a plate of perhaps $\frac{1}{2}$ -inch thick iron flanged along one side to suit the curve or sweep. The length of the plow flange to be about 3 inches long and riveted to the plow, the flat part to

extend under the pilot and to be bolted fast.

The advantage of this brace is that it makes the bottom edge so nice and strong, that part generally giving out first from striking against obstructions of different kinds. There is one matter I wish to mention; that is, it is immaterial what sweep is used, or in what position the sheets stand as to being vertical. If the sweep is the same the whole length, and the method shown is followed, the results will be all satisfactory.

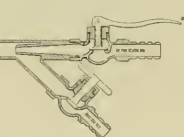

WHEEL-HANDLING JACK.

Painting, Sanding or Whitewashing by Compressed Air.

For some three years they have been whitewashing shops on the Southern Pacific at and around Oakland by compressed air. The apparatus used was mentioned in this paper, and the plan adopted by several roads for painting and whitewashing.

The Erie, for instance, are painting their freight cars now with a nozzle and without a brush. Much of the painting and lamsome done at the Fair buildings was done with air.

Many have asked for details, but we have never been able to show anything special.

The liquid must be confined in an airtight tank capable of sustaining the pressure of air carried, the air inlet pipe merely enters the top of this tank, the paint or liquid hose is connected to a pipe that reaches nearly to the bottom. The pressure forces the liquid up, where it is controlled by a valve and sprayed by a strong blast of air. This is the usual plan.

Mr. David Patterson of M. M. of the U. P. shops at Salt Lake City, Utah, has applied for a patent on a device for painting, whitewashing or sanding by compressed air, and in his device no pressure reservoir is required; it takes paint or sand out of a pail or other open vessel and spreads it in gusted shape.

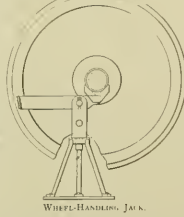

WHEEL-HANDLING JACK.

As will be seen by the sketch, his device is a small affair, requiring only hose connections for air and paint.

Valve *B* controls the flow of material, be it what it may, and the lever valve admits air, causing the device to operate, slow up or stop, without other manipulation than moving the lever. It is a jet apparatus, the air passing out of nozzle *I*, causing a strong suction on the connecting pipe below it.

In operation strained paint is used, the

operator stands about six feet from the object to be painted and goes through the motions of handling a paint brush, with the nozzle.

This manner of painting cars and buildings has many advantages over the brush, it drives the paint into every crack and check where a brush could not possibly reach; for shingled roofs it is particularly efficient. In applying sand it is just as efficient, they merely disconnect the paint hose and put on a slightly larger hose three or four feet long, and it takes the sand out of a pail, distributes it evenly and forces it into the paint.

All freight cars at Salt Lake are painted with this device, they paint a 60,000-lb. box car in fifteen minutes and a flat car in eight minutes. One man can paint as many cars with this device as fifteen men can with brushes. The only limit to the speed seems to be the agility of the operator. The paint is in the form of mist, but if valve *B* is opened, the paint will flow fast enough to flood the work, no matter how fast the operator moves.

Jos. McConnell, superintendent of motive power of the U. P., has recently ordered an engine fitted up with two pumps to supply air, and she is now out on the road with the paint cars, painting station buildings. With this device the painting up of an ordinary station is the work of hours where it was formerly days.

Used as a sand distributor for painted

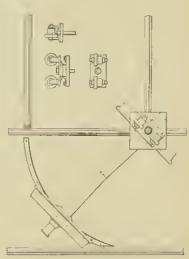

SCHEMATIC FOR TURN-TABLE IN WHEEL SHOP.

roofs etc., it is excellent and is as well a powerful sand blast, frosting panes of glass in a minute or so of work.

This is one of those simple inventions that do a lot of work and save a lot of expense, themselves costing less than they can save in a day.

Two Handy Tools for the Car Shops.

At the Cedar Rapids shops of B., C. R. & N., they use the two tools shown here-with and their value can be seen at a glance.

The first device consists of a stand and lever; the fulcrum of the lever is swivelled in the head of the stand as shown, and the short end of the lever has a *V* piece on it for taking hold of the axle. With this device two men can turn a pair of wheels around, switch them to other tracks, or place them on tracks at right angles to the ones they are on with the minimum of effort.

The second device is a cheap and efficient substitute for a turn-table in car shops.

A pair of rollers, *P, P'*, are hung in a forked casting which swivels on a plate fast to a floor timber. These rollers are set flush with top of rail and a pair of wheels are run along the track until one wheel drops between the rollers. A curved rail is laid, as shown in the sketch, and it is an easy matter for one man to turn a pair of wheels as shown.

This device leaves the main track practically unbroken for the movement of cars, as the little roller turn-table can be picked up and a short rail section dropped into its place.

A Wind Attachment.

From *London Engineering* we take this little cut and description of a recent English patent on locomotives, which goes a great way toward proving that all the modernities in locomotive design do not come from this side of the bigough.

The invention was patented by J. Musgrave and G. Dixon, Bolton, and K. Field and F. S. Morris, London. This invention has reference to means for heat-

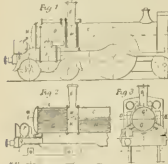

WIND ATTACHMENT.

ing air in locomotive engines in which the top air and steam are used in the smokers. The engine cylinders *A* are provided with admission valves for heated air. Upon the frame *B* in front of the boiler *C* is mounted the heater, which comprises a shell *D*, tube plates *E*, *F*, tubes *G*, *H*, and end cover *I* enclosing the pipes *J*. A horizontal flange *K* is earthed against the space traversed by the tubes *G* in that traversed by *G*. A flange *L* is arranged in the smokebox *M* above the ends of the highest of the boiler tubes *N* and above the highest of the heater tubes *G*, so that hot gases issuing from the smokebox into the boiler tube *N* pass forward through the heater tubes *G* into the space *I* and thence to return through the upper pipes *G* into the smokebox above the partition *L*, from which they escape through the chimney *O*. A blow-off *P* is fixed upon the flange *D* in front of the heater, and is driven from a moving part of the boiler tube. The cold air delivered by the blower passes to the rear end of the upper pipes, and returns by the lower one, when it passes in a highly heated condition to the engine cylinders, in which it is utilized with steam.

A Secret Drawer on a Locomotive.

A London paper states that a singular adaptation of the locomotive has just been made in Russia. Information having been given to the authorities at Alexandrovo, on the Polish frontier, that the locomotive of the express leaving that station for Warsaw had been ingeniously converted into a receptacle for smuggled goods, it was carefully examined during its sojourn at the station. Though nothing was found wrong, it was deemed advisable that a custom house official should accompany the train to the destination, where the engine furnace and boiler were emptied and deliberately tamped to pieces. In the interior was discovered a secret compartment containing 123 pounds of foreign cigars and several parcels of valuable silk. Several arrests were made, including that of the driver, but his acquittalment at finding the engine to which he had been assigned accented converted into a hardened offender against the laws was so genuine that he was released and allowed to return to his duties. The receptacle for smuggled goods was fitted into the bottom of the smoke box, which was made with a double bottom.

What You Want to Know.

Don't ask questions that simply require a little figuring to determine; make each question separate. No notice taken of anonymous questions.

(121) B. H., Birmingham, Ala., asks: What causes the humming or drumming noise in locomotive fireboxes? *A.*—Supposed to be caused by many miniature explosions due to a certain admixture of air with the gases.

(122) W. M. T., Bristol, R. I., asks: Who built the "999"? *A.*—The N. Y. Central Railroad. 2. What is the fastest speed? *A.*—We do not know; it is claimed 125 miles per hour. 3. What English locomotive is the fastest, and what is her speed? *A.*—We do not know. As long ago as 1848 English engines were built that made over eighty miles per hour. We doubt if they have any that can exceed this now.

(123) T. C. L., Horton, Kan., asks: What engine got prizes at the World's Fair? *A.*—All builders who entered their engines for competition have received notice that they will receive a medal and diploma, the medals are to be all alike and the diplomas to state for what points the prizes are given. Two builders, the Cooke Works and the Richmond, did not enter their engines for competition and will not receive the medals. They will be rather an empty honor anyhow, all medals are.

(124) J. B. G., Chicago, Ill., writes: Our foreman and myself had a dispute to-day. I was making a hand-hole plate of the usual shape, longer than wide, each half, if separated, the shortest way would be exactly alike, and I referred to it as an oval. He said it was not an oval, but an ellipse. I said an oval and an ellipse were one and the same thing. He said they were not. I bet him a hat, the question to be left to you. Who buys that kind of mathematical problems, but try to point out a way for self-help or information. Consult any engineer's pocket-book or mathematical work on plain trigonometry, where tables giving sines and cosines for any degree are given for one sized circle, from which any size can be figured easily. Every man who requires to know the answer to such a question should have Hasseloff's or Trautwen's Engineer's Pocket Books, or both.

(125) J. H., Pine Bluff, Ark., writes: Please work the following problem by trigonometry or geometry, as the case demands. Required, sine, cosine in inches for any degree on any circle, say 10 degrees, 3-inch circle. *A.*—We do not work out mathematical problems, but try to point out a way for self-help or information. Consult any engineer's pocket-book or mathematical work on plain trigonometry, where tables giving sines and cosines for any degree are given for one sized circle, from which any size can be figured easily. Every man who requires to know the answer to such a question should have Hasseloff's or Trautwen's Engineer's Pocket Books, or both.

(126) H. A. H., Brainerd, Minn., writes: I understand that the temperature of minimum friction in Fahrenheit degrees = 15 + velocity in ft. per min. but for any point above the minimum at present I am at a loss to know. Therefore I would ask what temperature would be attained at a brake shoe, the shoe having a pressure of 1,825 pounds upon a 30-inch wheel, and the wheel revolving at a velocity of 2,108 ft. per minute, the wheel to run thirty minutes, such to be used applied, wheel and brake shoe to be of cast iron. If a steel tire which was used with a cast iron brake shoe, what would the difference in temperature be? *A.*—We do not answer this question, perhaps some of our subscribers can. We only wish to say that we do not know the answer, nor do we work out mathematical problems.

(127) J. P. B., Jimales, Mex., asks: 1. Is it possible to siphon water from a lower to a higher level? *A.*—No. 2. What

is the principle governing action of a siphon? *A.*—The siphon is a bent tube, one leg being longer than the other. By filling the entire tube with liquid, or by exhausting the air from it, the pressure of the atmosphere forces the liquid up the short leg to the bend, where it runs over, filling the longer end. The weight of water in the long end causes a continuous flow until the vertical height of the two columns are equal. The atmospheric pressure is essential to support the column of liquid to the top of the bend, and varies with the density of the liquid. At sea level it is possible to siphon water from a depth of 34 feet for short end of siphon, while mercury can be siphoned less than 30 inches.

(128) J. P. B., Shamokin, Pa., writes: We broke a rocker arm, lower end, could not get pin out of valve stem, blocked crossed after taking down main rod; *quested* the center of seat in placing valve, and clamped it there by jamming the stuffing box. My engineer says this was not the right thing to do. Please say why. *A.*—You do not say what means you employed to prevent the link striking the broken end of rocker arm, and so moving your valve stem. As far as "guessing" the center of the seat, there is no B. B. in it, it is guessing right. When the rocker is straight up or perpendicular the valve will cover the ports; by pulling clear back, marking the stem, pushing clear ahead and marking again then dividing these marks and placing valve between them, you are safe, the valve could also be placed by guess, and tested by using a little steam to see which cylinder seat it came out of, if out of neither, the valve would be near enough in the center to cover ports.

(129) Queensland, Maryland, Australia, writes: As I have had some very strong arguments with some of my fellow workmen, I wish to ask you a question through the columns of your valuable paper, and to make myself understood, will explain that we have two classes of engines, one I shall call *A*, the other *B*. *A* engine has a rocking shaft with one arm up the other down, and the eccentrics follow the crank as it were—as you bring the lever to the center of the quadrant you increase the lead of the valve when running. Now, engine *B* has a rocking shaft with both arms down, or on one side the eccentrics in this engine had the lever to the center of the head of the valve in bringing the lever back to the center the same as engine *A*? I say no. Am I right or wrong? *A.*—You are wrong. In every arrangement of the shifting or Stephenson link the lead increases as the lever is "hooked up." If you were ordered to increase the lead on either of these engines, *A* or *B*, you would advance the center of the axle. In hooking up you do not do this, but you move the center line of the valve motion itself back on the axle and eccentrics. If you draw a line across the strap and eccentric of one of these engines, and then move the eccentric to the center of the strap, its will advance ahead of the center of the strap, if, instead of moving the eccentric you hook up the lever, the mark on the strap will move back of the one on the eccentric. If the valve was set line and line with the port, either of these movements would admit steam to the cylinder, and would be increasing the steam. *A* is an indirect motion engine, your class *B* a direct motion engine, and the lead increases on each of them when you hook up.

(130) Laurence B. Melville, Vicksburg Miss., asks:

1. What decimal part of an inch per inch would you allow in making a shrinking fit of steel tires to driving centers of wheels from three to six feet in diameter? *A.*—One eightieth of an inch per foot is the usual practice. The American Railway Master Mechanics' Association have adopted the following standard sizes for wheel centers and allowance for tire shrinkage

Size of wheel centers	Bore of tire, per shrinkage
38	0.047
40	0.049
50	0.053
56	0.060
60	0.066
66	0.070

2. Where can I get a New York air-brake instruction book? *A.*—Of the brake company. 3. Please recommend to me books on locomotive construction, repairing, etc. to be used by one whose only "motive power" is himself. I have Sinclair's latest. Also recommend what you think is the best book of mathematics to be used by a student. *A.*—"Myers' Locomotive Construction." You had better take a course, by mail, in the correspondence school of mechanics; it is a first-class thing. 4. Please give me an idea how to lay off a quadrant; know how to set valves. *A.*—Quadrants are usually cut full of notches from end to end. If certain points of cut-off are wanted it is usual to put up quadrant without notches, lay out the notches by setting the valve at the position wanted, then marking the quadrant. 5. Please give me a rule for finding the length of an arc any arc, from end to end, around the curved line? *A.*—We do not work out examples in mathematics. Consult any engineer's hand-book. See Haswell's pages 260, 261.

Trying to Put Water in a Red-Hot Boiler.

An inspector belonging to the Hartford Boiler Insurance Co. had a curious experience, which throws light upon the kind of men who are often to be found in charge of steam plants. His story, as told in *The Locomotive*, is both amusing and edifying. He reported:

"I called to make an inspection at a steam works here, where they have two boilers, but use only one at a time. The engineer was working at his two pumps, which he could not get to throw water, and was scolding because he had no steam to run with, although he had plenty only a short time before. The tubes in the boiler I was going to inspect were badly choked, and fast nearly filled with soot from the coal. I thought that might be the trouble with the boiler they were using, so I opened the front of that boiler and looked into the tubes. They were red-hot, I looked for the water. It was gone. I looked under the boiler to see the fire, and jets of burning gas were actually spurting out between the rivets on the seams over the fire. And the engineer was still working at his two pumps, trying to get some water. I had a queer feeling just at that instant. I got the engineer away from the pumps as soon as possible, and had him draw the fire, and I could see the gas burning along the seam while the fire was being drawn. As soon as the steam ceased in the arch a little, the water sheet laid on the bottom of the boiler was red-hot for a space about three feet square. As soon as the boiler cooled down we opened the manhole, and found the inside to be bone dry. The outcome was that the seam next to the bridge-valve was badly fire-cracked and sprung, so the new sheet had to be put in. The tubes all had become out, and the tubes on the fire surface had to be recast, which I consider to be a very fortunate escape."

The New "NATHAN"
(SEE ILLUSTRATION), AND
MONITOR INJECTORS
FOR
LOCOMOTIVES.

"NATHAN" SIGHT-FEED LUBRICATORS,
 For Locomotive Cylinders and Air Brakes.
STEAM FIRE EXTINGUISHERS.
 For Switching and Yard Engines.
HOTTER WASHERS,
 Road and Grate Oil Cups, etc.

Send for **DESCRIPTIVE CATALOGUES.**

**NATHAN MFG. CO., 92 & 94 Liberty St.,
 NEW YORK.**

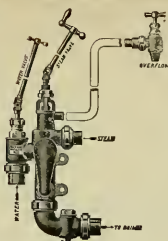

THE
Fire-Proof Baker Car Heater

MADE OF FLEXIBLE STEEL
 ONE-QUARTER INCH THICK.

Firmly Welded Into One Compact, Jointless, Seamless Whole.

**FIRE WITHIN A SAFE OF SAME MATERIAL
 AS THE EXPRESS CAR SAFE.**

NEARLY 1000 FIRE-PROOFS IN USE.

ALL OTHER STYLES OF "BAKER HEATERS."

WILLIAM C. BAKER,

Sole Proprietor and Manufacturer.

143 LIBERTY STREET, NEW YORK.



COLUMBIA BICYCLES

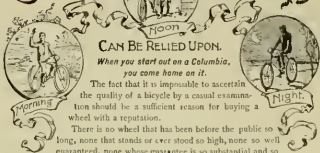

CAN BE RELIED UPON.

*When you start out on a Columbia,
 you come home on it.*

The fact that it is impossible to ascertain
 the quality of a bicycle by a casual examina-
 tion should be a sufficient reason for buying a
 wheel with a reputation.

There is no wheel that has been before the public so
 long, none that stands or ever stood so high, none so well
 guaranteed, none whose guarantee is so substantial and so
 liberally interpreted, none so safe to buy as a Columbia.

With Columbias listed at \$125, few riders will be so unwise as to invest in lower grade bicycles.

POPE MFG. CO.,
 Boston, New York, Chicago, Hartford.

TAYLOR BEST YORKSHIRE STAYBOLT IRON

Axles, Platen Rods, Crank Pins and Furgups of all
 Descriptions, used by Leading Railroads.

R. MUSHET'S SPECIAL AND TITANIC STEELS

SOLE REPRESENTATIVES IN THE UNITED STATES,

B. M. JONES & CO.,

BOSTON, 11 and 13 Oliver Street. NEW YORK, 143 Liberty Street.

MATCHLESS VALVE AND CYLINDER OIL.

Warranted not to corrode the iron or destroy packing, and to make more mileage than tallow or lard. Sold only to Railroad Companies direct
 or through our authorized agents. Matchless Cylinder Oil cannot be bought of Dealers. In use on 60 Railways.



—OILS FOR RAILROAD USE A SPECIALTY.—

ECLIPSE LUBRICATING OIL COMPANY, Limited,

MANUFACTURERS OF EVERY PRODUCT OF PETROLEUM.

HOLD OFFICE: FRANKLIN, Pa. REFERRALS: FRANKLIN, Pa. OLEAN, N. Y. ERIE, Pa. OIL CITY, Pa.

**KNOBBLER HAMMERED
 CHARCOAL IRON BOILER FLUES WE MAKE THEM.**

Will expand and contract
 more often than any
 other kind.

**The Tyler
 Tube and Pipe Co.,**

WASHINGTON, PA
 N. Y. Office, 39 Cortlandt St.

Carbon Steel Company, Pittsburgh, Pa.

MANUFACTURERS OF

OPEN HEARTH STEEL PLATES FOR ALL PURPOSES.

SPECIALLY SUITED FOR LOCOMOTIVE FIREBOXES AND BOILERS.
 PARTICULARS SENT ON APPLICATION.

Railroad Agents:

J. B. BRADY, 909 Havemeyer Building, New York.

W. M. WILSON, Western Union Building, Chicago.

PAUL S. REEVES, Philadelphia.
PHOSPHOR BRONZE IN INGOTS AND CASTINGS. * **LOCOMOTIVE AND CAR BEARINGS**
 A SPECIALTY.
 BRASS and PHOS. BRONZE CASTINGS from 1/4 lb. to 5,000 lbs. in WEIGHT.

TRIPLE RING
PIPE PACKING
 GUYTON and WATTS PATENT
(Patented June 8, 1881.)
 Originally made for Locomotives,
 now made for all uses.
 The Original Ring Packing
 is made of the best material of
 English Iron and Valve Bronze,
 and gives without the least
 trouble the best results.
THE DUNLOP PACKING CO.,
 East Cambridge, Mass.

SCHOEN MFG. CO.

**PRESSED
 STEEL MATERIAL
 FOR CARS.**

**PITTSBURGH,
 PA.**

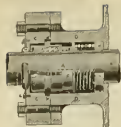

JEROME METALLIC PACKING.

This is the Standard Metallic Packing all over the world, and is more generally adopted and in use on more locomotives than any metallic packing in use. Give the JEROME a trial and be convinced. Put it in competition with any other packing and be convinced of its superior merits.

Office and Works, Nos. 35 and 37 Canal St., Chicago, Ill.

C. C. JEROME, Inventor and Proprietor.

Packing ring opened ready to apply without disconnecting the Piston from the crosshead. It runs longer and wears the rod less than any other packing in use.



SEND FOR CATALOGUE.

Graham's Patent Groove Shank Twist Drills and Chucks.



DETROIT TWIST DRILL CO., Detroit, Mich., U.S.A.

OUR ENGRAVINGS.

Of late we have had a great many inquiries as to who made the fine half-tone plates shown each month in LOCOMOTIVE ENGINEERING. Credit is, due the expert anywhere and we are glad to recommend the engravers of our plates to those wanting good work at reasonable prices. All the half-tones and reproductions we use are made by the STAR ENGRAVING & PRINTING CO., 607 & 609 Sanson St., Philadelphia, Pa. SINGLAK & BULL.

The Smith Triple Expansion Exhaust Pipe.



FRONT VIEW.

THIS Device is the invention of JOHN V. SMITH, the originator of the Smith Vacuum Brake. In the cuts of the Front and Side Views shown herewith, "AA" represent Air Passages; "SS" Exhaust Steam Passages, and "B" an Annular Blower forming part of the Nozzle.

It is an entirely new departure in the construction of Exhaust Pipes for Locomotives.

Its distinguishing features are that the exhaust steam is not restricted after it leaves the cylinders, and the gases and heated air in the smoke arch are mingled with the exhaust steam in the exhaust pipe. The exhaust steam is thus superheated and expanded, and a powerful, prolonged, pulsating blast is created, which keeps the fuel in a constant state of agitation, and produces more perfect combustion.

Some of the beneficial results obtained are: *Reduction of Back Pressure to a minimum (area of nozzle opening as large as the exhaust port); prevention of ejection of sparks from smoke stack; almost complete absence of noise from exhaust; prevention of formation of clinkers in fire-box; large saving of fuel.*

By the elimination of Back Pressure we have demonstrated the fact that the power of engines has been increased to be able to pull from thirty to sixty tons more than with any other form of exhaust pipe.

The pipe can be used with either straight or diamond stacks, in long or short front ends, and on locomotives burning hard or soft coal, wood or coke.

NEW YORK SALES OFFICE, Rooms 29 & 31, 115 BROADWAY.

GENERAL OFFICE DOYLESTON, PA.

FACTORY—READING, PA.



SIDE VIEW.

THE LESLIE

PATENT

Locomotive Fire Kindler

FOR

Cheapness, Simplicity, Cleanliness, Convenience, Absolute Safety, Durability and Economy,

STANDS
UNRIVALED.

IT IS THE ONLY SYSTEM OF KINDLING LOCOMOTIVE FIRES WITH CRUDE OIL WHICH HAS EVER BEEN PUT INTO GENERAL USE BY ANY RAILROAD COMPANY.

THOUSANDS OF FIRES

Have been Kindled for Less than

4 CENTS PER ENGINE.

During the past Winter ONE car tank of Crude Oil kindled more fires than 500 Cords of Wood.

Its adoption in all round-houses over their Entire System by the Roads, which had tested it in all kinds of weather, furnishes absolute proof of its Complete Success.

For particulars, address

J. S. LESLIE, Paterson, N. J.

RAILROAD ENGINEERING



Also, SURVEYING.

Courses AWARDED. Courses in other trades, including those in Marine and Mining, and in STEEL CONSTRUCTION, and you wish to study in the most complete school of Industrial Science, visitation, Pa.

Books for Railroad Men.

- LOCOMOTIVE ENGINE RUNNING and MANAGEMENT. By ANDREW SINGLAR. Price, \$2.00.
- INDICATOR PRACTICE. By FRANK F. HENKNEY. Price, \$2.00.
- ELEMENTS OF MECHANICS. By T. M. HOOPER. Price, \$2.50.
- PROGRESSIVE EXAMINATIONS FOR ENGINEERS AND FIREMEN. By JOHN A. HALL. Price, 50 cents.
- AIR-BRAKE PRACTICE. By J. E. PEARL. Price, \$1.00.
- COMPOUND LOCOMOTIVES. By A. T. WOOD. Price, \$2.00.
- CATECHISM OF THE LOCOMOTIVE. By M. N. FORNEY. Price, \$3.50.
- SIMPLE LESSONS IN DRAWING FOR THE SHOP. By O. H. REYNOLDS. Price, 40 cents.

Send price of any of these or of any other books of THE ENGINEERING LITERATURE COMPANY, East Orange, N. J., and they will be promptly mailed to any part of the world. Send for Catalogue.

Books You Want.

- "LOCOMOTIVE RUNNING REPAIRS," by L. C. BROWN, General Foreman "New" Shop. A practical treatise on the running repairs, by a practical man. Contains diagrams and illustrations that will be needed by men who handle and repair locomotives.
- "SIMPLE LESSONS IN DRAWING," by CHARLES H. BROWN, Chief Draftsman Northern Pacific Railway. A splendid book shows how to draw preliminary plan of mechanical drawing and mechanical.
- "PROGRESSIVE EXAMINATIONS OF LOCOMOTIVE ENGINEERS AND FIREMEN," by JOHN A. HALL. A complete Locomotive Engineering. A capital little book for new locomotives. An excellent pocket companion. Three hundred questions that the answers. Beautiful colored plates showing position and color of all signals carried on engines and trains according to standard code.

Send 50c. for any of the above to
DEBS PUB. CO.,
TERRE HAUTE, IND.

FOR EVERY RAILROAD MAN.
POCKET PRIMER
on Air-Brake
Instruction.



MODEL LOCOMOTIVES.
Complete sets of castings N. Y. Central Station, up to date. Three sizes.
O. H. OLNEY, 165 Delaware St., Brooklyn, N. Y.

SEND FOR CATALOGUE
OF
Purdue University.
The only Educational Institution in the world where a complete full-sized locomotive is arranged to run under steam for laboratory experiment.

COURSE IN
Mechanical Engineering,
Civil Engineering,
Electrical Engineering.
FINE SHOPS and EXTENSIVE LABORATORIES FOR
ADVANCED WORK.
TUITION FREE.
Address, SECRETARY PURDUE UNIVERSITY,
LAFAYETTE, IND.

LOCOMOTIVE ENGINEERING, N.Y.

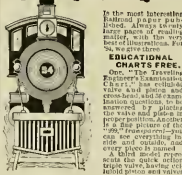

Send with this. The governor of the valve motion for 4-4-2 and 4-4-4.

KEEP YOUR PAPERS CLEAN.
Binders that will hold a full year's numbers for sale.
PRICE, \$1.00, POSTPAID.
LOCOMOTIVE ENGINEERING,
220 Broadway, New York.

WANTED Vol mes 3 and 4
of THIS PAPER.
WILL PAY DOUBLE PRICE FOR THEM.
Address, Locomotive Engineering, 220 Broadway, N. Y.

ENDORSED BY FAIRMOUNT LODGE, No. 333,
BROTHERHOOD OF LOCOMOTIVE FIREMEN.

Locomotive Mechanism and Engineering.

By H. C. REEGER, Explaining Fully and Clearly the Construction and Action of Simple and Compound Locomotives. Highlighting the principal "breakdowns" that happen to a Locomotive, with Complete Directions what should be done when occurs "on the road." Questions and Answers are so arranged that they can be used by Master Mechanics or Traveling Engineers, or by the Demonstrator in the Lodge Room. 145 Illustrations, 200 pages. 12mo, cloth. \$2.00.

JOHN WILEY & SONS,
NEW YORK.
AGENTS WANTED.

RIKARD DUDGEON, 24 and 26 Columbia St., New York.
Maker and Patentee of Improved Hydraulic JACKS,
Punches, Roller Tube Expanders and Direct Acting Steam Hammers.

THE "Southwestern Limited" RUNS DAILY BETWEEN NEW YORK, BOSTON and CINCINNATI, Indianapolis, St. Louis, and CHICAGO.

BIG 4 ROUTE.

E. P. MARSH, D. H. BROWN,
Passenger Traffic Mgr. and Gen'l Passenger & Ticket Agt.
CINCINNATI.

CINCINNATI HAMILTON & DAYTON R.R.
CH&D
CINCINNATI
CHICAGO DAYTON DETROIT

PULLMAN SLEEPERS on Night Trains.
ELEGANT PARLOR CARS on Day Trains.
DINING CARS between Cincinnati and Chicago.

W. B. GIBNEY, General Manager,
D. W. EDWARDS, Gen'l Pass. Agt., CINCINNATI, OHIO.

THE ONLY DOUBLE TRACK RAILWAY BETWEEN CHICAGO AND THE EAST.

Wagner Sleeping Cars, Drawee Boxes and Private Compartments Cars between Chicago, Indianapolis, Buffalo, Rochester, Syracuse, Albany, New York, Boston and intermediate points.

Route of the NEW YORK AND CHICAGO LIMITED, BOSTON AND CHICAGO SPECIAL, and the U. S. FAST MAILS.

W. B. CANNIFF, Gen'l Supt. CLEVELAND, O. A. J. SMITH, G. P. & T. A.

POWER
A MONTHLY JOURNAL devoted to Steam Engineering and Practical Work relative to the Economic Generation and Transmission of Power. 50 to 60 pages, size of this paper, profusely illustrated. Price, \$1.00 a year. Send for Sample Copy—FREE. Address: THE POWER PUBLISHING CO., WORLD BUILDING, NEW YORK.

AGENTS WANTED
Diseases OF THE
Air Brake System.
Causes Symptoms Cure.
By PAUL SYNNESTVEDT.

CONTAINS ILLUSTRATIONS of practically every piece of Air Brake Equipment in common use, in several different makes, old as well as new, arranged so that no cut occupies more than one page, thus assuring the trainman that this is the most complete work of the kind.

COVERS A FIELD ENTIRELY distinct from that covered by any previous publication. Especially valuable to:

- THE ENGINEER.
- THE FIREMAN.
- THE CONDUCTOR.
- THE BRAKEMAN.
- THE MACHINIST.

THE LATEST and BEST WORK ON AIR BRAKES SOMETHING NEW

Price, One Dollar.

W. F. HALL PRINTING COMPANY,
21 to 25 PLYMOUTH PLACE, CHICAGO.

LEONARD & ELLIS.
VALVOLINE
TRADE MARK
OILS FOR RAILROADS.

VALVOLINE OIL has long been used and tried and abroad. It has no equal in quality and economy.

W. A. BOYDEN, General Agent,
127 Chambers Street, NEW YORK.

AN ELEGANT TRADE CATALOG

Attracts attention and makes customers. The addition of a highly artistic Embossed Cover creates a good impression at first glance, that business to design and make catalogue complete, including engraving

GRIFFITH, Send six cents in stamps for your catalog "R. K." showing retail firm.

AXTELL & CADY CO based in Chicago design.

CADY CO DEDICATED PRINTERS
Holyoke, Mass. ENGRAVERS

REQUIRES NO ATTENTION.

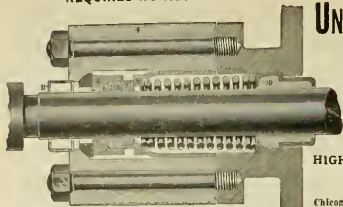

Seals and Oil Caps Furnished with every Packing.

IN USE ON THREE HUNDRED AND FIFTY RAILROADS.

UNITED STATES METALLIC PACKING CO.

For Locomotives, Stationary and Marine Engines.

The United States Metallic Packings

HAVE STOOD THE TEST OF YEARS AND ARE ACKNOWLEDGED TO BE SUPERIOR TO ALL.

Renewal of Packing Rings made without disconnecting, by cutting them in halves and breaking joints.

HIGHEST AWARDS COLUMBIAN AND PARIS EXPOSITIONS.

General Office, Bullitt Building; Works, 427 N. 13th St., Philadelphia, Pa.
 Chicago, Rotunda, Grand Pacific Hotel. St. Louis, 32 Laclède Building.
 Sao Francisco, 130 Mata Street. Montreal, Canada, 751 Craig Street.

SEND FOR CATALOGUE AND SPECIFICATIONS.

SURE TO GIVE

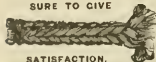

SATISFACTION.

DUVAL METALLIC PACKING

Send for Catalogues, Prices and detailed information to

THORNTON N. MOTLEY & CO.,
 SOLE AGENTS.

43 John Street, NEW YORK.

THE HALL SIGNAL CO.

Leads the World in the manufacture and installation of

Automatic Block Signals

Operated by either Track or Wire Circuits.

The ONLY Automatic Signal Systems in which the signals can be operated on the "Normal Danger" principle. Believed by many to be the best and safest plan.

HIGHWAY CROSSING SIGNALS,
 STREET RAILWAY CROSSING SIGNALS, ETC.

OFFICES:

80 Broadway, New York.

927 The Rookery, Chicago.

115 The Ames Building, Boston.

Equitable Building, Baltimore.

PERFECT



PUMP PACKING

AN ABSORBENT OIL CUSHION—INSURES PERFECT LUBRICATION.

WEDGE-SHAPED WEARING PIECES THAT MOVE ON EACH OTHER—INSURE A TIGHT JOINT, WITHOUT UNDUE PRESSURE FROM GLAND.

DOES NOT GET HARD OR BAKED: NONE WASTED—YOU KEEP PUTTING IN RINGS, NEVER TAKE ANY OUT.

THIS PACKING IS GUARANTEED TO KEEP TIGHT WITH STEAM, WATER, AIR OR AMMONIA.

PERFECT FOR AIR PUMPS.

A TRIAL SOLICITED

All kinds
 of Packing
 the P.P.P.
 is best.

C. A. DANIEL,
 313 Market St.,
 PHILADELPHIA, PA.

A. W. BOPER, Pres.

ROBT. ANDREWS, Vice-Pres.

C. H. BOWARD, Sec.

W. R. THOMAS, Treas.

R. M. DIXON, Engineer

THE SAFETY CAR HEATING AND LIGHTING CO.,

160 Broadway, New York.

HEATING SYSTEMS.—By hot water circulation and direct steam with regulating devices. Reliable and uniform heat. Economical and rapid circulation. Gibbs automatic coupler of Westinghouse type, absolutely steam-tight.

LIGHTING SYSTEM.—The celebrated Pintsch compressed oil gas method. In use on over 40,000 cars in Europe and America. Adopted by the U. S. Lighthouse Board for lighting Buoys. The best, most economical and only safe light for Railroad purposes. In brilliancy and cleanliness unsurpassed.

D. O. SETTLEHIRE, President. GEO. W. EVANS, Vice-President.

W. C. ARTHURS, Secy. and Treas. FRANK SYDNER, Supt.

Mt. Vernon Car
MANUFACTURERS OF
FREIGHT CARS OF EVERY DESCRIPTION, CA-
BOOSE AND REFRIGERATOR CARS,
MT. VERNON,



Manufacturing Co.
CAR WHEELS, CAR CASTINGS, AND GENERAL
FOUNDRY WORK.
Capacity, 15 Cars and 200 Car Wheels,
ILLINOIS.



MILLER'S ASBESTONE CAR ROOF.

THE COMING ROOF IS
HEAVY, DURABLE AND STRONG. Costs from \$10 to \$15 Less per Car.
WILL WEAR LONGER THAN ANY METAL ONE. CAN BE PUT ON IN ONE-HALF THE TIME.
WILL WEAR THE LIFE OF THE CAR.
HEAR WHAT THEY SAY ABOUT IT!
OUR WEST: M. E. & T. Ry. DOWN EAST: BOSTON & ALBANY R.R. 1302 HAVEMEYER BUILDING, 25 Carlhandt Street, NEW YORK.

RODGER BALLAST CARS.

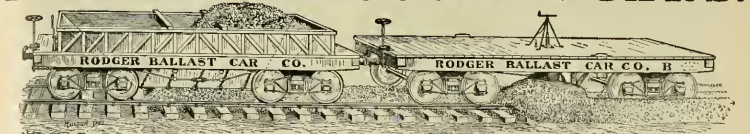

These cars are 34 feet long, and are built either 50,000 or 60,000 lb. capacity, M. C. B. Standard. They carry from 18 to 20 cubic yards of gravel or broken stone. In using them no ballast is thrown to the ditch, and hence is wasted, as the precise amount of ballast needed can always be distributed. A train of 22 cars, carrying 500 yards of ballast can be unloaded and the ballast distributed, leaving the track perfectly cleared and damped, as shown in the cuts, in from 12 to 15 minutes. This is all done by the regular "train service" in conductor and two brakemen, no extra help being required. The track is perfectly cleared by the spreader, so that a train can immediately pass over it at any rate of speed, without meeting any obstruction. No aprons are needed, no wire cables are used. There is no throwing ballast from between the cars, and no clearing the tracks with shovels. The ballast is left between the ties and on their ends, directly in position for tampering, when the track is raised, without being shoveled in from the ditch. The average saving per mile, in the amount of ballast needed to make a "train" of 10 or 12 miles, will be about 400 yards, and often far exceeds this. The total saving per mile in material, labor, time, use of cars, water in transportation, etc., is found to amount, in gravel, to from \$250 to \$400, and in broken stone it often amounts to \$500.

These cars are in use on the Great Northern Ry., the Illinois Central, the Gulf, Colorado & Santa Fe, the Chicago & Eastern Illinois, the Penn. Lines West, and other roads.

Detailed information will be furnished by circulars by addressing the
RODGER BALLAST CAR COMPANY, No. 1215 Menardock Building, CHICAGO, ILL.



Head Rest Seat.

THEIR SUPERIORITY IS PROVEN BY THEIR POPULARITY. **FINEST SEATS.** Coach, Parlor Car, Sleeping Car, Street Car, Rattan Elevated

IN USE ON ALL THE PRINCIPAL RAILROADS IN THE UNITED STATES



Spring Edge Seat.

THE HALE & KILBURN MFG CO.,

Simplicity, Durability, Elegance, Comfort.

IT IS SAFE TO SPECIFY THE **H. & K. SEATS**

PHILADELPHIA, NEW YORK, CHICAGO.

ALBANY, N. Y.
936 Broadway,
New York City,
115 BROADWAY.
STEAM COUPLERS
AND
FIRE PROOF HEATERS.

CONSOLIDATED
McElroy, Sewall, Westinghouse and other Patents.
CATALOGUES UPON APPLICATION.
Special Appliances and Extra Strong Fittings of Every Kind.
AUTOMATIC CONTROL OF HEAT.
CAR-HEATING CO.

CHICAGO,
200 Phenix Bldg.
Canada,
COATICOOK, P. Q.
COMMINGLER,
DRUM,
AND
DIRECT STEAM SYSTEMS.



THE MURPHY STEEL CAR ROOF.

HAS no surface mill or screw holes. It has no joints where eiders, rals or dno snow can get through. It allows for contraction and expansion, and has complete elasticity to provide for sagging, twisting, buckling and corrosion of the car body. It is as solid as the car frame itself. It has no soldered joints. It can be repaired readily, and without taking off more of the roof than is damaged. It is much cheaper than any other metallic roof now in use, and is cheaper than the double board roof, made of good lumber. It is made any other metallic roof for the reason that everything is furnished to make it complete; so that the parties buying it have no expense other than to apply it.
THIS ROOF can be applied on OLD LEAKY BOARD-ROOF CARS without making any changes in the board roof; thereby saving the expense of replacing the old boards with new, and thus utilizing material that must otherwise be thrown away.

Manufactured by the **P. H. MURPHY MFG. CO., East St. Louis, Ill.**

THE WESTINGHOUSE AIR-BRAKE CO.

Is now prepared to fill orders, at an hour's
notice, for One or One Thousand Sets of

AIR-BRAKES FOR FREIGHT CARS,

having, at their New Works, an annual capacity
for turning out Air-Brakes for 250,000 Freight
Cars, 6,000 Passenger Cars, 10,000 Locomo-
tives; besides repairs for the 350,000 Freight
and Passenger Cars, and 26,000 Locomotives
already equipped by

THE WESTINGHOUSE AIR-BRAKE CO.

PEERLESS ENGINE AND TENDER HOSE CONNECTION.

Air Brake Hose Guaranteed for 3 years.

Steam Hose for Car Heating.
Wonderful Steam Resisting Qualities.

E. L. PERRY, Pres. W. G. WINANS, Treas.



THIS HOSE is known as our ANACONDA brand. It is corrugated, made of three and four plies of duck, with a wire inserted to prevent it from collapsing or kinking, thereby making it impossible to break or shut off injectors when rounding a curve or striking a low joint. It is made any shape or length required. The outside is covered with a canvas jacket or covering to prevent oil, grease, etc., from destroying the hose. This hose is thought by many of the master mechanics of our large railroads to be the ideal hose for engine and tender connections.

MANUFACTURED EXCLUSIVELY BY
THE PEERLESS RUBBER MFG. CO.,
No. 16 WARREN STREET, NEW YORK.

C. H. DALE, General Manager.

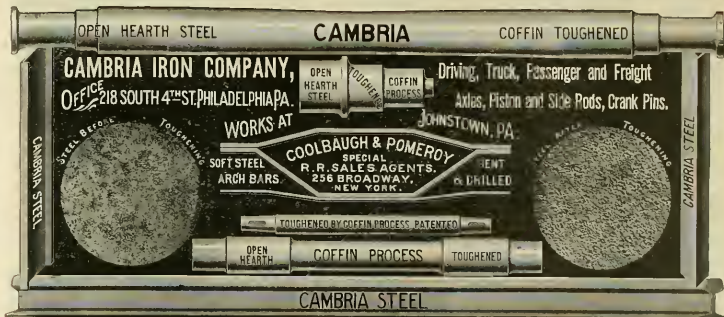

NEW YORK OFFICE FOR RAILS AND FASTENINGS—33 WALL STREET.

THE HAYDEN & DERBY MFG. CO.,

Sole Manufacturers of

Metropolitan Double-Tube Locomotive Injectors

These Injectors work at all steam pressures from 25 pounds up to 250 pounds without any regulation or adjustment.

It is impossible for the water to run out of the overflow when Injector is working.

They are not affected by leaky steam or check valves.

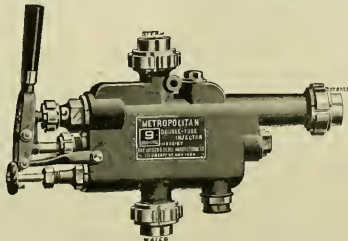

Owing to the peculiar form of nozzles used, repairs of these Injectors are reduced to a minimum. They are very slightly affected by bad water, there being no small relief holes or spills to wear or become clogged.

MADE INTERCHANGEABLE WITH STANDARD MAKES.

Office and Salerooms:

Nos. 111 and 113 LIBERTY STREET, NEW YORK.

THE ROTARY.

For full
Particulars,
Address

The Leslie Bros. Mfg. Co.,
Paterson, N. J.

WROUGHT IRON WHEEL CENTRES. VANGLIN'S PATENT.

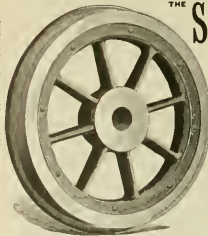

THE Standard Steel Works
PHILADELPHIA.

STEEL TIRES

Manufactured by an Improved Process
Insuring Solidity.

Wrought Iron Centres.
Steel Tired Wheels.

REPRESENTATIVES:

CHICAGO, 1013 MONMOUTH BLDG.
FITZ-HUGH & SPENCER.
ST. LOUIS, 516 NORTH THIRD ST.,
ANDREW WARREN.

THE CAMERON STEAM PUMP.

COMPLETE WITH BOILER.

THE A. S. CAMERON
STEAM PUMP WORKS,
Foot of E. Twenty-Third St.,
NEW YORK.

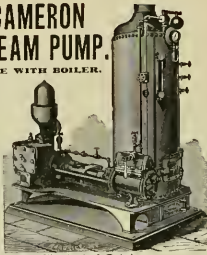

Send for Illustrated Catalogue.

MILLS ESTABLISHED IN 1864.

Ewald Iron Company,

OWNERS AND OPERATORS

Tennessee Rolling Works, Tennessee Rolling Mills,
CERRILLAND RIVER, LOUISVILLE, KY.

MANUFACTURERS OF

Tennessee Charcoal Bloom and Laurel Stay Bolt,
"E. I. C." and "BOONE" IRON.

Also, Tank, Flange, Fire Box and Boiler Steel and Iron.

PRINCIPAL OFFICE AND WAREHOUSE:

939, 941, and 923, 925, 927 N. Second Street, St. Louis.



THE WASHBURN
Car-Wheel Company,
HARTFORD, CONN.,
MANUFACTURERS OF
**CRUCIBLE
STEEL-TIRED WHEELS**

For Parlor and Sleeping Cars,
Passenger Coaches, Locomo-
tive and Tender Tracks.



RAMAPO WHEEL AND FOUNDRY CO.

MANUFACTURERS OF

BOLTLESS STEEL-TIRED WHEELS

FOR PASSENGER AND LOCOMOTIVE SERVICE.

Tires with Annular Web and Hook,
Best Charcoal Iron Double-Plate or Spoke Centers,
Wedge-Shaped Retaining Ring.



SECTION OF BOLTLESS PASSENGER

Continuous
Circumferential
Fastening.



SIMPLE, +
SAFE, +
ECONOMICAL.

CHILLED IRON WHEELS

OF SUPERIOR QUALITY,
Drawing Room, Passenger and Freight Cars,
Locomotives, Tenders, Pipelines
and Rio-Cans.

CYLINDER PACKING RINGS.

CONGDON BRAKE SHOES

FOR CHILLED IRON WHEELS,
Outwear from 4 to 6 ordinary
shoes and enhance
mileage.

Office and Works: RAMAPO, N. Y.

RAMAPO IRON WORKS, Hillburn, N. Y.,

MANUFACTURE

Brake Shoes for Steel Tired Wheels.

ROSS, for Steel Tired Car and Tender Wheels,
ROSS-MEEHAN, for Locomotive Drivers,
SHEPPARD, for Blind or Bald Tired Drivers.

NARROW GAUGE CARS, SWITCHES, AUTOMATIC STANDS.

YOKED, BOLTED and SPRING RAIL FROGS,
CROSSINGS, TRACK EQUIPMENT,

RAILROAD AND MACHINERY. CASTINGS, HEAVY AND LIGHT.

C. E. ROOD,

H. M. BROWN.

ROOD & BROWN,

CAR WHEEL WORKS,
BUFFALO, N. Y.

Railroad, Car, Engine, Tender and Truck Wheels, Made from Best Charcoal Iron.
Office and Works: HOWARD and THOMAS STS.

C. M. FARRAR.

JOHN TREMPER

C. E. ROOD

EAST BUFFALO IRON WORKS,

FARRAR, TREMPER & ROOD, PROPRIETORS.

GREY IRON CASTINGS
of every description. Special Attention Given to Car and Locomotive Work.
Works: N. Y. C. & N. H. R., Broadway Station, Belt Line. Office: 60 Perry St., Buffalo, N. Y.

C. E. ROOD,

MANUFACTURER OF
MALLEABLE IRON,

QUALITY GUARANTEED
RAILROAD WORK A SPECIALTY.
Office and Works: LANCASTER, NEW YORK.

THE ALLISON MFG. CO.,

MANUFACTURERS OF

FREIGHT CARS AND
LOCOMOTIVE BOILER TUBES.

WROUGHT IRON PIPE OF SUPERIOR QUALITY.

PHILADELPHIA, PA.

DRAKE & WEIRS, Cleveland, Ohio.

ASPHALT CAR ROOFING

The Cheapest, Best and Most Durable Car Roof known. In use by Seventy Railroads. Over 7000 successful uses without a single failure. A new roof furnished free for every one that falls in 120 days.

BEMENT, MILES & CO.,

PHILADELPHIA, PA.,
MANUFACTURERS OF

METAL WORKING MACHINE TOOLS

FOR
Railroad Shops, Locomotive and Car Builders, Machine Shops, Rolling Mills, Steam Forges, Ship Yards, Boiler Shops, Bridge Works, etc.



**STEAM
HAMMERS**
**STEAM AND
HYDRAULIC
RIVETING
MACHINES.**

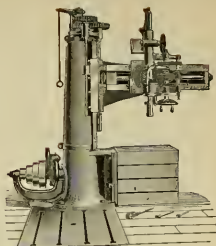

Special Air Tools for R. R. Shops.

**Automatic
Compound
Belt Com-
pressor. = =**

Only runs when air is used, requires no attention except oiling, delivers 35 cubic feet of free air per minute — great economy over steam air pumps.

Air Hoists of all sizes, — saves more labor and time than any other shop tool, speed of hoist being entirely at will of operator. Will save ten times their cost per year over a wheel lathe.

Let us quote you on above tools.

PEDRICK & AYER CO.,

1001 Hamilton Street,
PHILADELPHIA, PA.

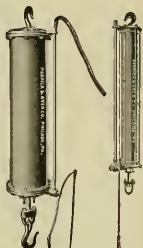
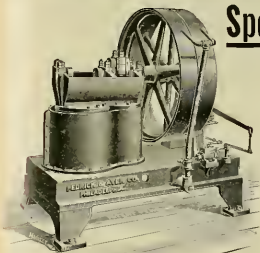

Nicholson's Expanding Lathe Mandrels.



Set of 9 takes from 1 in. to 7 in. Set of six from 1 in. to 4 in.

Either set sent subject to Thirty Days Trial, and Guaranteed Absolutely Accurate and Labor Saving.

Send for catalogue for full description and references.

GEORGE L. WEISS, General Agent, 139 INGLECISE AVENUE, CLEVELAND, OHIO.

THE PRATT & WHITNEY CO.,

HARTFORD, CONN., U. S. A.,
MANUFACTURERS OF

STANDARD CYLINDRICAL SIZE and U. S. STANDARD THREAD GAUGES.

Special Gauges of every variety of later-changeable production.

REAMERS, TAPS and DIES,

In all usual styles for Machinists, Pipe Fitters and Boiler Makers.

Renshaw Ratchet Drills, Combination Lathe Chucks, Die Stocks, Bolt Cutters, Lathes, Planers, Drilling, Milling, Profiling, Cutter Grinding, Die Sinking, and Drop Forging Machines, Forging and Trimming Dies.

MONITOR MACHINES FITTED WITH TOOLS

For Reaming to Sample. Seven-Stroke, Locomotive Fitters, Plombers' and Gas Fitters' Brass Goods.

CATALOGUE SENT ON APPLICATION.

THE INEVITABLE RESULT OF USING INFERIOR STAYBOLT IRON IN THE CONSTRUCTION OF THE MODERN, HIGH PRESSURE LOCOMOTIVE BOILER.



TO AVOID EXPLOSIONS and consequent GREAT LOSS of LIFE and PROPERTY, use the

SAFETY HOLLOW STAYBOLT,
inventor of the
FELLS HOLLOW STAYBOLT CO.
Cuyahoga Falls, O.

Furnished in all sizes from 1/4 to 2 in. outside diam., with any size hole required from 1/8 to 3/4 in.

THE LONG & ALLSTATTER CO.,

HAMILTON, OHIO.
Double, Single, Angle-Bar, Gang, Bird's-foot, Crow, Knives, Spacing, Lath, Multiple, Belt and Steam-Driven

**PUNCHES
AND
SHEARS.**

Over 300 Sizes.



Horizontal Punch. Made in 5 Sizes.



THE ACME MACHINERY CO.
CLEVELAND, OHIO,
Manufacturers of

ACME BOLT & RIVET HEADERS
ACME SINGLE AND DOUBLE
AUTOMATIC BOLT CUTTERS,
Cutting from 1/4 in. to 1 1/2 in. diam.
Also, SEPARATE HEADS and Dies.



THE DETROIT

No. 2 and 3

SIGHT-FEED CYLINDER LUBRICATORS
FOR LOCOMOTIVES
ARE THE BEST.



This Lubricator discharges oil to cylinders accompanied easily by dry steam, and consequently full effect of oil is obtained.
Cannot cross-feed.
No broken gaskets by wear of steam and water.

DETROIT LUBRICATOR CO., Detroit, Mich.

Awarded Gold Medal and Highest Premium at the World's Columbian Exposition.

FLAT TURRET LATHE

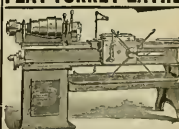

TURNS STRAIGHT and TAPER FRAME BOLTS, ETC.

SEND FOR A COPY OF

"RAPID LATHE WORK,"

By New Method—Hartness System.

JONES & LAMSON MACHINE CO.,
SPRINGFIELD, VERMONT, U. S. A.

THOMAS PROSSER & SON,
15 GOLD STREET,
NEW YORK.



STEEL TIRES

ON LOCOMOTIVE DRIVING WHEELS
AND ON STEEL-TIRED WHEELS
GIVE THE BEST RESULTS
FOR EVERY VARIETY OF SERVICE.

The CAST-STEEL WORKS of FRIED. KRUPP, Essen, Germany, cover an area of 1,200 acres, employ about 25,000 men, have the most improved plant, and stand unique from the fact that they have their own Ore and Coal Mines, Blast Furnaces, etc., and that every stage of manufacture is under their own supervision, and are not (like others) dependent on the open market for a miscellaneous assortment of crude material; which, in connection with 75 years' experience, enables them to turn out a product of a very superior quality, second to none, and at the same time the different grades of Steel are always of the same uniform quality.

Crank Pins, Piston Rods, Spring Steel, Steel-Tired Wheels, Etc.

After a test of over 35 years, the "KRUPP TIRE" has proved itself the best in the market. If a reliable article is wanted, which will give satisfaction, get KRUPP'S.

SCHENECTADY LOCOMOTIVE WORKS, SCHENECTADY, N. Y.

LOCOMOTIVES
OF
STANDARD
DESIGN
FOR ALL
CLASSES OF
SERVICE.



OR FROM
DESIGNS
FURNISHED
BY
RAILROAD
COMPANIES.

EDWARD ELLIS,
President.
WM. D. ELLIS,
Vice-Prst. and Treas.

A. J. PITKIN,
Superintendent.
A. P. STRONG,
Secretary.

COMPOUND LOCOMOTIVES, Showing an Economy of 15 to 30 per cent. in Fuel and Water. Annual Capacity, 400.

M. L. HENMAN, Pres. and Treas. DAVID RUSSELL, Supt. R. TANDY, Asst. Supt.



Brooks Locomotive Works, DUNKIRK, N. Y.

Builders of Locomotive Engines for any required service from our own designs or those of purchasers. Perfect interchangeability and all work fully guaranteed.

COMPOUND LOCOMOTIVES

FOR PASSENGER AND FREIGHT SERVICE.

J. G. HENDRICKSON, Pres.
F. J. CLAMER, Vice Pres.
J. R. NELSON, Sec. and Treas.

"AJAX TIN" USED WITH COPPER PER OUR FORMULA, MAKES EMPIRE STATE EXPRESS BEARING METAL, WHICH RUNS COOL AT ANY SPEED; RECORD: 90 MILES PER HOUR.

AJAX METAL COMPANY
INCORPORATED,
PHILADELPHIA, PA.

Latrobe Steel Works
MANUFACTURERS OF

TIRES

FOR LOCOMOTIVE and CAR WHEELS.

Main Office and Works, Latrobe, Pa.
Branch Office, Hubert Building, Philadelphia.
Chicago Office, Western Union Building.
New York Office, Home Insurance Building.

William Sellers & Co. Incorp.
PHILADELPHIA, PA.

MACHINE TOOLS

For Railroad Shops, Car Builders, Etc.

HIGH SPEED
TRAVELING & SWING CRANES.
ALSO
TURNABLES, INJECTORS,

SHAFTING,
ETC., ETC.



"LACKAWANNA"

Sight Feed Locomotive
Cylinder Lubricator.

ABSOLUTE UNIFORMITY OF FEED.

Perfect distribution of oil to both cylinders from one feed glass, and entire efficiency under all working conditions.

Only One Glass,

and that short and stout; almost unbreakable. Absolutely no use for any more. They are an unnecessary source of trouble and danger.

Write for full particulars.

LACKAWANNA LUBRICATING CO.,
1212 Capouse Avenue, Scranton, Pa.



Rhode Island Locomotive Works, PROVIDENCE, R. I.

CHARLES FELIX MASON, President. ARTHUR LIVINGSTON MASON, Secretary.
EARL PHILIP MASON, Vice-President. JOSEPH LYTCHER, Agent and Supt.
WILLIAM P. CHAPIN, Treasurer. S. A. STEPHENS, Traveling Agent.

NEW YORK OFFICE,
Nos. 31-33 Pine Street.

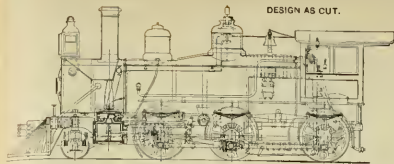

DESIGN AS CUT.

BALDWIN LOCOMOTIVE WORKS

Standard Gauge Locomotive,
FOR IMMEDIATE DELIVERY.

Cylinders 19" x 24", displacement, 507 cubic feet; stroke, 27" thick; total wheel base, 37' 6"; driving wheels, 19" dia., weight in working order, 100 tons; weight on driving wheels, 60,000 pounds; boiler 36" in diameter; fire box, 7'11" x 21'6"; flues, 100 in number; 2" diameter, 14' 6" long; riveted plate track wheels 36" diameter; trunks of 3,000 gallons capacity; 48" chilled wheels. Engines in stock with best quality feed water; also in stock for plate iron and valve stems, balanced valve gears; two No. 2 injectors, horizontal, adjustable; piston cement tapping; New York air brake on driving and tender wheels; also in stock for National hollow brake hoes; footboard left hand; and all necessary tools.

FOR PRICE AND PARTICULARS, ADDRESS
BURNHAM, WILLIAMS & CO., Philadelphia, Pa.



Pittsburgh Locomotive Works.

PITTSBURGH, PA.,

Manufacturers of
LOCOMOTIVE ENGINES

For Broad or Narrow Gauge Roads
From standard designs or according to specifications, to suit purchasers.
Tanks, Locomotive or Stationary Boilers
FURNISHED AT SHORTEST NOTICE.
WILSON MILLER, Pa. & Trs. D & WESTMAN, Eng.



DICKSON MANUFACTURING CO.

SCRANTON, PENN.

Locomotives of every style and size, Standard and narrow gauge, made to Standard Gauges and Tenders. Also for Plantations, Mines and Logging.
SPECIFICATIONS ON APPLICATION.
J. W. F. DICKSON, President.
E. W. WESTON, V. Pres. W. E. FISKE, Sec. & Treas.
JOHN DENTON, Superintendent.

CROSBY



POP SAFETY VALVES,
RIFLED AND FLAIN.
IMPROVED
STEAM GAGES,
SINGLE BELL
CRIME WHISTLES.
A perfect equipment for a locomotive, giving prompt relief, economy and absolute reliability. Specify these goods when ordering locomotives.
CROSBY STEAM GAGE AND VALVE CO.,
Boston, Mass.
BRANCHES: New York, Chicago, and London, England.

ROGERS LOCOMOTIVE COMPANY

OF PATERSON, N. J.
New York Office, 41 Exchange Place.
MANUFACTURERS OF
LOCOMOTIVE ENGINES AND TENDERS,
And Other Railroad Machinery.
R. S. HUGHES, President.
G. E. HANNAH, Treas. G. H. LONGFOTTON, Sec'y.
REUBEN WELLS, Superintendent.



FLEXIBLE STEEL RULES.

Watch Spring Tempered Steel.
Graded in 32ds and 64ths on one side only.
SEND FOR CIRCULAR.

VALLENTINE TOOL CO.,
Hartford, Conn.

PORTLAND CO. INCORPORATED 1846.

LOCOMOTIVES OF ALL TYPES.

STANDARD OR NARROW GAUGE FOR ANY SERVICE FROM OUR OWN OR TO RAILROAD CO'S SPECIFICATION.
Freight Cars, Derrick Cars, Push Cars and Car Wheels.
Boilers of Locomotive, Horizontal, Tubular and Vertical Type
FRANKLIN C. PAYSON, President. JAMES E. GREENSMITH, General Manager. J. HENRY D. VERRILL, Treasurer



ESTABLISHED 1865.
Richmond Locomotive
AND MACHINE WORKS,
RICHMOND, VA.
Locomotives for Every Service.

The Sample Tells the Story.

A sample of Dixon's pure, black lubricating Graphite, with interesting and instructive pamphlet,
Sent Free of Charge.
Every engineer and machinist should make himself better acquainted with Dixon's Pure Ticonderoga Fluke Graphite. It will save both time and labor, and is infinitely superior to the common forms of plum-bago or black lead.
JOS. DIXON GRUGIBLE CO.,
JERSEY CITY, N. J.

You can get back numbers to January, 1894,
NOW. You can't next year.

COOKE LOCOMOTIVE AND MACHINE CO. PATERSON, N. J.

(Formerly Danforth Locomotive & Machine Co.)



JOHN B. COOKE, President & Gen. Mgr. PATERSON, N. J.
FRED W. SHANK, Vice President.
W. B. BRIDAN, Sec'y & Treas.
New York Office, 45 BROADWAY, E. A. ALLEN, Agent.



MAGNOLIA METAL

For All Bearings.

Sterlingworth Railway Supply Co.,
Exclusive Railway Agents,
256 Broadway, New York.

ALWAYS ==
== COOL!!

M. C. B. STANDARD
Automatic Freight Car Coupler.

Locomotive and Car Axles,
Coupling Links and Pins.

New York Office, . . . 66 Broadway,
Chicago Office, . . . 941 Rookery,
St. Louis Office, 319 Commercial Build'g.

GOULD
Goupler Co.

WORKS: OPEW, N. Y.
BUFFALO, N. Y.

M. C. B. Passenger Coupler
Used in Place of Miller Hook
WITHOUT CHANGES IN PLATFORM.

Gould Continuous Platform and Buffer.
GOULD VESTIBULE.

THE HAMPSON



Flexible Steam Joint

Does away entirely with Rubber Hose for Steam Heating

HAS NO GROUND JOINTS.

F. A. BARBEY & CO., 215 FRANKLIN STREET, BOSTON.



YOU are now looking at a picture of the Best **BOILER WASHER** and **TESTER** made Washes with hot water, tests to any pressure with hot water. Requires no foundation, takes up no shop room. Has no moving parts, and a record of efficient service for ten years. We also make the FAMOUS "Little Giant" Injector. Ejectors and other Jet Apparatus

Rue Manufacturing Co.,
119 N. 5th St., Philadelphia, Pa.

Ask for Catalogue.

LOCOMOTIVE SPRINGS
WITH PATENT V SHAPE BANDS.
Gives more Elasticity to short Plates and Better Riding Qualities.



MANUFACTURED BY
A. FRENCH
SPRING CO.

A. FRENCH, Pres.
J. R. FRENCH, Vice-Pres.
GEORGE W. MORRIS, Gen. Mgr.
D. C. NOBLE, Sec. and Treas.
F. N. FRENCH, Gen'l. Supt.

A. FRENCH SPRING CO.
PITTSBURGH, PA.
Manufacturers of
ELLIPTIC AND SPIRAL SPRINGS
OF ALL DESCRIPTIONS.

THE TROJAN CAR COUPLER Co., Troy, N. Y.

The following is the description for coupling to the land rail in the axle of the car rendering it unnecessary for the trundle to go between the cars it opens the knuckle.

M. C. B. TYPE.
THE STRONGEST AND THE ONLY SAFETY COUPLER.
New York Office; 49 WALL ST.

THE JANNEY FREIGHT CAR COUPLER



THE MCCONWAY & TORLEY COMPANY

W. M. CONWAY - PRESIDENT.

48th ST. & A. V. RY. - PITTSBURGH, PA.

Locomotive Engineering



A Practical Journal of Railway Motive Power and Rolling Stock.

COPYRIGHTED, 1914, BY ANDREW SINCLAIR AND JOHN A. HILL.

VOL. VII, No. 10.

NEW YORK, OCTOBER, 1894.

20 Cts. Monthly
\$2.00 Per Year.

Mastodon Broad Gauge Locomotives for Brazil.

The engravings show the class of heavy locomotives that the Brooks Locomotive Works are building for the Brazilian government roads.

The order is for sixty locomotives, fifteen of them being of five foot three inch gauge and the remainder of meter, or 39 $\frac{3}{4}$ -inch gauge.

These great engines are 'splendid specimens of work, the material being all of the best quality and the workmanship has been subject to especial inspection.

The "Improved Belpaire," patented by their mechanical engineer, Mr. John Player—there is not a straight line in it.

The top of wagon top is arched as is the crown sheet about two inches and the crown stays go through the sheets radially.

The firebox is of $\frac{11}{16}$ in. copper, fluesheets $\frac{11}{16}$ in.

The front, back and the corners of the mud ring are double riveted.

The door hole is formed without a ring, and with both ends of the rivets outside and away from the fire, the back fire sheet being flanged back, and the back head flanged in and then cut to make the

boarls and headlight stand are brass covered; there are brass bands on the stack, and the handrails are of the same material. The cab is finished in natural oak. All the paint of engine and tender is bronze green, relieved by gold leaf stripes.

There are three signal lamps, one on rear of tender, and two on the front of the engine, that are as large as the headlights now used on the New York Central or Pennsylvania roads.

The buffers in front fold back when not in use, and a similar pair are used on the rear of tender.

There are three tank valves and three

when using steam in the Le Chalelier brake.

Just over the engineer's head is located the whistle lever, and on the shaft running across the top of the cab is the sand lever, there being no other place to locate it that would be so handy or work so easily.

The steam turret is placed in a vertical position on the boiler head as shown; this leaves the top of the boiler head clear of everything and brings all valves within handy reach of the engineer.

The engines have Nathan lubricators, with independent cup for air pump.

The boiler head is lagged and jacketed down to the fire door.

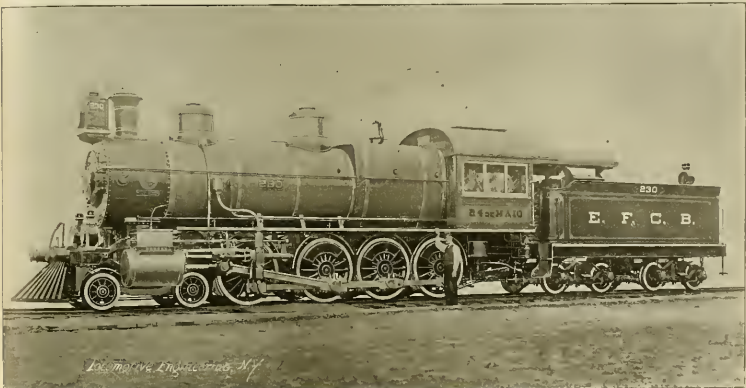

BROAD GAUGE MASTODON LOCOMOTIVE FOR BRAZIL. WEIGHT, 170,000 POUNDS; CYLINDERS, 21 X 26 INCHES.

The general style of the engine can be seen from the engravings. The machine might have been made to look a little better, perhaps, had the headroom been greater, but they are held down to 14 ft. 4 in. by the size of the many tunnels on the line. This caused the cabs to be made with such a rounding roof and the lowering of the running boards so as to get the cab deck down.

The cylinders of these engines are 21 x 26 in. The steam ports are 18 $\frac{1}{2}$ in. long 1 $\frac{1}{4}$ in. wide and the exhaust port 3 $\frac{1}{2}$ in. wide. Richardson balanced valves are used, with $\frac{3}{4}$ in. lap and $\frac{1}{4}$ in. lead.

The driving wheels are 54 in. in diameter with 9 in. axles. The smallest ring in the boiler being 68 in.

This boiler is worthy of especial mention, and is shown very plainly in the excellent engraving. The shell is of $\frac{11}{16}$ in. steel, the seams extra heavy riveted, and the upper stays on the side sheets being spaced very close together.

The form is what the Brooks people call

two edges of sheet come outside the fire door hole.

The boiler, just as you see it, is 28 ft. 7 $\frac{1}{2}$ in. long and 68 in. diameter. The shallow firebox is 114 in. long and 38 $\frac{1}{2}$ in. wide inside. The grates are water tubes and pull bars, and the brick arch is supported on tubes from the crown sheet to the flue sheet. There are 24 iron flues 2 $\frac{1}{2}$ in. in diameter and 13 ft. 10 $\frac{1}{2}$ in. long. The boiler weighed (without flues or dry pipe) 31,100 pounds, with flues and dry pipe complete, as shown, 46,500 pounds.

The total weight of this engine in working order is 170,000 pounds. Weight on drivers, empty, 138,250 pounds, on truck, 29,750 pounds. Weight of tender, loaded, 82,000 pounds.

The Brazilians admire nice looking things, and require that even freight engines shall have considerable brass and joint. The cylinders, steam chests, sand-box and dome have brass casings, the boiler bands, the edge of the running

water hose, on the pump shown and for the two No. 10 Monitors.

On the meter gauge suburban engines there is a Pintsch gas cylinder and arrangements for lighting signal lamps and headlight with it.

The engines and tenders are equipped with the latest Westinghouse air brake equipment, the American equalized brake being used on the drivers.

The reversing gear is a combination of lever and screw, either can be used.

The arrangement in the cab is plainly shown. The injectors are placed on the boiler head because of the want of room on the side of boiler.

There are four gauge cocks, arranged as shown, and a glass gauge also.

The Le Chalelier water brake is used and has a steam and water valve arranged as shown to the right of the gauge cocks. On the chest cover, there are large plug valves operated from the cab, and these are piped to the exhaust pipe of the air-pump; these are used as governing cocks

There is one thing about these cabs that is good, the three windows slide into the space occupied by one and there is no post in the center—the whole side of the big cab is open, and a man can get out very easily and comfortably.

The seat is of the drop pattern, and slides on a rod so as to let the engineer adjust himself to his work.

The tender has a roof over the gangway and front of cab, as shown—these engines carry two firemen.

The engine, truck and tender wheels are cast iron centers with steel tires. All tires are Krupp crucible steel. The apron and running boards are made of diamond rolled steel that seems well adapted to this kind of work.

Taken altogether, they are about the finest appearing and most striking looking locomotives built this year, and if they do not make a record in South America it will be because they are not well handled, and not because they are not well designed and carefully built.

MASTER CAR-BUILDERS' ASSOCIATION.

Subjects and Committees for Convention of 1895.—Secretary John W. Cloud announces the following committees for next year's work:

1.—*Interchange of Cars*.—To suggest how cars in interchange may be maintained equitably to owners and operators with least expense and detention. Pulaski, J. W., Marple, L., Packard, J. N., Leeds, B. E., Nelson, Samuel Irwin, J. H., Rankin.

2.—*Road Tests of Brake Shoes*.—To conduct and report upon a series of comparative tests of different brake shoes in service, with as complete data as possible. R. H. Soule, W. S. Morris, S. A. Crane, L. W. Rhodes, A. E. Mitchell, W. H. Lewis, J. W. Marple, A. M. Watt, Jos. Townsend, Sam'l Potcher, J. C. Barber, W. L. Hoffecker.

3.—*Laboratory Tests of Metal for Brake Shoes*.—To conduct and report upon laboratory tests of different brake shoes, with as complete data as possible. S. P. Smith, L. L. Barnes, J. W. Cloud.

4.—*Lubrication of Cars*.—Continued from 1894 to pursue its own recommendations as to tests of oil for lubrication, and consider the economies of journal bearings as suggested in its report, if feasible. A. M. Watt, P. A. Stinson, W. H. Thomas, W. K. Carr, L. E. Wood.

5.—*Brake Tests*.—G. W. Rhodes, P. Bush, Cass Gibbs, A. S. Vogt, R. A. Adams.

6.—*Air Brake and Hand Brake Apparatus on Cars*.—Continued from 1894, to consider the question raised in its report, and to include the standard levers and all the important improvements pertaining to the subject. R. D. Branner, Wm. McWood, Pulaski Leeds, W. P. Siddons, Jas. Melice.

7.—*Automatic Couplers*.—To advise what changes may be desirable in the standard size of M. C. R. automatic coupler tanks, and to recommend a standard design pocket stem for test and standard use. J. M. Wallis, A. E. Mitchell, P. Chamberlain, R. D. Wade, Wm. Corstang, T. G. Duncan, Thos. Kearley.

8.—*Mounting New and Secondhand Wheels*.—To report upon the best method for mounting new and second-hand wheels so that they shall be properly located upon the axle. J. N. Barr, G. L. Potter, J. H. McCounell, Wm. Forsyth, T. J. Hatwell, Thos. Sutherland, John Hodge.

9.—*Passenger Car Ends and Platforms*.—To consider what improvements may be made in the construction of passenger car ends and platforms for increased strength in ordinary service and in emergencies. E. W. Greaves, P. D. Adams, Samuel Potcher, C. A. Schroyer, M. M. Martin, T. A. Russell, J. J. Hennessy.

10.—*Coal Car Ends*.—To suggest best methods of construction and siting of the sides of two-ton capacity coal cars with high sides. R. E. Marshall, R. McKenna, G. W. West, R. P. C. Sander-son, Samuel Higgins, R. C. Binkall, La Motte Ames.

Engineer Thos. R. Berry has run one engine on the New Orleans & Southern R. R. one hundred thousand and seventy miles without having his main rod brasses filed or out of the strap, and they were not pounding when she was taken off the run.

Back Pressure in Compound Engines.

BY H. H. SHARP.

When I was serving my time in a locomotive shop in the old country, I remember not being able to get any intelligible explanation of the principle on which a compound engine worked. Back pressure was my difficulty. I could not understand how the high pressure (thereafter h. p.) piston could move when it could not ex-

ceed beyond these, and, by way of getting increased power, an oil-fashioned beam engine and condenser was added to the plant. The beam engine, however, did not get live steam from the boiler but had to make out with the exhaust from the horizontal engines. The old man running this badly matched team ought, I thought, to be able to give me a pointer in the plant. I put the same question to him with regard to back pressure that I had previously put to the creator.

book on the steam engine which was back pressure on the h. p. piston, and at the same time believing that this proves a stumbling-block to other beginners besides myself, I thought the following may be of some service to them. I have made no reference to the action of the valves in controlling admission and exhaust as such reference is not necessary and not relevant, and for the same reasons I have not considered the effect of the receiver, points of cut off, etc.

An outline section is given of a high and low-pressure cylinder with pistons. Steam at 120 lbs. to the square inch is admitted to A, the "live" side of the h. p. piston. Suppose, for a moment, the exhaust from B had been suppressed. Obviously the h. p. piston would be unable to make a complete stroke, as the back-pressure would quickly equal that of the boiler steam, causing the piston to be in equilibrium. But let the exhaust between B and C be opened. The effect will be that the confined steam in B will have approximately four times as much room to expand in—

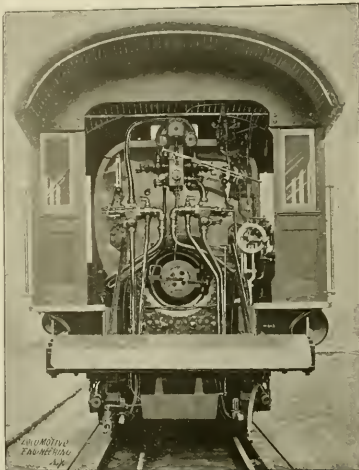

THE "KILGARD" OF A BRASS CENTRAL MASSACHUSETTS LOCOMOTIVE.



BOILER FOR MASSACHUSETTS LOCOMOTIVE, OF A BRASS CENTRAL

haust freely into the atmosphere. Applying to my creator, I was told: "That there could be no back pressure, as all connection between the two pistons was cut off." I had sense enough to see that this meant nothing at all, and rightly put him down as being as ignorant as myself on this particular point.

It happened that the erecting shop machinery was run by a curious sort of compound engine. Originally the work was done by a pair of high-speed, non-condensing horizontal engines, but in time it

"It's the condenser as does it, sonny," answered the veteran, cheerfully. "The condenser just draws the steam out'n her. Come over here, and you can hear the air pump as-sucking."

"But a compound locomotive hasn't got a condenser," I objected.

"Compound locomotive. Never heard tell of a compound locomotive (this was in 1870), but if it ain't got a condenser 'tain't worth a damn!"

Eventually I thought the matter out for myself, and never having seen any text-

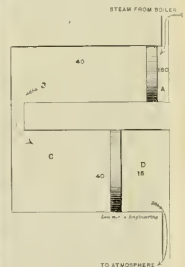

supposing the ratio of 3 to 1 exists between the two cylinders, which represents the usual practice—and with a four-fold volume there will be a four-fold reduction in pressure; so that the back pressure will fall from 120 lbs. to 30 lbs. to the square inch. In other words, the effective pressure—the pressure available for moving the piston—will be 120 lbs. to the square inch. We need not consider the h. p. cylinder further.

Turning to the l. p. cylinder, it will be seen that the exhaust it has just received from the h. p. cylinder is 40 lbs. to the square inch. This is not effective pressure as the back pressure on the exhaust side is 15 lbs. to the square inch. This latter is not steam pressure, for it will be noted that the exhaust is represented as open to the atmosphere; it represents the normal atmospheric pressure, which always has to be reckoned with in non-condensing engines, for it is evident that if expansion is carried too far, or if the boiler pressure is too low, the atmospheric pressure on the exhaust side of the l. p. piston may exceed the steam pressure, and that piston, so far from doing any work, will act as a brake. The same undesirable result may, of course, be brought about by throttling. The dragging of a piston from one or either of these causes is more likely to occur in a compound than in a simple engine, but it may occur in the latter also.

Secretary Jas. W. Cloud, of the M. C. B. Association, has sent me the twenty-eighth annual report, and a good one it is. The details of all ballots are published, as well as all the decisions of the year by the Arbitration Committee. New lithographic plates of all the Master Car Builders' standards are inset into the back of the book. The papers submitted at the last convention of the association were particularly interesting, and contained many illustrations, all of which appear in the reports.

New Class "P," With 8-¹/₂-inch Drivers for the P. R. R.

Our illustrations on this page will convey some idea of the new class "P" engines recently turned out of the Juniata shops of the P. R. R. for the fast express service of that road.

The principal difference between this engine and its predecessors is the employment of a driving wheel 30 inches in diameter.

However, the details of the engine have been gone over most thoroughly and every part improved where the service seemed to call for improvement.

The stack is one casting, of very small size. A single nozzle with 4¹/₂-in. up is used.

The handholds and steps are first-class.

The cab has a ventilator, but is rather hot and crowded. The reverse lever is very short and not too easily handled, and the throttle rig is one of those grapevine affairs that climb around the boiler and crawl into a hole in the end.

The Belpaire boiler is not far different, except that the corners are not so square, the mud ring is double riveted, and hand-holes and plates are used on the water leg in place of wash-out plugs.

Train Brakes in Europe.

[EDITORIAL CORRESPONDENCE.]

There are several kinds of train brakes in use on the Continent of Europe, but the Westinghouse is by far the most popular. In talking with officials in charge of brakes, I found that while slow to pass an opinion upon the merits of other brakes, they were never slow to praise the Westinghouse, the conspicuous merit being that it was always ready for doing its work when wanted. The implication conveyed was that the others were much less reliable.

whole of my rambles where there was not evidence of wheel sliding such as would not be tolerated on any road in America. I stood for two hours at a crowded junction point in Scotland and watched the wheels of numerous trains as they stopped. I did not find a single train that stopped without wheel sliding.

I spoke to the officials of several railway departments about the prevalence of wheel sliding, and they all attributed it to the carelessness of the engineers. My own opinion is that it is due to high air pressure and too great leverage. Wheel sliding is just as common with vacuum brakes as it is with air brakes.



NEW CLASS "P" EXPRESS LOCOMOTIVE, WITH 8-¹/₂-INCH DRIVERS, FOR PENNSYLVANIA R. R.

This series of engines is the first in America that we know of that have what may be called a first class ash pan. The pans are made of cast iron and the dampers close air tight.

The form of guide is the four bar variety, except that for the two top bars are substituted a cast iron one, 10 inches wide, with a large strengthening rib in the center. The lower guides are of steel, as is also the crosshead. This has been improved in making it lighter and in the method of holding the piston rod, a nut being used and the troublesome key discarded altogether.

The ties are 4 inches thick. The link motion has been redesigned through out, the principal improvement being in the links themselves, these are 3 inches wide and have ample oil cups forged on them, the link hangers also have cups forged on them, and the rods, eccentrics and straps are exceptionally heavy.

The rocker shaft is some 6 inches longer than usual, and has two bearings in the box with a collar on center of shaft between them.

The travel of the valves is 6 inches, lap 1¹/₂ inches.

All rods are of 1 section, all cups forged on.

The pistons are made of one thin plate of steel carrying a wide cast-iron shoe or ring, that in turn carries the packing rings proper. These are only half an inch wide, and are sprung in with an improved lap joint.

The cylinder cock rig operates a third cock, that is tapped into the steam passage to the cylinder to prevent water from going over. This is a first-class rig, worth more in dollars per trip than it costs cents in the first place.

The front trucks have air brakes, the equalized pull brake being used on the drivers.

The headlight bracket is something new, neat, uncluttered and sensible.

The sand box has been put on top of the boiler, instead of in the wheel covers.

The tender is fitted with a scoop of a new pattern.

In addition to the dimensions given on the detail drawing, the following particulars will be of interest—

- Capacity of tender—water, 3,000 gals.
- coal, 1,500 lbs.
- empty, 30,000 lbs.
- loaded, 70,000 lbs.
- Spread of cylinders, 6 ft. 5 in.
- Distance between center of frame, 44 in.
- Width of cab roof, 9 ft. 8 in.
- Width of cab, 9 ft. 7 in.
- Height of cab roof from rail, 13 ft. 5 in.

An official of one of the French railways was quite enthusiastic about the service the Westinghouse brake had performed just a few days before in preventing a disastrous accident. While one of their crowded express trains was running at a speed of about forty-five miles an hour, a tire of one of the carriage wheels broke, and a piece in flying off broke the air-brake pipe. The car went off the rails, but the brakes did their work so well on the other cars that the train was stopped in a remarkably short space and before any serious damage was done.

In going through railway repair shops one is struck with the number of wheel lathes to be seen at work. I am persuaded that the prevalence of wheel sliding is responsible for a great deal of the work that has to be done.

On all European railways that use the air brake there are rules demanding the testing of the brakes when the engine is coupled on or when the train has been broken to take on or put off a car. This rule is regularly adhered to when engines are changed, but I noticed several times when cars were put off that they did not

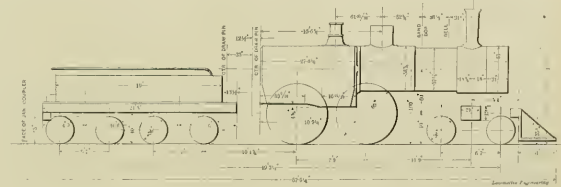

- Inside length of firebox, 9 ft. 11¹/₂ in.
- width, 40 in.
- Number of tubes, 258.
- Length of tubes between sheets, 136 in.
- Outside diameter of tubes, 4¹/₂ in.
- Weight of engine—empty, 114,500 lbs.
- on drivers, 79,500 "
- " " on truck, 35,000 "
- " " in working order, 125,800 "
- Weight of engine on first drivers, 47,400 lbs.
- Weight of engine on second drivers, 44,500 lbs.
- Weight of engine on truck, 38,000 lbs.
- Total weight of engine, 125,800 lbs.

When one familiar with American railway train service begins to ride in European trains he is almost certain to be struck with the amount of wheel sliding that goes on in the stoppage of trains. The cars are nearly all very light and comparatively little damage results from wheel sliding, but still there is nothing more common than the peculiar bump of flat wheels. In fact, flat wheels made several of my journeys decidedly uncomfortable. My attention was directed to the prevalence of wheel sliding on the first trip I made in France after landing, and I did not travel on a single railway during the

stop to test the brakes. There is great pressure put upon the men to get the trains through on time, and they take chances to save a few minutes.

Very little progress has been made in Europe in applying air brakes to freight cars, but some of the leading railway authorities believe that all cars carrying merchandise will eventually be equipped with continuous brakes.

The Senior Philosopher is home again from a foreign shore, the J. P. will now "visit round."

A. S.

How Rails, Cross-Sleepers and Ballast Usually Behave to Each Other.

By J. H. ANTHONY.

Both by observation and by accurate measurements, the superstructure of a railroad, while trains are passing over it, may be shown to undergo a constant series of vertical movements, and thus there is furnished no real and due plan for the moving loads.

The accompanying figures are drawn to illustrate track conditions as they ordinarily prevail in the common cross-sleepers system of rail supports.

When a railroad track is newly built the usual relation to each other of the rails, ballast sleepers and the ballast, is represented by Fig. 1. Everything in this combination is apparently as it should be.

Place the load on the rails that the structure is built to carry, and Fig. 2 represents the changed relations of the several parts. In a vertical direction the ballast has proved to be partially unstable, and the sleepers being in a measure flexible and having a less area of bearing on the ballast which is outside of the rails than it has on that inside of them, have bent, and thus accommodated itself to the condition. Whatever is true of one sleeper is largely so of them all, and with like materials and so arranged, a tendency to no other result than that of bending under passing loads and a consequent compression or displacement of the ballast can be expected.

When the load has been moved off of that portion of the rails which is immediately over the sleeper, all the parts, except the ballast, tend to regain their normal relations. In this last there is no elasticity, and Fig. 3 shows what that relation is, practically largely as it is.

If the sleeper was positively stiff, the pockets here shown to be under it, could not obtain. While a ballast that was alone yielding, might allow a rigid sleeper to settle, it would say scilted, it would have no tendency of itself, to regain its level, and the rails could not, under the somewhat changed conditions of the loads, be that displacement of ballast, as either dust or mud, that the present pockets show, and in actual use, prove to be so well fitted for.

These last named three figures show the successive changes that take place in a track in daily use when it is viewed in cross-section through one of its sleepers. A further view is to be had by showing a longitudinal section at the sleepers' ends, as by Fig. 4. Each sleeper of the seven in the figure is here shown to be unloaded, also use, like the one in Fig. 3, and needs no further explanation. If Fig. 3 shows the truth so must Fig. 4. Fig. 5 is a further view, and for convenience of reference, this cut shows the track loaded, the sleepers numbered, and the load to be on the middle sleeper in it and which is numbered 4.

A rail, as here shown, is no less rigid vertically than is a sleeper, and the first affects it as it does the sleeper beneath, and over whatever sleeper the load may happen to be (No. 4 in this cut) that one will be most bent, and, as shown by Fig. 2, will be likely to rest on the ballast quite along the whole of its length. As a consequence of this, there is no constant effect, it, while slight ones exist and are shown under 3 and 5 on each side of it. Under sleepers next farther away, 2 and 6, the cavities are of greater vertical extent, until at a distance yet more removed from the loaded rail's influence, as at 1 and 7, they reach to near the top of the sleeper height. Thus the weight from any source—say a pair of drivers—while on the rails over any sleeper, as the one 4, rests on a diamond-shaped area of ballast like that embraced by the shaded portions of the sleepers 4 and 7 in the next figure. These shaded portions represent the vertical bearings of all the sleepers while the load is over the one marked 4. This Fig. 6, in

plan, is of such a length as to embrace the seven sleepers in Figs. 4 and 5, and shows how the shaded portions that the loads which are borne are as really floated as are the loads which may pass over a ponton bridge. No one sleeper, as the foregoing figures show, is of sufficient base area on the ballast to remain absolutely intact in a vertical direction; and ballast under each yields in a degree, and relief to the sinking sleeper comes through the rail's agency, from its neighbors on each side of it. Sleeper 4, the loaded one in this, as in Fig. 5, presents the whole of its bearing surface on the ballast, say equal in extent to 5 square feet, sleepers 3 and 5 jointly, furnish say 7 feet bearing, sleepers 2 and 6, say 6 feet, and sleepers 1 and 7 about 5 feet more, making in all some 21 square feet of bearing which is required to float the load.

These figures are in no wise given as

danger and large cost involved in a plant which is maintained under such conditions of instability, may no longer obtain. Both for economy of operation and for easy riding it is needed that the rolling plant of a railroad should run under the same conditions of stability and smoothness as does a stationary plant of like extent and value. For this, its substructure, ash approximates to a oneness of plane under loads, instead of many of them, will be effective, and a large waste in its maintenance will be stopped, and in that of the rolling plant as well.

The Long Distance Fast Run Record Broken.

The Plant system of railroads and the Atlantic Coast Line, the Richmond, Fredericksburg & Potomac and the F. R. R., seven different lines in all, have taken an

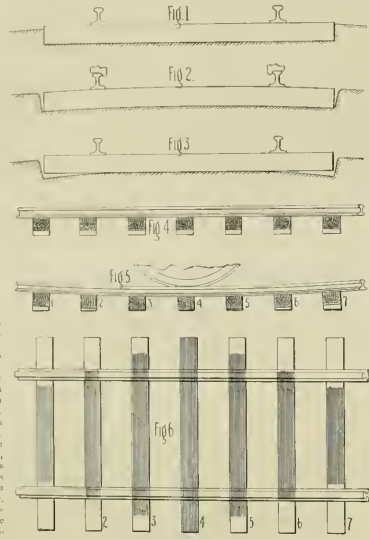

exact measurements, but rather in connection with the cuts, to illustrate the principle which is involved in the support of a track when it is made of materials that are yielding in their nature.

Thus, by the combined aid of a number of sleepers only, are the rails kept above ground. What one sleeper lacks in floating power is supplied by its adjoining ones until the sum total suffices for the purpose. This, too, is true along all portions of the track, for the condition accompanies and is ever under the moving load.

A ballast which is unyielding in the least degree, as would be a solid masonry foundation, being out of our reach, even if such were desirable, the question then is, may there not be, within reasonable cost, a rail support devised having within itself alone a sufficient base area to float the load on the ballast without, by the rails leading, seeking so largely to neighbor's aid? This done, the last resting, the mud from the sinking, and the over-adjustment of the rail's plane, and the

N. E. Divison, A. C. L.—Engine had a 5-foot 6 inch wheel; engineer, William Corrie.

Will Divison, A. C. L.—Engine had a 5-foot wheel; engineer, Jack Bross.

Rich. Divison, A. C. L.—Engine had a 5 foot, 4½-inch wheel; engineer, Jas. O'Brien.

R. F. & P.—Engine had a 5-foot wheel, engineer, H. Perdue.

The P. R. R. engine also had a 5-foot wheel and was run by R. B. Donald.

Such a string of road's engines and engines of such dimensions are not expected to make long fast runs, there are usually too many "hitches." But these roads and the men have shown that they could do it given a show.

Jacksonville is 1,020.9 miles from New York, yet some of the passengers on this train, after stopping in Washington 30 minutes before a regular P. R. R. train arrived in New York City 22 hours and 10 minutes from Jacksonville. The engine and train, empty, before leaving Jacksonville, weighed 242,300 pounds.

Two Hundred Miles per Hour!

From Orange City, Florida, comes a glowing account of the Lewis engine, which is to make the run from New York to Chicago in five hours. The report says a full description is very properly withheld—yes indeed. But it is a rotary, transmits its steam into electricity, condenses its own steam into water again (by use of a wind wheel), and yet the report adds:

"This anomalous machine is divested of all superfluous and disagreeable concomitants. It will have no fire, no smoke, no cinders, no sparks, no tender or stoker. It will have no piston-rod, no dead center, no crank, no cylinder, no cam rods or cut-off, thus minimizing friction."

The driving wheels are to be 30 feet in diameter, covering 30 hual feet of track at each revolution. But its comparative superiority will be more readily comprehended by the statement that it has a leverage of 240 inches, while the best engines now in use have but 46 inches.

"Oh, dear! oh, dear!" Suppose the engineer gets dizzy—or, horrors! some one should build another with a leverage of 241 inches and beat it.

The inventor says it will only be in a log-trail at 60 miles per hour, and that it will run continuously as long as there are rails for it to run on, without having to stop for water, etc.

It will be the run of the budding lossness of compounding, too, for it's going to save 80 per cent. of the fuel. May be the inventor would put another condensing "wind-wheel" on the front it would save a 100 per cent., and that would run the coal business.

It's no wonder people hide their money now, one never knows when one makes a safe investment—with all these remarkable inventions.

The Heroes of the Great Fire.

We are glad to present herewith the pictures of the four heroes of the St. Paul & Duluth train that saved some 50 lives at Hinkley, Minn., during the great forest fire.

Fire and wreck at sea, the captain is the man who, as a rule, gets the most praise, and Engineer Root will have his praises sung for a generation as the hero of Hinkley—and he deserves it—but we want the reading public to recognize all the heroes of that awful day, for surely it is not fair to leave out of the account one of the right kind of stuff, with cool nerves, iron constitution, and a will to "do and dare"; Root has his train load of human beings, and he has trained.

Conductor Sullivan did his duty in the place—and no hero can do more.

Partner Blair was so covered when it came to the trial by fire, and did manfully what

excursion train from Jacksonville, Fla., to Washington, D. C., a distance of 780.9 miles, in 45 hours and 40 minutes.

In this distance there were thirty-four stops made in all, consuming 71 minutes of time. The average time, including all stops, was 49 37 miles per hour, excluding stops, 53.30 miles per hour.

They changed engines seven times, the longest change requiring 10 minutes, the shortest only 4 minutes. The fastest time by any one of the roads was over the N. E. Ry. in part of the Atlantic Coast Line), they ran over the division of 95.7 miles in 99 minutes. The fastest mile was made by the S. E. & W. time, 45 seconds, or 75 miles per hour.

All the engines used had 18x24-inch cylinders, and were American 8-wheelers, except one mogul, on the R. F. & P.

The S. F. & W. engine had a six-foot wheel and was in charge of Engineer M. W. Cahill.

The S. E. & S. engine had the same sized wheel, Engineer L. M. Raymond in charge.

he was put in his place—protected the ladies in his car.

The horror of Hinckley will never be forgotten by those who saw it nor by the people who read of its disasters. Those who stop to think will be glad they live among men capable of such heroic sacrifice as the crew of this train exhibited in saving the lives of the people on that train. They were selected at random from 30,000 train crews in service in the country, and were not found wanting. Perhaps we can best tell the story of Hinckley by copying from a personal letter from Mr. George D. Sullivan, master mechanic of the St. P. & D., in charge of the men at Hinckley.

"The condensed facts of this event are as follows:

"Engineer Root left Duluth on the afternoon of September 21st, on our regular train for St. Paul. The train consisted of locomotive, one coach and two chair cars, Engine No. 19, Fireman John McGowan, and Conductor Thomas Sullivan. During the previous two weeks the smoke from forest fires was thick in the vicinity of Hinckley that the front of the engine could not be seen from the cab in the daytime, and it was frequently necessary to run with the headlights lit in night daylight.

"The conditions on this day were not different from what they had been attending with for a number of trips until they began to approach Hinckley when the smoke became denser and more oppressive. They kept on, however, expecting to get through it shortly after leaving Hinckley. When within three-quarters of a mile of the station they ran amongst a lot of fleeing people, signaling them to stop, which they did. The engineer and conductor then found out that Hinckley was all on fire and the track impassable, and that our bridge right at the town was on fire.

"There was an extra freight train running behind them, but the conductor and engineer decided that it would be safe for them to back up as far as Skunk Lake, six miles back, which owing to the total absence of rain for the last three months had evaporated down to a mere mud hole and morass. After loading up all the refugees in sight, and waiting until the cars began to catch fire, they started back. Although they ran the six miles in about eight minutes,

the hurricane of flame overtook them. Almost at the start the heat burst cut glass windows, pieces of glass cutting Engineer Root severely in the neck near jugular vein and in the head. The cab was on fire. Flames shooting in at the windows, which, with the loss of blood, soon weakened him so that he fell over on deck, while the fireman had gone to drop himself in a manhole of tank in order to thoroughly wet his clothes, after which he came back with a bucket of water and throwing it on Engineer Root revived him and assisted him to his place again. About this time

the cab curtain strings burned off letting curtain down, which immediately took fire, but was torn off by the fireman. Fireman McGowan then commenced drawing water from tank, throwing it continuously over the engineer, himself and a refugee who had crawled on the engine just as they started back, and who lay overcome in the gangway.

"With the reviving action of the water, Engineer Root managed to retain his seat, while the fireman fed the firebox and operated the injector. After reaching the trestle at Skunk Lake the engineer stopped

he had to give it up. He then filled the engine with water, put in a good fire, and cutting her loose from tender, ran her ahead. He then went down in the lake and spent the rest of the time caring for his engineer and others until the relief train reached them from Duluth.

"This limited train had between 125 and 150 regular passengers, and they picked up at least 500 refugees, if not more; the exact number can never be determined. The conductor, Thos. Sullivan, as soon as his passengers were unloaded, started back to protect his train and send notification of

himself but assisted Engineer Root to stick to his post. To give you a faint idea of the condition of affairs in that city, the lagging caught fire and notwithstanding the rapidity with which they backed up the flames were swifter and blew back in cab, setting front of cab on fire, burning all the wooden handles of steam connections, and melting cab lamp. Running boards were also burned as well as cab seats charred.

"Engineer Root is the ranking engineer on this road, having run here since May, 1871, and is a whole-souled specimen of generous manhood, and knows no fear when working in the interest of others. He will be recollected by the B. & L. E. delegates throughout the country as one of the Executive Committee at their recent convention in this city.

"The officials of this company are proud to say that all their trainmen proved themselves heroes in the truest signification of the word, in this, the greatest emergency they have been called upon to pass through. All of them are doing well and are around. Engineer Root, however, being extremely weak on account of the great amount of blood lost.

"As another instance connected with this fire, Engineer C. P. Fadden and Fireman N. Reider were bringing crippled Engine 19 on one side, light, from Duluth to St. Paul and had reached Hinckley before the fire. Dispatcher was just sending him orders for continuance when the fire reached the wires south of Hinckley and they went down. This tied him up at Hinckley with his engine, and when the flame struck the town, without going through the formality of asking permission, he ran his engine over on the Eastern Minnesota tracks and backed down near their roundhouse, which was protected slightly by an open patch and a grove of green trees and was the only building left standing in the town. Engine was slightly scorched and lagging burned, but crew stayed with her and brought her out in good shape.

"Engineer Fadden is next to Root in standing rights, having been on the road since 1872, and when asked for a description of the conflagration at its height, flames and smoke being all around and over him, replied that 'he had been in hell, and saw everything there was to be seen, except Satan himself.'

Everyone loves a hero, and our railroads are manned by many of them, but few have had the chance to show what was in them as these men have, but when it comes to a trial most of them are there. The trouble with most railroad heroes is that they are killed in their acts of heroism.

All honor to Root, and McGowan, and Sullivan, and like them, who acts with firmness as heroic as a charge in battle—and two hundred people owe them their lives.



JAMES ROOT, ENGINEER.



J. E. MCGOWAN, FIREMAN.



THOMAS SULLIVAN, CONDUCTOR.



J. W. BLAKE, PORTER.

his train, which in the meantime was all on fire, with windows all on one side, and the train crew unloaded the passengers and got them down in the lake. All that remained in the lake were saved. Some of the refugees, however, jumped off before the stop was made, owing to the heat and flames, and were burned.

"In the meantime the fireman helped Root down from the engine to the lake, and then went back to try and get the engine away from the burning train and off the trestle. He endeavored to put out the fire on tender, but as the coal was on fire

the disaster. After reaching Miller station and sending his message, human nature could stand no more, and he had to succumb to the strain.

"Our brakeman, colored porter and news agent proved themselves the right men in the right place. The porter using the fire extinguishers putting out the flames as they broke out in the dresses of his lady passengers.

"Of the heroism of Engineer Root too much cannot be said, and a chief second comes his brave fireman, John McGowan, whose physical ability not only sustained

Some Automatic Valve Closing Devices

The accompanying illustrations show the details of several cap fittings recently patented by Mr. G. W. Alverind, one of the inventors in the arena contest for such improvements offered by this paper. Mr. Alverind has tried to cover every point of danger on the boiler. The engravings were made direct from his drawings and quote from his own description.

The accident automatic valve arrangement as shown on accompanying drawings is intended to automatically prevent steam from leaving the boiler through broken pipes and valves, etc., in case of collision, front or rear, or other accident to the locomotive, the most serious damage to life and limb often being caused by steam from broken parts of the engine.

The injector or fountain 1, shown in Fig. 1, contains the steam outlets for injectors, air pump, blower pipe, steam heating, lubricator, etc., and also the momentum weight 2, the links 3 and 4, the stem 5 and the lifting arrangement 6.

The fountain is connected to the boiler and the ball joint 8 with the studs 9.

The ball joint 8 connects to the valve house 10, which contains the valve 11, seated on the spring 12 and guided by the cover of cap 13, and the bridge 14 in

position of the momentum weight 2, links 3 and 4, stem 5 and valve 11 the moment after collision, when the momentum of the device breaks the safety rivets 16 and center, striking the end of fountain 1 or the lug 22, as the case may be.

Center of gravity of momentum weight is set to below center of support to insure proper position of weight, the motion sideways being limited by the lugs 22.

Should an accident break off the whole fountain 1, the stem 5 will leave bridge 14 in ball joint 8, or else break the point 24 and thereby release the valve 11, which will then be closed against the edge 17 by the spring 12 shutting off the steam.

The ball joint 8, of ample strength, and connected to the valve house inside the boiler in such manner as to insure the greatest possible safety.

For repair work the valve 11 may be closed by raising the momentum weight 2 and the stem 5 by the handle 25.

In Fig. 2 the fountain 1 contains the steam outlets for injectors, air pump, blower pipe, steam heat, lubricator, etc., and also the momentum weight 2, the links 3 and 4, the stem 5 and the lifting arrangement 6, and also the additional links 1A and 4A.

The fountain is connected to the dome of boiler by the steam pipe, in which the stem 5 is inclosed.

the valve 9, which will then be forced against the edge 13 by the spring 10 and the steam pressure.

The stem pipe 7 being slightly grooved at the point 19 to facilitate the breaking at that point.

In Fig. 3, the steam whistle is fastened to dome of boiler with the connection 1

screwed into the flange 3 riveted to the boiler.

The valve 4 is guided by the nut or cap 5, and kept in position by the stem fastened to the bridge 7.

If the check valve 1 is broken off the breakage will take place at the point 8, thereby releasing the valve 4, which will

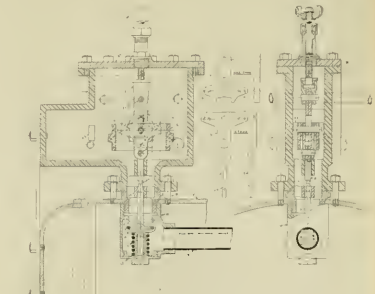

FIG. 1.

screwed into the valve house 2, which in turn is screwed into the flange 3, riveted to the dome.

The valve house 2 has openings 4 to permit in steam, and the nut or cap 5 supports and guides the valve 3, forced against the spring 6, by the stem 7 fastened to the bridge in the connection 1.

The steam whistle is screwed into the elbow 8 containing the valve 9, forced against its seat by the spring 10 and the steam pressure and opened by the lever 11.

If the steam whistle and the elbow 8 with the valve 9 is broken off, the breakage will take place at the point 12, and thereby releasing the valve 5, which will be forced against the edge 13 by the spring 6 and the steam pressure, shutting off the steam.

The safety valve is attached to the connection 1, which is screwed into the valve house 2, which in turn is screwed into the lid 3, covering the dome.

If the safety valve is broken off, the

then be forced against the edge 9 by the spring 10 and the steam pressure.

The safety valve shown is intended to be placed in the smoke arch or other protected place; said valve set to open at a higher pressure than the ordinary safety valves on dome of boiler, and should these valves be broken off, prevents the steam pressure from rising to a dangerous point.

The safety valve house 2 has a number of small openings 4 drilled at an angle so as to spread the escaping steam over the flue sheet.

Into the valve house 2 the cap is screwed, and cap guiding the valve 3 and tappet for the set screw 4, which compresses the helical springs to allow the valve 3 to leave the seat at the desired pressure.

Outside the safety valve is a casing, in two parts, 5 and 6, the latter being forced to leave 5 as soon as valve admits steam.

This casing to prevent cinders and dirt from entering the safety valve.

The automatic safety valve for the

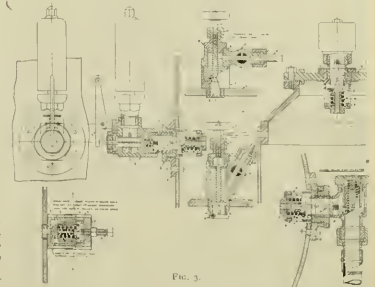

FIG. 3.

breakage will take place at the point 4, thereby releasing 5, which will then be forced against the edge 7 by the spring 6, the arrangement being practically the same as for steam whistle.

The injector check valve 1 is screwed into the valve house 2, which in turn is

steam gauge consists of a main body 1, including the valve 2 and a three-way cock 3, cap 4 with packing nut 5 and coupling 6 and 7, and also screw 8 and handle 9.

This safety valve will work in the following manner:

In the position of valve 2 and cock 3

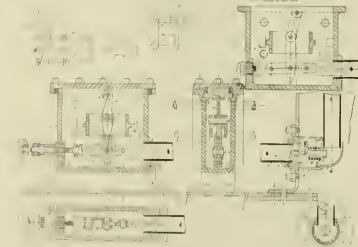

FIG. 2.

ball joint 8. The steam pipe 15 leads the steam from dome of boiler.

The arrangement will work in the following manner:

In the position of the arrangement, as shown by full lines on drawing No. 1, the momentum weight 2, the links 3 and 4, and stem 5 are screwed down by the arrangement 6, and compresses the spring 12, leaving free admission for the steam into the fountain 1, from where it is distributed thereby by the cap 13.

The pressure of the spring 12 is carried on the safety rivets 16 of sufficient strength for the pressure, but in case of collision, front or rear, the momentum of the weight 2 will break said safety rivets 16 and thereby disengage the links 3 and 4, when the spring 12 will lift the momentum weight 2, and force the valve 11 against the edge 17 of the valve house 10, and thereby shutting off the steam from the fountain 1.

The valve 11 contains a ring of soft metal or gasket, in which the edge 17 will be forced by the spring 12 and the steam pressure and form a steam-tight joint.

Should the collision not disable the engine, the valve 11 can be opened by screwing down the arrangement 6 until the end of the link 4 bears on the stem 5, the slot 15 passing over the pin 19 in the momentum weight 2.

By taking off the lid 20, the momentum weight can be taken out and new safety rivets 16 put in.

The dotted lines on drawing show

Fastened to the dome is the valve house 8, containing the valve 9 supported on the spring 10 and guided by the elbow 11, which takes a pipe to convey dry steam from top of dome.

The arrangement will work in the following manner:

In the position of the arrangement, as shown in full lines on drawing No. 2, the valve 9 is kept open by the stem 5 and the screw arrangement 6.

The force of the spring 10 is carried by the safety rivets 12 of sufficient strength for this purpose, but will be broken by the force of the momentum weight in case of front or rear collision.

Dotted lines show position of the arrangement the moment after collision, front or rear, the safety rivets 12 being broken by the stem 5 and link 3 forced back by the spring 10, and the valve 9 forced against the edge 13, and thereby the steam shut off from the steam pipe 7 and the fountain 1.

Should the engine not be disabled by the collision, the valve 9 may again be opened by the screw arrangement 6, the rib of stem 5 being guided by the steam pipe.

The lugs 14 and 15 will limit the movement of the momentum weight which is hung on the link 4A, and will describe an arc with the pin 16 for center.

By the force of the spring 10 valve 9 may be closed or opened at will.

Should the whole fountain be broken off, the stem 5 will leave the bridge 17 or else break at the point 18, thereby releasing

shown on drawing, the steam will enter at a point and pass the narrow circular opening at the end of the outlet 17.

By the speed of the current of steam the valve 2 will be lifted and strike the edge 13, and by the force of the pressure will remain in that position, shutting off the steam.

If the cock 3 is turned half a revolution, the screw 4 passing down the valve 2, the steam will enter the pipe leading to the steam gauge. When the steam pressure is equal on both sides of the valve 2, the screw 5 may be raised, valve 2 remaining open until the pipe is broken.

Should the whole valve house be broken off the breakage will take place at points 11 and 13, thereby leaving the end screwed into the boiler, together with the valve 2, which will close at the breakage and be held in position by the pressure of the steam and thereby prevent steam from leaving the boiler.

Economy in Use of Oil.

BY C. B. COBBER.

Doc tells me that they are having a great time on his road trying to get bigger mileage out of a pint of oil. They used to have all the oil they wanted to use, when they oiled around, to make a sure thing, they gave her a good oiling, so she would not run hot."

But the M. M. issued a circular telling them that less oil and more care in looking after the engines was needed to do away with delays and expenses of hot boxes. He only wanted them paid must see to it at first. They thought it was a bluff. Well, let him tell about it in his own way.

Doc says he was sitting up on his engine the other day talking with Brown, his old fireman, who was promoted about five or six months ago. Brown says to me, "Father Troy" (he tended a wedding at my house a while ago, he wasn't a spectator neither—likely it will be grand—other Troy in a year or two)," how did you come to brace up and be saving in oil. You know you used to pour as much on the ground every time you oiled around as you use altogether now, trying to do better in your old age, are you?" Just about that time young Bonaparte, who had been set up about three months, and felt pretty gay, got up on the engine and says to me, "Old man, where do you steal your oil now?" Says I, "If I thought you knew enough to tell whether you meant that, I would cuff your ears for that remark. Don't have to steal any oil; we can get all we want out of the storeroom." Says he, "You know darned well that there ain't any man can run on as little oil as they say you are doing now. Three months ago you used as much oil as anybody. Now you don't show up half as much. How is it?" Says I, "That's so, and next month I won't use as much as I do now."

Catching onto how to do it—see my free friends?—You fellows will have to come first before long too. After the M. M. got out his circular about making better mileage on oil, Ike came to me and says, "Doc, you know if you just half try, you can cut down your oil bill to just half. If there is anything wrong with your engine that runs hot or uses more oil than you think it should, let us know about it and we will get it fixed. If the pans run hot because the brasses do not fit, or any of the journals are cut or have poor brasses on them, they ought to be paid first. Don't depend on valve oil, and lots of it, to make a bad bearing run. We'll report it on the book, telling what it is the matter with it."

Well, I tried hard. Those rules, Clinton, that you gave me for saving oil were a big help, and the first month I made a big increase in miles to a pint of valve oil, because it wasn't poured on all the warm bearings and was in red cups; had to get all the feeders changed, though, they fed machine oil out too fast.

About a month after that, Ike came around again and says, "You are doing very well, but you ain't quite up to the mark yet. Get a move on you, old man, some of the young fellows will beat your record." That made me hot to have him throwing what the young runners could do up into my face. Says I, "See here, Ike, if you get the men running against each other to see who can run the best, you will have the worst lot of cut pups and hot axles you ever saw, besides having hard feelings among the men; because some extra man takes an engine and runs her a week on next to nothing, which a regular man can't do. Say it, 'If a man don't use oil enough and has something hot, it takes more oil to get it cool, besides losing time with his train. He won't make that mistake more than once without hearing from it. As to hard feelings, never mind that; in this oil business the best man will get to the front. If you have any hard feelings against any man because he is making a better record than you are with the same chance, you had better try a little harder yourself on

dollar when this thing blows over, and they get onto some new plan of running cheap. I ain't going to wear myself out jumping down to look her over every few miles and putting on about three drops of oil at a time. I am going to pour on enough to make a sure thing, and not worry if some of it does run on the ground. It is too much work to run so fine on oil.

The other fellows are kicking worse than I am about it. When we first started in we all agreed to make a little improvement each month and try to make that do; but a lot of them got right down to business and made such big mileage, they got after the others; so we had to commence to scratch around, each fellow for himself. Ike don't say much, but you can see he is at the bottom of the whole thing. Four of the engineers were called in the old man's office on the carpet the other day, and he talked to them like a "Dutch uncle"; said the idea was not to save a little oil half so much as to make them look after the bearings closer, and know what shape they were in. He showed just what it cost to do the running

account of poor quality of brass that would buy a good article which would last twice as long, and give satisfaction. Oil cups that feed three times too fast, or not at all, can't help the oil record, lubricators that feed ten drops a minute when throttle is shut and two drops a minute when working steam are of no use—they can be fixed to feed alike at all times. Oil used when the engine is standing still is generally wasted. Stop all the wastes and you can make a good record. Others do it.

Supposen It Had Been Gone.

The "mixed" train was poking along late, and had stopped to take water and let the steam shovel take water from the engine tank—the process was slow. The passengers sat on the bank and the two policemen and told how the road should be managed.

Two elderly ladies watched the throbs of the hose over in the tank hole, as the little steam pump filled the steam Irshman's tank. "They are taking water out of the engine, ain't they?" asked one lady as the gaffer went by.

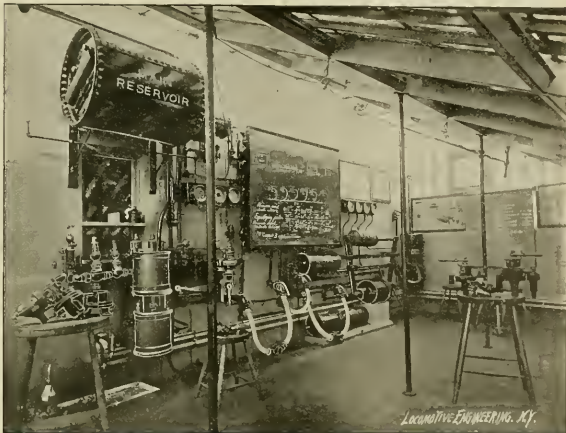

ENDORS'D EXHAUSTOR. AN INTERESTING CORNER IN THE D. & H. RAILWAY SHOPS AT GREEN ISLAND, N. Y.

your own engine, you have too much sense to do anything else." Says I, "When we get to making pretty good mileage, what will satisfy you; will you like to get down five every month, or how will you set a standard?" Says he, "The fellows that are at the foot of the list will catch it every month, till you are all about up to the average. The standard ain't what the poorest fellow feels like making, but it has got to be as good as the average." "Yes," says I, "but how about the fellows stealing oil, some of them will steal enough, so they won't need to draw very much?" Says he, "Just name some one who steals oil, we will put a stop to that mighty quick, most of this stealing oil is in your mind's eye. If you know a man is getting oil where it is not charged to him, say so, we will hunt him up, but the trouble is you can talk about stealing oil and don't mention names."

Well, I see it was no use to talk with him; he is awful set in his notions, so I buckled down to it and the next month made about as good a record as any of them, but you can just bet your bottom

repair for each man for the last six months, and the fellows that made the biggest kick on oil cost the company the most for coal, repairs and oil. That staggered them, but they came out pretty sober, and went to the shop to do their kinking.

Dick looks, not so much on the risk of hot boxes and expense for machinery work, as because it is a new departure for him to try to save oil. He daresn't put on too much for he gets "jacked up" for wasting oil, if a bearing gets cut or runs hot he gets "jacked up" for damage to engine and laying out the train, so he is between two fires. But, just the same, it is more a test of skill to run cheap on oil than the economy on the oil sheet shows. Close on oil means close inspection of your engine, both before and on the run, close figuring for speed and amount of oil required for it, seeing that bearings are in good shape so it does not take a quart of valve oil to cover up a machinist's mistake in reducing brasses, or a brass molder's mistake in mixing his metal so it is too hard or too soft. More oil is wasted on

"Yessum"

"My' I should think the engine would be dry by this time," said the second lady after ten minutes.

"I wonder what'd happen then," said the other.

"Why, the boiler'd bust—course!"

Just then the fireman got up and took off the sand-box cover.

"My goodness," said the elder lady, "he's a lookin' to see if it's all gone out of the boiler now!"

The Hull automatic block signals are now installed and in full operation on the Morris & Essex Division of the D., L. & W. road, from Hoboken, N. J., to Morristown, and are doing their work splendidly. It is a pity there had to be martyrs to prove their ability, but such is ever the case. This is perhaps the best example of the latest Hall signal extant, and the very officials who claimed they needed no block system on the D., L. & W. are now prouder of their signal than any other feature of the road—and they are worth being proud of.



236 Broadway, New York.

PUBLISHED MONTHLY BY

ANGUS SULLIVAN, Editor and Proprietor

JOHN A. SULLIVAN.

Subscription Price.

\$1.00 per year, \$1.50 for six months, postage paid to any part of the world. Single copies, 5 cents. Remitt by Express Money Order, Draft, Post Office Order or Registered Letter.

The editor reserves the right to use or discuss matter for the reading columns entirely on his own merits. The reading columns will not be sold. Correspondents must give their names and addresses, but not necessarily for publication. Nothing addressed can be charged as often as necessary, always give old and new address. If you subscribe in a club state who put up with the paper, please send notice when your paper fails to reach you properly.

Entered as Post Office, New York, as Second-class mail matter.

For Sale by Newsdealers Everywhere.

NO BACK NUMBERS BEYOND THE CURRENT YEAR.

PUBLISHERS' AGENTS.

American News Company, New York, England, International News Co., London, York, W. Williams, a Fink & Co., Melbourne, Australia.

Increase the Load of Freight Cars.

A subject which is of the highest importance to all the interests connected with transportation problems was very intelligently discussed at the last meeting of the New York Railroad Club through the reading of a paper by Mr W. W. Wheatley, on "How Can the Present Method of Rating Train Loads be Improved?" We are all in general agreement that the loads that train loads are regulated more by guess than by calculation, but most of us required the exact figures presented by Mr Wheatley to thoroughly realize how expensive to railroad companies must be the existing loose methods in assigning loads to cars and locomotives.

The author of the paper advanced very pertinent and logical objections to the practice of rating the capacity of a locomotive as many loaded cars without any consideration of what constitutes the load of the cars in the train. Investigation has shown that the load of a car may vary from one ton to thirty tons, and in too many instances no care whatever is exercised to see that a car carries something approaching a full load. Owing to this state of affairs great inequality necessarily exists in the weight of different trains on the same road. The most extraordinary diversity of performance of locomotives is frequently witnessed on the same road, and those immediately responsible for the work done are frequently unable to understand why a good engine will fail with a load that an inferior engine has handled successfully. The explanation is that both may be assigned the standard load of one or forty cars, and while one locomotive is pulling 1,000 tons of freight, the other may not have more than 500 tons of load in the cars. There is urgent necessity for a reform which will introduce exact methods for indicating the loads carried by cars instead of the opinion of the conductor, yardmen and yardmasters, who seldom inquire closely into the weights carried. A car load is generally reckoned as a full load when it does not contain half the weight for which the car is rated. A very bad case cited by a Grand Trunk representative is a sample of what is going on in daily train movements. A car was received by the Grand Trunk from the New England under bonded seals and locks loaded for Illinois. It contained a ton of butter weighing less than thirty pounds. The Grand Trunk people received 25 cents for carrying the freight over their line and the Illinois people pay \$1.75 as mileage charges for the use of the New England car. This and similar cases induced the Grand Trunk people to devote close attention to the contents of cars, and they have introduced a system of transporting goods when cars are insufficiently

loaded. In one day the contents of sixty-four cars were put in fourteen cars. In one month the loads arriving from one connection in 1,151 cars were carried away in 473 cars—a saving of 678 cars to be hauled 500 miles. It is easy to figure up the expense saved by this act of intelligent attention to details.

It is safe to assert that every railroad in the country is paying grievously for the haulage of small portions of freight put into heavy cars. A case was mentioned where the officers of a trunk line proceeded to investigate the extent of loads carried, and discovered that in the westbound cars 52 per cent contained less than 5,000 pounds, and that the average revenue tonnage in cars going in that direction was only 11,750 pounds. Many of the light loaded cars belonged to foreign lines for which heavy mileage charges were exacted. By giving the matter a little attention the percentage of cars carrying less than 5,000 pounds was reduced by half in one month. There is no reason why this little attention should not become the rule at every interchange point in the country. It would certainly result in greatly reducing the cost of moving freight. The margin of profit in freight haulage is so extremely small that it often disappears altogether, and the business is done at an actual loss. From such conditions come failures to pay interest on bonds, delay in the starting out of the pay car, and the rapid progress towards the hands of receivers. The old estimate of a particularly useful member of society was a man who made two blades of grass grow where only one had grown before. Modern railroad necessities call for men who will make one car haul the load that two cars have been employed carrying. The author of the paper believes that since the income of railways cannot be increased at present, the outgo should be diminished. The largest single item of operating expenses being the cost of conducting transportation, the efficient and economical handling of the car and train service is the true basis of successful financial operation of railways.

Steam Jackets for Cylinders.

A correspondent having written to this office for information about the steam-jacketing of steam engine cylinders, we shall devote a little more space to the subject than we could give in the Questions column. Steam jacketing of cylinders is done by casting or fitting a steam-tight casing around the cylinder and keeping the cavity filled with live steam from the boiler. The practice has been largely followed with stationary and marine engines, and a few locomotives have been tried with steam-jacketed cylinders. There is some conflict of opinion among engineers as to the value of steam jackets for stationary and marine engines, but we do not know of any one who has an opinion of any weight that advocates steam jackets for locomotives.

The steam jacket was invented and patented by James Watt, and was first applied by that famous engineer, for the purpose of checking the heat losses due to the condensation of steam inside the cylinder. Watt was the first to recognize that the cooling of the admission steam by the metal of the cylinder, which falls in temperature during the expansion and release period, caused great waste of heat, and his idea was that the steam jacket would hold up the temperature of the cylinder to the point where it was equal to that of the incoming steam. There is little doubt that with the slow piston speeds of Watt's time, the cylinder condensation was so great that the steam jacket did good service, but it does not seem to be so efficient for the faster working modern engines. Some engineers believe that a steam jacket is of no economical value under any circumstances, that the steam used in the jacket is not compensated by any saving effected inside the cylinders.

To be thoroughly efficient a steam jacket must be constantly charged with steam at boiler pressure, otherwise it is liable to be cooler than the steam entering the cylinders, in which case it will act as a condenser instead of a heat protector. Unless there are proper appliances in use for removing the condensed vapor from the jackets the moisture will absorb heat from the cylinder metal and thereby waste steam instead of saving it. This is a report of which has happened very often, and which of engine tests have frequently proved that the steam jacket was a source of loss. Steam jackets have been used on the cylinders of the cylinders of compound locomotives, but no benefit has resulted from their use. In every case where they have been tried they have been abandoned. If it were possible to pass the hot gases from the tubes round the cylinders of locomotives without complication a saving of steam might be effected.

Disaster in Hoosac Tunnel.

A bad accident happened in the Hoosac Tunnel on the 9th of September. A freight engine went into this four-mile loop with a heavy train, and when near the center the engine broke down—report says a spring hanger—and the engineer stopped to jack up his engine. The smoke of the motor, by the time the train going the other way made it worse. The operator at the tunnel entrance "took chances," he assumed that the train was out, or nearly out, at the other end, did not wait for a signal, disobeyed orders, and let a second train into the tunnel behind the first, consequence—a rear-end collision and three dead men. There is no excuse for the motor, but the same lack of judgment somewhere that will let a man stop in a long tunnel for such a trivial thing as a broken spring hanger. If the engine was on the track and would pull her train (even at considerable damage to herself) she should have gone to daylight. There is almost as much danger from gas in such a tunnel as from approaching trains.

A derailing switch at the tunnel-mouth, interlocking with the signal at the other end, would have prevented the careless "guessing" of the operator. Why will men take such chances with moving trains who would shudder at the thought of pointing a loaded gun at another employe, yet the first is a risk of the wholesale class, while the latter is a small retail business—both are bad, hey, criminal.

Whistles too Loud.

Every year or two an agitation is stirred up in some part of the country against the too free use and abuse of the whistle by train running locomotives. The most recent movement of the kind was started by Mr. John Burroughs, the well-known novelist, whose voice has given forth a powerful shout against the noisy whistle. It seems that Mr. Burroughs lives on the banks of the quiet Hudson between two railroads, and the screeching of the whistle from the right and to the left is making the life of the town a burden, and indicating that the clam that a rural residence gives a quiet life to be a detraction. A complaint is made that the whistles are painfully unmusical, besides being noisy beyond the needs of signaling.

We are inclined, in a great measure, to sympathize with the complaints against the ordinary locomotive whistle, for it is generally made much louder toned than necessary. The powerful whistle used on this continent was introduced to meet a condition of railroading, which no longer exists, but for many years has been the thing after the conditions which made it useful have passed away. When single tracks were universal, when the methods

for controlling the movement of trains were very crude and when fixed signals were unknown, a locomotive whistle that could be heard ten miles away, often proved useful in preventing accidents. Now, when almost now-a-days that the locomotive whistle is of any service in giving information that a train is five miles away. If signal men and others can hear a whistle when a train is half a mile away nothing more is required. The country is getting thickly settled along many railroads and the constantly rising population of powerful whistles picked on the ground is a discordant note is certainly a source of discomfort to many people. We believe that those in charge of locomotives would readily make the changes necessary to abate this nuisance if a combined and temperate movement was made to demonstrate the necessity for a change.

Cheap Labor and Hot Boxes.

A group of master mechanics had been talking about the reasonable subject of hot boxes, and there was an inclination to blame bad oil for much of the trouble. A close observer dissented from that conclusion and expressed the belief that carelessness in connection with the running gear had more to do with hot boxes than people were willing to admit. In many engine houses, he said, the cheapest quality of oil is employed in adjusting running gear and in repairing defects to the same, and the stupid things naturally done cause more expense from hot boxes than would pay three times over for a superior class of workman.

When an engine is fitted up in the shops every care is taken to have the parts adjusted so that the weight will rest on the boxes as evenly as possible. The engine goes out, and after a while comes in with a broken driving spring. The broken spring had eleven leaves, but there are none of that kind in hand, and a spring with twelve leaves is put in. The pressure on the boxes is now out of adjustment, and one runs persistently hot. It is the same with the new brass put in the car than the others, and this aggravates the evil, and the engine gets a bad name for causing delays on the road, while everybody having anything to do with it has his temper ruffled, and recrimination is often exchanged that lead to personal enmities. The engine house foreman blames the engine and man for not doing wrong, and blames the engineer. The engineer is certain that he has not neglected the boxes, and resents attempts to blame him. Suspicion is thrown upon the quality of the oil and upon the kind of brass supplied, but no one searches backward into the true cause of the disaster.

This kind of disorder frequently originates with a broken spring hanger which is replaced by one shorter than the original. The result is about the same. Sometimes it is the truck bearings that are thrown out of adjustment by renewal of parts that are larger or smaller than the original. The personal inconvenience that result are the same. The moral of this is to keep your eye on the laborers employed to do running gear repairs.

Heroes of the Great Fire.

The recent awful forest fires in Minnesota and Wisconsin showed up some rail road heroes—as trying times always do. A train in charge of Conductor Sullivan and Engineer James Root stopped at a reached Huckleberry, Minn., when several hundred panic-stricken people rushed on board. The forest beyond and the town were on fire. Although the train stopped but a few moments, the cab of the locomotive was filled with the pallid faces of Root and his men. The thing after the conditions which made it useful have passed away. When single tracks were universal, when the methods

Before reaching there the entire train was on fire; many had jumped to certain death in frantic efforts to escape the peril.

As the lake was reached Root was safely burned, but he was calm and had the satisfaction of seeing some hundreds of people, whose lives he had saved, plunge into the lake.

With all his bravery, Root and his entire train of people would have perished had it not been for the heroic acts of Pirmann and McGowan.

Men like Root are not uncommon, they are behind throttle valves on every road in the land, and when the emergency comes they are there—they are heroes of a day and are then forgotten.

Had "Jim" Root led a squad of soldiers that killed 400 men instead of having saved that many lives alone, he would have had the thanks of Congress, a gold medal and a monument.

He deserves something better than a monument—and so do all his comrades.

We are in receipt of Vol. I, No. 1 of *Machinery*, a new paper in the mechanical line. In size the paper is 7x 11 inches and there are twenty pages of reading matter. The number is a very handsome one, topographically, and seems to be level full of matter interesting to mechanical readers. I read H. Colvin, a practical machinist, who is not unknown to our readers, is, after, with W. H. Wakeman and W. L. Cheney, associates, and the illustrations are in charge of F. W. Jopling. We would think more of their proof reader, who should not abbreviate the name of this paper. The publishers of *Machinery* evidently appreciate the fact that advertisers are commencing to take note of the circulation of trade papers, as putting their subscription price at fifty cents per year is evidently an attempt to get a large list quickly. We wish the new venture success; there is room for good papers everywhere. If the owners of this one make a good paper they will have clothes to wear and eat pie, if a poor paper is offered no one will find it out soon as the publishers. *Machinery* is launched by the Industrial Publishing Co., owners of *Railroad Appliances* and the *Poor Current*, whose place of business is at No. 411 Pearl street, New York.

NEW BOOKS.

STEAM TABLES AND ENGINE CONVERSIONS. By Thomas Pray, Jr. D. Van Nostrand Co., New York. Price, \$2.00.

This book contains a great deal of valuable information for the mechanical engineer, much more than the modest title seems to imply. The need for such a book was brought home to the author during years of active practice in steam engine work, and it is a factor in the form deemed most convenient for reference. The book is not a compilation of old tables, but is very complete and as far as we can find is very accurately done. Besides the tables there are some thirty-five pages of text matter relating to steam engineering, put in very clear, concise and comprehensible shape. Among the subjects that information is given on are: Ratio of expansion, cut-off, efficiency of expansion, Economy of feed-water heating, Heat of steam, Hyperbolic logarithms, Pressure, temperature, volume and density of steam, and a variety of others of equal importance. The book will be found of much service to every engineer interested in steam and heat problems.

Mr. John W. Cloud, secretary of the Master Car Builders' Association, has sent out a circular intimating that lithographic copies of the latest revised standards and recommended practice may be had from his office, Rookery Building, Chicago. The sheets are 25 x 35 inches, and are issued for 25 cents each. The proper way to keep standards standard is to use these drawings, which are perfect and admit of no mistakes.

The Q. & C. Co., of Chicago, have issued a pamphlet containing a digest of all the State laws on cattle-guards and fences.

Interchange of Cars in Europe.

[EDITORIAL CORRESPONDENCE.]

A surprising amount of thought and labor has been devoted in America to the devising of a system of car interchange which would be equitable and just towards all who send cars, and which would lead towards those who receive them. The annual discussions at the Master Car Builders' convention, and the disputes that have to be settled at every meeting of the Arbitration Committee supply convincing evidence that our system of car interchange is far from being perfect or equitable. The condition of railway freight transportation in America has peculiarities not to be found elsewhere, but it seemed probable that the rules and practice followed in the interchange of cars in European countries might furnish suggestions that would be useful to those having charge of our interchange system. With this idea in mind I inquired closely about the systems of interchange followed in every country where I traveled. There was very little learned that would be of practical value to our people, but it may interest our readers to know how car interchange is carried on abroad.

The first system inquired into was that followed in the British Isles. They have in these countries an institution called the Clearing House, which is a bureau of railroad officers all the agencies that arise with us from disputes in the interchange of cars. This Clearing House manages the whole of the details connected with the interchange of all railway business. When passengers or freight is passed from one line to another, the originating line has nothing to do about the settlement of the question of payment that goes to the connecting line. All that is done by the Clearing House, and the same institution supervises the movement of cars from one line to another.

At every interchange point there is a Clearing House inspector who examines the cars and notes their condition. If a car, or wagon, as such vehicles are called in England, has any defects, they are noted. If repairs are necessary they are executed at the expense of the owners of the car. If the car receives damage while on a foreign line, the company doing the damage is charged with the expense of effecting the repairs. But the spirit followed in the interchange of cars is that the owner is responsible for leakage in the cars when they are not the result of accidents. The breakage of draft attachments is charged to the road where such breakage happens.

When a car is sent upon a journey that takes it over one or more foreign roads a fixed time is specified in which it has to be returned. The road that receives a car is held responsible for its condition. When a car exceeds the specified time in getting back, demurrage is strictly exacted to pay for the delay. The Clearing House manages all the details of reporting how long a car has been subject to demurrage and collects the amount from the company at fault and pays it to the other one. In consequence of the promptness of the companies are exceedingly prompt in returning foreign cars.

Thirty years ago, when I was in train service in the British Isles, I remember that if anything happened to the engine of a freight train which required putting off part of the train, perishable goods and foreign empties took the preference in going forward. If our cars were returned as promptly as foreign railroad cars go back to the owners, we would not hear so much about scarcity of cars in busy times.

The conditions of car interchange on the Continent of Europe resemble ours to some extent, and the preference in going forward is a people might adopt with advantage. They have no Clearing House, and the individual companies have to watch that their cars get fair treatment on interchange lines. The first principle of the rules of interchange is that a company re-

ceiving a car must return it in the same condition as it was when received. The government control of the lines makes inspection more satisfactory than it is with us, for, for inspectors, who are officials who have no unfair leanings on either side of the place where they work.

As in England, a car is allowed a certain time for the distance it has to go, and if it does not get back in time a demurrage charge of sixty cents a day is exacted and paid. As the cars are of less than half the capacity of our cars, the charge is high enough to cover the cost of the car should it remain long away from home. As a car has to be returned the same way as it went, and as the receiving company is responsible for its safe and prompt return, there is no stealing of foreign cars to keep them on construction all summer.

Although the rate is to return cars in the same condition as they were when received, the good service of the men in charge of the rolling stock of the several lines has brought about an arrangement which saves a great deal of annoyance and correspondence. They found by examining the records, extending over many years that the charges for repairs of foreign cars were mostly for trifling sum, and that the debits and credits nearly balanced. That is, the charges made by the Chicago & Northwestern against the Lake Shore for cars westward would nearly balance the charges of the latter road against the former for similar services.

This being proved, the mechanical superintendents of the French railway agreed that no charge should be made for repairs that did not exceed \$50. This change has done away with a vast volume of correspondence, and all concerned are said to be much better satisfied than with the old plan, which is the practice our roads still follow.

In Austria, Germany and Holland they work on the principle of a car being returned in the same condition as it was when received. In Germany they are trying to arrange a plan of repair charges similar to that followed in France. In all these countries demurrage charges are strictly enforced for delay of cars.

I questioned the mechanical superintendent of the largest line running into Warsaw about how car interchange was carried out in that country, and said that when they gave a car to a connecting road they got another in exchange, and kept it till they got their own one back. He did not appear to see how they could possibly ever get their cars back if this hostage plan were not followed. He did not seem to understand about the system of charging other companies for car repairs.

Another photographer in his room showing a bad wreck, with several cars smashed up. He said that it did not happen on his line. "Now," I said, "suppose some of these were your cars. How would settlement be made?" "We should keep the cars we have belonging to them until our cars were returned," was the reply. The plan is, at least, simple.

Some of the railways in Germany are using chilled cast iron wheels under their freight cars that have no brakes. The wheels look very much like those made in America, but there is very little confidence in their reliability, although we could find no report of breakage. Railway material is supposed to be much cheaper than it is here, but most of our wheel makers would be glad to supply wheels at the prices paid. The Kaiser Ferdinand's Northern Railway, of Austria, uses cast iron wheels and pays 12 florins per wheel, which is about 35 cents. The wheels are not more than 600 pounds weight.

Mr. Jas. F. Blackwood, who has been general foreman of the South Carolina & Georgia shops at Charleston, S. C., has been appointed acting superintendent of motive power vice E. M. Roberts, resigned. The management could not do better than confirm this appointment. Mr. Blackwood is the right man in the right place.

PERSONAL.

Mr. J. H. Berry has resigned as master mechanic of the Cincinnati & Sandusky division of the C. C. & St. L.

Mr. S. Gano, Jr. has been appointed general manager of the Addyston & Ohio River, with headquarters at Cincinnati, Ohio.

Mr. H. D. Norris has been appointed purchasing agent of the Flint & Kru Marquette, in place of Mr. E. F. Weld, resigned.

Mr. Lewis M. Hamilton has been appointed general superintendent of the Cumberland & Pennsylvania, with headquarters at Cumberland, Pa.

Mr. James A. Keegan has been appointed master mechanic of the Cincinnati & Sandusky division of the C. C. & St. L., with headquarters at Delaware, O.

Mr. J. H. Foster has been appointed superintendent of the Jumes River division of the Chicago, Milwaukee & St. Paul, with headquarters at Aberdeen, S. D.

Mr. W. S. Rogers, lately air-brake instructor on the D. & H., has been appointed superintendent of the shops of the New Steam Pump Works, at Buffalo, N. Y.

Mr. E. W. Knapp, foreman at Monterey, on the Mexican National Railway, has been promoted to the position of master mechanic in charge of the Acumbaro shops.

Mr. J. B. Caven, general passenger and freight agent of the Valley Railway Co., and one of the best known railroad men in Ohio, was murdered in Cleveland last month.

Mr. F. G. Lauer, foreman of locomotive repairs of the Buffalo, Rochester & Pittsburgh, at Rochester, N. Y., has been appointed master mechanic of the road at that place.

Mr. L. H. Sherman has resigned as master mechanic of the Nantago shops, Mexican National Railway, City of Mexico, to take a better position with the Trinidad-Laguna Mining Co.

Mr. Robert Dewar, master mechanic of the Mexican National, at Atambaru, has been placed in charge of the Santiago shops of that road in place of L. H. Sherman, resigned.

Mr. J. P. Bay has been appointed superintendent of motive power and machinery of the Denver & Gulf divisions of the Union Pacific, with headquarters at Denver, Col. His jurisdiction is also extended over the South Park road.

Mr. F. C. Webb has been appointed division superintendent of the third, fourth and fifth districts of the Union Pacific, Denver & Gulf R. R., with headquarters at Denver, Col. Mr. Webb was formerly with the Chicago & Alton.

Mr. H. M. Laird, chief car inspector and foreman of shops of the Nashville, Chattanooga & St. Louis, at Atlanta, Ga., has been appointed master mechanic of the Savannah Iron Car Line, with headquarters at Atlanta.

Mr. S. D. King, for several years purchasing agent and superintendent of stock of Pennsylvania Coal Company, at Pittston, Pa., has been appointed superintendent of motive power of the Erie & Wyoming Valley Iron Car Line, with headquarters at Dunmore, Pa.

Mr. Joseph F. Kirchgraber has been re-appointed traveling engineer of the Gulf divisions of the Union Pacific. The position was abolished for a time, but the com-

pany's work and doing off the pay of a traveling engineer did not reduce expenses—quite the contrary.

Mr. J. M. Barr has resigned as division superintendent of the Chicago, Milwaukee & St. Paul, at Chicago, and has been appointed superintendent of the Breckenridge division of the Great Northern with headquarters at Willmar, Minn., taking effect September 1st.

Mr. Albert Griggs has been appointed assistant superintendent of the Chicago & Eastern Illinois, with headquarters at Louisville, Ill. Mr. Griggs was formerly superintendent of motive power of the New York & New England, and is one of the best known master mechanics.

Mr. E. T. Horn, formerly superintendent of the Macon & Brunswick divisions of the East Tennessee, Virginia & Georgia, and recently appointed trainmaster of the Southern Railway, at Atlanta, Ga., has also been appointed general manager of the Macon & Northern, with headquarters at Macon, Ga.

Mr. W. A. Vaughan, who has been for many years general superintendent of the East Tennessee, Virginia & Georgia, has been appointed superintendent of car shops of the Southern Railway. Mr. Vaughan was for many years on the Michigan Central, and was exceedingly popular and successful.

Mr. John Johnson of New York for Brazil has been elected in September, to superintendent of the city engines building works. This is Mr. Johnson's third year in the office. His twenty years' experience makes his success in working the engine and taking them out, and we can only hope that his trips have insured his life against any low pay, "small-pox" and influenza.

With the new organization of the Central has Mr. R. W. Wade, superintendent of motive power, had his position extended over what was formerly the East Tennessee, Virginia & Georgia system. Mr. W. H. Thomas, formerly superintendent of motive power of the Tennessee system, has been transferred to superintendent of motive power of the whole Southern system.

Mr. Warnon, the ex-engineer port, who took a "pay streak" in his song "Sweet Marie," has gone to Europe for the *Original Sweet Marie* with him. Cy wrote up a trip on the engine of the Empire State Express from New York to Chicago that gave him a little reputation for a while, and he has now been to Europe to write up a trip in the engine room of a fast ocean steamer.

Mr. C. E. Schaff has been appointed assistant general manager of the Cleveland, Cincinnati, Chicago & St. Louis R. R. For several years past he has been assistant to President Ingalls, and his intimate knowledge of the business has commended him for promotion to the position he now holds. Mr. Schaff has a very intimate acquaintance with all the details of railroad work, for he commenced maintaining as a steam locomotive engineer at Hannale, and successively served as fireman, conductor, yardmaster and trainman. He was for a time general superintendent of the Peoria & Pekin Union.

Mr. E. M. Roberts, superintendent of motive power of the South Carolina & Georgia R. R., has resigned that. He had been head of the mechanical department since 1891 and effected very great reforms in the service he had charge of. It is certainly one of the ablest of our younger class of master mechanics, and the officers of the N. C. & G. R. R. testify very warmly concerning his ability and admirable management of his depart-

ment. Mr. Roberts has been a very industrious worker on committees of the Master Mechanics' and Master Car Builders' Associations, and has been in the habit of doing special work to obtain information for the committees he was connected with.

One of the best known of the older class of railroad managers in the West passed away when Mr. John C. Gault died last month, in Chicago, from a stroke of apoplexy. Twenty years ago, when Mr. Gault was assistant general manager of the Chicago, Milwaukee & St. Paul, he appeared to be on his way to enjoy the very highest honor in railroad service. At that time three out of four railroad men in the West, if asked who was the best railroad man in the country, would have answered John C. Gault. He was drawn away from Mr. Gould from the St. Paul to manage the Wabash, at a salary of \$10,000 a year, which was a record. He exceptionally held on at that time. His last railroad work was on the Cincinnati Southern, where he was for five years general manager.

Mr. H. W. Caldwell, president of the New York, Chicago & St. Louis, has been appointed general manager of the Lake Shore & Michigan Southern, and will be elected president to succeed Mr. Newell when the board meets. The successful manner, in which Mr. Caldwell has managed the Nickel Plate road has commended him to the Vanderbilts as a suitable man for the important business of managing the Lake Shore. He is 44 years of age, but is a well preserved man. Of fine executive ability he puts upon others the working end of all details of management, and does not burden himself with work that can be done by subordinates. He is a graduate of the Pennsylvania system, where he passed through the engineering department and rose to be general manager of the Pennsylvania lines west of Pittsburgh. The Lake Shore people are to be congratulated on the kind of successor they have got to their president.

Mr. John Newell, president of the Lake Shore & Michigan Southern, died suddenly in the end of August, having been stricken with death while riding in his private car, where he spent the greater part of his time. The most conspicuous monument which Mr. Newell has left behind him is a big steel spring, the condition of the railway which he has managed for eleven years. It is now in a better position to haul passengers and freight at low cost than any other railway on this continent, and this condition is principally due to Mr. Newell's sound views concerning track and machinery. Several other railroad managers who have passed away, Mr. Newell worked himself into his grave by striving to do more labor than nature allows one man to accomplish. He knew no pleasure but what pertained to duty, no pastime that did not involve thoughts of his business. Mr. Newell was a Vermont man and began his life's work as a red man in an engineering corps that was surveying part of the Chesapeake Railroad. By the time he reached Montreal he had gained some reputation for ability as an engineer, and was in charge of important work. His strong characteristic was an upright industry. That with devoted aptitude for the work, soon elevated him to a high position in his profession. He had a very wide railroad experience and was for a time president of the Illinois Central before going to the Lake Shore.

James N. Lauder.

Few of the persons who attended the last Master Mechanics' Convention, at Saratoga, failed to note with sadness how fearfully the old stalwart lion of debate, James N. Lauder, had dropped from his ancient vigor within the year. The shadow of

death appeared to cling to his face, and his voice, so strong and fearless in the past, had taken a feeble tone which indicated painful loss of force. Only the power of an indomitable will prevented the man from remaining at home in bed. His friends, who parted from Mr. Lauder in those closing days of June will not be surprised to learn that in the last days of August his life ended.

Mr. Lauder was one of the best known and most popular railroad mechanical men in the country. Although a man of most decided opinions and convictions upon railroad and public questions, and although he always had the courage to express his views and defend them, he made remarkably few enemies for an outspoken man. As a master mechanic his strong point was in the general grasp which he took of the best forms in machines, and of the best methods of organization in management. He was not strong on details, but no one could more quickly detect the weak points of any mechanical appliance offered for adoption, and how vigorously he would explain to an inventor the shortcomings of the device he was offering to



laud and men. But he was equally keen to appreciate the merits of a good thing, and many a device now recognized as essential attachments of locomotives and cars was helped into popularity by commanding words from Mr. Lauder. As a designer of locomotives Mr. Lauder had few peers, and his influence in favor of proper proportions did much to improve the engines over the whole country. He was one of the first men to recognize that there was a tendency among our designers to make the boilers too small for the cylinders, and his voice sounded out the doctrine that the boiler, not the cylinder, is the measure of a locomotive's capacity. This he proclaimed for years, when his sympathizers were not numerous; but as their master mechanics and locomotive designers became converts.

James N. Lauder was born of Scotch parents, in Vermont, in 1838. He learned the machinist trade in a country machine shop, and shortly after finishing his apprenticeship he went to Uttonia, Pa., and began work in the Pennsylvania Railroad shops, where his uncle, Mr. Laird, was superintendent of motive power. He had not the elements of a man that would cling to the coattails of an uncle or of any other man as an aid and moving alibi, so as, after a few months spent in Uttonia, he returned to New England, and went to work gaining experience in the business. In the shops of the Northern Railroad of New Hampshire, at Concord, Mass., he rose to be foreman, and from that was appointed master mechanic in 1866, a position which he held till 1881, when he was appointed general master mechanic of his old road, and the Boston & Lowell, which consolidated. The courts broke up the consolidation, and Mr. Lauder led the companies and went to Mexico to

be superintendent of motive power of the Mexican Central. This position he held for two years and then returned to New England to be superintendent of rolling stock of the Old Colony, a position he held at the time of his death.

In 1870, Mr. Lauder joined the American Railway Master Mechanics' Association, and from the first was one of its most active and energetic members. In 1881 he was elected president, and held the position for two years. On that year he elected the second time his master mechanics against the president holding the position longer than two years. He was president of the New England Railroad Club for two years, and was held in high esteem by every society where discussions of railroad mechanical subjects caused his voice to be heard. We know of no one whose voice and counsel will be more seriously missed when master mechanics and master car builders come together to reason about their common interests.

On September 2d at Augusta, Ga., Mr. Henry O. Rowarth, the oldest locomotive engineer in America, died. A portrait of Rowarth is in the paper of the 12th of December, 1892. Mr. Rowarth entered the employ of the South Carolina road in 1824 and began running an engine in 1824, putting fifty years in this service. He was engineer of the "Best Friend," the first locomotive for actual service built in the United States.

EQUIPMENT NOTES.

The Mexican Central are in the market for 250

Baldwins are building some narrow gauge locomotives for the government of Japan.

The Merchants Dispatch Co are reported to be moving bids for the building of 250 refrigerator cars.

Cook's people are making six new fire-boilers for the New York, Chicago & St. Louis, of Schoenberger steel.

Plint & Co. of New York, are reported to be authorized to order 200 cars for the Central Railway of Brazil.

The Rhode Island Locomotive Works are doing a great deal of heavy repairs to locomotives belonging to the New York & New England Railroad.

Rumor has it again that the Savannah, Florida & Western are about to order some new low-motives. Rumor also says that great many railroad managers are anxious to increase their car equipment if they could only see their way to pay for building the same.

The Boston & Albany have ordered fourteen eight-wheel passenger engines from Schoenberger, and also a number of standard engines of the road. Nine of the boilers will be carbon steel and five of Schoenberger steel. Locomotive tires are specified, and steel for the piston rods made by the Coffin toughened process.

The Illinois Central have ordered eighteen new locomotives, of which ten are equipped with cylinders of 48 and 48 and eight are eight-wheel passenger engines with driving wheels 6 inches diameter. The boiler of the Argand will be part of the boiler, and the passenger engine built at Rogers' and the passenger engine at Brooks. Krupp tires are specified for the passenger engines.

The headlight equipment of the Brazilian suburban engine is a special feature. Each locomotive is supplied with 20-inch headlights, constructed for burning Argand lamps. The Argand burner, one light being located in the usual place and one on top of the tender tank. The supply of gas is carried in a tank hung below the top of the cab and under the side frames of the tender. The Argand gas headlights are much more powerful than the usual headlights. Several engineers witnessing the recent tests made in the yards of the Delaware, Lackawanna & Western, are of the opinion, stating that the light was at least three times as powerful as that of similar oil headlights, and that it did not in any way obstruct the clearances of the signal and other lights about the yard, as is the case with the objection to the use of electric headlights. Tests of gas headlights have been in use on locomotives in Europe and South America for several years with excellent results. Why not in this country?

FACTS WANTED.
There's a glut of Opinions.

Practical Letters
from Practical Men.

Write on one side of the paper, state your point plainly and briefly, and then quit. We supply the generalities. No letters notice unless name and address are enclosed.

An Engineer's Opinion of Independent Driving Brakes.

There seems to have arisen in the past year or two a great deal of prejudice against the "independent driving brake" and a great tendency to change all such brakes be they steam, vacuum or air to dependent brakes, that is to work driver, tender and train brakes with one action and one valve. Now I do not think any first-class practical engineer ever suggested such a change, and it would seem to me, perhaps narrow brain and mind, that an engineer, if at all bright, in regard to train and engine brakes, would be the proper one to make necessary suggestions in regard to changes, improvements, etc., as to the best manner of having brakes connected for efficient handling. While I rather favor independent brakes for fast passenger service on account of fast time, shorter trips and equipment in good shape, besides a general quicker action, I feel positive that for heavy freight or switching service an independent driver brake is far in advance of one that is cut in and works with the one brake valve, for many reasons which will state. I am greatly in favor of an engine improvement that will get rid of the dangers of running heavy trains on fast time or slow time either, for there is, of course, danger in both, but I certainly fail to see where anything is gained whatever by having driving brakes on freight engines cut in with the train and handled with one valve. If an engineer takes any interest at all in what he will not object to the slightest additional care of one more valve, especially when that valve helps him in so many different ways to make smooth stops, etc. Say, for instance, I am using a steam-driving brake on engine, and have tender equipped with air. I am called to go out with a train of forty cars, all air. I have two or three switches to make, and I dislike plugging an engine (especially if I am trying to be light on valve oil) and I want a heavy pressure to accumulate in main reservoir to charge those forty cars and get out of town. How nice it is to leave valve on lap and not charge tender auxiliary up to sixty or sixty-five pounds while doing the switching, and still have a power to stop engine without reversing, also how easy to run up to car and couple on with the independent driving brake, without releasing or reversing engine. Steam is so much quicker, can be applied and released quickly or slowly or like straight air, partially, that it is possible, if stopping two or three feet short of car, to partially release just sufficient to let engine move up to car and couple on while on lap grade was steep and driving brake cut in with train brakes. I would have to release for those two or three feet, and unless I wanted to waste a lot of air, by using emergency port would have to reverse engine or bump the car a little on hard. I hear some critic say why not tank and driver brake off and just let engine run from reservoir, and train pipe to push up triple piston and set again. This, of course, can be done, but the pressure in auxiliary is equalizing down less all the time that is being done, and if many couplings are made you will soon have to get over to give auxiliary a chance to charge. Again, when going down grade, you will have to have to stop and take water at a tank where engine can't back up twenty cars. My judgment is not good enough to stop right at the spot always, and I dare not go by a foot, so I am stopping a few feet short. How to release those forty brakes on this grade and move ahead and set brakes

with valve in service position? I will be several feet past the tank before I can get what air out of train pipe I had to let in to push up piston, and release brakes. Of course, if auxiliaries could be recharged as quick as brakes could be released, this problem would be easy, but the feeding port past triple valve piston will not of course admit of this, on account of its small size and, by the way, a good many men do not understand why it is so small, therefore we have to figure different. Now, then, even with the dependent brake that stop cars so easily, and without reversing engine or using emergency, but it is injurious to cars, and for that reason I dislike the practice—that is, by kicking off head brakes. The independent steam or vacuum brake on drivers does away with this difficulty very simply, as it can be set and hold weight of engine against train, when head brakes can be kicked off to our heart's content. The chance of breaking in two, or if a fall release is made with the independent brake, we can hold slack back and it will give us time to make a service application before we get by.

Again we are pulling out of a siding that is slightly down grade, our pump is working through and we do not wish to make any more applications than is absolutely necessary, with the independent brake train can be steadied so brakeman can throw switch and get on without train coming to a full stop, result—time and air both saved.

Again we are heading in on siding where there are cars standing, and we have to approach and couple on very carefully, and we do not wish to stop and start forty cars very often if we are in any hurry. Here is where our independent brakes or drivers come in again, as we can leave it set to hold slack and couple on without stopping until coupling is made. I could give many more reasons why an independent driver brake is the best for freight service and on switching engines, but will say low for criticisms. I believe the main reason why independent driver brakes are being done away with on many roads is that some engineers won't use them though to keep them in shape. My idea is, that it is the engineers of that kind, and not the independent brake, that should be done away with. An engineer who takes so little interest in an engine that he won't take care of very improvement that is put on for his benefit, or for the benefit of the company he is working for, should be made to do so or resign. This in all kinds and conditions. If our traveling engineers would educate engineers a little better, never to return, and if our traveling drivers there would be no other reason for changing to dependent brakes.

L. D. SHANKER
Anaconda, Mont.

His correspondent is like many other engineers, but he is too late with his argument—the independent driver brake has been used for years, and it is well that it has. The engine is the heaviest part of a train and the most obedient place to brake. When independent driver brakes are provided, the train has to stop the engine in nine cases out of ten, and great damage is done to draft rigging on account of it.

The independent driver brake is handy for yard and tank stop, but since the introduction of the automatic from pilot to caboose, many men who said "it couldn't be done," are making gilt edged stops with it. The only thing for the first-class engine to do is to study the brake as it is—it has come to stay.

Increase and Decrease of Lead with Shifting Link.

I am much interested in your paper, for I think you are doing a good work. I note an error in your September issue in your reply to Queensland, of Maysborough, Australia, which was doubtless due to haste. "In every arrangement of the shifting, or Stephenson link, the lead increases as the lever is hooked up." That is true as the motion is usually arranged, but the motion can be arranged on any ordinary locomotive without change of parts or making anything new, so that the lead will decrease as the lever is hooked up. Still another adjustment will give a constant lead for one motion (the forward is best), and a lead which diminishes from the center to full gear for the other motion.

Scranton, Pa. TOWNSEND DODGE.

[Perhaps we should have said "In any usual arrangement of the link." The motion can be distorted to do as our correspondent says, but is not done for service. It would be just as far to assume that the shifting link had a constant lead because the lever could be left in the corner. As a matter of fact it could be so left, but is not in practice.]

Improved Cylinder Cock.

Acting on a hint in the September number in regard to improvements in locomotive details, I inclose tracing of cylinder cock.

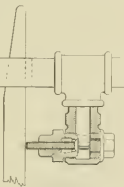

It is easy to get at for repairs. Take off top nut and out comes the valve for examination, slack off the bottom nut, and out comes valve and seat, without touching wedge rod and connections.

When a man adjusts his posterior development on the dump floor of a jerk-water roundhouse to fix a cylinder cock rig, it is hardly to make him feel tired. If this design don't impress the iron horse any, it will, at least, improve the moral tone of the gang.

We have put a set built on the same principle on a hoisting engine, but with this alteration from the chief draughtsman, using a T for the body.

Chicago, Ill.

Some More Air Brake Ruts.

The tendency to keep in the same old rut is not confined to those who use air brakes. The manufacturers have kept up with the times and deserve and receive credit for their continued improving, and the air brake is now practically perfect, but they are not altogether clear of the rut. How long it was that they continued to furnish that reducing valve for the train air signal, Plate D 28, Fig. 1. It is well said that anything gets wrong with it except with the times and deserve and receive credit. If a little bit of dirt gets between it and its seat the signal line will be charged with full main reservoir pressure, and engineers know how confusing the signals are then. When the brake is released, after stopping at a station, the air whistle shrieks out the signal to "go

ahead," and thinking that he has stopped too far back, the engineer pulls ahead and turns over a track load of trucks and a few passengers, but he got the signal all right and obeyed it.

The Westinghouse Company now make a reducing valve something similar to the feed valve attachment of the new engineers' brake valve, and it is intended to be used in the future. After using a station the engineer can close the stop cock and cut off the pressure from main reservoir, take out and clean the supply valve, replace it and have the signal line in working order before waiting for the next stopping place. The supply valve in the old style reducing valve cannot be taken out without disconnecting its piping and removing it from the main reservoir, and this represents an hour's time for the ordinary repair man, while with a properly designed and located valve the engineer could remedy the trouble in a few minutes at no cost, and with the benefit of correct signal the remainder of the trip.

The Westinghouse Company furnished those old valves years after their faults were plain, and they were known to be a constant source of trouble, and when the New York Company got out their air-signaling apparatus, they imitated and fell right in the same rut, then the Westinghouse people got out of it.

It would be a saving in the end to throw away the old reducing valves, and buy the new ones, instruct engineers as to keeping them in good condition, and hold the engineers responsible for it.

I have never known the conductor's brake valve being any where on a passenger car except in the closet. It is put there because the brake company recommended it. The car builders thought it a convenient place, and as nothing seems to have happened yet to give reason for changing its location, it is always placed in the closet.

We had the same three cars on a local passenger run all summer and for several days there was a bad leak somewhere in the train pipe that could not be located by either the trainmen or inspectors, and it was all that the 6-inch pump could do to furnish pressure enough to make the frequent stops; finally a farmer from Pecksburg told the conductor that "there was a thing about to bust in the closet." The conductor's valve, one of the old ones, was dirty and leaking badly. If it had been out of the closet the leak would have been noticed sooner.

Suppose that an extremely nervous person or a lady in a delicate condition was in the closet when the conductor's valve was pulled open. Or a mother might be attending to her infant when the valve opened, and be so frightened as to drop the child, or break beneath it. It looks inhuman, and having the conductor's valve in the closet may prove expensive to some railroad company eventually.

After the conductor has applied the brake and stopped his train, it is necessary to close the valve and get the brakes released. It must often be done quickly, and without the aid of the following closely, as if the closet is occupied, the engineer there may have the safety of the trains in his hands, for it takes some time to bleed off all the brakes when the train pipe is empty, and the fullest explanations will be necessary, and make the passenger understand that he can unhook the closet door without sacrificing any of the rights he secured when he paid his fare.

I never saw where the exhaust air from the conductor's valve was piped out of the closet, and most roads still use some of the old valves that have to be held open. Some roads do not cord the valves, when the air is not used, and the air is usually forced on the inside, and an emergency would be past before the conductor could gain admission.

It is a general rule or custom to lock the closet doors on approaching terminals and some other stations, and if the conductor wants to pull the air while going

through the yards, he must unlock his valve first, if it is not forced.

The car discharge valve for the train air signal is outside and at one end of the car. Wouldn't it be getting out of the safe at the other end of the car.

There seems to be a general impression that the air brake companies are behind the times in not exchanging their plan form of angle cocks for some complicated mechanical absurdity that will perform impossibilities—such as being able to rotate a shaft in one direction, employ and disengage a valve, and have brains for that. It is not likely that the angle cock will be changed, it will remain as it is, or be entirely abandoned, and the latter is safely possible.

Thirteen years ago the Westinghouse Air Brake Co. patented, and later a while manufactured, a hose-coupling, the use of which obviated the necessity of having angle cocks at the ends of the train pipe. The coupling contained a valve that would open when a pair of them were united, and close when separated by hand, but it operated by a straight pull as the train breaks in fact, the valves would remain open, allowing the train pipe air to escape and apply the brakes. This form of coupling was illustrated and described in the Westinghouse Instruction Book for 1891, and if it was in general use there would be no need for angle cocks. It is curious to me that this is the only remedy proposed, since there is no reason for argument. The Westinghouse pattern of '89 would not do so, its valve does not open and close automatically when united with a plain coupling, but one could be made that would, and with better designed valves that would not be so easily deranged by dirt, noise or accident, with a check valve on the angle fitting that would close when the loose angle was removed, the angle could be used with the greatest safety.

In my letter in the September number one paragraph was made meaningless by a change in the punctuation and a sentence divided. It should read: "If high steam pressure is used, an 8-inch pump will give as good service as a 10-inch pump, but with little or no excess the pump is the main factor in releasing brakes on a long train after an emergency application," etc.

W. H. WOOD.

Terre Haute, Ind.

Old and New Brake Valves Volume vs. Pressure—Leaks.

Editors,

Will W. Wood in September number devotes considerable space to an article headed "Getting Out of the Rut." The article is very good, but is in some places somewhat misleading, I think. He states that "one bad feature of the old valve is that an extremely high pressure may accumulate in the main reservoir, and that hose or start leaks in the train pipe when the brake is released." On another page he states "his theory of high pressure has been unfavorably critiqued and a larger volume proposed instead." He then states "this may be accomplished by carrying a higher pressure of air in the main reservoir, and he would like to have some one give one good and sufficient reason why this should not be done." Will, you have given one very good reason yourself, and in my estimation the main reason, that is, that heavy reservoir pressure, when turned into train pipe, is liable to burst a hose or cause leaky joints and in the area of bursty up you can't be bothered with why it can be avoided. And if, as you advocate, we set governor at 120 pounds for main reservoir we will very often be delayed by hose bursting, etc. Now, Brother Wood, our idea is, use large main reservoirs, if half as large again as is generally used so much the better. This you can have the volume to recharge with. Carry 50 pounds train pipe pressure, and, if you have an 1802 valve, set governor at 100 pounds and mainly have a brake piston travel of not

more than seven or less than six inches. Right here is the main part of the brake equipment, and that does not receive the attention it should, and in forty and fifty articles it makes a very pleasant stop if you happen to have cars ahead with medium and long travel, and behind ones with six inch, especially if engines is not equipped with independent driver brake. I also differ from friend Wood in regard to where the main reservoir of cars differ every trip. I prefer for long trains the 1802 D B valve, as it does away with adjusting governor for different lengths of train, and as far as the feed valve attachment goes it should be unnecessary, as there should be no leaks in train pipe, and if engineers and car and/or an inspectors understand their business there will not be any leaks that require the attention of feed valve. The new governor and pump, however, are necessary, and splendid for any service. Brother Wood speaks of trains moving off while standing at coal chutes, etc. They must not look after piston packing very sharply on your coal. Well, as trains of that kind would not do in this mountain region, where retainers are used, and of course depend on tight piston packing on brake cylinder. Brother Wood also speaks of seeing hot discharge pipes from air cylinder. We have been handling from thirty-five to fifty car trains that for the past five years, and have not seen that yet, but we don't pull leaky trains (farther than yard hauls, and, after we delay train once or twice to fix a leak, the air inspector will be more careful. Your ideas about running pumps at right, give them time, keep out of air cylinders, and they will never get hot if receiving valves have 2, and its large valves 3, inch lift (in inch pump). In regard to stopping the brake valve handle in running position by putting in a stud, don't ever do it. Will, as you will surely get left if you ever want to release in a hurry or recharge on a mountain grade. If there was a plug needed the Westinghouse people would have put it in, sure. I could state a dozen reasons why, but must come to an emergency stop for the caller.

Mission, Mont. I. D. S. RAFFERTY.
Another Welding Tool Steel Flux—Twenty Years Old.

Editors,

In your August issue there appeared an article on "Welding Cast Steel," also a photograph of a lathe tool. This recalls some experiments made by our smith shop foreman some twenty years ago, when he succeeded in welding several pieces of steel together by means of a flux. He made several lathe tools this way, and he also made a razor from steel welded in this manner, and those that had the privilege of using the razor for the razor pronounced it a very good one. One of these lathe tools in a single cut reduced the diameter of an iron axle 1 1/2 inches, and they were considered as good as any other tools made from hot steel for machine work at that time.

Nothing more was done with them, and the matter was entirely forgotten until this article appeared. We have reworked one of them from among a lot of curiosities that we have. This one was drawn down 1 1/2 in. The end shows portions of two old files, three nut taps and a piece of a broken die. Our flux was also homemade, and was simply the slag from the heating furnace pulverized.

Kingston, Va. F. W. ALDRICH.
[The specimen sent was a twin brother of the one we illustrated, or, perhaps, its father, at it was twenty years older.]

Brake-Cylinder Pressure Graduating and Maintaining Triple Valve—Its Virtues and Its Faults.

Editors,

I herewith enclose a blue print, which is a sectional elevation of a brake-cylinder pressure graduating and maintaining

triple valve. The invention consists in an improved triple valve, in which the new features are additional to those of the ordinary quick-action Westinghouse valve, so that they can be readily incorporated in existing systems.

By this improvement the valve will do everything that the present valve will do, and, in addition, six other desirable features are introduced not possible with the valves as now constructed.

1. It will stop a train quicker, because of a practically constant auxiliary reservoir pressure, thereby getting a quicker equalization between the auxiliary reservoir and brake cylinder, and as every car throughout the whole train will have the same pressure on brake pistons.

2. When the brakes have been set they cannot leak off.

3. It will do away with the "pressure-retaining valves," and place the braking of the train in the hands of the engineer altogether.

4. Every car throughout the whole train will have the same pressure on brake pistons, irrespective of the piston travel.

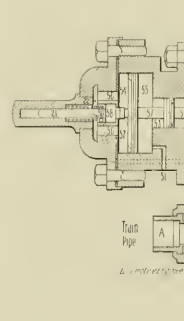

5. The engineer cannot "lose his air" by the injudicious application of his brakes.

6. The engineer will have better control of his brakes, for if he should control that he had set them too hard, he can charge his train pipe with any additional pressure and get brake service according, and not have to "knock them off" and then reset them.

The equipment of a train and the action of this valve in service is as follows:

The auxiliary reservoir B is preferably made considerably larger than is now the custom, so as to give a greater body of air to draw on, or in lieu of this, a second train pipe (not shown) may be provided, and connected with the auxiliary reservoir through a suitable check valve, and connecting to the engineer's brake and equalizing discharge valve through the tee valve when the handle of valve in its service application and on lap, in order to keep up the pressure in auxiliary reservoir.

The train pipe A, passage e, chamber h, piston and rod 4, knob j, port z, slide valve v, valve 7, ports e, w, s, n, t, r, s, chamber and passage C and the pistons and valves of the quick-action movement are all those usually found in the Westinghouse quick-action triple valve, and need not be described at length. The ports are shown in the position they occupy when the brakes are released, the train pipe being in communication with the auxiliary reservoir through the port z.

In carrying out my improvements, I arrange in line with the knob j and rod 4, a stem 57, on which are secured two pistons 52, 53, the former considerably larger

than the latter, and each moving in a cylindrical chamber 54, 55.

The smaller chamber 55 forms a passage between chamber 54 and chamber h, and the space between the pistons 52 and 53 communicates with the atmosphere, as by port 51. In line with the stem 57 is the equalizing stem, or plunger 21, sliding in its socket, and pressed outward therefrom by the helical spring 22. On its end it carries a piston valve 58, sliding in a cylinder, as shown, which communicates with chamber 54 by ports 56. A port 59 runs from the chamber and passage C to the cylinder of piston valve 58, into which it opens behind the piston 58, when the latter stands in its normal position, as shown.

The stem 57 normally abuts against the plunger 21, so that when a service stop is made, the travel of piston and rod 4 is arrested, as usual, by the knob j striking the end of stem 57.

When the ports stand as shown in the drawing, the train pipe A, chamber h, and auxiliary reservoir are charged to the normal pressure of seventy pounds. There-

is no pressure in the chamber 54, and the stem 57 is kept pressed against the stem 21 by the pressure on the small piston 51.

Upon reducing the pressure in the train pipe, as usual to set the brake, the piston and rod 4 moves to the left until the knob j strikes the stem 57, allowing the air in the auxiliary reservoir to pass into the brake cylinder by way of passage e and chamber and passage C. The pressure also passes through port 59 into cylinder of piston valve 58 and chamber 54, and when it has reached a point high enough to enable the large piston 52 to move the stem 57 against the still higher pressure on the small piston 53, the stem will be forced to the right, carrying before it the piston and rod 4, and positively seating the graduating valve 7—a result that does not occur in the usual triple valve until the pressure in auxiliary reservoir has equalized to that in the train pipe.

With my invention, the valve 7 is positively closed as soon as the pressure on piston 52 and on one side of piston 4 reaches that on piston 53 and the other side of piston 4.

Now, if there should be a leak in the brake cylinder or its connections, the pressure on the large piston 52 will be reduced, because chamber 54 is in communication with the brake cylinder by port 59. The pressure remaining in the auxiliary reservoir would then, acting upon the piston 4, move all the pistons to the left, positively opening valve 7 and again renewing the pressure in the brake cylinder. This action of the valve will continue automatically so long as the pressure in the train pipe and chamber h is kept below that in the auxiliary reservoir.

It will be noticed that the pressure in the brake cylinder depends not upon the amount of reduction in the train-pipe pressure, but upon the proportions of the pistons 4, 51, 52. As the diameter of freight triple-valve piston 4 is at present $3\frac{1}{2}$ inches, the diameter of piston 51 is made $1\frac{1}{2}$ inches, and the diameter of piston 52 is made $2\frac{1}{2}$ inches, then the pressure in the brake cylinder for every reduction in the train-pipe pressure will be as follows:

Train-pipe pressure	Train-pipe Cylinder	Brake Cylinder
70	70	0
65	65	21.3
60	60	42.3
55	55	63
50	50	84
45	45	105
40	36	126

It will then be seen that a gradual reduction of thirty-four pounds in the train-pipe pressure will set the brakes with the full auxiliary reservoir pressure on the brake cylinder.

To set the brakes at once with the full auxiliary reservoir pressure, as in cases of emergency, a sudden reduction of ten or twelve pounds is made in the train-pipe pressure, causing the auxiliary reservoir pressure to force the piston and rod 4, the stem 53 and plunger 21 as far as they will go to the right. This movement of the piston and stem brings into play the question parts of the valve, admitting the train-pipe pressure directly into the brake cylinder in the usual manner. The piston rod 53 closes the port 50, preventing the pressure in the brake cylinder from having access to the large piston 52, and thus rendering inoperative the automatic action of the pistons, which occurs when a slight reduction of train-pipe pressure is made, as just described above.

It will thus be seen that I enable the engineer to keep the brakes set a constant pressure during a long period, when running down a long grade, without the use of "pressure-retaining valves," and without any danger of "losing his air," while the usual operation of the brake cylinder parts of the angle valve is not in any way interfered with. It will also be seen that since the brake-cylinder pressure bears a fixed ratio to the train-pipe pressure and is governed solely by the relative sizes of the pistons, the pressure in all the brake cylinders on the train will be the same, irrespective of the travel of the brake cylinders. This gives a uniform effect on all the cars, which is a great advantage. With the system in common use, the pressure in the brake cylinder varies with the travel of the brake piston—being greater on the piston which has the shortest travel.

It will be seen that cars equipped with these valves will work in harmony with cars equipped with the present valves, and that the passenger cars are already supplied with the Frost Dry Carburetted system of lighting, these valves can be advantageously attached directly to that air reservoir, thereby doing away with the trouble experienced now, when the check valve from train pipe to air reservoir leaks.

Although, when charging up a train with large auxiliary reservoirs, as suggested, would require a greater volume of air than at present, yet when once charged up and in actual service, the amount of air required will not be any greater than now, and the main reservoir volume on engine for controlling brakes, need not be very much greater than at present either.

J. A. STEININGER.

Creton, Pa.

We have published the above communication from Mr. Steininger, with a cut of his device, as it is an excellent illustration of a class of communications which we are constantly receiving.

Mr. Steininger has evidently given a good deal of study and thought to the matter which he presents, using certain apparently desirable objects in view and displaying a good deal of ingenuity in attaining them. The great difficulty with inventions of this kind, is the lack of

proper consideration of certain indispensable features in the improvement of the air brake and similar apparatus used upon railroads and we have thought it would be a good plan to publish this communication and point out some of these features for the benefit of others who are giving a good deal of their time to matters of this kind upon a basis which is wholly impracticable.

The indispensable feature of Mr. Steininger's invention is that two lines of train pipe must be used, or a very much larger auxiliary reservoir than that now used in connection with the air brake. It has long been known that a great many things, some of which would be desirable, could be accomplished if two lines of train pipe could be used. Long ago, too, such a line of train pipe were used and it was one of the improvements which made the air brake generally applicable to the railroads when one of the lines of pipe was discarded, and the automatic operation of the brakes became possible with one line of pipe. While it is known, therefore, that some advantages would result from the use of two lines of pipes, it is generally regarded by railroad men that these advantages would be more than offset by the disadvantage of the additional apparatus, and so long as a brake operated by a single line of pipe will meet all the requirements of service in this country, with reasonably good judgment in handling by the engineer, there is no possible field for a brake with two lines of pipes. There is only one thing left to do in order to use Mr. Steininger's improvement, which is to use a larger auxiliary reservoir.

It is well known that, if a quantity of compressed air is drawn off from the reservoir containing it, the pressure in the reservoir is reduced. If the pressure is to be reduced only slightly, by drawing off a small quantity of air, the reservoir must be so large that the quantity of air drawn off is very small in comparison with the volume of the reservoir. In order to carry out Mr. Steininger's plan, therefore, it would be necessary to have a very large auxiliary reservoir. Without so opting to point out that, on a large proportion of the freight car equipment now in use, which is lower-bottom gondolas, it would be impossible to find room for a larger reservoir than is now used, we want to indicate what difficulties would be encountered if the plan were carried out.

In the first place, the system proposed by Mr. Steininger would not work harmoniously with that now in use. A certain reduction of the train pipe pressure would apply the brakes now in use harder than it would those of Mr. Steininger's system. A 20-pound train pipe reduction would fully apply the brakes of the cars now in service, while Mr. Steininger's brakes would be applied with only about two-thirds their full force. This, as everybody who has ridden the air-brakes, knows, would cause a very bad effect in trains where the two brakes are mixed, causing trains to break in two, etc. It would therefore be necessary, if Mr. Steininger's system were adopted, to change the brakes on the 250,000 or more freight cars now in use. This would require first that the present reservoirs be removed, and very much larger ones be substituted for them, then, as a full application of the brakes would give a higher pressure in the brake cylinder than is now obtained, it would be necessary to change the levers on all these cars so that the pressure of the brake shoes on the wheels would be the same as with the higher cylinder pressure than it is now. It is wild to think for a moment that the railroads would put into use upon their cars any kind of brake apparatus which would not work harmoniously at least for special applications, with what they now use. It is well known, however, that the brake apparatus must be such that its advantages can be obtained upon cars equipped with it, while in all other respects the brakes must work in harmony with those now in use.

There is another serious objection to this system of operation. As a higher cylinder pressure is than is now employed would be used to do the same work, more air would have to be compressed by the pump for each application. Also, as a greater reduction of pressure in the train pipe would be required to operate the brakes than is now the case, a greater quantity of air would be wasted from the train pipe at each application. On long trains, this would be very serious. From both these causes, therefore, a considerably greater service of the pump would be required. It would also take a longer time to charge up a long train, which would oftentimes cause delays, and, although the auxiliary reservoir pressure would be reduced only a little with each application, it would take a longer time to recharge to no pounds again. On this account, where an engineer made bad use of his air by frequent applications, he would get his pressure reduced and would hardly, at any time, have time enough to get the apparatus recharged, so that he would have poor backing of the train.

Another defective feature of such a system would be the greater difficulty in releasing brakes. The brakes are released only by the difference of the pressures in the train pipe and the auxiliary reservoir. The higher the pressure in the auxiliary reservoir, after the brakes are applied, the higher the pressure must be in the train pipe in order to get the train moving, and it will be necessary to carry much larger main reservoirs on the engine, or a considerably higher excess pressure, than is now the custom, in order to release the brakes on a long train. The hardest problem in air brake construction is to secure a prompt and sure release of the brakes and any device or scheme which renders this particular problem more difficult is an objectionable one.

Beside the fact that Mr. Steininger adds two pistons and an extra valve to the apparatus now in use, as well as a much larger auxiliary reservoir, making it considerably more costly, there is one defect in construction which is so often overlooked by the inventor, that we ought to point it out. It has long been known that it is practically impossible to keep a small piston tight against air pressure. The small piston 53 is the only means of preventing the air in the train pipe from passing directly to the atmosphere through the port 51. As it may be well set down as a fact that the piston 53 cannot be kept tight, it is evident that there will be a constant leakage of air from the train-pipe to the atmosphere by the piston 53 and through the port 51, whether the brakes are on or off. The accumulated leakages of this kind on a long train would, in all probability, prevent charging up the large auxiliary reservoirs, and, when the brakes are once partially applied, the leakage of the air from the train pipe would soon cause them to be fully applied, which, in descending long, heavy grades, would practically result in the engineer's losing control of his train. Such leakage would also very seriously interfere with the release of the brakes. It is undesirable how easily and generously piston valves of this kind are thrown into designs for air brake apparatus by persons who have not had the right kind of experience. There is no place in an air brake system where the escape of air to the atmosphere will be prevented, in which a piston valve will work satisfactorily.

It might also be profitably considered whether the objects sought by Mr. Steininger are desirable ones. He proposes to do away with the pressure-retaining valve. It is now regarded by a good many railroad men as one of the greatest improvements that can be done with the pressure-retaining valve. Since the pressure-retaining valve is present and has to be used, it requires that the trainmen shall have some part in the handling of brakes down heavy grades. As it is un-

doubtedly true that no air brake system could ever be made so perfect that accidents due to it would be impossible (such as the giving out of the pump, or some similar difficulty), it is important that the trainmen should always be prepared to operate the brakes by hand, if such a difficulty, however remote it may be, should arise. The presence of the pressure-retaining valve requires the presence of the trainmen on top of the train near the brake wheels, and the time will probably never come when this will not be a desirable feature.—ENTRICKS.]

One More Angle Valve.

Editors:

I noticed in the last issue of your valuable journal an improved angle cock, the "turn cock." It reminded me of sending my improvement, which I consider far better than any yet published in your journal. Inclosed please find blue print of same. It is impossible to cut the air out after the train pipe has been once charged with air and angle cock is afterwards put in cut-out or partly cut-out position.

In Fig. 1 you will see all my improvements. Port D, valve E, seat F, port G.

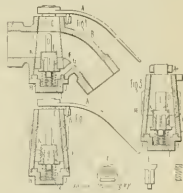

stop M and spring I, also cock in cut-out position.

Fig. 2 shows cock in cut out position, showing port D in communication with train-pipe, also shows valve E open, allowing air to pass through port D to main portway L, down through opening in seat F to space below plug valve C, out through port G to space back of cock in cut-out position, allowing engineer to control his brakes by air on entire train, if angle cock is cut out after train pipe has once been charged with air.

W. R. HOWSON.

Innison, Ala.

The U. S. Metallic Packing Co. are supplying the packings for all the engines being built for Brazil.

A New Dummy Coupling.

We illustrate herewith a new form of dummy coupling, recently designed and patented by Mr. J. A. Jesson, air brake inspector of the L. & N. Railway, at Nashville, Tenn.

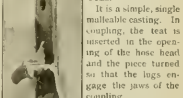

It is a simple, single malleable casting. In coupling, the test is inserted in the opening of the hose head and the piece turned so that the logs engage the jaws of the coupling. The test slightly compresses the rubber gasket, keeps it in place and makes a dust-tight joint, without the necessity of the face of gasket. One of the best advantages of the device is that the hose cannot be hung up without closing the opening in the hose. There is no hook to cause half a job and run the gasket.

Pneumatic Tank Lift, M. K. & T. Ry.

The accompanying illustrations show the plan adopted to lift tanks off tender frames when it becomes necessary to inspect or repair either of them. The plan adopted to make one piston handle four ropes evenly is a simple and efficient one. About all there is to the device is the cylinder, pulleys and ropes, the timbers of

The superintendent of motive power will assign engines to the different divisions, and change such assignment from time to time as may be necessary.

He will prepare and issue plans for standard locomotives and cars of different classes and standards for all details for repairs, which must be strictly adhered to.

The superintendent of motive power will report to the third vice-president.

where the value of a tool is fixed. If heated too high no drawing down will ever restore the original strength of the steel.

Do not forget that if a tool is overheated for hardening it is vastly better to let it go cold and then reheat, than to let it cool down and then plunge on a descending heat.

The blast pressure in heating steel in

much stronger that it will do from fifty to one hundred per cent. more work.

If, in hardening delicate tools, a portion of the tool is only black but while other portions are red hot, the tool would be more certain to crack from the uneven heat than it would from the same unevenness where the lowest heat was red and the highest a little hotter. But both conditions should be avoided.

We have received from the Richmond Locomotive and Machine Works a pamphlet describing their two-cylinder compound locomotive. The book shows photo reproductions of the engines, illustrates and describes their intercepting-valve gear and gives dimensions of the engines and copies of the performance sheets of the roads using them. In the announcement they say "In presenting our compound locomotive, we think it proper to state that, in view of the many objections that have heretofore embarrassed the general adoption of the compound locomotive, we have hesitated in offering our arrangement until it should have been demonstrated by actual service that it would fill the requirements in every respect. To this end we have left the management of the engines entirely to the railroads and their regular crews, without any trained assistance from us, with a confidence that is shown not to have been misplaced, in the efficiency, simplicity and durability of our valve mechanism. Thus we have the testimony from the railroads themselves, as shown on the accompanying performance sheet, that establish beyond question the superiority of our device at every point over simple engines of the same build, age type and carrying the same boiler pressure, in economy of fuel and maintenance, and at the same time hauling full trains on schedule time." Any one interested can, we

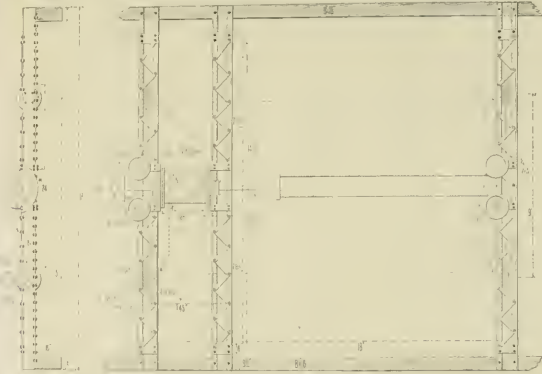

of handling being used as a frame, fixed with tall frames are used to lower them up, to take together parts of the same and build it at a convenient height for making repairs to the bottom, where as most are needed.

This is another of these handy time-savers gotten up by Mr. C. T. McElvany, M. M. of the M., K. & T. shops, at Dixon, Mo.

Mechanical Organization of Southern Railway.

A general order has been issued by Vice-President Baldwin, of the Southern Railway, as follows:

"The jurisdiction of R. D. Wade, superintendent of motive power, is hereby extended to include the Western system.

"He will be assisted by an assistant superintendent of motive power, with office at Washington, D. C.

"The assistant superintendent of motive power and master mechanics will report to and receive their instruction from the superintendent of motive power. Road foremen of engines and engineers and firemen will be under the control and supervision of the superintendent of motive power and will report to him through the master mechanics in all matters relative to the condition of locomotives; but in all matters pertaining to the discipline while on the road they will be under the direction and control of the superintendents, who will have full authority to suspend or discharge engineers or firemen. Engineers and firemen will be appointed by the superintendent of motive power, through his assistants, but no engineer or fireman shall be appointed until he has passed an examination on the rules and regulations, by the superintendent or his representative, and received a certificate of competency from him.

"The superintendent of motive power will have general supervision of all machinery, shops, engine houses, cars, sheds and all employes engaged in the work of constructing, reworking, or repairing rolling stock.

To Engineers Desiring to Go to South America.

We have received numerous letters from engineers and other classes of railroad employes asking for information in regard to securing employment in Brazil.

These inquiries are no doubt brought about from the fact that a large order for locomotives for that country has been placed with the Brooks Locomotive Works, of Dunbar, N. Y.

We have taken some pains to inquire into this matter, and from a railroad man recently returned from Brazil we learn that there are no vacancies in that country but what can be filled by native Brazilians, and the rate of pay would be no inducement for a railroad man from this country to seek employment in Brazil.

The locomotives mentioned above are not intended for a new road, they are merely to replace those on existing roads worn out in service.

Tool Dresser Lore.

We call the following items of advice to tool-dressers, from that splendid little house organ of the Crescent Steel Co., *Sparks from the Crescent Anvil*.

One purpose is mighty apt to win. Quit hardening steel at the forging heat. There is nothing better to quench in than water.

Do not lay hot steel in a draft, or where it will cool unevenly. A drill hardened on an ascending refining heat will cut twice as much as one that is slightly overheated.

Annel in charcoal dust, putting sawdust next the steel, and it will come out soft and work like decarbonized steel. Where high steel has been put improperly into shapes liable to crack, try a bath of warm, muddy water, if oil is not at hand.

In annealing steel, care should be taken to get it hot through, and then it should not be soaked in the fire long enough to raise a hard scale.

Watch the hardening heat, for this is

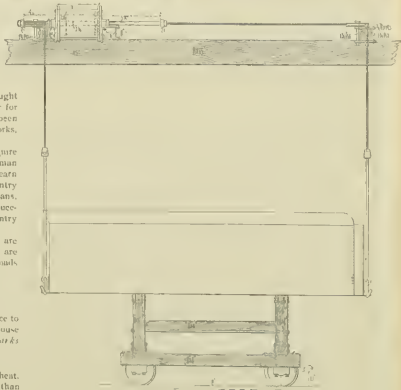

moderately heavy work should not exceed one-quarter pound per square inch of air column. A good body of fuel should be placed between tuyere and piece operated upon.

No hardened piece is as strong as the tempered piece, a slight tempering, say to dark straw or very light brown, gives great increase of strength, a much tougher edge and so little decrease in hardness that the difference is not noticeable.

Although the coarser grain obtained by overheating is really a little harder than the fine grain obtained by dipping at the refining heat, yet this fine grain is so

suppose, secure a copy of this pamphlet by addressing the works at Richmond, Va.

We have been shown some very nice castings of "Ironmaster" metal (principally aluminum) for frames and other parts of model locomotives, made by Mr. Geo. H. Olney, of Brooklyn, Mr. Olney has taken New York Central Express Engine "897" as his standard and made his parts to scale from her measurement. Anybody making a model locomotive can get these parts, either finished or in the rough, very much cheaper than they can be made. Some two patterns are in use and any part can be had.

Hammer Dies for Making Car Links.

The ingenious hammer dies shown herewith have recently been perfected by General Foreman J. H. Ebert and Foreman Blacksmith Jos. Smith, of the Interocenic Shops, at Puebla, Mexico.

Fig. 1 is the upper, and Fig. 2 the lower die.

Fig. 3 shows how the lug L^1 on the upper die binds the link into the recess of the lower one.

Fig. 4 shows the recesses in dies for forming the ends to be welded. These recesses are also shown at A^2 in Fig. 2.

Fig. 5 shows the link scarfed, and Fig. 6 shows the bending die at end of hammer, also shown at L^2 Fig. 6. Fig. 7 shows one side of the link after being bent, and also both ends are bent.

Fig. 8 shows the welding recess of the dies, and it is also shown at A^3 in Fig. 2, and L^3 in Fig. 1.

Thus this single set of hammer dies and block will complete a link without taking any material away from it.

In practice they form the link complete before heat except the welding, which is a final operation, the material being resaturated.

With a small furnace this arrangement will turn out lots of work, and the links made on it are exactly uniform and the welding perfect.

Simple Machine for Grinding Steam Pipe Joints.

The hard draggery of the dirty job of grinding in steam pipe joints, so representative to the ordinary mechanic that he will object to do a whole job if he can make

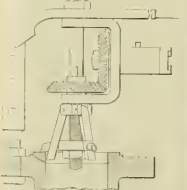

a joint hold steam until the engine gets out of the house.

Mr. William H. Hill, of the U P shops at Denver, Col., has recently patented a simple device for doing this kind of work that deserves mention.

The construction is made quite plain in the detail drawing, which shows the machine set for work on a steam pipe joint. The ring is held by three wings that are clamped tight on the inside by the lower nut, which expands them, a steel plug on the outside of each wing keeping the ring from slipping up. The upper ends of the wings, or chuck jaws, are linged in the collar under the U frame. By having the stud and lever bolts loose considerable side and cross motion can be given to the ring, and the pressure is regulated by the hand lever.

Our second engraving shows the tool set on a T-pipe, or "wigger head," a hard place to get at.

It is driven by a flexible shaft and speeded up to over 300 revolutions per minute.

It is easy to turn the machine over to examine the ring, just as is done with the wooden plug when grinding by hand.

At the U P shops, in Denver, they use this device to grind in steam pipe joints, while the pipes are lying on the floor.

The tendency of hand work is to let it when a thin joint shows good contact all around with the machine, there is always time and inclination to make a good job of fit the entire width of ring.

An Instructive Shop Mate.

It is strange to reflect on the quality of the human instruments that are sometimes employed to exert supreme influence over our lives. My boyhood, and probably most of my life, has been greatly influenced by the training, direct and indirect,

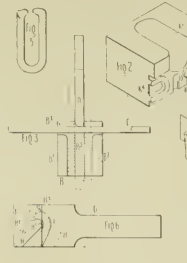

HAMMER DIES FOR FORMING LINKS.

given by a working boilermaker named William Laurie. Willie was not of the class heroes are generally molded from, but for a time he was a good deal of a hero to me. He had the reputation of being the best boilermaker on the railway system. Excellence in any art carries astonishing

of horns he had sat on for two hours would never make a boilermaker. Then he made me guess the size, and laughed at the length I was off.

The next firebox we went into I measured the length of the fire bars on the sly, and after we went out he asked me the distance from the fire bars to the crown sheet. He had a mocking tongue, and I never enjoyed being called a blockhead. As there appeared to be no end of the things he would ask questions about, I began to prepare myself that I might escape ridicule. One day it would be the number of stays on the side of a firebox, another day it would be the thickness of sheets or the number of rivets in a seam and their size.

When I was not otherwise engaged I used to go into fireboxes and boilers to study details so that I would be ready with answers to Laurie's questions. This developed habits of observation which proved very useful in after life.

Laurie was a man who had intense admiration for skill and knowledge of boiler-making business, and a man possessing these had all other faults or sins readily forgiven. He appeared to have very little

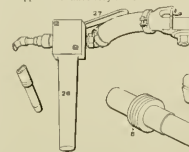

Fig. 2

knowledge of anything else, but the designing, building and repairing of boilers he knew to perfection.

The workmen had a joke at Laurie's expense. Although he loved the flowing bowl not wisely but too well, he was like most of his countrymen, a God-fearing man, and a member of the Kirk. It happened that his better half brought a son into the world, and on application being made for the baptism of the babe, William was invited to a private interview with the minister.

The latter, an austere man, whom I re-

member for his strong denunciations of Popery, and his graphic pictures of the brimstone regions, where he said most of us were destined to spend our future. This shepherd took William to task about his moral conduct, and within a few minutes, with upturned eyes, exclaimed:

"Willie Laurie, ye're not fit (able) to hold up an infant for the Lord's baptism."
"No fit the hand up the hoarn?" replied Laurie boldly. "I could hand up it if he was as heavy as a firbush."—From *Lectures at Sibley College by Angus Sinclair.*

Thomas' Pneumatic Flue Cleaner.

Mr. C. F. Thomas, M. M., of the R. & D. shops, at Alexandria, Va., has recently patented a device in use some time at his shops for cleaning out locomotive tubes.

He uses compressed air alone, without the use of fuel auger, and removes the cinders from the stopped flue to the front end by using a clear flue as a conveyor.

Fig. 1 shows the complete device in place ready to use.

Fig. 2 shows the details. In Figs. 1 and 2 the part marked 21 is simply a plug which is shoved into any convenient flue, and to which is attached the hose head for coupling onto the shop supply of air, and carrying the air valve 27 and the small hose connecton.

The central device in Fig. 2 is merely a wedge operated by a lever to fasten the whole apparatus to the flue sheet firmly, 2 is a pipe for conveying cinders to the clean flue, and 3 a rubber washer to prevent their being blown into the firebox.

The part marked 22 is a rubber diaphragm through which the small hose is shoved into the tube. This piece also has a rubber ring to prevent cinders from escaping.

When the device is shoved into two flues, one stopped, the other clear, the lever in the center locks the device against the flue sheet and a second lever operates eccentric in such a way as to force the two rubber rings 8 and 5 against the flue heads.

As it turned on, and the jet dislodges the cinders and sends them through the hollow tube frame to the front end. As

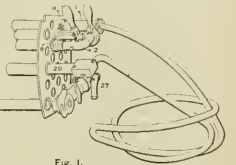

Fig. 1.

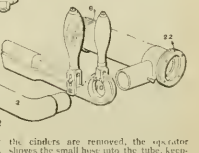

Fig. 2

the cinders are removed, the operator shows the small hose into the tube, keeping it well up to the obstruction.

This device can be used behind a brick arch without disturbing it at all, and is so neat and handy, being small, that it is bound to come into use where flues must be cleaned—and where they not.
At present, to use an auger where the arch must be removed—which means a new one nine times in ten or the front end being changed—must be demolishing and it has been kept to bear with the loss of a lot of effective heating surface rather than go to the expense of new arch or taking out draft pipe, diaphragm or nozzle stand.

LOCOMOTIVE ENGINEERING.

Some More Blacksmith Shop Kinks.

Continuing the subject of small tools and handy rigs for blacksmith's work, we show herewith—

SPRING LEAD SPLITTER GUIDE.

The Fig. marked 4 is in use on the C, H & D for slotting hangers and spring leaves. Its construction and use will be perfectly plain to any blacksmith; it holds the work and the punch securely, and admits of doing the job on a steam hammer.

1875 ROU FORMER.

Fig. 5 is a device for bending such eye-bolts, brake beam hangers etc. As shown, levers A and B are in position to receive the rod, then lever C is brought to pin D, which makes the first bend and prevents the work from slipping forward when lever B is brought around to the right, thus forming the eye complete. E is a roller, F stop-pin, C slot in lever D to hold iron in place.

Eye bolts or brake beam hangers with an eye on one or both ends are expensive things to make by hand, by cutting up the stock the



FIG. 6.

right length and using this tool uniform work can be turned out very fast.

These tools were designed by Foreman Blacksmith A. L. Woodworth.

HAMMER DIE FOR FLANGING KEY BARS IN DRAFT BOLTS.

This is a simple die plainly shown, it is in use on the B & O. Southwestern, designed by Foreman Blacksmith J. A. Mick.

This cut hardly needs an explanation.

The upper part shown is the lower one on the hammer, the upper one is kept in proper alignment by flanges, as shown, and a fork with handle, shown at bottom of cut, is used to handle the top die.

On the right is shown a hole of draft bolt they make that requires two punches. They also punch holes in spring hangers with a similar rig.

IMPROVED PORTER BAR

At these shops they make their own axles, etc. from scrap, and to save welding a porter bar on to an axle or wrought chunk of iron from furnace, they make a bar scarfed as shown, place the hot iron under the hammer and drive the bar into the edge of it as shown, this holds all right and is not hard to get out.

FLANGING OF WHEEL RIMS AND DEEPENING BLADES.

Harry Jefferys, foreman blacksmith at the Pittsburgh Locomotive Works, has done lots of railroad work, and shows how

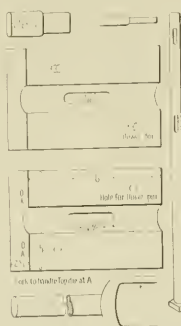

to do some things by punching that as a rule, are done in some other way. For instance, he shows in the accompanying sketch how to punch out switch rods and the bars that are usually welded up. To do this he uses three punches, first to make



a square hole in the bar, next to enlarge this hole to proper shape to receive base

of rail, and then to reduce body of rail back of head, leaving a fillet from which the iron is sheared down.

He uses the same method to form the fork of eccentric blades from a square bar of iron, as shown in the next sketch.

His dies are cast iron and without finish, used as they come from the foundry. He leaves plenty of room in the solid die block, and uses a loose wedge to keep the hot iron in place and prevent its "squandering out."

He also shows a method of bending heavy links by putting two rollers on the

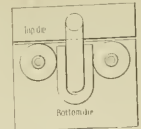

side of the lower die, and using a hp on upper die of the proper shape.

MAKING IRONS ON BELLEFONTE LADDER RINGS IN A DIE MACHINE.

John Cotteral, foreman blacksmith of the D. & R. G. road at Grand Junction, Col., had lots of small braces, such as shown in lower figure, to make. He conceived the idea of using his belt hanger for the purpose. He accordingly countersunk the bending dies of the machine and concealed the plunger end; this made a ball on each end of the rod; the blacksmith flattened the ball under a hammer and punched it, and the set was given at the same heat.

This blacksmith makes ladder rungs for cars in the same way.

The same man uses a hand bending device, shown herewith, for making the eyes and bends in the standard brake hangers of the road. The eye in the end of the tool is slipped over the large post in the block shown, the shank of which is held in the anvil, the steel stud serves as a guide, and the roller in the tool does the bending.

The gauge shown is the form used for measuring and testing the work done by the tool and in cutting up the stock for it.

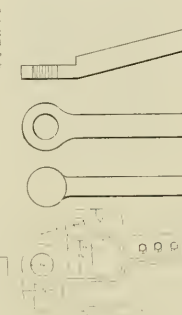

All railroad men know that one of the desirable things in life—railroad life—is to reduce the dead weight of trains in proportion to the load hauled. Those who are sundrying this problem may be interested to know that Supt. of M. P. Mitchell, of the Erie, has been experimenting in this line with results. He took all cast iron parts off a 50,000 pound car, and substituted malleable iron of equal strength, saving in weight 1,100 pounds. On some heavy, double hopper-car items a saving of 1,300 pounds per ton was made.

Judge Swan, of the United States Circuit Court at Detroit, in a decision rendered August 21st, denied the motion for a rehearing in the Cody patent case, thereby affirming a previous decision of the same court in favor of the Consolidated Car Heating Company of Albany, N. Y.

The articles on "Coppersmithing for Railroad Shops," will be concluded with the next issue of the paper.

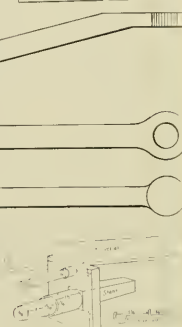
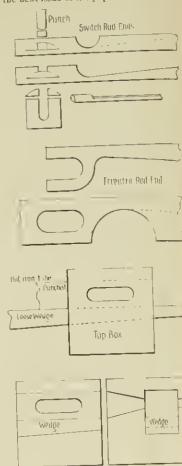

Last year the Peerless Rubber Co. put out, on the quiet, some steam-heating hose made on a new plan—that of using pure Para rubber, without wires or mineral substances. The result of trying what the best pure rubber hose would do, instead of inventing a steam proof mixture, was something new, and was found to be something better than known. They now guarantee this steam hose for one year, with 80 per cent. of it lasting two years.

The Traveling Engineers' Association have just completed a very successful meeting—their second annual—at Denver. We shall publish a synopsis of the paper in the next issue of this paper.

The Union Railroad, of Providence, R. I., have ordered the Consolidated Car Heating Co.'s electric heaters for their 200 street cars.

Railroad Coppersmithing—XI.

By JOHN FULLER, Sr.

PREFACE FOR CHIEF CLERK.

In many railroad shops the tinmen and copper-smiths are huddled together under a single roof, or under the direction of one foreman, and all kinds of sheet metal jobs done their way there, and are expected to be done by the men engaged or working in these branches. Perhaps some one of the tinmen can do an occasional copper job, or a coppersmith must do some stray job of tin or sheet metal work as hinted at in Chapter VII. In these shops there is often work to be done which requires a knowledge of cones or their envelopes. When I was a boy the questions involved in cones greatly puzzled me, as it has many before who, like me, were in the unfortunate position of having no opportunity of getting an education except that arising from the exigencies of surrounding circumstances and the school of stern experience. There were no books or papers of a practical nature on those subjects within my reach, and a boy must make his jobs of the men with whom his lot is cast or work out his own destiny by himself. I tried both expedients.

Perhaps it will interest my boy readers to tell of my first lessons in the direction of conical work, and show their application in a few articles in every-day use furnishing as they do stepping stones to further search in the mysterious but interesting science of sheet metal working, or more properly, practical geometry. My first lessons in the direction of cones was making common extinguishers and bed-room candlesticks.

These two articles were of much interest to me, an anxious boy, right at the very threshold of the sheet metal trade. After I had been working some two or three years, diligently investigating all the problems that came in my way, I found out that the old workmen had or used five primary fashions or standards in cones by which they denoted their work, so that they might understand what they were talking about when discussing or giving directions in the various kinds of conical work in which they might be engaged. These primary fashions were named and understood as follows, namely, extinguisher, muller, funnel, lantern-head and bowl, and are illustrated in Figs. 150, 151, 152, 153 and 154. The envelope of the extinguisher, Fig. 150, it will be seen, is formed of one-sixth of a circle, or sixty degrees, and, when turned, forms at the apex an angle of twenty degrees, that is near enough for ordinary practice. The muller, Fig. 151, is formed of two-sixths of a circle, or one hundred and twenty degrees, which, when turned, forms at the apex an angle of forty, nearly. The funnel, Fig. 152, requires three-sixths, or one hundred and eighty degrees, and makes, when turned, an angle of sixty at the apex. The lantern-head, Fig. 153, takes four-sixths, or two hundred and forty degrees, and forms an angle of about eighty when turned, while the bowl, Fig. 154, takes five-sixths, or three hundred degrees, making an angle of one hundred and ten at its apex, approximately. Within these five standard fashions once lay all the principal varieties of conical shapes used by the old workmen in sheet metal working requiring ranging sides. To explain first, in *J*, Fig. 151, is represented the pattern of an extinguisher once used to put out the light of a candle. This first primary fashion gave the initial lesson in pattern cutting, and was an excellent boy's job.

We were once kept pretty busy in their shop manufacture. The writer made many a globe, and they afforded a good preparatory lesson in the art of turning by hand, as well as wiring and laying edges true and even, but for soldering. To get the

dimensions of this pattern we multiply the base by three; this gives the radius of the circle of which the pattern is a part. Thus, suppose an extinguisher *A* Fig. 151, or cone for any similar article, is required an inch and a half in diameter at the base *F*, then $1.5 \times 3 = 4.5$, and one-sixth of a circle whose radius is four and one-half inches will make our extinguisher, without anything allowed for wire or lap, the tin coming together edge to edge. Next, in the same figure, *B* is an old-fashioned quart cup. This cup is made, as will be seen, extinguisher fashion, and the radius of the pattern is obtained in the

cup, and the pattern it will be seen is obtained in the same manner, and one-third the radius *a* deep. The asp and catch for the cover is shown beside the can at *C*. These are three illustrations of this fashion with the base down, two of which are in thirris, that is, a third of the generating radius as the depth of the vessel. The next, Fig. 156 *D*, illustrates the same fashion in halves, that is, the article is made one-half the generating radius deep. *D* represents a coffee pot, with a strap handle and lip, and *E* is the same thing with a wood handle and spout. It can readily be seen that the same ratio of

circles of which their bodies are a part. This slop pall affords a good example or lesson for careful study, as it embraces three primary fashions in one article, thus, the barge (or breast) is cut lantern-head, the body extinguisher, while the foot *H* is funnel fashion. Suppose now the pall, as shown in Fig. 107, is to be ten and a half inches at the brim, *I* *H*, then $10.5 \times 3 = 31.5$, the length of the radius *E* *A*, and, if *E* *A* is divided into four equal parts, we have here in this instance the depth of the side, or $31.5 \div 4 = 7.875$, that is, seven and seven-eighths without edges. Now the slop pall, Fig. 157, is the same as the milk pail, hence for the body at the section *H* *G*, it is ten and a half, and at the foot, *E* *A*, three-fourths of ten and a half, or seven and seven-eighths, then, *E* *A*, or seven and seven-eighths, is the diameter of the inside or small end of the foot *H*, and the inner radius of a semicircle of which the foot *H* forms a part, or a hundred and eighty degrees of a circle whose radius is seven and seven-eighths will make the form of the foot funnel fashion. The foot may be any depth to suit the taste, although one-fourth the depth of the body, or two inches, has always been considered the right proportion. The barge (or breast) at *H* *G*, is ten and a half inches, then $10.5 \times 3 = 31.5$, the radius *E* *G*, of which four-sixths is required to make the barge, which is also cut one-fourth the depth of the pall wide, and hollowed in the hollowing block to give it the required curve and make it ready for the pall. From the foregoing explanation, and accompanying familiar illustrations given previously, together with careful examination of the hundreds of things about him, the reader may soon become acquainted with the subject presented for his investigation and guidance.

MULLER FASHION.

In Fig. 155 is shown three examples in the next or "muller fashion," which is formed of one hundred and twenty degrees, or two-sixths of the circle of which it is a part. This fashion, an ordinary tinshed, is principally used for oil-burners, *J* and deep basins or puddling pans *B*, and some other articles, as the grease kettle *C*, all of which were once made by hand. When the fashion or standard shape has been determined, and we wish to make a dishpan or any similar article of a given diameter, say twelve inches, then we proceed thus $12 \times 3 = 36$, and find the radius of a circle eighteen inches, two-sixths of whose circumference will make the pan (without edges), and one-third the radius, or six inches, for the depth. It should be noticed that many other vessels of exactly the same principle are made, but the skirt reversed. I here present a grease kettle, which is an exact pattern of a round but kettle for fishing, and is the same fashion as the pass but reversed, or the base of the cone turned down, the depth being one-third the generating radius as before. The pan *B* may be made any depth to suit, or as deep as required, its pattern being obtained in the same way by multiplying the diameter of brim by three and dividing the product thus obtained by two, when two-sixths of the circle, of which the quotient is the radius, will be the pattern required, as shown by *a* *b*, *d* in *C*, Fig. 155.

FUNNEL FASHION.

The funnel fashion, Fig. 152, is formed as shown, of three-sixths, or one-half of a circle, and is adapted especially to the flange and a few pans and similar shallow funnel articles. Several applications of this fashion are here shown. Fig. 159 shows down a spittlecan, and the cone base is down. Fig. 160 is a lamp filler, also with the base down. Fig. 161 is a pan for the use of the tinman, and the brim, and Fig. 162 is a candlestick, the pan of which was once made in press. To obtain this pattern we take the diameter *a* *b* of the bottom of Fig. 159, or the diameter *d* of the



same way, namely, by multiplying the diameter of the bottom of the cup by three, which gives the radius of the circle of which the body of the cup is a part. Now take for the length of the body one-sixth of the circumference of the circle, and for the depth of the cup one-third of the generating radius *a* *b*, thus suppose the bottom *b*, of the cup *B* is four inches in diameter, then $4 \times 3 = 12$, the radius *a* *b*, of a circle one-sixth of whose circumference will be the length and form the outer edge of our pattern for the cup *B*, and one-third of twelve, or four, will be the depth, also without edges for seam or wire. The pattern for the handle is shown in *d* inside the cup. In *C* is shown a pretty milk can, also cut in the same fashion, and is exactly like the quart

fashion is used here, thus if a coffee pot or any similar article measures six inches at the bottom, then $6 \times 3 = 18$, the radius of the circle of which one-sixth of the circumference is taken to form the body of the coffee pot *D*, with one-half the generating radius taken for the depth. Many other illustrations could be given, but these are deemed enough to show the principle. In Fig. 157 are illustrated two common pails, one an open milk or water pail, the other a slop pall. Here the order is reversed in the article, and the small end is made to serve for the bottom, but the law is unchanged. The bodies of both are extinguisher fashion as before, which can be seen at a glance; the depth of them in these cases being one-fourth of the radius of the

Copyrighted by John Fuller, Sr., Newell, Can. All rights reserved. This article is reprinted in September, 1893.

form of Fig. 164 as radius, and three-sixths of a circle whose radius is equal to the bottom or brim diameter will make the pattern required. Many other examples could be given to illustrate where this fashion can be and is used in the construction of many articles called for and made in a railroad shop where tinmen, lampmakers and coppermen all work together.

LANTERN-BEAM FASHION.

The lantern-head is formed of four-sixths of a circle, and was used for the tops of old-fashioned horn and mica lanterns, shown in Fig. 151, also oil bottles, Fig. 163, colanders, Fig. 164, hand-bowls, Fig. 165. To obtain this pattern we must draw a circle, and then, if it be required to make a colander, Fig. 164, twelve inches at the brim A , then the rule is $12 \times \frac{2}{3} = 8$, and four-sixths of a circle whose radius r , is nine inches will make our colander, which should be one-half the radius, or four and a half inches deep, that is, without edges for seam or wire. Hand-bowls, Fig. 165, sprinkler nozzles, Fig. 166, and all similar articles the same. Lantern-benches and oil-bottle tops are examples with the base shown. I will here give the proportions of this rule to oil-bottles or cans. When I made oil cans the tops were all made lantern-head fashion, and if the reader will carefully examine the best specimens that come under his notice, he will find those that please the eye the best are still constructed in accordance with the base shown. A top of funnel fashion never looks well because the symmetry is not in harmony with the body. Let us make a gallon oil can or bottle, Fig. 161. Now we need to make gallon oil cans from middle plates, that is, tin plates which measure 11 1/2 x 18 1/2 inches after spinning up.

Then a middle plate and a quarter inch, making the pieces 7 1/2 x 11. Noted the two ends of each piece as shown and fold them in growing, then turn them into cylindrical shape by passing them through rollers, and groove down the seams, the two seams, it will be found, have taken up about three-quarters of an inch, leaving twenty-one and a quarter inches in the circumference of the body. Then $21 \times \frac{2}{3} = 14$, or a little over six and three-eighths inches, the diameter of our oil can body. Now burr both ends of the body a neat eighth of an inch, and the lantern top, we are now ready for the top. Here we see the diameter of the base of our can top is a little over seven inches, then proceeding in accordance with the rule $7 \times \frac{2}{3} = 4 \frac{2}{3}$, that is, forty-sixths of a circle whose radius is five and a quarter inches will make our top as shown in Fig. 163. Now add enough on each side for seam parallel with the edge as shown, and the pattern is complete ready for forming.

Now let us see if our oil can will hold a gallon. We find by dividing the number of cubic inches in an imperial gallon, or 277.274 by 285.4, we get the number of cylindrical inches contained in it thus $277.274 \div 285.7$, and if we multiply this result by three we obtain the number of conical inches in a gallon also, thus $327.573 \div 282.21$. Here then we have the figures necessary for our work, and we proceed. First with the body of the can, which is 7.25 high and 6.75 in diameter, then $6.75 \times 6.75 \times 7.25 \div 390.3281$. Next the top, which is 6.75 inches in diameter and 3.70 high, then $6.75 \times 6.75 \times 3.70 \div 36.1937$, and adding these two quantities together we have $390.3281 + 36.1937 = 326.473$, which shows large enough over 277.274 so that the bottle is of full capacity. The same formula used with an American gallon and a sheet 14.25 in a good example for practice.

HOOP FASHION.

The hoop, or cap for stove-pipe, is formed of five-sixths of a circle, and is illustrated in Fig. 154. This fashion is

used principally for caps for stove-pipe and flat covers, such as lard cans, spice boxes, bucket covers of different kinds, lamp crowns and many similar pieces used in the make up of lanterns and lamps where made by hand.

All these examples named are instances of its use with the base hood. Let it be required to make a hood for a stove-pipe eleven inches in diameter, then proceeding by the rule in a similar way as before, we have $11 \times \frac{5}{6} = 9 \frac{5}{6}$, or six and six-tenths inches as the radius of a circle, five-sixths of which will make the hood required without anything allowed for seam, which must be added parallel with the edges.

The foregoing rules I have used for many years. They are simple and practical, requiring but little thought or mathematical knowledge, and for the general run of work sufficiently accurate, and when the matter is not of great and rarely grasped by the learner he will find it one of the most valuable systems for ready application in ordinary work. Sometimes, however, it happens that greater accuracy is necessary in the premises, and we have an example which calls for closer reasoning.

For instance, in Fig. 167 is an example which once occurred to the writer, and perhaps it has been to the reader. It was required to make a large hood to hang over a smith's fire, A, B, C , Fig. 167, having an angle of one hundred and twenty degrees at the apex, or a rise of thirty degrees from the base. I lined it out on a board in a similar way I had done for a longer apex, as in Fig. 2, and was pleased to find that the outlines A, B, C, D, E, F , or the three figures of the cone or hood required, completed the circle, and I was puzzled to know what part of the circle it was necessary to take out to make the cone required. In the emergency I could only cut and try, and study the matter out at home.

I then waded through many books patiently-searching years for the required information, and finally found the key to it in an old measurement by John Bonnyycastle, published in 1723, and I here present the result of my search, or its application, for the benefit of the reader, which will be found applicable to resolve cones of any given height or rise from the base or angle at the apex accurately. To illustrate let it be required to make a cone, A, B, C , Fig. 168, eighteen inches in diameter at the base, and any height taken at random from the base to the apex, or say eight inches perpendicular, D, B . Now, we want to know how many degrees of a circle whose radius is the slant height A, B of the cone A, B, C , it will take to form the cone. To do this it may be shown that where the radius of a circle is 1, half the circumference is 3.14159, and, therefore, $3.14159 \times .7475 = 2.34919$, or the length of an arc of one degree. Hence, 0.1725 multiplied by the number of degrees in the arc, will give the length of that arc. In the example before us $A, B = 9$, and $D, B = 8$, then $9 \times .8 = 7.2$, or the radius A, B , then $12 \times .414 = 4.968$, or the length of an arc of one degree of a circle whose radius is 12.414. The diameter of the base circle, $A, C = 18$, then $18 \times 3.1416 = 56.448$, and 2.34919×123 , the number of degrees, or the length of that part of the circumference A, C, H, H, G , whose radius, $A, C = 12.414$. To measure or cut out 56.423 degrees from the circle A, C, H, G , which is 24.082 in diameter, divide two hundred and sixty-nine and an eighth degrees by sixty degrees, or $269 \frac{1}{8} \div 60 = 4.485$, that is, four steps or spaces of $\frac{1}{60}$ and nearly one-half of another, which proves to be half way between lantern and hood fashion.

Now step off on the circumference with a pair of compasses four times the radius A, B , that is, $4 \times 9 = 36$, and $\frac{1}{60}$ of another space, as shown by A, A', A', H, H, G , and on to G , which will be the

number of degrees required for the cone A, B, C .

One other example, Fig. 169. Let it be required to make a cone A, B, C , or a frustum of a cone, having a diameter at the base, eighteen inches in diameter at A, B , and the slant height A, C fifteen inches, then $D, C = \sqrt{A, C^2 - A, B^2} = \sqrt{15^2 - 9^2} = 12$, therefore D, C , or the perpendicular height, will be twelve inches. Now the slant height A, C of the cone A, B, C , that is, the radius of the cone w is 12, is fifteen, then $15 \times .07475 = 1.12125$, the length of an arc of one degree of a circle whose radius is fifteen inches, and circumference of A, B of the cone is $18 \times 3.1416 = 56.448$, and $56.448 \times .20175 = 11.3693$, or the number of degrees of a thirty-inch circle necessary to make the cone A, B, C , which proves to be between funnel fashion and lantern-head. Dividing 210.335 degrees by 16 degrees we get $13 \frac{1}{4}$ or 13.625, or three steps of

the generating radius A, C around the circumference of the circle A, B, C , and six tenths of another step on to F , which measures off 210.6, or a little more than half way between funnel fashion and lantern-head.

Electricity for Power Transmission.

The use of compressed air is becoming general in all well managed railroad shops for driving special tools, and for a great variety of purposes that hand power was employed upon only a few years ago. It is still, however, an open question whether electricity could not be used to better advantage in many cases, especially where electric lighting has been introduced into a shop.

Mr. G. R. Joughins, speaking on the subject, said "It is very evident that our modern shops must be equipped with an electric power plant and with an air plant also. It is, therefore, very important that we should have power use ought to encourage the use of for driving our small tools. It appears to me that electricity is the proper power to use for all our large machines, such as overhead cranes and transfer tables and such heavy tools as those are, because we can get a very quick movement of tools with electricity which we cannot obtain in any other way."

"You have already seen some prints given out by the Siemens & Halske Company, of Chicago, which illustrate the use of electricity for driving tools in a machine shop. They have it in use in their works in Germany in such a way that they have done away with shafting entirely. They claim that they make a very much cleaner, more show, and they claim that they make a saving in motive power required of about 10 per cent. They say that this can be applied to any shop at a cost of about \$100 per horse-power. The means which they use is that they have a common electric light plant—the same plant can be used for electric lighting, and they apply a motor to each machine in the shop, so that you can have one machine running without the loss of power. There is no waste of power in shafting, etc. But I think it is a very general feeling that electricity is a very expensive power to use. Although they claim a saving of 40 per cent. in power, I think that those who have tried it, especially where there is a loss of about 20 per cent., and it is very possible that it may not be so useful for all small tools."

Mr. George Gibbs, who has given the subject of compressed air and electricity great attention, expressed the belief that the efficiency of electricity for transmitting power is only about 50 per cent. Electricity, on the other hand, he said, has a much wider field of application. Nearly all large railway shops have now an electric lighting plant. This plant can be run at small additional expense for attendance day long and supply current—have current on tap for special tools,

such as transfer tables, hoisting and conveying machinery, staybolt cutters, and a number of tools, and it is very power is used for more than one or two strokes of the piston. I think that the electricity will be found vastly more economical. There are disadvantages, it is true, in the electric transmission, and one of the greatest has been the complication and delicate mechanism of the motor itself, which has until very lately, constructed more with a view of being run in a laboratory than in a machine shop. In other words, it will not stand rough usage and its depreciation has been very heavy. But this objection is being rapidly overcome lately, and we can now get motors from all the large companies having a very low rate of depreciation.

Cleanliness Not Rewarded.

"How did you find things in California?" we inquired yesterday of a drummer newly returned from the Pacific coast.

"Nothing but complaints about Congress and general mixing up of opinions as to the cause of the bad business." "Anything new at all?" Any railroad companies talk of buying cars or locomotives? Any extensions projected? Any new shops to be built?"

"Nothing, nothing but torpidity of business mixed with languid hopes that something will happen soon to set the ball of work rolling. The only living movement I noticed about here was on the Pacific coast was the Coxey army, and the people were not making fun of the movement either, as they were in the East."

"Can't you give me any item of interest for the paper? Any hundred-mile an-hour runs or any compounds running without fuel?"

"Don't know anything about that," replied the drummer, "but I saw one thing that amused me. I was making a short trip, and was riding in the day coach. It was raining hard, and a good deal of red mud had been carried into the car on the feet of rough looking fellows who had not learned that cleanliness belonged to the moral creed."

"The Chinamen came on to the train at one station and they kept scraping the mud off their shoes before they left the platform in a way that aroused attention. They walked quietly into the car and sat down on seats facing each other. After a little while they began settling themselves comfortably for a long journey, and they pulled up their feet over the cushions, but first took off their shoes evidently to keep from soiling the plush."

"One ferret-faced, pug-nosed apology for a man, who was sitting opposite the Chinamen, eyed them angrily for a few minutes and then cried out—

"It's a fine pass that decent white people can make out, when they must ride with the stink of the feet of heathen Chinese under their noses!"

"A rush was instantly made for the benches, and they were roughly handled by an active conductor made his appearance and restored order."

"The Chinamen were given to understand that they might repose muddy shoes upon the plush cushions, but they must not display their stockings to the gaze of the haughty Caucasian."

Our esteemed contemporary, *Dial*, of Atlanta, proposes an exposition of American manufactured products in the City of Mexico in the winter of '96 or '97, to be followed by similar exhibitions in South American countries later, all for the purpose of promoting trade with our neighbors. But how about the tariff? Does not the tariff interfere with American trade in the Pan-American republics?

We have received a number of letters saying that the A. T. & S. F. had to remove some 10-wheelers with the headlights on the forward axle. They are of Baldwin build.

The Elements of Boiler-Making—VII.

SHEET-IRON WORK.

By C. E. Fourness.*

How to Build a Snow Plow. (No. 2.)

In this article I will give another pilot snow plow. The first one, was one sweep the whole length. A great many are not satisfied with that kind, as the snow is very apt to slip over the top at the back, and to prevent this they want the back end to curl over more than the front. Fig. 83 is a plan of the front, and Fig. 84 is a plan of top view, showing the pilot with a plow attached. Fig. 85 is the front sweep, and is shown in position dotted in Fig. 83. Fig. 85 is the back sweep and is shown in position in Fig. 83. In full lines, the bottom of the front is 4 inches, and the bottom of the back sweep is 7 inches from the base of back sweep 15 inches from the base of the pilot, at which points make marks. Find the distance these marks are located from the front, refer to the plan, Fig. 82. In this case (Fig. 84) the front sweep is 21 inches from the front, and (Fig. 85) the back sweep is located 4 feet 2 inches from the former. Draw a line through the marks, and this line will represent the bottom edge of the plow in position. To find the length of the bottom it will be necessary to draw the center line *A B*, and a line *C D* representing the side or one-half of the bottom. Then by measuring along this line (the bottom line) the length is found to be, viz.,

1 foot 1½ inches long; every thing is to be laid out now to construct Fig. 86. This can be drawn out on a sheet of iron or on paper on any convenient place (but beware of tobacco choppers, if on the floor, as no place is sacred to some of them), and start by drawing the long line 1 1 1, representing the bottom edge of the plow and extending this line far enough at each end to allow the sweep to be drawn at these points. Next, draw two lines at right angles to the bottom line 1 1 1, 1.4 feet 2 inches apart, the sides at these points are to conform to the sweeps in order to have the ends come out right. Now for the pant. Draw the line *E F*, the point *F* is 21 inches from the front sweep line *K L*, and the point *E* is 14½ inches from the bottom line 1 1 1 on the line *K L*. This will cause the line *E F* to occupy the proper angle to the bottom if drawn through these points. Draw *G H* parallel to and 4 feet from *E F*—one-half the width of the plow apart, take the sweep of the point or front (Fig. 84) and lay it in the position occupied by Fig. 86, *A*, the bottom point at the bottom line 1, the top 7 inches from the same line. Take the sweep of the back (Fig. 85) and lay it in the position occupied by Fig. 86, *B*, the bottom point at the bottom line 1, the top 3 inches from the same line, and draw the curved lines. Space off both these curved lines into fifteen points, keeping in view that the sheet to use is 48 inches wide, and number these points from 1 to 15, beginning with No. 1 at the bottom. I failed to mention sooner that the sweeps for each end are just the same from the bottom up to the tenth mark or point, then from the 20 to the top, the back sweeps come over with a smaller circle, 4 inches nearer to the bottom line than the top of the front sweep. This leaves the top of the back sweep 3 inches from the bottom line 1. Now for the ordinates. As both sweeps are similar draw to No. 10, draw the ordinates from No. 4 to No. 10, to clear through between and just cutting the front and back lines *E F* and *G H*, and parallel to the bottom line 1. For the remaining ordinates from No. 11 to No. 15, make a short mark across the line *E F*, or the front (at which place the side mark is made to conform to the front sweep). These marks are to be made the same distance from the bottom line as the

occupy, and mark them 11, 12, 13, 14 and 15, same as on the curved line, Fig. 86. *A*. For the back make a short mark across the line *J*, at which place the side must be made to conform to the back sweep, these marks to be made the same distance from the bottom line 1, as on the curved line for the back (Fig. 86, *B*), and mark them 11, 12, 13, 14 and 15. Draw ordinates through the correspondingly numbered marks on front and back lines *K L* and *J*, being very careful not to get them mixed. Notice in Fig. 86, ordinate No. 15 I draw low, as that is the top edge. The others, Nos. 11, 12, 13 and 14 are drawn dotted lines, so they could be distinguished better or easier.

Notice, it will be necessary to cut out the sides to fit the pilot and bumper beams, consequently show the beams in position, same as shown in Fig. 86. For the back of the bumper beams I just drew a straight line and marked it back of mark, usually

length between those points on ordinate No. 2. Proceed in the same manner until all the length of the ordinates are marked upon the stick from No. 2 (as No. 1 is already found) up to and including No. 15. Now, as all these marks are upon this strip, all that is necessary is to lay the strip upon each line, Nos. 2, 3, 4, 5, etc., Fig. 87, and mark the lengths successively as they are upon the strip, until all have been treated by this mode of procedure. Considerable time is saved by this method over marking and transferring one or two lengths at a time. Make a short mark at the intersection of this center mark with the lines Nos. 2, 3, 4, 5, etc., and after allowing 1½ inches outside of these center marks for flanging, the point or front is all ready. Now for the back. By laying the two sweeps together they will be found to conform to each other up to the tenth mark, consequently all the lines will be the same length up to and including No. 10. Set the trams to the length, or mark the length (7 feet 1½ inches) upon a stick or strip, and using either the tram or strip, mark this length upon the lines Nos. 1, 2, 3, 4, 5, etc., at the back, up to and including No. 10, measuring from the center marks off flanging at the front. For Nos. 11, 12, 13

mark Nos. 10, 11, etc., the same number as the ordinate is numbered from which the length was taken. Carry the strip to the sheet, Fig. 87, and set the end of the strip to the center mark for flanging on the lines Nos. 10, 11, 12 and 13, and mark the lengths for the front and back of the beams upon these lines, then a line drawn through the front and back of the opening, for the top a straight line drawn through 1½ inch above the line No. 13, and for the bottom a line 1½ inches from the lines above and parallel to the No. 10 line.

You will notice that the beam tapers down at the ends, and that the side of the plow comes partly on the tapered and partly on the flat, or parallel part of the beam, which gives the line to cut on for the front of the beam the peculiar shape that it takes. For the sides for the braces, for all of the front, draw a line at right angles to and from No. 6 line up to the top, and for the back draw the line at right angle from No. 6 to No. 10, as the sweep is the same as at the front up to No. 10, line, and above No. 10 line the sheet rolls over more and it throws these two top holes off a straight line, on the tapered part, and for the line they are located upon, measure and mark the distance between the lines *E F* and *J* on the ordinates Nos. 10 to 15, Fig. 86, measuring from the point *E F*, and mark these distances upon the lines 11 to 15, Fig. 87, measuring from the center marks for flanging. Then these holes are, the first 2½ inches from the top, the others 3 inches apart. There is now but one tier more, and then the side will be complete, that is the draw-bar will, for this find the standard height of draft irons on the cars and mark this height of the center of the opening, upon the front sweep less the height the plow stands above the rails, and as the hole in this case is to be 2 1/8 inches, make a mark 2½ inches above and 1½ inches below this center, and the top of the opening comes just to No. 13 line, and the bottom 1½ inch above No. 10 line. In the first plow, the draw-bar hole was square. In this case it is round, and as a consequence it is more difficult to lay out; but that is what we are after, so the first thing to do is to make a view looking right on the front of the plow, and as the only thing that is needed is from the No. 10 to No. 13 line, draw a short straight line, *M N*, Fig. 89, and upon this line draw a circle 9 inches in diameter. Next, mark the vertical distance that Nos. 10, 11 and 13 points or marks are apart upon the front sweep, Fig. 86, *A*, and mark these upon the line *M N*, Fig. 89, as shown. Draw lines through these points and mark them Nos. 10, 11, 12 and 13. As stated previously regarding ordinates, the closer together the greater the accuracy. Draw a line midway between these lines as shown in Figs. 87 and 89, measure the distance from the center line to the line *M N*, and mark it on the line. After this is completed, Fig. 89, comes under consideration. This is just the same as Fig. 86 at the point, and when laying out a plow that view would answer the purpose. But in this case, as the drawing is made on a small scale, the sweep line coming in there and the figures numbering the lines being scattered around the line, being very promiscuous, this part could not be shown very plainly in that view. In Fig. 86, consequently, I made Fig. 89. In this figure the line *O P* occupies the same position to Nos. 10, 11, 12 and 13 ordinates as *E F* does in Fig. 86, but in Fig. 89 I only drew the ordinates that are around the line *O P*, as the opening in Fig. 89 is a view of the front and gives the width of the opening at the different points, but in order to lay out the opening on Fig. 87 these same widths must be found upon the plan or top view, Fig. 88.

Notice the width of the line between Nos. 12 and 13. Fig. 89 is the same as Fig. 88, upon the extra ordinate between Nos. 12 and 13. Set the dividers from the

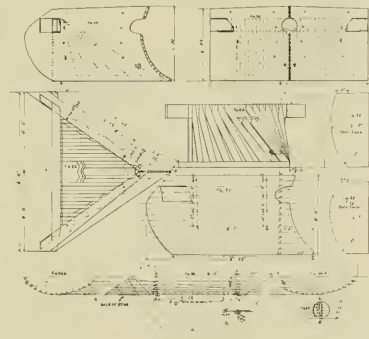

This piece would cut clear out to the back and a piece bolted on afterward. It is cut this way now just to show how it is accomplished. For the braces, the back one will be placed up on the line *J*, the back sweep line. The front brace will be located upon a line 7 feet 5½ inches from the back sweep line and 2 feet 5 inches from the point. The front brace cannot be located upon the front sweep line, as this line cuts through the hole cut out for the draw bar to operate through, the laying out of which will be treated upon later. Every thing is now in shape to tackle the sheet, Fig. 87. Each side requires a sheet 48 inches by 101½ inches by about ½ inch in thickness, and the operation to perform will be to draw the two sweep lines, the front one 21 inches from the front and the back one 4 feet 2 inches from the first. Space off these lines into fifteen points and number them from 1 to 15, calling the bottom edge No. 1 and the top edge No. 15. Draw lines through the points the full length of the sheet, and next in order comes finding the form or line to cut upon for the front end or point. I usually accomplish this by taking a small strip of wood, perhaps 1 inch wide by ¼ inch thick, planed smooth, and have it each end, one cut square. Set the square end to the line *L K* on ordinate No. 2. Fig. 86. Make a short mark on the strip where the line *E F* cuts the ordinate No. 2, and make a figure 2 at this mark to designate that this is the

*Foreman Boiler-maker, C. M. & S. P. Ry. Duquesne, Iowa

point just found to the line *OP* upon the extra ordinate, and make a mark this distance from the line for flanging upon the extra line between Nos. 12 and 13, Fig. 57. Now for No. 12. This is 4 1/2 inches, Fig. 59. This distance mark at right angles to the line *OP* upon the extra ordinate between Nos. 12 and 13, Fig. 58, and the distance from the point just found and to the line *OP* mark upon the line No. 12, Fig. 57, measuring from the center mark for flanging. On the line between Nos. 11 and 12, Fig. 58, the width is 1/2 inch, this length measure at right angles to the line *OP* upon the extra ordinate between Nos. 11 and 12, Fig. 58, and the length of this ordinate from the point just found to the line *OP* mark upon the line between Nos. 11 and 12, Fig. 57, measuring from the center mark for flanging. The width for No. 11, Fig. 56, is 4 1/2 inches. This distance measure and mark on the ordinate, No. 11, Fig. 57, at right angles to the line *OP* and the length of the ordinate from the point just found to the line *OP* convey to No. 11, Fig. 57, measuring from the center line for flanging. Now for the last one, the extra line between Nos. 11 and 12, Fig. 58. This width again measure, and mark it upon the extra ordinate between Nos. 11 and 12, Fig. 58, and the length of the ordinate from this point to the line *OP* convey to Fig. 57, and mark it upon the extra line between Nos. 10 and 11, Fig. 58, drawn from the center mark for flanging on No. 11 line, through this point in intersection on the different lines, and ending cutting through the line *OP* extending at a point 7/8 inch above the line *OP*, will cut to form a round hole when drilled up. After shearing and punching the hole, use it as a pattern for the other holes, and, turn it over before marking off the hole and fit this plug up similar to the one.

Some Special Tools for Railroad Repair Shops.

We illustrate herewith three special tools that are particularly adapted to railroads and shop work.

There are so many places around machinery and boilers where a ratchet drill is the best thing that can be used that the market is flooded with them, good, bad and indifferent—mostly bad. Cheap malleable iron heads, gas pipe handles and poor work has made the tool generally despised—tolerated as a necessary evil.

The makers of these tools commenced some years ago to build ratchet tools in a new way by making them as tools should be made. The ratchet head of forged steel, teeth cut by machines, a hollow steel handle, made from bar, and machine fits it around.

This ordinary ratchet drill, shown herewith, is a first-class tool, better made than the usual. It is particularly adapted to railroad boiler work. A square shank ratchet socket is furnished as shown when removed the standard Morse taper socket remains.

The detail cut shows the plain steel part and how it is reversed by lightly pulling and partially turning, the knob on the end of the handle. The square socket can be discharged by screwing down the feed screw to extreme limit.

The other tools are the ones that will be appreciated in the railroad shops and roundhouse. One is a stud driver, and the simplest form of ratchet wrench with a set of steel holders, as shown at *H*. A stud can be driven home with this device without the possibility of marring the thread and without one taking the wrench out of the stud. In screwing down the holder it "bottoms" on a piece of brass against the set screw in the end. When the stud is home, the ratchet handle is held and the steel screw slacked and the stud is free at once, the threads being a loose fit. Besides its use as a stud driver it is equally useful in driving home screw stays, operating live expanders, etc.

The other tool is a socket wrench of some use. The socket being of steel is little liable to get out of true. In putting on nuts, especially finished nuts there is no liability to mar them, as every face bears its share of the strain and the wrench is not removed from the nut until it is home—it is taking off and putting on the monkey or solid wrench that mar work. Besides this the work is done quickly. These two tools for just what work is done on cylinder heads and steam chests in the ordinary roundhouse would pay for themselves in no time at all.

The immortal "Chordal" once wrote some good advice about the difference in value of two monkey wrenches of the same size, by the same maker, and told his readers that they would always be money by paying the higher price of the black stretch for the finished product—because the best material is always used to finish. We like

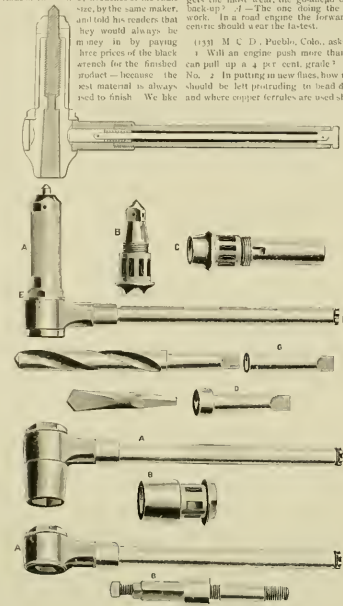

These tools because they are first-class finished tools made by mechanics for mechanics. They are built by the Keystone Mfg. Co. at Buffalo, N. Y.

The Union Car Co. recently turned out a lot of gear wheels for the Southern railway. In the test made, which was a very severe one, eight wheels were broken under the duress of test, as follows:

No.	Diam. of Hub, in.	No. of Teeth.	Depth of Chisel	
			To Tread	In Throat
12	30	57	1/8 in.	1/16 in.
21	21	31	1/8 "	1/16 "
101	15	23	1/8 "	1/16 "
152	9	16	1/8 "	1/16 "
221	11	14	1/8 "	1/16 "
239	31	19	1/8 "	1/16 "
240	14	16	1/8 "	1/16 "
154	17	28	1/8 "	1/16 "

Previous to the test every wheel was struck nine times under the flange and between the knuckles with a 1 1/2 lb. hammer. With this severe test none of the wheels were fractured. The uniformity of the chordal is the most remarkable feature in this lot of wheels.

? A. — Want to Know. — ? A.

Don't ask questions that simply require a little figuring to determine; make each question separate. No notice taken of anonymous questions.

(131) G. S. B., Brainerd, Minn., asks
Is there a table giving the different temperatures of compressed air at different pressures? — Not that we know of.

(132) F. W. S., Birmingham, Ala., asks
I. Where can I get photographs of all the old style locomotives that were first made in this country? — We know of no such collection. 2. Which eccentric gets the most wear the gear-back or the back-up? — The one doing the most work. In a road engine the forward eccentric should wear the fastest.

(133) M. C. D., Pueblo, Colo., asks
1. Will an engine push more than she can pull up a 1 per cent. grade? — No. 2. In putting in new flues, how much should be left protruding to lead down, and where copper ferrules are used—should

(130) C. S., Spokane, Wash., writes
It is necessary to disconnect engine when backing up, you break gear-back eccentric strap? I had such an accident and did not disconnect but took broken strap and worked engine till it was run to end of division. Do you consider it perfectly safe to run engine in such a way? — It is considered unsafe to do this. It is far safer to run ahead with the back-up eccentric rod down, as there is no possibility of the eccentric striking a cramping position. That it is done safely is not always proved that it is safe, many a man has brought in an engine with one side rod up, but many a job has been taken off that way.

(134) A. W. W., Beardstown, Ill., writes
We have been having a little discussion at the shop in regard to an air-pressure problem, and I thought I would ask you about it. If one air jack will lift 10,000 (ten thousand) pounds at 100 (one hundred) pounds pressure, how much will two jacks lift if both are connected to the same reservoir? Some say that one jack would lift as much as two, and others say that every jack you add will each lift 10,000 (ten thousand) pounds. Now, which is correct? — If the pressure in reservoir is the same (100 pounds) each jack will lift an equal amount, or 10,000 pounds. If this were not so, area of piston would cut in a figure, and a 1-inch piston jack would lift as much as one with a piston 1 foot in diameter. It is merely a case of increasing the cylinder area. Will you engine men as many cars with one cylinder as with two?

(135) W. E. T., Charlottesville, Va. writes:

1. Will you kindly advise through the columns of your valuable paper on the following subject: How far can an engine be run with main rod up, with the ports covered, without damage to the cylinder, and is there any way to get oil in the cylinder in such a case? — We do not know how far an engine could be run in this condition. It is not safe, and much damage may result from a trial. 2. Is it safe to run an engine without disconnecting the back motion eccentric in case the forward one was broken or *vice versa*, if so, under what conditions? — This has been done, and is not unsafe under most circumstances. It is better to only run in this condition until relief can be had or the train gotten out of the way. Circumstances alter cases, and should always govern the man in the emergency. There are times when great damage to engine may be risked, to save greater disaster or more expensive delays.

(136) J. T. T., Albany, Ga., writes:

My friend contends that the cross-head of a locomotive stands still on each dead-center, while the crank pin moves a distance of half its diameter across the center line. I say it does not, but continues to move until crank pin gets to center line in either case when crank pin crosses center line. Who is right? — This is one of those academic kind of questions. It is a point often quarreled about. The best way to reason on such a thing is to carry your figuring to extremes. Suppose now that the crank pin is 10 inches in diameter with a one-inch pin and the other with a ten-inch pin, would one crosshead stand still while the other moves five inches, while the other crosshead stand still only while the small pin traveled half an inch? It travels as far as the pin. The best way to travel is at each end of the stroke and starts up, as soon as the pin leaves the center. It is also true that the crosshead stands still, so you had to look up a direct-motion engine toward center would increase the lead. I say I will demand and not concede the lead? Were you not wrong? — No, we were right. A direct-motion gear may be put up so as to increase the lead but seldom, if ever, done purposefully. How can the use of a rocker arm change the link-rod and lead to movements at of the link-rod? It merely acts as a rod and valve to open up the valve, but as the top moves ahead with the bottom is moved back, and *vice versa*, it causes the valve to open one way while the direct motion would open the other one.

A MECHANICAL DRAWING MAN, of twelve years' experience in machine-power and rolling stock construction, desires situation. For particulars, address: PIERCE BUTLER, Louisville, Ky.

BRIDGE ENGINEERING



Also, SURVEYING.

Improve Awarded Courses for other trades, including thorough instruction in Mathematics and Practical Surveying. Send for FREE circular and subject on which to study. For Correspondence, send of Industrial Science, Scranton, Pa.



THE "Southwestern Limited" RISE DAILY Express NEW YORK, BOSTON, Cincinnati, Indianapolis, St. Louis, To **BIG 4 ROUTE.**

E. H. McPHERSON, D. D. SMITH, Passenger Traffic Mgr., 1017 Passenger & Ticket Agt., CINCINNATI.

Books You Want.

- "LOCOMOTIVE RUNNING REPAIRS," by I. C. HERRICK, General Foreman "Emp" Shops. A practical treatise on running repairs, by a practical man. Numerous diagrams and illustrations that will be needed by men who handle and repair locomotives.
- "SIMPLE LESSONS IN DRAWING," by ORVILLE A. FERRISS (Chief Draftsman Northern Pacific Railway). A splendid book. Shows how to learn the elementary principles of mechanical drawing and sketching.
- "PROGRESSIVE EXAMINATIONS OF LOCOMOTIVE ENGINEERS AND FIREMEN," by JOHN A. HILL. Editor LOCOMOTIVE ENGINEERING. A capital little book for new firemen. An excellent pocket companion. Three hundred questions and the answers thereto, covering engine, running position and color of all elements carried on engines and trains according to standard code.

Send 50c. for any of the above to **DEBS PUB. CO., TERRE HAUTE, IND.**

FOR EVERY RAILROAD MAN.

POCKET PRIMER OF Air-Brake Instruction.

sample

Every Lesson on pages of Matter First sent free. Mail to any address on receipt of 5c.

W. S. ROGERS, Mechanical Engineer, BUFFALO, N. Y.

THE CHICAGO, MILWAUKEE & ST. PAUL RAILWAY

RUNS

Electric Lighted Vestibuled Trains between Chicago, Milwaukee, St. Paul and Minneapolis daily.

Through Parlor Cars on day trains between Chicago, St. Paul and Minneapolis.

Electric Lighted Vestibuled Trains between Chicago and Omaha and Sioux City, daily. Only two hours from Chicago to Milwaukee seven fast trains, each way, daily, with Parlor Car service.

Local trains between Chicago and principal points in Northern Wisconsin and the Peninsula of Michigan.

Through Trains with Palace Sleeping Cars, Parlor Chair Cars and Coaches between Chicago and points in Iowa, Minnesota, Southern and Central Dakota.

The best and latest type of private Compartment Cars, Free Reclining Chair Cars and Buffet Library Smoking Cars.

City routes of road in Illinois, Wisconsin, Northern Michigan, Iowa, Minnesota, Missouri, South Dakota and North Dakota.

Ticket Agents everywhere sell tickets over the Chicago, Milwaukee & St. Paul Railway, 7 address.

GEO. H. HEAFFORD, General Passenger Agent, CHICAGO, ILL.



PULLMAN SLEEPERS on Night Trains. ELEGANT PARLOR CARS on Day Trains. DINING CARS between Cincinnati and Chicago. W. H. GREGORY, General Manager, 210 N. BROAD AVENUE, CHICAGO, ILL.

LOCOMOTIVE ENGINEERING, N.Y.



Is the most interesting technical paper published in the world. It contains large plates of machinery, with the very best of illustrations. For \$1.00 we give three.

EDUCATIONAL CHARTS FREE. One of "The Locomotive Engineer's" Examination Charts, with explanation of valve and piston, and cross-sections, and many other questions, to be answered by placing the valve and piston in proper position, and by pointing out the parts of the engine and machinery, and every error is marked. A labeled pocket edition costs the quick reader 50c. Single copies and every part sent full length.

Send with this. The paper for 1894 and these three little educational charts for \$1.00. Address **LOCOMOTIVE ENGINEERING, 210 Broadway, New York.**

KEEP YOUR PAPERS CLEAN.

Binders that will hold a full year's numbers for sale.

PRICE, \$1.00, POSTPAID.

LOCOMOTIVE ENGINEERING, 210 Broadway, New York.

RICHARD DUDGEON, 24 & 26 COLUMBIA ST., NEW YORK.



MAKER AND PATENTEE OF IMPROVED HYDRAULIC JACKS

Fences, Roller Tube Expanders, and Direct Acting Steam Hammer.

THE ALLISON MFG. CO., MANUFACTURERS OF

FREIGHT CARS AND LOCOMOTIVE BOILER TUBES.

WROUGHT IRON PIPE OF SUPERIOR QUALITY.

PHILADELPHIA, PA.

TAYLOR BEST YORKSHIRE STAYBOLT IRON

Axles, Piston Rods, Crank Pins and Forgings of all Descriptions, used by Leading Railroads.

R. MUSHET'S SPECIAL AND TITANIC STEELS

SOLE REPRESENTATIVES IN THE UNITED STATES,

B. M. JONES & CO.,

BOSTON, 11 and 13 Oliver Street. NEW YORK, 143 Liberty Street.

PATENTS FOR INVENTIONS.

GEO. P. WHITTLESEY, D.C.

Atlantic Building, Washington, D.C. EXPERT SEARCHES & OPINIONS. RAILROAD INVENTIONS A SPECIALTY.

TRACK SANDING APPARATUS FOR LOCOMOTIVES

HENRY L. LEACH, (Inventor of Freshberg's)

BOSTON, MASS., Room 45, Mason Building, 70 Kilby Street.

WANTED VOLUME 3 (Year 1893)

OF THIS PAPER. RETURN ME BY POST WILL PAY DOUBLE PRICE. IF YOU HAVE SEVERAL ADDRESSES, LOCOTIVE ENGINEERING, 210 BROADWAY, N. Y.

MODEL LOCOMOTIVES.

If you want to build a Working Model, I can furnish you all the castings, boiler, etc., for three sizes. Fit to order. Finished 1893. Bought partly or wholly finished. "Jobbing" done. Write for particulars. Woodlands, Providence. Ask for catalogue. Address G. H. GASKIN, 101 Marlborough St., New York, N. Y.

ENDORSED BY FAIRMOUNT LODGE, No. 333, BROTHERHOOD OF LOCOMOTIVE FIREMEN.

Locomotive Mechanism and Engineering.

By H. C. Horgan. Explaining Fully and Clearly the Construction and Action of Simple and Compound Locomotives. Highlighting the principal "break-downs" which happen to a Locomotive, with Complete Directions what should be done when an occurs "on the road." Questions and Answers are so arranged that they can be used by Master Mechanics or Trimming Engineers, or by the Demonstrator in the Lecture Room. 145 Illustrations, 300 pages, 12mo, cloth, \$2.00

JOHN WILEY & SONS, NEW YORK.

AGENTS WANTED

AGENTS WANTED Diseases OF THE

Air Brake System.

Causes—Symptoms—Cure.

By PAUL SYNNESTVEDT.

CONTAINS ILLUSTRATIONS of practically every piece of Air Brake Equipment in common use, of several different makes, old as well as new, arranged so that no one occupies more than one page, thus avoiding the troublesome folder which has so often failed or just COVERS A FIELD ENTIRELY DISTINCT from that covered by any prior publication. Especially valuable.

THE ENGINEER, THE FIREMAN, THE CONDUCTOR, THE BRAKEMAN, THE MACHINIST.

THE LATEST AND BEST WORK ON AIR BRAKES. SOMETHING NEW

Price, One Dollar.

W. F. HALL PRINTING COMPANY, 21 to 25 PLYMOUTH PLACE, CHICAGO.

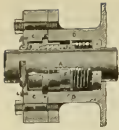

JEROME METALLIC PACKING.

This is the Standard Metallic Packing all over the world, and is more generally adopted and in use on more locomotives than any metallic packing in use. Give the **JEROME** a trial and be convinced. Put it in competition with any other packing and be convinced of its superior merits.

Office and Works, Nos. 35 and 37 Canal St., Chicago, Ill.

C. C. JEROME, Inventor and Proprietor.

Packing ring opened ready to apply without disconnecting the Piston from the crosshead. It runs longer and wears the rod less than any other packing in use.



SEND FOR CATALOGUE.

Graham's Patent Groove Shank Twist Drills and Chucks.



DETROIT TWIST DRILL CO., Detroit, Mich., U.S.A.

OUR ENGRAVINGS.

Of lists we have had a great many inquires as to who made the fine half-tone plates shown each month in *LOCOMOTIVE ENGINEERING*. Credit is due the expert anywhere and we are glad to recommend the engravers of our plates to those wanting good work at reasonable prices. All the half-tones and reproductions we use are made by the **STEAM ENGRAVING & PRINTING CO., 607 & 609 Sanson St., Philadelphia, Pa.** **SINCLAIR & HILL.**

The Smith Triple Expansion Exhaust Pipe.



FRONT VIEW.

THIS Device is the invention of **JOHN Y. SMITH**, the originator of the Smith Vacuum Brake. In the cuts of the Front and Side Views shown herewith, "A A" represent Air Passages; "S S" Exhaust Steam Passages, and "B" an Annular Blower forming part of the Nozzle.

It is an entirely new departure in the construction of Exhaust Pipes for Locomotives.

Its distinguishing features are that the exhaust steam is not restricted after it leaves the cylinders, and the gases and heated air in the smoke arch are mingled with the exhaust steam in the exhaust pipe. The exhaust steam is thus superheated and expanded, and a powerful, prolonged, pulsating blast is created, which keeps the fuel in a constant state of agitation, and produces more perfect combustion.

Some of the beneficial results obtained are: *Reduction of Back Pressure to a minimum (area of nozzle opening as large as the exhaust port); prevention of ejection of sparks from smoke stack; almost complete absence of noise from exhaust; prevention of formation of clinkers in fire-box; large saving of fuel.*

By the elimination of Back Pressure we have demonstrated the fact that the power of engines has been increased to be able to pull from thirty to sixty tons more than with any other form of exhaust pipe.

The pipe can be used with either straight or diamond stacks, in long or short front ends, and on locomotives burning hard or soft coal, wood or coke.



SIDE VIEW.

GENERAL AGENTS CO., 32 PARK PLACE.

GENERAL OFFICE DOYLESTON, PA.

FACTORY READING, PA.

THE LESLIE

PATENT

Locomotive Fire Kindler

FOR

Cheapness, Simplicity, Cleanliness, Convenience, Absolute Safety, Durability and Economy,

**STANDS
UNRIVALED.**

IT IS THE ONLY SYSTEM OF KINDLING LOCOMOTIVE FIRES WITH CRUDE OIL WHICH HAS EVER BEEN PUT INTO GENERAL USE BY ANY RAILROAD COMPANY.

THOUSANDS OF FIRES

Have been Kindled for Less than

4 CENTS PER ENGINE.

During the past Winter ONE car tank of Crude Oil kindled more fires than 500 Cords of Wood.

Its adoption in all round-houses over their Entire System by the Roads, which had tested it in all kinds of weather, furnishes absolute proof of its Complete Success.

For particulars, address

J. S. LESLIE, Paterson, N. J.

REQUIRES NO ATTENTION.

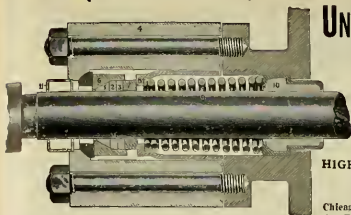

Swab and Oil Caps Furnished with every Packing.

IN USE ON THREE HUNDRED AND FIFTY RAILROADS.

UNITED STATES METALLIC PACKING CO.

For Locomotives, Stationary and Marine Engines.

The United States Metallic Packings

HAVE STOOD THE TEST OF YEARS AND ARE ACKNOWLEDGED TO BE SUPERIOR TO ALL.

Renewal of Packing Rings made without disconnecting, by cutting them in halves and breaking joints.

HIGHEST AWARDS COLUMBIAN AND PARIS EXPOSITIONS.

General Office, Bullitt Building; Works, 427 N. 13th St., Philadelphia, Pa.

Chicago, Botanda, Grand Pacific Hotel.

San Francisco, 130 Main Street.

St. Louis, 32 Laclede Building.

Montreal, Canada, 731 Craig Street.

SEND FOR CATALOGUE AND SPECIFICATIONS.

SURE TO GIVE

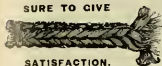

SATISFACTION.

DUVAL METALLIC PACKING

Send for Catalogues, Prices and detailed information to the

Duval Metallic Packing Co.,

39-41 CORTLANDT ST.,

NEW YORK CITY.

THE HALL SIGNAL CO.

Leads the World in the manufacture and installation of

Automatic Block Signals

Operated by either Track or Wire Circuits.

The ONLY Automatic Signal Systems in which the signals can be operated on the "Normal Danger" principle. Believed by many to be the best and safest plan.

HIGHWAY CROSSING SIGNALS,
STREET RAILWAY CROSSING SIGNALS, ETC.

OFFICES:

80 Broadway, New York.

927 The Rookery, Chicago.

115 The Ames Building, Boston.

Equitable Building, Baltimore.

PERFECT



PUMP PACKING

AN ABSORBENT OIL CUSHION—INSURES PERFECT LUBRICATION.

WEDGE-SHAPED WEARING PIECES THAT MOVE ON EACH OTHER—INSURE A TIGHT JOINT, WITHOUT UNDUE PRESSURE FROM GLAND.

DOES NOT GET HARD OR BAKED; NONE WASTED—YOU KEEP PUTTING IN RINGS, NEVER TAKE ANY OUT.

THIS PACKING IS GUARANTEED TO KEEP TIGHT WITH STEAM, WATER, AIR OR AMMONIA.

PERFECT FOR AIR PUMPS.

A TRIAL SOLICITED

All kinds of Packing—the P.P.P. is best.

C. A. DANIEL,

313 Market St.,

PHILADELPHIA, PA.

A. W. SOPER, Pres.

ROBT. ANDREWS, Vice-Pres.

C. H. HOWARD, Sec.

W. R. THOMAS, Treas.

R. M. DIXON, Engineer

THE SAFETY CAR HEATING AND LIGHTING CO.,

160 Broadway, New York.

HEATING SYSTEMS.—By hot water circulation and direct steam with regulating devices. Reliable and uniform heat. Economical and rapid circulation. Gibbs automatic coupler of Westinghouse type, absolutely steam-tight.

LIGHTING SYSTEM.—The celebrated Pintsch compressed oil gas method. In use on over 40,000 cars in Europe and America. Adopted by the U. S. Lighthouse Board for lighting Buoys. The best, most economical and only safe light for Railroad purposes. In brilliancy and cleanliness unsurpassed.

THE ROTARY.

For full Particulars, Address

The Leslie Bros. Mfg. Co., Paterson, N. J.

YOU HAVE BEEN WANTING to know more about this famous Engine. You should have framed in your room our "Chart No. 2," showing transparent picture of the engine, with every piece numbered and named. Printed on satin gloss paper, and sent in a tube, ready for frame, 50 cents, stamps will do.



Locomotive Engineering,
256 Broadway,
NEW YORK.

POWER
A MONTHLY JOURNAL devoted to Steam Engineering and Practical Work relative to the Economic Generation and Transmission of Power. 56 to 64 pages, size of this paper, profusely illustrated. Price, \$1.00 a year, profusely illustrated. Price, \$1.00 a year. Send for Sample Copy—FREE. Address: THE POWER PUBLISHING CO., WORLD BUILDING, NEW YORK.



THE WASHBURN Car-Wheel Company,
HARTFORD, CONN.
MANUFACTURERS OF
CRUCIBLE STEEL-TIRED WHEELS

For Parlor and Sleeping Cars, Passenger Coaches, Locomotive and Tender Trucks.



RAMAPO WHEEL AND FOUNDRY CO.



BOLTLESS STEEL-TIRED WHEELS
FOR PASSENGER AND LOCOMOTIVE SERVICE.
Tires with Annular Web and Hook,
Best Charcoal Iron Double-Plate or Spoke Centers,
Wedge-Shaped Retaining Ring.

Continuous Circumferential Fastening.



SIMPLE, + SAFE, + ECONOMICAL.

CHILLED IRON WHEELS
OF SUPERIOR QUALITY,
Drawbar Hook, Passenger and Freight Cars,
Locomotives, Tenders, Flatcars,
and Box Cars.

CONGDON BRAKE SHOES
FOR CHILLED IRON WHEELS,
Outwear from 4 to 6 ordinary shoes and enhance mileage.

Office and Works: RAMAPO, N. Y.

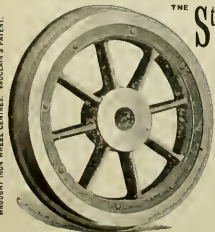

THE Standard Steel Works
PHILADELPHIA.

STEEL TIRES

Manufactured by an Improved Process Insuring Solidity.

Wrought Iron Centres, Steel Tired Wheels.

REPRESENTATIVES:
CHICAGO, 1013 MONAGNOCK BLDG., FITZ-HILDEN & SPENCER.
ST. LOUIS, 516 NORTH THIRD ST., ANDREW WARREN.

STEVEN'S PATENT NIPPERS. Patent **STEVEN'S Spring Calipers.**

TOOLS.

The best tools made for Telegraph Linesmen and Marliners. Sold by mail post paid.

1/2 inch \$1.50
3/4 inch \$2.00
1 inch \$2.50

Ideal and Leader Spring Snippers and Cutters, Metal Surface Gauges, Depth Gauges and Pin V. Gauges, Tools, etc. Illustrated catalogue free for all.

J. STEVEN'S ABBEY & TOOL CO., 25 So. 3rd St. Bridge Falls, Mass.

THE ONLY DOUBLE TRACK RAILWAY BETWEEN CHICAGO AND THE EAST.

Wagner Sleeping Cars, Drawing Rooms and Private Compartment Cars between Chicago, Toledo, Cleveland, Buffalo, Rochester, St. Louis, Albany, St. York, Boston and intermediate points.

Route of the NEW YORK AND CHICAGO LIMITED, BOSTON AND CHICAGO SPECIAL, and the U. S. FAST MAILS.

W. D. CANNIFF, Gen'l. Mgt. CLEVELAND, O. A. J. SHUTT, O. P. & T. A.

THE HAMPSON Flexible Steam Joint

Does away entirely with Rubber Hose for Steam Heating

HAS NO GROUND JOINTS.

F. A. BARBEY & CO., 215 FRANKLIN STREET, BOSTON.

RAMAPO IRON WORKS, Hillburn, N. Y., MANUFACTURERS

Brake Shoes for Steel Tired Wheels.

ROSS, for Steel Tired Car and Tender Wheels,
ROSS-MEEHAN, for Locomotive Drivers,
SHEPPARD, for Blind or Bald Tired Drivers.

NARROW GAUGE CARS, SWITCHES, AUTOMATIC STANDS.

YOKED, BOLTED and SPRING RAIL FROGS, CROSSINGS, TRACK EQUIPMENT,

RAILROAD AND MACHINERY. **CASTINGS, HEAVY AND LIGHT.**

C. E. GOOD. **ROOD & BROWN,** H. M. BROWN
CAR WHEEL WORKS,
BUFFALO, N. Y.
Railroad, Car, Engine, Tender and Truck Wheels, Made from Best Charcoal Iron.
Office and Works: HOWARD and THOMAS STS.

C. M. FARHAR. JOHN TREFFTS. C. E. GOOD
EAST BUFFALO IRON WORKS,
FARHAR, TREFFTS & GOOD, PROPRIETORS.
GREY IRON CASTINGS
of every description. Special Attention Given to Car and Locomotive Work.
Works: N. Y. C. & N. E. R. R., Broadway Station, Belt Line. | Office: 60 Perry St., Buffalo, N. Y.

C. E. ROOD,
MANUFACTURER OF
MALLEABLE IRON,
QUALITY GUARANTEED.
RAILROAD WORK & SPECIALTY.
Office and Works: LANGASTER, NEW YORK.

BROUGHT IRON WHEEL CENTRES. WICKLISS'S PATENT.

is a SETTLEMENT, President.

GEO. W. EVANS, Vice-President.

W. C. ARTHURS, Secy. and Treas.

FRANK SNYDER, Supt.

Mt. Vernon Car

MANUFACTURERS OF

FREIGHT CARS OF EVERY DESCRIPTION,
CABOOSE AND REFRIGERATOR CARS,

MT. VERNON,



Manufacturing Co.

CAR WHEELS, CAR CASTINGS, AND GENERAL
FOUNDRY WORK.

Capacity, 15 Cars and 300 Car Wheels.

ILLINOIS.



MILLER'S ASBESTOS CAR ROOF.

THE COMING ROOF!

HEAVY, DURABLE AND STRONG. Costs from \$10 to \$15 Less per Car.
WILL WEAR LONGER THAN ANY METAL ONE. CAN BE PUT ON IN ONE-HALF THE TIME.
WILL WEAR THE LIFE OF THE CAR.

HEAR WHAT THEY SAY ABOUT IT:
OUT WEST: M. & T. Ry. Down East: Boston & Albany R.R.

1302 HAVEMEYER BUILDING, 26 Cortlandt Street, NEW YORK.

RODGER BALLAST CARS.

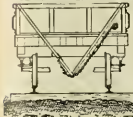

These cars are 34 feet long, and are built either 50,000 or 60,000 lb. capacity, M. C. B. Standard. They carry from 15 to 20 cubic yards of gravel or broken stone. In using them no ballast is thrown in the ditch, and none is wasted, as the precise amount of ballast needed can always be discharged. A train of 25 cars, carrying 600 yards of ballast can be unloaded and the ballast distributed, leaving the track perfectly cleared and dinged, as shown in the cuts, in from 12 to 15 minutes. This is all done by the "outer" "trails" service" (a conductor and two brakemen) no extra help being required. The track is perfectly cleared by the conductor, so that a train can immediately pass over it at any rate of speed, without meeting any obstruction. No aprons are needed; no wire cables are used. There is no discharging ballast from between the cars, and no closing the tracks with checks. The ballast is left between the ends of their ends, directly in position for loading, when the track is raised, without being shovelled in from the ditch. The average saving per mile, in the amount of ballast needed to make a "raise" of 16 or 12 inches, will be about 400 yards and often far exceeds this. The total saving per mile in material, labor, time, use of cars, saving in transportation, etc., is found by amount, in gravel, to from \$250 to \$400, and in broken stone it often amounts to \$500.

These cars are in use on the Great Northern Ry., the Illinois Central, the Gulf, Colorado & Santa Fe, the Chicago & Eastern Illinois, the Penn. Lines West, and other roads.

Detailed information will be furnished by circular by addressing the

RODGER BALLAST CAR COMPANY, No. 1215 Monroek Building, CHICAGO, ILL.



Head Roll Seat.

THEIR SUPERIORITY IS PROVEN BY THEIR POPULARITY.

FINEST SEATS.

Couch, Parlor Car, Sleeping Car, Street Car, Rattan Elevated

IN USE ON ALL THE PRINCIPAL RAILROADS IN THE UNITED STATES



Spring Edge Seat.

THE HALE & KILBURN MFG CO.,

Simplicity, Durability, Elegance, Comfort.

IT IS SAFE TO SPECIFY THE **H. & K. SEATS**

PHILADELPHIA, NEW YORK, CHICAGO.

ALBANY, N. Y.
936 Broadway,
New York City,
115 BROADWAY.

CONSOLIDATED

McElroy, Sewall, Westinghouse and other Patents.
CATALOGUES UPON APPLICATION.
Special Appliances and Extra Strong Fittings of Every Kind.

CHICAGO
200 Phenix Bldg.
Canale,
CANTON, P. Q.

STEAM COUPLERS
AND
FIRE PROOF HEATERS.

AUTOMATIC CONTROL OF HEAT.
CAR-HEATING CO.

COMMINGLER
AND
DRUM DIRECT STEAM SYSTEMS.

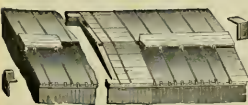

THE MURPHY STEEL CAR ROOF.

It has no surface nail or screw holes. It has no joints where spiders, rats or fire even can get through. It allows for contraction and expansion, and has ample elasticity to provide for sagging, twisting, buckling and cornering of the car body. It is as solid as the car frame itself. It has no soldered joints. It can be repaired readily, and without taking off more of the roof than is damaged. It is much cheaper than any other metallic roof now in use, and is cheaper than the double-board roof, made of good lumber. It is unlike any other metallic roof for the reason that everything is furnished to make it complete; so that the parties buying it have no expense other than to apply it.
This **ROOF** can be applied on **OLD LEAKY CAR-BODIES** without making any changes in the board roof, thereby saving the expense of replacing the old-board with new, and thus utilizing material that must otherwise be thrown away.

Manufactured by the **P. H. MURPHY MFG. CO., East St. Louis, Ill.**

THE WESTINGHOUSE AIR-BRAKE CO.

Is now prepared to fill orders, at an hour's
notice, for One or One Thousand Sets of

AIR-BRAKES FOR FREIGHT CARS,

having, at their New Works, an annual capacity
for turning out Air-Brakes for 250,000 Freight
Cars, 6,000 Passenger Cars, 10,000 Locomo-
tives; besides repairs for the 350,000 Freight
and Passenger Cars, and 26,000 Locomotives
already equipped by

THE WESTINGHOUSE AIR-BRAKE CO.

The Peerless Rubber Mfg. Company,

E. L. PERRY, President,
CHAS. H. DALE, General Manager,
W. G. WINANS, Treasurer.

GENERAL OFFICE AND SALESROOM:

16 WARREN STREET,
NEW YORK.

Rainbow Sheet Packing,
Peerless Packing, $\frac{3}{8}$ inch, for Westinghouse
Pumps,
Pump Valves, Sheet Rubber, Matting, etc.

Guaranteed Steam Hose

FOR CAR HEATING CONNECTIONS.

Air-Brake Hose

GUARANTEED FOR 2 YEARS.

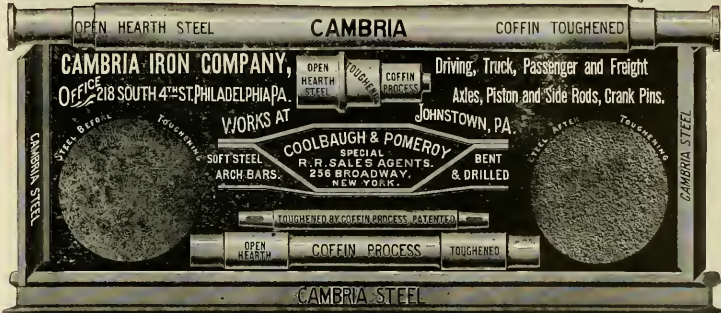

NEW YORK OFFICE FOR RAILS AND FASTENINGS—33 WALL STREET.

THE HAYDEN & DERBY MFG. CO.,

SOLE MANUFACTURERS OF

Metropolitan Double-Tube Locomotive Injectors.

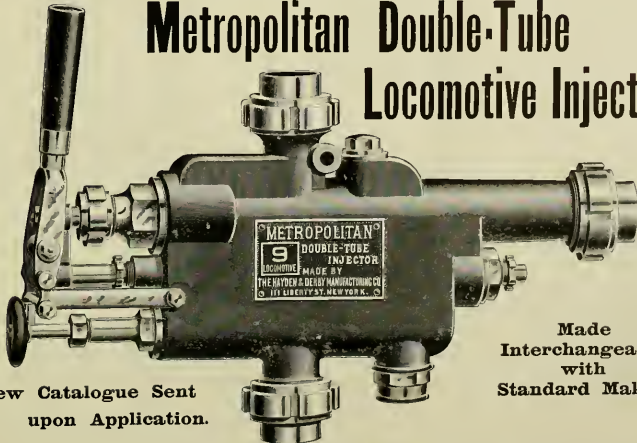

Made
Interchangeable
with
Standard Makes.

New Catalogue Sent
upon Application.

Office and Salesrooms:

Nos. 111 and 113 LIBERTY STREET, NEW YORK.

THE JOHNSON SELF-FEEDING BOILER TUBE EXPANDER.

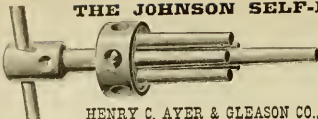

HENRY C. AYER & GLEASON CO., N. E. Cor. 2d and Diamond Sts., Philadelphia, Pa. Central Office, No. 919 Betz Building, Philadelphia, Pa.

This is a very simple and efficient tool, it is constructed on correct mechanical principles, and it does its work more effectively and in less time than any other expander made; it will outlast three similar tools of any other manufacture. There are five small rollers, each of which revolves when the centre pin is turned, and the tool itself has a rotary motion which produces a uniform pressure, and the expansion of the tube is perfect; the small rollers being started at an angle, the turning of the centre pin feeds the expander into the tube without driving, and it is released by turning in the opposite direction. The driving of the centre pin of an expander not only damages the tool but injures the tubes. This never occurs with the Johnson Tool. There is no part of this expander that can be broken when in use, there are no screws, no castings, no rollers on pivots. It will wear for years without costing a penny for repairs.

MATCHLESS VALVE AND CYLINDER OIL.



Warranted not to corrode the iron or destroy packing, and to make more mileage than tallow or lard. Sold only to Railroad Companies direct or through our authorized agents. **Matchless Cylinder Oil cannot be Bought of Dealers. In use on 80 Railways.**

OILS FOR RAILROAD USE A SPECIALTY.

ECLIPSE LUBRICATING OIL COMPANY, Limited,

MANUFACTURERS OF EVERY PRODUCT OF PETROLEUM.

Main Office: FRANKLIN, Pa. Branches: FRANKLIN, Pa. OLEAN, N. Y. ERIE, Pa. OIL CITY, Pa.

Carbon Steel Company, Pittsburgh, Pa.

MANUFACTURERS OF

OPEN HEARTH STEEL PLATES FOR ALL PURPOSES.

SPECIALLY SUITED FOR LOCOMOTIVE FIREBOXES AND BOILERS. PARTICULARS SENT ON APPLICATION.

Railroad Agents:

J. B. BRADY, 909 Havemeyer Building, New York.

W. M. WILSON, Western Union Building, Chicago.

PAUL S. REEVES, Philadelphia.

PHOSPHOR BRONZE IN INGOTS AND CASTINGS. **LOCOMOTIVE AND CAR BEARINGS** A SPECIALTY. BRASS and PHOS. BRONZE CASTINGS from 1/4 lb. to 5000 lbs. in WEIGHT.

Trade Mark

GOLD'S STEAM and WATER PACKING
 Patented June 1, 1891
 The Original and Best
 The Original Ring Packing
 is being put in use on
 Engines, Boilers and
 MACHINERY without stop
 the
THE GOLD PACKING CO.
 East Cambridge, Mass.

The New "NATHAN"
 (THE REINVENTION, AND
MONITOR INJECTORS
 FOR
LOCOMOTIVES.

"NATHAN" SIGHT-FEED LUBRICATORS,
 For Locomotive Cylinders and Air Brakes
STEAM FIRE EXTINGUISHERS.
 For Switching and Yard Engines
BOILER WASHERS,
 Road and Globe Oil Cops, etc.

Send for DESCRIPTIVE CATALOGUES.

NATHAN MFG. CO., 92 & 94 Liberty St.,
 NEW YORK.

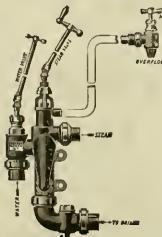

THE CAMERON STEAM PUMP.

COMPLETE WITH BOILER.

THE A. S. CAMERON
STEAM PUMP WORKS,
 Foot of E. Twenty-third St.,
 NEW YORK.

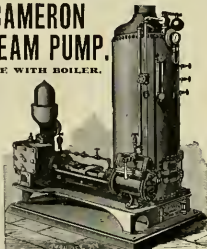

Send for Illustrated Catalogue.



THE Fire-Proof Baker Car Heater

MADE OF FLEXIBLE STEEL
 ONE-QUARTER INCH THICK.

Firmly Welded Into One Compact, Jointless, Seamless Whole.

FIRE WITHIN A SAFE OF SAME MATERIAL
 AS THE EXPRESS CAR SAFE.

NEARLY 1000 FIRE-PROOFS IN USE.

ALL OTHER STYLES OF "BAKER HEATERS."

WILLIAM C. BAKER,

Safe Proprietor and Manufacturer.

143 LIBERTY STREET, NEW YORK.



Ask for Catalogue.

YOU are now looking at a picture of the Best **BOILER WASHER** and **TESTER** made. Washes with hot water, tests to any pressure with hot water. Requires no foundation, takes up no shop room. Has no moving parts, and a record of efficient service for ten years. We also make the FAMOUS "Little Giant" Injector. Ejectors and other Jet Apparatus.

Rue Manufacturing Co.,
 119 N. 9th St., Philadelphia, Pa.

DRAKE & WEIRS, Cleveland, Ohio.

ASPHALT CAR ROOFING

The Cheapest, Best and Most Durable for Roof Known. In use by Seventy Railroads. Twelve years successful use without a single failure. A new roof furnished free for every one that fails in ten years.

SCHOEN MFG. CO.

PRESSED
 STEEL MATERIAL
 FOR CARS.

PITTSBURGH,
 PA.

BEMENT, MILES & CO.,

MANUFACTURERS OF
METAL WORKING MACHINE TOOLS

FOR
Railroad Shops, Locomotive and Car Builders,
Machine Shops, Rolling Mills, Steam Forges,
Ship Yards, Boiler Shops, Bridge Works,
ETC., ETC.

STEAM HAMMERS
STEAM AND HYDRAULIC RIVETING MACHINES

Philadelphia, PA.

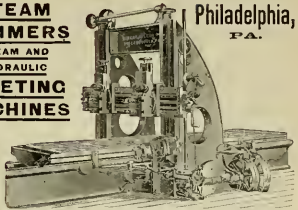

Special Air Tools for R. R. Shops.

Automatic Compound Belt Compressor. = =

Only runs when air is used, requires no attention except oiling, delivers 35 cubic feet of free air per minute — great economy over steam air pumps.

Air Hoists of all sizes, — saves more labor and time than any other shop tool, speed of hoist being entirely at will of operator. Will save ten times their cost per year over a wheel lathe.

Let us quote you on above tools.

PEDRICK & AYER CO.,
1001 Hamilton Street,
PHILADELPHIA, PA.

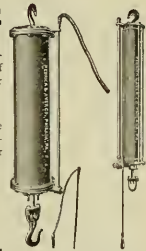
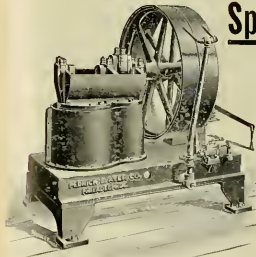

Nicholson's Expanding Lathe Mandrels.

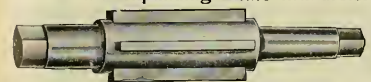

Set of 9 takes from 1 in. to 7 in. Set of six from 1 in. to 4 in.
Either Set sent subject to Thirty Days Trial, and Guaranteed Absolutely Accurate and Labor Saving.
Send for catalogue for full description and references.

GEORGE L. WEISS, General Agent, 139 INGLETON AVENUE, CLEVELAND, OHIO.

THE PRATT & WHITNEY CO., Hartford, Conn., U. S. A.

SINGLE AND DOUBLE HEAD MILLING MACHINES used as Substitutes for Planers for Heavy and Rapid Cutting in Cast and Wrought Iron and Steel.

TURRET-HEAD MACHINES AND TOOLS for Turning and Threading Irregular Pieces of Circular Cross-section in Brass, Iron and Steel.

METAL BAND SAWING MACHINES for Cutting Sprues from Brass Castings.

MILLING CUTTERS, HOLDERS, with Inserted Cutters for Turning Shaping and Threading Metals. **SPIRAL SHEAR PUNCHES.**
CATALOGUE L SENT ON APPLICATION.

MILLS ESTABLISHED IN 1844. EWALD IRON CO.

OWNERS AND OPERATORS
TENNESSEE ROLLING WORKS, TENNESSEE ROLLING MILLS,
CERRILLAND HOVEL, MANUFACTURERS OF, LOUISVILLE, KY.
TENNESSEE CHARCOAL BLOOM AND LAUREL STAY BOLT.
"E. I. C." and "BOONE" IRON.
Also, TANK, FLANGE, FIRE BOX AND BOILER STEEL AND IRON.
PRINCIPAL OFFICE AND WAREHOUSES:
939, 941, and 923, 925, 927 N. SECOND STREET, ST. LOUIS.

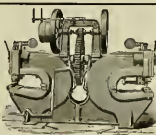

The Long & Allstatter Co. HAMILTON, OHIO.

Double Single Angle-Bar, Gang, Horizontal, Tandy, Boiler, Spacing, Gate, Multiple, Belt, and Steam Driven Punches & Shears
OVER 300 SIZES.



THE ACME MACHINERY CO. CLEVELAND, OHIO.

Manufacturers of
ACME BOLT & RIVET HEADERS
Acme Single & Double Automatic Bolt Cutters
Cutting from 1/2 in. to 6 in. diam.
Two, Straddle Bevel and Top Post Premium Cincinnati Cast-iron.

THE DETROIT No. 2 and 3

SIGHT-FEED CYLINDER LUBRICATORS
FOR LOCOMOTIVES ARE THE BEST.



This Lubricator discharges oil to cylinders accompanied only by dry steam, and consequently full effect of oil is obtained.
Checked cross-feed.
No broken gears by wear of steam and water.
DETROIT LUBRICATOR CO., Detroit, Mich.
Awarded Gold Medal and Highest Premium at the World's Columbian Exposition.

FLAT TURRET LATHE

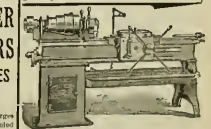

TURNS STRAIGHT AND TAPER FRAME BOLTS, ETC.
SEND FOR A COPY OF
"RAPID LATHE WORK,"
By New Method - Harless System.
JONES & LAMSON MACHINE CO.,
SPRINGFIELD, VERMONT, U. S. A.

THOMAS PROSSER & SON,
15 GOLD STREET,
NEW YORK.



STEEL TIRES

ON LOCOMOTIVE DRIVING WHEELS
AND ON STEEL-TIRED WHEELS
GIVE THE BEST RESULTS
FOR EVERY VARIETY OF SERVICE.

The CAST-STEEL WORKS of FRIED. KRUPP, Essen, Germany, cover an area of 1,300 acres, employ about 25,000 men, have the most improved plant, and stand unique, from the fact that they have their own Ore and Coal Mines, Blast Furnaces, etc., and that every stage of manufacture is under their own supervision, and are not (like others) dependent on the open market for a miscellaneous assortment of crude material; which, in connection with 75 years' experience, enables them to turn out a product of a very superior quality, second to none, and at the same time the different grades of Steel are always of the same uniform quality.

Crank Pins, Piston Rods, Spring Steel, Steel-Tired Wheels, Etc.

After a test of over 35 years, the "KRUPP TIRE" has proved itself the best in the market. If a reliable article is wanted, which will give satisfaction, get KRUPP'S.

SCHENECTADY LOCOMOTIVE WORKS, SCHENECTADY, N. Y.

LOCOMOTIVES
OF
STANDARD
DESIGN
FOR ALL
CLASSES OF
SERVICE.

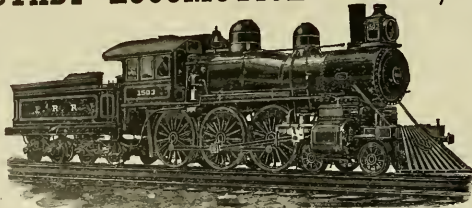

OR FROM
DESIGNS
FURNISHED
BY
RAILROAD
COMPANIES.

EDWARD ELLIS,
President.
WM. D. ELLIS,
Vice-Prest. and Treas.

A. J. PITKIN,
Superintendent.
A. P. STRONG,
Secretary.

COMPOUND LOCOMOTIVES, Showing an Economy of 15 to 30 per cent. in Fuel and Water. Annual Capacity, 400.

M. L. DENMAN, Pres. and Treas.
F. D. HOFFER, Sec'y to the Pres.
H. J. GIBSON, Vice-Pres.
T. M. HARRINGTON, Gen'l. Mgr.

DAVID BEASLEY, H. TANDY,
MGR. ASST. MGR.

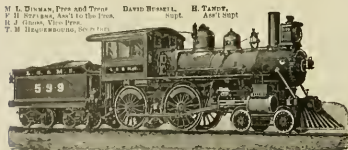

Brooks Locomotive Works,
DUNKIRK, N. Y.

Builders of Locomotive Engines for any required service from our own designs or those of purchasers. Perfect interchangeability and all work fully guaranteed.

COMPOUND LOCOMOTIVES

FOR PASSENGER AND FREIGHT SERVICE.

J. G. HENDRICKSON, Pres.
F. J. CLAMER, Vice Pres.
J. R. NEILSON, Sec. and Treas.

AJAX TIN
USED WITH COPPER PER OUR FORMULA, MAKES EMPIRE STATE EXPRESS BEARING METAL, WHICH RUNS COOL AT ANY SPEED; RECORD: 90 MILES PER HOUR.

AJAX METAL COMPANY,
INCORPORATED,
PHILADELPHIA, PA.

Latrobe Steel Works

MANUFACTURERS OF

TIRES

FOR LOCOMOTIVE and CAR WHEELS.

Main Office and Works, Latrobe, Pa.
Branch Office, Hubilit Building, Philadelphia.
Chicago Office, Western Union Building.
New York Office, Home Insurance Building.

William Sellers & Co., Incorp.
PHILADELPHIA, PA.

MACHINE TOOLS

FOR Railroad Shops, Car Builders, Etc.

HIGH SPEED
TRAVELING & SWING CRANES.
ALSO
TURNABLES, INJECTORS,

SHAFTING,
ETC., ETC.



"LACKAWANNA"
Sight Feed Locomotive
Cylinder Lubricator.

ABSOLUTE UNIFORMITY OF FEED.

Perfect distribution of oil to both cylinders from one feed glass, and entire efficiency under all working conditions.

Only One Glass,

and that short and stout; almost unbreakable. Absolutely no use for any more. They are an unnecessary source of trouble and danger.

Write for full particulars.

LACKAWANNA LUBRICATING CO.,
1212 Capouse Avenue, Scranton, Pa.



Rhode Island Locomotive Works,
PROVIDENCE, R. I.

CHARLES FELIX MASON, President. ARTHUR LIVINGSTON MASON, Secretary.
EARL PHILIP MASON, Vice-President. JOSEPH LYTHGOE, Agent and Supt.
WILLIAM P. CHAFIN, Treasurer. S. A. STEPHENS, Traveling Agent.

NEW YORK OFFICE,

Nos. 31-33 Pine Street.

BALDWIN LOCOMOTIVE WORKS.

DESIGN AS CUT.



STANDARD GAUGE LOCOMOTIVE,
For Immediate Delivery.

Cylinders, high-pressure, 14 x 24, low-pressure, 24 x 24, driving-wheels, 60" or 72" diameter, tires, 3" thick, total wheel-base, "24 2" - driving wheel base, 12' 6" - weight in working order, 133,000 pounds, weight on driving-wheels, 100,000 pounds, boiler, 62" diameter, fire box, 120 1/2 x 33 1/2 - flues, 270 in number, 2" diameter, 14" long, wrought iron centre steel tread truck wheels 31" diameter, tender, 3,600 gallons capacity, 36" chafed wheels. Engine is fitted with Nathan No. 8 safety-feed lubricator, United States metallic packing for piston-rod and valve stems, balanced piston slide valves, fluted main and side rods, two No. 91 Seliger's 1587 injectors, ventilator in cab, head light, glass water gauge and lamp, Westinghouse-American outside equalized air brake on driving and tender-wheels, Westinghouse train signal, water scoop, and all necessary tools.

FOR PRICE AND PARTICULARS, ADDRESS

BURNHAM, WILLIAMS & CO., PHILADELPHIA, PA.

Pittsburgh Locomotive Works.

PITTSBURGH, PA.,

Manufacturers of

LOCOMOTIVE ENGINES

For Broad or Narrow Gauge Roads

From standard designs, or according to specifications, to suit purchasers.

Tanks, Locomotive or Stationary Boilers

FURNISHED AT SHORT NOTICE.

WILSON WILLES, P. & T. D. A. WHEATMAN, Supt.



CROSBY

POP SAFETY VALVES,
REFILED AND PLAIN.

IMPROVED
STEAM GAGES,

SINGLE BELL
CHIME WHISTLES.



A perfect equipment for a locomotive, or large industrial plant, so every engine and stationary screw-boiler user. Specify these goods when ordering locomotives.

CROSBY STEAM GAGE AND VALVE CO.,
Boston, Mass.

BRANCHES:
New York, Chicago, and London, England.

DICKSON MANUFACTURING CO.

SCRANTON, PENN.

Locomotives of every style and also, Standard and Narrow Gauge, made to Standard Gauge and Templates Also for Plantations, Mines and Logging.

REGISTRATION ON APPLICATION.

JAS. P. DICKSON, President.

17 WESTON, 7-TRAIL, W. H. FRENCH, Sec. & Treas.

J. W. DUFFIN, Superintendent.



ROGERS LOCOMOTIVE COMPANY

OF PATERSON, N. J.
New York Office, 41 Exchange Place.

MANUFACTURERS OF

LOCOMOTIVE ENGINES AND TENDERS,

And Other Railroad Machinery.

R. S. HUGHES, President.

G. W. BARNHART, Treas. G. H. LONGFROTTON, Sec'y

ERBEN WELLS, Superintendent.



FLEXIBLE STEEL RULES.

Watch Spring Tempered Steel.
Graduated in 32nds and 64ths on one side only.

SEND FOR CIRCULAR.



VALLENTINE TOOL CO.,
Hartford, Conn.

PORTLAND CO. LOCOMOTIVES OF ALL TYPES.

INCORPORATED 1846.

STANDARD OR NARROW GAUGE FOR ANY SERVICE FROM OUR OWN OR TO RAILROAD CO.'S SPECIFICATION.

Freight Cars, Derrick Cars, Push Cars and Car Wheels,
Boilers of Locomotive, Horizontal, Tubular and Vertical Type

FRANKLIN C. FAYSON, President. JAMES E. GREENSMITH, General Manager. BYRON D. VERHILL, Treasurer



ESTABLISHED 1865.
Richmond Locomotive AND MACHINE WORKS,
RICHMOND, VA.

Locomotives for Every Service.

The Sample Tells the Story.

A sample of Dixon's pure, flake lubricating Graphite, with interesting and instructive pamphlet,

Send Free of Charge.

Every engineer and machinist should make himself better acquainted with Dixon's Pure Ticonderoga Flake Graphite. It will save both time and labor, and is infinitely superior to the common forms of plumage or black lead.

JOS. DIXON CRUCIBLE CO.,
JERSEY CITY, N. J.

You can get back numbers to January, 1894,
NOW. You can't next year.

COOKE LOCOMOTIVE AND MACHINE CO.

(Formerly Danforth Locomotive & Machine Co.)



JOHN S. COOKE, President & Gen. Man. PATERSON, N. J.
FRED W. COOKE, Vice-President.
W. M. BERDAN, Sec'y & Treas.

New York Office,
45 BROADWAY,
B. A. ALLEN, Asst.

MAGNOLIA METAL



For All Bearings.

ALWAYS ==
== COOL !!

Sterlingworth Railway Supply Co.,
Exclusive Railway Agents,
256 Broadway, New York.

M. C. B. STANDARD
Automatic Freight Car Coupler.

New York Office, . . . 66 Broadway,
Chicago Office, . . . 941 Rookery,
St. Louis Office, 319 Commercial Build'g.

GOULD
Coupler Co.

WORKS: OPEW, N. Y.
BUFFALO, N. Y.

Gould Continuous
Platform and Buffer.
GOULD VESTIBULE.

M. C. B. Passenger Coupler
Used in Place of Miller Hook
WITHOUT CHANGE IN PLATFORM.

Locomotive and Car Axles,
Coupling
Links and Pins.

THE POOLEY COUPLER.



POSITIVELY
AUTOMATIC.

Made from the Best Material.
THE LONGER IN SERVICE THE
BETTER IT OPERATES.

MANUFACTURED BY **PRATT & LETCHWORTH, Buffalo, N. Y.**



Safety Hollow Staybolt,

MANUFACTURED BY THE
FALLS HOLLOW STAYBOLT CO.
CUYAHOGA FALLS, O.

Furnished in all sizes from 7/8 in. to 2 in. outside diam., with any size hole required from 3/16 to 3/4 in.

THE inevitable result of using INFERIOR STAYBOLT IRON in the construction of the MODERN, HIGH PRESSURE LOCOMOTIVE BOILER.
TO AVOID EXPLOSIONS AND CONSEQUENT GREAT LOSS OF LIFE AND PROPERTY, USE THE

LOCOMOTIVE SPRINGS
WITH PATENT V SHAPE BANDS.
Gives more Elasticity to short Plates
and Better Riding Qualities.



MANUFACTURED BY
A. FRENCH SPRING CO.

A. FRENCH, Pres.
J. E. FRENCH, Vice-Pres.

GEO. W. MORRIS, Gen. Mgr.

D. C. NOBLE, Sec. and Treas.
F. N. FRENCH, Gen'l Supt.

A. FRENCH SPRING CO.
PITTSBURGH, PA.
Manufacturers of
ELLIPTIC AND SPIRAL SPRINGS
OF ALL DESCRIPTIONS.

THE TROJAN CAR COUPLER Co., Troy, N. Y.

The knob may be thrown open for coupling by the hand rod at the side of the car, rendering it unnecessary for the trainman to go between the cars to open the Latches.

M. C. B. TYPE. THE STRONGEST AND THE ONLY SAFETY COUPLER. New York Office: 49 WALL ST.

THE JANNEY FREIGHT CAR COUPLER



THE Mc CONWAY & TORLEY COMPANY

W. M. CONWAY—PRESIDENT.

48th ST. & A.V. RY.—PITTSBURGH, PA.

Locomotive Engineering



A Practical Journal of Railway Motive Power and Rolling Stock.

ESTABLISHED, 1864, BY ARTHUR NEWLAND AND JOHN A. HILL.

VOL. VII, No. 11.

NEW YORK, NOVEMBER, 1894.

\$30 Cts. Monthly
\$3.50 Per Year.

Heavy Eight-Wheeled Passenger Locomotive for the Boston & Albany Railroad.

The Schenectady Locomotive Works have recently turned out some fine eight-wheelers for the fast "Boston and Chicago Special Limited" train of the B. & A. road, that our artist has shown in the accompanying engraving.

These engines were designed to run over the mountains between Albany and Springfield, and were expected to haul six vestibule cars, two Wagner sleepers, a diner, two day coaches and a baggage car. The first two engines built are now doing this work successfully.

In designing these engines the builders were limited to 74,000 pounds on the drivers, and did a very sensible thing in

Weight of engine, in working order, 114,700 lbs.
Weight on drivers, 74,000 lbs.
Wheel base, driving, 8 ft. 6 in.
Wheel base, rigid, 8 ft. 6 in.
Wheel base, total, 22 ft. 13 in.

CYLINDERS AND VALVES
Diameter of cylinders, 40 in.
Stroke of piston, 24 in.
Horizontal thickness of piston, 4 1/2 in. at rim, 5 1/2 in. at hub.
Kind of piston packing, cast iron rings.
Kind of piston rod packing, U. S. metallic.

Diameter of piston rod, 3 1/2 in.
Size of steam ports, 18 in. long by 1 1/2 in. wide.
Size of exhaust ports, 18 in. long by 2 1/2 in. wide.
Size of bridges, 1 1/2 in. wide.
Greatest travel of slide valves, 5 1/2 in.
Outside lap of slide valves, 7/8 in.
Inside lap of slide valves, nose, line and pin.

Thickness of plates in barrel and outside of firebox, 3/4 and 5/8 in.
Horizontal seams, butt jointed, with wet strip inside and outside.
Circumferential seams, double riveted.

Firebox, length, 50 1/2 in.
Firebox, width, 40 1/2 in.
Firebox, depth, F. 71 1/2 in., B. 59 1/2 in.
Firebox, material, Schoenberger steel.
Firebox thickness, crown 3/4 in., tube 5/8 in., sides and back 3/4 in.
Firebox water space, front 4 in., sides 3 1/2 in., back 3 in.
Firebox crown staying, 1 in. radial staybolts.
Firebox stay-bolts, Taylor iron.
Tubes, material, charcoal iron No. 13 W. G.
Tubes, number of, 508.
Tubes, diameter, 2 in.
Tubes, length over tube sheet, 11 ft.
Heating surface, tubes, 1703.3 sq. ft.
Heating surface, firebox, 141.4 sq. ft.
Heating surface, total, 1844.7 sq. ft.
Grate surface, 25.29 sq. ft.

A Trip to North Wales.

(CORRESPONDENCE.)

The city of Manchester in England is the center of what is probably the most densely settled manufacturing district in the world. It is good for regions of this kind to have ample recreation and breathing ground, it is good to have places where workers can go out to breathe the pure air of heaven or to surcease for a time the cares of business. One cannot be long among Englishmen without feeling that from the workman to the merchant prince, there is a much more healthy sentiment about the necessity for rest and recreation than there is among the millioners of America. It is looked upon as a matter of course that everybody shall get out of the city as long

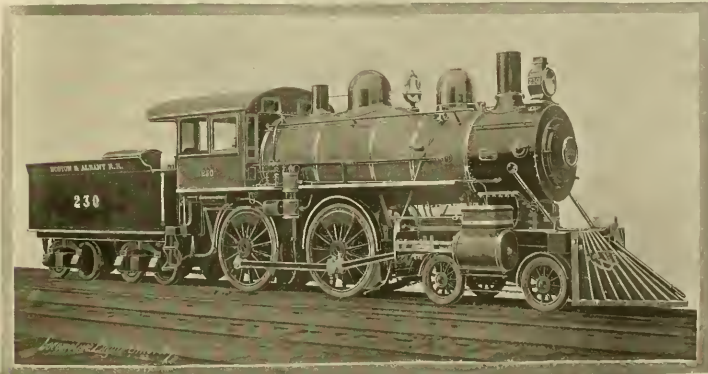

HEAVY FAST PASSENGER LOCOMOTIVE FOR THE BOSTON & ALBANY RAILROAD

shaping to lighten other parts, and put as much as possible of this weight into the boiler.

They made the driving-wheel centers, driving boxes, eccentrics and straps of cast iron, thereby getting the same strength as cast iron with less weight.

The revolving and reciprocating parts were also the subject of special design to lighten weight, and that they succeeded is shown by the actual weight of these parts. The piston complete (with a 3/4 in. rod) weighed but 304 pounds, the crosshead 302 pounds, main rod (I section) 422 pounds, side rod 246 pounds. The crank-pins are hollow, the main pin weighing 110 pounds and the back pin 104 pounds.

The builders believe that these engines have the largest boiler capacities of any engines of the same weight in this country.

The general dimensions of the engine are as follows:

Fuel, bituminous coal.
Gauge of road, 4 ft. 8 1/2 in.

Lead of valves, in full stroke, 1/2 in.
Kind of slide valves, Richardson balanced.
Kind of slide valves stem packing, U. S. metallic.

WHEELS, ETC.

Diameter of driving wheels, outside of tire, 60 in.
Tire held by shrinkage and retaining rings.
Diameter and length of driving journals, 8 in. diam. by 11 in. long.
Diameter of engine truck wheels, 33 in.
Diameter and length of main crank-pin journal, 4 1/2 in. diam. by 4 1/2 in. long.
Diameter and length of side rod crank-pin journal, 4 1/2 in. diam. by 3 1/2 in. long.
Driving box, material, cast iron.
Engine truck wheels, No. 10 hollow steel tire.
Driving springs, hung underneath the driving boxes.
Driving springs, centers, 42 in.
BOILER
Style, extended wagon top.
Outside diameter of first ring, 60 in.
Working pressure, 190 lbs. per sq. in.
Material of barrel and outside of firebox, carbon steel.

Grate, style, rocking, in two sections.
Ash pan, style, sectional, with dampers F. and B.

Exhaust pipes, double.
Exhaust nozzles, 3/4 and 3/8 diam.
Throttle, balanced valve, double poppet.
Smokestack I. D., 14 in. at center, 10 in. at top.
Smokestack top above rail, 14 ft. 1 1/2 in.
Boiler supplied by two No. 30 Muck injectors, placed right and left.

TENDER.

Weight, empty, 37,200 lbs.
Wheels, number of, 8.
Wheels, diameter, 36 in.
Journals, diameter and length, 4 1/2 x 11 in.
Wheel base of tender, 14 ft. 2 in.
Tender frame, 7 x 3 1/2 x 1 in. angle iron.
Tender trucks, steel bearing wood bolster.
Water capacity, 4,200 gallons.
Coal capacity, 8 tons.
Total wheel base of engine and tender, 46 ft. 11 ins.
Total length of engine and tender, 55 ft. 7 1/2 in.
Engine fitted with Westinghouse-American combined air-brake on front side of all drivers, on tender, and for train.
Martin's steam car heating apparatus.

and as often as circumstances will permit during the summer months. The workman with his wife and children get out to the popular resorts in the neighborhood of Manchester on Saturday afternoon and on Sunday, and those with more money to spare go to the sea-side, to the lakes or to the mountains.

The railway companies of Great Britain have encouraged this tendency of the people to make holiday journeys by giving low excursion rates and giving the best possible train facilities. From every industrial center of the British Isles are to be seen in summer and when the weather is fine, heavily loaded special trains carrying multitudes of people towards the green pastures, the seashore and the wooded uplands. This business is a valuable source of revenue to the railway companies and is a real benefit to the communities. The favorite health resorts for the business men of Manchester are in North Wales. I lunched one day with that genial

LOCOMOTIVE ENGINEERING.

354

prince of machine manufacturers, Sir William Hailey, the Mayor of Salford, and the magistrates of the borough which is to the city proper of Manchester what Brooklyn is to New York, and it appeared that every one had just returned from North Wales or was about to go there. The beauties and attractions of the region were praised so lavishly that I made up my mind that an editorial traveler was not doing himself or his readers justice by failing to visit North Wales. While I was hesitating between two opinions my brother mentioned that a tour through the enlorged district would take me to the famous Britannia tubular bridge over the Menai Straits, and that decided me.

The journey was something to be remembered. We went from Manchester to Liverpool by train over what most students of railway history consider the most fa-

vorable road, and it looked as if this opposition was overcome by payment of sums which would make even New York Aldermen green with envy.

There is some exceedingly heavy rock cutting in the neighborhood of Liverpool. There are several large viaducts and bridges, all of solid masonry, and the embankments have been rather costly, but on the greater part of the line the work is light.

We pass over the historic Chat Moss, which was so deep and soft that it seriously threatened for a time to stop the advance of the line in that direction. This terrible moss is now covered with fertile fields where herds of kine look up lazily at the passing train. Another historic place is Rainhill, where the competition of locomotives took place which gave Stephenson and his "Rocket" fame that will endure as long as railroads are used.

Were it not that the background is more rugged and imposing, a stranger might readily mistake the sights on the coast of North Wales for those on New Jersey.

The tiresome thing about all such places is that they are so much alike. Even the health resorts on the Pacific Coast have little to distinguish them from the "genteel cottages" for rent on the coast of Wales.

But these Welsh places have attractions that are all their own. They have a peculiar form of mountain that looks like a peak of the Rockies with its head well combed, the inequalities smoothed down and plasters of green foliage stuck fitfully about the cranium. But on the level parts these green expanse take full possession, and make luxurious pictures rich beyond comparison with our verdant hues. They have greenness that makes the emerald

land, but by some of the tumultuous conclusions that the earth has sometimes suffered from the nose was broken away and an opening made through which the sea flows. This is Menai Straits. The broken off part is the island of Anglesea, a rich and fertile piece of country which for centuries was a granary and packing house for the people of England. To render intercourse easy between the island and the mainland was very desirable, but was not easily accomplished. The tide, which rises and falls from 20 to 25 feet, rushes through the straits with a violence that the most turbulent days of Hell gate never approached. The only method of crossing up to 1835 was by ferry boats, and even these could not have been very good, for there were a number of accidents when hundreds of people were drowned. In 1825 Telford finished a suspension bridge across the straits which brought security.

Shortly after the railway era began certain English capitalists perceived the value of an enterprise that would build a railway from England which would end at Holyhead, the point on Anglesea nearest to the Irish coast. This led to the organization of the Chester & Holyhead Railway, which was constructed under the supervision of Robert Stephenson as chief engineer. As the work progressed the chief engineer had to solve the problem of spanning the Menai Straits with a bridge that would carry a railway train. It was a new feat in engineering. There were peculiar difficulties thrown by the Admiralty in the way of the erecting of a bridge over the straits. That board, always noted for the thickness of skulls of its members, would allow no scaffolding to be employed in the erecting of a bridge, but it should structure with navigation.

The first idea was to erect cast-iron arches, but the opposition of the Admiralty defeated the plan to be abandoned. Then the idea of a tubular bridge was conceived. An accident to a ship in the Thames convinced Stephenson that he could make a tube of sufficient strength to span the Menai Straits and carry a railway train safely. In launching an iron ship an accident happened which left her resting on the bow and stern during several tides, the distance between points of support having been 120 feet. When the vessel was got into the water it was found that the plates had been sufficient to sustain the weight without injury to any part.

After a great many experiments to test the resistance offered by various forms, Stephenson decided on a rectangular section for the Britannia Bridge. The bridge, as built, consists of two independent continuous tubes 45 feet wide and varying from 23 to 30 feet in height. It has four spans 100 feet above high water, two 450 feet in length and two 250 feet long. The success of this bridge led to the building of the Victoria Bridge across the St. Lawrence at Montreal, which Stephenson also designed. This form of bridge is now obsolete, because it does not distribute the metal in the best form for obtaining the maximum strength, but it inaugurated a revolution in bridge construction. Before Stephenson had the courage to use the tube it was supposed that the arch was the only form that could be employed for a long span.

From Menai we came back by the Chester & Holyhead Railway—now part of the Northwestern, which was engineered by Robert Stephenson. The line follows a very rugged route, and there are numerous tunnels, rock cuttings and sea walls that have been erected to keep the Irish Sea from taking entire possession of the railway structure. It is said that the waves hit the rocks on some parts of the coast with an impact of about two tons.

The whole part of this railway which I was able to examine gave me the opinion that it was the most substantially built structure I had ever seen. Everything is designed as if traffic and the elements



CONWY CASTLE AND TUBULAR BRIDGE.

mous railway in the world. This is the Liverpool & Manchester Railway, now a part of the London & North-Western system, which was constructed under the direction of George Stephenson, and where the "Rocket" first demonstrated the great possibilities of rapid transportation. It is a short line, only 24 miles long, and a traveler over it now has difficulty in appreciating the reputed stupendous feats of engineering displayed in overcoming the obstacles which were encountered. The country is fairly level, and an American engineer would probably undertake to build a first-class line through the district for \$30,000 a mile. This Liverpool and Manchester line cost \$2,700,000 for the 34 miles, an average of about \$80,000 per mile. Much of the enormous expense was, however, incurred through the opposition of land owners and others who hated this greatest innovation on the old order of things that the world had ever seen. The necessity for organizing the carrying on of novel operations and the expense of educating men to do work they had never performed before added greatly to the total cost. There was also tremendous opposition to the enterprise presented when application was made to Parliament for the right to build

I had hardly begun to meditate on the wonderful harvest that had been reaped by the seed of which the Rainhill contest was the first fruits, when we were in Liverpool.

Without loss of time we found our way to the harbor, and there boarded a boat that looked like those which trade between New York and Staten Island. A particularly mixed freight of passengers was quickly aboard, and we were soon steaming down the Mersey. For half an hour we watch the interesting variety of craft dancing on the channel that leads to England's maritime metropolis, and then we find that we are drawing away from the main artery of commerce and begin skirting the coast, which gradually becomes bolder and more picturesque. We traverse channels with unpronounceable names, and watch tiny isles rising out of the water, where wealth has established many a summer home set up in positions to catch the breeze and to excite attention. All along the coast is dotted with small villages with the peculiar "summer residence" offered at reasonable terms," which seems to be a stereotyped feature of all places where the unwary are allured into temporary abiding places by the seaso-

look yellow and a variety extending from blue to yellow. The thing that makes a modest wanderer stand aghast is the spelling and pronunciation of the names. An acquaintance we had forgotten with was just telling me about the achievements of the famous engineer Telford in building a suspension bridge over the Menai Straits at Llan-y-moch when the suspension bridge and the famous Britannia tubular bridge came in view. The place for landing was reached immediately afterwards. The engraving that accompanies this article gives a good idea of the appearance of the bridge as seen from a neighboring height. The first and parting impression of the structure was disappointment. But that feeling vanished when I had time to reflect that the work was done by an apprentice hand in bridge-building and that the knowledge and skill learned in the construction of works of this character prepared the way for successfully building the Forth and the Brooklyn bridges.

The coast of Wales resembles roughly a rugged human face, with the nose protruding out into the Irish Sea, forming the closest land connection with Dublin. This nose originally adhered firmly to the main-

were conspiring to tear the whole apart, but Mind, more powerful than all destructive forces, had fashioned shields which were impregnable.

We stopped off and visited a variety of attractive scenes, almost every mile opening up new beauties of a character rarely seen elsewhere. The picture marked "Penmaenmawr" shows a scene that is

thickness, formed the principal lines of defence. A town of smaller buildings were inside.

Conway Castle figured conspicuously in many of the interesting wars of England. When the people made up their minds to do without kings and rebelled against the high-handed acts of Charles I, Conway Castle was persistently held by a warlike

Human Flesh and Blood as Steel-Tempering Material.

In following up the history of human progress we find that steel has exercised an extraordinary influence in advancing the arts and in developing industries. Looking at the improvements in steel-making that are within the memory of middle-aged people we find ourselves witnessing a steel revolution such as the world is never likely to see again. The effects of Bessemer's invention which made steel direct from the ores are more important to the world than any other event that ever happened. Emperors, kings, princes, lawgivers and generals have at

Benjamin Huntsman, of Sheffield, England, who discovered the process of making cast steel. His process produced the tool steel which has done so much to develop our mechanic arts.

When we look back beyond Huntsman's time for another hero of steel development, we encounter a fog of uncertainty that research cannot fathom. We find, away back in the portals of metallurgical history, mention of famous steel, but who originated the methods of production is away beyond human ken.

The most famous of the ancient alloy of iron and carbon was called Damascus steel, and was used for making swords which were known as "Damascus blades." This



BRITANNIA TUBULAR BRIDGE

located with varied settlements on many parts of this coast. The older part of the place, which is called Dwygyfylchi, is remarkably picturesque, and there are numerous places about that have interesting, historical associations connected with them. On the summit of a hill called Ery-diaid is the ruin of a castle, the fortifications of which are said to have been capable of accommodating twenty thousand men. It was here that Griffith-ap-Ilelyllin was assassinated while bravely defending his country against Harold the Saxon. This is a rather sterile district of the slate raising quality. I have always noticed that a naturally famine-producing country has always been valiantly defended by the natives against invaders.

We were told that we missed much by not being able to linger for a few hours amidst the rustic shades of Llanfairfechan, near which is Llyn-Nanhafon, a beautiful lake, and Y-Foel-Fras Druids' circle, which every one with antiquarian sympathies ought to examine. We preferred to move towards Conway Castle, which holds the distinction of having a railway underneath part of its ancient foundations. The railway bridge behind the suspension bridge, in the illustration, is a tubular bridge erected by Robert Stephenson, about the time the Britannia Bridge was put up.

Conway Castle is the most extensive ruin I have ever seen. It looks like a town of towers and battlements. The place was built a century before Columbus discovered America, and part of its foundations were laid on the site of a monastery that dated back towards the infancy of the Christian religion.

The castle was built by the first English king who ruled Wales after the conquering of the material life of that country. The new rulers evidently believed that they had a troublesome time in prospect, if we are to judge by the strength and number of the strongholds they erected. This castle was built in the form of a parallelogram, on an elevated rock, which was partly surrounded by water. On the outside eight massive embattled towers, forty feet in diameter, with walls of enormous

archbishop for the king. Cromwell proved too powerful for royalty, and the Parliamentary party got possession after a time. When Charles II came back to the throne he rewarded those interested in Conway Castle in the way the Stuarts were notorious for rewarding those who stood by them in the day of adversity. To help to maintain the extravagance of his dissolute court he sold the lead roofing of Conway Castle, and from that day the magnificent structure began to descend to the condition of a roofless ruin.

But there is little in that of interest to railroad readers. We return by Chester and Crewe with the consciousness that the



TANA-BWELU, NORTH WALES, AND TWO-FOOT GAGE RAILWAY

times made a slight scratch on the surface of the globe. Compared to the greatest feats performed by these people the work of Bessemer is a deep chasm which will endure for all time.

More than five-quarters of a century before Bessemer's time there was another master of steel-making who put his stamp upon the art and made the kind of steel that men never forget. This was

steel was of a variegated, watery appearance, and was made principally in the ancient city from which it took its name. The name of Damascus, in itself, was enough to give fame to a good steel, for it was an important town in the time of Abraham. Up to modern times no steel had displayed tenacity, edge-holding qualities and hardness equal to Damascus steel. The process of its manufacture has been always a mystery.

A discovery reported by a German professor may shed a ray of light on some grim methods connected with the tempering of Damascus steel. He reports that in making excavations in ancient Tyre he found the shop of an ancient armorer with a



PENMAENMAWR

short tour through North Wales has been one of the most enjoyable outings of two months' rambling. Any of our railway friends who make a pilgrimage to Crewe, the famous industrial center of the London & Northwestern Ry., can make the trip to Menai Straits and back in one day. A. S.

quantity of sword blades in different stages of manufacture, though badly corroded. A copper cylinder with a close-fitting cap was found among a pile of dry rotted wood, evidently the remains of an arm-chest, the brass nails and copper arm-chest, the brass nails and copper arm-chest of which had retained their original form. This cylinder contained a patch-

When the train stopped at Robesonia, twelve miles west of Reading, the fireman was startled by seeing a tall young man all covered with ashes, stick his head out of the opening below the firebox door and ask: "How far is it to Reading?" "How did you get in there and where?" asked the fireman. "At Harrisburg." "And

They are built of different sizes to suit the business of the yards; they are intended for . . . Nearly all railroad repair shops have one or more of these cranes about the yard handling material, and they are reported to be a great convenience

A Dangerous Practice.

Fireman Frank D. Brady, employed on the Brooklyn Elevated road, was killed last month by falling off the engine. He was cleaning the jacket.

This is a practice that should be prohibited on every road, not so much to keep from killing the men who practice it as for the fact that it is dangerous in other ways.

Every locomotive is entitled to the use of four eyes when running, anything that lessens this number tends to let down the barriers a little and increase the chances of other avoidable accidents.

Means of Applying Boiler Compound.

The Minn & St. L. road, like others in the northwestern country, have considerable trouble on account of bad water, and the water in the various tanks has been carefully analyzed and classified according to the standard R. R. Chemists' rules, as follows:

8 to 15 gr. solid matter per gal.	very good.
14 to 20 "	good
20 to 30 "	fair
30 to 40 "	poor
40 & over "	bad.

manner, as per sketch. This pipe is closed at the bottom and perforated on the sides,



close to bottom with four 1/4-inch holes. The pipe has a suitable cap or cover at top.

"There are strange things about the way some locomotive improvement work," remarked a well-known railroad man in this office last month. "Just before leaving home I was reading the report sent out about a locomotive with an improved valve gear. Two engines of the same class had been kept upon the same runs for months, one of the engines having the link motion and the other one the improved motion. A close record of the coal and water used by both engines was kept. The saving of coal for the improved valve motion was about 10 per cent, but at the same time it was shown that this engine always used more water than the other one. 'Now, gentlemen,' he said, 'what I want to know is, how did the engine burn less coal while evaporating more water? If the valve motion saved steam, what came of the extra steam evaporated?' We gave it up.

In June fifty-eight engines on the M. & St. L. Railway made 142,012 miles, with a total cost of \$23,357 71, or a total cost of 15 87 cents per mile. They ran an average of 99 1/2 miles to a pint of valve oil, 38.40 miles to a pint of engine oil, and 40.40 miles to a ton of coal. Some of the boys think this is first-class work, and so it is—especially the coal record.

The Prescott & Arizona Central Railroad has entered suit against the Atchafalaya, Topeka & Santa Fe, claiming \$100,000 damages, owing to the failure of the Atlantic & Pacific to fulfill a contract made by the plaintiffs.

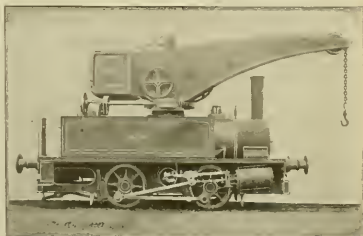

Tanks on the Pacific division run from 7 1/2 to 40.3 grains to the gallon.

On the same division they were unable to keep a set of flues intact six months. This difficulty led Mr. Tonge, the M. M., to try the "Tri-soda Compound," which has worked wonders and has proven a legitimate cure. The water is made perfectly clear, no precipitation or rust, whereas before the use of this compound the reverse was true.

One quart of the Tri-soda Compound per 100 miles is used, and is placed in a three-inch pipe led into the tank in a suitable

It has been decided to hold the next meeting of the Association of Railroad Aviators Men at St. Louis on the second Thursday in April next.

The boiler of a locomotive belonging to the Delaware, Lackawanna & Western exploded on the Bloomfield branch last month while pulling a passenger train. The explosion started with a fracture of an inside side sheet near the mud ring. The force of the explosion made the engine turn a somersault. The fireman was killed and the engineer fatally injured.

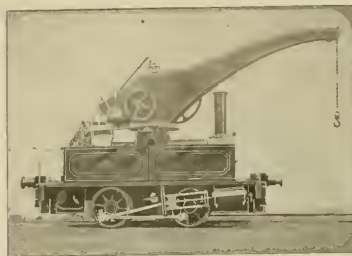

ment inscribed in ancient Syriac characters and in a fair state of preservation. The professor, after months of close study, has pronounced it an extraordinary discovery—one calculated to cast much light upon the heretofore mysteries of the ancient craft of weapon-making, giving in detail the methods followed in making the perfect Damascus blades.

The manner of tempering these blades when intended for a ruler of an officer of high rank was as follows: "Let the high dignitary furnish an Ethiopian of fair frame and let him be bound down, shoulders upwards, upon the back of the god Bah-hal, his arms fastened underneath with thongs; a strap of goat skin over his back and wound twice around the neck, his feet close together lashed to a dozel of wood and his head and neck projecting over and beyond the end of the block . . . Then let the master workman, having cold-hammered the blade to a smooth and thin edge, thrust it into the fire of cedar wood coals, in and out the while reciting the prayer to the god Bah-hal, until the steel be of the color of the red of the rising sun, when he comes up over the desert toward the East, and then with a quick motion pass the same from the heel thereof to the point, six times through the most fleshy portion of the slave's back and thighs, when it shall have become the color of the purple of the king. Then, if with one swing and one stroke of the right arm of the master workman, it sever the head of the slave from his body and display not nick nor crack along the edge, and the blade may be bent round about the body of a man and break not, it shall be accepted as a perfect weapon, sacred to the service of the god Bah-hal, and the owner thereof may thrust it into a scabbard of moses' skin, braced with brass and hung to a girdle of camels' wool dyed in the royal purple."

A Perilous Ride.

Probably one of the most thrilling rides ever heard of occurred on the Lebanon Valley branch of the Reading road on September 28th. A young man crawled into the subpit of a Western engine at Harrisburg. The pit is divided in two sections, and both are directly beneath the fire grates. He entered through under the door of the firebox and took a seat in the second compartment, unobserved by the engineer or fireman. Shortly after taking this position the engine was attached to the fast line and started for this city.

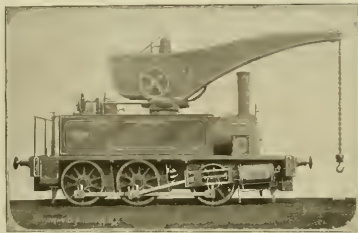

you were not burned." "Well, it kept me hanging to dodge the hot coals as they dropped down on me. It was a good ride, pardner," he said, and hurriedly left as the train pulled away from the station. The engineer says the only thing that saved the man from being burned up was that the fire had been padded with large coal before leaving Harrisburg.—Philadelphia Ledger.

Peripatetic Cranes.

A striking difference in the practices to be seen in American and in European freight yards as to the methods followed for loading and unloading heavy material. In the American yard extremely heavy weights are generally handled by bar-wood methods. In the early days of rail-roading there were always to be found men who could move heavy weights by the aid of a few blocks and crude levers, and that practice set the fashion which is still adhered to. In European countries men were not accustomed to lifting an article weighing five or six tons by means of skids, and therefore proper appliances had to be provided. The proper article was a crane which was provided in the yard of even the smallest station.

In large yards it was often found inconvenient to get the cars to the cranes, and this led to the building of locomotive cranes, similar to those shown in the annexed engravings. These forms of peripatetic crane are built by Dubs & Co., locomotive builders, in Glasgow, and the demand for them is every year increasing.

Taking Water on the Fly.

There are thousands of railroad men who have never seen a track tank, and more who never saw a locomotive scoop water without stopping.

The track tanks and scoops were invented by H. Lambdottom, superintendent of machinery of the London & Northwestern, London, England, and is now in extensive use in Great Britain, and in the Eastern States of the Union.

The track tank is usually about 18 inches high, 6 inches deep and 1,200 feet long. It has a steam pipe connection to prevent freezing in winter.

The tender is provided with a jointed pipe that is let down by a lever in the cab. Its open mouth drops into the tank and the speed of the train forces the water up the spout, this turns near the engine tank and empties into it.

In America the speed is reduced to about 10 miles per hour in order to scoop water, and in England they scoop at full speed. These engine tanks are made stronger to stand the flux, their scoops are better, and the lines so well guarded that pieces of coal and stones do not get into the tank trough.

Mr. Blauvelt photographed this engine when she was doing the scoop act at 25 miles per hour, and the spray of water can be seen beside the tank.

There was an exceedingly clever piece of photography work, as the camera must be close to the track and the shutter opened while the engine was but three rail lengths away. The ordinary photographer snaps quick and gets away. Mr. Blauvelt is a patient enough to get wet for the sake of a good negative of what he wants.

Crossing the Ocean.

(BY FRANKLIN CORRIE-SOUTH WEE.)

On a scorching day in the end of July I found myself on the good ship *La Touraine* steaming down New York Bay bound for Havre and thence for a free world through Europe. I have tried various ways of courtier rest and recreation, but I know of no way in which complete satisfaction from toil can be so thoroughly accomplished as by taking an ocean voyage. No mail to look for, no telegrams to be sent to business, nothing but lethargy to be won, and no temptation to escape from pure lacy rest.

As we steamed out into the ocean on the 10th morning, we find most of the passengers trying to locate themselves, with their chairs, rugs and books, on the deck in the points most suitable to the individual's taste. Some try to get the places where they can display themselves to the best advantage, others look for the most sheltered nooks, and others again, with a view to the future, select places where they can spring to the rail conveniently and hold their drooping heads towards the rolling follows that seem to draw the dainties from the strongest stomachs.

Little by little the day and the ceaseless thrum of the engines pushes the great ship with relentless force through the corrugated surface of the ocean. Hour after hour, day after day and night after night the great pulse of the propeller keeps up its monotonous rhythm. Fogs may rest upon the deep so thickly that vision is suspended and motionless about the deck, to be guided by touch alone; the waves may rise and dash over the vessel with fury that appears destruction, and the eerie wail of the fog whistle may drown all other sounds, but the throeb of the screw goes on without a break, and its note brings the comforting feeling that the promised land, also the home, will soon up at the appointed time.

An observer who is in a condition to watch things soon finds that the population of an ocean steamer is a miniature society as found ashore. In a very few days the passengers assert themselves in groups according to their real or imaginary standing, and the grades become more clearly defined day after day if the waves

do not step in to exert a temporary leveling effect. From the experience of land and of many sea voyages, I have come to the conclusion that the further you descend in the social scale, the more enjoyment you find going on among the people. The temporary inhabitants of *La Touraine* were no exception to this rule. The steerage passengers exhibited a decided lack of familiarity with water. Some of them lounged round all day on the deck basking in the sun, and children brooded the wings of a hen, but old and young were in for taking all the enjoyment to be got. All day long there was music and dancing and games and frolic, and laughter from the steerage was the most cheering sound heard on the voyage. The music was not always melodious, but it was hearty; it fanned hilarity and helped to beguile the monotony of the voyage. A few of the "upper" classes got some small enjoyment from watching the on-gings of the lower strata, but most of the

difficulty arose. But, then, men with nothing else to do must use the safety valve between their jaws.

The mention of jaws reminds me of the amount of amusement some people enjoy on shipboard by keeping their jaws at work on masticating duty—that is, when they are not distending them to throw into the ocean articles of food which could find no secure hold inside the stomach. On the first day out I amused myself by passing four sessions at the table, but a silent voice admonished me to go slow, and I took the hint. Perhaps I obeyed Nature's laws more readily on account of the doings of a neighbor who furnished an awful example.

This man was dressed in clerical garb, and was demonstrative and loud in letting all and sundry understand that he was the Rev. Something of a well-known Episcopal church in New York. His face was suffused with the hue of the peony rose, and his nose resembled a well-cooked beet of generous proportions.

his neighbors. On the first night, about the hour of retiring, the Rev. Something gave emphatic injunctions to his mild and meek partner to get him up in time for the first breakfast. "You know, my love," he added, "I never feel well on shipboard unless I take my meals regularly."

He was up at 7 a. m., and I had a clear demonstration that he stuffed himself with "coffee and milk," as the French have it, with a generous padding of eggs, etc. At 9:30 he was at the table taking in the regular substantial breakfast, which rates up like a heavy luncheon. At 11 a. m. he was at table devouring regular luncheon. By industrious stuffing at this meal he contrived to hold out till 1:30, when the regular seven-course dinner was served. After getting through with the dinner, the Rev. loafed patiently around until 9:30, when he was invariably the first man in at the supper table. There he went to bed and snored like a Daniel's plover suffering from asthma.

What first attracted my attention to this



DOUBLE TRACKS AND TANKS (N. Y. & L. H. RAILROAD) NEAR LONG BEACH, N. J. ENGINE NO. 6010.
WALTER RUSSELL, 25 MIERS 17th HOOR.

salooned passengers gloomed around, but dignified and exclusive to make enjoyment for strangers or to associate with people to whom they had not been regularly introduced.

The smoking-room, which is the democratic headquarters of the upper classes, was about the same here as on all other steamers. The habits of this part of the ship generally spend a great part of the day and night smoking, drinking, betting on the progress of the vessel, and in giving their views on how the officers perform their duties. The smoking-room of an ocean steamer has always reminded me strongly of the room where brakemen spend their time between runs. A brakemen's room is the place to hear emphatic views as to the ability and policy of the management. There the talk is of a character that would lead a novice to believe that brakemen were the bosom friends and confidants of presidents, and that their counsel and advice were asked before any new movements were undertaken. The men who frequent the smoking-room of a steamer talk as if they could give points on navigation to the captain, and they would lead those who did not understand them to believe that the chief engineer was liable to consult them if any

I was not drawn towards this man, yet his appearance and actions called up tender memories of my boyhood in connection with a character of my native village, who had a decided resemblance to this divine. This character was called John Murray, and he was the warmest-hearted man in the Mearns, no matter if the wine which he red entrenched his blood and painted his nose. We boys had a nickname for him, suggested by the appearance of his protrusion.

John Murray was visiting a friend's house one day, and the friend had a bright little lassie, who came in with her mother. John began to joke with the child, and pretended that she did not know him.

"Oh, I ken ye vera weel," protested the child, in answer to his joking.

John Murray was visiting a friend's house one day, and the friend had a bright little lassie, who came in with her mother. John began to joke with the child, and pretended that she did not know him.

"You don't know my name, anyhow!"

"Oh, yes, I do. Your name is John Murray Strawberry Nose."

Our reverend member had so much of my old townsman's appearance that I got watching his actions, which I could very readily do, since he was in the next stateroom to me. Ship builders do not waste much energy in providing means to confine sounds to the staterooms they originate in, and consequently an inquisitive person can learn a good deal about the affairs of

Rev. was a loud remark he made to the effect that he never drank anything but champagne. He was a good representative of high living on shipboard, but I noticed when he was ordering beverages in the sanctity and seclusion of his stateroom that Milwaukee was his favorite drink. I am not posted about champagnes, but I hardly think that any noted brand bears the name of "Milwaukee," and Wisconsin is not celebrated as a grape-raising State.

When we were about five days out the waves from some storm that did not reach us began to rock the ship. Rocking in the cradle of the deep is very practical to people ashore, but to many poor sinners on shipboard it is worse than anything that has been related about purgatory. Understand that I am perfectly disinterested as to the condition of the weather or the waves, but when these particular waves were disporting themselves on our bow, beams, keel and stern I was awakened one night by unearthly sounds. I had several times listened to the coughings of the other staterooms in Central Park, and I thought at first that I was rhapsodizing near the shades of New York's own menagerie. But as the cloud of sleep cleared off my mind, I discovered that the unearthly

noises proceeded from the adjoining chamber, and that they were the audible wrestlings of the Rev. in some efforts he was making to turn himself inside out.

After a particularly noisy spasm the wife was heard asking, "Dear, is that you, Alphonse, dear?" "Hurr!" he groaned. "Perhaps you think I am doing this for fun. I believe there is nothing left of my anatomy except the walls."

Sea sickness is agonizing, hot, like tooth-ache, its victims receive little sympathy because it is seldom fatal. It is caused by the actions of different people under the influence. When the first symptoms appear women, and men, too, for that matter, will retire to the seclusion of their rooms to hide the contortions their faces undergo while trying to invert the processes of nature. But after a day or two, when the advantages of breathing the fresh air of the upper deck are understood, they will hold to the rail and go through all the movements regardless of who is looking on. Some of the expressions heard from sea-sick people are rather moving. Mrs. William Smith, of the Chicago and Northwestern, was crossing and had a sister along. The latter began to empty herself. After she had hung over the basin for a long time the sister asked sympathetically, "Mona, do you think you are done now?" "Well," said Mona, looking at the basin, "I ought to be empty, for that looks as if I had swallowed a cow."

Some people are not so ready to give out what they have swallowed, some contrivances of mine were enjoying themselves on the first day out, and suddenly one of them began to show symptoms of distress. He held his hand on his mouth, (as is usual to hold on to what he had got), "Let it out, Sully," said one of his companions, "and you will feel better." "No, no," groaned Sully, "I wanna let it up. Why, man, it's whiskey!"

But the propeller keeps up its industrial tune. The season of sickness is over past. People come on deck who have not appeared since the morning of the first day, and longing looks are searching for the coast of Cornwall. The lizard light-house creeps up from the bottom, the outline of welcome land appears. After signaling their arrival in European waters, the vessel veers towards the east, and we are presently in the open sea again, but a few hours brings us to the coast of France. After steaming up through picturesque islands and occasionally sighting the rock-bound coast, we reach the estuary where the river Seine joins its waters into the sea. We approach the city of Havre, finely situated on the sides of a bold promontory, and our voyage is ended.

A. S.

A Cannon for Shooting Out Tight Frame Bolts.

At the Erie shops—say, Erie shops, for all have them now—can be seen a unique tool for taking out tight bolts. It does its work very quickly and efficiently, has but one moving part and its motive power is powder.

The engraving shown here will make its construction plain.

The one the writer saw was made of a crank-pin and cost but a few dollars.

The cannon sets up in its breech, has a trench-hole at the bottom of bore into a 1/4-inch hole bored across both sides part 1/4 inch as shown. This is a character and serves another purpose described later. The 2-inch plunger fits the bore of gun and has a head reduced to 1 inch.

In practice the gun is loaded with one-half ounce of powder and a short fuse is placed in the trench-hole. The plunger is raised up and a 1/4-inch rod thrust through the holes under it for support, then the cannon is blocked up under the bolt to be struck just so that the top touches the bolt fall. Then the rod is removed and the plunger dropped back onto the powder, the

fuse lighted, the workman step back, and—there you are.

It has never failed to get out the worst bolt yet loaded.

Some cylinder bolts 16 inches long, worn and rusted fast, that refused to be coaxed by any known plan, jumped up 5 inches when the gun went off.

It is said this tool was first introduced in this country at the Susquehanna shops of the Erie by a Frenchman who had used them in France.

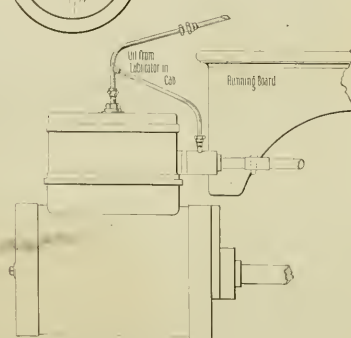
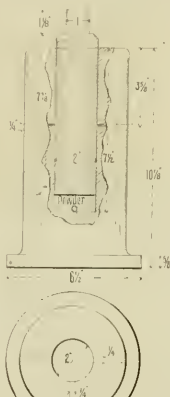

They are a first-class thing anyhow, and every railroad repair shop should have one. They cost less than the drilling out of one set of frame bolts.

A Sensible Way to Oil Metallic Packing.

Every master mechanic who has the care of engines using metallic packing will agree that their freedom from galling depends on the efficiency of the oiling devices that keep the rod or stem well lubricated.

Master Mechanic H. A. Childs, of the Erie, having the usual amount of trouble, tried the experiment of tapping the packing ring case and running a small pipe

from there to the lubricator pipe, as shown in our sketch.

This insures oil in the right place, and a good quality of oil, if the stem gets too much the surplus simply goes to the valve and cylinder, where it does some good instead of being wasted outside, as with swab cups.

A switch-engine has been at work in the yards in Jersey City for some months with her valves stems so lubricated. The results have been so good that Mr. Childs

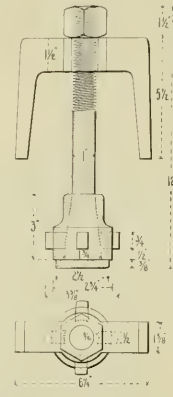

has taken steps to apply it to the pistons, and to protect his invention.

A Nozzle Puller.

Builder-makers and roundhouse repair men who have wasted much time and patience trying to get a set of nozzles out of the ordinary stand will appreciate the little link shown here, the invention of Master Mechanic H. A. Childs, of the Erie shops at Jersey City.

The expanding jaws are slipped inside the nozzle and the taper bolt drawn up, thus forcing them open and taking a grip on the nozzle. The yoke is then slipped over the bolt and a nut put on. A few turns will persuade the most stubborn nozzle to "have her hold."

Quality of Service More Important than Wages.

During the time the Traveling Engineers' Convention was in session at Denver, Col., President Jeffrey, of the Deaver & Rio Grande, gave an interesting address. Mr. Jeffrey rose through the mechanical department, and naturally is very familiar with the work done by the traveling engineers. Among other good things he said:

"I know that the general conception of a president is a man who can command results. No greater mistake ever dwelt in the minds of men. It is one thing to earn money and another to expend it judiciously and honestly, and a railway spends its money through every employe on its pay rolls. I have come to the conclusion that the wage question is not so important as honest, capable, faithful and reliable service. A careless engineer can lose for his company thousands of dollars yearly on his engine, and it takes the most careful, painstaking scrutiny to discover the loss.

"I see by the papers that you have a committee for the purpose of studying the most economical use of coal. Suppose the cost of the coal consumed is \$100,000,000. A saving of 1 per cent, is a saving of \$1,000,000. Not saved by economy of physical exertion, but by brain power. It is the same with oil and with all other supplies. This is to the end that the corporation being loyally served is benefited thereby. The reason I speak of this subject is that, considering the loss in revenue, the wage question may remain undisturbed. You will have interesting questions to solve and you will be happy in solving them. I remember that when I was a boy one of my happiest moments was when I found out how the steam got into the cylinder of an engine, and this was equalled a few weeks later when I found how it got out again."

Electric Motors for Machine Shops.

Among recent improvements carried out in the Baldwin Locomotive Works was the removing of all overhead shafting from the wheel shop, and the providing of each machine with an electric motor for transmission of the motive power. This improvement has greatly increased the output of work and has materially reduced the power required for operating the machines. Mr. Vaucian estimates from the reduced coal consumption, due to the change from shafting and belting to electric motors, that the saving in power is about 6 per cent. A very important advantage enjoyed by the change is keeping the space above the machines perfectly clear of obstruction. A traveling overhead crane has been put in, which takes the work to and from the different machines, saving a great deal of time and manual labor. The electric motors were used by Mr. George Gibbs, of the Chicago, Milwaukee & St. Paul, and are particularly well adapted for the work. They are substantial machines, that have the appearance of being designed by a man who understood the importance of producing an apparatus that would go on doing its work for months without having to stop for repairs. This is a characteristic that many electric motors sadly lack, and it has prevented this kind of a motor from attaining the popularity which its convenience deserves.

In the admirable report submitted to the last Master Mechanics' Convention on "Shop Tools," attention was directed to electricity as a character of transmitting power, but the committee were constrained to say that they had found very little progress made in utilizing electricity in locomotive repair shops. Owing to the success achieved in operating heavy cranes and other machinery by electricity, the committee recommended members

who contemplated the erection of new shops or extension of old ones to investigate the possibilities of a good electric plant for the transmission of power. If the chairman of that committee could have examined the electric motors driving the heavy tools in the Baldwin Locomotive Works, or the same class of motors transmitting the power to the Juniata shops of the Pennsylvania Railroad, we feel certain that the recommendations in favor of this system would have been much more emphatic. After a careful investigation of the merits of electric motors for driving machinery, the Illinois Steel Company lately applied these motors to perform a great variety of operations in the rolling mills at Joliet.

We believe that it would pay nearly every railroad company in the country, where electric connections could be obtained, to run by electric motors their wheel lathes and other tools that have to be used frequently at night. There is nothing more common than to see a large engine toiling away all night operating a wide line of shafting in order to drive a wheel lathe or a planer that has to be kept in an emergency work. It is like a locomotive being sent out to pull a hand car, with twenty flats in front to steady the load. We feel sure that the knowledge of all improved methods are available, all that is necessary to induce nearly all the

expert like Millen there, and the youngsters are always firing questions at me which I cannot answer.

"Your last paper gave them great enjoyment, and of course gave me an equal proportion of embarrassment. That picture of a boiler with a man standing in the snakebox seemed a wonderful thing. What does the man do inside the boiler? Is there always a man kept inside? Open the door of that other engine and let us see if there is a man inside. These were specimen questions, and then they went for the picture showing the engine cab. I was expected to tell what every attachment was for, which I could not do.

"Then came your 'ignorance exterminator.' What are all these things in the picture? 'An ignorance exterminator.' What is that? A thing that lets people know things, did you say? But how does it work?"

"Every page was gone over, and it was expected that papa could tell what every picture was. Then they would go over the paper again next day and find out more puzzling questions. I must either stop the paper or leave it in the office."

Pump Plant of the A. T. & S. F. Shop at La Junta, Col.

At the La Junta shops, of the A. T. & S. F., they use a great deal of compressed

air, and failing to make out a stock report, was notified a number of times and finally ordered to report at headquarters. The superintendent asked him why he did not make out a stock report, to which he replied "I kill no stock." But said the superintendent "You did kill the stock, and I want a report." "No, I no kill same stock," persisted Old Dutch. "But I say

that. Then there was some polishing in arrears, so he was directed to do that, and the margin of his time was utilized in wheeling coal from a distant part of the boiler house.

There are few people who travel much on railroad trains that have not had narrow escapes from accidents that they hap-



TRAIN WORK IN SILESIA.

you did," repeated the superintendent, "and have proof of it."

"'What kind stock you call him?'" asked our German friend. "Why, hogs," said the superintendent. "Oh," replied Old Dutch, "dat ish not stock—dese is insects."

On another occasion, after being killed a horse, he commenced a vigorous tooting of the whistle, whereupon his freeman asked "What are you whistling now for? You killed that horse, way back there." "Yah," said Old Dutch, "but dese beoples 'round' here don't know dot!"

Utilizing the Energies of a Burglar.

There is a night freeman and watchman with the Menlo Park Manufacturing Co. at Metuchen, N. J., who has a keen sense of practical humor. This man was attending to his duties one night when he heard some one opening the scuttle on the top of the boiler house, and presently a would-be burglar dropped into the stokehole. The watchman had a revolver ready for the intruder, and the first performance was to compel the man to hold

ply knew nothing about. This is a case where ignorance is decidedly bliss. Of all the close calls we have ever heard about, that experienced by the passengers on a train on the Philadelphia, Wilmington & Baltimore last month was about the most awe-inspiring. There is a private railroad crossing on the line. A large wagon containing a ton of smokeless powder while on this crossing was struck by the engine of a passenger train. The vehicle was hurled a distance of about twenty-five feet. Two of the horses broke loose and ran away the other two were thrown down an embankment and the driver was badly injured. If that ton of powder had exploded there would have been nothing but fragments left of train and passengers.

Those familiar with the writings of Shakespeare will remember the weird scene in "Macbeth," where a witch stirs the ambitions of the King's general with the prophecy: "Thou shalt be Thane of Cawdor," intimating thereby that he was on his way to the supreme position of King of Scotland. It is common in some parts of England to let an industrious man "Thou

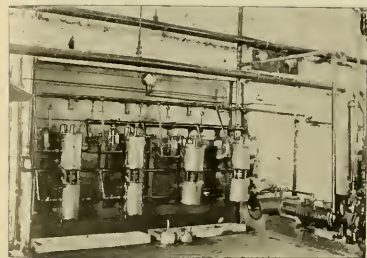

PUMP PLANT, LA JUNTA, COL. SHOPS, A. T. & S. F.

men interested to look into the merits of the electric motor. The electric motor has been applied with great success to all purposes for which flexible shafts have been employed, and it is much more convenient because it is applied directly to the machine without the intervention of belts, and the objectionable rigging that often has to be used with the flexible shaft. Air has been very serviceable in operating special machinery used to facilitate repairs, but we believe that the electric motor is destined in the near future to take the place of many air-driven appliances.

Children's Questions About Our Pictures.

"LOCOMOTIVE ENGINEERING is costing me a great deal of time and gives me no end of bother," remarked President Vreeland, of the Metropolitan Railroads, the other evening at the club. "and I guess," he continued, "I shall have to give it up." The scribe was slightly alarmed and anxiously demanded particulars.

"Well, it's this way," continued our genial friend. "I am in the habit of taking the paper home with me, and I have a small boy and a smaller girl at home who would rather look at the pictures in *LOCOMOTIVE ENGINEERING* than go to bed. They study the pictures in the day time and have all sorts of embarrassing questions to ask me about them when I come home. You see, I am not a locomotive

air, having a main reservoir containing 120,000 cubic inches.

General Foreman M. J. Drury knew well enough that an ordinary air pump was a very wasteful compressor for shop purposes and he arranged to do the best he could with the means at hand.

"He took an old Drane water pump out of the scrap and, removing the water cylinder, put on an ordinary freight car cylinder with a piston to fit, arranged the valves to handle air and the discharge was piped into an ordinary auxiliary reservoir. Into this same reservoir the two long stroke pumps, shown in picture, also deliver, and from the reservoir the two 5-inch pumps take the air further compress it up to the necessary 90 pounds and deliver it to the main reservoir.

The pump nearest the right is connected up by hose, this plant being the test pump for new pumps. The 1 1/2 connections are used to facilitate handling. The lower connection is hinged, and the upper one consists merely of keys in studs to hold pump up. By removing these keys the pump drops forward and rests on the floor, where it can be relieved from lower fastening. One man can take down one pump and put up another.

Stock-Killing Loro.

One of the divisions of the S. P. R. R. has a number among its engineers an Old German known as "Old Dutch." One day he ran over and killed a number of

up his hands, which he readily did on sight of the six-shooter. Presently the fire had to be attended to, and the freeman compelled the burglar to handle the scoop and keep the necessary supply of coal in the furnaces. That seemed to work well, and the freeman concluded that he might as well make the best of his unexpected help. The ash-pits would soon need cleaning, so the burglar was made to do

shall be Thane of Cawdor." During a recent election for presidents of a well-known railroad company a friend of the man elected vice-president, waxing poetical with "Thou art Thane of Cawdor." The fortunate candidate for the high office imagined that his friend must have got drunk, for when he received the message it read, "Thou art class of chowder."

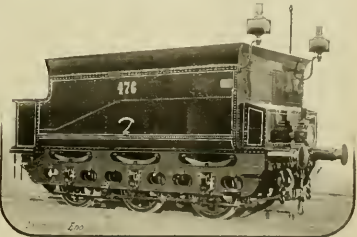

TENDER OF KAISER FERDINAND RAILWAY OF AUSTRIA.

LOCOMOTIVE ENGINEERING

A PRACTICAL JOURNAL OF
 THE SCIENCE OF RAILWAY MOTION

255 Broadway, New York

PUBLISHED MONTHLY BY
 ANGELO SINI LAIR, Editor and Proprietor
 JOHN A. HILL, Associate Editor
 A. LEITCH DONNELL, Artist

Subscription Price.

By mail, per year, \$5.00. Single copies, 15c. Remit by Express Draft, Money Order, Postal Note or Registered Letter.

The editors reserve the right to use any material for the reading column, entirely on its merits. The reading column is not for sale. Correspondents must give their names and addresses, but not necessarily for publication. Standing orders will be filled on all terms, as necessary—always give old and new addresses, and if possible, send a photograph. Please give prompt notice when your paper fails to reach you properly.

Entered at Post Office, New York, as Second-Class Matter.

For Sale by Newsdealers Everywhere.

NO BACK NUMBERS BEYOND THE CURRENT YEAR.

PUBLISHERS' AGENTS.

American News Company, New York,
 International News Co., London, England,
 W. Williams, at Fink's Bldg., Melbourne, Australia.

Notice.

We have less than 100 copies each of January, February and March of this year. When these are gone back numbers for 1904 will be out of print. Not blame us and say we didn't tell you in time.

SINI LAIR & HILL

For 1905.

The American people know a good thing when they see it, and are willing to pay a fair price for it. We have found that the more money we spent in making LOCOMOTIVE ENGINEERING, the better, the more 25 cents double sized it.

This paper is purely a mechanical one, its business is life is to *teach*, to keep men in the mechanical department of railroads posted, it is no good for anything else, but in this line it is unique and stands alone.

Last year we gave our readers their money's worth in the paper, and also gave three Educational Charts. One of these, Chart No. 23, is now framed in thousands of railroad offices and homes all over the world—25,000,000 have been printed and sold—and still there is a demand for it from every corner of the globe.

We have now employed regularly the artist who made the picture of the famous "999," and he will have charge of all our illustrations in the future.

During the year we shall issue a chart, for framing, by Mr. Donnell, that will be in itself a complete dictionary of the sleeping car and of the passenger coach—such a picture in the car line as the "999" picture was of a locomotive.

Another fine picture for framing will be a beautiful color plate of the modern, heavy-wheeled passenger locomotive type. This will be the finest locomotive picture ever turned out by any one.

Beside the two pictures we will send each subscriber for one year a copy of a little book entitled "A Uniform Method of Examining Engines for Promotion and Engineers for Employment." This is the plan just adopted (September, 1904) as standard by the "Traveling Engineers' Association," and is one that every fireman and engineer wants. It has in it the standard blank form of application for position, and the forms of standard test for color blindness. This little book contains the questions proposed to be asked in all future examinations, and is one more educational extra given by LOCOMOTIVE ENGINEERING to its readers. We intend to keep up on our part of things until the very fact that a man in a regular reader of this paper will be a certificate of horse sense in his business.

Our club-runners will offer the above additions to the paper for 1905, not forgetting that the greatest of all extras will be the extra fine engravings and subject matter to be found in the pages of the paper itself.

To Our Advertisers.

We have come to the conclusion that advertising will not pay you—provided your competitors are advertising.

Advertising is a fine art, and the average business man makes a bad job of it—they all know more about their business than they know about properly advertising it.

A large general advertiser employs experts to write and arrange his ads, but those of our advertisers seemed likely to do this, we have employed the expert ourselves.

Mr. Clarence P. Day will hereafter have charge of our advertising columns. He will suggest ideas and help you arrange and change your advertising in an effective manner—make it worth employing regularly an artist, Mr. A. L. Donnell, who will also do our advertisements—he will make a good engraving for the ad of every yearly order free. His man object in being alive, however, will be to make the engravings in the reading columns of LOCOMOTIVE ENGINEERING better and provide more of them.

Maybe these extra articles are expensive luxuries for these times, but we think we know what we are doing. We intend that from this on to the end of the chapter, our contemporaries—to use a Hovey expression—"they won't be in it with us." If you want the services of either one of these artists just say the word—they are yours.

Frictional Resistance and Brake Efficiency.

The republication by the Westinghouse Air Brake Company of papers read by Captain Douglas Galton at meetings of the Institution of Mechanical Engineers, in 1878, on "Effects of Brakes Upon Railway Trains," has revived the interest in a subject which is of absorbing interest to railway men. A study of the paper in the first place impresses us with the inaccuracy of what were formerly accepted as absolute laws relating to frictional resistance. Turning our mental vision to the same laws as propounded to-day, we are inclined to conclude that they are to a great extent guesses, with little claim to scientific accuracy.

The laws of friction as formulated in the text-books are supposed by many people to be as invariable as the laws of gravitation, and are accepted as being equally correct. Unless it be the accepted laws relating to the resistance of trains, we do not suppose that scientific laws were ever established on more insubstantial data than those on which a pretentious system of rules respecting frictional resistance was built up—rules which are still to be found in nearly all engineering text-books. There is a certain class of so-called scientific men who are fond of attempting to establish laws on any natural phenomena which seem to repeat themselves, and they do not have the caution or patience to prove whether or not they are right before going ahead. This has led to an amazing amount of misrepresentation. Fallacies have been declared to be immutable laws. We have seen no attempts until 1913 to establish rules relating to frictional resistance of bodies rolling over or rubbing upon each other. About that time (General Morin of the French army conducted a series of experiments on frictional resistance of different bodies, and which he enumerated three fundamental laws of friction. These "laws" were 1st. Friction between two bodies is directly proportioned to the pressure; that is, that the coefficient is constant for all pressures. It is not so, for instance, when a weight of 4,000 pounds was placed upon a journal the resistance of motion would be exactly double what it would be when the weight was 2,000 pounds. The second law says that the coefficient and amount of friction pressure being the same, is independent

of the areas in contact. The third law holds that the coefficient of friction is independent of velocity, although static friction or resistance to start is greater than the friction of motion.

General Morin's experiments found these rules to be fairly correct under ordinary conditions, but they were not strictly accurate, and were therefore not entitled to be considered as laws. Yet their author considered that he had discovered some new law of nature, and proclaimed them to the world.

There was nothing very strange in the fact that Morin considered acts which repeated themselves under the same circumstances as being likely to produce results of the same proportions under all conditions. We have seen the same thing happen scores of times with men who made experiments with locomotives. A certain valve or smoke-stack or exhaust nozzle arrangement would be reported upon as superior to everything else and uniform in the results produced and worthy to be offered for universal practice, when it was merely superior to others for the particular condition it had to meet.

There is nothing more curious in the history of scientific delusion than the confiding faith with which Morin's doctrines were accepted by the men whose duty it was to investigate and prove before accepting the new theories as gospel. We never heard of the least murmur of doubt. The author of the friction theories was a positive man, with abiding faith in himself, and he carried along the whole world with him in his delusion. The first man to throw doubt on Morin's laws was Prof. Thurston, now of Sibley College, Ithaca, N. Y. While professor of mechanical engineering in Stevens Institute of Technology, he engaged in an extensive series of tests of oils, and by implications of the frictional resistance of lubricants of different viscosities demonstrated beyond question that under ordinary circumstances a journal carrying a load of 4,000 pounds did not offer double the frictional resistance that was offered by a journal carrying 2,000 pounds. This discovery was corroborated by experiments made with dynamometers by the mechanical department of the Pennsylvania Railroad and of the C., B. & Q. Railroad, also by independent experiments carried out by Mr. A. M. Wellington in Cleveland. It was proved that the axial resistance of a loaded car was only about 1 pound per ton, while the resistance of an empty car was about 6 pounds to the ton. The first practical result of this discovery was the readjustment of locomotive loads by all the railroad companies whose officers had kept themselves informed on the progress of knowledge. Guided by the Morin law, it used to be considered proper to load an engine with the same tonnage of empties as the engine was to haul loaded cars. The new light showed that two-thirds of the weight made a train equally hard to pull.

Before the correct law of frictional resistance of lubricated surfaces was properly understood we have frequently heard intelligent engineers arguing that they could not have the same weight of empties as the engine was to haul loaded cars. An important principle deduced from the first of Morin's laws was that the resistance of a brake shoe or of any other unlubricated surface was constant, no matter what the speed might be. This was implicitly believed to be correct until the Galton-Westinghouse experiments with railway brakes were carried out. At a meeting of the Institution of Mechanical Engineers held in London in 1878, Mr. George Westinghouse, Jr., called attention to the fact that in testing the action of various kinds of brake shoes, he observed a reverse law. The coefficient of friction of shoes upon the wheels at high and low speeds. He offered to construct an apparatus to ascertain if the friction of brake shoes varied at different speeds, if the Institu-

tion would appoint any person to supervise the tests. Captain Douglas Galton was appointed and data was obtained which proved that Morin's law was no law at all. It was shown that the coefficient of friction (resisting forces) between the brake shoe and the wheel, diminished as the speed was increased. The coefficient of friction seemed to be controlled by a law for it diminished regularly as the speed increased, and *vice versa*. Heating of the shoes increased the frictional resistance at all. It was shown that the discoveries made in these experiments are very as described in the publication mentioned at the beginning of the paper.

The lessons of the experiments were that brakes should be designed for fast trains in such a way that the shoes could be pressed upon the wheels with a force to suit the speed of the revolving wheels. This has lately found practical application in the reinforced brakes that have been tried on some fast passenger trains. As railroad men come to a realizing sense of the difference in the resisting force of brake shoes at low and high speeds, they will be more and more inclined to make use of a brake with a high ratio of efficiency and a low coefficient of friction. The frictional resistance of brake shoes at 20 miles an hour is about double that it is at 60 miles an hour. A fact of this kind cannot be too widely known.

One important thing concerning the action of brake shoes was unfortunately not demonstrated in the Galton-Westinghouse experiments. This was the relation between the resistance of the existing power. There is some conflict of opinion among experimenters as to whether a large or a small brake shoe holds best, and it is very desirable that the question should be settled beyond dispute. Certain experiments carefully conducted have appeared to show that a generous bearing surface produces the best braking effects, while others have equally well conducted have shown quite the reverse. It is quite conceivable that a brake shoe lightly applied might be too large to produce in a high degree the locking action of surfaces which causes friction. On the other hand, a shoe might be so small that its effect was similar to a wheel when it slides. There is a committee of the Master Car Builders' Association engaged in making laboratory tests of metal for brake shoes which may be able to present accurate information that will be of great value to the whole engineering world. More knowledge is certainly needed about metal for brake shoes. It would be directly in the same line to investigate the most suitable area of metal for doing the most effective braking. Many particulars relating to the laws of frictional resistance have yet to be elucidated.

Interior Boiler Tubes.

The investigations carried out by the railroad mechanical associations and by railroad clubs have left few details connected with railway machinery to be investigated and discussed. There is, however, one subject which seems to have received less attention than its importance deserves, that is the proper material for boiler and firebox bars. These have been thoroughly investigated and railroad men who do not understand what is likely to produce the most satisfactory results in these parts have not kept in touch with advanced knowledge respecting their business. The economical service obtained from a boiler is not to be had until the material of the boiler tubes that it is on the quality of material in any other part, yet there is little attention bestowed upon seeing that the very best boiler tubes are specified.

There is an impression among many master mechanics that charcoal iron makes the best boiler tubes, and they are inclined to specify that material, and in the majority of cases, something less reliable is supplied. Charcoal iron is not a cheap

tubes. In addition to this, the system is harassed by the constant demoralization of the train service due to delays which are almost inevitable in leaky tubes.

A committee has been appointed by the Railway Master Mechanics' Association to investigate and report on the "Best Materials for Boiler Tubes and Specifications for Same." The investigation is in the hands of an excellent committee, and we have no doubt but valuable information will be submitted in the report. There are now standard specifications for boiler steel, and there is every reason to believe that should be added to the list specifications for boiler tubes. It would prevent a great deal of deception, not to say fraud.

correspondent in another column makes some very timely and practical suggestions concerning the danger of making mistakes between the ordinary figures and the full-face figures used on time cards, and in the figures themselves. When a time card becomes soiled or when it is folded on the figures, it is frequently difficult to distinguish one figure from another. This is a source of danger which ought not to exist when there is a simple and highly practical remedy. Time cards are consulted by engineers at night under very difficult circumstances, and every care should be taken to help them in reading correctly. The remedy proposed to make the two sorts of figures more distinctly different is to use script figures in place of the full-face. The script is a figure of different shape than the Arabic figure in common use. It is so distinctive in shape and line that there never would be any danger of mistaking it for an Arabic figure, and a 9 and a 6 are distinctly different. A change of this kind could be made so easily that we can see no good reason why it should not be carried out. We cordially urge the attention to this important matter on all those who have the arranging of time tables.

Secretary Cloud, of the Master Car Builders' Association, has issued a circular saying that the Executive Committee have not been able to arrange for the making of the standard gauges of the Association, because a sufficient number of railroad companies could not be induced to order the gauges. They considered the prices quoted by makers of gauges to be too high. Railroad companies are therefore recommended to make their own gauges. Mechanical engineers are closely associated with heat manifestations, a book which makes these varied manifestations clear to the student is certain to be valuable. The author in this treatise has endeavored to give a clear and concise explanation of the leading phenomena of heat, and has fairly treated from the names of the chapters, which are: Thermometry, Dilatation of Bodies, Calorimetry, Profundity of Heat, Expansion of Gases, Change of State, By Geometry; Conduction; Radiation; Thermic Dynamics; Terrestrial Temperature; Aerial Meteors; Aquatic Meteors. To the engineer the first nine chapters are of the greatest importance, and the remaining three are less so.

Those interested in weather phenomena will find the last two chapters interesting and instructive.

PERSONAL.

Mr J. R. Bissett has been appointed foreman of the shops of the Atlantic Coast Line at Rocky Mount, Va.

Mr. W. B. Poland has been appointed assistant chief engineer of the Cleveland, Cincinnati, Chicago & St. Louis at Cincinnati, O.

Mr. B. A. Cunningham has been appointed division engineer of the Lehigh Valley between Manchester and Wilkes-Barre, Pa.

Mr. J. H. Simpson has been appointed assistant to the general manager of the Flint & Pere Marquette, with headquarters at Saginaw, Mich.

Mr. S. J. Morris has resigned as general foreman of the Louisville & Nashville shops at New Orleans to accept a position on the Western of Alabama.

Mr. R. E. Riggs has been appointed chief engineer of the Mexico, Cuernavaca & Pacific. He was formerly chief engineer of the Denver & Rio Grande.

Mr. T. Carmody has resigned as master mechanic of the New York Pennsylvania & Ohio Division of the New York, Lake Erie & Western at Cleveland, O.

Mr. H. O. Burroughs has been appointed foreman of the shops of the Florida Central & Peninsular at Jacksonville, Fla., to succeed Mr. Charles G. Mann, transferred.

Mr. L. R. Brooks, of Birmingham, Ala., has been appointed superintendent of motive power of the New Orleans & Southern, with headquarters at New Orleans, La.

Mr. Walter Shepard, heretofore assistant chief engineer of the Boston & Albany, has been appointed chief engineer of that road, with headquarters at Boston, Mass.

A dispatch from Chihuahua, Mex., states that ex-Union mechanic McKelvey, of the Iron Mountain Road at Little Rock, Ark., has been stabbed twenty-six times by a Mexican.

Mr. Thomas Crow has resigned as master mechanic of the New Orleans & Southern at New Orleans, La. to accept the position of chief engineer of the Belle View plantation.

Mr. S. K. Kramer has been appointed superintendent of the Peoria Division of the Lake Erie & Western, with headquarters at Lafayette, Ind., to succeed Mr. E. O. Grady, resigned.

Mr. F. D. Thompson has been appointed general superintendent of the Chesapeake, Ohio & Southwestern Railroad, with headquarters at the general offices of the receivers in Louisville, Ky.

Mr. George L. Bradburn, general manager of the Lake Erie & Western, has been chosen vice-president of the Cincinnati, Jackson & Mackinaw, in charge of the operation of the road.

Mr. H. E. Burt has been appointed general superintendent of the Minnesota & Wisconsin in place of Mr. James Monogue, who was acting superintendent, headquarters, Spring Valley, Wis.

Mr. Wilbur Lee has been appointed general manager of the Oregon Railway & Navigation Co. He is a son of Mr. David Lee, engineer of maintenance of way of the Baltimore & Ohio Railroad.

Mr. F. F. Robb, superintendent of the Bedford Division of the Pennsylvania Railroad, has been appointed superintendent of the Camden & Clearfield division, with headquarters at Cresco, Pa.

Mr. T. F. De Garmo, president of the Railway Supply Men's Association, so well known to railroad men through his connection with the Trojan car coupler, has taken the management of the Burns' car coupler.

Mr. J. N. King has been appointed superintendent of the Philadelphia, Reading & New England, succeeding Mr. G. T. Royer. Mr. King was for some time a division superintendent of the Lehigh Valley.

Mr. J. H. Emmert, general manager's assistant of the Kansas City, Fort Scott & Memphis, has been appointed superintendent of the Springfield and Orank division of that road, with headquarters at Springfield, Mo.

Mr. J. D. Begg, who has for a number of years been a machinist in the shops of the Columbus, Hooking Valley & Toledo at Columbus, O., has been appointed master mechanic of the Southern Pacific at Houston, Tex.

B. F. Pabst, traveling engineer of the Baldwin Locomotive Works, left New York on October 2d for Brazil. Will McCarell is in Europe, and Chief Inspector Crawford in Japan. The Baldwin engine are trade builders.

Mr. David M. Watt, for nearly thirteen years superintendent of the Montgomery division of the Pennsylvania Railroad, has been appointed superintendent of the West Pennsylvania division, with headquarters at Allegheny City, Pa.

Mr. H. B. Harper, trainmaster of terminals of the Chicago & Eastern Illinois at Danville Junction, Ill., has been appointed division superintendent of that road, in charge of the Brazil division, with headquarters at Brazil, Ind.

Mr. E. F. Weld, who some time ago resigned as purchasing agent of the Flint & Pere Marquette to go to the Southern Railway, has been appointed general storekeeper of the latter system, with headquarters at Richmond, Va.

Mr. James Reed, who has been superintendent of the West Pennsylvania division of the Pennsylvania Railroad since January, 1901, has resigned that position. He has been connected with the Pennsylvania system in various positions since 1872.

Mr. J. W. Garsule has been appointed commission foreman of the Interoceanic, at Puebla, Mex., under Superintendent of Motive Power W. R. Barclay. Mr. Garsule learned his trade at Hornsville, N. Y. Everyone is glad to see him climb the ladder to promotion.

Mr. R. D. Fowler, heretofore trainmaster of the Chicago & Eastern Illinois at Brazil, Ind., has been appointed division superintendent of that road, with headquarters at Danville, Ill., in charge of the main line, St. Louis division and Cissna, Rossville and Brazil branches.

We are informed by the Ajax Metal Co., Philadelphia, that Messrs. P. A. Lester & Co., Monroeville Building, Chicago, will take orders and represent all their products including bearings metals, electrical supply department, roofing plates and all other articles manufactured by the Ajax Metal Co.

Mr. Willard A. Smith, so well known through the duties he performed as chief of the transportation department of the World's Fair, has been made vice-president of the National Malleable Castings Co., and will have charge of the railway sales department with headquarters in the Old Colony Building, Chicago.

Mr. Charles L. Sullivan has been appointed mechanical engineer of the railway department of the National Malleable

BOOK NOTICES.

ELEMENTARY LESSONS IN HEAT. By W. E. Tillman, Professor of Chemistry, United States Military Academy. John Wiley & Sons, New York.

This is the second edition, revised and enlarged, of a useful book treating on a subject which is of great value and interest to all students of physical science. As a mechanical engineer, one is closely associated with heat manifestations, a book which makes these varied manifestations clear to the student is certain to be valuable. The author in this treatise has endeavored to give a clear and concise explanation of the leading phenomena of heat, and has fairly treated from the names of the chapters, which are: Thermometry, Dilatation of Bodies, Calorimetry, Profundity of Heat, Expansion of Gases, Change of State, By Geometry; Conduction; Radiation; Thermic Dynamics; Terrestrial Temperature; Aerial Meteors; Aquatic Meteors. To the engineer the first nine chapters are of the greatest importance, and the remaining three are less so.

Those interested in weather phenomena will find the last two chapters interesting and instructive.

Castings Co., with headquarters at Colony Building, Chicago. Mr. Sullivan was formerly engineer of tests of the Baltimore & Ohio Railroad, and was for a time with the Byrdon Brake Co.

Mr. Walter G. Berg, principal assistant engineer of the Lehigh Valley Railroad, has been elected fourth vice-president of the American International Association of Railway Superintendents of Bridges and Buildings. Mr. Berg is author of a book on railroad buildings, and he is an excellent authority on cooling stations for railroad use.

Mr. S. C. Boutelle, a well known engineer, of Los Angeles, California, on the 1st of September appointed master mechanic of the San Diego, Oldtown & Pacific Beach R. R. But Boutelle is an old-time railroad man, having been for a number of years master mechanic of the California Southern. The S. D., O & P B is to congratulate him on securing the services of so competent a man.

The jurisdiction of Mr. John Henney, Jr., superintendent of motive power of the New York, New Haven & Hartford system, has been extended to the Old Colony system, covering the duties formerly performed by J. N. Lander. Mr. Henney has been with the New Haven Company for many years, having risen through successive grades to his present position. He is a highly conversative man, and is deservedly popular with his management.

The numerous friends of Mr. C. A. Moore, of Manning, Maxwell & Moore will be concerned to hear that he met with a painful accident last month, which nearly ended his career. He was out riding in a carriage and the horses ran away, throwing out the occupants. The coachman was instantly killed, and Mr. Moore was badly shaken and sustained a painful injury to his side. His little daughter, who was in the carriage with her father, escaped without injury.

Mr. Edmund S. Bowen, formerly assistant to the president of the New York & New England, has been appointed general manager of the South Carolina & Georgia, in charge of transportation and maintenance, with headquarters at Charleston. S. C. Mr. Bowen is a railroad manager of mature experience, and is known as one who has a particularly keen eye for reducing expenditures not absolutely essential. He was general manager of the Rome, Watertown & Ogdensburg when Mr. C. H. Parsons was in control.

Mr. W. D. Fwing, the enterprising general superintendent of the Fitchburg Railroad, is reported to be endeavoring to be striving to effect a re-organization of the use of the locomotive whistle. He holds correctly that there is confusing diversity among engineers in sounding long and short whistles. Mr. Fwing is working to instruct the men how to give time in sounding the whistle. Many mistakes have been made by trainmen through misunderstanding whistle signals, and this subject is certainly worthy of more attention.

The numerous friends of Mr. Orlando Stewart, formerly superintendent of motive power of the Fitchburg Railroad, will be pleased to learn that he has been appointed superintendent of machinery of Bangor & Arundel, with headquarters at Oldtown, Me. We converse all his friends know that Mr. Stewart is treasurer of the Railway Master Mechanics' Association. Before going to the Fitchburg he had experience on the Lake Shore and other leading railroads, and was for a time in the employ of the Government in the South during the war.

Mr. Daniel Coxe, Supt. of the D. S. & S. road, was married on October 10th to Miss Margaret Eliza White, of Drifton, Pa. It was only a month ago, and we heard a prominent railroad man say

"Dannie Coxe is the youngest man designing locomotives in the country. He has ideas out of the usual and the courage of his convictions—he builds his engines the way he believes—and every idea advanced has proven a success in practice. He keeps out of the old ruts." And now "Dannie" goes west and spins a new thread for the old, old rule, and getting married, just like the rest of us. But here's long life to you and yours!

Mr. Wilford Kells, for two years general foreman of the New York, Lake Erie & Western shops at Meadville, Pa., has been appointed master mechanic of the New York, Pennsylvania & Ohio division at Cleveland, Ohio, in charge of the shops at that point. Mr. Kells is a son of the late Ross Kells, formerly superintendent of motive power of the road. Wilford was made the master trade in the shops at Noysephanna, when his father died. He was the kind of youth that good men are made from, and was ambitious to render himself worthy of promotion. Mr. Mitchell took a warm interest in him and has given the young man the opportunity to help himself, and the good offices were not wasted, and that indicates that he will be a success as a master mechanic.

Mr. Henry S. Manning, of the firm of Manning, Maxwell & Moore, inherited a taste for art which he has cultivated until he is an authority in several art lines. He has a warm liking for fine wood carving, and some time ago he employed a famous artist to make designs for staircase and room carving decorations. They were very satisfactory, and Mr. Manning imagined that he had something unique. Last summer and winter he spent several months in Europe, and on his way made a visit to Northern Africa to see the ruins of some ancient cities. There were excavations going on among the ruins and Mr. Manning thought he would like to try his hand on digging for relics. He did not dig long when he unearthed some fragments of marble work beautifully carved. When he examined these designs he was greatly fascinated, and close examination convinced him that they were the same as some of the oak carvings in his house. He has been trying to get the artist to explain how it came that his designs were copied by the people who carved that marble.

Two Hundred Engineers.

The authorities who confer honors in the French Republic appear to have a proper appreciation of the importance of engineering. During a recent visit to Paris, the writer met two superintendents of railway machinery who had been decorated with the Legion of Honor.

The first was Mr. George Whaley, of the Western Railway of France. Mr. Whaley was sent by his government as Commissioner of the Columbian Exposition, and while attending to his duties in that appointment, he spent several months in the United States. He visited our leading engineering and railroad establishments, and made many friends wherever he went. His name is English and he talks English without the least trace of French accent. He is surprised to find that everything relating to railway engineering as it is seen in all parts of the world.

The other engineer who carried the devotion of the Legion of Honor was Mr. Edouard Sauvage, superintendent of machinery of the Eastern Railway of France. He is the author of a book on the locomotive, which is greatly used by engineers. Mr. Sauvage is preparing for their examination of his countrymen, and is a greater part of a life to showing the writer about his establishment. He is remarkably well informed concerning American railway practice and reads our engineering literature with much attention and interest.

John Wiley & Sons, New York, have in the press a new mechanical engineer's pocket-book, prepared by Mr. William Kent, a well-known member of the American Society of Mechanical Engineers.

Place For Next Railroad Mechanical Conventions.

The joint committee of the Master Car Builders' and Master Mechanics' Associations met at Chicago on October 10th to consider where the next convention should be held. A number of letters were read respecting the hotel accommodation that could be provided at Mantion and Colorado Springs. The committee concluded that the accommodation was not sufficient. Letters were also read from a variety of other places that wished to secure the convention.

On an informal vote being taken it was found that most of the committee favored Thousand Islands, Alexandria Bay, N. Y. That place was selected. A committee of arrangements was appointed, consisting of S. A. Cronk, R. C. Blackall, C. F. Fuller, Jr. This committee has sent out a circular intimating that arrangements have been made with the Croton House and the Thousand Islands House as joint headquarters. Parties who expect to attend the conventions ought to apply for rooms without delay.

At the Traveling Engineers' Convention there was inclination among some of the members present to hold that a fireman could not be instructed about brakes in the thorough way recommended by a committee. When the subject was under discussion Mr. R. D. Davis, of the Illinois Central, said: "I want to state an occurrence that happened in the air-brake instruction car the other day at Chicago. I had seven engineers in there, and one fireman asked if he could come in and listen. I said, 'Certainly.' I had instructed all those engineers, and then was asking them to trace the air through the chart I had on the side of the car, and there was not one that could commence to do it. After I had instructed them, I am sorry to say, they couldn't do it. This young man, this fireman, said, 'I would like to do that.' He got up there and traced the air through better than I could. I believe, that is, he could name every part and number letter than I could. There was nothing when he got through that I could tell him. Others possibly could have told him, but I never saw a man in a car in my life that could trace the air through and explain the air brake and workings better than that fireman. It was not three months after that when I had him on a locomotive, and he is running to-day and giving good satisfaction, and he learned it himself."

The American International Association of Railway Superintendents of Bridges and Buildings held the fourth annual meeting at Kansas City last month. President J. E. Wallace of the Wabash presided. Papers were read on "Best Methods of Bridge Inspections," "Maintenance of Pile and Frame Trestles," "The Best Scale Foundation," and on "Depressure Cider Pits." All the papers were of a highly practical character. The meeting will be held next year at Atlanta, Ga. The officers elected were: President, Gen. W. Andrews, Baltimore & Ohio, Philadelphia, Pa.; Vice-President, W. A. McConaghe, Duluth & Iron Range, Two Harbors, Minn.; Second Vice-President, L. Spafford, Kansas City, Fort Scott & Memphis, Kansas City, Mo.; Third Vice-President, James Sionnard, Wabash, Moberly, Mo.; Fourth Vice-President, Walter G. Berg, Lehigh Valley, Jersey City, N. J.; Secretary, S. H. Patterson, Concord & Montreal, Concord, N. H.; Treasurer, George M. Reid, Lake Shore & Michigan Southern, Cleveland, O.

The *Street Railway Journal* have made their tenth anniversary the occasion for issuing a special number containing an account of the American Society of the American Street Railway Association. The number shows very great enterprise on the part of the owners of this publication.

It contains a sixteen page article on Atlanta, a ten page article on the association, a thirty page article on the street railways of Southern cities and a twenty page article on the history of the street railway industry. All these are handsomely illustrated, containing over 500 engravings, among which are 125 portraits of leading street railway men. The number ought to be highly appreciated by all street railway interests.

A very interesting and valuable department has been inaugurated by the *Engineering Magazine*, called a "Review of the Industrial Press." Engineers and business men interested in industrial matters have generally so much to do that they cannot give the reading of industrial publications the time they would like to devote to this line of reading, and consequently they often miss things that are important for their business. The plan adopted by the *Engineering Magazine* will prove a great boon to such men if it purposes to call the fairest flowers of the industrial press and perform the function of the kind of literature that the *Reviews of Reviews* does for the light literature of reading. We consider the enterprise a highly valuable one, and we have no doubt that it will meet the deserved appreciation.

The *Car Journal* has been made the official organ of the Master Car and Locomotive Painters' Association.

EQUIPMENT NOTES.

The Mexican Central are in the market for 200 cars.

The Swift Refrigerator Car Co. are about to order 200 refrigerators.

The C. N. O. & T. P. are said to be in the market for 300 box cars.

Baldwin's people have just shipped a number of locomotives for Japan.

The Wells & French Co., of Chicago, are building 500 cars for Armour & Co.

The Mount Vernon Car Works are building 500 freight cars for the Louisville & Evansville & St. Louis.

The Niles Tool Works have lately shipped a large quantity of tools for the Boston & Albany shops and for the Georgia Central.

The Savannah, Florida & Western are in the market for the building of ten refrigerators cars of a new form designed by President Platt.

The Southern Railway have ordered eight new engines. Five have gone to the Richmond Locomotive Works and three to Rhode Island.

The Southern Pacific has given out the building of forty-three new locomotives. Cook's people received twenty of the engines, and the others went to Schenck's.

The proprietors of the "Official Railway Equipment Guide" have arranged to issue quarterly a pocket list of railroad officials. We have examined a specimen number and find that the names and addresses are correct and up to date. The fact of the publishing this book four times a year will add very materially to its value. Mr. J. Alexander Brown has charge of the new list.

The Consolidated Car Heating Co., Albany, N. Y., report that they have just received orders for the entire equipment of the Norfolk & Western Railway with its Commingler Storage System and several steam coupler, also for the entire equipment of the Ulster & Delaware R. R. with its Direct Steam System No. 2 and the Sewall steam coupler. The orders include equipment of all locomotives on both these roads with the Consolidated improved locomotive equipment.

Practical Letters

from Practical Men.

Facts Wanted.
There's a glut
of Opinions.

Write on one side of the paper, state your point plainly and briefly, and then quit. We supply the generalities. No letters noticed unless name and address are annexed.

Reform Needed in the Figures of the Time Cards.

Editors

That a particular kind of type, often used in the printing of railroad time tables, is dangerous, may seem improbable to those who are responsible for the cards, and possibly to everyone who consults it, except engineers and conductors. Those two classes of railroad men are responsible for a passenger and bit of freight that goes out on the road, and as the traffic represents the sole source of income to the railroad companies, and as engineers and conductors must correctly read and understand the time card in order to take their train over the road safely, it is a matter of no little importance that the card should be printed in the figures easiest to read and easiest to identify in case of a partial erasure, or obliteration from soil or shade.

The regular time tables that I am acquainted with were issued for use on representative, first-class roads, but I am sure that if the officials who arranged them and were satisfied with the kind of type used had ever been locomotive engineers, the time card would not have been printed in these materials.

Sketching a time table printed in Roman type from the seat box or foot plate of a locomotive in motion, is very trying to the eyes and brain of a man of perfect sight and sound broad daylight. It isn't like sitting in a office with the paper spread out before you, without ether or stim, or in a comfortable, in the steady light of day of a city office, when your eyes have time to rest on your finger up and down the column until the right figure is found. An engineer's attention is diverted from the card several times before he finds what he wants to know, and then it's a glance, and he finds the card and shoves it down in his pocket. Trying to read a time card at night in the cab of a passenger engine for twenty or fifty miles an hour, by the necessarily dim light of the cab lamp, the engine bounding, jolting and careening sideways and back, and the eyes temporarily blinded by the intermittent flash from the firebox door, is one of the hardest duties of an engineer, and excites nervousness even with old runners, for a correct reading of the time card is necessary to the safety of the train and every use of it including himself, and necessary in order that he may hold his position as engineer.

Arabic numerals are dangerous, because half of the figures look alike under certain conditions that easily and often occur. They have the same dimensions, height and width. The eight and numerals 0, 4, 6, 8, 9, or in full face, to designate meeting points, 0, 3, 6, 9, fill the outlines of similar sized ellipses or ovals, and may, by the use of a sharp instrument, be partially effaced so that they appear as five eights, or grease or dirt may produce the same effect. I have seen time cards where the zeroes from fading, make everyone of those five characters illegible, where the zeroes crossed the shingle.

There is one style of figures that bear no resemblance toward each other whatever—the kind that is easiest to write and easiest to read—script. I have seen a few of them on the time cards, and would be impossible to mistake any one figure for another, or to fail to recognize the power of a character, unless it was almost entirely obliterated. Possibly there are roads that print their time-card figures in script. I have never seen such a card.

Ever, Ever, Ever, Inc., W. H. WOOD.

A Strange Wreck.

Editors

A heavy passenger engine while running at a high speed broke the left side rod (solid end). Very little other damage was done on the left side, but on the right side the wreck was more complete. I inclose sketches of a pair of each right driver. Fig. 1 is back wheel, Fig. 2 forward one. The crank-pin hub on back wheel had one half of it and part of spoke A broken out completely. Spokes 1, 2, 3, 4 front and back wheels, were broken. Spokes B, C, D, E, back wheel, each had a large piece broken out of the outside edge of the spoke. Forward crank pin hub was

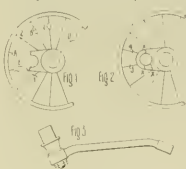

broken through at the dotted lines. That part of the wheel not shown was un injured. Fig. 3 is the right side rod with the back pin in it, the forward end of rod was on the forward pin, which remained in the wheel. The rod was bent about as shown, and with the holes in solid end somewhat elongated. Now what wrecked the right side and what broke the pieces out of the spokes? The back wheel was in a generally battered condition. I have a theory bearing on the subject, but what say the readers of this article? The man on the right side claims he had just put on the air when she let go, but as he was not going to make a stop why did he put on the air? Guess he put on the air after the racket began, for report says that when the train stopped he and the fireman were at back steps of rear coach.

Indianapolis, Ind. W. H. SANNO.

Location of Gauges for Instruction Plants.

Editors

The interesting cut that you present in your October issue of the "Ignorance Extremist" in the D. & H. shop, calls to my mind a suggestion which I should like to make to those contemplating the erection of such an outfit.

It is in reference to the location of the gauges. In my experience as an instructor, I noticed frequently that confusion arose in the minds of the pupils in regard to the explanation on a certain car, because I had a double gauge above it with the red pointer connected to the reservoir and the black one to the cylinder. It was so seemed to be bothering trying to remember which was which that I finally adopted the plan of using only single pointer gauges, and in all cases, where possible, screwing them directly into the reservoir or cylinder they were intended to indicate. This proved to be a far more satisfactory way, as any man seeing a gauge screwed directly into a reservoir knows at once that it is the pressure in that reservoir that it is intended to record. No explanations or labels are necessary. To be sure it does not look as well from an aesthetic standpoint as it would to have them all in one row or artistically arranged on a circle, but one soon learns to regard the greatest use as of the greatest beauty.

I think I hear some one say, "If they are so separated they cannot all be seen from one point," and in reply to that remark I would say that this can easily be arranged by turning all the gauges so that they will face the operator while standing at the engineer's side, and that if they are of a fair size, with black pointers, no difficulty in that line will be experienced.

Chicago, Ill. PAUL SANNETT.

That Lead Question Again.

Editors

I know the shifting link as usually arranged with lead increasing as the lever is hooked up, is best for a locomotive, but "Queenlander" wanted to know the capabilities of this most wonderful piece of mechanism, and as you are never intentionally unfair I wish to say that there is no "distortion" in either the arrangement which gives decreasing lead as the lever is hooked up, or in that which gives constant lead for the forward motion, and a lead which decreases from center to corner for back motion. The company for which I work, like many others in the coal regions, has a great number of large reversible hoisting engines, with balanced slide valves and shifting links, the links so arranged that the lead decreases as the lever approaches the center. This arrangement gives security against any failure of the throttle, for the engines can be handled perfectly by the reverse lever alone. One engineer running a pair of engines with cylinders 36 x 60 inches, having slide valves 32 inches wide, can open the throttle in the morning and run all day without closing it, controlling the engines by the reverse alone, and the hoisting is very rapid, and the stop must be made at exactly the same point.

Scranton, Pa. THOMAS POPE.

A Cheap Machine for Putting on Hose Fittings.

Editors

Seeing a cut and a description of an apparatus for putting fittings on air hose, and believing the apparatus used in the U. P. D. & G. shop at this place to be a little better than the one described, I send you herewith a rough sketch and a

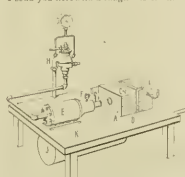

description of my machine. It is the invention of and built by Mr. Henck Baker, a machinist in charge of air-brake work at this point.

It is a bench built along the shop wall near the rack for testing air pumps. It is an oak block fastened securely to bench, the upper portion hinged to the lower one, and a hole through the latter large enough to take in air hose. It is a lever fastened to upper block at one end, D, is an iron catch fastened to lower block to hold lever of upper one. C, is two pins which go through upper block and into lower one to take strain off of hinges and it loosely so they will raise out with upper block. E is a tender brake cylinder bolted to bench, as that piston comes opposite hole in block and about ten inches from it. A clamp fixed to upper side of cylinder directly over piston, G is a hook fixed on upper side of piston in line with clamp above. It is a brake valve placed up over

cylinder, with gauge J on back of it. J is air pump or reservoir placed under bench.

The operator opens block, places hose in position, clamps it with lever, while leads the fitting and places it in position between hose and piston, applies air lightly, and the fitting is pressed into hose solidly.

One man has, with new hose, put fittings on both ends, together with clamps, ready for bolts, and filled up fifty hose in one hour, and with old fittings has fitted up six hose in one-half hour, complete, putting in both fittings, clamping and putting both ends of hose together, and putting in new gaskets in all of them.

The clamp and hook on top of cylinder and piston is used to pull out old fittings from worn out or bursted hose.

Just catch fitting on hook on piston, clamp hose through clamp on cylinder and apply air and the fitting is out.

This machine, as you can see, is the best for this work that I have seen, and is a credit to the builder, Mr. Ben Demer

Pitkin, Col. FRANK BODIER.

Bunching Trains Where Only Partly Equipped with Air-Brad Inspection the Cause of Much Road Troubles.

Editors

The argument in favor of engine brakes that may be operated independent of the train brakes, printed in the October number, was cordially received by a man who gives air brakes on the road. Mr. Shaffner tells why he wants an independent engine brake, and his reasons are good, but it is not likely that he will get what he wants, because the manufacturers and purchasers of air brakes know of no practical reason for using independent brakes, and do know of some practical and many theoretical reasons against their use.

I think that whenever the train brakes are applied, every brake shoe on the train and engine should do its worst squeezing, but I do not think, and know, that there should be some means of "bunching" the train—closing the cars tightly together—before the train brakes are applied, and if the head of the railway transportation departments had ever been train employes in the freight service since freight trains began to be controlled by the air brakes of twenty or thirty per cent. of the cars in the train, freight engines would be equipped with some sort of a brake to close the slack of the train when necessary, regardless of the ideas of the motive power departments and the air brake companies on the subject.

Mr. Shaffner had forgotten his best argument, and but few train cars, as yet, equipped with air brakes "from pilot to calouse." When a freight train has only a number of cars at the head end working air, and the rest is usual on non-mountaintop roads now, it is very hard and almost impossible for the engineer to apply his brakes without causing severe and damaging shocks to the cars and their contents in the rear of the air cars. "Theory says to make the severe application of from five to seven pounds of air, and you will see, if you are not close to the train to jam together. Practice says that when the brakes of the engine and tender and first ten cars of a thirty-car train are applied simultaneously, be it never so lightly, shocks are unpreventable, and I have seen brakemen and conductors wear their feet apart, their clothes and with stitches in their skin, and even with arms in slings as testimony to that effect, and what is the effect on the goods that are fragile and to be handled with care?" At first, trainmen were inclined to blame the engineers, and call them "Jonahs" with the air, but soon they learned that air-brake trouble on the road gave a calouse as severe punishment as the other engineers did, and the trainmen interested themselves in learning to apply, and most of them have learned a great deal more

about the air in the question would seem to suggest.

If the engine and train brakes are in perfect condition, shocks must occur at the lightest application of the brakes, because the train is always stretched when they are to be applied. If using steam, the engine draws out the slack from the head end, when the engineer shuts off, the rear brakemen sets his hand brake and keeps the train stretched to prevent its breaking apart. If it were possible to operate the driving or tender wheel brakes without affecting the train brakes, the slack of the train could be taken gently, after which the train brakes could be applied with any degree of force and no shock would be felt.

It is nearly every time a freight engine has occasion to shut off and feel for danger, it is more the train he is following, or the sliding may not hold the opposing train at the meeting point, or he guesses that there will be orders for him at the station around the curve, and there is no time to take care of it, there is he must stop quickly, and he would find a train-braking brake invaluable. If an engineer sees danger and applies his train brakes only to take up the slack and slightly check the train, each car's application goes toward rendering the application mechanism of the triple valve ineffective. He knows that, and if he could control the slack with an independent driver valve, he would not hesitate to take the advantage offered by the emergency feature of the brakes if a quick stop was necessary, and he could do it without damage to the train or its loading.

I have assumed that the train brakes are in good shape, but of freight cars, none more than a third are in condition to give reliable service. I refer to them the interstate traffic. The trouble is especially in foundation brakes, but it is also often defective, one or more of the following: application too weak, and thus that the air in the same cylinder. When the train cars in train, but partly equipped with air, have triple valve defective in this way, a brake on the engine that would check the slack of the train might injure itself on a single trip.

The statement as to the condition of freight air brakes may be disputed, but I am sure that I speak before committing myself. It is the result of imperfect air-valve condition, or as the cause in some cases of leaks, in our inspection whatever. This is a pity of very false economy, but is not peculiar to any certain roads. Of cars that I have seen with defective air brakes, an approximately large per cent. of them have the initials of one of the largest and most prosperous roads in the country, and one of the roads owning the greatest number of air-braked cars.

The railroads have been enlarging their air brake equipment, until now nearly every freight train that goes out on the road has some air-braked cars. The engine, too, but engineers and trainmen know that their roads are not getting full benefit of the brakes, because they can see that the brakes are not kept up in shape. It is known that when one-third of the cars in a train have perfect working air brakes it is an easy matter for the engineer to control the speed of his train, and if he gets into trouble because the engineer couldn't stop it with air brakes on a third of the cars, he is censured or punished according to the extent of damage done, or for an accident for which his employers are directly to blame. He knows when the brakes are not holding his train as they ought, but it is not his duty, nor has he the time to go back and inspect them. The trainmen, too, know when there are defective brakes in their train, but it is hard for them to locate the trouble, and harder still to get them to assume the responsibility of keeping the air brake system in order.

A freight train came in on the east division the other day with bad brakes, as usual, and the next day the same engine

and train crew were sent west. The engineer invited me to ride out to the yard with him and look at the brakes on the train which he was to take out. After we coupled on to the train the conductor came up and said it was the same train they had brought in the day before, and he hoped something had been done to the brakes. The engineer made me look along the train, examining the brakes, and appearing satisfied if the shoes were so tight against the wheels that they could not be moved with the foot. I looked at the piston travel and condition of rods and levers, and they were in bad shape. Some of the shoes were barely seated against the back head, their rods were pushed out so far. Both brakemen disappeared under a car, and I found them trying to take up the slack of the brake rigging with the dead track levers while the brake was set. They nearly did it, too. The piston was at full stroke, and the shoes were so loose that the rods in the wheels were next to the last holes in the brackets. The engineer released the brake, the levers were drawn to the last hole, air was again applied and the brake of this car set, but the piston still made nearly its full stroke. This was the worst brake in the train, but many other brakes were bad, the train had about four or five bad shoes next to the last holes in the brackets. The engineer released the brake, the levers were drawn to the last hole, air was again applied and the brake of this car set, but the piston still made nearly its full stroke. This was the worst brake in the train, but many other brakes were bad, the train had about four or five bad shoes next to the last holes in the brackets. The engineer released the brake, the levers were drawn to the last hole, air was again applied and the brake of this car set, but the piston still made nearly its full stroke.

Will W. Wood

Very Hable, Ind

Locating Brake Defects.

Editors

Some time ago a complaint was made by the engineer running a train that something was wrong with a coach brake. It would not release promptly, and sometimes leaked very bad at exhaust port, at other times brake worked first class. The train was engine, tender, combination luggage and smoker, and one passenger car. Going one way the tender was coupled to the train, on the return trip, front end of engine was coupled to train, there being a pilot on back end of tender. The triple valve was taken down, their rubber seal on emergency valve found out of order. No other work done to trip except giving it a good seat, engine was coupled to train at tender, the brake worked very nice, set as it should, and released safe every time; engineer and trainman pronounced it good. The next trip it was just as bad. Another expert happened around that way, took the offending triple apart, and it was O. K., but that did not make it O. K., for it kept leaking, not every time it was set, but often enough to be troublesome. By all of it then the engineer thought it only stuck on them when front end of engine was coupled to train. He uncoupled the hose, opened angle-cock, a very small amount of air came out, showing a stoppage somewhere.

On taking down the angle-cock the whole trouble was found. The angle-cock the whole angle cock had been broken or taken off, and a wooden plug driven in the end of pipe. When the machinist came to put another angle cock on it was easier to drive the plug into the pipe than to get it out, so he drove it inside and left it there. This plug was not tight enough to slide along in the pipe and let some air out, so a service application could be made, but when air was turned back into train-pipe to release brake plug slid up against angle-cock and air went past it, so slow coach brake failed to let off as promptly as it should. Now, if it had been stated in the first place that brake was not set, and when coupled to tender and poorly when coupled to front end of engine, the trouble

could have been located at once as a stoppage in train line at front end of engine. If it had been stated that coach brake had to be bled each time it stuck, that pumping up a high train line only made it stick tighter, it would have indicated a leaky piston-packing ring in triple, two faults which did exist, when these two faults were corrected, the triple worked as it should. When coupled to a clear train-pipe, the excess pressure took care of the leak past triple piston, but when it had to get by the wooden plug slow, train-line pressure in coach increased so slow the leaky ring set its work in most every time. Excess pressure takes care of lots of leaky piston-packing rings.

Here is another one.

A driver brakes triple was reported out of order; another one was put on which would not work at all. An expert was called on for an opinion. He said, "Try the brake." It did not set, no air came into brake cylinders from the triple; it looked all right, and blind joint in one car of the units; the auxiliary had a good stiff pressure in it before setting the brake and none at all after an emergency application, and train line was emptied. When brake was tried first time with service application the air-brake man noticed there was air enough came out of train line exhaust port for at least six cars, and it was a four-car train, so he made a mental note that D. 8 valve ought to have the equalizing piston fixed, as it stuck up when the pressure was equalized. On a closer examination the triple was found to have been piped wrong when it was put up by the machinist, the train pipe being coupled to top connection of plain triple and driver brake cylinder pipe coupled on where train pipe ought to be. When this job was first done and triple piston was up in full release position, air came out of exhaust a full stream from train pipe by passing under air valve No. 6 through exhaust cavity, so it had to be cut out at four-way cock, but after the piston had worked down to its seat, the air was covered and air could accumulate in auxiliary reservoir it pressed piston down to the bottom of its stroke, this holding air port over valve 6 open so there was open communication between train line and auxiliary. When train line reduction was made to set the brake the air pressure in this auxiliary had to be reduced also, thus adding about two and one-half car lengths to capacity of train pipe, which explained the peculiar action of brake valve piston. Also when testing brake valve for sticky piston, after trouble was located, with angle cock on rear of tender closed so as not to set train brake every time, the auxiliary had to be reduced also, almost after releasing air out of train line exhaust port, so that the auxiliary had to be reduced so that train line was not heard, another evidence of train line longer than ordinary engine and tender. The triple was cut out for that trip, piping put up properly and brake now works as it should. When you tell about a curious action of brake failure give the man who reports it a chance to try to remedy it. *Miss B. Cassara.*

Grand Rapids, Mich.

Overcoming Leaks in Signal Apparatus.

Editors

Spicing of the improved Westinghouse feed valve for the signal apparatus is one of an arrangement which I put on several locomotives in order to circumvent the omnipresent little leak, which, working in conjunction with a slow-feeding reducing valve, committed such deprecations upon the engine man's peace of mind.

This device, which was simply a small spiral spring placed over the diaphragm in the signal valve, Fig. 4, Plate 3, was designed to render the valve responsive only to a sudden reduction in the signal pipe pressure, while a small leak equalized without moving the diaphragm. The spring was, in every case, three

turo of the kind used under the overhaul valve in the Mack injector No. 7.

One end of the spring was straightened and driven into a small hole drilled in the top of spindle 10, thus pressing against spindle 10 and the top of the hollow which receives the air.

This arrangement has always been satisfactory, and needless to say has saved us to much labor in hunting for little leak under tanks and other "pleasant" places with soap and water and brush.

Boston, Mass.

GEO. E. LYMAN.

Proportioning Oil to the Kind of Engine Used.

Editors

The article in the current number of the *LOCOMOTIVE ENGINEERING*, from the pen of Mr. C. B. Cunger, in regards to the economical use of oil supplies, branches a very important subject for railway people to consider, owing to the different cost of oil in service on trunk lines and short roads.

Some companies use a high wheel and small cylinder, which renders efficient service on level roads, but roads that have steep grades require large cylinder and low wheels, that they may compete with the road having no grade in the way of hauling an equal number of cars with any additional expense.

An engine with a high wheel and small cylinder may run a division comfortable, well with a small amount of cylinder oil, while an engine with a low wheel and large cylinder capacity could not begin to run the division with such small quantity of cylinder oil without doing damage both to the valves and cylinders.

Mention will be made of a few examples of ordinary dimensions running on road, with heavy gradients, excluding Baldwin compound equipped with its multiplicity of cylinders and numerous bearings to be noted.

A mogul engine with a wheel 30 inches in diameter and cylinder 18 x 24 in. will cover a space of 14.66 feet (14.66 x 100 = 1466 inches) in making one revolution, and in running a division of 100 miles (5,280 feet by 100) it will make as many revolutions as 14.66 is contained times in 5,280,000 feet, or 360,444.

Since for each revolution the piston travels two times through the cylinder, or 4 feet in making 360,444 revolutions, it will travel 1,465,776 feet (4 x 360,444).

A mogul with the same size cylinders and a 68-inch wheel will pass over a space 17.8 feet for each revolution, and in running the above division will make 296,589 revolutions and the piston will travel equal to 1,169,657.3 feet. This makes a difference of 251,119 feet or 46.1 miles in traveling the last division, an important item to be considered in proportioning oil supplies.

To illustrate more fully and show these facts more minutely, a 10-wheel passenger engine and consolidation engine will be considered, both having cylinders 20 x 24 inches, with a 68-inch wheel and a 50-inch wheel, respectively.

The consolidation engine will cover 13.94 feet in making a revolution and will travel 4,330.4 times in running the division, and since this one's piston also travels 4 feet for every turn of the wheel, its piston's travel amounts to 17,321.6 feet.

The diameter of this cylinder is 20 inches, its circumference is 62.81 feet and its internal area is 10.472 square feet, but as the piston travels 4 feet for each revolution its actual area is equivalent to 20.944 square feet and for 4,330.4 revs., and 3,435 revs. it will be 84,709.9 square feet. This diameter of this cylinder is obtained by multiplying the distance traveled of the piston in going over the division by the circumference of the cylinder.

The 10-wheeler with its 68-inch wheel will make 296,589 revolutions in going over the same division, and since 16 cylinders are of the same diameter as the

consolidation engine, its interior area for each revolution will be 20 044 square feet, and its internal surface for the division will be 6211754 5 square feet, hence the difference in the surface to be lubricated in these engines is 8477994 1 square feet minus 6211754 5 square feet, or 2199239 5 square feet in favor of the locomotive.

As this shows the result obtained for one side, for both sides it will be 4377279 square feet.

A vast surface has to be oiled in this class of an engine, yet they are allowed as much as 150 lbs. of oil for the consolidation engine.

This is the cause of engineers on the low wheel engines borrowing oil from their regular engine during its absence, with a view of not returning it. Engineers never steal.

In any opinion, there should be some distribution made in the distribution of services among these engines with regards to the service they are required to perform, and not be as arbitrary as the sagacious yardmaster with his irrevocable commands and absolute authority in assigning a certain complement of cars for engines to haul without regards to the capacity of the cars or the capability of the engines.

J. F. BARRETT

Carlisle, Pa.

Safety Steam Valve.

To all you herewith a print of a safety valve. It is, I think, an improvement on the ordinary style, and so far as I am able to do the work that it is designed to do, namely, prevent the steam from escaping in case the body is broken off, but

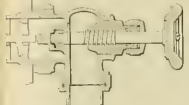

anybody can see that it is of no particular value should the check pipe break or become detached, but still I think it is an improvement on the regular style used.

It is easy to get at in case of a leak it can be repaired without much trouble, can be placed in any convenient place in the boiler.

H. A. FRANKLTON

Allegheny, Pa.

We had in this office a stenographer and typewriter who was celebrated for the severely practical way she would interpret the matter given to her by those who did the dictation. Shandy Maguire, the railroad poet, had signified his willingness to write a poem about LOCOMOTIVE ENGINEERING, if some points were furnished him about what should be said. Accordingly, the J. P. called the stenographer to his assistance and dictated a long letter of pointers. He concluded "if you let your muse loose upon that you are sure to make something worth reading." His emotions were beyond words when he found that the typewriter had written, "if you let your muse loose upon that," etc.

It is only a few years since the preserving and drying of fruit was begun in California yet the industry has now reached astounding proportions. The business has been rather depressed this year like that of most other lines, but up to September 24th the following shipments of California fruits to Eastern points were made: Raisins, 250 carloads, other dried fruits, including prunes, 1,100 carloads, green fruits, 5,500 carloads, canned fruits and vegetables, 1,500 carloads.

A Graphic Car Report.

We show herewith a blue print of car report used by the Southern Railway Co. It shows at a glance just what part of the

(through the bottom of the cup) into the rod, its upper end is threaded to receive the split yoke that serves as a stop to regulate the throw of the plunger. The plunger is heavy enough to always seat

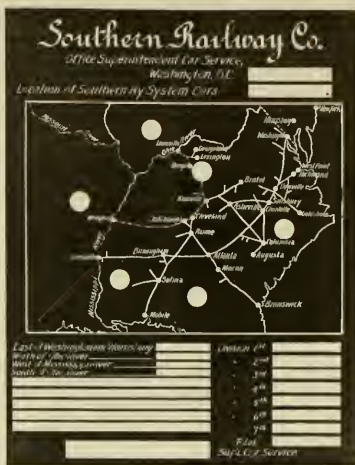

A GRAPHIC CAR REPORT.

system its cars are located on and in what part of the country, outside of the lines, that the tramps are located. We think it a great improvement over the ordinary blank car report.

A Sensible Oil Cup.

The cuts shown herewith will make plain the details of a new oil cup recently put on the market by F. J. Cole, of No. 1035 John street, Baltimore, Md.

It has distinct advantages over the ordinary cup that are plain at a glance.

In the first place, the cup itself has no stem, to be twisted off by a fifteen-inch monkey wrench with no sense behind it

itself and in the thickest oil, and thus prevent waste while engine is standing still. The yoke can be adjusted with the fingers. The plug is screwed through the cup by a special socket wrench furnished with each set of cups—one end serving as a wrench to remove the cover.

This cup can't be stolen by turning it out with a common wrench. It cannot be broken off with a blow. It cannot be jammed loose.

This cup is a plain, neat, sensible affair, and will doubtless meet with a good demand when its merits become known beyond the confines of the B. & O. road, where it originated, and where it is extensively used.

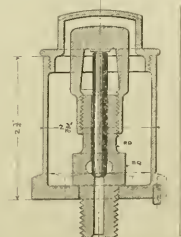

It is a plain brass shell with a hole in the bottom, and threaded at the top to receive the cover. It has a hexagonal base, but this is not at all necessary.

The central plug is steel and screws

A Safety Turret Device.

Mr E. L. Penrodocke, of Scranton, Pa., sends us prints of a device he has recently gotten up to prevent scalding accidents.

He describes the device as follows:

The turret is screwed into a flange joint which is riveted to boiler, and into same flange is screwed an angle valve or check, to which is connected the steam pipe from dome.

The valve *D* in the check is held open by the spindle *C*, which extends into steam gauge stand.

The turret has a weak neck at its con-

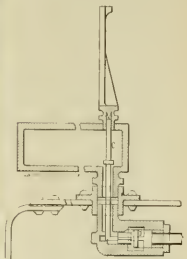

nection with flange, so that it would in all likelihood be broken there. This would allow the spindle *C* to be lifted by the valve *D*, and, coming just above the opening of turret, the steam would help to lift it, and so allow the valve *D* to close. Should only the steam gauge stand be broken, as it is made weak at its connection with turret, this would also allow the spindle to lift, and so close the valve.

The valve being inside of the boiler and lying horizontally, it would be protected from any debris that might fall and so displace it.

During our fiscal year ending September 30 LOCOMOTIVE ENGINEERING received \$10,235.35 more for subscriptions than were received in the same time for advertising. We doubt if there is another trade paper in the business that can show so healthy a subscription department. We are willing to prove this to advertisers by the books.

The Baldwin Locomotive Works are putting into their erecting shop weighing scales which have a capacity of 300,000

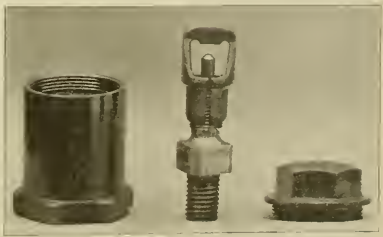

LOCOMOTIVE ENGINEERING has declined to be the official organ of several railroad associations. There is nothing like being free to publish only that part of everything that is thought to be interesting.

ponds. They think that when locomotives become too heavy for the capacity of these scales that it will be time to remove the works to some place where there is a good rock foundation.

Second Annual Convention of Traveling Engineers.

We have received from Secretary Thompson proofs of the proceedings of the Second Annual Convention of the Traveling Engineers' Association held at Denver Col. in September last. There were thirty members present, viz: S. J. Kiddle, C. E. Clayton, M. M. Meahan, E. J. Carney, R. D. Davis, F. W. P. Wilson, O. Lamphugh, H. C. Frazer, T. A. Heledahl, J. B. Holtman, N. S. Mast, W. J. Anthony, Merritt Turner, George Royal, M. Mast, A. J. Scheyers, C. Davis, P. H. Slack, George Royce, Jr., Wm. Coeiger, J. H. Little, M. B. Rapp, C. McCullum, C. B. Coeiger, J. W. Hall, W. J. Thompson, Martin Monroe, F. Selgrath, C. A. Brown, J. H. Kitchingler, W. K. Scott, F. Connor, R. M. Year, P. P. Egan, W. C. Chapman.

President Connor in his opening address dwelt first on the necessity and importance of members interesting themselves actively in the work of committee. They were urged to furnish all the information in their possession to committees, and assure that they themselves would be more busy by putting on what they know. They were particularly warned against the danger of getting into rats that forced out improvements or the desire to make a better record. "Well enough" is a dead man's doctrine. The belief was expressed that the master mechanics are improving the locomotive every year and it behooves the traveling engineers to see that the methods of handling be improved also. The indications are that the members are doing their duty in this, for with the higher paid and heavier trains the economical performance is steadily improving. In making the business of running a locomotive is not so much more difficult as it was a few years ago. The need of such education is much more decided than usual in the past and members were urged to encourage their men to habits of study. The reports of secretary and treasurer showed the association to be in a flourishing condition.

Several new regular and associate members were admitted. The first report read was on "The true and false economy of using fuel and the safe handling of the air brake under all conditions," and when examining a fireman for promotion, how much knowledge of the air brake is necessary for him to have to be considered fully competent to take a train on the road. This is an excellent report, and is highly creditable to the committee, Messrs. R. D. Davis, T. A. Heledahl, C. E. Weaver, F. C. Schraug and L. S. Putnam. The class of men who supply facts for these reports are to be much about the prevalent condition of air brakes as any men alive. Part of this report was:

CONDITIONS OF AIR BRAKE.

"We had cars with the braking power reduced far below the best recognized practice, for the purpose of minimizing the cost of renewing the wheels, and at the same time this fact was, on one form of invitation for a track worker or later.

"We see engines running without a governor to control the train line pressure, the fact being entirely overlooked that the apparent economy in saving the cost of a governor is many times but by resulting damages to rolling stock, on one form of another. We see pumps kept in service which have become greatly injured by long use or lack of care, the fact being entirely overlooked that the continued use of such defective machinery lacks the essential features of economy.

"We see engines, who, in handling the train, realize the importance of carefully taking the slack of the train, but in the manipulation of the brake lever value handle. It is a recognized fact that the different applications pertaining to an engine or train require exact adjustment of attention, while the air brakes when once

attached to a car or engine are expected to perform their proper functions with no care so long as they will do their work, and the only time they require repairs is when they fail completely to perform their mission. Even then, in many instances, the work of repair is put in the hands of men who little understand mechanism of the kind, and needless time and money are expended in doing what in the end proves to be an imperfect job."

This is certainly true economy.

A strong plea is made for first-class material in brakes to start with, the strict maintenance of standard parts and the avoidance of make-shifts. Cheap, inferior material for doing air brake work was condemned.

In passing a fireman for promotion it was recommended that he should be very familiar with the working of the air brake from beginning to end. He should be able to report intelligently on defects of the brake and competent to handle it with the skill and knowledge of the principal details.

DEFINITION OF TERMS.

Mr. Turner thought it would be impracticable to delegate the fireman to the extent suggested by the committee.

Mr. Davis thought differently. There was no difficulty in getting an intelligent fireman to learn all about the air brake.

Mr. Clayton said that his practice was to keep a fireman back from promotion if he did not put himself sufficiently about the air brakes. This has a very salutary effect on the young men.

As a reason arose about the necessity for new engineers among the road before they went out with a train handled by air brakes, and the general opinion was that having the road was of the first importance.

Mr. Heledahl dwelt upon the importance of discussing air brake matters thoroughly. The subject engages the attention of locomotive engineers more than any other and it ought to have proper attention in these articles. He said that they did not have one engineer running who was not capable of starting out with an air-braked train and placing everything in shape so that the air would not fail.

A discussion arose about the advantage of applying the brake at the caboose when a train composed partly of air brake cars was approaching a water station. Some opinion was expressed to the practice, but the general opinion was that it prevented shocks and saved couplings.

Next report was on—

"What is the best means of saving coal and increasing or holding the mileage per ton at a desirable figure."

REVISIONS OF 1991.

This report, prepared by M. Mast, W. E. Chapman, J. W. Sheldon, G. H. Brown and P. A. Egan, consisted of fifty questions, with the answers given in condensed form. It covers the subject fairly well. The principal items recommended for economical use of fuel is careful firing and skilful handling of the engine in regard to feeding and using the steam expansively. The brake rack is also commended as a good auxiliary. A cash statement is made to the effect that the road report that their firemen disobey instructions about careful firing, expecting that seniority will save them their jobs. The premium system as an encouragement for saving fuel is commended by most of the roads, answered the circular, but some of them believed that it tends to make firemen dishonest.

Next report was on "What relation does a clean engine bear to the economical use of oil and supplies?"

CLASS A DUESY ENGINEERS.

The committee was J. W. Hall, J. B. Johnson, Chas. B. Hogan, C. W. Poole, P. E. Riley.

This consisted of twenty questions with the answers following. The answers show that most railroad men are in favor of

clean engines, although untripped engines is the rule rather than the exception.

The Committee say that clean engines cut quite an important figure in the economical use of supplies. A few of the benefits derived from well-cleaned engines are: Men are more careful, take better interest in their engines, take better interest in making good showings on the monthly performance sheet, it aids inspection, thereby reducing failures; discipline is better maintained, holding extravagant men in check by comparison; it prolongs wearing parts, it reduces cost of repairs. Clean flues and grates give greater heat and effect in saving of fuel. Air line boilers are kept well washed, so they will not prime (which is often lost sight of in rush of business), effect a saving of valve oil, also less valve rod and piston packing is required. Close attention to smoke arch, nozzles and other front end work, more especially keeping nozzles well cleared out, make a very perceptible showing on the cost pile. We could follow in any length, and from every point of view the conclusion must and would be the same. That covers the whole subject.

EXAMINATION OF FIREMEN.

The next report is on "A uniform form of examination of firemen for promotion and new men for employment," and is probably the most valuable in the report.

The committee was M. M. Meahan, J. G. Goodman, J. A. Hill, J. W. Sheldon, H. T. Hart and W. C. Chapman. The committee covering the whole field of knowledge respecting the locomotive and its appurtenances and the best methods of operating the same. The report cannot be condensed, but all of our readers will receive it with our January issue.

POOLING ENGINES.

The last report is entitled, "How can traveling engineers improve the service when engines are double-ended or pooled?" The committee consists of W. J. Simpson, P. Frazer, W. Coeiger, J. O. Bradley, C. M. Binsley. The tone of the report is to the effect that the practice of extra crewing and pooling of locomotives has come to stay, and it is the duty of all concerned to work it to the best advantage. An extract from an opinion given by one of the members appears to cover the case. He says:

"If all take the interest in pooled engines we did under the old methods, meanwhile the time formerly given by the engineers and firemen put on pooled engines will keep them in good shape, and idleness of engines will be reduced to a minimum. There is no doubt that a system is needed. The best that can be done for a system is to anticipate the demands on your particular line and provide for these demands, making such changes as experience calls for. Roads that the pooling system has been in use on present our best field for information. The first and most important requisite is to obtain the cooperation of the men. The engine on which it is checked by the change, check it as little as possible. If waste occurs, reduce that as quickly as possible. Anything that can be done by roundhouse men should be done well and done under the personal supervision of a competent man. Have as little work done by the engineer and fireman as possible. Have the engine men simply operate the engine on the road and report what work is needed. Have competent inspectors and shop men to do the rest. The requirements of trunk lines are so exacting, and so much is expected of enginemen, that they cannot work on their engines on the road or be harassed with inferior facilities.

Block Signaling.

Mr. W. G. Watson, chairman of the American Railway Association's Committee on Signaling, presented an interesting report on Railway Signaling at the meeting of the Association held in New York last month. He said there are three distinct systems of block signaling worked to

a considerable extent on American railways, all of which have been sufficiently developed under conditions that admit of their capacity being reckoned with accuracy, viz: The telegraph signal system, which is operated manually by a signaller, the controlled manual block signal system, which is operated manually but prevents by mechanical device or otherwise the display of a clear signal while the block is occupied by a train, the automatic block signal system which is self-operative whether by mechanical electric, pneumatic or other device. There is a marked difference in the capacity of these three systems—that is, in the number of trains that can be moved over a road under the protection of block signals in a given time. With the telegraph system, the signaller are required to record the time of all passing trains, report to the signaller in the rear and in advance, and to manipulate a number of signal levers, all of which requires more or less time. In the operation of the controlled manual system practically the same procedure is required, but owing to the use of distinct and advance signals which are worked quickly by mechanical devices and which are not used to advantage in the telegraph system, more trains can be moved in a given time, especially during fog and storms than under the telegraph system. With the automatic system, everything being self-operative, the factor of time required in the operation is reduced to the minimum, and the capacity of track is limited only by the maximum length of the trains, their speed and the efficiency of the track brakes. Therefore, so far as time is concerned, the telegraph system represents the first stage of block signaling, the controlled manual an improvement over the telegraph system, and the automatic the system of greatest possible capacity.

He then argued that railroads handling considerable traffic could no longer afford to do without block signaling. It is the duty of the signaller to see that the operation of this means of safety is a duty that cannot longer be neglected. Those interested in each system claim that it is superior to all others, but each road should consider which system is adapted to meet the requirements of their own particular service.

The cost of installation of plant and expense of operating varies great between the three systems. The cost of installing the controlled manual plant and the permanent monthly expense for a signaller and repairman is very great. The cost of installing the pneumatic automatic plant and also the cost of maintenance is greater than the controlled manual, but the cost of operation is somewhat less, no signaller being required. The cost of either of these systems prohibits their introduction on any line except those enjoying large volume of traffic as to overtax the capacity of the telegraph system. The electric automatic system costs less for operation than the controlled manual and less for installation and maintenance of a signaller, but the maintenance of the controlled manual. However, with the installation of the electric track circuit system, which is the only reliable electric system yet developed, there will sometimes be involved a large expenditure in the preparation of track for its introduction, a thoroughly drained road and an equal expenditure in the maintenance of the electrical to the maintenance of a reliable circuit. Therefore, under certain conditions, the electric automatic system may be as costly to install, maintain and operate as the pneumatic automatic system.

For crowded lines, with fast and dense passenger trains and freight train moving at the same time, the desirability of the use of the automatic manual system. For moderate traffic the telegraph system will afford protection without hampering the movement of traffic. On roads running through sparsely settled districts the electric automatic system was recommended.

Prevaling Defects of Car Brakes.

Most of the reports presented at the Trailing Engineers' Convention, said "As a rule passenger car brakes are found to work fairly well on most well regulated railroads, but in a great many instances brakes are found with altogether too great variations in the range of piston travel," from 1/2 inches to 1 1/2 inches in the same train, which cannot be regarded as "true economy" in the air brake field. As a mechanic cannot execute first-class work with inferior tools, neither can a locomotive engineer do first-class braking with poor brakes.

But let us go back and investigate as to the primary cause for such great variations in piston travel. In most instances the brake shoes are found to hang a very unequal distance from wheels on all cars, suggesting that car men in charge give this point alone their exclusive attention, and supposing that the distance which brake shoes hang from the wheels (when brake are off) tends to govern piston travel, and as an offset is most absurd, inasmuch as the rigidity or flexibility of brake beams and levers regulates to a great extent the angle as well as the brake leverage. The number of times the piston power is multiplied on the brake beams, is also a very important factor in this respect; hence it is absolutely necessary that car men, in order to produce proper results, strictly govern themselves by the distance that pistons travel under a full force application of brake, irrespective of the position of brake shoes, except that shoes must hang clear of and parallel to wheels when brakes are off.

While discussing the piston travel on railroad tenders it may be well to analyze its effects under various conditions. All who have given the subject attention, only too frequently and practically, fully understand the evil results of greatly different piston travel viz with the automatic brake, each brake cylinder obtaining its supply of air pressure from its own auxiliary reservoir, which, when brakes are applied, is entirely separate and distinct from all others in the same train, while prior to an application all reservoirs are united through a train pipe, and have essentially a uniform pressure. Now, if one piston has 4 inches of travel, the small quantity or volume of air drawn from the auxiliary reservoir necessary to fill this 4 inch space in cylinder would reduce reservoir pressure but 8 or 9 pounds when pressure in the two chambers is equalized, and brake fully on. Thus if auxiliary pressure be 30 pounds before application is made, this cylinder would have 61 or 62 pounds (with service application), or from 11 to 12 pounds in excess of calculated pressure, viz., 50 pounds, and this full force application would be also produced by a train pipe reduction of only 8 or 9 pounds. Then, assuming another piston to travel 12 inches, and reservoir constant, it requires a double quantity of air as compared with the former, and also reducing the auxiliary reservoir pressure about double, or from 15 to 18 pounds, thereby leaving but 52 to 54 pounds of cylinder pressure, and if another piston travel 12 inches, it would take about three times the volume of air compared with the one with 4 inches of travel, and also reduce the auxiliary pressure from 24 to 27 pounds, and leave but 21 to 26 pounds of effective cylinder pressure. It also remains a fact that with 12 inches of piston travel, if the piston does not quite come against cylinder head (thereby destroying all brake pressure) this air is required but a very few applications of brake and the slightest wear of brake shoes to bring this about.

Now, assuming the three cars referred to above are of a uniform light weight, and are carrying an indicated leverage of 10, the one having a piston travel of 4 inches will be exerting a power of 480 pounds, with a service application of over 100 per cent. of power to the weight of car,

hence slid flat wheels would certainly follow.

"The car having a piston travel of 8 inches would be producing a total power of about 42,000, which would be very close to the limit for which brake was calculated, viz., 90 per cent. of power to light weight of car.

"The car with a piston travel of 12 inches would carry from 41,000 to none." "Another serious feature arises from this great difference in piston travel, viz., brakes "sticking." For example, the brake having the shortest piston travel would reduce by expansion the auxiliary reservoir pressure but slightly, thus leaving a high pressure to be overcome by train-pipe pressure—hence the more apt cause "sticking"—than those of longer travel. "Abnormal variation in piston travel resolves itself in the following, viz. Flat slid wheels, "sticking" brakes, irregular and poor-holding brakes as a whole, train jerking when making application of brakes, and hence I believe that uniformity in piston travel comes within the limit of "true economy."

A French Compound.

The handsome engraving on this page will make plain the details of a large compound locomotive that has been doing work for the past two years.

high and low pressure cylinders through a small pipe designed to be used only in starting. Excess of pressure in the receiver is avoided by a relief valve of ample size. The receiver is unusually large for a four-cylinder compound, being over four and one-half times the volume of the high-pressure cylinder. The truck center bearing is arranged so that the front of the engine is slightly raised in curving or by lateral displacement, the truck tending to return to a position parallel with the longitudinal axis of the engine when free to do so. Lateral motion is limited to .50 inch.

The following are the principal dimensions of the engine with four-wheel truck:

- Grate surface, 24.97 sq. ft.
- Firebox—Length inside at grates, 87.8 in.
- " Width inside at grates, 49.95 in.
- Tubes—Serves, ribbed.
- " Material, steel.
- " Number, 133.
- " Outside diameter, 2.59 in.
- " Thickness of, .095 in.
- " Length between sheets, 9.84 ft.
- " Number of ribs in each, 7.
- " Height of ribs, .47 in.
- " Thickness of ribs, .093 in.
- Heating Surface—Firebox, 112.10 sq. ft.
- " " Tubes, 1478.79 sq. ft.
- " " Total, 1590.89 sq. ft.
- Boiler—Diameter of cylindrical part, 57.07 in.

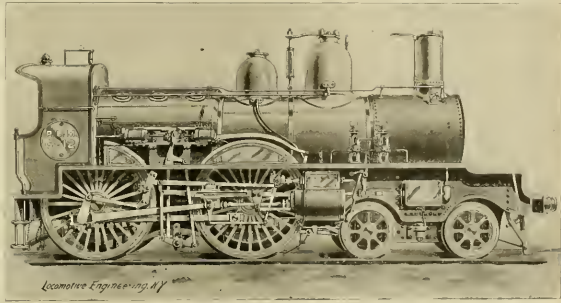

1892 CLASS, COMPOUND, PARIS, LYONS & MEDITERRANEE RY.

Boiler—Thickness of shell sheets, 57 in.
" Center line above rail, 7.38 ft.

Cylinders	Number	Diameter	High Pressure		Low Pressure	
			Stroke	Area	Stroke	Area
"	"	31.10	24.00	21.00	21.00	21.00
"	"	31.10	24.00	21.00	21.00	21.00
Valve motion	center	4.10	4.10	4.10	4.10	4.10
Valve motion	Walsbarger	4.10	4.10	4.10	4.10	4.10
Valve motion	Allen	4.10	4.10	4.10	4.10	4.10
Valve motion	Allen	4.10	4.10	4.10	4.10	4.10
Outside lap	None	0.00	0.00	0.00	0.00	0.00
Inside lap	None	0.00	0.00	0.00	0.00	0.00
Steam Ports	Length	4.45	4.45	4.45	4.45	4.45
Exhaust Ports	Length	4.45	4.45	4.45	4.45	4.45
Volume of receiver		1.15	1.15	1.15	1.15	1.15

The engines have four cylinders, the high-pressure cylinders are outside and connected to the back pair of wheels, while the low-pressure cylinders are between the frames and connected by crank axles to the forward pair of drivers. Unlike the Webb compound the two pairs of wheels are coupled with side rods, the cranks of the inside cylinders being 135 degrees ahead of the outside ones. This engine as you see it, weighs 151,600 pounds.

These engines are among the first in that country to have steel fireboxes, this was done to reduce the weight; the thickness is 3/32 inch.

The tubes are the Serves ribbed kind, and are only 9 feet 10 1/4 inches long and of 2 inches diameter.

The barrel of the boiler is 57.07 inches, and there are 133 tubes used.

The Walsbarger valve motion is used for the high-pressure cylinders and an independent valve motion of special design, without eccentrics, for the low-pressure cylinders. Both motions are controlled by a single stem reversing gear so arranged that for each point of cut-off there is a definite ratio between the expansion in the high and low pressure cylinders.

The starting valve is provided, admitting live steam into the receiver between

Company, which is final. It will be remembered that about one year ago, Judge Townsend of the United States Circuit Court, handed down a decision enjoining the New York Air Brake Company from furnishing the air brake apparatus they had been manufacturing and selling.

An appeal was taken from the decision of Judge Townsend, and the decision now rendered by the United States Circuit Court of Appeals has reference to the appeal from Judge Townsend's decision.

It was decided by Judge Townsend that both forms of the triple valve which had been furnished by the New York Air Brake Company, infringe two patents issued to George Westinghouse, Jr., which were respectively Nos. 376,837 and 448,457, and they were enjoined under both patents. He denied an additional injunction, asked for under the patent of Harvey S. Park, No. 393,274, now controlled by the Westinghouse Air Brake Co. He also granted an injunction against the New York Company's engineer's brake valve, under a patent issued to George Westinghouse, Jr. The decision of Judge Townsend is affirmed by the Court of Appeals in all respects, except as to Westinghouse patent No. 448,457, in reference to which the decision is reversed. The Court of Appeals broadly and favorably holds that patent No. 376,837 which is the patent for the style of brake apparatus now in general use is a

pioneer patent, and is entitled to a sweeping construction. The two claims of patent No. 448,457 which were in issue are declared void, on the ground that they are for construction fully covered by patent No. 376,837.

The Park patent is declared to be subordinate to patent No. 376,837, on the ground that the emergency valve is operated by a separate piston from the triple valve piston, the only difference being that in the Park patent the emergency piston is operated by train pipe pressure instead of auxiliary reservoir pressure.

All of the brake apparatus of the New York Air Brake Company which came under the injunctions of Judge Townsend is still under injunction. It also appears from the decision of the Court of Appeals that patent No. 376,837 of the Westinghouse Company broadly covers all constructions of triple valves in which the emergency valve is operated by a separate piston from the triple valve piston.

It takes from fifteen to twenty years for a patent in the United States to obtain a patent in Mexico. The great delay is not of much consequence, because after a patent is applied for the inventor has protection.

Final Decision of the Air Brake Units.

The United States Court of Appeals has rendered a decision in the infringement suits of the Westinghouse Air Brake Company against the New York Brake

The Tower Coupler.

The coupler shown herewith illustrate the M. C. H. coupler now being put on the market by the National Malleable Castings Company. It is known as the "Tower" coupler, and is of the knuckle opening class, in operating the knuckle from the corner of the car no additional parts are required, either in the unlocking gear or the coupler itself. It has been very carefully designed and the metal properly distributed to meet the strains encountered

through that contact, instead of by contact with the outer face of the opposing knuckle. This is conducive to smooth action in coupling, which is further promoted by the fact that the lock does not have to be raised as the knuckle swings in. This also prevents the lurching and failure to couple, to which certain couplers are liable. From Fig. 2 of our illustration it will be seen that the buffing strains received by the knuckle are transmitted to the head by means of a broad flat bearing at the end of the tail of the knuckle. A tendency

than one of compression. To uncouple, the lock is raised until it strikes the under side of the top wall of the head, being guided vertically in this movement by the bearing of its stem in the bottom wall of the head. If it is desired simply to unlock the knuckle, the lock is held in this position by the unlocking position in the usual manner. If, however, it is desired to swing the knuckle open, the lever of the unlocking gear is lifted still higher and, the lock pivoting on a ridge on the top wall of the coupler head, is rotated about

lock swings the knuckle open in a way that is perfectly clear from Fig. 1. The lock remains in the position shown in dotted lines after the operator has dropped the unlocking lever, and only falls into its normal position when the knuckle closes.

The lock cannot be interfered with in its operation by ice, dirt or cinders. It is provided with ample bearing surface on the knuckle, the area of contact being 41 square inches. It can not be struck by coupler links, as they cannot enter the

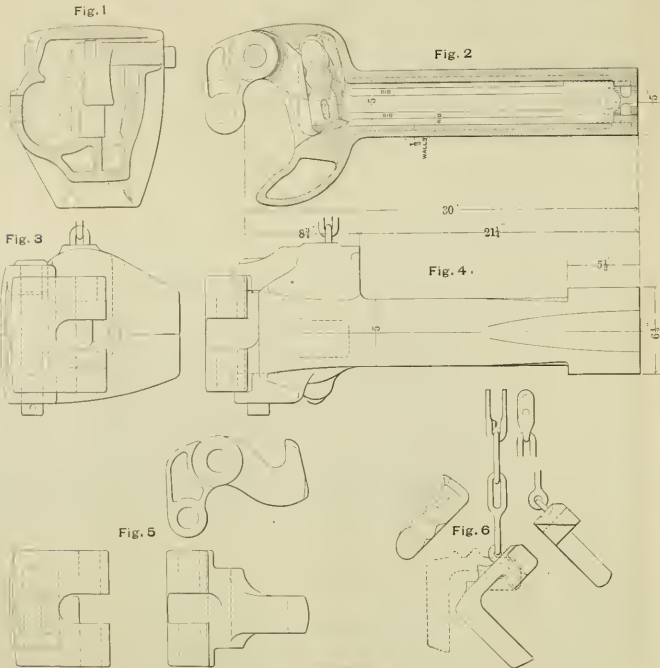

in service. The merits of the coupler may be concisely stated to consist in its simplicity and great strength, combined with a meritorious knuckle opening device which does not add any parts to the coupler, and which cannot get out of order.

The body of the coupler is made of malleable iron, and the knuckle, lock and pivot pin are of steel. The shank is square for its entire length and the liner blocks are cast on. The walls of the shank are thick and well ribbed, but sufficient room is left for the use of a tail bolt, if desired, and a slot for the American continuous draft rigging can be added. The knuckle is flared back far enough to give great strength to both it and the head, and yet smooth action is obtained even on the sharpest curves. The face of the tail of the knuckle is so shaped as to come in contact with the outer face of an opposing knuckle when in the act of coupling, so that it is swung into the closed position

to the knuckle to rotate in readily under these blows is also resisted at the same point and by a bearing against the vertical wall of the head at a point considerably nearer the fulcrum pin. By its shape and size the knuckle is amply strong to receive and transmit without damage any strains encountered in service.

The conspicuous part of the coupler is the lock which always serves to throw the knuckle open. Its shape will be readily understood from Figs. 1 and 2 in our illustrations. In Fig. 1 the full lines show the lock in the normal position, and it will be seen then, when receiving the pulling strain, the lock is amply supported by a vertical wall on the guard-rod side of the head, so that it is subjected to no strain other

than that point, as shown in Fig. 1, the stem of the lock disengages from the hole in the lower wall of the head, and slides along a groove provided for it. This motion of the

head far enough owing to the size of the tail of the knuckle.

All parts of the coupler are carefully inspected and made to conform accurately to standard contour lines. The Tower coupler has been repeatedly tested under the drop and for a considerable period in service, and has fulfilled all requirements. The railway department of this company's business is located in the Old Colony Building, Chicago.

The Hall Signal Co. have received an order to equip the yards at Los Angeles, Cal., for the Los Angeles Terminal Co. This is the first order of modern signal for the Pacific coast.

We have received so many requests to send books to subscribers that we have determined to open a book department. We will supply any engineering book at regular rates.



•Railroad Coppersmithing—XII.

By JOHN FULLER, JR.

SHIP VENTILATORS.

In many railway shops, as also in private engineering shops, ship ventilators made of sheet iron are sometimes in great demand, and I have seen some unpleasant disappointments, together with wasted material, seemingly from the want of a geometrical perception or training, and as a result very many unskillful jobs are sent out which could have been avoided. Before proceeding to give the instruction how to produce a pretty, symmetrical vent, let me say, that the piece of work, if made by hand, requires more than ordinary mechanical skill, and should command and receive proper recognition in wages. I have made many dozens of ventilators, and in several different ways, and have spent much time and study on them, and after repeated failures have succeeded in devising a method, that exact not alone in symmetry of form, but to reduce the time and trouble usually expended in making to a minimum.

In Fig. 170 are shown the outlines complete of one of the prettiest, neatest, and most symmetrical ventilators made. Its dimensions are given in Fig. 172 as follows: Outside diameter bb of ring or bell mouth 22 in., inside diameter of mouth 24 in., height from foot to mouth dd 13 in. Now let us suppose we have one of these ventilators to make of the dimensions stated above. We must first mark out the pattern for each section, which are four in number, namely: The back, Fig. 173, the sides, Fig. 174; the saddle or throat piece, Fig. 175, and the ring at the mouth, Fig. 176. Now examine Fig. 172 carefully. You will notice the circumference of the circle AA' is divided into four equal parts by the corners of the inscribed square AA' , shown by the dotted lines, and you see this measures off the size of the two sides, the throat and back, at the mouth, and the same at the foot CC . First, then, we see the back, Fig. 173, is one-fourth the circumference of a twenty-four inch circle wide at the large end cc , and one-fourth of a twelve inch circle at the small end gg , that is,

$$\frac{24 \times 3.1416}{4} = 18.8464$$

$$\text{at } cc, \text{ and } \frac{12 \times 3.1416}{4} = 9.4248 \text{ at } gg, \text{ and}$$

forty-five inches long at ff , and the radius h of the arc ef e twenty-four inches, now add enough on each side for riveting, as shown by the dotted lines, and the pattern for the back is complete. Second—The pattern for the side is shown in Fig. 174, and is laid out as follows: Continue the dotted line bb , Fig. 172, and at right angles to it draw $d'e$ Fig. 174. From the point e , on ae , lay off $e'a'$ and $e'c'a$, making ae' equal to one-fourth of a twenty-four inch circle, or 18.8466. From the point e' , with radius $e'a'$ equal to 4.70 inches, describe the arc $f'a$, making it equal to 57 degrees from a to f' . From the point f' on $f'a$, continued with a radius $g'f'$ equal to 23.5 inches (or five times the length of $e'o$) describe the arc $f'h$, making it equal to 14.25 degrees. Erect on gh the tangent $h'a$, making $h'a$ equal to 10.5 inches, and draw aa' parallel to AA' . Now make aa' equal to 9.4248, or one-fourth the circumference of a twelve-inch circle, and divide aa' in X , Y , and erect the perpendicular xy . Now lay off on ae the distance $a'x$ equal to 13.30 (that is, 12.75 or $a-d$ Fig. 171—multiplied by 2 then by 3 and divide by 5.75 thus, $\frac{12.75 \times 2 \times 3}{5.75} = 13.30$) and from d through a and at right angles with XY draw $d'x$. From the point d' with a radius $d'x$ equal to 13.30 inches, describe the arc $P'M$, making it equal to 84 degrees from M to P , join $M'O$. From x with a radius $x'a$ equal to twenty-four inches (or the diameter of ventilator mouth), describe

the arc $P'A$. Now add enough on each side, as shown by dotted lines, for riveting, and the pattern is complete.

Third. The pattern for the throat or saddle, Fig. 175. Continue the dotted line dd (Fig. 172) through xy , Fig. 175, and at right angles to it draw xy . From the point x on xy lay off xy and xy' , making xy equal to one-fourth of a twenty-four inch circle, or 18.8466. With a radius of twenty-four inches describe the arc $W'X'V'$. From x' on $X'Y'$ lay off the distance $x'a'$ equal to 1.00 inches, and draw $r'a'$ at right angles to $x'a'$. From the point r' lay off $r'f'$, $r'g'$ making $r'f'$ equal to one-fourth of a twelve-inch circle, or

length, and with a radius equal to ae describe the arc $f'e'u$ and point $f'e$ and h . Now add on the riveting edge parallel to the ends as shown, and the pattern $f'eag'h$ is complete. It should be noticed here the arc $ca'g'h$ is four and one-half times the radius, which measures off 270 degrees. This gives the pattern when a formed up a pitch half way between the two fashions called lantern-head and hood, Figs. 153, 154.

We will now proceed to work these several parts up, and commence by filing all the edges smooth to free them from rough burrs or cracks, if any, made by the shears. In Fig. 171 is reproduced a photo-

curve is obtained (this is shown by the dotted ellipse in Fig. 171), measured at the close of every three courses; when planed smooth, wire the edge with a quarter rod and the ring is complete. The back, Fig. 173, is next. Make of a stiff iron rod a template of the outside bend of the back, and also of the curve at each end. Then compare the pattern to the shape of the long template, and divide the 180 edges regularly the length of the bend, then take it to a hollowing block, Fig. 21, having a suitable hollow in it, and proceed to follow the back evenly until it has curled round and is one-third smaller curve than it was before, permitting the wrinkles to come in regular and even.

Now commence to work the wrinkles out, first from the inside in the block, then from the outside on a rod with a razing hammer, Fig. 33. When the required shape has been obtained, smooth and plane, and proceed with the saddle, Fig. 175. First bend a wire template to the curve of the throat $A' C'$, Fig. 171. Now bend the saddle pattern, Fig. 175, halfway a third smaller curve than the template, take it to an anvil, Fig. 4, and with a razing hammer, Fig. 33, raze down the outside edges of the saddle, then work in a course from the inside toward the middle of the pattern; then work a course along the edge to r' of the pattern and anneal. Continue the process until the curves conform to the templates, then proceed with the sides as follows. Bend each side a sixth smaller curve than they are intended to be when finished, similar to the directions given for working Fig. 28, turning one to the right, the other to the left, then turn the throat edge in a course on an anvil or suitable mandrel to begin the forming, then turn the outer edge up a course and a wrinkle at regular intervals, as shown in Fig. 29, and take it to a hollowing block and follow the side, letting the wrinkles come in regularly until it has curled enough, then work the wrinkles out, keeping close attention as it proceeds to fasten it at the point when nearest the shape required. To guide or assist in this the throat and back may be bolted on to the ring, and also to a twelve-inch hoop at the small end, and the sides fitted to them. When the sides are formed, and the seams all lay true, punch the edges intended to lap on the outside, and place them in position again to mark the holes of the inside edge, then rivet and scrub the seams so that the surface inside is all smooth. Now fit the ring tight inside the mouth, rivet up and finish.

HEADLIGHT REFLECTORS.

Headlight reflectors are a nice job when properly made. It should be noticed, Fig. 178, the curve or shape of this article is that of an hyperbolic conoid. This curve has been adopted so that the rays of light from the lamp may be thrown to a greater distance than could be done if they were made spherical. When the lamp is placed so that the flame stands in the focus of the curve, the reflector has its greatest power and efficiency. There are two ways of making this reflector, namely: By raising it from a solid disc, Fig. 179, or by cutting a pattern for a frustum of a cone, and working it to the curve after being braced together, Fig. 182. We will make one each way. First, we will work one up from a disc, and will suppose, as in Fig. 180, it is desired to measure 22 inches in diameter at the opening $A B$, with a flange g inch wide and 16 inches deep from C to D . Now we want to know the size of a disc of sheet copper it is necessary to have that we may raise up the reflector and have it the proper size when finished. This we obtain in the following manner: In Fig. 180 the distance from E to F is 18 inches, from G to H 22 inches, and the slant height DF 17.75 inches, here, then, we add the diameters of the two ends together, and divide by 2, which gives us 20 as the mean diameter, multiply this by 3.1416 and divide by 7552 to convert into disc inches, now add the square of 7 inches or the diameter of the

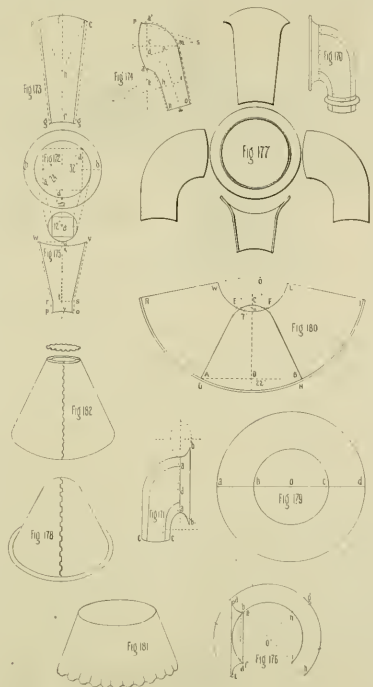

9.4248. Lay off $r'p$ equal to four inches and complete the parallelogram $r'op$. Now add on to the sides enough for riveting edge, and the pattern for the saddle, Fig. 175, is complete, ready for forming.

Fourth. The pattern for the ring, Fig. 176. Let $a'b'd'$ represent the curve of the mouth ring (Figs. 170, 171). Unroll the wire edge as shown at a and c , Fig. 176. Now through the points a and c , and d where the curve begins from the riveting edge and ends at the top of the wire edge, draw the lines $AOA'O$ and let them meet in O . From the points a and f on $a'b$ lay off the length of the curve or width of the ring toward a and c , then with a radius a describe the arc $ca'g'h$ and make it three times a in

graph, in which is shown the several parts of a model ventilator, made to a scale of one and a half inches to the foot, and then taken apart and photographed especially for this article; each part is therefore shown exactly as worked up from these patterns, and as they should be before riveting together. Now take the ring pattern, Fig. 176, and after riveting together take it to a mandrel of the proper size, and with a suitable mallet or hammer work out a course at the small end; then turn it up and work out a course at the large end, and be careful that the blows are even and at regular intervals. Now hang it on the mandrel and work in a course from the outside, and continue the courses first inside and then outside until the necessary

Copyrighted by John Fuller, Jr., Seneca, Kan. All rights reserved. These articles commenced in September, 1893.

small end, and extract the square root of the sum, and we have the diameter of a disc whose surface is equal to that of the frustum $G E F H$, excepting the surface of the base, thus $\sqrt{74.22 + 14.5} = \frac{9.192}{2}$

diameter, then $\frac{14.5 \times 3.1416 \times 17.25}{2} = 1029.5$

and $1029.5 \div 107.5 = 9.575$, the number of discs in the sides and crown, and extracting the square root of this sum we have $\sqrt{1029.5 \div 49} = 51.24$. Cut out a disc of sheet copper $3\frac{1}{2}$ inches in diameter, Fig. 170, and divide the diameter into four parts a, b, c, d . With the radius a describe the circle b, c . Now wrinkle the edge regularly all round, forming the pan, Fig. 181, and take it to a gibbet shank, Fig. 133, or to a suitable mandrel at the block, Fig. 122, and proceed to raise down the wrinkles with a raising hammer, attending at the conclusion of every course. Continue the operation until the required pitch is obtained, and the small end is 7 inches in diameter, then on a bullet

steak in the block, Fig. 137, break down the corner or lag to the curve, and true up to shape, then at the angle I , Fig. 111, lay off the flange. The job is now ready to finish and smooth.

We will now work up one the other way and give it the first form by brazing the pattern together, as a frustum of a cone, to $E F H$, Fig. 176. To obtain this pattern draw $A B$, making it 22 inches, and divide it equal to D . Erect the perpendicular $D C$. Now lay off the line $D E$ on $A B$ 15.54 inches, and draw $E A$ at right angles to $D E$. With a radius $D F$ describe the arc D, F, I, L , and with the radius $O H$ describe the arc $R, G, H I$, then $V R G H I$ is the pattern required. Cut out the pattern and then the two edges $A B$ and $I J$, lay out one of them on the block, then as in Fig. 181, and hold it together with four dogs as shown, close down the joint smooth with a hammer and chatter to loosen it, now sling with a chain to a traveler, charge with a reed and run the joint.

When cool, clean off the joint and knock it down, so as to make the joint the same thickness as the sheet, and anneal. Now round up smooth with a mallet and stag in the lag and cramp in the crown, Fig. 182, and after brazing smooth up the joint as before directed. Now break down the lag and true up to size and shape as before. I find that reflectors that have come under my notice are placed either with nickel or silver, but it would seem to me that if they were tinned and polished in the grain they would last longer and cost less.

In closing, if those articles shall be the means of guiding or rendering the assistance needed by the student, they may be struggling along holding a position in which they are anything but welcome, or if they shall afford a hint to those men willing to learn something from the experience of others, although they may have no immediate use for the information offered, then the purpose of the writer has been attained.

The Franklin Institute, of Philadelphia, has awarded the Edward Longstreth Medal of Merit to Wm. F. Mattes and John P. Lewis, inventors of the Lackawanna lubricator, for devising a lubricator which their committee says, "is simple for simplicity and perfect working under varied conditions is proven to be in advance of its competitors."

The new Union Station at St. Louis is said to be the largest and best arranged in the Union. The building is a handsome stone structure, the train shed, covering thirty tracks and ten acres of ground. The entire cost of the site, tracks and buildings was \$6,500,000. It was opened for traffic on September 2d.

A New Nut-Facing Machine.

This machine has many new and valuable improvements over others made heretofore for chamfering and facing nuts and bolts.

The cutting head is arranged to hold three tools made of bar steel, one for forming, one for chamfering the corners, and a third to remove the first thread in the nut. They can be removed, ground and replaced in a few minutes.

The spindle to which the cutter head is attached is driven by a four-step cone pulley and geared 4 to 1, thus having sufficient power to face the large nuts with ease, and the additional advantage

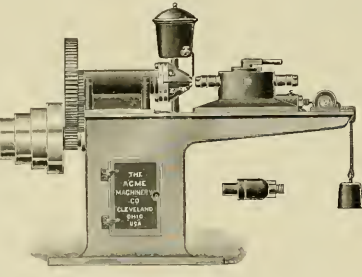

of facing the smaller sizes at the proper speed.

On the carriage is mounted a turret with a broad key to keep it in place, and a lever out to clamp it to position, as shown. The carriage is moved forward to the cutting head by means of a cam journal on the ways of the bed. This cam is driven by a worm and worm wheel, thus giving the carriage a steady forward movement, and the weight hanging from the front end of the bed returns same after the nut has been faced.

The advantage of a turret head to hold the nut above it is that the nuts can be removed and replaced much quicker and with less exertion than is possible on a machine where the arbors revolve and the cutting head remains stationary.

This is one of those time and money saving machines with which old lathes cannot compete.

The name of the builders is shown on the cut.

The Johnson Stay-Bolt Cutter.

The illustration accompanying this article shows the construction of a splendid tool for cutting off stay bolts after same are screwed into boiler.

The tool was gotten up some four years ago at the Kingston, Pa., shops of the D. L. & W road and has been in constant use there ever since.

It puts no strain whatever on the bolt being cut—simply shears it off. It is light and easily handled—twenty-five bolts having been sheared off in one minute with it.

This cutter leaves the bolt projecting $\frac{1}{8}$ of an inch, just right for heading over, and two sizes of cut dies are furnished with each machine—for $\frac{3}{8}$ and 1-inch bolts.

The tool is made and sold by the Henry C. Ayer & Gleason Co., Philadelphia, Pa.

What a Patent Lawyer Does

We are often asked about employing patent lawyers, and what they do for clients. The following answers to that question we take from the card of a patent lawyer, Mr. Geo. P. Whittlesey, of Washington, D. C. They tell the whole story in a nutshell.

Sends you a copy of the Patent Laws and Rules of Practice free.

Sends you printed copies of patents at low rates.

Advises you whether the new device you are proposing to use is an infringement on any patent now in force.

Examines the office records to find out

Dangerous Locomotives—If Injured, They Scald!

BY GEO. S. HOGGINS.

Some years ago the editor of *Punch* gave the English people a very good method for reducing the frequency of accidents to excursion trains. The advice was given after a disastrous wreck on the London, Chatham & Dover Railway, which road, by the way, was referred to as the "Leave 'Em, Smash 'Em, and Turn Over Key." The proposal was simply that upon the buffer beam of each excursion engine a director of the company should be tied, and that, in the event of a serious damage or the wrecking of the locomotive they may be boiled alive. The policy of reduction of this kind of unnecessary risks to these men, not only would benefit them as a class, and would be dictated by a humanitarian instinct, but would also secure a dollar-and-cent advantage to the company following such a policy. It would at the same time render the transportation of the traveling public correspondingly safer, because passengers run a similar though less probable risk of being scalded as do employees, and the consequent immunity from accident and death in this terrible form could be made the basis of truthful advertising, and it would also materially reduce the large amounts annually paid as indemnity to injured travelers, or to sorrowing friends.

The locomotive of today is supplied with a most efficient brake apparatus—air pumps, governors, whistle-signal, etc.—an outside manufacturing concern. The same engine is equipped with two trustworthy and carefully constructed safety-valves, supplied by an outside firm. The steam gauge is also of approved pattern and supplied by special manufacturing firms outside of the railway itself. The injectors used are various in kind and excellent in design, and are procured ready-made in open market. The regular, constant and satisfactory lubrication of the main valves and pistons is also the result of the adoption of eight-feed lubricators made by outsiders. The heating of passenger coaches is also accomplished by the use of appliances of outside origin. We have, therefore, six most useful appliances or sets of appliances, placed upon engines at the present date, not designed or made by the railways themselves. This fact has led many to believe that the mechanical superintendents and others engaged in the manufacture and maintenance of locomotives are willing to wait for some outside agency to supply the necessary protective appliances for the fast-running locomotives of the future. There is, however, no reason why the railroad mechanical world should rest content of patiently put up with dangerous engines, waiting until some deliverer arise in the shape of an outside company with patent rights and royalties to be bought and paid for. The mention of a few points will justify this statement. There are many such points apparent to any thinking man who will carefully and seriously consider the question of how best to protect the locomotive runners and the traveling public in case of serious damage to engine or train.

If your invention is patentable, if you send a sketch and description of it and a fee of five dollars.

Advises you what patents have become public property, so that you are at liberty to use them.

Prepares all the drawings and documents for your application for a patent, and gives the care careful attention until the patent is allowed.

Readers opinions upon the scope and validity of patents.

Draws up and records assignments of patents.

Scratches the records of assignments and makes abstracts of title, showing the present owner of any patent.

Conducts suits at law and in equity against people who infringe your patent.

Defends you in court from patentees who sue you for alleged infringements of their patents, or, in case you have other lawyers, backs up the state of the art to get material for the defense, and testifies as a patent expert.

The price of Muecher's steel has been reduced on account of the tariff. The "special" brand now sells at 46 cents per

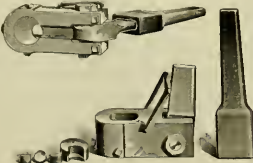

pond and the "Titanic" brand at 10 cents.

The B. & A. engines mentioned in last paper as having steel pistons, will have Taylor Yorkshire iron pistons—the standard of the road.

In the first place, both boiler cheeks should be placed inside the circumference of the boiler, or out of the way of any possible contact with obstacles or wreckage. They should be so placed as to automatically close in the event of the delivery pipes being torn off. The safety-valves should be protected by some strong shield, which would bear the brunt of a collision, or the tearing action of wrecked cars or coaches. It should be able to resist the tearing action of wrecked cars or coaches. It should be able to resist the tearing action of wrecked cars or coaches. It should be able to resist the tearing action of wrecked cars or coaches.

The Chicago and Northwestern Railway is using on some of its engines a protected blow-off cock, designed with an inside valve, acting as a check and intended to close if the exterior parts were accidentally broke off. The water-gauge glass and try-cocks should be, if possible, combined, as is often done on stationary boilers. They should be so arranged as to require only two openings into the boiler, and each opening to be provided with a suitable inside valve capable of promptly closing in an emergency which had carried away the whole of the boiler mountings. A more difficult matter would probably be the arrangement of the turret. It should stand in a comparatively protected position behind the dome. It should be provided with an inside valve which would at once close in the event of the turret being broken off and a purposely weakened portion might regulate the line of fracture. Steam drawn from the turret by pipes for the two injectors, the blower, the air pump, the steam gauge, the coach heater, the lubricator, the bell-ringer, and should also supply the whistle, and by so doing reduce all these openings into the boiler to but one.

Many of these pipes have steam passing through them intermittently, and consequently cannot depend upon any automatic action unless the turret itself be destroyed. In the event of an injector steam pipe being torn off while the injector is working, the inside top check would prevent the escape of boiling water, but steam might still flow from the uninjured turret.

A fractured air-pump steam pipe might also pour out live steam without any chance of shutting it off, if access to the turret was not possible. The opening in the dome of the steam pipe which supplies the turret should be fitted with a throttle-valve similar, though of course smaller than the one for supplying the cylinders. It should be held open by a bell crank lever and stem; the latter should pass through the boiler-head in the same manner that the main throttle-stem does, and come out just above it. The handle should be so arranged that by simply throwing it out of a single catch or notch, the valve in the dome would promptly close, as a double-faced valve will do if the upper area is much greater than the lower. By this means, at the first approach of danger a fireman could shut steam off completely from all the boiler mountings as rapidly and as surely as the engineer shuts off steam from the cylinders. With the turret throttled, the engine might go into a collision with no boiler openings liable to exposure but those which would be instantly blocked by the automatic action of inside valves. Firemen and engineers would readily learn the value of such an appliance, and fail to operate it would not often be laid to

their charge. Even after, or during the wrecking of a locomotive the handle might be thrown out of the turret and so close the dangerous apertures, and the chances of this being done are much greater than in the case now with ordinary globe valves.

The present position of railroad mechanical engineering in this respect may well be contrasted with a kindred mechanical art. In the science of gunnery an improvement was at one time made in the method of giving rotative motion to projectiles while passing down the rifled bore of a cannon. It consisted in the substitution of a gas check instead of brass studs on the sides of shot and shell which filled the grooves of the gun in passing out. The gas check consisted of a copper saucer placed at the base of a projectile, with concave surface towards the powder chamber. When the shell began to move under the pressure of the powder gas, the edge of the saucer or gas check would be pressed outward and so cut sharply into the grooves of the rifled gun. The center of the saucer having been previously made to engage with corrugations in the base of the shot, a rotary motion was thereby imparted to the smooth missile without the use of studs or lead coating. The advantages gained were full utilization of the pressure of the gas, as none could blow out of the gun, over and around the projectile at the moment of firing and before the inertia had been overcome. The gas check also lent itself more readily to the increasing twist, which had been found so advantageous a system of rifling. When the shot left the gun, the gas check flew off sideways or in any direction, its work being done. This very erratic flight of the gas check was at one recognized as a dangerous thing in case artillery were to protect an advance of infantry or covering a retreat. In firing into an enemy's camp over the heads of allies, the gas check was found to be a source of uneasiness, as the fire from a battery might almost be as disastrous to friends as to foes.

With this before them, artillerymen did not go on for years firing projectiles with loose gas checks in the vague hope that none of them would fall among friends, or if they did, that the casualties would be few and far between, or because none of the bombardiers themselves could be injured. They saw the menace to the life of fellow-soldiers, and a remedy had to be provided. The gas check was made a fixed appendage to the shell when firing, and though the corrugated and rough edge somewhat increased the resistance to the flight of the shell in the air, it was retained sooner than plate friends even under the shadow of a possible mishap.

This illustration points to the fact that in a kindred mechanical science a defect noticed or a source of danger discovered, is a danger removed. Not so in locomotive engineering to-day. There are many intelligent, thinking men now in the employ of every railway and locomotive works who are capable of designing some simple and effective protective appliances along the lines roughly indicated above. There are many humane managers who would welcome such improvements. These men would be set to work, if sufficient interest could be aroused, and that without waiting for some outside deliverer to arise or subjecting railway directors to the fate of Mæzappa.

The Pennsylvania Railroad is now using a patented inside boiler check of improved design which adds to the boon of safety the probable advantage of cheaper maintenance. The trenchant words of LOCOMOTIVE ENGINEERING may well be quoted in conclusion: "Half the fatalities of railroad wrecks and more than half the tortures can be prevented if steam can be kept in the boiler." This subject has a mechanical, a humanitarian, and a "divinely-paying" aspect, capable of interesting alike the workman, the philanthropist, and the managing director.

Forging a Hex. Nut with a Collar.

This ingenious set of dies is in use on the St. P. & D. road, and were made by Foreman Blacksmith Geo. F. Hinkens, Association of the Master Blacksmiths' Society. Many large nuts are re-

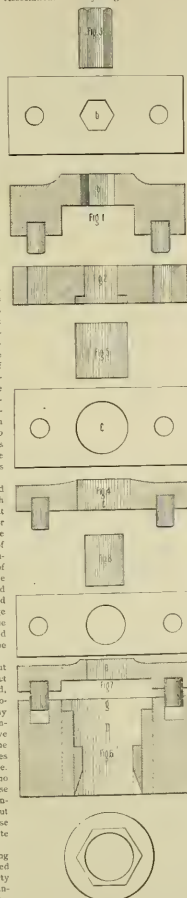

quired with a solid collar on one side, such as are used on front end of piston rods on many engines.

In Figs. 1 and 2 are shown the dies. The larger opening is hex., the smaller opening round.

The first operation is to cut out the hex. blank. This is done by placing the iron on Fig. 2, used as lower die, putting the

guide cap, Fig. 1, on top, the guide pins keeping it in proper place. Then punch, Fig. 3, is placed in guide cap, a rap of the hammer punches out the blank.

In the next operation Fig. 2 is reversed; the cap shown in Fig. 4 is used, and upsetting punch shown in Fig. 5 used to upset the blank, thus forming the collar on the end of the nut.

The next operation is punching the hole. This is done with another set of dies altogether. The blank is placed in Fig. 6, opening shown at D., guide cap, Fig. 7, is used, and punch shown in Fig. 8, the top of the cavity in Fig. 6 is round, for the collar; the part at D is hex., for the nut. But the die edge below is round to cut out the hole, this die is made of a separate piece of steel and put in loosely from the bottom.

A very strong and striking example of English ignorance of American institutions is seen in a full-page picture in the *Illustrated London News* of September 29th. The picture illustrates the late forest fires in Minnesota, and represents a locomotive dashing at full speed through the flames. From a railroad man's standpoint that locomotive is the funniest thing the unconsciously humorous English journalist has perpetrated in a long time. The engine has an almost perpendicular cowcatcher, has no headlight and no bell, and has a fat, bilious smokestack like a Japanese one. The man fisherman, is pulling the steam dome is very English, and has the English horizontal lever on the top. The cab is one of those shallow English shelters with bull's-eye windows in the front, and the reversing lever is in the middle of the cab, right in front of the furnace. The engineer, who has a sea-wester hat on, and looks like a true fisherman, is pulling the lever with his left hand, and the fireman is sitting on the right hand seat instead of the left hand seat, where he ought to be. When the prominent position of the *Illustrated London News* in the world of illustrated journalism is considered, no American can fail to see what a perfect example of crystallized English ignorance of things American this picture is.

Sometime ago an item appeared in this paper to the effect that the Leach Sound- ing Device people were manufacturing models to be placed in grammar school cars, call for these models from engineers' and firemen's clubs has been so great that they are in danger of financial embarrassment, and respectfully decline to send more to these clubs unless they are paid for the cost of manufacture, which is \$5 each.

The Board of Trustees of the Field Columbian Museum, of Chicago, has appointed Willard A. Smith honorary curator of the transportation division of the department of industrial arts.

The Cleveland Twist Drill Co. writes: "It seems to us that business is steadily improving. We are running our full complement of men ten hours per day, and have been doing so for some time." This is the kind of news that is heard all along the line now—cannot be overdone.

H. O'Neil, the photographer, who sold photographs of the "99," has gone out of business. Orders for these should be sent direct to F. W. Blawett, 247 Ninth avenue, New York.

The fine new two-volume press that carries the editor of LOCOMOTIVE ENGINEERING, has cast into its frame this legend: "Remember, oil is cheaper than iron." That motto would be a good one to put up in some locomotive cab—and also some master mechanics' offices.

"Comfort in Travel" is the title of a handsome little illustrated book just issued by the Passenger Department of the Michigan Central. It's an artistic job throughout.

The Elements of Boiler-Making—VIII.

SHEET-IRON WORK.

By C. E. Fournier.*

PLAIN FLETCHER PIPE.

I will now proceed to lay out a plain Fletcher pipe, Fig. 95, flare 16 inches in petticoat pipe, Fig. 96, flare 16 inches in diameter at the bottom and 6 inches high, waist 10 inches in diameter and 12 inches high. Total height of pipe 18 inches. First draw a center line, $A'B$ Fig. 91, then a base line $B'C$ 8 inches long, which is one-half the diameter of the base of the flare. Next draw $D'E$ 5 inches long 6 inches above, and parallel to $B'C$. Draw a line through C and E , and extend far enough to cut the center line $A'B$ at F , this makes an outline view of one-half of the flare or cone. Draw a line $E'G$ parallel to $A'B$ and 12 inches up from E , this represents the waist.

I will now lay out the waist. Draw a line 12 inches from the side of the sheet that is to form the top of the waist, and at this line the waist is to be flanged. Draw another $\frac{1}{2}$ inch down from that, or 12 $\frac{1}{2}$ inches from the top edge; this line is for the holes, and still another line $\frac{1}{2}$ inch farther down, that is to shear on. This allows the lap. Draw two lines for the straight seam, one $\frac{1}{2}$ inch from the side of the sheet, and at right angles to the other lines already drawn. Draw the other line parallel to the last, and 31 inches the circumference of the pipe, apart. Allow $\frac{1}{2}$ inch for lap outside of this line, and then proceed to space off six holes in the straight seam, leaving the top hole $\frac{1}{2}$ inch from the top edge of the sheet, and the bottom $\frac{1}{2}$ of an inch above the line. For flanging, space off fourteen holes for riveting to the flare, but only punch the corner or lap holes when punching the straight seam before rolling, for if these holes along the flange were punched before flanging, the sheet would crack out from the holes, and the holes would pull out of shape in flanging, so just center-mark them, so as to be able to find them. After flanging, also drive a rivet in the lap hole, and it will keep that hole fair and make the sheet draw equal all around. After flanging, punch the holes with the center, and if I will go onto the flare nice and straight. I have seen men in fitting a waist to a flare after flanging, and not having the holes marked, look around quite some time in a place to set the flare down alongside of something heavy, and get a long stick for a pry to hold the waist down to place; then after the helper had slipped the waist back and forth several times, and the waist had fallen down in trying to hold it steady in place, as he would have to bear all its weight upon the pry, the boiler maker would reach away down and mark off the holes ready to punch.

I will now finish laying out the bolts, waist by laying out the holes for the bolts that hold the hangers to the pipe. As the hangers are exactly opposite, I will do this by dividing the sheet into one-quarter, by spacing or by division, $31 \div 4 = 7\frac{1}{2}$, inches is the distance from the straight seam, and $15\frac{1}{2}$ inches the distance apart of the holes. Then the top holes are $\frac{1}{2}$ inches from the top and the others $\frac{1}{2}$ inches from the lower. (See Fig. 93.) Now for the flare, take the trams and set them to the distance, F, C , Fig. 91. This distance I carry to the sheet of iron, of which I will now make the flare, and draw an arc H, I , Fig. 92, with that radius, where it will cut with the least waist. Preserve the center F , Fig. 92, from which this arc was drawn. Return to Fig. 91 and set the trams to the distance F, E , and with this radius from the center F draw another arc J, K , Fig. 92, and draw another arc L, M $\frac{1}{2}$ inch from K, L for the rivet holes. Next comes the

line for the straight seam. Set the straight edge to the point K and the center F , and draw a line to cut through and between the arcs H, I and K, L . Measure off on the line K, L 15 $\frac{1}{2}$ inches, if the flare is to be made in halves or of two pieces, or 31 inches if it is to be made of one. It is customary to make them in two, as there is so much waste of material in cutting. Measure off 15 $\frac{1}{2}$ inches on line K, L with a flexible rule, or mark that length on a thin strip, and use this to measure with and mark the point L , and through this point draw another line from the center F

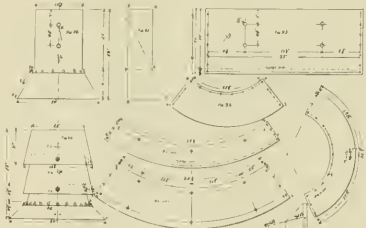

for the straight seam. Allow $\frac{1}{2}$ -inch lap outside of these lines for the holes for the straight seam. Lap and space off the holes in the straight seams for four rivet holes, counting the corner hole, and leaving the bottom rivet at least $\frac{1}{2}$ inch from the edge. Next, the rivets to attach the waist. Space this off for eight rivets, one-half the number in the waist, counting both lap holes. Center-mark the holes, and one-half inch ready for punching. After shearing and punching, this part can then be used as a pattern to mark the other half, or it can be laid out similar to the first.

FLANGE FLETCHER PIPE.

The following is a flange petticoat pipe, made up of three flares bolted together with three $\frac{3}{4}$ -inch bolts with thimbles or distance pieces, 1 inch long between the flares at each connection. The two upper flares are similar, but the lower flare is made up of two pieces riveted together, the lower part having the most opening. First, on any convenient piece of sheet of iron draw an outline view of the pipe, showing all the flaring in position same as Fig. 91. Only be careful that you allow the thickness of the iron right, as the thimbles are on the outside of one flare, and inside on the other, and if everything is allowed all right the outfit will go together without any pulling, hauling, planing or forcing. Perhaps it would be best for most men, instead of making an outline to make a sectional view to show the thickness of the metal used, then they can get exact dimensions.

It is the same in this as any other thing, when a person knows exactly what he wants he will need but very few lines to do what he needs. When drawing the sides of the flares, continue the line till it cuts the center line at K' for No. 1, L' for No. 2, and M' for No. 3, Fig. 94.

Now for the flares. Set one leg of the trams or dividers to L, E , Fig. 94, and the other to H , the top of the No. 3 flare. I will now set the one point from L to K' and J , and I find the other point just

touches the top of those flares. Consequently, I can use that radius for all. I now, on the sheet of which I am to construct the pipe, draw the two arcs, C, D and E, F , lines to shear on to form the tops of the flares Nos. 2 and 3.

Preserve the centers from which these arcs are drawn. Next set one point of the trams at K' the other at G , then set one point in the center, from which I drew the top of the flares Nos. 2 and 3, and draw an arc or hue G, H , No. 2, and I, J No. 3, for both. No. 3 does not require this line. Again set the trams to K', F , Fig. 94, and draw another arc, M', N , on No. 3 flare. No. 3 does not require this. Set the trams to K', F , Fig. 94, and with that radius draw O, R , the bottom of the No. 2 flare. Set the trams from L to N , Fig. 94, and with this radius draw the arc S, T . For flanging on the No. 3 flare, again draw an arc, $\frac{1}{2}$

inches and ready to shear and punch, but as in the waist, Fig. 93, only punch the lap straight seam, and $\frac{1}{2}$ inches for bolting together. Leave the last seam on the flange of the No. 3 flare till after flanging, then punch off the No. 3 flare. Set the trams to the distance, M', V , Fig. 94, and with this radius draw the arc forming the top of the flare No. 4. One-half inch inside of this arc draw another arc, upon which to punch the rivet holes.

Set the trams again to the distance M', O , Fig. 94, and with this radius draw the arc U, V forming the bottom of the flare of No. 4.

Now for the circumference. The bottom is 20 inches in diameter outside, $20 \times \frac{3}{4} = 62\frac{1}{2}$ inches, less $\frac{1}{2}$ inch, equals $62\frac{1}{4}$ inches. But as this is made in halves only one-half or 31 $\frac{1}{4}$ inches needed.

This length lay off on the arc U, V , and at the points U and V draw lines toward the center or radiating from the center. For the straight seam off for three holes, space off the arc drawn for the rivet holes, eleven of which are required on each half to rivet Nos. 3 and 4 flares together. The hangers to hold up the pipe are attached to this flare, and as they are opposite each other they will require to be on a line radiating from the center one-half the circumference apart and one-fourth of the circumference from the straight seams $62\frac{1}{4} \div 4 = 15\frac{1}{4}$, the distance from each hanger 1 inch apart, and on a line 1 inch from the bottom.

The No. 2 flare can be used as a pattern to mark off the No. 1, only leave out the three holes for bolting together at the top, as they are not needed.

Fig. 95 is the outline of the flares Nos. 3 and 4, No. 3 being extended down the bottom line, which makes it similar to Nos. 1 and 2 flares, with the distance the bolt holes are from the top and bottom marked upon it as shown, is all that is required to lay out the pipe after a man knows what he wants.

British Railway Men.

[EDITORIAL CORRESPONDENCE.]

When one connected with an American engineering journal goes to Europe he naturally supposes that the kind of railway machinery which he sees will provide the best subjects for writing about. The descriptions of things, strange and novel, are likely to interest him, but the differences between American track, bridges, signals, and rolling stock has been so thoroughly discussed that I thought our readers would be more interested in the "personal" of foreign railways, and accordingly I devoted considerable time and attention to the human part of the railway systems abroad. Most of us, after all, sympathize with the sentiment of Johnson, the famous lexicographer, who, on being invited to drive into the country, refused, saying, "One field looks just like another. Let us walk up Fleet street and look at the people."

One of the first things that strikes an American railroad man when he goes to Europe is the great number of men about the stations dressed in uniform, but being really railway employes. I stood around Euston Square station, in London, and did about the same business as the Grand Central station in New York, and it seemed that there were ten railway men to be seen for one on our side. When the list of men begins to be doing clerical work is examined, it is found that the number in Europe greatly exceeds those employed on American railways doing a similar volume of business.

The conditions of railway service all over Europe are much more permanent than they are in America. When a youth begins to work for a railway company he expects to remain on it for his life, just the same as those who enter government service; and on most lines he expects to be pensioned when he grows old.

*Formerly Boiler-maker, C. M. & St. P. Ry., Dubuque, Iowa.

Many men remain the whole of their working life at the same occupation, but the greater part of the men rise to higher positions than those they began with. In the early years of railway existence the highest positions were almost invariably filled by men who had commenced in the lower ranks, ability alone having been the power that worked them upwards. That state of affairs has gradually changed, and promotion is gained to great extent by family connections or influence. This is a sore subject with the men in the lower ranks, but most of them admit that being a railwayman consists of a director will not be able to man a responsible position unless he has the ability necessary to perform the duties satisfactorily. The men who fill the positions equivalent to our managers, superintendents and train-masters are now generally taken from the clerical departments. Formerly trainmen often reached the positions mentioned. Now a young man is appointed to him to be employed as a clerk, and from that he is promoted to be a station master at perhaps a small station. Here he gains valuable experience which prepares him for taking charge of a larger station, where he learns enough to take a position near the general manager. A station master is a much more important position than a European railway than he is in America. On some of the Continental lines he is dressed finer than a driver, and puts on more airs than a city marshal.

In the British Isles the locomotive superintendent, who is head of the mechanical department, is nearly always a practical mechanic, who has risen through the grades of fireman, shaf fireman and engine driver in progressive steps in that line which led to the top. He holds in every European country a much more independent position than that held by most mechanical superintendents in America. He is responsible only to the directors for the way his department is managed, and is no more under the control of the operative department than any other man in the firm. This is the same with the head of the permanent way, buildings and bridges.

The men who run locomotives are treated with much more consideration in Europe than their workmen, but the engineers and firemen on most of our roads would think themselves very badly treated if they were subject to the rules in force here. The pay of a locomotive driver varies from 75 cents to \$1.25 a day, according to locality and character of service. An engineer gets from \$1.25 to \$2 per day. Mileage receives no consideration. A first class mechanic receives about \$1.25 a day. A day is 12 hours for a trainman, and a man is not entitled to overtime until that length of time is exceeded. With the exception of train engineers frequently make over 300 miles a day. A Government department called the Board of Trade exercises control over railway operating, and reports have to be sent in daily of the number of hours that all trainmen, switchmen and others have been on duty. If men are worked more than 12 hours their rates are certain to be demanded as an explanation.

Persons who wish to become engine drivers in Britain now invariably begin work as wipers. These are taken on as apprentices. When a fireman is wanted the oldest wiper is taken, but before being advanced he is examined in reading and writing, and in arithmetic. The oldest fireman is promoted as a rule when an engine driver is needed, but he is examined regarding his knowledge of the work to be done. The examination relates to engine and brake mechanism and to firing—little different in fact from the examination given to firemen on our roads.

The fireman acts as a rule when an engine driver is needed, but he is examined regarding his knowledge of the work to be done. The examination relates to engine and brake mechanism and to firing—little different in fact from the examination given to firemen on our roads.

find how skillfully the firemen did their work. I rode from Glasgow to Carlisle on the engine of a Caledonian Railway express train of twelve carriages, and both the firing and the handling of the engine were as near to perfection as anything I could conceive.

I shall postpone my remarks about the condition of railway men on the Continent of Europe to another letter.

A. S.

The Fastest Regular Train

Trains have been running all the past summer on the Philadelphia & Reading railway between Philadelphia and Atlantic City and return, which were the fastest trains ever run regularly on any railroad. The trains were not of the two or three car variety which is generally arranged for fast runs, but were composed of six or seven heavily loaded cars, the average weight of train being 417.7 tons. During the month of August these trains were run every day by engine "569," a four-cylinder compound of the Vulcan type. The average speed from start to stoppage for the whole month was 59.1 miles per hour.

The engine which made this remarkable record is of the same type and general dimensions as the celebrated "Columbia," that attracted so much attention at the World's Fair. She has two pairs of drivers and a leading and trailing pony truck. The driving wheels are 7 feet diameter and the trailing pony truck is connected with the hand pin. The boiler which has the Wootton firebox is straight, 41 inches diameter, and gives 1,178 square feet of heating surface.

The peculiar wheel arrangement produces a finely proportioned engine, with a good distribution of the weight. The leading pony truck equals with the leading pair of drivers and the trailing pony truck equals with the back drivers. There is no equalizer between the drivers. The engine rides very well indeed.

The Long & Alstalter Co. of Hamilton, O., report that business is improving as rapidly as might be expected. They are making particularly good tools for manipulating plates, and the demand for the same is increasing. In the railroad trade their great stand-by is the "bulldozer" for forming and shaping for structural work. The hard times they have been peculiarly favorable to this tool, for they have compelled railroad companies to use the scrap heap as stock for repairs. The "bulldozer" is a great help in making this kind of stock into useful entities.

The Bridgeport Machine Tool Works, owned by E. P. Bullard, has been incorporated into a company hereafter to be known as the Hillard Machine Tool Co. Mr. E. P. Bullard is president, H. A. V. Post is treasurer, and J. H. Ballard is assistant treasurer and secretary. The same line of tools will be built—and they build good ones.

The Niles Tool Works, at Hamilton, O., are running full time with rather more than a half force of men. Business is improving, but orders from a railroad company for machines are very scarce. They have lately built some exceedingly heavy tools for government work, and they have now in the shops very large tools for contract shop work.

Bement, Miles & Co., machine tool builders, of Philadelphia, have opened a New York office in the Taylor Building, No. 29 Cortlandt street, and have placed Eric H. Mumford, recently with Henry R. Worthington, in charge.

The Cleveland Twist Drill Co. have been awarded a gold medal at the Antwerp Exposition for fine tools.

? A. — What You — ? A. — — Want To Know.

Don't ask questions that simply require a little figuring to determine; make each question separate. No notice taken of anonymous questions.

(140) J. McNally, Halifax, N. S., writes: If a locomotive reverse lever is drawn up to the center notch, does the valve move, and if so, how much? *A.*—The valve moves to and fro to the extent of the lap and lead. 2. How can I calculate the area of a steam port? *A.*—Multiply the length by the breadth.

(141) D. P. Aurora, Ill., asks: Is it possible for an engine to slip ahead when shut off and runnng fast? Detailing a case. *A.*—This question was discussed *pro* and *con* a year or two ago. We were very skeptical about it, but many good men testified that it had actually occurred with them, and some explanations of the slip laid the trouble to the counterbalance and to engine being out of quarter.

(142) S. B. Quasqueton, Ia., writes: How do you find the pressure on the shell of a boiler? I should think that it would be that part of the shell out of water multiplied by the pressure per square inch, plus the surface of the water multiplied by the pressure above, heads not included. *A.*—The total pressure on the shell of a boiler is found by multiplying the circumference by the length, and the product by the pressure. The height of the water does not cut any figure.

(143) P. D. Paduch, Ky., asks: What is the best "dope" to clean a headlight with? *A.*—Alcohol and lampblack. Put some of the latter into a fair sized bottle of alcohol to make a thin paste. Wipe this on the deflector, from the center to the edge (never round and round), the alcohol will cut off all smoke stains and immediately evaporate. Then the lampblack is dry wipe it out with a clean piece of waste and you have a clean reflector, the least possible work, and without danger of scratching the reflector.

(144) S. B. Quasqueton, Ia., writes: On page 25 of "Progressive Examinations" is the following "Q. Suppose, after pitching overboard, you had only a "flutter" in the lower gauge cock, what would you do? *A.* Keep supplying water, but instruct fireman to keep fire bright, to prevent flues from leaking." If he didn't keep fire bright, why would the flues leak? *A.*—When the engine approached the summit her fire was forced to its hottest, and the flues were expanded to their greatest length. If the draft is stopped and the fire allowed to die down and the water in the boiler cooled by introducing cooler water, the flues will contract, move in the tube sheet—and leak. A clean fire prevents, in a great measure, differences in temperature (and, therefore, differences in length) of the tubes.

(145) A. L. B. Monet, Mo., writes: In Grimshaw's "Locomotive Catechism," page 24, where "Q. Suppose that a firebox has an A pressure of 150 pounds per square inch, what do you think the bolts are in inches between centers, what will be the strain on each bolt? *A.* There will be 16 square inches held by each bolt making 19,600 pounds that the bolt will have to hold." Please explain in your information column how this amount is obtained, giving reasons for each step. *A.*—If the bolt supports a load of 16 pounds per square inch and there are sixteen square inches on it there would be a strain of 2,560 pounds, instead of the enormous load quoted, which is, perhaps, a typographical error. 2. Also, please state what disposition is made of such shop engineers' activities after the exhibition at the World's Fair? *A.*—It is now at the shops of the builders, The Cooke Locomotive & Machine Co., Paterson, N. J. We understand that it is for sale.

(146) C. S. San Francisco, Cal., writes: I should like to ask you a few questions in regards to safety angle valves for air lines on a train. I have an arrangement that could be very cheaply applied to any angle valve at present in use; but it would act as follows. In case any cock on a train became partly closed, my valve would automatically seal all brakes on the train; but if cock was closed altogether, only a portion of the brakes would be set. Do you think this would be in case of an emergency? It might also happen that only the brakes on engine or tender would be set, or perhaps only on the last car, depending on which cock was turned? Will this do? *A.*—We do not think so. There are already too many devices invented to take the place of the angle valve. All the improvement necessary or desirable (if such is an improvement) is a cock that will let the air out of the train pipe if turned wrong. There are now about thirty patents out on cocks for doing this.

(147) H. F. B., Oswego, Mich., writes: Please give me a simple rule to find the proper size of steel and number of plates to put in a spring when the weight upon the drivers is known. *A.*—The width and thickness of the plates are decided arbitrarily. Springs 36 inches long have generally plates 3 1/2 inches wide. Shorter springs may be only 3 inches wide. Some springs are made 2 1/2 inches thick, but 1 1/2 inch makes a more durable spring. After the length, width and thickness of the springs have been settled, the number of leaves to be used can be calculated thus: Multiply the length in tons of 2000 pounds which the spring will carry by the width in inches, and multiply this by 11. This product one. Then multiply the width of the plate in inches by the square of its thickness in sixteenths of an inch. This will be product two. Divide product one by product two and the quotient will give the number of plates required. Suppose a spring 30 inches long, with carry 2 inches wide and 1/2 inch thick, has to carry a weight of 5 tons. According to the rule given we figure $5 \times 30 \times 2 = 153$ which shows that fifteen leaves would be about right.

During the floods that happened in a Western district last fall, a passenger train was caught in the water and the fire of the locomotive quenched. The railroad officials didn't back to prevent the passenger train from being damaged, but they taken back to terra firma as simply as possible, all the backs of a neighboring town having been used for the purpose. In writing the news of what was done there was a slight mistake made in spelling a word, and friends of the passengers were rather alarmed to read that the flood quenched the passengers were taken ashore in *ra. Et.*

The Southern Railway Company expect soon to begin equipping the new machine shops at Knoxville, Tenn., with the machinery required to put them in working order. All the heavy repairs required for engines running on divisions within any reach of Knoxville will be done in the new shops.

"Thump Nall Railroad Cyclopedic" is the title of a little vest pocket folder we have just issued. It contains more information than ever before crowded into so small a space. Your club banner will give you one.

The Westinghouse Air-Brake Works at Wilmerding, near Pittsburgh, are doing about double the business called for a year ago.

FLAT TURRET LATHE



TURNS
STRAIGHT AND TAPER FRAME BOLTS, ETC.
SEND FOR A COPY OF
"RAPID LATHE WORK,"
By New Method—Hartness System.
JONES & LAMSON MACHINE CO.,
BRINCFIELD, VERMONT, U. S. A.

MASON
AIR-PUMP
REGULATORS

800 in use on the
P. & M. lines.
Adapted as the standard on
many roads.
SENT ON TRIAL.
Mason Regulator Co.,
BOSTON, MASS.

WANTED Nos. 4, T and 10, Vol. 5
Locomotive Engineering
—must be in good condition. Will pay
double price. Write before sending.
Address: Locomotive Engineering,
46 Broadway, New York

FOR EVERY RAIL-ROAD MAN.
POCKET PRIMER
of
Air-Brake
Instruction.

Simple,
Easy Lessons
in pages of Meat. First
the Color. Mailed to any
address, on receipt of 50c.
W. S. ROGERS,
Mechanical Engineer,
BUFFALO, N. Y.

Books for Railroad Men.

LOCOMOTIVE ENGINE RUNNING and MANAGEMENT. By ANDREW SINCLAIR. Price, \$2.00.

INDICATOR PRACTICE. By FRANK P. HENSWAY. Price, \$2.00.

ELEMENTS OF MECHANICS. By T. M. GODFREY. Price, \$2.50.

PROGRESSIVE EXAMINATIONS FOR ENGINEERS AND FIREMEN. By JOHN A. HILL. Price, 50 cents.

AIR-BRAKE PRACTICE. By J. E. FULLER. Price, \$1.00.

COMPOUND LOCOMOTIVES. By A. T. WOONA. Price, \$2.00.

CATECHISM OF THE LOCOMOTIVE. By M. N. FARBER. Price, \$1.50.

SIMPLE LESSONS IN DRAWING FOR THE SHOP. By O. H. REYNOLDS. Price, 50 cents.

Send price of any of these or of any other books of the **ENGINEERING LITERATURE COMPANY**, Orange, N. J., and they will be promptly mailed to any part of the world. Send for Catalogue.

PATENTS
FOR INVENTIONS.
GEO. P. WHITTLESEY,
Atlantic Building, Washington, D. C.
EXPERT SEARCHES AND OPINIONS.
RAILROAD INVENTIONS A SPECIALTY.

The Westinghouse Air-Brake Company

Is now prepared to fill orders, at an hour's notice, for One or One Thousand Sets of

AIR-BRAKES FOR FREIGHT CARS,

having, at their New Works, an annual capacity for turning out Air-Brakes for **250,000** Freight Cars, **6,000** Passenger Cars, **10,000** Locomotives; besides repairs for the **350,000** Freight and Passenger Cars, and **26,000** Locomotives already equipped by



THE WESTINGHOUSE AIR-BRAKE COMPANY.

RAILROAD ENGINEERING

TAUGHT BY MAIL
4500
STUDENTS

Also, SURVEYING.

DISPLAYS AWARDED Courses in other branches, all including thorough instruction in Mathematics and Physics—used for THREE classes, starting where you wish to study in The Correspondence School of Industrial Science, Scranton, Pa.

THE "Southwestern Limited" RUNS DAILY between
NEW YORK, BOSTON and Cincinnati, Indianapolis, St. Louis, via BIG 4 ROUTE.

E. H. MURPHY, D. R. MARTIN,
Passage Traffic Mgrs. Don't Pass Up a Ticket Agt.
CINCINNATI

CINCINNATI HAMILTON & DAYTON R.R.
CH&D
CINCINNATI
MILWAUKEE
DETROIT

PULLMAN SLEEPERS on Night Trains.
ELEGANT PARLOR CARS on Day Trains.
DINING CARS between Cincinnati and Chicago.

W. H. GOREN, General Manager,
P. O. BOX 4310, Gen'l Pass. Agt., CINCINNATI, OHIO.

THE CHICAGO, MILWAUKEE & ST. PAUL RAILWAY
TURNS

Electric Lighted Vented Trains between Chicago, Milwaukee, St. Paul and Minneapolis daily.

Through Parlor Cars on day trains between Chicago, St. Paul and Minneapolis.

Electric Lighted Vented Trains between Chicago and Omaha and Sioux City, daily.

Only two hours from Chicago to Milwaukee; seven fast trains, each way, daily, with Parlor Car Service.

Solid trains between Chicago and principal points in Northern Wisconsin and the Peninsula of Michigan.

Through Trains with Palace Sleeping Cars, Free Chair Cars and Coaches between Chicago and points in Iowa, Minnesota, Southern and Central Dakota.

The best and latest type of private Compartment Cars. Free Reclining Chair Cars and Buffet Library Smoking Cars.

45 miles of road in Illinois, Wisconsin, Northern Michigan, Iowa, Minnesota, Missouri, South Dakota and North Dakota.

Ticket Agents everywhere, sell tickets over the Chicago, Milwaukee & St. Paul Railway, of address

GEO. H. HEAFFORD,
General Passenger Agent,
CHICAGO, ILL.

REQUIRES NO ATTENTION.

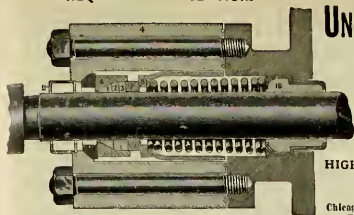

Swab and Oil Cups Furnished with every Packing.

IN USE ON THREE HUNDRED AND FIFTY RAILROADS.

UNITED STATES METALLIC PACKING CO.

For Locomotives, Stationary and Marine Engines.

The United States Metallic Packings

HAVE STOOD THE TEST OF YEARS AND ARE ACKNOWLEDGED TO BE SUPERIOR TO ALL.

Renewal of Packing Rings made without disconnecting, by cutting them in halves and breaking joints.

HIGHEST AWARDS COLUMBIAN AND PARIS EXPOSITIONS.

General Office, Bullitt Building; Works, 427 N. 13th St., Philadelphia, Pa.
 Chicago, Rotunda, Grand Pacific Hotel. St. Louis, 32 Laclede Building.
 San Francisco, 130 Main Street. Montreal, Canada, 751 Craig Street.

SEND FOR CATALOGUE AND SPECIFICATIONS.

SURE TO GIVE

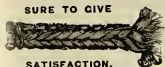

SATISFACTION.

DUVAL METALLIC PACKING

Send for Catalogues, Prices and detailed information to the

Duval Metallic Packing Co.,

39-41 CORTLANDT ST.,

NEW YORK CITY.

THE HALL SIGNAL CO.

Leads the World in the manufacture and installation of

Automatic Block Signals

Operated by either Track or Wire Circuits.

The ONLY Automatic Signal Systems in which the signals can be operated on the "Normal Danger" principle. Believed by many to be the best and safest plan.

HIGHWAY CROSSING SIGNALS,
STREET RAILWAY CROSSING SIGNALS, ETC.

OFFICES:

80 Broadway, New York.

927 The Rookery, Chicago.

115 The Ames Building, Boston.

Equitable Building, Baltimore.

PERFECT



PUMP PACKING

AN ABSORBENT OIL CUSHION—INSURES PERFECT LUBRICATION.

WEDGE-SHAPED WEARING PIECES THAT MOVE ON EACH OTHER—INSURE A TIGHT JOINT, WITHOUT UNDUE PRESSURE FROM GLAND.

DOES NOT GET HARD OR BAKED: NONE WASTED— YOU KEEP PUTTING IN RINGS, NEVER TAKE ANY OUT.

THIS PACKING IS GUARANTEED TO KEEP TIGHT WITH STEAM, WATER, AIR OR AMMONIA.

PERFECT FOR AIR PUMPS.

A TRIAL SOLICITED

All kinds
of Packing
—the P.P.P.
is best.

C. A. DANIEL,
313 Market St.,
PHILADELPHIA, PA.

A. W. SOFER, Pres.

ROBT. ANDREWS, Vice-Pres.

C. U. HOWARD, Sec.

W. B. THOMAS, Treas.

E. M. GIXON, Engineer

THE SAFETY CAR HEATING AND LIGHTING CO.,

160 Broadway, New York.

HEATING SYSTEMS.—By hot water circulation and direct steam with regulating devices. Reliable and uniform heat. Economical and rapid circulation. Gibbs automatic coupler of Westinghouse type, absolutely steam-tight.

LIGHTING SYSTEM.—The celebrated Pintsch compressed oil gas method. In use on over 40,000 cars in Europe and America. Adopted by the U. S. Lighthouse Board for lighting Buoys. The best, most economical and only safe light for Railroad purposes. In brilliancy and cleanliness unsurpassed.

M. C. B. STANDARD
Automatic Freight Car Coupler.

GOULD
Coupler Co.

WORKS : DEPEW, N. Y.
 BUFFALO, N. Y.

Gould Continuous
Platform and Buffer.
GOULD VESTIBULE.

M. C. B. Passenger Coupler
Used in Place of Miller Hook
WITHOUT CHANGE IN PLATFORM.

Locomotive and Car Axles,
Coupling
Links and Pins.

MILLS ESTABLISHED IN 1844.

EWALD IRON CO.

OWNERS AND OPERATORS
TENNESSEE ROLLING MILLS, TENNESSEE ROLLING MILLS,
CUMBERLAND RIVER, MANUFACTURERS OF LOUISVILLE, KY.

TENNESSEE CHARCOAL BLOOM AND LAUREL STAY BOLT,
"E. I. C." and "BOONE" IRON.
Also, TANK, FLANGE, FIRE BOX AND BOILER STEEL AND IRON.
PRINCIPAL OFFICE AND WAREHOUSES -
939, 941, and 923, 925, 927 N. SECOND STREET, ST. LOUIS.

THE INEVITABLE
RESULT OF
USING INFERIOR
STAYBOLT IRON
IN THE
CONSTRUCTION OF
THE MODERN,
HIGH PRESSURE
LOCOMOTIVE
BOILER.



To AVOID EXPLOSIONS
and consequent GREAT
LOSS OF LIFE AND
PROPERTY, use the
SAFETY HOLLOW
STAYBOLT,
MANUFACTURED BY THE
FALLS HOLLOW STAY-
BOLT CO.,
CUYAHOGA FALLS, O.

Furnished in all sizes from $\frac{1}{2}$ to 2 inch, outside diameter, with any size hole required from $\frac{1}{8}$ to $\frac{3}{4}$ inch.

LOCOMOTIVE SPRINGS

WITH PATENT V SHAPE BANDS.
Gives more Elasticity to short Plates
and Better Riding Qualities.



MANUFACTURED BY
A. FRENCH **SPRING CO.**

A. FRENCH, Pres.
J. E. FRENCH, Vice-Pres.

GEO. W. MORRIS, Gen. Mgr.
D. C. NOBLE, Sec and Treas.
F. N. FRENCH, Gen'l. Supt.

A. FRENCH SPRING CO.

PITTSBURGH, PA.
Manufacturers of
ELLIPTIC AND SPIRAL SPRINGS
OF ALL DESCRIPTIONS.

THE TROJAN CAR COUPLER CO., Troy, N. Y.

The key may be thrown open for coupling by the hand rod of the car, rendering it unnecessary for the trainmen to go between the cars to open the knuckle.
M. C. B. TYPE. THE STRONGEST AND THE ONLY SAFETY COUPLER. New York Office: 49 WALL ST.



THE JANNEY FREIGHT CAR COUPLER



THE MCCONWAY & TORLEY COMPANY



W. M. CONWAY - PRESIDENT.



48th ST. & A.V. RY. - PITTSBURGH, PA.

PEERLESS

ENGINE AND TENDER HOSE CONNECTION.

Air Brake Hose Guaranteed for 3 years.

Steam Hoses for Car Heating.
Wonderful Steam Resisting Qualities.

E. L. PERRY, Pres. W. G. WINANS, Treas.



THIS HOSE is known as our ANACONDA brand. It is corrugated, made of three and four plies of duck, with a wire inserted to prevent it from collapsing or kinking, thereby making it impossible to break or shut off injectors when rounding a curve or striking a low joint. It is made any shape or length required. The outside is covered with a canvas jacket or covering to prevent oil, grease, etc. from destroying the hose. This hose is thought by many of the master mechanics of our large railroads to be the ideal hose for engines and tender connections.

MANUFACTURED EXCLUSIVELY BY

THE PEERLESS RUBBER MFG. CO.,
No. 16 WARREN STREET, NEW YORK.

NEW YORK OFFICE FOR RAILS AND FASTENINGS—33 WALL STREET.

THE HAYDEN & DERBY MFG. CO.,

SOLE MANUFACTURERS OF

Metropolitan Double-Tube Locomotive Injectors.

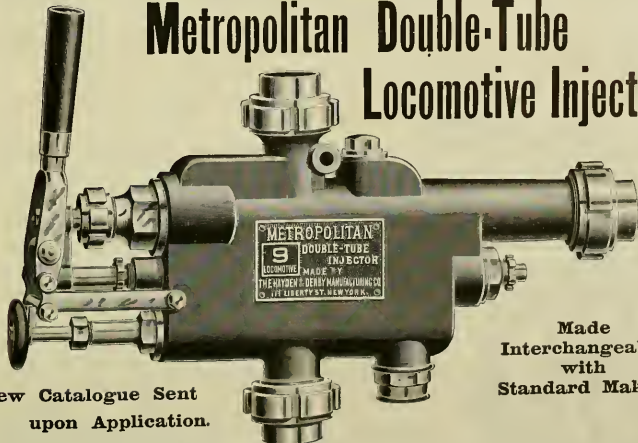

Made Interchangeable with Standard Makes.

New Catalogue Sent upon Application.

Office and Salesrooms:

Nos. 111 and 113 LIBERTY STREET, NEW YORK.

THE ROTARY.

For full
Particulars,
Address

The Leslie Bros. Mfg. Co.,
Paterson, N. J.

YOU HAVE BEEN WANTING to know more about this famous Engine. You should have framed in your room our "Chart No. 2," showing transparent picture of the engine, with every piece numbered and named. Printed on satin gloss paper, and sent in a tube, ready for frame, 50 cents, stamps will do.



Locomotive Engineering,
256 Broadway,
NEW YORK.



A MONTHLY JOURNAL devoted to Steam Engineering and Practical Work relative to the Economic Generation and Transmission of Power. 58 to 64 pages, size of this paper, profusely illustrated. Price, \$1.00 a year. Send for Sample Copy—FREE. Address

THE POWER PUBLISHING CO.,
WORLD BUILDING, NEW YORK.



**THE WASHBURN
Car-Wheel Company,**
HARTFORD, CONN.,
MANUFACTURERS OF
**CRUCIBLE
STEEL-TIRED WHEELS**

For Parlor and Sleeping Cars,
Passenger Coaches, Locomotive and Tender Tracks.



New York. Boston. Chicago.
HOWE, BROWN & CO., (Limited) PITTSBURGH, PA.

STEEL. HOWE'S SPECIAL TOOL CAST STEEL for Taps, Dies, Reamers, Cutters, Punches, Chisels, Drills, Shear Blades, Lathe Tools, etc., etc. Crucible Spring Cast Steel, Crucible and Open Hearth Firebox and Sheet Cast Steel, Forgings, etc.



**THE ONLY DOUBLE TRACK RAILWAY
BETWEEN
CHICAGO AND THE EAST.**

Wagner Sleeping Cars, Dining Room and Private Compartment Cars between Chicago, Toledo, Cleveland, Buffalo, Rochester, Niagara, Albany, New York, Boston, and intermediate points.
Route of the NEW YORK AND CHICAGO LIMITED, BOSTON AND CHICAGO SPECIAL, and the U. S. FAST MAILS.

W. H. CANNIFF, Gen'l. Supt. CLEVELAND, D. A. J. SMITH, G.P. & T. A.



**HAMPSON
Flexible Steam Joint**

Does away entirely
with Rubber Hose
for Steam Heating

HAS NO GROUND JOINTS.

F. A. BARBEY & CO., 215 FRANKLIN STREET, BOSTON.

RAMAPO WHEEL AND FOUNDRY CO.

MANUFACTURED BY

BOLTLESS STEEL-TIRED WHEELS

FOR PASSENGER AND LOCOMOTIVE SERVICE.

Tires with Annular Web and Hook,
Best Charcoal Iron Double-Plate or Spoke Centers,
Wedge-Shaped Retaining Ring.



SECTION OF BOLTLESS FASTENING

Continuous
Circumferential
Fastening.



SIMPLE, +
SAFE, +
ECONOMICAL.

CHILLED IRON WHEELS

OF SUPERIOR QUALITY,
Drawing Boxes, Passenger and Freight Cars,
Locomotives, Tenders, Plantation
and Mine Cars.

CYLINDER PACKING RINGS.

CONDON BRAKE SHOES

FOR CHILLED IRON WHEELS,
Outwear from 4 to 6 ordinary
Shoes and enhance
mileage.

Office and Works: RAMAPO, N. Y.

RAMAPO IRON WORKS, Hillburn, N. Y.,

MANUFACTURE

Brake Shoes for Steel Tired Wheels.

ROSS, for Steel Tired Car and Tender Wheels,
ROSS-MEEHAN, for Locomotive Drivers,
SHEPPARD, for Blind or Bald Tired Drivers.

NARROW GAUGE CARS, SWITCHES, AUTOMATIC STANDS.

VOKED, BOLTED and SPRING RAIL FROGS,
CROSSINGS, TRACK EQUIPMENT,

RAILROAD AND MACHINERY. CASTINGS, HEAVY AND LIGHT.

C. E. BOOD. H. M. BROWN.

**ROOD & BROWN,
CAR WHEEL WORKS,**

BUFFALO, N. Y.

Railroad, Car, Engine, Tender and Truck Wheels, Made from Best Charcoal Iron.
Office and Works: HOWARD and THOMAS STS.

C. M. FARRAR. JOHN TRIPP. C. E. BOOD.

EAST BUFFALO IRON WORKS,

FARRAR, TRIFTS & HODD, PROPRIETORS.

GREY IRON CASTINGS

of every description. Special Attention Given to Car and Locomotive Work.
Works: N. Y. C. & N. E. R., Broadway Station, East Side. (Telephone) 60 Perry St., Buffalo, N. Y.

C. E. ROOD,

MANUFACTURER OF

MALLEABLE IRON,

QUALITY GUARANTEED.

RAILROAD WORK A SPECIALTY.
Office and Works: LANCASTER, NEW YORK.



**Standard Steel Works
PHILADELPHIA.**

STEEL TIRES

Manufactured by an Improved Process
Insuring Solidity.

**Wrought Iron Centres.
Steel Tired Wheels.**

REPRESENTATIVES:

CHICAGO, 1013 MONMOUTH BLDG.,
FITZ-MUHL & SPENCER.

ST. LOUIS, 618 NORTH THIRD ST.,
ANDREW WARREN.

WROUGHT IRON WHEEL CENTRES. VAUGHAN'S PATENT.

D. O. SETTLEMEYER, President.

GEO. W. EVANS, Vice-President.

W. C. ARTHURS, Secy. and Treas.

FRANK SYDNER, Supt.

Mt. Vernon Car

MANUFACTURERS OF

FREIGHT CARS OF EVERY DESCRIPTION,
CABOOSE AND REFRIGERATOR CARS,

MT. VERNON,



Manufacturing Co.

CAR WHEELS, CAR CASTINGS, AND GENERAL
FOUNDRY WORK.

Capacity, 15 Cars and 300 Car Wheels.

ILLINOIS.

MILLER'S ASBESTONE CAR ROOF.

THE COMING ROOF

HEAVY, DURABLE AND STRONG. WILL WEAR LONGER THAN ANY METAL ONE.

Costs from \$ 70 to \$15 Less per Car. CAN BE PUT ON IN ONE-HALF THE TIME. WILL WEAR THE LIFE OF THE CAR.

HEAR WHAT THEY SAY ABOUT IT. Oct Warr: M. K. & T. Ry. Down East: Boston & Albany R.R.

1302 HAVEMEYER BUILDING, 26 Cortlandt Street, NEW YORK.



RODGER BALLAST CARS.

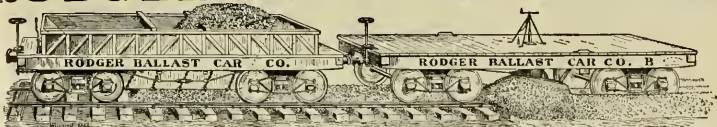

These cars are 34 feet long, and are built either 50,000 or 60,000 lb. capacity, M. C. B. Standard. They carry from 16 to 20 cubic yards of gravel or broken stone in using them no ballast is thrown in the ditch, and none is wasted, as the precise amount of ballast needed can always be discharged. A train of 20 cars, carrying 300 yards of ballast can be unloaded and the ballast distributed, leaving the track perfectly cleared and leveled, so shows to the cars. In from 10 to 15 minutes the ballast is all done by the regular "train service" (a conductor and two brakemen, no extra help being required). The track is perfectly cleaned by the car, so that a train can immediately pass over it at our rated speed, without meeting any obstruction. No wires are needed; no wire cables are used. There is no shoving when ballast from between the cars, and no cleaning the tracks with shovels. The ballast is left between the ties and in their gaps, directly in position for stamping, when the track is raised, without being shoveled in from the ditch. The average saving per mile, in the amount of ballast needed to make a "raise" of 10 or 12 inches, will be about 600 yards, and often far exceeds this. The total saving per mile in material, labor, time, use of cars, saving in transportation, etc. is found to amount, in gravel, to from \$20 to \$40, and in broken stone it often amounts to \$60.

These cars are in use on the Great Northern Ry., the Illinois Central, the Gulf, Colorado & Santa Fe, the Chicago & Eastern Illinois, the Peck, Lines West, and other roads.

Detailed information will be furnished by addressing the
RODGER BALLAST CAR COMPANY, No. 1215 Monandnock Building, CHICAGO, ILL.

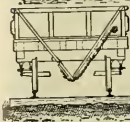

THEIR SUPERIORITY IS PROVEN BY THEIR POPULARITY.

FINEST SEATS. Coach, Parlor Car, Sleeping Car, Street Car, Retain Elevated

IN USE ON ALL THE PRINCIPAL RAILROADS IN THE UNITED STATES

Spring Egg Seat



THE HALE & KILBURN MFG CO.,

Stimulity, Durability, Elegance, Comfort, Combined.

IT IS SAFE TO SPECIFY THE

H. & K. SEATS

PHILADELPHIA, NEW YORK, CHICAGO.

Steam Heating from the Locomotive: Locomotive Equipments, Direct Steam, Commingler, Storage and Multiple Circuit Systems. Cars equipped 6,170. SEWALL COUPLERS sold 55,617; the standard in U. S. and Canada.

ALBANY

Electric Heaters for Street Cars:

With Temperature Regulating Switch, 5 intensities of heat using from 2 amperes up. Radiating surface 3 to 20 times that of other heaters. Two years guaranty. Cars equipped 1,000.

CONSOLIDATED CAR-HEATING CO

Pope Light Compressed Oil Gas: Interchangeable with "Pintach" and superior thereto. Uses same gas as "Pintach." In Great Brittain 14,209 steam and cable cars already equipped. Patents guaranteed.

Albany, N. Y., 413-423 North Pearl Street. CHICAGO, 200 WESTERN UNION BLDG.; Canada, Centinawk, P. Q.; London-Moscow. Specially tested fittings and car lighting repair parts at reasonable prices. Electric Heaters for offices.

THE MURPHY STEEL CAR ROOF.

HAS no surface mill or screw holes. It has no joints where wind, rain or fire snow can get through. It allows for contraction and expansion, and has suppo elasticity to provide for sagging, twisting, bending and cornering of the car body. It's as solid as the car frame itself. It has no soldered joints. It can be repaired readily, and without taking off more of the roof than is damaged. It is much cheaper than any other metallic roof now in use, and is cheaper than the double board roof, made of good lumber. It is unlike any other metallic roof for the reason that everything is furnished to make it complete; so that the parties buying it have no expense other than to apply it.

This ROOF can be applied on OLD LAKY BOARD-ROOF CARS without making any changes in the board roof, thereby saving the expense of replacing the old boards with new, and thus utilizing material that most otherwise is thrown away.

Manufactured by the P. H. MURPHY MFG. CO., East St. Louis, Ill.

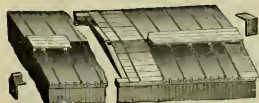



The Original Gleason Ratchet Drill.

Has been in satisfactory use for years in the principal Machine Shops, Navy Yards, and by Railroad Companies. It is a first-class drill in every respect and will stand the strain that it is daily subjected to in the rough usage of Railroad Track Drilling, Bridge Building, etc. It is guaranteed in every particular.

HENRY C. AYER & GLEASON CO.,
N. E. Corner 2d and Diamond Streets, Philadelphia, Pa. Central Office, 919 Betz Building.

MATCHLESS VALVE AND CYLINDER OIL.



Warranted not to corrode the iron or destroy packing, and to make more mileage than tallow or lard. Sold only to Railroad Companies direct or through our authorized agents. Matchless Cylinder Oil cannot be Bought of Dealers. In use on 80 Railways.

—OILS FOR RAILROAD USE A SPECIALTY.—
ECLIPSE LUBRICATING OIL COMPANY, Limited,

MANUFACTURERS OF EVERY PRODUCT OF PETROLEUM.
Main Office: FRANKLIN, Pa. Branches: FRANKLIN, Pa. OLEAN, N. Y. ERIE, Pa. OIL CITY, Pa.

Carbon Steel Company, Pittsburgh, Pa.

MANUFACTURERS OF

OPEN HEARTH STEEL PLATES FOR ALL PURPOSES.

SPECIALLY SUITED FOR LOCOMOTIVE FIREBOXES AND BOILERS.
PARTICULARS SENT ON APPLICATION.

Railroad Agents:

J. B. BRADY, 909 Havemeyer Building, New York.

W. M. WILSON, Western Union Building, Chicago.

PAUL S. REEVES, Philadelphia.
PHOSPHOR BRONZE IN INGOTS AND CASTINGS. * **LOCOMOTIVE AND CAR BEARINGS** A SPECIALTY.
BRASS and PHOS. BRONZE CASTINGS from 1/4 lb. to 5,000 lbs. in WEIGHT.

Trade Mark
GOULD'S
STEAM and WATER JACKING
(Patented June 1, 1891)
Keeps the engine in motion.
No matter how long it has been out of use.
(The Only & Best Packing)
It is made of a special kind of
rubber, and is the only one that
will not become brittle with time.
It is the only one that will
not become brittle with time.
THE GOULD ENGINE CO.
East Cambridge, Mass.

The New "NATHAN"

(See Illustration) AND
MONITOR INJECTORS
FOR
LOCOMOTIVES.

"NATHAN" SIGHT-FEED LUBRICATORS,
For Locomotive Cylinders and Air Brakes
STEAM FIRE EXTINGUISHERS.
For Switching and 3rd Engines.
BOILER WASHERS,
Road and Guide Oil Cups, etc.

Send for DESCRIBED CATALOGUES.

NATHAN MFG. CO., 92 & 94 Liberty St., NEW YORK.

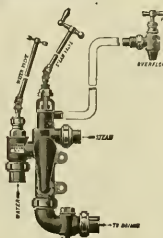

THE CAMERON STEAM PUMP.

COMPLETE WITH BOILER.

THE A. S. CAMERON
STEAM PUMP WORKS,
Foot of the Chestnut Street Bridge,
NEW YORK.

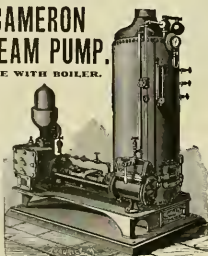

Send for illustrated Catalogue.



THE Fire-Proof Baker Car Heater

MADE OF FLEXIBLE STEEL
ONE-QUARTER INCH THICK.
Firmly Welded into One Compact, Jointless, Seamless Whole.

FIRE WITHIN A SAFE OF SAME MATERIAL
AS THE EXPRESS CAR SAFE.

NEARLY 1000 FIRE-PROOFS IN USE.
ALL OTHER STYLES OF "BAKER HEATERS."

WILLIAM C. BAKER,

Sole Proprietor and Manufacturer,
143 LIBERTY STREET, NEW YORK.

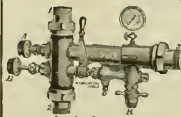

Ask for Catalogue.

YOU are now looking at a picture of
the Best **BOILER WASHER**
and **TESTER** made. Washes with hot water.
Tests to any pressure with hot water. Requires
no foundation, takes up no shop room. Has no
moving parts, and a record of efficient service
for ten years. We also make the FAMOUS
"Little Giant" Injector. Ejectors and
other Jet Apparatus.

Rue Manufacturing Co.,
119 N. 9th St., Philadelphia, Pa.

DRAKE & WEIRS, Cleveland, Ohio.

ASPHALT CAR ROOFING

The Cheapest, Best and Most Durable Car Roof Known. In use by seventy
Railroads. Twelve years successful use without a single failure. A new roof furnished free for
every one that fails in ten years.

SCHOEN MFG. CO.

PRESSED
STEEL MATERIAL
FOR CARS.

PITTSBURGH,
PA.

BEMENT, MILES & CO.,

PHILADELPHIA, PA.,

METAL WORKING MACHINE TOOLS

FOR
Railroad Shops, Locomotive and Car Builders, Machine Shops, Rolling Mills, Steam Forges, Ship Yards, Boiler Shops, Bridge Works, etc.



New York Office
TAYLOR BUILDING,
39 Cortland St.
E. H. MUMFORD,
Representative.

**STEAM
HAMMERS**
**STEAM AND
HYDRAULIC
RIVETING
MACHINES.**

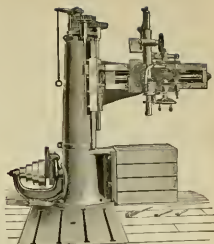

Special Air Tools for R. R. Shops.

**Automatic
Compound
Belt Com-
pressor. = =**

Only runs when air is used, requires no attention except oiling, delivers 35 cubic feet of free air per minute—great economy over steam air pumps.

Air Hoists of all sizes,—save more labor and time than any other shop tool, speed of hoist being entirely at will of operator. Will save ten times their cost per year over a wheel lathe.

Let us quote you on above tools.

PEDRICK & AYER CO.,
1001 Hamilton Street,
PHILADELPHIA, PA.

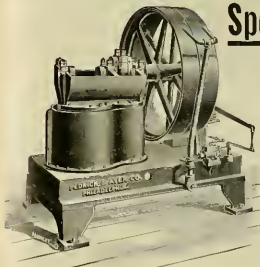
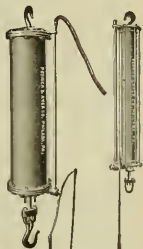

Nicholson's Expanding Lathe Mandrels.



Set of 9 takes from 1 in. to 7 in. Set of six from 1 in. to 4 in.

Either Set sent subject to Thirty Days Trial, and Guaranteed Absolutely Accurate and Labor Saving.

Send for catalogue for full description and references.

GEORGE L. WEISS, General Agent, 130 INGLETON AVENUE, CLEVELAND, OHIO.



THE ACME MACHINERY CO.
CLEVELAND, OHIO.
Manufacturers of
ACME BOLT & RIVET HEADERS
Acme Single & Double Automatic Bolt Cutters
Cutting from 1/4 to 6 in. diam.
Also, SURFACE GRINDERS and Dies,
First Premium Cincinnati Centennial.



THE PRATT & WHITNEY Co.,

HARTFORD, CONN., U. S. A.,

MANUFACTURERS OF
STANDARD CYLINDRICAL SIZE and U. S. STANDARD THREAD GAUGES.
Special Gauges of every variety of interchangeable production

REAMERS, TAPS and DIES,
In all usual styles for Machinists, Pipe Fitters and Boiler Makers

Renshaw Ratchet Drills, Combination Lathe Chucks, Die Stocks, Bolt Cutters, Lathes, Planers, Drilling, Milling, Profiling, Cutter Grinding, Die Sinking, and Drop Forging Machines, Forging and Trimming Dies.

MONITOR MACHINES FITTED WITH TOOLS

For finishing to Sample. Screws, Stalls, Locomotive Fittings, Plumbers' and Gas Fitters' Brass Goods.
CATALOGUE SENT ON APPLICATION.

THE ALLISON MFG. CO.,

MANUFACTURERS OF

FREIGHT CARS and
LOCOMOTIVE BOILER TUBES.

WROUGHT IRON PIPE OF SUPERIOR QUALITY.

PHILADELPHIA, PA.

STEVENS PATENT IDEAL
COMBINED DIVID-R & CALIPER SPRING SCREW THREAD CALIPERS
No. 62.
Price, per set, \$4.00
All included
Packed for transmission by mail.
Ideal Surface Gauges, Depth Gauges, Ideal and Lender Spring Dividers and Fall-gauges and Fine Marking Tools, etc. Illustrated catalogue free for 100.

STEVENS PATENT
LEADER, No. 71,
price by mail, postage
paid, 40¢. Single, \$1.00
Double, \$1.50
These tools for fine work,
especially nut dies, have no
equal in the world.

TOOLS.

J. Stevens Arms & Tool Co., P. O. Box 3770 Chicago Falls, Minn.

THE LONG & ALLSTATTER CO.,

HAMILTON, OHIO.



**PUNCHES
AND
SHEARS.**
Over 300 Sizes.

Horizontal Punch. Made in 5 Sizes.

TAYLOR BEST YORKSHIRE STAYBOLT IRON

Axles, Piston Rods, Crank Pins and Forgings of all Descriptions, used by Leading Railroads.

R. MUSHET'S SPECIAL AND TITANIC STEELS

SOLE REPRESENTATIVES IN THE UNITED STATES,

B. M. JONES & CO.,

BOSTON, 11 and 13 Oliver Street. NEW YORK, 143 Liberty Street.

THOMAS PROSSER & SON,
15 GOLD STREET,
NEW YORK.

K R U P P

STEEL TIRES

ON LOCOMOTIVE DRIVING WHEELS
AND ON STEEL-TIRED WHEELS
GIVE THE BEST RESULTS
FOR EVERY VARIETY OF SERVICE.

The CAST-STEEL WORKS OF FRIEDRICH KRUPP, Essen, Germany, cover an area of 1,200 acres, employ about 25,000 men, have the most improved plant, and stand unique, from the fact that they have their own Ore and Coal Mines, Blast Furnaces, etc., and that every stage of manufacture is under their own supervision, and are not (like others) dependent on the open market for a miscellaneous assortment of crude material; which, in connection with 75 years' experience, enables them to turn out a product of a very superior quality, second to none, and at the same time the different grades of Steel are always of the same uniform quality.

Crank Pins, Piston Rods, Spring Steel, Steel-Tired Wheels, Etc.

After a test of over 35 years, the "KRUPP TIRE" has proved itself the best in the market. If a reliable article is wanted, which will give satisfaction, get KRUPP'S.

SCHENECTADY LOCOMOTIVE WORKS, SCHENECTADY, N. Y.

LOCOMOTIVES
OF
STANDARD
DESIGN
FOR ALL
CLASSES OF
SERVICE.



DR FROM
DESIGNS
FURNISHED
BY
RAILROAD
COMPANIES.

EDWARD ELLIS,
President.

WM. D. ELLIS,
Vice-President and Treas.

A. J. PITKIN,
Superintendent.
A. P. STRONO,
Secretary.

COMPOUND LOCOMOTIVES, Showing an Economy of 15 to 30 per cent. in Fuel and Water.
Annual Capacity, 400.

M. L. HENMAN, Pres. and Treas.
F. H. STURGEON, Asst. to the Pres.
E. J. HANCOCK, Vice Pres.
T. M. HANCOCKMAN, Secretary

DAVID RUSSELL, Supt.
B. TAPPY, Asst. Supt.



Brooks Locomotive Works,
DUNKIRK, N. Y.

Builders of Locomotive Engines for any required service from our own designs or those of purchasers.
Perfect interchangeability and all work fully guaranteed.

COMPOUND LOCOMOTIVES

FOR PASSENGER AND FREIGHT SERVICE.

J. G. MENDRICKSON, Pres.
F. J. CLAMER, Vice Pres.
J. R. NEISON, Sec. and Treas.

"AJAX TIN"
USED WITH COPPER PER OUR FORMULA, MAKES EMPIRE STATE EXPRESS BEARING METAL, WHICH RUNS COOL AT ANY SPEED: RECORD 90 MILES PER HOUR.

INCORPORATED,
PHILADELPHIA, PA.

Latrobe Steel Works
MANUFACTURERS OF

TIRES

FOR LOCOMOTIVE and CAR WHEELS.

Main Office and Works, Latrobe, Pa.
Branch Office, Hollis Building, Philadelphia.
Chicago Office, Western Union Building.
New York Office, Home Insurance Building.

William Sellers & Co., Inc.
PHILADELPHIA, PA.

MACHINE TOOLS

for Railroad Shops, Car Builders, etc.

HIGH SPEED
TRAVELING & SWING CRANES.

ALSO
TURNABLES, INJECTORS,

SHAFTING,
ETC., ETC.



"LACKAWANNA"
Sight Feed Locomotive

Cylinder Lubricator.

ABSOLUTE UNIFORMITY OF FEED.

Perfect distribution of oil to both cylinders from one feed glass, and entire efficiency under all working conditions.

Only One Class,

and that short and stout; almost unbreakable. Absolutely no use for any more. They are an unnecessary source of trouble and danger.

Write for full particulars.

LACKAWANNA LUBRICATING CO.,
1212 Capouse Avenue, Scranton, Pa.



Rhode Island Locomotive Works,
PROVIDENCE, R. I.

CHARLES FELIX MASON, President.
EARL PHILIP MASON, Vice-President.
WILLIAM P. CHAPIN, Treasurer.

ARTHUR LIVINGSTON MASON, Secretary.
JOSEPH LYTHGOE, Agent and Supt.
S. A. STEPHENS, Traveling Agent.

NEW YORK OFFICE,
Nos. 31-33 Pine Street.

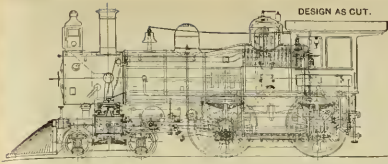

Baldwin Locomotive Works

STANDARD GAUGE LOCOMOTIVE,
For Immediate Delivery.

Cylinders 16" x 24" driving wheels, 60" diameter; 1125 steel 2" thick; total wheel base, 20' 10"; driving wheel base, 9' 7"; weight in working order, 110,000 pounds; wheels on driving wheels, as two outside, better, 60" diameter; fire-box, 244 in number, 2" diameter; 10' 11/2" long; vermicular in centre front-flued; triple wheels, 20" diameter; 1000 lbs. capacity; 20" diameter wheels; driving journals, 5" x 10"; triple journals 6" x 10"; triple journals 6" x 7". Engine is fitted with Detroit sight feed lubricator, Detroit side valve, two for piston and valve stems, balanced slide valves, with various valves, fluted side rods, one Muller and one New Nathan No. 8 injector, brightlight, two Libbey's view-safety valves, glass water-gauge and lamp, Westinghouse air brake on driving and tender wheels, with 25-pump, asbestos foot lagging, Janney coupler, National hollow brake-booms, and all necessary tools. For price and particulars, address:

BURNHAM, WILLIAMS & CO., Philadelphia, Pa.



Pittsburgh Locomotive Works.

PITTSBURGH, PA.,

Manufacturers of LOCOMOTIVE ENGINES

For Broad or Narrow Gauge Roads

From standard designs or according to specifications to suit purchasers.
Tanks, Locomotive or Stationary Boilers FURNISHED AT SHORT NOTICE.
WILSON MILLER, Jr. & Co. D. A. WESTMAN, Supt.



DICKSON MANUFACTURING CO.

SCRANTON, PENN.

Locomotives of every style and also, Standard and Narrow Gauge, made to Standard Gauge and complete also for Plantations, Mines and Logging.

SPECIFICATIONS OF APPLICATION.

JAN. P. DICKSON, President.
J. W. WELCH, V. Pres. WM. L. FRENCH, Sec. & Treas.
JOHN DEWITT, Superintendent.

CROSBY

POP SAFETY VALVES,
BUFFED AND PLAIN.

IMPROVED
STEAM GAUGES,
SINGLE BELL
CHIME WHISTLES.

A perfect equipment for a locomotive, giving maximum relief, economy and absolute safety. These goods when ordering locomotives.

CROSBY STEAM GAGE AND VALVE CO.,
Boston, Mass.

BRANCHED:
New York, Chicago, and London, England.

FLEXIBLE STEEL RULES.

Watch Spring Tempered Steel.
Graduated in 32nds and 64ths on one side only.

SEND FOR CIRCULAR.

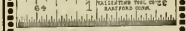

VALLENTINE TOOL CO.,
Hartford, Conn.

ROGERS LOCOMOTIVE COMPANY

OF PATERSON, N. J.
New York Office, 44 Exchange Place.
MANUFACTURERS OF
LOCOMOTIVE ENGINES AND TENDERS,
And Other Railroad Machinery.
H. S. HUGHES, President
G. E. HANNAH, Treas. G. H. LONGBOTTOM, Sec'y
REUBEN WELLS, Superintendent.



PORTLAND CO. LOCOMOTIVES OF ALL TYPES.

STANDARD OR NARROW GAUGE FOR ANY SERVICE FROM OUR OWN OR TO RAILROAD CO.'S SPECIFICATION.

Freight Cars, Derrick Cars, Push Cars and Car Wheels,
Boilers of Locomotive, Horizontal, Tubular and Vertical Type

FRANKLIN C. PAYSON, President. © JAMES E. GREENSMITH, General Manager. © BYRON D. VERHILL, Treasurer.



ESTABLISHED 1865. Richmond Locomotive AND MACHINE WORKS,

RICHMOND, VA.

Locomotives for Every Service.

The Sample Tells the Story.

A sample of Dixon's pure, flake lubricating Graphite, with interesting and instructive pamphlet,

Sent Free of Charge.

Every engineer and machinist should make himself better acquainted with Dixon's Pure Ticonderoga Flakes Graphite. It will save both time and labor, and is infinitely superior to the common forms of plumbeous or black lead.

JOS. DIXON CRUCIBLE CO.,
JERSEY CITY, N. J.

You can get back numbers to January, 1894.
NOW. You can't next year.

COOKE LOCOMOTIVE AND MACHINE CO. PATERSON, N. J.



JOHN S. COOKE, President & Gen. Mgr. PATERSON, N. J.
FRED W. COOKE, Vice-President.
W. H. BRIDGMAN, Sec'y & Treas.
New York Office,
45 BROADWAY, N. Y.
H. A. ALLEN, Agent.

MAGNOLIA METAL

ALWAYS --
-- COOL !!



For All Bearings.
Sterlingworth Railway Supply Co.,
Exclusive Railway Agents,
356 Broadway, New York.

JEROME METALLIC PACKING.

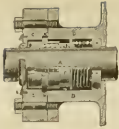

This is the Standard Metallic Packing all over the world, and is more generally adopted and in use on more locomotives than any metallic packing in use. Give the JEROME a trial and be convinced. Put it in competition with any other packing and be convinced of its superior merits.

Office and Works, Nos. 35 and 37 Canal St., Chicago, Ill.

C. C. JEROME, Inventor and Proprietor.

Packing ring opened ready to apply without disconnecting the Piston from the crosshead. It runs longer and wears the rod less than any other packing in use.



SEND FOR CATALOGUE.



THE CHAPMAN JACK. PATENTED.

THE screw being lubricated and protected, the Jack is always ready for instant service. Railroad men appreciate the importance of having Jacks always in good working condition. Serious delays frequently occur in getting common Jacks so that they can be worked when suddenly required in train service.

Common Jacks are frequently destroyed in efforts to make them work quickly after the screws are set with rust and dirt. This consideration alone makes the Chapman Jack the most economical one to purchase.

THE CHAPMAN JACK CO., CLEVELAND, OHIO.

BRACK SANDING APPARATUS FOR LOCOMOTIVES

HENRY L. LEACH,

(Inventor of Process)

BOSTON, MASS.

Room 46, Mason Building, 70 Kilby Street.

OUR ENGRAVINGS.

Of late we have had a great many inquiries as to who made the fine half-tone plates shown each month in LOCOMOTIVE ENGINEERING. Credit is due the expert anywhere and we are glad to recommend the engravers of our plates to those wanting good work at reasonable prices. All the half-tones and reproductions we use are made by the STAR ENGRAVING & PRINTING Co., 612 Chestnut Street, Philadelphia, Pa. SINGLAR & HILL.

The Smith Triple Expansion Exhaust Pipe.



FRONT VIEW.

THIS Device is the invention of JOHN Y. SMITH, the originator of the Smith Vacuum Brake. In the cuts of the Front and Side Views shown herewith, "A A" represent Air Passages; "S S" Exhaust Steam Passages, and "B" an Annular Blower forming part of the Nozzle.

It is an entirely new departure in the construction of Exhaust Pipes for Locomotives.

Its distinguishing features are that the exhaust steam is not restricted after it leaves the cylinders, and the gases and heated air in the smoke arch are mingled with the exhaust steam in the exhaust pipe. The exhaust steam is thus superheated and expanded, and a powerful, prolonged, pulsating blast is created, which keeps the fuel in a constant state of agitation, and produces more perfect combustion.

Some of the beneficial results obtained are: *Reduction of Back Pressure to a minimum (area of nozzle opening as large as the exhaust port); prevention of ejection of sparks from smoke stack; almost complete absence of noise from exhaust; prevention of formation of clinkers in fire-box; large saving of fuel.*

By the elimination of Back Pressure we have demonstrated the fact that the power of engines has been increased to be able to pull from thirty to sixty tons more than with any other form of exhaust pipe.

The pipe can be used with either straight or diamond stacks, in long or short front ends, and on locomotives burning hard or soft coal, wood or coke.



SIDE VIEW.

GENERAL AGENTS CO., 32 PARK PLACE.

GENERAL OFFICE GOYLESTON, PA.

FACTORY-READING, PA.

THE LESLIE

PATENT

Locomotive Fire Kindler

FOR

Cheapness, Simplicity, Cleanliness, Convenience, Absolute Safety, Durability and Economy,

STANDS UNRIVALED.

IT IS THE ONLY SYSTEM OF KINDLING LOCOMOTIVE FIRES WITH CRUDE OIL WHICH HAS EVER BEEN PUT INTO GENERAL USE BY ANY RAILROAD COMPANY.

THOUSANDS OF FIRES

Have been Kindled for Less than

4 CENTS PER ENGINE.

During the past Winter ONE car tank of Crude Oil kindled more fires than 500 Cords of Wood.

Its adoption in all round-houses over their Entire System by the Roads, which had tested it in all kinds of weather, furnishes absolute proof of its Complete Success.

For particulars, address

J. S. LESLIE, Paterson, N. J.

Locomotive Engineering



A Practical Journal of Railway Motive Power and Rolling Stock.

COPYRIGHTED, 1916, BY ANDREW SINCLAIR AND JOSE A. HILL.

VOL. VII, No. 12.

NEW YORK, DECEMBER, 1904.

30 Cts. Monthly
\$3.00 Per Year.

Let in the Daylight.

About a year ago the writer happened to walk through the shops of a railroad noted for providing the best of facilities for doing work, and he was struck with the dark and somber appearance of the machine shop. The windows were small and some of them were shadowed by other buildings, the effect being that at mid-day artificial light had to be employed in some parts. The walls and posts and rafters were as black as long years of smoke accumulating could make them. We suggested

good lighting are not properly realized. When the light is so obscure that a workman must use a tallow common oil lamp, the chances are that his capacity to perform work is reduced one-quarter. On some jobs it may be greater, on others it will be less. Every man in charge of mechanical work is aware how much the dark days of winter reduces the output compared in summer, when good sunlight is enjoyed through the whole working day. It is common for railroad companies to work short time in summer and full time in winter, which is very poor policy,

of light were not an important matter, so the windows are small and badly located. As these are considered of small importance no effort is made to keep them efficient. They are never cleaned, and when a pane of glass is broken the hole is filled with a shingle, a piece of tin or lump of waste. This condition of affairs is not rare. Those in charge of shops to which this description applies should mend their ways. It is near the first of the year, a good time for forming good resolutions. To those in need of advice we would say,

Going Through Normandy.

[EDITORIAL CORRESPONDENT]

Have, where my land journey began, is the Liverpool of France, and a striking place, the finer part of the town being built on the face of hills that show off the fine substantial residences to good advantage. The town is insignificant compared to many which a traveler sees in Europe, but to one from America it gives a peculiar impression which is everywhere made deeper—that is, that he has reached a place which is finished. When our cities

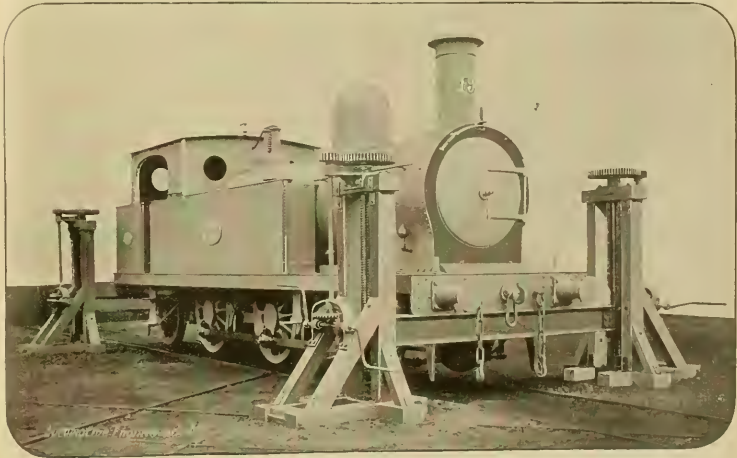

PECULIAR FORM OF SCREW JACKS USED IN MANY EUROPEAN SHOPS

to the master mechanic that a coat of whitewash would improve the light of the place and enable the workmen to labor to better advantage. It had never struck him that white walls would improve the light, and when the philosophy of the thing was explained he readily fell in with the idea. We visited the shop lately and it looked like another place. An apparatus had been improvised to do the whitewashing by compressed air, so that the work was done at little cost, and the walls were not permitted to become dingy. The M. M. spoke in the highest terms of the benefit they had derived from the increase of light.

This incident recalls the fact that in many shops the advantages that arise from

for the long hours are worked when production is done at the greatest disadvantage. That this practice is so common is a proof that those in charge do not fully realize the advantages of good light.

Dark shops represent a double line of waste which furnish strong arguments in favor of light. If the light of heaven is not freely admitted artificial light must be employed, the cost of which is money thrown away. Darkness reduces the capacity of the workmen and tools so that the work is done at greater expense. Black walls and shadows from adjoining buildings are not the only things that make shops expensively obscure. Many of them have been built as if the admission

of light were not an important matter, so the windows are small and badly located. As these are considered of small importance no effort is made to keep them efficient. They are never cleaned, and when a pane of glass is broken the hole is filled with a shingle, a piece of tin or lump of waste. This condition of affairs is not rare. Those in charge of shops to which this description applies should mend their ways. It is near the first of the year, a good time for forming good resolutions. To those in need of advice we would say,

During the month of October 3,819,947 passengers rode in the cable cars over the New York and Brooklyn Bridge. This was an increase of 201,894 over the record of the same month a year ago.

are as old as those seen abroad, they may also possess less of the developing appearance; but we will have to wait a long time for that. Havre is a comparatively young city for Europe, having been founded shortly after Columbus discovered America, but its position on an excellent harbor at the mouth of the Seine has given it advantages possessed by few of the older towns.

In one respect Havre has a homelike appearance, for the railways go through the town on the level, and the tracks are to some extent used as thoroughfares. As the train was pulling slowly through the town, young-sters of both sexes, clad in little more than native impudence, ran along the side of the cars soliciting money

I happened to have a good supply of copper coins, which I dropped off slowly, and witnessed curious sights in return, as the gamins and gamines rolled over each other in the scramble for the treasure. I felt sad to see the poor wretches. One look for a good deal of that sort of thing in Europe, but that scene was the most pathetic I witnessed in travels that extended over more than two thousand miles.

The train that took us to Paris was made up of small compartment carriages and pulled by a locomotive that looked very much like the engine illustrated on page 379 of *LOCOMOTIVE ENGINEERING* of last month. The engine is representative of a type now found on every railway in Europe, pulling passenger trains. It has two pairs

a merchant in Paris. Before leaving he gave me his card and invited me to call.

That, of course, was an exceptional company, as I did not fail to observe during my subsequent travels. You notice the peculiarities of the people in different countries very well by their habits in the cars. The French are the frankest and my own countrymen vie with the English for the place of being stiffest and most reserved. This applies principally to the third-class people, no matter what country they belong to, do not generally act as if they would suffer contamination from speaking to people they were never introduced to.

everywhere of neatness, thrift and industry. Great attention is bestowed upon details. The nameless fruit trees loaded with their kind give evidence of careful attention—they are cultivated to bear fruit and do it. No waste land devoted to raising of noxious weeds. Every citizen is encouraged to produce something useful. With sight of the prevailing industry one can understand how easily France passed through the treasure drainage of the German war infidelity and of the Panama Canal Company. Here for the first time I saw the wheat gleaming that we read about in the Bible. At several places rows of children and women were walking through the stubble, carefully "gleaning" every bead of wheat that had escaped the rake.

The people themselves are as interesting as their country. I did not see the Norman cap and kirtle because I was not there on a Sunday or holiday, but I saw many strap-

wards came back to me recollections of people seen in a pedestrian tour I took through Kent and Surrey, in England, many years ago. I had rambled away from railways and frequented routes, away into pure England, that had shouted for no reform bills, among men and women who would throw a potato at anyone who wanted even the land lease changed, or anything else altered that seemed an inheritance of Englishmen. These people had the same characteristics and the same appearance as the rustics to be seen on the lower banks of the Seine. They were the same race. Their forefathers had probably the aristocratic distinction of having "come over with William the Conqueror."

Those who are familiar with history are aware that there was a time when the whole of Europe was one nation like what the North American Continent would be if Canada and Mexico joined the Union. The great nation of Europe was the Roman Empire. In the day of its might the Roman Empire represented irresistible power. Its iron hand bound together in peace tribes of men who were as ferocious as wolves and as blood-thirsty as tigers, it touched them with a varnish of civilization and taught them principles of obedience, with a respect for law and order. When its time came, this Empire fell to pieces, and its fragments settled down where they could most comfortably exist by peaceful pursuits or by rapine, as taste and inheritance moved. The people who then dwelt in the region now called Normandy were a black-haired, swarthy race who loved ease more than strife. They lived peacefully on the fruits of the bountiful earth and water. But evil times overtook them. Away in the frozen North a fair-haired race had been growing and multiplying, and the struggle for existence was so hard that none but the soundest stock survived. With all the thinning out that the searching environments brought about, the pro-



of drivers coupled and a four-wheeled truck. There are differences in details to suit the tastes of the designers of the men in charge, but the essential features are becoming nearly uniform in France they use outside cylinders with the valve motion outside of the wheels, as seen in the suburban engine herein illustrated. The same practice prevails to a great extent in all Continental countries. In the British Isles, the fashion runs towards inside-connected engines, with every moving part that it is possible to hide kept out of sight.

The cars are finely upholstered and are very comfortable for a short journey, but their shortness makes them jump about a good deal when the train is running fast. There is one thing in which the compartment car is superior to the American type, and that is, it encourages sociability if the right kind of people get together. This struck me on this journey. The train was crowded and there were eight persons in this compartment, only two of whom seemed to have had previous acquaintance, yet we had not been together ten minutes when a general conversation was going on and it was kept up throughout the whole journey.

They smoked (after asking permission of two ladies who were present), joked, laughed and told anecdotes and had a tremendous good time considering that they were mostly strangers to each other. There was one man with an exaggeration of the facial peculiarities of the third Napoleon who seemed to be a vet, for he kept the party convulsed with laughter, but I never could catch the point of the jokes, and the best I could do was to laugh with the others. The conditions of his face were, however, funny enough to excite a call to laugh. A gentleman who sat beside me was very much interested in finding out how the United States compared with the part of Normandy we were passing through, and he gave me a great deal of interesting information about the places on the route. He turned out to be



This Normandy which the Western Railway of France takes us through, is a wonderfully interesting country in many ways. The railway goes through a fine fertile region which is cultivated to draw from the soil all the riches that art, labor and skill can entice. The first part is rolling and we traverse some pretty wooded valleys. Further on we reach the valley of the Seine and follow it or go through its shoulders during the remainder of the journey. The river is very crooked, indeed, and the arm of the engineers who located the railway was to make the latter straight. To do this they had to go through or under the ridges that border the river. Accordingly there are several long tunnels and deep cuttings gone through and the river is crossed four or five times. It is a fine substantial track and the grades appear to be light.

As we spin along we see evidences



ping women who no doubt gave these ancient specimens of woman's wear the means of showing off to good advantage. I had read a great deal about the influence Normans had exerted upon the development of the world, and my eyes were wide open to absorb whatever of the curious or the picturesque there was to be seen among the people. They had on their everyday attire, and were going through the ordinary walk of their lives, and yet I could not get rid of the impression that I had seen them all before.

I guess most of us who are gifted with any imagination have looked at scenes human and landscape for the first time that seemed perfectly familiar, giving a little support to weird theories that they were seen in a previous condition of existence. This feeling was very strong on me as I was watching the population of Normandy. Two or three weeks after-



ple kept increasing in numbers till the food supply was unequal to the demands. There is nothing that stimulates enterprise like hunger, and this people who became known as Normans resorted to emigration.

This practice of seeking new pastures appears to have been the only remedy for over-production of human beings devised since the time when Lot wandered away from Abraham by compulsion and planted his tents in the Valley of Jordan. The greatest safety-valve for over-production of people known since the world began has been the facilities for emigration to America. The Normmen knew how to build ships and manage them, and therefore the remedy for excess of bread-eaters was in their own hands. There was no contract labor law or other law to restrain them, nothing beyond their own sweet will, so they sailed away in search of more

room. One of the first places that suited their fancy was the northwest district of France. They immediately proceeded to take possession. Those who were already in the place objected, but their opposition was quickly overruled by means of spears, swords and other weapons which the Normans knew how to use by long practice. Immense swarms of these fair-haired emigrants crowded into Gallia Lugdunensis, as Normandy was then called. The new-comers were too busy to attempt learning to pronounce the old name of the country, so they called it after themselves.

The daughters of the soil suited them very well as wives, and no comely damsel was put to the sword. In the course of a few centuries this rich region came to be known even outside Normandy. The manners of the conquerors, and the contemplation of races had produced a people of splendid vitality. Like a famous Scotchman's dog, they looked very seriously upon life because they could never get enough of fighting. It was not long when they in their turn needed more room, and a certain chief called William was prepared to lead his warlike followers to new territory. England was badly governed by contending factions, and the leaders had not acquired the art of controlling men. William of Normandy intimated that he wanted to rule England, and to prove his sincerity took an army of his friends and followers across the channel, with a host of memories and an ample stock full possession of the country. In doing this he set an example that his successors have faithfully followed when they found a country that needed govern-

ment. I cannot dwell more upon the momentous consequences to the human race that came from this engrafting of Norman-Norsemen blood upon the heliargic stock of the native English. It produced a human being who was always jealous of any infringement upon his rights, material or moral, and this individual has been an important element in the conservation of human liberty.

At this point of the narrative the J. P. asks: "But what has all that got to do with roads?" I answer that it has everything to do with them, for were it not for the impulse given to progress and liberty by these Norman robbers, when they put vitality into the barbarian English tribes, the clock of time would have been held back two centuries and the railroad era would be still in the far future.

As we speed along we catch glimpses of quaint-looking towns and villages that have been here for centuries, but have been finished by a series of after-thoughts. There are many churches of the sub-artificial kind which was a stamp the Normans put upon everything they touched. The Parisians call the Normans greedy and grasping, and make fun of their odd ways, but it would be good for France if all her population had the frugal, industrious habits of the Normans.

A thing that soon strikes an American traveling on the European Continent is the number of women employed on unwomanly labor. The fields are full of them, we see them driving carts, plowing, leading hay and manure and performing all the toil-some work that we are accustomed to think belongs to man. On this Western Railway of France we find women on guard at all level crossings. At one place, I think it was in Germany, I saw women working on the track. There are very few women employed in offices at the light work for which they are adapted. The usage of the barbarism that made warriors of men and drudges of women has not entirely died out in Europe yet.

This Western Railway of France is one of the most important railways in the world. It has over 3,000 miles of double track that twists about through the most

populous regions of the country, and does an immense business, the extent of which may be guessed from the fact that 1,494 locomotives are employed handling 4,161 passenger cars and 23,500 freight cars. There are 2,377 men employed repairing locomotives and 2,331 men on car repairs, which does not include an army of cleaners. The nozzle of this immense railway system is the Gare (Station) St. Lazare, which we expect to illustrate soon. It is one of the busiest points in Paris.

I had a personal experience in the neighborhood of Paris the day after my arrival, which may seem funny. It was Sunday morning. As I walked along the fine promenades on the banks of the Seine, I noticed many excursion boats taking loads of people down the river. I am fond of watching people enjoying themselves, so I followed the crowd and got aboard. We passed many places well known to readers of history. The river swept along the base of a low hill beautifully wooded and dotted with fine mansions. As we went

Block Signaling on the New York Central Railroad.

BY D. B. MCCOY.*

The subject of block signaling has been very fully and ably discussed, and very many and instructive articles have been written on it. It occurs to me, however, that some few thoughts that have suggested themselves to my mind might yet be interesting, since they originate from intimate connection with the operating of an admirable system of block signaling.

Block signaling is not of recent origin, it dates back to the early and primitive days of railroading, when engineers used as their block by day the smoke of the preceding engine and by night the reflection of the firebox. There are many engineers in service to-day who will recall that they ran with a greater degree of confidence when they were thus enabled to follow the previous train than when they

few block signals that can oftentimes be operated and maintained without any additional expense or cost of operation, after the first cost, would bring a railroad many benefits. These, of course, should be placed at specially desirable points.

Great care should be taken in the location of block signals, so as to command as distant and uninterrupted a view as possible. The three prominent systems now in use on different roads all have merits, viz.: the Telegraphic, the Automatic and the Manual Controlled. With the latter I will deal, and endeavor to explain its functions and the history of its installation on the Hudson Division New York Central & Hudson River Railroad.

The Manual Controlled system is the only one that admits of being operated under the absolute or positive principle of allowing but one train to occupy the block land, to my mind, this is the only perfect and correct practice of blocking. When it was determined to equip the Hudson division with block signals, after it

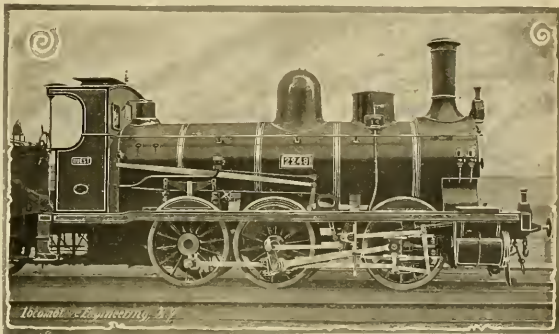

SUBURBAN ENGINE, WESTERN RAILWAY OF FRANCE.

on, a town half hidden with foliage appeared and a sign on the landing stage indicated St. Cloud. The place brought back a host of memories connected with events of the revolution of 1789, and I went ashore. I remembered that a very ancient marie here belonged to the ill-fated Marie Antoinette, and I wished to see a place associated with so many historical events.

I hailed a cab and asked the driver what he would charge to take me to the palace. He said two francs and I got aboard. He drove me a long time through some rustic streets and lanes where glimpses of curious old buildings were to be seen, and I kept inquiring for the palace, and he said "Soon." After a time I could see that he was returning, and I kept shouting for the palace. He kept repeating "Pretty soon," or its nearest equivalent in French, until we came back to a square which had been our starting point. Then he said, "This is where the palace was, but it was burnt by the Commune and there is no stone left." I felt moved to wrath, but the joke of his action struck me and I laughed at my own simplicity. Then I gave the man a half franc *pour rien*, with the advice that he had better not try that joke on others, especially Scotchmen, for they might fail to see it as a proper light.

A. S.

were without this signal and indication of where that train was. An engineer will run his train with more confidence and safety when he is informed by any method of signals after he becomes accustomed to looking for them, and once established their indication is reassuring. With an engineer who has experience in running under block signals, he will feel as anxious were they taken away from him as though he was obliged to run his train without the air-brake, and I date say, if the question were asked engineers which they would prefer to be without, could they have only the one, you would find many prefer signals to air. What engineer does not feel an anxiety in starting out on a dark, stormy night, with no signals to show him his track is clear? It is like navigating without the always welcome lighthouse.

The recent improvements in the different systems or methods of block signaling have advanced to such a degree of perfection that many roads to day are enabled to handle their immense traffic with safety and dispatch, that otherwise they could not do without their system of block signals.

There is no railroad too poor to be without some form of block signals. Even a

* Superintendent Hudson River Division of the New York Central & Hudson River Railroad.

was decided what system was to be used, the first thing to be done was to locate the different signal towers. This was done with the use of a special engine going over the road, great care being taken in locating the towers to at all times have as far a view as possible of the tower, and at the same time give the towerman a view of the approaching train. After the locations were determined, the erection of the signal towers was commenced at the south end of the division, completing them and throwing them into service consecutively, the engineers and trainmen first being notified to familiarize themselves with the location, and as they neared completion to memorize their location, as far as possible, so that when they were ready to be thrown into service they would know where to look for the signals.

In order to avoid possible confusion, and at the same time not to overtax the memory of the men, it was decided that as first as five or six towers were completed notice would be given that on a certain date and hour they would be thrown into service.

There being over one hundred towers on the division to equip and operate, it was no simple task to select and appoint qualified signmen. This was accomplished by having alternates in each of the five or six towers, posting and becoming familiar

with the duties of signalmen, so that when the next five or six towers were ready to be put in service those originally employed in the first lot were advanced to the next series, retaining the alternates in the first lot of towers, and selecting another lot of alternates.

About every week or ten days we would thus be ready to put into service additional five or six towers, and in this way we continued until the entire division was equipped, interlocked and tied up with blocking. Not a train was delayed or a mistake made—the engineers becoming

sensible exception of two or three trailing ones, every switch on the division is either interlocked or controlled from a signal tower electrically or by means of mechanical bolt locks.

Our signals at block towers, as well as interlocks, are all reinforced by a distant governing signal. This signal is located about 2,500 feet from the home signal, and with sufficient view by the approaching engineer to enable the fastest train to be stopped before reaching or passing the home signal. It may be remarked by

feet. The theory that distant signals should not be distant from the home more than 1,200 to 1,000 feet, because of the liability of the conditions changing after a train has passed the distant, does not admit of argument, in view of our experience. Theoretically it seems to possess the elements of sound judgment, but in practice there is nothing in it.

With the use of the distant signal, trains are enabled, through all kinds of weather, storm or fog, to make their schedule time. There have been any number of instances where we have had heavy banks of fog

During the summer of 1893 we had the fastest trains in the world, namely, the Empire State Express and the Exposition Flyer, with any number of through limited express trains, fast mail trains, local express trains, and with a very great number of suburban trains, together with the fast stock and dairy trains, through freights and local freights. Many trains running the entire division without making a stop, and oftentimes following each other over the same division on a two and three minute headway. A superintendent will once see of what benefit the block system was in moving this traffic.

With the signals located as frequently as they are, trains can with safety follow each other from two to three minutes apart. As an illustration, the Chicago Limited and the Southwestern Limited ran from Albany to New York with seven and eight cars each in less than three hours, and at no time were these trains more than four minutes apart in passing any one given point, and with neither of them stopped or slowed up. This illustrates to what degree of efficiency the block system on the Hudson Division is being operated.

We claim to be pioneers in this country in the adoption and installation of the system of signaling. There were none of us who had any experience whatever with the system, and when it was decided that the correct principle was the absolute block, it was quite a task to introduce it and have the men all educated to operate the road so that at no time would more than one train occupy a block, and to keep all trains moving without delays.

It has been demonstrated without a doubt that with the immense traffic the Hudson Division has, that trains can be run under the absolute block system and make time without any delays.

As the work progressed, and with the operation of several blocks, it was developed from time to time what rules and instructions were necessary and points to be covered. Before the entire division was equipped, we had in use and operation rules and instructions governing the operation of the blocks and movement of trains that are perfectly satisfactory rules, such as the American Railway Association has now been over two years trying to formulate, and they have not yet been able to prepare or recommend a system of rules and instructions. From the experience we have had, and so far as I can see, the instructions that we are operating under cover every point.

The system has now been in use complete over the entire division for about two years, and a great portion of it nearly three years, and from the time the first tower was put into operation up to the present time there have been no accidents or trouble of any kind whatever.

For the first 34 miles out of New York there are forty-four signal towers, making an average of a little less than $\frac{1}{2}$ of a mile between the towers, and 113 signal towers between Grand Central Station and Albany, a distance of 143 miles.

Sellers' Electric Cranes.

During the dull times the Baldwin Locomotive Works improved their works in many ways, the most noticeable improvement having taken place in the wheel shop.

Here they did away with countershafts and overhead belts and substituted an electric motor for each tool. These improvements were briefly noted in our last issue. We now present engravings of the cranes put into this shop—made possible by the removal of belts. The photographs incidentally show the application of motors to machine tools.

The cranes were built by Wm. Sellers & Co., who furnish the following description: The traveling crane has a capacity of 10 tons, a span of 47 feet 8 inches, and is upon a runway 200 feet long. All its movements, longitudinally, transversely



SELLERS' ELECTRIC JOB-CRANE, FRIENDLY, BALDWIN LOCOMOTIVE WORKS.

sufficiently well posted about the custom and operation of the first five or six towers were well prepared for the next five or six towers, and so on.

To know that all facing point switches are effectually locked in their proper positions, and that a white signal light is a guarantee that such is the case at night, goes far toward giving an engineer that confidence that all is right, which is essential in order to get over the road on schedule time. This is what has been done on the Hudson Division, interlocking control all such switches, and with the posi-

sible exception of two or three trailing ones, every switch on the division is either interlocked or controlled from a signal tower electrically or by means of mechanical bolt locks. Our signals at block towers, as well as interlocks, are all reinforced by a distant governing signal. This signal is located about 2,500 feet from the home signal, and with sufficient view by the approaching engineer to enable the fastest train to be stopped before reaching or passing the home signal. It may be remarked by

The average for all distant signals on the Hudson Division is in excess of 2,700

along the Hudson River where our early morning trains were thus enabled to go over the entire division and arrive at the Grand Central Station on time, and in many cases making up time, doing it with perfect safety. Without the use of the distant signal, where trains are as frequent as they are on the Hudson River Road, too much time would be lost in cases of fog in approaching the home signal, and there are many places where, on account of sharp curves, the engineer, in running and making schedule time, cannot see the signal in time to stop before passing it.

and hoisting, are obtained from a single electric motor carried upon the operator's platform, and actuating the train of friction clutches grouped upon the outside of and towards one end of the bridge. All the movements can be made simultaneously at maximum or varying speeds or independently, at the will of the operator. The load is always automatically sustained, it is therefore never a source of anxiety to the operator. The rates of travel are as follows:

Longitudinal, 100 and 200 feet per minute.

clutch trains upon the same principle as the traveling crane, and it will be noticed that all the operating machinery is carried upon the back of the frame, placing it out of danger from the load and making it all very accessible.

The crane in the immediate foreground is of 10 tons capacity, and is capable of hoisting the full load at 40 feet per minute or two tons at 40 feet per minute, and the full load at 55 feet per minute, and rotate one complete revolution per minute. The crane beyond it, and also the one shown upon the ground—not yet erected—have a

being a student of the times, concluded in just thirty seconds by the watch that he didn't mind about the nine dollars the cut took off his monthly check—but he had trouble about it.

The rammers commenced to be careless about their work and reported lots of it that they formerly did themselves. Skiney kept after the rounhouse force with a sharp stick and was just about keeping his head level, when the company ordered the shop force reduced twenty per cent.—Skeevers asked for his ran again.

The old man refused.

little reasoning of the general managerial order.

"You fellows know, just as well as I do, that the company is in a hole," said he, "they are losing money hand over fist, and I say it's no more than fair that the men stand some share of it—don't they promise to restore the wages when times pick up?"

"Have you got any notes in your diarre showin' as how the company divided up with the men year before last when we had five months of a coal rush? You know they had a bulge on the price and

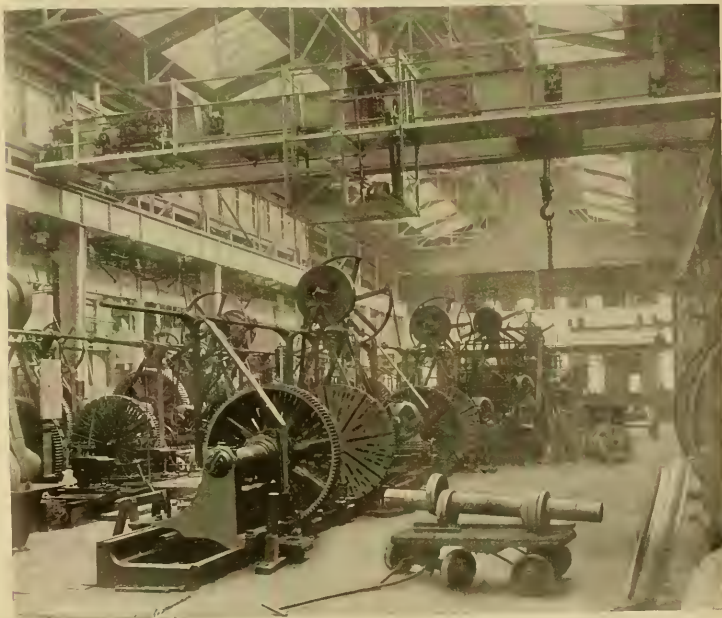

SUBSTITUTION OF BELIEVED MOTORS FOR STEAM AND SHAFTING, AND INTRODUCTION OF ELECTED OVERHEAD CRANES, BALDWIN WHEEL SHOP.

Trolley travel, 50 and 100 feet per minute.

Hoisting and lowering, 5, 10, 20 and 40 feet per minute.

All variable from zero to maximum or vice versa without shock.

It will be seen that the trolley or carriage is carried entirely within the bridge, which arrangement permits both members of the bridge to be tied together across the top the full length, thus forming a compound beam and making a very stiff structure in all directions.

The job or swing cranes have the frame constructed upon the same principles as the bridge of the traveling crane—that is, the carriage is placed within the frame and both members of the crane tied securely together. The absence of the usual diagonal struts, extending from the bottom of the frame towards the outer end of the job, will be particularly noticeable. In these cranes all the motions are derived from a single electric motor actuating

capacity of 6 tons, and will hoist the full load at 15 feet per minute, rack at 35 feet per minute, and rotate at one revolution per minute. These cranes also have the automatic retaining device to hold the load at all points, and all movements can be made simultaneously at maximum or varying speeds, or independently, at the will of the operator.

An Object Lesson on Jim Skeevers.

Skiney Skeevers has had a hard row to hoe this last year—he's been rounhouse foreman.

Skeevers has been trying for eight mortal months to find out whether he is an "official" or just "one of the hands," and he don't know yet.

He had hardly had time to warm the seat in his "little office" near "the board" when the company cut the pay ten per cent.—kind o' sudden, like

Skiney had been in one strike, and

Skiney thought great guts of think. He concluded to shame the runners' no doing something.

"Jim Loftus," said he, "you don't want the reputation of running as expensive as Crazy Horse Hays. Now, look here, last month your running repairs were higher than Hays' and almost double what they were the same month last year. Now you've reported a set-screw put in front end of your main rod, a machinist will charge up an hour on the '318' for that. Why don't you go into the back shop and get a set-screw and put it in yourself, like you used to?"

"Company pays for puttin' that set-screw in, don't it Skeevers?"

"Yes, but man—"

"All right, Skiney, me boy, if the company likes about it, tell 'em I'll pay for the time—they ken just take it out o' the 10 per cent. they took out o' me!"

Skeevers couldn't argue much against that kind of logic. He found the stove committee in a hot discussion, and tried a

the freight. What'n'sess for the rooster is good enough desert for the hen. Them's my sentiments!" This from Hen, Jerge, one of the oldest and best men on the road.

"Yous' you vate," said Otto Detrich, the socialist member, "undil' ve ged dot co-ohervative com—"

"Right ye air, Dutchy," said Hank Lutters, "when we get to heaven 'ther'll be no sorrow there." In the meantime I set up no more wedges till they pay me three-eighty-five for a hundred miles, see!"

The strike fever got epidemic. Some of Skeevers' men were exposed, and it broke out among the firemen. Dirty Evans refused to wipe off the "113," and Skeevers advised him to go into the fertilizer business—and gave him his time.

Then the whole lay-out took their time—to go out.

The master mechanic ordered Skeevers to send out wipers, helpers and pumpkin hangers from the four corners of the earth to fire engines.

The boilers had chills, the trains were ate—and Skeevers got red-hot letters from the transmaster.

Skeevers had smoke coming out of 4% per cent. of his mills when the engineers concluded that it wasn't safe to run the engines.

The master mechanic undertook to make up No. 8, and got the "31" off a short rail—then he ordered Skeevers to make it up.

The chairman of the committee told Skeevers he'd be expelled if he did. The master mechanic said he'd be fired if he didn't. Skinny compromised by making up half the train, and then getting off the track himself.

The superintendent said Skeevers was too much in sympathy with "the rest of the men."

The oldtimers said they could win if it wasn't for "officials" like Skinny Skeevers here! "men's work."

After the trouble was over the men who got back said "Skeevers was just as nice an 'official' as they ever worked for." Those who didn't get back called him a "chub."

Skeevers had his wedding last month, and the general manager sent him a manted clock "for faithful and efficient service during the recent labor troubles," and the Knights of Labor sent him a set of engraved resolutions thanking him for "demonstrating his fealty to the cause of labor in the recent upheaval."

Skeevers is muddled for once in his life and don't just know where he stands. He stated the case at great length to his wife on Sunday last and asked for an expert opinion—she was alarmed.

"Why, bless my soul, James Skeevers," said she, "what's a 'goin' to happen?" This is the first time in my life I ever saw or heard of a thing you couldn't squirm around into one of your infernal 'object lessons. This is one of 'em, I know; but I can't get for the life of me see where it comes in—but you ought to. There's

benefit as a manufacturer, that its plant might not rust; that its competitors might not invest their money; that it might keep its cars in repair, that it might be ready for resumption when business revived with a live plant and competent help, and that its revenue from its tenements might continue. Wages were reduced to an unreasonable extent, but rents were kept at the old figures. The commission thinks that the men were unreasonable in demanding the wages that prevailed before

not identical, they are reciprocal. The commission is satisfied that if employers everywhere will endeavor to act in concert with labor, that if when wages can be raised under economic conditions they be raised voluntarily, and that if when there are reductions reasons be given for the reduction, much friction can be avoided. It is also satisfied that if employers will consider employees as thoroughly essential to industrial success as capital, and thus take labor into consultation at proper

ryin' sixty pounds of steam and the water company pressure is 105 pounds up there—but keep it dark—there's a boom in the injector business."

To Use Hand Brakes at Terminals.

There is talk in the English papers about a curious move being contemplated by the Board of Trade, which has supervision over railways in the same way as our Interstate Commission.



ONE OF FIFTEEN TRAINS, OF TWENTY-EIGHT CARS EACH.

the season of depression, but the conclusion come to is that the arbitrary methods followed by the Pullman people aggravated the workmen into striking.

The American Railway Union is very tenderly treated, none of its acts is censured, and its existence is attributed to the working of the General Managers' Association. This association, the report says, was formed in 1886, and has as members the 26 railroads terminating in Chicago. The impression is conveyed that the principal purpose of the association was to exert more powerful control over the wages

times, much of the severity of strikes can be tempered and their number reduced.

Some Hydraulic Engineering Experience.

"I don't know as all the fool mechanics are connected with railroads," said the old-timer, reflectively. "One't upon a time I hit Leadville, in the far west, out of a job and lookin' for anything. I got a job in Frank Gay's machine shop.

"He made a fortune repairin' mining machinery and in the palmy days how he did it 'em for the dust!"

"I remember one day a scientific cuss who was chief engineer and superintendent of a big mine up Stray Horse Gulch, rode up to the shop like a house afire and commenced to yell fer Gay.

"Their pump was broke down and the mine fillt' with water—got some one up there quick—and his boister.

"They had a big forcing engine and a independent steam pump that fed the boiler—it was her that was ailin'.

"Says Gay, 'Major,' says he, 'it's no use loomin' time fixin' up a broken-down steam pump—takes too long. What d'ye say if I send up an injector?' We can get it to work in two hours, and I'll 'low ye \$25 fer the old pump."

"Will she work?"

"Every time—and no movin' parts to wear out."

"Well, git her up as quick as the Lord will let ye."

"You and Thompson go up to the Red-headed Mary," says Gay to me, "and git the best injector we have to work there lively as you know how—don't eat or sleep till everything is runnin'."

"We put up the biggest injector we had and got things runnin' O.K. that afternoon."

"The saper was around awful anxious, and the engineer had never seen an injector. After it was all up, the engineer and the saper both worked it to be sure they knowed low, and then the saper paid his little old \$200 for it and was glad to be rid of the pump."

"On the way home Thompson be says to me, says he, 'I'm bettin' that if that scientific cuss makes a test to see how much steam it takes to run that squirt that 'll be the economist thing in camp."

"How?" says I.

"Did ye ye note me puttin' a blind gasket in that ere steam pipe joint?"

"No."

"Allas do in such cases. He's only car-

Last year there was rather a serious accident in St. Pancras Station, London, when a train ran into a buffer stop and did considerable damage; but no one was seriously injured. The writer was in London at the time, and learned from railway men that the accident was due to the greasing of the rails by a cargo of herrings which had gone into the station shortly before. When the engineer of the train, whose cars met with the accident, tried to stop the train as it entered the station the brakes did not hold the cars, owing to the condition of the rails.

The principal inspector for the Board of Trade proposes a curious preventive for accidents of this kind. It is no more or less than that trains should be stopped, on entering stations, by the use of the hand brake alone. A proposition to this effect means that the automatic brakes cannot be relied on. It is a curious movement on the part of a government official.

As a sort of an echo from the labor troubles of last summer, we have heard considerable talk about the advantage it would be to railroad companies to have their car and locomotive repairs done in large contract shops where first-class tools could be provided and subdivision of labor carried out to its fullest extent, one man engaged constantly doing the same operation. This plan appears to have great attractions to some people, but there are objections to it which are carefully kept in the background. It would likely work fairly well in dull times when there was not a great deal of business doing, but when locomotives and cars had to be repaired with the utmost dispatch the plan would give annoyance and delay that would outweigh all considerations of expense. When a road can scarcely move its traffic for want of power and cars, the prompt repairing of these is often worth ten times the cost of the repairs. For this reason the co-operation or contract system of repair shops is not likely to become popular or successful.

We have a communication from Mr. J. E. Mahfield, Toledo, O., taking the stand that the front ends and cabs of locomotives should be designed with a view to presenting as little flat surface as possible. Reducing this to the lowest possible limit would be to materially reduce the effect of air resistance. He calls for a discussion of the subject. If any reader can send us facts bearing on the subject we shall gladly publish them, but we do not want any mere theories.



EXPLOSION OF TWENTY-SEVEN BOILERS ON A TRAIL OF THIRTY-TWO AT HENRY CLAY COLLEGE, SHAWANK, PA., DECEMBER 11, 1894.

something the matter with your liver, or digestion, or something. Lie right down, dear, and I'll make you some ginger tea—what you want is a good sweat."

Report of the President's Commission on the Chicago Strike.

At the time of the railroad strikes last summer President Cleveland appointed a commission to investigate the causes which led to the strike and the conduct of all concerned with the trouble lasted. The commission was composed of Carroll D. Wright, of Washington; John D. Kernan, of Utica, N. Y.; and Nicholas E. Worthington, of Peoria, Ill. The report of the commission was published about the middle of last month. It blames the Pullman Company very severely for the harsh and unjust treatment accorded to the employees. Although the Pullman Company tried to make people believe that the works were kept running at a loss through benevolent sentiments, the commission thinks that the evidence shows that it sought to keep running mainly for its own

and treatment of employees. The refusal of this association to treat with the American Railway Union is called arrogant and absurd.

The remedy proposed for disputes between railroad companies and their employees is in a general way methods of conciliation. An effort should be made to provide certain means for bringing the leaders on both sides of a dispute into a position to reason together. The legal machinery proposed for this purpose is the establishing by law of a permanent United States Strike Commission of three members who would have powers in labor disputes similar to those exercised by the Interstate Commerce Commission in regard to rates. The report concludes

The commission urges employers to recognize labor organizations, that such organizations be dealt with through representatives, with special reference to conciliation and arbitration when difficulties are threatened or arise. It is satisfied that employers should come in closer touch with labor and should recognize that, while the interests of labor and capital are

Keep Down the Dead Weight.

In a recent issue we mentioned the fact that Mr. A. E. Mitchell, superintendent of motive power of the Erie line, had directed his attention to reducing the weight of cars by making the metal parts lighter, stronger material being employed to maintain the requisite strength. He took all cast-iron parts of a 60,000-pound car and substituted malleable iron of equal strength, saving 1,100 pounds of dead

Excessive Wear Caused by Babbitt.

In the course of considerable experience with babbitt metal in bearings, we have always found that while the material had useful qualities, its use invariably had the effect of producing very rapid wear of journals. In a discussion at the Central Railroad Club on journal bearings, there was an inclination displayed to favor the use of babbitt which surprised us. Some of the speakers, however, talked about

Simple Tests of Lubricating Oils.

During a recent visit to the master mechanic of a small railroad we found him fuming over a roasting sent in by the superintendent on account of hot boxes. The M. M. insisted that inferior oil was the cause, that he had no control over the quality purchased, and he had no means of testing the quality. Could the scribe show him some way to test the oil? Of course, an oil tester would meet the case,

but should not change, nor should it become acid on being heated continuously above 150 degrees Fahr. Heated in open vessels it should not give off combustible vapors except at a very high temperature. At a low temperature the oil should not lose its lubricating properties, nor should it become solid at the lowest natural temperature, but merely assume the appearance of oilment.

Another authority on oils gives the following easy method of testing lubricating



LOADED WITH BROOKS LOCOMOTIVES FOR BRAZIL CENTRAL RAILWAY.

weight. On heavy double-bottom boiler cars a saving of 1,300 pounds was effected. This is a highly important matter, and one which ought to receive the attention of every man who exercises influence over the design and construction of cars.

The growth of the freight car has not been intelligently controlled. When we walk through a freight yard and note the weight of cars having the same carrying capacity, we discover differences of dead weight ranging from 1,000 to 3,000 pounds. It may be that the light cars are weak in proportion to their lack of weight, and that the consequent cost of repairs makes them more expensive to operate than the heavy cars; but we are inclined to doubt this, and believe that the extra weight is mostly due to a careless habit of making each part strong enough and then adding 50 per cent. to make sure.

We have frequently heard the expression about members of the rolling stock family. "The thing cannot be made too strong." That was a very safe kind of a sentiment, but it originated in a desire to prevent ignorance from being dangerous. Ignorance was uncertain what power of resistance the article ought to possess, and double the necessary weight was frequently carried so that the strength should be ample. There has been a great deal of this kind of designing done in all kinds of railroad machinery and there is good reason for believing that a process of adjusting the size of parts to meet the requirements would result in lightening both locomotives and cars sufficiently to make important saving in operating expenses.

Another thing that has been hindered very injudiciously is the substituting of stronger material for what was reputedly weak. Where even steel has been substituted for cast iron the same dimensions of parts have in many instances retained, even when there was previously no trouble from breakage. The principal advantage from the employment of steel and malleable iron ought to be the lessening of dead weight, yet that has received little or no consideration. The fact is that the reducing of dead weight has not received the proper attention. Master car builders and master mechanics have been occupied principally with the problem of making cars and locomotives as durable as possible, so that the operating expenses on their side of the establishment should be kept as low as possible. It is time now that the interests of the company as a whole receive attention. Freight rates are too low now-a-days to leave it of little consequence how much dead weight is carried.

babbitt as we have found it. A report had been made favoring the use for driving boxes of brass gibs with the spaces filled in with babbitt. Soft metal was recommended to reduce the friction between the hub of the wheel and cast-steel driving boxes.

Mr. S. Higgins, of the Lehigh Valley, was against the use of soft metal between wheel hub and driving box. He had found that the soft metal acted as a lead to wear out the wheel hub.

Mr. John Mackenzie, of the Nickel Plate, was decidedly against the use of babbitt metal, which he had used more or less for twenty years. The idea in using it was that it was cheaper than brass. His experience with the alloy was that it caused excessive wear of journals. For some time they used bearings with about a per cent. of babbitt in strips, and the journals

but he could not procure that luxury. Then we suggested sending specimens to a laboratory, but even that was out of his reach. On looking through our note book after returning home, we found some facts about oil which may be useful to this man and to others similarly situated. They were propounded by a celebrated German chemist.

The oil should be perfectly clear and as light as possible. It should not be turbid, which may be caused by the presence of water or other objectionable substances. If the oil be turbid through water, it froths on heating, whereas a turbidity produced by solid matter, such as paraffin, disappears on warming and reappears on cooling. The characteristic feature of all mineral oils is their fluorescence, and the small smelt was as little perceptible as possible, and should not increase on warm-

ing. Place single drops of each oil to be tested upon near the end of a piece of plate glass about two feet long, one end being about six inches higher than the other. The quality of the oil for lubricating purposes is shown by the distance traveled by each drop. Thus, on the first day sperm oil will be found in the rear, but it will pass most of the others in time and retain its power of motion after the others have dried up. A light-bodied oil flows quickly, like water, but soon dries, whereas what is wanted is a good body combined with liquid flow. Many oils have a good body but tend to gum, which will be shown on the glass.

A meeting of the American Railway Master Mechanics' Association's Committee on Wire Gauges was held in Philadelphia last month jointly with a committee of the American Society of Mechanical Engineers on the same subject. Mr. G. R. Henderson, chairman of the Master Mechanics' Committee, was chosen chair-man. The meeting outlined a system of exact measurement to take the place of the confusing wire gauge, and the committee are to recommend it to their respective societies. It is expected that all the other mechanical and engineering societies in the country will adopt the method of measurement recommended.



WRECK ON SOUTHERN PACIFIC DURING THE STRIKE, LAST JULY.

were from $\frac{1}{4}$ to $\frac{1}{2}$ inch in 400,000 miles. They now use a strip of babbitt only $\frac{1}{8}$ inch wide, which is employed because it helps lubrication.

Mr. Smith was opposed to the use of babbitt for taking up lateral motion. On a division where this practice was followed, 90 per cent. of their wheels had to be taken out and the hubs lined. Once he turned an engine out in a hurry and took up the side wear by running in babbitt, and within six weeks he had to drop the wheels and put in a proper lining.

If any one wishes to test how babbitt causes excessive wear, let him take a driving box and not let the recesses run clear to the end where the babbitt is lined, leaving a small brass section at each end to hold it in. When the wheel is dropped it will be found that where the babbitt rubbed it has worn from $\frac{1}{4}$ to $\frac{1}{2}$ more than with the brass. This induced us to adopt brass.

ing the oil. It mostly smells like petroleum.

If three parts of oil be shaken with one part of water in a test tube, warmed and allowed to stand in a water bath for some time, no emulsion must appear between water and oil, but the latter stand clear above the water, which should pale only very faintly and be perfectly neutral.

If the oil is mixed with a little caustic lye of 1.40 specific gravity, it should not be attacked when cold or warm. Saponification is a certain evidence that the oil is mixed with animal or vegetable fat.

On mixing the oil with sulphuric acid of 1.80 specific gravity, it must not be colored brown, but yellow at the most, otherwise the resins have not been properly removed.

When spread in a thin layer and exposed to the air for some time its consistency

The Norfolk & Western Railroad Company have in use a table made up in decimals of an inch for use in ordering sheet metal, wire and tubing less than $\frac{1}{2}$ inch in thickness. The figures embrace all the sizes of the Birmingham wire gauges and seven others. The table is quite comprehensive and is likely to be adopted by the various engineering societies as a standard. If that happens, iron gauges will be put upon the market with measuring slots made to conform to the various sizes.

We continue to receive catalogues of goods intended for railroad use that are not cut according to any of the Railway Master Car Builders' standard sizes. This is a very short-sighted policy, for many railroad officers are purchasing cases to hold publications of the standard sizes, and all those that do not conform to this are left out in the cold. Some of the catalogues which are destined to go to the waste basket are gotten up in first-class style, and it makes us sorry to think that a small change in shape would have given them a place in every file of such works kept for reference.

LOCOMOTIVE ENGINEERING

265 Broadway, New York.

PUBLISHED MONTHLY BY
ANGUS SING LAMER, Editor and Proprietor
JOHN A. HILL,
CAROLINE F. FAY, Advertising Manager
& LEONARD DANIEL, Artist

Subscription Price.

\$5.00 per Annum in Advance. Single Copies, 15 Cents. Remitt by Express, Money Order, Draft, Post Office Order or Registered Letter.

The editors reserve the right to use or discard matter for the reading of the most valuable merits. The reading columns will not be sold.

Correspondents must send their names and addresses, but not necessarily for publication.

Mailing address can be changed at often as necessary, always giving the new address. If you subscribe in a club state who got it up you give prompt notice when your paper falls to reach you properly.

Entered at Post Office, New York, as Second-class matter.

For Sale by Newsdealers Everywhere.

NO BACK NUMBERS BEYOND THE CURRENT YEAR.

PUBLISHERS AGENTS.

American News Company, New York.
International News Co., London, England.
W. Williams & Co., Melbourne, Australia.

Seven Years of Age.

With this issue of Locomotive Engineering she completes her seventh year.

It wouldn't be modest at all to tell how good she has been how proud she is, she has grown and prospered and done some good, and is altogether happy.

Almost any young lady of her years can be indulged in a new dress, or hat, or ribbon, and Locomotive will have a new outfit complete, from parlour to garters, when she steps out on the stage of 1895, again on eight years old.

Twenty-four thousand readers have been her friends through thick and thin. She promises to extend her acquaintance.

LOCOMOTIVE ENGINEERING was established on different lines and runs under different rules from the average railway paper, but made a success of living and hopes to attain to a ripe old age. Ah! there's a little hell the trouble comes in—we figure out and too far—the paper is living for the present. It will try to be the best thing going in its line and to lead in improvements for the time being. It will try to be the best and "most interesting railway paper published" for 1895—let 1900 take care of herself.

Growth of the Steam Engine.

The people who interest themselves in the growth of the steam engine are, as a rule, above the average in intelligence, yet there is prevailing lamentable ignorance concerning the development of the most important machine ever put into operation. As questions relating to the invention and evolution of the steam engine are among the most common sent in for answer by our readers, we shall devote a little space to a brief treatise on the subject.

Readers of historical works relating to the steam engine will sometimes find the statement made that the steam engine was evolved from the fertile brain of James Watt and that his attention attracted to the subject by seeing the lid of his mother's kettle bobbed up by the steam from the boiling water. That is more or less a fable. The minds of inquiring men were directed to the possible power of steam more than two thousand years before the beginning of the Christian era, strange, mystic hand of Egypt began attracting the wise men of the East, and a great seat of learning was established in Alexandria where a library was formed that was to contain copies of all books of authority in the world. Round this center of knowledge, flourish, art and all the known sciences flourished, for learning had patrons in the highest potentates of

the earth. How far their knowledge of heat and steam extended is not now known, but it was sufficient to enable some inventor to devise a form of steam engine which turned a globe by the reaction of a jet of steam. This invention was described in the work of Hero, one of the philosophers of Alexandria, who lived about 250 years B. C. The machine was the germ of the modern steam engine, and the means of converting the energy of heat into mechanical effort it was more efficient than anything tried until the cylinder and piston combination was invented.

When the wisdom and learning of Egypt and of Asia Minor was crushed out by the savage hand of barbarism which dominated the world for many centuries, knowledge of science and art was almost for a time annihilated. When the new modern civilization began to grow up, the minds of men turned to the problem of converting the elements of nature into working forces for the benefit of mankind. The potential power of running water and of moving wind were utilized to the best of the last there were insurmountable obstacles in the way of applying these sources of power to many of the purposes where artificial power was greatly needed. Philosophers were aware that heat, as represented by wood and coal, contained untold energy that might turn the mills and carry the burdens of the world, but the secret of harnessing the power of fire. Slowly steam was identified as the intermediary between fire and mechanical work, but the next difficulty was in finding some practical method for making steam perform useful operations. Science labored for two or three centuries on the problem of utilizing the power of steam, but none of the attempts succeeded in improving on the Egyptian apparatus. They discovered that by filling a vessel with steam and then condensing it, a vacuum would be formed, and this was tried in a variety of ways for raising water, but those who were wrestling with the problem all conceived one method of making steam perform direct work. But there were all through the 17th century, the scientific men in every progressive country in Europe were speculating on the possibilities of steam and experimenting with apparatus intended to make it perform useful work. The efforts were not wasted, for they led to the construction of that safety valve was invented, methods of opening and closing steam vessels were devised, and many exact facts were ascertained concerning the generation and condensation of steam. But they could conceive no means by which the pressure could transmit motion to a solid body.

When modern science was practically beaten to produce anything better than the Egyptian apparatus, a working blacksmith devised the cylinder and piston combination which are the most important members of the modern steam engine. This achievement took place in England in the first years of the last century, and the principal actor was Thomas Newcomen. The steam engine was developed in Great Britain because there the necessity was greatest for something more powerful than horse or manual labor. The need for something that would pump water out of existence, under any circumstances, urged forward the work of improving the engine which Newcomen first put in motion.

His was a surprisingly cheap machine. It was really only a cylinder open at the top, to which was fitted a piston with a rod connecting it to a walking beam above, a pump rod running to the other end. The steam was admitted below the piston and filled the cylinder. Then a jet of water was injected into the cylinder which created a vacuum and the piston was forced downwards by the pressure of the atmosphere. The pressure of the

atmosphere did most of the work, the same as does, in the operating of a vacuum brake. The valve to admit steam and water were opened by hand. The first automatic valve gear was applied by a boy named Humphrey Potter, who wanted to have some time to play while attending the valves. He made an arrangement of cords connecting with the walking beam which opened the valve when the beam proper lifted. This improved the working of the engine so much that more substantial valve gearing was soon afterwards applied.

This Newcomen engine was very wasteful in the use of steam, owing to the cooling of the cylinder by the injection of water at each stroke. Of course, the cylinder had to be warmed up when the steam was admitted, and the condensation that resulted was enormous. In spite of this source of waste the atmospheric engine was incomparably cheaper than horse power for pumping purposes, and great numbers of these engines were built during the last century. Most of them were for use in Scotland, but there were few European countries that did not erect some Newcomen engines, and several of them were imported to America. In fact, the Newcomen atmospheric engine was the only steam engine used to any extent during the eighteenth century.

Towards the end of the century James Watt, in Scotland, invented an improvement on the Newcomen engine, which essentially consisted in condensing the steam in a separate vessel to prevent the loss from condensation that resulted from the practice of injecting water into the cylinder each stroke. About the same time Oliver Evans, of Delaware, was working on improvements on the Newcomen engine which consisted of arrangements for using direct steam pressure to create any vacuum. Consequently, his engine was called the high pressure engine, as the piston was driven in both directions by steam of much higher pressure than that employed by European engineers, and the exhaust steam was not condensed, but allowed to escape into the atmosphere.

All Watt and his contemporaries and successors in Great Britain devoted their attention to the development of a heavy, slow working engine elaborated to perform a given quantity of work with the least possible expenditure of coal. Evans was the leader in the construction of a light, fast-working engine that could be made and transported at small cost. American inventors and improvers of the steam engine followed the practice introduced by Evans, and the typical American engine became noted for its high steam pressure and high piston speed. Early in this century a few European engineers made use, in a limited way, of the high pressure engine, but it was not popular abroad. The claim is made that the high pressure engines that worked most successfully in Europe during the early development period were imitations of Evans' engine. Be that as it may, there is no question that an American inventor worked out the design of engine best adapted to European motive purposes. When the time for using locomotives came, our engineers did not require to look abroad for models. Cooper's "Tom Thumb," first tried on the Baltimore & Ohio, was in every respect a native engine. Although smaller, as a power motor it was as successful as "Rocket."

Location of Black Signals.

In his interesting article on the black signals on the Hudson River Division of the New York Central, published in another page, Superintendent McCoy tells of the great care that was exercised in locating the signals on anything so subtle as the view of the engineer. It is a detail which has not always received the attention its importance deserves. As the installation of black signals is likely to make

great progress in the near future, it is proper that those having charge of locating the signals should have a proper appreciation of the dangers incurred when a signal is placed in a position where it can not be readily seen.

Systems of black signaling have been more universally applied in the British Isles than anywhere else, and their experience with them has been of service to us. There were few railroads where there were no signals set in such a position that it would be difficult for the engineer to see them. Complaints would be made, but, as a rule, were unheeded, for those in charge of signals always think that their judgment is infallible. Then after a time the inevitable accident would happen, and the investigation held to find out how to bring out the truth. It was painful to find the number of cases of this character which occurred for years until the companies learned wisdom from expensive experience. Then the complaints of the engineers received the attention they deserved. If our railroad companies are wise, they will not only listen to any complaints the engineers have to make about badly located signals, but will encourage them to suggest improvements. This policy may be very profitable in preventing accidents.

A well-inflected English railway engineer writing years ago on the defects of signals said: "The selection of position and the location of signals is usually placed in the hands of a separate department, which leaves the locomotive department to be merely, the duty of the engine driver being merely to obey them. Instead of an intelligent system being adopted and strictly carried out, the drivers on many roads state that the signals are placed here, there and everywhere, some on the line, some at a separate department, which could not be seen at any distance.

One of the most important requirements is that the signals should be placed on the side of the line that the train sees. If by any chance it is absolutely impossible for a signal to be placed on its proper side, special attention to the fact should be directed by a printed notice. Every station should be provided with a home, distant and starting signal. Home signals should be placed as to completely protect any train which may be crossing from one track to another or into a siding. Starting signals ought to be placed so that the longest train the engine will not pass the signal for even a few yards. These are very practical suggestions.

Keeping New Cars Years Out of the Shop.

Two master car builders were exchanging experience at a recent club meeting, and each was apparently doing his best to show that he had risen to the occasion which requires close figuring to make a success of a separate department. One had a good deal to say about improvements in shop arrangement and methods, the other had been devoting his energies to the increasing of the mileage of cars between periods of shopping. As a great record in this line he mentioned that some passenger cars built for the World Fair at Chicago had not yet been in the shop. Both were evidently doing their best according to their lights.

We could not, however, help reflecting that too much energy devoted to keeping new passenger cars out of the shop is liable to represent loss of effort. We are inclined to think that after, say, 50,000 miles running, it would be sound policy to take in the car long enough to have important bolts examined and the nuts tightened and strains adjusted. The best of seasoned wood is not always employed in car construction, and six months' usage in our dry climate causes shrinkage which would be compensated for at the car as a whole at intervals. There are also scorching tracks in paint and varnish after the

last six months of service which ought to be filled up if the wood is to be made long-haul. The trucks should also receive a careful overhauling and have all loose parts tightened up. A few days work applied at this period of a car's history will have an important effect in promoting its durability. Little damage will come of its being kept long out of the shop after it receives the first overhauling.

The Past and Present of Car Ventilation.

Those whose taste for light literature inclines them to devote their leisure hours to the reading of books reports of the Master Car Builders' Conventions, are familiar with the fact that about twenty years ago the men representing the railroad car departments attempted to settle for all time the all-exiting question of car ventilation. That was a subject which had been familiar to the mind of every sane one. The speaker proceeded to open a car window while another person was protesting that the car was too cold already. The man who desires more than his share of fresh air is always an aggressive animal, and he habitually makes it cold for his fellow passengers and hot for the railroad company that fails to provide means for changing the air in a car every three minutes.

We suppose that it was the fresh air agitators who brought the thing about, but be this as it may, there was a perfect reform in car ventilation about twenty years ago, and the Master Car Builders' Association was made the leading medium for exploiting the agitation. Elaborate reports were submitted to the successive conventions, and the whole subject was discussed from A to Z and several times over again. The subject was discussed from the standpoint of the practical man, the scientist, the man who wants to be let alone in unhygienic comfort, and of the crank who insists that it is better to die of pneumonia than to violate nature's laws of cleanliness. There were many opinions advanced concerning the nature of cases that contaminate the atmosphere of badly ventilated cars. The dreadful exhalations that exude from a crowded passenger car and the fearful disease germs that are disseminated when air is not circulated rapidly enough, were pictured in a terror-inspiring manner. The discussions waxed hot the wonder grew in many persons ever surviving the ordeal of riding for a night in a badly ventilated car. Working in a sewer appeared a healthy occupation by comparison.

The agitation was a season of clover and wild words for the inventors of car ventilating appliances. There was no want of inventors or of their ventilators, and it seems certain that food air would have no resting place in passenger cars till the end of time's chapter. The whole problem was figured out to a nicety. It was decided that 2,000 cubic feet of fresh air ought to be supplied every minute to a car containing sixty persons. The needs of patient ventilators were quite prepared to supply this volume of air every minute, and double it if necessary, but the man responsible for keeping the temperature above the freezing point declared that ventilating on this scale would never work. How could 2,000 cubic feet of air be raised from perhaps zero or below zero to degrees above, every minute, by two men, which constituted the heating facilities of that day? A compromise was effected, and 1,000 cubic feet per minute was settled upon as the volume of air to be admitted every minute. The poison and contamination contained in the other 1,000 cubic feet of air must be endured since it could not be cured.

We cannot estimate the number of patented car ventilators which were permitted to enjoy a brief popularity or were applied to cars on account of this agitation for fresh air, but there were a great many of them. The world notes not how the

agitation died down, but it came quietly to an end, and the average car was not disturbed with improved ventilators. The clerestory sashes and the windows were still there, and those in charge waited till the clouds of reform rolled by, and they rolled without making many permanent changes.

There was like going back twenty years when we received a few days ago the proceedings of the New England Railroad Club, and a wined through two long papers on the Ventilation of Passenger Cars, with a profuse discussion thrown in. Although a little sleep-inspiring, the report made us almost feel twenty years younger and imagine that we were listening to another set of men telling how cars ought to be ventilated. They were not always right, either in the old days, for we remember one member, describing the patent ventilators, said that they caused such a strong upward suction that straw hats were drawn off the heads of passengers, and they were afraid to add children into the cars for fear they might be drawn in and suffocated.

There was a striking difference in the tone of the discussions—a car ventilating twenty years ago and now. Then the speakers were noted for the positive views expressed as to how the thing should be done. There was no uncertainty about how the work should be carried out. Every man was positive that he knew all about car ventilation. The only striking difference that we noted after a lapse of twenty years was that all the speakers not interested in a particular invention were extremely non-committal, some even going to the extent of admitting that they did not know anything about car ventilation. To judge by this, our progress has been merely in the direction of catching people and making how difficult it is to change the air in a car quickly and regularly and at the same time keep the inside warm enough to prevent people from catching cold. We fear the problem will not be satisfactorily settled until people's tastes and constitutions are all made uniform.

The gentlemen who presented the papers at the New England Railroad Club had, of course, their own inventions to offer as a solution of the car ventilating difficulty. They had no hesitation in saying that they were prepared to do the business. We only hope that their devices were more original than their arguments. Those who sometimes find it necessary to walk through a train full of passengers, towards daylight, are certain to agree that the need for improved methods of ventilation is real. If anyone can change the air and yet leave the car warm, his invention will be a sanitary improvement worthy of general adoption.

Several of the roads out of Chicago have adopted a new time table plan invented by Corbett & Skidmore, of that city. All the figures between 6 o'clock A. M. and 6 o'clock P. M. are ordinary time figures, all those figures representing time from 6 A. M. to 6 P. M. are what figures on a high ground. This will surely prevent mistakes between P. M. and A. M. but it does not remove the objection pointed out by a correspondent in this paper last month, and that is that the outline of the figures generally used are the same, a 3 looks, in uncertain light on a shuffling engine, as an 8. Figures of the script order do not have the same general outlines and would be a big improvement on the new day and night system—in itself a good thing and a step in advance.

BOOK NOTICE.

TABLES OF DIAMETERS, AREAS, WEIGHTS OF GOLD DRAWN SEAMLES, TUBING, PIPE, ETC., BY J. H. EDWARDS, Edw. D. City, Pa. Price, 50 cents.

This is a little pamphlet of ten pages containing the tables indicated in the title. It would be very useful to anyone having to figure on steel tubing.

PERSONAL.

Mr. W. B. Thomas, general manager of the Augusta Southern, has been appointed receiver of the Atlanta & Florida.

Mr. W. H. Whalen has been appointed general foreman of the Chicago & Northwestern shops, at Jansville, Wis.

Mr. C. H. Wade has been appointed foreman of West Chicago roundhouse of the Chicago & Northwestern Railway.

Mr. Norman E. Sprowl has been appointed master mechanic of the Central of New Jersey shops at Phillipsburg, N. J.

Mr. George Donahue has been appointed master mechanic of the Mahoning Division of the New York, Lake Erie & Western.

Mr. Frank Sheegren has been appointed secretary to President Samuel Hill, of the Montana Central, office in Minneapolis, Minn.

Mr. R. V. Miller has been appointed chief clerk to General Superintendent Fagnon, of the Kansas City, Fort Scott & Memphis.

Mr. T. W. Ford has been appointed general manager of the La Porte, Houston & Northern, with headquarters at La Porte, Tex.

Mr. Frederick J. Harrison has been appointed general foreman of the Buffalo, Rochester & Pittsburgh shops at Lincoln Park, N. Y.

Mr. George A. O'Keefe has resigned as master mechanic of the Detroit Lansing & Northern and Saginaw Valley & St. Louis roads.

Mr. J. W. Hamilton has been appointed chief clerk to General Manager Farrington, of the Eastern Minnesota, with office at Duluth, Minn.

Mr. James Prendergast, of Columbus, O., has been appointed general foreman of the Baltimore & Ohio shops at Benwood Junction, W. Va.

Mr. E. O. Smith, formerly of the West Chicago shops, of the Chicago & Northwestern Railway, has been appointed general foreman at Belle Plaine, La.

Mr. J. C. Clarke has been appointed roundhouse foreman of the A., T. & S. F. at La Junta, Col. He formerly held a similar position at Woodward, I. T.

Mr. J. J. Chappell has been appointed steekeeper and mechanical accountant of the Prince Edward Island Railway, with headquarters at Charlottetown, P. E. I.

Mr. J. L. Butman, of Saratoga, N. Y., who recently leased the Delaware River & Lancaster, is now general manager of that road, with headquarters at St. Peters, Pa.

Mr. W. R. Sweet, master of transportation of the Augusta Southern, has been appointed assistant general manager of that road, with headquarters at Augusta, Ga.

Mr. Z. D. Lancaster has been chosen president and general manager of the Schuylkill & Moschohad, in place of Mr. Wesley Van Wart. General offices, Hartland, Me.

Mr. P. H. McGraw, general foreman of car shops of the Indianapolis Division of the Pennsylvania lines at Indianapolis, Ind., has been transferred to Chicago as general foreman.

Mr. C. C. Burnett, of Southboro, Mass., has been appointed assistant superintendent of the Worcester division of the Old Colony system of the New York, New Haven & Hartford.

Mr. S. D. Chittenden has been appointed purchasing agent of the Carrabelle, Tal-

hassie & Georgia Railroad and the Gulf Terminal and Navigation Company, with headquarters at Tallahassee, Fla.

Mr. R. T. Geff, formerly acting superintendent of the Jacksonville, St. Augustine & Indian River, has been appointed superintendent of the entire system, with headquarters at St. Augustine, Fla.

Mr. C. W. Huntington has been appointed general superintendent of the four divisions of the entire system, with headquarters at Des Moines, N. W. He was formerly superintendent of the Des Moines N. & Western.

Mr. F. T. Gates has been elected president of the Duluth, Missabe & Northern, with headquarters in New York. He was formerly private secretary to Mr. J. D. Rockefeller, of the Standard Oil Company.

Mr. Alfred Walter, general manager of the Erie, has resigned, and his office has been abolished. All communications formerly addressed to him should be sent to C. R. Fitch, general superintendent, New York.

We were in error last month in stating that Mr. Willard Kells, of the Erie, had been appointed master mechanic. The advance he received was having his jurisdiction extended over the car department at Meadville.

Mr. Joseph Herrin has been appointed superintendent of the Western of Alabama and Atlanta & West Point, with headquarters at Montgomery, Ala. He was formerly superintendent of the St. Louis & Iron Mountain.

Mr. Samuel T. Fulton has been appointed assistant to President McElmish, of the Kansas City, Fort Scott & Memphis, with headquarters at Kansas City, Mo. He was formerly chief clerk for General Superintendent Fagnon.

Mr. C. A. McAlpine, superintendent of the northern division of the Old Colony system of the New York, New Haven & Hartford, has been appointed superintendent of the Providence division, with headquarters at Boston, Mass.

Mr. Walter T. Rupert, heretofore foreman of locomotive repairs of the Detroit, Lansing & Northern and Saginaw Valley & St. Louis, has been appointed acting master mechanic of those roads, with headquarters at Ionia, Mich.

Mr. W. D. Sprigg, heretofore master of transportation of the State Island Rapid Transit, has been appointed superintendent of that road, with headquarters at St. George, S. I., and the office of master transportation has been abolished.

Mr. Leslie McClain, formerly connected with the Washab, has been appointed master mechanic of the Kansas City, Orestola & Southern, with headquarters at Clinton, Mo. He will have charge of the machinery and car departments.

Mr. S. G. DiKerson, division superintendent of the Seaboard Air Line at Abbeville, S. C., has been appointed superintendent of transportation, with headquarters at Atlanta, Ga., and the office of division superintendent has been abolished.

We received a pleasant call last month from Mr. John W. Adams, purchasing agent of the Chicago Great Western Railway, or Mr. Warwick sailed with his wife and children on the *Yan York* November 21st, to pay a visit to Scotland, the land of his nativity.

Mr. E. B. Wasmann has been appointed supervisor of the Shamokin division Northern Central. He has been assistant supervisor Philadelphia and Erie division of the Pennsylvania Railroad and acting supervisor of the Shamokin division of the Northern Central.

Mr. A. McDonald has been appointed superintendent and Mr. H. W. Anderson mechanical foreman of the Prince Edward

Island Railway, in place of Joseph L. Usworth, deceased, whose title was superintendent and mechanical superintendent, Headquarters, Charlotte, N. C. P. E. I.

Mr. H. C. Barlow has been elected president of the Evansville & Terra Haute Railroad. He was formerly vice-president and general manager. The writer spent an evening with Mr. Barlow a month ago and found him one of the best informed young railroad managers he had ever met.

Mr. Charles H. Schlacks has been appointed assistant general manager of the Denver & Rio Grande. Mr. Schlacks is the son of Mr. Henry Schlacks, superintendent of motive power, and has been for many years private secretary to Mr. E. T. Jeffrey, now president of the Denver & Rio Grande.

Mr. James Meehan has been appointed superintendent of motive power of the South Carolina & Georgia Railroad, in place of Mr. E. M. Roberts, resigned. Mr. Meehan is one of the best-known master mechanics of the country, having been long at the head of the mechanical department of the Queen & Crescent system.

A paragraph has gone the rounds of all the railroad papers to the effect that Mr. William N. Bonnard, of the Pennsylvania Railroad, had been appointed superintendent of the Buffalo division of the New York Central. There is no truth in the statement. Merely another case of too much imagination among rumor retailers.

In our last issue we mentioned that Mr. James D. Beegh had been appointed master mechanic of the Southern Pacific Railway at Houston, Tex. The correspondent who sent this information stretched a point. For Mr. Beegh was only appointed machine shop foreman. We are entirely in the possession of correspondents in cases of this kind, and they sometimes make mistakes.

Mr. E. M. Roberts, lately superintendent of motive power of the South Carolina & Georgia Railroad, has accepted the position of general manager of the Washington Carbon Co., Pittsburgh. Mr. Roberts was one of the ablest mechanical men in railroad business, and we regret to see him wander into a new field, but have no fear that his success in any line he engages in will be away up.

Mr. G. A. Haggerty, for the last eight or ten years master mechanic at McAvam Junction, an important point on the Canadian Pacific in New Brunswick, has resigned. Mr. Haggerty was intensely popular in New Brunswick, and was regarded as one of the most accomplished engineers in the province. He was a graduate of the Mason Locomotive Works, and held several important positions on railroads in the United States before going to Canada.

In an address on "Arbitration of Labor Disputes," delivered before an audience largely composed of railroad men, at the Union League Club, in Chicago, Mr. Carroll Wright made plain some principles of attitude between labor and capital which cannot be too well understood. The text of an excellent address was: You must not injure your neighbor's property, you must not injure your neighbor's health, and you must not interfere with your neighbor's way of making a living.

We are always glad to make a note of the fact when a man who has begun work in the lower ranks of railroad life rises into prominence. One of the latest notices of this kind which we are pleased to make, is the appointment of Mr. William B. Biddle to be freight traffic manager of the Atchison, Topeka & Santa Fe, with headquarters at Chicago. Sixteen years ago Mr. Biddle entered the service of the Santa Fe as a brakeman. It rejoices in his credit and may have something to do with his success that he was

one of the best brakemen that ever took possession of a fireman's seat.

Mr. George W. McGare, the well-known representative of the National Malleable Castings Co., of Cleveland, has gone to Florida to spend the winter. His health is not entirely restored, but it improves steadily, and there are good prospects that he will soon be as good as ever was, which will be good news to his numerous friends. We know of no one who has made such a brave fight with a terrible disease. There is no doubt that Mr. McGare's steady courage which led to no extent in the presence of the worst symptoms, did much to lead him victorious over his sickness. In his fight he was aided by a most devoted wife.

Mr. Franklin Murphy, president of the Murphy Varnish Co., of Newark, N. J., and well known among railroad men who

division superintendent. He has shown great ability in railroad matters, and his many friends will be glad to learn of the important position which he now assumes with the Consolidated Car Heating Co.

Mr. Thomas P. Egan, president of the J. A. Fay & Egan Co., of Cincinnati, is taking a very warm interest in organizing the manufacturers of the United States to work for the renewal of the reciprocity treaties which were abrogated by the Wilson bill. He is in a business which profited materially by the reciprocity treaties, and is in a position to appreciate the industrial needs of this country. Mr. Egan has recently secured a controlling interest in the Cincinnati Gazette. His is a good illustration of what push and energy can do to raise a workman from the lowest to the highest rank of the ladder of life. He looks to be about forty-five years old. Twenty years ago he was working as a

EQUIPMENT NOTES.

The Brooklyn Bridge Co. are asking for bids on two bridge engines.

The special refrigerator cars of the Plant System have not yet been let.

It is rumored that the Southern Pacific are about to contract for 500 freight cars.

The Schenectady Locomotive Works have just closed with the Ftitchburg for five switchers.

The Mt. Vernon Car Mfg. Co., of Mt. Vernon, Ill., have taken the Mexican Central order for 225 freight cars.

Harlan & Hollingsworth Co. have an order from the Savannah, Florida & Western for ten passenger coaches.

The South Carolina & Georgia Railway Co. are in the market for 250 box cars. Bids are being asked for.

The New York & New England order for 1,000 cars has been partially placed, balance is likely to be let within a few weeks.

The rumor, so vigorously circulated, that the Lehigh Valley are about to let 1,200 additional cars is stoutly denied by officials of that road.

The New York, New Haven & Hartford have placed an order with the Rhode Island people for twenty-five locomotives. They have also given out an order for 100 cars.

The Mason Regulator Co., of Boston, Mass., report that their business for the last month was better than it has been for any month since the business depression began.

The balance of the 500 freight cars to be ordered by the Southern Railway Co. has not yet been placed. The Lenoir Car Co., of Lenoir City, Tenn., have the order for 250 cars.

The Rhode Island Locomotive Works have just shipped a locomotive of the Hudson type to Jamaica, West Indies. They formerly sent other engines of this type to Jamaica, and they are reported to be in high favor.

The Consolidated Car Heating Company, Albany, N. Y., has just awarded the contract for an addition to its factory which will practically double its capacity. It rapidly increasing business in electric heating appliances and the requirements of its compressed gas lighting business have necessitated increased facilities for manufacturing.

A Catechism of Car Painting, by Mr. Frederick S. Ball, master car painter, of the Pennsylvania Railroad, at Altoona, Pa., has been published by the Railroad Car Journal, New York. It is in neat pamphlet form and costs only ten cents. Everyone who wants to know something about car painting ought to send for this useful little book.

The Crosby Mfg. Co., Boston, find that the duplex check valve and stop-cock which they put upon the market lately is becoming highly popular. This is a very ingenious device, for it is so arranged that should a valve get out of order another valve inside the same shell can be instantly thrown into service. The valve can be closed. A suit was brought against the company because when repairs have to be done hurriedly.

Everybody knows something about "Magnolia" metal and the celebrity it has obtained as an anti-friction metal. An enterprising firm in New York, wanting to share the benefits that the Magnolia metal's fame gave forth, started selling it to the public under the name of "Magnolia" metal, the idea evidently being that the name was so near like Magnolia that the ordinary reader would not detect the difference. A suit was brought against the parties who attempted this shrewd piece of business, Benjamin and Moses La Croix, and Judge Lacombe, of the United States Circuit Court, has granted an injunction against them restraining them from selling the metal.



THREE OF A KIND—W. W. SNOW AND AMOS FINCH, Ohio—TIM SUFFLY MEN.

use good varnish, is spoken of as a highly available candidate for Senator from New Jersey. Mr. Murphy is one of highly patriotic stock, his grandfather having fought in the revolutionary war. Mr. Murphy himself joined the Union army as a private during the rebellion, when he was sixteen years old, and came out a lieutenant. Like many other soldiers, he devoted his abilities after the era of peace with so much energy to industrial pursuits that he achieved great business success. The road now appears open to him to high political honors.

Mr. Charles A. Sheldon has resigned as Assistant Division Superintendent of the Michigan Division of the Lake Shore & Michigan Southern R. R. to accept a position with the Consolidated Car Heating Company, Albany, N. Y. He will have charge of the Compressed Gas Lighting department of the Consolidated Company, which is about to introduce the Pope system, interchangeable with the "Pintach," throughout the United States. Mr. Sheldon is a graduate of Yale, class of '39, and has been with the Lake Shore road since graduation, four years ago, having risen through several grades to the responsible position of assistant

machinist. Now he is the head of one of the most important business houses in Cincinnati. We do not need to look far in this country for grand examples of self-made men.

At the annual meeting of the New York Railroad Club, held in New York last month, the following officers were elected for the current year: President, George W. West, superintendent of motive power, New York, Ontario & Western; First Vice-President, A. E. Mitchell, superintendent of motive power and machinery, New York, Lake Erie & Western; Second Vice-President, W. H. Lewis, master mechanic, Delaware, Lackawanna & Western; Third Vice-President, H. H. Vreeland, president Metropolitan Railway Co.; Treasurer, C. A. Smith, superintendent Union Tank Line; Executive Committee—W. G. Watson, superintendent West Shore; W. C. Ennis, master mechanic, New York, Susquehanna & Western; W. W. Snow, president Ramapo Iron Works; S. Higgins, superintendent motive power, Lehigh Valley; C. E. Fuller, Central Vermont. Finance Committee—F. M. Patrick, H. W. Johns Mfg. Co., R. M. Dixon, Safety Car Heating & Lighting Co.; D. M. Brady, Brady Metal Co.

Practical Letters

from Practical Men.

Write on one side of the paper, state your point plainly and briefly, and then quit. We supply the generalities. No letters noticed unless name and address are enclosed.

Early Use of Curved Shell and Crown Sheets in Belpaire Boiler.

Editors:

In your October issue, in describing the Brooks engines recently built for Brazil, you refer to the boilers as being "what the Brooks people call the 'Improved Belpaire,' patented by their mechanical engineer."

You further state that the peculiarity of this patented boiler lies in the form of the crown sheet and the roof or shell sheet over it, — to quote from your description, "the top of wagon top is arched, as is the crown

point where the jar or jerking takes place, which is just before the last piston reaches the front end of its stroke.

My conclusion is that the vertical influence on the centrifugal life of the counterweight, coupled with the high initial pressure, is what causes the pound and the flat places.

I really want to know something about this matter, and would like to have it pointed out where I am wrong. If it's the hammer blow, why will dropping the reverse lever down relieve it?

Again, why is it that men who reverse draw their steam and work the reverse lever down where engine runs free, are able to run these engines two years without flattening tires, while the men who run the same engines with full throttle and close cut-off will flatten their tires in from eight to nine months?

I have long been an advocate of full throttle and close cut-off, but can't help but note that the full throttle engineer's engine is always in the shop first.

D. O. SMITH, M. M.

M & O. R. R.

Whittier, Ala.

[This is a question which deserves to be thoroughly investigated. We should like very much to hear from others who have opportunities of noting the causes of wheel flattening. If there are other facts to substantiate the views of Mr. Smith let them be known.—E. J. C.]

First Invention of the Track Tank.

Editors:

In your issue of November, 1894, page 357, you make a statement that the track tank was invented by Ramsbottom, Superintendent of Machinery of the London & Northwestern, in 1828.

The impression given by this article would imply that he was the first inventor of this very useful device, when, in fact, an American named A. W. McDonald, of New Creek Depot, Va., secured a patent in the United States for the same, four years prior, the date being Nov. 25, 1854. Thinking that your readers would find this information of some interest, I herewith enclose a drawing and a brief description of the same.

GREENVILLE LEWIS,

Examiner U. S. Patent Office,

Washington, D. C.

[This is interesting information. We do not consider a description of the McDonald

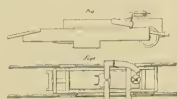

device necessary. The engraving shows it plainly enough. The tank is the same as now used. The scoop was double, taking water to tender by two large round pipes and hose. Ramsbottom was the first to put a track tank into practical use, and has always received the credit for its invention. McDonald, doubtless, was a prior inventor, but not a user.]

Duplex vs. Single Gauges on Instructional Plants.

Editors:

In perusing Mr. Synnestvedt's article in the November issue of LOCOMOTIVE ENGINEERING, I am pained to note his complimentary remarks on our "Ignorance Extremator," as our air-brake schooling

plant at Green Island has been termed, but in the interest of others who contemplate equipping their shops with such a plant, and who may possibly be misled if his erroneous assertions are not refuted, I cannot pass his suggestion to use single-pointer gauges instead of double ones, especially when the latter are available.

I consider the statement remarkable one to come from an instructor, for I do not believe the auxiliary reservoir pressure and that of the brake cylinder can be better shown than upon a duplex gauge, where the relationship of the two is graphically shown by the rise and fall of the red and black pointers and their ultimate equalization, or in a manner by which it can be more easily comprehended by the pupil.

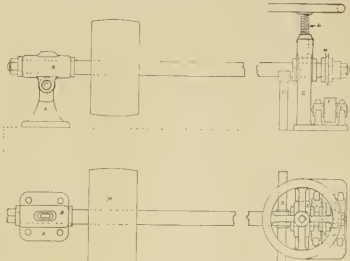

The ground he takes that a man is liable to become confused in trying to watch the two hands of the duplex gauge, as he is obliged to do when the red one, say, marks the auxiliary reservoir pressure and the black registers the brake cylinder pressure, is very weak. His idea of placing gauges is frequently impracticable, even if it were desirable; and a man who must have a gauge screwed directly into the part whose pressure it is to register, or must have different gauges to mark each pressure to avoid becoming confused, is indeed dull of comprehension, and would, in the same line of reasoning, demand, and be entitled to, two single-pointer gauges instead of the one duplex gauge given him on his engine, that he might avoid becoming bewildered in operating his brakes.

When Mr. Rogers, my predecessor, installed the plant at Green Island, single-pointer gauges were used as they were the only ones available at that time. Later on, when a sister plant to this one was placed at Whitehall, another division terminal of the D. & H. C. Co., duplex gauges were available and were accordingly used, as it was believed that pupils would more easily comprehend their meaning when so employed. Experience has confirmed this belief.

Having a plant at each terminal of this division almost precisely like each other in equipment, except in the one feature of gauges, I find much more satisfaction is derived by the men, as well as myself, from the Whitehall plant, where duplex gauges are used, than at Green Island where single gauges are now employed, but which will be replaced by others of duplex pattern soon, for experience has taught me that the latter kind is greatly preferable in every way, and I would advise their use by others who desire to have a serviceable and comprehensive air-brake schooling plant.

R. C. CORY,

Green Island, N. Y.

Machine for Cutting Off and Scarfing Flues.

Editors:

When flues are cut out of a boiler undergoing repairs, the first thing done with

them is to clean the scale and dirt off, then the rough, split ends must be cut off preparatory to welding on new ends. This operation is with some a slow and tedious one, being in many cases obliged to take them to the machine shop, where some old lathe is utilized for a cutting-off machine. While this method is an improvement over hand cutting, I have found the machine illustrated to be far superior. It is quicker and cheaper; no chucking, no stopping of the machine.

By referring to the drawing it will be seen the tube is laid on the rollers *F* and the cutter *H* is forced on the flue by the screw *L*. The outer bearing is pivoted on its support *A* to allow a vertical movement of the shaft at the end carrying the cutter. The spring *D*, $1\frac{1}{2}$ inch, surmounted by

the half box *N*, carries the weight of the shaft as shown. The spring is attached to the timber forming the bed of the machine. After the rough ends are cut off it will be found necessary to scarf the end for welding. This can be done with the same machine, by taking off the cutter *H* and replacing it with a shell reamer tapered to suit the scarf or bevel required. By arranging a wooden lever lugged at one end the tube can be forced on the reamer and scarfed in a very short time. To prevent the tube from turning, a simple clamp can

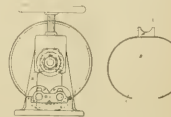

be secured close to the end being scarfed. The supports of the machine *A* and *E* should be at least 5 feet apart.

F. M. ARTHUR

Reading, Pa.

The Last of an Old Question.

Editors:

Referring to the September number of your paper, in the criticism on my article in the August issue, I wish to state that the gauge hands did not fall after the heavy oil mentioned was used until so much time had elapsed that men who were not posted on air, and who were in the habit of riding over on the emergency notch, would see no difference in the black hand, and were misled in their efforts precisely on that account, when, if the black hand had fallen as on the brake valves of later date, it would have been observed, and much light thrown on a subject then not very well understood. When giving instructions some three or more years ago, in order to emphasize this point, I was in the habit of putting brake handle on lap, exhausting train pipe, and, while striking or jarring the gauge pipe, show that the

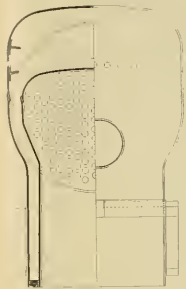

sheet, about 2 inches, and the crown stays go through the sheets radially." As a matter of record I inclose a blue print, showing the back end of the boiler of some engines built for the Denver & New Orleans, and the Boston, Hoosac Tunnel & Western Railroads, by the Rogers Locomotive and Machine Works in the year 1881. You will note that the crown sheet was curved to a radius of 5 feet 8 inches, and the roof sheet to a radius of 10 feet 3 inches, and that the crown stays passed through both sheets radially, just as you mention them to be in the "Improved Belpaire" referred to.

If the patent was granted on the claim of curved crown and roof sheets and radial stays, it would seem that the Rogers boilers embraced all of these features and anticipated by several years the "Improved Belpaire."

W. F. DIXON,
Chief Draftsman, Rogers Loco. Co.
Paterson, N. J.

Does Full Throttle and Close Cut-Off Have Anything to Do with Worn Ties?

Editors:

In your letter replying to mine inquiring cause of flat tires, you say that the hammer-blow crank was not such a crank after all, and that the hammer blow is something that must be dealt with in every case.

As I understand it, the hammer blow is the same, whether running with or without steam.

The engines that give us the most trouble are well counterbalanced, and have no pound or jerk, except when working full throttle with the reverse lever hooked close to center. This knocking and jerking is relieved as soon as the lever is dropped a notch or two.

The flat places in the tires occur at the

black hand removed practically stationary. I finally found a valve that would hold, and believing the rotary valve to be the cause, changed the brake valve, and put on one that held the black hand at 20 pounds, having scraped the valve, but it was found still leaking, and then the repairman located the trouble. He found the piston of Plate D 1/8, 2 1/2 lbs less in size than the cylinder, so he with a soldering iron tinned the outside of piston and turned it to fit. When the valve was placed on an engine the black hand showed all right, but here is where the trouble came in, and I suppose others have been there, too.

The main reservoir is under the foot board and fastened to frame, the brake valves were fastened to brace on boiler head, and there was a constant springing of the bottom cup No. 1 because of expansion, and sometimes when the brakes were applied the piston would stick up, and I soon came to the conclusion that the Spring-mounted rod, namely, that it was not necessary.

As to the correct reading of engraving shown on page 231, July number, I have taken this matter up with a number of draughtsmen, pattern shop foremen, machinists and others used to reading drawings, and the opinion is unanimous that but three pulling points are shown on lever referred to, one at either end and one in the center. On explaining the explanation taken to this reading all parties agreed that the lever was not shown passing through the slot, nor was there any pin or fulcrum shown in the sketch at the point mentioned, and unless it was another source from which to get an idea of the workings of the brake, they would be forced to reject the plan on account of the unequal leverage. As to the best point taken up, the object in calculating the leverage, was merely to indicate those who have no drawing or models accessible to use when they are in a workshop obtain the information needed. The writer wants to perhaps show someone else who wants to know that there are methods of gaining points within the limits of oil, but of which advantage is enormous not taken, because they do not follow the old road. Geo. C. HODGINS, Roanoke, Va.

Handy Jobbing Chucks.

Editor:
In the 10 years of locomotives it is safe to say that for any job and yet they have other devices for the same, as the number of times that the job will come will only be limited by the number of engines that pass through the shop and occasionally some from the roundhouse. When they come from the latter place, they are almost always in a hurry, and yet they have no one want to have something to handle them quickly, and not have to hunt up bolts, straps, clamps, and a half dozen other things that someone else is using just then, and which will cause you to have some new ones made. It is then that a special chuck will be appreciated. Did you ever notice that the job that is wanted to hold, or for which you are getting some device to hold securely, seems to come the most often until you are prepared for it? After that you never seem to know when it comes.

There is one job in the shop that will always have a lot of planning and holding done by hand in the vise, and that is making tools. The reason, I suppose, is that they are not made very often, and when you start in to make a tool it is most likely wanted as soon as possible, and you do not have time to rig up anything to help do the work better than the vise. After the tool is made, you do not have to make another for a year or two, and do not need the tool-making appliances that, if it does not break, for it is well known that a tool in a locomotive shop very seldom wears out—I was going to say never.

The two chucks here shown are for do-

ing just such jobs. They are easy to make, save lots of time, and do the jobs better. One is for holding the case of a tube roller while the slots are being cut, and the other to hold sections of expanders while planing the taper.

For the castings in Fig. 1, anything that one has convenient will do, and drill holes to bolt on slider. Then bore a 1/4-inch hole through and counter-bore 1/4-inch deep, one side of shank end of roller case, the other the size of end that goes in tube. Bore for largest size, and for smaller ones make bushings to fit 6, and a 1/4-inch or 1/2-inch bolt to hold all together. After the case has been turned and laid out, all of which should be done in lathe, except



the three holes, i. e., Fig. 1, lay these out the size of slot and drill. Use chuck for holding and you will be ready to slot the balance.

Get a piece of steel the size used in the slider, and make tool with square face 1/4-inch and round back, as heavy as will go through hole and not more than 1 inch long, so there will be no spring. Set on slider table so that the hole will be one side of center, to give the clearance to the roller, and when one side is done loosen the half-inch bolt and turn work to the other side of center. Tighten up again,

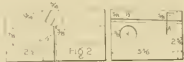

and finish that side. Repeat on each slot and you finish the case without any work. This is for a case where the case bolts in the rollers. We use a case where the rollers are held in with a spring. In this case the slots are square through 1/2 inch longer than roller.

In making expanders, we have the forgings 8 inches long. Center each end for planing, plane the exact angle for three rings, with the same number of set-screws and there are sections. Put one on each end and one in the middle, with 1/2-inch mandrel taken through center. After they are turned and taken apart and the end broken off, as it will be found best not to cut them clean off, they are finished, except the taper. As there is nothing straight about them, they are hard to handle, as you are sure to spoil the edges. By following this plan you get two expanders with very little more labor than is needed to make one.

Fig. 2 shows what I rig up—two blocks of iron 2 1/2 inches square, 3 1/2 inches long. Plane all sides, then lay into the groove and plane when you drill well through to tighten together. Have in a piece of square iron so as to hold it in. Then put in bolt that just fits hole. Now plane oil bottom of blocks to taper that you want section of expander, drill the hole and put in a 1/2 inch pin to serve as a stop, and you are ready to do the work. Bolt one block to table of shaper, the other is held with the bolt that clamps the two together. The bolt should be loose in hole. Put in one section and tighten up. Set drill so as to leave a finishing cut. Change sections instead of a cut. It is best to have them all the same size when finished. By doing this work in this way, you will have done another job without the aid of a vise. W. A. ROBBINS, Cedar Rapids, Ia.

The First Gun for Shooting Out Bolts.

Editors:

In the columns of your paper I note an article on a cannon for shooting out light frame bolts, which is credited to the Erie shops. The true history of this invention, at least so far as I know, is this: It had been used for some years in France, and in the winter of 1891 I was going over the Erie Railroad with one of the Leslie snow plows. The chief draughtsman for the Leslie Company, Mr. Metzger, was in the caboose with me, and we were talking over various shop practices and handy tools, and he described the gun which you

Wales alone. In 1813 a book on railroads, by Von Gerstner, was published in Germany, and it contained particulars about a great many railroads that were in operation on the Continent.

How Rail Joints May Be Well Made.

By JOSEPH ANTHONY.

In preventing an ill, or in attempting to cure one, the best results obtain when the ill's origin is understood. The origin of weak and low joints arises from want of the rail's continuity—however long they may be they cannot be endless. While

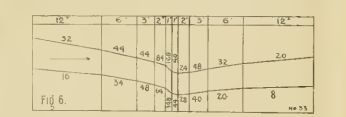
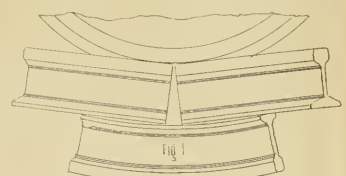

illustrate. Shortly after coming to the Roanoke Machine Works as general foreman in February, 1893, my attention was called to the large number of bolts which had to be drilled out of frames and cylinders, and very naturally the suggestion of my friend in the caboose came to mind, and we built what so far as I know, was the first gun of this kind built in the country. Last summer, while visiting the Susquehanna shops of the Erie Railroad, I described the gun to Master Mechanic Bond. In fairness to Messrs. Mitchell and Bond, both of these gentlemen have recently informed me that they gave credit to the Roanoke Machine Works for the suggestion. I think, however, the credit belongs to my friend, Mr. Metzger. We heartily endorse all you say in regard to the great advantages of the gun, and will say that it is in general use along the line of the Norfolk & Western Railroad. H. A. GILLEN, Roanoke, Va.

There was very little done in America towards railroad building of any kind until 1830, and there is an impression among our people that the Liverpool & Manchester Railway, which was opened in 1825, was the first railroad put in operation in Europe. This is a mistake. There were a great many railways in use before that time, most of them operated by horses. In 1811 there were reported to be 150 miles of railway in operation in South

the coming-to-foot and inter-ended rail will lessen the number of joints, they will not perfect those that remain. The study of joints is therefore yet important.

As is apparent to an interested observer all ballast in which the sleepers are bedded is to some extent compressed by the weight of passing trains, and the rails over them partake of a like vertical movement. The sleepers, while thus sinking in detail, yet leave most of the rail's surface practically in the desired plane. It may be a depressed plane, but as the valley that the weighted wheel makes, and in which it runs, ever accompanies it, the plane is therefore, to the wheel's path, yet intact. While this is true along the middle portions of the rail's length, it is not true at its ends, at these points the action is intensified and here the fault is developed. By its own stiffness the rail, along by its middle portions, distributes the load it bears over several sleepers at one and the same time. This it cannot do at its ends, for here its continuity, its stiffness, practically ends. The result is that a chuck was a valley-like depression of the rail's surface elsewhere, at the joint becomes an angular depression through which the wheel can pass save as it administers a shivering blow on the upward angle that the first end of the rail forms one side of, and each such blow prepares the way for a worse one to follow. With a yielding sub-structure this result is apparently unavoidable. No joint—piece per se can be made

strong enough to avoid it. Fig 1 makes this point clear.

Here is represented a low joint, exaggerated in order to make its working plain, which is spliced by an inverted piece of rail of the same strength as that of the track itself. The kind of fastenings are immaterial and more are shown. In all cases of subsidence at joints, as they are now laid, it is plain that the best splice that is made will fail to bend the rail above it to the curve that it itself may be brought to assume. If a splice of this kind should even be solidly welded in place, the increased stiffness of the combined parts, each way from the rail's end, would yet cause the injurious angle, instead of an innocent curve, for the wheels to pass over. Now it instead of a splice having a degree of rigidity like the one just shown de-

posed to be—as the piers of a bridge—and there are a number of splices that are amply stiff to carry the load from one of them to the other; but let there be a pumping or vertical movement of these members as the wheels go over them, and the joint question will remain, as it ever has been, the prime cause of tracks that are costly to maintain and uneven and dusty to ride over.

the track alike, a sure and a desirable plane.

Weak Cast-Iron Driving Boxes.

One of the weakest parts about the ordinary locomotive is the cast-iron driving box. Steel and strong alloys, such as bronze and Ajax metal, are slowly but

use the box square, and goes clear down the whole length of the box. The cellar is fitted in between the brass and the oil cup, so that we have a perfect contact of brass and metal, easily fitted. The brass is made square, as I said before, with a flange cast on the outer edge of it, which is the hub protector. Or, in other words, we run the brass against the hub instead of the steel. Now, so far as those boxes are concerned, in running, we have an engine in the shop now that has made nearly 115,000 miles in fifteen months. The boxes were worn a little loose on the



pendence is placed on the ordinary angle bar, which is authoritatively stated to have only 30 per cent. of actual strength of the rails to which it is attached, and which, furthermore, begins, as soon as used, rapidly to deteriorate, what wonder that the joint problem is deemed to be difficult of solution.

Without tracing into account the angle formed by the rails at a sun joint, Fig. 2 shows the relation of the parts, thereat when spliced by the ordinary angle bar.

The small area of bearing surface under the heads of the rails, and that too, mainly at their extreme ends, admits of a quick abrasion and a narrowing of the bar at its middle and vital point. The consequence is that, as the cut shows, there is ever a changed vertical relation of the rail's ends as a wheel passes from one to the other, which is unmechanical in an extreme degree. No master mechanic, if he had charge of the track's mechanism, would for an hour tolerate such an absurdity.

Fig. 3 is from a photo, showing the worn and thus faulty edge of an angle bar.

Figs. 4 and 5, also from photos, show the features of sunken joints and the battering by the wheels due to the angle formed thereat. Both are taken from the plant of the C & N. W. Ry., and are thus examples of what passes for good engineering.

Figs. 6 and 7 show in detail the grades in feet per mile of joints in the tracks of the same road. They show a length of two feet each way from the rail's end, and are representative of the average joint, after a few years' use, in all double track roads.

These diagrams of the ill under consideration show it to be due primarily to such a settling of the sleepers, or the ends of them, as to cause angles to be formed at the rail's ends, and its prevention, therefore, involves a more complete integrity of the rail's support from beneath. This means that where the vertical strength of the rail is least, where its continuity ends, there the area of bearing on the ballast should be increased, and increased exactly in proportion as the continuity of the rail is broken. Here has been our complete mistake. We have attempted to reinforce the rails at their ends instead of the foundations on which the ends rest. To be preventive of the ill, let such an area of bearing on the ballast be furnished as is due to the load it has to sustain, as modified by the rail's stiffness under all its length, and the splicing is effectively done. Let the supports on each side of a joint be in practice what in theory they are sup-

posed to be—made narrow enough to admit of a liner or liners to compensate for wear where needed between its upper edge and under the rail's head. If this liner remedy for wear is deemed or proves insufficient, there is the Churchill (N. & W. Ry.) bottom-bearing splice which, in principle, leaves nothing further to be sought. I emphasize the fact and urge all who would have the track as perfect as the machinery it carries to beware of any kind of a rail splice alone, as a sufficient joint support. To accomplish this last, the anxious and studious roadmaster must go deeper, must use a form of support and a method of vertical and lateral rail adjustment that will be preventive of harm rather than be remedial after the harm has resulted.

Fig. 8, from a photo, shows perspective such a form and arrangement of parts, in principle, as admits of furnishing a bearing on the ballast which may be proportioned to the rail's want of continuity, and the effects of the passing load. These bearings should be individual ones in order to avoid pumping the ballast from beneath them, neither should the rails be fastened to their supports. The rails' vertical movements, if any, must not affect the members on which they rest, they therefore must be tied and anchored substantially as shown. As tampering for vertical adjustment is thus happily gotten rid of, some of the many known means of exactly and surely accomplishing the same end, and which may be applied above the supports and below the rail's foot, should be used. A last and further perfecting feature of a joint is to have the rail's ends, for a foot or two in length, bent upward, the joint raised, just to the extent that upon passing trains the slight though probable and useful elasticity and consequent depression will cause the wheels to ever find for their path, in all portions of

surely crowding out the cast-iron box, but it will be many years before it entirely disappears.

Mr. John Mackenzie, of the Nickel Plate, who is a man noted for accepting the lessons of experience, said on this sub-

ject, "The boxes were absolutely as tight as they were the day they were put in—the brasses—but we found a terrific wear on the wedges. The cast-iron wedge and the steel box will not wear. That is the only trouble we find with those boxes. Now we are planing those boxes out and putting a bronze gill on the face of the box where it wears, and using wrought-iron wedges. We propose to case-harden those wedges, and we think we will have a driving box that will not give out for a good many years."

At the late election in the city of New York a vote was carried by a large major-

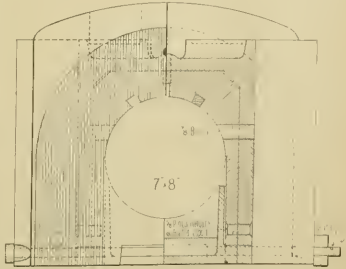

MACKENZI'S DRIVING BOX.

ity in favor of the municipality building a system of rapid transit railways. The inadequate service and accommodation provided by the Manhattan Elevated Railroad Company had much to bring about the people taking rapid transit into their own hands.

The announcement is made that the Pennsylvania Railroad have decided to increase the standard weight of rail from 85 to 100 pounds. All renewals on the main line between New York and Pittsburgh will be made with steel of that weight.

Nickel Plate Notes.

The problem on the N. Y. C. & St. L. Ry. (Nickel Plate road) when our genial friend, Mr. Mackenzie, took hold, was a very difficult and trying one. As originally constructed, the road was built to sell, and no particular requirements of conditions placed upon those furnishing the power, other than so many freight and so many passenger locomotives; and, as would naturally be expected, a great many over-



FIG. 1.

loaded and weak-kneed engines were furnished. Mr. Mackenzie had a very trying and wearing problem to get results, bring up the power to a maximum degree of efficiency, and keep down the expenses of the motive power department, but the magnitude of the problem did not discourage him. He has gone steadily on, strengthening weak parts, and when reinforcements have been made they have been done on "up to date" methods.

The general policy of reconstruction has gone steadily on, the boilers of the 18-inch freight engines replacing worn out boilers on the 17-inch passenger engines, and new modern boilers furnished the larger freight engines. It goes without saying that the new power ordered from time to time is of the best and most approved design, so that all the power now looks well, does good work, and compares favorably with other representative roads. The writer spent the day in the shops of the company, and from his knowledge of former days could appreciate the march of improvement along the line.

At the Conaught shops, we entered a novel and excellent way of prolonging the life of cast iron or steel crossheads. Ordinarily, when the pin is reduced in diameter below the safe limit, or worn out of round, the whole cross-head is scrapped. The Nickel Plate people, however, cut out the old pin and make a dove-tailed slot on either side, and fit in a forged pin in accordance with shaded portion of Fig. 1. This method has given great satisfaction and even better results than with the original pin.

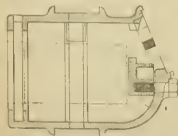

FIG. 2.

A novel form of end stop for tender axles is used (see Fig. 2)—the large tender axles with collarless journals, after making the required mileage, are turned down to journals with collar, and used under 40,000-pound cars. This form of end stop provides for the insertion of liners between the stop and box to take up any excessive lateral wear.

The economies in the use of oil instituted have produced satisfactory results. The record of oil used on guides has increased from 44 to 90 miles per quart, and valve oil from 16 to 25 miles per quart. One engineer has made a record of 100 miles per quart of valve oil by arranging his feed to drop two drops uniformly per minute.

The provision for oiling wedges and hubs between driving boxes is provided for by

an oiling device in the box, so no oil is used en route by the engineer.

Making the Most of Scrap.

During a brief visit to the repair shops of the Chicago, Milwaukee & St. Paul, at West Milwaukee, we found a notable improvement in the storing of scrap which is well worthy of imitation. The condition of the average scrap heap is too well



SCRAP CITY AT MILWAUKEE.

known to call for long descriptions. Every article of iron, steel, and sometimes brass used in railroads, from the fish plate to the rim of the smokestack is thrown together in a confused heap. The theory is that useful articles in the scrap will be utilized in repairs, but when a particular article is wanted, it is so hard to find that after wasting more time looking for it than the stock is worth, the smith or machinist goes and gets an order for new material. And so the scrap heap is constantly augmenting, and none of it is used except what goes for reworking at the few places where they have scrap furnaces.

At the Chicago, Milwaukee & St. Paul shops they have introduced a systematic method of arranging scrap, so that a large proportion of it will be used without having to go through the furnace.

The preliminary process of selection is the arranging of scrap of a similar character together. A large space in the yard has been laid off in streets and alleys, with scrap bins for the houses. The streets are so arranged that cars containing the scrap to be deposited in the bins can be brought alongside, while easy access is provided for trucks to carry the assorted scrap to the shop where it can be used.

As we pass through the streets and alleys accompanied by Mr. A. K. Manchester, we

find bolts, oil box cellars, rockers, piston rings, follower plates, slide valves, hangers and various other parts that were considered too good to throw away. They would come handy when an engine came in needing one of these parts. But very rarely did they come in. The accumulation went on till a cleaning up was ordered and then the whole lot went to the scrap heap.

In the Milwaukee scrap city, these parts and many others are placed in their

suitable for re-using in its own line is converted into something else under the hammer or steam hammer. The policy is to avoid using new material as long as scrap can be utilized without too much work. Mr. J. N. Barr has taken a very practical interest in this method of cutting down expenses, and he is to be congratulated upon the results.

Material for Driving Boxes.

At the last meeting of the Central Railroad Club a report, prepared by Mr. Geo. W. West and Mr. S. Higgins, was presented on "The best construction and practice in locomotive driving boxes, including a consideration of the comparative merits of solid bronze boxes compared with cast iron or cast steel with bronze lining." A decided stand was taken against the use of bronze driving boxes, for the reasons that the first cost was greater, and that the great expansion of the metal when heated causes it to stick readily in the jaws of the frame. Besides these objections, it was stated that when the crown gets worn there is apt to be a pinching of the journal which results in a hot box.

One member had got good results from cast-steel boxes having brass bearing gibs with soft metal between them. The soft metal strips were made sufficiently long to bear against the driving wheel hub, thereby preventing the cutting that usually ensues when the hub rubs against a cast steel box.

The favorite kind of driving box was reported to be cast iron with bronze bearing gibs having soft metal filling.



STREETS AND ALLEYS IN SCRAP CITY.

articles and put them, if possible, into standard forms.

The saving effected by the plan is readily appreciated in the case of bolts. In ordinary circumstances, in big scrap

Attention was directed to the practice now adopted by many roads of placing the driving box flanges straight at the center for a distance of 2½ inches, tapering them from there to the top and bottom. This permits the box to adjust itself when the wheel strikes a low joint and is a valuable means of preventing broken boxes.

In the discussion that followed the paper some of the members favored the use of solid bronze driving boxes.

The practice of cleaning the cushions of passenger cars with compressed air is rapidly spreading, and in some places it is customary to take the cushions to the platform and clean them when the car is not held long enough to go into the yard. Several roads tried cleaning the whole inside work of passenger cars by jets of air, but the practice is falling out of favor. Mr. A. M. Want, of the Lake Shore, speaking of this practice, said that it raised more dust than they got rid of, and Mr. Mackenzie, of the Nickel Plate, said it acted like a sand blast on the varnish of the window sills.

The Westinghouse Electric Company, of Pittsburgh, have built immense works on the main line of the Pennsylvania Railroad, about fifteen miles south of Pittsburgh. They are now putting in the machinery, which will be the most complete of its kind to be found in any shop in the country.



A BOSTON & MAINE ROUNDHOUSE.

find that every bin contains material different from the others. They are rather more than scrap bins; they are storage places of old and spare material. A locomotive or car is broken up the good parts that can be used again in repairs are stored in these bins and a workman knows where to find the thing he wants.

We all know how, in many shops, the machinist would stow away under his bench

heaps, we may find tons of bolts that have got bent or the threads damaged. The work of heading all these bolts represents a large expense, but heads and threads ignored, they go to the scrap furnace. Here these bolts are straightened and used over again, if the thread is good. If it is damaged, the bolt is cut and threaded to suit a shorter size. All kinds of rods, arch bars, splice bars and other parts not

Dangerous Boilers.

The Hartford Steam Boiler Inspection and Insurance Company publish monthly a journal called *The Locomotive*, devoted to matters connected with steam boilers. A valuable feature of the paper is a part devoted to the record of boiler explosions. This record makes largely sad reading to those who have any feelings of humanity, and illustrates the recklessness for human life and suffering that our loose system of placing responsibility produces. In the month of August there were thirteen explosions of threshing-machine boilers reported, nearly every one of them causing death and suffering. A threshing-machine boiler is the most dangerous of any kind of steam generator, because it is generally in the care of incompetent engineers and because that class of boiler is not subject to proper inspection. The ignorant politicians who are sent to State Legislatures to make laws for the commonweal are to a great extent responsible for the death and suffering caused every year by this character of boiler explosions. They have the same ideas about boilers that existed fifty years ago when they used to put a freight car between the locomotive and passenger cars to take the shock of the explosion that might be expected at any moment and could not be provided against. They think that boiler explosions just as a dog takes the rabies, and that it is as futile to try to prevent the one as it is to the other. The fact that nearly all other steam boilers carry higher pressure than the boilers of threshing engines, yet threshing engine boilers exploding much more frequently than all others combined, conveys no lesson to them. There would be no difficulty in arranging a boiler inspection law which would make threshing engine boilers as little murderous as others, but there are always some cranks in State Legislatures that oppose the passage of laws of this character. It is high time that the good sense of the people was asserting itself to show that their sense of humanity is higher than that of the politicians.

Brake Leverage of Freight Cars

Mr Palaski Leeds, of the Lonsville & Nashville, who is noted for the practical character of his ideas about railroad machinery, made some suggestions last year to the Master Car Builders' Committee on Brakes and Brake Rigging, which deserved more attention than they obtained. The suggestions made indicated us to devote particular attention to the subject, and from what we have seen of brake rigging within the last six months, we are inclined to believe that Mr. Leeds has indicated the proper remedy for a serious defect.

He holds that with the present method of connecting the axle brake the efficiency of the hand brake is destroyed. As we will likely have to wait a long time before hand brakes are entirely dispensed with, anything that tends to impair their efficiency is worthy of serious consideration. He considers further that the practices which reduce the efficiency of the hand brake, destroy to a great extent the efficiency of the air brake.

The source of this trouble is the arrangement of levers. Originally the power of brake levers was multiplied five to one, and as an increase of power was obtained by using an 8-inch cylinder, an attempt was made to diminish the transmitted power, that was produced by several innovations. While the brake leverage is fairly adapted for a car 40,000 and upwards, it is entirely unsuitable for cars that weigh 30,000 and under. With cars of light weight, the cylinder lever has to be so long that the connection between the top of the brake lever and cylinder lever has to be not awkwardly angled, and close the short end of the cylinder lever has to be so short that with a 12-inch travel it

is thrown into opposite extremes of angularity, making the end that is connected to brake lever travel in a circle of about 7 or 8 inches radius, and distorting the apparatus to such an extent that there is not a straight pull on the axle. To avoid this, we apply brakes to flat cars with fairly simple movements of levers, which would be to long enough to reach clear across the car, or else make the short end of the lever so small that it is impracticable to get 12-inch piston travel.

The highly practical remedy proposed by Mr. Leeds was that gondolas and other light cars weighing say from 15,000 to 22,000 pounds should have 8-inch cylinders and 12-inch stroke, cars weighing from 22,000 to 28,000 pounds should have a 7-inch cylinder and 12-inch stroke, cars from 28,000 to 36,000 pounds in weight, an 8-inch cylinder, and for large, heavy cars above 36,000 pounds weight, a 10-inch cylinder. With this cylinder arrangement a truck lever four to one could be adopted, and the same lever for all car bodies. By doing this there would be no probability of an intelligent car inspector applying long levers to cars, and as they would never have to change the cylinders, the probability of variation and application of wrong dimensions would be very remote with intelligent men.

Impairing the efficiency of the hand brake, as the existing arrangement of air brake levers does, is a very serious matter. Although the leverage for the hand brake is made greater than for the air cylinder, it is not nearly enough, for it is difficult to get the hand brake lever longer than half the power that the air cylinder transmits to the brake shoes. This could be remedied in several ways and it appears to be a plain duty of the Master Car Builders' Association to have the improvement carried out.

Converting Iron Scrap Into Axles.

The season of using up the scrap heap to produce new stock is not entirely over yet, although many scrap heaps have been cleaned up and are very small. Those who are trying to make new garments out of old material may be interested in a description which Mr. William Smith, of the Chicago & Northwestern, gives of his method of making axles and crank pins from scrap iron. He writes:

"I will commence with our car axles. We generally use the heat after which we scrap iron and pile it in piles about 12 inches long and 4 inches wide and about 6 inches high. We put ten of these piles into the furnace at once and take a heat up on them. We then commence pulling them out of the furnace and hammer them on the top and sides until we hammer them partially solid, after which we hammer them on the ends, about an inch or an inch and a half thick and about 6 inches wide. After we have handled them in this manner, we cut them across the middle and throw them to one side until cold. We follow this method of scrapping for a day or two. We then put these slabs away from the fire and reheat them, and back into the furnace a slab, as already described. This we use for car and tender axles."

"What we use for crank pins and driving axles is what the blacksmith calls the 'knobs' off the car and tender axles, for, as you know, there are six or seven inches cut off each end of the reheat, and we cut out of each end these knobs into the furnace as it will hold and bring up a heat. We then take them out, and place one on the anvil and flatten it out, and then place another on top of that, and sometimes a third one, until we get a slab about the proper size. We then hammer in the usual way. This is reheat, but we pay no attention to that and lay it to one side, and when we get enough of these slabs, we reheat them again and draw them out to the proper

size. You will see by this process the iron has been twice reheated, once when made into a car axle and again when made into driving axle or crank pin. The slabs are generally cold when we reheat them. When the heat is any good or not, I cannot say, but they are more convenient to handle in that condition. All our crank pins and driving axles are made from this material."

"At one time I tried to make new car axles out of old ones by simply cutting off the journals, flattening out the axle, cutting them in two and forming them into slabs, and letting them cool at that, and I thought I would have a very good axle; but when they were put into the drop test I found they were all crystallized and would not stand the test, and I finally came to the conclusion that we would reheat all the old axles the same as scrap, and have made a practice of that when using old car axles. The way I do with these old car axles is this: I take one thick reheated slab, about 2 inches thick, which I put in the middle, placing a slab that has only been worked once on each side of it, and put them in the furnace in this way and get excellent results."

"The way I account for this is as follows: Of course, the mass of the iron is soft when it comes out of the furnace and goes under the hammer, and the hammer and anvil are cold and hard, and work the two outside slabs down in good shape, the center one, being a reheated slab, is affected only by the two outer slabs, and the reheated slab is in good condition before it is placed in the furnace at all, or, in other words, you save the heat. The center slab has been well worked up before being placed there, and the outside is worked up from the hammer and anvil, and, to my mind, you have almost as good an axle as if you had used three reheated slabs. This saves the reheating of the two outside slabs and makes the axle a little cheaper."

Favors Soft Journal Bearings.

Some interesting facts were given by Mr. T. A. Reynolds, general manager of the Wagner Car Works, during a discussion on journal bearings. He said: "We find in running cars over different roads that they will heat on one and not on another, when built up exactly the same. Now, would it not be well to specify the lubricant?" There is altogether 100 much difference in the oil that is used in different parts of the road, so in one more point I would like to make. We run cars on some lines and never have a complaint. We never have a chance to run cars about the yard to break them in. We send them from the shops on the fastest trains, including the Empire State, and have no trouble whatever. I have seen a number of single axle cars in which cars sent right from the shop on the fastest trains have not run cold. There may have been something of that kind, but not reported. Our boxes are made so that they can rest the entire length of the journal, and there is no rocking motion in any part, and there is no swinging of the journal, and there is made perfectly in the first place, and fitted properly, they do not heat. In the first place, we make all of our boxes so that they will fit, inside and outside, and they all go through steel templates, and the bearings the same, and the wedges the same, and when they are put on the journal they rest the whole length of it. We also take great pains in trimming the equalizer that is put on the plate on the bearing, and when placed under the car they do not tip one way or the other, but there is equal pressure on the different ends of the brass; and we find that with the use of the soft oil, about what we do not have any trouble. The Pullman trucks are built in the same way. I have run brasses down to 5/16-inch in thickness and still they ran cool. I have run the leading axle 60,000 miles without wearing it out. When with the same device one

man gets one result and another gets other results, there must be something back of that. It is either in the castings not being perfectly true and the existence of an unequal bearing—they do not use the proper method of getting them true—or else they do not have the right lubricant. We do not seem to understand the problem unless we go clear back and get the whole facts in the case."

The lead lining starts the journal running cool. If that is not properly lubricated, so that the stir it will rub entirely off, a thing that sometimes happens when cars are allowed to rest.

An experiment made some years ago was mentioned by Mr. J. D. McIlwain, where they had run a car with some of the bearings lead lined and others with plain brass. They found no difference in the wear of journals. He favored the use of lead-lined bearings because when equipped with a car could be put on one or a train and would run without danger of hot boxes. When plain brasses were used they had to move cars about yards for two or three days before they could be safely put upon trains.

We occasionally receive complaints from railroad officials because we did not make personal mention of changes or promotions of which they were the party of the first part. The trouble is that we are not gifted with omniscient vision, and cannot tell when promotions and other changes take place unless our friends send us word. If we had such omniscience as to give personal notice. We have several times lately suffered in another way from want of omniscience when zealous friends sent us notices of promotions that had not materialized. We are always willing to wait till a promotion takes place before we announce it. Do not send us word that a change has happened without a greeting. A great many changes that railroad men feel sure are coming never happen.

In the book published by the Pennsylvania Railroad, showing the company's World's Fair exhibit, there is an engraving of a primitive truck which was used under a boat car in the infancy of railway car trucking. It is called "primitive," but we are inclined to think it was built on sound mechanical principles than the ordinary freight truck of to-day. It has a frame put very strongly together, with jaws for the axle boxes and half elliptic springs set over the frame of the truck, with stem resting on the axle box. A truck of this kind would be very easy on the track, and we consider it a pity that it was not made the model for the development of trucks suitable for modern cars.

The officers responsible for the obnoxious condition of water-logged and muddy streets on the average railroad ought to take note of an inexpensive remedy recommended by a committee of the Central Railroad Club. It consists of thoroughly washing the places with water, which is followed by a solution composed of chloro-naphtholium, one gallon of the compound to a gallon of water. Those who have tried this remedy for nastiness say it is very efficient, and makes the use of sea and other disinfectants in urinals unnecessary.

When the first part of what is now the Chicago & Northwestern Railway was chartered in 1856 the proposal was made to call it the Chicago & Galena Union. This name was objected to, on the grounds that Galena was a more important place than Chicago, and so it was named the Galena & Chicago Union. There is some change in the relative standing of the two places since that time.

Announcement is made of the removal of the Westinghouse, Church, Kerr & Co.'s office from Atlantic avenue, Boston, to Exchange Building, 53 State street, of that city.

Simple Tool for Turning Lift-Shift Bearings.

At the Denison, Tex., shops of the M. K. & T. they use one of the best designs of the well-known plans of turning off tumbling-shaft bearings.

A long center goes into the live spindle, and a sleeve, sliding on a feather fitted

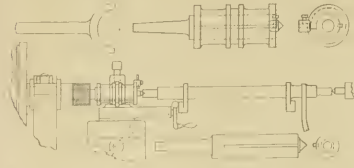

into the center shank, carries the tool for turning. A fork held in the tool and pressing the groove on outside of the sleeve furnishes a means of feeding the tool.

Where Hand-Books Differ.

We have discovered that a species of literature very badly in want of reform is engineers' books of reference. We have been in but years in the habit of consulting engineers' hand-books for facts relating to work we were engaged in, and it never occurred to us to doubt the accuracy of the information found. We were aware that some men preferred one book of reference and others another, and we had heard the remark made that such and such a book was no good, but we supposed the objections were raised to the arrangement and not to the accuracy of the data. A new light has dawned upon us lately. It came in this way. Two questions had been answered which related to the melting point of gray cast iron, and on reading the proof we discovered that there was over 1000 degrees difference in the melting points given. One question had been answered by the S. P., the other by the I. P., and each consulted his favorite engineers' book, with the result stated. Then it was determined to compare a few books used for reference. Here is what we find:

	Melting point of cast iron, Fahr.	Melting point of cast iron, Cent.
Hawell	2200	1200
Franklin	2200	1200
Clark's Tables	2200	1200
Mechanics' Hand-Book	2200	1200
Chemical Works Engineering Co's Hand-Book	2200	1200
Jones & Laughlin's Hand-Book	2200	1200
Encyclopedia on Iron and Steel	2200	1200
Richard's Iron Foundry	2200	1200

The Committee of the Master Mechanics' Association on gauges for sheet metal, tubes and wire have sent out very comprehensive circulars to members of the association and to manufacturers, requesting the expression of views on the necessity for an improvement in the system of gauges. In the circular they say "It is evident that nothing but confusion can result from the present practice of ordering by Birmingham or Stubbs, Imperial Birmingham, American, United States Standard and other gauges without making any reference to the name of gauge in the orders, and we believe that if a system of ordering sheet metal, wire and tubing by expressing the thickness in decimals of an inch should be generally adopted, all trouble from this source would cease, and there would be no ambiguity under any circumstances."

Very elaborate plans for elevating most of the surface railroads running into Chicago have been worked out by Col. G. Howard-Ellers consulting engineer for the City Council of Chicago. There are stupendous difficulties in the way of elevating the complex system of tracks, for there are numerous crossings by other roads of lines that must be elevated, so it has taken

ingenious scheming to avoid calling for a great deal of double elevation of tracks. Col. Howard-Ellers appears to have done his work with remarkable skill. He is unusually well informed about elevated railroad matters, having designed the first elevated railroad proposed for Chicago.

The Engineer, New York, announces the publication of a series of lectures on marine engineering, which have just been delivered by Passed Assistant Engineer W. M. McFarland, U. S. N., before the Naval College at Newport. These lectures were carefully prepared with a view

cently received by the Consolidated Company, are 140 car equipments for the West End Railway, Boston, 185 for the Union Railroad, Providence, 60 for the Nassau Road, Brooklyn, and many other smaller orders aggregating in all about 500 car equipments.

We have received from the Lenknechtner Co., Cincinnati, a very handsome catalogue and price list for 1895. It appears to contain everything in the line of steam specialties that we can think of. It has cups of all kinds and sizes, lubricators, gauges, whistles, safety valves, and, in fact, everything required in the fitting up of steam boilers and in the lubricating of machinery. Parties interested in these things will find the catalogue a very useful reference. A good feature about the publication is that it is cut to the Master Mechanics' standard size.

Half a year is nearly gone since the railroad mechanical conventions were held. We learn that some of the committees that have to report at the next convention are already actively at work. That means that the reports will be ready in time, and that the investigations will be thorough. This is a good time to indulge in good resolutions. The members of committees might with justice resolve not to leave all the work to the chairman and if they held to their resolution it would profit themselves and the association.

We have received from the Sterlingworth Railway Supply Co. a canvas pocketbook intended for holding papers and memoranda. A very good feature about the pocketbook is a tablet on which

Ross-Meehan shoe by a different form of construction.

The West End Railway, of Boston, has ordered 140 cars equipped with the electric heater manufactured by the Consolidated Car Heating Company, Albany, N. Y. This is perhaps the most important order yet given in electric heating, and was obtained by the Consolidated Company only after most rigorous practical tests in competition with electric heaters offered by five other companies.

The human nature part of railroad travelers appears to be about the same now as it was in 1857, when Oliver Wendell Holmes wrote "The Autocrat of the Breakfast Table." In that delightful gossipy book he speaks of having "sat behind females that would have the window open when one could not wink without his eyelids freezing together."

The boiler explosion that we illustrated as happening in New South Wales some months ago, we have just learned happened over the fence in the sater colony of Victoria. It is only right to add that this is the first boiler explosion they have had for many years.

A patent has been granted to John Kriebel, Cleveland, Ohio, for a combination on a railway car platform having two parallel bars under the platform which lock into sockets, the idea being to resist the vertical movement of the platform when low joints are struck.

The Mason Regulator Co., of Boston, are making small feed pumps for boilers and tanks which are reported as becoming quite popular. The pump has many novel



LOCOMOTIVE ENGINEERING N.Y.

A LESSON IN IVY.

of best seating the audience addressed, a number of naval officers interested in engineering but not dearing a highly technical treatment. Any of our readers interested in naval engineering matters will find these lectures very interesting. They began in the October issue of *The Engineer*, and will extend through January.

Consolidated Car Heating Co. Albany, N. Y., has received this week an order from the People's Traction Company, of Philadelphia, for the equipment of 300 cars with its system of electric heating. This is the largest order ever given for electric heaters. Other large orders re-

quires can be taken and erased after they are noted in a more permanent position. Railway men who wish to obtain this pocketbook should write to the Sterlingworth Railway Supply Co., 256 Broadway, New York.

A curious form of car brake shoe and dresser has been patented by James E. Wainwright, America, Va. It consists of a piece of spiral, hard metal set on the outside of the shoe, inclosed in a softer metal, the purpose of the hard metal being to cut away the part of the tire which does not usually wear by contact with the rail. Its purpose is to perform the functions of the

features and is very simple in its mechanism. It is a single-acting pump, yet it cannot be stopped at the center.

An improvement in car brakes has been patented by Peter McMullen, of Buffalo, N. Y. He proposes employing one of the vertical members of the diamond truck as the holder of a beam to which the brake mechanism is attached. It is only intended to apply brake shoes to the inside of wheels.

C. D. Gibbons, the owner of the Cook Coupler Co. patents, at Cleveland, O., is commencing suit against several other drawer concerns for infringement of patents controlled by him.

The Elements of Boiler-Making—IX.

SHEET-IRON WORK.

By C. E. Fourness.*

SNOW PLOW NO. 3.

In this paper will be considered Snow Plow No. 3, which is an iron plow mounted on a wooden platform and screw fast. The platform is also covered with light sheet iron, about No. 12 in thickness. These plows are called platform plows, and this one is very similar to the latest plow built by the C. M. & St. P. Co., and the object the designers had in view was easy attachment to the engine and non-interference with the extended front end, as in the other designs it was necessary to remove the extended arch when an engine was equipped with a plow. Notice this

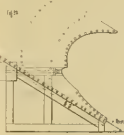

plow attaches similar to a pilot to the bumper beam, and the same braces that hold a pilot hold this plow up to place, and the draw bar is held in the jaw shown by a common round coupling pin. The front end of the same when not in use will rest upon the flat plate forming the nose of the platform. The sides of the plow itself are formed or rolled to a regular curve, a 24-inch radius, or as a boiler maker would express it, rolled to a 48-inch sweep. The top edge ends 12 1/2 inches from a line drawn from the bottom edge at right angles to the bottom. Fig. 96 is a side and Fig. 97 a front elevation of the braces. Those perhaps five pieces of 2 1/2 x 2 1/2-inch angle iron flattened and bent on the ends to fit and bolt to the angle iron ribs to hold the sides at the right distance apart, will also require braces to hold the plow down in place, and other means to attach to the smokestack saddle

Well, now to business. The first thing necessary is to find the angle the center line forms to the side. This is found in the triangle, Fig. 98, the length of the base (the center line) being 6 feet long (see Fig. 90) and the height of the perpendicular being equal in length to one-half of the width of the plow at the back, viz., 4 feet 9 inches, see Fig. 97. Then the diagonal line connecting the ends of these lines is the length of the side and the angle at the point is the angle desired. I would caution you now when laying out a plow to be very particular to use the right angle, as I remember a case where the draughtsman showed one side laid out similar to Fig. 100. On the working drawing he had the distance marked in feet and inches that the center mark for flanging was located upon the lines 1, 2, 3, 4, etc., from the end line at the point at right angles to the above-mentioned lines. In getting out this plow, I asked the foreman if I should lay out the point and prove the drawing, or work to the same. His reply was, work to the drawing. I followed instructions, and when the point was fitted together the plow was about 4 feet too narrow at the back. Of course, there was excitement for a while. The master mechanic's attention was drawn to it by the foreman; he sent for the draughtsman, after telling the foreman that we should have proved it, and the draughtsman claimed it was in the rolling, etc., to which I, of course, entered vigorous protest. But it was agreed that we should do the laying out in the boiler shop thereafter, as we had made them by the dozen and had no trouble previously. But I was obliged to block up the sides and mark them off with a large square, where they would trim and angle, to come right. All this trouble by not having the right angle at the point.

Now for Fig. 99. Draw the base line *AB* and the line *CD* at the same angle to the line *AB* as formed by the center line and the side, Fig. 98, and draw line *E* at right angles to *AB*, and 3 feet 1 1/2 inches from the point *A*. From this sweep in a regular circle, 2 feet or 24 inch radius, set the trams to that distance, and with one point set on the line *AB*, and at a point 2 feet from *A* draw the arc *FG*, locate *G* 12 1/2 inches from the line *AB*, and mark off this as into 16 points, and number them from 1 to 16, beginning with No. 1 at the bottom or at *F*. Draw ordinates through these points parallel to *AB*, and cutting the line *CD*. It would be best to number these ordinates at the point to prevent mistakes or confusion.

Everything is now ready for the sheet, Fig. 100. If the sheet to be used is not large enough, and will require to be made of several pieces, if to be butted, set the pieces together, and the rivet holes for the seams can be laid out when laying out the remainder of the sheet; but if lapped, I think it would be best to get the several pieces punched and bolted together first. Then sweep off a line drawn at right angles to the bottom and 3 feet 1 1/2 inches from the end of the sheet; that is, to form the point. Space this line into 16 points with the dividers set same as when used to space the arc, Fig. 99, and draw lines through these points parallel to the bottom and the full length of the sheet. Take a strip and mark the lengths of the ordinates Nos. 1, 2, 3, 4, 5, etc., between the lines *CD* and *E*, upon it numbering the mark the same as the ordinate from which the length was taken on Fig. 99. Carry this strip to Fig. 100, and mark the lengths upon the correspondingly numbered lines, measuring from the bottom to the right or left, as the case may be. Make a center mark at each of those marks as a guide for flanging; and after drawing a line 1 1/2 inches outside of these marks for

the flange the point is O.K. Now for the back. As the sides are one sweep the whole length, the back will be exactly the same shape as the line for flanging at the front. As all the ordinates are the same length, set the trams to the length 2 feet 4 inches or mark it upon a strip, and using this as a measure, mark the length upon the different lines, Fig. 100, measuring from the center marks for flanging. Then a line drawn through these marks will be the line for shearing at the back end. As these sides are made of quite large sheets of iron, and when the plows are perform-

ing the arduous labor required of them, they are under an immense strain and require to be well braced. It is customary to rivet angle iron ribs to the back to stiffen them, and they (the ribs) also furnish a convenient fixture to which to attach the braces. In this case there will be four ribs 2x2 inches attached to each side. The center of the holes for the front row to be located 6 1/2 inches from the center mark for flanging on the No. 10 line, and the back one located 1 foot and 4 1/2 inch from the back upon the same line, the others are 2 feet apart respectively. The number of holes for rivets in each angle iron is optional with the builder. In this case the holes are about 1 1/4 inches apart, and 13 holes in the full lengths and 11 in the shorter ones.

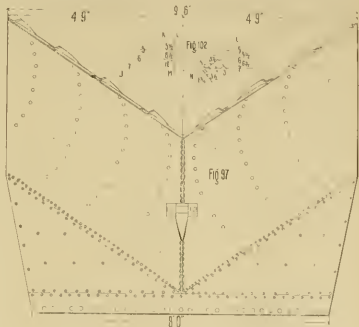

number 7 is 12 inches above the same line consequently these lines 5, 6 and 7 must be located this distance above the line of the bottom, Fig. 101. Draw the lines 5 1/2 and 6 1/2 midway between numbers 3 and 6 and 6 and 7. Now for results. Measure from the center mark for flanging on number 6 line, Fig. 101, to where the line of opening cuts the line number 6, this distance is 3 inches, and is marked upon number 6 line in Fig. 102. The point where the ordinate number 6 cuts the line *NO*, is where the center mark for flanging is located. Measure from this point back 3 inches and that gives the depth of the opening. Then from this point 3 inches back draw a line at right angles to *NO*, long enough to cut the ordinate number 6, and the length of this right angled line is one-half the width

of the opening at this point in Fig. 97, and the 1 1/2 inches the length of the ordinate between the point of intersection of the right angled line with the ordinate number 6, and the center mark for flanging is the distance between the edge of the opening and the center mark for flanging on the number 6 line, Fig. 101. Transfer the distance 3 1/2 inches between the center mark for flanging and the edge of the opening on the line number 6 1/2, Fig. 101, to the line *NO*, Fig. 102.

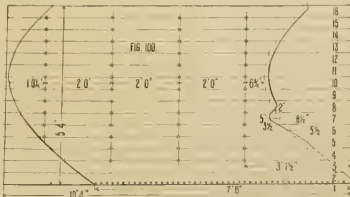

Next in order comes the hole for the drawbar, and in order not to spoil the appearance of Fig. 99 and make a confusing number of lines, etc., upon Fig. 99, I construct Figs. 101 and 102. Fig. 101 is the point of the snow plow exactly similar to Fig. 99, only that it just shows enough to give the location of the hole for the drawbar, Fig. 102; shows the ordinate numbers 5, 6 and 7, the ordinates that pass through the drawbar hole and on which the depth of the hole is to be measured. This small section is exactly similar to the same part of Fig. 99, the arc *K*, Fig. 102,

of the opening at this point in Fig. 97, and the 1 1/2 inches the length of the ordinate between the point of intersection of the right angled line with the ordinate number 6, and the center mark for flanging is the distance between the edge of the opening and the center mark for flanging on the number 6 line, Fig. 101. Transfer the distance 3 1/2 inches between the center mark for flanging and the edge of the opening on the line number 6 1/2, Fig. 101, to the line *NO*, Fig. 102.

Measuring toward the back from the intersection of that line with ordinate num

ber, and bolts to hold the front end casting to the smoke arch. I do not show, as the most master mechanics have distinctive ideas of their own on these matters, but would state that a draughtsman can show just about every hole required if he wishes, and in such shape that they can be laid out on the straight sheet without referring to anything but the drawing. But I will explain later how a boiler-maker can find in a practical manner the location of the holding down braces, providing he has the frame or platform. But a great many times the platform is being built the same frame as the plow, consequently it is not always accessible. Of course, a pattern may be made from the first one, and then everything will go along with very little trouble.

* Foreman Boiler-maker, C. M. & St. P. Ry., Debaque, Iowa.

ber 6½, draw a line from the point just found at right angles to A'O long enough to cut the ordinate number 6½. Then the length of this latter line will equal one-half the width of the opening in Fig. 97 at this point, and the length, 5 inches, of the ordinate must be transferred to line number 6½. Fig. 100, measuring from the cen-

To form the opening for the drawbar. The side is now ready to shear and punch, and after this is accomplished mark off the other side from it, using the first side as a pattern, after turning it over, as one side is to be right, the other left. When both sides have been sheared and punched, they require to be rolled to the 48-inch

top is reached, then come back over the flange and punch all the holes. I would generally, as these plows are quite heavy, set the plow upon the platform in pieces and bolt it together there, after raising the point of the platform so the deck lays level.

HOW TO MAKE AN ELBOW NO. 2.

In this article I will show three different methods of laying out elbows. I will not show an elevation of these elbows, but take it for granted that it is not necessary in this case. Figs. 103 and 104 are the outlines of an elbow of four sections made of No. 16 iron, and 21 inches in diameter. Fig. 103 is also the outline of an elbow of three sections made of No. 16 iron, to connect two pipes 21 inches in diameter. First construct Figs. 103 and 104 by drawing the lines A B C D and D E F G at right angles to each other. Set the trams to a radius of 18 inches and draw the arc B F. The center line draw A G and C E 10½ inches each side of B F, or 21 inches apart. Divide the arc A G into seven points, number them, and draw lines from the center through these points Nos. 2, 4, 5 and 6, and the line of rivet holes for the girth seams will be upon the lines Nos. 2, 4 and 6. Draw the line I J K for a diameter parallel to and 7½ inches from A B C, then extend the lines C 1, B I and A J K to cut this diameter at right angles to A B C, and 10½ inches apart. From the center I, with a radius of 10½ inches, draw the semicircle as shown and space it off into thirteen points, numbering them as shown. Draw ordinates through these points parallel to B I J and just cutting the line A B. This completes the outline, and is all that and really more than is necessary to lay out the sec-

taken between these two lines and save drawing those extra lines. But I have outlined the whole of the number one course or section.

Now for sheets. In this case three are laid out. Fig. 106 is No. 4, Fig. 107 is No. 2, and Fig. 108 is No. 1 course. As it is intended to work on three courses, it will be best to outline them all at once by drawing A B, C D, E F and G H parallel and 12½ inches apart, as that is the average width for Nos. 1 and 4 courses; then I J, K L and M N parallel and 5 inches apart, as 10 inches is the average width of that course, Fig. 107. As the courses are 21 inches in diameter, the circumference is required for that diameter, and is 21 x 3½ = 66½ = 66½ inches for the large end, and 66 - 7 = 59½ inches for the small end. Locate the lap holes on the large end 66½ inches apart on the lines D C, M N and H G, and on the lines A B, I J and E F, the lines for the small end 65½ inches apart and an equal distance each side of the center line drawn at right angles to the lines for the large ends of the courses. Space off each end for twenty-four holes and draw lines to connect the correspondingly numbered holes on each end of the different courses. Number these lines, beginning with No. 7 at the straight seams, but notice, in numbering them, the No. 1 line must be seven points from the opposite ends of adjoining courses. Fig. 108 is numbered to bring the straight seams on the same side as Fig. 106, when it should be on the opposite side, and, as a consequence, the sheet will require to be rolled inside out to bring it right. I laid it out this way to save space. Draw a line 5 inches from the lines D C and E F, Figs. 106 and 108, and use these lines to measure

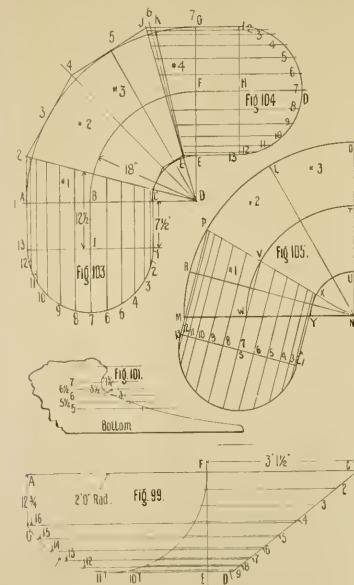

ter mark for flanging. Mark the length, 1¼ inches, between the center mark for flanging and the edge of the opening, Fig. 100, upon the line A'O. Fig. 102, toward the back from the intersection of ordinate number 2 with A'O, draw a line at right angles to A'O long enough to cut the ordinate number 2, and the length of this latter line equals one-half the width of the opening in Fig. 97. At this point and the length, 2 inches, of the ordinate number 2, between the point of intersection and the center mark for flanging, is the distance from the center mark for flanging to the edge of the opening on the line number 7. Fig. 100. Set the dividers to the distance from the center mark for flanging to the top of the opening where it cuts the line for flanging, Fig. 101, carry the distance to Fig. 100 and mark it across the line for flanging above, measuring from the center mark for flanging on the number 7 line. For the bottom, the edge of the opening just cuts through the point of intersection of the line for flanging with the number 5½ line. Measure from the center mark for flanging on the number 5 line, Fig. 101, to the termination of the opening on the edge of the flange, and mark this distance upon the line on the edge of the flange, Fig. 100, measuring from the center mark for flanging on the number 5 line, then a line drawn through these points of intersection just found will give the line to shear or cut to.

sweep, and after they have been rolled and rounded up, the angle iron ribs can be fitted, as can also the straps for the butt joints, providing it was necessary to piece out the sheets, and the pieces were luted. Then take the pieces that require flanging to the flange first and start at the long slim point at the bottom, and be careful in heating not to heat the sheet back of the center mark for flanging, as I always found everything progressed smoother and nicer by following that method. And to see when it is flanged over enough, sight over the flange from the top, as, notice in Fig. 97, by looking over the flange it is possible to see when it presents a plane surface. After flanging, in fitting the sheets together at the point, I made a practice of laying out and punching the rivet holes and even using rings with rings on the handles to hold them together to place. Take the screw punch and punch say three holes, one at the point, the others perhaps 10 or 12 inches apart. Put temporary or fitting up bolts in these holes to hold that part, then shift the tool and set the flanges higher up, punch additional holes for bolts and proceed in a similar manner until the

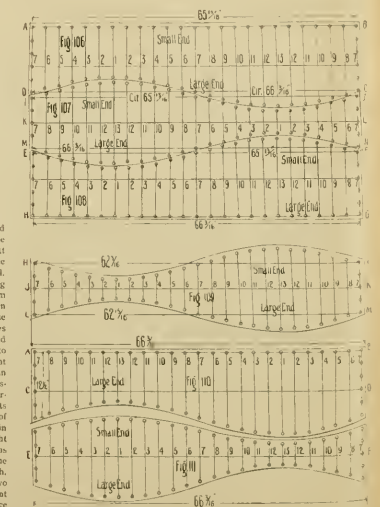

tions needed by an every-day method, and, as stated previously, as a man posted or rather becomes experienced, he draws no more lines than absolutely necessary to gain his points, as if the semicircle were drawn from the center B and the ordinates drawn to cut the lines A B C and 2 D, the measurements could be

from, as they are the same distance from the lap holes on the curved end as the center line is in Fig. 107, set the dividers to the length of the ordinate number 1, Fig. 103, between the lines A B C and 2 D. This length convey to the No. 1 line in Figs. 106 and 108, measuring from the last lines drawn, and to Fig. 107 on the No. 1

line. Mark this distance on each side of the center line *K L*, measuring from the latter line. Set the dividers again to the length of the ordinate number 2, Fig. 103, between the lines *E' C* and *D*. This marking this length upon the lines *N*, 2 and upon each side of the center line in Fig. 107. Set the dividers to the length of the ordinate number 3, between the lines *A' C* and *D*, Fig. 103. This length convey to the three Figs. 106, 107 and 108, and mark the points upon all the lines as in all the figures, and on each side of the center line in Fig. 107. Proceed to convey the lengths of the other ordinates in a similar manner, and these points found will be the center of the rivet holes on the curved ends. Give the plain ends of Figs. 106 and 108 the camber, as they will rivet an ordinary taper course. Space off the straight seams for four rivet holes, and three for three holes, exclusive of the lap holes, then allow $\frac{1}{4}$ inch all around outside of the holes for the lap, and these seats are all ready.

After shearing and punching, mark off another course similar to Fig. 107, only that Fig. 107 must be turned over to mark off the course, as the straight seam must be on the opposite side. The whole number of courses could be marked off from Fig. 107, using that as a pattern, turn either right or bottom side up, to bring the straight seam on the side required. First work off a course similar to that, as two of these are required, only using the pattern bottom side up to bring the straight seam on the other side, then when turned over mark off Fig. 106. Supporting the sheet to be all laid out, all that is curved (the large) end, keep the lap holes $12\frac{1}{2}$ inches apart upon the lines for the straight seams, and then mark the holes and the lap for shearing from the large end. Mark off Fig. 108 similar to Fig. 106, using the small end of the pattern. This completes the first method.

The next method under consideration for this boiler is as follows: as you will observe, is made of three sections, but can be made of any number of sections by dividing the arc *M I* into the required number of spaces. Draw two lines *M V* and *V O* at right angles to each other, set the trams from *N* to *T*, and draw an arc of quadrant, this will be the center line. Mark the points *I* and *I'* $1\frac{1}{2}$ inches each side of the center *T*, and draw the quadrant. Divide the arc *M I* into three equal parts, and again draw the center line *K N* through the center *N* through the point *K*, midway between *M* and *P*. Draw three lines *P M*, *I' I'*, *V' V* and *V' I'* parallel to each other. Draw the diameter *N O* parallel to *K N*, set the dividers to the length of *N O*, and draw the quadrant, divide this quadrant into thirteen parts and number them from 1 to 13, draw ordinates through these points parallel to *I' I'* and long enough to cut the lines *P M* and *M N*. This completes the outline.

Now for Fig. 109, the course. Draw three lines *A H*, *J K* and *L M* parallel and $4\frac{1}{2}$ inches apart. The $4\frac{1}{2}$ inch required is the circumference, and before finishing this an explanation will be in order. Notice in Fig. 105 the line of rivet holes are *M N*, *N V*, *L N*, and *O N*. This brings an ordinary square or taper course to rivet on to one end of these sections, and as it is all understood that that a straight line is the shortest distance between two points, the curved line as shown, beginning with No. 7 at the ends, and in order to have the straight seams on opposite sides it will be necessary to have the No. 1 line on the seventh line from the right end of Fig. 110, and the same distance from the left in Fig. 111.

Everything is now ready to find the rivet holes on the pattern. First take the large end, set the dividers to the length of the ordinate number 1, Fig. 104, between the lines *G F E* and *J L*, this length convey to Fig. 110, and mark this distance upon the line number 1, measuring from the

line *C D*. Mark the same length upon the line number 1, Fig. 111, measuring from the line *E F*, set the dividers to the length of the ordinate number 2, between the lines *G F E* and *J L*, Fig. 104. This length convey to Figs. 110 and 111, and mark it upon the lines number 2, measuring from the lines *C D* and *E F*, proceed in a similar manner until the lengths of all the ordinates, Fig. 104, between the lines *G F E* and *J L*, are marked upon the correspondingly numbered lines in Figs. 110 and 111, and these points of intersection are the center of the rivet holes on the large end. For the small end, set the dividers to the length of the ordinate number 1, Fig. 104, between the lines *G F E* and *K' L'*, this length mark upon the line number 1, Fig. 111, measuring from the line *E' F'*. Set the dividers to the length of the ordinate number 2, Fig. 104, between the lines *G F E* and *K' L'*, this length mark upon the line number 2, Fig. 111, measuring from the line *E' F'*. Set the dividers to the length of the ordinate number 2, Fig. 104, between the lines *G F E* and *K' L'*, and convey this length to the small end of Fig. 111, measuring from the line *E' F'*, transfer the lengths of the other ordinates, Fig. 104, between the lines *G F E* and *K' L'* in the same manner to Fig. 111, and these points of intersection just found will be the center of the rivet holes on the small end. Space off the straight seams for four holes in Fig. 110 and three holes in Fig. 111 exclusive of the lap holes, draw a line one-half inch all round outside of the rivet holes for the lap, and both figures are complete.

Now for the third. This is shown in Fig. 104. This method was given by a boiler-maker named John Cook in the *Engineer*, and at the time it was given I noticed some one found fault with the method in another mechanical paper, but I will state that I have made elbows by this method and found it simple. The parts fit nicely, and the elbow looks all O.K. when finished. This Fig. 104 is for an elbow of four sections, and this end of the outline view is constructed exactly similar to Fig. 103. (I did not think it necessary to make a separate outline view for this method, as one does not confuse the other.) The only difference and all there is to this method is in lines *J K* and *L M*, cutting off at the ends and the ends of the sections at a different angle, and the nearer the course cuts off at right angles to the axis or center line the shorter will be the curved line of rivet holes on the ends of the course, consequently if the line of rivet holes be placed upon the line *J K*, instead of *L M*, the end of the No. 3 course will be parallel and $2\frac{1}{2}$ inches from the end cut off by the same line on the No. 3 course, consequently the end of No. 3 will be small, and the end of No. 4 will be large. As this is No. 16 iron, the point *M* must be located $\frac{1}{4}$ of an inch from No. 6. (The allowances for different thicknesses of metal are: for No. 16 iron, $\frac{1}{4}$ inch; for No. 8 iron, $\frac{1}{2}$ inch; for $\frac{1}{2}$ inch, $\frac{3}{4}$ inch; and for $\frac{3}{4}$ inch, 1 inch.) And draw another line *L M* from the point *A*, $\frac{1}{2}$ inches from *G* to *L*, the object of this latter line is to save drawing the ordinates through the No. 3 course, as the distance from *K* to *G* is the same as the small end of the No. 3 course from *G* to *J*. Now for the sheets. Draw two lines *A B* and *C D* parallel and $2\frac{1}{2}$ inches apart, then *E F*, Fig. 111, far enough away not to interfere with Fig. 110. Lay off on the lines *A B* the circumference of the large end, $60\frac{1}{2}$ inches; space off the line for twenty-four holes, and draw lines for all of these marks through Fig. 111, parallel and right angles to *A B*, and number these lines as shown, beginning with No. 7 at the ends, and in order to have the straight seams on opposite sides it will be necessary to have the No. 1 line on the seventh line from the right end of Fig. 110, and the same distance from the left in Fig. 111.

Now for the third. This is shown in Fig. 104. This method was given by a boiler-maker named John Cook in the *Engineer*, and at the time it was given I noticed some one found fault with the method in another mechanical paper, but I will state that I have made elbows by this method and found it simple. The parts fit nicely, and the elbow looks all O.K. when finished. This Fig. 104 is for an elbow of four sections, and this end of the outline view is constructed exactly similar to Fig. 103. (I did not think it necessary to make a separate outline view for this method, as one does not confuse the other.) The only difference and all there is to this method is in lines *J K* and *L M*, cutting off at the ends and the ends of the sections at a different angle, and the nearer the course cuts off at right angles to the axis or center line the shorter will be the curved line of rivet holes on the ends of the course, consequently if the line of rivet holes be placed upon the line *J K*, instead of *L M*, the end of the No. 3 course will be parallel and $2\frac{1}{2}$ inches from the end cut off by the same line on the No. 3 course, consequently the end of No. 3 will be small, and the end of No. 4 will be large. As this is No. 16 iron, the point *M* must be located $\frac{1}{4}$ of an inch from No. 6. (The allowances for different thicknesses of metal are: for No. 16 iron, $\frac{1}{4}$ inch; for No. 8 iron, $\frac{1}{2}$ inch; for $\frac{1}{2}$ inch, $\frac{3}{4}$ inch; and for $\frac{3}{4}$ inch, 1 inch.) And draw another line *L M* from the point *A*, $\frac{1}{2}$ inches from *G* to *L*, the object of this latter line is to save drawing the ordinates through the No. 3 course, as the distance from *K* to *G* is the same as the small end of the No. 3 course from *G* to *J*. Now for the sheets. Draw two lines *A B* and *C D* parallel and $2\frac{1}{2}$ inches apart, then *E F*, Fig. 111, far enough away not to interfere with Fig. 110. Lay off on the lines *A B* the circumference of the large end, $60\frac{1}{2}$ inches; space off the line for twenty-four holes, and draw lines for all of these marks through Fig. 111, parallel and right angles to *A B*, and number these lines as shown, beginning with No. 7 at the ends, and in order to have the straight seams on opposite sides it will be necessary to have the No. 1 line on the seventh line from the right end of Fig. 110, and the same distance from the left in Fig. 111.

Everything is now ready to find the rivet holes on the pattern. First take the large end, set the dividers to the length of the ordinate number 1, Fig. 104, between the lines *G F E* and *J L*, this length convey to Fig. 110, and mark this distance upon the line number 1, measuring from the

line *C D*. Mark the same length upon the line number 1, Fig. 111, measuring from the line *E F*, set the dividers to the length of the ordinate number 2, between the lines *G F E* and *J L*, Fig. 104. This length convey to Figs. 110 and 111, and mark it upon the lines number 2, measuring from the lines *C D* and *E F*, proceed in a similar manner until the lengths of all the ordinates, Fig. 104, between the lines *G F E* and *J L*, are marked upon the correspondingly numbered lines in Figs. 110 and 111, and these points of intersection are the center of the rivet holes on the large end. For the small end, set the dividers to the length of the ordinate number 1, Fig. 104, between the lines *G F E* and *K' L'*, this length mark upon the line number 1, Fig. 111, measuring from the line *E' F'*. Set the dividers to the length of the ordinate number 2, Fig. 104, between the lines *G F E* and *K' L'*, and convey this length to the small end of Fig. 111, measuring from the line *E' F'*, transfer the lengths of the other ordinates, Fig. 104, between the lines *G F E* and *K' L'* in the same manner to Fig. 111, and these points of intersection just found will be the center of the rivet holes on the small end. Space off the straight seams for four holes in Fig. 110 and three holes in Fig. 111 exclusive of the lap holes, draw a line one-half inch all round outside of the rivet holes for the lap, and both figures are complete.

I would state that in making this elbow, if only Fig. 111 were laid out, sheared and punched, it could be used as a pattern to mark off all the other courses needed. No. 2 course would be just the same as the pattern, then for the No. 1 course, Fig. 110, turn the pattern, Fig. 111, over to bring the straight seam on the opposite end, and mark off (the curved end) the large end and lap holes at the other end,

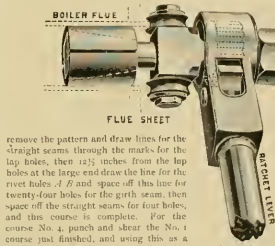

remove the pattern and draw lines for the straight seams through the marks for the lap holes, then $12\frac{1}{2}$ inches from the lap holes at the large end draw the line for the rivet holes *A B* and space off this line for twenty-four holes for the girth seam, then space off the straight seams for four holes, and the course is complete. For the course No. 4, punch and shear the No. 1 course just finished, and using this as a pattern, mark off all the holes, all lap holes included, except the large (the curved) end, then take Fig. 111 as a pattern, and turn either right or bottom side up as required to bring the straight seam at the right angle. To be finished, bring the lap holes in the small end (the curved end) to coincide with the marks for the lap holes at the blank end and mark off the holes across the end. And this will complete course No. 4, and all that is needed for the elbow, with every hole marked.

There is one method given here, and, as the above is remarked, "You pay your money, now take your choice."

A Useful Boiler Tool.

The Farris beater flue beater is a new and useful tool that has recently been placed upon the market, and it seems to possess considerable merit.

The illustration represents the tool in the use, ready for beating over the end, which is accomplished by revolving the block bearing the rollers, by means of the ratchet lever attached. The block is held up by the set nut, and the tool is held firmly in its position in the flue by the ex-

isting block, which rests partly on flue and flue sheet.

There is no danger of splitting the tubes or loosening them from the flue sheet in the operation of beating, and perfect work can be done by the most inexperienced hands. By removing one of the rollers, a cutter can be substituted to remove bead or cut the end of the flue. The tool can be arranged for power.

For any further information, address Geo. L. Weiss, 139 Ingleside avenue, Cleveland, O.

Let the Different Departments Co-operate.

In the course of some remarks made by Mr. W. F. Merrill, general manager of the C. B. & Q., at a banquet of the Western Railroad Club, he made some good points about the advantage that comes from the different departments of the railway service pulling together. Among other things, he said:

"If every department will take an interest in every other department, you can accomplish vastly better results for less money, and that is the great problem before us in this country. So far as our railroads are concerned to-day, with the terrible course of competition among railroads for freight and passenger, and with the almost insurmountable obstacles that possess the people of many States that they must cut down the earnings of railroads, it becomes necessary to exercise the most rigid economy.

"I do not believe that I ever impressed my men more fully with the desperate need of economy, than at a meeting that I called at one time of all our master mechanics and superintendents, when I told them that our stockholders would not take any excuse from us whatever if we failed

to pay a dividend and that in order to do so we must save. I do not know how they had got to save, because the prospect of earning that amount was very small. Well, the result of that was that every man in that room went to his place and put all the brains that he had at work to find out how he could accomplish more still with less money than he had been spending before. I know from my experience that mechanical men, as well as men in control of all other branches of railway service, if they are ever righted down to it, will accomplish immense results with very little money.

"I do very much as an old road master did that I had when I was on a poor railroad—a railroad so poor that we never knew where we were going to get the next meal. A section foreman would come out to him and say to him, Mr. Owens, I want this, I want that or the other. 'Denny, you can't have it, you can't have it.' That was all he said, but if the foreman didn't keep his section in shape he would either discharge him or threaten to do so. It was a great big Irishman he would rather thrash him than discharge him."

The month of October last bears the previous record for the number of train robberies committed in the United States. As a result of this, no doubt, the Government has issued standing orders of reward for the conviction of persons interfering with the mails.

? A. — What You — ? A.
— Want to Know.

Don't ask questions that simply require a little figuring to determine. make each question separate. No notice taken of anonymous questions.

A mistake was made in answering question 142 last month. Instead of circumference we should have said diameter of shell.

(174) J. A. H., Burbank, Cal., asks
 What is the cost of the maximum engines built for Brazil? *A.*—About \$10,000.

(175) E. C. D., Philadelphia, asks
 What is the alloy known as Muntz's metal composed of? *A.*—Six parts of copper to one part of zinc.

(176) M. T., Dart Jervis, N. Y., asks
 Will an injector work without difficulty at the check valve is located above the water level? *A.* Yes. It will make no difference.

(177) J. B. G., Flatbush, N. Y., asks
 What is the difference between the melting points of cast iron and steel? *A.*—Cast iron melts at 2250°, steel at 2595°, according to Haswell.

(178) Freeman, Cleveland, O., asks
 What temperature would the iron of a boiler be raised to before they melt and together as we often find the surface of a boiler do? *A.*—About 2,550 degrees Fahrenheit, according to Haswell.

(179) S. L., Wilmington, Del., asks
 Is there any breed of horses that are used to doing the work of a one-horse steam engine continuously? *A.*—No. A steam engine is reckoned to be equivalent to four and a half horses for continuous work.

(180) A. O., Milwaukee, Wis., writes
 I want to fill some blowholes with metal. Have tried Babbitt, but it gets loose when cold. What will answer? *A.*—An alloy composed of 10 parts antimony, 5 parts tin, 10 parts and 75 parts of lead, will expand on cooling, and always stay tight.

(181) K. B. C., Newark, N. J., asks
 Who was the first man to construct the idea of applying the steam engine to locomotive purposes? *A.*—That is not known. The first man to give the idea a practical application was a French engineer named Cugnot. He built, in 1770, a sort of traction engine intended for military purposes.

(182) C. A. R., Pittsburgh, Pa., writes
 We have been hearing a great deal lately about aluminum and the important place it is destined to take in the mechanic arts. Do you think it is destined to supplant steel in bridge building work? *A.*—We do not think that aluminum will ever take the place of steel for bridge building, for the reason that a ton of steel made into bars of equal length is stronger than a ton of aluminum.

(183) Apprentice, Louisville, Ky., writes
 I am learning the machine trade and am ambitious to get along in the world. What should I do to obtain an engineering education that would help me to the top of the ladder? *A.*—Take the course of the Correspondence Engineering School, Scranton, Pa. You can also work in the evenings. It gives the best help we know of for an ambitious young man. We offer the school course as a prize to club runners. Go in for it.

(184) J. McN., Halifax, N. S., writes
 In answer to my question (140) you give rule for finding area of port opening that is simple enough. What reply want to know is how to find the right area for a given size of cylinder, say 10-inch cylinder? *A.*—In order to calculate this properly the piston speed should be known. For a 10-inch cylinder with piston speed of 400 feet per minute, the steam port

should be 6½ inches in area. See "Myers' Locomotive Construction."

(185) H. S., Abilene, Tex., writes
A.—As the economy of a compound engine is dependent on the least range of cylinder temperature between admission and exhaust, why not decrease the size of the p. cylinder—make the ratio 6 to 1, for instance—and cut off as late as practicable in that cylinder? It appears to me that to carry out expansion in the p. cylinder is voluntarily throwing away the chief advantage that the compound system offers. *A.*—We would like answers to this question by men who have had experience with compounds.

(186) W. H., Brooklyn, asks
 1. Why is an engine keyed at any given point? In the L and how they key on? *A.*—The center is the rigid point. If the side rail is keyed here it will pass any point. 2. Do man rod brasses pound on centers or on the quarter? *A.*—On the centers, the point there, the push changes to a pull, or *vice versa*. A rod cannot pound when the strain is in one way. Think a little for yourself. If there is a pound on one side when the man rod is on one quarter, look for the trouble on the other side.

(187) Chief Clerk, Chicago, Ill., writes:
 We have had a dispute in the paper's office about who discovered electricity first. We have decided to ask you to decide it in your Asked and Answered department. I say it was Franklin, and my friend says Galvani. *A.*—It is about twenty-five centuries since a Greek writer told that when amber is rubbed it attracts light bodies. What discovered this electrical phenomenon no one can tell. Franklin made important electrical discoveries, but there was considerable knowledge on the subject before his time. Galvani, an Italian physician, discovered magnetism.

(188) J. V. M., Massillon, O., asks
 "Would you please tell me where a person may obtain a book or books on the Air Brake System—that is, a person who is entirely ignorant of the system, and who by reading and studying the book or books may obtain a fair idea of it. All the systems understanding the system, or at least a part of it. *A.*—We know of nothing better than the instruction books sent out by the Air Brake Company for this purpose. If you cannot understand the brake from the pictures in this book, you won't get much of an idea of it from ink and paper.

(189) Ignorance, Rotterdam Jet, N. Y., writes
 I am running an engine just out of the shop. She is a little lame and hard on coal. The valves have ¼-inch lead on one side and ½-inch lead on the other. If the lead was cut down to ¼-inch, would it not help her? *A.*—The chances are that it would. There is a tendency to give locomotives too much lead. 2. I am running an engine with a single bar guide. The guide breaks and engine must be disconnected, leaving no way to block the cross-head. I cramp the valve stem with the back steam port open, disconnect back end of main rod, leaving it hanging on guide valve, push the piston up to the front head and go on. Is it safe to work engine hard on this? *A.*—Just as safe as safe as any other disconnected engine.

(184) R. H. B., Philadelphia, writes
 The corrugated furnace admittedly gives greater heating surface than a plain furnace of the same diameter, yet I am told that a corrugated piston will not prevent

greater area for the steam acting upon them than a plain surface of equal diameter. Is not this a paradox? *A.*—There is no paradox or mystery about it. A heating surface increased by corrugations enables the water inside to absorb the heat over a greater area, but that is altogether different from the pressure of steam or anything else upon a corrugated surface. When pressure of steam is applied to a corrugated surface the force applied at one side of the ridge will be at an angle which is balanced by the pressure on the other side, and the two forces act according to the law of the composition of forces, so that the sum of the pressure is the same as if it acted on a plain surface. For instance, if a boat on a canal is hauled by a rope on each side, one inclines to pull the boat to each side, which is resisted by the tendency of the other rope to pull in the opposite direction. The composition of forces makes the effect about the same as if the two ropes were ahead in line of the motion. Steam pressing upon a corrugated surface acts in the same manner.

List of locomotive engines built by Messrs. Edward Bary & Co., of the Clarence Foundry, Liverpool, and sent to American railroads

Date when built.	Name of Engine.	Name of Railroad Company.
1854	"Liverpool"	Peterburg.
1855	"Baltimore"	Rich. & Alb. & Peto, Raleigh & Gaston.
1856	"Meribon"	"
1857	"Albion"	"
1858	"Fenton"	Pontchartraine.
1859	"Stamilton"	Raleigh & Gaston.
1860	"Peterburg"	South Carolina.
1861	"Stamilton"	"
1862	"Augusta"	Boston & Providence.
1863	"Boston"	Rich. P. & Alb. & Peto.
1864	"Pratt'sburg"	"
1865	"Boston"	Boston & Worcester.
1866	"Wilmington"	Phila. & Wilmington.
1867	"Wilmington"	Pontchartraine.
1868	"Raleigh"	R. & A. P. & Alb. & Peto.
1869	"St. Louis"	"
1870	"St. Henry"	"
1871	"Roanoke"	Raleigh & Gaston.

Total, 20 engines.

"Opposed to All Monopolies."

The above is the heading of an old railroad poster which is shown in the end of the book published by the Pennsylvania Railroad Company describing their World's Fair exhibit. The competing lines in those days used demagogue screaming worthy of a political orator. The poster read:

"The subscribers have placed on the road an entire new line of passenger cars called 'Our Line.' These cars have no superior in point of style, comfort and convenience. They have all the modern improvements, and are number one in every sense of the word."

After giving time card particulars the poster proceeded: "These cars are attached to the way train and run in the rear, which gives them a decided preference over any other cars in case of a collision or a run off, which under the best management will sometimes occur. Our passengers and cars must, from their position in the train, be comparatively free from danger."

"The subscribers are aware of the monstrous monopoly against which they are contending, but they are determined to encounter it, and, relying upon the encouragement of all who are opposed to monopolies and in favor of low rates of fare, they will run this line at the following rates, viz.: Three cents per mile, no more nor less, under any circumstances. These are the lowest rates at which passengers can be carried over this road under the present rates of toll charged by the State, which are 2 cents per mile on each passenger and \$4.00 on each car."

"In order that our friends may not mistake 'Our Line,' we give the color of the cars which is True Blue, and ask the patronage of a generous public to sustain us in our undertaking."
 —DAVID MILLER & Co.,
 "April 23, 1852."

Car cleaning is not a heroic subject for essay writing any more than house cleaning, yet both are equally necessary, and the more that is known about the best processes the better it will be for those who prefer to be dirty in surroundings. There was a discussion at car cleaning at the Central Railroad Club which brought out much valuable information on car cleaning. The following is an abstract of a report made by Mr. R. H. Soale

"Cars on long runs, of say 200 miles or more, are cleaned at intervals of 24 hours, on arrival at terminal points. In summer or non-freezing weather, should the cars be washed off on the outside with clear cold water. For such washing, an arrangement, consisting of a hollow handle attached to a perforated brush head, through which a stream of water is applied simultaneously with the rubbing of brush, for use where hose connections are available, has been recommended to this committee as superior to the common car brush, which is generally used. Where bucket and brush are used, care should be taken to renew the water before it becomes gritty through successive dippings of the brush. The hand rails and door knobs should be wiped clean, the other parts of car body being not wiped but merely washed thoroughly as above. The trucks should also be wiped on the outside and other parts that can be reached without going under the trucks.

"In freezing weather the cars should be cleaned on outside by dry wiping exclusively. No injury to varnish will occur under this process, and a better appearance will be attained than by the use of warm water.

"In addition to the ordinary washings at end of trips, the practice on one at least of the roads represented on your committee, is to give to the cars at intervals of three months care between stoppings a thorough cleaning with Perfection Car Cleaner, diluted with water, according to condition of car. This compound, however, is absolutely non-injurious to varnish, which is not for street use, dilute and may be applied by unskilled labor with perfect safety and with most gratifying results. The cleaner is applied with an ordinary car wash brush, and if the corners of the battens or bottom of panels are especially dirty, a two or four row bead car scrub is used. Cars cleaned under this process come out almost as good as new on outside and the gloss on the varnish unimpaired."

"In the course of the discussion it came out that the Michigan Central people are using very successfully a brush with a hollow bamboo handle, through which water for washing is applied. Others had tried brushes of this kind with hollow iron handles, but they were found too heavy to carry to advantage.

Some facts were advanced to show that soap or any alkaline material used in cleaning cars had an injurious effect upon the varnish. This is found to be the case with the small amount of alkaline material found in some well water.

Clean water is used more than anything else for cleaning the outside of passenger cars.

The Lake Shore people are using a patented article called Perfection Car Cleaner with success. It is applied in a liquid form and washed off.

On the Northern Central Division of the Pennsylvania about every three months they give the outside a cleaning with crude oil and trisulph.

The cleaning of cushions by means of compressed air is becoming quite general. Some roads employ the same medium for removing the dust from the inside of the car, but the more common practice is to do the work with brushes and water.

WANTED—To communicate with draftsman who has charge of drawing rooms for a large number of industrial concerns in and about the Middle States. Address
 W. H. MILLER & CO., 200 N. 4th St.,
 Care of LOCOMOTIVE ENGINEERING.



Head Roll Seat.

THEIR SUPERIORITY IS PROVEN BY THEIR POPULARITY.

FINEST SEATS. Coach, Parlor Car, Sleeping Car, Street Car, Rattan Elevated

IN USE ON ALL THE PRINCIPAL RAILROADS IN THE UNITED STATES

Spring Edge Seat.



Simplicity, Durability, Elegance, Comfort,

Combined.

IT IS SAFE TO SPECIFY THE **H. & K. SEATS**

PHILADELPHIA, NEW YORK, CHICAGO.

OPEN HEARTH STEEL **CAMBRIA** COFFIN-TOUGHENED

CAMBRIA IRON COMPANY,
Office 218 SOUTH 4TH ST. PHILADELPHIA PA.

WORKS AT JOHNSTOWN, PA.

STEEL BEFORE TIGHTENING SOFT STEEL ARCH BARS. COOLBAUGH & POMEROY SPECIAL R. R. SALES AGENTS, 2ND BROADWAY, NEW YORK. TIGHTENING AFTER TIGHTENING

TOUGHENED BY COFFIN PROCESS, PATENTED

OPEN HEARTH COFFIN PROCESS TOUGHENED

CAMBRIA STEEL

Driving, Truck, Passenger and Freight Axles, Piston and Side Rods, Crank Pins.

NEW YORK OFFICE FOR RAILS AND FASTENINGS—33 WALL STREET.

THE HAYDEN & DERBY MFG. CO.,

SOLE MANUFACTURERS OF

Metropolitan Double-Tube Locomotive Injectors.

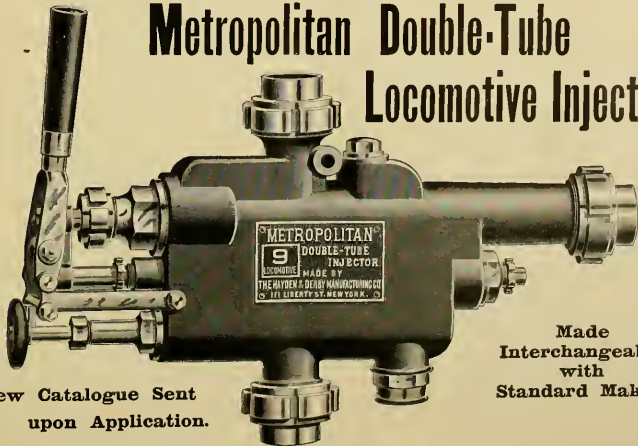

Made Interchangeable with Standard Makes.

New Catalogue Sent upon Application.

Office and Salesrooms:

Nos. 111 and 113 LIBERTY STREET, NEW YORK.

THE ROTARY.

For full
Particulars,
Address

The Leslie Bros. Mfg. Co.,
Paterson, N. J.

YOU HAVE BEEN WANTING to know more about this famous Engine. You should have framed in your room our "Chart No. 2," showing transparent picture of the engine, with every piece numbered and named. Printed on satin gloss paper, and sent in a tube, ready for frame, 50 cents, stamps will do.



Locomotive Engineering,
256 Broadway,
NEW YORK

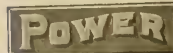

A MONTHLY JOURNAL devoted to Steam Engineering and Practical Work relative to the Economic Generation and Transmission of Power. 56 to 84 pages, size of this paper, profusely illustrated. Price, \$1.00 a year. Send for Sample Copy—FREE. Address:

THE POWER PUBLISHING CO.,
WORLD BUILDING, NEW YORK.



THE WASHBURN
Car-Wheel Company,
HARTFORD, CONN.,
MANUFACTURERS OF
**CRUCIBLE
STEEL-TIRED WHEELS**

For Parlor and Sleeping Cars,
Passenger Coaches, Locomo-
tive and Tender Trucks.



RAMAPO WHEEL AND FOUNDRY CO.

MANUFACTURERS OF

BOLTLESS STEEL-TIRED WHEELS

FOR PASSENGER AND LOCOMOTIVE SERVICE.

Tires with Annular Web and Hook,
Best Charcoal Iron Double-Plate or Spoke Centers,
Wedge-Shaped Retaining Ring.

DESIGN OF MILLIKEN PATENT

Continuous
Circumferential
Fastening.



SIMPLE,
SAFE,
ECONOMICAL.

CHILLED IRON WHEELS

OF SUPERIOR QUALITY,
Driving Room, Passenger and Freight Cars,
Locomotives, Tractors, Flat-tires
and Mine Cars.
CYLINDER PACKING RINGS.

CONDON BRAKE SHOES

FOR CHILLED IRON WHEELS,
Outwear from 4 to 6 ordinary
shoes and enhance
mileage.

Office and Works: RAMAPO, N. Y.

WROUGHT IRON WHEEL CENTRES. WAULGAN'S PATENT.

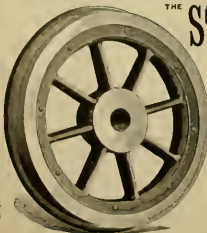

THE Standard Steel Works

PHILADELPHIA.

STEEL TIRES

Manufactured by an Improved Process
Insuring Solidity.

Wrought Iron Centres.
Steel Tired Wheels.

REPRESENTATIVES:

CHICAGO, 1013 MONADOCK BLDG.,
FITZ-HUGH & SPENCER.
ST. LOUIS, 516 NORTH THIRD ST.,
ANDREW WARREN.

New York. Boston. Chicago.

HOWE, BROWN & CO., (Limited) PITTSBURGH, PA.
STEEL.
HOWEN SPECIAL TOOL CAST STEEL for
Taps, Dies, Reamers, Cutters, Punches,
Chisels, Drills, Shear Blades, Lathe Tools,
etc., etc. Crucible Spring Cast Steel, Crucible
and Open Hearth Firebox and Sheet Cast Steel, Forgings, etc.

THE ONLY DOUBLE TRACK RAILWAY
BETWEEN
CHICAGO AND THE EAST.
Wagner Sleeping Cars, Drawing Rooms and Private Compartment Cars between Chicago,
Toledo, Cleveland, Buffalo, Rochester, Syracuse, Albany, New York, Boston
and intermediate points.
Home of the NEW YORK and CHICAGO LIMITED, BOSTON and CHICAGO
SPECIAL, and the U. S. FAST MAILS.
W. H. CANNIFF, Gen'l Mgt. CLEVELAND, O. A. J. SMITH, G. P. & T. A.

THE HAMPSON
Flexible Steam Joint
Does away entirely
with Rubber Hose
for Steam Heating.
HAS NO GROUND JOINTS.
F. A. BARBEY & CO., 215 FRANKLIN STREET, BOSTON.

RAMAPO IRON WORKS, Hillburn, N. Y.,

MANUFACTURE

Brake Shoes for Steel Tired Wheels.

RDSS, for Steel Tired Car and Tender Wheels,
RDSS-MEEHAN, for Locomotive Drivers,
SHEPPARD, for Blind or Bald Tired Drivers.

NARROW GAUGE CARS, SWITCHES, AUTOMATIC STANDS,

YOKED, BOLTED and SPRING RAIL FROGS,
CROSSINGS, TRACK EQUIPMENT,

RAILROAD AND MACHINERY. CASTINGS, HEAVY AND LIGHT.

C. E. ROOD. H. M. BROWN.
ROOD & BROWN,
CAR WHEEL WORKS,
BUFFALO, N. Y.
Railroad, Car, Engine, Tender and Track Wheels, Made from Best Charcoal Iron.
Office and Works: HOWARD and THOMAS STS.

C. M. FARRAR. JOHN CRUICK. C. E. ROOD.
EAST BUFFALO IRON WORKS,
FARRAR, TREETS & ROOD, PROPRIETORS.
GREY IRON CASTINGS
of every description. Special Attention Given to Car and Locomotive Work.
Works: N. Y. C. & N. R. R., Broadway Station, Wall Line. Office: 60 Perry St., Buffalo, N. Y.

C. E. ROOD,
MANUFACTURER OF
MALLEABLE IRON,
QUALITY GUARANTEED.
RAILROAD WORKS A SPECIALTY.
Office and Works: LANCASTER, NEW YORK.

OPERATED BY EITHER
TRACK OR WIRE
CIRCUIT

Automatic Block Signals

Manufactured by the
Hall Signal Co., New York, N.Y.



Hall

115 NASSAU ST.
BOSTON.

Signal Co.

300 HOLLAND ST.
NEW YORK.

77 ROCKERY,
CHICAGO.

Locomotive and Car Axles,
Coupling
Links and Pins.

M. C. B. Passenger Coupler
Used in Place of Miller Hook
WITHOUT CHANGE IN PLATFORM.

M. C. B. STANDARD
Automatic Freight Car Coupler.

New York Office, . . . 66 Broadway,
Chicago Office, . . . 941 Rookery,
St. Louis Office, 319 Commercial Bld'g.

GOULD
Coupler Co.

WORKS: DEPEW, N. Y.
BUFFALO, N. Y.

**Gould Continuous
Platform and Buffer.**
GOULD VESTIBULE.

MILLS ESTABLISHED IN 1844.

EWALD IRON CO.

OWNERS AND OPERATORS
TENNESSEE ROLLING WORKS, TENNESSEE ROLLING MILLS,
CHICKLAND RIVER, LOUISVILLE, KY.

MANUFACTURERS OF
TENNESSEE CHARCOAL BLOOM AND LAUREL STAY BOLT,
"E. I. C." and "BOONE" IRON.
Also, TANK, FLANGE, FIRE BOX AND BOILER STEEL AND IRON.

PRINCIPAL OFFICE AND WAREHOUSES:
939, 941, and 923, 925, 927 N. SECOND STREET, ST. LOUIS.

THE POOLEY COUPLER.



**POSITIVELY
AUTOMATIC.**

Made from the Best Material.
**THE LONGER IN SERVICE THE
BETTER IT OPERATES.**

MANUFACTURED BY
PRATT & LETCHWORTH, Buffalo, N. Y.

Break all the Samples of Tubes sent you and see for Yourself whether they are Steel or Charcoal Iron

CHARCOAL IRON FLUES are the only kind manufactured by THE TYLER TUBE AND PIPE CO.,
WORKS: WASHINGTON, PENN. NEW YORK OFFICE: 30 Cortlandt St.

The Coup Automatic Car Coupler. M. C. B. Type. Flexible Head. No Springs.

can be Cast or Drop-Forged Draft strain distributed over 12 surfaces, and shock or shunting force distributed over 28 surfaces WILL COUPLE OR UNCOUPLE ON ANY CURVE For further information, address

CHARLES D. GIBBONS, Sole Lessee, 202 SOCIETY FOR SAVINGS BLDG., CLEVELAND, O.

THE TROJAN CAR COUPLER Co., Troy, N. Y.

The head is kept by a thumb screw for setting by the hand rod at the side of the car, rendering it unnecessary for the trainmen to go between the cars to open the knuckle
M. C. B. TYPE. THE STRONGEST AND THE ONLY SAFETY COUPLER. New York Office: 49 WALL ST.

THE JANNEY FREIGHT CAR COUPLER



THE Mc CONWAY & TORLEY COMPANY

W. M. CONWAY - PRESIDENT.

48th ST. & A. V. RY. - PITTSBURGH, PA.

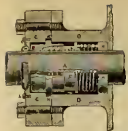

JEROME METALLIC PACKING.

This is the Standard Metallic Packing all over the world, and is more generally adopted and in use on more locomotives than any metallic packing in use. Give the **JEROME** a trial and be convinced. Put it in competition with any other packing and be convinced of its superior merits.

Packing ring opened ready to apply without disconnecting the Piston from the crosshead. It runs longer and wears the rod less than any other packing in use.



Office and Works, Nos. 35 and 37 Canal St., Chicago, Ill.

C. C. JEROME, Inventor and Proprietor.

SEND FOR CATALOGUE.

MATCHLESS VALVE AND CYLINDER OIL.



Warranted not to corrode the iron or destroy packing, and to make more mileage than tallow or lard. Sold only to Railroad Companies direct or through our authorized agents. **Matchless Cylinder Oil cannot be Bought of Dealers.** In use on **80** Railways.

OILS FOR RAILROAD USE A SPECIALTY.

ECLIPSE LUBRICATING OIL COMPANY, Limited,

MANUFACTURERS OF EVERY PRODUCT OF PETROLEUM.

Main Office: **FRANKLIN, Pa.**

Refineries: **FRANKLIN, Pa.**

OLEAN, N. Y.

EBIE, Pa.

OHIO CITY, Pa.

Carbon Steel Company, Pittsburgh, Pa.

MANUFACTURERS OF

OPEN HEARTH STEEL PLATES FOR ALL PURPOSES.

SPECIALLY SUITED FOR LOCOMOTIVE FIREBOXES AND BOILERS.
PARTICULARS SENT ON APPLICATION.

Railroad Agents:

J. B. BRADY, 909 Havemeyer Building, New York.

W. M. WILSON, Western Union Building, Chicago.

PAUL S. REEVES, Philadelphia.
PHOSPHOR BRONZE IN INGOTS AND CASTINGS. * **LOCOMOTIVE AND CAR BEARINGS** A SPECIALTY.
RASS and PHOS. BRONZE CASTINGS from 1/4 lb. to 5,000 lbs. in WEIGHT.

Our Line Engravings are made by the wax process, a plan securing accuracy and distinct lines on original copper plates. They are made by **BRADLEY & POATES**, 351 William Street, New York City.

The New "NATHAN" MONITOR INJECTORS FOR LOCOMOTIVES.

"NATHAN" SIGHT-FEED LUBRICATORS,
For Locomotive Cylinders and Air Brakes
STEAM FIRE EXTINGUISHERS.
For Switching and Yard Engines.
BOILER WASHERS.
Road and Guide Oil Cups, etc.

Send for **DESCRIPTIVE CATALOGUES.**

NATHAN MFG. CO., 92 & 94 Liberty St., NEW YORK.

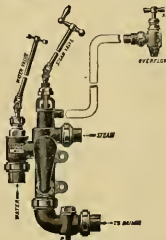

THE Fire-Proof Baker Car Heater

MADE OF FLEXIBLE STEEL
ONE-QUARTER INCH THICK.

Firmly Welded into One Compact, Jointless, Seamless Whole.

**FIRE WITHIN A SAFE OF SAME MATERIAL
AS THE EXPRESS CAR SAFE.**

NEARLY 1000 FIRE-PROOFS IN USE.

ALL OTHER STYLES OF "BAKER HEATERS."

WILLIAM C. BAKER,

Solo Proprietor and Manufacturer.

143 LIBERTY STREET, NEW YORK.



THE CAMERON STEAM PUMP.

COMPLETE WITH BOILER.

THE A. S. CAMERON
STEAM PUMP WORKS,
Foot of St. Lawrence Street,
NEW YORK.

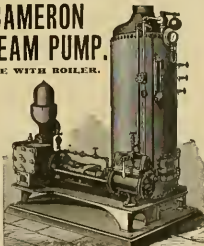

Send for illustrated Catalogue.



Ask for Catalogue.

YOU are now looking at a picture of the **Best BOILER WASHER** and **TESTER** made. Washes with hot water, tests to any pressure with hot water. Requires no foundation, takes up no shop room. Has no moving parts, and a record of efficient service for ten years. We also make the **FAMOUS "Little Giant" Injector**, Ejectors and other Jet Apparatus.

Rue Manufacturing Co.,
110 N. 9th St., Philadelphia, Pa.

DRAKE & WEIRS, Cleveland, Ohio.

ASPHALT CAR ROOFING

The Cheapest, Best and Most Durable Car Roof Known. In use by Seventy Railroads. Twelve years successful use without a single failure. A new roof furnished free for every one that fails in six years.

**PRESSED
STEEL MATERIAL
FOR CARS.**

**PITTSBURGH,
PA.**

SCHOEN MFG. CO.

D. O. SETTLEMIRE, President.

GEO. W. EVANS, Vice-President.

W. C. ARTHURS, Secy. and Treas.

FRANK SNYDER, Supt.

Mt. Vernon Car

MANUFACTURERS OF
FREIGHT CARS OF EVERY DESCRIPTION,
CABOOSE AND REFRIGERATOR CARS,
MT. VERNON,



Manufacturing Co.
CAR WHEELS, CAR CASTINGS, AND GENERAL
FOUNDRY WORK.
Capacity, 13 Cars and 300 Car Wheels.
ILLINOIS.

MILLER'S ASBESTONE CAR ROOF.

THE COMING ROOF!

HEAVY, DURABLE AND STRONG. Costs from \$10 to \$15 Less per Car.
WILL WEAR LONGER THAN ANY METAL ONE! CAN BE PUT ON IN ONE-HALF THE TIME.
WILL WEAR THE LIFE OF THE CAR.

HEAR WHAT THEY SAY ABOUT IT!

Get West - M. E. & T. Ry. Down East - Boston & Albany R.R.

1302 HAVEMEYER BUILDING, 26 Cortlandt Street, NEW YORK.



RODGER BALLAST CARS.

These cars are 54 feet long, and are built either 50,000 or 60,000 lb. capacity, N. C. B. standard. They carry from 15 to 20 cubic yards of gravel or broken stone. In using them no ballast is thrown in the cars, and no amount of ballast needed can always be discharged. A trial of 25 cars, carrying 100 yards of ballast can be unloaded and the ballast distributed, leaving the track perfectly cleared and flanged, as shown in the cuts, in from 12 to 15 minutes. This is all done by the "cable" "train system" (see cut), and two brakemen, no extra help being required. The track is perfectly cleared by the spreader, so that a train can immediately pass over it at any rated speed, without meeting any obstruction. No aprons are needed, no wire cables are used. There is no shunting, no ballast from between the cars, and no re-arranging of ballast with shovels. The ballast is fed out even the ties and on their ends, directly in position for tampering, when the ties are needed, without being shoveled in from the ditch. The average varies per mile, in the amount of ballast needed to make a "rain" of 10 or 15 inches, in gravel, to from \$200 to \$400, and in broken stone it often amounts to \$500.

These cars are in use on the Great Northern Ry., the Illinois Central, the Gulf, Colorado & Santa Fe, the Chicago & Eastern Illinois, the Penn. Lines West, and other roads.

Detailed information will be furnished by circular by addressing the

RODGER BALLAST CAR COMPANY, No. 1215 Monahan Building,
CHICAGO, ILL.

A. W. ROPEL, Pres.

JOSEPH ANDREWS, Vice-Pres.

C. H. HOWARD, Sec.

W. R. THOMAS, Treas.

R. M. DIXON, Engineer

THE SAFETY CAR HEATING AND LIGHTING CO.

160 Broadway, New York.

HEATING SYSTEMS.—By hot water circulation and direct steam with regulating devices. Reliable and uniform heat. Economical and rapid circulation. Gibbs automatic coupler of Westinghouse type, absolutely steam-tight.

LIGHTING SYSTEM.—The celebrated Pintsch compressed oil gas method. In use on over 40,000 cars in Europe and America. Adopted by the U. S. Lighthouse Board for lighting Buoys. The best, most economical and only safe light for Railroad purposes. In brilliancy and cleanliness unsurpassed.

Steam Heating from the Locomotive
Locomotive Equipments, Direct Steam, Coningler, Storage and
Multiple Current Systems. Cars equipped 6,000. **SEWELL COUPLERS**
sold 45,000—the standard in U. S. and Canada.

Electric Heaters for Street Cars:
With Temperature Regulating Switch, 5 intensities of heat using
from 2 amperes up. Radiating surface 3 to 20 times that of other
heaters. Two years guaranty. Cars equipped 1,000.

CONSOLIDATED CAR-HEATING CO

ALBANY

Pope Light Compressed Oil Gas:
Interchangeable with "Pintsch," and superior thereto. Uses same
gas as "Pintsch." In Great Britain 14,262 steam and cable cars
already equipped. Patents guaranteed.

Albany, N. Y., 413-423 North Pearl Street;
CHICAGO, 200 WESTERN UNION BLD'G; Canada, Coaticook, P. Q.—
London—Moscow. Specially tested fittings and car lighting repair
parts at reasonable prices. Electric Heaters for offices.

THE MURPHY STEEL CAR ROOF.

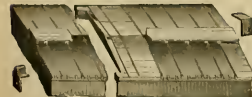

HAS no expense nail or screw holes. It has no joints where chides, rain or fine snow can get through. It allows for contraction and expansion, and fits snugly against it to provide for sagging, twisting, buckling and warping of the car body. It is as strong as the car frame itself. It has no soldered joints. It can be repaired readily, and without taking off more of the roof than is damaged. It is much cheaper than any other metallic roof now in use, and is cheaper than the double board roof, made of good lumber. It is unlike any other metallic roof for the reason that everything is furnished to make it complete; so that the parties buying it have no expense when they apply it.

This ROOF can be applied on OLD LEAKY BOARD-ROOF CARS without making any changes in the board roof, thereby saving the expense of replacing the old boards with new, and thus utilizing material that most otherwise be thrown away.

Manufactured by the P. H. MURPHY MFG. CO., East St. Louis, Ill.

REQUIRES NO ATTENTION.

IN USE ON THREE HUNDRED AND FIFTY RAILROADS.

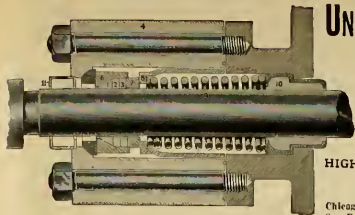

UNITED STATES METALLIC PACKING CO.

For Locomotives, Stationary and Marine Engines.

The United States Metallic Packings

HAVE STOOD THE TEST OF YEARS AND ARE ACKNOWLEDGED TO BE SUPERIOR TO ALL.

Renewal of Packing Rings made without disconnecting, by cutting them in halves and breaking joints.

HIGHEST AWARDS COLUMBIAN AND PARIS EXPOSITIONS.

General Office, Bullitt Building; Works, 427 N. 13th St., Philadelphia, Pa.

Chicago, Rotunda, Grand Pacific Hotel.
San Francisco, 130 Main Street.

St. Louis, 32 Laclede Building.
Montreal, Canada, 751 Craig Street.

Swab and Oil Caps Furnished with every Packing.

SEND FOR CATALOGUE AND SPECIFICATIONS.

SURE TO GIVE

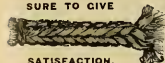

SATISFACTION.

DUVAL METALLIC PACKING

Send for Catalogues, Prices and detailed information to the

Duval Metallic Packing Co.,

39-41 CORTLANDT ST.,

NEW YORK CITY.

It's The Best Packing



we know how to make, and we honestly believe it is the best packing made. People who have used the P. P. P. Diagonal Rod Packing say it's best and that's good evidence. It's different from any other packing because it has two wedge-shaped pieces that, under pressure, slide on each other and press against the side of packing box and rod. The wear and scoring of a rod is filled and it stops drips automatically. Under the wedge pieces there's a ring of spongy material that carries oil and keeps rod lubricated. It's made of materials that wear best. It wont harden, and it will save lots of work with a monkey-wrench. Can set the nuts with the finger. Twice as deep as rubber core packing; saves a half that way. We're so sure that it's best that we'd like to send you a free sample.

C. A. DANIEL, MFR.,
323 Market Street, Philadelphia, Pa.

Boiler,
Locomotive
AND
Smoke Stack
STEELS.

QUALITY UNSURPASSED

Plates up to 100 ins. in width

FIRE BOX STEEL.

PITTSBURGH, PA.

PURITY AND
DUCTILITY AND
SOFTNESS.

THE INEVITABLE
RESULT OF US-
ING INFERIOR
STAYBOLT IRON
IN THE CON-
STRUCTION OF
THE MODERN,
HIGH PRESSURE
LOCOMOTIVE
BOILER.



TO AVOID EXPLOSIONS and consequent GREAT LOSS OF LIFE and PROPERTY, use the

SAFETY HOLLOW STAYBOLT,
manufactured by the
FALLS HOLLOW STAYBOLT CO.
Cuyahoga Falls, O.

Provided in all sizes from 1/4 to 2 in. outside diam., with any size hole required. Price 1/2 to 1/3 in.

FOR EVERY RAIL-ROAD MAN.

POCKET PRIMER

of

Air-Brake

Instruction.



Sample Every Lesson 50 pages of Most Practical Cover Mailed to any address, on receipt of 50c.
W. S. Rogers,
Mechanical Engineer,
BOSTON, N.Y.

LEONARD & ELIS.

VALVOLINE

OILS FOR RAILROADS.

VALVOLINE OIL has long been used on many of the leading railroads in this country and abroad. It has no equal in quality and

W. A. BOYDEN, General Agent,
157 Chambers Street, NEW YORK.

PEERLESS ENGINE AND TENDER HOSE CONNECTION.

Air Brake Hose Guaranteed for 3 years.

Steam Hose for Car Heating.
Wonderful Steam Resisting Qualities.

E. L. PERRY, Pres. W. D. WINANS, Treas.



C. H. DALE, General Manager.

THIS HOSE is known as our ANACONDA brand. It is corrugated, made of three and four-ply of duck, with a wire inserted to prevent it from collapsing or kinking, thereby making it impossible to break or shut off injectors when rounding a curve or striking a low joint. It is made any shape or length required. The outside is covered with a canvas jacket or covering to prevent oil, grease, etc., from destroying the hose. This hose is thought by many of the master mechanics of our large railroads to be the ideal hose for engine and tender connections.

MANUFACTURED EXCLUSIVELY BY

THE PEERLESS RUBBER MFG. CO.,

No. 16 WARREN STREET, NEW YORK.

FLAT TURRET LATHE

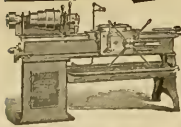

TURNS
 STRAIGHT AND TAPER FRAME BOLTS, ETC.
 SEND FOR A COPY OF
"RAPID LATHE WORK,"
 By New Method—Workless System.
JONES & LAMSON MACHINE CO.,
 SPRINGFIELD, VERMONT, U. S. A.

The Sample Tells the Story.

A sample of Dixon's pure, flake lubricating Graphite, with interesting and instructive pamphlet.

Sent Free of Charge.

Every engineer and machinist should make himself better acquainted with Dixon's Pure Ticonderoga Flake Graphite. It will save both time and labor, and is infinitely superior to the common forms of plumbeous or black lead.

JOS. DIXON CRUCIBLE CO.,
 JERSEY CITY, N. J.

"DOUBLE-LIFT" SAFETY HOISTS.



WITH the use of this hoist accidents are impossible. It simply consists of a chain sheave wheel, over which passes a chain with a hook fastened to each end, it being raised and lowered by a hand rope and wheel in conjunction with our AUTOMATIC SAFETY MECHANISM which prevents the load from running down, pulling one side of the rope causes the load to descend; pulling the opposite side causes the load to ascend; if you stop pulling and leave go of the rope the load will remain suspended. IT CAN SAVE LIFE, HOME, THE LOAD RAISED OR LOWERED ONLY AS FAST AND AS LONG AS THE ROPE IS PULLED, AS ONE-HOOK ARRANGES THE OTHER DESCENDS AND IS THEREFORE THE MOST USED, A GREAT SAVING OF TIME AS A RESULT. FOR LOADS AND QUANTITIES LARGER THAN THIS HOIST WILL BE FOUND VERY EFFICIENT. WITH NO. 1. MACHINE ONE MAN CAN LIFT THE FULL LOAD OVER THE TOWER 12 FEET PER MINUTE, LIGHTER LOADS AT A FAST SPEED. BEING A CHAIN, SAFER, SIMPLER AND BETTER MACHINE THAN THE OLD STYLE DANGEROUS DRUM AND ROPE HOIST, AND IS ESPECIALLY RECOMMENDED FOR MILLS, ICE-HOUSES, FACTORIES, STORES, FREIGHT HOUSES, ETC., IN FACT, ANY PLACE WHERE A GOOD, SAFE, QUICK AND SUBSTANTIAL HOIST IS NEEDED.

HENRY C. AYER & CLEASON CO.,
 N. E. Cor. 2d and Diamond Sts., Central Office, 919 Betz Building,
 PHILADELPHIA, PA.

The Westinghouse Air-Brake Company

Is now prepared to fill orders, at an hour's notice, for One or One Thousand Sets of
AIR-BRAKES FOR FREIGHT CARS,
 having, at their New Works, an annual capacity for turning out Air-Brakes for **250,000** Freight Cars, **6,000** Passenger Cars, **10,000** Locomotives; besides repairs for the **350,000** Freight and Passenger Cars, and **26,000** Locomotives already equipped by



THE WESTINGHOUSE AIR-BRAKE COMPANY.

RICHARD DUDGEON, 24 & 26 COLUMBIA ST., NEW YORK.

MAKER AND PATENTEE OF IMPROVED HYDRAULIC JACKS

Punches, Moller Tube Expanders, and Direct Acting Steam Hammer.

Get Jacks for Pressing on Cast Iron or cast Steels made to order. Custom-made by wire mill rollers through strainers.

THE CHAPMAN JACK. PATENTED.

THE screw being lubricated and protected, the Jack is always ready for instant service. Railroad men appreciate the importance of having Jacks always in good working condition. Serious delays frequently occur in getting common Jacks so that they can be worked when suddenly required in train service. Common Jacks are frequently destroyed in efforts to make them work quickly after the screws are set with rust and dirt. This consideration alone makes the Chapman Jack the most economical one to purchase.

THE CHAPMAN JACK CO., CLEVELAND, OHIO.

CHAMBERLAIN HAMILTON & DETROIT R.R. CH&D CINCINNATI

PULLMAN SLEEPERS on Night Trains.
ELEGANT PARLOR CARS on Day Trains.
DINING CARS between Cincinnati and Chicago.

W. B. GREENE, General Manager.
 D. U. BIRD ABBIN, Sales & Pass. Agt., CINCINNATI, OHIO.

THE "Southwestern Limited" RUNS DAILY Between NEW YORK, BOSTON, Cincinnati, Indianapolis, St. Louis, The **BIG 4 ROUTE.**

E. H. McBRIDE, D. B. HARTIN, Passenger Traffic Mgrs., Don't Forget a Travel Agent CINCINNATI

BEMENT, MILES & CO.,

MANUFACTURERS OF
METAL WORKING MACHINE TOOLS

FOR
Railroad Shops, Locomotive and Car Builders,
Machine Shops, Rolling Mills, Steam Forges,
Ship Yards, Boiler Shops, Bridge Works,
ETC., ETC.

STEAM HAMMERS

STEAM AND HYDRAULIC RIVETING MACHINES

Philadelphia, PA.

New York Office:
TAYLOR BUILDING,
39 Cortlandt St.
E. H. MUMFORD,
Representative.

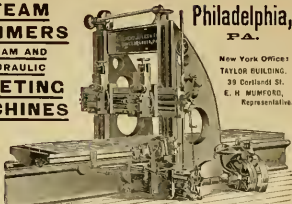

Special Air Tools for R. R. Shops.

Automatic Compound Belt Compressor. = =

Only runs when air is used, requires no attention except oiling, delivers 35 cubic feet of free air per minute — great economy over steam air pumps.

Air Hoists of all sizes, — saves more labor and time than any other shop tool, speed of hoist being entirely at will of operator. Will save ten times their cost per year over a wheel lathe.

Let us quote you on above tools.

PEDRICK & AYER CO.,

1001 Hamilton Street,

PHILADELPHIA, PA.

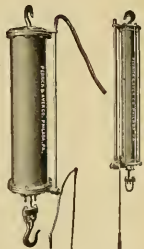
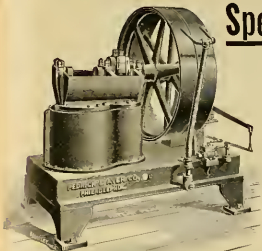

Nicholson's Expanding Lathe Mandrels.



Set of 9 taken from 1 in. to 7 in. Set of six from 1 in. to 4 in.

Either set sent subject to Thirty Days Trial, and Guaranteed Absolutely Accurate and Labor Saving.

Send for catalogue for full description and references.

GEORGE L. WEISS, General Agent, 130 INDIAN AVENUE, CLEVELAND, OHIO.

THE ACME MACHINERY CO.
CLEVELAND, OHIO.
Manufacturers of
ACME BOLT & RIVET HEADERS
Acme Single & Double Automatic Bolt Cutters
Cutting from 1/8 in. to 6 in. diam.
1 1/2 in. SEPARATE HEADS and DEES.
First Premium Cincinnati Celebration.



STEVENS' PATENT FIRM JOINT CALIPERS. STEVEN'S PATENT DEPTH GAUGE, No. 85.

8 inch. \$1.25	9 inch. \$1.50	10 inch. \$1.75
11 inch. \$2.00	12 inch. \$2.25	13 inch. \$2.50
14 inch. \$3.00	15 inch. \$3.25	16 inch. \$3.50

TOOLS. Our tools for fine workmanship and finish have no equal. Illustrated catalogue free for all.

Ideal and Leader Special Dividers and Calipers. Ideal Surface Gages, and Fine Mechanical Tools. **J. T. STEVEN'S ALBION & CHILL CO.**
P. O. Box 5733, Chicago, Ill., U.S.A.

The Long & Allstatter Co.
HAMILTON, OHIO.

Double, Single, Angle-Bar, Gang, Horizontal, Twin, Boiler, Spacing, Gate, Multiple, Bolt, and Steam Driven
Punches & Shears
OVER 300 SIZES.



THE PRATT & WHITNEY CO., Hartford, Conn., U. S. A.

SINGLE AND DOUBLE HEAD MILLING MACHINES used as Substitutes for Planers for Heavy and Rapid Cutting in Cast and Wrought Iron and Steel.

TURRET-HEAD MACHINES AND TOOLS for Turning, Forming and Threading Irregular Pieces of Circular Cross-section in Brass, Iron and Steel.

METAL BAND SAWING MACHINES for Cutting Spruce from Brass Castings.

MILLING CUTTERS, HOLDERS, with Inserted Cutters for Turning, Shaping and Threading Metals. **SPIRAL SHEAR PUNCHES.**

CATALOGUE SENT ON APPLICATION.

THE ALLISON MFG. CO.,

MANUFACTURERS OF

FREIGHT CARS AND LOCOMOTIVE BOILER TUBES.

WROUGHT IRON PIPE OF SUPERIOR QUALITY.

PHILADELPHIA, PA.

TAYLOR BEST YORKSHIRE STAYBOLT IRON

Also, Plate Rods, Crank Pins and Forgings of all Descriptions, used by Leading Railroads.

R. MUSHET'S SPECIAL AND TITANIC STEELS

SOLE REPRESENTATIVES IN THE UNITED STATES,

B. M. JONES & CO.,

BOSTON, 11 and 13 Oliver Street. NEW YORK, 143 Liberty Street.

THOMAS PROSSER & SON,
15 GOLD STREET,
NEW YORK.



STEEL TIRES

ON LOCOMOTIVE DRIVING WHEELS
AND ON STEEL-TINED WHEELS
GIVE THE BEST RESULTS
FOR EVERY VARIETY OF SERVICE.

The CAST-STEEL WORKS OF FRIED. KRUPP, Essen, Germany, cover an area of 1,200 acres, employ about 25,000 men, have the most improved plant, and stand out unique from the fact that they have their own Ore and Coal Mines, Blast Furnaces, etc. and that every stage of manufacture is under their own supervision, and are not (like others) dependent on the open market for a miscellaneous assortment of crude material; which, in connection with 75 years' experience, enables them to turn out a product of a very superior quality, second to none, and at the same time the different grades of Steel are always of the same uniform quality.

Crank Pins, Piston Rods, Spring Steel, Steel-Tired Wheels, Etc.

After a test of over 35 years, the "KRUPP TIRE" has proved itself the best in the market. If a reliable article is wanted, which will give satisfaction, get KRUPP'S.

SCHENECTADY LOCOMOTIVE WORKS, SCHENECTADY, N. Y.

LOCOMOTIVES
OF
STANDARD
DESIGN
FOR ALL
CLASSES OF
SERVICE.



OR FROM
DESIGNS
FURNISHED
BY
RAILROAD
COMPANIES.

EDWARD ELLIS,
President.
WM. D. ELLIS,
Vice-Prest. and Treas.

A. J. PITKIN,
Superintendent.
A. P. STRONG,
Secretary.

COMPOUND LOCOMOTIVES, Showing an Economy of 15 to 30 per cent. in Fuel and Water.
Annual Capacity, 400.

M. L. HOWARD, Pipe and Tank
P. H. ROYCE, Ass't to the Pres.
R. J. HANCOCK, Vice-Pres.
T. M. HERRICK, Sec'y and Treas.
DAVID HERRICK, Supt.
E. TAYLOR, Ass't Supt.



Brooks Locomotive Works,
DUNKIRK, N. Y.

Builders of Locomotive Engines for any required service from our own designs or those of purchasers.
Perfect interchangeability and all work fully guaranteed.

COMPOUND LOCOMOTIVES

FOR PASSENGER AND FREIGHT SERVICE.

J. G. HENDRICKSON, Pres.
F. J. CLAMER, Vice Pres.
J. R. NELSON, Sec'y and Treas.

"AJAX TIN"
USED WITH COPPER PER OUR FORMULA, MAKES EMPIRE STATE EXPRESS BEARING METAL, WHICH RUNS COOL AT ANY SPEED: RECORD: 90 MILES PER HOUR.

AJAX METAL COMPANY,
INCORPORATED,
PHILADELPHIA, Pa.

Latrobe Steel Works
MANUFACTURERS OF

TIRES

FOR LOCOMOTIVE and CAR WHEELS.

Main Office and Works, Latrobe, Pa.
Branch Office, DuPont Building, Philadelphia.
Chicago Office, Western Union Building.
New York Office, Home Insurance Building.

William Sellers & Co. Incorp.
PHILADELPHIA, PA.

MACHINE TOOLS
MODERN

for Railroad Shops, Car Builders, Etc.

HIGH SPEED
TRAVELING & SWING CRANES.
ALSO
TURNABLES, INJECTORS,
SHAFTING,
ETC., ETC.



"LACKAWANNA"

Sight Feed Locomotive
Cylinder Lubricator.



Extract from Report of the Franklin Institute.

"The state of the art shows this lubricator to be in lead of its competitors for simplicity and perfect working under varied conditions."

Are you interested enough to write for full particulars?

Lackawanna Lubricating Co.,
1212 Capouse Avenue, Scranton, Pa.

Rhode Island Locomotive Works,
PROVIDENCE, R. I.

CHARLES FELIX MASON, President.
ARTHUR LIVINGSTON MASON, Secretary.
EARL PHILIP MASON, Vice-President.
JOSEPH LYTHGOE, Agent and Supt.
WILLIAM P. CHAPIN, Treasurer.
S. A. STEPHENS, Traveling Agent.

NEW YORK OFFICE,
Nos. 31-33 Pine Street.

BALDWIN LOCOMOTIVE WORKS' Standard-Gauge Locomotive FOR IMMEDIATE DELIVERY.



DESIGN AS CUT.

Cylinders, 17" x 24", driving-wheel, 60" diameter; tires, steel, 3" thick; total wheel-base, 22' 2", driving-wheel-base, 8' 3"; weight in working order, 84,000 pounds; weight on driving-wheels, 28,000 pounds; boiler, 22' in diameter; fire-box, 60 1/2" x 34 1/2"; flues, 188 in number, 2" diameter, 10' 11" long; chilled cast-iron truck wheels, 28" diameter; total of 3,000 gallons capacity; 28" chilled cast-iron wheels; driving journals, 7" x 8"; truck journals, 4 1/2" x 7 1/2"; tender journals, 3 1/2" x 7". Engine is fitted with Nathan light-oil lubricator; balanced slide-valves; two No. 7 Frisvold-Mumler injectors; trolley; Westinghouse automatic air-brake on driving and tender-wheels; Janney coupler, and all necessary tools.

For Price and Particulars, address, **BURNHAM, WILLIAMS & CO., PHILADELPHIA.**

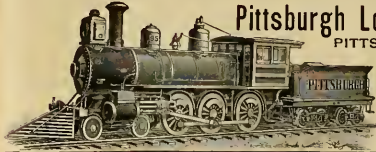

Pittsburgh Locomotive Works. PITTSBURGH, PA.,

Manufacturers of LOCOMOTIVE ENGINES

For Broad or Narrow Gauge Roads
From standard designs, or according to specific data, to suit purchasers.
Tanks, Locomotive or Stationary Boilers FURNISHED AT SHORT NOTICE.
WILCOX MILLER, Jr. & Co. D & WOODMAN, Eng.



DICKSON MANUFACTURING CO. SCRANTON, PENN.

Locomotives of every style and also, Standard and Narrow Gauge, made to Standard Gauges and Templates. Also for Plantations, Mines and Logging.
SPECIFICATIONS ON APPLICATION.
JAN. P. DICKSON, President.
E. W. WESTON, 7-7th St. W. E. FERRIS, Sec. & Treas.
JOSH. DEWINE, Superintendent.

CROSBY

POP SAFETY VALVES, REPEATED AND PLAIN.

IMPROVED STEAM GAGES, SINGLE BELL CHIME WHISTLES.

A perfect equipment for a locomotive, giving maximum riding, an easy and standard, adjustable engine. Specify these goods when ordering locomotives.

CROSBY STEAM GAGE AND VALVE CO., Boston, Mass.

Branches: New York, Chicago, and London, England.



ROGERS LOCOMOTIVE COMPANY OF PATERSON, N. J.

New York Office, 41 Exchange Place.
MANUFACTURERS OF LOCOMOTIVE ENGINES AND TENDERS, And Other Railroad Machinery.
E. S. BUGHES, President.
G. E. HANNAH, Treas. G. H. LONGBOTTOM, Sec'y.
REUBEN WELLS, Superintendent.



PORTLAND CO. PORTLAND, ME. LOCOMOTIVES OF ALL TYPES.

STANDARD OR NARROW GAUGE FOR ANY SERVICE FROM OUR OWN OR THE RAILROAD CO.'S SPECIFICATION.
Freight Cars, Derrick Cars, Push Cars and Car Wheels, Boilers of Locomotive, Horizontal, Tubular and Vertical Type.
FRANKLIN C. PAYSON, President. JAMES E. GREENSMITH, General Manager. BYRON D. VERHILL, Treasurer.



ESTABLISHED 1865. Richmond Locomotive AND MACHINE WORKS, RICHMOND, VA.

Locomotives for Every Service.

OUR BOOK LIST will not be ready until our January issue, when a complete list of all Books handled will be published.

LOCOMOTIVE ENGINEERING.

COOKE LOCOMOTIVE AND MACHINE CO. PATERSON, N. J. (Formerly Danforth Locomotive & Machine Co.)



JOHN B. COOKE, President & Gen. Man. PATERSON, N. J.
FRED W. COOKE, Vice President. JOHN B. COOKE, Sec'y & Treas.
NEW YORK OFFICE, 40 BRADWAD A. E. A. ALLEN, Ass't.

FLEXIBLE STEEL RULES.

Watch Spring Tempered Steel. Graduated in 32ds and 64ths on one side only.



VALLENTINE TOOL CO., Hartford, Conn.

TRACK SANDING APPARATUS FOR LOCOMOTIVES

HENRY L. LEACH, (Inventor of Pittsburgh) BOSTON, MASS., Room 45, Mason Building, 70 Kilby Street.

TANGYER'S HYDRAULIC LIFTING JACK.

A GOOD, RELIABLE JACK for Lifting or Pushing in any direction. The lever for pumping it up, the key covers and stays it at any point, when it is again only for lifting, saving time and trouble. Various sizes made, from 4 tons to 200 tons.
Joseph F. McCay Co., 26 Warren St., New York.



MAGNOLIA METAL



For All Bearings.

ALWAYS == == COOL !!

Sterlingworth Railway Supply Co., Exclusive Railway Agents, 256 Broadway, New York.



PROF. C. H. BENJAMIN

Three subscriptions for a dollar.

MACHINERY for December contains:
Points about Turret Lathes, James Hartness.
Naval Torpedoes and their Manufacture, Warren E. Willis.
Notes on Machine Design, Prof. C. H. Benjamin.
Old and New Methods with the Indicator, Edw. J. Willis.
Hints for the Pattern Maker, John M. Richardson.
The Patent Privilege, Geo. F. Whittlesey.
Two Neat Shop Devices, Walter L. Cheney.
Difficult Repair Jobs, James C. Hobart.
Why some Engines Pound, W. H. Wakeman.
Designing Stationary Engines (3), Theo. F. Scheffler, Jr.
The Slide Rule in the Shop (2), Wm. Cox.
 Various Short Articles of note. What Mechanics Think, Etc.

If you have not seen MACHINERY, send us your name and address and we will mail you a copy free. Address—
 SINGLE SUBSCRIPTIONS, 50 CENTS A YEAR.
 FOREIGN SUBSCRIPTIONS, 75 CENTS A YEAR.

For one dollar sent to us during the month of December, we will mail MACHINERY for the thirteen months ending Jan. 1, 1896, to three addresses anywhere in the United States or Canada.

This offer will close on Dec. 31, 1894, and no subscriptions on this basis will be received after that date.

We will mail you a copy free. Address—
MACHINERY,
 Scott & Bowne Building, N. Y. City.

The Smith Triple Expansion Exhaust Pipe.



FRONT VIEW.

THIS Device is the invention of JOHN Y. SMITH, the originator of the Smith Vacuum Brake. In the cuts of the Front and Side Views shown herewith, "AA" represent Air Passages; "SS" Exhaust Steam Passages, and "B" an Annular Blower forming part of the Nozzle.

It is an entirely new departure in the construction of Exhaust Pipes for Locomotives.

Its distinguishing features are that the exhaust steam is not restricted after it leaves the cylinders, and the gases and heated air in the smoke arch are mingled with the exhaust steam in the exhaust pipe. The exhaust steam is thus superheated and expanded, and a powerful, prolonged, pulsating blast is created, which keeps the fuel in a constant state of agitation, and produces more perfect combustion.

Some of the beneficial results obtained are: *Reduction of Back Pressure to a minimum (area of nozzle opening as large as the exhaust port); prevention of ejection of sparks from smoke stack; almost complete absence of noise from exhaust; prevention of formation of clinkers in fire-box; large saving of fuel.*

By the elimination of Back Pressure we have demonstrated the fact that the power of engines has been increased to be able to pull from thirty to sixty tons more than with any other form of exhaust pipe.

The pipe can be used with either straight or diamond stacks, in long or short front ends, and on locomotives burning hard or soft coal, wood or coke.



SIDE VIEW.

GENERAL AGENTS CO., 32 PARK PLACE,
 GENERAL OFFICE DOYLESTON, PA.

FACTORY—READING, PA.

THE LESLIE PATENT

Locomotive Fire Kindler

FOR

Cheapness, Simplicity, Cleanliness, Convenience, Absolute Safety, Durability and Economy,

**STANDS
 UNRIVALED.**

IT IS THE ONLY SYSTEM OF KINDLING LOCOMOTIVE FIRES WITH CRUDE OIL WHICH HAS EVER BEEN PUT INTO GENERAL USE BY ANY RAILROAD COMPANY.

THOUSANDS OF FIRES

Have been Kindled for Less than

4 CENTS PER ENGINE.

During the past Winter ONE car tank of Crude Oil kindled more fires than 500 Cords of Wood.

Its adoption in all round-houses over their Entire System by the Roads, which had tested it in all kinds of weather, furnishes absolute proof of its Complete Success.

For particulars, address

J. S. LESLIE, Paterson, N. J.







CALIFORNIA LIBRARY OF ARTS

3 1812 04298 5391