

TS 850

.V2

Copy 1



Class TS 850

Book -V2

Copyright N^o _____

COPYRIGHT DEPOSIT.

WOODWORKING SAFEGUARDS

For the Prevention of Accidents
in Lumbering and Woodworking
Industries : : : :

172
28

BY

DAVID VAN SCHAACK

Director, Bureau of Inspection and Accident Prevention



ÆTNA LIFE INSURANCE CO.

Accident and Liability Department

HARTFORD, CONN.

PRICE, ONE DOLLAR

T3-50
V2

COPYRIGHT 1911
ÆTNA LIFE INSURANCE COMPANY
HARTFORD, CONN.

#1, 97

11-25681

The Case, Lockwood & Brainard Company, Printers, Hartford, Conn.

©Cl.A297327
N-2

PREFACE.

This pamphlet undertakes to offer a few practical suggestions for safeguarding workmen engaged in lumbering and woodworking industries. It necessarily confines itself chiefly to machines, operations and conditions which are more or less common, but it is hoped that the suggestions contained herein will aid in impressing upon manufacturers possibilities in safeguarding which with some variation will be applicable to many of the special machines and operations that cannot be even touched upon in a work of limited extent.

There are of course many patented as well as home-made safety devices other than those mentioned herein, which could well be included did space permit, but an effort has been made to show as representative a collection as possible. We shall be very glad to render any assistance at our disposal to anyone who may be interested in obtaining further information about the methods of safeguarding to which we have called attention.

In preparing this book, the author has received invaluable assistance from the inspection force of the *ÆTNA LIFE INSURANCE COMPANY*, from many makers of woodworking machinery, from a large number of manufacturers in the various woodworking industries and from other concerns actively engaged in promoting the safety of their employees, from both foreign and domestic makers of safety devices, from various publications both in this country and abroad dealing with methods of guarding against industrial accidents, and from individuals who have aided him with both advice and criticism. He takes this opportunity of tendering grateful acknowledgment to one and all.

CONTENTS

	PAGE
GENERAL,	7- 13
LOGGING,	14- 20
SAW MILL,	21- 61
PLANING MILL,	62- 69
CIRCULAR SAWS,	70- 94
BAND SAWS,	95-100
JOINTERS,	101-110
SHAPERS,	111-120
SANDERS, ETC,	121-135
HANDLES, LATHES, WAGONS, COOPERAGE,	136-150
VENEER, FURNITURE, CHAIRS,	151-160
PATTERN SHOP, BOX FACTORY, ETC.,	161-171
POWER GENERATION, TRANSMISSION, ETC.,	172-191
GRINDING WHEELS, ELEVATORS,	192-199
LIABILITY INSURANCE,	200-203
INDEX,	204-217

GENERAL.

The many varieties of work included in lumbering and woodworking industries are among the most dangerous of modern employments. This is perhaps only natural in view of several facts. In almost all methods of working wood, once the tree has been felled and cut up into logs, the comparative lightness of the material makes it easier to bring it to the tool than the tool to it. Again, good work requires the use of instruments sharpened to the extreme and run at very high speed. In the third place, this high speed and the lightness of the material make it possible for waste pieces to be thrown about in a dangerous manner impossible in the case of metal or stone.

For these reasons, among others, it is peculiarly essential that every possible precaution be taken to safeguard workmen against injury. In subsequent chapters of this book an effort is made to suggest some specific mechanical and material safeguards applicable to woodworking plants, and also to call attention in some measure to the matter of safe methods in operating machinery. It is impossible to prevent all accidents, or even the greater number, by merely installing safeguards. Carefulness alone can avoid the great majority, and this can be secured only by proper organization and discipline, together with cordial co-operation on the part of both foremen and workmen.

Foremen. Foremen are such essential factors in the prevention of accidents that they should be carefully selected for their caution and ideas of discipline and should be thoroughly imbued with the employer's earnest desire to prevent accidents. It should be impressed upon them that they are personally responsible for prevention of accidents as well as doing of work, and that success in each will be duly taken into account. Foremen should make it their business to see that the rules of the plants are obeyed, and that repeated infractions of them are suitably punished. They should see that machines are not overspeeded, that safety devices are used on all work possible, that warning signs are properly placed and kept in position, and that discipline generally is preserved. No intoxicated person, whether workman or visitor, should be allowed to remain in the plant. An important part of a foreman's duty is to see that accidents are thoroughly investigated with a view to avoiding recurrence. For that reason he should insist that every accident, however insignificant, is reported to him at once.

When men are first put to work at dangerous machines, they should be fully instructed how to operate them with the greatest safety to themselves and others. To avoid familiarity breeding contempt, they should subsequently be warned from time to time to follow the instructions given them. Specially dangerous machines, such as saws, jointers, etc., should be operated only by men engaged for this work and qualified by experience, or by men who have

been fully instructed as to their operation and dangers. Boys should never be allowed to run such machines, even temporarily. In assigning a man to work, his special characteristics as well as qualifications should be taken into account. Slow thinking, heavy men should not be assigned to work requiring quick thought and bodily agility. Men who have a habit of getting injured should be put on jobs where they are least likely to get hurt.

Co-operation of Workmen. Cordial co-operation of workmen with their foreman and with each other will do much toward accident prevention. One man's effort to promote safety may seem small, but the sum of the united efforts of many will be large. Workmen should be encouraged to warn others of impending danger and to do all in their power to make others as careful as themselves. They should also be encouraged to report any defect affecting the safety of any employee. Each workman should be made to feel that he is a safety inspector, charged with the duty of seeing that everything is as safe as possible, and that suggestions coming from him on anything of a dangerous nature will be welcomed. Having the workmen serve on safety inspection committees, whose personnel is changed from time to time, is a good plan.

Too much effort cannot be made to inculcate habits of caution in workmen as such habits are as essential as guarding machines and making dangerous places safe. It should be impressed upon them that carefulness will avert many accidents to themselves and fellow-workmen which cannot otherwise be prevented. They should be warned especially not to fool or scuffle or to take short cuts over dangerous places.

Employment of Help. No person under the legal age should be employed in any capacity in or about a plant. Where there are no legal restrictions regarding the employment of minors, care should certainly be taken not to employ anyone under fourteen years of age, and no person under sixteen years of age should be allowed to operate any power machinery. The employment of young persons to do work for which they are not physically or mentally qualified should be particularly avoided, as their youth and inexperience make them unusually dangerous to other workmen as well as to themselves. Men subject to intoxication, fainting spells, or cramps, epileptics, and those who are deaf or have other defects which endanger life should not be employed.

Room, Light, Air, Cleanliness. Every effort should be made to have plenty of room about machines. Where there cannot be ample room, safe passageways should be railed off. If the space between machines, or a machine and a wall or transmission apparatus, is too narrow to afford safe passage, it should be blocked at each end. The moving part of any self-acting machine should not be allowed to run out within 18 inches of another structure or a wall unless this space is blocked against passage.

It is a good plan, whenever possible, to isolate dangerous machines by means of partitions, to prevent attention being diverted from work. Such isolation is often impracticable, on account of partitions interfering with the distribution of light and lessening available space for manipulation of machines and material, but where partitions can be used they will avert many accidents,

especially where a number of saws or such machines are placed side by side, and boys are employed as off-bearers.

Plenty of light should be provided, artificial when natural is not available. Good light is especially necessary where rooms are crowded, in lower floors filled with transmission machinery, and in the neighborhood of dangerous machines, particularly such hand-fed ones as saws, jointers and shapers. Good illumination means efficiency, economy, and profit, as well as increased safety. Liberal use of white paint, or even whitewash, will help diffusion of light, and so will keeping windows washed and artificial light globes clean. Good ventilation is also essential to safety, as foul air causes a loss of both mental and physical alertness.

It is important to keep a plant well cleaned up. Stock and finished product should not be allowed to fill up a large part of the space left free by the machinery. Waste material should not be left on the floor, to increase danger to workmen. Cleanliness will reduce the fire hazard, as well as help to prevent more direct accidents, and there should be systematic cleaning of floors and passageways and removal of waste. Floor sweepers can well be used in many plants to suck up dust and shavings from the floor and convey them away at once. Accumulations of odd pieces of wood and unnecessary quantities of stock on the table of a dangerous machine, such as a saw or shaper, or on the floor about it, should be especially avoided. It is a bad practice also to pile up work on the table. Men working at such machines need the utmost freedom of movement.

Safeguards. An employer will find it to his advantage to supply safeguards, whenever possible, for all dangerous places, and for all machines whose operation unguarded is dangerous. Such devices will not always prevent accidents, but they will prevent many, especially of the most serious ones, and they will often diminish the injury in the case of accidents which they cannot wholly avert. In making things safer, they also conduce to better work. The best time to safeguard a machine is when it is built, and many more machines would be protected by manufacturers if such protection were insisted upon by prospective purchasers. When a machine is not guarded by the maker, a patented or home-made device can usually be applied which will prove efficient in all possible cases.

To get the best results from safety devices, their use in their entirety should be insisted upon whenever the work permits, and their immediate replacement should be required after completion of work for which they cannot be used. A sign to this effect can well be placed in plain view of the operator of each machine equipped with a safety device. Employees should be forbidden to remove a safeguard from a machine without the consent of the foreman, or to start the machine unless the guard is in place. Safeguards can well be painted bright red, to make them readily distinguishable and to help foremen and other supervisors to detect displaced or defective guards. It is the practice in some places also to paint red, whenever possible, dangerous moving parts of machinery which cannot well be guarded.

The making of safeguards readily distinguishable is a great help toward their maintenance in place and in good condition. Seeing that safeguards are

always in proper working order and that they are not discarded is just as essential as installing them, and this can be accomplished only by frequent inspection.

All machines should be provided with adequate belt shifters or other efficient means of quickly disengaging the power. At all dangerous hand-fed machines, such as saws, jointers, shapers, etc., secure footing should be provided in the form of rubber mats, wooden slats, rough metal grating, powdered rosin, or other efficient means. If rubber mats are used, they should be watched carefully to see that their usefulness is not impaired by their tearing, wearing smooth, or filling up with sawdust. There should be feeding-in and feeding-out tables, whenever possible, for all machines to which stock is fed which is longer than the machine table, and for all roll-fed machines. Such tables should have solid beds.

Signs. Warning signs, judiciously used, will tend to prevent accidents, as they are a constant reminder that danger does exist. They should always be backed up, however, by supervision and enforcement. All signs should be as brief as possible, prominently displayed and durable. At all dangerous machines there should be signs forbidding operation until the workings and the dangers of the machine have been fully explained, and prohibiting oiling, wiping and repairing without stopping the machine. When a man is repairing a machine, a sign reading "Danger. Man on Machine" should be placed on the shifting lever or controller. When men are doing special work above other men, those below should be warned and a conspicuous sign should be placed below while the work is going on. Signs urging cautious practices and forbidding actions likely to create danger should be posted at places where all workmen will be sure to see them. A sign used at a special danger point can well have on it a hand pointing to the source of danger, especially where men of various nationalities are employed and there is not a sign in each language.

Inspection and Care. Careful inspection of all machinery and structures, in fact of the entire plant, will prevent many accidents by discovering defects and dangerous conditions due to wear and other causes. All structures and appliances should be tested regularly. Inspection and repair can well be under one central authority, either department or individual. This will tend to prevent misuse of equipment, lessen its depreciation, and promote general efficiency, as well as obviate accidents. Such a central authority is needed to see that knives, saws and other cutters are always in good repair and properly sharpened and adjusted, that babbiting is carefully done, that bolts and threaded collars and spindles have no bent shanks, damaged threads or crystallized metal, that proper splitters are used for different saws, that safeguards generally are in good condition and kept in place, and for many other reasons too numerous to mention.

An employer should take pains to supply the best of knives, tools, etc., but it is just as essential that they be properly cared for and used, and this can best be assured by placing them under the supervision of one central authority. This is especially necessary where different men run the same

machine, but it is advisable in all cases. In some shops, or rooms, one man often sets and adjusts all knives. There is some difference of opinion as to the advisability of this. On the one hand, it is held that this method assures expert service. On the other, it is contended that the machine operator will be more careful and that there will be no danger of his having to hurry in order to get to another job which is in urgent demand. It might be a good plan to combine the two methods, having an expert do the setting and then having the machine operator go over the fastenings after him. This would be apt to assure both expert setting and secure fastening. At any rate there should be a competent man in charge to keep an eye on the work in general.

Use of Machines. Before beginning work, a workman should examine the machine, tools, apparatus, etc., which he is to use and the safeguards for them. If they are not in proper order, he should report their condition to his foreman, not starting work until the defects have been remedied. Employees should be required to see that handles of hand tools are kept tight and in good repair. No workman should attempt a job on a new machine without first getting instructions from his foreman. Employees should be forbidden to use a machine, tool or appliance not especially assigned to them. A workman should always be required to stop his machine before leaving it. Employees should be forbidden to look around or talk to others while operating a machine.

Adjustments and placing of parts of machinery while it is in motion should be avoided as much as possible. A workman should be required to let his machine come to a stop before making an adjustment, even if he loses a little time thereby. Oiling or cleaning should never be done while a machine is in motion. When such is absolutely necessary, it should be done only by one who fully understands the machinery and the dangers of the work. The tendency of operators to remove a piece of waste material from a critical place should be curbed as much as possible. A dust brush similar to the large one used in painting is a good thing to have at many machines, and an air jet or a suction is advantageous in some cases. Much of the necessity for cleaning will be obviated by a good exhaust system. A machine should be tested regularly at least once a week, when it should also be thoroughly cleaned and oiled.

Clothing. All workmen should be required to wear tight-fitting clothing. Operators of machines and off-bearers should work with sleeves cut off at the elbow, if they are not tight-fitting. Rolling up loose-fitting sleeves is not so safe. Use of gloves should be avoided as much as possible, and overalls and jumpers should be kept properly buttoned. Dressing, undressing, or storing of clothes in close proximity to moving machinery should be prohibited.

Piling Material. Unfinished or finished material should be piled on a good foundation and in such a way that the pile will not topple over nor parts of it slide off the top. It should not be piled too high, nor in passageways, nor in dark places where workmen may have occasion to go.

Trucks. Many accidents in woodworking plants are caused by the overloading of trucks or the careless piling of lumber on them. If a truck is overloaded, a wheel may break and the load be thrown on some one near by.

Care should also be taken in loading a truck to avoid possibility of the load tipping over. Trucks should be examined frequently to see that their wheels are in good condition and that the fastenings are secure.

Blower System. A good blower system conduces to safety both by diminishing the likelihood of fire and by preventing injuries caused by flying chips. It also assists largely in the covering of dangerous parts so as to make contact with them less likely. In the turning and cutting of some kinds of hard wood it prevents injury to health caused by the inhaling of dusts, which not only affects the workmen's efficiency but makes them more liable to accident.

When blower hoods are used for a protection as well as to take away the dust, it is often advisable to make them adjustable, so that they can be raised or lowered or adjusted to the various positions necessary for complete guarding of the heads.

Motor Drive. The use of motor drive largely reduces the number of accidents, both directly and indirectly. Its elimination of much shafting, belting, etc., makes a room much lighter, cleaner and more roomy. Where individual drive is used, the machine and the motor being a self-contained unit, direct connection by gearing can do away with belts altogether.

Motor drive is expensive at first installation, but it soon more than pays for itself, not only in lessening the amount of power necessary but also in cutting out numerous shut-downs due to hot boxes and broken belts and shafts. It also permits certain parts of a plant to be run when other parts have to be shut down, and it enables parts to run if necessary without the entire mill running. In saw mills it avoids the necessity of the speed of the whole mill falling when a very heavy cut is being taken by some saw.

Fire Escapes. Every factory should have a sufficient number of exits and fire escapes to permit prompt egress, and no exit should be allowed to become temporarily blocked. Exits should be of proper size and there should be proper openings to fire escapes. All doors should open outward, and no door should be fastened in such a way that it cannot easily be opened from the inside. Stairways should be built regular, with no break in width or height of steps, and should be well lighted. There should be railings on both sides of outside fire escapes, and landings also should be railed. When employees are ordinarily conveyed to and from their places of work by elevators, they should be required to use the stairways at least once a week so as to become familiar with them.

Fire Precautions. Careful construction and equipment, in accordance with the rules of the National Board of Fire Underwriters, should be supplemented by good management with a view to avoiding fire. All parts of a building should be kept in good repair, to prevent fire reaching concealed places where it will be hard to extinguish. Each foreman should inspect his part of the premises before going home at night.

A good blowing system, venting outside of the building preferably, will take care of much of the dust, shavings, etc., and cleanliness should attend to the rest. Rubbish should not be allowed to accumulate in any part of a

building. Metal drip pans should be used to catch oil from bearings or elsewhere, and these should be emptied regularly. Ashes should be kept in approved cans or placed upon an incombustible floor. Smoking should not be allowed. Slats or wire mesh should be used for guards as much as possible, to prevent accumulation of inflammable stuff.

Explosives and inflammable substances and liquids should be stored in a separate building, and only enough for immediate use should be taken out at a time. Notices should be prominently displayed showing the amount of such which is safe to be used at a time and the proper way to handle it. Open lights should not be used where woodworking or finishing is done, or where highly inflammable material, oils or other volatiles are stored. Sand in pails or paper bags should be kept on hand in finishing rooms. Waste and finishing cloths should be discarded into metal receptacles, which should be emptied twice a day.

Care of Injured. Every injury, however slight, should be reported at once to the foreman. No injured employee should be allowed to continue at work unless his wound has been properly cleaned and dressed and is protected by a bandage to prevent dust and dirt getting into it. Every plant should have bandage materials within easy access in each department. In case of injury at all serious, the first thing to do is to send for the doctor.

In giving first aid care should be taken to attempt no treatment which can properly be given only by a physician. It is well to have two or more men in each department trained in giving first aid. At any rate, signs or posters should be prominently displayed giving detailed instructions regarding such treatment. An emergency room for furnishing first aid is a valuable adjunct to a plant, as it will not only afford quicker relief to the patient, but will also economize both his time and that of the concern.

LOGGING.

Probably the most effective means of preventing such logging accidents as can be prevented is found in constant and close supervision by competent superintendents and foremen, in the use of good tackle and apparatus, and in careful and thorough inspection of all structures and equipment. These will accomplish more than

safety devices, whose use is necessarily limited in such work. If work generally is done with reasonable regard for the safety of those near at hand as well as those doing it, if adequate signal systems are used where especially dangerous work is done in close proximity to a number of men, if tools, tackle and other appliances are kept in good shape, if chains are annealed at regular intervals, if explosives are properly handled, if camps, railroads, roll-ways, etc., are carefully



Courtesy of Eastern & Western Lumber Co.

Fig. 1. Walk Along Camp Buildings.

constructed, the majority of preventable accidents will be reduced to a minimum. Supervision, for instance, will prevent the use of old cables as guy lines on gin poles or fastenings for lead blocks, a practice which has caused many accidents. It is important to have a uniform system of signalling, as men on the same company's work often exchange with or supplement each other.

In steam logging the use of standard outfits tends to reduce accidents, by assuring that the various parts of an equipment are suited to each other and to the work. Standard plants also assist foremen in their supervision, making it more likely that they will always have under them men who have had experience with such machinery.

Explosives. Explosives should be handled only by a competent man engaged especially for the purpose. The main supply should be kept locked up and away from camp buildings or where men are working, and it should not be stored where there is any chance of trees being felled or blown down

on it. Only enough should be taken out at a time for immediate use. Frozen explosives should not be thawed before an open fire, nor in a stove, nor over a lamp, nor near a boiler or steam pipes, nor by placing cartridges in hot water. A thawer should be used, such as is furnished by the manufacturers.

Camps. If substantial, more or less permanent buildings are erected, the usual building safeguards as regards scaffolds, etc., should be provided. Whenever possible, the trees around a camp site should be felled before the camp is built, to avoid danger from trees not falling as planned when felled later.

An unloading platform for a railroad should not be so close to a cook house as not to clear anyone standing on the side of a car or locomotive. It is well to have all buildings far enough back from a track for men coming out of the doors to have a safe walk alongside the track, as shown in Fig. 1 (page 14).

Engine round-houses should be built with a pit over which an engine can be run to be repaired. Then men can get down underneath and work in safety. Lathes, drill presses, etc., in machine shops should have their belts and gears guarded. No set screws should be allowed to protrude. Grinders should be protected as suggested elsewhere (see index).

Railroad. A railroad should be as well constructed as the character and extent of the logging operations will warrant. The track should be kept in good condition. In large operations it should be ballasted. On marshy ground a track can well be laid on poles set close together. Trestles should be substantially built of timbers, rather than merely cribbed up with logs, and they should be equipped with safe walks and have guard rails on the curves, as shown in Fig. 2. On long trestles there should be emergency platforms at certain intervals. Safety switches should be provided on all steep grades.

Engines should have the best of air brakes and auxiliary steam brakes. Air brakes should be used on cars whenever the size of the timber handled permits. In handling big logs a flat car with bunks, as shown in Fig. 3 (page 16), is preferable, from the safety standpoint, to the car which consists merely of bunks and trucks. Care should be taken that logs are securely fastened on cars. Chucks, bunks, chains and other fastenings should be kept in good condition and adjusted carefully. When small logs are loaded on a flat car, sound side stakes should be set securely in substantial sockets. Engines and cars, their brakes and other equipment should be inspected regularly and kept in good condition. Men should not be allowed to ride on logging trains unless employed in work connected with them or at regular times for trans-

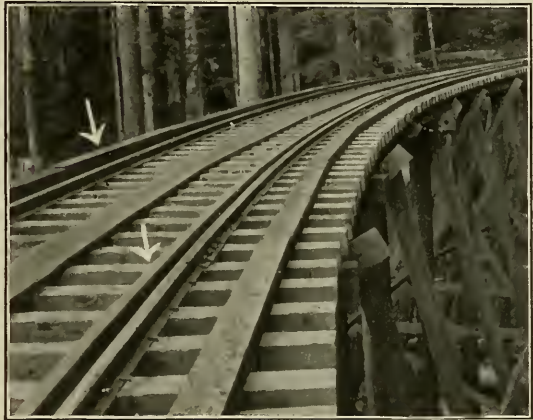

Courtesy of Eastern & Western Lumber Co.

Fig. 2. Trestle with Guard Rails and Walks.

portation of logging crews. When donkey engines are used in railroad construction for pulling out logs and small stumps, the same safety precautions should be taken as with yarder and road engines.

Felling. Only experienced and careful men should do this work. If a tree is not felled in the right direction, it may injure men working in the vicinity, either by falling on them or by hitting other trees and throwing branches in all directions. When a tree is ready to fall, the faller, or chopper, or sawyer, as he is variously called, should give ample warning to buckers or swampers who may be near. Whenever possible, it is best not to have buckers or swampers working close to where felling is being done. In many cases they can follow fallers at a sufficient distance not to be in danger on this account. This will also help keep the camp from having to stop operations because not enough timber has been felled.



Courtesy of Eastern & Western Lumber Co.

Fig. 3. Flat Car with Bunks.

sharp calks in their shoes, to help them make a quick getaway when a butt suddenly jumps back from the stump.

Buckers or Swampers. The men who cut up the tree into logs and trim off the limbs should work in pairs, whenever possible. In sawing off a log that lies up high, the log is apt to fall on the bucker or on some small tree which will pin him down. When sawing logs off a tree lying on an incline it is advisable to drive stakes to prevent the log from rolling, and also if possible to work from the upper side. Buckers' saws, wedges and other tools should be cared for like those of fallers.

Yarder Engine. This engine, often used to pull logs out from where they are cut to the roadway, should be guarded like any stationary engine, especial attention being paid to covering gears and placing a guard along the side of the crank, as shown in Fig. 4 (page 17). The water glass of the boiler should be guarded (see index). The safety valve should be tested often and kept in good shape. There should be substantial standards in front of the machine with a heavy cross bar between them, to take the whip out of a breaking cable. Hooks, chains and cables should be watched carefully for

Fallers should be provided with the best of tools, kept in good condition. Wedges and hammers should be watched for crystallization, and those with burrs on them should not be used. Ax handles should be of sound material. Springboards on which fallers work when they have to cut a tree above a pitch pocket should be substantial. Fallers should have very

signs of weakness. When a bad spot shows in a cable, it should be taken out and a new piece spliced in. The tackle is put to tremendous strain, as little road-making is done to yard logs out and small trees and stumps are constantly being struck. A good method of signalling should be adopted, and the signal should never be given the engine until everyone is in the clear.

Close supervision of yarding out work is essential. There is much manipulating of hooks, blocks and tackle, and the work must be skilfully done to avoid accident as much as possible. Snatch blocks should be carefully placed, and the men should make it a point to get quickly out of the way of the line. Close watch should be kept on the boiler, and the engineer should not be allowed to get up dangerous pressure.

Road Engine. The engine used in many large camps for hauling logs along the roadway or skid road to the roll-way from which they are loaded on cars or dumped into the water should be protected like the yarder engine. Tackle should be cared for and signalling done as in yarding out. The chaser, or signal man, should be rigidly prohibited from riding on the logs as they are hauled in and from riding back in the "pig" which carries his ax, tackle, etc.

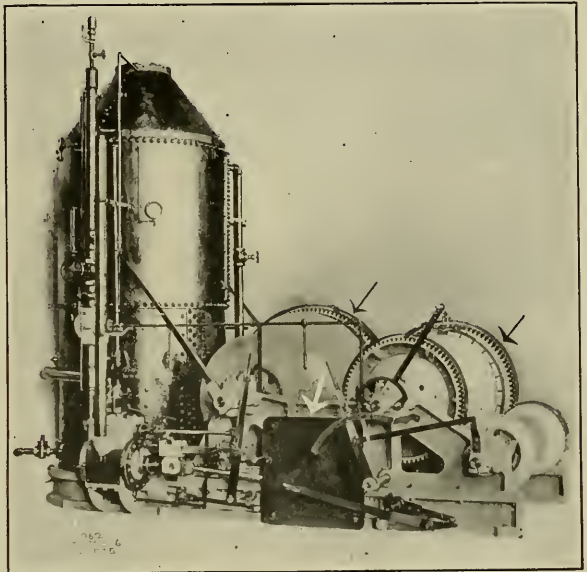

Courtesy of Lidgerwood Mfg. Co.

Fig. 4. Yarding Engine Guarded.

Loading Cars. In steam logging the loading of logs on cars is very dangerous, due largely to more men being gathered together than in any other part of the work. Methods of loading vary, but whatever the method, good tackle and close supervision are necessary. Many of the most serious accidents are caused by men being caught by moving cars and loaders, especially where the loader is moved from car to car along rails laid on the cars. Such accidents can be reduced only by having the moving of cars and loaders done under signals from a responsible man chargeable with this duty, and his taking proper care that everyone is in the clear before giving a signal. Cables or grappling hooks should be very carefully fastened on logs, to prevent their slipping and falling out of the sling or hooks. The work of handling the logs in loading should be closely supervised. In some work it is a common and bad practice to loop a cable around five or ten logs, to drag them to a point alongside the car from which they can be loaded singly. Often more logs are fastened on than the cable will pull. Then the cable breaks and its flying ends are apt to inflict serious injuries. Whether the engine is used

for loading or both loading and skidding, it should be guarded and cared for like any other stationary engine used in logging.

When cars are loaded from a roll-way alongside the track, the same pre-



Courtesy of Eastern & Western Lumber Co.

Fig. 5. Built-up Roll-way.

cautions should be observed as regards signalling and care of tackle. The usual method of doing this work, by means of a gin pole and tackle operated by an engine at the side or on another car, is very dangerous. The men are often injured by not getting out of the way of a log or by being hit by flying cables or broken blocks or swamp hooks. The tackle should be in the best of shape and the gin pole both strong and well supported by guys.

Skidders. These devices are used in many parts of the country both for yarding logs and for loading them on railroad cars or delivering them to a road engine or a waterway. The engine, or engines where loading also is done, should be guarded and cared for like yarder or road engines. Where they are mounted on a base at all high a safe walk around them should be provided and any stairways to an elevated engine should be railed.

The main cable and ropes should be of good quality and kept in good condition. Tongs should be kept sharp and sling chains watched carefully for crystallization. Blocks should be inspected frequently for defects. Head spars, tail trees and gin poles should be carefully selected and the guy lines should be strong and properly adjusted.

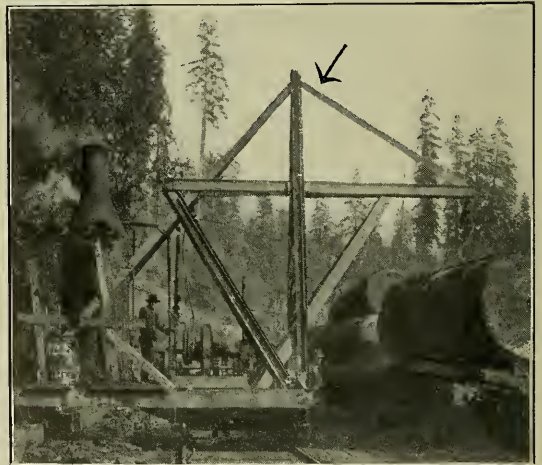

Courtesy of Eastern & Western Lumber Co.

Fig. 6. Unloading Apparatus.

The head tower used where a cableway is permanently installed for work at a mill or elsewhere, and sometimes in other work when it either is stationary or travels, the frame spar used on scows or pull boats, and the derrick boom

for some kinds of skidders, should be built or selected with special view to strength and solidity.

Much of the danger of yarding logs and loading them is eliminated by the use of the cableway yarder, as one variety of skidder is called, which yards the logs through the air instead of dragging them upon the ground. This system also saves band saws, as it enables logs to arrive at the mill free from much of the sand, grit, stones and mud which they otherwise gather. These cableways can also be used for unloading logs a carload at a time, for piling logs, for feeding a mill in place of a haul up chain, and for handling logs otherwise.

Unloading Cars. A dangerous method of unloading from cars into water is to run the trains in so that the cars slope toward the water, and then knock out the blocks or chucks by hand and jackscrew the logs off the car. It is much safer to use a cableway or other skidding device, or a crane running on an adjacent track, as shown in Fig. 6 (page 18) but the work will be facilitated by running the cars in on a slope. The same precautions regarding engines and tackle should be observed as in other logging work.

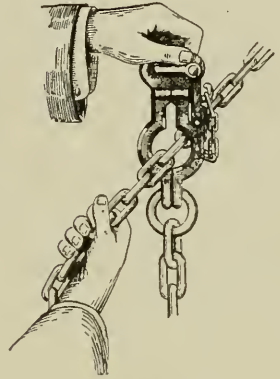

Courtesy of A. A. Sprogis.

Fig. 7. Safety Hook.

Safety Hooks. When a load of logs on a car is bound together by a chain, the releasing or unhooking of the load is very dangerous unless a safety grab hook is used, such as the Flexible Safety Grab Hook, shown in Fig. 7, or the American Safety Hook, shown in Fig. 8. With a safety hook, a cord or snatching chain operated from a safe distance will release the binding chain. Use of a safety hook also obviates the frequent necessity of cutting chains and the subsequent danger of makeshift repairs, and it enables unloading to be done more rapidly.



Courtesy of American Safety Hook Co.

Fig. 8. Safety Hook.

Travoying. All the tackle used in Northeastern and Lake States in tonging or snaking out logs from a cutting to a skidway should be kept in good shape. If a snub rope is used to hold a sled from going too fast down a steep grade, the rope should be both strong enough and sound. The same care is necessary in dragging out logs which lie away from the travoy road.

Skidways. The work at the skidways used in Northeastern and Lake States logging to store logs travoyed from the cuttings until the two-sleds haul them to the landing, and also to store logs at the banking ground, is extremely dangerous. The man at the top of the pile should be exceptionally cool and careful, and he should have a good system of signalling to the engineer or horse-driver at the rear who controls the power for rolling the logs up the skids. Carefulness on their part will reduce the number of accidents to the deckers, who send the logs up and straighten them with their cant-hooks if they stick and cant.

The chains and other tackle and the cant-hooks should be closely watched and kept in the best of condition. Decking should be very carefully done, so that the pile will not bulge and fall.

Ice Roads. Many accidents to the men driving the big log sleighs, in Lake State and Northeastern lumbering, can be avoided by proper loading and by keeping the road in good condition. Steep grades should be sanded, to prevent the great loads of logs from going too fast or from slewing about. In loading the sleigh the same precautions should be observed as in rolling logs up on skidways. Care should be taken that the logs are securely bound, and that the chain holding them is equal to the strain. The breaking of chains and the spreading of the load and rolling of the logs are a prolific cause of accidents. The care of sleighs, harness, horses and tackle should be in the hands of a competent man who will see that everything is always in good shape for the work.

Driving. Supervision is about the only safeguard in river driving, and even the best is none too effective. It is practically impossible for foremen to keep very close watch on the rivermen. They can, however, supervise breaking up jams and the especially dangerous work done by the rear in cleaning up wing jams. When dynamite is used to break up a jam, the man in charge of the work should see that everyone is out of danger before the charge is exploded.

SAW MILL.

(Including Lath Mill and Shingle Mill.)

The machinery used in a saw mill is so dangerous and runs at such great speed, the work is done under such high tension, and the conditions generally are so hazardous, that every possible precaution should be taken to protect employees against the many risks present. In addition to the specific safeguards suggested below for particular machines and operations, there are a number of general precautions which are necessary.

There should be sufficient space around all machines, and wherever possible there should be elevated runways all over the mill. There is a great deal of danger to even an experienced man in making his way over or around live rolls, transfer chains, and all the machinery that goes to make up a saw mill plant. Runways are especially necessary in crowded mills.

The mill should be kept as clean as possible all the time. This will avoid many accidents due to men stumbling over piles or pieces. All openings in the floor for conveyors or chutes to boiler rooms should be railed off and equipped with toe boards. All floors should be kept in good condition, sound and free from holes. Any stairways used should be properly railed and kept in good repair. Every counterweight used in a mill should be boxed up or provided with a safety chain. These counterweights are among the most dangerous things found in a saw mill.

Special attention should be given to making the transmission floor as safe as possible. Experienced saw mill men are so accustomed to the dangers here that they do not appreciate the risks they run. Screening of belts and other apparatus and provision of safe runways for overhead work will prevent many accidents in this very dangerous part of the mill.

Perhaps the most essential thing of all, however, is close supervision of work by competent foremen, who will see to it that rules and instructions designed to promote safety are rigidly enforced and strictly followed and that all the work is done in the safest way possible. This supervision should be supplemented by good warning signs prominently displayed at specially dangerous points. Carefulness in doing work is the only means of avoiding many accidents not preventable by mechanical safeguards. Such carefulness is particularly necessary on the part of the men who control machinery, notably the sawyer, who, besides running the band or circular mill and the carriage, is also apt to handle most of the appliances on the deck. Cool and

clear judgment is a prime requisite in a man controlling so much machinery likely to cause injuries unless it is carefully handled.

LOG HAUL.

A log haul, of whatever variety, should be substantial and durable, and every precaution should be taken against a log getting loose and possibly falling over the side of the haul, as the space beneath is frequently a thoroughfare. Where big timber is handled, it is perhaps best to have the haul V-shaped, with high sides and well reinforced with iron on the inside. When a bull chain is used, it is sufficient to reinforce the sides. Where the hauling is done by drum and cable, the haul should be entirely lined with iron. On the Pacific Coast heavy railroad rails are often used.

When a log haul is built entirely of wood, the wood should be of the best quality and the haul should be watched carefully and kept in good repair. A big knot catching in a hole or bad spot may cause a log to fall back or be thrown off the haul, and may tear the haul to pieces. The sides of a flat surfaced haul should be substantially fenced its entire length. So should hauls up which logs are drawn upon a tram car, as too long a log is apt to tip off the car. The spikes and bunks on such a car should be kept very sharp, to hold the logs firmly.

Chains and Cables. Chains and cables, and all hooks and fastenings used in connection with them, should be in personal charge of the head millwright or master mechanic, who should see they are always in good condition. Chains should be annealed at regular intervals, to avoid danger from crystallization. In severe weather chains and hooks can well be kept in a warm room over night, whenever possible, or thawed out before the day's work begins. Cables should be kept well lubricated, and when broken ends of wires show appreciable space between them the cable should be discarded. A breaking cable is apt to whip back at the man working the friction. The steel brackets of a bull chain should be kept sharp and upright, and the return part of the chain should be covered up beyond danger of contact.

Walks. When one man acts as both pond man and deck man, there should be a good cleated and hand-railed walk or stairway at the side of the



Courtesy of Defiance Lumber Co.

Fig. 9. Deck with Railroad Iron Skids, Band Mill Housing and Lever Lock.

haul. It is well to have such a walk for any haul. Workmen should never be allowed to ride up on the logs or log haul.

Machinery. All cog gearing, belting or frictions on the log haul machinery should be covered. It is a good plan also to have the whole log haul machine fenced in by pipe railings.

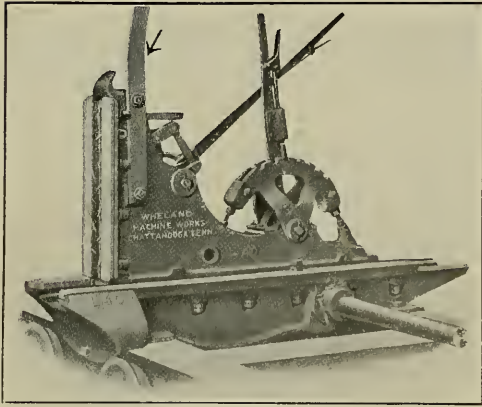

Courtesy of Wheland Machine Works.

Fig. 10. Extension Guard for Head Block.

Pike Poles. Pike poles used by pond men should be strong and sound, and the points should be sharp and well fastened. A cracked pole or blunt point may throw a man into the water, and many a man pushing hard on a cracked pole has received bad injuries from the pole giving way and a sharp broken end entering his body.

DECK.

The work of deck men, or roll-on men, varies according to the size of the timber handled and the equipment of the mill, but whether they put the logs on the carriage, roll them from the flat part of a deck to the incline, or merely keep the logs rolling down, adjust them with cant-hooks, and keep the deck clear of bark, their work is so hazardous that they need all the protection possible. They are always running the risk of being crushed by a log, and, when a kicker, or rocker, and a log loader and deck stop are used, they are in danger of being hit by a log thrown by the former or of getting their feet caught in the latter.

Condition of Deck and Cant-hooks. The deck should be kept in good condition, for the men are continually jumping out of the way of logs and they need as decent a footing as possible.

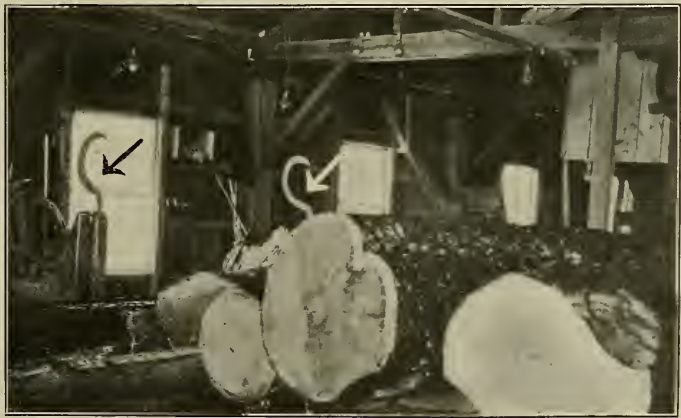

Courtesy of Kellogg Lumber Co.

Fig. 11. Extension Guards for Head Blocks.

It requires much attention, as big knots frequently knock holes in it, and the wear on it generally is both constant and severe. The skids of a deck can well be made of railroad iron, as shown in Fig. 9 (page 22). In this picture the solid connection

between the carriage and the deck is also noticeable. The cant-hooks with which the men work should be examined often to see that the shafts are sound and that the hooks are sharp, securely fastened and work properly.

Canter. When a canter, or log turner, is used to kick logs, to load them and turn cants on the carriage, or to get down to the carriage a log which has stopped before reaching the bottom of the deck, the chain should be kept in good condition, so as not to break unexpectedly, and the hook should always be sharp, to prevent its slipping or tearing out of a log. The machinery above, which runs the canter, should be well guarded, all gears and frictions being covered. On account of the strain on this machinery, much attention has to be given it. The oiler has to go up there often, and so do other workmen when a hook comes out and the chain gets tangled up around the drum.

Selection and Care. With all the safeguarding possible, deck men's work is so dangerous that great care should be used in their selection. Their best safeguard is caution, and many accidents would be avoided if foremen would put only cool-headed men on the job. Where a kicker is used to throw logs from the ridge to the deck proper, the scaler, or sawyer, whoever operates this apparatus, can save many a deck man from injury by being careful not to throw another log on the deck when anyone is in a position of danger there. Caution on the part of the sawyer, who is apt to handle most of the deck appliances, is, in fact, one of the most essential requirements for the safety of the deck men.



Courtesy of St. Paul & Tacoma Lumber Co.

Fig. 12. Carriage Feed Cable Sheave and Set Works Sheave Guarded.

CARRIAGE.

The setters and doggers who ride on the carriage are in danger on several accounts, chiefly from the saw breaking, from a log being thrown over the head blocks at them, from the carriage running away, and from losing their footing through a sudden movement of the carriage. When shot-gun feed is used, it is important to keep all valve arrangements in good condition, to prevent steam leaking into the cylinder or throwing a valve over center and shooting the carriage down the mill. Every rapidly moving carriage should be equipped with spring bumpers or air cushions.

It is a good idea to provide a strong hook and link for locking the carriage when saws are to be changed, repairs made, etc., unless there is a throttle connection close to the sawyer to shut off the steam supply to the feed with

a connection to the drain cocks which will free the cylinder of steam. Whatever the system of feed, whether shot-gun or steam feed, the lever controlling it should have an efficient lock, and any lost motion between the lever and the valve should be watched for and taken out. The sawyer should be careful never to take his hand off the lever without locking it.

A carriage should be completely floored over and the deck should be kept in good shape, as the men have to move rapidly and have no time to avoid danger spots. Cleats should always be placed so the men can brace themselves when the carriage starts back.

Carriage Run. There should be plenty of room, never less than 30 inches, between a carriage and the wall of the mill, or any fixed object, or else this space should be blocked against use as a passageway. If there is room enough between carriage and wall so the space can be used as a passageway, there should be a hand-rail 36 inches high along the wall. If there are entrances through the wall, as from a filing room, the doors should be kept

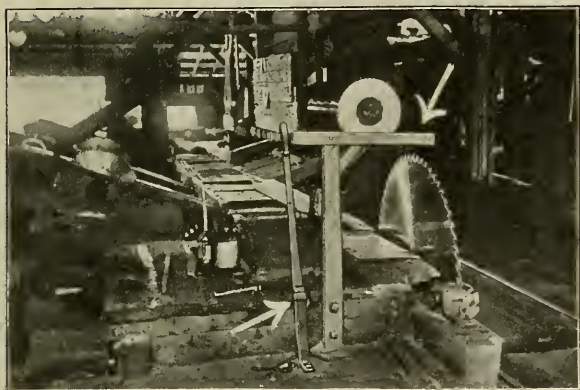

Courtesy of H. M. Loud's Sons Co.

Fig. 13. Circular Saw Guard and Lever Lock.

extension guards should be bolted to the tops of the blocks. These may be slightly curved at the top, as shown in Fig. 10 (page 23), or have hooks there, as shown in Fig. 11 (page 23).

Sheaves. Carriage feed cable sheaves should be substantially hooded, as shown in Fig. 12 (page 24), to prevent a man crossing in a hurry, and naturally watching the carriage, from getting his foot caught between sheave and rope or getting an arm caught there if he should fall. A heavy timber is securely fastened on each side of the sheave, extending well in front and back of it and coming up as high as the carriage will allow. At each end these are bevelled down to the floor. Across the tops of these is a substantial sheet metal cover. This is bent down at the front, to reach the floor, with a slot in it to let the cable go through. At the back it can be left open, as shown, or can have a hinged end coming down to the floor. The underneath part of a sheave should also be enclosed when low enough down for anyone to come in contact with it, the side guards extending well below the bottom, and the whole return portion of the carriage feed cable running underneath the mill floor

closed and warning signs placed outside them. Only persons whose work requires them to use this space as a passageway should be allowed in it. It is best, however, not to let any space between carriage and wall be used as a passageway, and to have no entrances to it through the wall.

Extensions for Head Blocks. To prevent a log being thrown over the head blocks at the carriage men,

should be covered or guarded. Sheaves of cables operating rope feed set works should also be hooded, as shown in Fig. 12 (page 24).

Gears, Couplings, Etc. All couplings, ends of shafts, set work gears and head block gears should be protected with heavy metal guards. When steam feed is used, the gears on the drum of the feed should be enclosed. So should frictions when such are used to drive the drum.

Care in Operation. The sawyer should operate the carriage with care, even if the head of the mill is behind the tail in the work. If the carriage is started before the dogs are set, the log may slip off against him, fall off on the off-bearers, or knock a setter or dogger off the carriage. The sawyer should be careful to reverse in time to avoid hitting the bumpers violently. The nigger should be worked with judgment, especially if it has a hook to pull logs off the deck and on to the carriage, to avoid throwing a log over to the carriage with too great force.

CIRCULAR MILL.

The saw of a circular mill should always have a disk splitter, or wedge wheel, close behind it, to help prevent wood from binding. This splitter should extend about six inches above the arbor and should be very strong and securely fastened. It is well also to have a device to prevent the sawyer or anyone else falling against the saw. Such a device is shown in Fig. 13 (page 25). It consists of an upright piece with a cross-piece, and is made of 4 x 4 pine and painted blue. Where the mill is double, the top saw should be covered down to the arbor with an adjustable hood supported from above. A properly counterweighted hood can also be used for much work done with a single saw mill.

Shield for Sawyer and Lever. There should be a substantial metal or wooden fencing in front of where the sawyer stands, to protect his hands on the carriage lever, and his body, and to prevent anything striking the lever. Metal makes a better guard than wood, as it will keep a flying inserted tooth from hitting the sawyer. Some circular mills come furnished with a semi-circular cast-iron hood inside which the sawyer stands. A home-made hood can be made by cutting an iron pipe of large diameter in two and fastening half of it to the floor with iron flanges. Above this guard a heavy wire screen should be attached, to protect the sawyer's eyes against flying



Courtesy of Paullson-Ellingson Lumber Co.

Fig. 14. Lever Guard and Lock.

bark, knots, slivers, stones, spikes, etc. A home-made guard, of plank below and wire mesh above, is shown in Fig. 14 (page 26).- The Dittbener lever guard, which encloses the run of the lever and has a detachable arm shield, is shown in Fig 15. Even a substantial maple strip, set in proper position, will ward off a slab coming back and make it pass by the lever.

Lock for Lever. The lever for operating the carriage should always have an efficient lock. One common type consists of a square or oblong piece of iron, with a hole cut out on one side to fit around the lever, hinged to another piece fastened to the floor. The first piece is bent up on the notched side, so the sawyer can kick it over into place around the lever. Another method of locking is by means of a bolt passing through a hole in the lever, the bolt being supported by a standard fastened to the floor. Sometimes a bent clevis is dropped over the lever from a standard at the side, a pin being then inserted through holes in the ends of the clevis, as shown in Fig. 14 (page 26). A small band sliding down over a standard alongside the lever, as shown in Fig. 13 (page 25), is often used, and is also arranged to be locked with a padlock. The cross lever shown in this picture is much safer than the old style lever working parallel with the carriage, especially when no guard protects both sawyer and lever. It also enables the sawyer to see the logs going on the carriage better.



*Courtesy of
Diamond Iron Works.*

Fig. 15. Dittbener Lever Guard.

Guide. The guide should be so arranged that it can be adjusted without the sawyer having to go closer to the saw than his usual position. In many modern mills this adjustment is done by means of a hand wheel within easy reach of the sawyer.

Inserted Teeth. Inserted teeth, which are much used where no rock saw is employed, should be set in and securely locked with the utmost care, to prevent their working loose and flying.

BAND MILL.

Housing. To protect the sawyer, the off-bearers, the carriage men and others in the vicinity, in case the saw breaks, the part of the band mill above the floor should be substantially enclosed as fully as possible. The upper wheel should be entirely housed, and as much of the saw as is practicable. Fig. 16 (page 28) shows an enclosure with lifting door for access to the saw. A somewhat different arrangement is shown in Fig. 17 (page 29). The lower door swings outward on hinges and the upper door swings up by rope and pulley. Guards with doors are safer than the stationary enclosures with room inside for working about the saw. They bring the housing closer to the machine, yet afford ready access. Another enclosure for a band mill is shown in Fig. 9 (page 22). A telescopic band mill should be housed in the same way, and the counterweight should be boxed its entire run. In addition to the housing, the band sawyer should have in front a substantial shield for him-

self and the carriage feed lever, similar to that described under the heading "Circular Mill," and there should be an efficient lock for the lever. Fig. 9 (page 22) shows the lever locked and a chain attached to the pin.

Rock Saw. When a rock saw is used to cut out, or give warning of, rocks, dirt and pieces of metal in the top of the log, this saw should be well counter-weighted, so it will swing up in the clear when not in use. It should also be hooded as fully as possible, by suction hood or otherwise, to prevent anyone falling on it or coming in contact with it when oiling or climbing on a log on the deck or carriage. Fig. 18 (page 29) shows a suction hood guard on a rock saw. The same hooding should be done when a rock saw frame has a planing head in it instead of a saw with inserted teeth. When logs are sawed which have been rafted down rivers, held together by chains attached to dogs at their ends, they should be barked with an ax or adze before being put on the carriage, unless a rock saw is used. These dogs sometimes break off, leaving their points in the logs.

Care in Operation. When the band mill is not double-cutting, and the carriage has no automatic set-off, the sawyer should watch the log very carefully as it comes back. A shim sticking out from the cut may catch the rear edge of the saw and throw it off the wheel, causing much damage if not personal injuries. The upper guide should be kept carefully adjusted to proper position under varying conditions. If it is set too low, the log may tear off the guide and throw the blade out; if too high,

the too limber blade is likely to break as well as make bad lumber. Some guides have a safety attachment, by which the guide is immediately detached if a log being fed to the saw comes in contact with it.

The sawyer should keep a close watch on what is going on down the rolls, so as not to cause an accident by sending cants too rapidly to them. If one cant comes along and hits another, men are apt to be badly injured. In many ways much depends on the sawyer's quick and cool judgment and his keen observance of all that is taking place. When there is no clutch by which the band mill can be stopped alone, there should be within easy reach of the sawyer means of sounding a loud whistle, audible all over the mill, when the mill has to be shut down on account of the band mill, or when it is to be started up again. A band saw should never be touched, for oiling or other purpose, inside the housing while it is in motion.

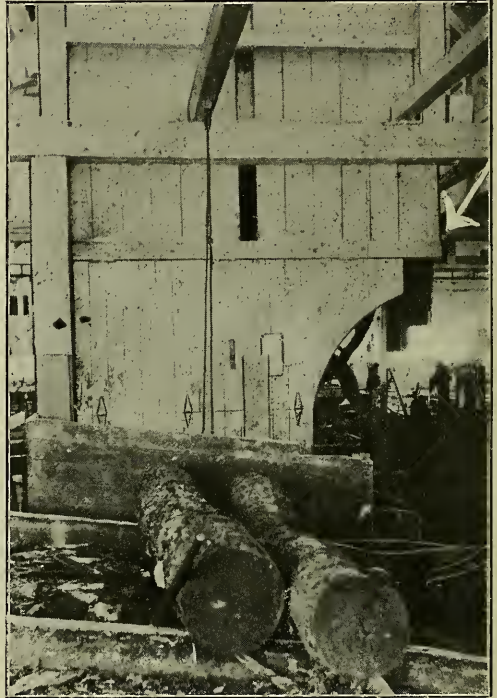

Courtesy of Paine Lumber Co., Ltd.

Fig. 16. Housing for Band Mill.

Saw. When a saw is cracked, it should be withdrawn from use until it has been brazed. Drilling a hole to prevent a crack from spreading is as bad a custom as it is common. Saws should be watched carefully to discover the beginning of cracks, which should be repaired at once.



Courtesy of Squaw Creek Lumber Co.

Fig. 17. Housing for Band Mill.

pressure rolls both in front and back of the saws. It is often advisable to have two rolls in each place, and when the work is very heavy, as in sawing up large cants, also to apply steam pressure. Pressure rolls should always be kept in good condition and properly adjusted, and, when steam pressure is used, it is important that the steam arrangements be kept in the best of order.

Finger Guards. Additional mechanical safeguards against kicking are often provided. One of these is the so-called finger guard, consisting of fingers hung at such an angle that stock can easily be fed under them, but it is impossible to bend them back. If the

stock pinches and starts to kick back, the fingers dig into it and hold it. Sometimes, as on the Pacific Coast, these fingers are placed back of the saws, in front of the back pressure roll, but usually they are suspended from a bar in

Short Side Band Mill. The protection outlined above should be given also to the short side band mill when one side of a double saw mill is used for sawing up cants turned out by the head saw on the long side.

EDGERS.

The edger is one of the most dangerous machines in a saw mill, and needs to be well guarded against material being kicked back, against the flying of slivers, knots, etc., and against contact with the fast-moving driving apparatus.

Pressure Rolls. To guard against kicking, an edger should have heavy

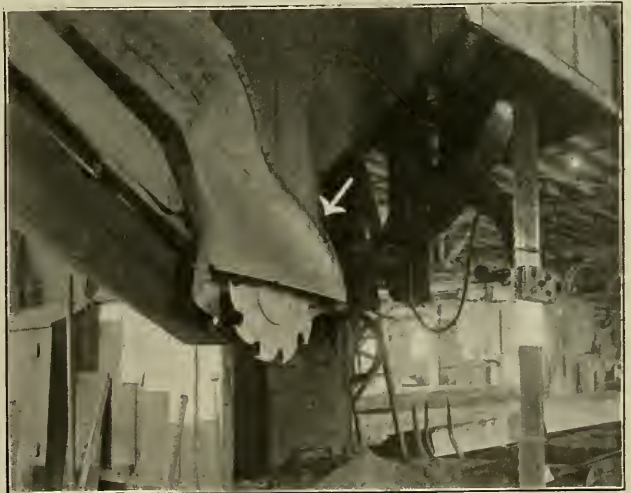

Courtesy of St. Paul & Tacoma Lumber Co.

Fig. 18. Guard for Rock Saw.

front of the front pressure roll, as shown in Fig. 19. The picture shows a board going through at the right, pushing up the fingers as it enters.

Another safety attachment, with which the American Wood Working Machinery Co. equips one of its gang ripping machines, is shown in Fig. 20. The stock passes under the front pressure roll and then under the four steel dogs of the safety attachment, which raise readily for the infeed but block the board absolutely against returning. The guard is attached to the swing.



Courtesy of Ingram Lumber Co.

Fig. 19. Finger Guards for Edger.

of the machine, as shown in Fig. 22 (page 32). Where this is done a screen should also be hung in front. A good way of covering the top of an edger used to cut dimension lumber is shown in Fig. 23 (page 32). It is a complete guard from the roll in front over the top. A wire screen can be used when it is necessary to see the saws.

When the front pressure roll is attached to a swinging frame, the open part of this frame is sometimes filled in with wire mesh. It is advisable also to carry a curving shield back over the saws, or to house the top of the machine. Fig. 24 (page 33) shows a heavy Pacific Coast edger with a board guard extending up from the front roll, the lower part hinged so as to work with the roll. When no front pressure roll is used, a plank is sometimes suspended in front of the saws, as shown in Fig. 25 (page 33). This should be hung as low as possible, to help prevent lumber from climbing.

Care in Operation. Kicking can be due to other causes than the stock pinching and climbing the saws before it reaches the back pressure roll, a knot or change in grain being struck, or a split or loose edging getting jammed or

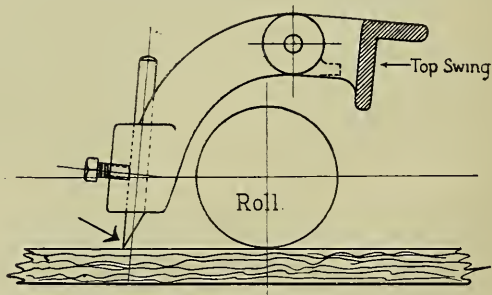

Courtesy of American Wood Working Machinery Co.

Fig. 20. Edger Dog Guard.

dropping in front of the feeding-out roll. The edgerman should be careful to put his stock through straight. If fed at an angle, it will jam and may kick. When several pieces are fed in at once, special care should be taken to send them in straight, as otherwise they are apt to get twisted up and cause an accident. Stuff should not be forced through too fast, nor pieces of different thickness fed in at once.

It is dangerous to raise a front or back pressure roll before the stock is clear of the saws. This is likely to allow warped or "snaky" lumber to get on top of the saws and be thrown back. The rear pressure roll should never be raised while stock is going through, if this can be avoided. When it is raised for a thick piece of stock following a much thinner one, the lever should never be placed in the notch intended to hold it while cleaning up is going on or new saws being put in. When it is necessary to raise the pressure roll, the edgerman should step to one side. A block should never be used for holding up a pressure roll when working on the saws. The lever should always be used, and locked.

It is a bad practice to lift the front pressure roll when a piece of edging or something else gets stuck about the saws and try to get the piece out with a stick, so the saws will not get hot and wobble, making poor lumber. The piece should be taken out

from the back or side of the machine. Dull saws should never be used as they are very likely to cause kicking. Wearing of gloves by edgermen working on short lever edgers should be avoided, but, if gloves are worn, they should be of canvas or other material that will tear easily, rather than of buckskin.

When there is no front pressure roll, it has been found advantageous to file the saws with a hook, to carry the stock back without pressure roll until it comes between the back feed and back pressure roll. This will tend to prevent lumber from kicking back before reaching the back roll and being prevented by it from creeping on top of the saws. The edger shown in Fig. 25 (page 33) has its saws filed in this manner, and is equipped with two back pressure rolls.

Short Lever Edger. The operator of the short lever edger, much used on the Pacific Coast, is in great danger of getting his hand caught in the rolls and pulled into the saws, either by following up stock with his hands when he is hurrying to keep up with the head saw, or by reaching in to prevent a picaroon

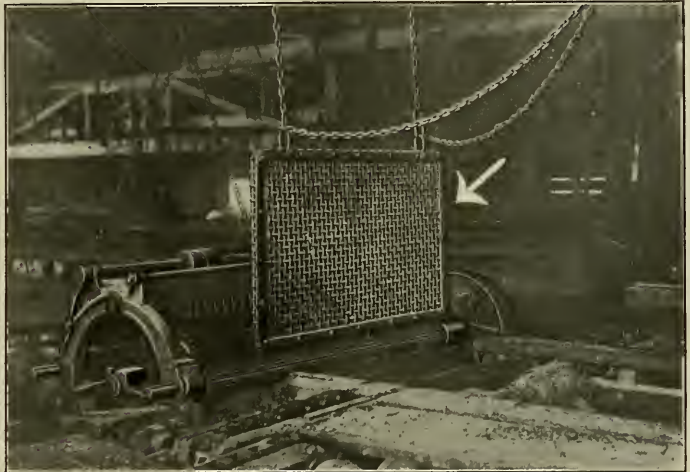

Courtesy of Menominee Bay Shore Lumber Co.

Fig. 21. Wire Screen for Edger.

that has got caught from going into the saws. An operator is also apt to be pulled into the rolls by his clothing getting caught in them. Fig. 26 (page 34) shows a bar guard against these dangers and that of an operator's hand, carelessly placed on one of the vertical side rollers when the pressure roll is up, being crushed by the pressure roll as it comes down. Such a bar should extend out 14 to 20 inches in front of the pressure roll.

A finger roll in front of the pressure roll and adjustable with it would be a better guard. It could easily be used with a pressure roll which raises straight up and could be made to adjust with even a swing roll by a proper arrangement of cams.

Belts, Gears, Etc. There is often a narrow passageway between an edger and neighboring rolls, and all the gearing, belting, sprockets and chains, etc., should be exceptionally well guarded. The gears operating the rolls of an

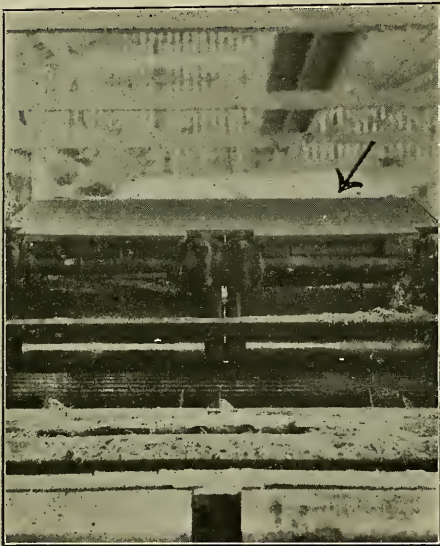

Courtesy of Paine Lumber Co., Ltd.

Fig. 22. Solid Cover over Edger Top.

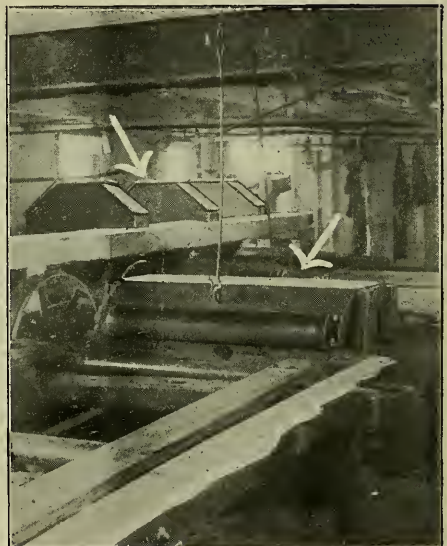

Courtesy of Grand Rapids Veneer Works.

Fig. 23. Edger Top and Front Covered.

edger should be entirely boxed in, preferably with a strong metal covering. Drive belts and pulleys should be boxed up, as edgers are run at very high speed. If the belt comes from below, the boxing should fully protect the floor opening; if from above, it should extend up at least six feet. A boxing is shown in Fig. 24 (page 33). In Fig. 27 (page 34) the gears and drive pulleys are shown partially boxed. Complete covering is preferable.

GANG SAWS.

Any opening in the floor for the machinery to pass through should be fenced. The run of the crank above the floor should be enclosed, and all gearing and sprockets and chains above the floor should be covered. There should be an efficient lock to prevent the pressure rolls coming down on men

working between the upper and lower rolls. Pressure rolls of ample weight should be used, and, if their weight is supplemented by steam pressure, the steam arrangements should be kept in the best of condition.

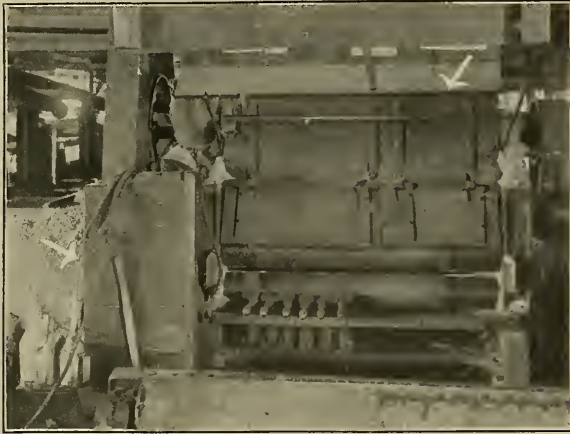

Courtesy of St. Paul & Tacoma Lumber Co.

Fig. 24. Pacific Coast Edger Guarded.

guarded at side and bottom. A pipe railing to keep anyone from getting too close is best. Where there is not room for this, heavy planking, firmly secured to the floor, can be set up close to the saw. The top of the saw when tripped up can be protected by a hood or board suspended from the ceiling or the rear. Any exposed sprockets of feeding chains should also be guarded.

When the saws are tripped from directly in front of the table, a slanting fence should run along the entire front, extending from table top to floor with slots in it for the tripping levers. The posts of the fence can fit into holes in the floor, so it can be lifted out of the way when necessary. The pulleys and shaft along the front of the table are dangerous, and belts sometimes fly out. It is safer to have these saws operated by hand levers or foot treadles at one end of the machine, or from an elevated cage, rather than for each saw to be tripped from directly in front.

To protect against flybacks, etc., a substantial guard, suspended from the ceiling, should hang down in front of the saws as low as possible without interfering with the trim man's view. This should extend the full length of the table, so as to give protection no matter what saws are used. Not only do

Means should be provided for locking the machinery from below the floor so that it cannot be started from above when a man is working below. If there is no such locking arrangement, a warning sign should be placed above to show that some one is working below. It is well to have such a sign in any case.

TRIMMERS.

Drop Saw Trimmers.

The end trim saws of drop saw trimmer tables should be



Courtesy of Paine Lumber Co., Ltd.

Fig. 25. Plank in Front of Edger Saws.

these saws throw knots, slivers, etc., but sometimes lumber is kicked if it goes into them at an angle and jams. Such a guard can be made of solid planking, or filled in with wire mesh. The mesh screen is better, as it enables the guard

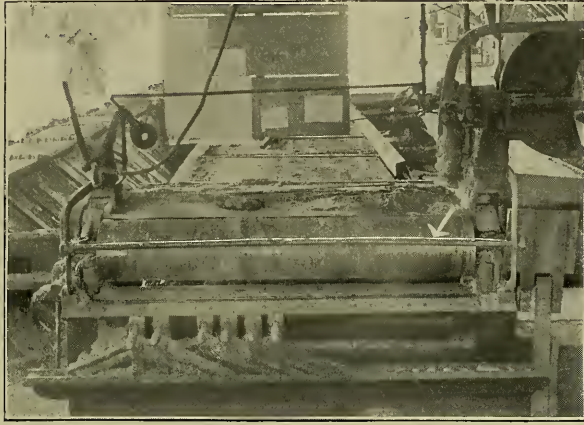

Courtesy of C. D. Danaher.

Fig. 26. Bar Guard for Edger Roll.

to hang lower and yet allow the saws to be seen. A good guard of this type is shown in Fig. 28 (page 35). It comes clear down to the table, and swings out on hinges as the chains or lumber comes in contact with it.

To prevent anyone falling on such saws, they can well be guarded by a long hood extending the entire width of the table directly over the saws. Such a hood can be suspended from the ceiling in such a way that it can easily be raised or lowered when necessary, and can be steadied by running the upright supports at either end in guides. The top of the hood should come down almost to the highest point of the saws when tripped up. A solid hood can be used whenever the saws are not tripped from an elevated cage.

Oiling of such saws should be done only when they are not running, as at morning and noon and at times when the mill is shut down during the day to change saws. Bad accidents have occurred when men have crawled under the back of such a table to fill oil cups while the saws were running. Oiling while the saws are in motion should not be necessary, but if there is any chance of its ever being done the under parts of the saws should be guarded by shields which will also protect the oiler against contact with the return part of the feed chains or with the sprocket wheels at the rear of the table.

The man feeding a trimmer should be very careful to have the stock go in straight, as otherwise not only is the likelihood of flybacks and kicking greatly increased

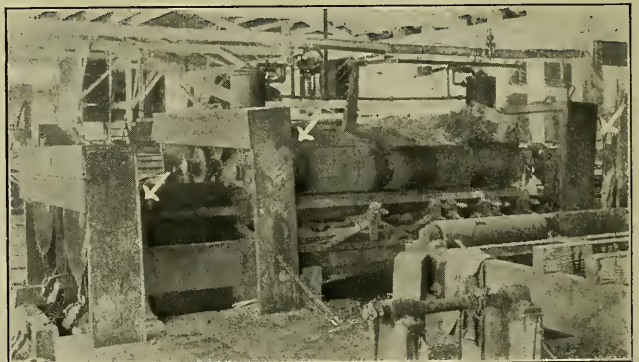

Courtesy of Defiance Lumber Co.

Fig. 27. Edger Belts, Pulleys and Gears Guarded.

but the jamming may result in breaking the saw to pieces. It is safest to have lumber run over to a trimmer table by transfers, if possible, and not have it transferred by hand from the live rolls.

Overhead Trimmers. The overhead, or undercut, drop trimmers are more dangerous than the ones tripped up from underneath the table, as they are very apt to kick backward. For this reason they should always have a substantial guard of heavy timber back of them, as shown in Fig. 29 (page 36), coming down as low as possible. Many a man working on a conveyor behind such trimmers, or pushing a truck of lumber there, has been badly hurt for want of such a guard. This picture also shows a board guard for the end trim.

These trimmers should also be well guarded in front, to prevent anyone falling on the saws. Fig. 30 (page 36) shows individual wooden hoods, and Fig. 31 (page 37) shows a plank guard swung from above and steadied against wooden supports. The latter picture also shows an inverted trough electric light reflector to throw light directly on the saws and the lumber, and, beyond the end trim at the extreme right, a sliding fence to prevent anyone getting too near that saw. These end trims should always be fenced off so that no one can get near them, especially when a narrow space adjoining can be used as a passageway. Sometimes men going to a conveyor behind will step close to an end trim. Then they may trip on some refuse wood that is lying on the floor and fall on the saw. This picture shows a swinging pipe railing placed to guard the end trim. Hoods for overhead trimmers should be open on top or otherwise so arranged that they will not obstruct the operator's view of the saws. Piping hoods can be used, if preferred, and these have decided points of advantage over wooden ones.



Courtesy of Grand Rapids Vencer Works.

Fig. 28. Trimmer Flyback Guard.

Transfer Chains. When lumber is carried to trimmer tables by transfer chains, the holes where these chains go through the floor after delivering the lumber to the table chains are very dangerous points, as men's feet are apt to be forced into them by the brackets. These holes are often torn out by brackets carrying knots and pieces of wood into them. Such a hole should never be larger than just enough for the brackets to go through it. Wear can best be prevented by having the hole cut in an iron plate set into the floor.

It is advisable also to have in front of these holes a swinging plank, running lengthwise, suspended from above at a height sufficient to let any material pass beneath it. This will act as a warning to a man getting near one of these holes before his foot can be caught by a bracket and pulled in.

Working on Tables. With both drop saw and overhead trimmers men often have to get up on the table to straighten out lumber. This should never be done when it can be avoided, as the men are apt to be caught by the chains and thus get into the

saws. To protect them when it is unavoidable, the saws should be hooded whenever possible, or otherwise guarded as fully as they can be.

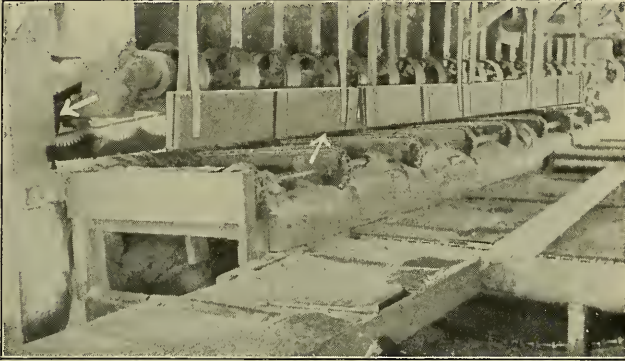

Fig. 29. Plank Guard Back of Overhead Trimmers.

saws, suspended from the ceiling and steadied by uprights at each end of the table. This rail, which is usually about three feet above the table, will tend to keep a man away from the saws and will also give him something to catch hold of if he should get caught in the chains.

Swing Trims. Swing trims should be guarded in similar fashion to swing saws generally (see index). There should be a sheet steel shield over the top of the saw and on either side, there should be a limit stop for the saw's run, the belt should be guarded near the handle, the machine should be housed at the back with a protection coming up at least as high as the top of the saw, and the saw should be hung on the side of the frame further from the way the lumber comes up so that the operator will not have to stand directly in front of it.

The most essential point, however, is good counterweighting. There should always be a stationary counterweight, attached to the frame, never a rope counterweight. When a saw is balanced by a lot of

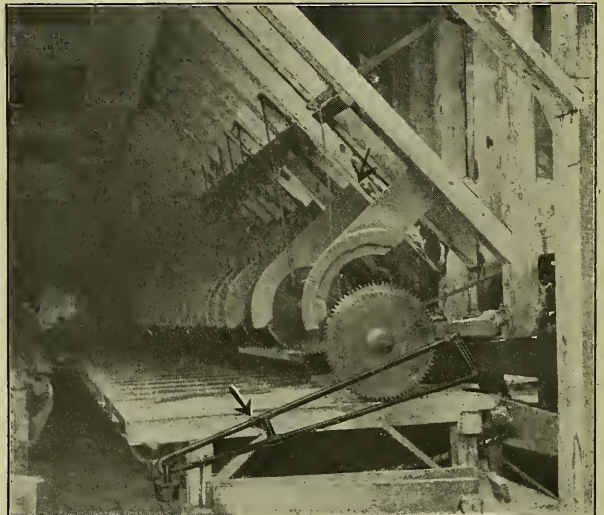

Fig. 30. Overhead Trimmers Hooded and End Trim Guarded.

junk attached to a cable running over a small sheave, the cable is apt to break when the operator lets the saw go back with a jolt, and, as he then is usually shoving lumber along in front of the saw, he is pretty sure to be injured.

Fig. 32 (page 38) shows a swing trim properly hung and equipped with a home-made stationary counterweight and with a stop above the counterweight box to prevent the saw from coming out too far. The saw is boxed at the back and has a shield over the top and one side. If the counterweight is attached to a swing bar, it should be prevented from falling by a safety chain supported from above, and another safety chain should restrict the saw's run. All swing trims should be equipped with a loose pulley and a belt shifter.

When a horizontal swing saw is used, it should be made fast when up, dependence not being placed on the counterweight alone, and when not in use should be shut down. The upper part of such a saw should be hooded on top and sides.

Jump or Bed Trims. When a jump trim is brought up through the table or rolls by a foot treadle, which is often merely a cap on top of a shaft like a bell treadle, there should be a substantial board or iron at back and front of the treadle, so that no one running along the floor can step on the treadle and bring up the saw while a man is working on the rolls or table. The trim man often has to get up there to straighten a cant and sometimes he stands directly over the saw. The saw may also be torn to pieces and thrown in all directions if a cant should strike it when so brought up. A better arrangement for a jump saw is to have its normal position back of the rolls or table, the saw being brought forward and through by a pull. Such a saw when at rest, and its run to rolls or table, should be completely boxed in.

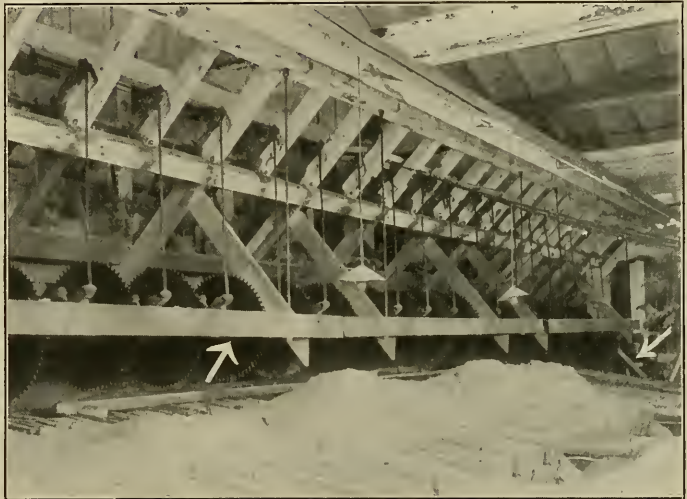

Courtesy of Defiance Lumber Co.

Fig. 31. Plank Guards for Overhead Trimmers.

A home-made guard for a bed saw can be devised by suspending four substantial strips from the ceiling, making a square frame at the bottom, and leaving space enough beneath for material to go through. This makes it impossible for anyone to get directly over the saw without crawling under the guard, which is not likely. A bed trim should be protected under the table. There should always be a limit stop so the saw can come up only so far. When such a saw is counterweighted, this can be effected by having the counterweight come up against a positive stop.

When a jump saw is brought up through the table by a hand lever, as is often done in the case of lighter sorts of work, it can be effectively guarded in the manner shown in Fig. 33 (page 39), which illustrates a German device.

The top of the saw can be covered when in use by a hood hung on a lever which swings around a bolt in an upright coming up from the back of the table and is counterbalanced by a weight in the rear of the table. As the saw is brought up through the slot the operator can at the same time bring down the hood, by means of the lever handle, on the stock to be cut. The saw blade will thus run below the hood. Such a hood will prevent many an injury due to an operator having one hand on the stock over the saw slot when he brings up the saw. Underneath the table the saw can be protected by an ample board guard on each side.

Fig. 34 (page 39), of another German device, shows how this hood can be made to work automatically. The hood hangs on the jointed lever (*n o p*), which swings around the pivot (*n*). When the saw is under the table the hood is drawn up by a bolt (*p*) which slides in a slot in the lever. When the saw is lifted for the cut, the bolt releases the lever and a counterweight (*l*) pulls the hood down over the saw. A hood of this kind not only guards the sawyer but helps hold the stock firmly in place on the table, if it is as substantial as it should be.

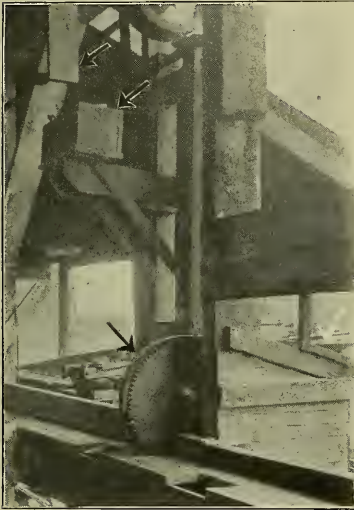

Courtesy of Defiance Lumber Co.

Fig. 32. Swing Trim Guarded.

Neither jump nor swing trims should be speeded too high, as they have hard work to do, and the saw, if running too fast, may stick in big timber or may break when jammed into it.

Care of Saws. Whatever its kind, a trim saw should be inspected frequently. A cracked saw should never be used, nor should a hole be bored at the end of a crack to prevent its spreading. No trim saw should be continued in use when it runs out of true.

SLAB SLASHERS.

Slab slashers should be guarded in practically the same manner as overhead trimmers, in front to protect the slasher men against contact with the saws and against flying pieces of a broken saw, and in the rear to guard men working there against pieces kicked back. The end saws should also be guarded, though they are not usually quite so near the ends of the table as end trims. Slasher saws should be carefully inspected every day, as they have very hard work to do and are put to a great strain.

Methods of Guarding. Fig. 35 (page 40), Fig. 36 (page 40), and Fig. 37 (page 41) show an excellent method of guarding slashers in front, on top and in the back, by means of heavy planking. In Fig. 35 the swinging front guard is shown hanging well down over the saw. Fig. 36, an end view, shows how the saws are guarded on top and in back, as well as in front, while Fig. 37 shows how the front guard can be swung out and the top one turned up on its hinges. Another form of guard is shown in Fig. 38 (page 41), consisting of planking suspended from the ceiling both in front and back of the saws,

with an opening in front for access to the saws. Another view of this guard is shown in Fig. 19 (page 30), illustrating edger finger guards.

Still another method is to put a V-shaped covering over the tops of the saws, supporting it from brackets brought out from a wall or framework at the rear and also by chains attached higher up. A heavy plank is sometimes placed well down in front of the saws, with an individual hood for the top of each saw, as shown in Fig. 23 (page 32), a picture used to illustrate edger guarding. Individual hoods, of wood or metal, as shown in Fig. 39 (page 42) and Fig. 40 (page 42) are often used for front protection. Such hoods should be so that they can easily be swung back, when necessary, and there should always be a shield back of the saws.

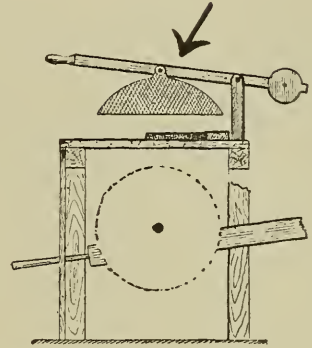

Courtesy of North German Woodworkers' Ass'n.

Fig. 33. Hood for Trim Saw.

Transfer Chains. When two sets of chains are used to get slabs to slasher saws, the same safety precautions should be taken as in the case of overhead trimmers. If both sets run on the same level, the danger of feet getting drawn into holes can be avoided by having the first set of chains continue on and go over the outside sprockets, instead of dropping through the floor and taking hold of the first shaft handling the transfer chains to the slashers. Such an arrangement is shown in Fig. 41 (page 43). It saves general breakage, too, as the brackets cannot back up pieces and crowd them down through the floor. This picture also shows a plank guard in front of the saws.

The suspended pipe railing guard mentioned in connection with trimmers is sometimes used also for slashers which are not protected by hoods or planking guards. A slasher man is not only apt to get caught in the chains, but he is also likely to slip on a slimy slab.

When slasher chains run far across the floor of a mill, there should be bridges crossing them, to prevent men walking among the chains to get from one end of the mill to the other. When saws have to be oiled, the last set of chains, if there are two, should be stopped, as well as the saws. All transfer and carrier chains leading to trimmer or slasher saws should be so arranged that they can easily be thrown out, by clutch or otherwise.

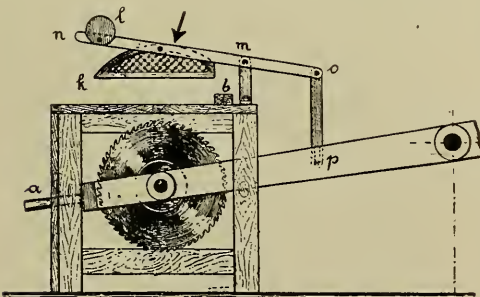

Courtesy of North German Woodworkers' Ass'n.

Fig. 34. Hood for Trim Saw.

HORIZONTAL BAND RESAW.

This saw should have its wheels entirely housed. Where the upper side of the saw is not used for the cutting, this should be included in the housing, leaving nothing exposed except where the stock passes in and out. Whether the table is of the roll bed type or is a slat table with live press rolls,

there is great danger in feeding stock. The man feeding often leans on the front end of the stock to carry it in straight, and is thus likely to be caught in the feed apparatus, either by letting his hands follow in too far or by another piece of lumber coming along and hitting him. This danger is increased by the tendency of the chains often used for feeding-out to sag from stretching. In some machines the dangerous parts are set further back from the feed entrance than is usually the case, but the hazard is great enough even then.

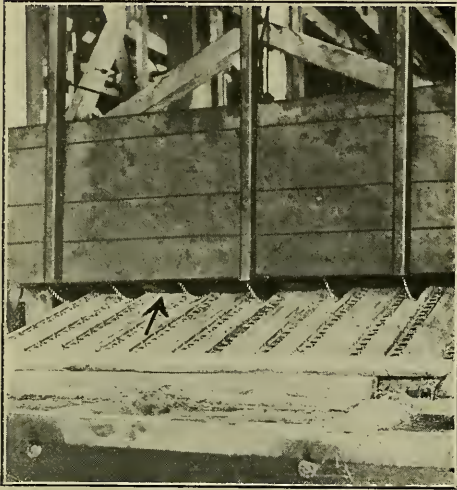

Courtesy of Kelley & Mayer.

Fig. 35. Slashers Guarded, Front View.

in thickness from 5-8 inch to 12 inches, and the distance from the bottom of the guard to the top of the table is 12 1-2 inches. This picture also shows the wheels housed.

Another method is to bring out metal arms from the machine frame at the height of the top of the feed opening, and attach to a cross-piece at the ends of these arms a swinging apron of wire mesh with a roll, or a row of wheels set some distance apart, on the bottom. The apron will be swung in and up by the stock as it comes along, but will drop back again after the stock has passed by. The operator can see the machine and stock all the time, but he will be warned by his hands touching the apron, or roll or wheels, that he is getting into danger.

When the hood method is used, it is advisable when possible to have also a metal bar well in front of the hood, supported from the machine frame at a height just sufficient to let stock pass beneath it. Such a bar alone is sometimes used, but it is not as effective as the other methods of guarding.

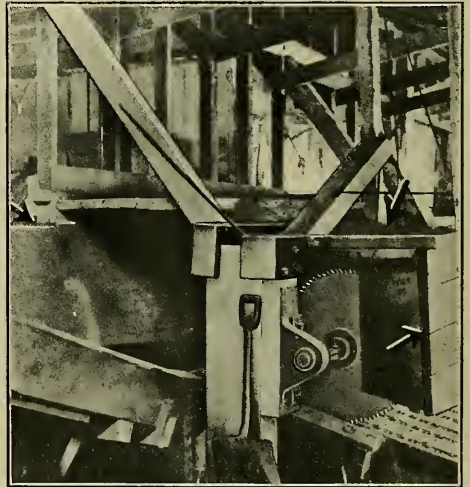

Courtesy of Kelley & Mayer.

Fig. 36. Slashers Guarded, End View.

WOOD SAWS.

Where fire wood is manufactured from slabs and edgings, they are often cut up by a gang of circular saws like slab slashers, the stuff being fed up an inclined table on chains on which they are placed from the conveyor. The table should be long enough so the man placing stock on it cannot reach the saws in endeavoring to straighten stock on the chains. These saws should be guarded like slasher saws, with especially good provision against kicking. When a cut-off saw, like a shingle cut-off, is used for this purpose, the saw should have a board suspended down over it in front of the crown and should be fenced in the rear. A good alternative is to cover the saw with a hood.

LIVE ROLLS.

The live rolls used as transfers from head saws to edgers or slashers, and elsewhere in the mill, have caused many accidents, chiefly through the gears or sprockets and chains used to drive them, and, in mills of old construction, through the necessity of going over the rolls to pass across the mill. The driving gear is very dangerous, as the men have to work close to the rolls, often leaning over them when a piece has canted, and the rolls are usually reversible. Frequently, too, men unfamiliar with the hazard are called upon to help out the regular men.

Gears, Sprockets, Etc. Driving gears or sprockets and chains and the shaft which drives them, with its dangerous couplings and key-ways, should be entirely enclosed on top, bottom and sides. They can be boxed in with plate or heavy planking (with doors, if desired, at necessary points of access), or can be covered by such a table and lifting apron arrangement, shown in Fig. 43 (page 44), as is used in steel mills to guard driving gear of roller tables. The rolls should be of enough diameter to allow of complete

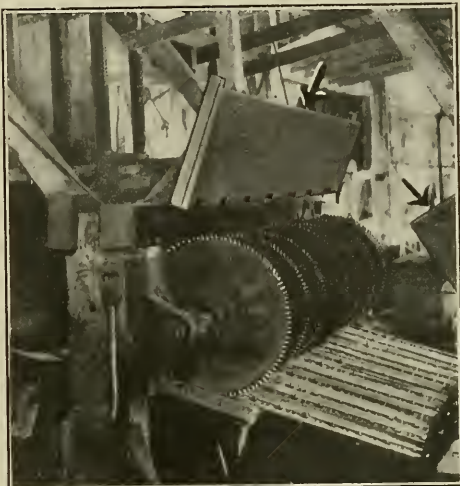

Courtesy of Kelley & Mayer.

Fig. 37. Slashers Guarded, Guards Raised from Saws.

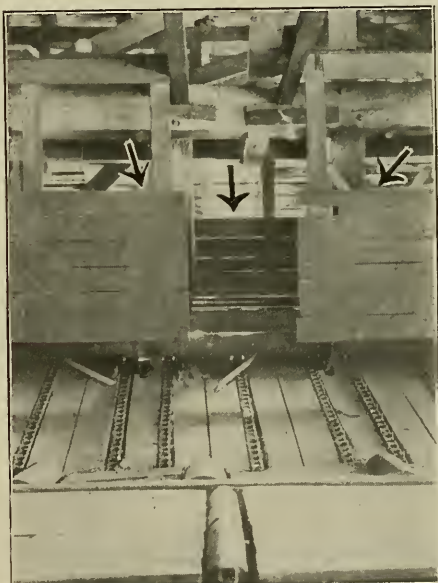

Courtesy of Ingram Lumber Co.

Fig. 38. Board Guards for Slab Slashers.

top covering, which should be very substantial, as heavy stuff often falls upon it. The diameter needs to be especially large when sprocket and chain drive is used. Fig. 44 (page 45) shows complete covering with heavy planking, the

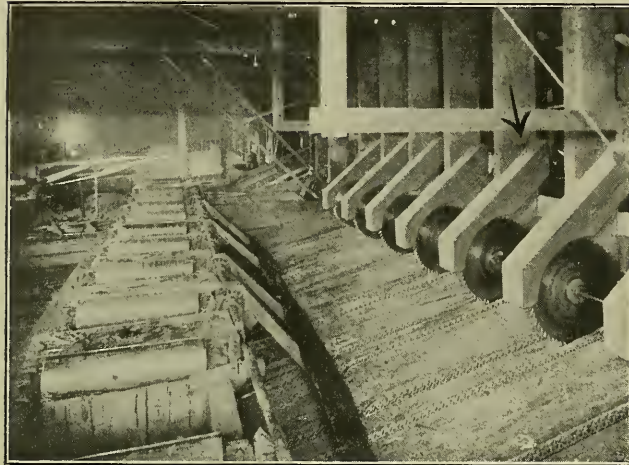

Fig. 39. Wooden Hoods for Slab Slashers.

top covering also guarding the ends of the rolls so clothing cannot get caught in them. The inverted trough above is a reflector for electric lights. Fig. 45 (page 45), a picture of rolls which extend out into the yard, shows also how the bottom of cog gearing can be covered substantially, yet cheaply.

When metal top gear covers are furnished with rolls, heavy planking should be set up along the side of the shaft, closed in at the bottom and its top level with the top of the table. When a cast iron roll is broken by a heavy cant, it should be replaced at once, to avoid accident due to its damaged condition.

Bridges Over Rolls. When it is necessary to cross rolls to get from one side of the mill to the other, or to get to the lath mill, there should be elevated bridges over the rolls at necessary points, and these bridges and the steps leading to them should have hand-rails, preferably double. Bridges are far preferable to passageways between the rolls. A good type of bridge is shown in Fig. 43 (page 44). When neither bridges nor passageways are used, special care should be taken to keep the table between the rolls in good condition.

Care in Operation. Great care should be taken by all men controlling live rolls to avoid accidents to other men. The first off-bearer, or tail sawyer, should avoid sending timber down too fast, or it may smash into other timber ahead. He



Courtesy of C. Crane & Co.

Fig. 40. Metal Hoods for Slashers.

should also be careful to keep his hand off the lever when he is cleaning out around the head saw. Otherwise he may reverse the rolls and run cants back, or may send a cant down too rapidly. He should not attempt to handle alone

a cant or slab too big for one man. There should always be enough men at hand to wedge off a cant or slab of any size.

Men handling transfers in live rolls should always see that no one is in danger before tripping them. Transfer chains should be examined often to see they work properly and will not cant stock in throwing it off the rolls. The chains should raise to equal height when tripped and go well down between the rolls when the trip is thrown off.

TRANSMISSION.

One of the most dangerous points in a saw mill or shingle mill is the first floor, or basement, in which is located the transmission by which the machinery above is driven. Generally speaking, this transmission, as well as that on the floor above, should be guarded as suggested in the chapter treating of Power Generation, Transmission, Etc., but the peculiar conditions below demand special care. Not only is there a great quantity of shafting, belts and pulleys, sprockets and chains, frictions, gearing, conveyors, etc., here, but the machinery is very heavy, has to be run at unusually high speed, and requires

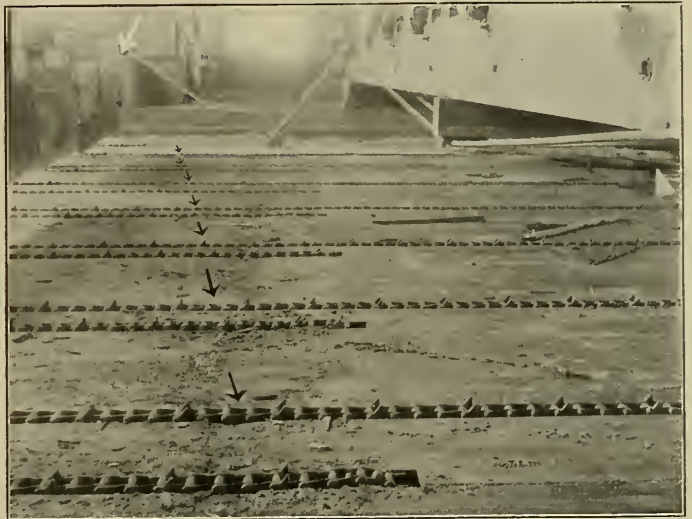

Courtesy of Defiance Lumber Co.

Fig. 41. Extended Transfer Chains.

much attention because of the severe strain put upon it by the peculiar nature of saw mill work, with its frequent abrupt throwing on and off of the load.

Light, Signs, Etc. There should be plenty of light, artificial if not natural, especially at danger points. Whitewashing timbers and woodwork will help reflection, as well as contribute to neatness. As much light and free working space as possible should be provided, as a great deal of work has to be done while the machinery is in motion. Signs should be posted up warning everyone out of this section of the mill except those employed there. Employees should not be allowed to idle around. When men who work on the mill floor are compelled or permitted to use the ground floor as an entrance, doors and stairways should be put in so that ready and convenient access can be had to floors above without going among or about the machinery below. There should be plenty of buttons here as elsewhere in the mill for stopping the machinery quickly when necessary. Saw mill boilers and engines, on the

ground floor of the mill or in adjacent buildings, should be protected as suggested in the chapter on Power Generation, Transmission, Etc.

Runways, Etc. Runways should give access to all places above reach from the floor where men have to oil, adjust or repair. These runways should have double hand-rails and toe boards, to prevent workmen or tools from falling into gears, sprockets, conveyors, frictions, belts, etc., below, which may not be entirely housed. Housing should always be done, however, whenever possible. Railed stairways should lead to runways. Safe passageways should be provided between or over any danger points to which it is impracticable to give close protection.

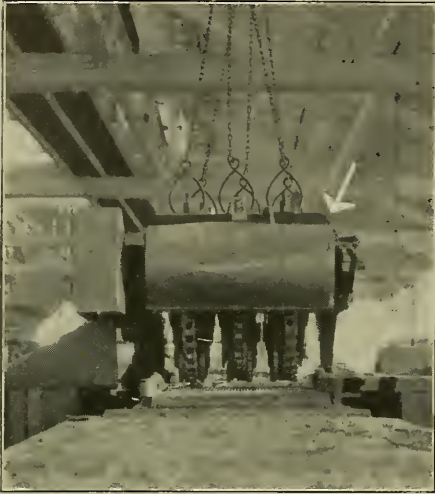

Courtesy of Paine Lumber Co., Ltd.

Fig. 42. Hood for Horizontal Band Resaw.

most of the time. Any openings cut in the floor for large pulleys and low running belts and shafting should be substantially fenced up to a height which will eliminate danger, and there should be toe boards to prevent anything falling into the holes.

It is well to cover low shafting entirely, and this should always be done

when near-by space is used as a passageway. If it is not covered, set screws should be protected or safety flanged collars used, key-ways should be covered, couplings boxed up, and shaft ends cut off or encased. Fig. 46 (page 46) shows a method of guarding low running pulleys and belts, which would be improved by having another rail half-way to the floor. Fig. 47 (page 46) shows a shaft 4 feet from the floor completely



Courtesy of Carnegie Steel Co.

Fig. 43. Live Roll Guards and Bridge Over Rolls.

boxed, two couplings covered, and a big sprocket wheel protected. Fig. 48 (page 47) is another good picture of guarded transmission. The shafting is all high enough to walk under, and there are high

elevated runways for oilers to reach places they cannot reach from the floor.

Elevated Shafting. On account of the frequent necessity for work on or about it, elevated shafting should be especially well guarded. Protruding set screws should be eliminated, keyways covered, and dead ends cut off or encased. When a coupling is between hangers, a metal covering can be fitted closely over it. When near a hanger or pillar, or the ceiling, a housing can be built out.



Courtesy of Defiance Lumber Co.

Fig. 44. Plank Guards for Live Rolls.

Frictions, Gears, Belts and Pulleys. All frictions, gears, and sprockets and chains should be enclosed as fully as possible. Fig. 49 (page 48) shows such transmission covered on all sides, doors affording easy access at necessary times. In Fig. 50 (page 48) is shown how a big friction can be covered. The board covering on the rear side is stationary, while that on the front is hinged and can be lifted up as shown.

Long horizontal belts driving the main line of shafting and the head saws should be fenced so that no one can walk into them. Fig. 51 (page 49) shows an ingenious but simple scheme for getting safely through a main drive belt



Courtesy of Defiance Lumber Co.

Fig. 45. Plank Guards for Live Rolls.

where no passageway could be made over or around it. If such a belt is elevated, its under side should be guarded, over all passageways at any rate and preferably its entire run. The idler on the main drive belt should always be secured with chains, instead of ropes, in addition to a substantial frame. The web pulley, or a filled in pulley, is preferable, but any pulley near a platform or runway, or a passageway below, should be boxed or have a substantial board guard to prevent contact with it or its belt.

Conveyors. Conveyors should be entirely covered wherever possible, special attention being paid to turning points. In passing over a conveyor, even a slow-moving one, a man runs great risk of being caught in the chain and not being able to release himself before reaching a danger point. Fig. 52 (page 49) shows effective guarding of conveyors, both those running upright and those on the floor being boxed in. A covering has been removed from one chain to show the method of boxing.

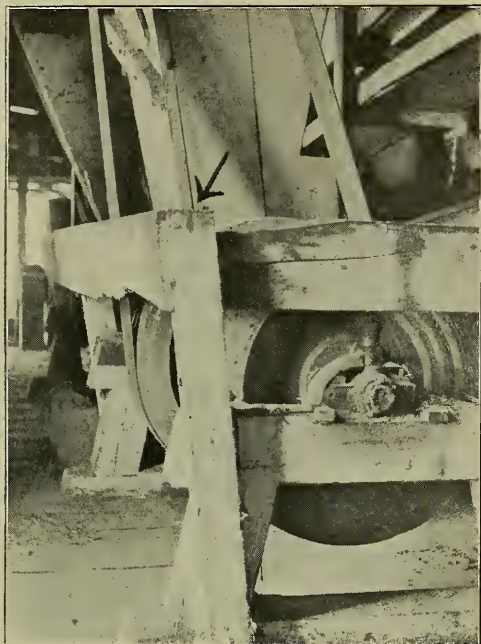

Courtesy of Kelley & Mayer.

Fig. 46. Guard for Low Belts and Pulleys.

gang saws used, should be completely housed. All overhead sheaves carrying cables or ropes running carriage or set gears, or carrying rope transmission, should be guarded. The spokes and the parts of sheaves where the cable enters should be entirely enclosed. All counterweights should run close to the floor, as shown in Fig. 49 (page 48), or in enclosed guides. It is well to box counterweights or have safety chains.

STEAM FEEDS AND MACHINERY.

The utmost care should be taken of all steam arrangements and machinery. Every shift should make careful examination of these, each man examining everything with which he has to do. Steam should be turned on to see if the kicker, the deck stop,

Valves, Etc. The valves of the nigger and other steam feeds should be kept in the best of shape. The stuffing-box of the nigger should be kept properly packed. Nigger cylinders should be railed off to prevent persons being injured by escaping hot water. Any pit in which nigger cylinders are placed is especially in need of railing. Exhausts from all steam feeds should be carried out so there will be no chance of their injuring anyone.

General. The lower parts of the band or circular mills, and of any



Courtesy of St. Paul & Tacoma Lumber Co.

Fig. 47. Guarded Transmission.

the nigger, and the carriage are working right. The sawyer should examine his head saw, and the other men the machines and parts of equipment with which each has to do. When the head saw is changed, and the mill shut down, which is likely to be several times a day, every man should examine his machine to see if it is in good condition, and oil it or do anything else necessary.

Before starting up the engine again, the engineer should sound a signal which can be heard all over the mill, so that men cleaning up or working around the machinery can stop in time to avoid being hurt. Such a whistle should be sounded also before stopping, to avoid material being left in a machine, which will cramp and strain it and put extra strain on the engine and transmission when starting up.

FILING ROOM.

Suggestions for suitable mounting, equipment, guarding and operation of

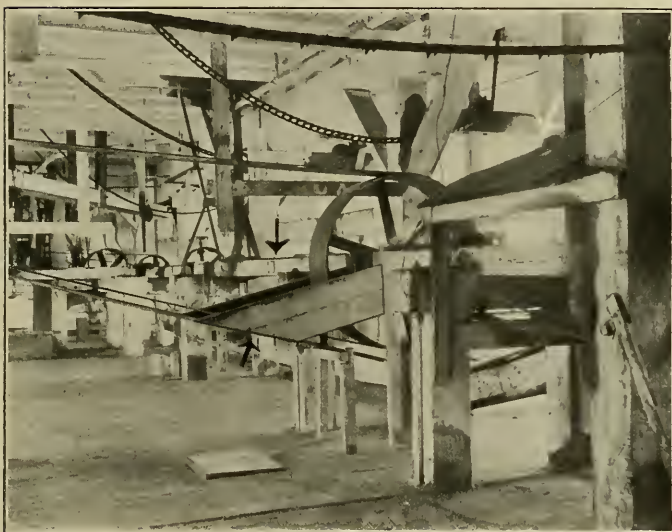

Courtesy of Defiance Lumber Co.

Fig. 48. Guarded Transmission.

emery wheels will be found elsewhere in this book (see index). The floor of the filing room should be kept in good condition, and all shafting, couplings, set screws, cog gearing and belts and pulleys should be guarded as suggested in the chapter on Power Generation, Transmission, Etc. If the filing room is located directly over the band mill, as is often the case, the sliding or lifting doors over the saw should be railed off, with an easily removable rail, so that no one will stand on them. Not only is there special danger at this point in event of a saw breaking, but the doors are apt to be very light in order that they may be moved quickly when necessary.

BLACKSMITH AND MACHINE SHOPS.

Proper appliances should be supplied for handling heavy material with perfect safety. Floors should be kept in good condition and all transmission should be well guarded (see chapter on Power Generation, Transmission, Etc.). Back and change gears of lathes and gears on drill presses should be protected with covers. No protruding set screws should be allowed on drill chucks. Tools should be watched for crystallization, and all chains should be annealed at necessary intervals. Small engines used in the machine shop

should be equipped, guarded and operated in the manner best calculated to

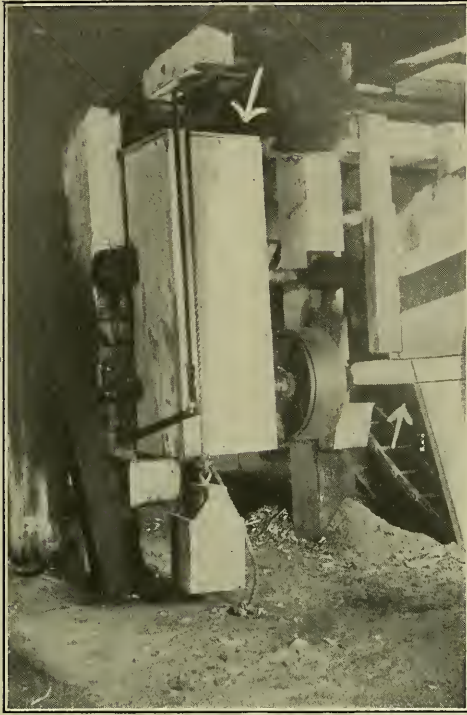

Courtesy of Paine Lumber Co., Ltd.

Fig. 49. Transmission Guarded.

assure safety (see index). When steam hammers are used, the valves should be kept in first class condition to prevent the hammer repeating. For drop hammers it is well to install a safety device which will prevent the hammer from accidentally dropping on an operator's hand. Under no circumstances should an attempt be made to shrink a hollow piston on a piston rod, or even to heat a hollow piston, without first boring it or opening it in some manner. Otherwise it is apt to explode and cause severe injuries.

THE YARD.

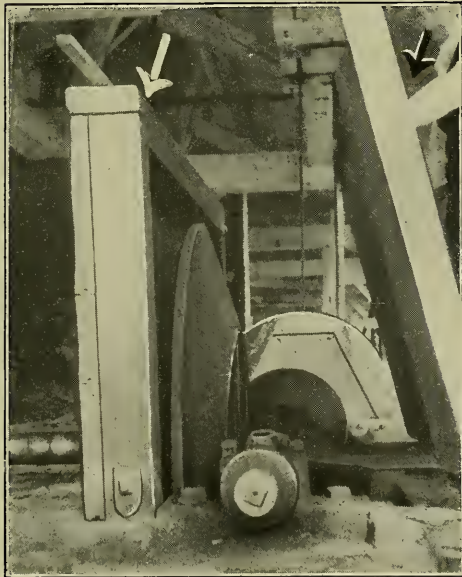

Courtesy of Paine Lumber Co., Ltd.

Fig. 50. Big Friction Covered.

If a sorting table supplied by sorting chains is used, the dangerous gears under the table driving the sorting chains and the table chains should be wholly enclosed, preferably in metal. The shafts running crossways under the table at each end should be guarded, and so should the gears of any live rolls that may be used at the front end of the table to carry stuff to a planing mill or a resaw shed. If the lumber is taken out of the mill by the drop system, running it down a slide at the tail to the platform, ground or wharf, the yard foreman should put only experienced and cool men on the job of sending stuff down the slide. A loud bell signal should be sounded to warn men below when lumber is coming. When the lumber is sent down on dead rolls set on an incline, these rolls should be boxed up high enough at the sides to prevent stuff from jumping off. There should also be a good signal system to prevent anyone at the bottom of the chute getting caught.

Platforms and Runways. All platforms and runways over which lumber is handled should be watched

closely for defects. A competent man should have charge of keeping them up so that trucks won't break through and throw heavy lumber off. Holes should be repaired at once. Inclines on runways should be cleated, if possible. Stair-

ways leading to elevated runways or platforms should have hand-rails and toe boards, and the treads should be kept in good condition.

When a platform is used for loading from, to cars or piles, there should be a heavy guard timber at the edge to keep trucks from running off and falling on anyone below. When platforms are not used for loading over, they should be substantially railed.



Courtesy of Defiance Lumber Co.

Fig. 51. Safe Passageway Through Main Drive Belt.

course of loading so that lumber need never be lifted up to the cars. Building

the railroad on an incline will accomplish the same purpose. Either will obviate also the danger of loading from a platform to a car way below it. At all inclined loading platforms there should be signs giving warning that cars run up so close that there is no clearance. In loading cars to be coupled together, care should be taken not to load on one car lumber which will project over the coupling. Two cars should be coupled together for such long stuff.



Courtesy of Paine Lumber Co., Ltd.

Fig. 52. Conveyors Boxed in.

cars can then be moved along in the

Hand and horse trucks and all other appliances used for conveying lumber to various parts of the yard should be inspected carefully and often. Wheels and bunks should be kept in good order. No vicious, kicking, or biting

horses should be used for hauling. In unloading horse or hand cars, the unloading should be done evenly from the top down, never off one side at a time. Otherwise the remainder of the load may overbalance and the bunks tip over.

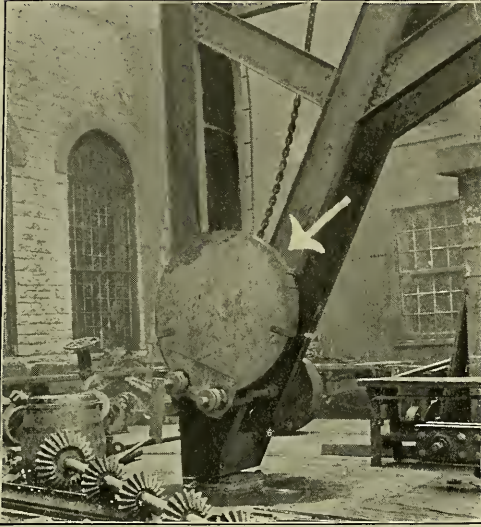

Courtesy of Illinois Steel Co.

Fig. 53. Crane Gears Covered.

Cranes, Etc. Timber cranes should have all gears covered, and cables, hooks and tongs should be kept in good shape. Points of hooks and tongs should be kept sharp and not allowed to get bent. A good method of guarding gears is shown in Fig. 53. A safety hook is shown in Fig. 54. The handle "A" enables the operator to handle the hook without danger of getting his fingers caught, and the hump "B" prevents the hook from

accidentally engaging with any object. A pair of safety tongs is shown in Fig. 55 (page 51).

If a crane is worked by hand crank, there should be safety locking devices to hold the handles on the shaft and a ratchet catch to lock the crane at any height and to prevent flying back. When cranes or block and tackle are supported from a gin pole, the leverage should not be so high up that the pole may break under heavy strain. Only skilled men should erect such a pole.

Lumber Piles and Sheds. Piles should be started on good foundations, and lumber should never be piled too high. Platforms used in passing lumber up should be made of good stock and the top boards should not extend far beyond the bracings, to prevent their tipping by a man standing outside a brace. There are safety lumber hoists which obviate the necessity for such passing up, and also that of men leaning over the edges of piles. Ladders used at lumber piles, or elsewhere, should be spiked. Lumber pilers should wear leather aprons and square leather pieces strapped across the insides of their hands, as protection against splinters. In piling, watch



Courtesy of National Tube Co.

Fig. 54. Safety Hook.

should be kept for high voltage wires, where such are used. Care should be exercised in fastening the covers, or roofs, on lumber piles, as many serious injuries have been inflicted through loose covers being blown off.

Lumber sheds should be well kept up. All stairways and open hatches should be railed, and the blocks and tackle used should be inspected often. When a shed has two stories, care should be taken not to pile so much lumber on the second story that the flooring will be likely to give way under the weight.

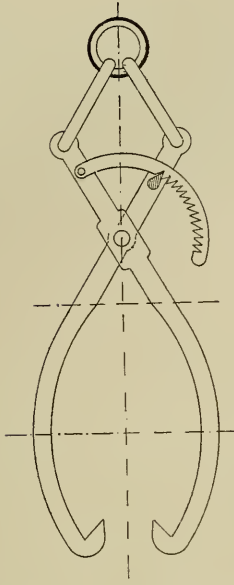

Courtesy of British Factory Dept.

Fig. 55. Safety Tongs.

Where trolley poles are used, they should be far enough from a track to prevent a man being caught between a pole and material overhanging from a car. No overhead wire or cable across a track should be low enough to come in contact with a man on the side or the top of a car.

All frogs and points between rails and ends of guard rails should be blocked, preferably with steel or iron, and the blocks should be kept in good shape. Tracks should be filled in at crossings with planks whose ends are beveled off, and wherever possible all tracks should be surfaced level with the ties between the tracks and to the ends of the ties. Railroad trestles should be planked over above crossings, and should be equipped with safe walks provided with railings and toe boards. When tracks pass under runways or bridges there should be telltales at each side, suspended from hanging boards to prevent their being thrown up out of the way.



Courtesy of Illinois Steel Co.

Fig. 56. Safety Gates to Railroad Track.

Switches should operate parallel with rails, instead of at right angles.

Tracks on an incline and those entering buildings should be provided with derailing switches. There should be substantial bumping blocks at dead ends of tracks. All tracks should be carefully examined once a week as to their condition and that of safety devices.



Courtesy of International Harvester Co.

Fig. 57. Guard at Railroad Track.

ways near a track, at points where there is not ample clearance between a track and any fixed structure or pile of material, and at points of entrance to a track from which a full view of the track cannot be had. If possible, there should be bridges over crossings. At any rate there should be swinging gates marked "Danger," and these should be provided with red lights at night. A guard railing should be placed at a doorway near a track, in addition to a sign, and there should be gates at approaches between buildings to a track.

Operation. A regular system of whistles, or an automatic bell kept in good order, should be used to give warning of the approach of cars. Walking on the tracks should be positively prohibited. Only persons whose duty requires it should be allowed to ride on locomotives or trains. Jumping on or off trains in motion, other than by trainmen, should be forbidden. Cars should not

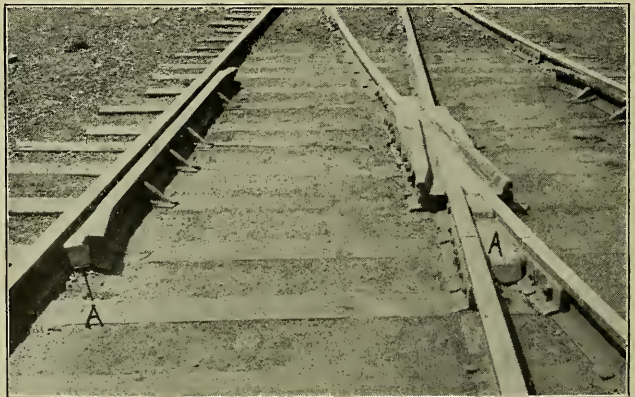

Courtesy of National Tube Co.

Fig. 58. Frogs and Guard Rails Blocked.

be speeded too high, and inclines should not be descended with more cars than can be safely handled, taking into consideration the condition of the track, wet or dry.

Cars and Engines.

All cars, engines and equipment should be kept in good repair. Whenever possible, all cars should be equipped with air brakes and with automatic couplings. Flat cars should be provided with suitable side stakes. Locomotives should have efficient safety fenders, hung as low as possible.

Guards and Warnings.

Warning signs should be placed at door-

A train should not be started until the engineer has received proper signal from the switchman in charge. When coupling cars, switchmen should first go along the track and see that no one is under the cars. When a car is being loaded, a sign should be hung on the coupling reading "Men working in this

car. Do not move." Cars improperly loaded should not be handled; trainmen should examine cars before moving them. A danger signal, preferably a red banner, should be placed far enough from the exposed end of a car upon the repair track, and upon which work is being done, to insure the safety of the repair men.

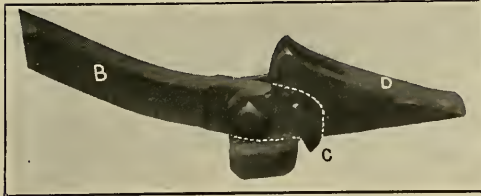

Courtesy of National Tube Co.

Fig. 59. Safety Car Shifter.

Trains should never bump into cars without the switchman first going ahead to see if men are working on or about the cars. Flying switches should be prohibited. If necessity requires that such be made to a track on which a car is standing, the switchman should warn any people working about the car. Switchmen should not go between cars in motion to pull pins, nor should pins be pulled or couplings made on the inside of a curve. Cars left on side tracks should be properly secured.

In moving cars by hand a safety car shifter, as shown in Fig. 59, can well be used in place of the ordinary pinch bar. With this shifter a man pulls up, instead of pushing down, and in case the bar slips the man is not injured. The sharpened prong "C" bites the rail when the handle is raised. The shape of the wedge makes it impossible for the car to slip backwards. At the end of the handle held by the workman is a hook to prevent his hands from slipping off.

LATH MILL.

Lath Bolters.

When a single saw is used without feed roll, a substantial board should be suspended in front of the crown, to prevent knots, gravel, etc., flying at the operator, or preferably a hood should be placed over the saw. Behind the saw should be a strong splitter. When the bolter, whether single saw or gang, has a feed roll, the whole top of the



Courtesy of St. Paul & Tacoma Lumber Co.

Fig. 60. Lath Bolter and Saws Guarded.

machine can well be housed with an easily removable cover, like that shown in Fig. 61, coming as close as possible to the table in front to prevent a hand getting caught between roll and stock. If there is no complete housing, the saw or saws should be guarded by a hood coming well down over the front of the roll, and the gears or sprockets and chains should be guarded.

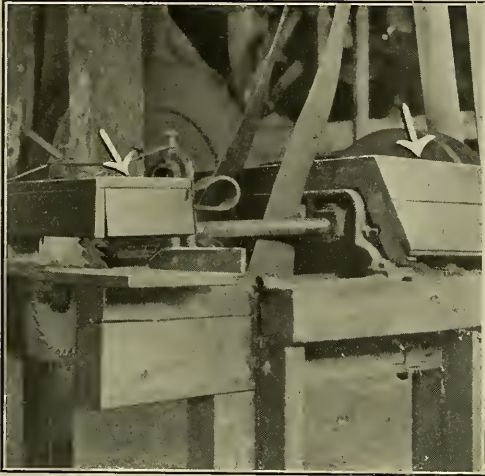

Courtesy of Kelley & Mayer.

Fig. 61. Lath Saws Guard, in Place.

splitting and bolting, the guide being slipped over and then slipped back, care should be taken to adjust the guide firmly in each case. Drive belts and pulleys should be well fenced.

Lath Machine. This machine needs guarding similar to that of a self-feed bolter. Fig. 61 shows feed rolls, saws and gearing boxed. The box over the rolls and saws can be lifted up, as shown in Fig. 62. When the feed roll is not protected by such a housing, such a guard as that shown in Fig. 63 (page 55) can be used. It is like the jointer guard which is pushed aside by the material fed and automatically recovers the knives when the stock has gone through. Such a guard holds the stock so firmly up to the guide that the operator does not have to keep his hands on until they are in danger from the roll. Its pressure on the bolt also helps prevent kicking. Pressure is given by a weight. Fig. 64 (page 55) shows a piece of stock entering the feed roll. These pictures also show a box covering for the saws. When one machine is used as combination bolter and lath machine, the protection should be the same as for individual machines.

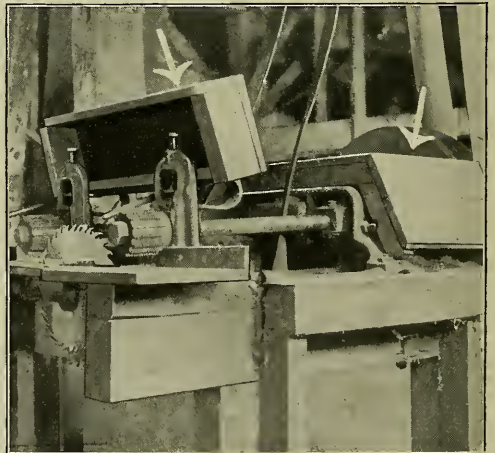

Courtesy of Kelley & Mayer.

Fig. 62. Lath Saws Guard, Raised.

Trimmers. Cut-off saws used as trimmers, single or double, should be boxed at back and ends of the machine. If the cutting is done with the under parts of the saws, hoods should cover the tops and come down in front and back as far as possible; if with the upper parts, the boxing at back and ends should come as far as possible over the tops. Fig. 65 (page 56) shows a double trimmer housed, and Fig. 66 (page 56) shows a single saw protected on top and at back and sides. If trimmers are near a wall, and not guarded at the back, the end guards should extend to the wall, to prevent the space behind the machine being used as a passageway. When a packing frame forms a part of the machine, the frame should lock as it comes back into position in front, so that it will not tip over when the packer is leaning over to bind a bundle and throw him into the saws.

Waste Holes, Transfer Tables, Etc. There should be plenty of waste holes, to get rid of rubbish, and these should be hopped, or preferably double-railed with piping, to prevent anyone falling into them. Sprockets on transfer tables should be protected, as shown in Fig. 60 (page 53), the guard coming down as far as possible. Floors where men stand to pick stock from conveyors should be kept in good shape, as the men are constantly on the jump to keep stuff suitable for lath from going on with the waste. If the floor is defective, they are apt to get nasty falls. Piling at such points or on transfer tables leading to bolters should be carefully done, to prevent toppling over.

Employing Boys. As lath-making is usually done under contract, young boys are often hired at small wages to do much of the work around a lath mill. This practice is a very bad one. No boy under 17 years of age should be employed, nor should boys of any age be put at the more dangerous work.



Courtesy of Freeman Lumber Co.

Fig. 63. Lath Machine Feed Roll Guard, in Place.



Courtesy of Freeman Lumber Co.

Fig. 64. Lath Machine Feed Roll Guard, Open.

work.

SHINGLE MILL.

Cut-off Saws. The various types of cut-off saws used for cutting logs, bolts or cants to shingle length should be guarded as fully as possible. Jump

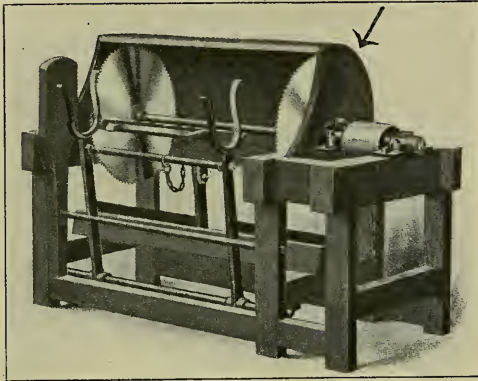

Courtesy of Diamond Iron Works.

Fig. 65. Lath Trimmer Guarded.

saws and swing saws, both horizontal and vertical, should be guarded like those used for trimming lumber in a saw mill. When the bolt is crotched in swinging legs and pushed to the saw, the saw should be protected like that used for trimming bunches of lath. The table cut-off saw to which the stock is fed on a carriage is especially likely to need guarding at the back, as it is large and apt to stick out beyond the table. A board hung down in front, with a pendant flap, will keep stuff from flying in the operator's eyes. Often a suspended hood can be used to advantage in connection with such a board. It is best to have an automatic feed table for this saw which will lock when at the front end and is tripped by the sawyer. The table should be so arranged that it cannot move while a bolt is being placed on it. The conveyor on which bolts are often brought to a cut-off saw should never be so located that the bolts coming up on it can bump into a bolt going through the saw. It should always be controllable by the cut-off sawyer.

Fig. 67 (page 57) shows a cut-off machine consisting of a large circular saw and a movable carriage with rollers in it for moving the logs ahead as the pieces are cut off. Often it is necessary for an assistant to stand on the carriage as it moves back and forth, and an "L" shaped guard makes it practically impossible for him to come in contact with the saw. The other guard shown covers the saw, but allows the logs to pass under it as they are being cut off. This latter device can be improved by running a small iron rod from

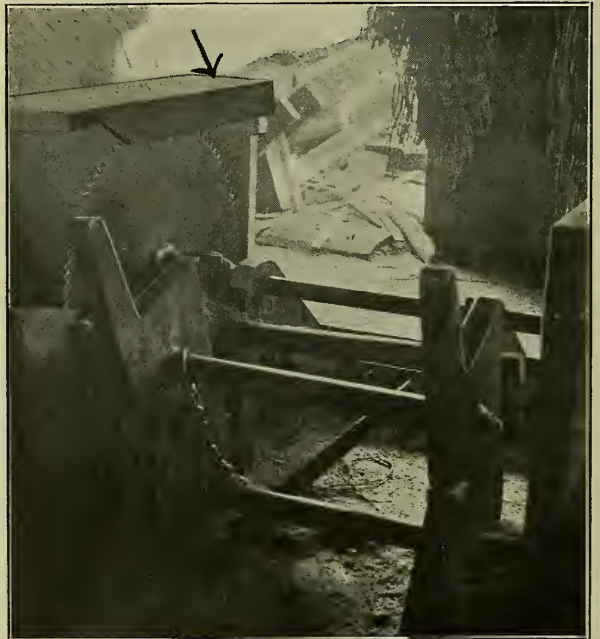

Courtesy of Western Lumber Co.

Fig. 66. Lath Trimmer Guarded.

The other guard shown covers the saw, but allows the logs to pass under it as they are being cut off. This latter device can be improved by running a small iron rod from

the roof beam to the end of the piece over the saw. In a shingle mill boys will run around over tables, and the only way is to protect everything possible to cover. The picture shows also the under part of the saw guarded, the main driving belt in the background boxed in and the pulleys on the main shaft guarded each by two half tires, taken from an old wagon wheel, to prevent injury from a belt breaking and flying. The blades of cut-off machines should be kept in the best of shape, as they are put to a nasty strain. No cracked saw should be used. Care should also be taken that any carriage and tracks used are in good condition.

Axes, Wedges, Etc. The axes, wedges and sledges sometimes used to split stock sawed to block length from logs or cants should be carefully kept in good condition. Handles should be sound and sledgeheads and wedges watched carefully for signs of crystallization. A wedge having burrs on it should never be used.

Knee Bolter. This dangerous saw should always be guarded at the rear to prevent anyone running into it, and a board should be suspended rigidly and as low as possible in front of the crown to keep knots, sawdust, etc., from being thrown at the operator. Machines so guarded are shown in Fig. 68 (page 58). It is well to have a pendant flap attached to the suspended board. A metal hood can well be used with the suspended board guard mentioned, the hood covering the entire back of the saw but being open on top to let knots fly out. There should also be a stop to prevent the carriage coming too far back and jumping the track, the drive belt and pulley should be boxed or otherwise guarded, and the waste hole alongside the machine should be fenced off. Such guards are shown in Fig. 68, which also shows a little flap running on the track to keep waste from accumulating on it.

The wheels of the carriage and the track on which it runs should be inspected frequently and carefully to see both are in good shape. If the carriage should sag or jump the track, the sawyer, who has to work close to the saw, frequently with an arm on either side, would be in great danger. The inserted teeth often used in this saw should be very carefully set in and locked, as they are put to a nasty strain. The sawyer frequently moves the bolt while it is in the saw, twisting it around, if it is a round block, to follow the contour of the sap.

To prevent the sawyer losing his footing when shoving a piece through the saw, the floor on which he stands should be kept free from holes and uneven



Courtesy of H. M. Loud's Sons Co.

Fig. 67. Shingle Cut-Off Saw Guarded.

places, and as clear as possible of the bark, knots and slippery and slimy pieces of wood which fall from the saw and the carriage.

Horizontal Shingle Saws. In operating the one-block or two-block power-

feed machines, one of the chief dangers is in reaching in to remove a spalt. It is advisable to use a machine whose carriage has a safety spalting curve which never goes over the saw and which keeps the sawyer's hand from being crowded on to the saw, several inches of the curve opening being clear of the saw when the carriage is over the blade. In operating the hand-feed one-block machine, the sawyer should take care not to saw down to too



Courtesy of St. Paul & Tacoma Lumber Co.

Fig. 68. Guarded Knee Bolters.

small a spalt, or his hand holding the block will be in danger.

The carriage of a power-feed machine should be kept in good condition, so as not to lock up and then start suddenly on the sawyer. Lost motion should be watched for and kept out. This carriage undergoes severe strain and should be closely inspected daily by the filer or foreman. The carriage of the hand-feed machine requires similar attention. Whether a machine is power-feed or hand-feed, there should be a clutch on the driving shaft, by which the shaft can be stopped for changing saws or doing any work unsafe to do with the saw running.



Courtesy of St. Paul & Tacoma Lumber Co.

Fig. 69. Shingle Saws.

The guard over the back of a horizontal shingle saw should never be touched for changing the saw until the saw is stopped. It should also be kept down over the saw when running. An operator of a one-block or two-block machine is apt to raise the guard, as shown in Fig. 69, so that if a knot, sliver or small spalt

gets off the saw it will fly out the back and not hit him on the hand. This practice is dangerous, the risk to those in the vicinity being much greater than the operator runs by leaving the guard where it belongs.

The ten-block rotary machines which automatically kick out the spalts are very safe machines, as the sawyer does not have to be near the saws. There should always be guards outside the saws, however, as shown in Fig. 69.

Upright Shingle Saw. This machine should have the run of the carriage enclosed, as shown in Fig. 70, and it is a good idea to have a railing along the outside of the run to prevent anyone falling into the saw or carriage gear. The back part of the saw should be guarded by a heavy plank set upright behind it. The carriage should be closely inspected daily by a competent man. It is especially important that the carriage trip works properly, so there will be no danger of its moving while being bolted. The operator should never attempt to take out a spalt or bolt the saw while the carriage is

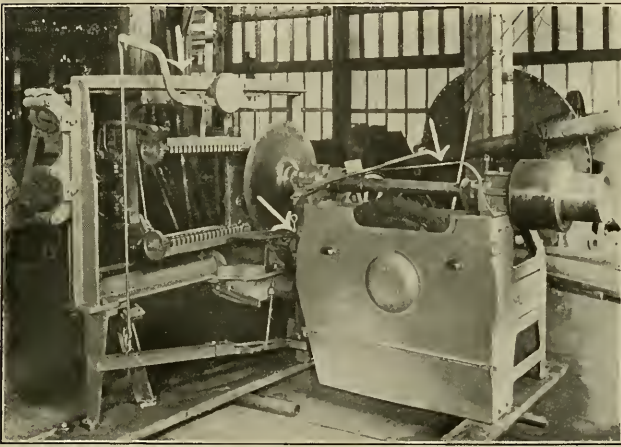

Courtesy of Sumner Iron Works.

Fig. 70. Upright Shingle and Clip Saws.

in motion. The floor around the machine should be kept both clean and in good shape.

The shaft of the machine, which usually runs right back of the neighboring clip saw or jointer should be guarded its entire length, and the belt should be both guarded and kept in good condition, to prevent its breaking and whipping over at the sawyer, who often works the clip or jointer as well as the upright machine. The upright and the clip saw should run on the same counter-shaft, so that when the upright is shut down to change saws or for other purpose the clip will also shut down. Otherwise men working on the upright may get into the clip saw.

Piling Blocks. Blocks should be piled up near the shingle sawyer with great care, as if the pile should topple over both shingle sawyer and block piler would be in danger. The blocks sometimes come faster than the shingle saw can handle them, and, if possible, there should be plenty of room for storing them without piling them too high.

Knot Saw. The part of the saw under the table should be covered by a dust spout or otherwise guarded. From the edge of the table down which the shingles are slid from the shingle saws, which usually extends a little more than half-way over the top of the saw, a stiff leather or metal strip should be hung down as close as possible to the saw. This will serve as a warning if the sawyer's hand, in reaching up to the table for more shingles, gets too close to the saw.

To prevent a flying shingle or spalt, coming down the inclined part of the table, from hitting the sawyer, a heavy wire screen should be suspended over the incline about half-way up. The screen should come down as close to the table as possible without interfering with the shingle supply coming down. Usually it should be from 6 to 12 inches above the table. The screen should be hinged above, so that if too big a bunch of shingles comes down at once it will check the bunch but not altogether stop the supply. The carriage and track should be kept in good condition, so the carriage will not jump the track.

Jointer. This machine should be completely housed with strong sheet iron, except for the feed opening, which should be just large enough to let the shingles through it. Jointer operators should never wear gloves when at work. The knives should be set only by an experienced man and they should be fastened very securely. If set too far out or unevenly, they may kick the shingle away from the rest and draw in the operator's fingers. If a knife should work

loose and come in contact with the housing or the rest, it might tear either to pieces, as well as break the rim, and throw the pieces far and wide. Knives should be kept very sharp, so the operator will not have to shove so hard that he may split a shingle and thus get his hands on the knives.

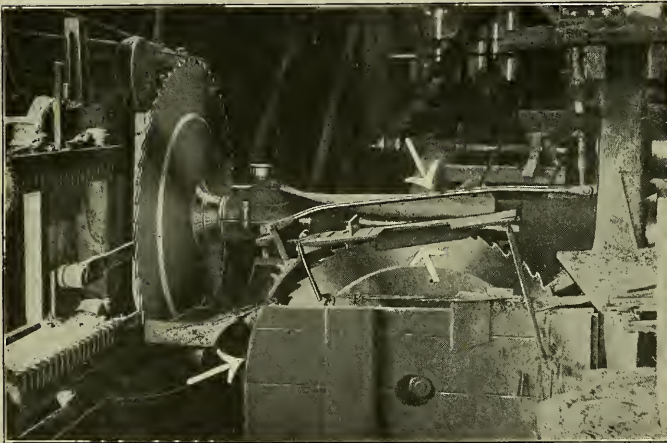

Courtesy of Woods Creek Mill Co.

Fig. 71. Clip Saw Guarded.

machine, the sawyer's hand being always close to the saw. There should always be an iron guard over the top of the saw, as shown in Fig. 71, and Fig. 70 (page 59), to prevent the operator's hand coming in contact with the saw when he reaches over it to hold the other part of a shingle to be split. This guard, preferably of flat iron, should be at least two inches wide and strong enough to support the weight of a man's body should he slip and fall on it. There should also be a finger guard underneath the front edge of the springboard, as also shown in Fig. 71, to prevent the operator's hand coming against the saw underneath the board when he is splitting, taking out a knot, working a narrow shingle, etc.

The bottom part of a clip saw should be housed in. A metal casing is shown in Fig. 70 (page 59) and a wooden housing in Fig. 71. The housing should come as far up as possible without interfering with the working of the springboard, and should be carried well down below the bottom of

Clip Saw. The springboard clip saw is a very dangerous machine,

the saw. Any hole cut in the housing for kicking waste down the spout under the saw should be as low as possible, to prevent the operator's foot getting against the saw. Such a hole should be as small as possible and should not be allowed to get dangerously large through wear.

If the shingles come down to a clip saw on a table, there should be a positive stop at the end of the table near the saw to prevent any shingles coming over on the saw teeth. The floor about a clip saw should be kept in good condition and clear of rubbish. An operator has to work very rapidly, especially if he also tends an upright shingle saw near by, and he needs secure footing.



Courtesy of St. Paul & Tacoma Lumber Co.

Fig. 72. Screen and Guards for Shingle Packers.

keep the shingles from coming too fast. The whole frame will swing in proportion to the number of shingles in the bin.

Other Machines, Etc. Drag saws used for cutting logs to block length, pull or jump cut-off saws, band saws used for pointing shingles and rounding them up, live rolls, conveyors, runways, log hauls, dry kilns, etc., should be guarded as suggested elsewhere (see index).

Transmission. This feature of a shingle mill should be treated like that of a sawmill. Shingle mill belts need especially good guarding, as they are apt to run close to the floor and are large and speeded high. All belts and pulleys and gears driving machines or feeds should be boxed up, screened or railed off.

For the guarding of belts and pulleys generally, and other driving apparatus in a saw mill or a shingle mill, see the chapter on Power Generation, Transmission, Etc.

Packing. To prevent a man knot-sawing, jointing or clipping from throwing stuff down on the packers, there should be a swinging screen guard, similar to that for knot-sawyers, suspended about half-way down the inclined table on which the shingles come to the packers. Such guards are shown in Fig. 72. Fingers and slats are hinged to the bottom part of the screens, to

PLANING MILL.

Sizers, Moulders, Etc. Many of the roll-fed machines used in a planing mill, such as sizers, big surfacers, planers and matchers, matchers and outside and inside moulders require substantially the same guarding in most respects. All knife-heads should be enclosed as fully as possible by suction hoods or other metal covers. No open heads should run under any circumstances. Some kind of enclosure can always be provided without choking or clogging up.

All cog gearing should be covered, by gear cases preferably. If such cases are not furnished with a machine, they can be purchased or suitable ones improvised at the mill.

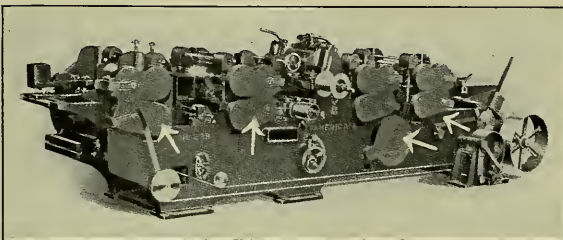

Courtesy of American Woodworking Machinery Co.

Fig. 73. Gear Cases for Planer and Matcher.

A good example of gear guarding is shown in Fig. 73, a picture of a hardwood planer and matcher made by the American Wood Working Machinery Co., of Rochester, N. Y. Any feed roll gears situated inside a planer frame should be completely guarded with metal covers.

The main drive belts and pulleys should be boxed or fenced in with wooden slats or wire mesh. There should also be a good strong guard along the pulleys likely to be found at the feeding end of the machine, to prevent the man feeding from being caught and to keep a broken belt from flying. This guard should be quickly and easily removable, for adjustment and lacing of belts, etc. An excellent method of guarding belts and pulleys, countershafts, etc., by surrounding them with wire mesh screens set in angle iron frames, is shown in Fig. 74 (page 63).

Projecting ends of drive pulley shafts, countershafting, etc., should be guarded if there is no housing or if they project through the housing, as they endanger the legs of men working around the machine. A fencing supported from the floor can be used, or a metal casing, or a piece of pipe can be fitted over the shaft which has ears fitting in slots in the bearing box and can be twisted around so it can be taken off when necessary.

All set screws in collars, on feed rolls, or elsewhere about the machine should be of safety type or so protected that they will not protrude. As heavy rolls as possible should be used. In machines working only one or two sides it is often deemed advisable to use sectional feed rolls, to prevent kicking if thick and thin pieces are in the machine at the same time. Every machine should

be equipped with an efficient belt shifter, clutch, or other means of quickly disengaging the power. It is advisable to use flanged pulleys on all heads.

The old style of big timber planer whose knife is set in the end of a revolving arm, or extends the whole length of the arm, is very dangerous. There should be a substantial upright guard extending on each side of the run of the arm, and a similar guard at both back and front. If the machine is set against a wall, only one side need be guarded. The guards should be very strong, so as to check a flying knife. Heavy wire mesh can be used, or metal hoods can be hinged to the frame, both front and back. The machine should be placed in such a position that should material be piled near it no one will get caught between the bed and such material when the bed is at its extreme travel either way.

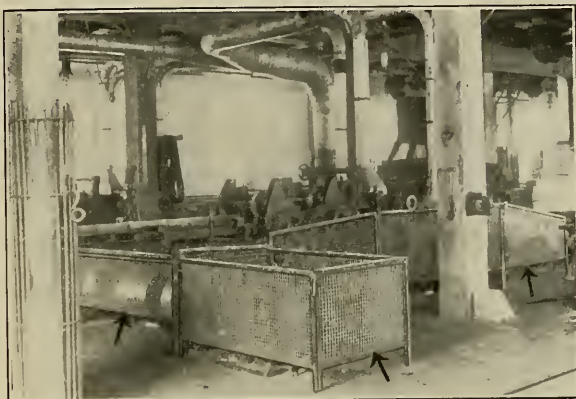

Courtesy of International Harvester Co.

Fig. 74. Screen Guards for Planer.

With the newer types of timber planer, in which the cutter head rotates, there should be a blower or other hood over the head, or at least an arm guard reaching out in front of it to warn an operator if his hands should get into a dangerous position.

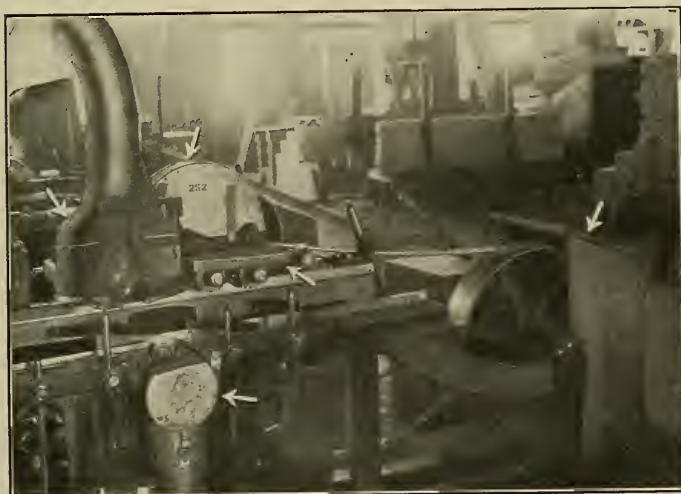

Courtesy of The Wheeler-Osgood Co.

Fig. 75. Door Sticker Guarded.

Feed Rolls of Outside Moulders.

The feed rolls of outside moulders should be guarded to prevent the operator getting caught by them, as he is kept feeding or adjusting at the side of the machine much of the time, and this work and necessary observation bring him very close. The guard should not only cover the tops of the rolls but should protect their

outer ends as much as possible, and should either come down over the front of the front roll as near to its bottom as may be or should extend well out from this roll. Fig. 75. shows a door sticker with a metal guard covering the tops

of the feed rolls and reaching out in front of them. This picture also shows the cog gearing protected by a galvanized iron covering, the drive pulley and belt boxed off, and excellent guarding of the upper head by a blower hood.

The guard for the lower head which will be noted can be slipped up to cover that head when in use.

To prevent an operator's hand getting crushed between the front feed roll and material being fed, a safety roll or bar is sometimes placed in front of the roll, attached in such a way that it will raise and lower with it and will always be just a little above its bottom.

The Germans sometimes protect the working side of an outside moulder with a metal grating extending the whole length of the machine and brought around the feeding end. The material being fed through this grating, the operator's hands cannot come near the rolls when feeding.

Knives and Cutter Heads. Care should be taken that only knives of

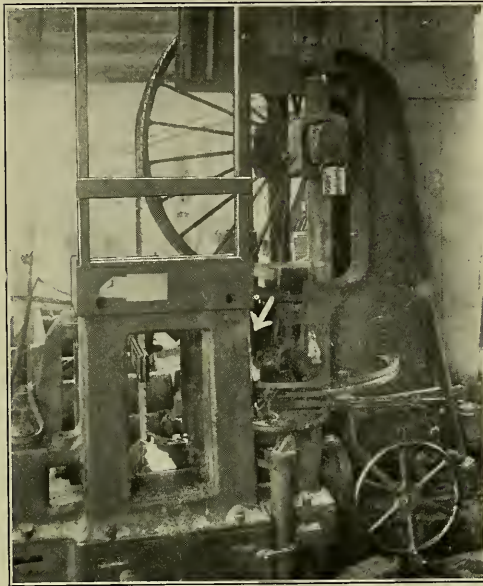

Courtesy of Defiance Lumber Co.

Fig. 76. Band Resaw Rolls Guarded.

the right kind, of the best quality and of even temper and of even temper are used, and that they are properly ground, correctly set and perfectly trued. It is well to have an automatic machine for grinding. Heads should be in "running" as well as "standing" balance. Cutter heads can well be cylindrical in shape, both for safety and for good work. Such a head avoids the tendency of shavings to pack under the lip and greatly reduces the danger of breakage. Cylinder heads can be obtained, too, in which the knives are fastened in such a way that they cannot fly out. Journals and boxes should be kept in the best of condition, and lubrication should be thorough. Great care should be exercised in setting knives, in order to prevent their flying out.

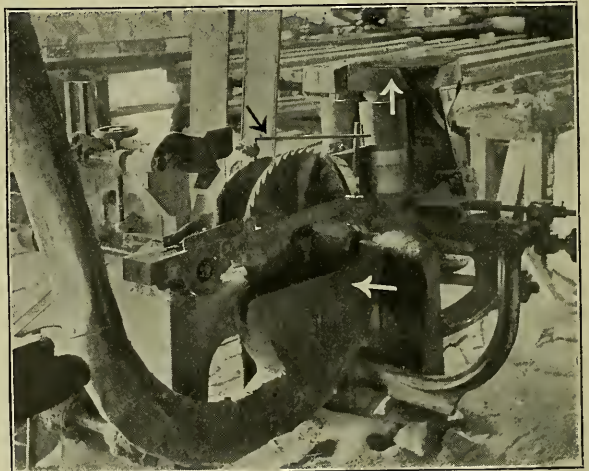

Courtesy of St. Paul & Tacoma Lumber Co.

Fig. 77. Circular Resaw Guarded.

Care in Operation. When adjusting a head or knives, cleaning or doing other work about the machine, the entire machine should be shut down, and a rule to this effect should be enforced. Cleaning out of knots or slivers should

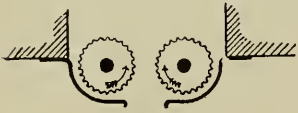

Courtesy of North German Woodworkers Ass'n.

Fig. 78. Guards for Resaw Feed Rolls.

not be done while the machine is running, nor should an operator reach in to pull out a broken piece. It is very dangerous to do any cleaning up about a machine while it is in motion. Workmen should not wear gloves when approaching moving parts, and their sleeves should be short or tight fitting.

Gang Ripping Machines. These machines should be guarded like saw mill edgers (see index). If a solid feed roll is used, it is advisable to feed only one piece at a time, as if two pieces of different thicknesses are in the machine at the same time the thinner may be kicked. Trying to increase the output by feeding one piece above another is a very dangerous practice. The feed rolls should be very carefully adjusted to assure a firm and steady feed, and should be heavy.

Resaws. Both circular and band resaws should have the gears at the tops of the feed rolls guarded, and the point of entrance to the feed rolls should be protected to prevent operators' hands getting caught. Some machines are guarded by the makers.

Fig. 76 (page 64) shows a band resaw in which both the gears and the feed entrance are protected by enclosing them in a square frame with an opening as large as the rolls will open. When guards are not furnished, home-made ones can easily be applied to both points. Fig. 77 (page 64) shows such a guard for feed roll gears. The point of entrance to rolls can be protected by fastening metal strips to the framework and curving them around the sides and front of the rolls, as shown in Fig. 78. Another method of guarding is by an arrangement resembling a split dish-pan, one half of which is placed outside of each front roll, the bent edges reaching in front of the rolls. In either case the two parts of the guard should come as near as possible to each other in front of the rolls.



Courtesy of Rockwell Mfg. Co.

Fig. 79. Blower Hood for Panel Raiser.

A circular resaw should always have a strong splitter back of the saw, and both top and bottom of the saw should be guarded. Fig. 77 (page 64) shows such a resaw equipped with a substantial splitter, with a bar guard for

the top of the saw and with the lower part of the saw protected by a dust spout. Such a spout can well be brought up close to the arbor. In place of a bar guard for the saw top, a hood is often used, extending from the feed rolls to a point well back of the saw. Such a hood can be built up from the table or supported from above. The combination machine for planing and splitting siding or weather boarding should have its cutter heads covered, and the saw should be entirely enclosed both top and bottom. An operator of a circular resaw should be very careful not to open up the feed rolls when a piece is going through, and thus allow kicking.

The wheels of a band resaw should be watched carefully for any defects or wear which might allow them to fly to pieces. Care should be taken not to overspeed the machine. The wheels should be housed, and the return part of the blade guarded if it runs exposed. It is a good idea when the upper

wheel is not housed to have a heavy plank, firmly supported, run along the top to diminish the force of a breaking blade. When there is a cross belt in front of, where the operator stands, as is often the case with big machines, it should be boxed, as the operator sometimes has to step over it to get close to the machine. Any wheel pit for a band resaw should be fenced.

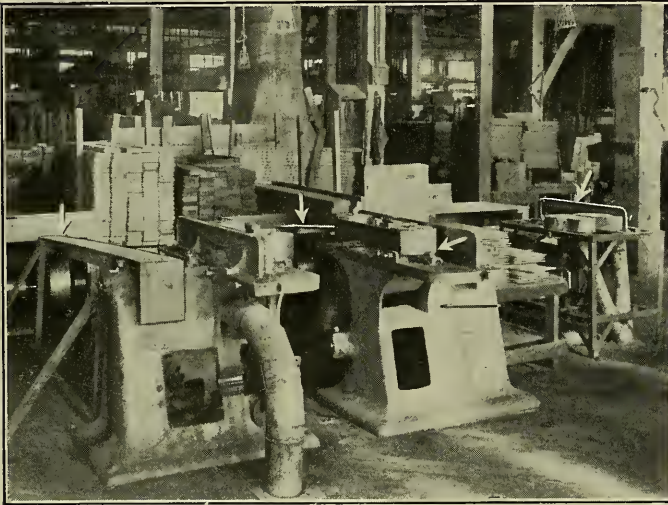

Courtesy of The Wheeler-Osgood Co.

Fig. 80. Panel Raisers Guarded.

Panel Raisers. The machines used for raising door panels should have their cutter heads enclosed as fully as possible. Fig. 79 (page 65) shows a hand-feed machine with its head guarded by a suction hood. The power feed machine in which the panel is carried through by vertical rolls or by a belt running on edge can well have the roll or belt at the feeding end protected by a shield, as shown in Fig. 80. This picture also shows the belts and driving pulleys guarded. At the right is a panel sander with its disks hooded and with a strap iron guide which helps to keep the operator's hand from slipping down the panel and into the machine.

There are double head machines for raising any shape of panel on both sides at once which require guarding of feed rolls like a sticker. When panels are raised on a shaper, the head should be entirely enclosed, by the guide and otherwise, except for the cutting point. The part left exposed can often be guarded largely by the arrangement for keeping the stock in proper position.

Relishers and Wedge Cutters, Dovetailers. Relishers and wedge cutters for sash and door work should have their saws covered as fully as possible, by permanent or hinged covers. With some machines a shield can be fastened to the framework back of the saws, extending out across their tops and curving down in front as far as the work will permit. Such a guard is furnished by some makers.

The grooving saws of sash dovetailers are often guarded by means of suction hoods. The cut-off saw or saws of such machines should also be guarded as fully as possible when they are so situated that contact with them is likely. A band guard can often be used when no suction hood protection is available.

Blind Slat Machines. The blind slat resaw should have its saws guarded both above and below the table. Some machines come equipped with a steel spring shield for the top of the saws, which also serves as a pressure to hold the lumber in position, and with a cast iron shield for the part of the saws beneath the table. The spurred feed roll should be guarded by a shield curved well down over the front as well as the top, and such a guard is often furnished by the maker. The safest blind slat planers are automatically fed, the under slat being taken each time from a hopper which the operator keeps filled. There are also automatic blind slat tenoning, boring, and boring and mortising machines.

Wood Trimmers. The trimmers used for cutting moulding for doors, etc., should have hinged metal shields at each end of the knife's travel. Such guards are often furnished by the makers. When they are lacking, home-made ones can be installed, each guard arranged on a spring which holds it in an upright position except when the knife is at its end. A projection beyond the edge of the knife will push the guard back to allow the sliding of the knife head.

Miter Saw Guard. Fig. 81 shows a guard for a saw set in a swinging frame which is used to miter moulding for doors. The guard, which is simply a piece of wood rounded out to conform to the curvature of the saw, is attached to the frame work back of the saw. It can be adjusted so as to guard all of the saw except what must be left exposed for the cutting. Saw and guard are brought down on the material to be worked by means of a foot treadle. Such a saw usually runs near the edge of a bench and the operator stands close up to it.

Other Sash, Door and Blind Machines. The saw often used in connection with a sash sander for cutting the check rail of the sash can well be substantially hooded, as shown in Fig. 82 (page 68).



Courtesy of Standard Millwork Co.

Fig. 81. Miter Saw Guarded.

In dadoing the safest plan is to feed the stock on a sliding table, and a lever should be used for clamping small stock. When the cutting is done with the upper part of the saws or heads the under part of the cutting tools should be guarded by suction or other hoods. If an under-fed machine is used, the top part of the cutters should be hooded as fully as possible. When these cutters are set along the back of the machine they are especially apt to be dangerous if the space behind is used as a passageway.

The hand-feed dowel pin machine should be boxed in except where the material is fed, and a substantial push-stick should be provided for pushing the last piece through. The automatic dowel maker should have the entrance

to the feed rolls so guarded as to prevent an operator's hand from getting caught.

The trimming saws of diagonal planers should be hooded down as far as the work will permit, and the gearing driving the feed rolls should be enclosed.

Butting Saws. The single and double butting saws often used for trimming flooring as it comes from high-speed floorers should be fenced off so that their backs, tops and sides will be guarded when they are at rest. Whenever possible, it is advisable to cover each saw with a hood, attached to the frame of the carriage so that all of the saw will always be covered except what must be left exposed for the work.

Picket Header. The machine in which the knives are set in a disk should have the bottom part boxed and the upper part covered by a hood, hinged to the machine frame, which will leave only working space exposed.

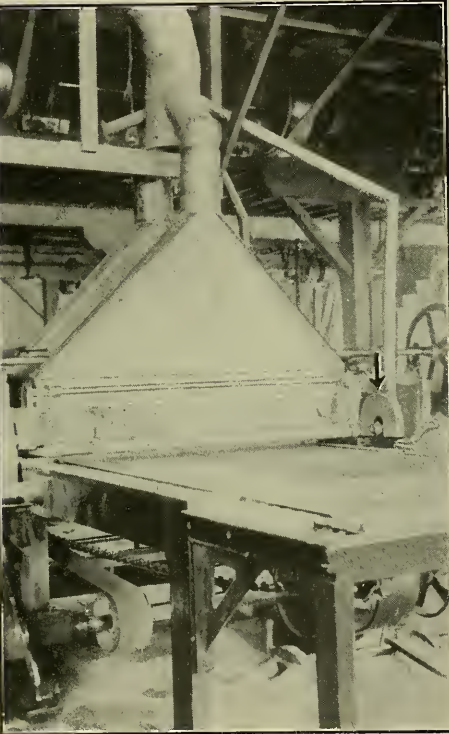

Courtesy of Rockwell Mfg. Co.

**Fig. 82. Sash Sander and Trimmer,
Saw Guarded.**

This machine is much safer than the saw picket header.

Conveyors. Any live roll conveyors used in a flooring or other planing mill to carry finished stock to the stock room or for other purposes should be guarded like saw mill live rolls (see index). Where no blowing system is installed, conveyors are often used to carry away the waste and refuse. These conveyors usually run under the floor, and there are holes in the floor for sweeping stuff into them. The loose plank often used to cover such holes when not in use is dangerous. There should be a trap door which closes automatically. This can be hooked open when stuff is being swept in. There should never be such a hole in an aisle. Holes should be preferably under a

bench or in a corner that can be railed off. Wherever possible, railings should be provided around openings in floors, in addition to covers, as employees are often very careless about closing covers.

Other Planing Mill Machines. The other machines used in one or another kind of planing mill, such as rip saws, cut-off saws, swing saws, borers, mortisers, sanders, surfacers, tenoners, shapers, jointers, band saws, grinders, lathes, etc., should be guarded as suggested elsewhere (see index).

Transmission, Etc. For the guarding of belts and pulleys generally, or other driving apparatus, see the chapter on Power Generation, Transmission, Etc.

CIRCULAR SAWS.

The circular saw is at the same time about the most convenient and the most dangerous of woodworking tools. The variety of uses to which it is applicable is only equalled by the variety of accidents which it can cause. A

very large percentage of saw accidents is attributable to the carelessness of workmen, but it is only natural that men working in close proximity to danger should come in time to lose the constant sense of it which is present with them at first. This is bound to happen even in the case of men who are naturally very careful. As for a new man on a saw, he may get dangerously near the teeth despite his utmost care. When a saw is revolving, the space between the teeth shows up much lighter than the solid part of the blade, sometimes

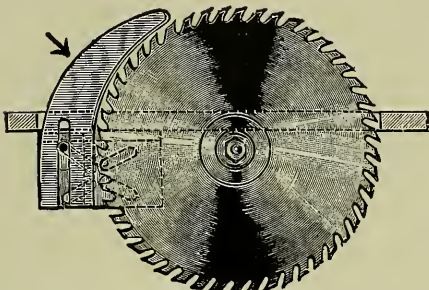

Courtesy of North German Woodworkers' Ass'n.

Fig. 83. Splitter Adjusted to Large Saw.

seeming to be hardly more than a light blur. Again, a sawyer's attention is open to distraction by innumerable things, any one of which may cause that only slight displacement of the hand which will result in an accident. And, too, there are many dangers connected with the operation of saws which the utmost carefulness cannot surely avoid. Such a dangerous tool demands that every effort be made to guard it.

RIP SAWS.

An effective guard for a rip saw should protect back, crown and front—the back because pinching there causes wood to climb and be thrown, the crown because it throws wood which has pinched and climbed, and to prevent accidental contact with it, and the front to prevent contact.

The Splitter. Every rip saw should have an adequate splitter, or spreader, behind it, to prevent wood pinching. This will also guard the hand of an operator reaching back of the saw, protect an off-bearer, and prevent

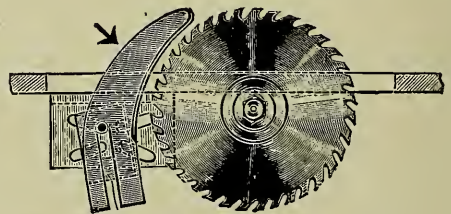

Courtesy of North German Woodworkers' Ass'n.

Fig. 84. Splitter Adjusted to Smaller Saw.

edgings being caught and thrown. A splitter may be either straight or curved, but the curved kind, conforming closely to the curvature of the saw and covering the back as far as possible up to the crown, is preferable. Whatever the

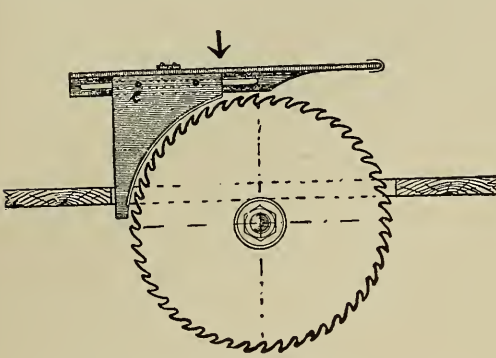

Courtesy of North German Woodworkers' Ass'n.

Fig. 85. Splitter Supported from Above.

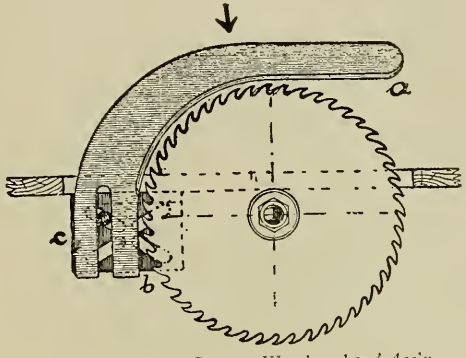

Courtesy of North German Woodworkers' Ass'n.

Fig. 86. Extended Splitter.

kind, a splitter should be of the best steel, smooth in finish, and slightly beveled on the inner edge. It should be slightly thinner than the saw kerf, but thicker than the saw disk. It should always be very securely fastened, and carefully adjusted so as to be in true alignment with the saw and not over 1-3 inch behind it.

A splitter can usually be attached to the table or, in the case of tilting tables and those in which the saw arbor raises and lowers, to the framework underneath. If it is attached to a throat plate, care must be taken that the plate is securely fastened in place, as if anything gets caught splitter and plate are both apt to be pulled out. If the plate is a loose board, it is well to have the rear end shaped to fit into a notch. Any buttons used for fastenings should be carefully watched to see they do not work loose.

To keep a curved splitter close enough to either a larger or smaller saw and have it always conform to the curvature, it should be adjustable both vertically and horizontally. Figs. 83

and 84 (page 70) show a way of effecting this in use in Germany, by means of two slanting slots in the gauge and one vertical slot in the splitter. Use of an intermediate plate between splitter and gauge enables the splitter to be kept in exact alignment with the saw. When the different saws used in a table vary sufficiently in thickness, different splitters should be used, so the thickness will always be right.

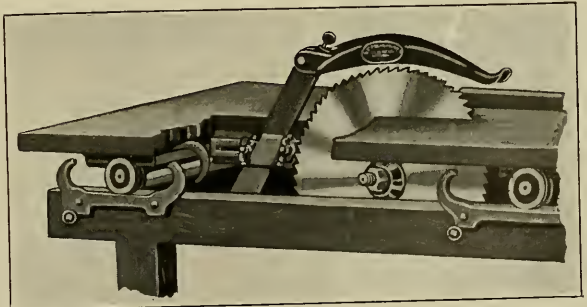

Courtesy of L. F. Grammes & Sons.

Fig. 87. Reliable Saw Guard.

When a splitter is removed frequently, for grooving or other work, and adjustment in either of the usual ways is therefore deemed impracticable, it is sometimes supported from above. Such an arrangement is shown in Fig. 85 (page 71). The splitter is adjustable along a slot in the strip supporting it,

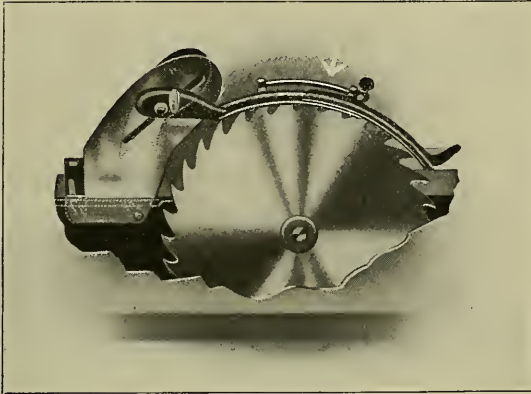

Courtesy of E. C. Atkins & Co., Inc.

Fig. 88. O. K. Saw Guard.

which also covers the saw top. This strip can be supported by an arm coming out from a standard at the side of the table, or by a framework hanging from the ceiling, in either case adjustable vertically. When even such a simple strip would be in the way, as in cutting very thin pieces which have to be shoved away from the saw with a stick, or when the strip would throw an undesirable shadow on work, the upper teeth of the saw can be covered by extending the splitter itself over them as far as possible, as shown in Fig. 86 (page 71).

A splitter is perhaps the most essential feature of rip saw protection, as it guards the most dangerous part of the saw. In Germany the law requires a splitter in connection with all rip saws which do not have pressure rolls close behind the saw blade.

Splitter Guards. Fig. 87 (page 71) shows a guard of the familiar Reliable type, made by L. F. Grammes & Sons, of Allentown, Pa., which is a combination of a splitter with a light and shallow hood protection for the top of the saw. Both splitter and hood are adjustable.

Another type, known as the O. K., and made by E. C. Atkins & Co., of Indianapolis, Ind., is shown in Fig. 88. It, too, is a combination of a splitter with a hood-like protection for the top of the saw, and it is adjustable to fit different sizes of saws. The hood is of the extension variety, adjustable by a thumb screw. A dog is attached to the splitter, to aid in holding wood down.

A German guard, the Goede, is shown in Fig. 89. To the adjustable splitter is attached a light wooden hood hollowed out so as to cover the upper teeth of the saw. At the left of the cut the guard is shown adjusted to a larger saw; at the right, to a smaller one.

Fig. 90 (page 73) shows another splitter guard, made by the J. A. Fay & Egan Co., of Cincinnati, O. The hood is adjustable on the straight splitter, and is hinged so as always to be close down over the saw except when raised by



Courtesy of North German Woodworkers' Ass'n.

Fig. 89. Goede Saw Guard, Adjusted to Large and Small Saws.

material coming in contact with the split finger arrangement in front.

Hood Types of Guard. Some prefer hood guards, supported from above or from a standard at the side of the table, to splitter ones, on the ground that, in addition to keeping wood from climbing, they prevent such kicking as may result from a knot or change in grain being struck or a piece jamming between saw and guide or being dropped on the teeth, guard an operator better against being cut by the saw teeth, keep slivers, loose knots and pieces of knots from striking him, and protect him against blinding sawdust. It is always best, however, to use a splitter in connection with a hood guard, whenever possible.

A hood guard should be kept down as close as possible on the material. To enable the sawyer to see the line of his cut well, the hood can be turned up a little in front, or the top or all of it can be made of wire mesh. The Germans often leave the top

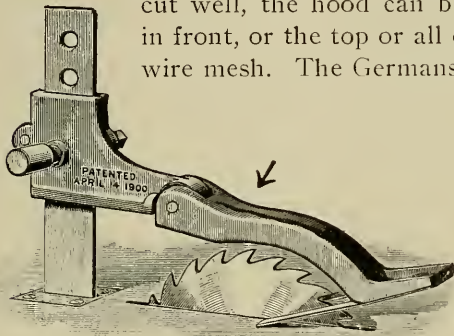

Courtesy of J. A. Fay & Egan Co.

Fig. 90. Fay & Egan Saw Guard.

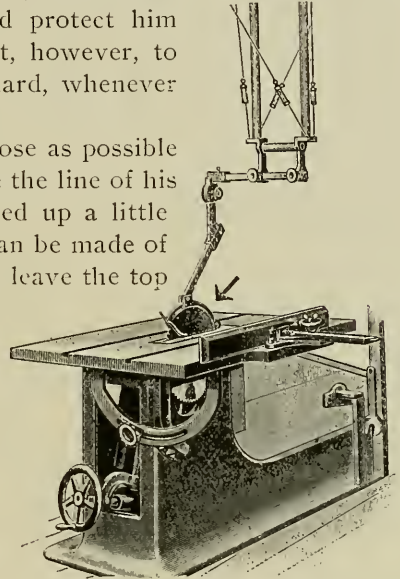

Courtesy of Jones Safety Device Co.

Fig. 91. Jones Saw Guard.

open save for enough cross-pieces to hold it together, and frequently their hoods have slatted sides also. A hood should always be wide enough to allow for vibration, which should also be guarded against by having the supports substantial, keeping taut any guy wires used, and having adjustment joints tight enough to avoid lateral vibration. A hood should also be deep enough not to touch the crown of the saw if it should fall.

Some Hood Guards. Fig. 91 shows a hood guard, made by the Jones Safety Device Co., of Buffalo, N. Y., which automatically adjusts itself to different thicknesses of material. It is furnished with either sheet steel or wire hoods, and they can be of closed variety or with open front. The hood is equipped with a steel dog at the rear.

A wire hood guard suspended from the ceiling is shown in Fig. 92. It automatically adjusts for different thicknesses of material. A slight movement on the counterweight will raise or lower the hood, and the sliding parts can be secured by a turn on a thumb screw. There is a steel dog on the back of the hood. This guard is made by

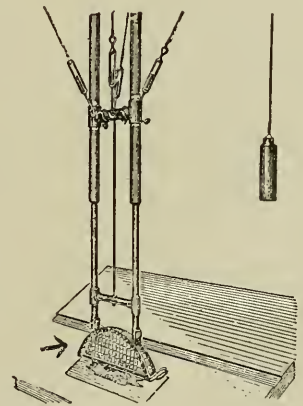

Courtesy of Zeiller & Nagel.

Fig. 92. Zeiller & Nagel Saw Guard.

WOODWORKING SAFEGUARDS

Fig. 93 shows a wire hood supported by a bracket coming from the side of the table. The pedestal is curved, and therefore permits cross-cutting, or dadoing where lumber overhangs the table, 16 inches in the rear of the arbor.

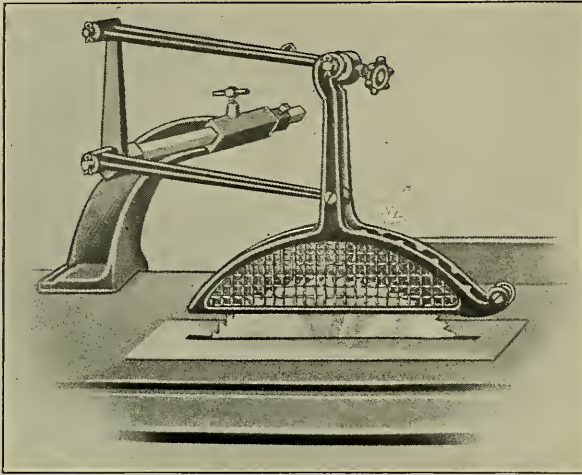

Courtesy of L. F. Grammes & Sons.

Fig. 93. Grammes Saw Guard.

It is suitable for two mandrel tables. It can be swung up out of the way as shown in the cut. This guard is made by the Crescent Machinery Co., of Leetonia, O.

Two home-made adjustable hood guards are shown in Fig. 95 (page 75) and Fig. 96 (page 75). They are similar in all respects except that the former has a closed hood and the latter an open one made of spring steel bent into proper form. The supporting frame in each case consists of a 2-inch pipe fastened on the ceiling with a floor flange and held rigid by wrought iron rods tightened by turnbuckles. Inside this pipe slides another, to the lower end of which the hood is fastened.

An English guard, the "Nonpareil," is shown in Fig. 97 (page 76). It is a balanced hood, moving parallel to the table top and taking up its position by pressure on a roller from the work fed to it. The guard automatically adjusts itself to any thickness. It offers no resistance to entrance of stock, and immediately after stock has passed it automatically covers the saw. It can be attached to the table as shown, or supported from the ceiling.

Other Types of Guards. There are many other types of guard than the two general classes mentioned. The splitter is often used in connection with one kind or another of hood, and the number of home-made devices is simply legion. A splitter and hood guard,

This hood can also be suspended from above, balanced by a counterweight. The makers of this guard are L. F. Grammes & Sons, of Allentown, Pa.

A wooden hood supported from the side of the table is shown in Fig. 94. It is open at the front end, so the operator can see the line of cut. The hood is automatically raised by material coming in contact with it. It is fastened to a sliding steel bar that can readily be adjusted forward or backward, making it

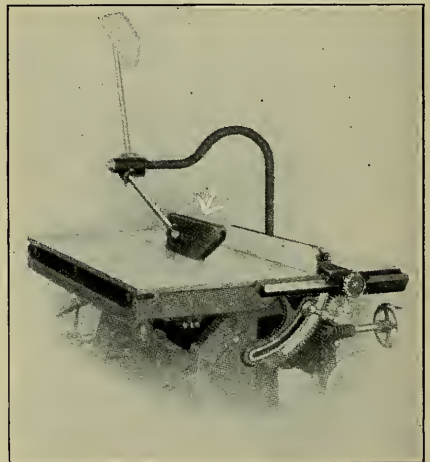

Courtesy of Crescent Machinery Co.

Fig. 94. Crescent Saw Guard.

manufactured by the H. B. Smith Machine Co., of Smithville, N. J., with hood made of wood is shown in Fig. 98 (page 76). This guard is adjustable both vertically and horizontally, and it can be turned up out of the way when desired. A German splitter and hood guard is shown in Fig. 99 (page 76). The hanging support of the hood is fastened by a screw to the wooden hanging post suspended from the ceiling. A slanting slot for this screw enables the hood to be adjusted to saws of different sizes. The hood is automatically raised by stock coming in contact with the turned-up finger in front. When stock work is to be done, the hood can be fixed at a certain height by means of the thumb screw.

Fig. 100 (page 77) shows a rip saw used in a show case factory which is fed by a moving carriage, has a splitter behind it, and is protected both above and below the table by suction hoods. An inexpensive German guard, applicable to a general utility saw, to prevent kicking is shown in Fig. 101 (page 77). The cam-shaped piece (a) has teeth around it to grip a piece of wood that catches on the saw. When the cam grips the wood, the latter is forced more closely against the guide, and thus there is no twist further to grip the saw and make trouble.

Offutt Guard. Fig. 102 (page 78) and Fig. 103 (page 78) shows the Offutt rip saw guard, which has the unique feature of being used to finish sawing the piece. When there is no piece being sawed, the guard hangs down, completely covering the saw. When a board is started, the guard rises up at (A), as shown in Fig. 102, rising against the springs (CC) and also turning on the joints (DD) and (EE). When the cut is nearly completed, the operator grasps the handle (F), as shown in Fig. 103, and pushes the board on through the saw. Thus his hands do not come near the saw. The guard can be swung up on the supports, so as to be out of the way for examining the saw or setting the guide.



Fig. 95. Adjustable Hood Guard.



Fig. 96. Adjustable Open Hood Guard.

German Finger Guard. A peculiar German guard is shown in Fig. 104 (page 79). To a splitter is attached a strip extending along the top of the saw. From this strip depend iron-plate strips fastened in such a way that they are

turned toward the splitter and kept oblique to the sawing direction. They are so superposed as to slip one upon another when lifted. These strips are lifted one by one by material fed, and each falls back into place after the material has passed by.

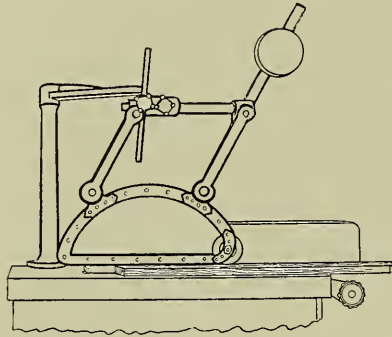

Courtesy of British Factory Dept.

Fig. 97. Nonpareil Saw Guard.

within which the saw runs. In operation the iron hood is adjusted so it will just clear the material. As the material is fed, it pushes up the wooden hood, which is curved at the front. As soon as the material has passed by, this wooden hood drops down again, completely covering the saw. Attached to the clamp at the rear is a swinging toothed dog. This guard is made by the Olympic Foundry & Machine Co., of Tacoma, Wash.

An unique automatic guard manufactured by the Rockwell Mfg. Co., of Milwaukee, Wis., is shown in Figs. 106 (page 80) and 107 (page 81). In operation the hood normally stands in its lower position entirely enclosing the working portion of the saw. When the work is advanced to the saw, its front edge engages the lower end of a lever, causing the lever to swing or draw upon a chain which lifts

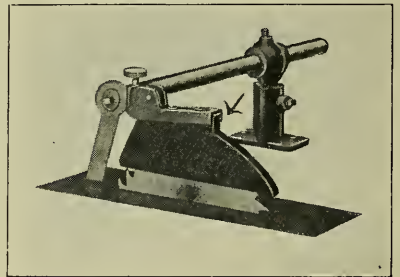

Courtesy of H. B. Smith Machine Co.

Fig. 98. Smith Saw Guard.

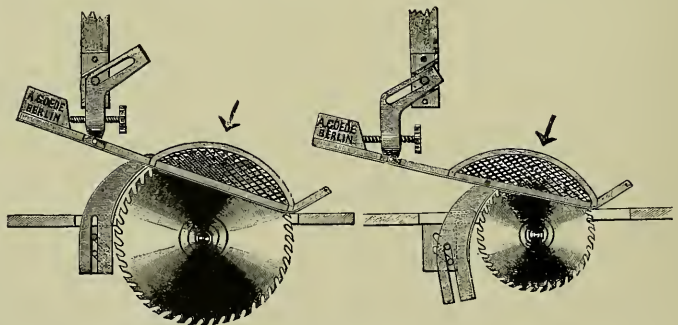

Courtesy of North German Woodworkers' Ass'n.

Fig. 99. Goede Saw Guard, Adjusted to Large and Small Saws.

the hood a distance corresponding to the thickness of the work, thus permitting the work to pass without the saw being uncovered. Should the saw start to throw the wood, either the dog or a separate spur tooth on the foot of the lever

will engage the work. There is a fulcrum connection for the lever which is made adjustable so as to adapt the guard for saws of different sizes and the hook on the lever is also adjustable so as to vary the leverage and the amount of movement of the hood produced by a given movement of the lever. Both hood and lever may be raised to permit the use of the saw without the guard. The sustaining parts of the guard may be attached to saw table, ceiling or floor, as may be most desirable. This guard may also be manufactured in such a way as to adapt it to the tilting table.

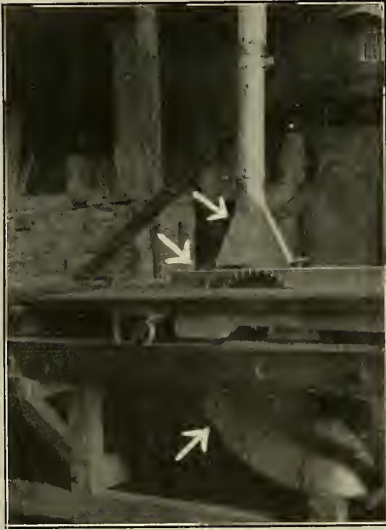

Courtesy of Grand Rapids Show Case Co.

Fig. 100. Blower Hood Saw Guards.

When desired, the hood can be shifted to the right by releasing a thumb screw.

Figs. 109 (page 82) and 110 (page 82) show an aluminum saw guard invented by F. McKee of Beloit, Wis. The principal feature of this guard is the link connection between the hood and where it is fastened. This enables the nose of the guard to ride up easily on material fed to the saw, friction being practically eliminated. In Fig. 109 the hood is attached to a splitter, while in Fig. 110 it is attached to an arm supported from the side of the table. The latter method of attachment is used for pattern shop work. If it is desired to remove the guard for work on which it cannot be used, loosening of one set screw will allow arm and guard to be swung to the side of the table. This guard can also be attached to a framework suspended from the ceiling.

Grooving Saws. Two German devices to guard grooving saws, for which no close hood protection is possible, are shown in Fig. 111 (page 82) and Fig. 112 (page 83). In the former a board supported from the side covers the saw. It is set high enough for work to go underneath it easily, and a slot in the front enables the operator to see the line of cut. It is hinged to the back of its supporting block, so it can be thrown back out of the

In Fig. 108 (page 81) is shown the Prybil saw guard, in which the hood is guided by two links which partially balance it and cause it to raise and lower easily. The guard is supported by pipes with flanges fastened to the ceiling and is rigidly stayed by wire ropes with turnbuckles. While the hood ordinarily raises and lowers automatically, it can be suspended at any height by a spring pin fitting into a series of holes for various adjustments. There is a toothed pawl at the rear end of the hood, to guard against material being thrown back.

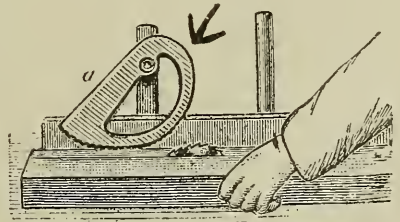

Courtesy of Deutsche Tischler-Zeitung.

Fig. 101. German Cam Guard.

way. Fig. 112 (page 83) shows a guard somewhat similar to an automatic jointer guard. The thin board (d), which turns around a support (e) and is held against the guide by the blade spring (c), is pushed aside by the material fed, and automatically covers the saw again after the stock has passed by. A counterweight might well be used in place of the spring, to give even tension for any width of stock. When no guard is used, operators should avoid the dangerous practice of letting the stock come back

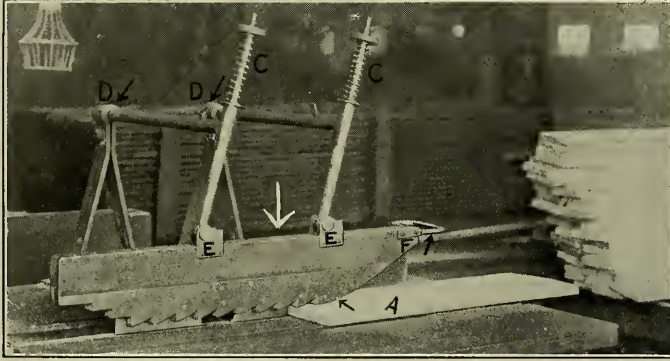

Courtesy of National Tube Co.

Fig. 102. Offutt Saw Guard, Raised by Material.

over the saw. After a piece has been run over the saw, it should always be picked up.

Self-feed Saws. A self-feed rip saw should have a strip metal or hood protection over the saw. If this guard is not furnished by the maker, as is usually done, it can easily be attached by any mechanic. A feeding-out roll also contributes to safety, in carrying pieces beyond the saw. Such a roll should be, and usually is, provided with a thin steel wedge-disk splitter to keep the stock from pinching. To prevent the feeding-in roll catching a hand kept too long on the stock, a guard should be placed over the roll coming down in front as far as possible. This should be attached to the shaft carrying the roll, so as always to be in proper position.



Courtesy of National Tube Co.

Fig. 103. Offutt Saw Guard, Finishing Cut.

Fig. 113 (page 83) shows a home-made device for protecting this roll.

Fig. 114 (page 84), a picture taken in a sash and door plant, shows a self-feed rip saw with a galvanized hood coming down over the front of the feed roll as far as possible. An extension of this hood covers the top of the roll as

far as the suction hood to prevent the operator's hand, when reaching up to the lever which shows close to the blow pipe, from getting in the teeth of the roll.

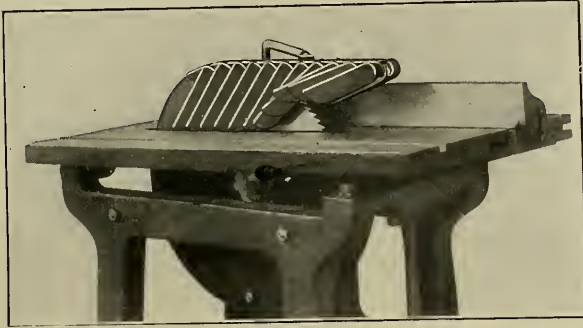

Courtesy of American Museum of Safety.

Fig. 104. German Finger Guard.

The saw is protected both top and bottom by suction hoods, and a slanting board guards the drive belt. The sprocket and chain or gearing driving the feed should always be well guarded, to prevent an operator's hand being caught when adjusting, or at other times.

While self-feed saws are normally safer than hand-feed ones, they should be carefully operated and adjusted. The whole feed framework is severely strained by operation, and should be examined carefully and often. Special attention should be paid to the feed drive, as, if the feed is thrown out of commission, the stock may kick before reaching the feeding out roll. In operating there is danger from the operator lifting the feed apparatus so as to drop it on the stock and get a better grip.

CUT-OFF SAWS.

The operation of cut-off saws does not involve the same degree of risk as that of rip saws, so the protection can take a simpler form and yet be reasonably effective. For the ordinary cut-off machine whose saw has a fixed position in the table, any of the rip saw hoods already illustrated or described which leave the table clear can be used. For many kinds of work a hood can overhang the saw from the rear, where it is fastened by a hinge so it can easily be thrown back when necessary.

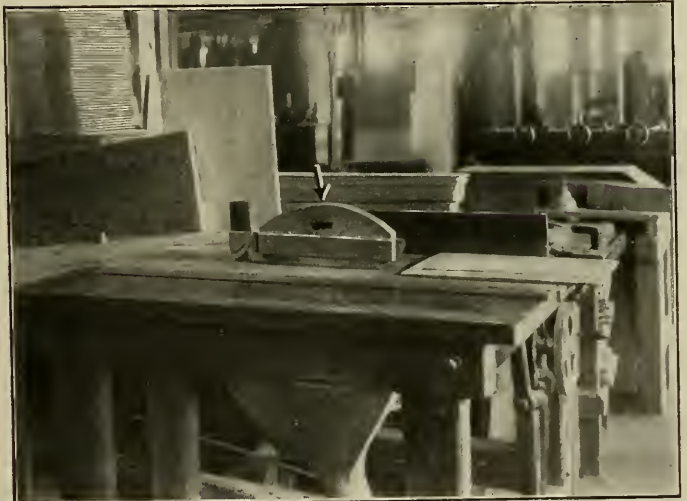

Courtesy of Olympic Foundry & Machine Co.

Fig. 105. Pogue Double Hood Saw Guard.

Even a strip of metal bent to conform to the curvature of the saw, and securely fastened at the rear, will prevent many accidents. Such a home-made device is shown in Fig. 115

(page 84), a picture of a stationary table saw used for cutting off the ends of wagon shafts.

To guard a cut-off saw further when not in use, a strip can be hinged to the front of the hood which will cover the front teeth when the saw is not being used but which can easily be thrown up when work is being done. When an off-bearer is employed, and a hood does not protect the rear teeth, it is a good idea to have a splitter back of the saw, to keep his hands from coming in contact with the teeth.

Another arrangement for guarding a cut-off saw is shown in Fig. 116 (page 85). A framework hinged to uprights at the rear of the table covers each side of the saw, its own weight holding it down on the table except when raised by material fed to the saw. The front is curved to allow easy feeding, and the top of the saw is covered by a horizontal strip.

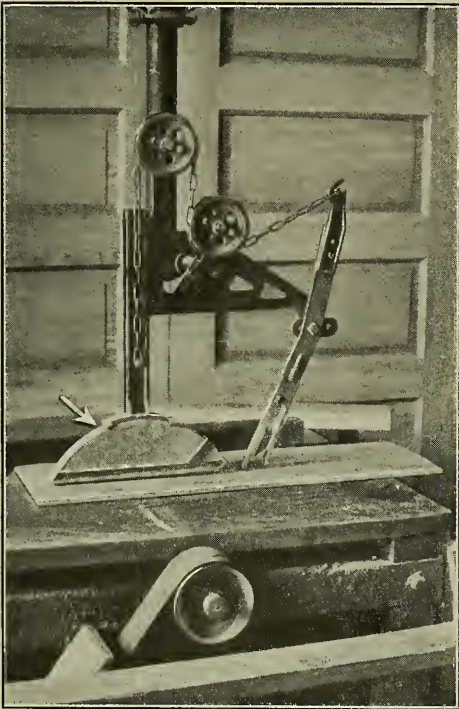

Courtesy of Rockwell Mfg. Co.

Fig. 106. Rockwell Saw Guard.

Double Cut-off Guard. For double cut-off saw machines, which are much used in many factories, hood guards can be suspended from the ceiling, adjustable along a bar extending the length of the table. Such an arrangement is shown in Fig. 117 (page 85), a guard made by the Jones Safety Device Co., of Buffalo, N. Y. The hoods adjust automatically for different thicknesses of material, are equipped with steel dogs at the rear, and can be turned up out of the way when necessary.

Traveling Cut-off Saws. Whenever possible, such a saw should be guarded by a hood the supporting frame of which is attached to the saw carriage, thus keeping the hood always over the saw as it moves to and

fro. The hood should also adjust automatically for different thicknesses of material. Such a guard for a railway cut-off saw, made by the Jones Safety Device Co., of Buffalo, N. Y., is shown in Fig. 118 (page 86).

Where it is impossible to apply such full protection, there should at least be a permanent covering which will guard the saw at rest. A saw so guarded by its makers, the E. & B. Holmes Machinery Co., of Buffalo, N. Y., is shown in Fig. 119 (page 86). If no such covering comes with the machine, a home-made one can easily be attached. When a traveling cut-off saw is operated by a handle extending above it from the rear, a hood can often be attached to this handle.

Feeding Material. It is much safer to feed material to a cut-off saw by

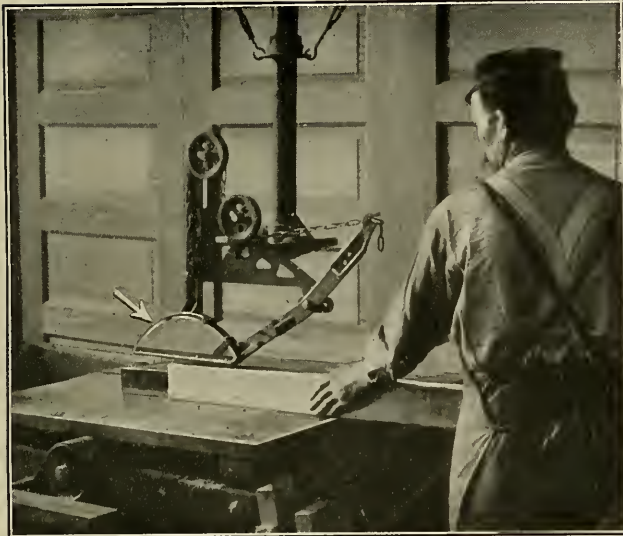

Courtesy of Rockwell Mfg. Co.

Fig. 107. Rockwell Saw Guard, 2 x 4 Being Ripped.

means of a sliding table rather than by hand, and such tables can well be used whenever practicable. When cross-cutting into several small pieces at one operation, there should be a clamping device for holding the stock on the carriage, as otherwise the operator runs much risk of injury in holding the stock as it goes between the saws. When round or polygonal material is cut, some secure scheme of holding should be rigged up so the stock can't get away from the operator. Such

irregular shapes are very hard to handle. Clamping the piece in a groove in a board gives a good grip on it.

An operator should be careful in feeding material to a cut-off saw, as jamming, though not so likely as with a rip saw, may occur unless the feeding is accurate, even between the two saws of a double cut-off machine. If the stock is fed by hand, one hand may press a little harder than the other, and so feed the material in at an angle.

Carriage Fed Cut-off Guards.

When a feeding carriage is used, and there is no hood supported from above, a hood can often be attached to the carriage which will cover the saw completely when not in use. Such a German guard is shown in Fig. 120 (page 87). From the top of the hood a strip extends to protect the top of the saw when not covered by the hood proper. The stock is held against the front of the hood while being cut. A counterweight brings the carriage back automatically.

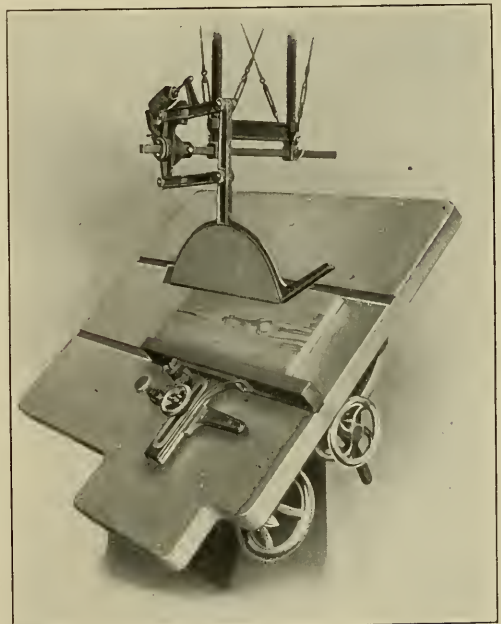

Courtesy of P. Prybil.

Fig. 108. Prybil Saw Guard.

A counterweight brings the carriage back

WOODWORKING SAFEGUARDS

Another German arrangement of similar nature is shown in Fig. 121 (page 87). The wood to be cut is placed on the carriage against the two iron strips (h). To the lower part of the carriage at the

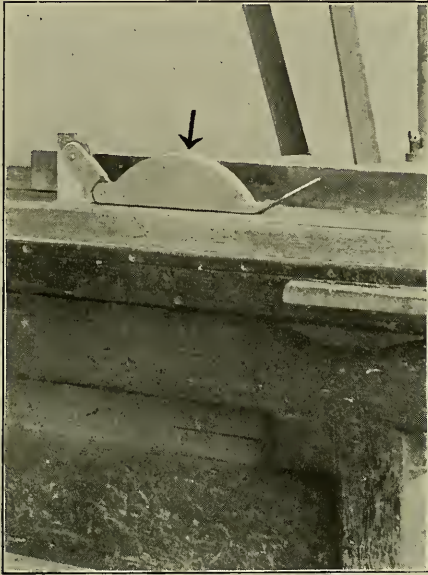

Courtesy of Fairbanks, Morse & Co.
Fig. 109. McKee Saw Guard, Attached to Splitter.

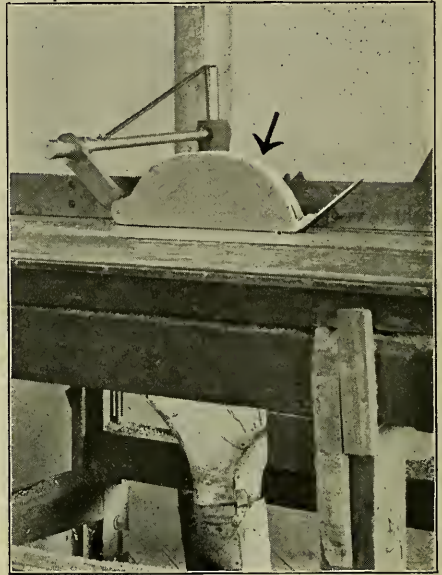

Courtesy of Fairbanks, Morse & Co.
Fig. 110. McKee Saw Guard, Supported from Side of Table.

back is fastened at (c) a double-acting lever. The hood is attached to the short shank (d) of this lever, while the long shank (e) glides on a roller (f) fastened to the frame of the table. The hood completely covers the saw when not in use, but is automatically raised as stock is fed. After the cut is made and the pressure against the strips (h) is removed, the weight (g) brings the carriage back and the saw is again covered by the hood.

Fig. 122 (page 87) shows a home-made cover for a miter saw, used in a picture frame factory, consisting of an oblong box-like arrangement made of wood. Fig. 123 (page 88) shows a clever guard, devised by the International Harvester Co., whose metal hood is self-adjusting, its carriage traveling on an inclined track. It is counterweighted so as to offer the least resistance when the piece of stock strikes the wheel at the front end of the hood. The friction is sometimes reduced by having, instead of this one wheel, a series of wheels reaching back from the front end. The principle of this guard can be applied to rip saw protection as well as cut-off.

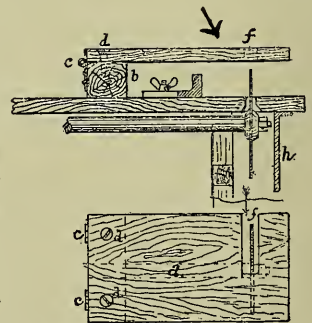

Courtesy of North German Woodworkers' Ass'n.
Fig. 111. Guard for Grooving Saw.

BOLTER SAWS.

The saws of machines for splitting sections of logs into bolts for shingle, heading and stave saws should be well guarded at both back

and side. Not only is there danger of some one falling on such a saw, but, with the low friction-driven split table often used, slivers, etc. are likely to drop through the slit in the carriage to the floor below and then be caught by the

under side of the saw and be thrown with great force toward the rear. There should never be an exposed passageway behind such a machine. Fig. 124 (page 88) shows such a heading saw with the side of the saw and the open space behind railed off. No employee should be allowed to ride on the carriage. At the left of the picture the run of the drag saw which cuts the logs to bolt length is shown fenced off.

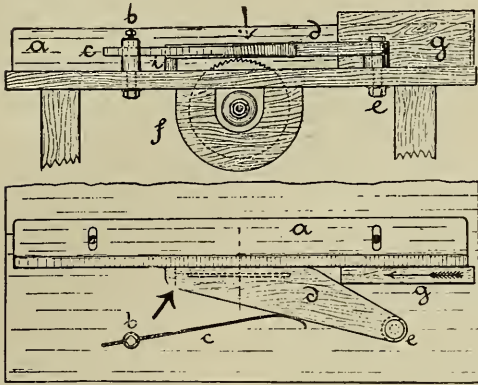

Courtesy of North German Woodworkers' Ass'n.

Fig. 112. Guard for Grooving Saw.

to the heading or stave sawing machine should have a wide hood suspended from above, or at least should be hooded at back and on top, with a band curving over as much of the front as is not required for the work. A feeding carriage with a V-shaped bottom could well be used. The operator should brush away slabs with a stick, as otherwise he comes dangerously near the saw teeth.

The carrier-fed machine for cross-cutting bolts should have its saw well guarded. If the cutting is done with the upper part of the saw, the entire saw below the mandrel, and above it to a point just below the swinging frame in which the bolt is held, can be protected by a cover, supported from the machine frame or the floor, open both top and bottom and with the outer side hinged for access to the saw. If the cutting is done with the lower side of the saw, there can be a fencing at the back and along the outside set far enough away not to interfere with the feeding frame. It is well also to have the upper part of the saw guarded by a hood or band supported from the machine framework.

EQUALIZING SAWS.

The equalizing saws used so extensively in coopeage and wagon work, and in box and excelsior factories, veneer mills, and many other plants, are dangerous machines and need careful guarding. The saws should always be protected as fully as possible on top by hoods, or

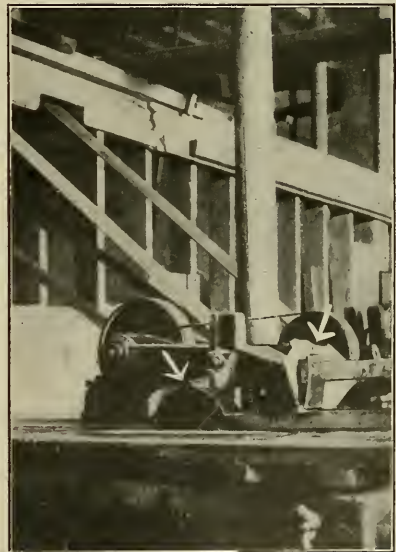

Courtesy of Paine Lumber Co., Ltd.

Fig. 113. Self-feed Rip Saw Guarded.

at least by bands, and they should be guarded at the back when there is a passageway there. When the saws are set near the ends of the arbor outside of the bearings, the outer part of each saw should be covered to a point below the bottom.

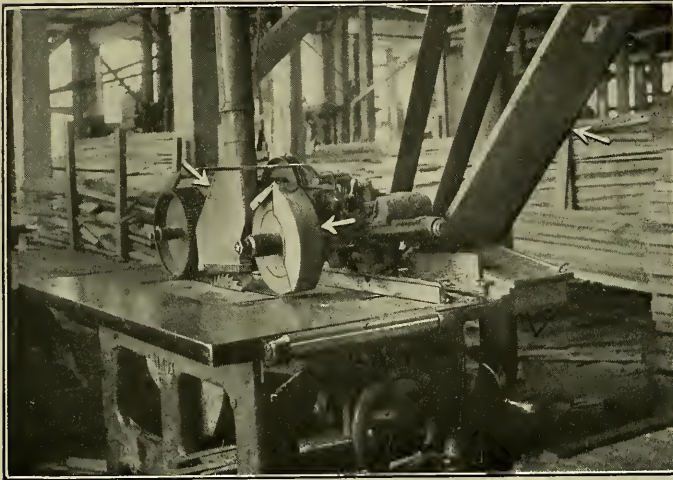

Courtesy of The Wheeler-Osgood Co.

Fig. 114. Self-feed Rip Saw Guarded.

Equalizers in which the saws are fully guarded and to which the stock is fed on a traveling chain fitted with brackets.

Equalizers fed by means of carriers should always have springs or weights to keep the carriers away from the saws except when stock is being fed, and these should be kept in the best of condition. The small stave equalizing saws used in pail and tub factories should have hoods coming down as far in front as possible, and the carrier should have a lever attachment for clamping the stock on it. When the saws are set very close together, one hood can cover both saws.

Fig. 126 (page 89) shows a home-made guard for stave equalizers. Each of the two wooden sections of which the guard is made is bolted to a frame of iron, bent to proper form and bolted to the framework of the machine. Beneath each saw is a box to catch the blocks, an excellent idea where there is no chute. If blocks pile up, the saw is apt to catch one of them and throw it with great force. The box also facilitates safe removal of the blocks.

A good and cheap way of guarding such equalizers is to set a board across the back of the machine, long enough to extend about six inches beyond the saw or frame at each end, and at right angles to this to run from each end a board along the outside of the saw as

Cooperage Saws.

Fig. 125 (page 89) shows a stave and heading equalizer equipped by its manufacturer, the E. & B. Holmes Machinery Co., of Buffalo, N. Y., with guards which protect the bottom of each saw and the back up to the crown. They are adjustable, along a bar at the front of the machine, for different positions of the saws. There are also self-feed equal-



Courtesy of W. H. Gillette Co.

Fig. 115. Home-made Cut-Off Guard.

far to the front as possible. Each board should be a little wider than the saw's diameter. It is well to have the side casings hinged for access to the saws. Such a guard will prevent anyone from backing up against the saws or running into them, yet it is far enough away to let the blocks fall inside.

Wagon Saws. Fig. 127 (page 90) shows a pair of saws, used in a buggy parts plant for equalizing the lengths of single-trees, guarded by substantial sheet iron hoods. The saw shaft and bearings are mounted on a solid table, and the guards are mounted on a piece of angle iron extending the full length of the shaft.

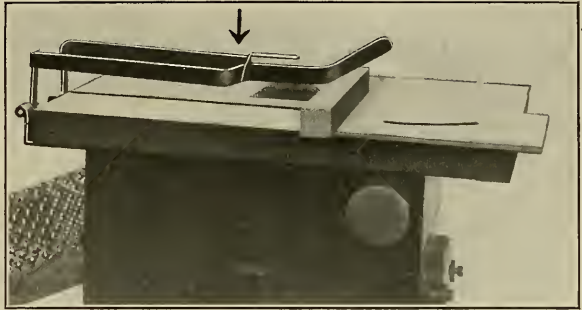

Courtesy of American Museum of Safety.

Fig. 116. German Cut-Off Saw Guard.

They are made wide so as to cover the saws when set for different lengths of material. Fig. 128 (page 90) shows a guarded double hub equalizing saw, made by the Defiance Machine Works, Defiance, O. The operator is protected by the convenient hand lever used for holding the hub in position and sliding the carriage to and from the saws. Such a feeding apparatus might well be used for many kinds of equalizing work.

Spoke and Handle Saw. Fig. 129 (page 91) shows a guarded machine, made by the Defiance Machine Works, for reducing spoke, handle and other blanks to exact length and preparing them for the turning lathe. The guards are adjustable on the frame of the machine with the saws.

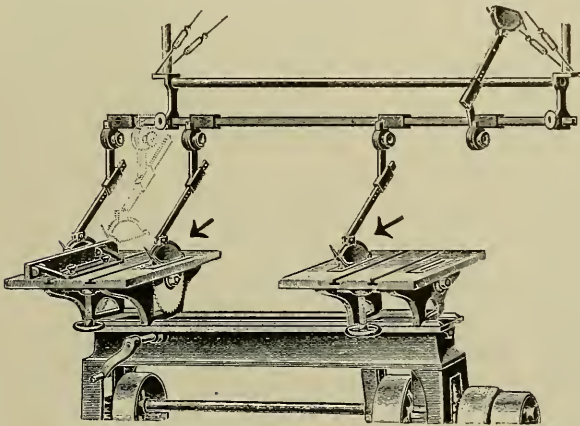

Courtesy of Jones Safety Device Co.

Fig. 117. Jones Double Cut-off Guard.

Such points should always be guarded.

Drum Equalizer. The guarded machine shown in Fig. 131 (page 92) made by the Chattanooga Machinery Co., of Chattanooga, Tenn., is used in box

Veneer Saws. Fig. 130 (page 91) shows a home-made method of guarding the saws used in veneer mills for cutting door or furniture panels to equal size. The hoods are adjustable both horizontally along the bar above, to suit varying sizes of panels, and vertically. The picture also shows guards over the main drive belt and pulley at the left and over two pulleys driving the saws, and a sleeve over a dead

factories and elsewhere. The boards or blocks are laid on the steps in front of the machine, and as the drum slowly revolves the stock is cut. Holding-down springs prevent the stock moving when in contact with the saws. The saws are hooded at the back and on top.

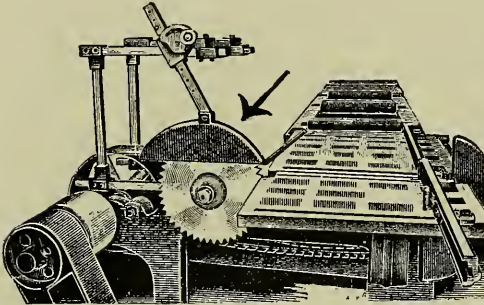

Courtesy of Jones Safety Device Co.

Fig. 118. Jones Railway Cut-Off Guard.

Tie Equalizer. A guarded railroad tie equalizer in a saw mill is shown in Fig. 13 (page 25). The two saws, 8 feet apart, sometimes throw ties or pieces. There is a front planking guard to prevent pieces striking employees. Two arms hung from pins lift up as the ties go under them, and then drop down and prevent the ties from sliding back on top of the saws.

SWING SAWS.

Counterweights. The most essential feature of swing saw protection has to do with the counterweight, so that there will be no danger of the saw unexpectedly swinging out toward the operator. Balancing the saw by a counterweight attached to a rope should be avoided whenever possible. A rope running over a small pulley is apt to become weak from wear and then to break when the saw goes back with a jerk after being released by the operator. The run of the rope behind the bench is usually enclosed, as it should be, to prevent sawdust and other stuff from clogging it so it will not work smoothly, and this practice is apt to prevent wear being noticed quickly. For the same reason it is unlikely that sufficiently close watch will be kept on the fastening of the weight to the rope. When a rope counterweight is used, frequent examination of the rope and of the fastening of the weight should be made, to assure the rope being in good condition and the weight being securely attached.

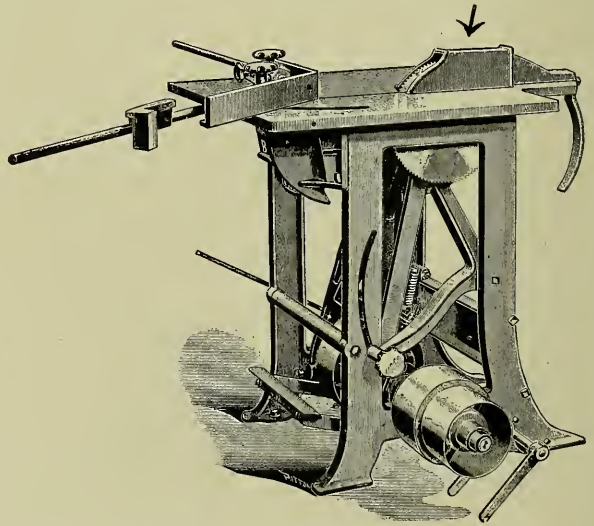

Courtesy of E. & B. Holmes Machinery Co.

Fig. 119. Cut-Off Saw Guard.

When the swing bar method of counterbalancing is used, the bar should be so arranged that it works from a horizontal position upward, as otherwise, if the weight should come loose, it may drop on the operator or some one else as well as let the saw come out at the operator. Care should be taken to fasten

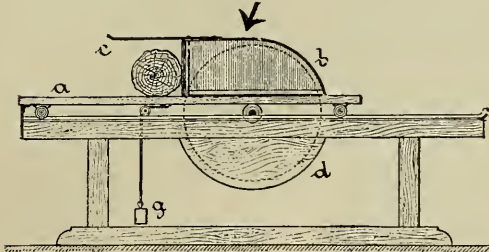

Courtesy of North German Woodworkers' Ass'n.

Fig. 120. Cut-Off Saw Guard.

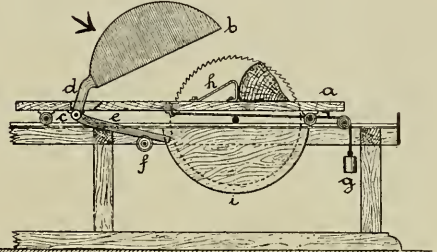

Courtesy of North German Woodworkers' Ass'n.

Fig. 121. Cut-Off Saw Guard.

the weight very securely to the bar. It is a good plan to have a positive stop on each side of it. Any bolts which fasten the bar to the framework should be tested frequently, as they are subject to heavy strain. The bar itself can well be made of wrought iron. To prevent any possibility of the weight falling, it can be attached to a safety chain coming down from the ceiling, as shown in Fig. 132 (page 92). If the saw is counterbalanced by springs, these springs should be very carefully adjusted, and frequently inspected to assure their working properly.

Guarding the Saw. The saw proper is usually equipped with a guard by its maker, in the form of a half hood covering the top of the saw and the side next to the handle. When no guard comes with the machine, a home-made one can easily be made. Fig. 133 (page 93) shows a home-made hood, with side of wood and top of sheet iron, bolted to the side of the frame. It is better, however, to enclose the top of the saw on both sides, as shown in Fig. 134 (page 93).

More complete protection yet can often be given. Fig. 135 (page 94) shows a reinforced wire mesh guard extending the protection given by the ordinary metal hood. The mesh guard slides in slots in the metal hood for an adjustment to $1\frac{1}{2}$ inches from the work. In Germany a telescopic hood is sometimes placed inside the usual hood, entirely covering the saw, as shown in Fig. 136 (page 94). The front part of this guard is lifted by the work striking the projecting forks, and the rear guard also raises when the work reaches it. Another European method is to attach



Courtesy of L. R. Harsha Mfg. Co.

Fig. 122. Home-made Cut-Off Guard.

to the front of the ordinary hood a metal strip working on a hinge, which glides on the wood being cut and pushes back an operator's hand carelessly left in the line of the cut.



Courtesy of International Harvester Co.

Fig. 123. Guard for Circular Saw.

this point, and Fig. 133 (page 93) shows boxing at both side and back.

Guarding the Belt. The belt of a swing saw should be well guarded, especially when it runs near the handle. Fig. 134 (page 93) shows a sheet metal guard back of the handle and a wire screen extending upward. Wire screen methods of guarding are shown in Figs. 135 (page 94) and 136 (page 94). Some machines are equipped with handle guards by the makers, but these should be supplemented by guarding the belt above. When there is no protection for the handle, and it is not on the side of the hood, it should at least set well out from the belt. A home-made handle can be attached to the framework well away from the belt, as shown in Fig. 133 (page 93).

Limiting the Swing.

In some machines the counterweighting mechanism is arranged so the saw can swing out only a limited distance. Whether this is the case or not, the swing can be limited by a safety chain running from the lower part of the swinging frame to a fixed

The lower part of the blade can well be guarded, when the saw is at rest, by boards set as close as possible to each side and projecting far enough beyond the blade in front to enable the operator to handle his stock on the table with perfect safety. When a swing saw is so situated that anyone can get in the rear of the table, it should be fenced off at the back. Fig. 134 (page 93) shows an excellent wire screen for

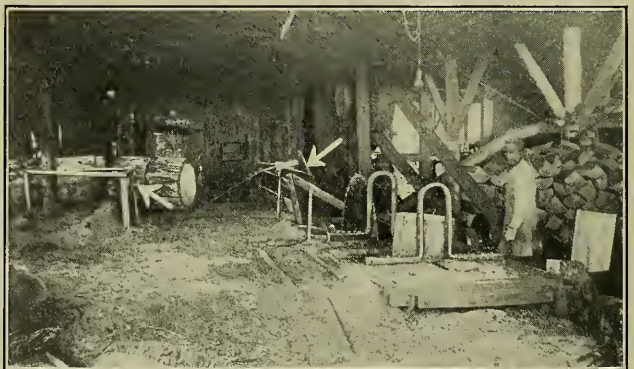

Courtesy of Jonesboro Heading Co.

Fig. 124. Heading Bolter Saw Guarded.

point in the rear. Fig. 132 (page 92) shows such a chain, attached at the rear to the framework of the guard for the back of the saw.

General. The saw should be hung on the end of the frame away from approaching material so the operator's hands will not be directly in front of the saw.

Every belt-driven saw should have an efficient belt shifter within easy reach of the operator. Some machines come equipped with shifters attached to the swinging frame, so the operator need not let go of the machine when shifting the belt.

Care should be taken not to attempt to saw material of thickness equal to the distance from the top of the table to where the drive belt passes over the pulley, as this may cause the pulley to ride over the material and throw the saw against the operator.

GENERAL SUGGESTIONS.

Guarding Under Part of Saw.

The part of a saw underneath a bench should always be well guarded against contact. This is often effected by means of a suction hood, or by placing on each side of the saw a metal or wood shield somewhat larger than the saw. Perhaps the best method, however, is to fence in any openings in the sides and ends of the bench with doors or shields, which slide in grooves or swing on hinges so they can easily be

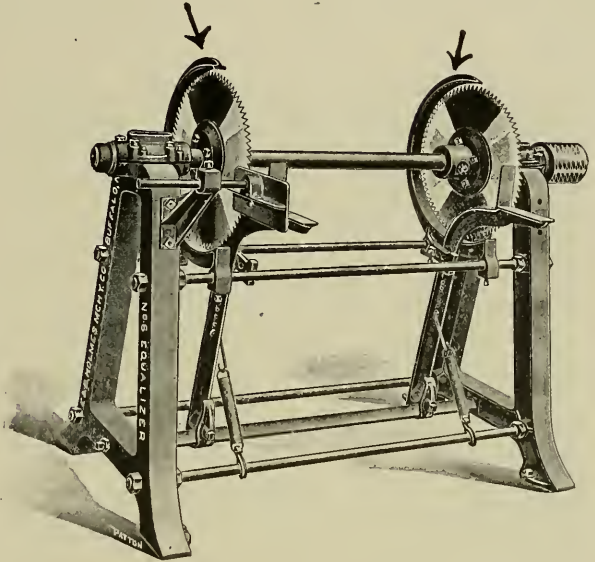

Courtesy of E. & B. Holmes Machinery Co.

Fig. 125. Stave Equalizer Guarded.

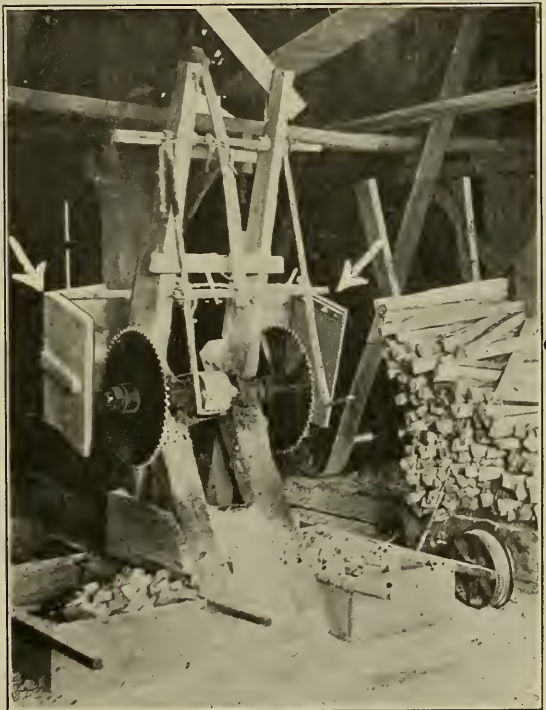

Courtesy of Royer Wheel Co.

Fig. 126. Stave Equalizer Guarded.

opened for necessary access.

Care in Operation, Etc. A sawyer cannot be too careful in operating a rip saw. Care is especially necessary when forcing a piece through after it has pinched or a knot or change in grain is struck, on account of the sudden jerk

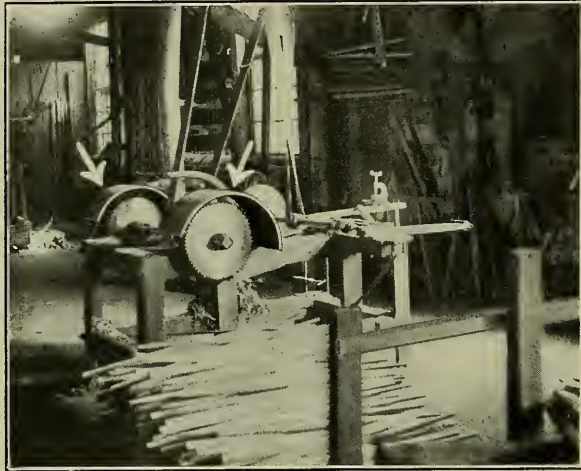

Courtesy of W. H. Gillette Co.

Fig. 127. Single-tree Equalizer Guarded.

apt to follow the extra pressure required, and in brushing waste pieces away from the back of the saw. An operator should never feed stock with his breast or abdomen, and he should try to avoid standing directly behind his work. In some plants rip saw operators wear thickly padded leather aprons. Holding on to a narrow strip when pushing a piece through the saw and cleaning out a dust chute while the saw is running are both dangerous practices.

Great care should be exercised in approaching a saw after the driving power has been disengaged, as inertia keeps it moving for some time. When stopping a belt-driven saw to adjust or clean up, the operator should see that the belt is well home on the loose pulley, so it will not slip back and start the machine while he is working about it. When there are two saws in a table, both should be stopped when one is to be adjusted or cleaned up. In feeling the run of a saw while adjusting, an operator should take care that his hand is not carried on to the teeth by friction.

It is important that the guide be always parallel with the saw, and securely fastened to prevent its slipping and suddenly throwing the operator's hand on the teeth. It is well to examine often the fastenings of a guide more or less permanently fixed in one position.

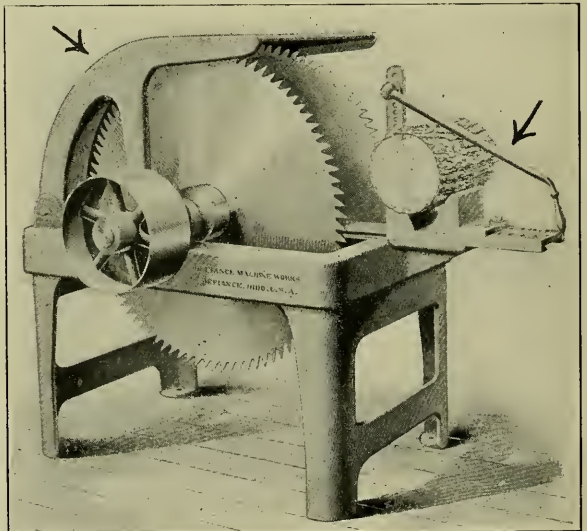

Courtesy of Defiance Machine Works.

Fig. 128. Double Hub Equalizer Guarded.

Working of saws in the open air or in a cold room should be avoided, to prevent accidents due to operators' hands becoming stiff or the wearing of gloves to keep them warm. When saw blades become cracked or dull, the operator should report their condition, and they should be removed at once from the workroom to avoid possible use of them.

Push-Stick. A push-stick is often a useful safeguard in finishing a cut, and suitable ones should always be provided so a workman may not improvise one out of some soft stuff lying handy which may break at a critical moment. The notch of a push-stick should be lined with metal, and there should be a hole in the other end for hanging it up conveniently at hand. Use of a push-stick is preferable, when possible, to using a second piece to push the first through.

When rabbeting or plowing is done on a saw, a push-block can often be

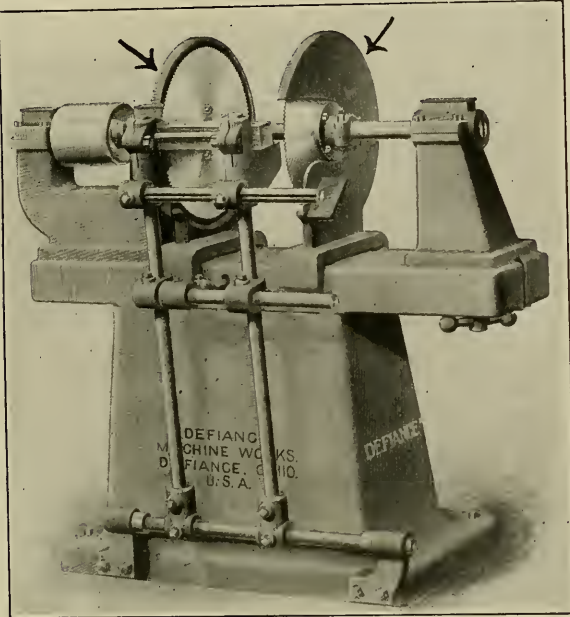

Courtesy of Defiance Machine Works.

Fig. 129. Guarded Equalizer.

used, made simply by rabbeting off the sole of a block of wood and putting on top a handle like that of a plane.

Off-bearers. There should always be an off-bearer when material is ripped which is longer than the saw table, and off-bearers can well be employed no matter what size of stock is being worked. An off-bearer should be careful not only to keep from the back teeth of an unguarded saw, but also to avoid pinching sawn pieces together and thus endangering the Sawyer as well as possibly himself getting a hand mangled. It is a good plan for off-bearer boys to use a hook, whenever possible, to pull wood past the splitter.

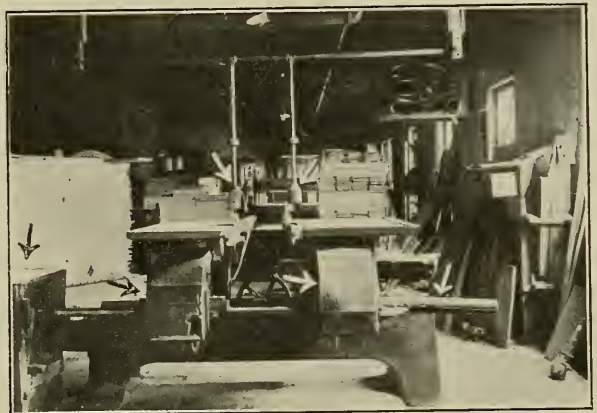

Courtesy of Louisville Veneer Mills.

Fig. 130. Veneer Equalizer Guarded.

Clothing. It is advisable for both sawyers and off-bearers to wear tight-fitting clothing. Sleeves which do not fit closely should be rolled up or preferably short-sleeved jumpers should be worn. The latter avoids dangerous bunching of cloth around the upper arm. Wearing gloves is a bad practice which should be prohibited.

Use and Adjustment of Guards. Guards are of no value unless used as

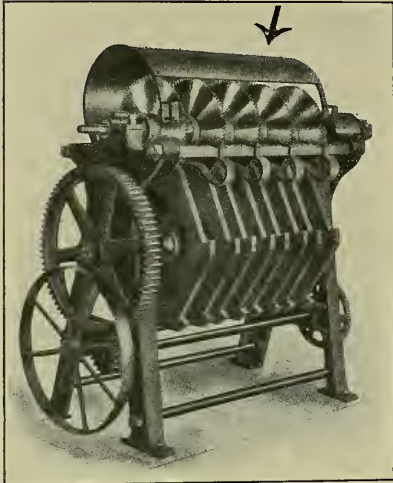

Courtesy of Chattanooga Machinery Co.

Fig. 131. Drum Equalizer Guarded.

intended. Complete use for all possible work should be insisted upon, and replacement required at once after completion of work for which they cannot be used. For short stock the use of a guard should be compulsory. There is nothing in all the wide range of woodworking more dangerous than short feeding small dimension stock.

Hoods used should adjust automatically whenever possible. If arranged otherwise, they should be adjustable by hand, and always set to cover the saw as fully as may be. When a saw is changed for one of another size, the splitter should be readjusted close behind the new saw, or, if necessary, a new one set in place.

The tendency of workmen to turn back the nosepiece of a splitter and light hood guard, so as to see the line of cut better, can be obviated, in many instances, by splitting the front part of this hood like two fingers or making it of wire mesh.

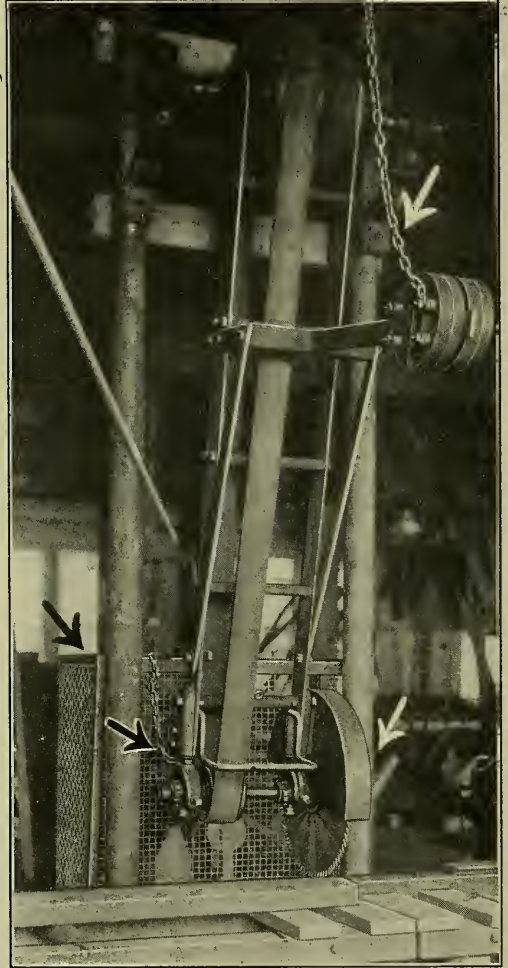

Courtesy of International Harvester Co.

Fig. 132. Swing Saw Guards.

Material of Guards. Whatever the material of a guard, it and its supports should be very substantial. If possible supports should not be of cast iron. Many prefer wood hoods, as likely to do less damage if struck by the saw. For this reason the Germans often line metal hoods with wood. Fibre is sometimes used in place of wood or metal.

Care of Saws and Bearings. Saws should be carefully inspected quite often for lost motion in the bearings. If the bearings are worn, the saw will wobble and jump and be more dangerous. End play in a mandrel has caused men to lose fingers on a rip saw, and has also resulted in the throwing of edgings with disastrous effect. The bearings should be kept well babbitted up, and in the intervals between babbittings the liners between the bottom half of the bearing and the cap should be changed. In this way one babbitting can be made to serve effectively much longer. Saws should also be kept well sharpened. There is nothing like a dull saw for making stock pinch and climb. Care in these two points is just as necessary for quality of work as for safety.

Fixing Speed of Saws.

When saw machines are set up, care should be taken to ensure the fixing of their speed at the proper rate. Overspeeding and underspeeding both

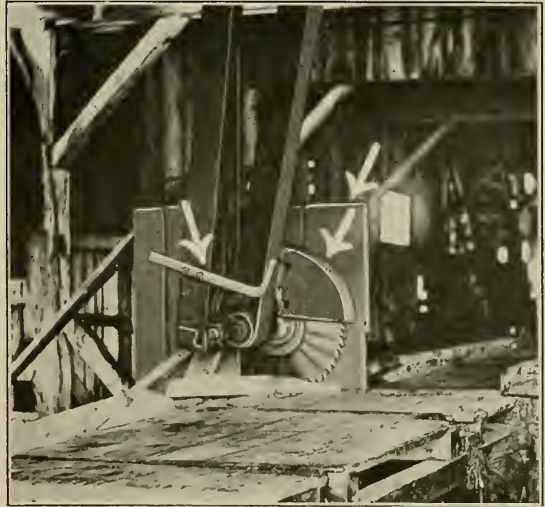

Courtesy of Kentucky River Poplar Co.

Fig. 133. Home-made Swing Saw Guards.

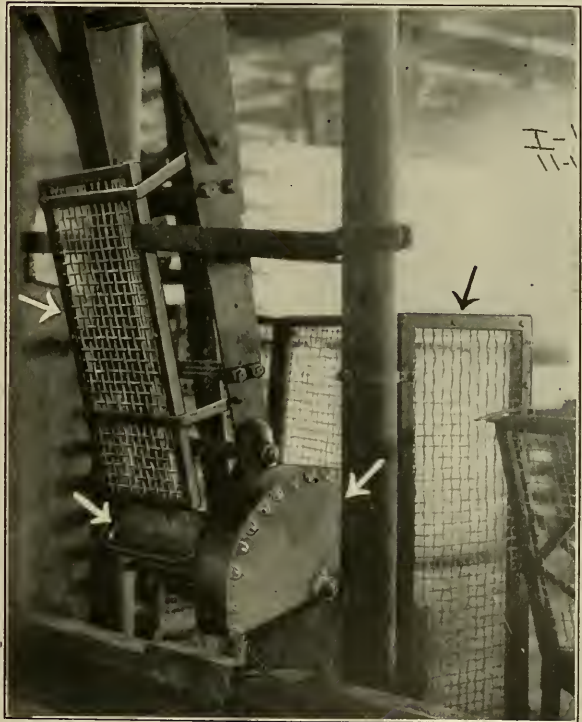

Courtesy of International Harvester Co.

Fig. 134. Swing Saw Guards.

have their dangerous points. While successful operation of saws, there is a point beyond which the saw not only becomes liable to cause many accidents, but it also cannot do good work. Too high a speed heats up the saw, and makes it touchy and limber. Then, if the teeth are at all dulled, the saw runs or dodges whenever it comes in contact with the least obstacle. Underspeeding also is apt to make a saw dodge either way on striking an object.

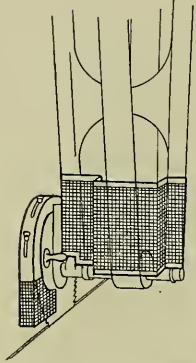

Courtesy of Remington Typewriter Works.

Fig. 135. Mesh Guards for Swing Saw.

While high speed is necessary for the successful operation of saws, there is a point beyond which the saw not only becomes liable to cause many accidents, but it also cannot do good work. Too high a speed heats up the saw, and makes it touchy and limber. Then, if the teeth are at all dulled, the saw runs or dodges whenever it comes in contact with the least obstacle.

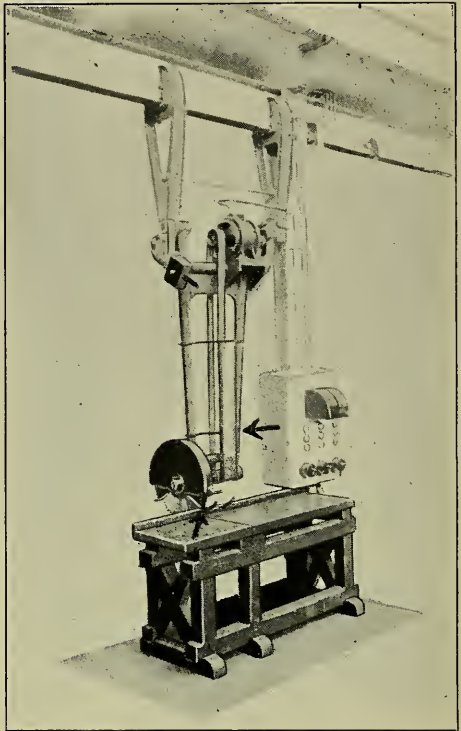

Courtesy of American Museum of Safety.

Fig. 136. German Swing Saw Guards.

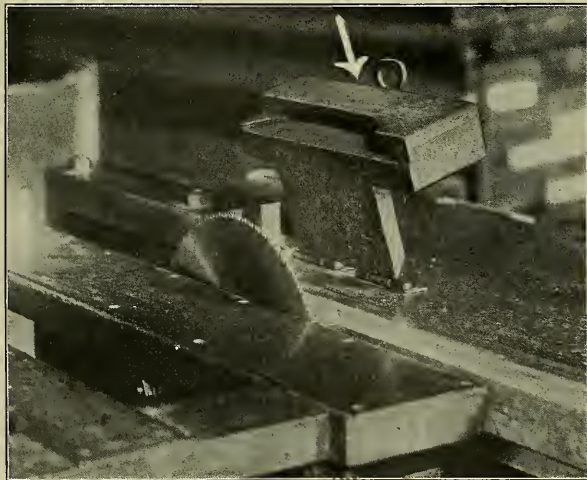

Courtesy of Diamond Match Co.

Fig. 137. Cover for Saw.

into holes in the table. A permanently attached cover is better, however, when such can be arranged, as it is always conveniently at hand and therefore more likely to be used. Fig. 137 shows such a cover used in a match factory. It is hinged so it can be thrown back at the side of the saw. In the picture the cover is raised to show its construction and how it works on its hinges. When a hood is used as a saw guard, this can often be adjusted to serve as a complete cover.

Transmission, Etc. For the guarding of belts and pulleys generally, or other driving apparatus, see chapter on Power Generation, Transmission, Etc.

BAND SAWS.

A band saw is much safer to operate than a circular saw, for there is no danger of the wood being kicked, but it has peculiar hazards of its own against which an operator should be protected. Fortunately it is unlike the circular saw also in that practically complete protection can be furnished.

Guarding the Lower Wheel.

When the lower wheel is left exposed, it is very likely to cause accidents, especially if it is a spoked wheel. The draught created by it is apt to draw in some loose part of the operator's clothing, his foot or leg may come in contact with the wheel or his toe get under it, or a block of wood may get tangled up in the wheel, if it is spoked, and be thrown or damage the wheel and thus cause an accident. The saw blade also may break under the table, and its ends or pieces fly out and cut the operator's legs.

The lower wheel should be entirely covered on the side towards the operator. Some manufacturers furnish such a guard, in the form usually of cast iron doors. When a machine is not thus equipped, it is easy to provide a home-made guard, of wire mesh, wood or metal. The guard should be so arranged that it can easily be opened, and it should come down close to the floor, to prevent anything getting under the wheel.

The lower wheel is often of the web type, which from the safety standpoint is decidedly preferable to the spoked kind. Its use practically eliminates the danger of the operator's clothing or a piece of wood being caught in the wheel, and there are no spokes to catch a breaking blade and tear it to pieces.

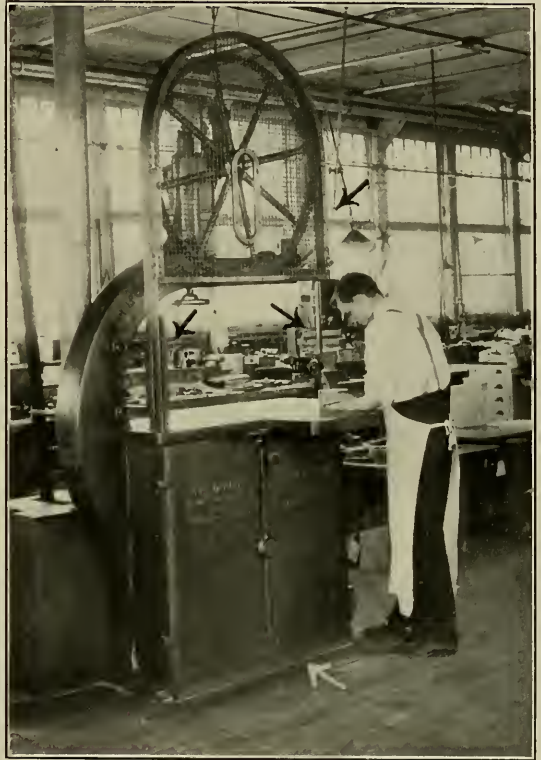

Courtesy of Brown & Sharpe Mfg. Co.

Fig. 138. Guards for Band Saw.

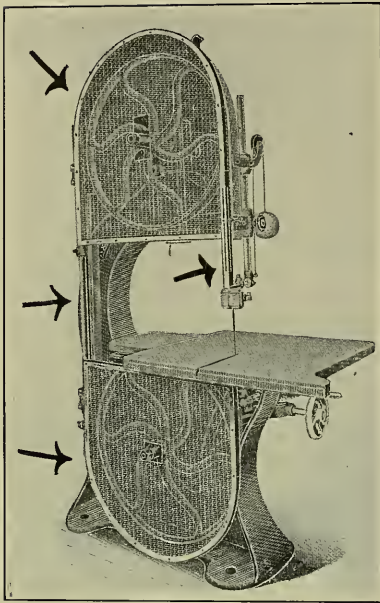

Courtesy of Jones Safety Device Co.
Fig. 139. Jones Band Saw Guard.

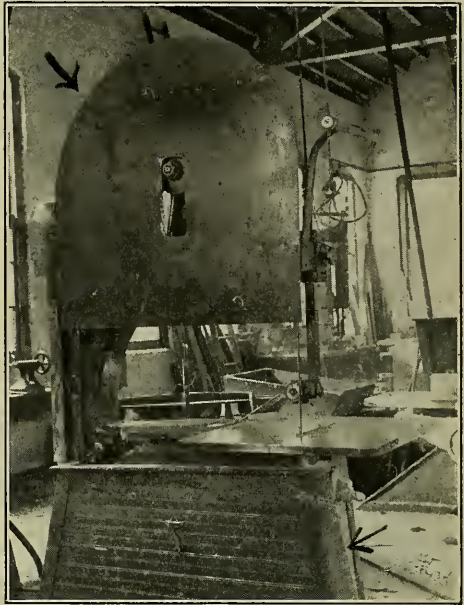

Courtesy of International Harvester Co.
Fig. 140. Band Saw Guarded.

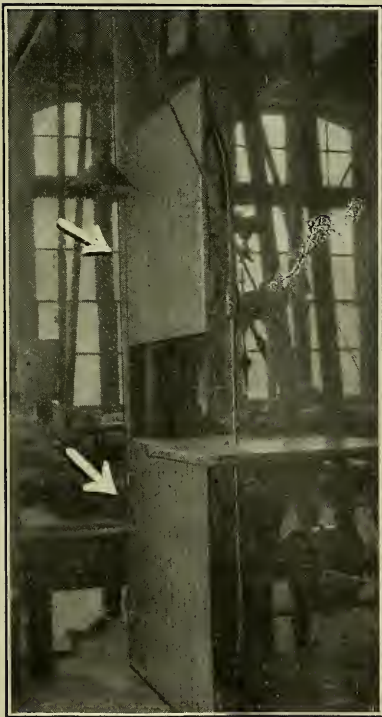
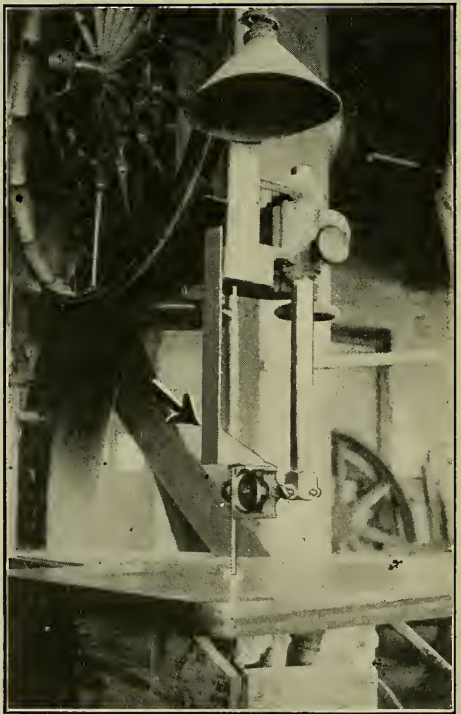
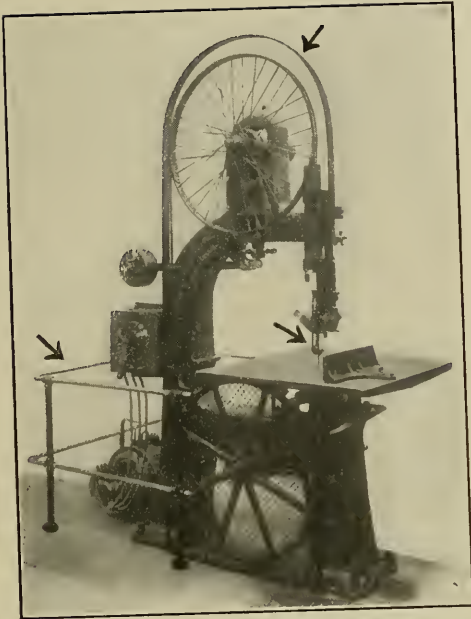

Fig. 141. Guards for Band Saw
Wheels.



Courtesy of Link-Belt Co.
Fig. 142. Guard for Band Saw Blade.



Courtesy of American Museum of Safety.

Fig. 143. German Guards for Band Saw.

casing should be arranged so that it cannot come in contact with the wheel, and it should be hinged at one side, or detachable, to facilitate the saw's removal. It is well also to have a protecting strip span the wheel. Such a strip will do much toward catching the parts of the blade if it should break. When the upper wheel is not encased, a bar is sometimes placed across the front, fitting in a rest at each side, to keep the saw from coming over on the operator if it should slip off the wheel.

Protecting Return Part of Blade.

The return part of the blade between the two wheels should be guarded for other reasons as well as in case of breakage. With it exposed, the operator or someone else may come in contact with it, or a piece of material be crowded on it, or the saw may be struck from the rear and thrown off the wheels.

Guarding this part is a simple matter. One method of protection is to place parallel strips of wood, each

The web wheel also gives a more steady movement to the blade, thus reducing the danger of breakage. It should be encased, however, just like the spoked wheel.

Guarding the Upper Wheel. The upper wheel should be enclosed in similar fashion to the lower. Protection only as far down as the hub is not sufficient, especially when the wheel is set low enough to reach down to the height of the operator's head. A complete covering is always better, as it is more likely to catch the saw if it should break or slip off the wheel. If the blade should merely slip off the wheel, a complete casing will tend to prevent the kinking which often causes a saw to break.

The wheel can be effectively encased in wood, slats, metal or wire mesh, as may be most convenient. The



Courtesy of International Harvester Co.

Fig. 144. Guards for Band Saw.

wider than the blade, one on each side of it. The strips should come down close to the table. Another way of guarding is to run a strip up along the side of the blade, and attach to it at right angles two other strips, one covering the saw teeth in front and the other protecting the back of the blade so that it cannot be struck from the rear and thrown off the wheel.

A third device is a piece of timber with a slot cut in the front of it in which the blade will run, the slot being deep enough for the blade to be some little distance from its front edges. Some manufacturers furnish a tube-like guard in which the blade can be enclosed. Others equip their machine with a U-shaped protection or a cast-iron channel in which the blade runs.

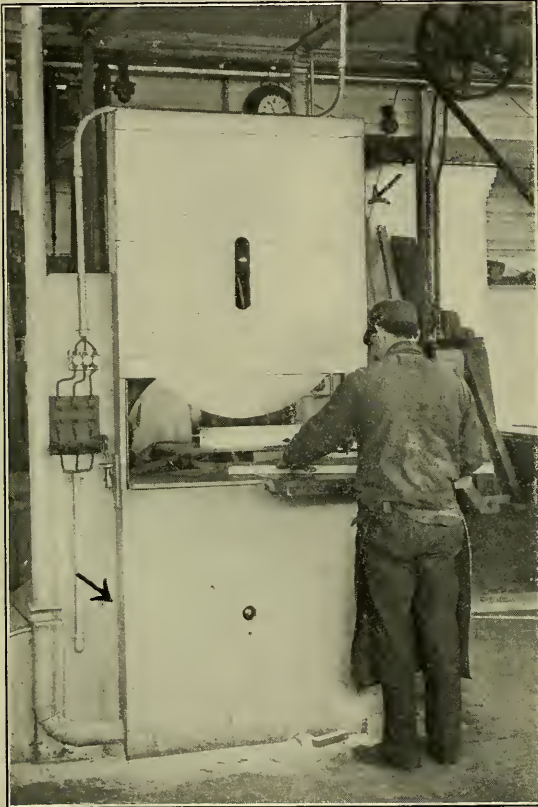

Courtesy of Brown & Sharpe Mfg. Co.

Fig. 145. Band Saw Guarded.

operator should see that the work lies straight and firm before feeding, so it will not turn and draw his fingers into the blade. He should keep his attention exclusively fixed on his work, and he should be careful in brushing away cuttings. After the power is disengaged he should always wait for the machine to come to a stop, never trying to stop the wheel with a piece of wood or with hand or foot. Sometimes, as in Germany, a brake is rigged up, brought into action by a foot lever after the belt has been shifted to the loose pulley, to stop the machine almost instantly. A device by which the belt shifter, when moved to the limit of its travel, would apply a brake effect and thereby bring the machine to a halt more quickly, would be preferable.

Guarding Working Part of Blade. The working side of the saw should be guarded both on account of the danger of breakage and to keep an operator's head from coming in contact with it, as when he bends over to follow penciled lines showing the desired cut. Some machines come from the maker equipped with a guard for this point. When there is none a home-made guard is easy to apply, and often it can be attached to the guide so as to raise and lower with it. A wooden or metal strip can be placed in front of the teeth, or strips can be placed at right angles to each other which will guard both the front and the outside of the blade. Only the part of the saw in actual use need be left exposed.

Care by Operator. The

When a band saw is stopped, it is advisable to lower the tension somewhat unless this is well provided for by the makers. While working, the saw becomes heated and expands; when not working, it cools off and contracts. So there is danger of a subsequent break, with possibility of an accident, if the tension is not slackened. When the saw is running, the tension, of course, has to be kept pretty firm, to prevent the blade slipping off the wheel and to keep it moving smoothly.

A band saw break sometimes comes gradually, its beginning being shown by a noticeable click. The machine should then be stopped at once and the blade removed.

Other Precautions.

Band saws should not be operated, either indoors or out, in a temperature low enough to cause the operator's hands to become stiff. Too low a temperature is also apt to cause the blade to snap when started. Use of gloves by operators should be positively prohibited.

Saw blades should be carefully sharpened, and brazed with great care when necessary. If a saw is not brazed properly, it is much more likely to break when next put in use. Too much emphasis cannot be laid upon the need of proper brazing, to assure the brazed joints being carefully made, the blades not being overheated, the flux and solder thoroughly uniting the parts, and the thickness being afterward brought down accurately to that of the rest of the blade. Cracked saw blades should not be used, and dull blades out of commission should not be left in the work-room.

Illustrations of Guards. Fig. 138 (page 95) shows a guarded band saw in use in the plant of the Brown & Sharpe Mfg. Co., of Providence, R. I. The return part of the saw is protected by parallel strips on either side, and the working side is also guarded. The lower wheel is enclosed in cast-iron doors, and the upper is protected by a spanning bow and by a hinged wire mesh shield slotted to fit over the hub. The makers of this machine, the Oliver Machinery Co., of Grand Rapids, Mich., furnish an L-shaped guard, of steel with a wood facing, for the working side of their saws, the guard cover-

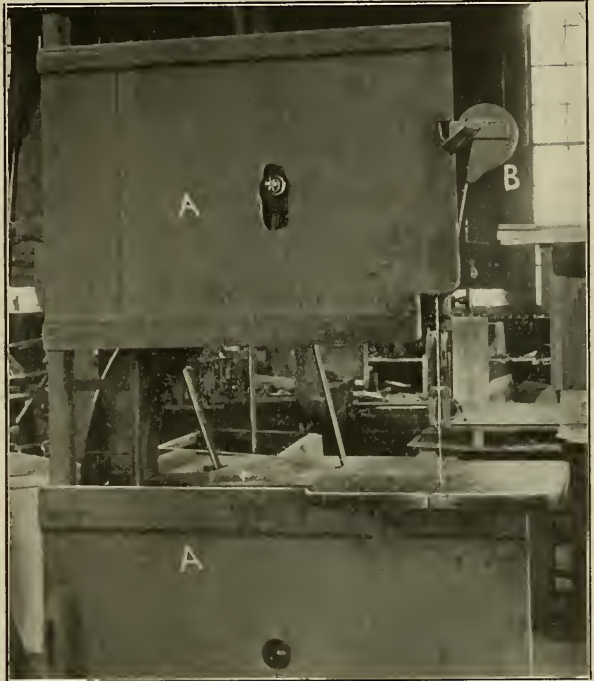

Courtesy of National Tube Co.

Fig. 146. Band Saw Guarded.

ing both front and side of the blade and adjusting with the guide, and a guard for the return part of the blade in the form of a U-shaped trough.

Fig. 139 (page 96) shows the guard made by the Jones Safety Device Co., of Buffalo, N. Y. The wheel covering is composed of wire mesh on an angle iron frame. The return part of the blade is guarded, and the working portion protected by a sliding guard which raises and lowers with the guide.

A method of guarding employed by the International Harvester Co. is shown in Fig. 140 (page 96). The lower wheel is protected by a removable wooden housing, and the upper by a sheet steel guard. The return part of the blade is also guarded.

A simple home-made guard for the wheels is shown in Fig. 141 (page 96). It consists of substantial wooden doors hinged at one side so they can be swung open. A home-made device for guarding the working side, shown in Fig. 142 (page 96), is in use in the plant of the Link-Belt Co., of Chicago, Ill. It is a metal strip which is fastened to the guide and moves up and down with it.

Fig. 143 (page 97), a picture of a German machine, shows the upper wheel surrounded by a protective bow and the lower covered with lattice work. A patented safety device, attached directly over the table, rests upon the material being sawed and prevents the fingers from hitting the teeth. A pipe railing guard for the motor furnishing the power is also shown.

Another International Harvester guard is shown in Fig. 144 (page 97). The lower wheel is protected by a removable housing and the upper by a wire screen guard slotted so as to slip over the hub. The latter guard can be raised clear by means of a rope working over a pulley attached to the ceiling. The return part of the blade is guarded.

The method of boxing in the wheels shown in Fig. 145 (page 98) is in use in the plant of the Brown & Sharpe Mfg. Co., of Providence, R. I. Both upper and lower wheels are encased in wooden housings, and an exhaust is attached to the lower cover to carry away the sawdust.

Fig. 146 (page 99) shows wooden shields (AA) in front of both wheels of a band saw used in a National Tube Co. pattern shop, and also a curved block of wood (B) to catch a flying end of the blade in case it should break.

Self-feed Band Saws. The same wheel protection should be furnished self-feed saws as is given the hand-feed machine. It is advisable to have the front feed roller guarded to prevent the operator's hands being drawn in between it and the stock, and the sprocket and chain gearing, or other form of power transmission for the feed should be protected. So also should the belt and pulley driving the feed works, if such are used for the purpose. When the top rollers act as hold-downs, the feed being by means of an endless chain beneath the stock, the part of the chain below the table should be fenced in.

Transmission, Etc. For the guarding of belts and pulleys generally, or other driving apparatus, see the chapter on Power Generation, Transmission, Etc.

JOINTERS OR BUZZ PLANERS.

Next to the circular saw, the jointer or buzz planer has probably the widest range of usefulness of all woodworking machines, and, with the shaper, it also ranks next to the saw in its capacity for doing injury to its operator. The planer often shortens the fingers of dreamers, and it is a poor machine for anyone to run unless he places his mind on his work and follows the instructions of experienced hands.

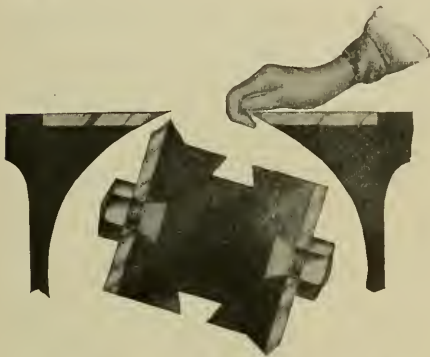

Fig. 147. Old Style Square Head.

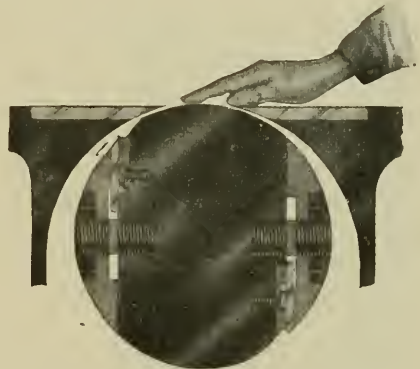

Fig. 148. Safety Circular Cylinder.

Its danger lies in the fact that under ordinary circumstances the operator is dependent wholly upon his hands for control of his work. With them he pushes the stock over the knives and also keeps it firmly pressed to the table so as to secure an even cut. They are therefore brought frequently into close proximity to the danger point, the gap between the two tables in which the knife head is rapidly revolving. Any one of a number of causes is apt then to throw a hand off the material and into the knives. A knot or change in grain may be struck, too heavy a cut may be taken, the piece of stock may be too small for such planing, or the operator may be doing his work carelessly. Whatever the cause, the result is pretty sure to be a serious injury unless everything possible has been done to guard the machine. Some of the causes of accident can be foreseen by the operator and avoided, but others are beyond his control, and on both accounts the jointer demands as complete protection as can be given it.

Circular Safety Cylinder. One of the most effective mechanical safeguards that can be installed on a jointer is the circular safety cylinder. This form of head fills up the gap between the tables to such an extent, and the knives project so little from the head, that if an operator's hands should come in contact with the knives

they cannot be mangled as they would be with a square head. Figs. 147 and 148 (page 101) show the difference between the two kinds of heads very plainly and Figs. 149 and 150 show the nature of the injuries apt to be inflicted by each.

Space does not permit of mentioning all of the many makes of circular cylinders. The one illustrated in Fig. 148 (page 101) is made by the Oliver Machinery Co., of Grand Rapids, Mich. Special thin knives are used in the Oliver cylinder, and the knives are prevented from flying out by notches at their ends fitting over small lugs in the cylinder. In addition to those makes which require special knives, there are circular heads in which the same kinds of knives can be used as in the square head.

Not only does the circular cylinder prevent a workman's hands from getting materially below the table top, but the danger of kicking back is much diminished. Use of such a head largely increases the capabilities of a jointer. Shorter pieces of wood can be planed, and planing can be done against the end of a piece of stock. The circular head is steadier running than the square one, has less tendency to vibrate, and is less liable to get out of balance.

A circular head should be used on every jointer. It does not obviate the need of other guarding, but it goes a long way toward giving the protection which should be given. It will also minimize many accidents due to failure of operators to use other guards provided.

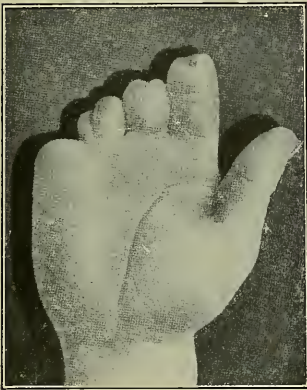

Fig. 149. Done with Square Head.

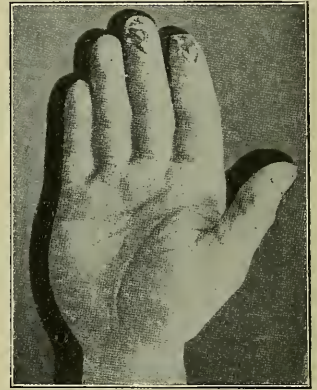

Fig. 150. Done with Circular Cylinder.

Types of Guards.

There are two general classes of jointer guards, the sliding and rising type, in the use of which for facing the hands pass over the guard and the

material beneath it, and the automatic, which is pushed aside by the stock and does not require the hands to be lifted from the stock. Each has its points of advantage. A sliding and rising guard keeps the knives covered all the time, except for edge work, but it always has to be adjusted for edging and usually for different thicknesses of stock. An automatic guard leaves part of the knife gap exposed just before and after the passage of the material, but its automatic adjustment gives less opportunity for carelessness or failure to use the guard as intended.

Sliding and Rising Guards. One of the popular guards of this type is the "Wills," shown in Fig. 151 (page 103), manufactured by the John A. White Co., of Dover, N. H. It is adjustable vertically and horizontally and can be swung to one side, as shown by the dotted lines.

Fig. 152 (page 103) shows the Jones adjustable guard, made by the Jones Safety Device Co., of Buffalo, N. Y. The top covering is made in sections which telescope into each other, to avoid getting into the operator's way. The guard can be lowered to the side, as shown by the dotted lines.

An ingenious English guard, made by J. Campbell & Co., of Manchester, England, is shown in Fig. 153 (page 104). It is adjustable vertically and horizontally. The steel rod cover for the knives enables the operator to see his work. The uppermost rod revolves and can be used as a roller to bring back material.

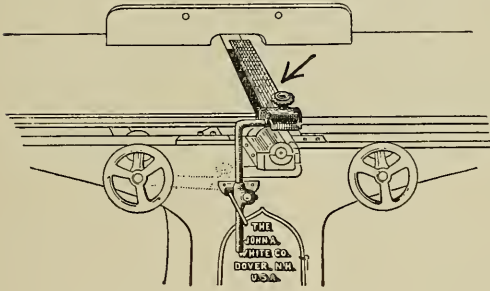

Courtesy of John A. White Co.

Fig 151. "Wills" Jointer Guard.

the entire covering flexible. The guard is held up against the guide by a spring at the point of attachment to the table. When it is pushed away by material being fed to the knives, the flexible cover drops down to the side of the machine frame so as not to be in the way of the operator. The picture shows the material going through, the guard being pushed aside just enough to permit its passage.

Other Automatic Guards. Another guard of the automatic type is the "Badger," shown in Fig. 155 (page 105) manufactured by the Badger Jointer Guard Co., of Eau Claire, Wis. In operation, the guard-plate is pushed aside by the approaching material so as to uncover just so much of the knife length as is required. As soon as the material has passed by, a spring brings the guard-plate back into position over the knives.

A home-made guard resembling the Badger, but made of pierced aluminum so as to be light, is shown in Fig. 156 (page 105). At the end of the straight edge nearest the guide the guard rides on the table. Such guards are also made of wood. It is well to have them as light as possible, to reduce friction. Sometimes they are made in the form of a disk, which is revolved by the material fed.

In some plants a guard is used which resembles the Badger in general design, but which has a beveled nub extending up from the inside edge of the guard plate at the point directly over the knife gap when the guard is in normal position. This nub makes it possible for a piece of material to be dropped down between the guard and the guide and jointed in one or more places instead of its entire length.

Many prefer a weight to a spring for an automatic guard, on the theory that a spring has only a certain amount of life, while the action of a weight is both positive and permanent and gives more even tension. The weight principle is a feature of the "Porter" jointer guard, shown in Fig. 157 (page 106) manufactured by the C. O. Porter Machinery Co., of Grand Rapids, Mich.

There are sliding and rising guards where the adjustment for thickness of material is automatic, the position being governed by a balance weight.

Champion Guard. A well-known guard of the automatic type is shown in Fig. 154 (page 104). It is called the Champion Automatic Flexible Safety Guard and is manufactured by the Champion Machinery Co., of Joliet, Ill. The cover for the knives is of wooden slats so fastened together as to make

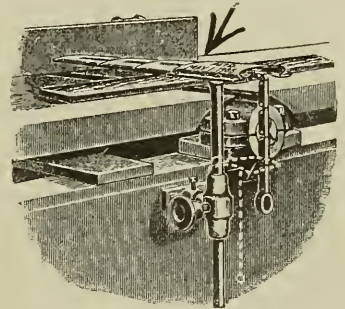

Courtesy of Jones Safety Device Co.

Fig. 152. Jones Adjustable Jointer Guard.

Fig. 158 (page 106) shows an English automatic guard patented by H. W. Gibbs, of Bedford, England. It is designed to meet the objection that an automatic guard leaves part of the knife gap exposed just before the material reaches it and just after it has passed by.

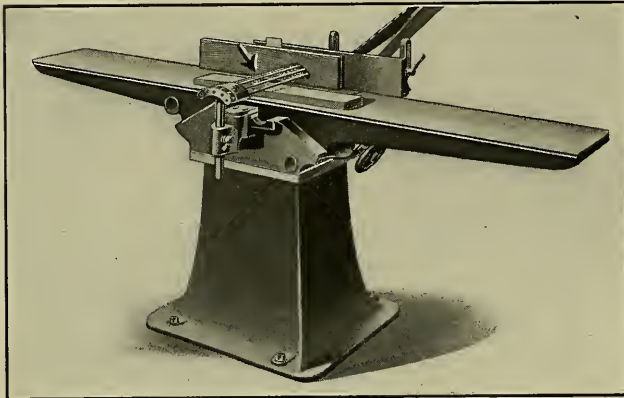

Courtesy of British Factory Dept.

Fig. 153. Campbell Jointer Guard.

Home-made Automatic Guards. A home-made automatic guard is shown in Fig. 159 (page 107). A polished metal strip is placed on the curved part where the material comes against the guard to push it aside. This reduces the friction between guard and material. The picture shows the method of hinging the guard at the edge of the table and the placing of the spring which keeps it in position against the guide.

A home-made automatic guard worked by a weight is shown in Fig. 160 (page 107). A 7-8 inch board is cut to the shape shown and hinged to the table. About midway of the guard a piece of iron bent to right angle shape is fastened to it. The rope for the weight is fastened to the lower end of this piece, crossing the machine under the table and then being led over a small pulley and down the rear side of the machine.

Swing Paddle Guard. Another home-made guard, which does not work automatically, is shown in Fig. 161 (page 108). It can easily be shaped out of a piece of hard wood by any mechanic, and at small cost. It is bolted to the surface of the machine and can be set for any width of stock, covering all that part of the knives not in use. This guard is sometimes made with a curved edge on the feeding side, so that the material pushes it away when fed to the knives.

Sometimes, too, it is fastened to the front table, to leave the rebating portion clear and also to reduce the likelihood of its interfering with the operator as he walks along the machine. When so attached, its action practically becomes automatic through the operator's body



Courtesy of Champion Machinery Co.

Fig. 154. Champion Jointer Guard.

pushing it back against the guide as soon as the material has passed by. A guard of this swing paddle type can easily be equipped with a spring or weight to make it automatic.

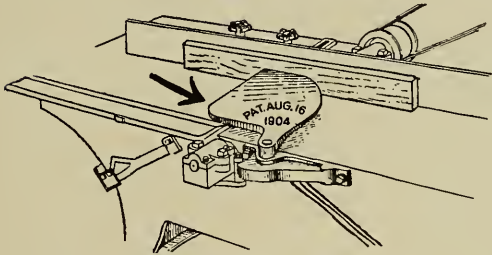

Courtesy of Badger Jointer Guard Co.

Fig. 155. Badger Jointer Guard.

An ingenious variation of this type of guard, designed especially to prevent its getting in the way of the workman, consists of making it in two pieces, one sliding over the other. The under part has a cleat beneath it which comes against the rebating edge and acts as a stop. Each part covers about half of the knife gap, and both are

pivoted to the rear table at the same point.

Double Automatic Guard. In cabinet shops and other establishments where much planing of cross-grained hard-wood is done it is sometimes advisable to remove the guide entirely and place two automatic guards, a right hand one and a left hand one, on opposite sides of the table, letting them meet in the middle. Either springs or weights may be used to work them. Such an arrangement, in use in Germany, is shown in Fig. 162 (page 108). The action of the two guards is governed by weights. With such a device the knives can be used along their entire length, but all except the part in immediate use is covered. A guard of this kind might often be used in taking out the wind.

Finger Guard. Fig. 163 (page 108) shows an ingenious jointer guard devised by the General Electric Co., at its Schenectady works. As the stock is run over the knives the fingers, as many as obstruct the passage of the work, are pushed back under the table. As soon as the work has cleared the knives they spring back into place. The action is of sliding in a grooved casting under individual tension for each finger.

Taking Out the Wind. The guard shown in Fig. 164 (page 109) is used on a buzz planer in taking out the wind. While not a perfect guard it has proved quite effective for such work. It makes the

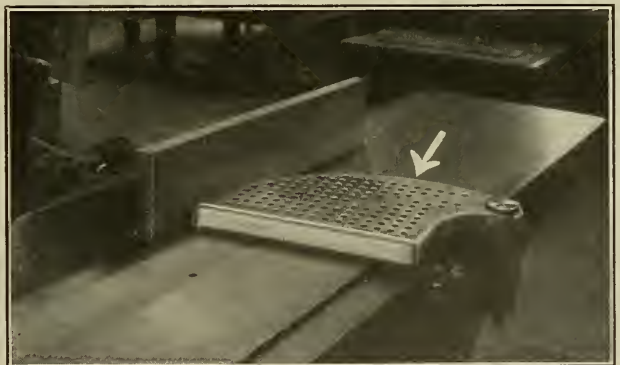

Courtesy of American Steel Foundries Co.

Fig. 156. Aluminum Jointer Guard.

operator begin to feed with the end of the piece of material and also prevents his pulling the piece back over the knives. The guard consists of a flat, thin board extending clear across the table and

held about three inches above the knives by band springs, one at each end.

Self-feed Jointers. Automatic feed jointers eliminate most of the danger attaching to the operation of a jointer. It is well, however, to have the guard

at the feeding point cover as much of the feeding chain as possible, to avoid the chance of the operator's fingers being nipped between the stock and the chain.

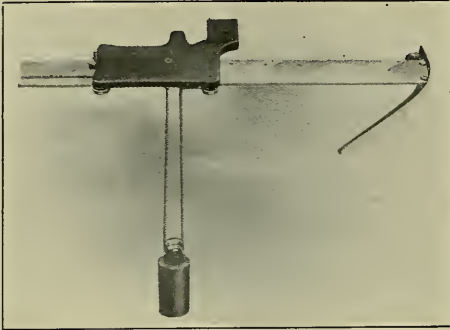

Courtesy of C. O. Porter Machinery Co.

Fig. 157. Porter Jointer Guard.

are used even for taking out the wind. It is well to have a bar guard extending down in front of the rollers as close as possible to the table to prevent a man's hands following stock in and getting caught. A covering for the tops of the rollers is also advisable.

There is also a self-feed jointer attachment which can be used in connection with ordinary jointers. In this the stock is fed to the knives and pressed to the tables by an endless chain carrying a series of fingers, which extend the full width of the jointer table. Their pressure upon the stock is regulated by coil springs.

Irregular Work. The danger of the jointer increases greatly when it is used for such work as moulding, beading, tonguing and grooving, as the knives used necessarily protrude further from the head than under ordinary circumstances. A circular head should be used for all such work, and some mechanical arrangement should always be employed to give the necessary pressure on the material. Such a device, in use in Germany and manufactured by Blumwe & Sohn, Bromberg. Prinzenthal, is shown in Fig. 165 (page 109). On the guide (D) is placed a weight lever (bc) which swings around (b) and is adjustable. The weight lever carries in its center a cast iron stool (h) on the lower surface of which are placed three rollers (e) which facilitate the feeding of the wood. The stool (h) is shiftable horizontally in a slot of the weight lever, so that the

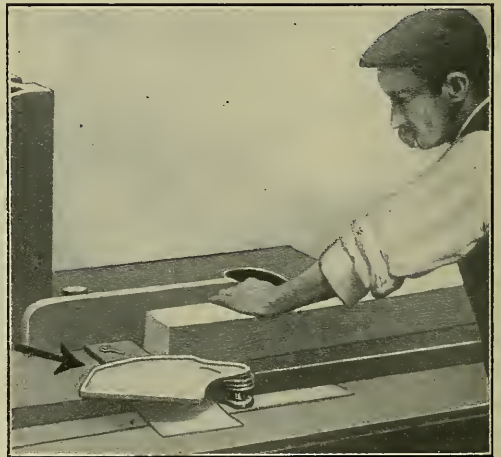

Courtesy of British Factory Dept.

Fig. 158. Gibbs Jointer Guard.

weight lever carries in its center a cast iron stool (h) on the lower surface of which are placed three rollers (e) which facilitate the feeding of the wood. The stool (h) is shiftable horizontally in a slot of the weight lever, so that the

pressure on the wood may be exerted at the necessary point. All the part of the table gap not covered by the apparatus is protected by an adjustable guard.

Short Pieces. Special danger is involved in the working of short pieces on a hand jointer. Such pieces may tip at the table's edge, or a blunt knife may give a blow that does not cut clean, or a ragged end, knot or bulging place on the stock may catch—in any event throwing the workman's hand into the knives. Short pieces are also very likely to kick, owing to their lightness and the difficulty of holding them close to the table. Many shops will not allow short strips to be planed on a hand jointer, and this rule should be generally followed.



Courtesy of U. S. Cast Iron Pipe & Foundry Co.

Fig. 159. Home-made Jointer Guard.

Where such work is done, however, some safe means of holding the stock should be furnished and its use insisted upon. One of these means is a push block, made somewhat in the shape of a hand plane with a cleat at the back to cover the end of the stock. It is well to have the under side of the block a notched metal plate, to hold the material squarely and prevent it from kicking sideways. Or a strip of iron having the lower edge toothed can be fastened to the front end of the block so that the teeth will protrude a little below the bottom of the block. An appliance of this sort can be used to advantage in connection with an automatic guard. Such a push block is shown in Fig. 166 (page 110). Similar appliances can be made, and should be used, for three-cornered pieces and other irregular shapes.



Courtesy of Harris & Cole Bros.

Fig. 160. Home-made Jointer Guard.

It is difficult to state the minimum length of stock which should be worked on a hand planer. The rules of the German woodworking associa-

tions require a push block or other feeding apparatus for all pieces shorter than 15 3-4 inches and thinner than 2 3-4 inches. In some shops in this country 12 inches is fixed as the minimum length.

It is well to be on the safer side and put the figure high enough.

There are self feed planers made especially for short pieces, on which it is claimed that even 5-inch stock can be safely handled. The feeding apparatus consists of rollers driven by sprocket chains, and the operator has to push the stock only a short distance to start the cut.

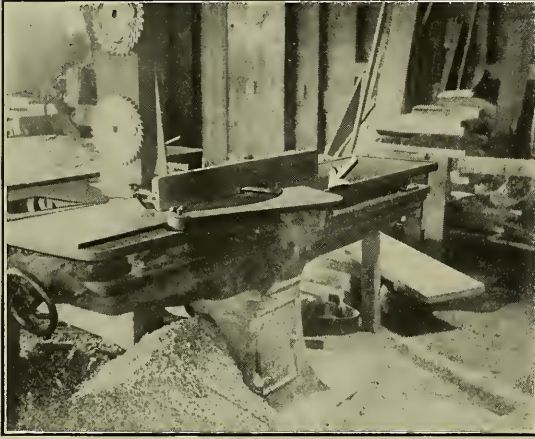
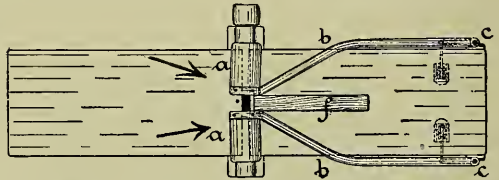

Fig. 161. Home-made Jointer Guard.

of board should be clamped on, or some other device used.

Care in Operation. No one should be allowed to run a jointer or buzz planer without full instructions as to the points of danger, and an operator cannot be too careful about his work and the adjustment of his machine in order to avoid injury. He should always work from the side, never from in front. He should try never to let one of his hands rest upon that part of the stock which is directly over the knives. He should also be careful not to let either of his hands get too near



Courtesy of North German Woodworkers' Ass'n.

Fig. 162. Double Automatic Jointer Guard.

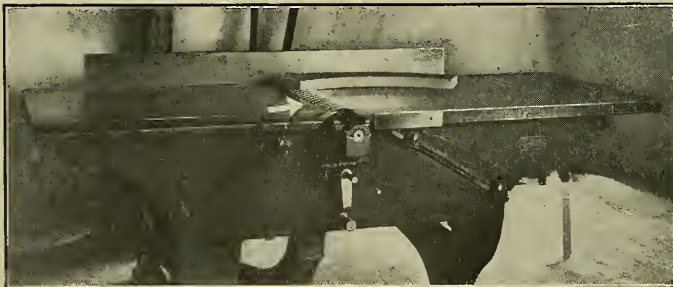

Courtesy of General Electric Co.

Fig. 163. Finger Guard for Jointer.

either the front or the rear end of the material which he is working. The stock should not be pushed forward too rapidly, and the pressure of the hands upon the stock should be evenly divided. The operator's footing should be secure, his grip firm, his position well taken, and his eyes and mind wholly on the job. An operator should never wear gloves while at work and his sleeves should be tight-fitting or short.

A workman should try a jointer before using it, to see that the knives are not set to take too heavy a cut, as this is almost sure to kick the stock, especially if a knot or change in grain is struck. Special care should be taken to see that the rear table is in a plane with the highest position of the knives.

When adjusting or changing knives, the belt should be removed from the pulley attached to the head, as otherwise the belt may creep on the tight pulley and unexpectedly start the machine. Great care

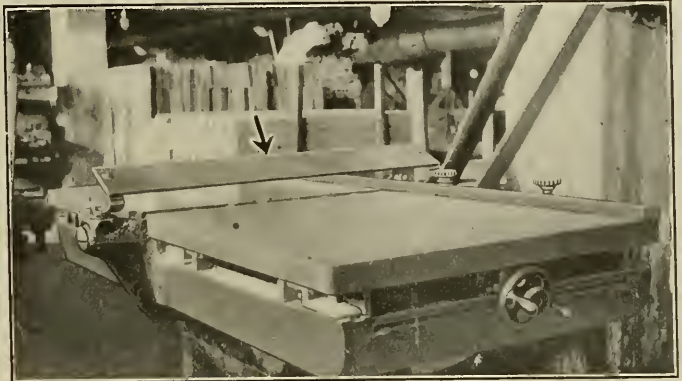

Courtesy of Grand Rapids Show Case Co.

Fig. 164. Buzz Planer Guard.

should be exercised in cleaning up around a jointer. Many a man's fingers have been badly cut by the knives catching the waste with which he was wiping off the bed. Brushing away shavings is another dangerous operation. When a guard is removed for rebating, it should be replaced as soon as that work is completed.

Setting and Care of Knives. Many accidents are caused by the condition or setting of the knives. Dull knives cause kicking, and so do those unevenly sharpened. Knives should be sharpened and balanced with great care, and should then be set with no more than the necessary overhang for free cutting. They should be attached to the head so that the latter is in "running" as well as "standing" balance. Bearings should be close, yet free. Loose journals or insecure caps on bearings cause vibration and lead to accidents. To help avoid vibration, as well as secure good alignment, babbitting should be very carefully done.

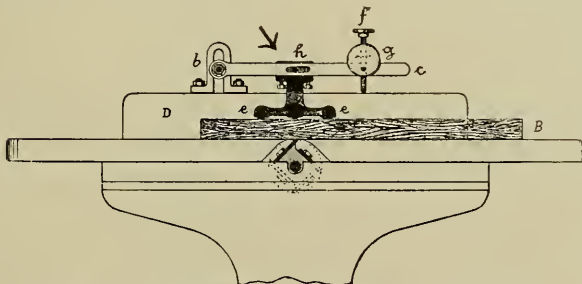

Fig. 165. Pressure Apparatus for Jointer.

(being set at an angle or something as bad), or some foreign substance getting between the clamp and the knife. Then, when the machine is working, the knife is likely to fly out or to gouge into the wood and kick it back.

The Guide. To assure good work, as well as to prevent accidents due to twisting of stock and its irregular presentation to the knives, the guide on a

Too much emphasis cannot be laid upon the necessity of avoiding hurry or carelessness in changing knives. Either is apt to result in a knife being badly set, or the bolts not being tightened enough, or the wrong knife being used, or the knife not fitting properly

jointer should be exactly at right angles to the head. In changing the position of the guide great care should be taken to fasten it securely in its new position so as to avoid any danger of its slipping.

Steel Lips for Tables. It is highly important that the edges of the tables be kept in good condition, as the possibility of injury increases naturally with the width of the gap between the two tables. To guard against this gap being made irregular and wider by the edges breaking off, it is advisable to have the tables equipped with steel lips so made that they will extend over the head as far as possible without interfering with the cutting.

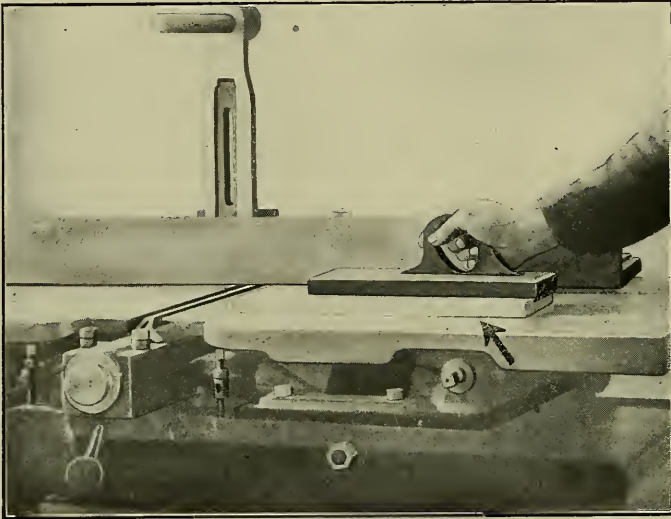

Courtesy of North German Woodworkers' Ass'n.

Fig. 166. Push-block for Short Pieces.

Transmission, Etc. For the guarding of belts and pulleys generally, or other driving apparatus, see the chapter on Power Generation, Transmission, Etc.

SHAPERS.

The shaper, as the irregular moulder is commonly called, is one of the most dangerous of woodworking tools. For every operator who has run a machine for a number of years without suffering injury there are hundreds who have lost all or parts of fingers or hands, and there have been many cases of loss of life.

The exceptional danger of the shaper is due to the facts that the material must be guided by the hands, that for much of the work a guide cannot be used, and that, on account of the necessity of leaving the work smooth-finished, the knives must be run at a high rate of speed.

Shaper work is of such variety that a universal guard would be difficult, if not impossible, to find. There are patented guards adaptable to many kinds

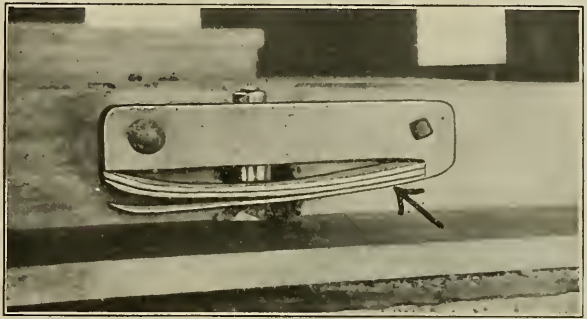

Courtesy of Olson Stair Co.

Fig. 167. Wooden Spring Shaper Guard.

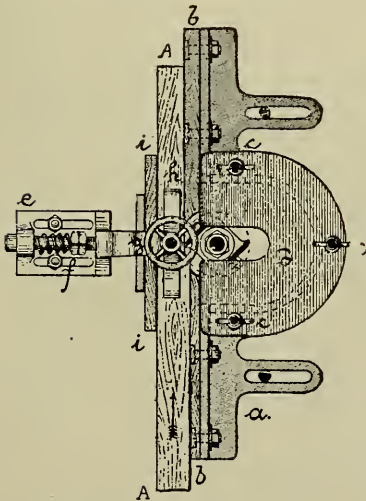

Courtesy of North German Woodworkers' Association.

Fig. 169. Guard for Grooving.

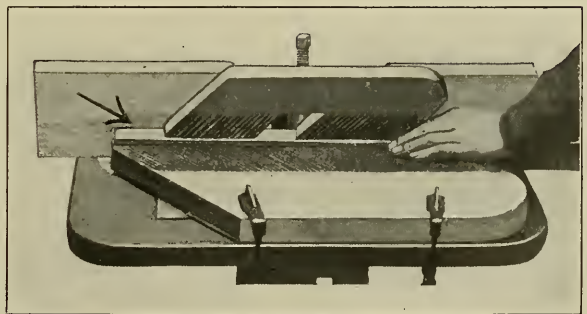

Courtesy of North German Woodworkers' Ass'n.

Fig. 168. Notched Board Shaper Guard.

of work, however, and home-made guards can be devised for particular work which will fulfil the necessary double purpose of protecting the operator's hands and acting as tension on the material.

Straight Work. For straight work a guide can be applied in such a way as largely to lessen the risk of accident, and a guard can generally be used in connection with it, either in the form of a patented article or of some such home-

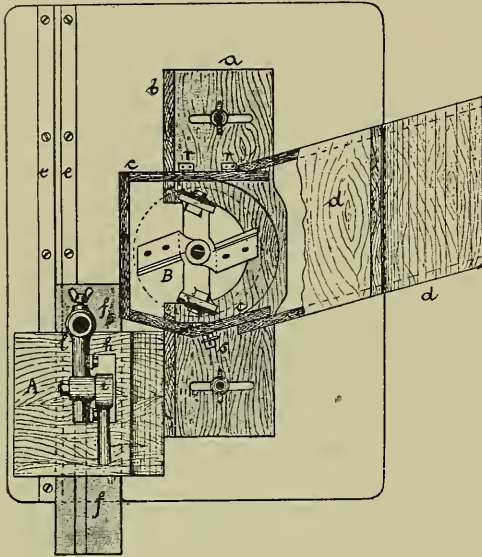

Courtesy of North German Woodworkers' Ass'n.

Fig. 170. Feeding Apparatus.

worker, is shown in Fig. 168 (page 111). A piece of wood notched comb-like is fastened to the shaper table in such a way that the wooden teeth press like a spring against the wood to be shaped. The angle at which the teeth are cut prevents the throwing back of the stock. A similar notched board, attached to the guide, serves as a hold-down and also protects the operator's hands.

Sometimes a blade spring is used to give horizontal pressure. A strip of wood or metal is fastened to the table in front of the spindle and parallel with the guide. On the inner side a blade spring is attached. As the stock is fed between this spring and the spindle, the spring holds it firmly against the knives. The strip holding the spring can be arranged to run along grooves in the table so that it will be adjustable forward and backward.



Courtesy of Grand Rapids Show Case Co.

Fig. 171. Home-made Shaper Guard.

Grooving Work. Where grooving is to be done by cutters or saws, many consider it too dangerous to press the stock against the cutting tool by hand,

and therefore require the use of mechanical pressure apparatus. A German arrangement for giving both vertical and horizontal pressure is shown in Fig. 169 (page 111). The material (A) is pressed horizontally against the knife through a screw spring (f) and down pressure is given by a blade spring (h) adjusted by a hand wheel. Similar pressure apparatus is used generally in Germany for much work.

Where a circular saw is used in a shaper head for grooving and no pressure apparatus is used, the guide can be built so as to surround the head on three sides, the back part being beveled at an upward slant to allow chips to fly out. To the guide can be fastened, on top, a protection plate which will overreach the saw. This plate can be either of wood or of wire mesh.

Feeding Apparatus. For some kinds of work done on a shaper, the Germans often use special feeding apparatus, such as is shown in Fig. 170 (page 112). The spindle is surrounded on three sides by a wooden frame on which is fastened in front the guide (b). To this frame is fastened also a wooden casing (c) working at one side on hinges (rr) and fastened at the other side by a bolt (s). This covers the entire knife head, leaving only enough room in front for the material to pass beneath. The chips are carried off by the slanting roof (d) at the rear. The stock to be worked is set on an iron carriage (f) which slides in an iron channel (e) screwed fast to the table. A press plate (h) holds the stock firmly on the carriage. It is brought into position by a lever (i) which then serves also as a handle for pushing the apparatus and material by the knives. Both press plate and lever are adjustable on a supporting horizontal arm and are carried by a post (l) attached to the carriage.

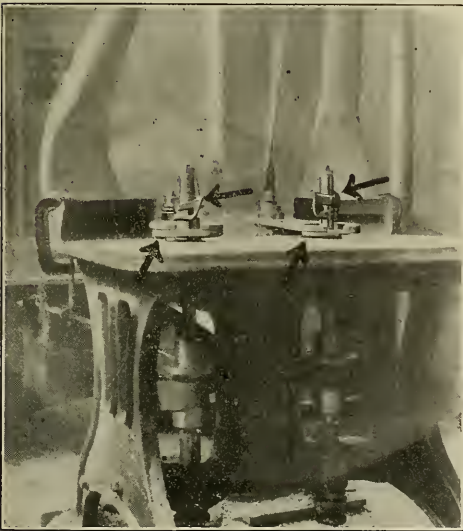

Courtesy of Grand Rapids Show Case Co.

Fig. 173. Home-made Shaper Guards.

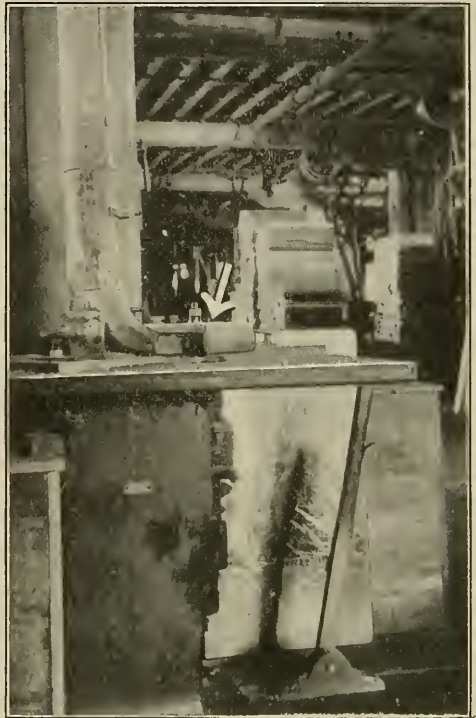

Courtesy of Widdicomb Furniture Co.

Fig. 172. Home-made Shaper Guard.

Fig. 172. Home-made Shaper Guard. This covers the entire knife head, leaving only enough room in front for the material to pass beneath. The chips are carried off by the slanting roof (d) at the rear. The stock to be worked is set on an iron carriage (f) which slides in an iron channel (e) screwed fast to the table. A press plate (h) holds the stock firmly on the carriage. It is brought into position by a lever (i) which then serves also as a handle for pushing the apparatus and material by the knives. Both press plate and lever are adjustable on a supporting horizontal arm and are carried by a post (l) attached to the carriage.

Variety Work. Shapers used for a large variety of work in which no guide can be employed are especially hard to guard. Some of the patented guards are very effective, however, and local ingenuity has devised all sorts of

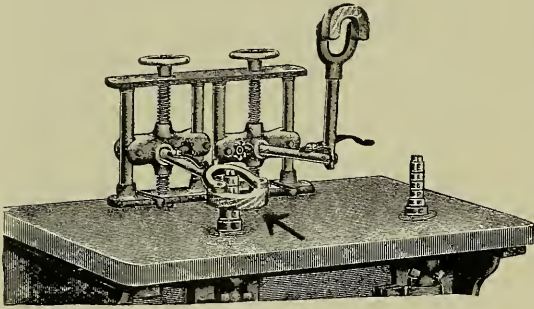

Courtesy of Jones Safety Device Co.

Fig. 174. Jones Shaper Guard.

Patented Guards. Fig. 174 shows the Jones adjustable guard, made by the Jones Safety Device Co., of Buffalo, N. Y. Each arm is jointed so that it can be thrown up when necessary. When in position, a spring puts tension on the stock.

The guard shown in Fig. 175 is made by the American Wood Working Machinery Co., of Rochester, N. Y. The curved block in front of the spindle is supported by adjustable spring bars.

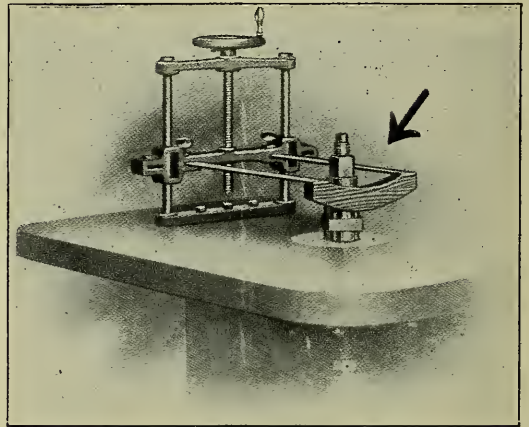

Courtesy of American Wood Working Machinery Co.

Fig. 175. Shaper Guard.

Another adjustable guard, made by the J. A. Fay & Egan Co., of Cincinnati, O., is shown in Fig. 176. The wooden front piece can be moved about by adjusting the spring bars.

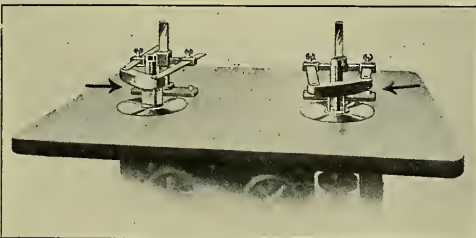

Courtesy of J. A. Fay & Egan Co.

Fig. 176. Fay & Egan Shaper Guard.

automatically adjustable. The dotted lines show how it can be opened.

The Grammes guard, made by L. F. Grammes & Sons, of Allentown, Pa., is shown in Fig. 177 (page 115). It is hinged for throwing back. The fender is held down on the work by a spring.

Fig. 178 (page 115) shows the K. C. guard and chip breaker, made by the Kansas City Shaper Guard Co., of Kansas City, Mo. It is made of steel and malleable iron and is

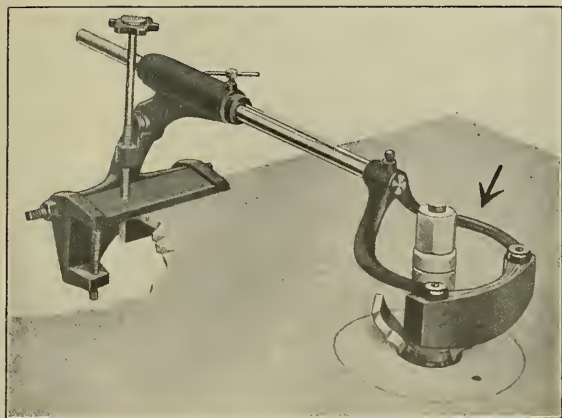

Courtesy of L. F. Grammes & Sons.

Fig. 177. Grammes Shaper Guard.

(page 116). The springs for tension are placed around bolts, attached to the bottom ring and coming up through the top one. Smaller rods are inserted between the spring-encircled bolts for additional safety.

Gelvin's attachment, made by Vandergrift & Morris, of Shelbyville, Ind., is shown in Fig. 182 (page 116). It is adjust-

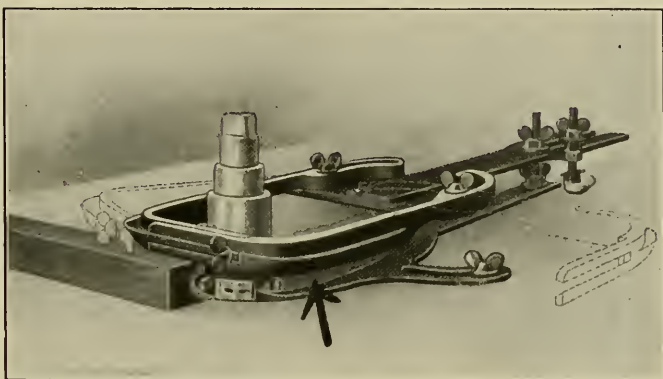

Courtesy of Kansas City Shaper Guard Co.

Fig. 178. K. C. Shaper Guard.

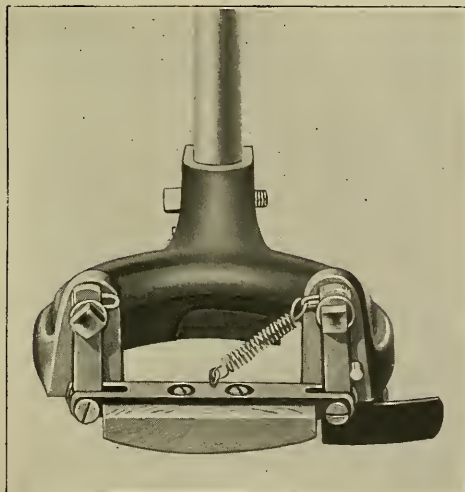

Courtesy of W. S. Richards.

Fig. 179. Richards Shaper Guard.

Another combined guard and chip breaker, the Richards, made by W. S. Richards, of Albany, Oregon, is shown in Fig. 179.

The Racine Guard, made by the Fair Mfg. Co., of Racine, Wis., is shown in Fig. 180 (page 116). This guard is finished with aluminum paint to give better light around the shaper head.

The Buckeye guard, made by Butterfield & Canty, of Logan, O., is shown in Fig. 181

able for thickness and for different sizes of bits, and each of the two arms is removable.

A well-known English guard, Campbell & Greenwood's, is shown in Fig. 183 (page 117). The picture shows the convex shield in position for straight work and for circular work, and when turned up for access to cutters. The shield is pierced for observation and can be slid up and down.

A German guard is shown in Fig. 184 (page 117). It is hinged so the front part can be lifted up, as shown in the picture. Tension on the work is given by a spring.

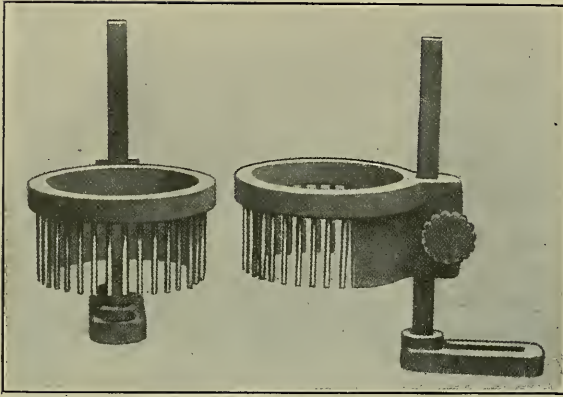

Courtesy of Fair Mfg. Co.

Fig. 180. Racine Shaper Guard.

heavy work, it is very substantial. The iron ring guarding the spindle is made of heavy bar metal. The guard is adjustable up and down on the strong wooden framework hung rigidly from the ceiling.

Ring, Plate and Cap Guards. Where curved pieces of wood are handled, as in furniture factories, and consequently a guide cannot be used as a rule, the German woodworking associations recommend protection rings as the best form of guard. These rings are made of metal or inlaid wood, the latter having the advantage of being light and not

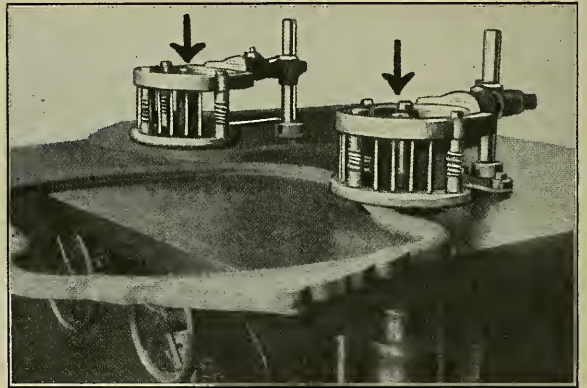

Courtesy of Butterfield & Canty.

Fig. 181. Buckeye Shaper Guard.

warming up. Fig. 188 (page 119) shows one of the metal rings, in the form of a light spoked wheel. The ring is fastened on the spindle, as close as possible to the cutters, and revolves with it. Through its rapid rotation the spokes become invisible to the workman. An assortment of rings of different sizes is usually kept on hand. Rings are also used which are so attached to the spindle that they revolve with it when no work is being done, but as soon as anything comes in contact with them they cease to move.

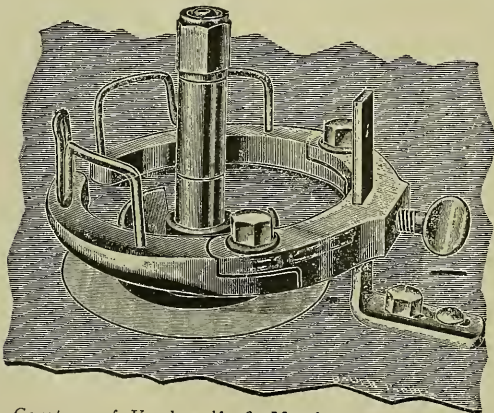

Courtesy of Vandergrift & Morris.

Fig. 182. Gelvin's Shaper Guard.

Circular plates curved so as to come down over the cutters as far as possible, rounded at the edges and pierced on top to form arms, can also be employed. Brass caps of various diameters, pierced for arms and rounded off at the edges, are sometimes used in England. A German device, in the form of a pulley-like guard for the cutters, is shown in Fig. 189 (page 120). Any of these arrangements leaves the table entirely clear.

Suction Pipes. Several of the pictures shown, notably Figs. 171 (page 112), 172 and 173 (page 113), 185 and 186 (page 118), illustrate the suction pipes which should always be used on shaper tables to keep them clear of shavings.

This is an important feature of shaper guarding, as in brushing away shavings with his hands an operator runs much risk of coming in contact with the cutters, even under guards when set for certain kinds of work. Suction pipe openings should take the form of a flat orifice lying on the table, and it is desirable to have them arranged so they can be swung around in any way.

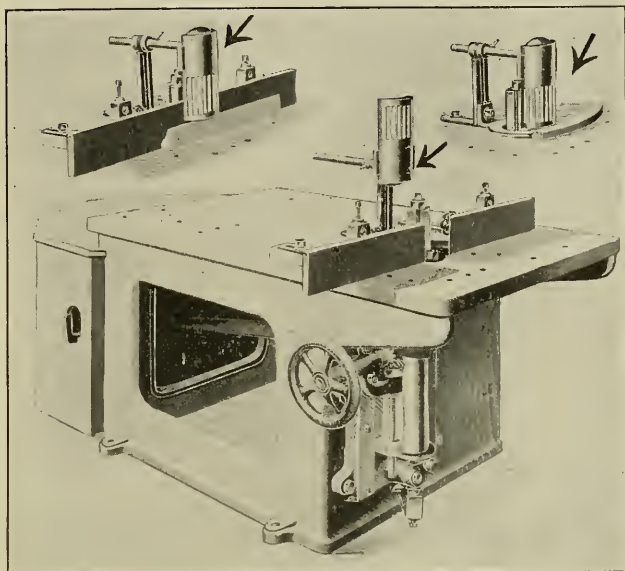

Courtesy of British Factory Dept.

Fig. 183. Campbell Guard for Shaper.

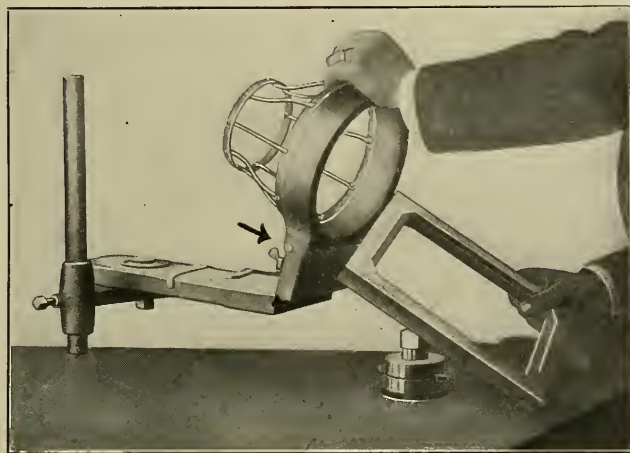
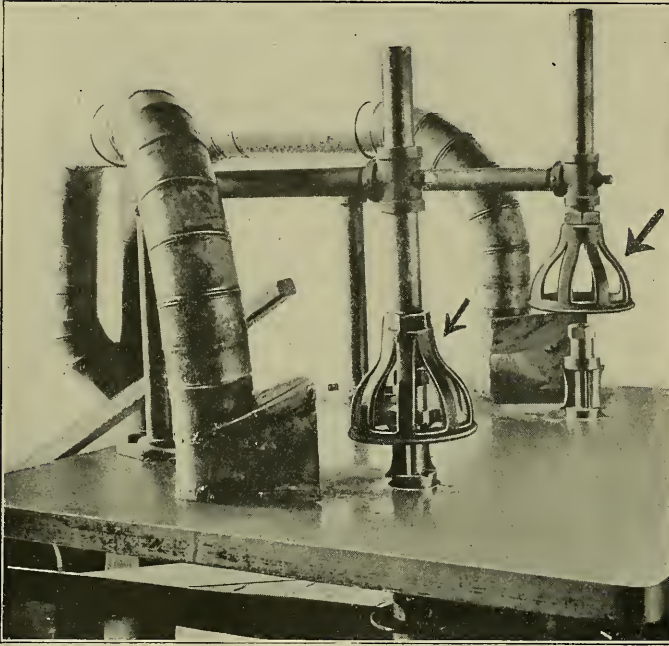

Fig. 184. Hinged Shaper Guard.

clear of chips, but its flapping ends warn the operator if his hand gets too close to the cutters.

The shapers in Fig. 173 (page 113) are equipped with leather devices to fan the cuttings off the work. These are made by cutting two slots parallel half way of a piece of leather. By buckling out the middle between the slots, the leather is then slipped over the spindle. Not only does such a device help keep the material

Home-made Feeding Device. For certain work on short pieces a feeding arrangement can well be used. A simple device of the kind, invented by a chair factory foreman, makes use of a pair of common laundry wringers. By continual turning of the wringer, the pieces push each other through. Strips arranged on the table act as springs to hold the material against the guide.



Courtesy of International Harvester Co.

Fig. 185. Pierced Shield Shaper Guard.

back of the guide fenced off, unless protected by any guard used. A covering can easily be made, and often it can be a part of the guide.

Setting and Care of Knives. Knives should be set in the spindle with the utmost care, and fastened very securely. Many bad accidents have been caused by flying knives. The threaded collars and spindles should be watched closely for damaged threads and crystallized metal. Shaper knives should be sharpened very carefully, both for cutting edge and to keep them in proper balance.

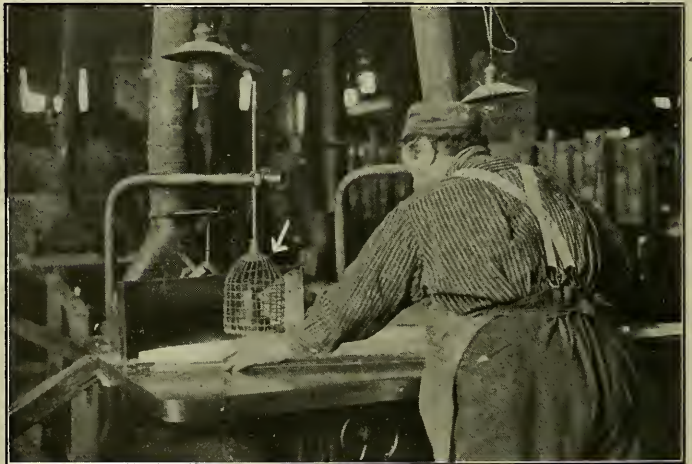

Courtesy of International Harvester Co.

Fig. 186. Wire Cage Guard for Shaper.

An ingenious arrangement for holding knives securely is in use in a large plumbers' supply plant in which very heavy knives are used on many of the shapers. Both the knives and the collars which hold them are grooved, as shown in Fig. 190 (page 120). The grooves are made twelve to the inch. Since this scheme was put into effect not a single knife has flown in this factory.

In some plants knives and head are made in one solid piece, which of course prevents any possibility of a knife flying. Such an arrangement is very expensive and the workmen do not like it, as grinding is more difficult and takes longer.

Care in Operation. Guards are designed to keep the workman's hands from coming in contact with the knives should they slip from the material being worked, or should the material be kicked back, or the stock break unexpectedly, or a glue joint pull out, or any one of a number of other possibilities materialize. While they minimize the likelihood of accident, they cannot wholly take the place of caution on the part of the operator. He should see to it that his mind is concentrated on his work, that his footing is firm, and that everything about his machine is in good working order and properly adjusted. No accumulations of stock or finished work should be allowed on the table, to get in his way, nor should there be rubbish on the floor, over which he may trip.

Shaper operators should not wear gloves, and their sleeves should be short or tight-fitting. When a guide is used, the operator should be sure that it is so well fastened that it will not slip. Care should also be taken that the work is securely fastened to any working forms, or patterns. Such forms, with clamps, should be used on all work possible.

General Suggestions. A shaper machine should be of the most heavy and rigid construction and should set very firmly on the floor, to avoid the vibration, chatter, or "give," which are as fatal to the doing of good work as they are likely to cause accident.

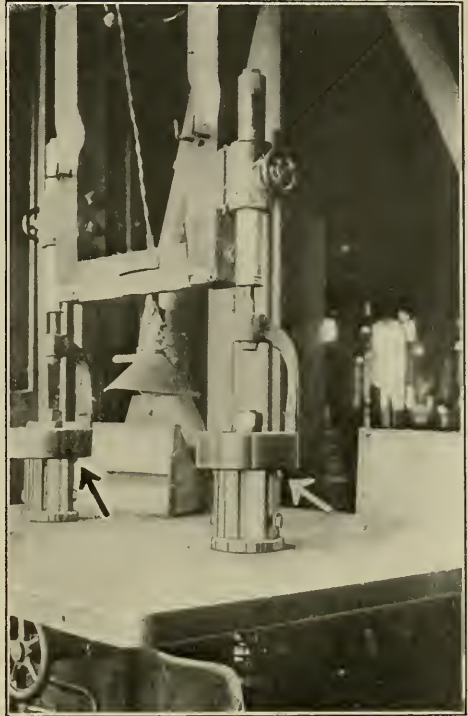

Courtesy of Peter Schuttler Co.

Fig. 187. Home-made Shaper Guard.

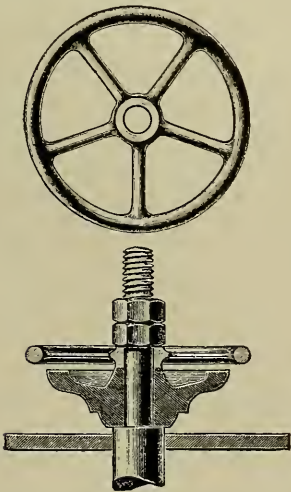

Courtesy of North German Woodworkers' Ass'n.

Fig. 188. Ring Guard for Shaper.

It is advisable to use an endless belt on the spindle. The countershaft and the belts leading from it to the machine should be surrounded by a fencing, preferably of wire mesh, raised a little above the floor at the bottom and several feet high.

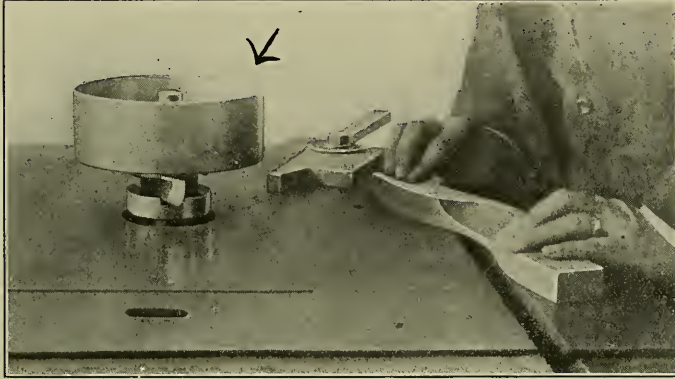

Fig. 189. Pulley Shaper Guard.

Every shaper should be equipped with an efficient belt shifter, with its control convenient to the operator in his working position. The handle should be so situated or guarded that it cannot be accidentally moved by the operator.

If the mechanism under the table is exposed, the whole table front beneath the top can well be fenced in, leaving openings for adjustment wheels and for the foot treadle shifting the belts, if such is used. Lock nuts should always be provided for spindles. A rubber mat or slats should be furnished to give the operator firm footing.

Only experienced men should be employed to run shapers. Care should be taken to supply only proper knives and that they are kept in perfect condition. Shaper operators should be cautioned from time to time as to the danger of the machine. Familiarity is apt to breed contempt, and the least carelessness may cause a bad accident.

Transmission, Etc. For the guarding of belts and pulleys generally, or other driving apparatus, see the chapter on Power Generation, Transmission, Etc.

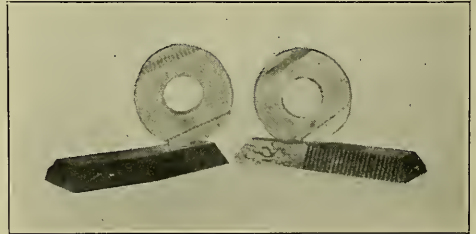

Courtesy of L. Wolff Mfg. Co.

Fig. 190. Grooved Knives and Collars.

SANDERS, ETC.

(Including Surfacers, Borers, Mortisers, Tenoners,
Derricks, Drag Saw and Dry Kilns.)

Sanders vary so greatly in form that they have practically only one point in common which requires guarding, the belts and pulleys or other driving mechanism. Many machines can also be guarded considerably by exhaust apparatus.

Feed Entrance. The ordinary sander, in which the material, held down by pressure rolls, is fed over revolving drums, needs guarding at several points. One is the feed entrance. If an operator's hands should be caught by the rolls there, they would be severely injured. Some sanders come equipped with a metal bar in front of the feed rolls, leaving just enough room beneath for the stock to enter, as shown in Fig. 191, a machine commonly used for furniture work. When not so guarded, a metal bar should be placed in front of the front top feed roll, so attached that it will raise and lower with the roll, its lower edge always being just a little above the bottom of the roll.

Take-away End. The take-away man is very apt, especially when short pieces are being sanded, to reach over the little feeding-out table and allow his fingers to drop over its inner edge. Then a piece of stock coming along is likely to cut the fingers off. Whenever possible, an extension of the feeding out table, as shown in Fig. 192 (page 122), should be provided. It is well also to have a guard at this point to keep a man's hands away.

One device is a board or sheet of metal extending from the upper frame of the machine down as close as possible to the table, with another piece, connected with it at right angles at the bottom, reaching out parallel with the

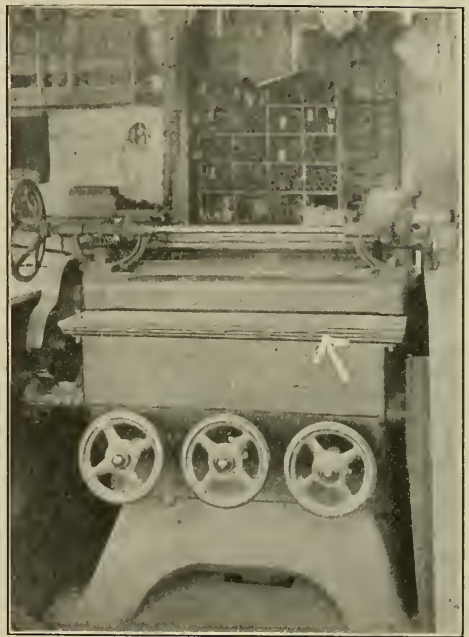

Courtesy of C. S. Paine Co., Ltd.

Fig. 191. Bar Guard on Sander.

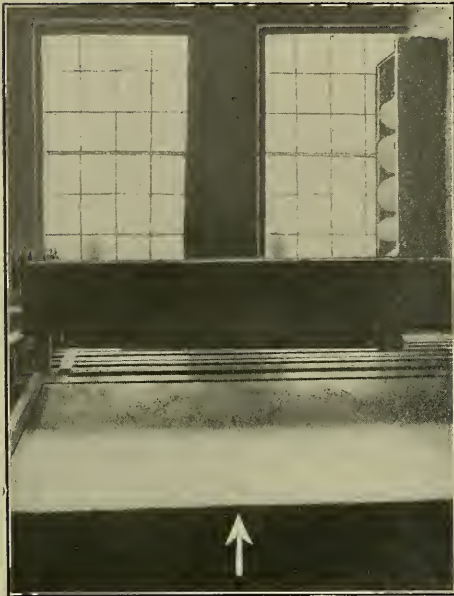

Courtesy of Gruhl Sash & Door Co.
 Fig. 192. Feeding-out Table for Sander.

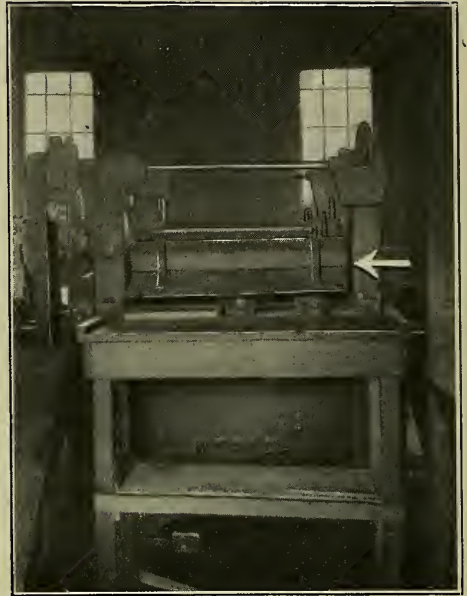

Courtesy of Grand Rapids Show Case Co.
 Fig. 193. Take-away Guard for Sander.

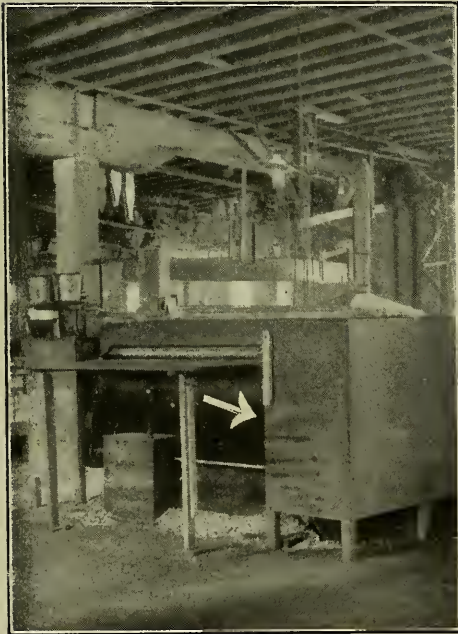

Courtesy of Widdicomb Furniture Co.
 Fig. 194. Sander Belt and Gear Housing in Place.

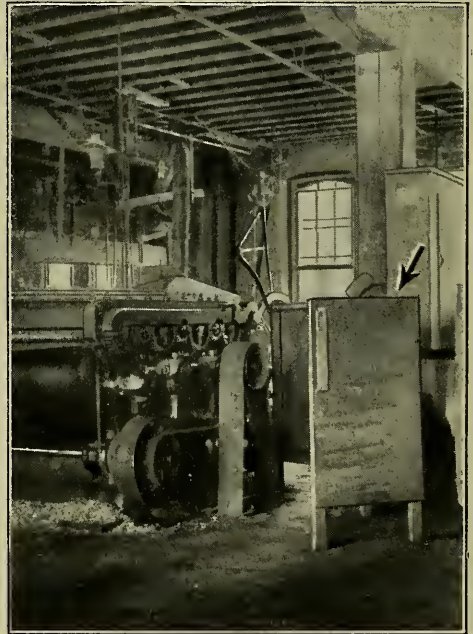

Courtesy of Widdicomb Furniture Co.
 Fig. 195. Sander Belt and Gear Housing Removed.

table for several inches. Another is an apron, hinged to the machine frame, which is pushed up and out by the stock coming through. To avoid tracking where very fine wood is being sanded, as in furniture and chair factories, this apron is sometimes made stationary in a slanting position, as shown in Fig. 193 (page 122). The board which acts as an apron is attached to the machine frame by angle iron. It reaches far enough down and out to keep hands out of danger.

Gears, Belts, Etc. Another danger point is at the sides of the machine, where belts and pulleys and nests of gears operating the feed rolls are situated. The risk here is the greater because the sanding drums oscillate as well as revolve. Fig. 194 (page 122) shows how this driving mechanism can be completely covered by wooden housings, stopping a little short of the floor so that sweeping out may prevent accumulation of rubbish there. The guard is removable and can be lifted away, as shown in Fig. 195 (page 122) when necessary. Fig. 196 shows a method of guarding this point by wire screening on an angle iron frame.

Where the press rolls are adjusted from the bottom of the machine, a flat board cover is often provided for the top of the machine to prevent anyone reaching over and putting his hand down into the machine between the rolls.

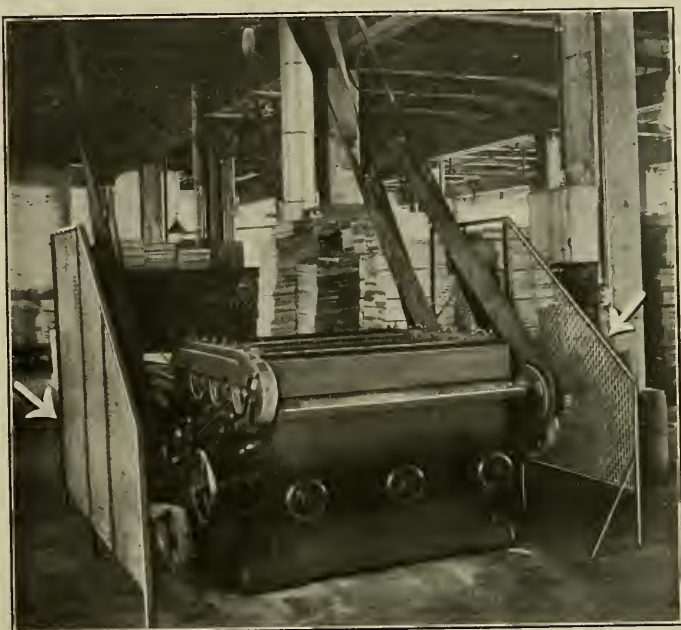

Courtesy of International Harvester Co.

Fig. 196. Screen Guards for Sander.

Endless Bed Feed Sander. In furniture and chair factories and other plants where many small pieces are polished, as well as larger work, the endless bed feed sander is much used. Such a machine, made by the H. B. Smith Machine Co., of Smithville, N. J., is shown in Fig. 197 (page 124). This machine needs guarding only at the sides, where the belts and pulleys and sprocket wheels and chains are located. There are no feed or pressure rolls, the frame of the machine in front comes well down to the bed, and the sanding drums, which are on top instead of underneath, are completely covered.

Disk Sanders. The disk sander, much used in furniture, box and wagon factories and other plants, can often be well guarded by the exhaust apparatus, as shown in Fig. 198 (page 124), a picture of a double disk sander in a furniture plant. Each wheel is entirely enclosed under the table, and as much as

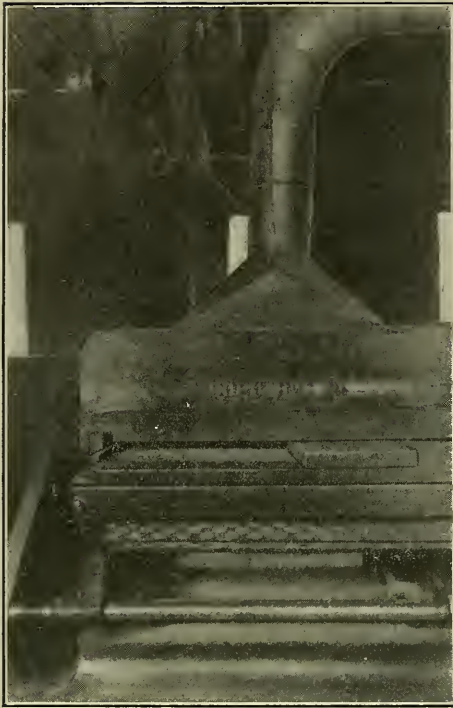

Courtesy of Michigan Chair Co.

Fig. 197. Endless Bed Feed Sander.

give a bad scraping, which may result in blood poisoning. The horizontal machine can always be guarded at least by a semi-circular exhaust hood partly encircling the pulley towards which the dust is driven, and the other pulley can usually be boxed or fenced off. The hood should be so large or set so close to the belt that a hand cannot get caught between belt and hood. Fig. 202 (page 126) shows well guarded sanding belts in a wagon plant.

Moulding Sanders. The sander used in picture moulding and other plants which polishes and brushes the moulding at the same time can be completely housed on top, with the covering hinged on one side so that it can be lifted up when necessary. If the front feed rolls are not protected, the bar guard suggested for the ordinary sander should be used.

possible above it. Fig. 199 (page 125), another furniture picture, shows a single disk sander with the bottom part and the back of the upper part enclosed, and also a spindle sander guarded as much as possible by its suction pipe.

The sanding wheel used for such work as polishing doors and sash can be well guarded by a suction hood, as shown in Fig. 200 (page 125). Similar protection, though not quite so complete, can be given such sanding drums as those used for polishing felloes. Fig. 201 (page 125) shows a door panel sander whose wheels are enclosed in suction hoods.

Belt Sanders. The various styles of belt sanders can be guarded quite effectively by exhaust apparatus. Wherever possible, they should be completely housed except at working points. When near a passageway or so situated that persons may fall on them, they should be fenced off. They can

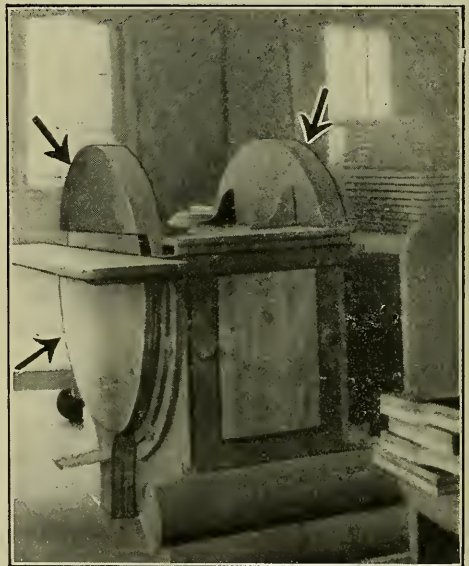

Courtesy of Widdicomb Furniture Co.

Fig. 198. Disk Sanders Guarded.

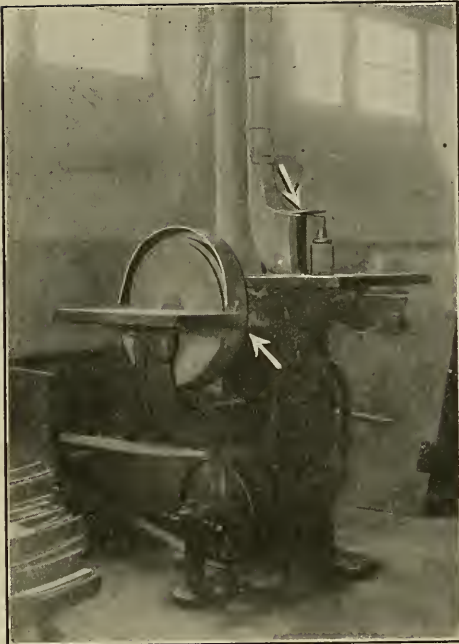

Courtesy of Grand Rapids Show Case Co.

Fig. 199. Disk Sander Guarded.



Courtesy of Gruhl Sash & Door Co.

Fig. 200. Sanding Wheel Guarded.

The same bar guard should be used on the moulding sander employed in furniture factories.

SURFACERS.

The surfer, or power feed planer, is one of the most widely used of wood-working machines. Either single or double, and in one or another of its many sizes and forms, it is employed in saw mills, planing mills of all kinds, box factories, bridge, boat and ship-building shops, car, wagon and agricultural implement plants, furniture and chair factories, cabinet and carpenter shops — in fact in practically every woodworking establishment.

Driving Mechanism.
Whatever their sizes and whether designed to plane two sides or only one, all surfacers need the same sort of guarding in many respects.

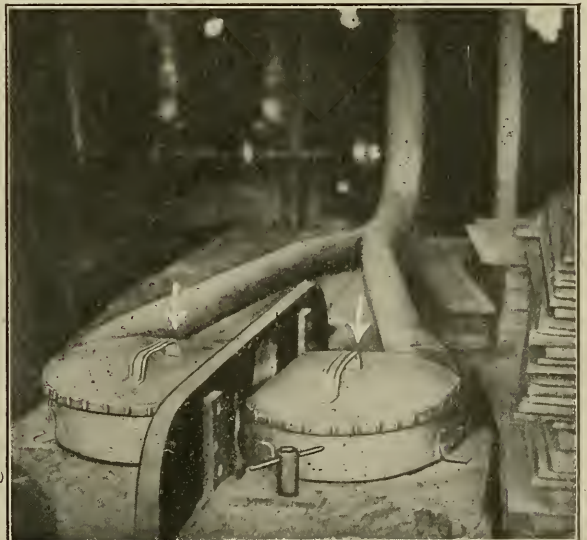

Courtesy of Standard Mill Work Co.

Fig. 201. Panel Sander Guarded.

The belts and pulleys or other driving apparatus should be fenced off. If pulleys are located at the front, they can well be protected like those of sizers, moulders, etc., as suggested in the chapter on "Planing Mill."

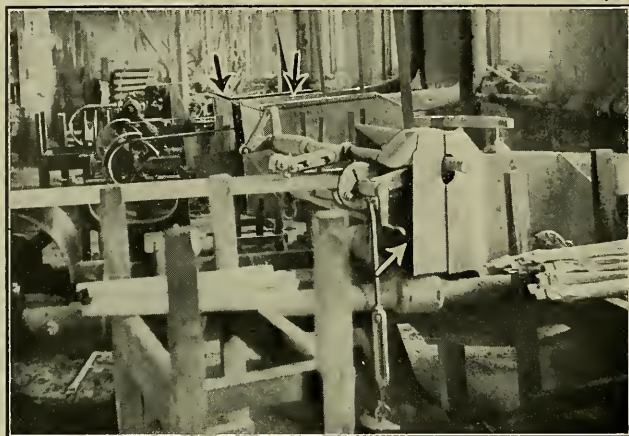

Courtesy of McDowell-Trammell Co.

Fig. 202. Sanding Belts Guarded.

Fig. 203 and Fig. 204 (page 127) show a single surfacer well guarded on both sides. Fig. 203 shows how the guard on that side opens.

Feed Entrance. Many surfacers are equipped with a substantial bar guard in front of the feed entrance, which prevents an operator's hands following stock into the rollers. Such a machine is shown in Fig. 205 (page 127). The guard is bolted to the machine and always remains in place. Where a surfacer is not so guarded, and short stock is being worked or a feeding table long enough to keep the operator out of danger is not used, a safety strip can well be placed in front of the feed roll. This strip, or bar, should be fastened to the frame carrying the roll, so as to remain in adjustment for any thickness of stock. The pony planer used for light work in furniture plants, etc., is especially likely to require this bar protection. Many of these machines have the fixed bar shown in Fig. 205 (page 127).

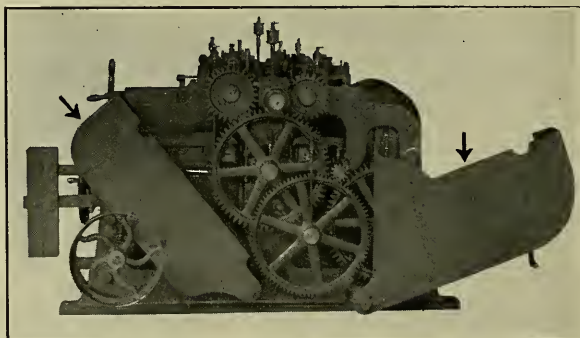

Courtesy of Baxter D. Whitney & Son.

Fig. 203. Single Surfacers Guarded, Guards Open.

General. Every surfacer should be equipped with an efficient belt shifter, clutch, or other means of quickly disengaging the power. It is best to use a sectional feed roll, which will allow simultaneous feeding of pieces of stock of varying thickness without danger of a thinner piece being kicked out or

The gears ordinarily used to drive the feed rolls should be encased. Some surfacers are built without gears, both heads and rolls being driven by roller chains working over sprocket wheels, and all moving parts being situated on the rear side of the machine, out of the operator's way. Most of them, however, have a number of dangerous gears which if left exposed even partially are apt to cause accidents.

otherwise causing trouble. Knives and heads should be cared for and adjusted as indicated for sizer, moulder, etc., knives in the chapter on "Planing Mill." As in the case of sizers, etc., it is advisable, when working about a head, to throw the power off the main drive belt as well as the belt driving the head.

BORERS AND MORTISERS.

The chief dangers connected with boring machines are found in the gears or belt driving the spindle and in the protruding set screw frequently used to hold the bit in the chuck. These points should be guarded both when borers are used separately and when in machines which also do other work.

Gears. When gears are used to drive a spindle, they are sometimes encased by the manufacturer. If this is not done, they should be enclosed in a home-made cover, which can advantageously be of sheet metal or wire mesh.

In the case of multiple borers, whether vertical or horizontal, all the spindle gears can often be covered by one shield, as shown in Fig. 206 (page 128), a picture taken in a wagon plant. This can be either removable or hinged for necessary access. It is well to have it hinged, so that when thrown back it remains attached to the machine. The shield should come down as low as the work will permit. Fig. 207 (page 128) shows a hinged wire screen guard in two sections, each of which can be raised by a rope running over a pulley above.

Set Screws. A chuck which will hold the bit without the aid of a protruding set screw is the safest to use. Many machines come equipped with round safety sockets. When a protruding set screw is used, it should

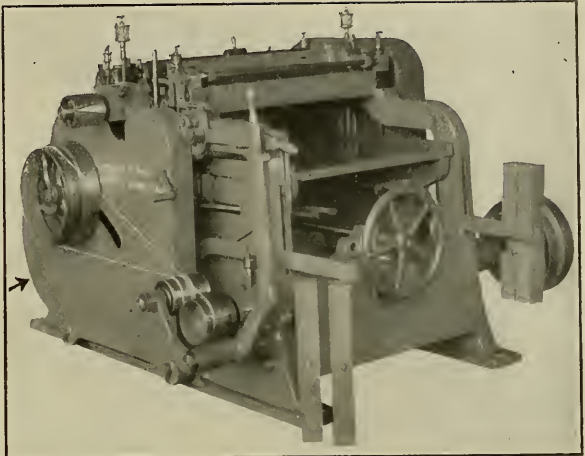

Courtesy of Baxter D. Whitney & Son.

Fig. 204. Single Surfacer Guarded.

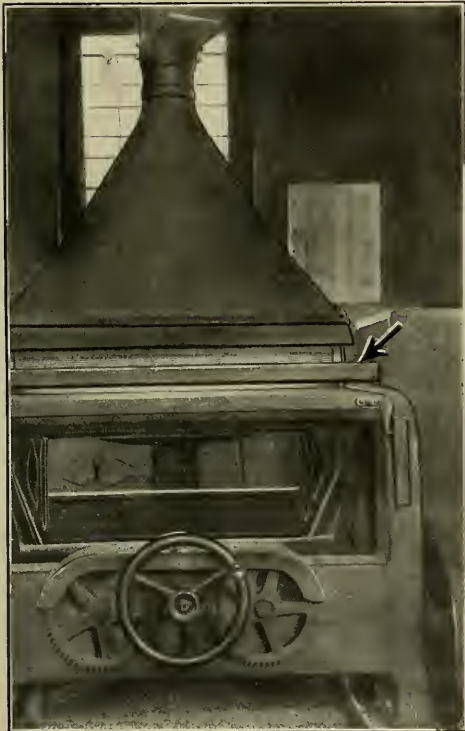

Courtesy of Grand Rapids Show Case Co.

Fig. 205. Surfacer Feed Roll Guarded.

always be covered. A collar hollowed out underneath can be dropped over the chuck so as to cover the screw head. When the thickness of the socket is great enough, a sunken screw can often be used. (For other means of protection see the chapter on Power Generation, Transmission, Etc.) Any protruding set screws in collars on spindles should also be covered or countersunk.

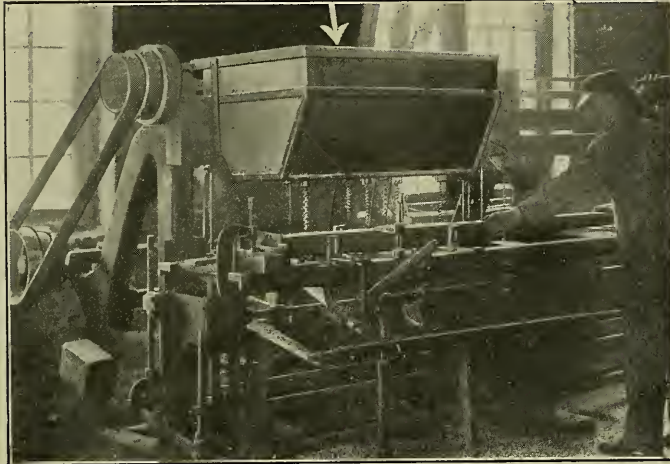

Courtesy of International Harvester Co.

Fig. 206. Multiple Boring Machine Guarded.

Fig. 208 (page 129) shows a bung borer, used in a cooperage, equipped with home-made guards. Leather is wound around the protruding set screw and the gears at the top are encased in a sheet metal boxing.

Belts. In borers with belted spindles the belts are sometimes dangerously near the operator. In such cases they should be protected by shields.

Counterweights and Springs. If a counterweight is used on a vertical borer to effect return movement of the bit, care should be taken that the counterweight is firmly fastened. When springs are used for the return movement, they should be kept in good condition and proper tension.

Holding Work. It is essential that work be firmly held. Accidents have happened through a bit whirling loosely held work around and badly bruising or cutting the operator's hands.

Protecting Hands. Fig. 209 (page 129) shows a home-made guard used in an office and bar fixture factory to keep an operator's

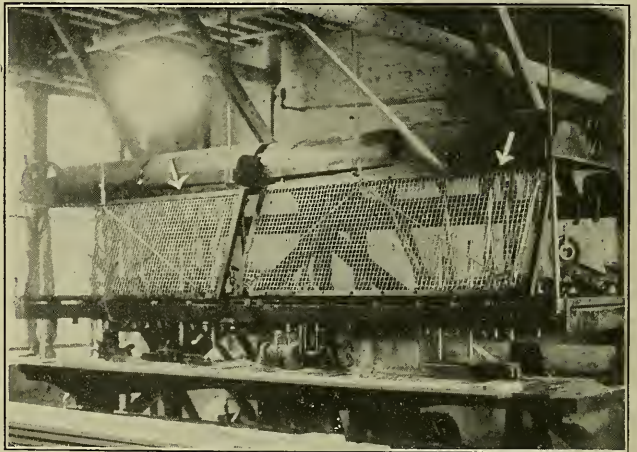

Courtesy of International Harvester Co.

Fig. 207. Screen Guard for Multiple Boring Machine.

hand from getting into the boring tool if it should slip off the work. The guard fits into slots in the uprights at the back of the sliding table on which the stock is fed to the tool. If more than one bit is to be used, this guard can be

slipped out and one put in place having the required number of holes.

Fig. 210 (page 130) shows a horizontal boring machine for boring tenon holes in felloes for wagon wheels. The guard is made of sheet metal. It is pushed forward over chuck and bit by a spring on top. As the chuck holding the bit comes forward, the top part of the guard remains stationary against the felloe.

Mortisers. In some of the automatic hollow chisel mortisers the big driving belt at the side in the rear especially needs guarding, as the bit runs at high speed. An upright sheet of metal should be placed in front of the belt, with a horizontal piece extending out from it over the belt.

The chain mortiser, much used in sash and door and other plants, should always have a suction hood at the top. Many accidents have resulted from an operator carelessly attempting to brush off chips carried around on the chain and thus getting his hand injured by the chain. Fig. 211 (page 130) shows such a mortiser with a suction pipe attachment and also with a removable shield covering the upper part of the chain.

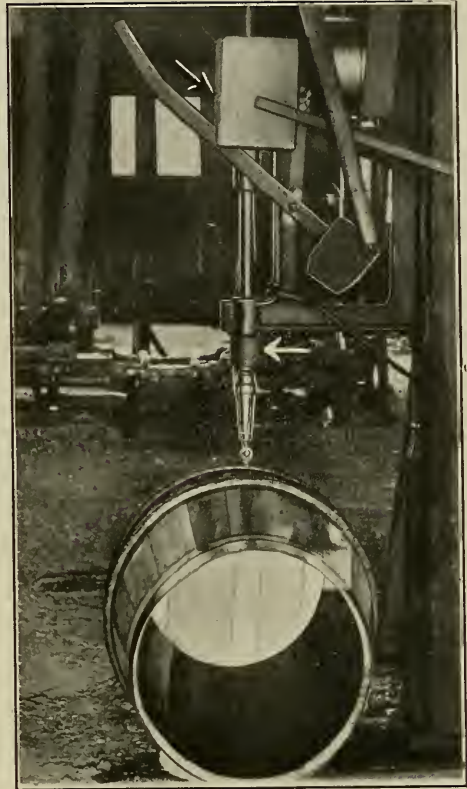

Courtesy of Louisville Cooperage Co.

Fig. 208. Bung Borer Guarded.

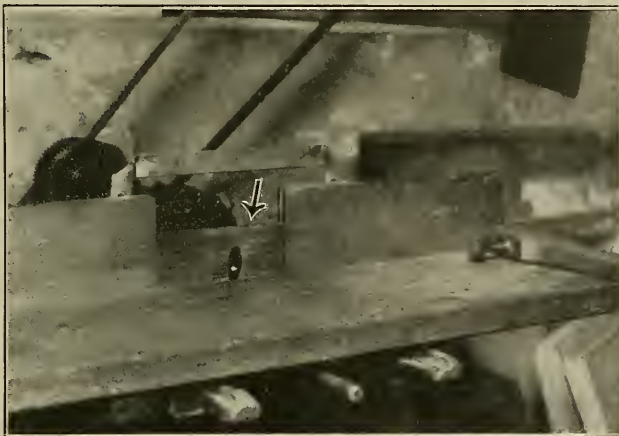

Courtesy of Lehnbuter & Deichman Mfg. Co.

Fig. 209. Home-made Guard for Borer.

TENONERS.

The tenoning machines of various kinds used in furniture, chair, piano, wagon, car, handle, and sash, door and blind plants, cabinet and other woodworking shops should have their cutter heads guarded, and also any cut-off and grooving or slitting saws or shaper heads with which they may be equipped. Many machines come furnished

with metal shields for cutters and saws, but while some of these give enough protection others can well be supplemented.

Suction hoods can generally be arranged to give most if not all of the needed protection. When

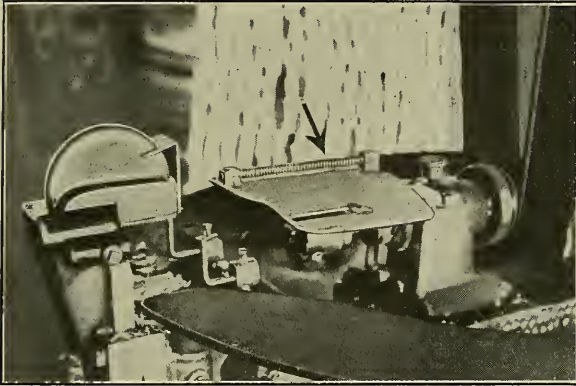

Courtesy of Peter Schuttler Co.

Fig. 210. Felloe Borer Guarded.

this is not possible for tenoner saws, these saws should have broad bands of metal covering all of the teeth except what must be left exposed to do the work. Tenoner cutters should have the same attention and be set with the same care as shaper cutters.

Guard for Hand on Lever. The single end tenoner fed by hand carriage is especially likely to need extra guarding. The opera-

tor's hand holding the lever for pressing the stock on the carriage comes dan-

gerously near the cutter head. Fig. 212 (page 131) shows a guard consisting of a piece of sheet iron placed so that the operator's hand cannot slip off the lever handle into the tool in going by. Such a guard can be fastened to the lever. The cutter head is also guarded by a suction hood. Hand carriages for tenoners should be kept in the best of condition.

Self-feed Double End Tenoner. This machine can as a rule be almost

entirely guarded by suction hoods, or hoods of similar style. Figs. 213 (page 131) and 214 (page 131) show front and rear views of a continuous automatic feed double end tenoner used in a furniture factory. This machine has two sets of knives in front and two in the rear, and all are well guarded by suction hoods and extensions. Part of one of the rear hoods is shown raised for access to the knives.

Fig. 215 (page 132), a picture taken in a sash and door plant, shows a double end tenoner with its cutters guarded by blower hoods, with sheet iron guards around the vertical shafts and with an extension to the feed chains at the feeding-out end. This extension, which consists of two long iron bars bolted to the frame of the machine, makes it unnecessary for the off-bearer boy to step in close to the machine and thus be in danger of contact with the belts. The bottom pulley

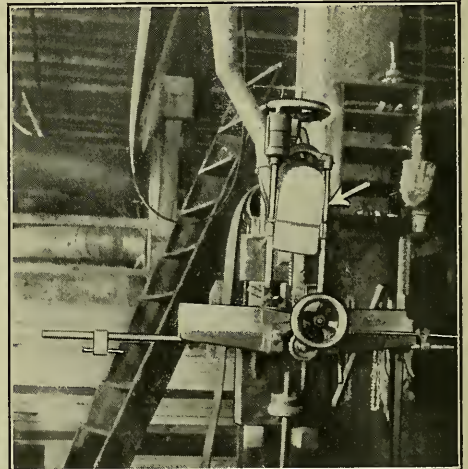

Courtesy of Rockwell Mfg. Co.

Fig. 211. Chain Mortiser Guarded.



Courtesy of Rockwell Mfg. Co.

Fig. 212. Guard for Tenoner Lever Handle.

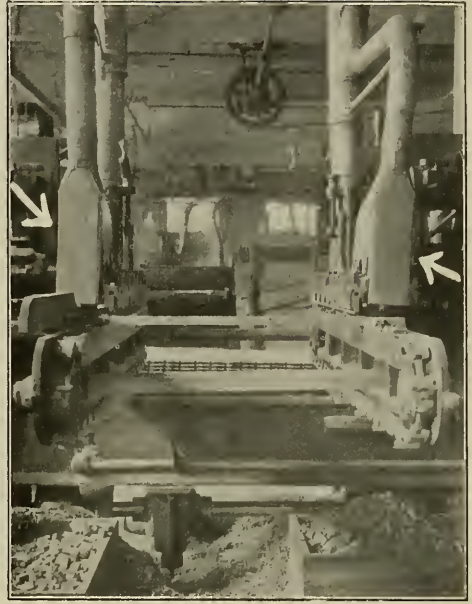

Courtesy of Grand Rapids Show Case Co.

Fig. 213. Double End Tenoner Guarded, Front View.

could be protected by extending the sheet iron guard to the floor and hinging it so it could be swung aside, whenever necessary, for changing the belt.

Spoke Tenoners. Fig. 216 (page 132) shows a method of guarding the saws of an automatic feed tenoner and equalizer used for cutting off both ends of the spoke and cutting the tenon for the mortise in the hub at one operation. In addition to the shield which comes with the machine, there is a broad hinged flap over the teeth, and as much as possible of the outside of the saw, both above and below the mandrel, is covered. Such a flap guard is also shown in Fig. 217 (page 133), which illustrates too an excellent method of guarding the belts and pulleys of the machine, and shows the blower hood over the tenoning head.

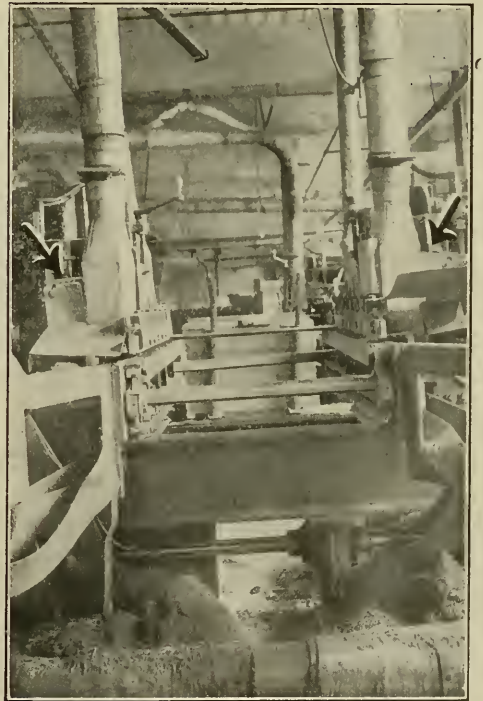

Courtesy of Grand Rapids Show Case Co.

Fig. 214. Double End Tenoner Guarded, Rear View.

Fig. 218 (page 133) shows a spoke tenoning and mitering machine with the cutter heads well guarded by castings and blower hoods. The picture shows how the operator places the spoke on the feeding chain.

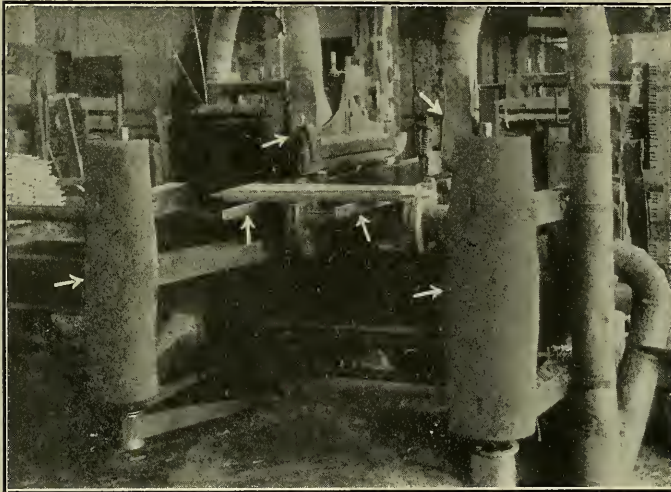

Courtesy of The Wheeler-Osgood Co.

Fig. 215. Double End Tenoner Guarded.

when necessary. It is advisable also to guard the belt, as the lever works in front of it.

In Fig. 220 (page 134) a tenoner and cut-off saw is shown with a metal shield guarding the cutter head at the side where contact would be most likely. This picture also shows a screen to prevent ends of spokes, which often are thrown with great force, from striking persons. The holes and dents noticeable in the screen have been made by flying ends.

DERRICKS.

Derricks should always be erected by men experienced in such work. All material used should be strong and of good quality, and should subsequently be watched carefully for deterioration. All cables, blocks, hooks, guy wire fastenings, etc., should be inspected frequently by a competent man. The cables usually run over small sheaves and are subject to heavy wear, and they also are generally exposed to all sorts of weather. Keeping the cables well lubricated will both protect

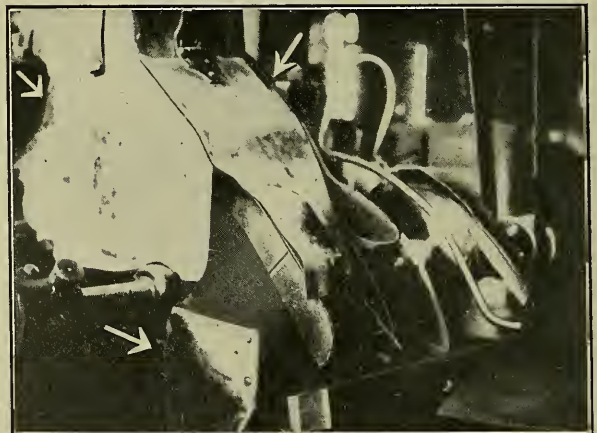

Courtesy of Peter Schuttler Co.

Fig. 216. Spoke Tenoner Saw Guarded.

them from the weather and reduce wear. The posts to which guy wires are fastened are apt to rot off at the surface of the ground. Setting the posts in concrete grout or painting or tarring the part set in the ground tends to protect them.



Courtesy of International Harvester Co.

Fig. 217. Spoke Tenoner Guarded.

Means of approach to the bearings at the top of the mast pole should be kept in good shape. A ladder made of U-shaped irons bolted to the pole or iron steps such as are used on telephone poles is better than a ladder made of wooden cleats nailed to the pole. When the approach is by means of a saddle, the rope, saddle, block, etc., should be kept in good condition, and the hoisting should be done very carefully by hand, never by power. Whenever a man goes up the pole for oiling, he should be sure to examine the guy fastenings at the top.

The throttle valve of the derrick engine should be kept in the best of condition. It needs frequent attention, as the constant wear is likely to get it into bad shape.

When a hand-power derrick is used, care should be taken that the handles are properly secured, that any open cog gearing is covered and that there is a ratchet stop to prevent the load dropping.

DRAG SAW.

The trip for raising and lowering a drag saw should be kept in the best condition, to prevent the saw suddenly falling on some one under it. The drag saw machine should be enclosed by a fence all around it. The low running drive belt and the crank should be well protected, and so should all gears, set screws, etc., about the machine. An operator should never attempt to make any adjustments without first shutting down the saw.

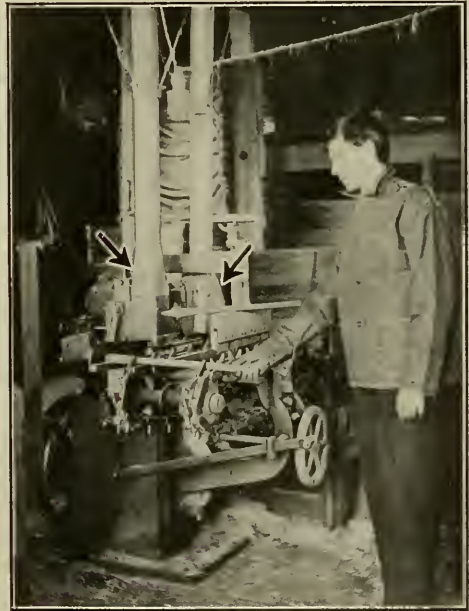

Courtesy of McDowell-Trammell Co.

Fig. 218. Spoke Tenoner Guarded.

Warning signs reading "Look out for the drag saw" should be put up at both sides of the saw run, and also at its outer end. If the limit of the saw's run is close to a passageway, there should be a fence at this point. If the saw runs close up to a wall, as is often the case, there should be a fence at each side, to prevent anyone using this point as a passageway.

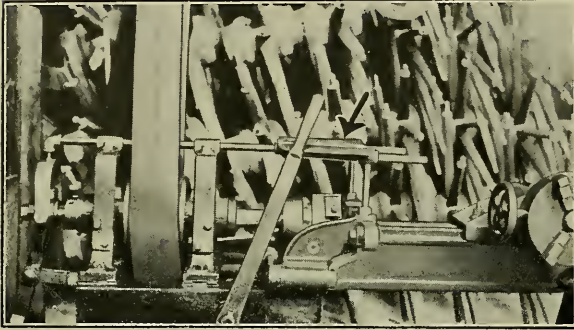

Courtesy of Peter Schuttler Co.

Fig. 219. End Tenoner for Spokes Guarded.

it off without first seeing it is properly secured, as the saw is apt to jump around.

In sawing short ends, as of logs for shingle blocks, the ends should be held in place by long arm levers, or securely dogged to the haulway. It is very dangerous to hold a short end with the hands, or to endeavor to saw

DRY KILNS.

The pit of a dry kiln should be floored over, to prevent workmen from falling into it and possibly on the steam pipes below. Such a flooring can well be of iron grating or slatted, and it should be well supported and kept in good condition, as should also the tracks. Material put into kilns should be carefully piled, and cars should be handled with care to avoid crushing employees. When blower fans are used, the fan blades should be effectively guarded so that no one can come in contact with them.

An elevated tramway or runway to a kiln, such as is used in many shingle mills, should be well planked and substantially hand-railed on both sides. The entrance to a kiln

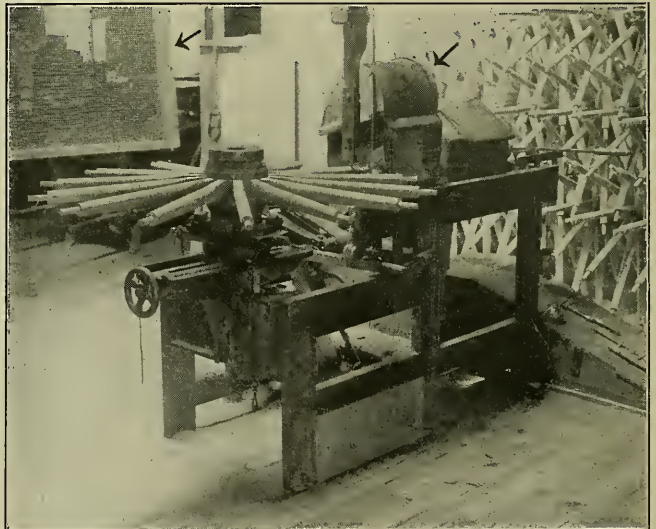

Courtesy of Studebaker Mfg. Co.

Fig. 220. Spoke Tenoner Guarded.

should be kept in good shape and any elevated platform outside should be railed.

Cables of counterweighted doors should be examined frequently for defects, as they run over small sheaves and are exposed to all sorts of weather.

They should get a coat of some good lubricant once in three months. Runs of all counterweights should be boxed up, to prevent their falling on anyone. When space beneath is used for a runway a timber should be placed across the lower end of guides to support a counterweight in case it should drop. At one side of the kiln door there should be a strip set on end and hinged so that when the door is raised it can be swung around under it, to prevent its falling down. If a door is improperly balanced and sticks above, it should not be pulled down by reaching up with the hands. Long hooked bars, with pulls at the other end, should be used, and the men using them should not stand directly under the door, as sometimes the cable breaks and the door then comes down with a rush. The best plan, however, is to balance the door properly.

Transmission, Etc. For the guarding of belts and pulleys generally, or other driving apparatus, see the chapter on Power Generation, Transmission, Etc.

HANDLES, LATHES, WAGONS, COOPERAGE.

Some handle, cooperage and wagon plants get out the rough stock from the logs as well as manufacture the finished products, but the former work is usually done in a separate mill, sometimes called a billet mill, especially when it turns out stock for handles and spokes.

Short Log Sawmill. This machine, for sawing logs into plank to be ripped into spoke and handle blanks, for cutting cooperage bolts and wagon

and carriage stock, for getting out box boards, etc., for turning out furniture and chair stock, and for cutting up veneer cores, is difficult to guard completely. Substantial protection, however, can be furnished.

There should always be a strong splitter back of the saw, to prevent the wood closing if it reaches that far. A guard is needed to prevent anyone falling on the saw, as the frame of the machine is apt to be low. In the case of the machine with a split table, one part passing on either side of the saw, a wire mesh or metal or wooden rail guard can be fastened to the machine frame or built up from the floor. Where part of the table is stationary, an adjustable rectangular iron frame may be supported from the stationary part at the level of the top of the saw, or a hinged adjustable sparred shield may be used in the same way. Another method of guard-

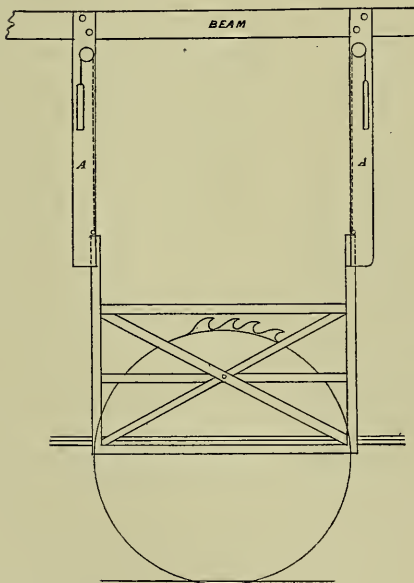

Courtesy of British Factory Dept.

Fig. 221. Guard for Short Log Saw Mill.

ing is by means of a wooden or metal gate suspended from the ceiling, as shown in Fig. 221, illustrating an English device. The gate is balanced by weights, working in grooves in AA. To make it rigid when protecting the saw, the lower part of the guard should rest, if possible, against the edge of the machine frame. If there is a wall conveniently at hand, this may offer a good means of supporting a guard.

Hooding the saw is especially difficult, as so much of the saw is apt to be used. Where the general run of the work will permit, an oblong frame of wire mesh or wooden slats may be suspended rigidly from above, operated by balance weights so as easily to be adjustable to any height. In one large English mill a guard has been successfully used consisting of a hood-like arrangement actuated by a drum put in motion by the traveling table. As the wood moves up to the saw the hood is gradually raised, and as the table moves away the hood is lowered.

Hand Feed Machines. When a split table worked by hand, instead of by rack and pinion or rope feed, is used, the operator should be protected against flybacks by suspending in front of the saw, and as low as possible, a heavy plank or such a wire mesh screen as is suggested for saw



Courtesy of Turner, Day & Woolworth Handle Co.

Fig. 222. Block Saw Guarded.

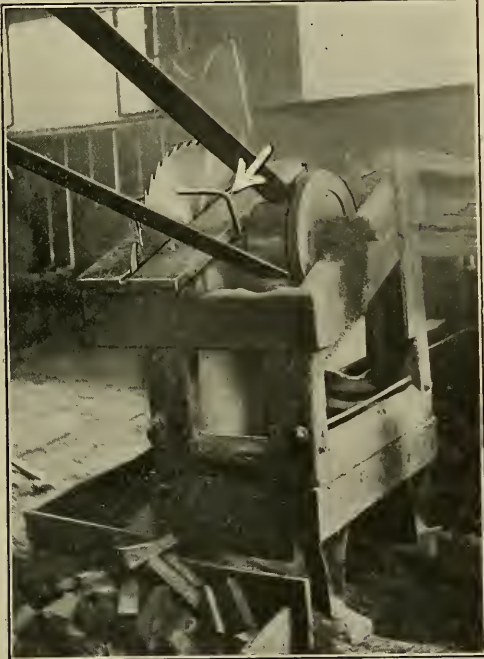

Courtesy of Turner, Day & Woolworth Handle Co.

Fig. 223. Block Saw Guarded.

machine. To guard against kicking, band metal can be attached to the sides of the slanting table and curved up over the saw, as shown in Fig. 222.

mill edgers (see index). The feeding table should be watched carefully, so that it will run smoothly and that no damaged roller causes trouble. This machine, or one very like it, is often used to saw spoke and handle blanks from planks turned out by the short log saw mill. For such work closer protection for the saw can be furnished, in the form of a suspended hood or otherwise.

When the logs do not come to the billet mill cut to length, but are there cut by a drag saw or the rough stock is equalized by a bolt equalizer, these machines should be guarded as suggested elsewhere (see index).

HANDLES.

Block Saw. This machine is used in a handle factory for cutting the billet roughly to nearly the shape of the handle before it goes to the turning

machine. To guard against kicking, band metal can be attached to the sides of the slanting table and curved up over the saw, as shown in Fig. 222.

It is bent over in such shape as to fit close to the top of the saw and thus catch material that may start to climb and prevent it from passing over the crown. To guard against slivers and other flybacks, a board guard is suspended over the saw.

Fig. 223 (page 137) shows another block saw, with the same suspended board but with a different guard against kicking. In this instance a round iron bent to right angles is fastened to the table at each side of the saw so that its end will just clear the saw. The block saw should also be equipped with a splitter. The saws shown have little splitters behind them.

A somewhat similar saw, set in a slanting table, is sometimes used in a billet mill in making a second cut of bolts or billets to get the proper width after getting proper thickness on some form of the short log saw mill.

Header or Smoother Machine. The machine for smoothing the bevel end

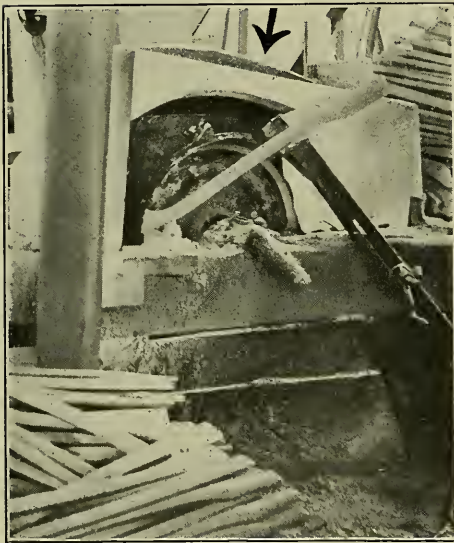

Courtesy of Turner, Day & Woolworth Handle Co.

Fig. 224. Handle Smoother Guarded.



Courtesy of Turner, Day & Woolworth Handle Co.

Fig. 225. Throater, Rest in Place.

on ax handles should be hooded in a metal casing like a picket header or at least boxed in, as shown in Fig. 224. The blades are set through slots in the rim on the disk and the bolts holding them are on the outside.

Throating Machine. This machine, with its gang of little saws, for taking the extreme roughness out of the curve near the end of ax handles should be guarded as much as possible by means of the rest for the work, as shown in Fig. 225.

Other Machines. A number of the other machines used in making handles, such as plow handle shapers, D handle jointing and backing and shaping and finishing machines, ferrule seat shaping and boring machines and the machines for cutting threads, should have their cutters (or saws) guarded as much as possible by shields or hoods. Where the knives are inside,

as in some chucking and tenoning machines, the projecting bolt heads on the outside should be covered. Some of the modern machines come furnished with the needed protection. Where it is lacking or insufficient, it can be supplied by blower hoods or otherwise.

Handle tenoners and borers should be guarded as suggested elsewhere (see index).



Courtesy of W. H. Gillette Co.

Fig. 226. Turning Machine Guarded.

LATHES, OR TURNING MACHINES.

The danger points of a lathe or turning machine are its cutters, its holding spur and its belts. The latter can often be eliminated wholly or partially by use of motor drive. There are motor head lathes for certain kinds of work which do away with all belting, and in which the motor and controller can both be entirely enclosed. A hand wheel at the end of the motor allows the turning of the spindle to see the work. With this on, an operator is not likely to try to stop the lathe by putting his hand on the work, as he is pretty sure to do after the work is nearly completed and as he sometimes thoughtlessly does when the work is still in the rough state. Whenever possible a spur and cup center should be used for holding the stock. Where a spur runs exposed, it should be covered by a collapsible hood or shield.



Courtesy of Widdicomb Furniture Co.

Fig. 227. Turning Machine Guarded.

Lathe operators should not wear loose-fitting jumpers or loose or flowing neckties or work with their sleeves down, as loose clothing may catch on revolving material and be wound around it. Operators should take care never to reach through a belt to oil outside bearings or for any other purpose.

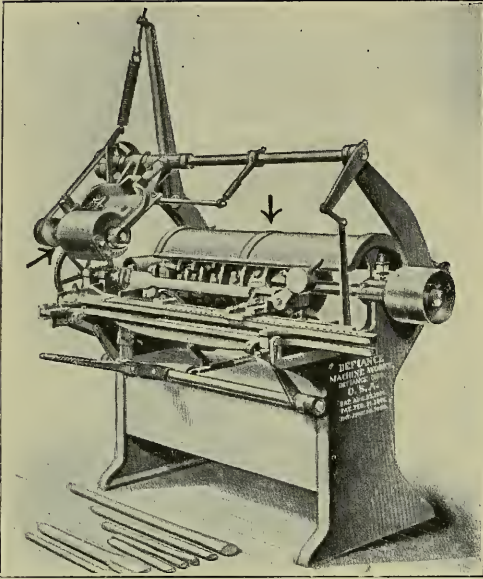

Courtesy of Defiance Machine Works.

Fig. 228. Guarded Lathe with Swinging Head.

carrying off the chips, as shown in Fig. 226 (page 139), a picture taken in a furniture factory. Such a machine as that shown in Fig. 227 is sometimes set up against a window and the shield left open at the back, so that the chips may fly out through the window and be collected in a box outside.

Swinging cutter heads, found in some automatic spoke and handle lathes, should also be shielded as fully as possible. Fig. 228 shows a guarded lathe of this kind, made by the Defiance Machine Works, of Defiance, O., both stationary and swinging heads being protected.

Whether a turning machine is protected by a hood or not, it is advisable for the operator to stand as much as possible to the side, to avoid flying chips. Where a shield is not curved sufficiently to throw chips downward, a screen can well be used to keep them from flying about the shop.

Shields for Cutter Heads. Cutter heads, whether rotating or not, should be covered as completely as possible by hoods or shields. Where the head or heads are set along the rear of the machine, a long curved shield hinged to the back end of the machine frame can be placed over them as far as possible without interfering with the work. This will tend to prevent injury to the operator and to discharge dust and shavings at the rear. With many modern machines such guards are furnished by the makers, but these can often be extended to advantage, without interfering with the work. Where there is none, a home-made one can be installed. Either can usually be supplemented advantageously by connection with a blower system for

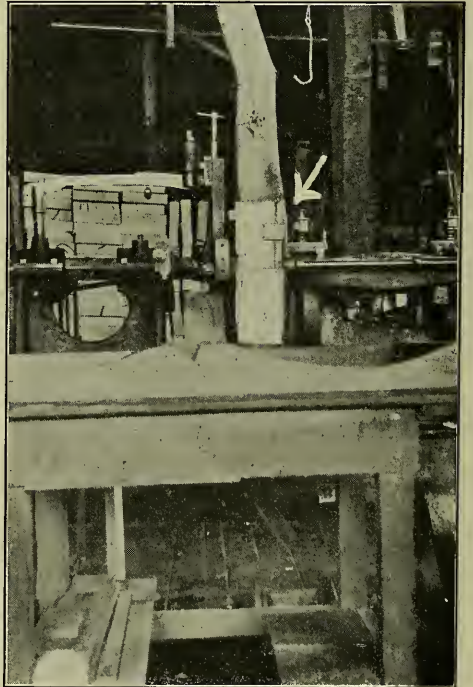

Courtesy of Paine Lumber Co., Ltd.

Fig. 229. Blower Hood Guard for Lathe.

Heads and Knives. To avoid danger of the bursting of rotating heads, the utmost care needs to be taken to have the heads in perfect balance and the knives sharp and set true. The same vigilance should be exercised in adjusting and fastening these knives as in the case of shaper knives. It takes a very experienced man to care for heads and cutters properly. In some machines the knife holders sit in dove tailed slots, to keep them from working loose or flying out when the head is in motion.

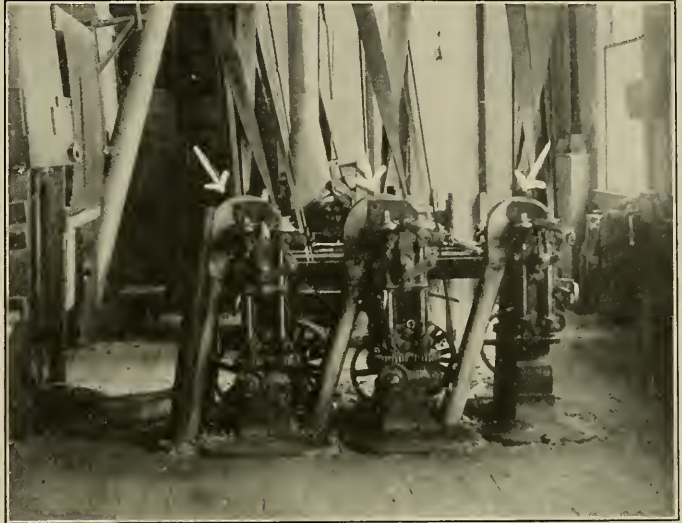

Courtesy of American Thread Co.

Fig. 230. Rounding Machine Guarded.

Some machines are provided with adjustable back rests which press against the stick while it is being turned, helping to keep the stick from springing or the knives from gouging.

Blower Hood Protection. Fig. 229 (page 140) shows blower hood protection for a corner

block, rosette and plug turning lathe. The cutters are bolted to a head which is fastened on the end of a revolving shaft and is completely covered by the hood except a small opening on the side in front of the cutters. The pieces to be machined are placed on a block with an automatic clamp attachment and are pressed against the cutters on the head by a lever. Fig. 230 shows handle

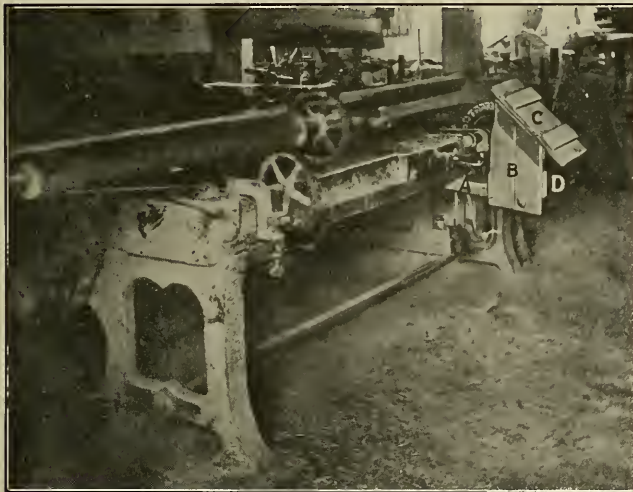

Courtesy of Grant Mfg. Co.

Fig. 231. Guard for Lathe Saw.

rounding machines well protected with blower hoods. The gears driving the feed rolls could also be covered to advantage.

Back Knife Lathe. The back knife gauge lathe, which is largely used in furniture, chair and all sorts of spindle work, is especially apt to have a danger point in the spur in the center holding the material. This is revolving all the time, and has caused many injuries. It can be guarded by a collapsible tube, which will be pushed back by the roughing out tool carriage as it comes across. This tool should be guarded as much as possible, to prevent the operator's accidental contact with it. A blower hood or curved shield can easily be applied.

The back knife itself should not be dangerous, as it moves slowly, yet many persons have been injured by it. An operator should be careful never to reach under the knife to place a new piece of stock in the centering frame in the rear. He should always wait until the knife is low enough for him to reach over it.



Courtesy of International Harvester Co.

Fig. 232. Screen for Spoke Driver.

the material to be turned, as in modern copying lathes, it can easily be hooded except for the cutting point, the hood being attached to the cutter head frame. Machines are made so guarded. In some automatic copying lathes the cutter head is brought forward to the work by a hand lever, remaining locked back out of harm's way when not in use. The cutting is done on the under side of the material, throwing the chips downward and lessening chance of injury to the operator.

Guarding Lathe Saws. In some of the lathes for turning handles, spokes, etc., there is a saw at the front across which the material moves endways by means of a traveling screw. This should be guarded, as the operator gets very close to it in removing the turned piece and putting rough stock in place. An effective home-made guard is shown in Fig. 231 (page 141). A strong support (A), securely bolted to the machine frame, extends out horizontally

Automatic Feed Lathes. For turning broom, rake, fork and other handles, curtain and pike poles, and many other straight or tapering articles, there are automatic feed lathes, in which a number of pieces of material are placed in a rack on a table from which feed rollers keep taking the bottom piece. On some of these machines there is a mass of gears at the side which should be guarded by an easily removable cover.

Copying Lathes. Where the cutter head travels across the path of

beneath the saw and several inches beyond it. To this is hinged a vertical board (B) across the upper end of which is fastened a slanting board guard (C) for the top and front of the saw. A horizontal cleat (D), on the side of the vertical board, rests on the support and prevents the guard from swinging against the saw. The top piece of the guard is made slanting to guide the cuttings, which are heavy and sharp and fly with great force, toward the floor.

Sometimes there is a belt at the right of the saw running directly under and close to a crank for tightening the rough stock between the centers. There should be a shield for this belt both under the crank and around the pulley in front.

WAGONS.

Box Board Edger. The machine to which stock is fed on a traveling table should be guarded for both kicking and flybacks. Heavy pressure rolls are often placed back of the saws and a metal hood over each saw. A wishbone-like pronged device is sometimes used to hold stock down firmly and tends to prevent its kicking before it reaches the pressure rolls. If hoods are not used, a screen can be hung in front of the saws.

Spoke Drivers. When the hammer swings, such a machine should be railed off at back and sides. Fig. 232 (page 142) shows such a guard, made of reinforced wire mesh. Hammer handles should be watched carefully

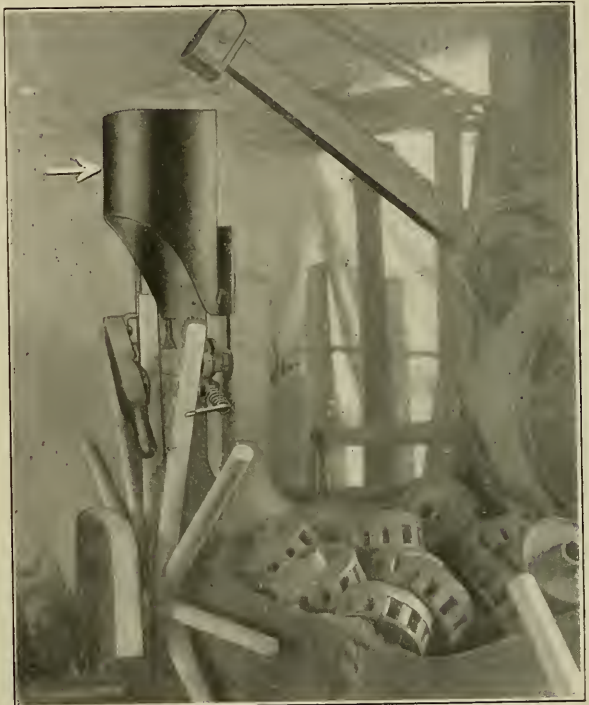

Courtesy of International Harvester Co.

Fig. 233. Guard for Spoke Driver.

for defects which might cause them to break, and the heads should be examined frequently to assure their being in good condition and securely fastened. It is well to have an adjustable metal guard, as shown in Fig. 233, to prevent the operator being accidentally struck by the hammer. The guard should come down within 2 inches of the end of the spoke.

For driving light spokes into carriage and spring wagon hubs there are also pneumatic machines, which are especially safe. The safety valve of the air compressor for such a machine should never be set above safe working pressure.

Spoke-facing Machines. The disk spoke facing and tapering machine should be encased at the back to cover the bolt heads there, and it is well to



Courtesy of McDowell-Trammell Co.

Fig. 234. Spoke Facer Guarded.

without interfering with the work. Shields are usually furnished by the maker, but sometimes these can well be supplemented, as shown in Fig. 237 (page 146). A shield should cover the pulley driving the head, as well as the head. The cutter heads of axle shoulder shaping machines, whether single or double, should also be shielded except at the working point.

Wheel Rim Planers. The automatic machine for truing up the face and one side should have its cutter heads enclosed, and they usually are, even though the operator is at the other side of the wheel. The hand-feed planer often used for truing up the other side of the rim should have a wooden guard over the cutters, as shown in Fig. 238 (page 147), held up against the face of the rim by a weight or spring, to prevent the operator's fingers resting on the face as the rim goes over the cutters.

cover the front as far down as the work will permit. The machine in which the spoke passes between two heads which face both sides at once can have its knives thoroughly guarded by blower hoods, as shown in Fig. 234.

Spoke Throaters. On the machine in which the spoke is fed on a revolving carrier driven by gearing there should be a guard on the side of the cutter head toward the operator, as shown in Fig. 235. It is well also to have blower hoods both above and below the head. Fig. 236 (page 145) shows an automatic throater with cast iron guard furnished by the makers, with blower hood, and with home-made leather guards at the front to keep chips from being thrown with violence. The cutter heads of the machine to which the spoke is fed on reels should also be shielded or hooded.

Axle Machines. The automatic machine for gaining axles should have its heads covered as fully as possible

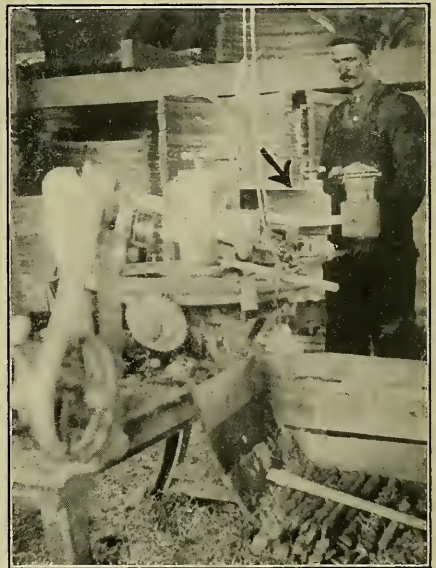

Courtesy of McDowell-Trammell Co.

Fig. 235. Spoke Throater Guarded.

Felloe Machines. The heads of the two-side felloe planing machines should be shielded as much as possible, and exposed gearing, especially at the front, should be covered. Fig. 239 (page 147) shows two such machines with blower hoods connected to the cast iron guards furnished by the makers, that at the left planing the straight sides and that at the right planing the curved sides.

Wheel Boxing Machine. The bit for boring the hub for the box should be protected when in normal position by a hood guard, one-half of which is hinged at the top so it can be turned back for change of bits.

Rimming Machine. When the saw which cuts the rim to proper length is brought up through the table by a foot lever, the lever should be guarded so that no one in passing can accidentally come in contact with it and bring the saw up against the operator.

Hub Machines. The hub reamer can be guarded by fastening a shield of sheet metal formed into a semi-circle to the attachment which holds the hub in place, as shown in Fig. 240 (page 147). This attachment moves to the left as the reamer enters the hub, and the shield moves with it and thus covers the reamer during the entire operation. Another way of guarding the reaming bit is to have a hood held out over it by a spring, the hood collapsing as it is forced back by the hub.

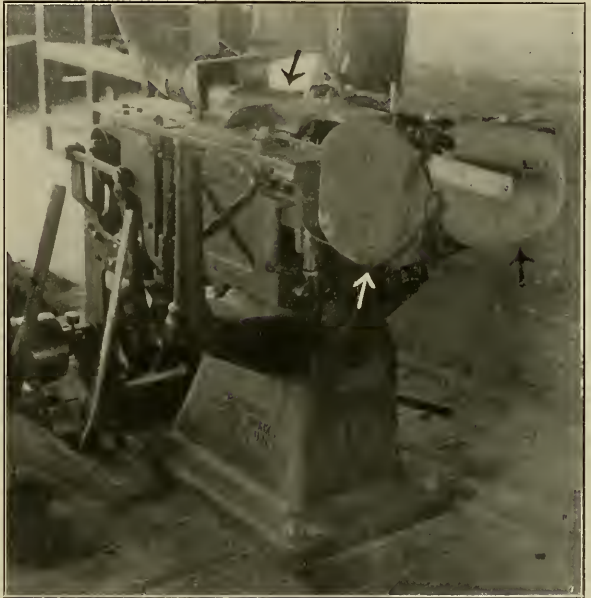

Courtesy of Studebaker Mfg. Co.

Fig. 236. Spoke Throater Guarded.

When the hub is reamed after the spokes have been driven into it, prongs can extend out around the bit, so placed as to fit between the spokes when the wheel is pushed on the bit.

Hub turning machines should have the roughing knife at the back guarded by a curved shield, which will tend to hold the pieces if the hub should break. The big circular cut-off machine for cutting logs to hub block length, to which the log is fed on a carriage traveling on a saw mill track, should have its saw railed off at the back and hooded on top down to the mandrel.

Panel Sticking. When the edges of panels, as for buggy frames, are worked on a shaper, an efficient guard can be used, as shown in Fig. 241 (page 148). Bolted to the guide, which is cut out to fit the head, is a piece of wood shaped so as to cover the opening in the guide left for the cutters. This not only acts as a hold-down for the stock, which is fed under it, but it also keeps the operator's hands from the cutters.

Poles, Shafts and Single-trees. When the old cut-off-rip saw-shaper method of making poles is used, the cut-off saw should be hooded or guarded by a band coming down as low as possible. For the rip saw there should be a splitter, a long table and a board rigidly suspended over the saw a little in front of the crown. The shaper should be guarded in one of the ways suggested elsewhere (see index).

The shaft and pole heel tapering machine should have its disk heads covered at the back, and in front down to the working point just above the table. The single-tree dressing and pointing machine should have its cutter head guarded by a blower hood which will come up around the outer end of the head. On the automatic feed pole machines which turn out a pole a minute the side and top heads should be hooded, and the belts and pulleys and feed

chain and sprockets should be fenced off like big planing mill machines. A combination guard and table for a pole sticker are shown in Fig. 242 (page 148).

Other Machines.

The many other machines used in wagon and carriage work, such as jointers, surfacers, shapers, sanders, rip saws, cut-off saws, equalizing saws, tenoners, borers, mortisers, should be guarded as suggested elsewhere (see index).

Automobiles and Cars. Automobile manufacturing employs practically the same

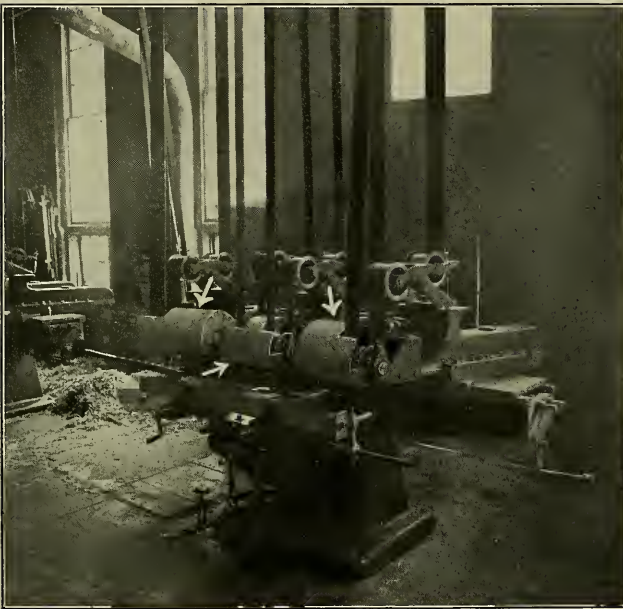

Courtesy of Studebaker Mfg. Co.

Fig. 237. Automatic Gainer Guarded.

special machinery as wagon making, so far as the woodworking goes. The same is true largely of the manufacture of cars, though the machinery is apt to be of heavier build.

COOPERAGE.

Stave Sawing Machines. The cylinder machine known as the drum saw should have as much as possible of its teeth guarded, to prevent a stave getting caught or being dropped on the saw and then thrown, and to guard the off-bearer when one is employed. A metal band can be brought up from the side of the machine frame, extending over the teeth as far as the work will permit. The band should reach out beyond the teeth, and it can have a cleat under its outer edge. This guard can be braced from the front of the frame,

if necessary. Such a band guard for barrel stave saws is often furnished by the makers. The bilging cylinder saw for kegs can be protected in the same way. The small drum saw used in pail and tub factories is often guarded by a home-made wooden box hood set into the machine

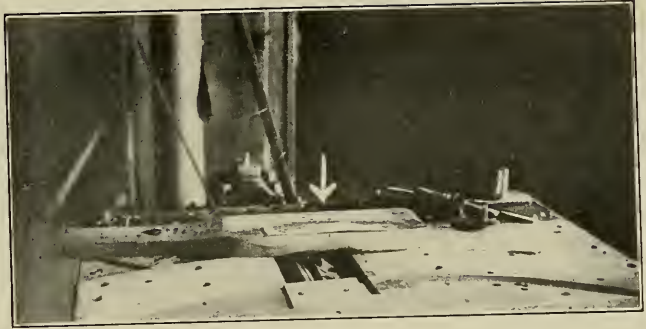

Courtesy of Peter Schuttler Co.

Fig. 238. Wheel Rim Planer Guarded.



Courtesy of McDowell-Trammell Co.

Fig. 239. Felloe Planers Guarded.

ated like shingle saws, as suggested elsewhere (see index). When a vertical pendulous saw is used, the rear teeth should be protected by a metal band, and it is well to fence the saw off as much as possible at both back and sides.

Stave and Heading Jointers. When the knives are set in a disk, the disk should be entirely encased at the back, and it can well be in front except for the necessary working point.

frame and covering practically all of the teeth not in use, as shown in Fig. 243 (page 149). A drum saw should also have a metal band covering the projecting bolt heads where the saw is bolted to the head, or spider, which is keyed to the shaft.

Heading Saws.

The horizontal heading saw should be guarded and oper-



Courtesy of International Harvester Co.

Fig. 240. Guard for Hub Reamer.

The little hand jointer often used in pail and tub factories can well be equipped with a small automatic guard, or with two if the guide is set in the middle.

Stave and Heading Planers. When the feeding point is not well guarded

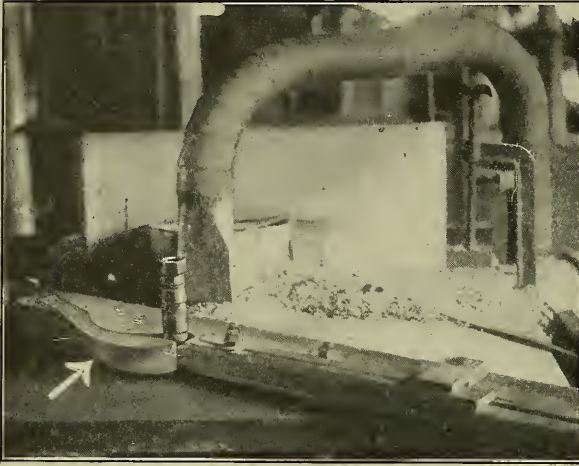

Courtesy of Heberer & Co.

Fig. 241. Panel Sticker Guarded.

by the makers, a hood should be arranged to cover the rolls or chains, coming down over the front as far as possible without interfering with the entrance of the stock, and if necessary guarding any exposed ends of rolls. The head line planer should be protected in the same way, the hood covering the head as well as the feed roll.

Head Rounder. The barrel head rounding or circling machine should have its saw covered as much as possible by a blower hood, as shown in Fig. 244 (page 149)

or otherwise, to keep pieces from flying about the shop and to prevent contact with the saw teeth. The hood can well be brought even further over the top of the saw than as shown in the picture. The knives in the head of this machine should be very securely fastened to prevent their flying out. In some machines they are dovetailed, to do away with the chance of screws or other fastenings working loose.

When the heading is circled on a heading lathe with stationary cutters, as in pail and tub plants, there should be a board fencing around the plane in which the pieces fly.

Pail Trimming Lathe.

In operating this machine care should be taken to work the carriage properly and not to take so heavy a cut as to force a stave out, and possibly cause the pail to collapse and a number of staves to be thrown. The operator should also endeavor to keep in a working position out of range of thrown staves.

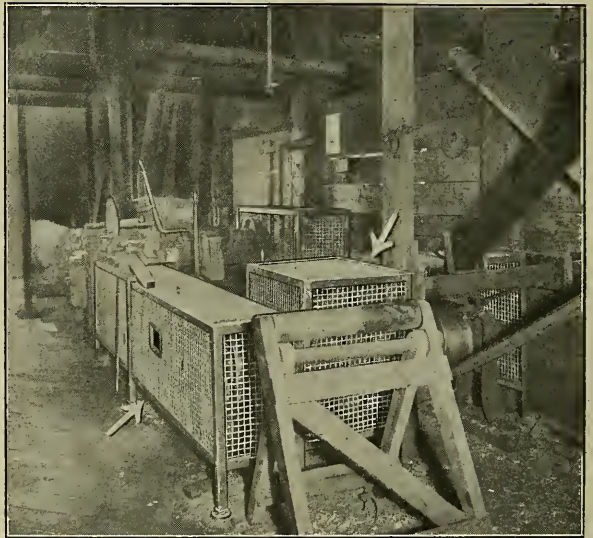

Courtesy of International Harvester Co.

Fig. 242. Pole Sticker Guarded.

Crozers. Machines for chamfering and crozing barrels, casks or kegs while in a horizontal position should have their cutter heads guarded so that there will be no danger of injury to the operator in the event of an arm getting

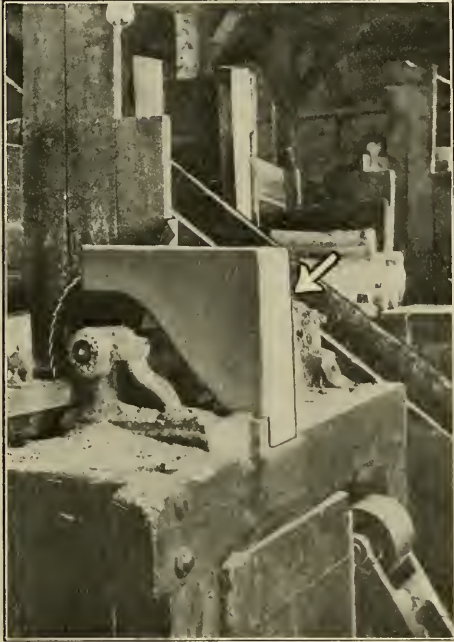

Courtesy of E. Murdock & Co.

Fig. 243. Drum Saw Guarded.



Courtesy of Louisville Cooperage Co.

Fig. 244. Head Rounder Guarded.

beyond the end of the barrel while placing it in position or removing it. Semi-circular shields around the sides of the heads nearer the operator's working position make effective guards. Some machines come equipped with such shields. There are machines in which the cutter heads move entirely out of the barrel before it is released by the chuck rings and do not return to working position until brought there by a lever.



Courtesy of Tight Barrel Cooperage Co.

Fig. 245. Vertical Crozer Guarded.

In the machines in which the barrel is placed vertically the cutter head can be guarded by a wire screen, as shown in Fig. 245.

Edging Saw. The rip saw often used in pail and tub plants for edging heading before it goes to the jointer should have a splitter at the back and a board suspended in front of the crown with a pendant flap. A feeding carriage could well be used for such work, especially when very small pieces of stock are sawed.

Hoop Machines. Hoop planers should be guarded like stave and heading planers. The automatic hoop cutting machine can well have finger guards like those suggested for veneer clippers (see index). The hoop bar chuck pointing machine should have the bolt heads on the outside guarded by a shield. The hoop pointing machine in which the knives are set in disks should have the disks encased at the back.

Vats. Vats for slack barrel hoops should at least have a fence around them 30 inches high, with a gate at one side counterbalanced so it can easily be raised out of the way when occasion requires. Whenever possible, it is well to build such vats with their sides 30 inches above the floor level.

Barrel Hoist. This conveyor should be guarded to prevent a barrel tipping off the prongs or dogs of the chain and falling on the man below who is placing the barrels on the conveyor. A simple but effective guard consists of boards hanging from the ceiling as close to the outer points of the dogs as possible and extending as far down as can be.

Other Machines. Windlass ropes should be regularly inspected. The dangerous gears on stave bending machines, power punching and flaring machines and some trussing machines should be guarded, unless guards are furnished by the makers. The punches should be equipped with a ring guard, the bottom edge of which will allow the placing of the stock but will not let the operator's fingers get under the punch and the top edge of which is above the highest movement of the punch. Rip saws, cut-off saws, etc., should be guarded as indicated elsewhere (see index).

Transmission, Etc. For the guarding of belts and pulleys generally, or other driving apparatus, see the chapter on Power Generation, Transmission, Etc.

VENEER, FURNITURE, CHAIRS.

Vats. One of the most dangerous features of veneer manufacturing is found in the vats in which the logs are softened by boiling. These vats should be well guarded to prevent anyone falling into them, as, whenever the lids are removed, a body of boiling hot water is exposed. There is much risk of such accidents, as men have to do a lot of work around the edges of a vat.



Courtesy of Roberts & Connor Co.

Fig. 246. Fence around Vat.

One method of protection is a railing along the edge, or a fence with a walk inside, as shown in Fig. 246. Such a guard should be made strong, as workmen will use the fencing as a brace and it is likely to be hit by logs being swung out of the pit. A better method is to build the sides of the vat up above the ground or floor level, as shown in Fig. 247. Such a guard can be so substantial that there will be little chance of its giving way.

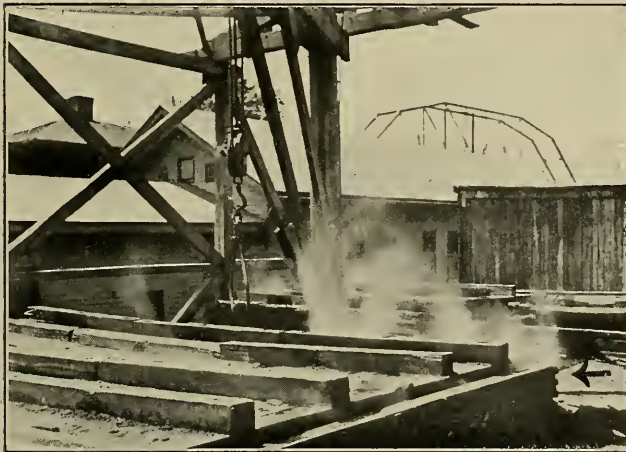

Courtesy of Louisville Veneer Mills.

Fig. 247. Vat with Built-up Sides.

One of the best means of guarding vats has been devised by the Paine Lumber Co., of Oshkosh, Wis., who have applied for a patent on it. A pipe railing guard surrounds the vat, and there are horizontal bars 12 inches apart over the top, secured to an iron pipe at the back and loose at the front ends. In raising logs from the

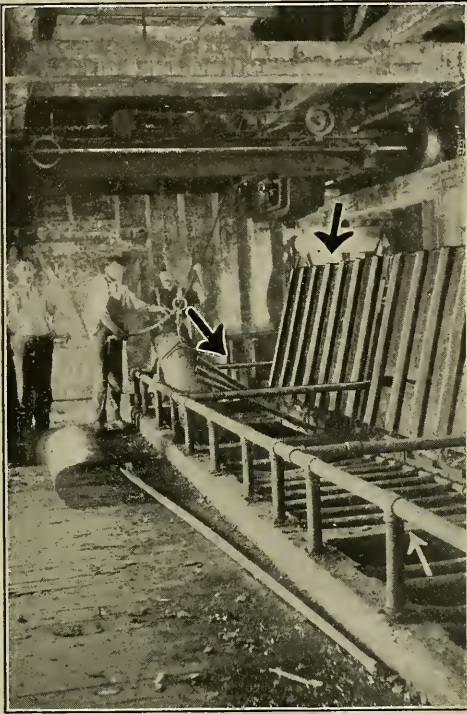

Courtesy of Paine Lumber Co., Ltd.

Fig. 248. Veneer Vat Guard.

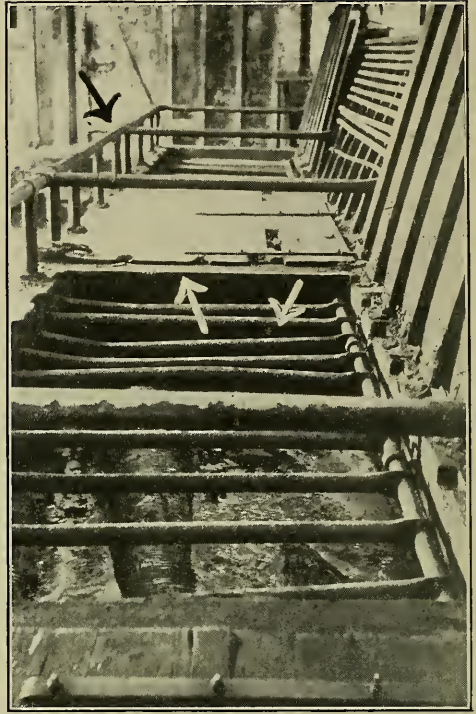

Courtesy of Paine Lumber Co., Ltd.

Fig. 249. Veneer Vat Guard, Cover Down.

vat, as many bars as necessary raise with the log. As the log is removed, the bars drop back into place. Each bar raises separately and drops by gravity into its individual socket. Hinged wooden covers are dropped from the back over the vat when there is no need of its being open. These are in sections, so all the vat not in active use may remain covered. Fig. 248 shows a log being lifted out by the traveling crane used for the purpose, and the wooden covers thrown up. Fig. 249 shows one of the covers in place over its section of the vat.

Workmen should be provided with suitable spike poles, etc., for use in floating logs to the edge of a vat, where the hooks can be made fast. Planks should never be placed across vats for the men to work from, as they are decayed by the acids developed by the process. This decay is often inside, leaving the

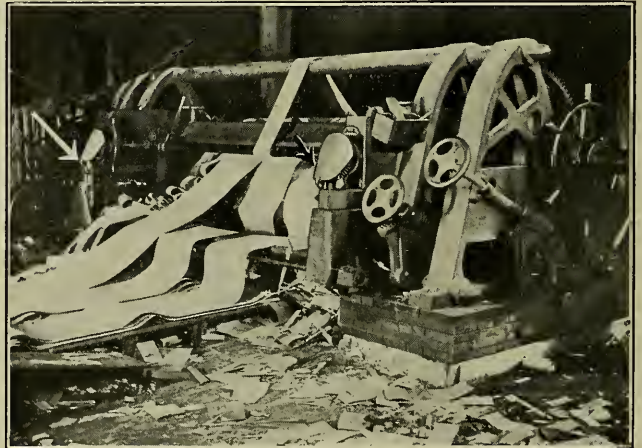

Courtesy of Louisville Veneer Mills.

Fig. 250. Rotary Cutter Guarded.

surface in apparently good condition. Breaking of such planks has caused many fatal accidents. When bar guards are used over the top of a vat, the workmen should not be allowed to get out on them to hook the logs. It is a good plan to have a warning sign at a vat, cautioning the workmen against dangerous practices.

Steaming Process. Vats used in the steaming process should be guarded like boiling vats. While a workman does not run much chance of being scalded, as the steam is turned off before the vat is opened, he can get a bad fall, and possibly other injury. Sometimes, too, the drain stops up and condensation causes a few inches of water to accumulate at the bottom of the vat. The drain should be arranged, if possible, so it can be cleaned from the outside.

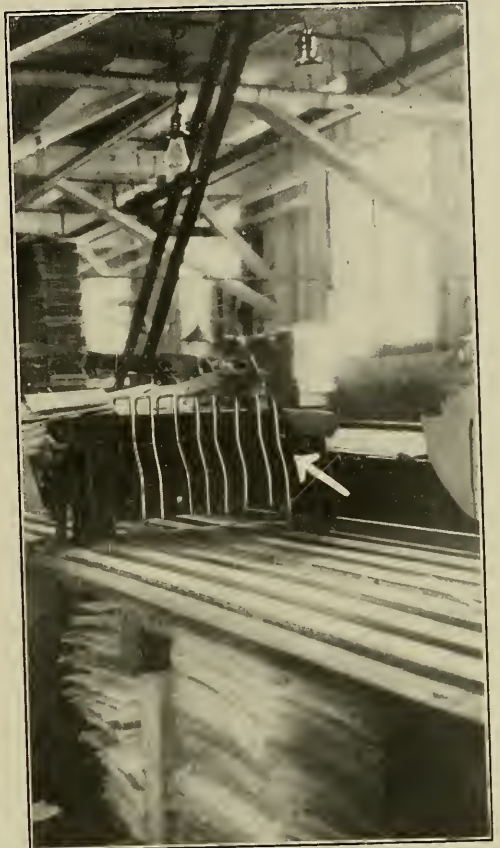

Courtesy of Paine Lumber Co., Ltd.

Fig. 251. Guard for Veneer Clipper.

When steaming boxes are used and the doors slide up and down, inspection should frequently be made of the cables and their connections to the weights and doors, to avoid accident due to the doors falling. In some plants the doors are held in place by bars. To avoid decay, the boxes can well be made of reinforced concrete.

Rotary Cutter. There is practically no danger from the knife of this machine. In some makes, however, the men off-bearing and removing waste have to work, and in a great rush, close to bevel gears actuating the movement of the knife toward the log. These gears should be covered, as shown in Fig. 250 (page 152), and so should the

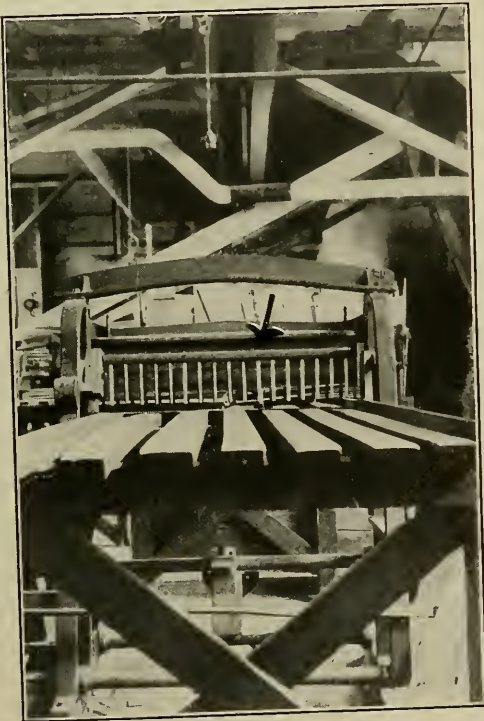

Courtesy of Paine Lumber Co., Ltd.

Fig. 252. Veneer Clipper Guarded.

chain and sprocket transmission regulating them. Unless protected by the drive belts and pulleys, the change gears at the end of the machine which actuate this transmission should be guarded by a cover which can easily be opened or removed. The drive belts and pulleys should be well guarded.

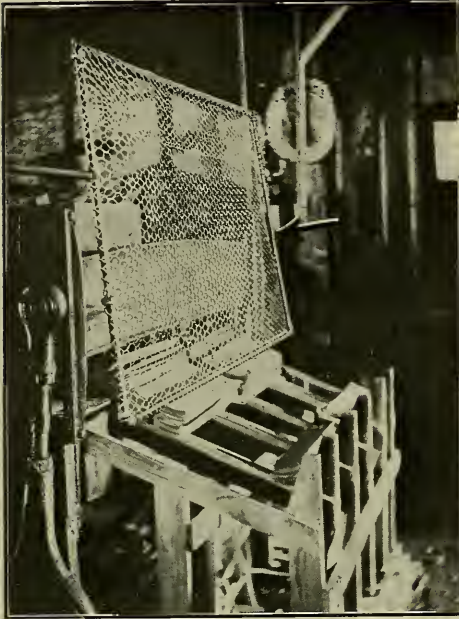

Fig. 253. Guard for Veneer Clipper.

Slicing Machine. The driving parts of the machinery, such as connecting rods, gears, belts, etc., should be guarded, and so should any pits in which the machinery may be set. The slides along which the stay log has a reciprocating movement on a horizontal machine should be protected by a railing.

Veneer Clipper. This machine, which is of the same class as the paper cutter and is used for cutting veneer to size, is dangerous both to the man operating and the one taking away, on account of the risk of getting a hand under the knife. An effective guard consists in having prongs come down as close as possible to the table both in front and back of the knife, as shown in

Fig. 251 (page 153) and Fig. 252 (page 153). Fig. 251 shows a machine used to cut veneer to length. The prongs, which are of wire, are 2 inches apart. They are 3 3/4 inches from the knife on one side and 5 inches on the other. The prongs in Fig. 252, which shows a clipper used for cross-cutting and also for cutting to width short lengths of veneer stock, are made of wood. They are 1 1/2 inches apart and 3 inches from the knife. These prongs are made to swing away from the knife when the machine is cutting widths. Such a prong guard is advisable for veneer clippers, whether power-feed or hand-feed. With it installed, a hand of either operator or take-away man will be stopped before it can get into danger.

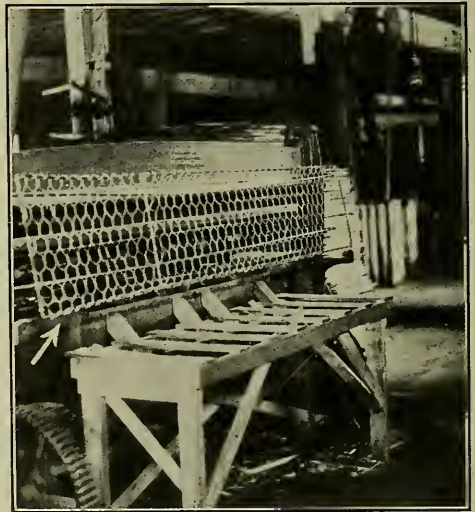

Fig. 254. Veneer Clipper Guard.

A guard for the off-bearing side of a clipper used for cutting veneer to narrow widths is shown in Fig. 253. It consists of an oblong frame made of

gas pipe, filled in with wire mesh. The guard is hinged on each side, a little nearer the top than the bottom, so as to keep it in an upright position and yet allow it to swing out under slight pressure and let the cut veneer fall out under it. The table is on an incline so that gravity will carry the strips of veneer down it. The guard is built high to prevent reaching over the knife to pull the rod throwing the clutch in or out. It also comes down a little below the lowest travel of the knife when no veneer is in the machine, thus tending to prevent accidents due to off-bearer boys pulling scraps from under the knife while idly waiting for more veneer. This guard and inclined table obviate the danger to off-bearers involved in removing strips by the armful from a flat table and an unguarded knife.



Courtesy of Roberts & Connor Co.

Fig. 255. Segment Saw.

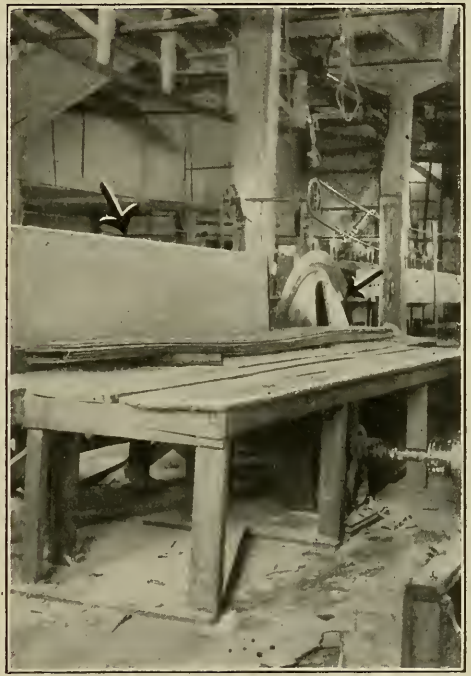

Courtesy of Grand Rapids Veneer Works.

Fig. 256. Segment Saw.

Fig. 254 (page 154) shows a stationary wire mesh guard for the off-bearing side of a clipper used for cutting veneer to narrow widths. It is hung by hooks from rods extending from one side of the machine to the other and is easily removable when it is necessary to take out the knife. This screen sets out about 7 inches from the knife and works even with or a little below the lowest travel of the knife.

Segment Saw. The chief danger connected with the segment saw is found in the segment feature. Great care should be exercised in selecting and tightening the flat head countersunk screws by which the segments are fastened to the saw disk. No chance should ever be taken with an old screw which may not remain tight. Not only might the particular segment fly, but if it became loose and dug into the wood it might cause a wreck of the saw, throwing

segments with violent force. Off-bearers get considerable protection from the arrangements for taking care of the material sawed, two forms of which are shown in Fig. 255 (page 155) and Fig. 256 (page 155).

Band Mill. The band saw used to cut veneer logs into flitches for a segment saw or a slicer should be guarded like a band mill in a saw mill (see index). There is one bad practice indulged in by some sawyers, which should be avoided whenever possible. To cut flitches so as to get the best "gloss," as the grain is called, requires very skilful and careful work. If the setters do not quickly grasp the sawyer's idea as to the dogging of the log on the carriage, he is apt to step around the front of the band saw and show them how to do



Courtesy of Paine Lumber Co., Ltd.

Fig. 257. Slasher Guard, Hood in Place.

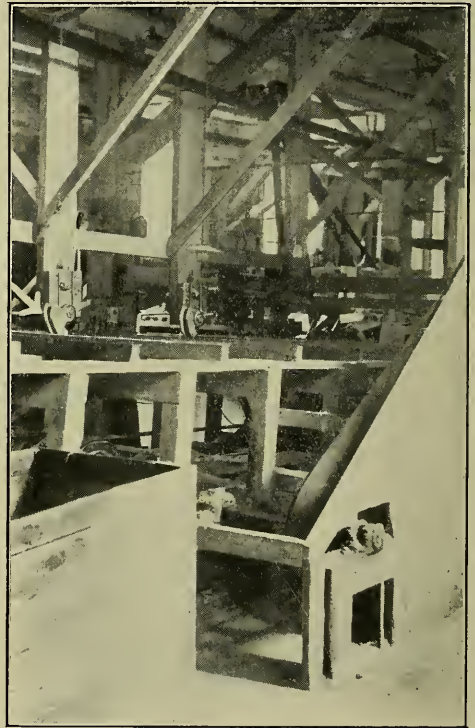

Courtesy of Paine Lumber Co., Ltd.

Fig. 258. Slasher Guard, Hood Raised.

it or do it himself. This is very dangerous. The saw is often running at very high speed, and the space around it is likely to be both slippery and littered up. This space should be kept clean, at any rate, and the practice referred to should be discouraged.

Slashers. Fig. 257 and Fig. 258 show a six saw slasher, used for cutting rail and panel veneers to length, guarded so that when in operation the operator's hands cannot touch the saws. The guards also hold the veneer in place while it is being cut and prevent the pieces from being thrown by the saws. Each guard is hinged to its upright support. It is swung up by the slats on the conveyor and drops back over the saw after a slat has passed.

In Fig. 257 the guard is shown in normal position and Fig. 258 shows how it is swung up by a conveyor slat. The particular machine illustrated is run by six operators. Each stands between saws and pulls the veneer for the desired cut.

Splicer. This machine for jointing and glueing sheets of veneer after its operator has matched them needs to be guarded at its feeding point, where the material passes between two solid link chains. Fig. 259 shows a guard for this point in the form of flat springs set just ahead of the nip in the chains.

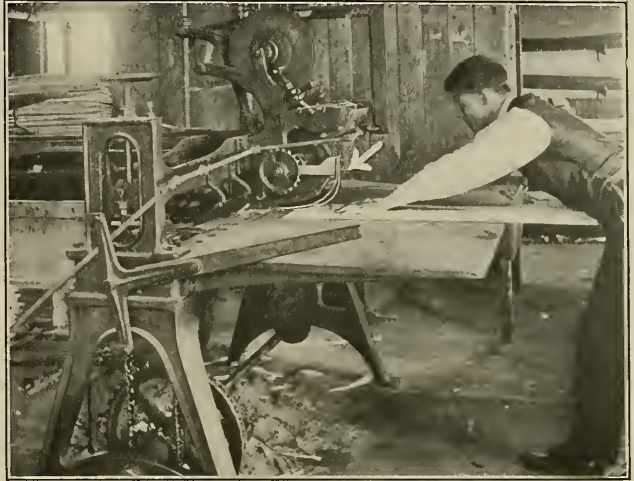

Courtesy of Louisville Veneer Mills.

Fig. 259. Veneer Splicer Guarded.

These springs hold the veneer flat and also prevent the operator's hands from following into the chains with the material. Some such device should always be used.

Glue Machine. There is little danger from the rollers of this machine, as they run very slowly and the top roller fits loosely on the lower one. The gears at the end of the machine should be covered, however, as operators often stand very close to them when feeding.



Courtesy of Grand Rapids Show Case Co.

Fig. 260. Miter Saw Guard.

Dryers. The belts and pulleys along the side of many of these machines should be fenced off to a sufficient height, and the gears and sprockets and chains should be covered or fenced.

Lifting Tackle. All lifting tackle used in moving logs should be regularly and frequently inspected for defects and should be kept in the best of working condition. Hooks should be kept sharp and chains annealed at intervals. Gearing should be covered. If a log haul is used in a veneer mill, it should be guarded as suggested in the chapter on "Saw Mill."

Other Machines. The other machines used in veneer mills of one kind or another, such as rip saws, drag saws, cut-off saws, swing saws, equalizing saws,

jointers, sanders, edgers, matchers, slab slashers, etc., should be guarded as indicated elsewhere in this book (see index).

FURNITURE, CHAIRS, ETC.

Many of the machines used in furniture, chair, desk and show case factories are common to practically all woodworking plants doing fine work. A large number of the guards suggested elsewhere (see index) for rip saws, cut-off saws, swing saws, buzz planers or jointers (both hand-feed and automatic), band saws, resaws, shapers, mortisers, tenoners, boring machines, sanders, etc., are applicable.



Courtesy of Widdicomb Furniture Co.

Fig. 261. Grooving Saw Guarded.

the stock passes is so arranged that it allows the stock to be moved freely beneath it. In edge grooving for stock a guard often used consists of a wooden block higher than the saw and extending a little beyond both its front and back. This is secured on the table in such a position that there is just enough room between it and the guide for the stock to pass over the saw.

Dovetailing Machines. The gang dovetailer can be guarded about as much as is necessary by a metal shield in front of the spindles and gearing, as shown in Fig. 262 (page 159), or by a suction hood. There are automatic dovetailers for drawer work in operating which the material is clamped on a feeding carriage which, once started, automatically feeds the work to the cutting tools.

So much stock work is done in such factories that machines can often be guarded much more effectively than is possible when they are constantly being put to a variety of uses. A little ingenuity on the part of foreman or operator will often devise better protection for a specific operation than could be given by a safety device intended to adapt itself to a wide range of work. The variety of such home-made guards is endless.

Miter Saw Guard. A home-made guard for a miter saw, to prevent the triangular blocks cut off the stock from riding up on the back of the saw and being thrown, is shown in Fig. 260 (page 157). It consists merely of a bevelled board set upright close behind the saw and held in place by a clamp at the rear edge of the table.

Grooving Saws. Fig. 261 shows a guard for a grooving saw which also acts as a spring to hold the stock down on the table. The wheel under which

Tenoners. These should be guarded like tenoners used in other shops (see index). On the chain feed double end tenoner, when small pieces are fed, as in coat hanger work, additional protection is often given the cutters by appliances for holding the stock down firmly. Such an appliance sometimes takes the form of a block sliced into closely set teeth like a comb. These teeth are flexible and long and give the required tension for holding the stock on the feed.

Double Saw and Chuck Machine. Automatic machines can be used for sawing off both ends and chucking or sizing one or both ends of chair legs, chair spindles, stretchers, etc. The chucking heads and saws should have protection in the form of shields covering them as much as possible or by suction hoods.

Rod Machines. The two-side sticker often used for working material into flag sticks, dowels, and rods of

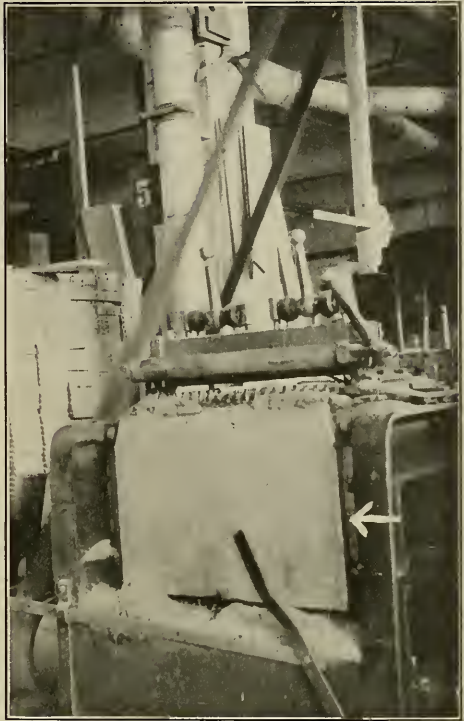

Courtesy of Grand Rapids Show Case Co.

Fig. 262. Gang Dovetailer Guarded.

various kinds, as well as chair spindles, should have its cutter heads and feed rolls guarded like those of any other sticker (see index).

The feed rolls and cutters of the power-feed rod machine used for turning stretchers, curtain poles, flag sticks and other kinds of rods should be guarded. It is well also to have a shield over the pulley and belt in the center of the machine.

Carvers. The operators of these machines should work with sleeves short or rolled up, to avoid being caught by the cutters. Where there is any length of spindle exposed, it is well to enclose it in a sleeve whenever possible. Set screws in collars on spindles should always be of the headless type.

Heading Machine. The machine for heading out back posts for chairs, with its one horizontal and two vertical



Courtesy of Michigan Chair Co.

Fig. 263. Heading Machine Guarded.

saws, should have wooden block guards on each side of the saws, as shown in Fig. 263 (page 159). These are so arranged that they leave only enough open space for the material to pass through.

Veneer Cutter. The machine used for cutting veneer to size can be guarded like any veneer clipper, as already described in this chapter. When not so guarded, it should be worked with great care, especially when one man operates the knife and another handles the material. Even if equipped with a holding bar, fingers are apt to be badly pinched.

Finishing Room. One of the danger spots in a furniture plant is the room where the filling is rubbed in. The filling mixture used generally contains naphtha, which makes it highly explosive. To guard against fire, discipline and cleanliness are highly important. The men employed there should be instructed how to handle a fire, by smothering it, and sand in pails or paper bags should be kept within easy reach. Only a small amount of the filling mixture should be kept in a pot at a time, and the pots should be entirely emptied at the end of the day. The supply of naphtha should be kept in an outside building, and should be in charge of a competent man. It is best to use electric lights in such a room. When gas is used, a pot containing mixture should never be allowed to stand under a gas light. Fire has been known to originate from a burned bug dropping from a lamp into a pot below. To avoid the danger of fire from spontaneous combustion, the rags used in rubbing in the filler should be very carefully handled. Spontaneous combustion sometimes occurs within six hours. Discarded rags should be placed at once in a metal receptacle, which should be taken to the boiler room twice a day and its contents burned.

Transmission, Etc. For the guarding of belts and pulleys generally, or other driving apparatus, see the chapter on Power Generation, Transmission, Etc.

PATTERN SHOP, BOX FACTORY, ETC.

The high rank of the pattern-maker among woodworking mechanics and the widely varying sizes and shapes of material worked make the guarding of machines in pattern shops unusually difficult. Patterns are largely made up of small pieces, however, and guards can be used for most of the work. As for the pattern-maker's intolerance of guards, it can be impressed upon him that they imply no reflection upon his skill.

Two rules should be rigidly enforced in pattern shops, one that each machine shall be shut down as soon as any work upon it is completed, and the other that guards shall be used whenever possible and shall be replaced immediately after completion of any work for which they cannot be used.

Pattern Shop Saws. The universal saw bench with two arbors is the hardest to guard of all pattern shop machines. Until recently the only practical protection was a hood suspended from above, or from the side of the table if it did not tilt. The Oliver Machinery Co., of Grand Rapids, Mich., however, has worked out a new method of guarding. It consists

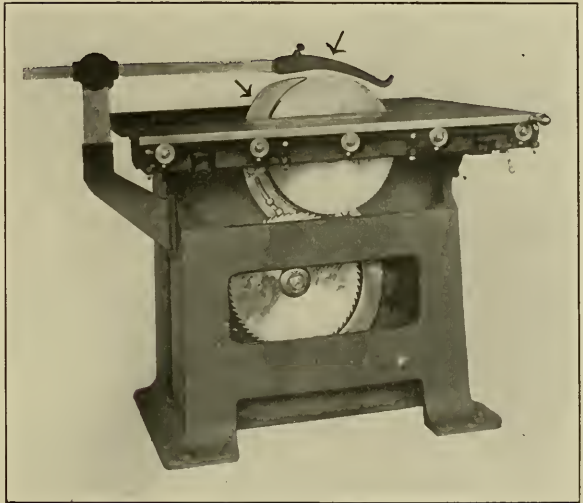

Courtesy of Oliver Machinery Co.

Fig. 264. Pattern-maker's Saws Guarded.

consists of a splitter for each saw and a light hood supported by an arm attached to a support back of the table. The hood guard is adjustable, to take care of the depth of cut and also the position of the saw either backward or forward. The splitters are adjustable so as to be useful whether the cut is deep or not. Fig. 264 shows a saw in its highest position, and Fig. 265 (page 162) shows it in a very low position.

Where the hood method of guarding is used, the hood must be easily and quickly adjustable and so arranged that it can be thrown out of the way when bulky pieces are to be handled. It must be large enough to cover the entire throat. A guard of the suspended type is shown in Fig. 266 (page 162), which also shows a fence and casing for the belt and a sign requiring replacement of

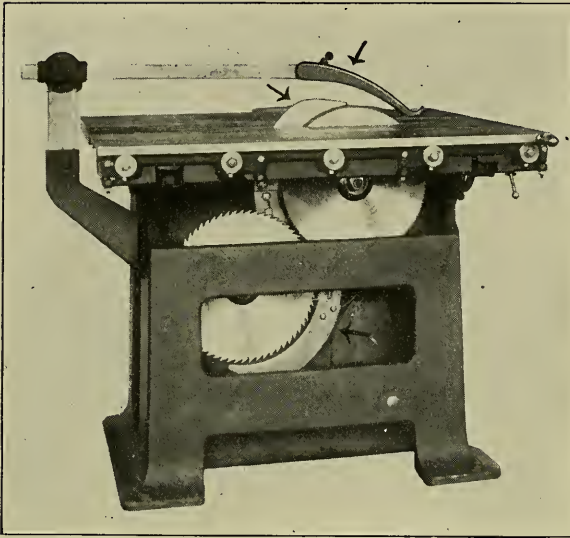

Courtesy of Oliver Machinery Co.

Fig. 265. Pattern-maker's Saws Guarded.

from rip to cut-off and from one size to another, there can well be a false throat for each rip saw, equipped with a splitter and a light hood attachment. When unwieldy pieces are to be worked or other work done for which a guard cannot be used, the original throat plate can be put in.

Buzz Planer or Jointer. This machine should have a safety cylinder head, and often additional guards can be used, such as the automatic ones referred to in the chapter on "Jointers or Buzz Planers." If a big piece is to be worked with such a guard on, the operator can loosen up the spring or land the weight, as may be necessary, and set the guard to cover what he does not need of the knife gap. A guard which has been found practical for a great deal of work is shown in Fig. 268 (page 163). The sliding wooden shield (A) is counterweighted so the portion of the knife not used is covered

the guard. Fig. 267 (page 163) shows a hood held over the saw by a strong arm. This arm is fastened to the table by a hinge, and when the guard is thrown back it stands in a vertical position. Raising of the guard is effected by a foot lever. The hood is made of band iron with side pieces of fiber. It has a roller in front and at the rear a small dog to prevent kicking. The saw in which the arbor raises instead of revolving, or the table is raised and lowered, can be guarded by a hood.

Where frequent changes of saws are made in a table,

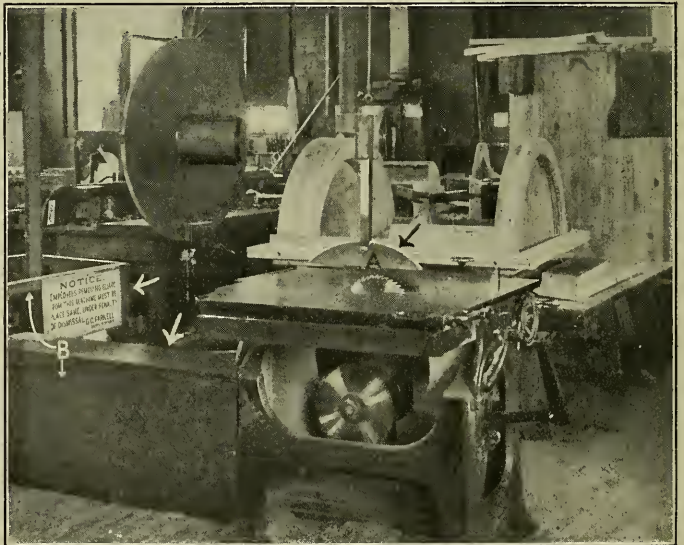

Courtesy of National Tube Co.

Fig. 266. Hood Guard for Saws.

automatically. The handle (C) may be used for adjusting the shield for small work, while the foot-lever (B) is used when the operator has a long or heavy board requiring both hands to handle. A brass shoe (D) on the shield reduces friction. The picture shows a sign forbidding the jointing on this machine of any piece containing less than one square foot of lumber.



Courtesy of Illinois Steel Co.

Fig. 267. Pattern Shop Saw Guard.

No one should be allowed to run a buzz planer without full instructions as to the points of danger, and an operator should carefully note how much of a cut the knives are set for before doing any kind of planing. Short pieces should not be run over the machine. A sign should be put in plain view stating the minimum size of piece which can be run. In many shops 12 inches is the minimum allowed. If a short piece is forced against the knives when they are set to take a large chip, the piece is apt to be forced back from the operator's grip so quickly that his hands drop instantly on the knives if they are over the gap. If there is any projecting knot or other bulging place on the side being planed, this is practically sure to happen.



Courtesy of National Tube Co.

Fig. 268. Pattern Shop Jointer Guard.

Universal Wood-working Machine.

This wood milling machine, which does a large variety of work that formerly required a number of machines, eliminates much of the danger attaching to pattern work. It bears the same relation to pattern-making that highly specialized machinery does to tool-making. After

the work has been placed on the table the machine can be operated without the workman having to bring his hands near the cutters.

Other Machines. The other machines used in a pattern shop, such as band saws, shapers, surfacers, lathes and grinders, should be guarded as suggested elsewhere (see index). Direct motor drive will do away with the difficulty of guarding

against the belting dangers of lathes. Fig. 269 shows a screen to protect workmen against flying pieces from a neighboring lathe. Fig. 270 shows sheet metal guards for the belts and pulleys of a planer. Fig. 271 (page 165) shows shields over gears, discs and blades of a dowel pin machine used in a pattern shop.

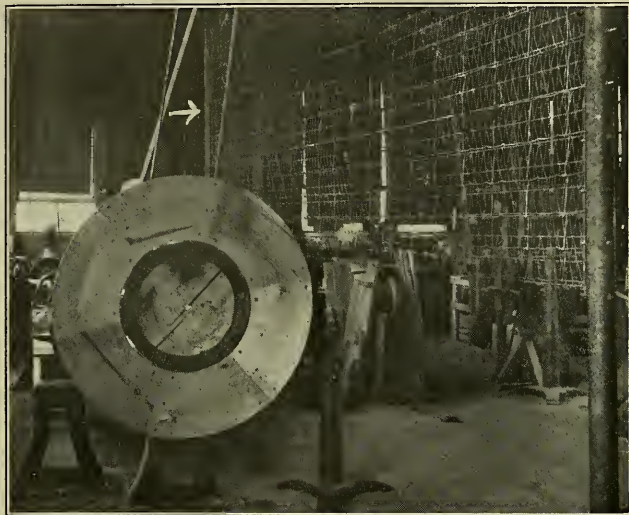

Courtesy of National Tube Co.

Fig. 269. Screen for Lathe.

dangerous work, especially when short stock is used. Boys should never be allowed to run such saws. In making rough boxes the saw should have a hood, in addition to a splitter, coming well down to the stock, as there are many knots in the stock. The front of the hood can be of mesh on top, so the operator can see the cut. An iron strip can hang from the front of the hood, curved up to allow easy passage of material. Where a light and narrow hood is attached to the splitter, a board can be suspended over saw and hood, to protect the operator's eyes, cut out in the center so as to come well down toward the table on each side of the saw. This board can be arranged to swing back as material is pushed through.

Home-made guarding of a rip saw with splitter and metal hood is shown in Fig. 272 (page 165).

In Fig. 273 (page 166) is shown a guard devised to meet the requirement of a clear table on all sides of a saw in the center. The reinforced mesh guard, pivoted on the splitter and positioned by an extra pin, allows

BOX FACTORY.

Rip Saws. Building up box shooks by edging them on a rip saw is dangerous work, especially when short stock is used.



Courtesy of Illinois Steel Co.

Fig. 270. Planer Belts and Pulleys Guarded.

every part of the saw line to be visible. Fig. 274 (page 166) shows an overhung saw equipped with a splitter and with reinforced-mesh guards for both upper and lower part of the saw. Clearance is given for a stroke of 3 feet by the sliding feed table. The rear support of the upper guard is of hard wood reinforced with sheet metal.

Whenever possible, for short stock anyway, a feeding apparatus, such as that shown in Fig. 275 (page 166) should be used. The stock is held on the carriage by a hand clamp or lever with a band spring at the back. The under side of the lever is fitted with spikes or a small tooth plate to hold the stock firmly. The saw shown has also a splitter, which should always be used, and a board guard against fly-backs with a pendant flap. A German feeding arrangement

used in making small boxes is shown in Fig. 276 (page 167). The boards are held firmly by a lever. When box shooks are built up by running them through a self-feed edger, the edger rolls should be protected like those of any self-feed saw (see index). In many box factories with saw mill connection box boards are cut on regular shingle or heading machines. These should be guarded and operated as suggested elsewhere (see index).

Cut-off Saws. Cut-off saws should be hooded, and equipped with splitters to guard the off-bearer. When a carriage-fed overhung cut-off is used, the spout carrying waste to the conveyor should be brought up close to the saw or there should be a partition covering the side of the saw to below the bottom, to protect the operator when he reaches into the spout to push anything down. The operator should not bring up stock to the carriage as he pulls the carriage back for another cut.

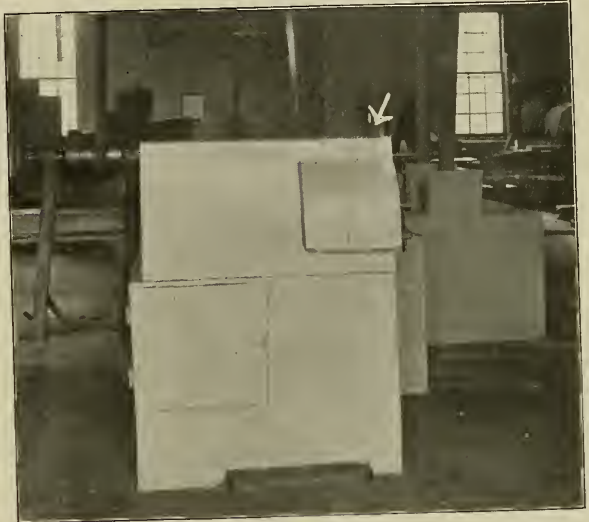

Courtesy of Tennessee Coal & Iron Co.

Fig. 271. Dowel Pin Machine Guarded.

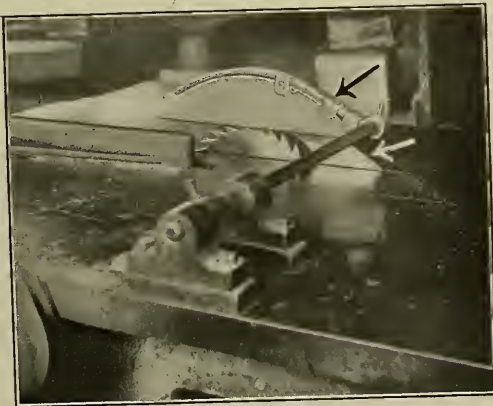

Courtesy of J. N. Roberts Mfg. Co.

Fig. 272. Guard for Rip Saw.

When saws are set close together in gangs and fed by a hand carriage, there should be means of clamping the pieces together for steady feeding. If they have to be held by hands as they go through, there is much risk of the

hands being cut. It is a good idea to cover these gangs with an inverted "V" trough. Self-feed gang saws, in which the stock is carried through by a chain with brackets, are much safer than the hand-feed ones. It is well to use these always for heavy work.

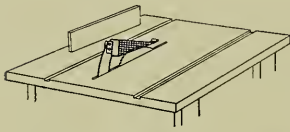

Courtesy of Remington Typewriter Works.

Fig. 273. Mesh Guard for Saw.

Fig. 277 (page 167) shows guarding of a combination trimmer and edger having three saws on one shaft. The overhung saws, a rip and a cut-off, are stationary at either end, but the cut-off

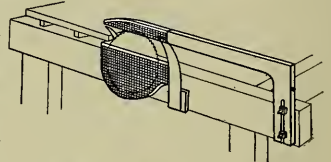

Courtesy of Remington Typewriter Works.

Fig. 274. Overhung Saw Guarded.

saw in the middle has to traverse the shaft freely for a distance of 18 inches. Each saw is guarded both above and below by reinforced wire mesh, the rip saw has a splitter behind it, and the pierced fingers projecting in front of the upper guards prevent the operators' hands holding the stock on the feeding carriages from getting into the saws.

It is a good idea, when conditions permit, to fence off cut-off saws placed in a row. Off-bearer boys are apt to fool with each other, increasing the chance of their being injured. Using a carrier belt to take away sawn-off pieces is safer than employing off-bearers.

Other Machines. The feed rolls of the self-feed box board matcher should be guarded, to prevent hands being caught, by the split pan arrangement, each half of the guard adjusting itself with its roll. The cutters of the sizing machine used in making small boxes should be covered as much as possible, the guard for the movable spindle and cutter head being attached so it will move with them.

A special combination of jointer and edger can be used to joint one side and two edges of stock for lock corner boxes, which is apt to become badly twisted and warped before it is re-sawn. The pieces are fed by a chain with dogs on it, and sectional pressure feet, with spring hold-downs, keep the stock true on the rear table, in which the saw is set. Nailing machines should have all gears covered, and any belts and pulleys used.

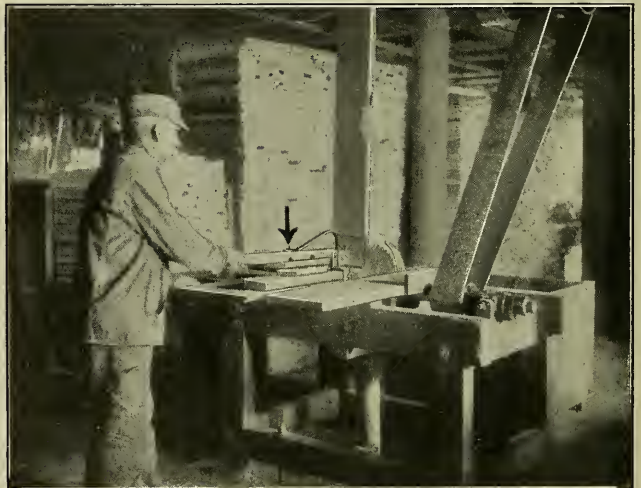

Courtesy of Heywood Bros. & Wakefield Co.

Fig. 275. Feeding Apparatus.

The safest box board printing presses are those in which the boards are taken by the machine from the bottom of a hopper. When a cylinder press is used to which boards are fed one at a time, it is best to have a chain transfer with brackets and a long table. The gears actuating the cylinders should be encased, and the big pulley and belt at the side guarded. A platen press should have a safety device to prevent a hand getting caught between platen and bed. Other machines used in a box factory, such as swing saws, band resaws, sanders, mortisers, gang dove-tailers, etc., should be guarded as suggested elsewhere (see index). Fig. 278 (page 168) shows a horizontal resaw, used in a box factory, with wheel boxings which act also as guards for the wheel pits, and with a blower hood (swung back in the picture) which serves as a protection for the saw.

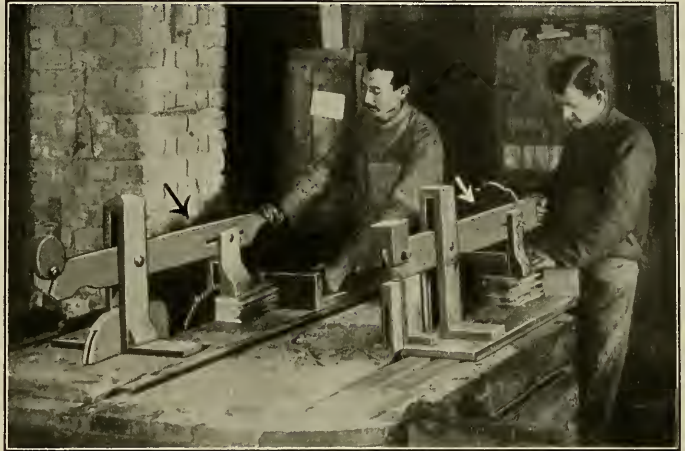

Courtesy of American Museum of Safety.

Fig. 276. Feeding Apparatus.

General. Waste holes should be double railed to a height of 3 1-2 feet, or hopped with an open space at the bottom into which rubbish may be swept. A good blower system is especially desirable. When a saw is not guarded underneath by the suction pipes of such a system, and no other protection is furnished, the spout leading down to the conveyor should be arranged to protect all of the saw running under the table. Great care should

be used in piling boxes to a height above the head.

The yard requires protection similar to that suggested for a saw mill yard (see index). Swinging bridges, or lift platforms, leading from one building to another should be railed on both sides and each entrance to a bridge should be guarded. This can be automatically done by means of a bar raised as the bridge is lifted up.

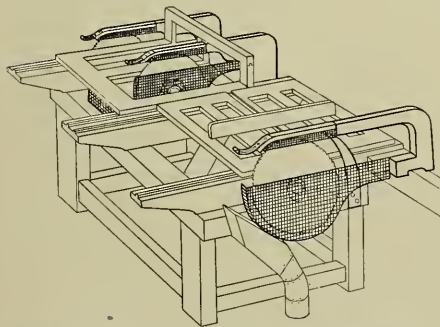

Courtesy of Remington Typewriter Works.

Fig. 277. Trimmer and Edger Guarded.

The open side of a permanent outside platform along which stock is taken on a conveyor from stock room to factory should be fenced. Openings left at places where piling of stock taken from the conveyor is done should be guarded when not in actual use by bars hinged at one end and fitting into sockets at the other.

MISCELLANEOUS.

Woodenware. The manufacture of wooden chopping bowls, ladles, other kitchen utensils, etc., involves the use of a number of machines common to many wood-working plants, such as drag saws, bolter saws, rip saws, cut-off saws, band saws, buzz planers, sanders, variety and back knife lathes and rounding or dowel machines (see index).

The bowl lathe

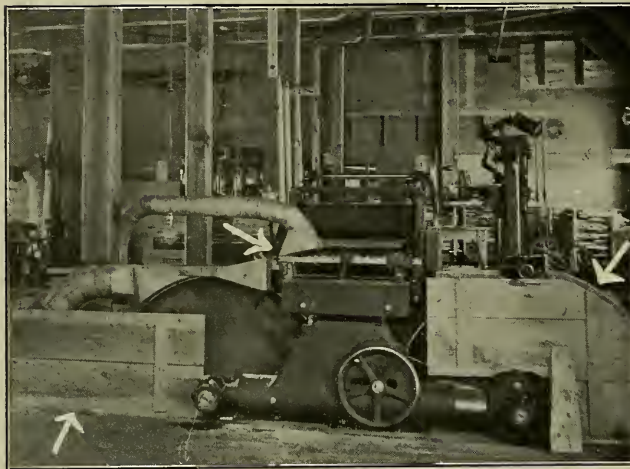

Courtesy of American Thread Co.

Fig. 278. Band Resaw Guarded.

used for cutting wooden bowls from a split or half bolt, which has a stationary knife, is more dangerous to others in the room than to the operator, whose working position is alongside the machine practically out of the range of flying pieces. To prevent anyone being injured if the spinning bolt should fly off the spindle or should break into pieces, as well as by flying chips, there should be a substantial guard on each side of such a lathe. The operator should take care that the bolt is securely fastened on the threaded spindle and that the machine is not speeded too high. Fig. 279 shows the type of screen guard often used to protect employees against chips flying from a variety lathe.

The chief dangers of the rounding or dowel machine, through which many of the smaller articles are put before going to the variety lathe, are found in the gearing, pulleys and transmission, which should be well guarded. Fig. 280 (page 169) shows sheet metal guarding of the gears. In operating this machine a workman should be careful not to feed a small piece when the machine is set for a larger one, as the piece is then apt to be thrown out.

Fig. 281 (page 169) shows a lading machine, used for dishing out the



Courtesy of Chapman-Sargent Co.

Fig. 279. Screen for Variety Lathe.

inside of the ladle, with a guard protecting the rear side and top of the knife. The same protection should be applied to the ladling machine which makes the back of the ladle.

A similar curving shield should be employed to guard the cutters of the automatic machine for cutting such oval wood dishes as are used for holding butter, lard, berries, etc., and some machines come furnished with it.

The machine used for finishing, or making a square bottom on wooden trays, in which the knives are set in a disk, should be guarded at the back, to prevent contact with the bolt heads there, and, whenever possible, protection should be given as much of the front as need not be left exposed for doing the work. The dauber, which finishes the inside of the tray, should be fenced in except at the point where the work is held against the revolving wheel in which the knives are set.

Baskets. Many of the machines used in the manufacture of baskets, such as drag saws, rotary veneer cutters, veneer clippers and circular and band



Courtesy of Chapman-Sargent Co.

Fig. 280. Rounding Machine Guarded.

saws, should be guarded as suggested elsewhere (see index). Some of the machines used for stapling involve the danger of the operator getting a finger pierced by a staple or crushed by the staple drive. When such danger exists, the operator having to place finger or thumb quite close to the stapling point, it is difficult to provide protection, as it is necessary for the operator to see the stapling point in doing the work. For some of such work the metallic thimble used in connection with corner staying machines in paper box making might advantageously be employed. For making one-piece baskets there are automatic machines to which the veneer is fed from a roll and in which stapling and all is done by the machine.

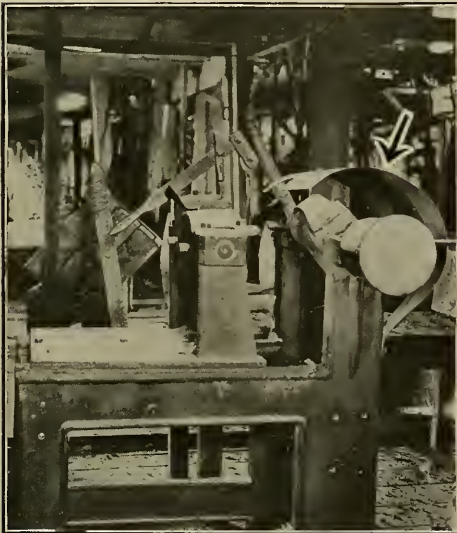

Courtesy of Chapman-Sargent Co.

Fig. 281. Ladling Machine Guarded.

There are also automatic basket strip cutting machines.

The bottom machine, for making the rounded end for the bottom of a peach basket, should have its revolving disk in which the knives are set covered at back, on top, and in front well down toward the stand or rest on which the material is placed, leaving just room enough for the cutting to be done.

Brushes. The saws, planers, shapers, turning lathes, borers and other common machines found in a brush factory should be guarded as suggested elsewhere (see index). In drilling brush handle holes it is well to use some mechanical arrangement instead of pressing the wood with bare hands against the boring tool. Such arrangements are used largely in Germany, and they have reduced the number of accidents in this work very materially.

Spools and Bobbins. The circular saws, lathes and rounding machines used in making spools and bobbins should be guarded generally as suggested elsewhere (see index). When a blower system is used, the knives of the

rounding machine can be completely covered by a hood. Automatic turning machines for spools can be used, to which the rounded pieces are fed through a hopper.

Some of the double spindle bobbin boring and reaming machines should have a shield alongside of the spindles back of the hand wheel for moving the work from one bit to the other. The bobbin grooving machine, for cutting grooves in the ends of bobbins, should have a band guard over the top and back of the saw at the end of the machine.

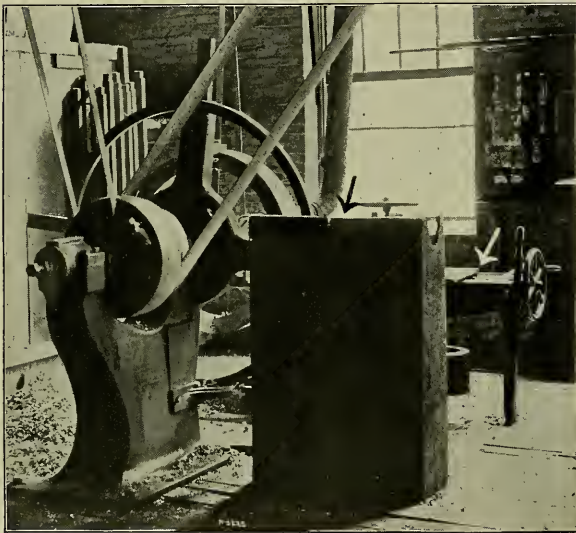

Courtesy of Dodge Mfg. Co.

Fig. 282. Rimming-out Machine Guarded.

Spool and bobbin disc dividing saws should be protected by a hood coming down as low as possible.

Cross Arms. The rounding planer, for chamfering or rounding tops of cross-arms, should have its cutter head guarded by a hood, or at least by a curving shield, and the front feed roll should be protected. When the cutting heads of a rounder travel, each can be protected, and is by some makers, by a shield attached to its framework.

Wood Pulleys. One of the potentially dangerous machines used in making wood pulleys is the rimming-out machine for facing or rimming out the inside of the pulley. The fast-moving traveling arms of this machine have caused many very serious injuries to employees passing by. The plane of rotation of these arms should be well guarded whenever there is any danger of contact with them. Fig. 282 shows such a machine guarded by a wooden

boxing and by a table which prevents anyone walking into the machine while in motion.

Transmission, Etc. For the guarding of belts and pulleys generally, or other driving apparatus, see the chapter on Power Generation, Transmission, Etc.

POWER GENERATION, TRANSMISSION, ETC.

BOILERS.

Only experienced men should be in charge of boilers, and no one not employed in a boiler room should be allowed there. In every boiler room an easily readable placard containing rules for boiler tenders should be hung up in a conspicuous place. A boiler room should be well lighted, especially in the vicinity of the gauge glass and the steam gauge. The room should be kept well cleaned up, all material being kept far enough away so as not to prevent

ready access, especially to the safety apparatus. During working hours the exits should be kept free and unlocked.

Care. The most important thing in taking care of a boiler with a view to its safety is to have it examined frequently by an expert boiler inspector and to follow his directions implicitly.

The water column should be blown out and the gauge cocks tried the first thing each morning, to determine the height of the water in the boiler. Fires should never be started or unbanked until this is done. The steam gauge should be tested by opening and closing the stop cock to see if the hand moves freely, the safety valve lifted to see if it is working properly, and the feed tried to see if water will go in. All valves

should be opened very gradually. To make sure that the water column is kept clear, it should be blown out by opening bleeder valve, for a few seconds, several times daily. In addition to this the gauge cocks should be frequently used.

In case of low water the fire should immediately be covered with wet ashes. The feed should not be turned on under any circumstances, nor the safety valve tampered with or opened. The steam outlets should remain as they are. After pressure is reduced the fire should be drawn and the boiler

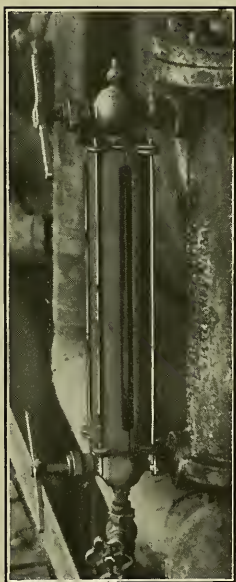

*Courtesy of National
Tube Co.*

**Fig. 283. Gauge
Glass Cover.**

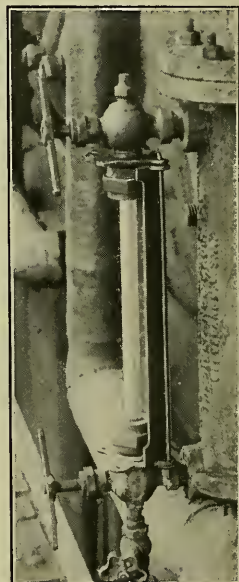

*Courtesy of National
Tube Co.*

**Fig. 284. Gauge
Glass Cover, Front
Half Removed.**

cooled off, after which the boiler should be opened up and examined by an expert.

If the boiler is "dead" and has to be fired up, this should be done gradually without forcing the fire, to prevent unusual expansion of the boiler.

The steam gauge should be compared with the safety valve when the latter blows off, and if they do not agree the trouble should be located at once.

All gauges, cocks, etc., should always be kept clean and in good order.

Automatic valves should be examined sufficiently often to assure their acting properly in such emergencies as the bursting of tubes.

Generally boilers should be blown down two gauges once or twice a day, and entirely emptied and cleaned and examined once a week. Internal surfaces should be kept free from scale or deposit.

Every boiler should be provided with a fusible plug, the inner end of which should be kept free from scale, and it is advisable to have a high and low water alarm. These should be watched carefully and the latter tested every day.

When leaks are discovered, they should be repaired as soon as possible. If leaks occur at longitudinal seams, the boiler should be shut down immediately and investigated. No leak should be calked when a boiler is under pressure.

Cold water should never be pumped into a hot boiler. No water should be allowed to come in contact with the exterior of a boiler.

If there are two gauge glasses, both should be used continuously. The steam gauge should be tested from time to time to see whether the indicator goes back to zero when the steam is shut off.

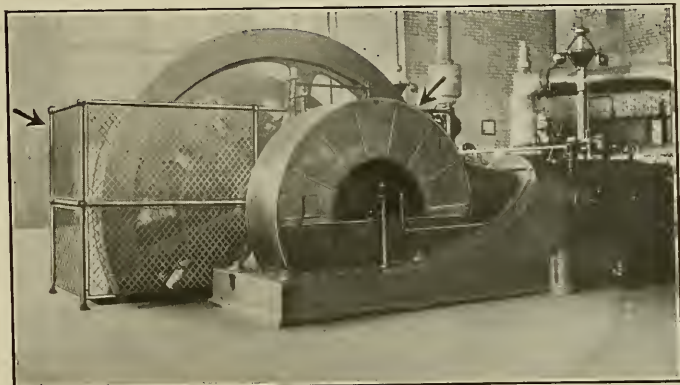

Courtesy of Link-Belt Co.

Fig. 285. Engine Flywheel and Crank Guarded.



Courtesy of Illinois Steel Co.

Fig. 286. Manhole Guard.

When the steam pressure exceeds the amount allowed, on account of shutting down of the engine, etc., water should be run into the boiler and the draft diminished. If this is not sufficient, the fire should be partly covered. Care should be taken that the steam pressure does not exceed the highest pressure allowed.

When cutting a boiler into header, the pressure should be equalized as nearly as possible. Then the by-pass should be opened first, and afterward the main valve. If there is no by-pass, the header valve should only be cracked open until the pressures are perfectly balanced, then opened wide.

Safety Valve. The safety valve should be of sufficient size to handle all the steam a boiler can make. There should be no valve between the safety valve and the boiler. No extra weight should be hung on a lever valve, and the tension springs in pop valves should be set by a boiler expert. Safety valves should be arranged so that the escaping steam does not fill the boiler room.

Feed. There should be two independent means of feeding a boiler. All water column connections to a boiler should be of ample size and kept free from scale and corrosion. The feed line to each separate boiler should be provided with a check valve, between two stop valves so that the check valve can be taken apart and examined.

Blow-off. Every boiler should have a bottom blow-off pipe, and a surface blow-off when the nature of the water requires it. Blow-off pipes should be of extra heavy material, should if possible be equipped with swing or expansion joints, and the discharge should be so located as not to involve danger to passers-by. Blow-off

pipes should be inspected regularly for corrosion inside and outside. Blow-off valves should be kept tight. When boilers are blown off into an overflow tank or any enclosed tank with vent and overflow, such tank should be built to stand boiler pressure.

Gauge Glass. Gauge glasses should be made of the best Scotch glass and the glands should be kept in line. The gauge glass should fit as loosely as possible in the glands to allow for expansion, and the water column valves should be perfectly true so that the glass in expanding will not bind on one side. No gland should be tightened on the gauge glass without the water column first being shut off. In turning on, steam should be turned on first, and water next.

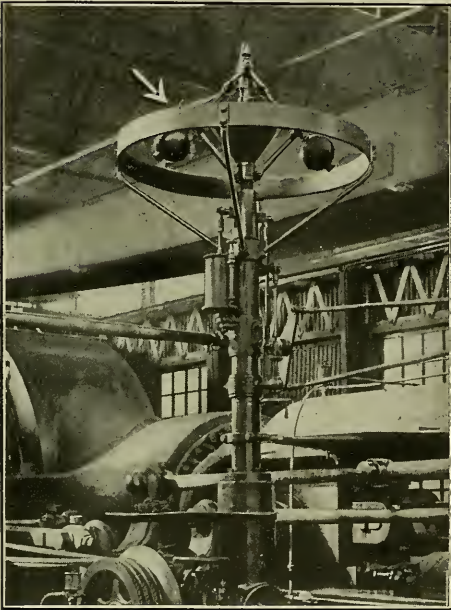

Courtesy of International Harvester Co.

Fig. 287. Guard for Governor Balls.

The gauge glass should be of such height that when water appears in it there is an inch of water over the front end of tubes.

Gauge glasses should be guarded by slit tubing or Mississippi wire glass, or otherwise, in such a way as not to prevent ready observation of the state of the water. When inserting or testing a water gauge, a workman should wear wire gauze goggles to protect his eyes.

Runways, Valves, Etc. Runways, properly railed and lighted, should be placed on boilers, and should lead from boiler to boiler. These runways should provide access to all valves, etc., which need to be regularly used and inspected. Properly guarded stairs or ladders should give access to these runways. If possible, main stop valves should be workable, in case of need, by hanging chains or from an adjoining room.

Sewers or hot-wells for steam or hot water should be covered with metal,

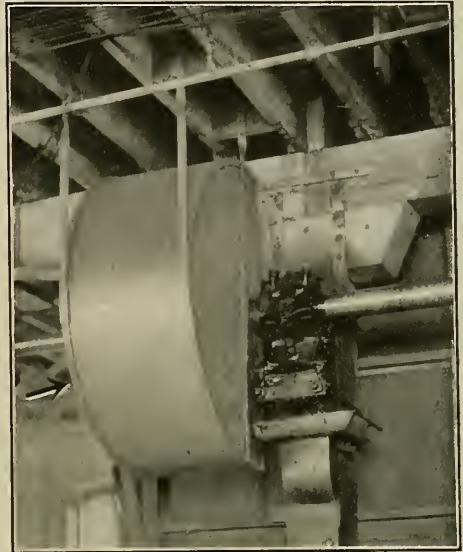

Courtesy of International Harvester Co.

Fig. 288. Metal Hood for Line Shaft Clutch.

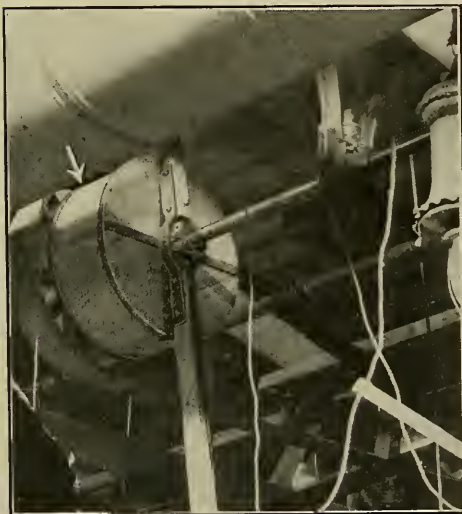

Courtesy of Fairbanks, Morse & Co.

Fig. 289. Screen Guard for Overhead Clutch.

brick or cement, never with planking alone. Pipe lines should not be laid on the top of a floor, as they may cause men to trip over them. Steam and hot water pipes within reach of passageways, etc., should be properly covered to avoid burns.

Boilers and steam lines should be equipped with non-return valves. Two valves should always be provided between each boiler and the main header, so that one valve may be taken apart for repairs and kept perfectly tight without taking steam off the main. It is well to drill a hole in the steam gauge case, to let possible leakage out and prevent explosion.

Cleaning. A workman should never go into a boiler before closing main stop, blow-off and feed valves and attaching to each of them a sign warning everyone not to move it, as there is a man in the boiler. No workman should open a valve or slide to

which such a sign is attached, until he has seen that no one is in the boiler. In plants of the National Tube Co. a split and hinged metal case painted red is slipped over the header valve wheel and locked, the man who is going into the boiler taking the key with him. It is advisable that a workman should never go into a boiler unless there is someone outside on the watch. Two men should "spell off" in cleaning a boiler, one man being on the outside to assist the man cleaning in case of need.

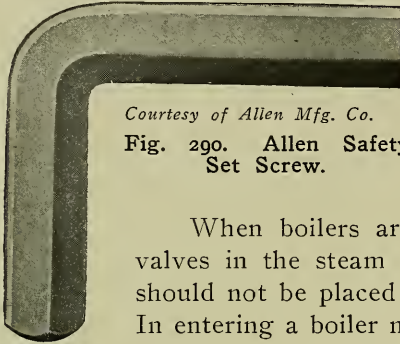

Courtesy of Allen Mfg. Co.

Fig. 290. Allen Safety Set Screw.

When boilers are taken off for cleaning, the main stop valves in the steam connection should be shut. Dependence should not be placed on automatic quick closing valves alone. In entering a boiler no lighting material should be used which is easily inflammable at higher temperatures.

Dutch Ovens. When Dutch ovens are used, the holes in the top should be kept covered, preferably with a hinged cover counterweighted, at all times when not actually in use. They should have pipe railings on three sides whenever the method of feeding will permit.

WATER WHEELS AND TURBINES.

Protection should be provided at head gates and passageways over dams, raking platforms and forebay.

Where flash boards are used on a dam and have to be removed at high water, on account of there being no overflow gate, a bridge should be built over the dam and a railing provided on both sides. The flash boards should be taken up through the platform of the bridge and covers should be provided for the openings in the platform through which the flash boards are passed. The dam construction in all cases should be so that flash boards from six to eight feet long can be used. Where flash boards have to be replaced occasionally, especially at high water, they should never be over eight feet long. If longer, a control or overflow gate should be provided so that workmen will not have to handle flash boards under high water. A railing, preferably of iron, should be provided around the headgate, and also on any passageways along the forebay.

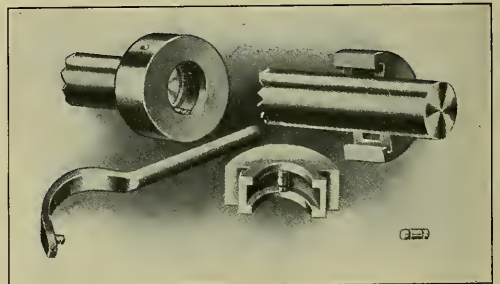

Courtesy of Murchie Iron Collar Co.

Fig. 291. Safety Clamp Collar.

On the raking platforms where racks are raked or cleaned a railing should be provided the entire length. The uprights or supports for this railing should extend outward from the face of platform at an angle of about sixty degrees,

and should be three feet high, and placed some eight or ten feet apart. They should be fastened very rigidly and a substantial railing placed on them, allowing a good margin for safety should anyone fall over on the railing or take hold of it for protection. If the railing is placed in this position, it will not interfere with the rackman raking the racks. He can place his rake under the rail and it will allow him to pull the rake up in a vertical position, so as to remove the waste. If the uprights are placed some eight or ten feet apart, it allows space enough to remove logs under all ordinary conditions.

Water Wheels. A water wheel should be wholly fenced in, whether the wheel is in a house or out in the open. An iron railing or a strong picket fence, at least 3 1-2 feet high, is the best protection. If a railing is used, there should be double rails. A passage leading to an outside bearing should be double hand-railed, well clear of the rim, spokes and hub of the wheel. All wooden walks and runways out over a dam and around a wheel should be cleated, to prevent slipping on them when wet by spray. Walks and runways should be double hand-railed. Clutch connections, shafts and gearing should be covered. All connections to oil bearings should be equipped with an extended pipe, so the oiler can work in safety.

Turbines. The bevel gears above and the top of the shaft should be well guarded. A housing of slatted wood or heavy wire mesh, with facilities for opening at oiling points, is preferable to even the heaviest railings. Platforms or runways over pits or penstocks should be protected on both sides, as they are nearly always wet. When an electric generator is direct driven by a turbine, the flywheel should be fenced around.



Courtesy of B. F. Goodrich Co.

Fig. 292. Guard for Floor Countershafts, Etc.

ENGINES.

No one but a competent engineer should be allowed to run an engine. Persons not employed in the engine room should not be allowed in it. Engine rooms should be well lighted and kept clean. Parts of the floor most used should be covered with rubber mats or other arrangements for assuring a firm footing.

An engine should be equipped with an efficient governor, with an approved automatic speed limit stop which should be kept in the best of condition, and with buttons in the engine room and throughout the mill by which the

engine can be shut down from different points in case of need. This button system should be tested at least once a week. In some plants the engine is shut down daily by means of the button system. So far as possible, engines should be provided with automatic lubricating devices.

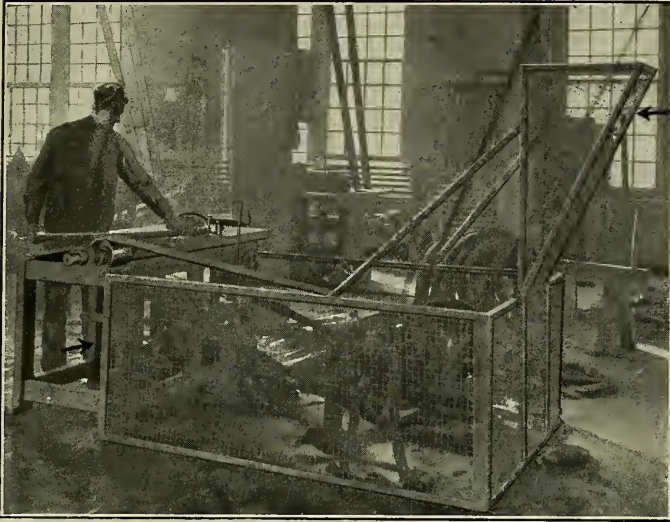

Courtesy of International Harvester Co.

Fig. 293. Screen for Belts and Pulleys.

engine should be done only when it is standing still.

When men work on line shafts or anything directly connected with the engine, the man in charge should first hang a sign on the throttle-valve wheel, and the engine should not be started until this man has himself removed the sign. When men are so working at times when the engine is shut down, the engine should not be started up until notice has been received from these men, and then only after blowing the warning whistle.

Fencings. The flywheel should be guarded with a plate or mesh screen or an iron picket fence coming down to the floor, or with a double pipe railing with a toe board at the floor level extending up at least 6 inches. If possible, this fencing should be at least 15 inches from the wheel or belt, when it need not necessarily be higher than 3 1-2 feet. If it has to be set close for lack of space, it should be at least 6 feet high, and if of piping should be filled in with wire mesh.

Care. A factory engine should never be started or stopped without first blowing a warning whistle audible all over the mill. Safety devices on the engine should be examined daily to see that they work properly. All belts, pins, and cams should be examined daily for defects. Cleaning of moving parts of an



Courtesy of Paine Lumber Co. Ltd.

Fig. 294. Slat Belt and Pulley Guards.

The connecting rod, cross-head, crank-pit and crank shaft in many cases require similar fencing to a height of at least 3 1-2 feet. When the drive belt or ropes are within 7 feet of the floor, they should be guarded. If such a belt runs partially under the floor, its entire run should be covered with sound flooring. Flywheels of air pumps, air compressors, lighting engines and auxiliary engines should be fenced.

All railings or other fencings should if possible be far enough away from moving parts to prevent accidental contact, but not so far away as to give room for a passageway inside them. No tools, clothing, or other articles should be kept within fencings. Every floor opening should be railed off, with a toe board at the floor, or have some suitable trap door, such as is shown in Fig. 286 (page 173). All entrances to floor depressions should be on an incline, and the other sides of the depressions railed.

Governor. The governor should be kept clean and examined daily to see that its mechanism is in proper working order. If the governor is belt-driven, the belt should always be an endless one, never made up of several pieces. The belt should run on well-flanged pulleys, or have a belt guide. It should be strong, securely fastened, and kept in good shape, so it will not slip. An oil-soaked belt should never be allowed to run a governor. Belt-driven governors should always be equipped with broken belt stops.

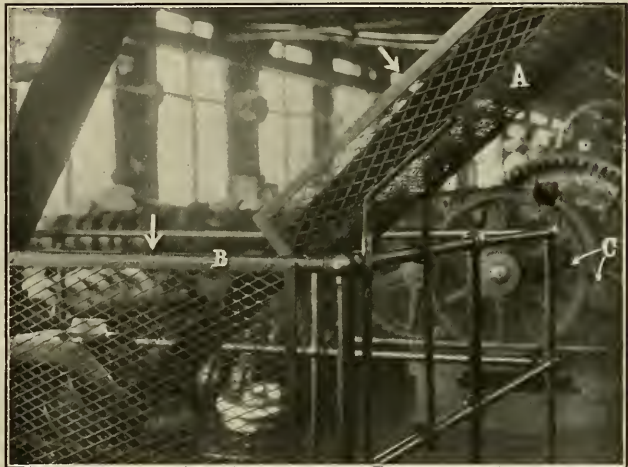

Courtesy of National Tube Co.

Fig. 295. Line Shaft Motor Drive Guards.

The keys and screws securing the gears of a gear-driven governor should be examined frequently to avoid any chance of slipping. To assure governor pulleys or gears being tight on the shaft they should be fastened with a set screw as well as a key. Governor gears should be guarded at the meshing point, if not wholly covered.

On fly-ball governors the stop pin should always release automatically from the governor as soon as the engine has come up to speed. An automatic device can easily be installed to assure the removal of this pin. One way is to hinge the stop pin at the bottom to the governor frame so it will drop by gravity as soon as the pressure of the governor shaft on it is removed. The safety cams should never be removed or set back or the governor blocked.

If the governor balls are located near a passageway or so that close approach to them is necessary, they should run inside of a hemispherical metal or wire mesh cup, or be encircled by a metal strip or rod, as shown in Fig. 287 (page 174).

Flywheels. A flywheel should be inspected daily to see that its bolts and keys are tight. It should also be examined frequently for cracks, and many consider a hammer test advisable at regular intervals. Flywheels should be kept clean. A flywheel should be kept running true, as running out of true will tend to crystallize the shaft, which then may break at any time. The shaft for a flywheel should always be of ample diameter and strength. Otherwise the wheel will twist the shaft and run out of true.

To prevent a flywheel breaking from overspeeding it, it should be examined periodically by a flywheel expert, who should after each examination furnish a written statement of the speed within which the engine can be run to allow sufficient factor of safety for the flywheel. This statement should be posted up in the engine room where the engineer will be sure to see it in the course of his daily work.

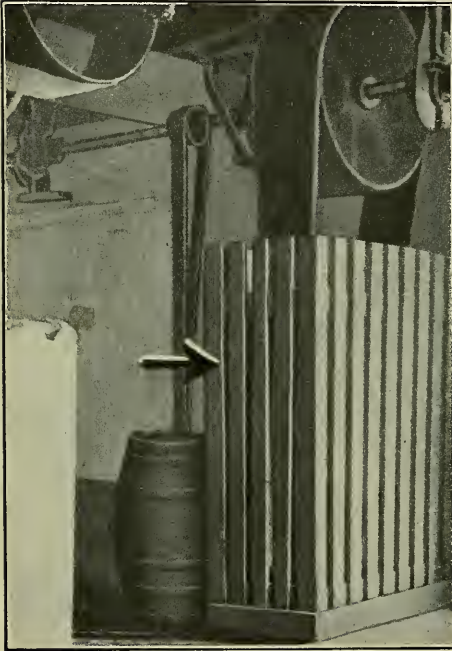

Fig. 296. Guard for Belt Coming Through Floor.

Runways, Stairways, Etc. Runways or stairs or ladders should be provided by which to reach valves. Stairs or ladders giving access to emergency valves should always be stationary. Preferably emergency valves should be arranged so that they can be worked from below by means of a chain hanging down. Where an oiler goes on top of the engine or bearings, iron stairs should be provided, with suitable railings.

All elevated platforms and walks should be provided with double handrails and toe boards, both on the outside and on the side toward moving parts. Railed stairways or stationary iron ladders should lead to them. Stairs should not be built at a sharper angle than 50 degrees, beyond which only ladders should be used. Ladders should always be made of iron, and stationary.

Gears, Keys, Shafts, Etc. Any gears about the engine, or elsewhere in the engine room, should be wholly covered if possible. Keys should not be allowed to project from hubs of small flywheels where no outboard bearing is used, as on some lighting and auxiliary engines. All shafts to which close approach is necessary should be tubed, railed or otherwise guarded. A projecting tail rod should be wholly enclosed in a stationary casing.

Steam pipes and cylinders subject to outside contact should be covered with non-conducting material or otherwise properly guarded. Sewers or catch basins for steam or hot water should be covered with metal, brick or cement, never only with planking. Exhaust pipes should always discharge into exhaust pits with metal covers, or well over the roof, unless carried to points where the exhaust steam is put to use.

Other Safety Devices. Suitable means should be provided for turning the engine off center, when necessary, without danger to employees. Condensing engine safety devices for shutting off steam in case the engine begins to "race" should be such that they will also break the vacuum at the same time.

There should be a steam gauge in the engine room showing the pressure on the boilers in use. There should be a steam separator on engine supply pipes, placed as close as possible to the throttle. Separators, steam-reservoirs, and drop-legs should be provided with gauge glasses. A drain pipe should lead from all low places in steam line, separators, water-legs, etc., to a trap.

SHAFTING.

The ideal system of transmitting power is motor drive, preferably by an individual motor for each machine in a plant. When line shafting is used, one line should drive machines on two floors wherever possible. Power should be transmitted independently to each line of shafting on different floors, and clutches should be provided so one shaft may be cut out without interfering with others. Means of ready communication with the prime mover room should be provided in each room of a factory, and it is advisable also to have there means of immediately shutting down the prime mover. Plenty of bearing surface should be provided for a shaft to run in. Hangers should be numerous and strong, and should be examined often to see they are secure. A realignment of shafting and bearings should be made at least once a year. Shafting should be kept clean.



Courtesy of Hutwelker & Briggs Co.

Fig. 297. Guard for Motor Belt near Passageway.

Guarding. High overhead shafting should be protected, for a sufficient distance on either side of points which may have to be approached, by means of metal tubes, U- or V-shaped metal or wood shields supported from ceiling or wall, or other effective device, or a service platform should be provided, railed and toe-boarded on both sides. Elevated shafting within reach from the floor should have a U- or V-shaped trough of metal or wood beneath it, or other efficient protection. Shafting near the floor should be entirely encased or guarded by fencings, with doors or flaps for access at necessary points. When such shafting cannot be entirely enclosed, railings should prevent people approaching it except at points where safe passageways are provided. Vertical shafts should be surrounded by metal, wire mesh or wood casings to a height of 6 or 7 feet. Drive shafts of live rolls or roller tables should be guarded by hinged metal covers over the top and by hinged aprons of metal or wire screen extending down from the top covers over the shafts.

Couplings, Gears, Clutches, Etc. All couplings should be of safety type or be covered. Spur, bevel, or other gears should be covered. Safety collars or headless set screws should be used, or projecting set screws guarded. Keys should be covered or cut off, key-ways covered, and projecting shaft ends cut off or encased in a stationary cover. Friction clutches should be guarded. A metal hood for a clutch is shown in Fig. 288 (page 175), and a screen guard in Fig. 289 (page 175).

Oiling, Etc. An automatic system should be used, wherever possible, for oiling overhead bearings, or the oiling should be done from the floor above by means of small pipes, or the oiling should be done when the shafting is not in motion. Where oiling is not done thus, and there is no service platform, oilers should use safety ladders. Even with a service platform, the oiling can well be done through metal pipes extending out from the bearings. One experienced man specially charged with the duty should do all oiling, and he should wear tight-fitting clothing and should use oil cans with long enough stems to keep his hands out of danger. There are safety cans through which the oil is forced by pressing a button, and which can be provided with as long a spout as necessary, so a man can stand on the floor and oil overhead bearings which are not too high up.

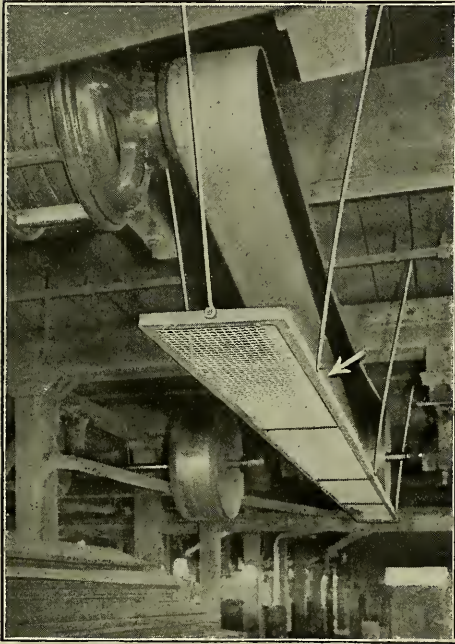

Courtesy of International Harvester Co.

Fig. 298. Guard for Overhead Horizontal Belt.

a wall close to line shafting in motion, as a man working in a cramped position between shafting and wall is especially exposed to danger.

When a man is going to do work on line shafting which is shut down, he should always hang a danger sign on the throttle of the engine or the controller of the motor or the lever of the friction clutch or pulley. On motor driven shafting it is well to have a safety switch at the top of the means of approach to the shafting, which can be opened by anyone working on the shaft.

COUPLINGS, COLLARS, SET SCREWS.

Couplings. Safety couplings requiring no bolts or keys should be used, or couplings should be so made or guarded that no projecting bolt heads and

Work on Shafting. It is best not to place a ladder against shafting in motion on which oiling or other work has to be done, but when this cannot be avoided the ladder can well have hooks at its upper end to hold it on the shaft. It should also have sharp steel points, or other means of preventing slipping, at the bottom, and should be built wider at bottom than at top. It is dangerous to place a ladder against

nuts or key-ways are left exposed. Good styles of couplings are made either with a thickened flange in which the bolts are countersunk or with a rim flange beyond which the fastenings need not project. With each of these care should be taken to keep the bolt heads below the flanges. It is well also to enclose the sides with metal disks. When couplings are near the floor or a wall, it is a good idea to have them entirely enclosed or protected with shields.

Collars. The projecting set screw should be eliminated from all collars, wherever situated. One of the best methods is to countersink the screws, or use a collar with safety flanges high enough to keep the head of a screw from protruding beyond them. A protruding head can be guarded by a rubber protector fitting over it, by a wooden collar with a hole in it for the head, by a metal plate shaped to fit over the screw and sprung around the shaft, or by leather or rubber belting wound around the collar, the screw extending through a hole in the belting at each turn until belting and screw are flush. Headless set screws are now made which thorough tests have proved to be practical, and flat-headed screws, slotted for a screw-driver, are sometimes used for certain kinds of work. There are also safety collars which clamp a shaft without the aid of set screws.

In saw mills set screws in collars are often protected by nailing a 2 x 4 strip of wood to a timber below or at the side of the collar and fastening to it a metal band about four inches wide curved over the screw. When it is necessary to get at the screw the strip can be quickly pulled loose and slid along the shaft out of the way. A couple of taps with a hammer will put the guard back in place.

Set Screws. The revolving set screw is dangerous elsewhere as well as on a shaft, and all set screws on revolving parts of machines should be of safety type, countersunk, or guarded. Machine spindles and chucks can easily be made to hold tools without set screws, and often the headless or slotted head screw can be used on them. When a protruding screw is used, it should be guarded as suggested above.

Key-ways. Open key-ways should always be covered.

BELTS AND PULLEYS.

As woodworking machinery is necessarily driven at a very high rate of speed, belts and pulleys require special attention in the matter of efficient guarding as well as those of equipment and care.

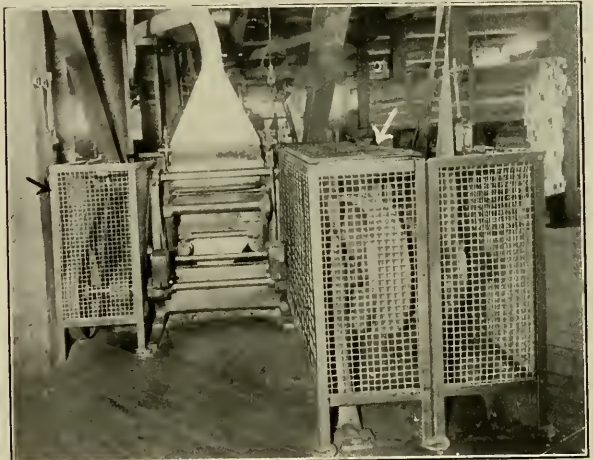

Courtesy of International Harvester Co.

Fig. 299. Planer Belt Guards.

Guarding. All pulleys and belts of woodworking machines need good guarding, because of their great speed, the tendency of floors about them to be slippery, and the frequent crowded conditions due to machines setting close together or material filling up space that otherwise would be open.

Floor countershafts and the belts running from them to machines should be fenced off. Belts coming down from overhead shafting should be encased up to a height of 7 feet from the floor. Belts running in a slanting direction can be guarded by a channel or trough, in which the lower part of the belt runs. The upper part of such a belt can be protected to a sufficient height, when necessary, by an inverted channel. Belts running through a floor should be encased above the floor to a height of at least 7 feet. If the belt is not otherwise protected below the floor, it is a good plan to have a curved board or metal guard, somewhat wider than the pulley, encircle the pulley and extend on the outer sides of the belt to fastenings on the ceiling. All belt holes in floors should be guarded, to prevent workmen stepping through them or tools and material falling through and being caught and thrown. Belts should not lead to machines on an angle when this can be avoided, whether coming up from below or down from above. Such belts are especially dangerous when unguarded, and guarding them takes up much space.

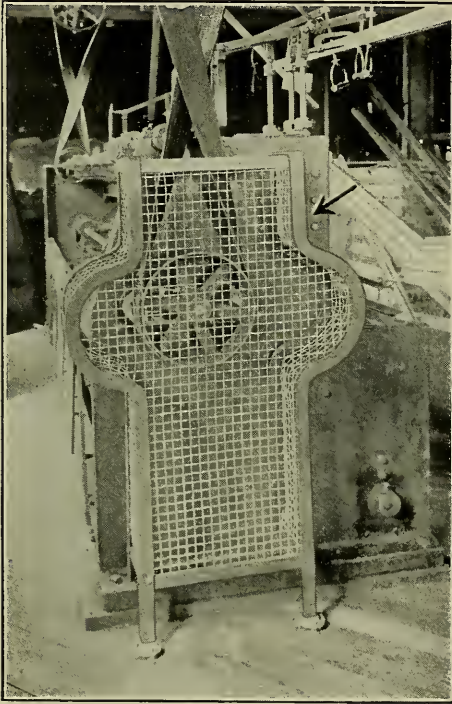

Courtesy of International Harvester Co.

Fig. 300. Guard on Boring Machine.

When a low-lying belt has board guards placed vertically along each side, as is sometimes done, the boards should be wide enough to allow for sagging. When a belt runs horizontally at a height greater than 7 feet above the floor, the under part should run in a channel, preferably of wire mesh, supported from the ceiling and extended at each end up to above the pulley, or a screen or flat board should be placed beneath it.

All low running pulleys should be completely housed and other pulleys near points which ever require to be approached should be fenced. If not housed or fenced, and of the spoke variety, the spokes should be covered with a metal or wooden disk. This disk should be easily detachable to facilitate frequent examination of the pulley for broken spokes or cracks. All friction clutch pulleys should be guarded. They can well be enclosed in metal or mesh casings.

Owing to the fire hazard, guards of wire mesh, expanded metal or wooden slats are preferable to solid housings, as they tend to prevent the accumulation of dust and dirt and other inflammable material. For the same reason it is usually desirable that guards around floor countershafting, etc., do not extend quite down to the floor, so that stuff accumulating at the bottom can easily be swept out. Where the belt or countershaft mechanism is so situated, however, that a stray piece of waste stock or other material might get into it, the guard can well extend close to the floor, having a hinged section for clearing out accumulated rubbish and for access for lubrication, etc.

Belt Shifters, Etc., Every machine not direct driven by an individual motor should have a loose pulley and a belt shifter, or a clutch. A machine direct driven by motor should have its switch within easy reach of its operator.

A belt shifter should be permanent and within easy reach of the operator, and whenever possible it should be so designed that it cannot rest at any intermediate place between having the belt entirely on the loose pulley or absolutely to the extreme limit away from it. The shifter sometimes may well be equipped with an efficient device for locking the belt on the loose pulley only. A home-made shifter is often in such a position that anyone coming near it can easily move it one way or the other.

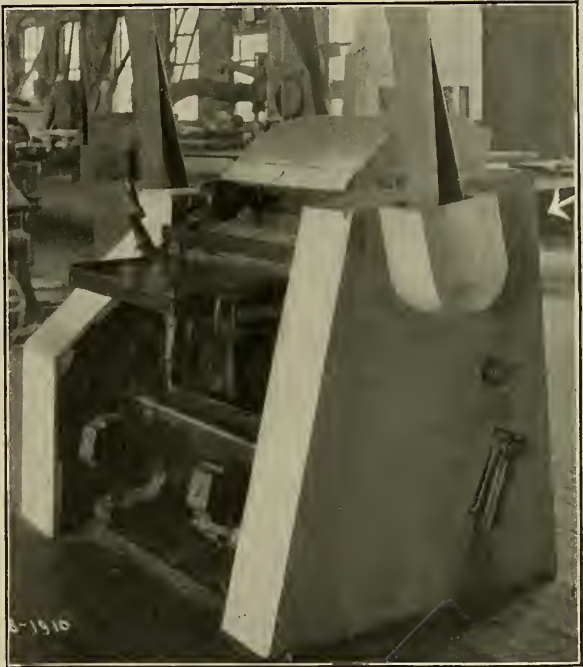

Courtesy of Tennessee Coal & Iron Co.

Fig. 301. Planer Gears and Belts Guarded.

Where no lock or balance weight is used, a man shifting a belt from tight pulley to loose should be careful to see that the belt is well home on the loose pulley, so that it will not slip back and start the machine. Creeping of a belt from loose pulley back to tight is sometimes prevented by having the loose pulley run on a sleeve not revolving with the shaft or spindle, collars on the sleeve preventing end motion of the loose pulley toward the tight one. Sometimes a tight pulley is made a little larger than the loose one, with a slight bevel edge on it. All loose pulleys should be well lubricated.

When a belt persists in slipping from one pulley to another, it is best to go to the root of the trouble, lining up the overhead rigging, leveling the machine and squaring up the pulleys, and seeing that the belt is not strained to

death nor pulled out of shape. If the belt is flexible, will stay straight on the floor when laid out free from a load, and is square at the butt and properly spliced, it can be depended upon.

A belt shifter should be used with cone pulleys, as well as the ordinary kind. There are cone pulley shifters which are practicable for most kinds of work.

Care of Belts. The equipment and care of belts in woodworking plants are very important as they get severe usage, being run at very high speed and often at great tension over small pulleys. Belts should always be of sufficient size to transmit the power, as otherwise the life of the belt will be shortened and it will be a continual source of trouble. It will also become dangerous, as when it works under conditions more straining than those for which it was intended it is liable to part and fly. Belts should have as few lacings or other fastenings as possible, and frequent examination should be made to see that the fastenings are secure and that no parts of them project beyond the belt. Endless belts are the best to use and the whole belt should be of the same width and thickness.

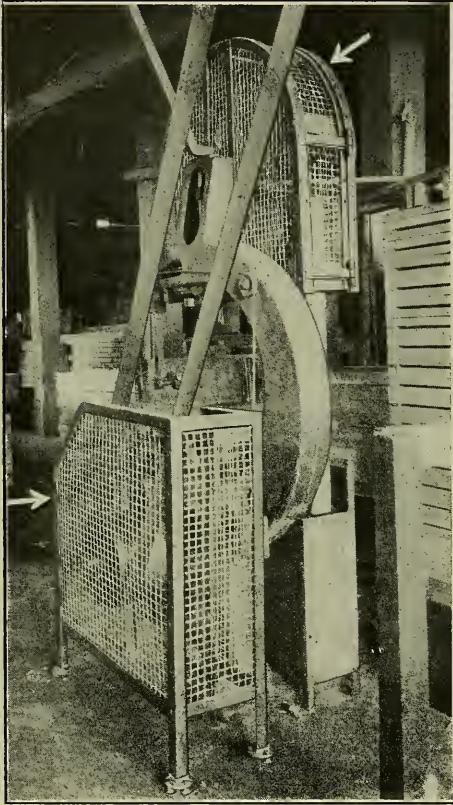

Courtesy of International Harvester Co.

Fig. 302. Band Saw Guards.

of catching on anything. The cemented joint or splice is excellent in its way and with the help of a tightener pulley is kept in tension with ease. Such a joint needs to be very carefully cemented, and the extreme ends of the overlapping belt must be intimately united where the thin section meets the thick one. This is the point where they may pull away when in use, causing an end to project dangerously.

Belts on Overhead Pulleys. Belt placers should be used, when possible, for replacing belts on overhead pulleys. These appliances should be kept in a conspicuous place where they may easily be found. A simple appliance consists of a pole with a coned or straight and smooth spindle secured to the

Endless belts are the best to use and the whole belt should be of the same width and thickness.

Belt fastenings should not be of a character to catch clothing, they should be kept as smooth as possible, and they should not be too close to the edges of the belt. Laces should set close to the belt and have no projecting ends. The ends of the belt should butt close. A gap caused by the lacing slackening and the ends drawing apart is dangerous, both to operator and machine. Metal fastenings should be turned over with a hammer on the points or teeth, so that there will be a minimum chance

end. A belt placer frequently used consists of a pole with a bolt through one end fastened with a nut on either side of the pole to hold it rigid, the head of the bolt being cut off to make it a straight smooth pin. The pole of a belt placer should be about 1 foot shorter than the distance from the pulley to the floor, so that the man using it will have to hold it at his side. A belt should not be placed on or taken off an overhead pulley by hand when avoidable.

A belt should always be placed on the side of the pulley running away from the man placing it. In unshipping a belt it should always be thrown off the driving pulley, not the driven. If a ladder is used for replacing a belt on an overhead pulley, the ladder should be set on the side of the pulley opposite the belt. Another man should be stationed at the bottom of the ladder to prevent its swinging to one side. It is best to have one experienced man to take care of belts and to put them on overhead pulleys and remove them.

When a belt is removed from the driving pulley on shafting, it should never be allowed to hang loosely on the shaft, as the two sides of the belt may come in contact and the resulting friction wrap both around the shaft and then wind the belt around it. There should always be a perch on which to hang the belt, made of strong material and preferably of a shape conforming to the arc of the pulley.

General. When two pulleys are close together, or one is near a hanger, there should be a hook to catch the belt if it should slip off and prevent its wedging or falling on the shaft. If two pulleys are very close together and no such belt rest can be provided, the space between them can be filled up with a wooden pulley of the size of the regular pulleys or of the smaller one of the two. Unguarded belts should be approached with great care. They not only catch clothing easily, but the electricity a belt accumulates may throw anyone touching it off his balance and possibly into danger.

Cast iron pulleys should be tested often with a hammer, and it should be borne in mind that the sound is usually much different if the belt is or is not on the pulley. A common and objectionable practice with pulleys held by compression on a shaft is not to have a close contact at rim. Care should be taken that no dangerous gap is left at this joint. Pulleys with small pieces broken out of the rim are dangerous, both on account of possible contact of clothing with them and through the possibility of wear upon the belt.

Direct individual motor drive will do away with most belting and is advisable wherever possible.



Courtesy of Illinois Steel Co.

Fig. 303. Guard for Electric Switches and Controllers.

GEARS, FRICTIONS, SPROCKETS AND CHAINS.

Gears. All gears should be guarded, no matter what their location. Wherever possible they should be entirely boxed in, by removable or hinged covers if necessary. When very frequent oiling must be done, small hinged openings can be arranged in a cover at requisite points. Gear covers are best made of sheet metal, but wire mesh or wood may sometimes be used.

Where only band metal guards are practicable, the bands should extend far enough around the wheels to prevent anyone getting caught between wheel and guard or any stationary framework. From each edge of the band a metal shield should extend beyond the meshing point. Care should be taken to avoid danger from any projecting set screw, key end or shaft spline, as well as from teeth. The sides of armed gear wheels not wholly encased can well be filled in with disks of metal. Reversible gears should be guarded both top and bottom, if not entirely enclosed. Bevel gears should always be wholly encased.

A nest of small gears, as on sanders, can well be enclosed in one casing, which is removable or can be opened when necessary. When spur gears run partly beneath a floor, and are not boxed, a solid enclosure around the floor opening should extend as high as the rims of the wheels. When a dangerous pinion cannot well be protected by a guard attached to the machine frame or supported from the floor, the meshing point is sometimes guarded by mounting in front of it, and on the same

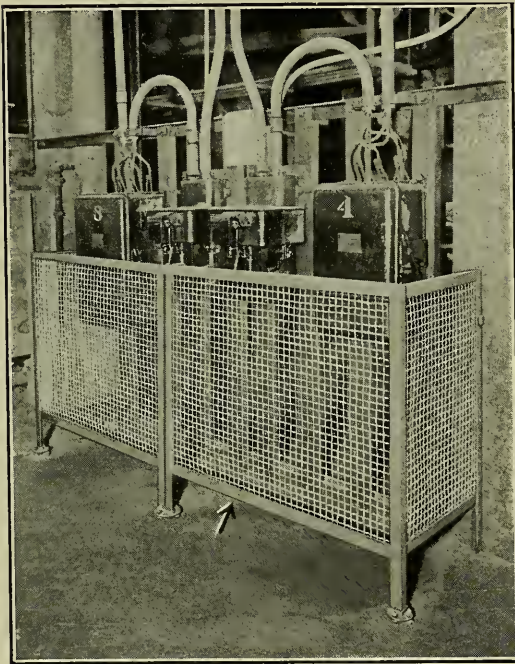

Courtesy of International Harvester Co.

Fig. 304. Guard Around Motor Switch.

spindle, a disk of sheet metal larger than the pinion.

Frictions. All frictions should be guarded, whether near a ceiling or situated low. Friction transmission is as dangerous as gears, as even when not in friction the pinion is running all the time and is very close to the larger pulley. Elevated frictions should be covered on the bottom as well as the sides and ends, and low frictions should be similarly covered on top. All coverings except top ones can well be made of screening or slats, so conditions can be seen at all times. Top covering should be of plate metal or planking, to prevent water from dripping through, or bolts, knots, etc., falling in. Covers should never be removed when frictions are in motion. Arrangements should be made so bearings can be oiled without removing covers. Frictions not

covered should have all projecting bolts protected, by sinking them in a wooden disk fastened to the back or in some other efficient way.

Sprocket Wheels and Chains. All sprocket wheels should be boxed, and wherever possible the entire run of the chain should be boxed or railed off. These wheels and chains are even more dangerous than belts and pulleys. Covers can be hinged, so access to wheel and chain will be easy, and can be made of any material suitable for gear covering. When a sprocket wheel cannot be covered on top, it can at least be entirely boxed elsewhere and the coverings can extend up to the top of the chain. No keys or bolts on sprocket wheels should extend outside of a covering.

ELECTRICAL APPARATUS.

Grounding and Guarding. Frames and bed plates of generating machines, transformer boxes, ladders, and other metallic parts should be jointly and efficiently grounded. It is advisable also to surround such machines with an insulated platform for use by workmen, and they should be fenced off with wood, or some other non-conducting material. All instrument cases, switch mechanism, and oil switch cans should be grounded.

All dangerous parts, such as terminals and connectors, should be located, as far as possible, so a person cannot touch them with his body, his clothing, or a conducting tool. Where this cannot be done, they should be fenced off or efficiently covered, wherever practicable, with non-conducting material. All motors should be thoroughly grounded, and any projecting armature shaft should be covered with a stationary cap.

Switchboards and Switches. Switchboards should be properly insulated and provided with enclosed fuses, and there should be insulated platforms or rubber mats in front of them. It is well to have switches enclosed with swing doors, as shown in Fig. 303 (page 187). Such guards should be grounded. Fig. 304 (page 188) shows a wire mesh guard around a motor switch. Safe disconnecting means should be provided for rendering switchboards and switches "dead" for necessary work. In series arc circuits each individual lamp should have its own absolute cut-out, for rendering the lamp "dead" in case of necessary repairs. It is well also for the workman to wear rubber gloves.

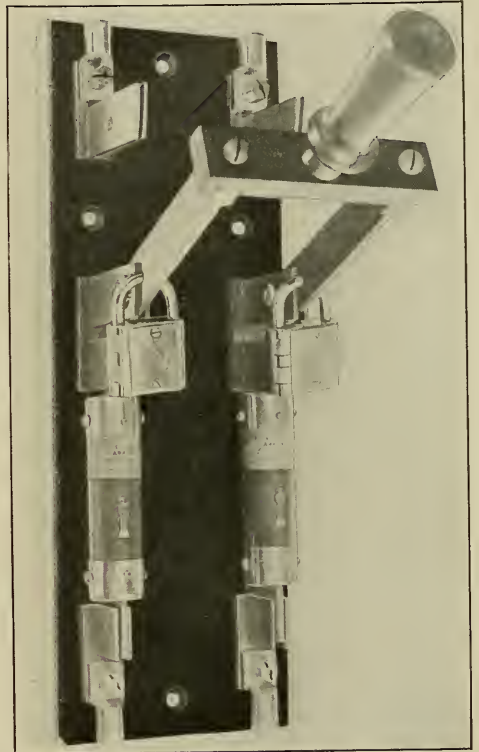

Courtesy of National Tube Co.

Fig. 305. Open Switch Padlocked.

To protect a man working on a line or about a machine, a danger sign should be placed on the controlling switch, preferably by the man doing the work, and removed only by the man placing it. It is a good idea to use a sign which can be locked in place or a safety switch which can be locked.

Fig. 305 (page 189) shows a two pole safety lock knife switch used as a cut-out switch to protect men when working on electric machines. When a man starts to work he places a lock bearing his name in the open switch. Another man starting afterward will also place his lock. This switch cannot be closed until the men have removed the locks, thereby preventing the danger of an unauthorized person closing the switch. The locks are stamped with workmen's names as a means of locating the responsibility of putting the switch in working order when through work.

General. Only persons experienced and competent to handle the apparatus should be allowed in any room where dangerous apparatus or wires are installed. Danger signs should be prominently displayed, in as many languages as may be necessary, in connection with all dangerous apparatus or parts, and with poles carrying high voltage. Emergency outfits for use in case of shock should be kept in places the location of which is known to all employees. Directions for artificial respiration should be posted where they will be frequently seen.

PLATFORMS, STAIRWAYS, LADDERS, FLOORS, DOORS, ETC.

Platforms and Runways. Platforms should be surrounded with substantial double railings at least 3 1-2 feet high, and with a toe board at the base sufficiently high to prevent tools and material from slipping off. Runways should be double railed on both sides and equipped with toe boards.

Railings can well be made of angle iron or pipe. Stairways or stationary ladders should lead to all platforms.

Stairways and Ladders. Stairways should have hand rails on each side, should be kept free from protruding nail heads and splinters, and the treads should be kept in good condition. Rubber strips, renewed when necessary, make good treads. Stationary ladders can well be made of iron. Portable ladders should be of safety type, wider at the bottom to prevent swinging, and should have sharp metal points or wooden or rubber shoes at the bottom. Recessed rubber makes a good shoe for a ladder set on a wet surface in which



Courtesy of International Harvester Co.

Fig. 306. Triangular Ladder with Steel Points at Bottom.

a spike cannot get a grip. A lead-coated base is sometimes used. Ladders should be placed in a slanting position when possible, as a perpendicular ladder is dangerous, and portable ladders should reach two or three feet above the highest point of the place to be reached.

Floors, Doors, Etc. Floors, their aisles, and passageways should be kept free from protruding nails, splinters and broken boards. Holes should be filled up flush with the floor and all projections removed, especially about dangerous machines. Holes left when machines are moved should be carefully plugged. Care should be taken not to load a floor beyond its safe capacity, and aisles and passageways should not be blocked by heaping up material there. Floor openings should be provided with protection trap doors, as shown in Fig. 286 (page 173).

Swinging doors should be provided with windows so large that anyone coming from the other side can easily be seen. These windows should be kept clean, and there should be ample light on each side of the door. When a machine operator has to stand near a swinging door, there should be a stop to prevent its hitting him. Counterweights used on doors should be boxed up. An open pit should be pipe-railed. Truck and wheelbarrow handles should have hand shields.

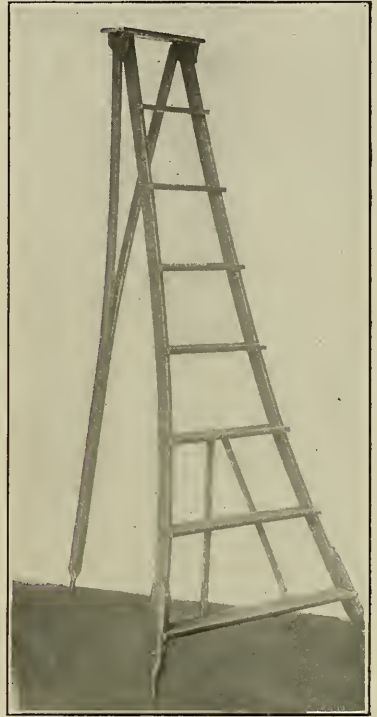

Courtesy of International Harvester Co.
Fig. 307. Safety Oiler's Ladder.

GRINDING WHEELS, ELEVATORS.

Grinding machines should be of heavy, rigid design, set on firm foundations. Grinding wheels should be bought only of responsible makers and of suitable kinds for the work to be done.

Mounting. Wheels should be mounted with safety flanges, covering one-half of the wheel's diameter. If a nut is screwed against the wheel, it is apt to creep and break the wheel. Safety flanges are loaned by many makers of emeries. Flanges should bear against the sides of the wheel near their edges only, leaving plenty of clearance, and should be tightened only enough to hold the wheel firmly. It is advisable to have wheels of over 8 inches in diameter made with a safety taper of 3-8 inch to the foot and mounted with correspondingly concaved flanges. The inside flange should be keyed or pressed on the shaft, never loose. Pulp or rubber washers, a little larger than the flanges, should be placed between the wheel and the flanges, or flanges should be used which have facings of soft metal. Wheels should be mounted on spindles of ample size, and very carefully, so as to run true and steady. A wheel should never be forced on an arbor. It should fit easily, the nuts being screwed against the collar just tight enough to prevent slipping.

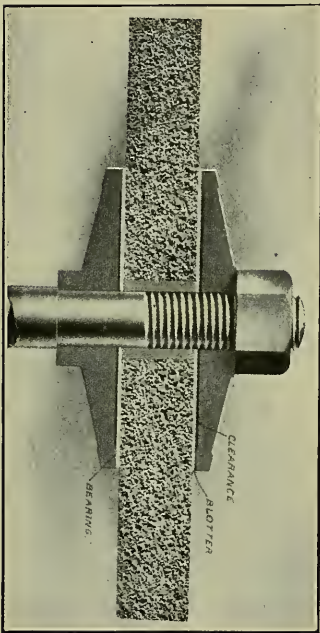

Courtesy of Norton Co.

**Fig. 308. Correct Mounting
of Grinding Wheel.**

pieces if the wheel should burst. To protect the operator's eyes, a leather or rubber spark brush can hang from the hood down to the wheel or a piece of plate glass can be attached to the front of the hood or be supported from the table. As further protection, the operator can wear large glasses, or goggle glasses, and try to avoid standing in the plane of the wheel's rotation.

Such glasses, as well as a steel hood with a leather spark brush hanging from it, are shown in Fig. 309 (page 143). Hoods and plate glass eye shields are shown in Fig. 310 (page 193) and Fig. 311 (page 194). Other hoods are shown in Fig. 312 (page 194) and Fig. 313 (page 195).

Drive belts and pulleys should be well guarded, and a cap should be placed over the end of an arbor and the nut. Good guarding of belts is shown in both Fig. 310 and Fig. 311 (page 194), and the latter shows the end of the arbor protected. Every grinding wheel should be equipped with an efficient belt shifter, within easy reach of the operator in his working position.

Operation and Care.

On each machine should be indicated the revolutions of spindle and the size of the wheel to be run on it. Wheels should never be run above the proper speed indicated by the maker's specifications, and they should be trued frequently. Rests should be kept adjusted close to wheels, to prevent accidents due to work being caught between rest and wheel, or a releasing rest should be used. It is a good plan to have one competent man to mount wheels, true them, adjust the rest and regulate the speed. Belts should be run as slack as possible for the speed desired, so that, if material being ground digs into the wheel, the wheel will be apt to stop instead of breaking.

Every wheel should be examined each morning to see if the bearings are tight and well oiled and the wheel in good condition. Boxes should be kept well babbitted up, so the arbor will not get loose in them, and well oiled to prevent the arbor getting heated and expanding, breaking the wheel. Careful watch should be kept for vibration, and if such occurs the journal should be trued up and the boxes rebabbitted, or the wheel trued, or both.



Courtesy of International Harvester Co.

Fig. 309.. Grinding Wheel Guarded and Glasses for Grinder.

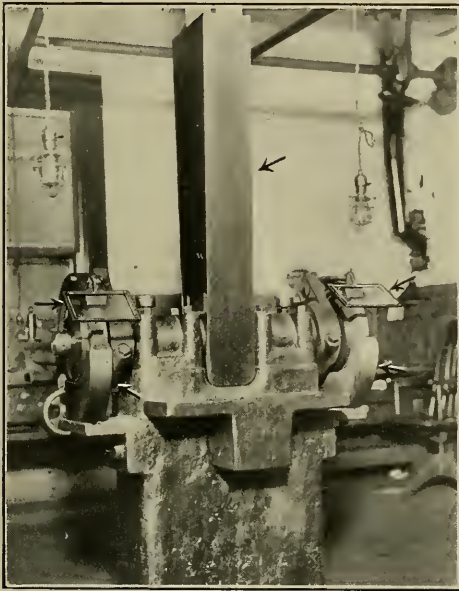

Courtesy of National Tube Co.

Fig. 310. Grinding Wheel Hoods, Eye Shields and Belt Guard.

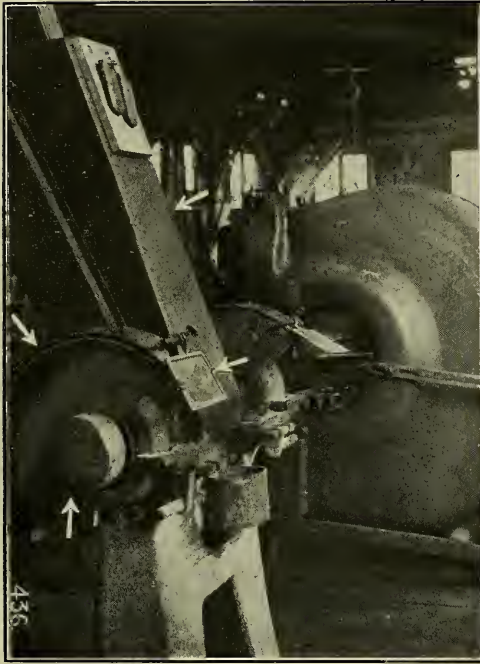

Courtesy of National Tube Co.

Fig. 311. Grinding Wheel Hoods, Eye Shields, Belt Guard and Arbor Cap.

without first being carefully raced. Mounting, racing, and truing up should be done with great care.

Stones should not be used which have been quarried by explosives or which are plainly not of homogeneous formation or have cross veins. Stones should not be stored in wet places or standing on the ground. Stones should be tested frequently by tapping, especially new ones.

Grindstone belts and pulleys should be thoroughly guarded. When a stone is driven by geared motor, the gears should be encased. There should be a fixed rule as regards speed of stones, and no workman should be allowed to exceed this speed. Use of a releasing rest will prevent many injuries due to a workman's hand being caught between a tool he is sharpening and the stone.

ELEVATORS.

General Equipment. Good construction should be used for a factory elevator. Short turns of cable should be avoided. Large drums and sheaves should be used, and as few sheaves as possible. When a drum is keyed on a shaft, the key should not be depended on to hold the drum tight. Set bolts also should be used, and there should be a set bolt in the key to keep it from coming out.

Wheels should be carefully examined and tested before given out to workmen. It is well to have a regular testing pulley. Wheels are sometimes cracked in shipping. The workman also should examine the wheel before using it. Wheels should be kept dry, and should not be stored resting on the ground. Those used in wet grinding should not be left standing in water over night.

Grindstones. Generally speaking, the same safety precautions should be used as in the case of emery and other grinding wheels. Stones should be mounted with metal plates, not wedges, and there should be elastic washers between plates and stone. It is well to have the stone a little thicker at the center, so as to fit into the concave plate. The axle hole should be round. No stone should be mounted

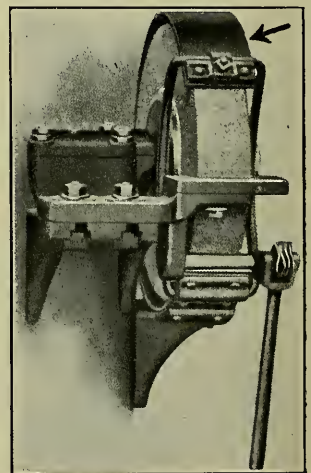

Courtesy of Norton Co.

Fig. 312. Hood for Grinding Wheel.

There should be a substantial grating below overhead timbers for protection against material falling down the shaft. Safe access to overhead sheaves, speed governor, etc., should be provided by stairs or ladder. There should be at least 3 feet clearance at both top and bottom of a hoistway. There should be stop buttons on an operating cable to stop the car at its highest and lowest points of travel. This should be in addition to an automatic limit stop.

Ample light should be provided for all cars and at all landings. The sides of hoistways can well be painted white. Elevators and all apparatus should be thoroughly inspected at least once a week.

Safety Devices. Every elevator should be equipped with an automatic safety device and a speed governor for actuating it. Generally the safety device is best placed under the elevator platform. The speed governor can well be placed on the overhead timbers or supports, and it should be kept properly set. Machines of the winding drum type should be provided with a slack cable device, properly adjusted, which automatically cuts off the power in case the elevator or weights are obstructed in their descent. Safety appliances should be carefully adjusted, kept clean and in good order,

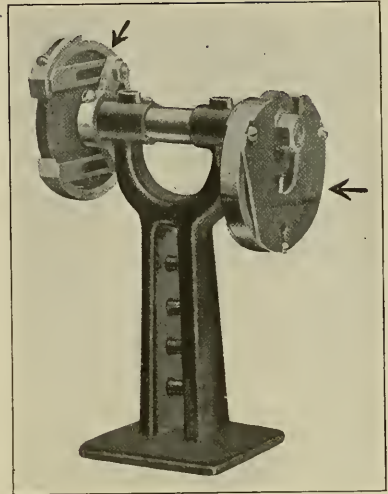

Courtesy of William Stone.

Fig. 313. Hood for Grinding Wheel.

and tested often to see if they are working properly.

Hoistway. A hoistway should be enclosed from floor to ceiling on every floor and also in the basement. At any rate there should be an enclosure to a height of 7 feet above each floor. Hoistways not enclosed in a shaft should have automatic hatch covers at each floor which will open and close as the elevator passes, as shown in Fig. 315 (page 196). Railings or other suitable guards should be placed around such covers to prevent persons walking across them.

Projections in a hoistway should be removed or

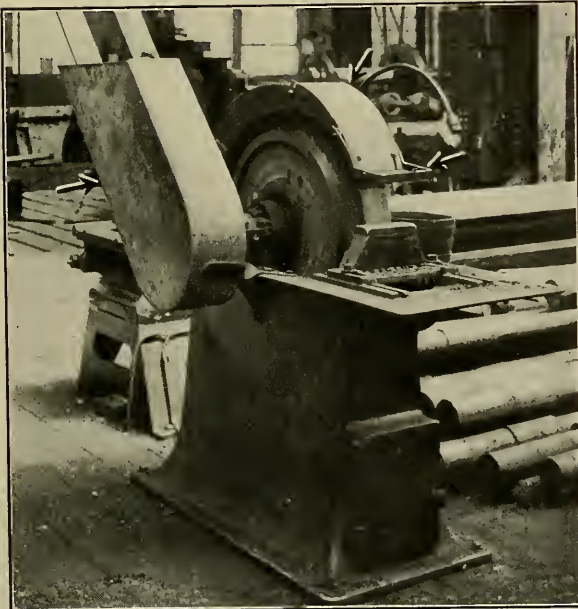

Courtesy of National Tube Co.

Fig. 314. Tool Grinder Guarded.

protected with a bevelled board or piece of sheet metal running down from the projection to the side of the hoistway, so as to push away any part of the body or material coming in contact with it. Open parts of a car or hoistway

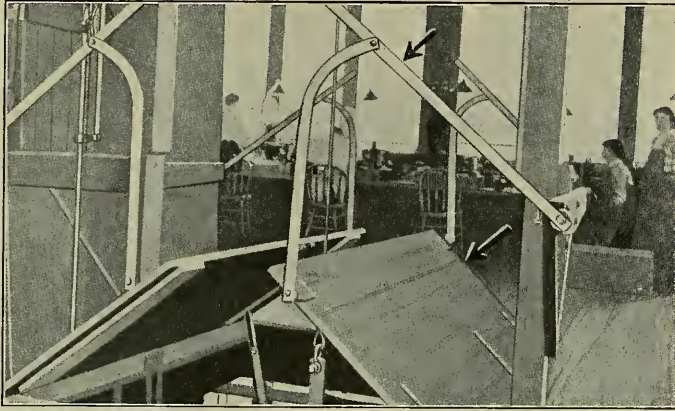

Fig. 315. Automatic Hatch Cover Guard.

near which counterweights run should be protected. The bottom of a hoistway should never be used as a passageway. Stock should not be piled up high near a hoistway. No one should be allowed to work in a hoistway while the car is running.

Car. A car should be guarded

on the sides, and if possible at the back, to a height sufficient to prevent anyone leaning over and getting hurt.

This requirement is imperative when the car runs in a hoistway wholly or partially open. A car should be roofed over with a screen or other covering, which can be hinged if necessary so that half can be swung up when long material is carried. When more than one side of an elevator is used for loading or unloading, the part not in use should always be guarded by a wide bar hinged at one end and fitting into a socket at the other.

Gates. Safety gates should be used at all entrances to an elevator, not excepting the basement. A door that swings open or a bar or a chain is not a safe type of guard. The gate should be of rising and falling, rather than horizontally sliding type. It should be so high that no one can lean over it, and the bottom should come down to the floor.

If slats are used, they should be so close together that no one can put his head through the gate, and the bottom should be fenced up with screening to a height of one foot, as shown in Fig. 317 (page 197). If clearance is not



Courtesy of Westinghouse Electric & Mfg. Co.

Fig. 316. Elevator Screened on Sides and Top.

sufficient for a high gate, a telescopic or collapsible gate can be used. When a gate cannot be made of sufficient height to prevent anyone leaning over it, it should be set back 8 to 12 inches from the edge of the floor, to give room for a car to pass without acting as a shear for any part of a man leaning over the gate. Gates that can be seen through, such as wire mesh ones, are preferable to solid ones. The semi-automatic gate is safer than the full automatic, as it is not disturbed by the passage of the car. When fire doors only are used at entrances into hoistways, they should be made self-closing. This can be arranged by having the upper half of the door a little heavier than the bottom half. An attachment can be provided on the car to hold the door open when the car is at the landing.

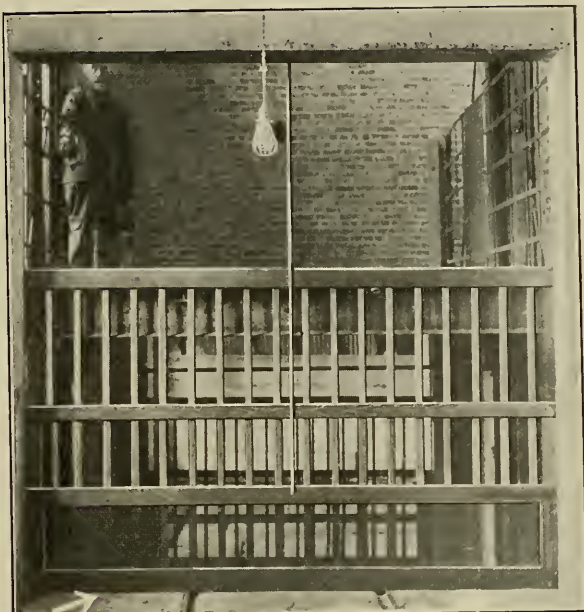

Courtesy of International Harvester Co.

Fig. 317. Elevator Gate Screened at Bottom.

when the car is at the landing.

Cables. There should be at least two cables for the car and two for each set of counterweights. Hoisting cables should have at least two turns around the drum when the car is at the bottom of the hoistway, and back drum counterweight cables should have two turns around the drum when the car is at the top of the hoistway.

Cables should be watched carefully and kept in the best of condition. They should be thoroughly lubricated, but not so thickly coated as to interfere with easy examination. A wire cable should not be used when the wires (not the strands) commence to crack. No wire hoisting cable should ever be spliced. In replacing worn cables great care should be given to the fastenings. Drum counterweight



Courtesy of Westinghouse Electric & Mfg. Co.

Fig. 318. Wire Screen Elevator Gate.

cables running through, or passing by, car counterweights should have a suitable covering to prevent chafing and wear.

Counterweights. Counterweights should be hung in guides and the guideways should extend far enough up at the top to prevent the weights coming out when the elevator is at the bottom of the hoistway. Guideways should be guarded so that the weights cannot strike anyone. For at least 15 feet down from the overhead timbers they should be guarded with sheet metal, so the weights can't pull out, and it is best to carry this protection all the way down. Counterweights running outside of a hoistway should be boxed their full run,

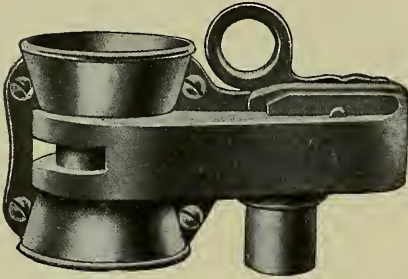

Courtesy of L. Christiansen.

Fig. 319. Elevator Safety Lock.

with a hinged door at each floor to permit examination of cables. Counterweights for gates should be outside of the hoistway and boxed up. The drum counterweights should not be placed above the car counterweights. Counterweights should be properly strapped and bolted together.

Locking. An efficient locking arrangement for the operating device should be provided and the operator should be required to lock the hand rope or lever on leaving the car. The hand rope or lever should also be securely locked while repair work is being done or while the elevator is being used at a landing. A simple locking device for a hand rope is a hook into which the part of the cable between the button stops can be swung. This hook can be fastened to the car itself, if enclosed, or to the hatch covers.

Warnings. A gong should be sounded while a car is moving. Telltails, in the form of pendant chains a few inches apart, should hang down at least five feet below the entrance edge of a car. A sign showing the lifting capacity should be placed conspicuously in each car and at each entrance to the hoistway. A sign reading "Don't lean over gate" should be placed at each hoistway entrance.

Operating. Operation of a freight elevator should be confined to certain specified and competent men, if possible to one operator. Boys should not be allowed to operate cars. No one should be allowed to ride on a car except operators and workmen with loads. Jumping on or off a car when in motion should be prohibited.

A car should be started and stopped carefully. Before starting his car, an operator should see that the entrance is closed and that his load and any persons on board are in safe positions. An elevator should never be loaded beyond its maximum carrying capacity. Trucks and material should not be allowed to remain on a car. An operating lever can well be

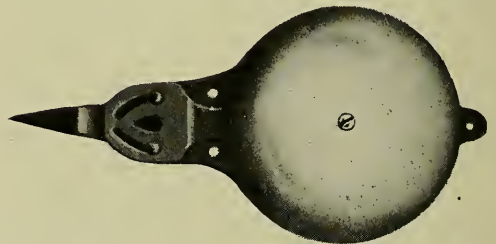

Courtesy of L. Christiansen.

Fig. 320. Elevator Gong.

surrounded by a sheet metal guard. When an elevator is operated from the floor, and not by an operator, fixed signals should be provided.

Carriage Hoists. Special care should be taken of cables of a back guide carriage hoist, as if one cable should break the platform would tip. A hand power elevator should never have the rope operated by an electric motor or other mechanical power, as there are no automatic stops at the top and bottom landings and no safety device on the car.

Outside Hoists. These hoists can well be completely enclosed, as is sometimes done with corrugated iron. Two sides of the platform should certainly be enclosed. Unless a permanent operator is provided, and he does not assist in loading or unloading, there should be a locking device which will compel persons to go to the elevator when wishing to use it.

LIABILITY INSURANCE

What it covers

Why you need it

Who furnishes the best

Where to get it

WHAT IT DOES

ÆTNA Liability Insurance affords to its holders protection against financial loss, and relief from annoyance and anxiety, on account of injuries accidentally sustained by any person for which they are alleged to be liable.

WHY YOU NEED IT

All employers of labor, owners or lessees of property, or owners of horses and vehicles may be held liable for such injuries. They and, in fact, all business men will find it for their interest to read carefully these pages in which the advantages of the liability insurance furnished by the ÆTNA are briefly outlined.

THE FIRST CONSIDERATION

DURATION OF PROTECTION

In placing liability insurance the first consideration is to be assured that you are obtaining the protection for which you pay. Claims for damages on account of personal injuries may, and frequently do, *arise years after the occurrence of an accident.*

STABILITY

In buying a liability policy, therefore, you should, in the first place, be satisfied beyond a question of doubt that the company issuing the policy will be able, if called upon, to pay losses thereunder many years hence.

The great financial strength of the ÆTNA LIFE INSURANCE COMPANY is an absolute guarantee for the payment of claims under its contracts *whenever they mature.*

SCOPE OF THE INSURANCE

No less important than this matter of security is that of the quality and quantity of the protection furnished. The ÆTNA Liability Policies are the most comprehensive ever issued. Where other companies agree to indemnify only against loss from, or by reason of, the liability imposed by law, *the ÆTNA insures against loss and expense arising or resulting from claims*, regardless of whether liability exists or not. That is to say, the ÆTNA policies afford complete protection against any and all claims brought by persons injured, or by or in behalf of their beneficiaries, while the policies of many other companies cover only such claims as upon trial are found to have a legal basis. The latter do not, if the companies so elect, cover the multitude of claims, with their attendant expenses, which have no merit in law. It is unnecessary to comment further upon this point, or to mention other features of the ÆTNA policies, in order to show their superior value to the Assured. It is enough to say that the policies, their interpretation, and the Company's service generally, are on the same broad scale of liberality and fair treatment.

**ÆTNA
POLICIES
PROTECT**

**CLAIMS
COVERED**

GENERAL REMARKS

An ÆTNA Liability Policy provides that *the Assured shall report every accident to the Company*. Where indemnity is or may be applied for, the Company, by competent inspectors, thoroughly investigates the circumstances relating to the case. If these indicate liability on the part of the Assured, immediate steps are taken with a view to *settlement without litigation*. Should, however, legal proceedings be taken, the Company undertakes, by able counsel, the *defense of the suit on the Assured's behalf*, relieves him from all trouble and responsibility, defrays expenses of litigation and, up to the limit named in the policy under which the accident is reported, pays damages which may be awarded.

**REPORTING
ACCIDENTS**

**COMPANY
DEFENDS**

The usual limits of liability undertaken are:

In event of an accident causing the death or injury of one person, \$10,000.

**USUAL
LIMITS**

In event of an accident causing the death or injury of several persons, \$20,000.

Payment of an additional premium will increase these limits, if desired.

The policies do not lapse upon these limits being reached, but continue their warranty to pay within such limits every accident that may take place during the policy year, whether few or many.

WOODWORKING SAFEGUARDS

SAVE BOTH MONEY AND WORRY

The Liability Policies of the ÆTNA LIFE INSURANCE COMPANY protect the Assured not only from monetary damage, but also from loss of time and the annoyance and anxiety involved in claims and suits. They fix and reduce to a minimum liabilities and expenses in the conduct of business which, if not properly provided for, frequently result in financial disaster.

INSPECTION SERVICE

INSPECTIONS

One of the most valuable features of the service which the ÆTNA LIFE gives its liability policyholders is found in its inspections. These are made by trained experts, who bring to their work the varied knowledge gained by a wide range of experience. The ÆTNA inspectors not only point out dangerous conditions, but recommend safeguards for them or suggest safer methods of doing work for which no safeguards are practicable. ÆTNA inspections not only prevent many accidents, but they tend to increase the general industrial efficiency of a plant.

KINDS OF POLICIES

CASUALTY LINES

The ÆTNA LIFE INSURANCE COMPANY issues liability policies covering:

- Employers' Liability
- Public Liability (Direct)
- Public Liability (Contingent)
- Elevator Liability
- General, or Landlords' Liability
- Teams Liability
- Automobile Liability
- Workmen's Compensation

The ÆTNA ACCIDENT AND LIABILITY COMPANY writes.

- Vehicle Property Damage
- Automobile Collision
- Burglary
- Plate Glass
- Flywheel
- Sprinkler Leakage
- Fidelity Bonds
- Surety Bonds

WORKMEN'S COMPENSATION

In States where Workmen's Compensation, whether optional or otherwise, is provided by statute, the ÆTNA LIFE INSURANCE COMPANY issues policies covering such liability. As in the case of its liability policies proper, this insurance relieves its holder of all worry and trouble connected with accidents to his employees, and it indemnifies him for any compensation which he may be called upon to pay to them.

**COMPENSA-
TION**

INDEX

	PAGE		PAGE
ACCIDENTS, investigation of,	7		
ÆTNA LIABILITY INSURANCE,	200		
AIR COMPRESSOR:			
flywheel,	179		
for spoke driver,	143		
AIR JET,	11		
AIR PUMP:			
flywheel,	179		
ARTIFICIAL RESPIRATION,	190		
ASHES, disposal of,	13		
AUTOMOBILES,	146		
AXES:			
in felling,	16		
in shingle mill,	57		
AXLE MACHINES,	144		
BABBITTING, careful doing of,	10		
BANDAGE MATERIALS,	13		
BAND MILL:			
care in operation,	28		
guide, adjustment of,	28		
housing of,	27		
housing lower part,	46		
rock saw, guarding,	28		
saws, use of,	29		
shield for sawyer and lever,	27		
short side mill,	29		
vener mill,	156		
whistle when starting up or shut- ting down,	28		
BASKETS:			
automatic one-piece machine,	169		
bottom machine,	170		
stapling,	169		
strip cutting machine,	169		
transmission,	171		
BELTS:			
care of,	186		
of drag saw,	133		
elimination by motor drive,	12		
of engines,	178		
of engine governor,	179		
fastenings,	186		
of log haul machine,	23		
of mortisers,	129		
perches for,	187		
placing on overhead pulley,	186, 187		
in saw mill, screening of,	21		
slipping of,	185		
of swing saws,	88		
of swing trims,	36		
wedging,	187		
BELTS AND PULLEYS,	183		
of band saw feed works,	100		
of borer spindle,	127, 128		
BELTS AND PULLEYS:			
of dowel machine,	168		
of drop saw trimmers,	33		
of edgers,	32		
of equalizers,	85		
of grinding wheels,	193		
of grindstones,	194		
of knee bolter,	57		
of lath bolter,	54		
of lathes,	143		
mesh or slats guards preferable,	185		
of panel raisers,	66		
of pole machines,	146		
of rod machines,	159		
of sanders,	121, 123		
in saw mill filing room,	47		
in saw mill transmission floor,	44, 45		
of shapers,	120		
in shingle mill,	57		
of sizers, moulders, etc.,	62		
of surfacers,	126, 164		
of veneer dryers,	157		
of veneer rotary cutters,	154		
BELT PLACERS,	186		
BELT SHIFTERS,	10, 185		
for grinding wheels,	193		
for planing mill machines,	63		
for shapers,	120		
for surfacers,	126		
for swing saws,	89		
for swing trims,	37		
BIG TIMBER PLANER,	63		
BILLET MILL,	136, 138		
BLACKSMITH SHOP, in saw mill,	47		
BLIND SLAT MACHINES,	67		
BLOWER HOODS:			
for band saws,	100		
for big timber planer,	63		
for circular resaw,	66		
for lathes,	140, 141, 142		
for panel sanders,	66		
for rip saws,	75		
for rounding machines,	170		
for sash dovetailers,	67		
for self-feed saws,	79		
for sizers, moulders, etc.,	62		
for spoke facers,	144		
for spoke throaters,	144		
for stickers,	63		
for tenoners,	130, 131, 132		
BLOWER SYSTEM:			
for cleanliness,	12		
for guarding,	12		
as preventative of fire,	12		
BOBBINS:			
boring and reaming machine,	170		
disc dividing saw,	170		

	PAGE		PAGE
BOBBINS :		BRUSHES,	170
grooving machine,	170	transmission,	171
transmission,	171	BUCKERS,	16
BOILERS :		BULL CHAIN :	
blow-off pipes and valves,	174	care of brackets,	22
care of,	172	covering return part,	22
chains for main stop valves,	175	BUMPERS, for saw mill carriage,	24
cleaning,	175	BURNER,	51
cutting into header,	174	BUZZ PLANER, see Jointer.	
expert inspection,	172		
feed,	174	CABINET SHOP :	
firing up,	173	surfacers,	125
fusible plug,	173	tenoners,	129
gauge glasses,	172, 174	CABLES :	
goggles, use of,	175	of cranes in saw mill yard,	50
high and low water alarm,	173	of derricks,	132
keeping room clean,	172	of dry kiln doors,	134
lighting room,	172	of elevators,	197
locking header valve wheel,	176	in logging,	16, 17
low water,	172	of log hauls,	22
non-return valves,	175	across railroad tracks,	51
overflow tank,	174	of vincer steaming box doors,	133
pipe lines and pipes,	175	CABLEWAY YARDER,	19
rules for tenders,	172	CALKS, for fallers' shoes,	16
runways,	175	CAMPS, logging,	14, 15
safety valve,	172, 173, 174	CANTER :	
of saw mill,	43	care of,	24
sewers or hot-wells,	175	guarding of,	24
steam gauge,	172, 173, 175	CANT-HOOKS,	24
of yarding engines,	16, 17	CAREFULNESS, necessary to prevent	
BOLTER SAWS, see Saws (Bolter).		many accidents,	7
BORERS :		CAR MAKING,	146
counterweights and springs,	128	surfacers,	125
guard for hands,	128	tenoners,	129
holding work,	128	CARPENTER SHOP, surfacers,	125
multiple borers,	127	CARRIAGE (FEEDING) :	
set screw in chuck,	127, 128	of bolter saws,	83
spindle collar set screws,	128	of equalizing saws,	85
spindle gears or belt,	127	of hand-feed split table saw,	137
transmission,	135	of handle blank saw,	137
BOTTOM MACHINES, for baskets,	170	of horizontal shingle saw,	58
BOX FACTORY :		of knee bolter,	57
box board matcher,	166	of shingle mill cut-off saw,	57
cut-off saws,	165	of tenoners,	130
disk sanders,	123	of upright shingle saw,	59
equalizing saws,	85	CARRIAGE (SAW MILL) :	
feeding apparatus,	165	dangers of,	24, 25, 26
horizontal band resaw,	167	deck,	25
jointer and edger,	166	feed, lost motion,	25
nailing machines,	166	gears, couplings, frictions,	26
off-bearers,	166	head blocks,	25
piling,	167	hook and link for locking,	24
printing presses,	167	lock for feed lever,	25
rip saws,	164	nigger, operation of,	26
rough stock,	136	operation of,	26
self-feed edger,	165	run,	25
sizing machine,	166	sheaves,	25
surfacers,	125	spring bumpers or air cushions,	24
transmission,	171	throttle connection for shutting off	
waste holes,	167	steam,	24
yard,	167	valve arrangements,	24
BOYS :		CARRIERS, of equalizers,	84
in lath mill,	55	CARS :	
running dangerous machines,	8	in dry kilns,	134
BRIDGE BUILDING, surfacers,	125	of logging railroad,	15
BRIDGES :		in logging, loading and unloading,	17, 19
over live rolls,	42	in saw mill yard, loading,	49
over slab slasher chains,	39	railroad, care of,	52
BROKEN BELT STOP, for engine gov-			
ernor,	179		

	PAGE		PAGE
CARS (ELEVATOR), enclosing and roof- ing,	196	COOPERAGE:	
CARVERS,	159	transmission,	150
CAUTION:		trussing machines,	150
habits of,	8	vats,	150
in saw mill work,	21	windlass,	150
of sawyer in saw mill,	21, 24, 26, 28	CO-OPERATION:	
signs urging,	10	of foremen and workmen,	7, 8
CENTRAL AUTHORITY, for inspection and care,	10	of workmen,	8
CHAINS:		COUNTERSHAFTS,	184
in logging,	14, 15, 16, 18	of shapers,	120
of log haul,	22	of sizers, moulders, etc.,	62
in saw mill,	47	COUNTERWEIGHTS:	
veneer,	157	of borers,	188
CHAIRS,	158	of doors,	191
back knife lathe,	142	of elevators,	198
carvers,	159	in saw mill,	21, 46
double saw and chuck machine,	159	of swing saws,	86
endless bed feed sander,	123	of swing trims,	36
finishing room,	160	of veneer steaming box doors,	153
heading machine,	159	COUPLINGS,	182
rod machines,	159	of live roll shafts,	41
surfacers,	125	on saw mill carriage,	26
tenoners,	129	in saw mill filing room,	47
transmission,	160	in saw mill transmission floor,	44, 45
CHUTES, in saw mill,	21	CRANE:	
CIRCULAR MILL:		for loading logs,	18
guide, adjustment of,	27	in saw mill yard,	50
housing lower part,	46	CROSS ARMS:	
inserted teeth,	27	rounding planer,	170
lever, locking,	27	transmission,	171
saw, guarding,	26	CROSSINGS, of saw mill yard railroad,	51
shielding sawyer and lever,	26	CROZERS,	149
wedge wheel or splitter,	26	CURTAIN POLES:	
CLEANING:		lathes,	142
of boilers,	175	rod machines,	159
of machines,	10, 11	CUTTERS:	
CLEANLINESS,	9	care of,	10
CLIPPER, veneer,	154	of jointers,	109
CLOTHING,	11	of lathes,	140, 141
CLUTCH:		of planing mill machines,	64
for slasher and trimmer chains,	39	setting of,	11
on shafting,	182	of shapers,	118, 120
COLLARS,	183	of shingle mill jointer,	60
COMMITTEES, safety inspection,	8	supply of,	10
CONVEYORS:		of surfacers,	127
in planing mill,	68	of tenoners,	129, 130, 131, 132
in saw mill,	21, 46, 51	DADOING,	68
in shingle mill,	56	DAMS,	176, 177
COOPERAGE:		DEAD ROLLS, of saw mill slide,	48
barrel hoist,	150	DEAF PERSONS, employment of,	8
bolter saws,	82	DECK:	
bung borer,	128	care of,	23
crozers,	149	canter,	24
edging saws,	149	cant-hooks,	23
equalizing saws,	84	caution on part of sawyer or scaler,	24
heading jointers,	147	dangers of work,	23
heading planers,	148	selection of workmen,	24
heading rounders,	148	skids of railroad iron,	23
heading saws,	147	DERRICKS:	
hoop machines,	150	blocks,	132
pail trimming lathe,	148	cables,	132
punches,	150	erection,	132
punching and flaring machines,	150	guy wires,	132, 133
rough stock,	136	hand-power,	133
stave bending machines,	150	hoisting to top of mast pole,	133
stave jointers,	147	hooks,	132
stave planers,	148	ladder for mast pole,	133
stave sawing machine,	146	material of,	132
		posts,	133

	PAGE		PAGE
DERRICKS :		ELEVATORS :	
ratchet stop for,	133	cars, enclosing and roofing,	196
throttle valve,	133	construction,	194
DESK FACTORY,	158	counterweights,	198
DISCIPLINE,	7	enclosing lever,	198
DOGGERs, dangers of,	24, 26	gates,	196
DOGS :		grating below overhead timbers,	195
for lath bolter,	54	hoistway, clearance at top and	
on rip saw guards,	72, 73, 76	bottom,	195
DOORS,	191	hoistway, enclosing,	195
over band mill,	47	inspection of,	195
of dry kilns,	135	light for,	195
opening and fastening,	12	locking operating device,	198
of veneer steaming boxes,	153	operating,	198
DOVETAILERS,	67	outside hoists,	199
gang machine,	158	safety device,	195
DOWEL MACHINES,	68, 164, 168	signs,	198
DRAG SAW :		slack cable device,	195
adjusting,	133	speed governor,	195
belts, gears and set screws,	133	stop buttons,	195
in billet mill,	137	warning chains,	198
fencing machine,	133	warning gong,	198
fencing run,	134	EMERGENCY ROOM,	13
short ends,	134	EMERY WHEELS, see Grinding Wheels.	
signs,	134	ENGINES :	
transmission,	135	automatic lubrication,	178
trip,	133	automatic speed limit stop,	177
DRILL PRESSES :		belts,	178
in logging machine shop,	15	care of,	178
in saw mill machine shop,	47	cleaning moving parts,	178
DRIP PANS, for oil,	13	crank pit,	179
DRIVING, in logging,	20	crank shaft,	179
DROP SAW TRIMMERS, see Trimmers.		connecting rod,	179
DRYERS, for veneer,	157	cross-head,	179
DRY KILNS :		drive belt,	179
doors, balancing,	135	exhaust pipes,	180
doors, cables,	134	floor openings,	179
doors, counterweights,	134	flywheels,	178, 179, 180
fans,	134	gears, shafts, keys,	180
flooring pit,	134	governor,	177, 179
moving cars in,	134	lighting and cleanliness,	177
piling material,	134	in logging, donkey,	16
runways and tramways, railing,	134	in logging, road,	17
DUST BRUSH, at machines,	11	in logging, yarder,	16
DUST, inhaling of,	12	pipes and cylinders,	180
DUTCH OVENS,	176	runways, stairways and ladders,	180
EDGERS :		in saw mill,	43, 47
box board, for wagons,	143	separators, steam reservoirs and	
for box shooks,	165	drop-legs,	181
care in operation,	30, 31	sewers or catch-basins,	180
dangers of,	29	signal when starting,	178
dog guard,	30	steam gauge,	181
driving apparatus,	32	stop buttons,	177
filing saws with hook,	31	trap doors,	179
finger guards,	29	turning off center,	181
flyback guards,	30	warning signs,	178
plank front guard,	30	EPILEPTICS, employment of,	8
pressure rolls,	29	EQUALIZING SAWS, see Saws (Equalizing).	
short lever edger,	31	EXCELSIOR FACTORY, equalizing saws,	83
swinging roll guards,	30	EXITS,	12
ELECTRICAL APPARATUS :		EXPLOSIVES :	
artificial respiration,	190	in logging,	14
grounding and guarding,	189	storage and use,	13
signs,	190	FALLERS,	16
switchboards and switches,	189	FEED ROLLS :	
ELEVATORS :		of box shook edger,	165
access to overhead sheaves,	195	of lath machine,	54
cables,	197	of outside moulders,	63
carriage hoist,	199	of panel raisers,	66

	PAGE		PAGE
FEED ROLLS:		GANG SAWS:	
of resaws,	65	guarding of,	32
of rod machines,	159	locking machinery,	33
of rounding machines,	141	GATES:	
of sanders,	121, 124	for elevators,	196
sectional for sizers, moulders, etc.,	62	in saw mill yard,	52
sectional for surfacers,	126	GAUGE GLASSES,	174, 175
of surfacers,	126	light about,	172
FEEDING APPARATUS:		GEARS,	188
for box factory rip saws,	165	of borer spindle,	127
for equalizing saws,	85	of cranes,	50
FEEDING TABLES,	10	of drag saw,	133
FELLING,	16	of dowel machines,	168
FELLOES:		of edgers,	32
borers,	129	of gang saws,	32
planing machines,	145	of grindstones,	194
sanding drums,	124	in engine room,	180
FENDERS, for saw mill yard locomotives,	52	of lath bolter,	54
FILING ROOM, in saw mill,	47	of lath machine,	54
FINISHING ROOM,	160	of live rolls,	41
FIRE:		of log haul machine,	23
escapes,	12	of sanders,	123
hazard reduced by cleanliness,	9	of saw mill carriage,	26
precautions against,	12	in saw mill filing room,	47
FIRST AID,	13	in saw mill machine shop,	47
FLAG STICKS, rod machine,	159	of saw mill transmission,	44, 45
FLASH BOARDS,	176	of shafting,	182
FLOORS,	191	of sizers, moulders, etc.,	62
cleaning of,	9	of surfacers,	126
for dry kiln pit,	134	of turbines,	177
about knee bolter,	57	of veneer dryers,	157
in lath mill,	55	of veneer glue machine,	157
in saw mill,	21, 47	of veneer rotary cutter,	153
for saw mill carriage,	25	of water wheels,	177
FLOOR SWEEPERS,	9	GIN POLE:	
FLYWHEEL:		at roll-way,	18
of air compressor,	179	in saw mill yard,	50
of air pump,	179	of skidders,	18
of engine,	178	GLASSES, for grinders,	192
of turbine generator,	177	GLOVES:	
FOREBAY,	176	avoiding use of,	11
FOREMEN:		in edger work,	31
duties of,	7	in jointer work,	108
inspection for fire,	12	in rip saw work,	92
selection of,	7	in shaper work,	119
FRICTIONS,	188	in shingle mill jointer work,	60
of log haul machines,	23	GLUE MACHINE, in veneer work,	157
in saw mill,	45	GOGGLE GLASSES, for grinders,	192
of saw mill carriage,	26	GOGGLES, for boiler tenders,	175
FROGS, blocking,	51	GONG, for elevators,	198
FURNITURE:		GOVERNOR:	
back knife lathe,	142	for engines,	177, 179
carvers,	159	for elevators,	195
disk sanders,	123	GRINDING WHEELS:	
dovetailing machines,	158	belts and pulleys,	193
endless bed feed sander,	123	belt shifter,	193
finishing room,	160	capping arbor,	193
grooving saws,	158	eye shields,	192
miter saw,	158	guarding of,	192
moulding sander,	125	in logging machine shop,	15
pony planer,	126	mounting,	192
surfacers,	125	operation and care,	193
tenoners,	129, 130, 159	in saw mill filing room,	47
transmission,	160	storage,	194
turning machine,	140	testing,	194
veneer cutter,	160	GRINDSTONES:	
FUSIBLE PLUG, for boilers,	173	driving apparatus,	194
GANG RIPPING MACHINE,	65	mounting, racing and truing up,	194
		selection of,	194

	PAGE		PAGE
GRINDSTONES:		HOOKS:	
storage,	194	in saw mill yard,	50
GROOVING:		in veneer work,	157
with circular saws,	77	HOOPS:	
on shapers,	112	automatic cutting machines,	150
GUARD RAILS, blocking,	51	bar chuck pointing machine,	150
GUIDE:		planers,	150
of band mill,	28	pointing machines,	150
of circular mill,	27	vats,	150
of jointers,	109	HORIZONTAL BAND RESAW:	
of lath bolter,	54	in box factory,	167
of rip saws,	90	dangers of,	39
of shapers,	112	hood and apron guards,	40
GUY WIRES:		housing,	39
of derricks,	132, 133	HORSES, in saw mill yard,	50
of logging gin pole,	18	HUBS:	
of skidders,	18	cut-off machine,	145
HAMMERS, in felling,	16	equalizers,	85
HAMMERS (DROP), in saw mill,	48	reamers,	145
HAMMERS (STEAM), in saw mill,	48	turning machines,	145
HANDLES:		ICF ROAD, in logging,	20
automatic lathes,	142	INFLAMMABLE SUBSTANCES AND	
blank saw,	137	LIQUIDS, storage and use,	13
block saw,	137, 138	INJURED:	
chucking and tenoning machines,	139	care of,	13
D handle jointing and backing machines,	138	first aid for,	13
D handle shaping and finishing machines,	138	INSERTED TEETH:	
equalizing saws,	85	of circular mill,	27
ferrule seat shaping and boring machines,	138	of knee bolter,	57
header or smoother machine,	138	INSPECTION:	
plow handle shapers,	138	Ætna Liability,	202
rough stock,	136	of boilers,	172
rounding machines,	141	for fire,	12
swinging head lathes,	140	of machinery and structures,	10
tenoners,	129	of safeguards,	10
thread cutting machines,	138	INSTRUCTION, of workmen,	7
throating machine,	138	INTOXICATED PERSONS,	7
transmission,	150	ISOLATION, of dangerous machines,	8
HATCH COVERS, automatic, for elevators,	195	JAMS, in logging,	20
HAULING, in saw mill yard,	49	JOINTER:	
HEAD BLOCKS, extensions for,	25	aluminum guard,	103
HEADER OR SMOOTHER MACHINE,	138	automatic face planing machine,	106
HEADING:		automatic feed machines,	106
jointers,	147	automatic guards,	102, 103, 104
horizontal saws,	147	care in operation,	108
founders,	148	circular safety cylinder,	101
vertical saws,	147	dangers of,	101, 107, 163
HEADING MACHINE, for chair back posts,	159	double automatic guard,	105
HOISTS:		finger guard,	105
barrel,	150	gloves, use of,	108
carriage,	199	guide, fastening of,	109
outside,	199	irregular work,	106
HOISTWAY (ELEVATOR):		knives, setting and care,	109
clearance at top and bottom,	195	light at,	9
enclosing,	195	operators,	7
hatch covers,	195	pail and tub,	148
painting sides white,	195	in pattern shops,	162
projections,	195	pressure apparatus,	106
HOOKS:		push-block,	107
of derricks,	132	rear part of knives, guarding,	108
in logging work,	16, 17, 19	sectional swing paddle guard,	105
for log haul,	22	secure footing,	10
safety hooks, in logging,	19	self-feed attachment,	106
		in shingle mill,	60
		short pieces,	107, 163
		sliding and rising guards,	102
		steel lips for tables,	110

	PAGE		PAGE
JOINTER:		LEVER:	
swing paddle guards,	104	elevator, enclosing,	198
taking out the wind,	105	of tenoner, guard for hand on,	130
transmission,	110	LIABILITY INSURANCE,	200
weight for tension,	103	LIGHT,	9
JOINTER AND EDGER, in box factory,	166	in boiler room,	172
KEYS, of engines,	180	in engine room,	177
KEY-WAYS,	183	in saw mill transmission floor,	43
of live roll shafts,	41	in saw mill yard,	51
of saw mill transmission,	44, 45	for stairways,	12
on shafting,	182	LIVE ROLLS:	
KICKER:		bridges over,	42
dangers of,	23	care in operation,	42
operation of,	24	dangers of,	21, 41
KNEE BOLTER:		driving apparatus,	41
carriage and track,	57	in planing mill,	68
floor about,	57	planking guards,	42
guarding of,	57	size of,	41
inserted teeth,	57	table and apron guard,	41
KNIVES, see Cutters.		LOADERS, for logs,	17
LADDERS:		LOADING, in saw mill yard,	49
for boiler runways,	175	LOCK:	
in engine room,	180	for elevator operating device,	198
portable,	190	for saw mill carriage lever,	25, 27, 28
stationary,	190	LOCOMOTIVES:	
LADLING MACHINE,	168	of logging railroad,	15
LATH BOLTER:		in saw mill yard,	52
dangers of,	53	LOGGING:	
guarding of,	53, 54	boiler,	16, 17
LATHES:		buckers and swampers,	16
automatic feed,	142	cables,	16
back knife,	142	cableway yarder,	19
belts and pulleys,	143	camps,	14, 15
blower hood protection,	140, 141, 142	chains,	16
bowl,	168	driving,	20
clothing of operators,	139	explosives,	14
copying,	142	felling,	16
corner block machine,	141	hooks,	16
dangers of,	139	ice roads,	20
heads and knives,	141	jams,	20
motor drive,	139, 164	loading cars,	17
operation of,	139, 140	machine shop,	15
saws, guarding of,	142	pull boats,	18
screen for,	164, 168	railroad,	15
shields for cutter heads,	140	riding on trains,	15
swinging head machine,	140	road engine,	17
transmission,	150	roll-way,	18
variety,	168	safety devices, use limited,	14
LATHES (METAL WORKING):		safety hooks,	19
in logging machine shop,	15	signal system,	14
in saw mill machine shop,	47	skidders,	18
LATH MACHINE,	54	skidways,	19
LATH MILL:		snatch blocks,	17
bolter,	53	standard outfits,	14
boys, employment of,	55	supervision,	14, 17
floors,	55	travoying,	19
gears,	54	unloading cars,	19
lath machine,	54	yarder engine,	16
sprockets and chains,	54, 55	LOG HAUL:	
transfer tables,	55	cables and chains,	22
trimmers,	55	construction,	22
waste holes,	55	gears, belts and frictions,	23
LATH TRIMMER,	55	hooks and fastenings,	22
LEVER:		pike poles,	23
of carriage, locking,	25, 27, 28	protection of,	22, 23
of carriage shielding,	26, 27	reinforcement of,	22
cross style for circular mill,	27	riding on logs or log hauls,	23
of edger pressure rolls,	31	spikes and bunks,	22
		tram car,	22

	PAGE		PAGE
LOG HAUL:		PENSTOCKS,	177
walks and stairways,	22	PIANO MAKING, tenoners,	129
wooden hauls,	22	PICKET HEADER,	68
LOG LOADER, danger of,	23	PICTURE FRAME FACTORY:	
LOG TURNER, see Canter.		miter saw,	82
MACHINE SHOP:		moulding sander,	124
logging,	14	PIKE POLES:	
saw mill,	47	for pond men,	23
MACHINES:		lathes for,	142
adjustment of,	11	PILING,	11
cleaning of,	10, 11	in box factory,	167
oiling of,	10, 11	in dry kilns,	134
repairing of,	10, 11	in lath mill,	55
stopping before leaving,	11	in saw mill yard,	50
use of,	11	in shingle mill,	59
MATCHER:		PINCH BAR,	53
for box boards,	166	PISTONS, shrinking on,	48
guarding of,	62	PIT, railing,	191
operation of,	65	PLANER, see Surfacer.	
METAL GRATING, for secure footing,	10	PLANER (DIAGONAL),	68
MILL POND, fencing in,	51	PLANER AND MATCHER:	
MINORS, employment of,	8	guarding of,	62
MORTISERS:		operation of,	65
chain mortiser,	129	PLANING MILL:	
driving belt,	129	big timber planer,	63
transmission,	135	blind slat machines,	67
MOTOR DRIVE,	12, 181, 187	butting saws,	68
for lathes,	139, 164	conveyors,	68
MOTORS, grounding,	189	dadoing,	68
MOULDERS:		diagonal planer,	68
guarding of,	63, 64	dovetailers,	67
operation of,	65	dowel machines,	68
NAILING MACHINE,	166	gang ripping machine,	65
NIGGER:		matcher,	62, 65
operation of,	26	miter saw,	67
valves, stuffing box and cylinder,	46	moulders,	62, 63, 65
OFF-BEARERS:		panel raisers,	66
in box factory,	166	panel sanders,	66
clothing of,	11, 92	picket header,	68
at live rolls,	42	planer and matcher,	62, 65
for rip saws,	91	relishers and wedge cutters,	67
OFFICE FIXTURE FACTORY, borer guard,	128	resaws,	65
OILING:		sash, door and blind machines,	67
of drop saw trimmers,	34	sizers,	62, 65
of machines,	10	surfacer,	62, 65, 125
of shafting,	182	transmission,	69
of slab slasher chains,	39	wood trimmers,	67
ORGANIZATION,	7	PLATFORMS:	
OVAL WOOD DISH MACHINE,	169	guarding of,	190
OVERHEAD TRIMMERS, see Trimmers.		over penstocks,	177
PAIL AND TUB FACTORY:		in saw mill yard,	48, 49
bolter saws,	83	POLES:	
edging saws,	149	automatic feed machine,	146
hand jointer,	148	heel tapering machine,	146
pail trimming lathe,	148	old method,	146
PANEL RAISERS,	66	sticker,	146
PASSAGEWAYS:		PRESSURE ROLLS:	
about machines,	8	of edgers,	29
keeping clean,	9	of gang saws,	32
PATTERN SHOP:		PRINTING PRESS, in box factory,	167
dowel machine,	164	PULL BOATS,	18
jointer,	162	PULLEYS:	
rules necessary,	161	broken rims,	187
saws,	161, 162	compression,	187
surfacer,	164	testing,	187
transmission,	171	web type for saw mill transmission,	45
universal woodworking machine,	163	PUNCHES,	150
		PUSH-BLOCK,	107
		PUSH-STICK,	91

	PAGE		PAGE
RABBETING, on rip saw,	91	SAFETY VALVE, of boilers,	172, 174
RAILROAD:		SANDERS:	
blocking frogs and ends of guard		belts and pulleys,	121, 123
rails,	51	belt sander,	124
cables across track,	51	board cover for top,	123
cars,	52	disk machines,	123
coupling cars,	52	endless bed feed machine,	123
crossings,	51	feed rolls,	121, 124
gates at approaches to,	52	gears,	123, 188
locomotives,	52	moulding sanders,	124
in logging,	15	panel sander,	66
operation of,	52	sanding wheels and drums,	124
repair work,	53	sash sander,	67
safety car shifter,	53	sprockets and chains,	123
signalling,	52	take-away end,	121
signs,	52	transmission,	135
switches,	51, 52	SASH, DOOR AND BLIND MACHINES,	
tracks,	51	door panel sander,	124
trestles,	51	relishers and wedge cutters,	67
trolley poles along track,	51	sanding wheel,	124
RAILROAD TIES, equalizer,	86	self-feed saw,	78
RAKING PLATFORM,	176	tenoners,	129, 130
RED PAINT, for safeguards and moving		SAW MILL:	
parts of machinery,	9	band mill,	27
RELEASING REST:		blacksmith and machine shops,	47
for grinding wheels,	193	carefulness in doing work,	21
for grindstones,	194	carriage,	24
RELISHER AND WEDGE CUTTER,	67	caution on part of sawyer, 2I, 24, 26, 28	
REPAIRING, of machines,	10	circular mill,	26
RESAWS (BAND),	65, 66	cleanliness,	21
RESAWS (CIRCULAR),	65	counterweights,	21, 46
RESAWS (HORIZONTAL BAND), see		deck,	23
Horizontal Band Resaws.		edgers,	29
ROAD ENGINE,	17	enforcement of rules,	21
ROCKER, see Kicker.		filing room,	47
ROCK SAW,	28	floors,	21
ROD MACHINE,	159	gang saws,	32
ROLL-WAY:		general precautions,	21
building of,	18	gin pole in yard,	50
loading from,	18	hammers, steam and drop,	48
ROSIN, for secure footing,	10	horizontal band resaw,	39
ROUNDING MACHINE:		lath mill,	53
for handles,	141	live rolls,	41
for woodenware,	168	log haul,	22
RUBBER GLOVES, for electrical workmen, 189		motor drive,	12
RUBBER MATS, for secure footing,	10	railroad in yard,	51
RUBBISH, disposal of,	12	runways,	21, 44
RULES:		signs,	21
for boiler tenders,	172	slab slashers,	38
enforcement of,	7	space around machines,	21
in pattern shop,	161	stairways,	21
in saw mill,	21	steam feeds and machinery,	46
RUNWAYS:		supervision,	21
for boilers,	175	surfacers,	125
over dams,	177	transmission,	43, 61
to dry kilns,	134	transmission floor,	21, 43
in engine room,	180	trimmers,	33
guarding of,	190	wood saws,	41
in saw mill,	21, 44	yard,	48
in saw mill yard,	48, 49	SAWS:	
SAFEGUARDS:		light at,	9
care of,	10	operators,	7
inspection of,	10	secure footing,	10
in logging, use limited,	14	SAWS (BAND):	
painting red,	9	block to catch flying end,	100
slats or wire mesh advisable,	13	brazing,	99
value and use of,	# 9	care in operation,	98
SAFETY DEVICE, for elevators,	195	cracked or dull blades,	99
SAFETY DEVICES, see Safeguards.		dangers of,	95, 97, 98

	PAGE		PAGE
SAWS (BAND) :		SAWS (RIP) :	
gloves, use of,	99	in cooperage, edging,	149
lower wheel, guarding,	95, 99, 100	covering when left running,	94
return part of blade, guarding,	97, 99, 100	cracked saws,	91
safety device for fingers,	100	dangers of,	70, 73
self-feed saws,	100	feeding apparatus,	165
sharpening,	99	feeling run of,	90
transmission,	100	finger guard,	76
upper wheel, bar in front of,	97	guarding of,	70
upper wheel, enclosing,	97, 99, 100	guards, material of,	93
upper wheel, spanning bow for,	97, 99, 100	guards, use and adjustment,	92
web wheel for,	95	guide,	90
working part of blade, guarding,	98, 99, 100	home-made guards,	74
SAWS (BLOCK),	137, 138	hood guards,	73, 74, 75, 76, 77
SAWS (BOLTER),	82	off-bearers,	91
transmission,	94	off-bearers, clothing of,	92
SAWS (BUTTING),	68	push-stick,	91
SAWS (CUT-OFF) :		rabbeting,	91
adjusting and cleaning,	90	sawyers' clothing,	92
bearings, care of,	93	self-feed saws,	78
in box factory,	105	speed of, fixing,	93
care of,	93	splitter,	70
carriage-fed,	81	splitter guards,	72, 74, 75, 76, 77
covering when left running,	94	transmission,	94
cracked saws,	91	under part of saw, guarding,	89
curved strip guard,	79	SAWS (SEGMENT),	155
dangers of,	70, 79	SAWS (SPLIT TABLE, HAND-FEED),	137
double cut-off,	80	SAWS (SPRINGBOARD CLIP),	60
feeding material,	81	SAWS (SWING) :	
framework guard,	80	belt,	88
guarding of,	79	belt shifter,	89
guards, material of,	93	care in operation,	89
guards, use and adjustment,	92	counterweighting,	86
hood guards,	79	handle,	88
for hub blocks,	145	limiting the swing,	88
of lathes,	142	saw, guarding,	87
miter saw,	82	saw, hanging,	89
in shingle mill,	56	SAWS (UPRIGHT SHINGLE) :	
speed of, fixing,	93	carriage,	59
transmission,	94	floor about,	59
traveling cut-off,	80	operation,	59
under part of saw, guarding,	89	run, railing,	59
SAWS (EQUALIZING),	83	shaft guarding,	59
cooperage,	84	SAWYER :	
drum equalizer,	85	in saw mill, good judgment re-	
feeding apparatus,	85	quisite,	22
handles,	85	in saw mill, need of caution,	21, 24, 26, 28
railroad ties,	86	SCALER, caution in operating kicker,	24
spokes,	85	SECURE FOOTING, at dangerous ma-	
transmission,	94	chines,	10
under part of saw, guarding	89	SERIES ARC CIRCUITS,	189
vener,	85	SET SCREWS,	183
wagons,	85	in borers' chucks,	127
SAWS (GROOVING),	77, 158	in borers' spindle collars,	128
SAWS (HORIZONTAL SHINGLE) :		in collars on shafting,	183
carriage,	58	on drag saw,	133
guard over back,	58	on gears,	188
safety spalting curve,	58	guarding,	183
SAWS (KNOT),	59	headless,	183
SAWS (MITER),	67, 82, 158	in logging machine shop,	15
SAWS (PATTERN-MAKERS'),	161, 162	on machines,	183
SAWS (RIP) :		in saw mill machine shop,	47
adjusting or cleaning,	90	of saw mill transmission,	44, 45
bearings, care of,	93	SETTERS, dangers of,	24, 26
in box factory,	104	SHAFT ENDS,	182
care in operation,	90	on saw mill carriage,	26
care of,	93	of saw mill transmission,	44, 45
		of sizers, moulders, etc.,	62

	PAGE		PAGE
SHAFTING:		SHINGLE MILL:	
arrangement and care,	181	transmission,	43, 61
couplings, gears, clutches, etc.,	182	upright shingle saw,	59
elimination by motor drive,	12	SHORT LOG SAW MILL,	136
guarding of,	181	SHOW CASE FACTORY,	158
oiling,	182	rip saw guarded,	75
in saw mill filing room,	47	SIGNALLING:	
in saw mill transmission floor, low and elevated,	44, 45	for band mill, when starting up or shutting down,	28
work on,	182	for engine, when starting up or shutting down,	178
SHAFTS:		in logging,	14
of drop saw trimmers,	33	in saw mill, when starting or stop- ping engine,	47
in engine room,	180	at saw mill slides,	48
of equalizer,	85	for saw mill yard railroad,	52
of heel tapering machine,	146	SIGNS:	
of live rolls,	41	character of,	10
of sorting tables,	48	at drag saw,	134
of upright shingle saw,	59	for electricity,	190
of water wheels,	177	for elevators,	108
SHAPER:		on engine throttle valve wheel,	178
belts and pulleys,	120	first aid instructions,	13
belt shifter,	120	at machine equipped with safe- guards,	9
blade spring for horizontal pressure, care in operation,	112 119	placing of,	7
construction and setting of machine, countershaft, fencing,	119 120	for railroad in saw mill yard, in saw mill,	52 21
dangers of,	111	in saw mill transmission floor, use of,	43 10
feeding apparatus,	113	SINGLE-TREES:	
gloves, use of,	119	dressing and pointing machines,	146
grooved knives,	119	equalizers,	85
grooving work,	112	SIZERS:	
home-made feeding device, home-made guards,	118 112, 114, 116, 118	guarding of,	62
knives, setting and care,	118, 120	operation of,	65
leather fan device,	117	SIZING MACHINE, in box factory,	166
light at,	9	SKIDDERS,	18
lock nuts for spindles,	120	SKIDS, of railroad iron,	23
notched board guard,	112	SKIDWAYS,	19
operators, employment of, panel sticking,	120 145	SLAB SLASHERS:	
patented guards,	114	bridge across chains,	39
pressure apparatus,	113	clutch for chains,	39
rear of spindle,	118	dangers of,	38
ring, plate and cap guards, secure footing,	116 10, 120	guarding of,	38
straight work,	112	oiling of saws,	39
suction pipes,	117	throwing chains out,	39
table front, fencing,	120	transfer chains,	39
transmission,	120	SLASHERS, veneer,	156
variety work,	114	SLACK CABLE DEVICE, for elevators,	195
wooden spring guard,	112	SLATS, advisable for safeguards,	13
SHEAVES:		SLEDGES, in shingle mill,	57
elevator,	194, 195	SLICING MACHINE, for veneer,	154
of rope feed set works,	26	SMOKING,	13
of saw mill carriage feed,	25	SNATCH BLOCKS,	17
in saw mill transmission floor, in saw mill yard,	46 51	SPACE:	
SHEDS, in saw mill yard,	51	around machines,	8
SHINGLE MILL:		around saw mill machines, in saw mill transmission floor,	21 43
axes, wedges and sledges,	57	SPARK BRUSH, for grinding wheels,	192
conveyors,	56	SPLICER, for veneer,	157
cracked saws,	57	SPLIT TABLE SAW, hand-feed,	137
cut-off saws,	56	SPLITTER:	
horizontal shingle saws,	58	adjustment,	71
jointer,	60	attachment,	71, 72
knee bolter,	57	for block saws,	138
knot saw,	59	for box factory saws,	164
packing,	61		
piling blocks,	59		
springboard clip saw,	60		

	PAGE		PAGE
SPLITTER :		SURFACERS :	
for circular mill,	26	belt shifter,	126
for circular resaw,	65	driving mechanism,	125
curved,	71	feed entrance,	126
extended type,	72	feed roll gears,	126
for lath bolter,	53	guarding of,	62
material of,	71	knives and heads,	127
for pattern-makers' saws,	161, 162	operation of,	65
rip saws, necessary for,	70, 72	pattern shop,	164
for short log saw mill,	136	sectional feed roll,	126
straight,	71	transmission,	135
SPOKES :		SWAMPERS, see Buckers.	
drivers,	143	SWING TRIMS,	36
equalizing saws,	85	SWITCHBOARDS,	189
facers,	143	SWITCHES (ELECTRICAL),	189
rough stock,	136	safety lock knife switch,	190
swinging head lathe,	140	SWITCHES (RAILROAD) :	
tenoners,	131, 132	in logging,	15
throaters,	144	in saw mill yard,	51, 52
SPOOLS,		TABLES, encumbering of,	
disc dividing saws,	170	9	
transmission,	171	TENONERS :	
SPREADER, see Splitter.		carriage,	
SPRINGBOARDS, in felling,		130	
SPROCKET WHEELS AND CHAINS,		cut-off saws,	
189		129, 131, 132	
of band saw feed works,	100	cutter heads,	
of drop saw trimmers,	33	129, 130, 132	
of edgers,	32	double end machine,	
of gang saws,	32	130	
of lath bolter,	54	extension for feeding-out chains,	
of live rolls,	41	130	
of pole machine,	146	furniture,	
of sanders,	123	159	
in saw mill transmission floor,	45	guard for hand on lever,	
of veneer dryers,	157	130	
SPUR, of lathes,	139, 142	shaper heads,	
STAIRWAYS,		129	
for boiler runways,	175	slitting saws,	
building regular,	12	129	
in engine room,	180	spoke machines,	
familiarity with,	12	131, 132	
lighting of,	12	transmission,	
for log haul,	22	135	
in saw mill,	21	TWOATERS :	
in saw mill transmission floor,	43, 44	for handles,	
to platforms and runways in saw mill yard,	49	138	
STAPLING, of baskets,	169	for spokes,	
STAVES :		144	
bending machines,	150	TONGS :	
jointers,	147	in saw mill yard,	
planers,	148	18	
sawing machines,	146	for skidders,	
STEAM FEEDS, in saw mill,	46	18	
STEAM GAUGE :		TRACKS, in saw mill yard,	
comparing with safety valve,	173	51, 52	
drilling hole in case,	175	TRAM CAR, for log haul,	
in engine room,	181	22	
lighting about,	172	TRAMWAYS, to dry kiln,	
testing,	172, 173	134	
STEAMING BOXES, veneer,	153	TRANSFER CHAINS :	
SUCTION HOODS OR PIPES, see Blower Hoods.		dangers of,	
SUPERVISION :		21	
in logging,	14, 20	of live rolls,	
of loading logging cars,	17	43	
in saw mill,	21	of slab slashers,	
SURFACERS :		39	
belts and pulleys,	164	of trimmers,	
		35, 39	
		throwing out, of trimmers and slab slashers,	
		39	
		TRANSFORMER BOXES, grounding,	
		189	
		TRANSMISSION :	
		baskets,	
		171	
		borers,	
		135	
		box factory,	
		171	
		brushes,	
		171	
		chairs,	
		160	
		cooperage,	
		150	
		cross arms,	
		171	
		drag saw,	
		135	
		furniture,	
		160	
		handles,	
		150	
		jointers,	
		110	
		lath mill,	
		61	
		lathes,	
		150	
		mortisers,	
		135	
		pattern shop,	
		171	
		planing mill,	
		69	
		sanders,	
		135	
		saws, band,	
		100	

	PAGE		PAGE
WOODENWARE,	168	WOUNDS, cleaning and dressing,	13
dowel machine,	168	YARD (BOX FACTORY),	167
ladling machine,	168	YARD (SAW MILL):	
oval wood dish machine,	169	burner, fencing,	51
transmission,	171	cables, hooks and tongs,	50
tray machines,	169	conveyors,	51
variety lathe,	168	cranes,	50
WOOD PULLEYS,	170	horses,	50
transmission,	171	lighting,	51
WOOD SAWS, in saw mill,	41	loading and hauling,	49
WOOD TRIMMERS,	67	piling,	50
WORKMEN:		platforms and runways,	48, 49
assignment to work,	8	railroad,	51
clothing of,	11	reservoirs, excavations and mill	
co-operation with each other,	8	pond fencing,	51
co-operation with foremen,	7	sheds,	51
employment of,	8	trucks,	50
on inspection committees,	8	YARDER ENGINE,	16
instruction by foremen,	11	YOUNG PERSONS, assignment to work,	8
instruction and warning,	7		
selection for deck work,	24		

61st Annual Statement

OF THE

Ætna Life Insurance Company

HARTFORD, CONNECTICUT

MORGAN G. BULKELEY, President

Life, Accident, Health and Liability Insurance

JANUARY 1, 1911

ASSETS		LIABILITIES	
Real Estate acquired by foreclosure	\$ 97,001.31	Reserve on Life, Endowment and Term Policies.....	\$ 82,794,149.00
Office Building	500,000.00	Special Reserve, not included above	704,525.00
Cash on hand and in Banks..	3,905,769.53	Premiums paid in advance, and other Liabilities.....	566,606.80
Stocks and Bonds.....	31,974,664.01	Unearned Interest on Policy Loans	222,446.57
Mortgages secured by Real Estate	49,061,500.71	Accrued Taxes	524,044.77
Loans on Collateral	1,320,470.76	Surplus reserved for special class of Policies and dividends to Policyholders payable on Demand	1,858,901.33
Loans secured by policies of this Company	8,325,149.36	Losses and Claims awaiting proof, and not yet due....	451,885.93
Interest due and accrued December 31, 1910.....	1,792,917.15	Unearned Premiums on Accident, Health and Liability Insurance	2,245,982.70
Premiums in course of collection and Deferred Premiums	1,680,133.81	Reserve for Liability claims	1,547,600.00
Market Value of Securities over cost, less Assets not admitted	2,360,536.32	Surplus to Policyholders....	10,102,000.86
Total Assets,.....	\$101,018,142.96	Total Liabilities....	\$101,018,142.96
INCOME		DISBURSEMENTS	
Premiums	\$ 16,695,501.40	Payments to Policyholders..	\$ 12,251,252.88
Interest, Rents, etc.....	4,811,085.42	Taxes	521,334.87
Total Income in 1910	\$21,506,586.82	All other Disbursements....	5,225,126.63
		Total Disbursements in 1910.....	\$17,997,714.38

OFFICERS:

ÆTNA LIFE INSURANCE COMPANY

Accident and Liability Department

HARTFORD, CONN.

WALTER C. FAXON, Vice-President

J. SCOFIELD ROWE, Secretary

JOHN M. PARKER, Jr., Secretary

E. C. BOWEN, Assistant Secretary

E. C. HIGGINS, Assistant Secretary

J. V. ADAMS, Assistant Secretary

ÆTNA LINE OF INSURANCE

Employers' Liability
Public Liability (Direct)
Public Liability (Contingent)
Elevator Liability
General Liability
Automobile Liability
Teams Liability
Excess Liability
Workmen's Compensation
Accident
Health
Life

ISSUED BY

ÆTNA LIFE INSURANCE COMPANY

Accident and Liability Department
HARTFORD, CONN.

Automobile Property Damage
Automobile Collision
Teams Property Damage
Plate Glass
Burglary
Fly Wheel
Sprinkler Leakage
Fidelity and Surety Bonds

ISSUED BY

THE ÆTNA ACCIDENT AND LIABILITY CO.,
HARTFORD, CONN.

WOODWORKING
SAFEGUARDS

Van Schaack



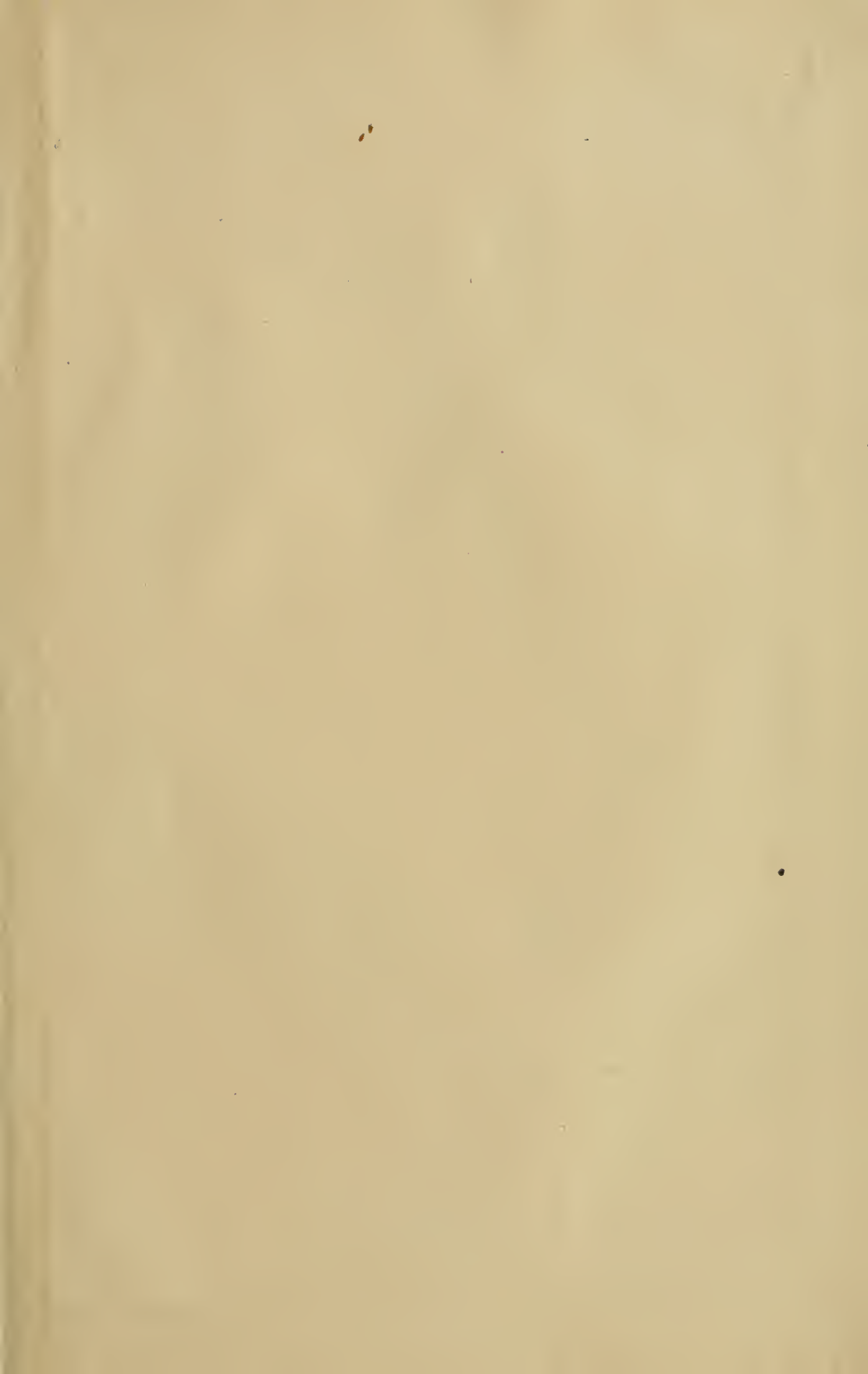

LIBRARY OF CONGRESS

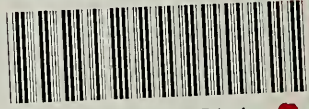

0 017 181 551 4

