

EX LIBRIS

VOLUME 10

THE UNIVERSITY OF CHICAGO PRESS

ANNALS OF THE ENTOMOLOGICAL SOCIETY OF AMERICA

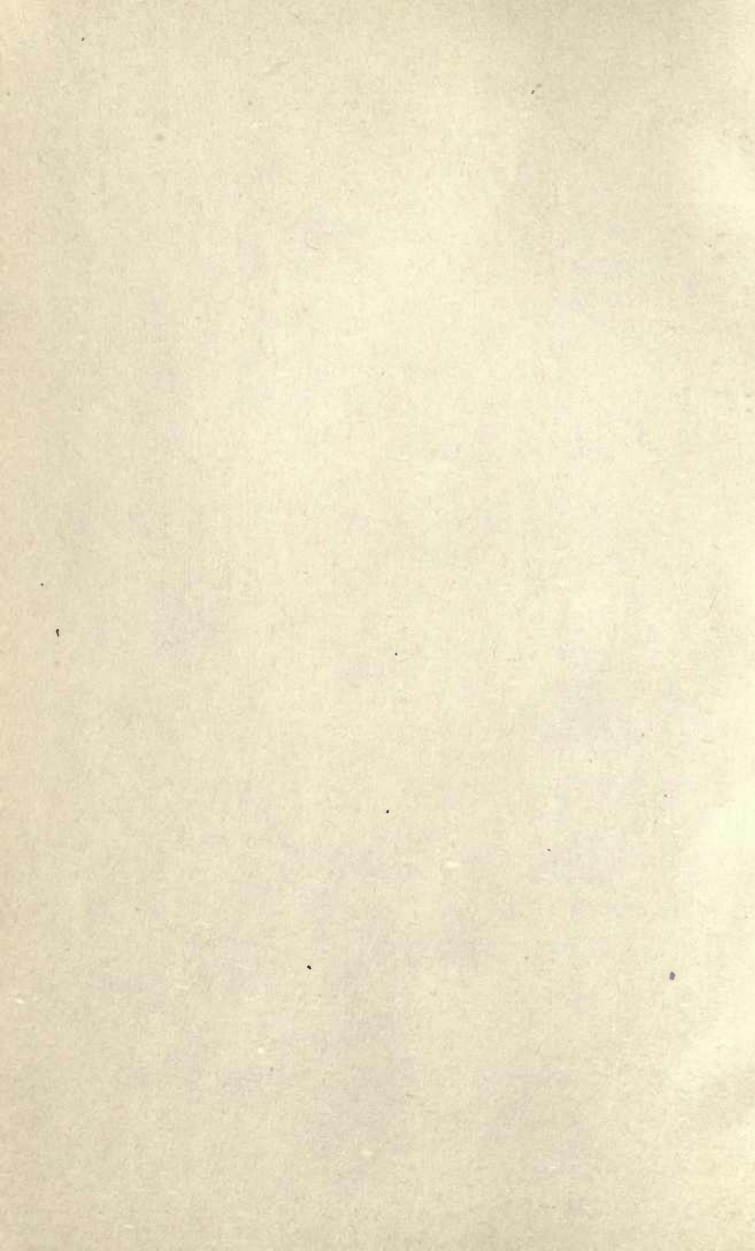

VOLUME II

ALTERNATING CURRENTS

AND

ALTERNATING CURRENT MACHINERY

•The  Co. •

ALTERNATING CURRENTS

AND

ALTERNATING CURRENT MACHINERY

BEING VOLUME II OF THE

*TEXT-BOOK ON ELECTRO-MAGNETISM AND
THE CONSTRUCTION OF DYNAMOS*

BY

DUGALD C. JACKSON, C.E.

PROFESSOR OF ELECTRICAL ENGINEERING IN THE UNIVERSITY OF WISCONSIN;
MEMBER OF THE AMERICAN SOCIETY OF MECHANICAL ENGINEERS,
AMERICAN INSTITUTE OF ELECTRICAL ENGINEERS, ETC.

AND

JOHN PRICE JACKSON, M.E.

PROFESSOR OF ELECTRICAL ENGINEERING IN THE PENNSYLVANIA STATE COLLEGE;
MEMBER OF THE AMERICAN INSTITUTE OF ELECTRICAL ENGINEERS, ETC.

New York

THE MACMILLAN COMPANY

LONDON: MACMILLAN & CO., LTD.

1896

All rights reserved

TR 1141
J2

Gift of Daughter of William Stuart Smith

COPYRIGHT, 1896,
By THE MACMILLAN COMPANY.

Norwood Press
J. S. Cushing & Co. — Berwick & Smith
Norwood Mass. U.S.A.

PREFACE.



THE matter of this book consists, in essence, of the lectures which have been delivered for two or three years past by Professor D. C. Jackson to the senior and graduate students in Electrical Engineering at the University of Wisconsin, but Professor J. P. Jackson, of the Pennsylvania State College, carefully revised and extended the manuscript before it was sent to the printers. The method carried out in the book is based on the self-evident but little recognized principle, that methods which have proved best in teaching other branches of Engineering must be equally advantageous in treating Electrical subjects. A treatise on electro-magnetism or on alternating currents should therefore deal with its subject in much the same way that thermodynamics and the steam engine, hydraulics and hydraulic machinery, or the theory of structures are respectively presented in the best works on those subjects. The startlingly rapid advances which have been made in our knowledge of the phenomena relating to electro-magnetism and the electric current, tend to confuse the best teachers, and doubtless account for the rather superficial methods used in many colleges, in which results only have been presented to the student with little reference to reasons. This error is generally admitted, and it is hoped that this work may, by furnishing a satisfactory text-book, aid those teachers who desire to improve their methods.

The book treats of the fundamental phenomena of alternating currents as met with in engineering practice, and points out their controlling principles and applications. Descriptions and illustrations of commercial machinery are not included *per se*, since they would be little more than repetitions of matter which is available in the current technical journals, and would crowd important material from the book. This does not mean that practical data are excluded; on the contrary, where they may be useful in illustrating deductions in the text, they are copiously used, selections having been made for the purpose from an extensive mass of data, most of which is original. A large number of references to articles are given in foot-notes for the fuller information of the reader. These cover, in general, those articles which may be read in the original by the student with most profit; except in the chapters on polyphase currents. Here the list of references is much less complete, since the subject has not yet been fairly wrought out, and material of overshadowing importance is being constantly published, so that only a few of the writings of most substantial importance can be advantageously cited. A number of excellent articles have lately been published upon polyphase currents but at too late a date to be put into the plates. Where articles of importance have been published in a number of prominent American and foreign technical periodicals, the references have usually been made to the *Electrical World* and the *London Electrician*.

Throughout the book, occupation of space by the description of classical experiments which have come to be of historical interest only, has been carefully avoided, except where it seems desirable to trace the natural development of knowledge in a particularly important subject: as, for instance, the subjects relating to the tracing of alternating-current curves, methods of measuring inductances, or practice in the paral-

lel running of alternators. The last is a subject of much importance at the present time, on account of its influence on the uniformity of the service given from alternating-current central stations, and its rapidly increasing adoption either for regular operation or for the purpose of transferring the load from generator to generator.

Much very important matter which heretofore has been found only in technical periodicals, and sometimes has been unavailable for use, is to be found in this book. In a number of cases original methods have been introduced to gain simple paths to results, every effort being made to present a full physical conception of phenomena to the reader's mind. The mathematics used are merely a means to the end, and are by no means to be considered from any other standpoint. In this respect it has been sought to avoid either the error of presenting unnecessary formulas or on the other hand of giving results without reasons, both of which are fatal to the reader's true progress as they leave him with no true physical conception of the phenomena studied. Numerous original demonstrations of the standard formulas, which it is thought have some merit, have been introduced, and a few additions have been made to the nomenclature. The most important of the latter is the introduction of the term *active* to represent the component of pressure or electromotive force in phase with current, and to represent the working component of current. The introduction of this term removes the inconvenience, of which Professor S. P. Thompson bitterly complains, caused by the use of the term *effective* in the formally adopted meaning of $\sqrt{\text{mean}^2}$.

Where the volume is used as a text-book, and time for completing the full course is not available, the following chapters may be omitted without interfering with the continuity of the subject: Chapters IV., X., XII., XIII., XIV., XV.,

and the appendices ; but an abbreviated course in this subject is not to be advised for electrical engineering students.

The foot-notes given in the text so fully acknowledge the authors' indebtedness to other writers that it is perhaps unnecessary to make further acknowledgment in this preface beyond the statement that all standard publications have been drawn from as seemed desirable, and that the authors are especially indebted to the delightfully lucid expositions of several French writers.

The proof of the entire book has received, to its great advantage, the careful reading of Professor George D. Shepardson, of the University of Minnesota, and several chapters have been read by Professor C. S. Slichter, of the University of Wisconsin, to both of whom we are indebted for many valuable suggestions.

THE AUTHORS.

May, 1896.

TABLE OF CONTENTS.



CHAPTER I.

| | PAGE |
|--|------|
| THE ELECTRIC PRESSURE DEVELOPED BY ALTERNATORS | I |
| Form of pressure curve; period and frequency; effect of style of winding on the pressure; relative dimensions and outputs of continuous-current and alternating-current machines; proportion of armature surface occupied by wire. | |

CHAPTER II.

| | |
|---|----|
| ARMATURE WINDINGS FOR ALTERNATORS | 15 |
| Classification of armatures; forms of windings; winding diagrams; drum armatures; ring armatures; disc armatures; pole armatures; collectors; inductor alternators; insulation; armature cores. | |

CHAPTER III.

| | |
|---|----|
| SELF-INDUCTION AND CAPACITY | 39 |
| Self-induction defined; inductive pressure; active pressure; impressed pressure; phase; angle of lag; triangle of electric pressures; self-inductance defined; the henry; examples; energy of self-induced magnetic field; curves of rising and falling current; divided circuits; shunted ballistic galvanometer; power expended in inductive circuit; time constant; examples; alternating current in inductive circuit; reactance; impedance; inductive circuits in parallel; resolution of irregular alternating-current curves; effect of capacity; capacity pressure; energy of charged condenser; curves of charge and discharge; alternating current in circuit with capacity; effect of self-inductance and capacity combined; methods for measuring self-induc- | |

tance; effect of varying permeability; power in alternating-current circuit; wattmeter; measuring angle of lag; power loops; power factor; active current; wattless current; induction factor; methods for measuring power; inductive spark; self-inductance of parallel wires; impedance factor; distribution of current in wires; skin effect. PAGE

CHAPTER IV.

GRAPHICAL AND ANALYTICAL METHODS OF SOLVING PROBLEMS IN ALTERNATING-CURRENT CIRCUITS 151

Graphical method explained; phase diagram; vector diagram; application to series circuits; application to parallel circuits; application to combined circuits; analytical method; examples.

CHAPTER V.

THE MAGNETIC CIRCUIT OF ALTERNATORS 221

Losses in alternators; armature ventilation; radiating surface; current density; magnetic leakage; determination of number of armature conductors; armature self-inductance; calculation of field windings; armature reactions; separate excitation; self-excitation; compound excitation.

CHAPTER VI.

CHARACTERISTICS, REGULATION, ETC. 266

Curve of magnetization; effect of armature reactions on exciting current; external characteristic; loss line; measuring instruments; curve of magnetic distribution; curves of pressure and current; tracing curves of pressure and current; contact makers; areas of successive curves; effective values from rectangular and polar curves.

CHAPTER VII.

REGULATION AND COMBINED OUTPUT 313

Constant-pressure regulation; constant-current regulation; synchronism and step; alternators in series; alternators in par-

allel; synchronizing; practice in parallel operation; effect of frequency; effect of armature inductance; effect of form of pressure curve; effect of varying the excitation; effect of irregular angular velocity.

PAGE

CHAPTER VIII.

EFFICIENCIES, ETC. 370

Testing alternators; shop tests; wattmeters on high-pressure circuits; output *vs.* efficiency, weight, and cost; single-phase; polyphase; armature reactions of polyphasers; connecting polyphase armatures.

CHAPTER IX.

MUTUAL INDUCTION 396

Transformers; mutual induction; mutual inductance; energy of mutual induction; transfer of electricity by mutual induction; primary and secondary coils; measurement of mutual inductance; effect of iron cores; mutual induction of distributing circuits.

CHAPTER X.

OPERATION OF IDEAL TRANSFORMER AND EFFECT OF IRON AND COPPER LOSSES 426

Ratio of transformation; magnetic leakage; exciting current; core magnetization; inherent regulation of ideal transformer; effect of losses on regulation; effects of self-inductance and capacity; graphical method; transformation from constant pressure to constant current; effect of hysteresis and Foucault currents on exciting current.

CHAPTER XI.

EFFICIENCY AND LOSSES IN TRANSFORMERS 461

Core losses; magnetic densities; copper losses; radiating surface; current densities; testing transformers; all-day efficiencies; full-load efficiencies; weight efficiencies; separation of core losses; Ford's tests; Fleming's tests.

CHAPTER XII.

| | PAGE |
|----------------------------------|------|
| DESIGN OF TRANSFORMERS | 513 |

Effect of frequency; effect of form of pressure curve; transformer calculations; example; joints in cores; ageing of cores; current rushes; impedance coils; compensators; boosters.

CHAPTER XIII.

| | |
|---|-----|
| POLYPHASE CONDUCTING SYSTEMS AND THE MEASUREMENT OF POWER IN POLYPHASE CIRCUITS | 546 |
|---|-----|

Polyphase conducting systems; star connection; mesh connection; uniform power in polyphase circuits; relations between currents and pressures; mutual- and self-induction in circuits; measurement of power in two-phase circuits; measurement of power in three-phase circuits; method with three wattmeters; method with two wattmeters; method with one wattmeter; proof of generality of method with two wattmeters; effect of lag on wattmeter readings.

CHAPTER XIV.

| | |
|--------------------------------------|-----|
| ALTERNATING-CURRENT MOTORS | 571 |
|--------------------------------------|-----|

Synchronous motors; effect of field strength on the working of synchronous motors; graphical illustrations; relation of armature current to excitation; breaking-down load; experiments of Bedell and Ryan; induction motors; rotating magnetic field; resultant magnetizing power; action of short-circuited armature; uniformity of rotating field; definitions of armature and field; induction motors are truly transformers; magnetizing current; motor speeds and slip; graphical illustrations; torque of ideal motor; effect of magnetic leakage; maximum torque; starting torque; maximum load; forms of armature windings; squirrel-cage; independent short-circuited coils; coils short-circuited in common; field windings; relation of speed to frequency and number of poles; relative core losses in fields and armature; starting and regulating devices; resistances in fields; resistances in armature; commutated armature; effect of rotating field on field windings; formulas derived from those of the transformer;

exciting current; field ampere-turns; slip and armature pressure; principles of design; constants for determining magnetic densities; formulas for field current; current density; radiating surface; resistance of armature; computation of losses; efficiencies; power factor and torque; relation of output to constructive details; electro-magnetic repulsion; single-phase induction motors; resolution of alternating field; formula for single-phase induction motors; starting single-phase motors; testing induction motors; direct measurement; stray power method; power factor; regulation and torque; illustrations; weight efficiency; effect of frequency; miscellaneous forms of induction motors; Stanley motor; condenser to supply wattless current; Shallenberger meter; Diamond meter; Ferranti meter; Thomson meter; Monocyclic system; effect of form of pressure curve; reversing induction motors.

CHAPTER XV.

POLYPHASE TRANSFORMERS 683

Stationary transformers for polyphase circuits; economy in the use of special polyphase transformers; transformation of phases; rotary transformers; connecting the armature windings; ratio of transformation; capacity.

APPENDICES.

A. THE APPLICATION OF FOURIER'S SERIES TO ALTERNATING-CURRENT CURVES 695
 B. THE CHARACTERISTIC FEATURES OF ALTERNATING-CURRENT CURVES 703
 C. OSCILLATORY DISCHARGES 703
 D. ELECTRICAL RESONANCE 709
 INDEX 719

LIST OF IMPORTANT SYMBOLS.

- ♦—
- A*, area, constants.
B, magnetic induction per sq. cm., or magnetic density.
B_m, maximum magnetic density.
B_a, magnetic density in armature core.
B_f, magnetic density in field core.
C, electric current, effective value of alternating current.
c, instantaneous current.
c_m, maximum value of alternating current.
C', primary current.
C'', secondary current. } In chapters dealing with trans-
C₁', exciting current. } formers and induction motors.
C_μ', magnetizing current. }
D, d, readings of instruments.
E, electric pressure or electromotive force, effective value of
 alternating pressure.
e, instantaneous electric pressure.
e_m, maximum value of alternating pressure.
E_a, active pressure (effective value).
E_i, impressed pressure (effective value).
E_s, reactive pressure (effective value).
F, friction loss in watts.
f, frequency.
G, galvanometer resistance.
H, magnetic force, hysteresis loss in watts.
I, impedance.

- K, k , constants.
 k , ratio of transformation in transformers and induction motors.
 L , self-inductance (in a few efficiency formulas L is taken to mean losses).
 L' , primary self-inductance. } In transformers and induc-
 L'' , secondary self-inductance. } tion motors.
 l , length.
 M , mutual inductance, magneto-motive force.
 m , number of phases in polyphase circuits.
 N , number of lines of force, }
 or total magnetism. } Maximum magnetism in
 N_a , armature magnetism. } transformers and induc-
 N_f , field magnetism. } tion motors.
 N_b , leakage magnetism. }
 n , number of turns in a coil. } Transformers and induc-
 n' , number of primary turns. } tion motors.
 n'' , number of secondary turns. }
 \overline{nc} , ampere-turns.
 P , magnetic reluctance.
 p , number of pairs of poles.
 Q, q , quantity of electricity.
 q , instantaneous quantity of electricity.
 R, r , resistance.
 S , number of armature conductors.
 S' , number of primary conductors. } In induction motors.
 S'' , number of secondary conductors. }
 s , capacity of condenser.
 T, t , time.
 t , instant of time.
 U , periphery velocity.
 V , revolutions per minute.
 v , instantaneous velocity, slip in induction motors.

| | |
|--------------|---|
| v_1 , | frequency of current in armature of induction motor. |
| W , | power. |
| w , | instantaneous power. |
| Z , | foucault current loss in watts. |
| z , | leakage coefficient. |
| α , | angles, phase of alternating current. |
| β , | angles or deflections. |
| δ , | deflections. |
| ϵ , | base of Napierian logarithms. |
| η , | commercial efficiency. |
| θ , | angles or deflections. |
| μ , | magnetic permeability. |
| π , | ratio of circumference to radius. |
| τ , | time constant. |
| ϕ , | angle of lag. |
| ψ , | angle between currents C' and C_1' in transformers. |
| ω , | angular velocity. |

NOTE. — Students who are acquainted with the methods of solving differential equations may pass over the solution of the equation

$$dc + \frac{R}{L} c dt = \frac{e_m}{L} \sin a dt$$

given in Section 24. This is a linear equation of the first order, and its solution may be written down at once.

Students who are not acquainted with the elementary principles of complex quantities may advantageously read Chapter 31 of Van Velzer and Slichter's *University Algebra* before entering upon Section 56.

Department of Chemistry

Chicago, Illinois

February 10, 1954

Dear Sir:

I have your letter of January 28, 1954, regarding the

matter of the proposed purchase of the

equipment for the laboratory.

I am sorry that I cannot give you a more definite

answer at this time.

The matter is being considered by the

Department of Chemistry.

I will contact you again when a decision has been

reached.

Sincerely,
[Signature]

ALTERNATING CURRENTS.

CHAPTER I.

THE ELECTRIC PRESSURE DEVELOPED BY ALTERNATORS.

IN dealing with alternating currents, several variables enter into the problem which make it impossible to use, without modification, the results gained in the study of continuous currents. But the same fundamental laws control the phenomena of both, and if care is taken to apply these with due regard to the limiting conditions, it will be found that the subject may be clearly grasped and be reduced almost to the simplicity of continuous-current work. In many particulars, the design of alternating-current machinery varies widely from that of continuous-current apparatus, as the requirements are materially different, though in the matter of good workmanship and substantial construction there is no difference in the two classes of machines.

1. Form of the Pressure Curve of an Alternator. — In a multiple-coil continuous-current armature, if S be the number of conductors, N_a the useful magnetic lines of force passing into the armature, and V the

speed in revolutions per minute, the pressure developed will be

$$E = \frac{SN_a V}{10^8 \times 60} *$$

In the demonstration in Vol. I. it has been assumed that the magnetic field is uniform, which is by no means the case in commercial dynamos. The assumption, however, simplifies the demonstration without introducing error into the result, as will now be shown.

Suppose the field be perfectly uniform, then each armature conductor will cut lines of force at the uniform rate of $\frac{dN}{dt} = \frac{2N_a V}{60}$ lines per second. If the field be not uniform, each conductor will, at any instant, cut lines of force at the rate $\frac{dN}{dt}$, which will be variable, but the average value of which is evidently $\frac{2N_a V}{60}$.

Since the conductors follow each other in consecutive order, and the sum of the lines cut by all the conductors at each instant is practically uniform throughout the revolution, the total electric pressure developed must be proportional to the average rate of cutting by each conductor multiplied by the number of conductors in series. Or, as above,

$$E = \frac{SN_a V}{10^8 \times 60}$$

In the case of alternating-current dynamos this averaging does not occur, because the number of lines which are cut at each instant by all the conductors in series is variable. Thus, assume that in Figs. 1 and 2 (reproduced from Fig. 36, Vol. I.), the field is altered so

* *Textbook*, Vol. I. Chap. 4.

that it is weakest near the centre ; then the rate of cutting lines no longer varies as a sine curve, but the curve

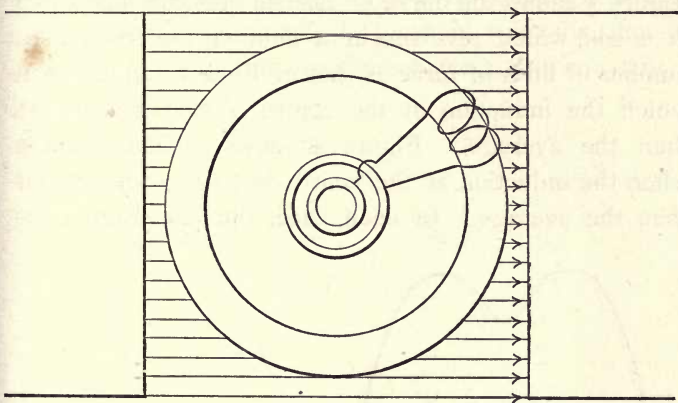

Fig. 1

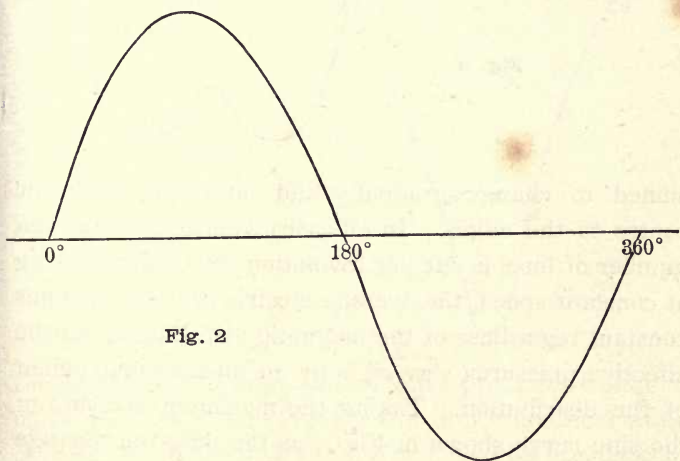

Fig. 2

rises more rapidly in its lower portions and does not reach as great a maximum. If the field be concentrated

towards the centre, the curve becomes higher at the centre, but does not rise as rapidly in its lower portions. Figure 3 shows the curve of electric pressure developed in a coil which revolves in a field of the same total number of lines of force as that of Figs. 1 and 2, but in which the induction at the centre is 50 per cent less than the average. Figure 4 shows a similar curve when the induction at the centre is 50 per cent greater than the average. In each case, the induction is as-

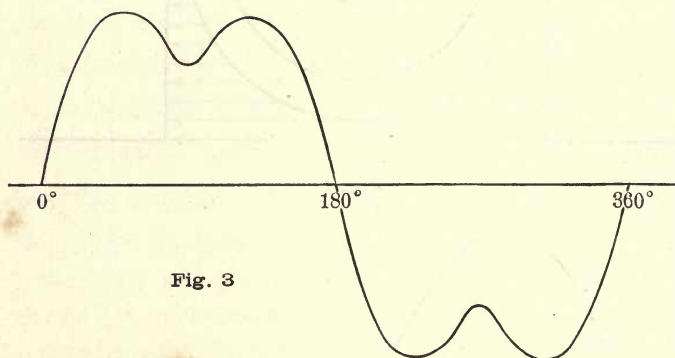

Fig. 3

sumed to change gradually and uniformly from the centre to the edges. In all cases where a certain total number of lines is cut per revolution by a coil revolving at constant speed, the average electric pressure remains constant regardless of the magnetic distribution, but the effective pressure ($\sqrt{\text{av. } e^2}$) is by no means independent of the distribution. Taking the maximum pressure of the sine curve shown in Fig. 2 as the unit, the average pressure in each figure is $\frac{2}{\pi} = .637$ (see p. 82, Vol. I.). The effective pressure of the sine curve shown in Fig. 2

is $\frac{1}{\sqrt{2}} = .707$. The maximum pressures shown in the curves of Figs. 3 and 4 are .81 and 1.5, and the effective pressures are .58 and .85. If the field were distributed as in Fig. 5 (the total magnetization remaining constant),

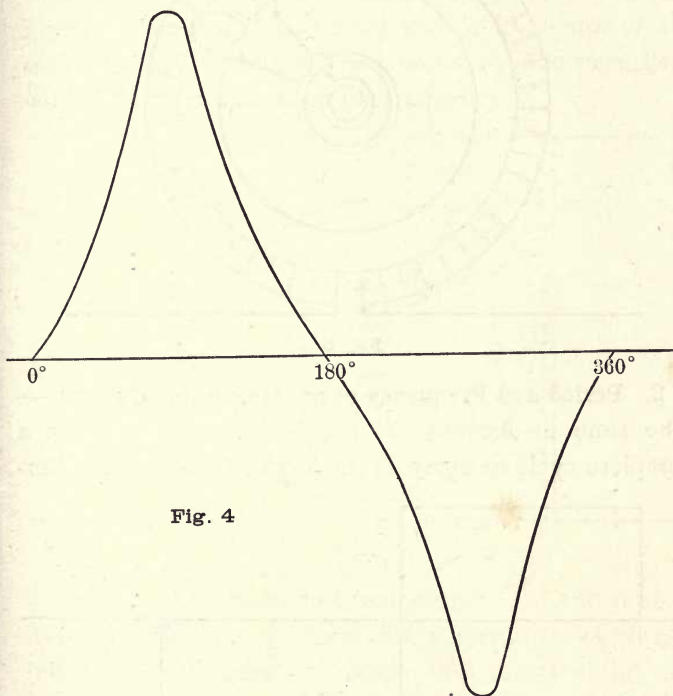

Fig. 4

the maximum, average, and effective pressures would be equal to each other (Fig. 6), and of a numerical value of .637. On the other hand, if the field be greatly concentrated towards the centre, as in Fig. 7, the maximum pressure is very great, and the effective pressure is con-

siderably greater than the average, though it by no means approaches in value the maximum pressure.

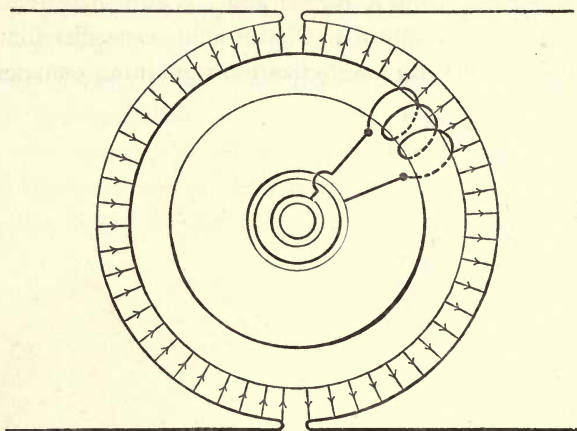

Fig. 5

2. Period and Frequency of an Alternating Current. —

The time in seconds, T , required to pass through a complete cycle or curve is called the **Period** of an alter-

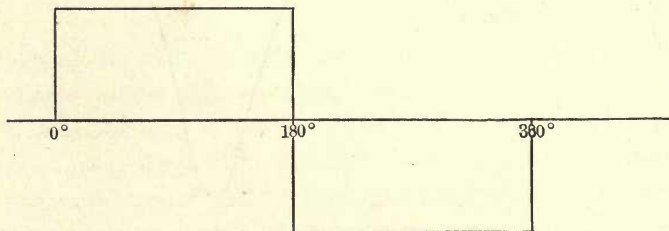

Fig. 6

nating electric current or pressure. The number of periods in a second is called the **Frequency** of the current or pressure (this term was adopted by the Paris

Electrical Congress). Usually an alternating current or pressure is designated by its *effective value and frequency*. It is quite common, however, to use the number of half-periods, or the number of **Alternations** in a minute, instead of the frequency. In this case, the number of alternations is equal to $2 \times 60 \times$ the frequency. Example: a current with a frequency of 100 makes 12,000 alternations per minute. The term **Periodicity** is sometimes used for frequency.

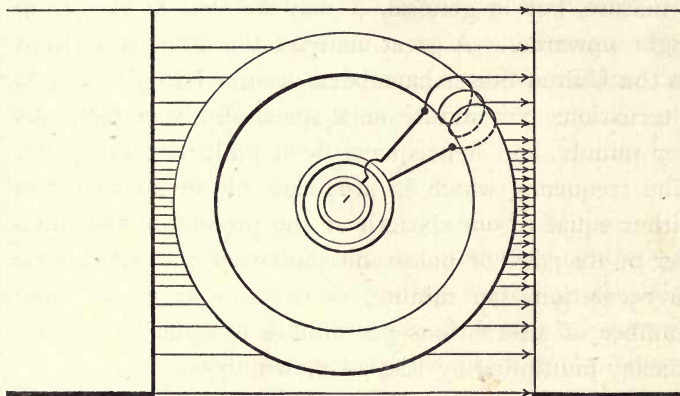

Fig. 7

For the general commercial purposes of the present day the frequency of alternating currents varies widely, but nearly all cases fall within the limits of 40 and 135 (4800 and 16,200 alternations per minute). The majority of American alternating-current dynamos, or **Alternators**, give a frequency of between 120 and 135, but in Europe a somewhat lower frequency is more common, and a frequency of 60 is coming into quite general use in this country. The rotation of a coil in a

two-pole field gives one complete period, or two alternations, for each revolution, and the frequency is therefore equal to the number of revolutions per second. Since the armatures of two-pole machines would be required to run at an impracticable speed in order to give the ordinary commercial frequencies, alternators are nearly always made with a considerable number of poles. The number of poles depends upon the size of the alternator and other conditions which may control the speed of the armature, but in general, it may be said to vary from eight upwards. A great many of the alternators built in the United States have been designed to give 16,000 alternations per minute at a speed of 1600 revolutions per minute, and hence have been built with ten poles. The frequency which is produced by an alternator is either equal to one-sixtieth of the product of the number of its pairs of poles and the speed of its armature in revolutions per minute, or is twice as great. The number of alternations per minute is equal to the frequency multiplied by 120, as shown above.

3. Field Excitation of Alternators. — As an alternating current will not serve to magnetize the fields of dynamos, some arrangement for obtaining a direct current must be made for the excitation of alternators. This may be done either by commutating or rectifying all or a part of the alternating current produced by the machine, or a small auxiliary continuous-current dynamo called an **Exciter** may be supplied for the purpose. Sometimes the exciter is mounted on the bed plate of the alternator (compare Sect. 71).

4. Effective Pressure. — Assuming that the armature

conductors are so arranged that all may be effective, it is seen from what has preceded that the average pressure developed by an alternator is $\frac{2 S' N_a V \rho}{10^8 \times 60}$, where S' is the number of conductors in series, N_a is the number of lines of force passing through the armature in each magnetic circuit (emanating from each pole), and ρ is the number of pairs of poles. If the windings of the armature are all connected up in series, as is common, this becomes $\frac{2 S N_a V \rho}{10^8 \times 60}$, where S is the number of conductors on the armature. From p. 278, Vol. I., it is seen that in multipolar continuous-current dynamos with series-path armatures,

$$E = \frac{S N_a V \rho}{10^8 \times 60}$$

Now, assuming two machines, one producing continuous currents and the other alternating currents, in which S , N_a , V , ρ , are equal, the formulas show that the *average* electric pressure developed in the alternator armature with its conductors all in series is twice that developed in the continuous-current armature with halves in parallel. The *effective* alternating pressure of commercial machines has been shown to be usually greater than the average pressure. Calling the ratio of effective to average pressure k , it is seen that the effective pressure of the alternator with armature conductors all in series is $2k$ times that of the continuous-current machine. On the other hand, in the continuous-current armature two paths exist for the current against one in the alternator armature. Consequently, the out-

put of the alternator armature is only k times greater than that of the continuous-current armature. The value of k when the current curve is sinusoidal is $\frac{1}{\sqrt{2}} \div \frac{2}{\pi} = 1.11$. Hence the electric pressures are to each other as 1 : 2.22, and the outputs are in the ratio of 1 : 1.11. The windings on alternator armatures are frequently connected so that the two halves are in parallel, instead of in series, in which case the pressure developed with a given number of conductors is halved, but the current capacity is at the same time doubled. In this case both the pressures and outputs of the continuous- and alternating-current machines have the ratio of 1 : 1.11. The value of k in commercial alternators depends upon the ratio which the width of the poles bears to the pitch (distance between poles, centre to centre) and upon the relative arrangement of the windings. It has been shown (Sect. 1) to have a minimum limit of unity and a maximum limit which may be very great. In commercial machines it may be said to generally lie between about 1 and 1.25.

5. The Effect of Differential Action by the Armature Conductors. — It is now well to examine the relative sizes of the two armatures compared above, and the effect of the arrangement of the windings upon the pressure developed. Thus far the alternator windings have been assumed to be in narrow coils, or arranged so that the conductors are equally effective at every instant. This cannot be the case in actual machines, as the coils must have appreciable width. If two collecting rings are placed upon the shaft of a contin-

uous-current armature, such as a Gramme ring, and connected to armature conductors which are in opposite coils, an alternating current may be taken from the rings. The electric pressure between the rings has its maximum when the conductors connected to the rings are under the points of commutation, and the pressure is zero when the armature has revolved 90° (compare Vol. I., p. 90). (In the case of a narrow coil, the latter point is the point of *maximum pressure*.) The maximum of the alternating pressure must be equal to the continuous pressure for which the armature was designed, and the effective alternating pressure is .707 times the continuous pressure if the field is uniform. In commercial machines the field is not uniform, but it is not likely to be sufficiently irregular to materially disturb the ratio of the continuous and effective alternating pressures when the armature is carrying little current. When the armature carries considerable current, armature reactions may disturb the relations to a greater or less degree. An armature thus arranged, with the conductors uniformly distributed over its surface, gives a sine alternating current. The value of k is therefore 1.11; but the effective alternating pressure is only .707 times that of the continuous pressure developed by the same conductors. The question at once arises as to the cause of this loss of 40 per cent or more. A little consideration shows that the Gramme ring acts like two broad coils in parallel, which cover the whole armature and unite at the points where the collecting rings are connected. When in the position of zero pressure the two halves of each coil are so located in the field

as to cut lines in opposite directions, and hence the pressure is zero. Similar differential action is found when the coils cover only a portion of the armature, the extent of the effect depending upon the ratio of the width and pitch of the poles to the width of the coils. It is almost entirely avoided if the coils are never wider than the distance between the pole tips. On account of this differential action, it is necessary to include another constant in the formula for the electric pressure developed by alternating-current armatures. Calling this constant k' , and replacing the product $k'k$ by K , the formula becomes $E = \frac{2KSN_aVp}{10^8 \times 60}$. Kapp states that K varies from .29 to 1.15,* but in the greater number of commercial cases it is between 1.00 and 1.11.

The output of an alternator is proportional to the product $SN_a = s\omega bw'$, where s is the number of conductors per unit width of coil, b the number of lines of force per unit width of pole face, and w and w' are respectively the widths of coil and pole face. In order to economize material, the distance between pole tips may be taken as equal to the width of coil, and this makes $w + w'$ equal to the pitch of the poles, which is constant; this makes the product ww' , and hence the output of the machine, a maximum when w is equal to w' , or when the width of coil and pole face are each equal to half the pitch. The result thus derived must be modified to suit practical conditions, since fringing tends to increase the width of field, and armature reac-

* Kapp's *Dynamos, Alternators, and Transformers*, p. 374.

tions tend to crowd the field towards the trailing pole tip, thus narrowing the field. Experiment has shown that it is best to have the coils somewhat wider than half the pitch, and it is often advantageous to have the poles of slightly less width.*

6. Relative Dimensions of Continuous- and Alternating-Current Dynamos. — From this discussion it is seen that only about one-half the surface of alternator armatures should be covered with wire, so that the construction is quite different from that of continuous-current armatures. With a fixed size of armature and depth of winding it is apparent that an alternating-current armature will carry only about half as much wire as is carried by a similar continuous-current armature. In order to gain an equal output from the machines, it is therefore necessary to increase either the size of the alternator armature or its speed. Both of these devices are used in common practice, and it is not unusual for an alternator armature to be run at a surface speed upwards of 7000 feet per minute. The attached table shows, to some degree, how far the effect of the difference in the lengths of the wire on the armatures is overcome in practice. In the comparison, it must be remembered that the induction in the alternator is usually considerably less than that in continuous-current machines (compare Sect. 61).

* Compare Elihu Thomson in *Proc. Institution of Civil Engineers*, Vol. 97, p. 101.

ALTERNATORS.

| Designation. | Revolutions per Minute. | Diameter rev. part. | Periphery Speed. | Frequency. | Conductor. Inches per Volt. | Capacity in K.W. |
|--------------|-------------------------|---------------------|------------------|------------|-----------------------------|------------------|
| 1 | 1200 | 18" | 5700 | 100 | 8 | 15 |
| 2 | 600 | | | 60 | 14.5 | 30 |
| 3 | 1500 | 18" | 7100 | 125 | 14 | 35 |
| 4 | 1500 | 18" | 7100 | 125 | 9 | 35 |
| 5 | | | | | 22 | 40 |
| 6 | 400 | 52" | 5400 | 86 | | 40 |
| 7 | 500 | | | 83 | 11.2 | 50 |
| 8 | 1650 | 18" | 7800 | 138 | | 50 |
| 9 | 600 | 48" | 7500 | 70 | 15 | 60 |
| 10 | 600 | 42" | 6600 | 100 | 9.6 | 120 |
| 11 | 1080 | 24" | 6500 | 144 | 15 | 140 |
| 12 | 335 | 66" | 5800 | 67 | 15.2 | 225 |

CONTINUOUS-CURRENT DYNAMOS.

| Designation. | Revolutions per Minute. | Diameter of Armature. | Periphery Speed. | Conductor. Inches per Volt. | Capacity in K.W. |
|--------------|-------------------------|-----------------------|------------------|-----------------------------|------------------|
| 1 | 1750 | 6.25 | 2850 | 10 | 6 |
| 2 | 2750 | 4.5 | 3200 | 11.5 | 6 |
| 3 | 800 | 10 | 2200 | 24 | 7.5 |
| 4 | 460 | 17.5 | 2250 | 26 | 20 |
| 5 | 900 | 12.5 | 3000 | 18 | 35 |
| 6 | 1650 | 12 | 3300 | 15 | 35 |
| 7 | 800 | 10 | 2100 | 13 | 35 |
| 8 | 530 | 14 | 1950 | 18 | 50 |
| 9 | 700 | 15.5 | 2850 | 18 | 55 |
| 10 | 900 | 16 | 3800 | 18 | 60 |
| 11 | 400 | 15.5 | 1600 | 26 | 70 |
| 12 | 450 | 17.5 | 2050 | 20 | 80 |
| 13 | 400 | 25 | 2600 | 19 | 150 |

CHAPTER II.

ARMATURE WINDINGS FOR ALTERNATORS.

7. **Classification of Armatures.**— Referring to page 93 of Volume I. it will be seen that dynamo armatures are classified under three divisions :

1. Where a wire cuts lines of force by moving across them, as in the case of a slider or of a wire moving around a magnet pole.

2. Where a coil, or set of coils, is moved parallel to itself, or nearly so, between points of different field strength.

3. Where a coil, or set of coils, is wound on a ring or drum and given a rotary motion in a fixed magnetic field.

The first division includes only the so-called unipolar armatures, and requires no treatment here. Alternator armatures are in general classed in the second division.

It is not uncommon for the field to move instead of the armature, and in some cases neither the armature nor field coils move, but the induction through the former is varied by the revolution of iron **Inductors**. Where the field rotates, or the variation of the induction is effected by moving inductors, the electric pressure generated in the armature windings is produced in exactly the same manner as if they moved, and such armatures therefore belong to the second division.

The construction of the machines thus enumerated requires an additional classification into :

1. Alternators with moving armatures.
2. Alternators with moving fields.
3. Inductor alternators.

The armatures of alternators belonging to the first and second of these classes may, for convenience, be divided into four classes :

- | | |
|--------------------|--------------------|
| 1. Drum armatures. | 3. Disc armatures. |
| 2. Ring armatures. | 4. Pole armatures. |

8. Drum Armatures. — Drum-wound alternator armatures are always chord-wound (see p. 273, Vol. I.). In two-path chord-wound continuous-current drum armatures, the individual turns of each armature section cross each other on the heads in very much the same way as in armatures for two-pole machines (Fig. 8). An exactly similar arrangement may be used in winding alternating-current armatures, but the armature surface is not entirely covered with wire (Fig. 9). Since either the whole or one-half of the armature wire is connected permanently in series and only the ends of the windings are carried to collecting rings, there is no advantage to be gained by permitting the wires to cross each other in alternator armatures. The crossing of the wires, on the other hand, presents a positive disadvantage by increasing the difficulty of satisfactorily insulating them. This is particularly marked on account of the high pressures for which alternators are commonly built. The winding of alternator

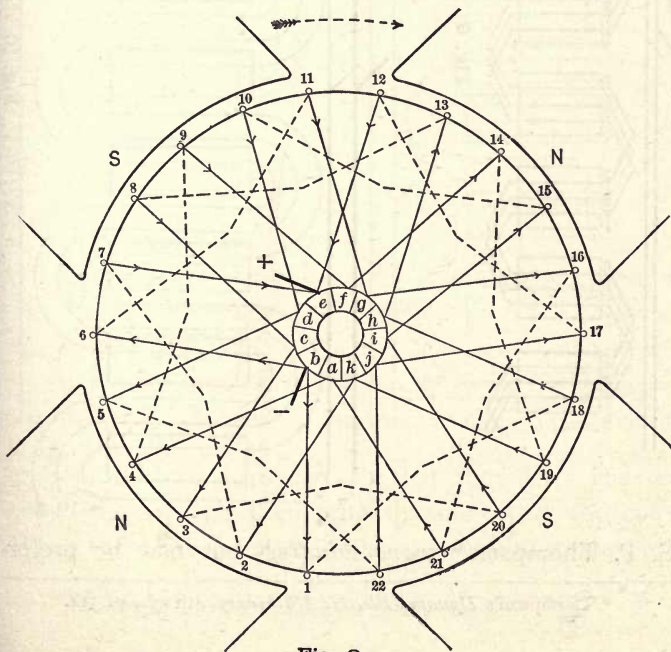
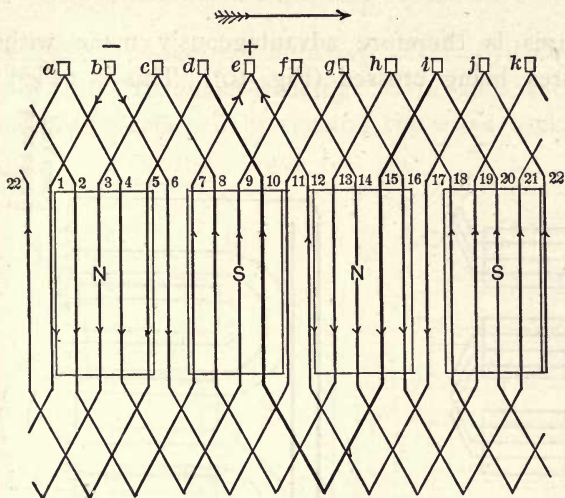

C

Fig. 8

armatures is therefore advantageously made without the wires being crossed (Fig. 10). This is called by

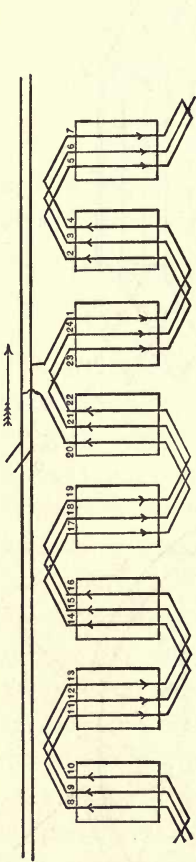

Fig. 9

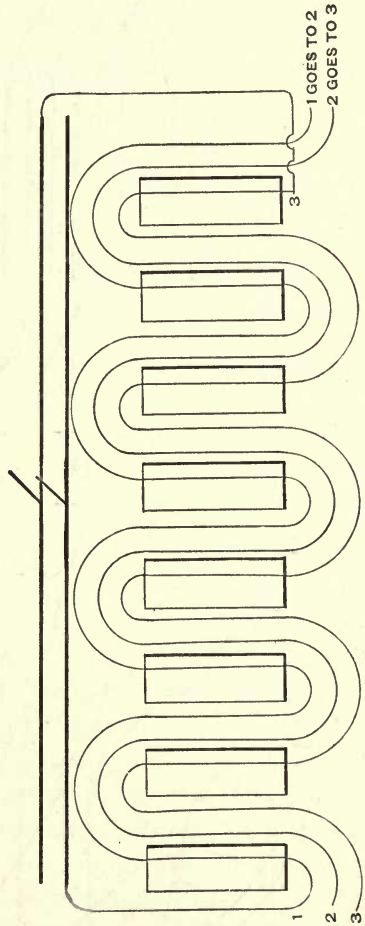

Fig. 10

S. P. Thompson * *wave winding*, but may be prefer-

* Thompson's *Dynamo-Electric Machinery*, 4th ed., p. 314.

ably called *undulatory winding* after Fritsche,* or better still, **Continuous Winding**. The same result may evidently be obtained by turning the wires back at the

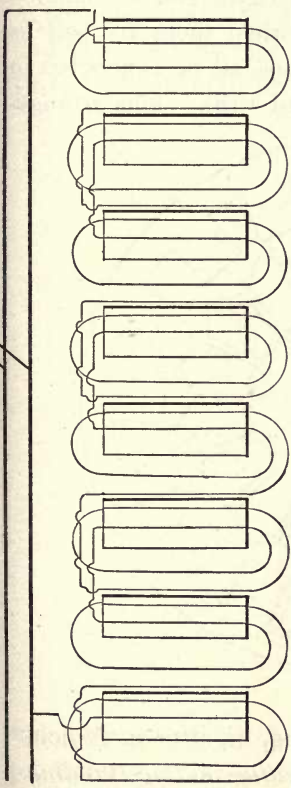

Fig. 11

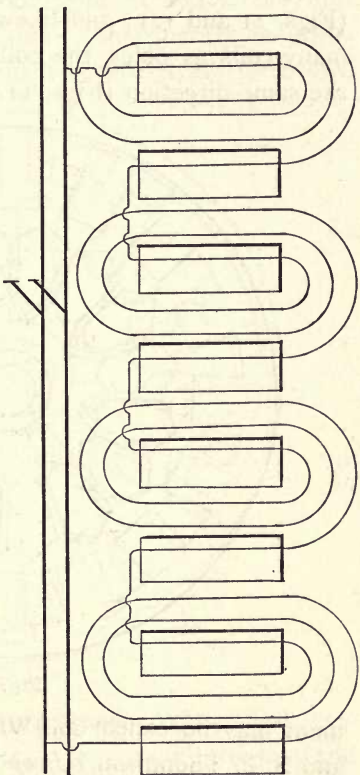

Fig. 11a

ends of the armature core so that they form isolated coils (Fig. 11), and then properly connecting the coils. When there are as many coils as poles, alternate coils

* Fritsche's *Die Gleichstrom Dynamomachine*, p. 43.

are moving at any instant under poles of opposite signs, and the electric pressures developed in them are in opposite directions. They must therefore be so connected that they are alternately right- and left-handed (Figs. 11 and 12); and likewise when there are half as many coils as poles, the coils must all be connected in the same direction (Figs. 11*a* and 12*a*). This arrange-

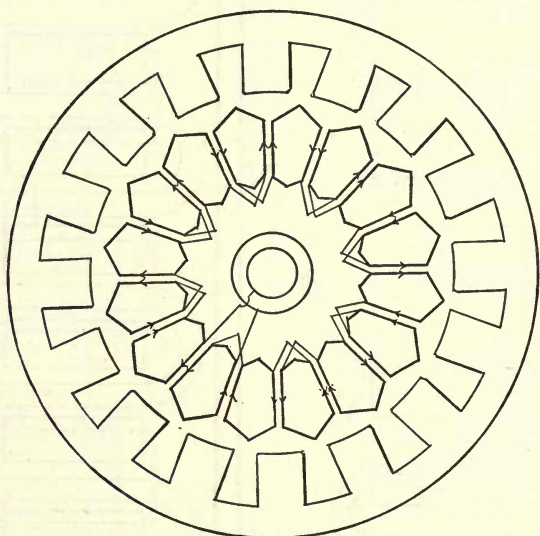

Fig. 12

ment may be called **Coil Winding**, or, after E. Arnold* and S. P. Thompson,† *Loop Winding* or *Lap Winding*.‡

As already stated (Sect. 4), alternator armatures are frequently connected with the two halves of the wind-

* *Die Ankerwickelungen der Gleichstrom-Dynamomachinen*, p. 13.

† *Dynamo-Electric Machinery*, 4th ed., p. 314.

‡ For numerous diagrams of alternator windings see Parshall and Hobart's *Armature Windings*, Chap. 12.

ings in parallel. In this case, the coils must be connected in each half so that they are alternately right- and left-handed, but where the halves join, both the coils must be either right- or left-handed (Fig. 13). When the coils are all connected in series, the first and last coils lie side by side; consequently in armatures built for high pressures a severe strain is thrown

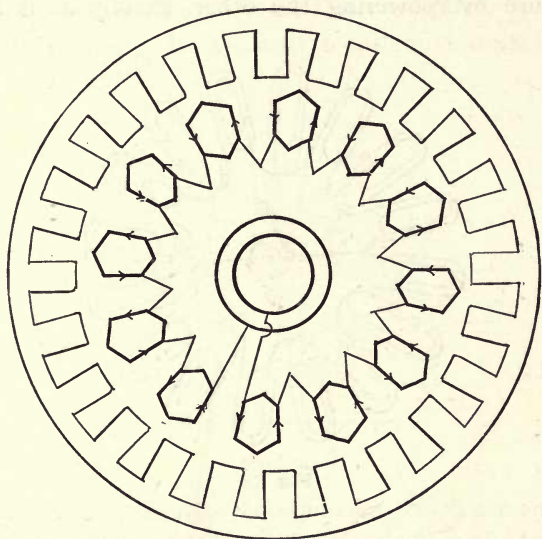

Fig. 12a

upon the insulation separating them. When the halves of the armature are connected in parallel, the first and last coils lie on opposite sides of the armature, and effective insulation is therefore less difficult of attainment. In this case, the pressure between adjacent coils cannot be greater than the total pressure divided by half the number of coils. When the coils are all in

series the pressure between any adjacent coils, excepting between the two end coils, is equal to the total pressure divided by the total number of coils. When an alternator armature is connected with its halves in parallel, every precaution must be taken to make the pressures developed in the two halves equal at every instant; otherwise there is danger of one portion of the armature overpowering the other, exactly as is some-

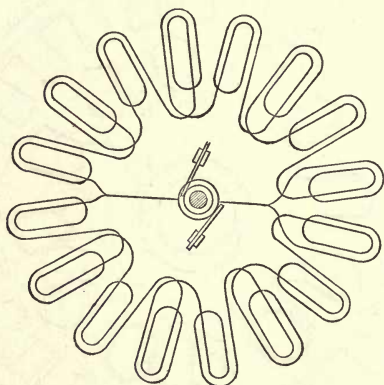

Fig. 13

times the case in multipolar continuous-current armatures (Vol. I., p. 275).

The armature conductors may lie upon the surface of the core or be imbedded below it. Where toothed cores are used, the teeth are equal in number to the number of coils, and the armature approaches the fourth class or pole type. Tothing increases armature reactions and self-inductance, thus interfering with regulation, but it is in general quite advantageous and is coming

into general use by the better class of manufacturers (see Sect. 11).

The coils for alternator drum armatures are ordinarily wound on formers and then fastened upon the armatures after having been well insulated. Where surface windings are used, the coils are frequently arranged to bend down over the ends of the core, as in Fig. 14, where they are securely fastened by end plates, or blocks of wood or fibre. It is usual to fill the spaces in the

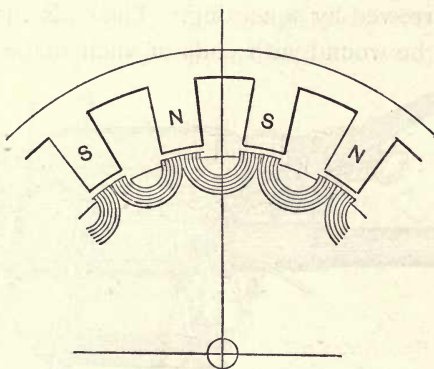

Fig. 14

centres of the coils with wood blocks, which are screwed to the cores or are held by the binding wires. (Examples: Westinghouse and National alternators.) In some machines the coils are flat, or pancake-like, and of the same length as the armature core. In this case they are laid upon the cylindrical surface of the armature core and securely bound with wire bands. (Examples: Thomson-Houston and Elwell-Parker alternators.) The high periphery velocities of alternator armatures make heavy bands essential to the preservation of surface

windings, and all blocking must be securely fastened. The wood blocks which fill the centre of the coils make excellent driving teeth, and therefore serve a good purpose. When imbedded coils are used, they may be made upon formers (lathe-wound), and then applied to the core, or the conductors may be threaded through the grooves, which are well insulated. When the core teeth are T-shaped, the coils may be wound of sufficient width to slip over the head, and when in place they may be narrowed by squeezing. The coils for this purpose must be wound with ends of such shape that they

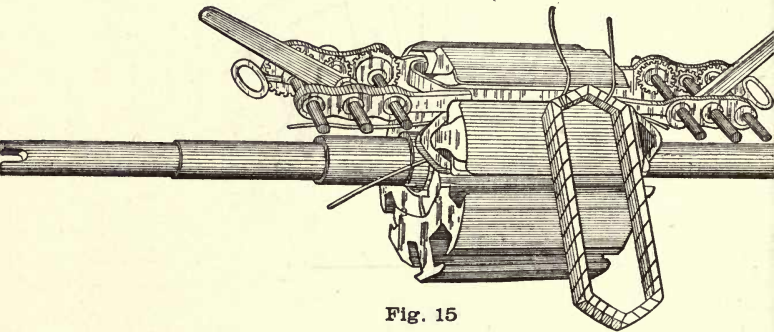

Fig. 15

will bend without injury, as is shown, for example, in Fig. 15. Lathe-wound coils are of decided advantage for armatures designed for high pressures, as their insulation may be made particularly safe. Such coils are usually served with layers of japanned canvas, fuller or press board, vulcanized fibre, and mica. The slots between the core teeth may be made of sufficient area to permit the use of any desirable thickness of insulation, and the teeth make a very complete mechanical protection for the coils. Toothed armatures with lathe-

wound coils should therefore be thoroughly reliable. If the magnetic surface of the armature is fairly complete, the wires are protected from magnetic drag (p. 153, Vol. I.), which decreases the chances of the conductors chafing and therefore injuring the insulation.

9. Ring Armatures. — Ring-wound alternator armatures were early used with commercial success, and some of the old **Magneto Machines** of the De Meritens type with permanent field magnets and ring armatures are still in operation. The invention of the ring armature for alternating-current machines is usually ascribed

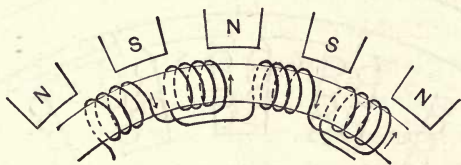

Fig. 16

to either Gramme or Wilde, who independently patented the form in France and England in 1878. In America, ring armatures have not been viewed with as great favor as have drum armatures, probably on account of the smaller mechanical stability in the ring and the greater self-induction in its windings. As in drum armatures, the coils of ring-alternator armatures must be connected alternately right-handed and left-handed (Fig. 16). The ring may be arranged so that the field-magnets surround it, as in Fig. 16; so that it surrounds the fields, as in Fig. 17, in which case the latter usually revolve (examples: Gramme and Siemens & Halske alternators); or with the field poles as a crown upon both

sides of it (example: Kapp alternator). In the latter case, the ring may be of quite large diameter, making the speed of the armature slow. The opposite poles are in this case of the same sign, and alternate poles of opposite sign. An inspection of Figs. 16 and 17 shows that ring armatures must require more wire than drum armatures for a given output, other things being equal, and therefore they must have greater self-inductance. The mechanical arrangement of surface-wound coils is, how-

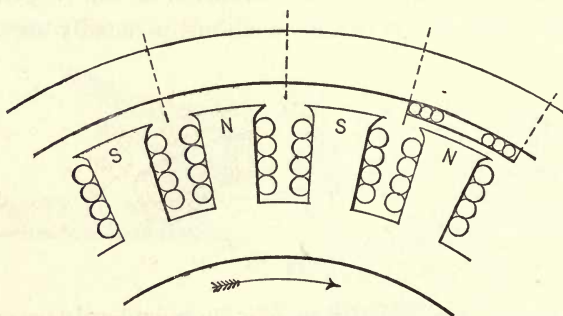

Fig. 17

ever, more secure on the ring, but the advantages of lathe winding cannot be secured. The possibility of a comparatively slow speed of revolution which is possessed by the ring has commended it to some European and English builders of dynamos, but the toothed armature for alternators has not been as fully developed, nor is it as well thought of, there as in America.

10. Disc Armatures. — The disc form of armature for alternators is the earliest that came into service. The first commercial alternator was a magneto-machine (*i.e.* with permanent field magnets) known as the Alliance

dynamo. This was originally devised as early as 1849, but was not developed into commercial form until after 1860. In 1867 Wilde built an alternator with electromagnets and a disc armature. Since that time the disc armature has received much attention in Europe and England, and has been an element of many successful machines. (Examples: Siemens, Ferranti, and Mordey alternators.) The disc has received less attention in America than it deserves, and is here represented by but few machines that are in commercial service. This may be partially due to the essential peculiarity of the disc, which admits of no iron core, and is therefore difficult to build in a substantial and workmanlike manner. That this difficulty can be overcome is shown by the success of foreign alternators with disc armatures. Disc armatures may be wound either with coils or with continuous windings, as shown in Fig. 18. Either the armature or the field may revolve. (Examples: Ferranti alternator, Mordey alternator, Brush alternator.) The absence of iron in disc armatures reduces the losses due to hysteresis and Foucault currents to a minimum, but it is likely to require an increase in the depth of the air gap. Hence a greater magnetizing current is likely to be required, or many turns must be placed upon the armature. That this difficulty also can be overcome is shown by the small amount of energy required to magnetize the Mordey alternators. In a 75-kilowatt machine of this type, the C^2R loss in the armature is 2.3 per cent and in the field 1.5 per cent, which compares favorably with continuous-current machines (see Vol. I., pp. 108 and 138). The curve of electric pressure in

disc armatures is, in general, quite near to that of a sine function. The first experimental determination of the form of the curve was made in 1880 by Joubert, who experimented upon a Siemens machine having a disc armature. The curve proved to be practically a sinusoid. This is also true of the curve of pressure developed by a Mordey alternator. In iron-cored ma-

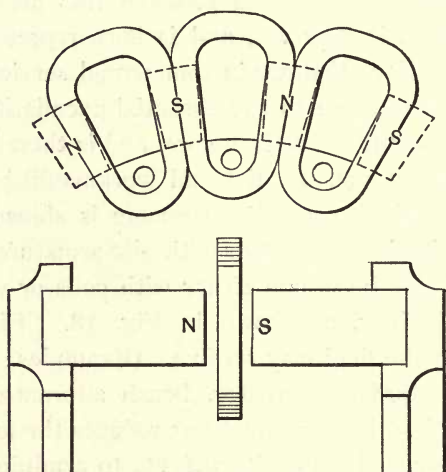

Fig. 18a

chines, armature reactions have a more apparent distorting effect and therefore modify the form of the curve (sometimes to a considerable degree). The variation is usually not great in surface-wound machines, but when imbedded armature conductors are used, the curves deviate widely from a sinusoid and sometimes become quite irregular.

11. Pole Armatures.—As already stated (Sect. 8), there is, in general, no distinct division between pole

armatures and drum armatures with imbedded conductors. In order to avoid foucault currents in the pole pieces, and sharp corners in the curves of armature pressure, precautions must be taken to make the magnetic surface of toothed armatures uniform, exactly as is done in the case of toothed continuous-current

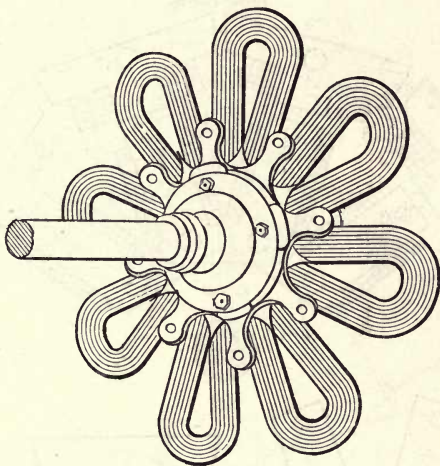

Fig. 18 b

armature cores (Vol. I., p. 154). If this is not done, it is necessary to thoroughly laminate the field magnets, since the fluctuations of the induction in the pole pieces, and sometimes in the whole magnetic circuit, are likely to become very much greater and more rapid than ever occurs in continuous-current machines. (Example: Ganz alternator.) This ordinarily entails an excessive expense, but in the Ganz alternator the use of segmental punchings for both field and armature

(Fig. 19) probably reduces the extra cost of the construction to some extent. The effect of a uniform reluctance in the magnetic circuit may be gained by placing narrow, deep armature coils in grooves as shown in Fig. 20. (Example: Gülcher alternator.) This is similar in many respects to the earliest alter-

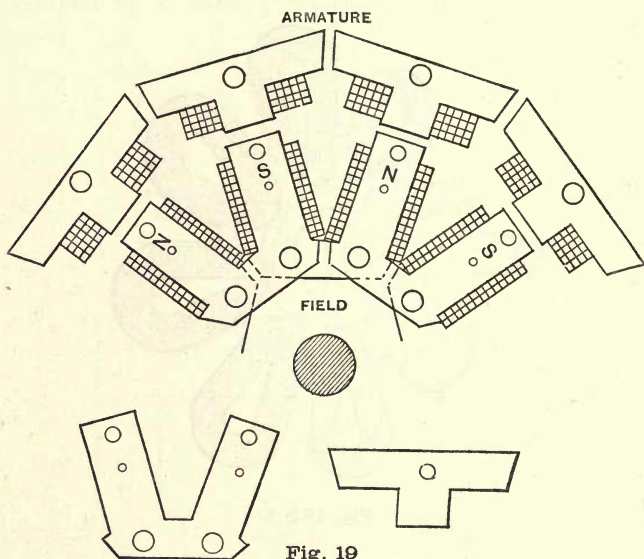

Fig. 19

nator in which the pole type of armature was used, which was built by Lontin without provision being made to secure an unvarying reluctance. If the pole pieces of both field and armature are made wide and quite close together, the changes in the reluctance of the magnetic circuit probably may be reduced so as to be practically negligible (example: Hopkinson alternator), but armature reactions and magnetic leakage

must be much increased by this construction (Fig. 21). In alternators having pole armatures, it is evident that either the fields or the armatures may be arranged to revolve.

12. **Collectors.** — In alternators having either type of armature here described, a portion of the magnetic cir-

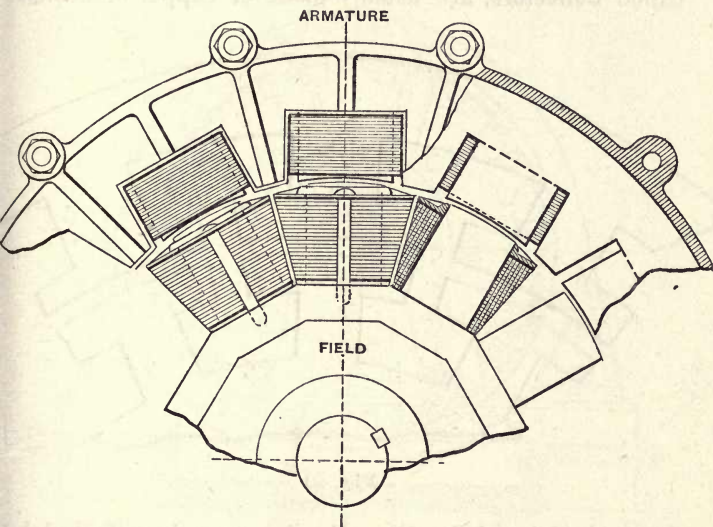

Fig. 20

cuit which carries either the field or the armature windings must be arranged to revolve. In some cases where the field magnets compose the revolving part it is possible to arrange the construction so that the magnetizing coils may remain stationary, but mechanical considerations usually render this inadvisable. It may, therefore, be said generally that either the armature or field windings must revolve with the iron on which they are wound.

This makes essential the use of some means for conveying the current to and from the revolving coils. In either case, no commutation is required, and therefore plain, insulated **Collecting Rings** serve the purpose when they are properly mounted on the shaft so that brushes may be arranged to bear against them. These rings, often called **Collectors**, are usually made of copper or bronze.

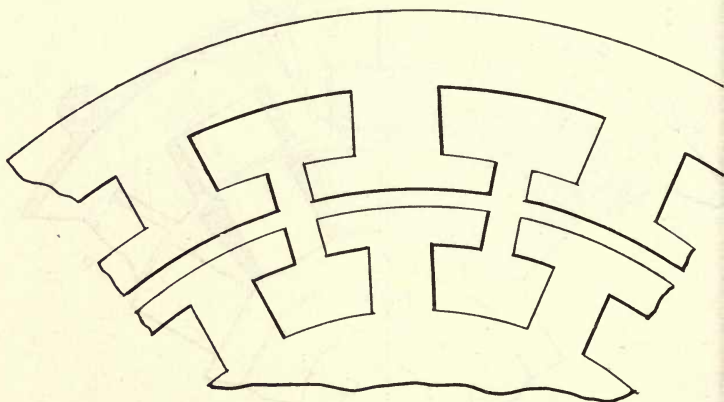

Fig. 21

Instead of brushes, the collection may be effected by means of flexible, weighted copper bands hung over the rings or by similar arrangements (Fig. 22). By the latter construction a large collecting area may be gained without unduly increasing the width of the rings. The current collected, per square inch of collecting contact, usually varies between 100 and 500 amperes. The safe limit is fixed by heating alone, and therefore may be quite large without danger. If mechanical considerations required it, doubtless more than 500 amperes per

square inch of contact might be satisfactorily collected. but as such extreme cases do not often arise, it is not generally advisable to exceed 200 amperes per square inch.

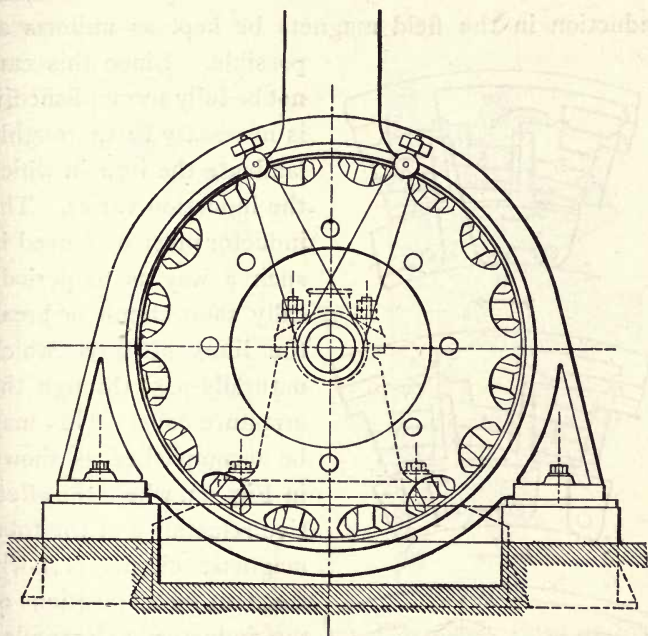

Fig. 22

13. Inductor Alternators. — The windings of inductor alternators may be made entirely stationary, thus avoiding collecting devices. (Examples: Stanley and Warren alternators.) These devices, however, are of so little expense in construction and material that there is no marked advantage in suppressing them, and the mechanical and magnetic difficulties encountered in the design and construction of inductor alternators has not

permitted them to come into general use, though there are several theoretical points of advantage presented in their design. In order to avoid excessive losses due to foucault currents and hysteresis it is important that the induction in the field magnets be kept as uniform as possible.

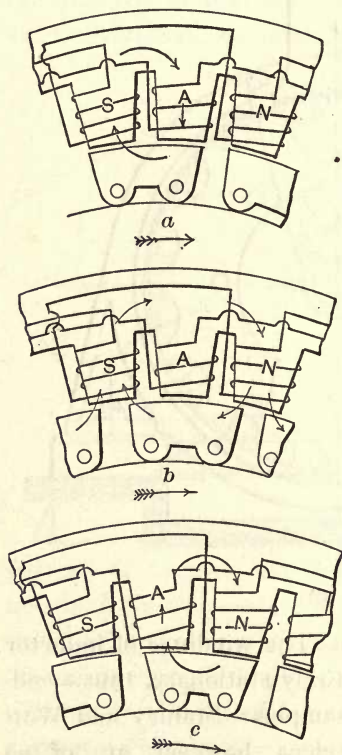

Fig. 23

also vary with the position of the inductor. In Figs. 24, 25, and 26 are shown two types of inductor machines in which no attempt is made to keep the magnetic cir-

cuit as uniform as possible. Since this cannot be fully accomplished, it is necessary to thoroughly laminate the iron in which the induction varies. The inductor must be moved in such a way as to periodically short-circuit or break the lines of force which naturally pass through the armature coils. This may be accomplished as shown in Fig. 23, where the effective reluctance of the total magnetic circuit is fairly constant for all positions of the inductor. (Example: Kingdon alternator.) The figure shows that the reluctance cannot remain entirely constant, and that the effective ampere turns in the magnetic circuits

cuit of constant reluctance, but in the latter the iron in the fields has been reduced to the minimum bulk. Each of these forms gains some economy in construction by uniting the coils. (Examples: Stanley, Royal, and Warren alternators.)

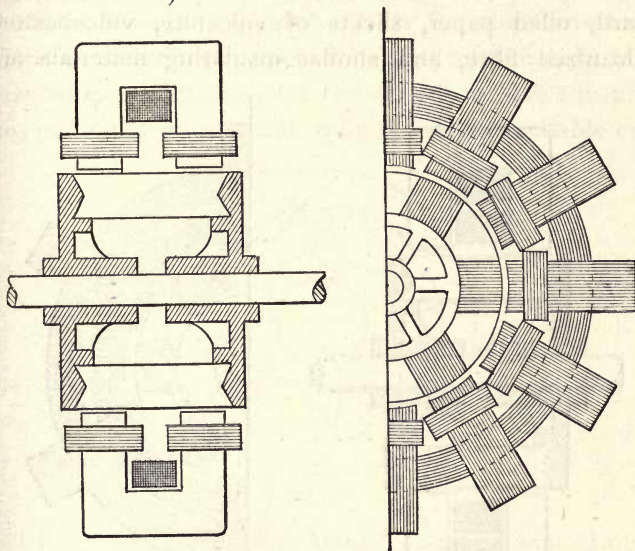

Fig. 24

In the Stanley and Warren alternators lines of force are caused by the motion of the inductor to sweep across the armature coils, while the total magnetism in the inductor remains fairly constant. The field windings embrace the inductor core, and the machines are not true inductor alternators but would be properly classified as machines having drum armatures and field magnets of a modified Mordey type.

14. Armature Insulating and Core Materials.—Before the conductors are placed on an armature core it is

usual to insulate it, very much as in the case of a continuous-current armature (Vol. I., p. 104), but more thoroughly on account of the high pressures usually produced in alternator armatures. For this purpose mica, micanite, mica cloth, shellacked canvas, fuller board, oiled paper, sheets of vulcanite, vulcabeston, vulcanized fibre, and similar insulating materials are

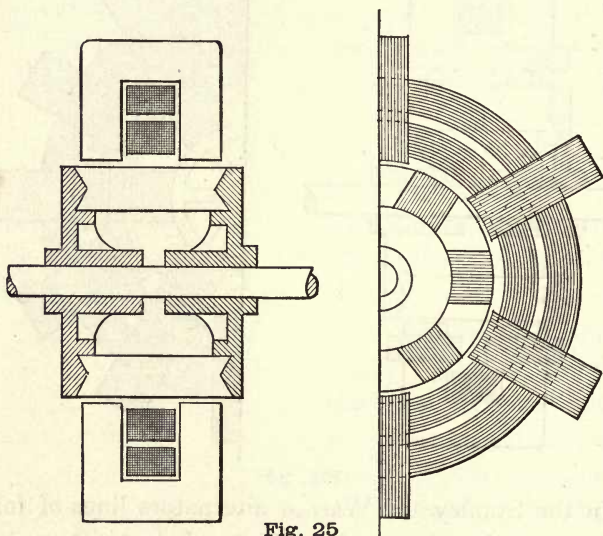

Fig. 25

used. Mica, micanite, vulcanite, vulcabeston, bonsilate, vulcanized fibre, asbestos paper, and similar materials are also used to insulate collecting rings and brush holders, and for insulation between the armature coils. The wire used for high-pressure alternator armatures is often triple-cotton covered, and is thoroughly japanned during the process of winding. Vulcanized fibre is made from paper fibre by a chemical process and is furnished

in sheets and tubes. Its convenient form, cheapness, and ease of working have brought it into extensive use. It unfortunately absorbs moisture when exposed to the air, which causes it to expand and contract to a remarkable degree. The moisture also reduces its insulating qualities to a large degree. It is therefore unsafe to place entire reliance upon it where continuously high insulation is required. Of the various available insulating materials, mica is the only thoroughly reliable one,

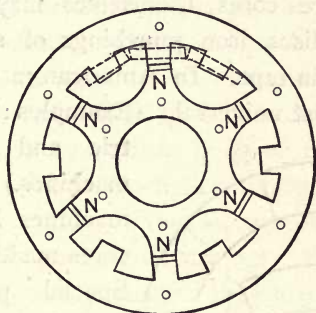

Fig. 26

but it is unduly expensive and of poor mechanical qualities. On the latter account it is generally used in combination with other materials. When made up in the form of micanite by treating with varnish and subjecting to high pressure and heat, its mechanical qualities are somewhat improved, and it may be formed into sheets and tubes or moulded as desired.* Materials such as vulcabeston and bonsilate are advantageous for insulating collector rings and similar details, since they can be moulded into any desired form. Vulcabeston, which is a

* *Trans. Amer. Inst. E. E.*, Vol. 9, p. 798.

compound containing rubber and asbestos, is also manufactured in sheets and has quite satisfactory mechanical and electrical properties. Bonsilate is not sufficiently tough for very general service. Boxwood and paraffined maple or mahogany are frequently used for insulation where considerable bulk is required and their mechanical properties will serve, though, as they are liable to be more or less affected by the surrounding condition of humidity, they must be used with care.

The armature cores themselves may be made of punched iron discs, iron punchings of special shapes, iron wire, or iron tape. In American machines the use of discs is almost universal. (Examples: General Electric and Westinghouse machines.)

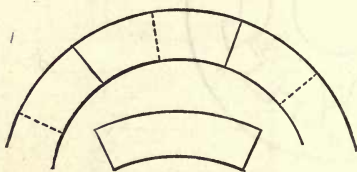

Fig. 27

The Kapp machines have armature cores made of iron tape.* Special punchings are used in machines made by Ganz & Co. (Fig. 19), Siemens & Halske, Gülcher, Elwell & Parker, and other foreign manufacturers, although foreign manufacturers also use punched discs to some extent. In the larger sizes of American machines, which are built for very low speeds to connect directly to steam engines, and therefore have armatures of large diameters, the discs are usually built up out of segmental punchings put together in such a way that the segments of alternate layers break joints (Fig. 27).

* Kapp's *Dynamos, Alternators, and Transformers*, p. 467.

CHAPTER III.

SELF-INDUCTION AND CAPACITY.

15. Self-Induction. — Before proceeding with the development of alternator design, it is essential to discuss the relation which exists between electric pressures and currents in a circuit which carries an alternating current. It is to be remembered that the current produced by cutting lines of force sets up in turn magnetic lines, which are in opposition to the original field. Again, when a current is introduced into a circuit, it produces a magnetic field the rise of which causes a counter electric pressure. These conditions are necessary under the law of conservation of energy and its corollary, Lenz's Law (see Vol. I., p. 77). This counter electric pressure is called the **Electric Pressure** or **Electromotive Force of Self-Induction**, and the phenomenon as a whole is called **Self-Induction**. Therefore self-induction may be defined as the inherent quality of electric currents which tends to impede the introduction, variation, or extinction of an electric current passing through an electric circuit. The electric pressure in a circuit which is due at any instant to self-induction is evidently proportional to the rate of change of the magnetization set up by the current of the circuit; therefore, magnetic reluctance remaining constant, the

electric pressure of self-induction is proportional to the rate of change of current in the circuit, which makes it again proportional to the rate of change of instantaneous pressure producing the current. The pressure which is effective in producing current may be called the **Active Pressure**, to distinguish it from the pressure which is **Impressed** upon the circuit. The latter is called the **Impressed Pressure**. It is evident that the active pressure at any instant is equal to the difference between corresponding instantaneous values of the impressed pressure and of the counter pressure. The

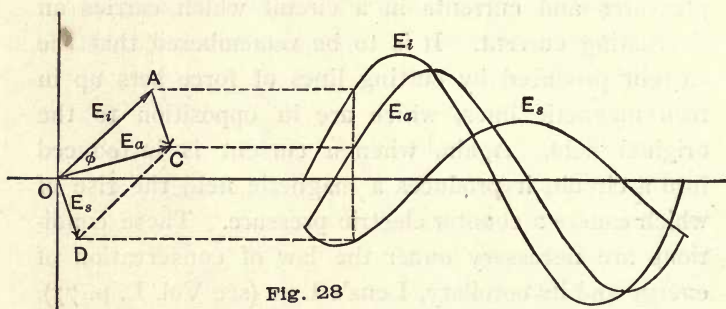
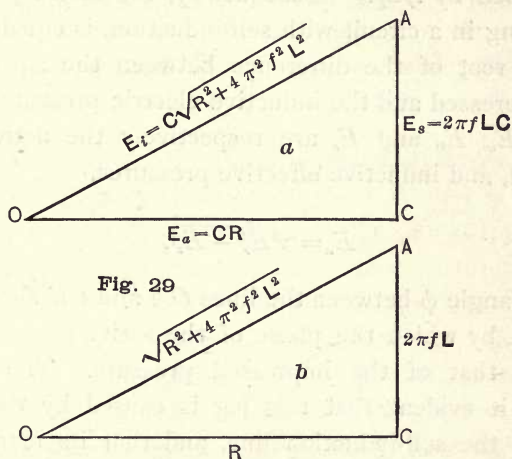

Fig. 28

corresponding instantaneous current in the circuit is given by Ohm's law, $c = \frac{e}{R}$, where c and e are instantaneous current and pressure in amperes and volts, and R is the resistance of the circuit in ohms. A little consideration will show that the **Phase** of the electric pressure of self-induction is not in unison with that of the current, although their periods are the same; because, the counter pressure is proportional to the rate of change of magnetism caused by the current, and, supposing the current to be an alternating one, its rate of

change is zero when it is a maximum, and the pressure of self-induction is therefore zero at the same time. When the curve of current is a sinusoid, the rate of change of its ordinates at any point is proportional to $\frac{d(\sin a)}{dt} = \frac{\cos ada}{dt} = -\frac{\sin(a-90^\circ)da}{dt}$. Hence the curve of counter electric pressure is a sinusoid, the phase of which lags 90° behind the phase of the current, and therefore of the active pressure. Suppose the line



OC (Fig. 28) represents the maximum value of the active pressure. If the line be uniformly rotated around the point O , its end C describes a circle and its vertical projection a simple harmonic motion. At each instant the vertical projection of the line proportionally represents the magnitude of the instantaneous active pressure corresponding to the angular advance of the line. The projection of the line OD , which is 90° behind OC , likewise represents the instan-

taneous counter electric pressure at each instant. The algebraic sums of the instantaneous projections of OC and OD , are always equal to the simultaneous projections of OA . But $\overline{OC}^2 = \overline{OA}^2 - \overline{OD}^2$ or $OC = \sqrt{OA^2 - OD^2}$. The lengths of the lines have been assumed to be proportional to maximum values of pressures, but the effective values of the pressures hold the same relation since each effective value is equal to the maximum multiplied by .707. Consequently, the active pressure operating in a circuit with self-induction, is equal to the square root of the difference between the squares of the impressed and the inductive electric pressures. Or when E_a , E_b , and E_s are respectively the active, impressed, and inductive effective pressures,

$$E_a = \sqrt{E_b^2 - E_s^2}.$$

The angle ϕ between the lines OA and OC shows the amount by which the phase of the active pressure lags behind that of the impressed pressure. The figure makes it evident that this lag is caused by the position of the self-induction line, and that its magnitude depends upon the length of that line. The tangent of the angle is $\tan \phi = \frac{AC}{OC} = \frac{\text{Inductive Pressure}}{\text{Active Pressure}}$. ϕ is called the **Angle of Lag**. The relations are plainly shown in Fig. 29*a*.

16. Self-Inductance. — The pressure of self-induction is proportional to the energy exerted by the current in a coil while setting up the lines of force which surround it (Vol. I., p. 69). Its magnitude is therefore dependent upon the number of lines of force enclosed by the circuit

per unit current, the number of turns composing the circuit, and the current flowing therein. From the reference just given, $E = \frac{ndN}{10^8 dt}$, where E is the pressure of self-induction for the given rate of change of magnetization, n is the number of turns in the coil, and, as before, N is the magnetic flux. But in a long solenoid, $N = \frac{4\pi n' CA}{10}$, where n' is the number of turns per centimeter, and A is the area of the solenoid. Then

$$dN = \frac{4\pi n' AdC}{10} \quad \text{and} \quad E = \frac{4\pi nn' A}{10^9} \times \frac{dC}{dt}$$

$4\pi nn' A$ is called the absolute **Self-Inductance** or the **Coefficient of Self-Induction** of the coil, and is usually represented by the capital letter L . $4\pi n' A$ is equal to the number of lines of force passing through the solenoid when the current is one C.G.S. unit. Hence *the C.G.S. value of the self-inductance of any circuit which is in a magnetic medium of unit permeability, may be defined as the product of the number of lines of force enclosed by the circuit when carrying a unit current, by the number of turns in the circuit, or* $L_a = nN_1$. Since the number of lines of force developed by a coil is proportional to the number of turns composing it, its self-inductance is proportional to the square of its turns. In order that the formula $E = \frac{4\pi nn' A}{10^9} \times \frac{dC}{dt}$ may be written $E = \frac{LdC}{dt}$, the values of C and E being given in amperes and volts, the practical value of L is made 10^9 times as large as that of the absolute unit. The Chicago Electrical Con-

gress has formally declared the name of this practical value to be the **Henry**. The formula plainly shows that the absolute dimension of the C.G.S. unit of self-inductance is one centimeter, and the practical unit is therefore 10^9 centimeters or one theoretical earth quadrant. The name **Quadrant** was therefore at one time assigned to the henry. Since the absolute dimensions of the ohm are that of a velocity equal to one earth quadrant per second,* the dimensions of the henry are equal to the ohm multiplied by one second, and therefore the term **Secohm** (second-ohm), a name suggested by Ayrton and Perry for the unit, came into some use. The use of the name *henry*, in honor of Professor Joseph Henry of Princeton College, was suggested by the American Institute of Electrical Engineers, and was officially adopted by the International Electrical Congress at Chicago.† The name *henry* is therefore now the proper and only name for the unit.

The definition of the henry is developed for a long solenoid in a medium of unit permeability. If the circuit does not comprise a long solenoid, the general definition still holds, as already said, but the summation of the number of lines of force passing through each turn individually must be taken, since the number of lines passing through the turns is a variable which depends upon their position in the coil. Thus, suppose Fig. 30 to represent a short solenoid of eight turns in which are developed ten lines of force when one ampere flows through the coil. Assuming the distribution of the

* Thompson's *Elect. and Mag.*, revised edition, Art. 357.

† *Proceedings International Electrical Congress of Chicago*, p. 18.

lines shown in the figure, the inductance is calculated as follows :

$$\begin{aligned} & \overline{10 \times 2} + \overline{8 \times 2} + \overline{6 \times 2} + \overline{4 \times 2} \\ & = 56 \text{ C.G.S. units, or } \frac{56}{10^9} \text{ henrys.} \end{aligned}$$

If an iron core be now placed in the coil, the number of lines of force will be increased directly

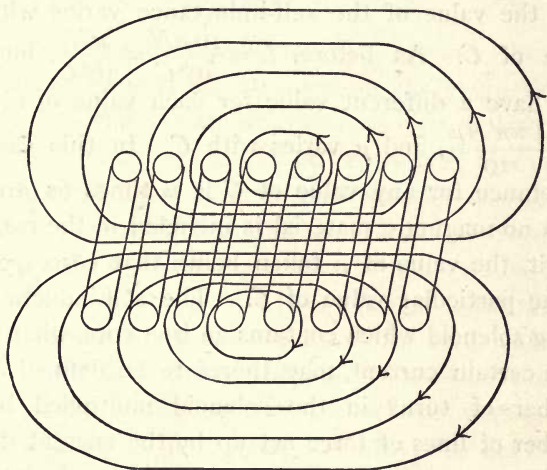

Fig. 30

as the reluctance of the magnetic circuit is decreased. Hence, assuming the distribution of the lines to remain unchanged, the inductance becomes $\frac{56 P'}{10^9 P}$ henrys, where $\frac{P'}{P}$ is the ratio of the reluctance before and after the iron core is inserted. In the case of a long solenoid $L = \frac{4\pi n^2 A}{10^9}$, when the permeability is unity, but when the permeability of

the magnetic circuit taken as a whole is μ , the number of lines of force due to unit current is $\frac{4\pi n' A \mu}{10}$, and therefore $L = \frac{4\pi n n' A \mu}{10^9}$. In general, where the magnetic circuit is composed wholly of non-magnetic material, the self-inductance is $L = \frac{10 n N}{10^9 C} = \frac{n N}{10^8 C}$, and is a constant for all values of C . When iron or other magnetic material is included in the magnetic circuit, the value of the self-inductance varies with the value of C . As before, $L = \frac{10 n N}{10^9 C} = \frac{n N}{10^8 C}$, but this may have a different value for each value of C , since $\frac{N}{C} = \frac{4\pi n' A \mu}{10}$, and μ varies with C . In this case the inductance for any value of C is μ times as great as when no magnetic material is included in the magnetic circuit, the value of μ taken being that corresponding to the particular value of C . The self-inductance of a long solenoid which contains an iron core, when carrying a certain current, may therefore be defined as the number of turns in the solenoid multiplied by the number of lines of force set up by the current divided by the current. As an example of the calculation of the value of L , consider a uniform ring of wrought iron 100 centimeters in mean circumference and 20 square centimeters in cross-section. Suppose a coil of 2500 turns be uniformly wound on the ring, and a current of two amperes be passed through the magnetizing coil. Taking μ as equal to 250, which is a fair value, $\frac{10 N}{C} = 4\pi \times 25 \times 20 \times 250 = 1,571,000$. Hence $L = \frac{2500 \times 1,571,000}{10^9} = 3.93$ henrys. If the current in

the magnetizing coil be taken as $1\frac{1}{2}$, the value of μ becomes roughly 350, and $L = \frac{2500 \times 2,199,400}{10^9} = 5.50$ henrys. If the ring be of brass or other non-magnetic material, the values figure out as follows :

$$\frac{10N}{C} = 4\pi \times 25 \times 20 = 6284,$$

and
$$L = \frac{2500 \times 6284}{10^9} = .0157 \text{ henrys.}$$

In the usual practical problems that are met, the conformation and numerical constants of the magnetic circuit and its windings are unknown, or are so irregular that the self-inductance cannot be determined by calculation, and experimental determination must be resorted to.

At the meeting of the Chicago Electrical Congress a general definition was given for the henry as follows : "As a unit of induction, the henry, which is the induction in a circuit when the electromotive force induced in this circuit is one international volt, while the inducing current varies at the rate of one ampere per second." This is in agreement with the definition already presented.

17. Examples of Self-Inductances.—Ordinary practical experience in electrical measurements and in handling wires soon gives a capacity for estimating the value of resistances ; in the same way facility is soon gained in roughly estimating electrostatic capacities, or the current which may be safely carried by a wire, or even the ampere-turns required to produce a given magnetization in a magnetic circuit. Ordinary practice, however, gives little clue to estimating the self-inductance in a

circuit. It is true that, as already shown, the self-inductance is dependent upon the magnetism enclosed in the circuit and the turns thereof, but experience in dealing with coils and magnetic circuits is not usually regarded in such a way as to aid in estimating self-inductances. The following values of self-inductance are therefore presented here to give a foundation for judgment.*

The range of self-inductances met in practice is very wide. The smallest which are practically met are in the doubly wound resistance coils used for Wheatstone bridges and similar devices. Since the wire in these is doubled back upon itself, the magnetic effect of the current is almost neutral and the inductance is often less than a microhenry. The inductance of a certain electric call-bell of 2.5 ohms resistance has been found to be 12 microhenrys; a telephone call-bell of 80 ohms resistance, 1.4 henrys; the armature of a magneto calling generator of 550 ohms resistance, from 2.7 henrys when the plane of the coil lay in the plane of the pole pieces, to 7.3 henrys when the plane of the coil was perpendicular to the plane of the pole pieces; a Bell telephone receiver measuring 75 ohms, with diaphragm, 75 to 100 millihenrys, without diaphragm about 35 per cent less; mirror galvanometers vary with their resistance from a few millihenrys to 10 or 12 henrys; a mirror galvanometer for submarine signalling of 2250 ohms resist-

* Compare Kennelly on Inductance, *Trans. Amer. Inst. of E. E.*, Vol. 8, p. 2; Sumpner on Measurements of Inductance, *Four. Institution of E. E.*, Vol. 16, p. 344; Modern American Telegraphic Apparatus, *Electrical Engineer*, Vol. 13, etc.

ance, 3.6 henrys; astatic mirror galvanometers of 5000 ohms resistance average about 2 henrys. The single coil of a Thomson galvanometer of 2700 ohms resistance measured 2.56 henrys; the coil of another Thomson galvanometer having 100,000 ohms resistance measured 70 henrys; the coil of an Ayrton and Perry spring voltmeter, without iron core, measured 1.462 henrys. This coil had a length of 2.88 inches, an external diameter of 3 inches, was wound on a brass tube .58 inch in external diameter, and had a resistance of 333.5 ohms. Each of the above measurements was made with a current of a few milliamperes. The following are measurements of telegraphic apparatus:

POLARIZED RELAYS OF VARIOUS TYPES.

| Type. | Resistance in Ohms. | Self-inductance in Henrys. | Testing Current in Milliamperes. |
|-------|---------------------|----------------------------|----------------------------------|
| 1 | 419 | 1.99 | 6.3 |
| 2 | 423 | 1.89 | 6.3 |
| 3 | 413 | 1.69 | 6.3 |
| 4 | 413 | 1.31 | 6.3 |

All armatures were 4 mils from poles.

A common Morse relay of 148 ohms resistance measured 10.47 henrys with the armature against the poles, and 3.71 henrys with the armature 20 mils from the poles, the measuring current being 6.3 milliamperes. In ordinary working adjustment, the inductance of a Morse relay is about 5 henrys. Telegraph sounders with bobbins, respectively, $1\frac{1}{4}$ by 1 and $1\frac{1}{2}$ by $1\frac{1}{4}$ inches, each

wound to 20 ohms resistance, measured 191 and 150 millihenrys, the armatures being 4 mils from the poles and the measuring current being 125 milliamperes. A single coil of a Morse sounder with a resistance of 32 ohms, and having an iron core .31 inch in diameter and 3 inches long, the bobbin being .94 inch in diameter, was found to have a self-inductance of 94 millihenrys. A complete sounder with a core like that of the preceding coil, but with a bobbin of 50 ohms resistance having a diameter of 1.25 inches, was found to have a self-inductance of 444 millihenrys. The self-inductance of a complete sounder of 14 ohms resistance measured 265 millihenrys.

Bare No. 12 B. and S. gauge copper wire erected on a pole line about 23 feet from the ground, is calculated by Kennelly to measure about 8.5 ohms and 3.15 millihenrys per mile; number 6 copper wire under similar conditions is calculated to measure about 2.1 ohms and 2.95 millihenrys. A quadruplex telegraph line, with all instruments in circuit, measures approximately 10 henrys.

The largest self-inductances met in practice are usually in the windings of induction coils or of electrical machinery. The secondary of an induction coil capable of giving a two-inch spark and having a resistance of 5700 ohms, measured 51.2 henrys. The primary of an induction coil which is 19 inches long and 8 inches in diameter, measured .145 ohm and 13 millihenrys, while its secondary measured 30,600 ohms and 2000 henrys. The inductance of dynamo fields is likely to vary from 1 to 1000 henrys; continuous-current dynamo armatures

measure between the brushes from .02 to 50 henrys; the fields of a shunt-wound Mather and Platt continuous-current dynamo built for an output of 100 volts and 35 amperes, measured 44 ohms and 13.6 henrys at a small excitation; the armature of the same machine measured .215 ohm and .005 henry; a Mordey alternator armature of the disc type, with a capacity for 18 amperes at a pressure of 2000 volts, measured 2 ohms and .035 henry; a Kapp alternator armature of the ring type, with a capacity of 60 kilowatts at 2000 volts pressure, measured 1.94 ohms and .069 henry; another Kapp machine, 30 kilowatts 2000 volts, measured 7 ohms and .0977 henry; the fields of a Ferranti alternator measured 3 ohms and .61 henry, while the armature of the same machine built for an output of 200 volts and 40 amperes measured .0011 to .0013 henry, with no current in fields; the primary and secondary windings of transformers measure roughly from .001 of a henry up to 50 henrys, depending upon their output and the pressure for which they are designed.

The effect of the field magnetism upon the self-inductance of a disc-alternator armature is shown by some measurements taken by Dr. Duncan* on a small Siemens eight-pole alternator, the results of which are given in the table on the following page.

Professor Ayrton found that the self-inductance of an unexcited Mordey alternator armature varied between .033 and .038 henry, and that this decreased about 10 per cent when the fields were excited.†

* *Electrical World*, Vol. 11, p. 212.

† *Jour. Institution of E. E.*, Vol. 18, p. 662, also *ibid*, p. 654.

SELF-INDUCTANCE OF ARMATURE IN PLACE.

| Current in Fields. | Position of Armature. | | |
|--------------------|-----------------------|------|------|
| | 0° | 11¼° | 22½° |
| 0. Amperes | .120 | .112 | .100 |
| 2.5 “ | .125 | .115 | .108 |
| 4.5 “ | .128 | .115 | .106 |

Self-induction of armature removed from field, .082 henry; resistance of armature, .7 ohm; pitch of the poles 45°.

18. **The Energy of the Self-Induced Magnetic Field.**— It has been shown (Vol. I., p. 69) that the work done against the electric current when the number of lines of force passing through a circuit is changed, is

$$dW = \frac{-nC dN}{10^8}.$$

If L has a fixed value, then $CdN = NdC$, and

$$dW = \frac{-nNdC}{10^8} = -LCdC.$$

Hence the work stored in the magnetic field when the current changes from a zero value to value C is

$$W = -\int_0^C LCdC = -\frac{LC^2}{2}.$$

When the current again falls to zero, work is restored to the circuit by an amount equal to $\frac{LC^2}{2}$. If L varies, as is the case where magnetic material is in the path of the lines of force, CdN is no longer equal to NdC , but

the work stored in the field still remains $\frac{LC^2}{2}$ if L is given its average value between the limiting values of the current. If there is hysteresis, the average value of L , when going up the curve, is greater than when going down the curve, and the work stored in the field by the increasing current is not all recovered when the current falls again to zero. If a coil be wound on a closed ring of soft iron, which exhibits great retentiveness and coercive force in this form, the value of L is very great if the ring be magnetized by an alternating current. If the ring be magnetized by a rectified periodic current, that is, one which varies uniformly between zero and a maximum, the value of L is practically the same as though the iron core were not present. This behavior is due to the ring continuously retaining the magnetization caused by the maximum current, and since the induction in the core therefore remains constant it does not set up a counter electric pressure. By making a cut in the ring, its coercive force may be reduced so much that the average value of L is practically the same for rectified and alternating currents.

19. Curves of Rising and Falling Currents in a Self-Inductive Circuit. — The work done by the effect of self-inductance is manifested, as already explained, by a counter electric pressure which tends to retard a rising current and to accelerate or continue a falling current. That is, it produces an effect in many respects analogous to the inertia of tangible matter. In the case of the latter, $\frac{MV^2}{2}$, MV , and $\frac{MdV}{dt}$ are respectively the energy, momentum, and rate of change of momentum

of the mass M , when moving at a velocity V ; while in the case of the electric circuit, $\frac{LC^2}{2}$, LC , and $\frac{LdC}{dt}$, may be called the energy, momentum, and rate of change of momentum (counter electric pressure) of its magnetic field. If a circuit having self-inductance be suddenly connected to a source of constant electric pressure, the current does not rise instantly to the value $C = \frac{E}{R}$, but it is retarded so that its rise is always along a logarithmic curve (Fig. 31). When the current has reached

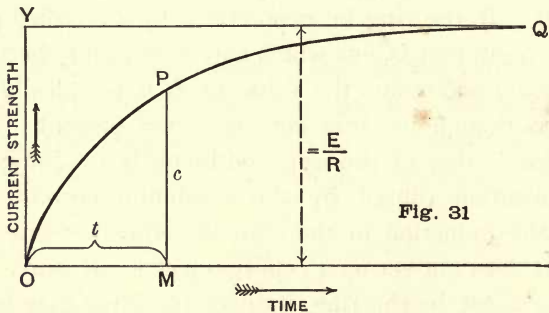

its full value, a smaller quantity of electricity has passed through the circuit during the interval than would have passed if the retardation, or momentum effect, had not been present. This decreased amount of electricity is proportional to the area OYQ between the curve of current and the horizontal line YQ (Fig. 31). The counter electric pressure at any instant during the rise of the current is $\frac{-ndN}{10^8 dt}$, and the instantaneous current which would flow through the circuit under its influence is $c = \frac{-ndN}{10^8 dtR}$. The total quantity of electricity

which would be transferred through the circuit due to a change of the induction from 0 to N is therefore

$$\int_0^i c dt = n \int_0^N \frac{-dN}{10^8 R} = \frac{-nN}{10^8 R} = -\frac{LC}{R}.$$
 This is equal to the deficit of electricity which flows through the circuit in the period during which the current is rising to its permanent value $C = \frac{E}{R}$. If the pressure be sud-

denly reduced to zero, the current does not stop immediately, but falls off along a logarithmic curve, and the quantity of electricity passing through the circuit is increased on this account. The increased quantity is proportional to the area between the curve and the X axis. That this quantity is equal to the quantity of electricity lost in starting the current is shown thus:

The counter electric pressure is, as before, $\frac{-ndN}{10^8 dt}$, and

$$c = \frac{-ndN}{10^8 dt R}. \quad \text{Whence } \int_t^0 c dt = n \int_N^0 \frac{-dN}{10^8 R} = \frac{nN}{10^8 R} = \frac{LC}{R}.$$

This is equal and opposite in sign to the quantity lost upon starting the current. Hence, if the induction passing through the circuit returns to its initial value, exactly the same total number of coulombs passes through a circuit having self-inductance as would pass were there no self-inductance. In the same way if a mass of moving matter be raised from a velocity V to a velocity V' , a certain amount of work is done in accelerating the body; but if after a certain distance has been traversed the velocity be allowed to fall to V again, the work of acceleration is returned and the total work during the cycle is exactly the same as if inertia did not exist in the mass. If the electric circuit have an iron core, the value of the in-

duction may not fall to its initial value upon breaking the circuit, and the energy given up is then not equal to that absorbed in building up the magnetization. The difference in the energy remains stored in the magnetic field in the form of residual magnetism. As an analogue, suppose that when the moving mass assumed above falls in velocity it comes to a velocity V'' , which is greater than the initial velocity V . Then some of the energy expended in acceleration is retained and the summation of the work done during the cycle is increased on account of the inertia of the body.

The condition under which the curves of rising and falling current are logarithmic and of exactly the same dimensions when pressure is applied and withdrawn, instantaneously, from a circuit requires that the resistance of the circuit remain constant. If the circuit is broken, by opening a switch or otherwise, it is an experimental fact that the counter pressure rises much higher than the original impressed pressure, frequently rising to many times its value. The extreme severity of the shock which may be received upon breaking a circuit of large inductance attests the fact. This is due to the exceedingly large increase of resistance in the circuit, introduced by the break. The increase in resistance causes the current to fall off more quickly, and hence a greater rate of change of magnetism. However, as before, the work given out by the field must be

$$W = \int_0^c LCdC = \frac{LC^2}{2},$$

and is equal to the energy stored in the circuit when

the current was introduced; and $q = \int_0^t c dt = \frac{LC}{R}$, which is the same as before. The total number of coulombs transferred being the same and the induced pressure being greater upon breaking a circuit than upon making it, the period of action, t , must be shorter upon the break.

20. The Effect of Self-Inductance in Divided Circuits. Application to a Shunted Ballistic Galvanometer. — The fact that the total quantity of electricity which passes through a wire when subjected to a transient electric pressure is independent of the self-inductance of the circuit, as is shown above, has a bearing upon the distribution of current in divided circuits. With no external disturbing factors, it is apparent that where a transient electric pressure is impressed upon parallel circuits of different inductances, the number of coulombs which flow through each circuit would also flow were the circuits without self-inductance, but the phase of the flow in each circuit is retarded so as to lag behind that of the pressure by an amount which is proportional to the self-inductance of the circuit. This reasoning would make it appear that shunting a ballistic galvanometer must change the constant in the ratio of the resistances of galvanometer and shunt without regard to their self-inductances, as is true when continuous currents are in question. This, however, is not correct, because the movement of the needle, which occurs before the end of the discharge generates a counter electric pressure in the galvanometer coils. This reduces the proportion of the discharge which passes through the galvanometer. Assuming

that the number of lines of force due to the needle which cut the coils are proportional to the sine of the deflection; calling r_g and L the resistance and self-inductance of the galvanometer coils; r_s the resistance of the shunt (the inductance of the latter being assumed negligible on account of its being wound with doubled wire); and c_g and c_s being the respective instantaneous currents; then the instantaneous impressed electric pressure is $e = c_s r_s$. The instantaneous active pressure causing currents to flow through the galvanometer coils is $c_g r_g$, and is equal to the impressed pressure less the counter electric pressure caused by self-induction and the swing of the needle. Therefore

$$c_g r_g = c_s r_s - \left(\frac{L dc_g}{dt} + \frac{k d(\sin a)}{dt} \right),$$

where k is a constant which depends on the strength of the needle. Whence $r_s c_s dt - r_g c_g dt = L dc_g + k d(\sin a)$

$$\text{and } r_s \int_0^t c_s dt - r_g \int_0^t c_g dt = L \int_0^t dc_g + k \int_0^a d(\sin a).$$

This is $q_s r_s - q_g r_g = k \sin a$. If the deflection be small then $\sin a$ is sensibly equal to $2 \sin \frac{a}{2}$, but $K \sin \frac{a}{2} = q_g$, where K is the ordinary constant of the ballistic galvanometer (Vol. I., p. 46). Hence $q_s r_s - q_g r_g = \frac{2 k q_g}{K}$. Calling Q the total discharge, which is equal to $q_s + q_g$, this becomes

$$r_s(Q - q_g) - r_g q_g = \frac{2 k q_g}{K}, \text{ and } q_g = \frac{Q r_s}{r_g + r_s + \frac{2 k}{K}}.$$

This discussion shows that the coulombs of a discharge which pass through a shunted ballistic galvanometer are less than the ratio of the resistances or $q_g < \frac{Qr_s}{r_g + r_s}$. The deficit is caused by the lines of force from the needle cutting the galvanometer coils while the discharge is passing, and its value is

$$\frac{Qr_s}{(r_g + r_s) \left(1 + \frac{K}{2k} (r_g + r_s) \right)}.$$

The shunted ballistic galvanometer therefore gives readings which are too small, unless the duration of the discharge is very small compared with the time of vibration of the needle.*

In the case of coils connected in parallel each having self-inductances, it is difficult to assign a true fixed value to the self-inductance of the circuit. In fact, only under special conditions can a single coil with self-inductance be substituted for the coils in parallel so as to produce the same effect as the latter upon transient currents of every duration. These conditions are fulfilled when the ratio of $\frac{L}{R}$ is constant for all the coils, and an equivalent coil may then be substituted for the parallel circuits. In this case the resistance of the equivalent coil must be

$$\frac{1}{R_c} = \frac{1}{R_1} + \frac{1}{R_2} + \frac{1}{R_3} + \text{etc.},$$

and its self-inductance must be

$$\frac{1}{L_c} = \frac{1}{L_1} + \frac{1}{L_2} + \frac{1}{L_3} + \text{etc.}$$

* See Gerard's *Leçons sur l'Électricité*, 3d ed., Vol. I., p. 213.

These values make $\frac{L_c}{R_c}$ equal to the constant value of the ratio for the individual coils.*

21. Rate of Work in a Self-Inductive Circuit when the Current is rising or falling. — The effect of self-inductance has been compared with the effect of inertia in a moving solid. The inertia effect of water flowing in a pipe, as suggested by Faraday, also represents many analogies. Thus, on impressing an electric pressure upon a circuit, the current does not rise to its full value instantly, but increases as a logarithmic function, the constant of which depends upon the self-inductance of the circuit. In the same way, if pressure be exerted upon water filling a pipe, the water cannot begin its full flow instantly on account of inertia. If a gate be suddenly closed in the pipe after the flow is fully under way, the momentum of the liquid tends to continue the flow, and the gate suffers a severe blow. In the same way, upon opening an electric circuit a bright spark passes on account of the so-called extra current caused by the tendency of self-inductance to uphold the flow. It must always be remembered that the analogies between the flow of electric current and moving solids or liquids are by no means exact (Vol. I., p. 11), but they are quite useful in fixing the meaning of the phenomena. There is a marked difference between the effect of bends on the inertia effect in the pipe containing water and in the electric circuit. Thus, in the electric circuit, a solenoid has much more self-inductance than has the same wire

* Hospitalier's *Traité de l'Énergie Électrique*, Vol. 1, p. 496; Ledebøer & Maneuvrier, *Académie des Sciences*, 1887.

straightened out. On the other hand, bends in a water pipe cause the inertia effect to be absorbed by friction. Notwithstanding the differences, the analogies are worthy of further consideration.

When water in a pipe is set in motion part of the force exerted upon it at any moment is utilized in accelerating its mass $\left(\frac{Mdv}{dt}\right)$, and the remainder in overcoming frictional resistances (Av). That is,

$$F = Av + \frac{Mdv}{dt},$$

where F is the pressure exerted, v the instantaneous velocity of the water, M is its mass, and A is a constant. It is here assumed that the frictional resistance is proportional to the velocity, which is true only when v is small. When the velocity of the water has become so great that $Av_1 = F$, where v_1 is the final velocity, the acceleration ceases, and the water continues to flow at a uniform velocity v_1 as long as the force is applied. In the case of the electric circuit, the impressed electric pressure is expended in overcoming the counter electric pressure due to self-inductance $\left(\frac{Ldc}{dt}\right)$ and in causing the current to flow through the resistance (R) of the circuit, or $E = cR + \frac{Ldc}{dt}$. This is similar to the expression for the flow of a liquid as given above. cR represents the electric pressure exerted in overcoming the electric resistance or electric friction of the conductor (the active pressure), and $\frac{Ldc}{dt}$ $\left(= \frac{d(LC)}{dt}\right)$, the pressure exerted in storing energy in the magnetic field, or in

changing the momentum of the magnetic field (compare Sect. 19). Likewise $\frac{Mdv}{dt} \left(= \frac{d(MV)}{dt} \right)$ in the formula relating to the flow of water represents, of course, the pressure or force exerted in storing energy in the water by increasing its momentum. The power expended in the electric circuit at any instant is $Ec = c^2R + \frac{Lcdc}{dt}$, in which c^2R is the power expended in heating the conductor and $Lc \frac{dc}{dt}$ is the power expended in storing energy in the magnetic field. In this discussion, it is assumed that the electrical resistance of a conductor is a constant and is the same for a variable current as for a constant one. This is correct within practical limits, provided the rate of variation of the current is not too great and the conductor is not too thick.

22. The Time Constant of a Self-Inductive Circuit.— From the equation

$$E = cR + \frac{Ldc}{dt} \quad \text{is given} \quad c = \frac{E - \frac{Ldc}{dt}}{R},$$

which represents the instantaneous value of the current flowing at any moment while the pressure E is applied to a circuit of inductance L . To find the value of the instantaneous current at any particular time t , we have from the same equation, by transposition, $\frac{dc}{E - cR} = \frac{dt}{L}$, whence

$$\int_0^c \frac{dc}{E - cR} = \int_0^t \frac{dt}{L},$$

which gives $-\frac{1}{R} \log(E - cR) \Big|_0^c = \frac{t}{L} \Big|_0^t$,

or
$$\log \left(\frac{E - cR}{E} \right) = -\frac{Rt}{L},$$

and finally $c = \frac{E}{R} (1 - \epsilon^{-\frac{Rt}{L}})$, where ϵ is the base of the Napierian logarithms.* This shows, as already stated, that the theoretical curve representing the rise or fall of the current is logarithmic. The formula shows that when L is very small the current almost immediately takes its full value $C = \frac{E}{R}$, since $\epsilon^{-\frac{Rt}{L}}$ quickly becomes negligible in comparison with unity. Theoretically, when inductance is present, the current can only rise to its full value after an infinite time, yet $\epsilon^{-\frac{Rt}{L}}$ becomes practically negligible after a comparatively short interval. Since resistance has the absolute dimensions of a velocity (a length divided by a time) and inductance has the dimensions of a length, the ratio $\frac{L}{R}$ has the dimensions of a time; this ratio, in the case of any circuit is, therefore, generally called the **Time Constant** of the circuit, and may be represented by the Greek letter τ . In the preceding equation, $\frac{E}{R}$ represents the value which the current would instantly reach when under the constant impressed pressure, were there no inductance in the circuit. This is the same as the ultimate value when there is inductance. The equation may therefore be written

$$c = C(1 - \epsilon^{-\frac{t}{\tau}}) \quad \text{or} \quad C - c = C\epsilon^{-\frac{t}{\tau}}.$$

* See Gerard's *Leçons sur l'Électricité*, 3d ed., Vol. I., p. 207.

When $t = \tau$, this becomes

$$C - c = \frac{C}{2.718} = .368 C.$$

This is the deficit of the current after a time in seconds equal to τ , and the current at that instant is therefore .632 of its ultimate or full value. The value of the time constant is therefore a *measure of the growth* of the current in a circuit, and it is obvious that in a circuit of great inductance and also great resistance, the current practically reaches its full value as quickly as in a circuit of small inductance and proportionally small resistance.

23. Examples of Time Constants. — The following are the time constants of some of the circuits for which inductances have previously been given (Sect. 17). Wheatstone bridge resistances, when properly wound, generally have a time constant of a millionth of a second or less; electric bell, 4.8 millionths of a second; telephone call-bell, nearly .02 of a second; armature of a small magneto generator, from .005 to .013 of a second; telephone receiver, with diaphragm, about .001 of a second; mirror galvanometer for marine signalling, .0016 of a second; mirror galvanometer of 5000 ohms resistance, .0004 of a second; 2700-ohm coil of a mirror galvanometer, .001 of a second; 100,000-ohm coil of a mirror galvanometer, .0007 of a second; coil of Ayrton and Perry spring voltmeter, .0044 of a second; polarized relays, types 1, 2, 3, and 4, respectively, .0048, .0045, .0041, and .0052 of a second; Morse relays, from about .070 to .026 of a second, with

about .034 of a second as an average for instruments in working adjustment; two telegraph sounders, .0095 and .0065 of a second; bare No. 12 B. and S. gauge copper wire on a pole line, .00037 of a second; No. 6 wire in a similar position, .0014 of a second; primary of large induction coil, .09 of a second; secondary of same, .065 of a second; dynamo fields, from about .01 to 10 seconds; continuous-current dynamo armatures, from .005 to 5 seconds; Mordey 36-kilowatt 2000-volt alternator armature, .017 of a second; Kapp 60-kilowatt 2000-volt alternator armature, .035 of a second; primary and secondary windings of transformers, from several thousandths of a second to a number of seconds. Finally, suppose 6 ohms is the resistance of the magnetizing coil figuring in the problem of Section 16. Then assuming the value of L to be constant, which is not exact when the core is iron, the time constant becomes in the three cases, respectively, .65, .92, and .0026 of a second.

24. Equation for Current in a Self-Inductive Circuit when an Alternating Sinusoidal Pressure is applied. —

The total quantity of electricity which is transferred through a circuit when a periodic electric pressure is impressed upon it has been shown to be independent of the inductance of the circuit, provided the period gives sufficient time for the current to follow its natural curve of rise and fall; the only change, in this case, in the flow caused by inductance being a retardation of the phase of the current relative to the pressure (Sect. 19). If, however, the pressure be an alternating one the quarter period of which is not materially greater than

the time constant of the circuit, the current does not have an opportunity to gain its full value before the pressure falls. This causes a deficit in the flow, of a magnitude depending upon the time constant of the circuit and the period of the impressed pressure (Sect. 22). In the case of an alternating current set up in a circuit by an impressed alternating pressure, this effect reduces the current uniformly in each period. The effect is therefore one which makes an apparent increase in the resistance of the circuit.

Returning now to the formula $c = \frac{E - L \left(\frac{dc}{dt} \right)}{R}$. Considering c and E instantaneous values of current and pressure which vary according to a sine curve, and writing for E its value $e_m \sin a$, where e_m is the maximum value of the sinusoidal pressure; then

$$c = \frac{e_m \sin a - L \left(\frac{dc}{dt} \right)}{R}, \text{ or } dc + \frac{R}{L} c dt = \frac{e_m}{L} \sin a dt.$$

It is desired to find from this equation the value of c in terms of $\frac{R}{L} \left(= \frac{1}{\tau} \right)$, t , e , and $\sin a$. In order to do this, the equation must be integrated. This may be most readily done by assuming two arbitrary variables, u and v , the product of which is equal to c . Thus $uv = c$ and $dc = u dv + v du$. Substituting these values for c and dc in the above formula, gives

$$u \left(\frac{v dt}{\tau} + dv \right) + v du = \left(\frac{e_m}{L} \right) \sin a dt.$$

Since u and v are entirely arbitrary and only their product is fixed by the assumed conditions, we are at liberty to make further assumptions regarding the value of one of them. Therefore, for further convenience in integrating, we will assume such a value for v that $\frac{vdt}{\tau} + dv = 0$, and the value of v is derived from this

by integration as follows: $\log v = -\frac{t}{\tau} + \log A'$, where A' is a constant of integration.

Hence $v = A' \epsilon^{-\frac{t}{\tau}}$. Since $\frac{vdt}{\tau} + dv$ is taken equal to zero, the principal equation reduces to $vdu = \frac{e_m}{L} \sin a dt$, or $du = \frac{1}{A'} \epsilon^{-\frac{t}{\tau}} \frac{e_m}{L} \sin a dt$ and $u = A'' + \frac{1}{A'} \int \epsilon^{-\frac{t}{\tau}} \frac{e_m}{L} \sin a dt$. Whence, placing $A' A''$ equal to A ,

$$uv = c = \epsilon^{-\frac{t}{\tau}} \left[A + \int \epsilon^{-\frac{t}{\tau}} \frac{e_m}{L} \sin a dt \right]$$

or,
$$c = A \epsilon^{-\frac{t}{\tau}} + \frac{e_m}{L} \epsilon^{-\frac{t}{\tau}} \int \epsilon^{-\frac{t}{\tau}} \sin a dt.$$

$\epsilon^{-\frac{t}{\tau}} \sin a dt$ may be most readily integrated by parts as follows:

$$\int \epsilon^{-\frac{t}{\tau}} \sin a dt = \int y dz = yz - \int z dy.*$$

Putting $\sin a = y$ and $\epsilon^{-\frac{t}{\tau}} dt = dz$, makes by integration $z = \tau \epsilon^{-\frac{t}{\tau}}$, and by differentiation $dy = \cos a da$, but $a = \omega t$ (Vol. I., p. 80), and therefore $da = \omega dt$, whence

$$dy = \omega \cos \omega t dt.$$

* See Price's *Calculus*, Vol. II., p. 358.

$$\begin{aligned} \text{Consequently, } \int \epsilon^{\frac{t}{\tau}} \sin a dt &= yz - \int z dy \\ &= \tau \epsilon^{\frac{t}{\tau}} \sin \omega t - \int \tau \epsilon^{\frac{t}{\tau}} \omega \cos \omega t dt. \end{aligned}$$

The last term may again be integrated by parts, putting $\cos a = y$ and $\epsilon^{\frac{t}{\tau}} dt = dz$, and the original equation becomes

$$\int \epsilon^{\frac{t}{\tau}} \sin a dt = \tau \epsilon^{\frac{t}{\tau}} \sin \omega t - \tau^2 \omega \epsilon^{\frac{t}{\tau}} \cos \omega t - \tau^2 \omega^2 \int \epsilon^{\frac{t}{\tau}} \sin \omega t dt.$$

Transposing, and substituting a for ωt , gives

$$(1 + \tau^2 \omega^2) \int \epsilon^{\frac{t}{\tau}} \sin a dt = \tau^2 \epsilon^{\frac{t}{\tau}} \left(\frac{1}{\tau} \sin a - \omega \cos a \right),$$

$$\text{or } \int \epsilon^{\frac{t}{\tau}} \sin a dt = \left[\frac{\epsilon^{\frac{t}{\tau}}}{\frac{1}{\tau^2} + \omega^2} \right] \left(\frac{1}{\tau} \sin a - \omega \cos a \right).*$$

Substituting the value of this integral in the expression for the current, found on the preceding page, gives

$$c = A \epsilon^{-\frac{t}{\tau}} + \frac{e_m}{L \left(\frac{1}{\tau^2} + \omega^2 \right)} \left(\frac{1}{\tau} \sin a - \omega \cos a \right).$$

The last term may be put in the form

$$\frac{e_m}{L \sqrt{\frac{1}{\tau^2} + \omega^2}} \left[\frac{\frac{1}{\tau}}{\sqrt{\frac{1}{\tau^2} + \omega^2}} \sin a - \frac{\omega}{\sqrt{\frac{1}{\tau^2} + \omega^2}} \cos a \right].$$

* See Price's *Calculus*, Vol. II., p. 84.

Now
$$\left[\frac{\frac{I}{\tau}}{\sqrt{\frac{I}{\tau^2} + \omega^2}} \right]^2 + \left[\frac{\omega}{\sqrt{\frac{I}{\tau^2} + \omega^2}} \right]^2 = 1,$$

and this may be written

$$\left[\frac{\frac{I}{\tau}}{\sqrt{\frac{I}{\tau^2} + \omega^2}} \right]^2 + \left[\frac{\omega}{\sqrt{\frac{I}{\tau^2} + \omega^2}} \right]^2 = \cos^2 \phi + \sin^2 \phi,$$

where ϕ is an angle whose cosine and sine equal respectively the first and second terms in the left-hand side of the equation.* Substituting $\sin \phi$ and $\cos \phi$ for their equivalents in the last term in the equation for current as developed, there results

$$\begin{aligned} & \frac{e_m}{L \sqrt{\frac{I}{\tau^2} + \omega^2}} (\sin a \cos \phi - \sin \phi \cos a) \\ &= \frac{e_m}{L \sqrt{\frac{I}{\tau^2} + \omega^2}} \sin (a - \phi). \end{aligned}$$

Consequently, $c = A e^{-\frac{Rt}{L}} + \frac{e_m}{\sqrt{R^2 + 4 \pi^2 f^2 L^2}} \sin (a - \phi),$

since $\frac{L}{\tau} = R,$ and $\omega = \frac{2 \pi}{T} = 2 \pi f,$ where T is the period and $f = \frac{1}{T}$ is the frequency of the alternating current under consideration. The angle ϕ is determined by the condition that

$$\tan \phi = \frac{\sin \phi}{\cos \phi} = \frac{\omega}{\frac{I}{\tau}}$$

* Chauvenet's *Trigonometry*, p. 90.

which is obtained by dividing

$$\frac{\omega}{\sqrt{\frac{1}{\tau^2} + \omega^2}} \text{ by } \frac{\frac{1}{\tau}}{\sqrt{\frac{1}{\tau^2} + \omega^2}};$$

and from this $\tan \phi = \omega\tau = \frac{2\pi fL}{R}$

25. Exponential term is practically negligible.—The exponential member of the equation for the value of c shows the natural rise of current when an electric pressure is first introduced in the circuit. Its value may generally be entirely neglected when the pressure is an alternating one, since its effect becomes negligible within a small interval after the pressure is introduced. This is shown by taking the current equal to zero, as it is at the instant the pressure is impressed upon the circuit, and then solving for the value of A . This is readily shown to be

$$A = -\frac{e_m}{\sqrt{R^2 + 4\pi^2 f^2 L^2}} e^{\frac{Rt_1}{L}} \sin(a_1 - \phi),$$

where a_1 is the phase of the alternating pressure when introduced in the circuit, and t_1 is the time of its introduction. Substituting the value of A in the current formula gives

$$c = \frac{e_m}{\sqrt{R^2 + 4\pi^2 f^2 L^2}} \left[\sin(a - \phi) - e^{-\frac{R(t-t_1)}{L}} \sin(a_1 - \phi) \right].$$

As t increases $e^{-\frac{R(t-t_1)}{L}}$ quickly becomes negligible. Therefore, the instantaneous current due to an alternating electric pressure which is impressed upon a circuit may be ordinarily taken to be

$$c = \frac{e_m}{\sqrt{R^2 + 4\pi^2 f^2 L^2}} \sin(a - \phi),$$

where e_m is the maximum value of the pressure. Therefore,

$$c_m = \frac{e_m}{\sqrt{R^2 + 4\pi^2 f^2 L^2}}, \text{ and } C = \frac{E}{\sqrt{R^2 + 4\pi^2 f^2 L^2}},$$

where C and E are the effective values of current and pressure. Since $\frac{2\pi fL}{R} = \tan \phi$,

$$\sqrt{R^2 + 4\pi^2 f^2 L^2} = R \sqrt{1 + \tan^2 \phi} = \frac{R}{\cos \phi}$$

Therefore, $c_m = \frac{e_m \cos \phi}{R}$ and $C = \frac{E \cos \phi}{R}$.

It is thus shown that when a sinusoidal electric pressure is impressed in an electric circuit having a constant inductance L , the current is also sinusoidal and lags behind the pressure by an angle ϕ , the tangent of which equals $\frac{2\pi fL}{R}$, and which is therefore directly dependent upon the inductance of the circuit and the frequency of the impressed pressure; the maximum and effective currents are less than the maximum and effective pressures divided by R , by an amount dependent upon the frequency and the inductance.

26. Definition of Impedance and Reactance. — The quantity $\sqrt{R^2 + 4\pi^2 f^2 L^2}$ is generally called the **Impedance** of the circuit and sometimes its **Apparent Resistance**, while $2\pi fL$ is sometimes called the **Reactance** or **Inductive Resistance**. The square of the impedance of a circuit is therefore equal to the sum of the squares of its resistance and reactance. Impedance and react-

ance are both of the dimensions of resistance and are therefore expressed in ohms. **Impedance** may be defined for self-inductive circuits in general, as the total opposition in a circuit to the flow of an alternating electric current, and **reactance**, as the component of the impedance caused by the self-inductance of the circuit.

27. Circuits of Equal Time Constants in Parallel and Series. — The joint impedance of circuits combined in parallel may be determined from the impedances of the individual circuits, *provided the angle of lag is the same for all* and the circuits have no magnetic effect on each other. Thus, the effective electric pressure at the common terminals of the circuits is

$$E = C_1 \sqrt{R_1^2 + 4\pi^2 f^2 L_1^2} = C_2 \sqrt{R_2^2 + 4\pi^2 f^2 L_2^2}, \text{ etc.}$$

Also $E = C \sqrt{R^2 + 4\pi^2 f^2 L^2}$, and $C = C_1 + C_2 + \text{etc.}$ In these expressions R and L are the joint resistance and apparent joint self-inductance, $R_1, L_1, \text{etc.}$, are the resistances and self-inductances of the individual circuits, C is the effective value of the total current, and $C_1, C_2, \text{etc.}$, are the effective currents in the different circuits.

The above formulas may be transformed as follows:

$$\frac{C_1}{E} = \frac{I}{\sqrt{R_1^2 + 4\pi^2 f^2 L_1^2}}, \quad \frac{C_2}{E} = \frac{I}{\sqrt{R_2^2 + 4\pi^2 f^2 L_2^2}}, \quad \text{etc.}$$

Adding these together gives

$$\frac{C_1 + C_2 + \text{etc.}}{E} = \frac{C}{E} = \frac{I}{\sqrt{R_1^2 + 4\pi^2 f^2 L_1^2}} + \frac{I}{\sqrt{R_2^2 + 4\pi^2 f^2 L_2^2}} + \text{etc.}$$

But
$$\frac{C}{E} = \frac{I}{\sqrt{R^2 + 4\pi^2 f^2 L^2}}$$

whence
$$\frac{I}{\sqrt{R^2 + 4\pi^2 f^2 L^2}} = \frac{I}{\sqrt{R_1^2 + 4\pi^2 f^2 L_1^2}} + \frac{I}{\sqrt{R_2^2 + 4\pi^2 f^2 L_2^2}} + \text{etc.}$$

This expression is similar to that giving the joint resistance of divided circuits, $\frac{I}{R} = \frac{I}{R_1} + \frac{I}{R_2} + \text{etc.}$ The apparent joint self-inductance of this formula will evidently be dependent upon the frequency except when the time constants of the circuits are the same (compare Sect. 20); and when the time constants and therefore the angles of lag of the individual circuits are not equal, the *geometrical sum* instead of the *arithmetical sum* of the reciprocals of the individual impedances must be taken to get the reciprocal of the joint impedance. This is fully developed later (Chap. IV.).

The impedance of circuits in series is always calculated from the summed resistances and self-inductances, provided the circuits have no magnetic effect on each other and contain no capacity.

Thus,
$$\sqrt{R^2 + 4\pi^2 f^2 L^2} = \sqrt{(R_1 + R_2 + \text{etc.})^2 + 4\pi^2 f^2 (L_1 + L_2 + \text{etc.})^2}.$$

This is correct whether the time constants of the individual circuits are equal or unequal.

28. Triangles of Resistance and Pressure.—In Section 15 it is shown that the impressed pressure in a circuit is equal to the square root of the sum of the

squares of the active pressure and the pressure of self-inductance. Dividing the effective values of the three pressures by the current gives, in each case, the equivalent of resistance, so that the three sides of the triangle of electromotive forces are also proportional to the impedance, reactance, and resistance of the circuit (see Fig. 29). Also, $\tan \phi = \frac{2 \pi f L}{R} = \frac{E_s}{E_a}$. The electric pressure of self-inductance is evidently equal to the rate at which self-produced lines of force cut the turns of a coil, multiplied by the number of turns, or $\omega LC = 2 \pi f LC$. Reactance is equal to the inductive pressure divided by current, or $2 \pi f L$ (Fig. 29). Since the line representing active pressure lags behind that representing impressed pressure by the angle ϕ , the length of the former is equal to that of the latter multiplied by $\cos \phi$, or $E_a = E_i \cos \phi$. Therefore,

$$C = \frac{E_a}{R} = \frac{E_i \cos \phi}{R}, \quad \text{and} \quad c_m = \frac{e_m \cos \phi}{R},$$

exactly as shown by analysis (compare Sect. 25). The triangle of electric pressures (Fig. 29*a*) and the equivalent triangle of resistances (Fig. 29*b*), therefore, foretell the more important of the results that can be gleaned from the rather laborious integrations which have just been performed.

29. Application. — The application to circuits in general, and to alternator armatures in particular, of the deductions which are thus made is evident.

Thus, suppose it is desired to design an alternator which is to generate 25 amperes at an effective pressure of 1000 volts at its terminals, the frequency being

100. Take first, for example, a disc armature without iron in its core, with a resistance of 1 ohm and an average self-inductance of .01 henry. The effective value of the total pressure to be developed in this armature at full load is then

$$\sqrt{(1000 + 25 \times 1)^2 + (2 \pi \times 100 \times .01 \times 25)^2},$$

which is equal to 1037 volts. Consequently, the effect of self-inductance is to demand an increase of the total pressure equal to 12 volts. Suppose, however, the armature is of a type having an iron core and has an average working inductance of .05 henry, the total pressure then becomes

$$\sqrt{(1000 + 25 \times 1)^2 + (2 \pi \times 100 \times .05 \times 25)^2},$$

which is equal to 1291. Hence, the total pressure must be increased by 266 volts on account of self-inductance. If the two machines were worked at full load upon resistances of absolutely no inductance or capacity, the lag of the currents with respect to the impressed pressure in the circuit in the two cases would be respectively $8^\circ 43'$, and $37^\circ 27'$ (Fig. 32).

30. Resolution of an Irregular Curve into Component Sinusoids or an Equivalent Sinusoid. — As already said (Sect. 5), it is not safe to assume a sinusoidal form for the curve of pressure developed by an alternator. In general, it is safe to say that the curve produced by nearly all machines having smooth core or disc armatures, is sufficiently close to a sinusoid to make the deductions applicable with some degree of accuracy.

When the curve does not follow a sinusoid, it is possible to resolve it into a number of component sinusoids according to Fourier's theorem, the effect of which can, to some extent, be separately estimated. The general analytical expression for the instantaneous current becomes $c = a \sin a + b \sin 2 a + c \sin 3 a + \text{etc.}$

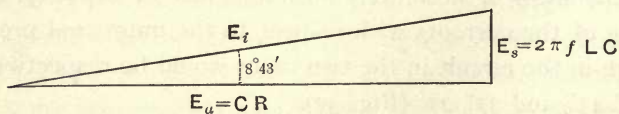
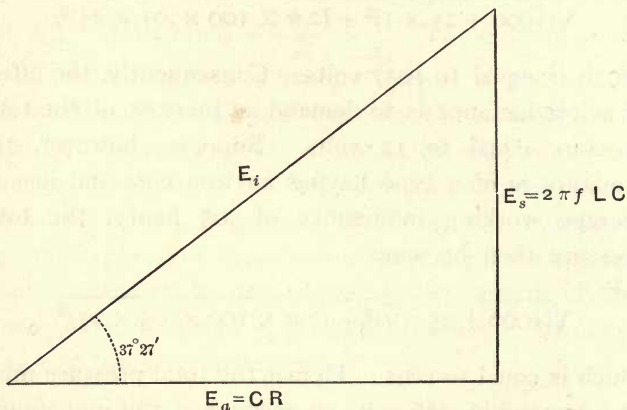

Fig. 32

$+ a' \cos a + b' \cos 2 a + c' \cos 3 a + \text{etc.}$, which is too complex for general use. The separation is often more readily effected by plotting sinusoids by trial and approximation (Fig. 33). The first or fundamental component sinusoid has the same period as the primary curve, and the other components are regular harmonics of the first. When even harmonics are present the

successive loops of the primary curve are dissimilar, but they are similar when only odd harmonics are present. Since the successive loops of alternating current curves are always similar, it is evident that only the odd harmonics need be looked for in distorted curves. In fact, such curves may nearly always be considered as composed of the fundamental sinusoid combined with sinusoids of three times and five times the frequency, higher harmonics being represented not at all or only by a small residual. The sines and cosines of the Fourier formula when taken in combination, cause the

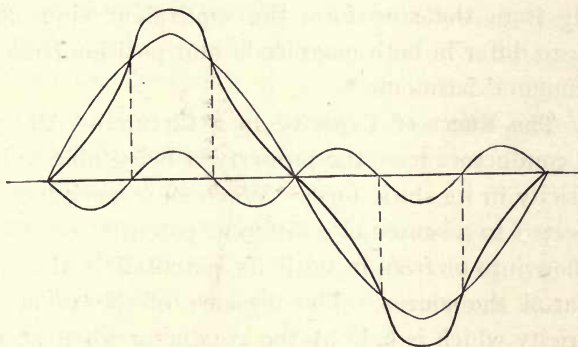

Fig. 33

lack of symmetry of alternating current curves. Even if the curve of pressure is an exact sinusoid, if L is not absolutely constant, the current curve varies from the sinusoidal form. In circuits containing iron cores, L varies with the value of the current on account of the variations of μ , and the current curve therefore takes an irregular form. The amount of irregularity depends upon the amount of iron present and upon the extent of its saturation. The expression for curves of pressure

or current which are not sinusoidal may be replaced for the purposes of analytical investigation by sinusoidal curves representing waves which give an equivalent effect. These sinusoidal curves may be called **Equivalent Sinusoids**; they must have the same frequency and effective values as the curves which they replace, and their relative phase positions must be such that they represent an equal amount of power. The equivalent sinusoids of curves that do not vary much from the sinusoidal form are practically the same as the fundamental harmonic, but when the primary curve varies widely from the sine form the equivalent sinusoid is likely to differ in both magnitude and position from the fundamental harmonic.*

31. The Effect of Capacity in a Circuit. — All insulated conductors have the property of being able to hold electricity in its static form. When such a conductor is connected to a source of a different potential, electricity will flow into or from it, until its potential is the same as that of the source. The measure of the amount of electricity which is held by the conductor when at unit potential is its **Capacity**, and the C.G.S. unit of capacity may be defined as the capacity of a conductor which contains a unit charge of electricity when at unit potential. The practical unit of capacity is the capacity of a conductor which contains a charge of one coulomb when at a potential of one volt. This is called a **Farad**,

* The analytical resolution of various alternator curves is illustrated by Steinmetz in *Trans. Amer. Inst. E. E.*, Vol. 12. The representation of alternating-current curves by empirical formulas is illustrated by Emery in *Trans. Amer. Inst. E. E.*, Vol. 12. See also Appendix A.

after Faraday, and is $\frac{1}{10^9}$ times as large as the C.G.S. unit of capacity. The farad is too large a unit of capacity to be convenient in practice, and the microfarad, or millionth of a farad, is commonly used as the unit of measurement. The capacity of a conductor depends upon its conformation and surroundings. The term **Condenser** is applied to any insulated conductor having an appreciable capacity, although it is more strictly used to designate a combination of thin sheets of conducting material, insulated, and laid together with the alternate layers connected in parallel. In the following discussion the term condenser will be used in its broader sense.

From the foregoing is at once derived the fundamental relation $Q = sE$, where Q is the quantity of electricity in coulombs, s the capacity in farads, and E the potential in volts.

When a condenser is connected to a source of alternating electric pressure, as indicated in Fig. 34, a current will flow into and out of the condenser, the value

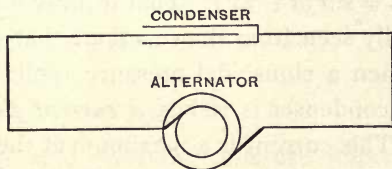

Fig. 34

of which at any instant is proportional to the rate of change of the active pressure (E_a); because the charge in the condenser at any instant is proportional to the electrical pressure between the terminals of the con-

denser at that instant, and the rate at which the charge changes must be proportional to the rate at which the pressure changes. The rate of change of the charge is equal to the number of coulombs flowing per second into or out of the condenser, and is therefore equal to the current flowing into or out of the condenser. Then at any instant the condenser current (c_s) will be

$$c_s = s \frac{de}{dt};$$

and since, when the alternating pressure is sinusoidal, $\frac{de}{dt} = 2\pi f e_m \cos a$, where e_m is the maximum pressure acting on the condenser, there results

$$c_s = 2\pi f s e_m \cos a,$$

and

$$\frac{c_s}{2\pi f s} = e_m \cos a = e_s.$$

This pressure, which is in phase with the condenser current, may be called the **Capacity Pressure** or **Condenser Pressure**. It is 90° in advance of the active pressure, as $\cos a = \sin(a + 90^\circ)$. That it must be in advance may be readily seen from the reactions that occur in the circuit. When a sinusoidal pressure applied at the terminals of a condenser is rising, *a current flows into the condenser*. This current is a maximum at the instant the pressure passes through zero, for at that time the rate of change of pressure is a maximum (see Fig. 35 at point *N*). When the pressure passes through its maximum point, its rate of change is zero, and the current at that instant is zero; when the pressure is falling, *a current flows out of the condenser*. If there is appreciable resist-

ance in the circuit the current takes a short time to build up; however, the principle remains the same (Sect. 33). From the formula for instantaneous current in the condenser the maximum current is seen to be,

$$c_{sm} = 2\pi f s e_m,$$

and the effective current

$$C_s = 2\pi f s E_i.$$

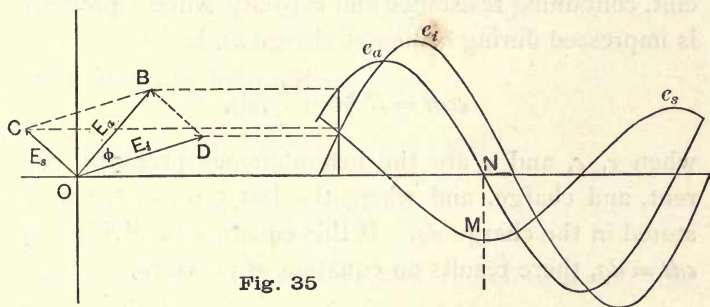

Fig. 35

32. The Energy of a Charged Condenser and its Curves of Charge and Discharge. — As a condenser is charged, a certain amount of work is done in raising the potential of the charge. During the time dt this is equal to

$$dW = Ecdt = Edq,$$

or

$$= \frac{1}{s} qdq,$$

(in which E is a constant pressure impressed on the condenser terminals, c is the current flowing into the condenser at the instant t , and q is the final charge in the condenser), from which, by integration, $W = \frac{1}{2} \left(\frac{1}{s} \right) q^2$. This represents a certain amount of work which is stored in the condenser when its charge is increased

from zero to q coulombs. When the condenser is discharged, an equal amount of work is returned to the circuit. The expression $\frac{1}{2}\left(\frac{1}{s}\right)q^2$ is similar to that giving the work stored in, or the kinetic energy of, a moving body or an electro-magnetic field, but the energy of a charge is truly potential and analogous to that stored in a compressed spring. The total work done on a circuit, containing resistance and capacity, when a pressure is impressed during a time of charge dt , is

$$ecd t = Rc^2 dt + \frac{1}{s} q dq,$$

when e , c , and q are the instantaneous pressure, current, and charge, and where the last term is the work stored in the charge dq . If this equation be divided by $cdt = dq$, there results an equation of pressure,

$$e = Rc + \frac{q}{s},$$

or
$$e = R \frac{dq}{dt} + \frac{q}{s}.$$

From these equations the charge at any instant may be determined when the applied pressure e is constant during charge; and

$$E = R \frac{dq}{dt} + \frac{q}{s},$$

or
$$\int_0^q \frac{dq}{q - sE} = - \int_0^t \frac{dt}{Rs}.$$

Integrating,

$$\log (q - sE) = - \frac{t}{Rs} + \log A';$$

hence,
$$q = sE + A' e^{-\frac{t}{Rs}};$$

solving for A' when $t = 0$, and therefore $q = 0$, there results

$$A' = -sE = -Q;$$

hence,

$$q = Q \left(1 - e^{-\frac{t}{Rs}}\right).$$

During discharge the condenser pressure is zero, and therefore

$$0 = \frac{dq}{dt} + \frac{q}{Rs};$$

from which, by integration,

$$\log q = -\frac{t}{Rs} + \log A'',$$

or

$$q = A'' e^{-\frac{t}{Rs}}.$$

Solving for A'' when $t = 0$, and therefore $q = Q$ (the total charge), there results $A'' = Q$; hence,

$$q = Q e^{-\frac{t}{Rs}}.$$

From these equations, which are exactly similar to those for self-induction (Sect. 21), it is seen that the curves of charge and discharge are logarithmic when an unvarying pressure is applied to the system (see Fig. 36 *a* and *b*). In many cases of practice Rs is so small that the charge and discharge of a condenser are practically instantaneous.

33. Time Constant of a Circuit containing Capacity.—

In these equations Rs has the same relation as $\frac{L}{R}$ in the similar equations for self-inductance (Sect. 22), and therefore Rs may be termed the time constant of the

condenser and may be represented by τ' . Substituting τ' for Rs in the equation for charge gives

$$q = Q(1 - e^{-\frac{t}{\tau'}}),$$

and when

$$t = \tau',$$

$$Q - q = .368 Q;$$

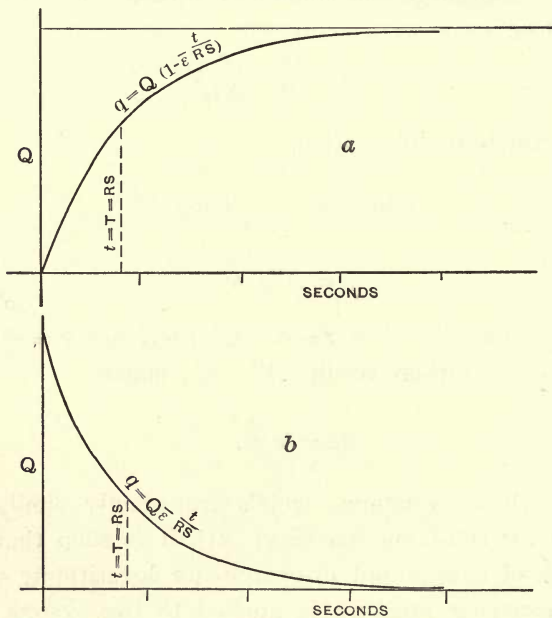

Fig. 36

which shows that when $t = \tau'$ there is a deficit in the charge of .368 of its full value, this full value being represented by $Q = Es$. It is then seen that a circuit containing capacity and resistance has a time constant similar to the time constant of self-inductance, and that it is a measure of the growth of the charge in the condenser.

34. Equation for the Current in a Circuit containing Capacity when an Alternating Sinusoidal Pressure is applied. — In the case when a sinusoidal pressure is impressed upon the circuit the equation of pressure

$$e = Rc + \frac{q}{s}$$

may be differentiated, giving

$$de = Rdc + \frac{dq}{s} = Rdc + \frac{cdt}{s},$$

and as $e = e_m \sin a$, there results

$$\frac{cdt}{Rs} + dc = \frac{e_m}{R} \cos ada.$$

This is a differential equation similar to that for self-induction and may be integrated in the same manner. The formula reduces to the practical form

$$c = \frac{e_m}{\sqrt{R^2 + \frac{1}{4\pi^2 f^2 s^2}}} \sin(a + \phi') + A\epsilon^{-\frac{t}{Rs}},$$

where ϕ' is the angle by which the current is in advance of the impressed pressure. The tangent of ϕ' is found during the development to be equal to

$$\frac{1}{2\pi fs} \div R$$

(see treatment on self-induction, Sect. 24).

The exponential term $A\epsilon^{-\frac{t}{Rs}}$ in the general equation represents the irregularity due to the fact that the current and impressed pressure must start at the same instant. That the term must usually disappear in an indefinitely short time, in practice, may be shown as in Sect. 25 in a similar instance.

Then
$$C = \frac{E}{\sqrt{R^2 + \frac{I}{4\pi^2 f^2 s^2}}}$$

is the effective current in the circuit, $\sqrt{R^2 + \frac{I}{4\pi^2 f^2 s^2}}$ is the impedance or apparent resistance, and $\frac{I}{2\pi fs}$ is the reactance due to capacity. The first formula may be written

$$E = C\sqrt{R^2 + \frac{I}{4\pi^2 f^2 s^2}} \text{ and } \frac{E}{C} = \sqrt{R^2 + \frac{I}{4\pi^2 f^2 s^2}},$$

from which triangles of pressures, similar to Fig. 38, and of resistances may be constructed (see Fig. 37 *a* and *b*).

Since
$$\frac{I}{2\pi fs} \div R = \tan \phi',$$

$$C = \frac{E}{R\sqrt{1 + \tan^2 \phi'}} = \frac{E \cos \phi'}{R}.$$

It is thus shown that when a sinusoidal electric pressure is impressed in an electric circuit, having a capacity *s*, the current is also sinusoidal, and *leads* the pressure by an angle ϕ' , the tangent of which is $\frac{I}{2\pi fRs}$, and which is therefore *inversely* dependent upon the capacity in the circuit and the frequency of the impressed pressure; the maximum and effective currents in the circuit are less than the maximum and effective pressures divided by *R*, by the ratio of unity to $\cos \phi'$, and the deficit is therefore dependent upon the frequency and capacity.

The triangles of pressure and resistance can be used to represent these relations, exactly as was illustrated in the case of self-inductive circuits.

In Fig. 35 suppose the line OB represents E_a , the active pressure in a circuit containing a condenser,

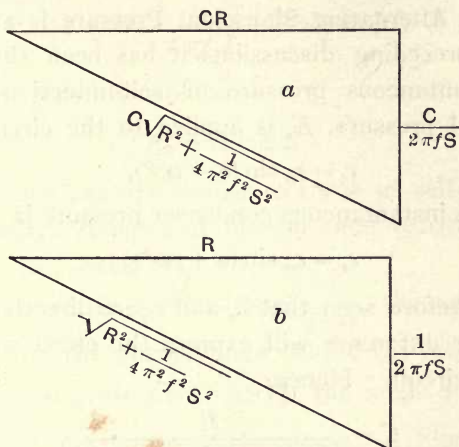

Fig. 37

then OC laid off 90° in advance of OB and equal to $E_s = \frac{c_s}{2\pi f s}$ will represent the capacity pressure.

The resultant, or OD , will be the effective impressed pressure (E_t).

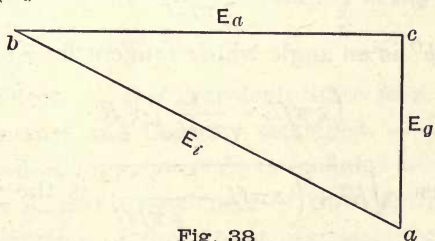

Fig. 38

It will be seen from this figure that E_a leads E_t and is shorter. From the relations shown in the construction, the expression $E_t = \sqrt{E_a + E_s}$ may be formed, and a triangle of pressure laid off as in Fig. 38, where the angle cba shows the current lead.

35. Effect of Capacity and Self-Inductance combined in a Circuit, and the Equation for the Current flowing when an Alternating Sinusoidal Pressure is applied. — In the preceding discussions it has been shown that the instantaneous pressure of self-induction when a sinusoidal pressure, E , is applied to the circuit is

$$e_i = e_m \sin(a - 90^\circ),$$

while the instantaneous condenser pressure is

$$e_s = e_m \sin(a + 90^\circ).$$

It is therefore seen that e_s and e_i are directly opposed, and their difference will express the effect when both are in a circuit. Hence,

$$C = \frac{E}{\sqrt{R^2 + \left(2\pi fL - \frac{1}{2\pi fs}\right)^2}},$$

and the instantaneous current is

$$c = \frac{e_m}{\sqrt{R^2 + \left(2\pi fL - \frac{1}{2\pi fs}\right)^2}} \sin(a - \phi'') + A\epsilon^{-\frac{t}{\tau}},$$

in which ϕ'' is an angle whose tangent is

$$\left(2\pi fL - \frac{1}{2\pi fs}\right) \div R.$$

In this case $\sqrt{R^2 + \left(2\pi fL - \frac{1}{2\pi fs}\right)^2}$ is the impedance and $\left(2\pi fL - \frac{1}{2\pi fs}\right)$ is the combined reactance of self-induction and capacity.

The term $A\epsilon^{-\frac{t}{\tau}}$ may be shown to disappear in a very short time, as has been done in the similar case under

self-induction. τ'' is the positive difference between τ and τ' .

$$\text{Since } \left(2\pi fL - \frac{1}{2\pi fs}\right) \div R = \tan \phi'',$$

the active pressure will be

$$E_a = E \cos \phi''.$$

As the equations are similar to those of self-induction and capacity, triangles of pressure and resistance may be drawn (see Sect. 28).

When $2\pi fL$ is greater than $\frac{1}{2\pi fs}$, the angle ϕ'' is positive, and the current lags behind the pressure, but when $\frac{1}{2\pi fs}$ is greater than $2\pi fL$, the angle ϕ'' is negative, and the current leads the pressure. Finally, when $2\pi fL = \frac{1}{2\pi fs}$, the angle ϕ'' is zero, and the circuit acts towards an alternating current as though it contained neither self-induction nor capacity, but only resistance; that is, the self-induction and capacity exactly neutralize each other. In this case, the relation between L and s is $L = \frac{1}{4\pi^2 f^2 s}$, or $4\pi^2 f^2 L = \frac{1}{s}$.

35 a. Effect, on the Transient State in a Circuit, of Self-Inductance and Capacity combined. — When an inductive coil of inductance L , is included in a circuit of resistance R , and a condenser of capacity s , is shunted across a portion of the circuit of resistance r , the following conditions are set up :

The condenser is charged with a quantity of electricity $Q = sCr$, where C is the steady value of the current. Now if the impressed pressure be suddenly removed, the

condenser will discharge, and the quantity of electricity which will pass from the condenser through the part of the circuit beyond its terminals is

$$q_s = Q \frac{r}{R} = \frac{sCr^2}{R}.$$

At the same time the self-inductance will cause a quantity of electricity to be transferred through the circuit in the opposite direction, which is equal to

$$q_l = \frac{LC}{R}.$$

Hence the total quantity of electricity transferred through the circuit is

$$q_l - q_s = \frac{C}{R} (L - sr^2),$$

and the effect of the condenser is to apparently reduce the self-inductance by an amount equal to the capacity of the condenser multiplied by the square of the resistance around which it is shunted.

36. Methods of measuring Self-Inductance. — While considering self-inductance and capacity, it is advisable to discuss the various available and practical methods of measuring the magnitude of the inductance of circuits. These methods are based upon a comparison of the unknown inductance, either with a known resistance or resistances; with a known capacity; or with a known inductance. The latter may be the inductance of a standard coil, and may have been determined by computation or careful comparative measurement.

1. Direct Comparison with Resistance (Joubert's Method). The unknown coil is inserted in an alternating circuit in series with a standard resistance of negli-

gible inductance. This may be gained by using a straight strip of German silver, or thin strips bent back on themselves, separated by thin silk or oiled paper for insulation. The pressures at the terminals of the standard and inductive resistances are measured by an electrometer or by a high-resistance voltmeter of negligible inductance. Then, if the impressed pressure in the circuit is approximately sinusoidal, the following relation holds :

$$\frac{E_1}{E} = \frac{C(R_1^2 + 4\pi^2 f^2 L_1^2)^{\frac{1}{2}}}{CR}$$

where E_1 , R_1 , and E , R are the respective pressures at the terminals and the resistances of the inductive and standard resistances ; C is the current flowing through them ; f is the frequency of the circuit ; and L_1 is the inductance to be determined. Hence,

$$\frac{E_1^2}{E^2} = \frac{R_1^2 + 4\pi^2 f^2 L_1^2}{R^2},$$

$$\text{and } L_1^2 = \frac{R^2 E_1^2 - R_1^2 E^2}{4\pi^2 f^2 E^2}, \text{ or } L_1 = \frac{R_1}{2\pi f} \left(\frac{R^2 E_1^2}{R_1^2 E^2} - 1 \right)^{\frac{1}{2}}.$$

R_1 is measured by means of a Wheatstone bridge, or by some other usual method, and f is determined from the speed and number of poles of the alternator producing the pressure. The measurement of pressure at the terminals of the non-inductive resistance is equivalent to measuring the current which flows through the non-inductive resistance ; for $C = \frac{E}{R}$. Substituting C for $\frac{E}{R}$ in the expression for L gives

$$L = \frac{R_1}{2\pi f} \left(\frac{E_1^2}{C^2 R_1^2} - 1 \right)^{\frac{1}{2}}.$$

The current may be measured by an electro-dynamometer, instead of taking the pressure at the terminals of a standard known resistance.

A modification of this method may be used to determine the working inductance of alternator armatures. Thus, first measure the pressure at the terminals of the alternator when on open circuit and normally excited. This measurement may be made by a high-resistance voltmeter of negligible inductance, such as a Weston voltmeter for alternating currents, a Cardew voltmeter with a considerable non-inductive resistance in series, or some type of electrostatic voltmeter. The latter follow in general the principle of the Thomson (Kelvin) quadrant electrometer, but are so constructed as to be portable and direct reading. If the armature current does not have too great a demagnetizing effect on the field, the open circuit pressure may be taken as the total pressure which acts when the armature is connected to a circuit; that is, it is the impressed pressure. Hence, connect the armature to a load composed of a known resistance with negligible or known constant inductance, and measure the current which flows. Then

$$C = \frac{E}{\sqrt{R^2 + 4\pi^2 f^2 L^2}}$$

if the curves of pressure and current are approximately sinusoidal. From this the inductance in the circuit is found to be

$$L = \left(\frac{E^2 - C^2 R^2}{4\pi^2 f^2 C^2} \right)^{\frac{1}{2}}.$$

If the load be an inductive resistance, the value of the armature inductance is found by subtracting the known

load inductance from the circuit inductance as determined above. For, the inductive pressure of the load is $2\pi fL'C$ and that of the armature is $2\pi fL''C$, while the total inductive pressure is $2\pi fLC$, which is equal to the sum of the other two. Hence,

$$2\pi fLC = 2\pi f(L' + L'')C,$$

and
$$L'' = L - L'.$$

If the armature reactions of the machine thus tested be considerable, the value of the inductance given is too great, but in their effect upon regulation, armature reactions and inductance are inextricably mixed, and therefore cannot be entirely separated.

This method of measuring inductance is a convenient one, as the instruments used are an electro-dynamometer, or other amperemeter reading effective currents, and a voltmeter reading effective pressures, which are portable and may be used where convenience dictates. The result given by this method is the actual working inductance, which is an important feature when the circuit contains iron and the inductance therefore depends upon the volume of the testing current. On the other hand, the accuracy of the method is not great. Under the most favorable circumstances an accuracy of two or three per cent is attainable. This is sufficiently close for many purposes where the method may be advantageously used.*

2. *Comparison with Resistance by Bridge* (Method of Maxwell and Rayleigh). The coil of unknown self-inductance L and resistance R is placed in one arm of

* Compare *London Electrician*, Vol. 33, p. 6.

a bridge (Fig. 39). The other resistance arms of the bridge are non-inductive and of values A , B , and R' . The bridge is first balanced in the usual way to determine the resistance R . With the balance for constant currents retained, the galvanometer key is depressed before the battery key. This causes a throw of the galvanometer needle due to the pressure of self-inductance or reactance developed in the coil. When C is the current in the coil, the quantity of electricity passed

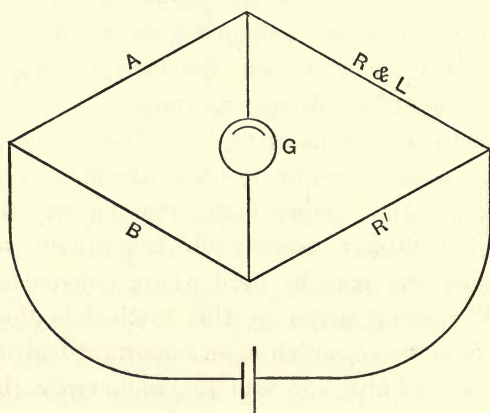

Fig. 39

through the bridge coils due to this pressure, is LC divided by the resistance of the bridge network (see Sect. 19). The flow of this electricity is through R and R' , in series with the divided circuit made up of A plus B in parallel with G , where G is the resistance of the galvanometer. The resistance of the network is therefore $R + R' + \frac{G(A+B)}{G+A+B}$, and the quantity of electricity in coulombs which passes through the circuit is

$$Q = \frac{LC}{R + R' + \frac{G(A+B)}{G+A+B}}$$

The proportion of this which passes through the galvanometer is

$$q : Q = \frac{G(A+B)}{G+A+B} : G, \text{ or } q = \frac{(A+B)Q}{G+A+B},$$

provided the galvanometer needle does not move appreciably until the impulse is past (Sect. 20). Hence,

$$q = \frac{LC}{R + R' + \frac{G(A+B)}{G+A+B}} \times \frac{A+B}{G+A+B} = K \sin \frac{1}{2} \theta,$$

where K is the ballistic constant of the galvanometer. Now the balance for steady currents is disturbed a small amount by the introduction of a small resistance r in the bridge arm with R . Suppose C' is the current which now flows through R ; the effect of the disturbance of the balance is the same as though a steady electric pressure $C'r$, opposed to the battery pressure, had been introduced into the arm R . The current flowing through the galvanometer on this account is

$$C_g = \frac{C'r}{R + R' + \frac{G(A+B)}{G+A+B}} \times \frac{A+B}{G+A+B} = K'\delta,$$

where K' is the galvanometer constant for steady currents and δ the deflection. From these two equations of flow, we get

$$\frac{C'r}{K'\delta} = \frac{CL}{K \sin \frac{1}{2} \theta'}$$

whence
$$L = r \frac{C'}{C} \frac{K \sin \frac{1}{2} \theta}{K' \delta}.$$

When the galvanometer is sensitive and r is made very small, the difference between C and C' becomes small and their ratio becomes sensibly equal to unity, whence $L = \frac{rK\theta}{K'\delta}$, provided the ballistic throw is sufficiently small. Since the ratio $\frac{K}{K'}$ equals $\frac{T}{2\pi}$ (Vol. I., pp. 17 and 39), this may be written $L = \frac{rT\theta}{2\pi\delta}$.

When $\frac{C'}{C}$ cannot be considered as unity its value may evidently be taken as equal to $\frac{A+R}{A+R+r}$. It is evident that a dead beat galvanometer cannot be used in this work.*

3. *Comparison of Two Self-Inductances by Bridge* (Maxwell's Method). The two inductive resistances having self-inductances L and L' are connected in two arms of a bridge, together with variable resistances which are non-inductive (Fig. 40). We will call the resistances of these arms R and R' . The other arms of the bridge are non-inductive and of values A and B . First balancing the bridge in the usual way for steady currents, the proportion $R : R' = A : B$ is given. Now the galvanometer key is depressed before the battery key, and if the ratio of the impedances of the inductive arms is not equal to the ratio of A and B , the galvanometer needle will throw. R and R' must then be adjusted until a balance is obtained for transient currents. This being done, the balance for steady currents

* See Gerard's *Leçons sur l'Électricité*, 3d ed., Vol. I., p. 322, and Gray's *Absolute Measurements in Electricity and Magnetism*, Vol. II., p. 477.

must again be gained by adjusting A and B . This will again disturb the balance for transient currents, which must be adjusted by changing R and R' . This process of trial and approximation is repeated until the

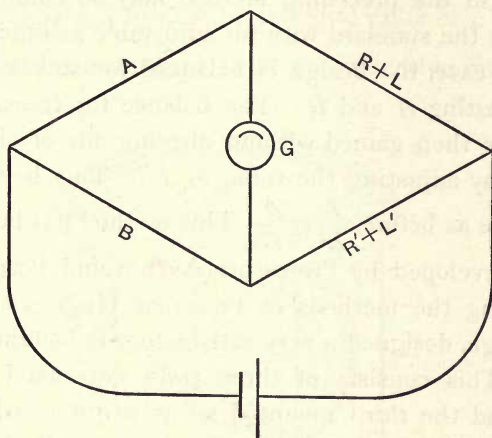

Fig. 40

balance exists for both steady and transient currents, when

$$\frac{\sqrt{R^2 + \frac{4\pi^2 L^2}{T^2}}}{\sqrt{R'^2 + \frac{4\pi^2 L'^2}{T^2}}} = \frac{A}{B}, \text{ or } \frac{R^2 + \frac{4\pi^2 L^2}{T^2}}{R'^2 + \frac{4\pi^2 L'^2}{T^2}} = \frac{A^2}{B^2}$$

But
$$\frac{R^2}{R'^2} = \frac{A^2}{B^2}$$

Hence,
$$\frac{L^2}{L'^2} = \frac{A^2}{B^2}, \text{ or } \frac{L}{L'} = \frac{A}{B}$$

Various modifications of the bridge arrangement have been made in order to facilitate the balancing, but

under the best circumstances the process is a laborious one.*

3a. (Ayrton and Perry's Standard Inductance.) The annoyances incident to making the adjustments required in the preceding method may be eliminated by making the standard with an adjustable self-inductance. In this case, the bridge is balanced for steady currents by adjusting A and B . The balance for transient currents is then gained without altering any of the resistances by adjusting the value of L' . This being done, we have as before, $\frac{L}{L'} = \frac{A}{B}$. This method has been quite fully developed by Professors Ayrton and Perry,† who, following the methods of Professor Hughes and Lord Rayleigh, designed a very satisfactory inductance standard. This consists of three coils, two fixed side by side and the third mounted so as to rotate within the others (Fig. 41). Calling the rotating coil A and the others B and C , evidently four arrangements can be made; thus, A may be connected with B alone, C alone, B and C in unison, or B and C in opposition. Each of these arrangements gives a maximum inductance when coil A lies within the plane of coils B and C and the field due to its current reinforces that due to the fixed coils. A smoothly graded variation of the inductance may then be gained by revolving coil A until a minimum value for the arrangement is reached with A at 180° from its preceding position. By means of a prop-

* Maxwell's *Electricity and Magnetism*, 2d ed., Vol. II., p. 367; Gray's *Absolute Measurements*, Vol. II., p. 455.

† See *Jour. Inst. E. E.*, Vol. 18, p. 290.

erly graduated circle the value of the inductance may be directly indicated for any position of A in either arrangement. If the ratio of the resistances of the unknown coil and the inductance standard does not give a value of $\frac{A}{B}$ which brings the required value of L' within the range of the standard, some non-inductive resistance

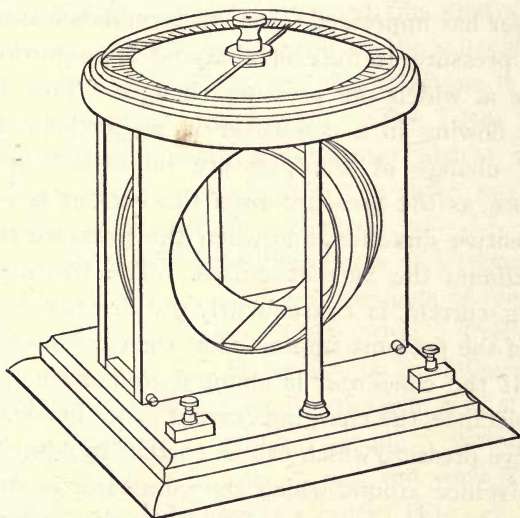

Fig. 41

may be included in one of the arms R or R' . Thus, suppose the unknown inductance to be nearly ten times as great as the highest value of the standard, then adjusting the resistances of R and R' so that $\frac{R}{R'}$ is greater than 10 makes $\frac{A}{B} = \frac{L}{L'}$ greater than 10, and the range of the standard inductance is sufficient. A somewhat sim-

ilar standard may be readily made by using two solenoids that telescope each other.

4. *Comparison with a Known Capacity.* In the case of condensers, the capacity may be said, in general, to be independent of the charge, that is, the capacity is constant. The charge of a condenser (that is, the quantity of electricity held by it) is then directly proportional to the difference of potential between its plates; and if the condenser has impressed upon its terminals a transient electric pressure, its rate of charging is proportional to the rate at which the pressure changes. That is, the current flowing in a condenser is proportional to the rate of change of the pressure impressed upon it. Therefore, as the pressure rises the current is flowing in a positive direction, and when the pressure reaches its maximum the current ceases. The phase of the charging current is consequently 90° in *advance* of the phase of the pressure impressed at the condenser terminals. If the condenser is shunted around a non-inductive resistance, the charging current is 90° in advance of the active pressure which causes current to flow through the resistance around which the condenser is shunted. In this respect a capacity is exactly the opposite of an inductance. If a conductor be shunted by a capacity, the quantity of electricity transferred in charging the condenser during a transient current is evidently $Q = sE = sCR$, where s is the capacity, R the resistance of the conductor, and C the current flowing through the latter. This quantity causes an apparent increase in the current passing through the conductor, and therefore an apparent decrease in the resistance of the con-

ductor (see Sect. 31). Here again the property of capacity is opposed to that of inductance, which when placed in a circuit increases its apparent resistance to a transient current. It is therefore possible to practically neutralize the effect of inductance by placing a proper condenser in circuit with it. If the inductance varies with the current, the capacity required for neutralization will also depend upon the current. Therefore, when alternating currents are used, the neutralization may be complete for the integral of the current taken over a full period, while the neutralization is by no means complete at any instant. The latter can be effected only by making a condenser with a capacity which varies with the charge in the same way as the inductance varies with the current.

These relations between the effects of a capacity and of an inductance lead to several methods of measuring the value of one in terms of the other. The original method suggested by Maxwell* is as follows: The unknown inductance is placed in the arm R of a bridge; the known capacity is shunted around a variable non-inductive resistance in arm B ; and the arms R' and A are variable non-inductive resistances (Fig. 42). By a process of trial and approximation similar to that of the third method, a common balance is obtained for both steady and transient currents, when $L = R'As = RBs$.

This is proved as follows: When balance exists for steady currents, $RB = R'A$, while balance for transient currents also requires that at every instant

* *Electricity and Magnetism*, 2d ed., Vol. II., p. 387.

$$Ac_A = Bc_B \text{ and } \frac{Ldc_R}{dt} + Rc_R = R'c_R.$$

The charging current of the condenser when balance exists, is

$$c_R - c_B = \frac{sBdc_B}{dt} = \frac{sAdc_A}{dt}$$

Whence

$$c_R = c_B + \frac{sAdc_A}{dt};$$

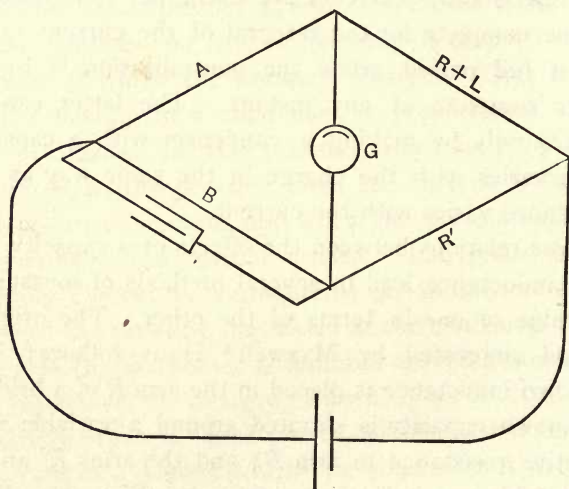

Fig. 42

but $c_B = \frac{Ac_A}{B}$ and $c_A = c_R$, so that

$$R'c_R = \frac{R'Ac_R}{B} + \frac{R'sAdc_R}{dt},$$

or $\frac{BLdc_R}{dt} + RBc_R = R'Ac_R + \frac{R'sABdc_R}{dt}$

Since $R'A - RB = 0$, this becomes $L = R'As = RBs$.

The correctness of this formula may also be seen from the fact that balance for transient currents only holds when the quantity of electricity transferred through the non-inductive half of the bridge is increased by the condenser by an amount equal to the deficit which is caused by the inductance in the other half of the bridge times $\frac{R}{R'}$, or $Q = se_B = \frac{R}{R'} \times \frac{L}{R} \times \frac{e_B}{R}$; hence, $L = RBs$.*

The formula $L = RBs$ may be written $\frac{L}{R} = Bs$, which shows that the time constants of the branches of the bridge which contain the inductance and capacity must be equal when the transient balance is obtained.

4 a. (Pirani's Modification.) To avoid the annoyances incident to the adjustment of a simultaneous balance for steady and transient currents, the following modification of the fourth method is advantageous.

The three branches A, B, R' of the bridge contain non-inductive resistances only. The fourth branch contains the inductive resistance in series with a non-inductive resistance r (Fig. 43). The condenser is shunted around the latter. The balance for steady currents being obtained, the balance for transient currents is gained by changing the connections of the condenser so as to alter that portion of r which is shunted by the condenser. Then, if r' is the value in ohms of that portion (Fig. 43), $L = sr'^2$. For, to give a balance for transient currents the charging current of the condenser must be equal and opposite to the effect of the inductance in the circuit. Hence, if x represent the

* Hospitalier's *Traité de l'Énergie Électrique*, Vol. I., p. 469.

resistance of the bridge network through which a discharge occurs,

$$sr' C \frac{r'}{x} = \frac{LC}{x} \text{ and } L = sr'^2.*$$

If the condenser is shunted around a portion r_1 of bridge arm B , as suggested by Rimington, the formula is

$$L = sr_1^2 \frac{R}{B}$$

4 b. Another modification of Maxwell's method may be made so that it becomes quite convenient for use in

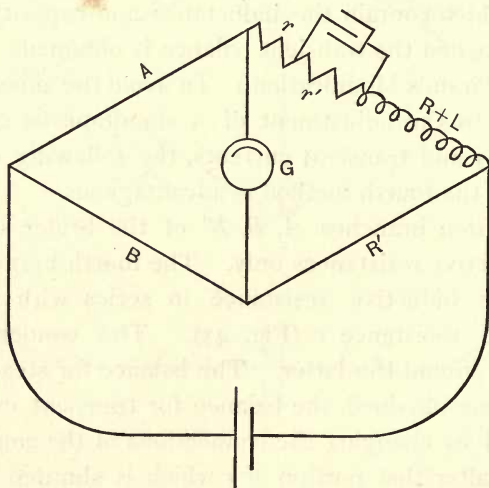

Fig. 43

some cases. The bridge connection is made, omitting the condenser, and the permanent balance is adjusted as before. Then the throw of the needle is taken when

* Gerard's *Leçons sur l'Électricité*, 3d ed., Vol. I., p. 324; and Hospitalier's *Traité de l'Énergie Électrique*, Vol. I., p. 470. (Compare Sect. 35 a.)

the galvanometer key is depressed first. This throw is caused by the effect of the unknown inductance. Now a subdivided condenser is connected as a shunt to one arm of the bridge, as in Maxwell's method (Fig. 42), and the throw of the needle is again taken. The throw is now due to the combined effect of the condenser and the inductance, and therefore must be numerically smaller than before, unless the effect of the condenser is greater than that of the inductance, when the throw will be negative, and may be numerically greater than the inductance throw. Another division of the condenser is now plugged into the circuit, and the throw is read as before. The value of the condenser which will give a zero throw, or a balance, may be determined by interpolation, when $L = RB_s$, as before.*

In all cases where condensers are used, it is assumed that their capacities are given in farads and the resistances are given in ohms, in which case the inductances are found in henrys.

37: Use of the Secohmmeter. — In either of those methods of measuring inductance which depend upon a bridge balance for transient currents, there is a certain lack of sensitiveness. In gaining a balance for steady currents a very small deflection of the needle may be multiplied and so made evident by properly closing and opening the galvanometer key. For transient currents, however, the direction of the throw of the needle differs upon closing and opening the battery key. In order that the multiplying effect may be obtained, it is necessary to reverse the galvanom-

* *London Electrician*, Vol. 33, p. 5.

eter terminals between each closing and opening. The closing and opening of the battery circuit (or what is equivalent, the reversal of the battery) may be effected in synchronism with the reversals of the galvanometer by means of two commutators mounted upon a rotating shaft. This is in effect the device designed by Professors Ayrton and Perry, and called by them a **Secohmmeter**.* It is shown diagrammatically in Fig. 44. The connections of a bridge with standard variable inductance and secohmmeter are shown in Fig. 45. When the secohmmeter is used in comparing an inductance, either with another inductance or with a capacity, the velocity at which the commutators rotate

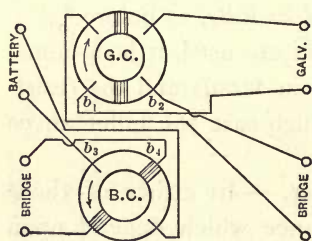

Fig. 44

does not affect the result, except to vary the sensibility of the test, provided that time is given between the reversals for the current to rise to its full value. This is evident from the fact that the total quantity of electricity moved under the influence of self-inductance

depends only upon the integral taken over the current-curve from zero to C , and from C to zero, and time does not enter as a factor of this total quantity. When, however, the secohmmeter is used in the second method, where an inductance is compared with a resistance, the number of reversals enters directly as a factor of the result. The expression for the inductance is then

* *Jour. Inst. E. E.*, Vol. 18, p. 284; *Electrical World*, Vol. 13, p. 232.

$$L = k \frac{r\beta}{V\delta} \frac{A}{B},$$

where β is the deflection when the secohmmeter is rotated at V revolutions per second, and the bridge is balanced for steady currents, while δ is the galvanometer deflection for steady currents when the balance is disturbed by altering B to $B + r$. k is a constant depending upon the relative angular positions of the two commutators, and can be determined by calibration.

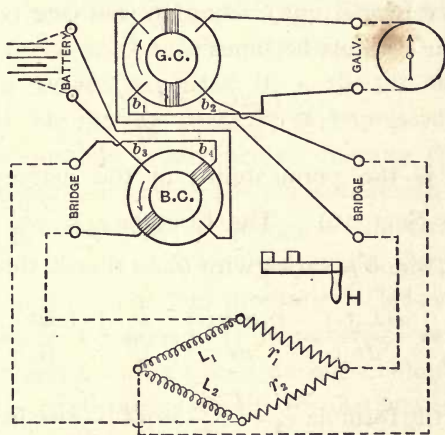

Fig. 45

When the secohmmeter is used, the galvanometer may always be dead beat, which gives an additional advantage to its use in the methods where it is required to read the galvanometer deflections for transient currents.

38. The Effect of a Varying Permeability in an Alternating-Current Circuit.—In the theoretical discussion of this chapter, the counter electric pressure in an elec-

tric circuit due to self-induction has been taken equal to $\frac{LdC}{dt}$, L being taken proportional to the permeability of the magnetic circuit. Thus, if e_1 and L_1 are the counter electric pressure and self-inductance of an electric circuit without an iron core, the formula gives

$$e_1 = \frac{L_1 dC}{dt}.$$

Now, if e_2 and L_2 are the counter pressure and self-inductance for current C when an iron core is within the circuit, the formula becomes

$$e_2 = \frac{L_2 dC}{dt} = \frac{\mu L_1 dC}{dt},$$

where μ is the permeability of the magnetic circuit (compare Sect. 16). The formula $e_2 = \frac{L_2 dC}{dt}$ is really incorrect, since μ varies with C , so that it should be

$$e_2 = \frac{d(L_2 C)}{dt} = \frac{L_1 d(\mu C)}{dt} = \left(\mu + C \frac{d\mu}{dC} \right) L_1 \frac{dC}{dt}.$$

In using the formula $e_2 = \frac{L_2 dC}{dt} = \mu L_1 \frac{dC}{dt}$ we have omitted the effect on the counter electric pressure of self-induction, which is caused by the rate of change of permeability with the current. The magnitude of this is represented by the term

$$\frac{Cd\mu}{dC} \frac{L_1 dC}{dt}, \text{ or } \left(\frac{Cd\mu}{\mu dC} \right) L_2 \left(\frac{dC}{dt} \right).$$

In general, it may be said that $\frac{Cd\mu}{dC}$ is small compared with μ , for the values of the induction in iron which

are ordinarily used in practice, and $\frac{Cd\mu}{\mu dC}$ is quite small compared with unity. Under some practical conditions it is possible that $\frac{Cd\mu}{dC}$ may be as great as $\frac{1}{5}$ or $\frac{1}{6}$ of the value of μ , but this is not common. The formulas as they have been worked out, therefore, may be accepted as indicative of the action in such circuits containing iron cores as are likely to be met in actual alternating-current machinery. The definition of self-inductance adopted by the Chicago Electrical Congress takes into account the variability of μ .

39. The Power expended in a Circuit on which a Sinusoidal Alternating Pressure is impressed. — If the circuit be without inductance or capacity the current wave agrees in phase with the pressure which sets it up. The rate of expenditure of energy in the circuit at any moment is equal to the product of the corresponding instantaneous current and pressure. The average rate of expenditure of energy, or the average value of the power expended, in the circuit during a complete period is equal to the average of all the instantaneous products. Or,

$$W = \frac{2}{T} \sum_0^{\frac{1}{2}T} ce, \text{ but } e = e_m \sin a \text{ and } c = \frac{e}{R},$$

where T is the time of a complete period and e_m is the maximum instantaneous pressure ordinate; hence,

$$W = \frac{2}{T} \sum_0^{\frac{1}{2}T} ce = \frac{e_m^2}{\pi R} \int_0^\pi \sin^2 a da = \frac{e_m^2}{2R},$$

but $E = \frac{e_m}{\sqrt{2}}$ and $C = \frac{E}{R} = \frac{e_m}{\sqrt{2}R}$.

Hence,
$$W = \frac{e_m^2}{2R} = CE,$$

C and E being the effective values of the current and pressure.

If the circuit under consideration is reactive, the current is caused to lag behind or lead the pressure by the angle ϕ . The rate of expenditure of energy in the circuit at any instant, is evidently still equal to the product of the corresponding instantaneous values of the current and pressure. The expression for the average power expended in the circuit is therefore, as before,

$$W = \frac{2}{T} \sum_0^{T/2} ce.$$

In this case, however, $e = e_m \sin a$, and $c = \frac{e_m}{I} \sin (a \mp \phi)$ (Sect. 24), where I is the impedance of the circuit.

$$\begin{aligned} \text{Hence, } W &= \frac{e_m^2}{\pi I} \int_0^\pi \sin a \sin (a \mp \phi) da \\ &= \frac{e_m^2 \cos \phi}{\pi I} \int_0^\pi \sin^2 a da \\ &\mp \frac{e_m^2 \sin \phi}{\pi I} \int_0^\pi \sin a \cos a da = \frac{e_m^2 \cos \phi}{2I}, \end{aligned}$$

and since $e_m = E\sqrt{2}$, and $\frac{e_m}{I} = c_m = C\sqrt{2}$, there follows

$$W = CE \cos \phi.*$$

Assuming the current and pressure curves to have

* Compare Picou's *Machines Dynamo Électriques*, p. 261; Gerard's *Leçons sur l'Électricité*, 3d ed., Vol. I., p. 224; Kapp's *Alternating Currents of Electricity*, p. 46; etc.

equal positive and negative loops (Sect. 80), the expression thus derived for the power expended in a circuit during one-half period applies to every half period, and therefore to continuous operation. In the ordinary measurement of current and pressure the effective values of the quantities are determined. Consequently, *the product of amperes and volts*, thus determined, *does not represent the power expended in a reactive circuit, but the product must be multiplied by the cosine of the angle of lag*. On the other hand, a **Wattmeter**, that is, an electro-dynamometer with one coil of low resistance connected in series with the circuit and another coil of high resistance connected in shunt with the circuit, averages the instantaneous products, and therefore gives readings that are directly proportional to the power absorbed.

40. Method for Measuring the Angle of Lag. — We have here a ready method for determining the angle of lag of the current flowing in a circuit. Measure the current flowing in a circuit by an electro-dynamometer; measure the pressure at its terminals by an electrostatic voltmeter or some type of non-inductive voltmeter of very high resistance. Finally, measure the power absorbed in the circuit by means of a wattmeter the pressure coil of which is non-inductive and of very high resistance. The power in watts determined by the wattmeter when divided by the product of volts and amperes gives the cosine of the angle of lag. If the curves of current and pressure are of irregular form this measurement will give the angle of lag between the equivalent sine curves (Sect. 30). We will later

take up the effect of inductance in the pressure coil of the wattmeter (Sect. 45).

41. Blakesley's Graphical Proof.—Blakesley has given a neat proof of the formula $W = CE \cos \phi$.* Returning to the graphical representation of alternating pressures or currents by means of rotating lines, let AB and AC (Fig. 46) represent respectively the maximum value of

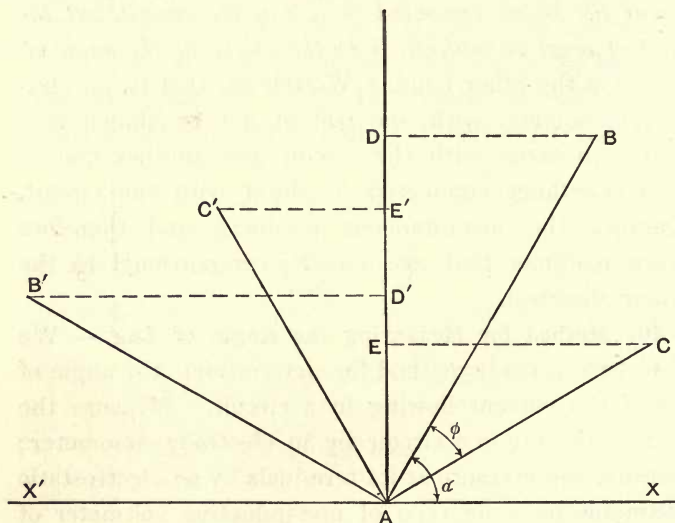

Fig. 46

the impressed electric pressure in a circuit and the maximum value of the resulting current. The angle BAC is the angle of lag. If the lines rotate about the point A , counter-clockwise, the instantaneous projections of the lines AB and AC upon the axis of Y represent the instantaneous values of the pressure and

* Blakesley's *Alternating Currents of Electricity*, 2d ed., p. 6.

current, when α is measured from the X axis. It is therefore desired to determine the average value of the products of these projections. Draw AB' and AC' respectively perpendicular and equal to AB and AC . These lines represent the positions of AB and AC after revolving through 90° . In the figure the angle BAX represents α , and CAX represents $\alpha - \phi$. Also the angle $B'AD' = BAX$, and $C'AE' = CAX$. It is then seen from the figure that

$$AE \times AD = AC \sin CAX \times AB \sin BAX,$$

or $ce = c_m \sin(\alpha - \phi) \times e_m \sin \alpha;$

and in the same way

$$AE' \times AD' = AC' \cos C'AE' \times AB' \cos B'AD',$$

or $c'e' = c_m \cos(\alpha - \phi) \times e_m \cos \alpha.$

The mean of these expressions is

$$\begin{aligned} \frac{ce + c'e'}{2} &= \frac{c_m e_m}{2} [\sin \alpha \sin(\alpha - \phi) + \cos \alpha \cos(\alpha - \phi)] \\ &= \frac{c_m e_m}{2} \cos[\alpha - (\alpha - \phi)] = \frac{c_m e_m}{2} \cos \phi = CE \cos \phi. \end{aligned}$$

This is the expression for the mean of the products of e and c for two values of α which are 90° apart. This mean value is independent of the positions of the lines in the figure, and is therefore the mean for all positions.*

* The maximum power that can be expended in an inductive circuit when a given pressure is applied, may be shown thus: $W = CE \cos \phi$, and since $\cos \phi = \frac{R}{I}$, where I is impedance, and $C = \frac{E}{I}$, there results $W = \frac{E^2 R}{R^2 + 4\pi^2 f^2 L^2}$. This is a maximum when $R = 2\pi fL$. Hence, $\phi = 45^\circ$,

Power loops or curves may be plotted as in Figs. 47 to 50, the ordinates of which represent the products of the corresponding ordinates of the current and pressure curves. Figure 47 shows the power loops for a non-inductive circuit in which the pressure and current reverse their directions at the same time, and the power

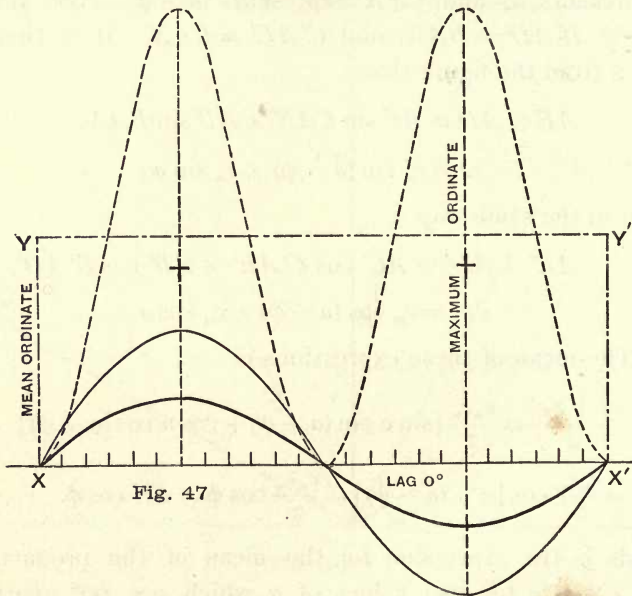

Fig. 47

ordinates are therefore always positive but their numerical value varies in each half period from 0 to $c_m e_m$ and back to 0, so that the power absorbed by the circuit

and the power factor is 70.7 per cent. This expression for maximum power is of no practical importance, as in the operation of electrical circuits and machinery the highest possible operating efficiency or *plant efficiency* is usually desired. A high plant efficiency is incompatible with a low power factor.

varies continually during each half period. In this case $\phi = 0$, $\cos \phi = 1$, and the average power is $W = CE$. Figure 48 shows the power loops for a reactive circuit in which the angle of lag is 45° . This may be taken to equally represent the condition when the current leads or lags. It will be seen in this case, that during a portion of each half period the current and pressure are in opposite directions, and some of the ordinates of the

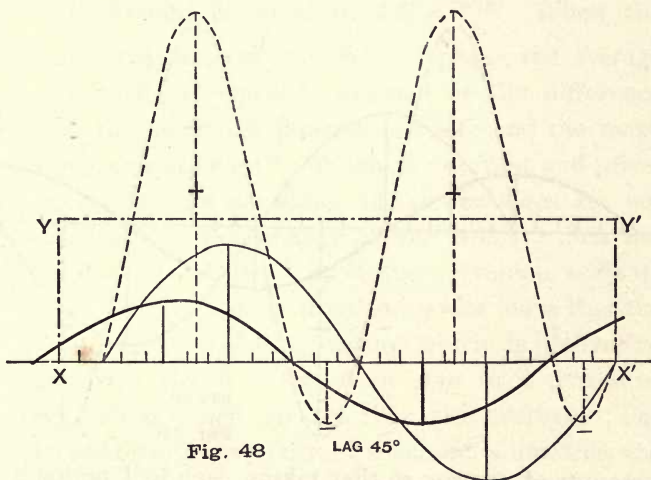
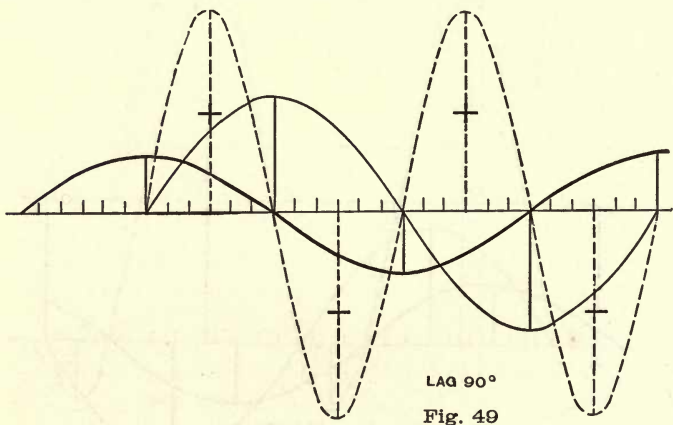

Fig. 48

LAG 45°

power loops are therefore negative. This must always be the case when the current and pressure do not coincide in phase. During the portion of the half period in which the ordinates of the power loop are positive the circuit absorbs power, but during the portion in which the ordinates are negative the circuit gives out power which was stored as magnetic field or condenser charge, and returns it to the source. The total energy given to the circuit during the half period is equal to the differ-

ence of that represented by the positive and negative loops, and the average power absorbed by the circuit is equal to this difference divided by the length of the half period. When $\phi = 45^\circ$, $W = CE \cos 45^\circ = .707 CE$. Figure 49 shows the power loops for a circuit in which the current and pressure differ in phase by 90° . In this case the negative loops are equal to the positive ones, or the circuit and source alternately give and take equal



amounts of energy, so that taking each half period as a whole, no power is absorbed by the circuit. In this case $\cos \phi = 0$, and therefore $W = 0$.

42. Definition of Power Factor. — The product of the effective values of the current and pressure, CE , in a reactive circuit is called the **Apparent Energy** or **Apparent Watts** in the circuit. The reading of a wattmeter applied to the circuit, which gives the value of $CE \cos \phi$, gives the **True Energy** or **True Watts** in the circuit. The ratio of the true watts to the apparent

watts in a circuit is generally called the **Power Factor**, as originally suggested by Fleming. The power loops for a circuit are exactly symmetrical, provided the original current and pressure curves are sinusoids (Figs. 47 to 49). When the pressure and current are in unison of phase the average ordinate of the power loops is equal to one-half of the maximum ordinate, since the maximum ordinate is equal to $c_m e_m$, and the average ordinate is equal to $CE = \frac{c_m e_m}{2}$. When the original curves are not in unison of phase, the average power ordinate is equal to one-half of the difference between the maximum positive ordinate and the maximum negative ordinate.* When the current and pressure curves are not sinusoids, the power loops are not symmetrical and the average power ordinate does not necessarily depend at all upon the maximum ordinate (Fig. 50). It is evident from the power loops that the torque on an alternator armature which is delivering current to a circuit varies from zero to a maximum value which is much greater than the average. The torque on a continuous-current machine is uniform, and the armatures of alternators are therefore subjected to severer strains than are continuous-current armatures.

43. Wattless Current. — The preceding expressions show that the energy expended in an inductive circuit is equal to the effective value of the impressed pressure and a component of the current which is in phase with the pressure, and has a value of $C \cos \phi$. This may be called the **Active** or **Working Current**. The remaining

* Fleming's *Alternate Current Transformer*, Vol. I., p. 124.

component of the current does no work, and therefore must be in quadrature with the pressure. This gives it a value of $C \cos(\phi + 90^\circ) = C \sin \phi$. This component, which does no work during a full period, is often called the **Wattless or Idle Current**. For illustration, suppose in Fig. 51 that OS is a pressure applied to a circuit, OA the current and ϕ the lag angle. Resolving OA into its

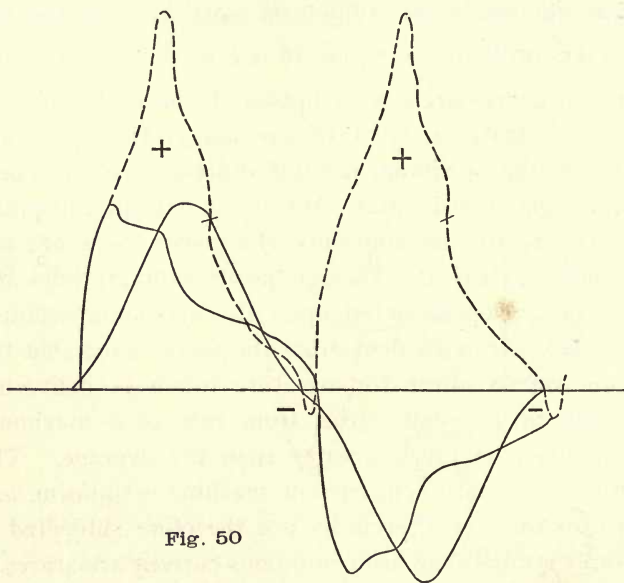

Fig. 50

components, OW and OI , in phase with and at right angles to OS , the component OW multiplied by the pressure will give the power absorbed by the circuit, and OI will be wattless.* If ϕ were 90° , the total current would be in quadrature with the pressure and therefore

* Thompson's *Dynamo-Electric Machinery*, 4th ed., p. 636.

wattless. While a wattless current may do a considerable amount of work in one quarter period, during the next quarter period the circuit returns an equal amount, and the total work for the period is zero. (Compare power loops.) A lag of 90° would only be possible in a circuit having no electrical resistance, since otherwise some energy would necessarily be expended in heating the conductors. It is possible, however, to make the ratio of inductive resistance, $2\pi fL$, so great in comparison with the true resistance R , that the lag is very nearly 90° . It is also possible to make the capacity of a circuit so great in comparison with its resistance that ϕ is a lead of nearly 90° . The latter condition is one not

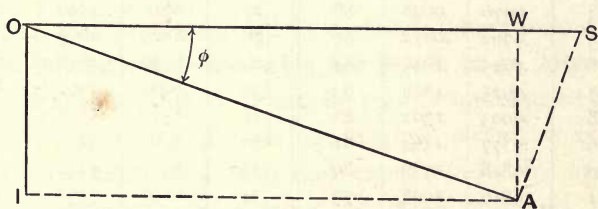

Fig. 51

met in practice, but the former may quite easily be brought about in circuits including underloaded transformers of poor design.

The value of the power factor of a circuit is evidently equal in numerical value to $\cos \phi$, for, power factor equals

$$\frac{\text{True Watts}}{\text{Apparent Watts}} = \frac{CE \cos \phi}{CE} = \cos \phi.$$

The total current in a circuit multiplied by the power factor is, therefore, equal to the active component of the current. A factor, which in the same way is propor-

tional to the wattless current, is sometimes called the **Induction Factor** of a circuit. It is evidently equal in numerical value to $\sin \phi$.

The following table, which is similar to one published by Mr. Emmet,* gives the power factor and induction factor in a circuit for any given lag.

| Lag Angle. $\pm \phi$ | Power Factor. $\cos \phi$ | Induction Factor. $\sin \phi$ | | Lag Angle. $\pm \phi$ | Power Factor. $\cos \phi$ | Induction Factor. $\sin \phi$ | |
|--------------------------|-------------------------------------|----------------------------------|-----------------------------|--------------------------|-------------------------------------|----------------------------------|-----------------------------|
| Degrees. | | | Degrees. | Degrees. | | | Degrees. |
| 0 | 1.0000 | .0000 | 90 | 23 | .9205 | .3907 | 67 |
| 1 | .9998 | .0174 | 89 | 24 | .9135 | .4067 | 66 |
| 2 | .9994 | .0349 | 88 | 25 | .9063 | .4226 | 65 |
| 3 | .9986 | .0523 | 87 | 26 | .8988 | .4384 | 64 |
| 4 | .9976 | .0698 | 86 | 27 | .8910 | .4540 | 63 |
| 5 | .9962 | .0872 | 85 | 28 | .8829 | .4695 | 62 |
| 6 | .9945 | .1045 | 84 | 29 | .8746 | .4848 | 61 |
| 7 | .9925 | .1219 | 83 | 30 | .8660 | .5000 | 60 |
| 8 | .9903 | .1302 | 82 | 31 | .8572 | .5150 | 59 |
| 9 | .9877 | .1564 | 81 | 32 | .8480 | .5299 | 58 |
| 10 | .9848 | .1736 | 80 | 33 | .8387 | .5446 | 57 |
| 11 | .9816 | .1908 | 79 | 34 | .8290 | .5592 | 56 |
| 12 | .9781 | .2079 | 78 | 35 | .8191 | .5736 | 55 |
| 13 | .9744 | .2249 | 77 | 36 | .8090 | .5878 | 54 |
| 14 | .9703 | .2419 | 76 | 37 | .7986 | .6018 | 53 |
| 15 | .9659 | .2588 | 75 | 38 | .7880 | .6156 | 52 |
| 16 | .9613 | .2756 | 74 | 39 | .7771 | .6293 | 51 |
| 17 | .9563 | .2924 | 73 | 40 | .7660 | .6428 | 50 |
| 18 | .9511 | .3090 | 72 | 41 | .7547 | .6561 | 49 |
| 19 | .9455 | .3256 | 71 | 42 | .7431 | .6691 | 48 |
| 20 | .9397 | .3420 | 70 | 43 | .7313 | .6820 | 47 |
| 21 | .9336 | .3584 | 69 | 44 | .7193 | .6946 | 46 |
| 22 | .9272 | .3746 | 68 | 45 | .7071 | .7071 | 45 |
| | $\sin \phi$ Induction Factor. | $\cos \phi$ Power Factor. | $\pm \phi$ Lag Angle. | | $\sin \phi$ Induction Factor. | $\cos \phi$ Power Factor. | $\pm \phi$ Lag Angle. |

* W. L. R. Emmet's *Alternating Current Wiring and Distribution*.

These deductions have all been based on the assumption that the pressure and current curves are sinusoids. It has already been shown (Sect. 30) that the current curves in working circuits are not likely to be sinusoids, though the pressure curves may approximate closely thereto. It is then impossible to determine the value of the angle of lag from the curves, since it differs at the zero and maximum points. Its equivalent value may be determined, however, by using pressure, current, and power readings, taken simultaneously, as already explained (Sect. 40), or by determining the inductance of the circuit when a working current is flowing, when the angle of lag is deduced from the expression $\tan \phi = \frac{2 \pi f L}{R}$.

It may also be determined by methods which follow.

44. Methods for measuring the Power in an Alternating Current Circuit. — It can be readily understood that the power in an alternating current circuit may be measured most accurately and expeditiously by means of a wattmeter. However, the other methods here given serve a purpose in special cases or when a wattmeter of the proper range is not at hand.

1. *Electrometer Method.* If the two pairs of quadrants of a quadrant electrometer be connected with points of potential, respectively, V_1 and V_2 , and the needle be connected with a point of potential V_3 , then the deflection of the needle is theoretically

$$d = k(V_1 - V_2) \left(V_3 - \frac{V_1 + V_2}{2} \right),$$

when k is the constant of the electrometer.

If v_1 , v_2 , and v_3 represent the instantaneous values

of the potential at the points when varying synchronously as a sine function, the deflection becomes

$$d = \frac{k}{T} \int_0^T (v_1 - v_2) \left(v_3 - \frac{v_1 + v_2}{2} \right) dt.$$

If it is desired to measure the energy absorbed by an inductive circuit the electrometer may be used in the following manner.

The inductive resistance BC is connected in series with the non-inductive resistance AB (Fig. 52). Let the potential of the points A , B , and C at any instant be represented respectively by v_1 , v_2 , and v_3 , when B is the junction between the inductive and non-inductive resistance. Then if a quadrant electrometer be connected with its quadrants to A and B , and its needle and case to C (Fig. 52 *a*), the deflection is

$$d = \frac{k}{T} \int_0^T (v_1 - v_2) \left(v_3 - \frac{v_1 + v_2}{2} \right) dt.$$

If the connection of the needle be interchanged so that it is connected to B while the connections of the quadrants remain unchanged (Fig. 52 *b*), this becomes

$$d' = \frac{k}{T} \int_0^T (v_1 - v_2) \left(v_2 - \frac{v_1 + v_2}{2} \right) dt.$$

By subtraction, this results in

$$d' - d = \frac{k}{T} \int_0^T (v_1 - v_2)(v_2 - v_3) dt.$$

Dividing this by kR , where R is the resistance of AB , gives

$$\frac{d' - d}{kR} = \frac{1}{T} \int_0^T \frac{v_1 - v_2}{R} (v_2 - v_3) dt.$$

Now $\frac{v_1 - v_2}{R}$ is equal to the instantaneous value of the current passing through the circuit, and $v_2 - v_3$ is the

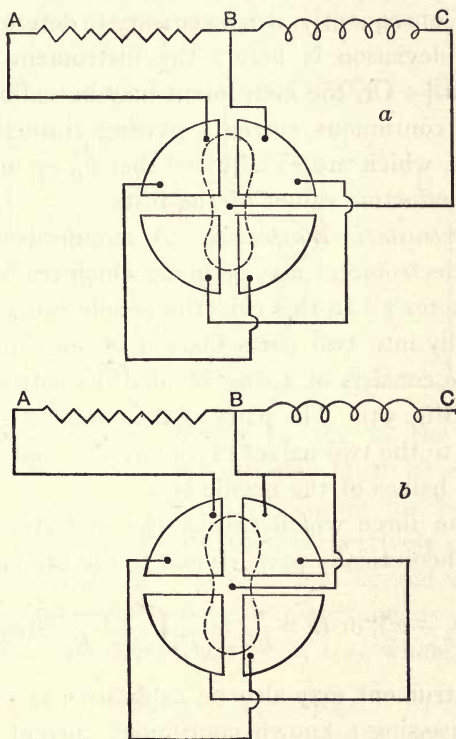

Fig. 52

instantaneous value of the difference of pressure between the terminals of the inductive resistance BC.

Consequently, $\frac{d' - d}{kR} = \frac{1}{T} \int_0^T cedt = W$, where W is

the power absorbed by the inductive part of the circuit.*

On account of structural defects, the deflections of electrometer needles do not always follow the theoretical law. Consequently, it is necessary to determine how great the deviation is before the instrument may be relied upon.† Or, the instrument may be calibrated by the use of continuous currents passing through known resistances, which are so adjusted that v_1 , v_2 , and v_3 are nearly the effective values of the tests.

1 a. *Electrostatic Wattmeter.* A modification of the quadrant electrometer may be made which reads directly as a wattmeter.‡ In this case the needle box is divided diametrically into two parts instead of into quadrants. The needle consists of a disc divided diametrically into two parts (Fig. 53). The parts of the circuit A and B are connected to the two halves of the needle, and B and C to the two halves of the needle box.

Then the force which causes the deflection of the needle is theoretically proportional to the product

$$(v_1 - v_2)(v_2 - v_3), \text{ or } W = \frac{d}{kR} = \frac{1}{T} \int_0^T \frac{(v_1 - v_2)}{R} (v_2 - v_3) dt.$$

This instrument may also be calibrated, as explained above, by passing a known continuous current through

* Ayrton, *Jour. Inst. E. E.*, Vol. 17, p. 163; Gray's *Absolute Measurements*, Vol. II., p. 698; Swinburne, Note on Electrostatic Wattmeters, *London Electrician*, Vol. 26, p. 571.

† Gray's *Absolute Measurements in Electricity and Magnetism*, Vol. II., pp. 662 and 699.

‡ Gerard's *Leçons sur l'Électricité*, 3d ed., Vol. I., p. 611; Hospitalier's *Traité de l'Énergie Électrique*, Vol. I., pp. 205 and 567.

a known resistance. A wattmeter of this type has been designed by Swinburne which may be made direct reading or may be read by means of a torsion head so that the needles will always remain in a fixed position in relation to the needle boxes.*

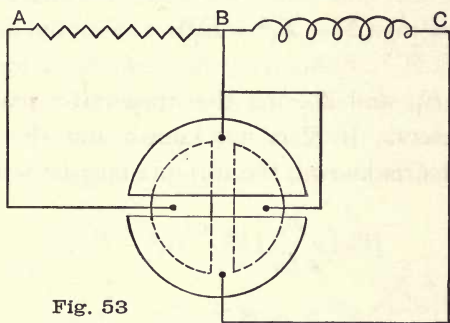

Fig. 53

2. *Three-Voltmeter Method.*† As in the previous method, a non-inductive resistance must be connected in series with the inductive circuit to be tested. (Fig. 54.) Voltmeters are then respectively connected between the points *A* and *B*, *B* and *C*, and *A* and *C*. Letting e_1 , e_2 , and e represent instantaneous pressures at the three voltmeters, then $e = e_1 + e_2$, whence

$$e^2 - e_1^2 - e_2^2 = 2e_1e_2.$$

But the instantaneous value of the power in the inductive circuit is $w = ce_2 = \frac{e_1}{R} e_2$. Substituting the

* Swinburne, Note on Electrostatic Wattmeters, *London Electrician*, Vol. 26, p. 571; *Electrical World*, Vol. 17, p. 257, and Vol. 19, p. 44.

† Suggested by Ayrton and Sumpner, *London Electrician*, Vol. 26, p. 736; *Electrical World*, Vol. 17, p. 329.

value of e_1e_2 already found gives $w = \frac{I}{2R}(e^2 - e_1^2 - e_2^2)$, and the mean power absorbed during a period is

$$\begin{aligned} W &= \frac{I}{T} \int_0^T w dt = \frac{I}{2RT} \int_0^T (e^2 - e_1^2 - e_2^2) dt \\ &= \frac{I}{2R} (E^2 - E_1^2 - E_2^2), \end{aligned}$$

where E , E_1 , and E_2 are the respective readings of the voltmeters. If R is not known and the value of the current C is known, the formula may be written

$$W = \frac{C}{2E_1} (E^2 - E_1^2 - E_2^2).$$

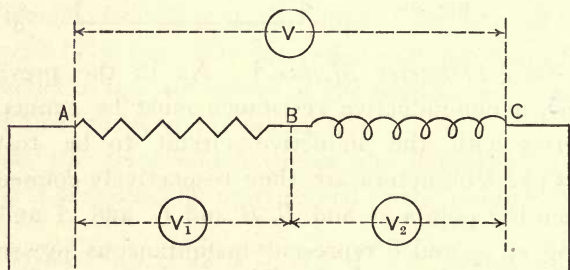

Fig. 54

In order that the results of measurements may be the most accurate possible, E_1 should equal E_2 , which makes the method inconvenient for use in ordinary testing. Neither is the method sufficiently accurate to compensate for its disadvantages. The accuracy of any particular measurement made by this method may be checked by inserting a known non-inductive resistance in place of the inductive circuit.

3. *Three-Ammeter Method*.* Instead of putting a non-inductive resistance in series with the inductive circuit, it may be placed in parallel with it. In this case amperemeters must replace the voltmeters of the preceding method (Fig. 55). One amperemeter measures the whole current C , another measures the current C_1 in the non-inductive resistance R , and another measures the current C_2 in the inductive circuit. It is evidently essential that the amperemeter which is in series with the non-inductive resistance shall be of negligible inductance. Supposing c, c_1, c_2 be the instantaneous values

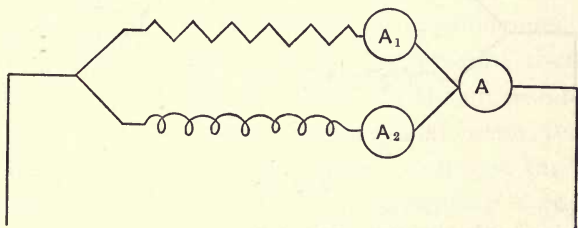

Fig. 55

of the currents at any moment, we have $c = c_1 + c_2$ and $c^2 - c_1^2 - c_2^2 = 2c_1c_2$, while

$$w = ec_2 = Rc_1c_2 = \frac{R}{2}(c^2 - c_1^2 - c_2^2).$$

Whence
$$W = \frac{I}{T} \int_0^T w dt = \frac{R}{2} (C^2 - C_1^2 - C_2^2).$$

This may also be written,

$$W = \frac{E}{2C_1} (C^2 - C_1^2 - C_2^2).$$

In this case the greatest accuracy is given when C_1 and

* Suggested by Fleming, *London Electrician*, Vol. 27, p. 9; *Electrical World*, Vol. 17, p. 423.

C_2 are about equal, but, at the best, the method is not very exact. Its accuracy may be checked, as in the previous case, by replacing the inductive circuit by a suitable non-inductive resistance.

4. *Other Three-Instrument Methods.* Various modifications of the last two methods have been suggested by Ayrton, Sumpner, Blakesley, and others.* One of the obvious arrangements is to omit the amperemeter

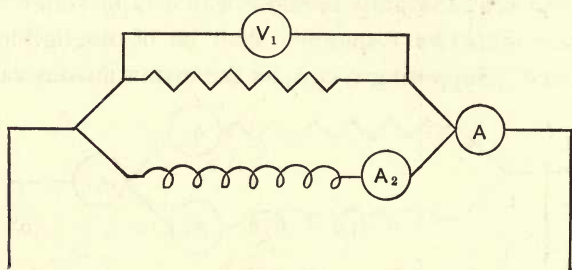

Fig. 56

in series with the non-inductive resistance of the third method, and connect a voltmeter across the circuit as in Fig. 56. In this case, the power becomes

$$W = \frac{R}{2} \left(C^2 - C_2^2 - \frac{E^2}{R^2} \right).$$

5. *Split Dynamometer Methods.* If separate alternating currents of the same frequency be passed through the two coils of an electro-dynamometer, its reading will be proportional to $\frac{1}{T} \int_0^T c_1 c_2 dt$. This is equal to $C_1 C_2 \cos \phi$. For

* Alternate Current and Potential Difference Analogies in the Methods of Measuring Power, *Phil. Mag.*, Vol. 32, p. 204; *London Electrician*, Vol. 27, p. 199; *Electrical World*, Vol. 18, p. 131.

$$c_1 = \sqrt{2} C_1 \sin a \quad \text{and} \quad c_2 = \sqrt{2} C_2 \sin (a - \phi),$$

where ϕ is the angle between the two current waves. Substituting, gives

$$\frac{1}{T} \int_0^T c_1 c_2 dt = \frac{2}{T} \int_0^T C_1 C_2 \sin a \sin (a - \phi) dt,$$

which is equal to

$$\frac{2 C_1 C_2}{\pi} \int_0^\pi \sin a \sin (a - \phi) da = C_1 C_2 \cos \phi.$$

An electro-dynamometer used in this manner is called a **Split Dynamometer**. Now suppose we determine the values of C_1 and C_2 by means of the dynamometer used as an amperemeter or by other instruments, then the value of $\cos \phi$ is at once found. If the measurements are all made by the same electro-dynamometer, its constant does not need to be known. Suppose the readings in the two circuits are $C_1^2 = k\delta_1$ and $C_2^2 = k\delta_2$, and the reading as a split dynamometer is $C_1 C_2 \cos \phi = k\delta_3$, then $\cos \phi = \frac{\delta_3}{\sqrt{\delta_1 \delta_2}}$. This plan was first suggested by Blakesley.*

5 a. Blakesley planned various methods for using a split dynamometer in measuring the power absorbed by an inductive circuit.† In one of the methods a non-inductive resistance is connected in parallel with the inductive circuit to be tested (Fig. 57), and a split dynamometer is connected so that one coil carries the total current, and the other carries the current of the inductive branch. An amperemeter is also placed in the induc-

* *Alternating Currents of Electricity*, 2d ed., p. 97.

† *Phil. Mag.*, Vol. 31, p. 346.

tive branch. Calling c the instantaneous value of the total current, and c_1, c_2 , respectively, the instantaneous currents in the non-inductive and inductive circuits, the following relations hold: the reading of the split dynamometer is proportional to $CC_2 \cos \phi$, and that of the

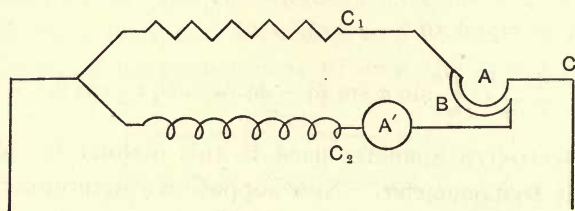

Fig. 57

ammeter gives C_2 ; but $c_1c_2 = (c - c_2)c_2 = cc_2 - c_2^2$, and $Rc_1c_2 = R(cc_2 - c_2^2)$. Rc_1 is equal to the instantaneous pressure between the terminals of the non-inductive resistance, and therefore Rc_1c_2 is equal to the instantaneous value of the power absorbed by the inductive circuit. Integrating gives

$$\begin{aligned} W &= \frac{R}{T} \int_0^T c_1c_2 dt = \frac{R}{T} \int_0^T cc_2 dt - \frac{R}{T} \int_0^T c_2^2 dt \\ &= R(CC_2 \cos \phi) - RC_2^2 = kRD - RC_2^2, \end{aligned}$$

where D is the scale reading of the split dynamometer, and k is its constant. Hence, the power absorbed by the inductive circuit is equal to R times the difference between the reduced split dynamometer reading and the square of the current in the inductive circuit.

A similar result may be gained by putting the ammeter in the non-inductive branch, provided the instrument is non-inductive.

6. *Wattmeter Methods.** Any instrument which directly measures the true energy in a circuit is called a wattmeter. The commonest form of a wattmeter is an electro-dynamometer with one of its coils connected across the terminals of the circuit under test and the other in series therewith. The electro-dynamometer in its ordinary arrangement measures the value of $\frac{I}{T} \int_0^T c^2 dt$.

When arranged as a wattmeter it measures the value of $\frac{I}{T} \int_0^T cedt$, which is evidently equal to $CE \cos \phi$, since $e = \sqrt{2} E \sin a$ and $c = \sqrt{2} C \sin (a - \phi)$, where ϕ is the angle of lag between the pressure and current (Sect. 39). The reading of a wattmeter of this type is therefore directly proportional to the power, while the reading of the same instrument when used as an electro-dynamometer is proportional to the square of the effective current. In the usual arrangement, wattmeters of this class have a series coil of a few turns of thick wire, which is placed in series with the circuit to be measured. The pressure coil is composed of a few turns of fine wire, which is connected in series with a non-inductive resistance, and is then connected across the terminals of the circuit.

45. **Corrections to Wattmeter Readings.**—It is essential that the pressure coil of the wattmeter be of entirely negligible inductance and capacity, or that these constants be so mutually adjusted that the time constant is practically zero. If this is not the case, the current in the pressure coil is equal to $\frac{E \cos \phi_1}{R_1}$, instead

* See also Method 1 a.

of $\frac{E}{R_1}$, where E is the pressure in the circuit, ϕ_1 the angle of lag in the pressure coil which is dependent on the relation $\tan \phi_1 = \frac{2\pi f L_1}{R_1}$, and R_1 and L_1 are respectively the resistance and self-inductance of the pressure coil. The currents in the series and pressure coils now have a difference of phase which is equal to $\phi - \phi_1$ instead of ϕ , where ϕ is the angle of lag in the main circuit. The reading of an inductive wattmeter is therefore proportional to $CE \cos \phi_1 \cos (\phi - \phi_1)$, while a correct reading is proportional to $CE \cos \phi$. The readings of an inductive wattmeter must therefore be multiplied by a factor equal to

$$\frac{\cos \phi}{\cos \phi_1 \cos (\phi - \phi_1)} = \frac{\cos \phi}{\cos \phi_1 (\cos \phi \cos \phi_1 + \sin \phi \sin \phi_1)},$$

in order that they may give the true power. This multiplier may be called the "correcting factor" of an inductive wattmeter. But

$$\cos \phi = \frac{R}{\sqrt{R^2 + 4\pi^2 f^2 L^2}}, \quad \sin \phi = \frac{2\pi f L}{\sqrt{R^2 + 4\pi^2 f^2 L^2}},$$

$$\cos \phi_1 = \frac{R_1}{\sqrt{R_1^2 + 4\pi^2 f^2 L_1^2}}, \quad \sin \phi_1 = \frac{2\pi f L_1}{\sqrt{R_1^2 + 4\pi^2 f^2 L_1^2}},$$

and the correcting factor therefore reduces to *

$$\frac{RR_1^2 + 4\pi^2 f^2 L_1^2 R}{RR_1^2 + 4\pi^2 f^2 L L_1 R_1} = \frac{1 + (2\pi f)^2 \tau_1^2}{1 + (2\pi f)^2 \tau \tau_1}$$

* Fleming's *Alternate Current Transformer*, Vol. I., p. 139; Gray's *Absolute Measurements in Electricity and Magnetism*, Vol. II., p. 680; Loppé et Bouquet's *Courants Alternatifs Industriels*, Vol. I., p. 55.

The formulas show that *when τ_1 is negligibly small* (in which case ϕ_1 is practically equal to zero), *or τ_1 is equal to τ* (in which case $\phi_1 = \phi$), the correcting factor reduces to unity, and *the readings of the wattmeter are directly proportional to power*. *When τ_1 is less than τ* , the correcting factor is less than unity, and *the wattmeter reads too high*, and *when τ_1 is greater than τ* , the correcting factor is greater than unity, and *the wattmeter reads too low*. The indications of an inductive wattmeter may, therefore, be either correct, too high, or too low, depending upon the algebraical value of the time constant of the circuit upon which measurements are being made. As a general rule, the time constant, τ , of the circuit is likely to be positive and greater than that of the wattmeter, so that the readings of an inductive wattmeter are generally found in practice to be too high; but in ordinary measurements it is impossible to determine the value of τ , so that the correcting factor of the wattmeter is unknown. The only safety in wattmeter measurements of power in alternating-current circuits, therefore, lies in the use of a wattmeter with such a very small time constant in the pressure coil that it may be considered absolutely negligible.

Another correction due to the power used by the wattmeter itself is also necessary. Thus, if the pressure coil be connected to the circuit between the current coil and the test circuit (Fig. 58), it is evident that the power measured includes that absorbed by the pressure coil. If the current coil be included between the point of connection of the pressure coil and the test circuit (Fig. 59), the power measured includes

that absorbed by the current coil. In either case this power should be small and usually may be neglected, but when this is not the case it is easily determined from the resistance of the coil included, if the pressure or current is known. In some wattmeters a special correcting coil wound over the series coil is introduced in series with the pressure coil which corrects

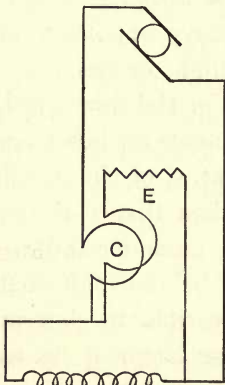

Fig. 58

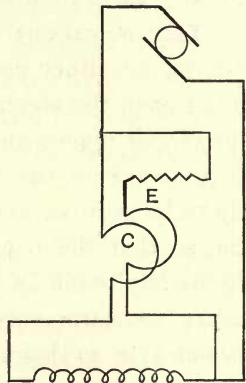

Fig. 59

for the current in the pressure coil, the instrument being connected as in Fig. 58. (Example: Weston wattmeter.)

As in the case of the electro-dynamometer, or other instruments operated by electrodynamic action, it is necessary that a wattmeter of the type here discussed shall have no metal in its frame in which foucault currents may be developed (Sect. 73). If this precaution is not carefully looked after, the constant of the instrument will vary with the frequency, and a calibration is necessary for every frequency. For a properly built

wattmeter, which is used at a point near which there are no masses of metal, a single calibration with continuous currents is sufficient.

46. The Spark caused by breaking a Self-Inductive Circuit.—It is to be expected (see Sect. 19) that a severe spark will pass upon breaking a circuit when it is carrying a continuous current, if it has a great self-inductance, since the self-generated electric pressure tends to uphold the falling current. This is indeed a well-known effect observed upon breaking circuits containing self-inductance. It is seen in exaggerated form in circuits containing such enormous self-inductances as those found in dynamo field windings. Again, breaking the external circuit of a continuous-current series dynamo causes a much more severe spark than breaking the external circuit of a shunt machine. In the latter case the *extra current*, or transfer of electricity due to the self-induction, flows from the field coils through the armature instead of attempting to jump across the break. It may therefore be dangerous to break the circuit of a series dynamo even while the normal working pressure is entirely harmless, while no special danger is likely to come from breaking the external circuit of a shunt dynamo. On the other hand, it is possible to get an exceedingly severe shock by breaking the field circuit of a shunt dynamo in which the working pressure may be quite low. The high pressure due to self-induction which is generated in the shunt field coils when the circuit is broken is a frequent source of injury to the insulation. The extra current, having no outlet, makes one by jumping from

the copper windings to the frame of the machine, thus causing a "ground" or "burn out."

There are many cases where it is desirable to frequently break a continuous-current circuit containing a considerable self-inductance. It is then necessary to arrange some way of diminishing the spark at the break in order to avoid burning up the break switch. There are four methods of reducing the spark:

a. The break may be made gradually by introducing resistance into the circuit before the switch is opened. This resistance should vary gradually from zero to infinity. The manipulation of the resistance may be caused by the same motion which opens the switch.

This device is used quite largely to reduce the spark caused by opening switches or automatic circuit-breakers in high-pressure electric-light or electric-railway circuits, and gives much satisfaction. For this purpose the switch carries an auxiliary contact of carbon. This contact is of much higher resistance than the firm copper contact, and the extra current spends its energy in flowing through it. Therefore when the carbon contact is broken but little spark passes, while what does pass causes comparatively little burning upon a portion of the switch which may be readily renewed (Fig. 60).

b. A coil of high resistance and wound in such a way as to be fairly non-inductive is placed in parallel with the inductive circuit (Fig. 61). The resistance of the non-inductive coil may be so great as not to materially alter the steady current when the circuit is closed; but when the circuit is broken the extra current flows around the high-resistance shunt rather than jump the

break, and thus the spark is reduced or entirely suppressed.

c. The switch may be shunted by a fine wire which acts as a fuse. When the switch is opened, breaking

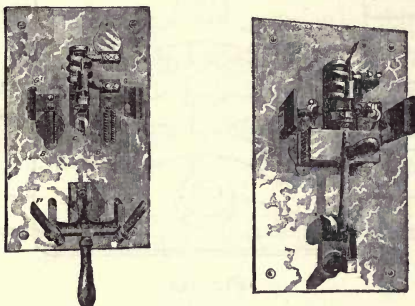

Fig. 60

the circuit, the extra current spends itself by flowing through the fine wire shunt, which it burns off at the same time. This arrangement makes it necessary to replace the fuse before the time of each break. The

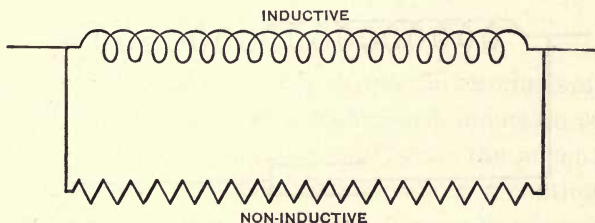

Fig. 61

arrangement is used to some extent upon the fuse blocks (Fig. 62) intended for use in high-pressure electric-light mains. The main fuse of comparatively low resistance is shunted by a fine high-resistance fuse.

When the main fuse blows out, the extra current, instead of causing a vicious spark, spends itself by flowing through the shunt fuse, at the same time blowing it out.

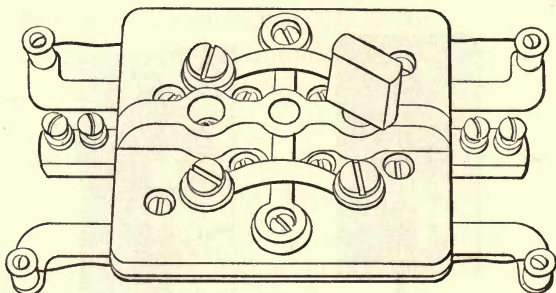

Fig. 62

d. A condenser may be so arranged that it neutralizes the effect of the self-inductance at the time of the break. This may be done in two ways: 1. The condenser may be connected in parallel with the inductive circuit (Fig. 63). Then upon the break the capacity of the condenser

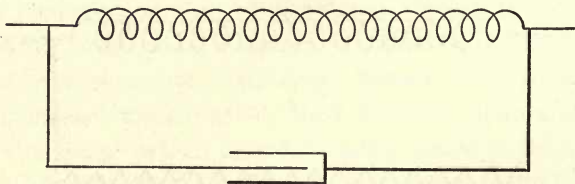

Fig. 63

tends to neutralize the effect of the inductance since the charging current of the condenser due to the rise of inductive pressure is opposite in direction to the extra current due to self-inductance, and the spark is therefore reduced or suppressed. 2. The condenser

may be connected in parallel with the switch (Fig. 64). In this case the extra current flows directly into the condenser, and the spark is reduced or suppressed. The effect of a condenser of fixed capacity in suppressing the spark at break due to a fixed self-inductance is evidently the same in the two positions. Upon closing the circuit, however, the condenser assists the rise of current in the circuit when in the first position, but has no effect whatever when in the second position, since it is short-circuited when the switch is closed. A con-

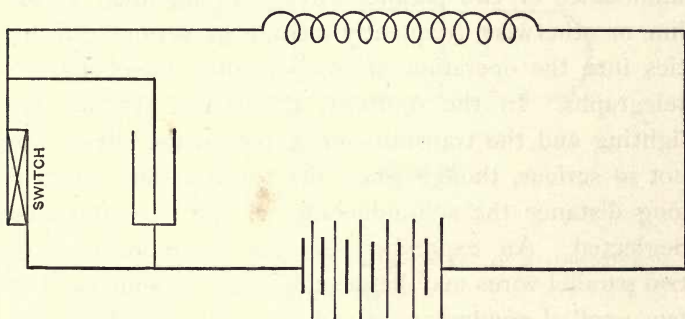

Fig. 64

denser is ordinarily connected across the terminals of the primary circuit-breaker of a Ruhmkorff induction coil.

There is a marked difference between the amount of spark ordinarily produced upon breaking a continuous current and an equal alternating one. For instance, breaking a continuous current of 25 amperes at 1000 volts pressure upon an ordinary hand switch without an especially quick break is likely to cause a lively arc, while breaking an equal alternating current ordinarily causes little more than an observable spark. Some-

times, however, a destructive arc is caused in breaking an alternating current. This is particularly true when fuses blow in high-pressure alternating-current mains where the metallic vapor from the fuse serves as a path for the arc. This difference in behavior on the part of alternating-current circuits is due to the fact that the circuit may be broken at different instants when the current, and the magnetism set up by it, have widely different values.

47. The Self-Inductance of Parallel Wires.—The self-inductance of two parallel wires, hanging upon a pole line or otherwise, frequently introduces serious difficulties into the operation of long-distance telephones or telegraphs. In the ordinary alternating systems for lighting and the transmission of power, the effects are not so serious, though when the transmission is over a long distance the self-inductance of the line cannot be neglected. An expression for the self-inductance of two parallel wires may be developed thus: suppose that two parallel conductors A and A' form a circuit of indefinitely great length. Let C be the current flowing through the conductors, r their radius, and δ the distance between their axes. Also let μ and μ' be respectively the permeability of the medium surrounding the wires and of the wires themselves. The strength of the magnetic field (H_a) at a point outside of the conductor A at a distance a from its centre, and due to the current in A is

$$H_a = \frac{2C}{a} *$$

* The lines of force due to the current in the conductor are circles with their planes perpendicular to the conductor, and if the force at any point

The magnetic induction (B_a) at the point is therefore

$$B_a = \frac{2\mu C}{a}.$$

Now consider a space cut out by two planes perpendicular to the axes of the conductors and one centimeter

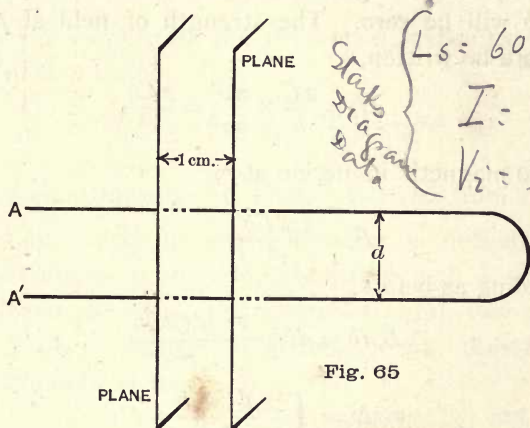

Fig. 65

apart (see Fig. 65). Within this space at a distance a from A a number of lines of force

$$B_a da = dN_a = \frac{2\mu C da}{a}$$

will pass through a radial width da . The total number of lines of force that will pass between the planes in the distance between the surface of A and the centre of A' will be,

$$N_a = \int_r^{\delta} \frac{2\mu C da}{a} = 2\mu C \log_e \frac{\delta}{r}.$$

at a distance a from the conductor is F , the work done against it in moving a unit magnet pole around the conductor is $W = 2\pi aF$. Also by Vol. I., p. 12, $W = 4\pi nC$, but in this case, $n = 1$, and therefore $2\pi aF = 4\pi C$, or $F = \frac{2C}{a} = H$.

At any point p within A and at a distance b from the centre of A , the magnetic effect will be as though the current within a circle of radius b were condensed at the centre, since the magnetic effect at the point, p , of the uniform layer of current in the conductor beyond b will be zero. The strength of field at p may therefore be written,

$$H_c = \frac{2C}{b} \times \frac{\pi b^2}{\pi r^2} = \frac{2Cb}{r^2},$$

and the magnetic induction at p ,

$$B_c = \frac{2\mu'Cb}{r^2}.$$

Proceeding as before,

$$B_c db = dN_c = \frac{2\mu'Cb db}{r^2},$$

and

$$N_c = \int_0^r \frac{2\mu'Cb db}{r^2} = \mu' C.$$

But this induction does not link with the whole current, but only with that within a circle of radius b . The product of the current with the number of lines of force enclosed by it is

$$\Sigma dN_c dC_c = \int_0^r \frac{2\mu'Cb db}{r^2} \times \frac{\pi b^2}{\pi r^2} = \frac{1}{2} \mu' C.$$

The self-inductance of A per unit length is equal to 10^{-9} times the number of lines of force linking the current when it has a value of unity (Sect. 16), and therefore,

$$L_A = \left(2\mu \log_e \frac{\partial}{r} + \frac{\mu'}{2} \right) \div 10^9.$$

The effect of the return conductor A' is to exactly double

the magnetism which is linked or enclosed by the current, and therefore the self-inductance per centimeter length of circuit or per two centimeters length of wire is

$$L_{AA'} = 2 \left(2 \mu \log_e \frac{\partial}{r} + \frac{\mu'}{2} \right) \div 10^9.$$

When the conductors are of copper suspended in the air, $\mu = \mu' = 1$, and

$$L_{AA'} = 2 \left(2 \log_e \frac{\partial}{r} + \frac{1}{2} \right) \div 10^9.*$$

As a rule the value of $2 \log_e \frac{\partial}{r}$, derived from the distances apart and diameters of wires in ordinary electric circuits, is quite large compared with $\frac{1}{2}$, and the impedance of such circuits consisting of two parallel wires, each l centimeters in length, may therefore be approximately written,

$$I = \sqrt{R^2 + 4 \pi^2 f^2 L^2} = \left\{ R^2 + \frac{4 \pi^2 f^2}{10^9} \left(4 \log_e \frac{\partial}{r} \right)^2 l^2 \right\}^{\frac{1}{2}}.$$

The ratio of the impedance of a circuit to the resistance of the conductors $\left(\frac{I}{R} \right)$ has been called by Kennelly the **Impedance Factor**, and its value has been calculated by him for circuits having a wide range in the values of ∂ and r , and for various frequencies from 40 to 140.† Kennelly has also measured the resistance and impedance of a certain circuit, and found that the actual measurements with an approximately sinusoidal current fully agree with the computation.‡

* Gerard's *Leçons sur l'Électricité*, Vol. I., p. 232; Kennelly, *Trans. Amer. Inst. E. E.*, Vol. 10, p. 213.

† Kennelly, *Impedance*, *Trans. Amer. Inst. E. E.*, Vol. 10, p. 175.

‡ Kennelly, *Trans. Amer. Inst. E. E.*, Vol. 10, p. 215.

Emmet* has calculated a table of the resistance, reactance, and impedance of circuits under various conditions for the frequencies of 60 and 125, which are frequencies now in general commercial use in the United States. The data of Emmet's table are given on page 145. The figures are calculated on the assumption of a sinusoidal current, but in practice the current is usually not sinusoidal, and the actual reactance and impedance are therefore likely to be increased from 5 to 25 per cent, depending upon the elements of the circuit and the distortions of the current curve. For average conditions, Emmet advises adding 15 per cent to the figures of the table on this account.

48. The Distribution of Current in a Wire.—The distribution of the current over the normal cross-section of a conductor along which it flows, is uniform, provided the current is steady, as this is the distribution which gives the least loss of energy in the conductor. The proof of this theorem is as follows: The total power lost in the conductor is, according to Joule's law, C^2R , where R is equal to $\frac{l\rho}{A}$, l , ρ , and A being the length, specific resistance, and area of the conductor. Considering that the conductor is divided into elementary filaments of equal area and resistance, r , and the current flowing in one of these is c , then the power lost in it is c^2r , and the total power lost in the conductor is Σc^2r , which must be equal to C^2R , while $\Sigma c = C$. These conditions can be simultaneously fulfilled only when the currents in the filaments are all equal, or the distribu-

* *Alternating Current Wiring and Distribution.*

| Gauge No. B. & S. Wire. | Reactance and Impedance in Ohms per Mile of Wire at a Frequency of 60. | | | | Reactance and Impedance in Ohms per Mile of Wire at a Frequency of 125. | | | | | | | |
|-------------------------|--|-------|----------------------------|-------|---|------|----------------------------|-------|----------------------------|-------|------|-------|
| | 12 Inches Between Centres. | | 18 Inches Between Centres. | | 12 Inches Between Centres. | | 18 Inches Between Centres. | | 24 Inches Between Centres. | | | |
| | React. | Imp. | React. | Imp. | React. | Imp. | React. | Imp. | React. | Imp. | | |
| 0000 | .259 | .570 | .557 | .615 | .591 | .646 | 1.06 | 1.092 | 1.17 | 1.190 | 1.23 | 1.260 |
| 000 | .324 | .616 | .573 | .658 | .607 | .686 | 1.09 | 1.138 | 1.20 | 1.237 | 1.26 | 1.305 |
| 00 | .412 | .682 | .588 | .725 | .618 | .749 | 1.12 | 1.194 | 1.23 | 1.297 | 1.29 | 1.357 |
| 0 | .519 | .756 | .603 | .796 | .633 | .818 | 1.15 | 1.258 | 1.26 | 1.360 | 1.32 | 1.415 |
| 1 | .655 | .865 | .614 | .896 | .648 | .920 | 1.18 | 1.349 | 1.28 | 1.436 | 1.35 | 1.50 |
| 2 | .826 | 1.008 | .629 | 1.038 | .663 | 1.06 | 1.21 | 1.466 | 1.31 | 1.55 | 1.38 | 1.61 |
| 3 | 1.041 | 1.196 | .644 | 1.223 | .674 | 1.24 | 1.24 | 1.61 | 1.34 | 1.70 | 1.41 | 1.75 |
| 4 | 1.313 | 1.448 | .656 | 1.467 | .690 | 1.48 | 1.26 | 1.82 | 1.37 | 1.89 | 1.44 | 1.94 |
| 5 | 1.656 | 1.76 | .670 | 1.78 | .704 | 1.80 | 1.30 | 2.10 | 1.40 | 2.17 | 1.47 | 2.22 |
| 6 | 2.088 | 2.18 | .685 | 2.20 | .720 | 2.21 | 1.32 | 2.46 | 1.43 | 2.51 | 1.49 | 2.56 |
| 7 | 2.633 | 2.71 | .700 | 2.72 | .730 | 2.73 | 1.35 | 2.93 | 1.46 | 3.00 | 1.52 | 3.04 |
| 8 | 3.320 | 3.38 | .712 | 3.39 | .742 | 3.40 | 1.38 | 3.59 | 1.48 | 3.63 | 1.55 | 3.66 |
| 9 | 4.186 | 4.21 | .727 | 4.22 | .761 | 4.23 | 1.41 | 4.39 | 1.51 | 4.43 | 1.58 | 4.45 |
| 10 | 5.280 | 5.32 | .742 | 5.33 | .776 | 5.34 | 1.44 | 5.47 | 1.54 | 5.50 | 1.62 | 5.53 |

tion is uniform. In the case of alternating currents, self-induction or "electro-magnetic inertia" comes in to interfere with the uniform distribution. Suppose the wire be divided into elementary filaments, then the formula

$$N = 2 \mu C \log_e \frac{\rho}{r} + \mu' C,$$

which exhibits the number of lines of force set up by current C , shows that a greater number of lines surrounds the central filament of the wire than those nearer the surface. In fact, the filaments composing the outside of the wire are surrounded by $\mu' C$ less lines of force than the central filament. When an alternating current flows through the wire, a counter electric pressure is set up in each filament which is equal to $\frac{dN_r}{dt}$, where N_r is the number of lines of force set up by the current and which surround the filament under consideration. Since N_r increases from the outside of the wire towards the central filament, the counter electric pressure is greatest at the centre and least at the surface of the conductors. Consequently there is a tendency for the current to forsake the centre of the conductor and to take a place nearer the surface. This tendency is directly proportional to the frequency when the current is sinusoidal. It is opposed by the tendency of the current to a distribution which will give the least loss of energy, and the current therefore distributes itself in such a way that the current density increases from the centre to the surface of the conductor. *This makes an increase in the actual resistance to the flow of the current and in the loss of energy caused*

by the current flowing through the conductor. The ratio of the resistance of a conductor to an alternating current, R_a , to its true resistance, or the resistance which it opposes to a continuous current, R_c , may be calculated by the following formula:*

$$\frac{R_a}{R_c} = 1 + \frac{1}{12} \frac{\mu^2 l^2 f^2}{R_c^2} - \frac{1}{180} \frac{\mu^4 l^4 f^4}{R_c^4} + \text{etc.}$$

When the wire is copper, μ is equal to unity, and the formula becomes

$$\frac{R_a}{R_c} = 1 + \frac{1}{12} \frac{l^2 f^2}{R_c^2} - \frac{1}{180} \frac{l^4 f^4}{R_c^4} + \text{etc.}$$

A table showing the increase in the resistance of wires when carrying alternating currents was first cal-

| Diameter. | | Area. | | Increase over Ordinary Resistance. | Fre- quency. |
|-----------|---------|---------|---------|------------------------------------|-----------------|
| MM. | Inches. | Sq. MM. | Sq. in. | | |
| 10 | .3937 | 78.54 | .122 | less than $\frac{1}{100}$ % | 80 |
| 15 | .5905 | 176.7 | .274 | 2½ % | |
| 20 | .7874 | 314.16 | .487 | 8 % | |
| 25 | .9842 | 490.8 | .760 | 17½ % | |
| 40 | 1.575 | 1256. | 1.95 | 68 % | |
| 100 | 3.937 | 7854. | 12.17 | 3.8 times | |
| 1000 | 39.37 | 785400. | 1217 | 35 times | |
| 9 | .3543 | 63.62 | .098 | less than $\frac{1}{100}$ % | 100 |
| 13.4 | .5280 | 141.3 | .218 | 2½ % | |
| 18 | .7086 | 254.4 | .394 | 8 % | |
| 22.4 | .8826 | 394.0 | .611 | 17½ % | |
| 7.75 | .3013 | 47.2 | .071 | less than $\frac{1}{100}$ % | 133 |
| 11.61 | .4570 | 106 | .164 | 2½ % | |
| 15.5 | .6102 | 189 | .292 | 8 % | |
| 19.36 | .7622 | 294 | .456 | 17½ % | |

* Gray's *Absolute Measurements in Electricity and Magnetism*, Vol. II., p. 329; Gerard's *Leçons sur l'Électricité*, Vol. I., p. 236.

culated by Mordey* on data presented by Lord Kelvin † (see table on preceding page). From this table it is seen that R_a is practically the same as R_c for the sizes of wire and frequencies which are ordinarily used; but Emmet ‡ has calculated a table which may be conveniently used in any case where R_a differs from R_c . This table is given below.

| Product of Circular Mils and Frequency. | $\frac{R_a}{R_c}$ | Product of Circular Mils and Frequency. | $\frac{R_a}{R_c}$ |
|---|-------------------|---|-------------------|
| 10,000,000 | 1.00 | 70,000,000 | 1.13 |
| 20,000,000 | 1.01 | 80,000,000 | 1.17 |
| 30,000,000 | 1.03 | 90,000,000 | 1.20 |
| 40,000,000 | 1.05 | 100,000,000 | 1.25 |
| 50,000,000 | 1.08 | 125,000,000 | 1.34 |
| 60,000,000 | 1.10 | 150,000,000 | 1.43 |

This table shows that the frequency or the diameter of the wire may be so great that no current at all will flow at the centre of the conductor, while if the frequency is very great, the current will all remain at the exact outer surface or skin of the wire. Thomson § shows that the value of the current at the distance x from the surface of a conductor is equal to

$$e^{-x\left(\frac{4\pi^2 f \mu}{\rho}\right)^{\frac{1}{2}}},$$

when ρ is the specific resistance of the material. Gray || shows that however great the diameter of a wire may

* *Four. Inst. E. E.*, Vol. 18, p. 603.

† *Four. Inst. E. E.*, Vol. 18, pp. 14 and 35.

‡ *Alternating Current Wiring and Distribution*.

§ J. J. Thomson's *Elements of Electricity and Magnetism*, p. 418.

|| *Absolute Measurements in Electricity and Magnetism*, Vol. II., p. 338.

be, its resistance to an alternating current will never be less than the true resistance of a wire of the diameter in centimeters given in the following table.

| Frequency. | Copper. | Lead. | Iron, $\mu = 300$. |
|------------|---------|-------|---------------------|
| 80 | 1.43 | 4.98 | .195 |
| 120 | 1.17 | 4.08 | .159 |
| 160 | 1.02 | 3.52 | .138 |
| 200 | .91 | 3.16 | .123 |

The specific resistance of lead is not far from that of ordinary German silver; it is about twice that of iron, and about twelve times that of copper. The remarkably large *skin effect* in the case of the iron is thus shown to be due to its large magnetic permeability. The permeability of 300 may be somewhat large to assume for an iron wire when under the ordinary circuit conditions. Kennelly states that iron telegraph or telephone wires show by measurement with small currents that μ is about 150. With increasing currents it would, of course, increase to about 1000, and then again diminish.

The value of the self-inductance of a wire was determined in the preceding section on the assumption of a uniform distribution of the current in the conductor. Any disturbance of this distribution on account of *skin effect* will reduce the value of the self-inductance by a small amount.* The correctness of these deduc-

* Gray's *Absolute Measurements in Electricity and Magnetism*, Vol. II., p. 329.

tions in regard to self-inductance and *skin effect* in electrical conductors is proved by extensive experimental researches by Professor Hughes* and Lord Rayleigh.

* The Self-induction of an Electric Current in Relation to the Nature and Form of the Conductor, *Four. Inst. E. E.*, Vol. 15, p. 6.

CHAPTER IV.

GRAPHICAL AND ANALYTICAL METHODS OF SOLVING
PROBLEMS IN ALTERNATING CURRENT CIRCUITS.

49. Graphical Methods. — Graphical methods lend themselves very satisfactorily to the solution of problems relating to circuits upon which a sinusoidal electrical pressure is impressed. This application of the methods was first brought to general attention by T. H. Blakesley.* The methods are those of vector algebra, and are entirely analogous to those which are so largely used in the graphical solutions relating to the composition and resolution of forces in graphical statics and relating to the composition and resolution of velocities, etc., in graphical dynamics. To make the treatment as simple as possible, the use of the methods herein will be made to conform as closely as possible to their use in the treatises on graphical statics.†

If the line OA in Fig. 66 is conceived as swinging at a uniform angular velocity ω around the point O , the angle a which it makes with the horizontal axis OX at any instant is $a = \omega t$, where t is the interval of time during which the line describes the angle a . The instanta-

* Blakesley's *Alternating Currents of Electricity*.

† See Dubois' *Graphical Statics*, Hoskins' *Elements of Graphic Statics*, etc.

neous projection Oa upon the vertical axis OY , of the line OA , has a value $Oa = OA \sin \alpha$. If OA is proportional to the maximum value of a sinusoidal function, its instantaneous values are proportionally represented by the instantaneous projections of OA ; and if OA is proportional to the effective value of a sinusoidal function, the instantaneous values of the function are proportionally represented by the product of $\sqrt{2}$ into the corresponding instantaneous projections. It is therefore possible to represent all the elements of a sinusoidal function:

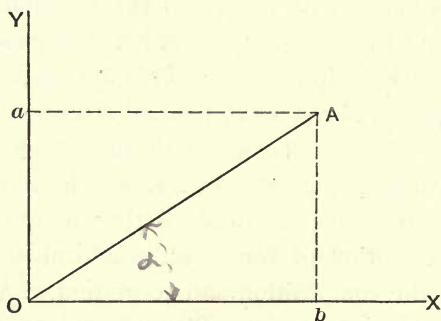

Fig. 66

(1) by a straight line which revolves at a uniform rate around one end; and (2) by the instantaneous projections of the line. It is evident that the motion which the projection of the end A of the revolving line makes along the axis OY is a simple harmonic motion, and that all the theorems relating to simple harmonic motion may be applied to these solutions. As is ordinarily done, the rotation of the line will always be considered to be left-handed in the following discussions; and angles measured from right to left will be considered

positive, while those measured from left to right will be considered negative.

If two sinusoidal electric pressures of the same frequency but having a phase difference ϕ , act in a circuit, the corresponding instantaneous values are,

$$e = \sqrt{2} E \sin a,$$

$$e' = \sqrt{2} E' (\sin a + \phi).$$

The total instantaneous electric pressure acting in the circuit is $e + e'$. In Fig. 67 the pressure E is repre-

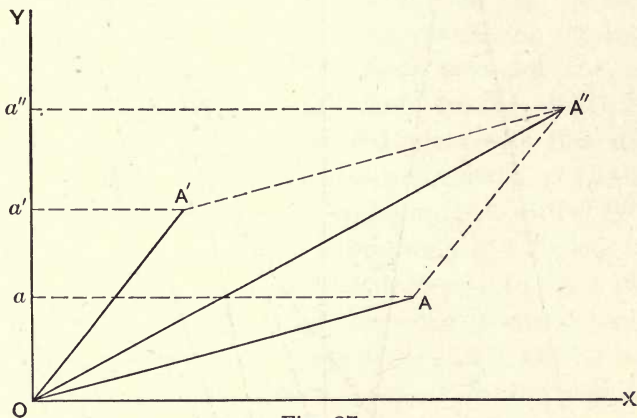
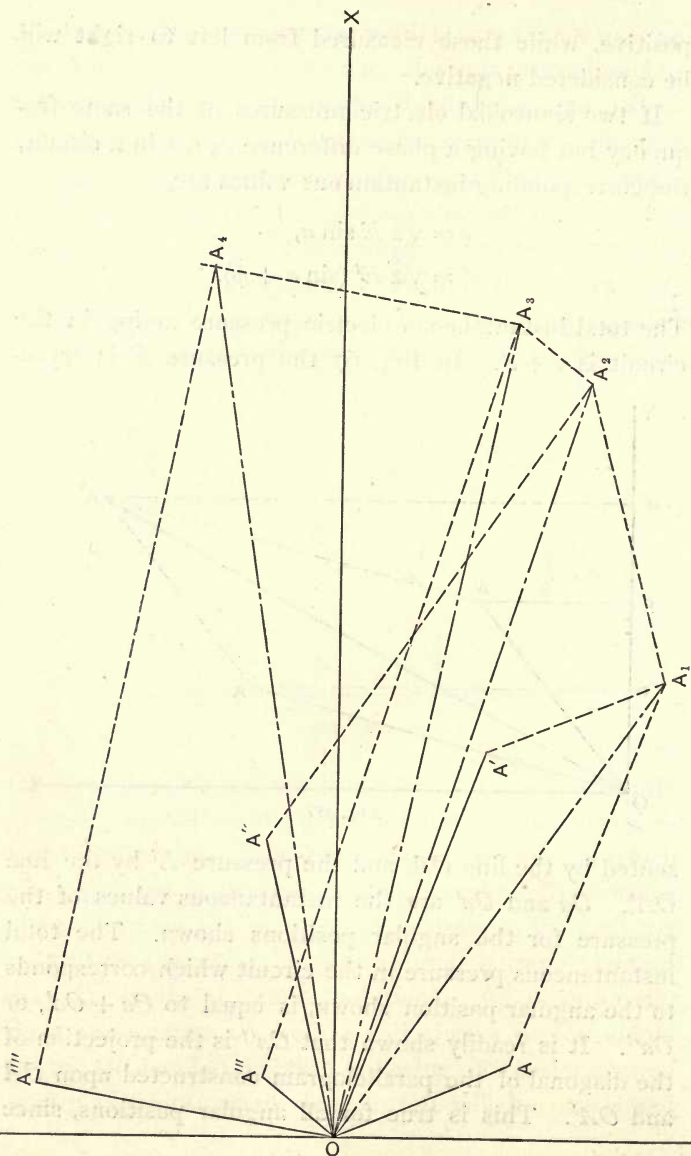

Fig. 67

sented by the line OA , and the pressure E' by the line OA' . Oa and Oa' are the instantaneous values of the pressure for the angular positions shown. The total instantaneous pressure in the circuit which corresponds to the angular position shown, is equal to $Oa + Oa'$, or Oa'' . It is readily shown that Oa'' is the projection of the diagonal of the parallelogram constructed upon OA and OA' . This is true for all angular positions, since



the sum of the projections of the lines OA and OA' must be equal to the sum of the projections of the lines OA and AA'' , which in turn is equal by construction to the projection of the diagonal OA'' .

The length of the line OA'' , therefore, proportionally represents the magnitude of the effective or maximum total electrical pressure in the circuit, and its position relative to that of OA and OA' , represents the relative phase position of the total pressure. If instead of two pressures acting in a circuit, there are three or more, as OA , OA' , OA'' , OA''' , and OA'''' , in Fig. 68, the same construction is used. Thus, completing the parallelogram for OA and OA' , their resultant OA_1 is found. Completing the parallelogram for OA_1 and OA'' , their resultant OA_2 is found, and again with this and OA''' the resultant OA_3 is obtained; finally, OA_4 , the final resultant, is obtained by combining OA_3 with OA'''' . The figure shows that it is unnecessary to complete all the parallelograms. It is only necessary to draw the lines AA_1 , A_1A_2 , A_2A_3 , A_3A_4 respectively parallel and equal in length to the lines OA' , OA'' , OA''' , and OA'''' , and the line drawn from O to the end of the last line laid off gives the phase-position and magnitude of the total pressure in the circuit, regardless of the number of the components from which it is derived (Fig. 69). The composition of electrical pressures is therefore exactly analogous to the composition of velocities or of forces. *As in the case of velocities or forces, the resultant of any number of electrical pressures may be determined by this method.*

The resultant of two sinusoidal alternating electric

currents which flow in a divided circuit may be graphically determined in the same manner. In Fig. 67, let

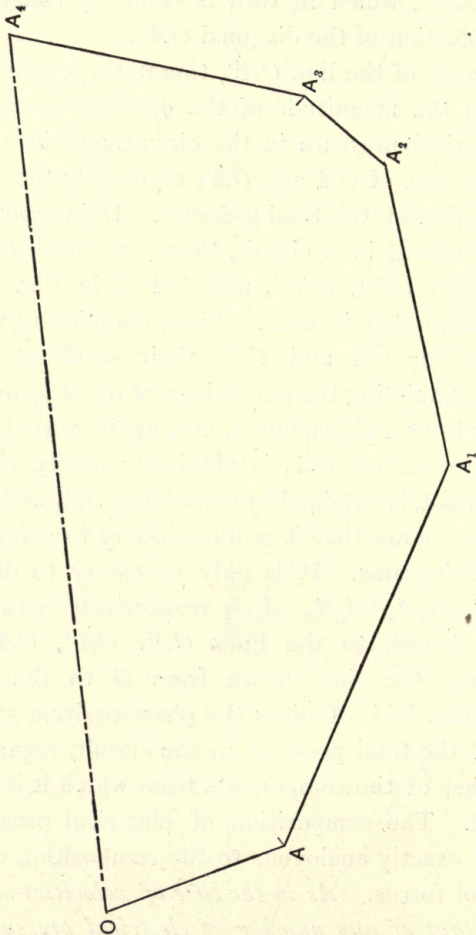

Fig. 69

OA and OA' be the currents in the two inductive branches of a divided circuit. The two partial cur-

rents differ from each other in phase by an angle ϕ . The instantaneous values of the currents are represented by the instantaneous projections of the lines as they revolve around the point O . At each instant, the total current in the main circuit is equal to the sum of the instantaneous partial currents, or to $c + c'$. Consequently, the magnitude of the effective or maximum value of the current in the main circuit is proportionally represented by the length of the line OA'' , and the angular direction of OA'' gives the angular relation of the phase of the total current to the phases of the partial currents. When the divided circuit contains more than two branches, the same method may be extended, as already explained for the composition of electric pressures.

For convenience in using the graphical methods for solving alternating-current problems, it is well to distinguish between two different diagrams. The first diagram represents the magnitude and relative phase positions of the electric pressures or currents. This may be called the **Phase Diagram**. The other diagram is the polygon formed by laying off lines equal and parallel to the lines in the phase diagram. This may be called the **Vector Diagram**. Figures 68 (full lines only) and 69 are respectively phase and vector diagrams for representing five electrical pressures. The resultant pressure is represented in magnitude and phase by the line OA_4 . If the closing line of the vector diagram is inserted in the phase diagram by drawing from O a line in the direction obtained by following round the vector diagram against the direction in which the lines were

drawn, the line so inserted evidently represents the resultant of the component pressures or currents. If the line be drawn from O in the opposite direction, it represents a balancing pressure or current.

These simple propositions, which so evidently come from the ordinary graphical mechanics (statics and dynamics), give all the foundation that is necessary for the rapid and accurate solution of problems relating to the flow of current in simple and compound circuits containing definite resistances, inductances, and capacities in their different parts. For solutions of complicated problems the graphical method is often preferable to the analytical, because the labor of analytical calculations is rapidly increased with the complication of the circuits, while the ease and accuracy of graphical calculations are not affected thereby. The graphical method also has the advantage of showing directly to the eye the relative phases of the pressures or currents in different parts of the circuit. The graphical solutions have the same limitations in regard to alternating currents or pressures which are not sinusoidal as have the analytical methods; and where the wave form is not sinusoidal, only an approximation can be arrived at by judiciously correcting the results shown by the diagrams based on sine functions.

The problems relating to alternating-current circuits which may be solved by graphical methods may be divided into three classes: (1) where the current flows through all parts of the circuit in series; (2) where the same electrical pressure is impressed upon all parts of the circuit (parallel circuits); and (3) where the first and

second classes are combined. Solutions in the third class are effected by combining partial solutions of the first and second classes.

50. Series Circuits.—*First Class.* Suppose a circuit is given which has a certain resistance and self-inductance and it is desired to know what impressed pressure with a frequency f is required to pass through it a certain current C . In this case the impressed pressure is made up of two components: (1) the pressure required to pass the current through the resistance of the circuit; (2) the pressure required to balance or overcome the counter inductive pressure. The inductive pressure is 90° in phase behind the active pressure, and the phase diagram which shows the relative phases of the pressures in the circuit is therefore like that shown in Fig. 70. The active pressure OA' is equal to CR , and the inductive pressure OA'' is equal to $2\pi fLC$. The inductive component of the impressed pressure is required to balance $2\pi fLC$ and is therefore equal to and opposite to OA'' . An arrowhead is therefore placed on OA'' to show that in the vector diagram its direction must be taken from A'' to O , instead of from O outwards, as is done with the other lines. The vector diagram is therefore given by drawing O_1A_1 equal and parallel to OA' , A_1A_2 equal and parallel to $A''O$, and closing the polygon by the line O_1A_2 (Fig. 70). The line O_1A_2 taken in the direction from O_1 to A_2 represents the magnitude and relative phase of the impressed pressure. When inserted in the phase diagram, it is the line OA''' . The angle ϕ , by which the current lags behind the impressed pressure, is the angle $A_2O_1A_1$.

If a number of inductive circuits are connected in series, the inductive pressure line of the phase diagram is equal to $2\pi fC(L_1 + L_2 + L_3 + \text{etc.})$, and the active pressure line is equal to $C(R_1 + R_2 + R_3 + \text{etc.})$, where

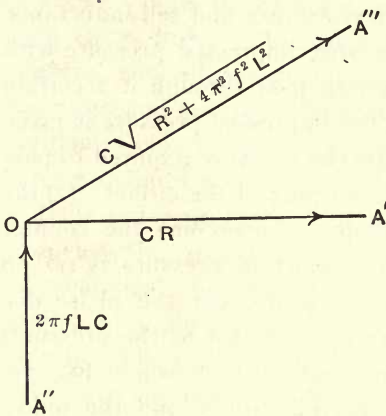

$L_1, L_2, L_3, R_1, R_2, R_3,$ etc., are the self-inductances and resistances of the different parts of the circuit. If the circuit is non-inductive the phase diagram and vector diagram each become a single horizontal line equal in length to CR , while if the inductive circuit contains no resistance the diagrams each become a single vertical line which is equal in length to $2\pi fLC$.

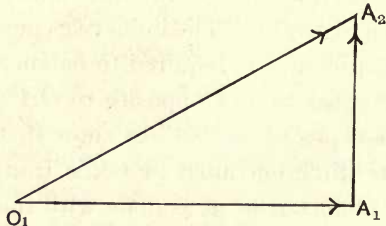

Fig. 70

Dividing the lengths of the sides of the vector polygon by the value of C gives the equivalent resistance for each. The vector polygon may therefore be used directly for determining the impedance of a circuit when the resistances and reactances of its various parts are known. A vector polygon representing pressures, and one representing equivalent resistances, may evidently be converted, one into the other, by a simple change of scale. It is to be remembered that in a series

circuit the current has the same phase, and is equal at any given instant, in all parts of the circuit, but the phase, with reference to the current, of the pressure impressed at the terminals of different parts of the circuit depends wholly upon the relation between the individual resistances and reactances of the parts.

EXAMPLES. — In the following examples it is desired to find for each of the given circuits: (1) the impedance of the circuit; (2) the current which flows through the circuit when the impressed pressure is 100 volts; (3) the impressed pressure which is required to pass 10 amperes through the circuit; (4) the angle by which the current lags behind the impressed pressure. The frequency in each case is taken to be $127\frac{1}{2}$, whence $2\pi f$ is equal to 800.

Circuits containing Resistance and Self-inductance.

a. The circuit consists of a non-inductive resistance of 10 ohms. The phase and vector diagrams for the first two solutions are resistance diagrams, each consisting of a horizontal line 10 units in length. The impedance of the circuit is 10 ohms, and the current which flows when a pressure of 100 volts is impressed on the circuit is 10 amperes. The diagrams for the third solution are pressure diagrams, each consisting of a horizontal line $CR (=100)$ units in length, and the impressed pressure required to pass 10 amperes through the circuit is 100 volts. The angle ϕ is zero.

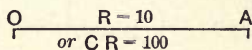
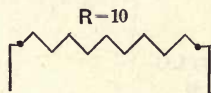

Solution α

b. The circuit consists of an inductive coil of 10 ohms resistance and .01 henry self-inductance. The phase and vector diagrams for the first two solutions are resistance diagrams, as shown in the figure. The impedance is shown by the closing line of the diagram

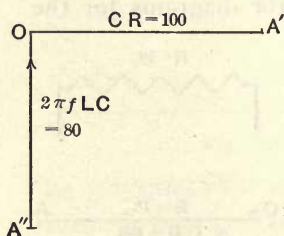
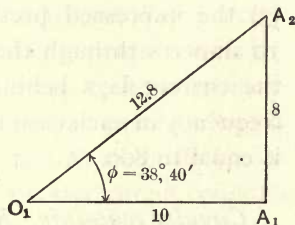
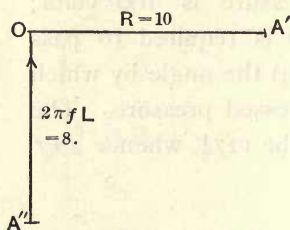
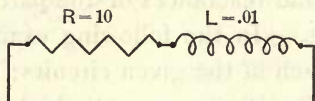

Solution b

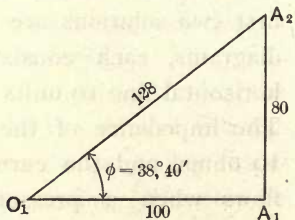

to be 12.8 ohms, whence it is seen that 7.81 amperes will flow through the circuit when the impressed pressure is 100 volts. The third solution shows that the impressed pressure required to pass 10 amperes through the circuit is 128 volts. The angle ϕ is $38^\circ 40'$.

c. The circuit consists of a non-inductive coil of 5 ohms in series with an inductive coil of 5 ohms and .01 henry. The total phase and vector diagrams for this are exactly the same as in example *b*. The vector diagram may be laid off as shown in the figure. This shows that the pressure impressed upon the circuit as a whole is not equal to the algebraic sum of the pressures measured between the terminals of the parts of the circuits, but it is still equal to their vector sum.

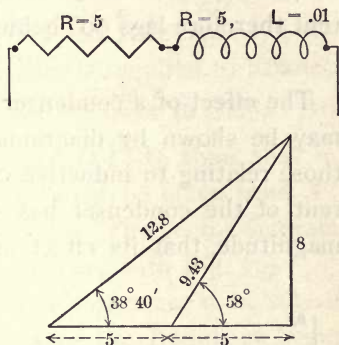
Solution *c*

d. The circuit consists of an inductance of .01 henry. The phase and vector diagrams for the first two solutions are each resistance diagrams consisting of a vertical line $2\pi fL (= 8)$ units in length. The impedance of the circuit is 8 ohms, and the current which flows through the circuit under an impressed pressure of 100 volts is 12.5 amperes. The diagrams for the third solution are pressure diagrams, each consisting of a

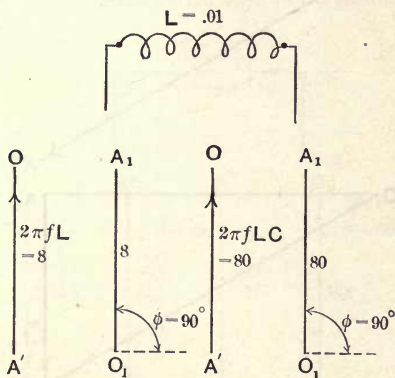
Solution *d*

vertical line $2\pi fLC (= 80)$ units in length, and the impressed pressure required to pass 10 amperes through the circuit is 80 volts. The angle ϕ is 90° , and the current therefore lags 90° behind the impressed pressure.

The effect of a condenser placed in series in a circuit may be shown by diagrams which are very similar to those relating to inductive circuits. The charging current of the condenser has such a phase position and magnitude, that its effect on the total current flowing

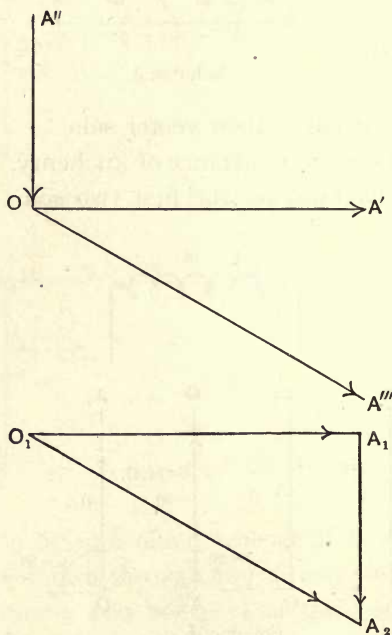

Fig. 71

in the circuit is the same as the effect of an electric pressure which is equal to $\frac{C}{2\pi fs}$ and is 90° in advance of the circuit current. This may be called the **Condenser Pressure** (see Sect. 31). The phase diagram is like that shown in Fig. 71. The pressure impressed on the circuit when current C flows, must consist of two components: (1) the pressure required to pass the current through the resistance of the circuit; (2) the press-

ure required to balance the condenser pressure. The active pressure OA' in the figure is equal to CR , and the condenser pressure OA'' is equal to $\frac{C}{2\pi fs}$ and is 90° in advance of the active pressure. The capacity component of the impressed pressure is required to balance $\frac{C}{2\pi fs}$, and is therefore equal and opposite to OA'' . An arrowhead is therefore placed on OA'' to show that in the vector diagram its direction must be taken from A'' to O , instead of from O outwards. The vector diagram is then as shown in Fig. 71 (compare with Fig. 70).

EXAMPLES.—The following examples are to be solved for the same constants as before, the frequency being taken as $127\frac{1}{2}$.

Circuits containing Resistance and Capacity.

e. The circuit contains simply a condenser having a capacity of 100 microfarads (= .000100 farad). The phase and vector diagrams for the first two solutions are each resistance diagrams consisting of a vertical line $\frac{I}{2\pi fs}$ (= 12.5) units in length. The impedance of the circuit is 12.5 ohms, and the current which flows through the circuit, when 100 volts is im-

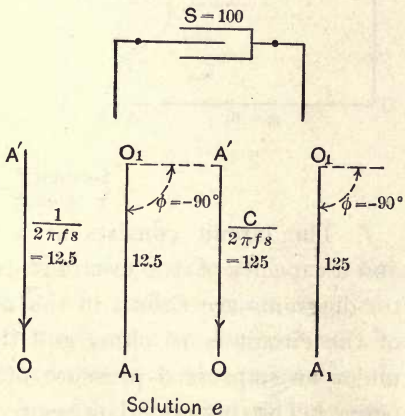

pressed on it, is 8 amperes. The diagrams for the third solution are pressure diagrams each consisting of a vertical line $\frac{C}{2\pi fs}$ ($= 125$) units in length, and the impressed pressure required to pass 10 amperes through the circuit is 125 volts. The angle ϕ is -90° , that is, the current is 90° in advance of the impressed pressure. The lines composing the diagrams for this example are drawn in a direction which is exactly opposite to that of the lines in the diagrams of the example *d*.

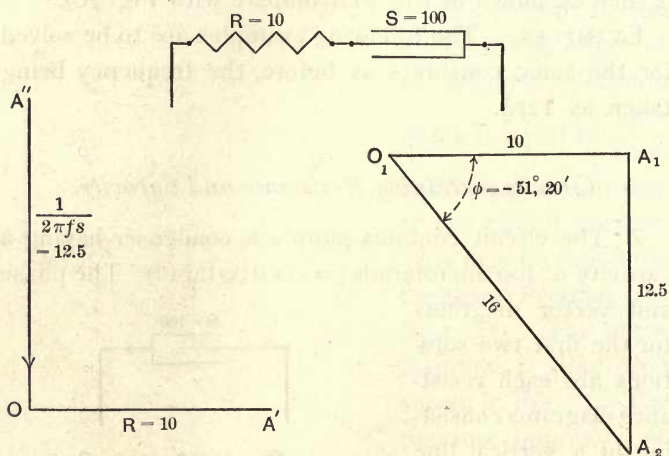
Solution *f*

f. The circuit consists of a resistance of 10 ohms and a capacity of 100 microfarads. The phase and vector diagrams are shown in the figure. The impedance of the circuit is 16 ohms and the current which flows under an impressed pressure of 100 volts is 6.25 amperes. The impressed pressure required to cause 10

amperes to flow through the circuit is 160 volts. The angle ϕ is $-51^{\circ} 20'$.

Circuits containing Self-inductance and Capacity.

g. The circuit consists of a capacity of 100 microfarads in series with an inductance of .01 henry. The

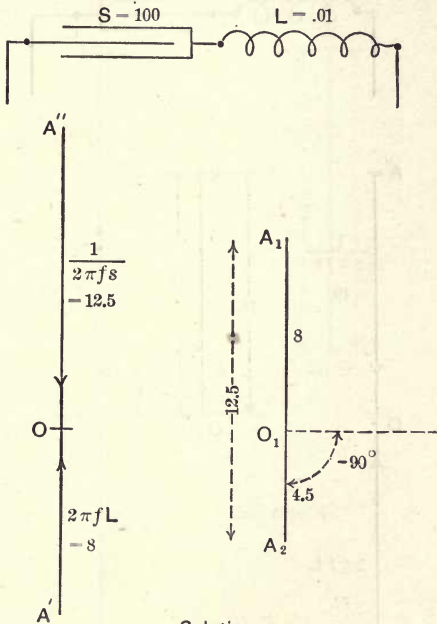

Solution g

diagrams are as shown. The impedance of the circuit is 4.5 ohms. The current which flows when the impressed pressure is 100 volts is 22.2 amperes, at which time the pressure measured between the terminals of the condenser is 277.6 volts and that measured between

the terminals of the inductance is 177.6 volts. The impressed pressure required to pass 10 amperes through the circuit is 45 volts. The angle ϕ is -90° .

h. The circuit consists of a capacity of 125 microfarads in series with an inductance of .015 henry. The

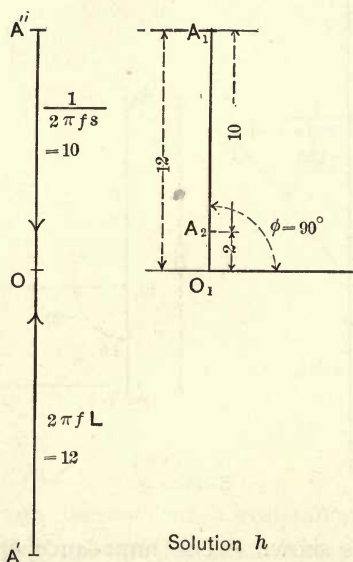
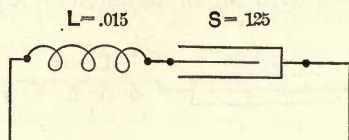

Solution *h*

impedance of the circuit is 2 ohms and the current which flows under 100 volts impressed pressure is 50 amperes, at which time the pressure measured between

the terminals of the condenser is 500 volts and between the terminals of the inductance is 600 volts. The impressed pressure required to pass 10 amperes through the circuit is 20 volts. With this current flowing, the

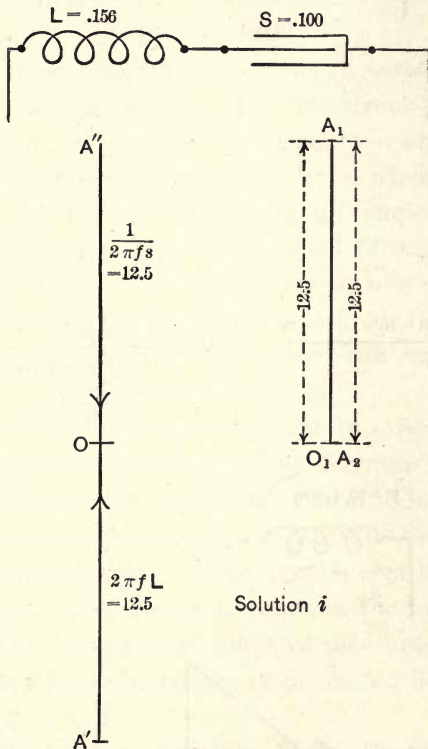

pressure measured between the terminals of the condenser is 100 volts and between the terminals of the inductance is 120 volts. The angle ϕ is 90° .

i . The circuit consists of a capacity of 100 microfarads in series with an inductance of .0156 henry.

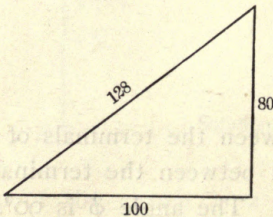
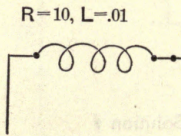
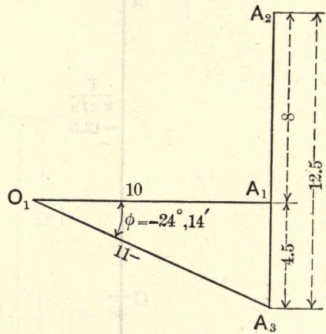
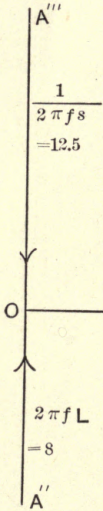
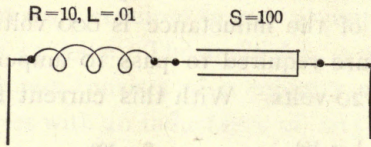

Solution j

The phase and vector diagrams are shown in the figure. In this case $\frac{1}{2\pi fs} = 2\pi fL$ and the impedance of the circuit is zero.

*Circuits containing Resistance, Self-inductance,
and Capacity.*

j. The circuit consists of 10 ohms in series with 100 microfarads and .01 henry. The impedance of the circuit is shown by the diagram to be 11— ohms. The current which flows through the circuit when 100 volts are impressed at its terminals is 9.1 amperes. The pressure required to pass 10 amperes through the circuit is 110 — volts. This is the vector sum of 125 and 128, which are the pressures measured respectively between the condenser terminals and the remainder of the circuit. The angle ϕ is $-24^{\circ} 14'$.

k. The circuit consists of 10 ohms in series with 150 microfarads and .01042 henry. The diagrams show that the impedance of the circuit is ten ohms. One hundred volts is therefore the impressed pressure that gives a current of 10 amperes. When 10 amperes flow in the circuit, the pressure measured between the terminals of the condenser is 83.3 volts, and that measured between the terminals of the remainder of the circuit is 130 volts. The angle ϕ is zero.

51. Conclusions in regard to Series Circuits. — The eleven examples thus given cover every fundamental arrangement of series circuits which may occur. An examination of the diagrams and of the principles involved in their construction, makes the following statements evident :

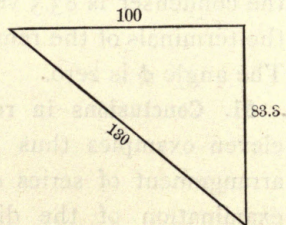
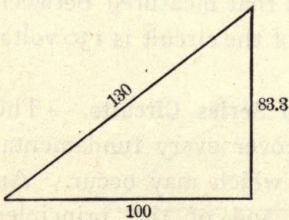
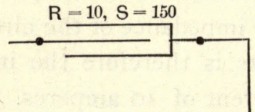
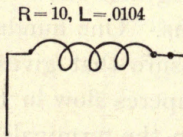
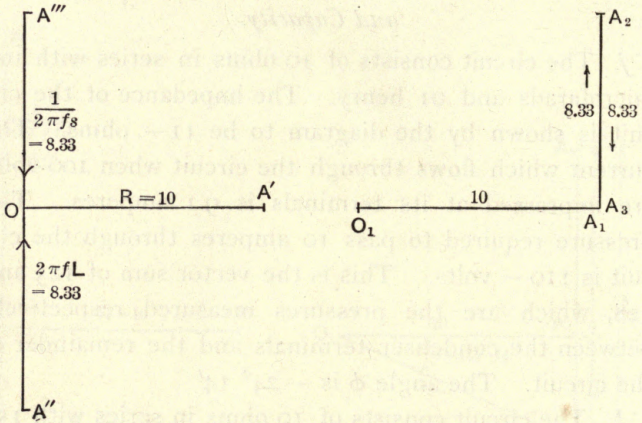
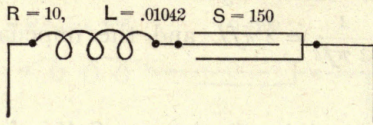

Solution κ

1. When *non-inductive circuits* are connected in series, the total impressed pressure equals the sum of the pressures measured between the terminals of the individual parts, and the total resistance of the circuit is equal to the sum of the resistances of the individual parts.

2. When *inductive circuits of equal time constants* are connected in series, the total impressed pressure equals the sum of the pressures upon the individual parts, measured between their individual terminals, and the total impedance of the circuit is equal to the sum of the individual impedances.

3. When *inductive and non-inductive circuits* are connected in series with each other, or when *inductive circuits of unequal time constants* are connected in series, the total impressed pressure equals the vector sum, which is always less than the algebraic sum, of the pressures measured between the terminals of the individual parts, and the individual pressures are each less than the total impressed pressure. The total impedance of the circuit is equal to the vector sum of the individual impedances, each of which is less than the total.

4. When *condensers* are connected in series *by conductors of negligible resistance*, the total impressed pressure equals the sum of the pressures measured across the individual condensers, and the total impedance of the circuit is equal to the sum of the impedances of the individual condensers.

5. When *condensers* are connected in series *with non-inductive resistances*, the total impressed pressure

equals the vector sum, which is always less than the algebraic sum, of the pressures measured between the terminals of the individual parts of the circuit, and the individual pressures are each less than the total impressed pressure. The total impedance of the circuit is equal to the vector sum of the individual impedances, each of which is less than the total.

6. When *condensers* are connected in series *with inductive resistances*, the total impressed pressure equals the vector sum, which is always less than the algebraic sum, of the pressures measured between the terminals of the individual parts of the circuit. Since the effects of capacity and self-inductance respectively cause the angle ϕ to become negative and positive, *the individual pressures may be either greater or less than the total impressed pressure*, depending upon the relation between the various resistances, capacities, and inductances in the circuit. The total impedance of the circuit is equal to the vector sum of the individual impedances, each of which may be either greater or less than the total impedance.

The third, fifth, and sixth paragraphs above make the following proposition evident: When in series circuits, the angles taken between the phases of the current and the individual pressures, measured at the terminals of the parts of the circuit, are all either positive or negative, the total impressed pressure is always greater than any of the individual or partial pressures. When the angles taken between the phases of the current and the partial pressures are in part positive and in part negative, *some or all of the partial pressures may be greater than the total impressed pressure.*

52. Parallel Circuits.—*Second Class.* The graphical treatment of problems relating to parallel circuits is entirely analogous to that given for series circuits. As the simplest cases of parallel circuits are those in which the same electrical pressure is impressed upon all the parts of the circuit, these will be treated first. In this class the same general operations are used in solving problems as in the first class, but alternating currents and proportional conductivities are dealt with instead of alternating pressures and proportional resistances. Suppose a circuit made up of two branches in parallel, each with a known resistance and reactance, and it is desired to know what impressed pressure with a frequency f is required to pass through it a certain current C . In this case, the total current is made up of two components, each of which flows through one of the branches and is inversely proportional to the impedance of the branch, and the phase of which has an angular retardation with respect to that of the impressed pressure which depends upon the time constant of the branch. The total current, which is inversely proportional to the equivalent impedance of the parallel circuit, is equal in magnitude and position to the resultant of the branch currents. The condition is represented by Fig. 72, in which OA and OA' are the currents in the two branches respectively, ϕ and ϕ' being their respective lag angles. The relative phase position of the impressed pressure is taken on the horizontal line. Then the resultant or total current in the circuit is represented in magnitude and phase by OA'' . OA is equal to $\frac{E}{I_1}$, OA' is equal to

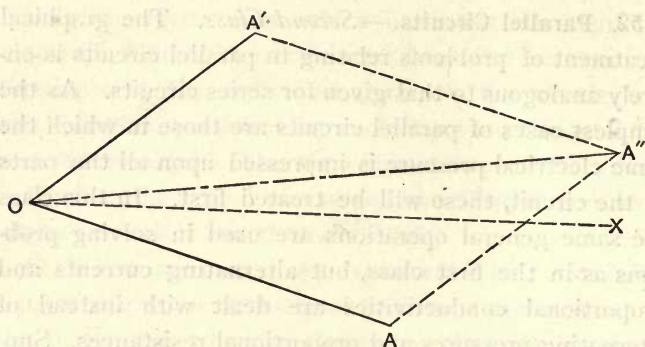

Fig. 72

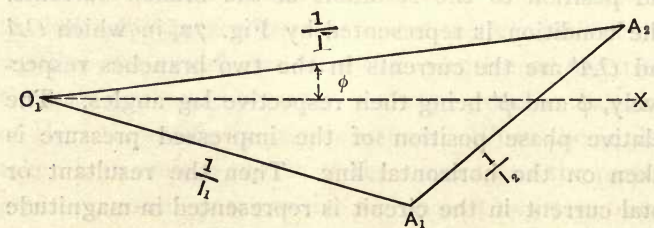
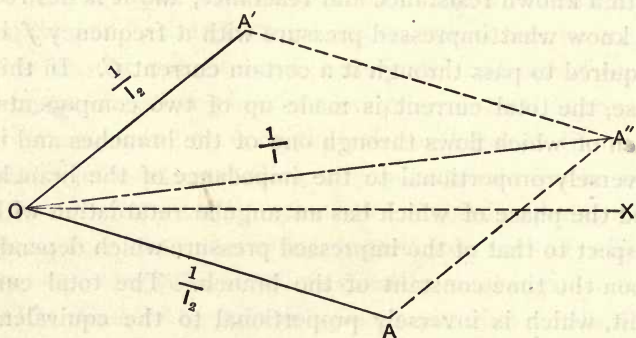

Fig. 73

$\frac{E}{I_2}$, and OA'' is equal to $\frac{E}{I}$, where E is the pressure impressed on the circuits, and the denominators of the fractions are the respective impedances of the branches and of the total circuit. It is therefore evident that the reciprocal of the equivalent impedance (= the equivalent apparent conductivity) on a parallel circuit may be at once derived from the apparent conductivities of

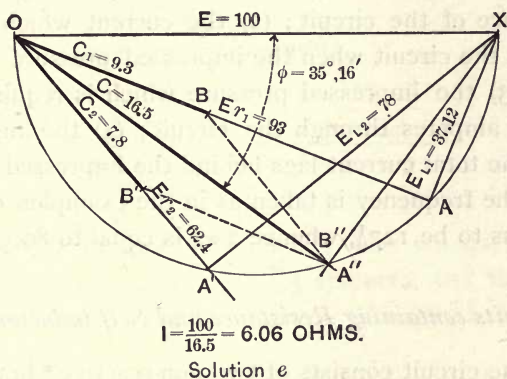

Fig. 74

the branches, by taking their vector sum, as is shown in Fig. 73. The equivalent apparent conductivity, or the equivalent impedance of a circuit being known, the pressure required to pass a given current through it, or the current flowing under a given impressed pressure, may be at once derived. In dealing with series circuits, the phase of the current (or active pressure) has been assumed to be along the horizontal line, or line of reference. In dealing with parallel circuits, it is more

convenient to assume the phase of the impressed pressure (or apparent conductivity) for the reference phase. It must always be remembered, however, that angles of lag are measured from lines representing current to lines representing pressure. Thus, in Fig. 74, the angle ϕ is positive because the current lags behind the pressure.

EXAMPLES. — In the following examples it is desired to find for each of the given circuits: (1) the equivalent impedance of the circuit; (2) the current which flows through the circuit when the impressed pressure is 100 volts; (3) the impressed pressure which is required to pass 10 amperes through the circuit; (4) the angle by which the total current lags behind the impressed pressure. The frequency is taken as in the examples of the first class to be $127\frac{1}{2}$, whence $2\pi f$ is equal to 800.

Circuits containing Resistance and Self-inductance.

a. The circuit consists of two non-reactive* branches in parallel, one having 20 ohms resistance and the other 10 ohms resistance. The phase diagram for the solutions, using the apparent conductivities of the circuits as a basis of work, is two horizontal lines superposed, of lengths respectively .05 and .10 unit. The vector dia-

* The terms *inductive*, *capacity*, and *reactive* circuit, will hereafter be used with the following significations: an *inductive circuit* is one containing inductance, but not capacity; a *capacity* or *condenser circuit* is one containing capacity, but not inductance; a *reactive circuit* is one containing either inductance or capacity or both inductance and capacity. A *non-reactive circuit* is, therefore, one which contains neither inductance nor capacity, that is, one which contains a plain resistance only.

gram is given by drawing these consecutively, and the equivalent apparent conductivity of the circuit is OA_2 in the figure. The equivalent impedance of the

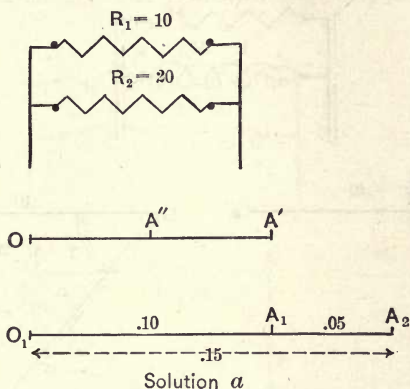

circuit is therefore 6.67 ohms. The current flowing under 100 volts pressure is 15 amperes, and the pressure required to pass 10 amperes through the circuit is 66.7 volts.

b. The circuit consists of a non-reactive branch of 10 ohms and an inductive branch of .01 henry. The phase diagram consists of two lines at right angles (one being horizontal), since the current in the non-reactive branch is in phase with the impressed pressure, and that in the inductive branch lags 90° behind the impressed pressure. The lengths of the lines are respectively $\frac{I}{R}$ ($= .10$) units and $\frac{I}{2\pi fL}$ ($= .125$) units. The vector diagram is shown. The equivalent conductivity of the circuit is .16 and the impedance is 6.25 ohms. The current flowing under an impressed pressure of 100 volts is 16

amperes, and it requires 62.5 volts to cause 10 amperes to flow. The angle ϕ is $51^\circ 20'$.

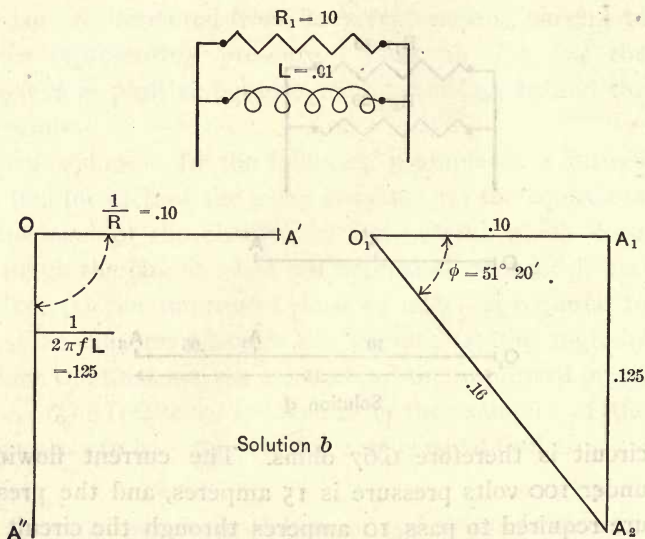

c. The circuit consists of a non-reactive branch of 10 ohms and an inductive branch having a resistance of 10 ohms and an inductance of .01 henry. The impedance and the angle of lag for the inductive branch are found by the method given under Series Circuits: First Class, and the conductivity of the branch is laid off in the phase diagram on a line making with the horizontal axis an angle equal to the angle of lag taken backwards. This is line OA'' in the diagram. The line OA' represents the conductivity of, and the relative phase of current in, the non-reactive branch. The length and direction of the line OA_2 in the vector

diagram shows the value of the equivalent or joint conductivity of the circuit, and the angle by which the phase of the main current lags behind the phase of the impressed pressure. The joint conductivity of the circuit

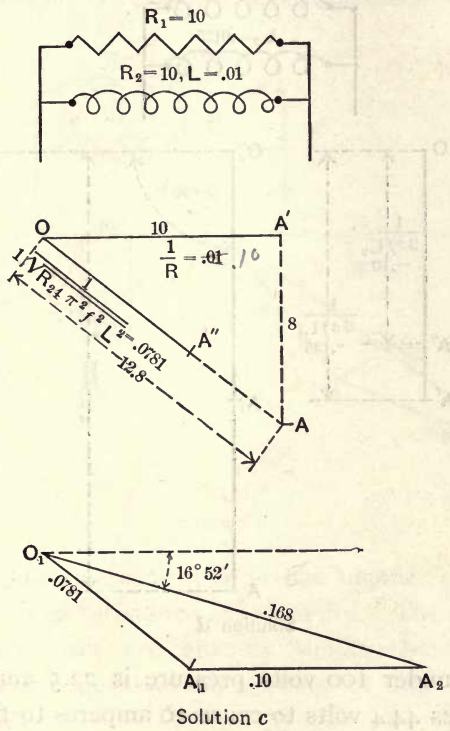

is .168 and the joint impedance 5.95 ohms. The current flowing under an impressed pressure of 100 volts is 16.8 amperes, and the pressure required to pass 10 amperes through the circuit is 59.5 volts. The angle ϕ is $16^\circ 52'$.

d. The circuit consists of two inductive branches of

respectively .01 and .0125 henry. The diagrams consist of vertical lines as shown. The conductivity is .225 and the impedance is 4.44 ohms. The current

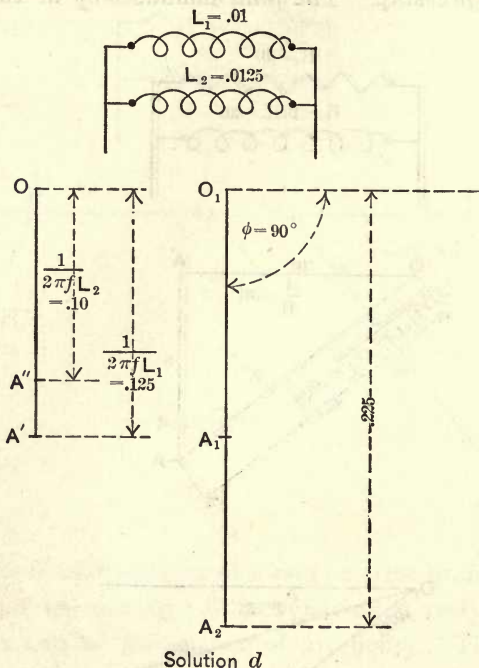

flowing under 100 volts pressure is 22.5 amperes, and it requires 44.4 volts to cause 10 amperes to flow. The angle of lag is 90° .

e. The circuit consists of two reactive branches of respectively .005 henry and 10 ohms, and .0125 henry and 8 ohms. The diagrams are as shown. The conductivity of the circuit is .165, and the impedance is 6.06 ohms. The current flowing under 100 volts pressure is

16.5 amperes, and the pressure required to pass 10 amperes through the circuit is 60.6 volts. The angle ϕ is $35^\circ 16'$.

The five preceding examples cover all the fundamental combinations of resistance and inductance in parallel

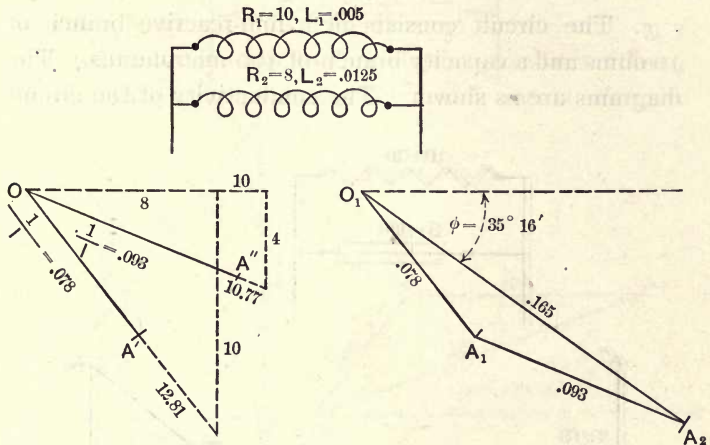

Solution e

circuits. The following four in like manner cover the combinations of resistance and capacity. The solutions in the two cases are entirely similar, but the lag angles become negative on account of the influence of capacities.

Circuits containing Resistance and Capacity.

f. When two or more condensers are connected in parallel by wires of negligible resistance, they evidently act upon the circuit exactly as though it contained one condenser with a capacity equal to the combined

capacity of those in parallel. The impedance of a condenser is equal to $\frac{1}{2\pi fs}$, and its apparent conductivity to $2\pi fs$. The apparent conductivity of several condensers in parallel is therefore evidently

$$2\pi f(s_1 + s_2 + \text{etc.})$$

g. The circuit consists of a non-reactive branch of 10 ohms and a capacity branch of 100 microfarads. The diagrams are as shown. The conductivity of the circuit

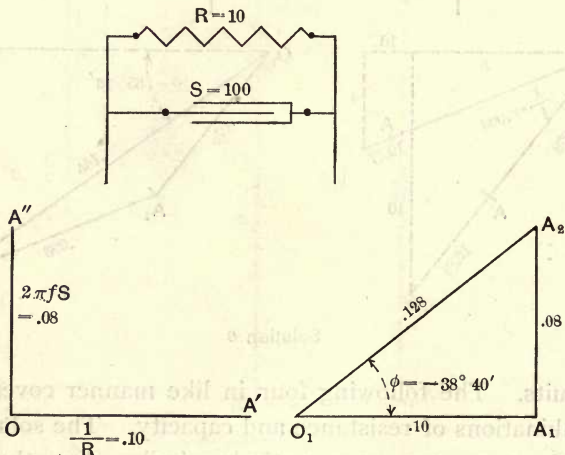

Solution *g*

is $.128$ and its impedance is 7.82 ohms. The current flowing under a pressure of 100 volts is 12.8 amperes, and the pressure required to pass 10 amperes through the circuit is 78.2 volts. The angle ϕ is $-38^\circ 40'$.

h. The circuit consists of a non-reactive branch of 10 ohms, and a reactive branch of 10 ohms and 100 microfarads. The conductivity of the circuit is shown

to be .147 and the impedance is 6.8 ohms. The current flowing under 100 volts pressure is 14.7 amperes,

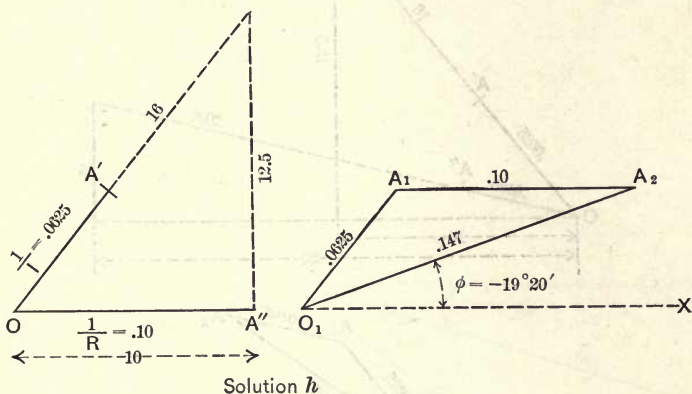
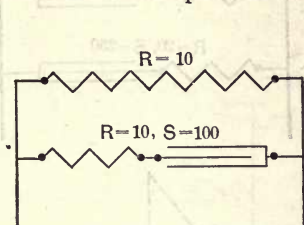

and the pressure required to pass 10 amperes through the circuit is 68 volts. The angle of lag is $-19^{\circ} 20'$.

i. The circuit consists of two reactive branches, respectively of 10 ohms and 100 microfarads, and of 20 ohms and 250 microfarads. The conductivity of the circuit is shown to be .105 and the impedance is 9.5 ohms. The current flowing under a pressure of 100 volts is 10.5 amperes, and the pressure required to pass 10 amperes through the circuit is 95 volts. The angle ϕ is $-35^{\circ} 10'$.

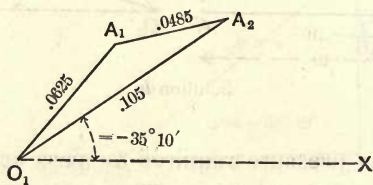
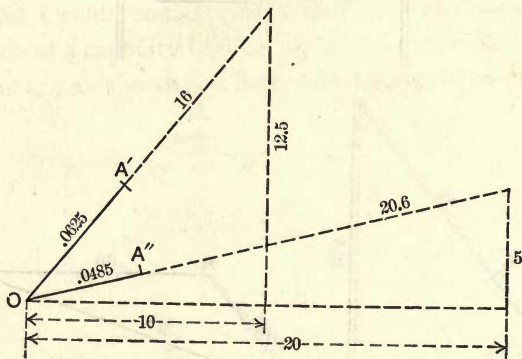
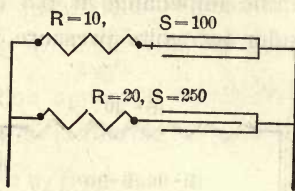
Solution i

The following examples cover the fundamental combinations of capacities and inductances.

j. The circuit consists of two reactive branches, respectively of 5 ohms and .005 henry, and of 10 ohms and 100 microfarads. The conductivity of the circuit is shown to be .168 and the impedance is 5.95 ohms. The current flowing under a pressure of 100 volts is

16.8 amperes, and the pressure required to cause a current of 10 amperes is 59.5 volts. The angle ϕ is $16^{\circ} 50'$.

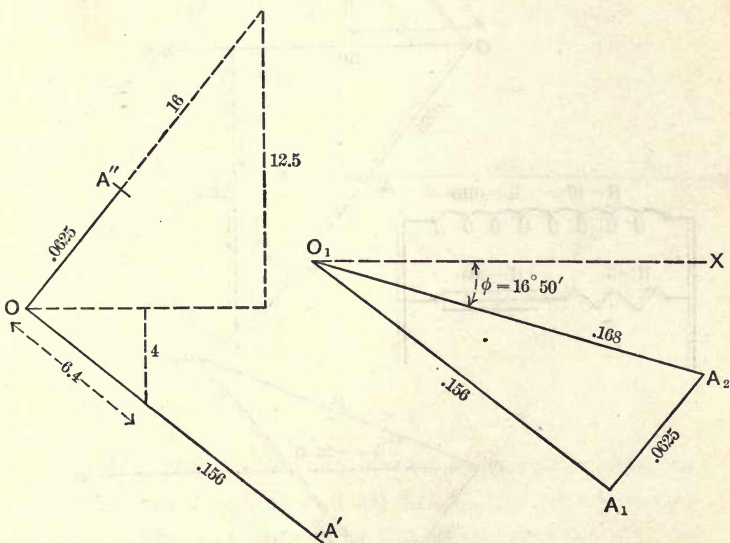
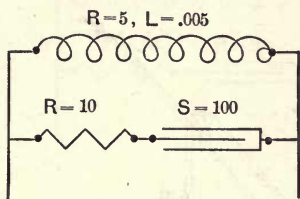

k. The circuit consists of two reactive branches, respectively of 10 ohms and .0156 henry, and of 5 ohms and 200 microfarads. The conductivity is shown to be .127 and the impedance of the circuit is 7.87 ohms.

The current flowing under a pressure of 100 volts is 12.7 amperes, and 78.7 volts are required to pass 10 amperes through the circuit. The angle ϕ is $-22^{\circ} 37'$.

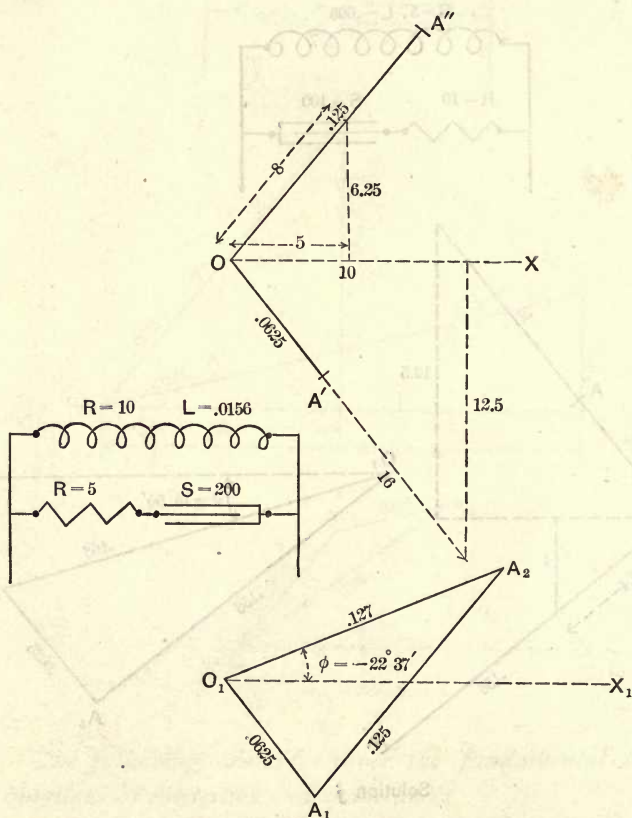

Solution *b*

1. The circuit consists of two reactive branches of respectively 10 ohms and .01042 henry, and 10 ohms and 150 microfarads. The diagrams show that the im-

pedance of the circuit is 8.47 ohms and the angle ϕ is equal to zero.

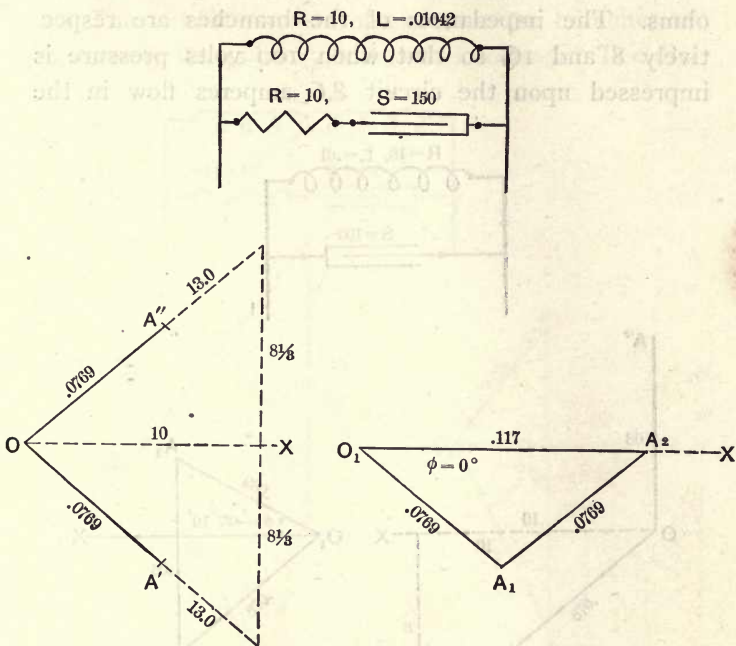

Solution 1

m. The circuit consists of two reactive branches respectively of 10 ohms and .01 henry, and of 100 microfarads. The diagrams show the joint impedance to be 14.5 ohms. The impedances of the branches are respectively 12.8 and 12.5, so that when the impressed pressure is 100 volts, 6.9 amperes flow in the main circuit, while 8 and 7.8 amperes respectively flow in the branches. The angle ϕ is $-27^\circ 10'$.

n. The circuit consists of two reactive branches re-

spectively of .01 henry, and of 10 ohms and 100 microfarads. The diagrams show the impedance to be 11.6 ohms. The impedances of the branches are respectively 8 and 16, so that when 100 volts pressure is impressed upon the circuit 8.6 amperes flow in the

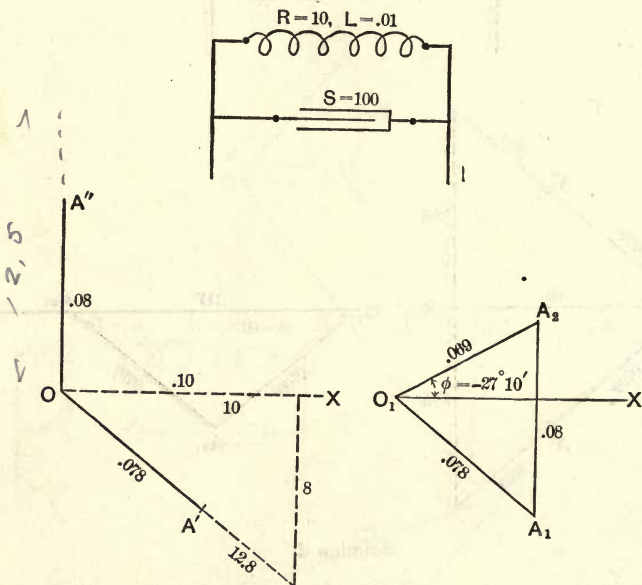
Solution *m*

main leads, while 12.5 and 6.25 amperes flow respectively in the two branches. The angle ϕ is $62^\circ 53'$.

a. The circuit consists of two reactive branches respectively of .01 henry and of 100 microfarads. The impedance of the circuit is 22.2 and the impedances of the branches are respectively 8 and 12.5 ohms. When the impressed pressure is 100 volts, the main current is

4.5 amperes and that in the branches is 12.5 and 8 amperes. The angle ϕ is 90° .

p . The circuit consists of two reactive branches of respectively .01042 henry and 150 microfarads. The dia-

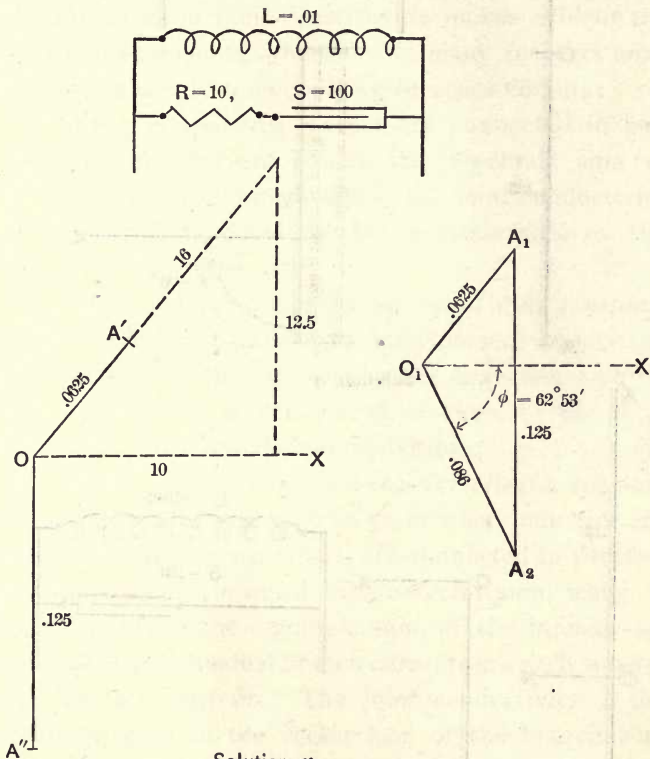

grams show that the two branch currents are in exact opposition and of equal value and that the joint conductivity is zero, so that the main current is zero. When the impressed pressure is 100 volts the branch currents are each 12 amperes, and when 10 amperes flow in each branch the pressure is 83.3 volts.

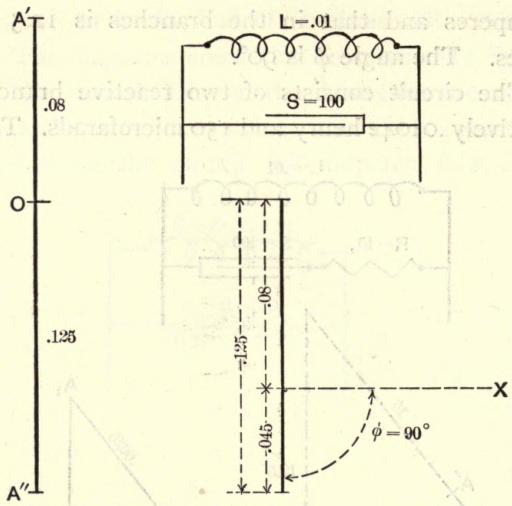

Solution o

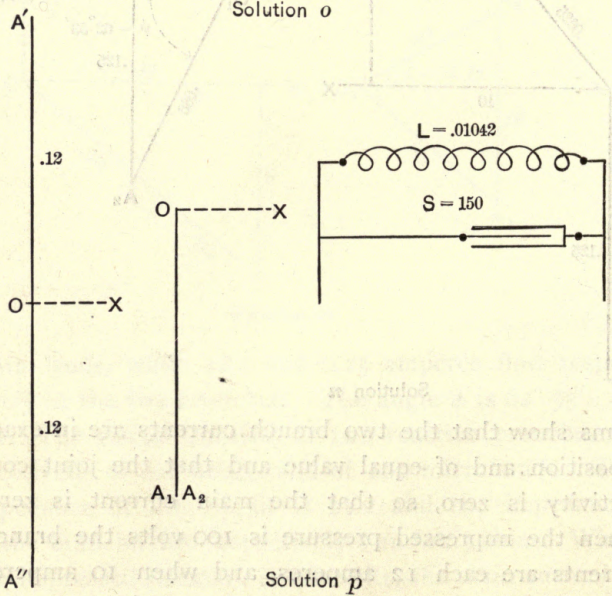

Solution p

53. Conclusions in Regard to Parallel Circuits. — *Second Class.* The sixteen examples just presented cover every fundamental arrangement of simple parallel circuits. An examination of the diagrams and the principles involved in their construction makes evident the following statements, which are in many respects analogous to those given as applying to series circuits :

1. When *non-reactive circuits* are connected in parallel, the total current equals the algebraic sum of the currents in the branches, and the joint conductivity of the circuit is equal to the algebraic sum of the branch conductivities.

2. When *inductive circuits of equal time constants* are connected in parallel, the total current equals the algebraic sum of the currents in the branches, and the joint conductivity of the circuit is equal to the algebraic sum of the branch conductivities.

3. When *inductive and non-reactive circuits* are connected in parallel with each other, or when *inductive circuits of unequal time constants* are connected in parallel, the total current is equal to the vector sum, which is always less than the algebraic sum, of the branch currents, and the individual branch currents are each smaller than the total current. The joint conductivity of the circuit is equal to the vector sum of the branch conductivities, each of which is less than the joint total.

4. When *condensers* are connected in parallel *by wires of negligible resistance*, the total current equals the algebraic sum of the branch currents, and the joint conductivity equals the algebraic sum of the branch conductivities.

5. When *condensers* are connected in parallel *with non-reactive resistances*, the total current equals the vector sum, which is always less than the algebraic sum, of the branch currents, and the individual branch currents are each smaller than the total current. The joint conductivity of the circuit equals the vector sum of the branch conductivities, each of which is smaller than the joint total.

6. When *condensers* are connected in parallel *with inductive circuits*, the total current equals the vector sum, which is always less than the algebraic sum, of the currents in the branches. Since the effects of capacity and of self-inductance respectively cause the angle ϕ to become negative and positive, *the individual branch currents may be either greater or less than the main or total current*, depending upon the relation between the various capacities and inductances in the circuit. The joint conductivity of the circuit equals the vector sum of the branch conductivities, each of which may be either greater or less than the joint conductivity.

The third, fifth, and sixth paragraphs make evident this proposition, which is similar to that given for series circuits (Sect. 51): When in parallel circuits the currents in the branches are all either lagging or leading with respect to the impressed pressure, the total or main current is always greater than the current in any one of the branches. When the currents in part of the branches lead the impressed pressure and in other branches lag behind the pressure, *some or all of the branch currents may be greater than the total or main current*. It is even theoretically possible for the angles

have such a relation that *a large current may flow in the branches while the main current is zero.*

54. With the methods thus set forth it is possible to solve any problem which may arise in regard to the impedance presented by any circuit to the flow of a sinusoidal current. When the current is not sinusoidal the deductions do not strictly apply, but for the alternating currents which are commonly found in practice the approximation of the deductions to the facts is fairly close.* In every case it is assumed that the parts of the circuits have no appreciable mutual magnetic effect. If the parts are mutually inductive, the solutions become entirely different and much more complicated.

The solutions for parallel circuits may be made by another method in which pressures and impedances are involved. This method may be best exemplified by illustrations. Suppose, for instance, it is desired to find the joint impedance of the branched circuit in example *e* (Sect. 52). It may be assumed that an impressed pressure of 100 volts acts on the circuit. Upon a line, *OX*, representing this pressure (Fig. 74) is drawn a semi-circle. From *O* draw the line *OA* making a lag angle of ϕ_1 with *OX*, where $\tan \phi_1 = \frac{2\pi f L_1}{R_1} = .4$. Then *OA* is equal to $C_1 R_1$ and *XA* is equal to $2\pi f L_1 C_1$ since the angle at *A* is a right angle. The current in this branch when the impressed pressure is equal to *OX*, is $\frac{OA}{R_1}$, and this may be laid off from *O* to *B*. The current in

* Compare Bedell on hedgehog transformer with condenser, *Trans. Amer. Inst. E. E.*, Vol. 10, p. 515.

the second branch is given by laying off the direction of the line OA' so that it makes a lag angle of ϕ_2 with OX , where $\tan \phi_2 = \frac{2\pi fL_2}{R_2} = 1.25$. The current in the second branch is equal to OA' divided by R_2 , and when laid off from O gives OB' . The total current in the

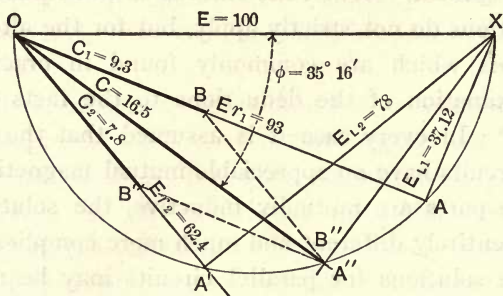

$$I = \frac{100}{16.5} = 6.06 \text{ OHMS.}$$

Solution *e*

Fig. 74

circuit is the resultant of OB and OB' , or OB'' . Its value in amperes is 16.5. The impedance of the circuit is then $\frac{E}{C} = \frac{OX}{OB''} = \frac{100}{16.5} = 6.06$ ohms. The angle of lag is $\phi = \tan^{-1}\left(\frac{XA''}{OA''}\right) = 35^\circ 16'$. Figures 75, 76, 77, 78, 79, and 80 give the solutions by the same method for examples *b, c, d, g, h, j* of Section 52. These show the application of the method fully.*

55. Series and Parallel Circuits Combined. — *Third Class.* Where series and parallel circuits are combined the fundamental solutions already given apply directly,

* Compare Bedell and Crehore, *Alternating Currents*, p. 292; Loppé et Bouquet, *Courants Alternatifs Industriels*, p. 111.

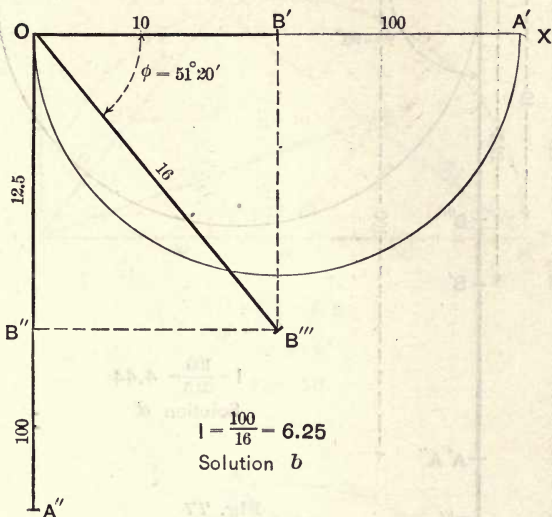

Fig. 75

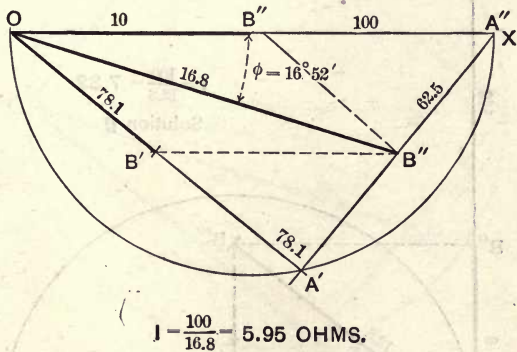

Fig. 76

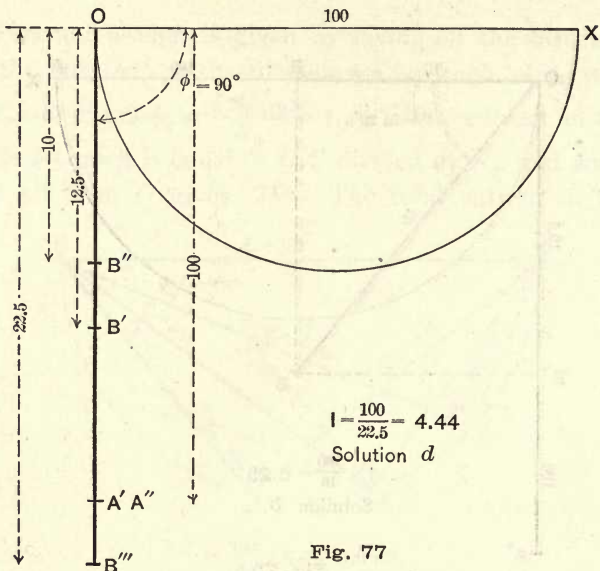

Fig. 77

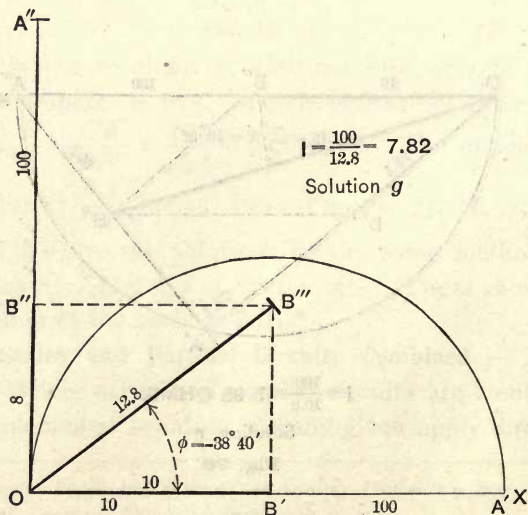
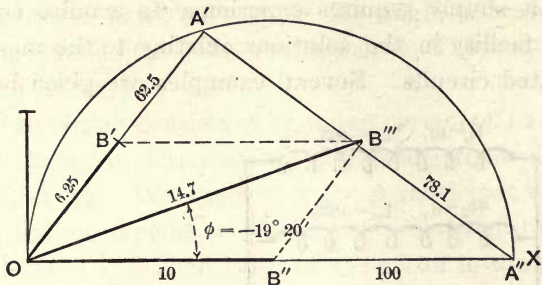

Fig. 78



$$l = \frac{100}{14.7} = 6.8$$

Solution *h*

Fig. 79

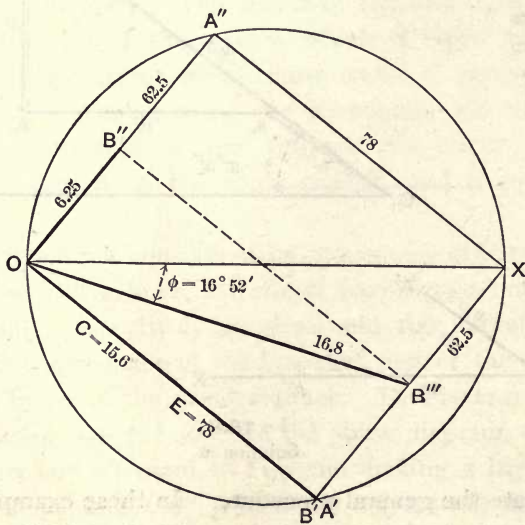

$$l = \frac{100}{16.8} = 5.95$$

Solution *j*

Fig. 80

and it simply requires experience to acquire considerable facility in the solutions relating to the most complicated circuits. Several examples are given below to

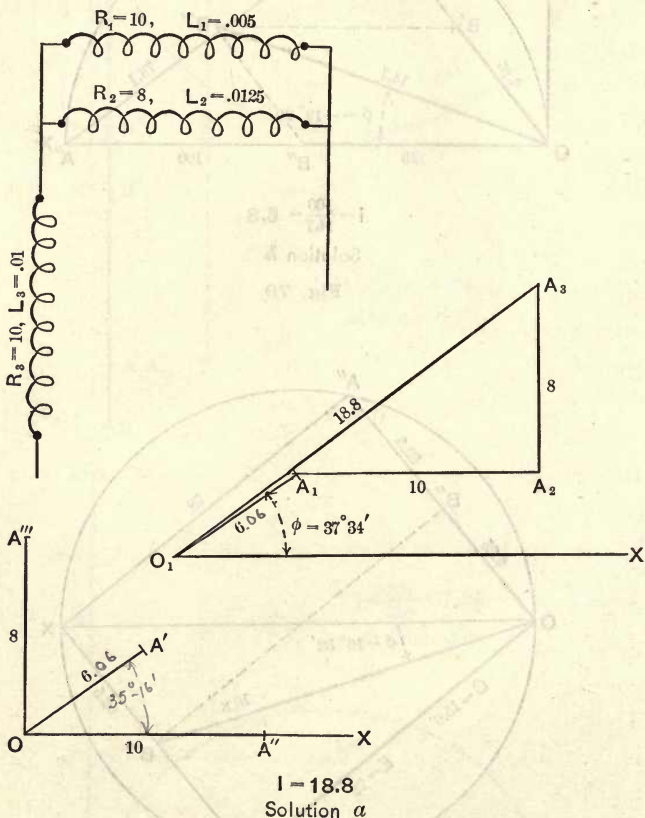

indicate the general procedure. In these examples it is desired to determine as before: (1) the total impedance of the circuit; (2) the total current flowing under a pressure of 100 volts; (3) the pressure required to cause

10 amperes to flow; and (4) the lag angle between the total current and the impressed pressure. The frequency is taken as $127\frac{1}{2}$.

a. The circuit consists of an inductive coil of 10 ohms and .01 henry in series with a branched circuit similar to *e*, Sect. 52. We know that the parallel part of the circuit has an impedance of 6.06 ohms, and that the lag angle is $35^\circ 16'$. Therefore OA' is laid off in the phase diagram 6.06 units in length, and making the proper angle with the horizontal. The line OA'' is then laid off horizontally $R_3 (= 10)$ units long, and OA''' is laid off vertically $2\pi fL_3 (= 8)$ units long. In the vector diagram O_1A_1 is equal and parallel to OA' , A_1A_2 to OA'' , and A_2A_3 to OA''' . The length of the line O_1A_3 gives the impedance of the circuit, which is equal to 18.8 ohms. The current which flows under a pressure of 100 volts is 5.32 amperes, and it requires 188 volts to cause 10 amperes to flow through the circuit. The angle of lag, ϕ , is the angle A_3O_1X , and is equal to $37^\circ 34'$.

b. The circuit consists of an inductance of .01 henry in series with a branched circuit having two branches containing respectively 40 ohms and 100 microfarads. The joint impedance of the branched part of the circuit is first found in the usual manner. This is 11.9 ohms, and the lag is $-72^\circ 40'$. In the phase diagram, OA' is therefore laid off equal to 11.9 and making a lag angle of $-72^\circ 40'$, and OA'' is laid off $2\pi fL (= 8)$ units in length and making a lag angle of 90° . Laying off the vector diagram gives O_1A_2 equal to 4.68 and making a lag angle of $-43^\circ 40'$. The current flowing under a press-

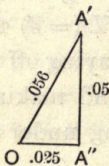
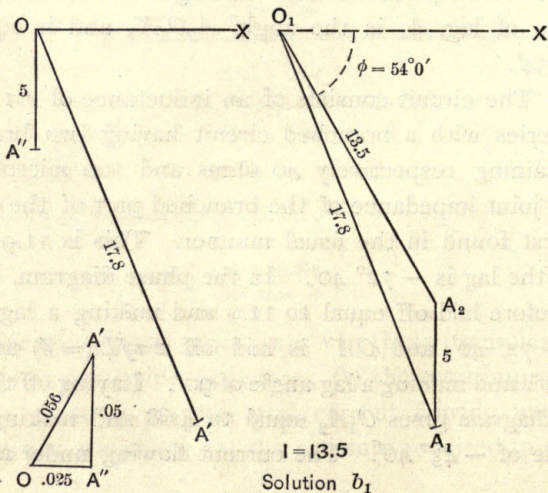
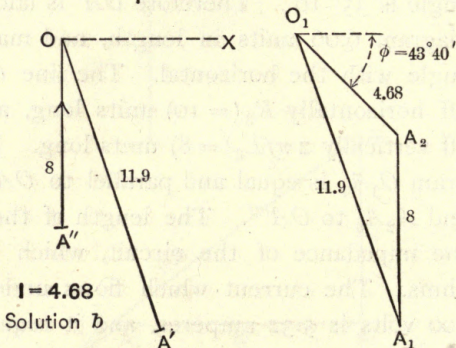
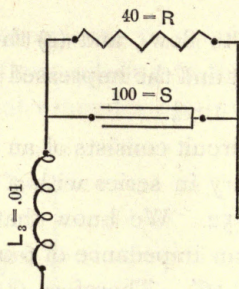
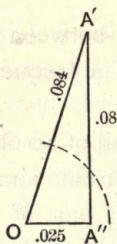

ure of 100 volts is 21.4 amperes, and the pressure required to cause 10 amperes to flow is 46.8 volts. When 10 amperes flow in the main circuit, the pressure at the terminals of the branched circuit is 119 volts, and the currents which flow through the resistance and the condenser are respectively 3 amperes and 9.5 amperes. The pressure across the inductance L_3 is then 80 volts.

b_1 . If the frequency in the preceding example is cut down to 80, the relations are materially changed. The impedance of the branched circuit becomes 17.8 ohms, and the lag angle in it is $-63^\circ 32'$. The phase diagram, therefore, is as shown. From the vector diagram it is seen that the joint impedance of the whole circuit is 13.5 ohms, and the total current is $54^\circ 0'$ ahead of the impressed pressure. The total current flowing when the impressed pressure is 100 volts is 7.4 amperes, and it requires 135 volts to cause 10 amperes to flow. When 10 amperes are flowing, the pressure at the terminals of the branched circuit is 178 volts, and the currents which flow through the resistance and the condenser are 4.45 and 8.9 amperes respectively, while the pressure across the inductance L_3 is 50 volts. To maintain a pressure of 100 volts at the terminals of the divided circuit requires an impressed pressure of 76 volts. With this pressure 5.6 amperes flow through the circuit.

c . The circuit consists of a combination as shown in the figure on page 204. The resistances of the branches of the circuit are $R_1 = 5$ ohms, $R_2 = 10$ ohms, $R_3 = 8$ ohms; the inductances are $L_1 = .005$ henry, $L_2 = .01$ henry, $L_3 = .0125$ henry; and the capacities are $s_1 = 150$ microfarads, $s_2 = 100$ microfarads, $s_3 = 125$ microfarads.

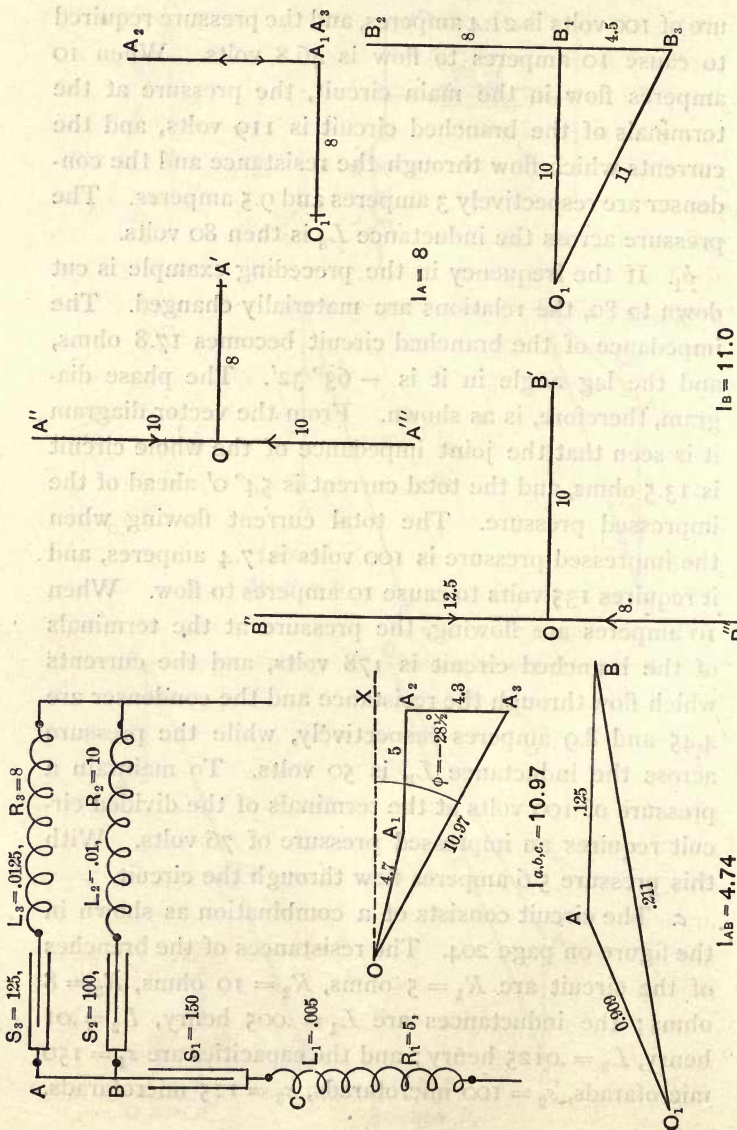

The diagrams show the impedance of the branched part of the circuit to be 4.74 ohms, and its lag angle is $-10^{\circ} 12'$. From the complete diagrams it is seen that the joint impedance of the whole circuit is 10.97 ohms, and the total current is $28^{\circ} 25'$ ahead of the impressed pressure. The total current flowing when the impressed pressure is 100 volts is 9.12 amperes, and it requires 109.7 volts to cause 10 amperes to flow. When 10 amperes are flowing, the pressure at the terminals of the branched circuit is 47.4 volts, and the currents which flow

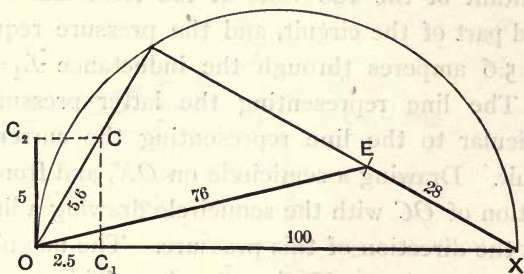

$$I = \frac{76}{5.6} = 13.5$$

Solution b_1

Fig. 81

through the branches are 5.9 and 4.3 amperes respectively. The pressure across the first part of the circuit is 66 volts. To maintain a pressure of 100 volts on the branched part of the circuit requires an impressed pressure of 231.5 volts. With this pressure, 21.1 amperes flow through the circuit.

The second method of solution for parallel circuits may be applied to circuits like those included in the above example. Figure 81 shows the solution for ex-

ample b_1 made by that method. In this it is assumed that 100 volts is impressed upon the branched part of the circuit. Then lay off a length OX on the horizontal axis representing 100 volts and mark $OC_1 = \frac{100}{40} = 2.5$, which is the current in the first branch. The current in the second branch is 90° in advance of the pressure, and is represented by OC_2 which is vertical and $2\pi f s_2 E (= 5)$ units in length. The resultant of these currents is OC , which is 5.6 units in length. The impressed pressure measured across the terminals of the entire circuit is the resultant of the 100 volts at the terminals of the branched part of the circuit, and the pressure required to pass 5.6 amperes through the inductance $L_1 = .01$ henry. The line representing the latter pressure is perpendicular to the line representing the current in the circuit. Drawing a semicircle on OX , and from the intersection of OC with the semicircle drawing a line to X gives the direction of this pressure. The magnitude of the pressure is $2\pi f L_1 C = 28$ volts. This pressure must be laid off from X to E , and the total impressed pressure is represented by OE . This shows that when 100 volts is maintained at the terminals of the branched circuit, 76 volts must be impressed on the total circuit. The resistances of the circuit may be calculated from the data thus found, as also can the pressure required to maintain a certain current through the circuit.

Figure 82 shows the solution of example c by this method. As before, the pressure at the terminals of the divided circuit is assumed to be 100 volts for the purposes of the solution. This is laid down as OX , and a semicircle is drawn upon the line as a diameter.

$\tan \phi_3$ is equal to zero, so that the current in the first branch is laid off on OX to B , a distance of 12.5 units. $\tan \phi_2 = .45$, as shown by calculation, and the line OA' is laid off at that angle from OX . From O on this line, OB' is laid off equal to the current in the second branch, or $\frac{1}{I} OX$. The resultant of the lines OB and OB' is OB'' , which represents the total current in the circuit. OA'' is the equivalent active press-

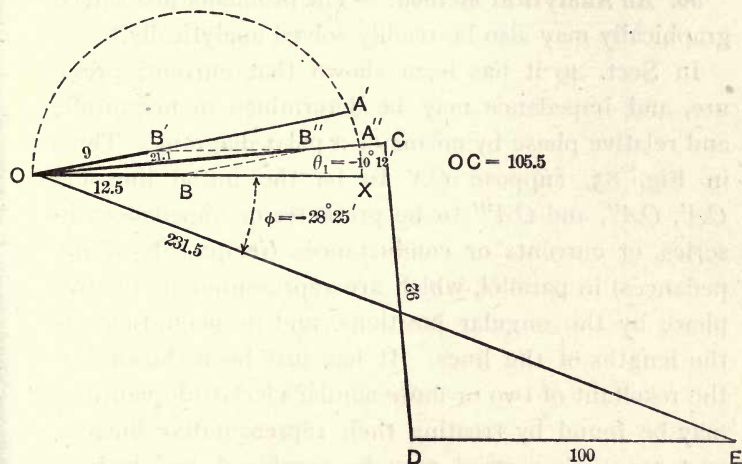

Fig. 82

ure in the circuit. The total pressure impressed on the circuit is the resultant of the pressure impressed on the divided circuit, the active pressure due to resistance R_1 , and the reactive pressure due to L_1 and s_1 . The active pressure required to pass current OB'' through R_1 is represented by OC , which is equal to CR_1 . The reactive pressure is perpendicular to this and is equal to

$2 \pi f L_1 C - \frac{C}{2 \pi f s_1}$; it is represented by the line CD .

The pressure impressed on the parallel circuit is represented by the line DE , which is equal and parallel to OX . The closing line, OE , represents the impressed pressure E on the circuit when the current is C , and the impedance of the circuit is $\frac{E}{C} = 10.97$. The angle of lag is the angle $COE = -28^\circ 25'$.

56. An Analytical Method. — The problems just solved graphically may also be readily solved analytically.*

In Sect. 49 it has been shown that current, pressure, and impedance may be determined in magnitude and relative phase by means of a polar diagram. Thus, in Fig. 83, suppose OX to be the initial line and OA' , OA'' , and OA''' to be pressures or impedances in series, or currents or conductances (reciprocals of impedances) in parallel, which are represented in relative phase by the angular positions, and in magnitude by the lengths of the lines. It has just been shown that the resultant of two or more similar electrical quantities may be found by treating their representative lines as vectors; such vectors may be combined by algebraically adding the vertical and horizontal components of the individual lines, by which means the vertical and horizontal components of the resultant are determined. If a' , b' ; a'' , b'' ; and a''' , b''' are the horizontal and

* Steinmetz on Complex Quantities, *Proceedings of the International Congress held at Chicago in 1893*, p. 33; Steinmetz on Hysteresis, *Trans. Amer. Inst. E. E.*, Vol. 11, p. 576; Tait's *Quaternions*, Hardy's *Quaternions*, etc.

vertical components of OA' , OA'' , and OA''' , and A , B , the components of the resultant, then

$$A + B = (a' + a'' + a''') + (b' + b'' + b'''),$$

or
$$A + B = (a' + b') + (a'' + b'') + (a''' + b''').$$

In this expression there is nothing to distinguish the horizontal from the vertical components; or, in general,

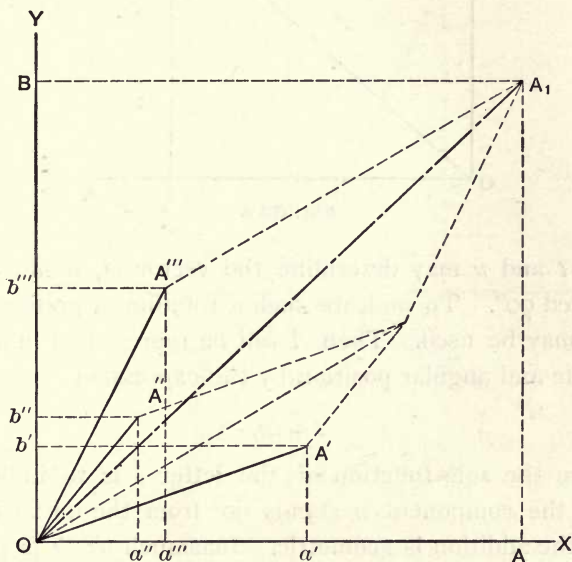

Fig. 83

there is nothing to indicate the angular positions of the components, or of the lines represented by them, with reference to the initial line. To fully indicate the magnitude and position of a line by its rectangular components, we must abandon the methods of algebra for geometric processes. Therefore we may consider, for

the moment, that the components t and u of the vector A (Fig. 83 *a*) both lie on the initial line OX , but in order

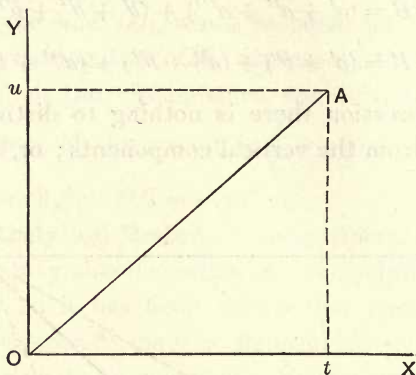

Fig. 83 *a*

that t and u may determine the vector A , u must be rotated 90° . To indicate such a rotation, a prefix such as i may be used. Then A will be represented in magnitude and angular position by the expression

$$t + iu,$$

where the sole function of the letter i is to indicate that the component u stands 90° from the initial line, and the addition is geometric. Inasmuch as iu is positive, u has been rotated ahead 90° ; $-iu$ would indicate that u had been rotated in a negative direction 90° , or u is measured downwards (the negative direction) from the origin. If t and iu are both negative, they are both measured in the negative direction; hence, if $t + iu$ be multiplied by -1 , there results $-t - iu$, t and u are both reversed in direction, and the vector line OA is rotated 180° (Fig. 84); $it - u$ means that the line has

been rotated forward 90° , since t is positive but stands at 90° from the initial line, and u is negative; $-it + u$ means that the line has been rotated back 90° . Finally, multiplying by i means advancing the vector line 90° ,

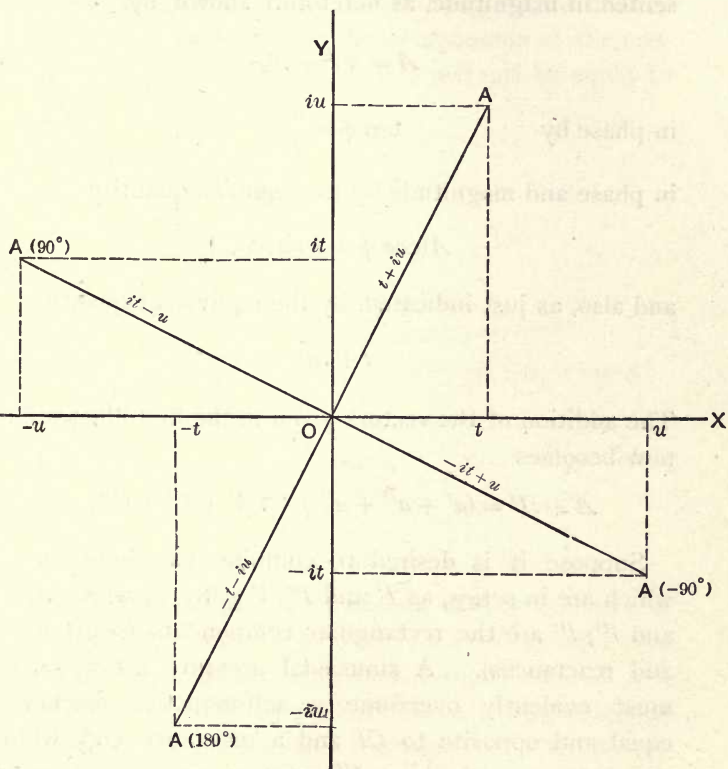

Fig. 84

for $i(t + iu) = it + (+i)(iu)$, and as i^2 indicates rotation twice forward, i^2u becomes $-u$, and therefore $i(t + iu)$ is geometrically equal to $it - u$; also multiplying by $-i$ means turning the vector back 90° , for $-i(t + iu)$

$= -it + (-i)(iu)$, and as $-i^2$ indicates rotation forward 90° and back 90° , $-i^2u = u$, and there results $-it + u$.

The vector expressing a sine wave may now be represented in magnitude, as heretofore shown, by

$$A = \sqrt{t^2 + u^2},$$

in phase by $\tan \phi = \frac{u}{t}$,

in phase and magnitude by the complex quantity

$$A(\cos \phi + i \sin \phi),$$

and also, as just indicated, by the equivalent quantity

$$t + iu.$$

The addition of the vectors given in the first illustration now becomes

$$A + iB = (a' + a'' + a''') + i(b' + b'' + b''').$$

Suppose it is desired to combine two impedances which are in series, as I' and I'' , Fig. 85, in which r' , l' and r'' , l'' are the rectangular components (resistances and reactances). A sinusoidal pressure acting on I' must evidently overcome a self-inductive reactance equal and opposite to Ol' and a resistance Or' , while the pressure acting on I'' must overcome a capacity reactance equal and opposite to Ol'' and a resistance Or'' . Then, if R , H , are the components of the resultant (I'''), this equation may be written

$$I''' = R + iH = (r' + r'') + i(l' - l''),$$

from which the magnitude and phase position of the resultant impedance may be found.

If the impedances are in parallel, their reciprocals must be combined, in which case the resultant is the reciprocal of the impedance (conductivity) of the divided circuit. It is evident that the components of the conductivity (reciprocal of impedance) will not be equal to

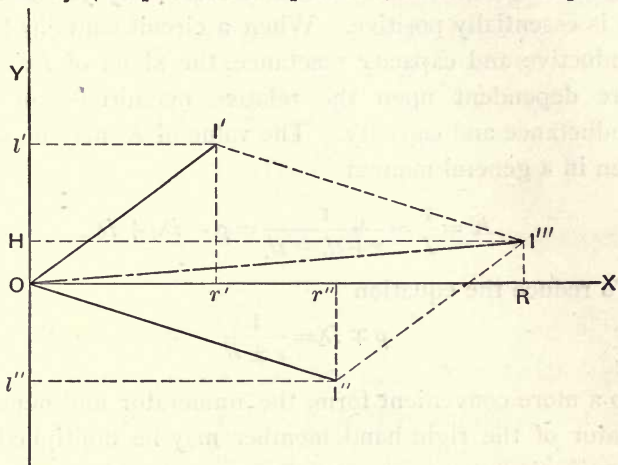

Fig. 85

the reciprocals of the components of the impedance. The components of the conductivity must therefore be found in terms of the impedance components. If ρ , λ are the conductivity components and r , l the impedance components (resistance and reactance) of a single circuit, we may write by the principles of geometric multiplication,

$$K = \frac{I}{I} = \rho \mp i\lambda = \frac{I}{r \pm il} \quad (a)$$

The numerical values of the first and second terms of the right-hand member of the expression $K = \rho \mp i\lambda$ are

respectively proportional to the active current and wattless current in a circuit. When a circuit contains inductive reactance only, l is essentially positive, but the wattless current *lags* 90° behind the active current, so that λ is essentially negative. When a circuit contains capacity reactance only, l is essentially negative, but the wattless current *leads* the active current by 90° , so that λ is essentially positive. When a circuit contains both inductive and capacity reactance, the signs of l and λ are dependent upon the relative magnitudes of the inductance and capacity. The value of K may be written in a general manner

$$K = \frac{I}{I} = \frac{I}{r + il_i - il_s} = \rho - i\lambda_i + i\lambda_s.$$

To reduce the equation

$$\rho \mp i\lambda = \frac{I}{r \pm il} \quad (b)$$

to a more convenient form, the numerator and denominator of the right-hand member may be multiplied by $r \mp il$, whence

$$\rho \mp i\lambda = \frac{r \mp il}{(r \mp il)(r \pm il)} = \frac{r \mp il}{r^2 + l^2},$$

since i^2 indicates the operation which is equivalent to multiplying by -1 .

Hence,
$$\rho \mp i\lambda = \frac{r}{r^2 + l^2} \mp i \frac{l}{r^2 + l^2};$$

but the impedance (I) is

$$I = \sqrt{r^2 + l^2}.$$

Therefore,
$$\rho \mp i\lambda = \frac{r}{I^2} \mp i \frac{l}{I^2}$$

or
$$\rho = \frac{r}{I^2} \text{ and } \lambda = \frac{l}{I^2}$$

Since r , l , and I are known or can be determined from the conditions presented, problems relating to parallel circuits can now be solved.

Returning to the example, if ρ' , λ' , and ρ'' , λ'' are the components of the conductivities of two parallel circuits having impedances I' and I'' (Fig. 85),

$$\rho' - i\lambda' = \frac{r'}{I'^2} - i \frac{l'}{I'^2}$$

and
$$\rho'' + i\lambda'' = \frac{r''}{I''^2} + i \frac{l''}{I''^2},$$

and if ρ , λ are the components of the final conductivity,

$$\rho + i\lambda = \left(\frac{r'}{I'^2} + \frac{r''}{I''^2} \right) + i \left(\frac{l''}{I''^2} - \frac{l'}{I'^2} \right).$$

The intrinsic sign of $i\lambda$ depends upon the relative signs and magnitudes of $\frac{l'}{I'^2}$ and $\frac{l''}{I''^2}$. The impedance of the circuit will be the reciprocal of the conductivity thus found.

When I is the impedance and K the conductivity of a circuit, we write $I = r \pm il$ and $K = \rho \mp i\lambda$, according to the principles of geometric addition which assert that the sum of two sides of a triangle taken in consecutive directions is equal to the third side. This is entirely opposed to the ordinary conceptions of algebra or arithmetic.

These processes which enable us to find the joint impedance of parallel or series circuits when the elements of the individual parts of the circuits are known, equally

enable us to find the impedance of any combination of such circuits by computations which are almost as simple and rapid as those which would be used in dealing with a continuous-current system. Also, when the impedances of any combination of circuits have been obtained, it is possible to find the pressures in any portion when a sinusoidal current is flowing and to find the current when a sinusoidal pressure is applied.

The meaning of the terms in the expression for impedance and conductivity may be explained by: multiplying $(r \pm il)$ by C (current in the circuit), when it is evident that rC is the active pressure and lC the component of pressure acting against the reactance; and also by multiplying $(\rho \mp i\lambda)$ by E_i (pressure impressed on the circuit), when ρE_i is the active component of the current and λE_i the wattless current.

The following is a recapitulation of the formulas for the analytical solution, by geometric processes, of problems relating to alternating-current circuits.

GEOMETRIC EQUATIONS.

$$I = r + il_L - il_s.$$

$$I_x = \Sigma I = \Sigma r + i\Sigma l_L - i\Sigma l_s$$

$$= \Sigma r + i\Sigma (l_L - l_s)$$

$$= I_x (\cos \phi_x + i \sin \phi_x).$$

$$K = \frac{1}{I} = \rho - i\lambda_L + i\lambda_s$$

$$= \frac{r}{I^2} - i\frac{l_L}{I^2} + i\frac{l_s}{I^2}.$$

$$K_x = \Sigma K = \Sigma \frac{r}{I^2} - i\Sigma \frac{l_L}{I^2} + i\Sigma \frac{l_s}{I^2}$$

$$= \Sigma \frac{r}{I^2} - i\Sigma \left(\frac{l_L}{I^2} - \frac{l_s}{I^2} \right).$$

ALGEBRAIC EQUATIONS.

$$\rho = \frac{r}{I^2} = rK^2, \quad \lambda = \frac{l}{I^2} = lK^2.$$

$$r = \rho I^2 = \frac{\rho}{K^2}, \quad l = \lambda I^2 = \frac{\lambda}{K^2}.$$

$$I = \sqrt{r^2 + l^2} = \frac{r}{\cos \phi} = \frac{l}{\sin \phi}.$$

$$K = \sqrt{\rho^2 + \lambda^2} = \frac{\rho}{\cos \phi} = \frac{\lambda}{\sin \phi}.$$

$$\tan \phi = \frac{l}{r} = \frac{\lambda}{\rho}.$$

$$C = \frac{E}{I} = EK.$$

For convenience in computations the geometric equations should be set out, for example, as follows:

$$\begin{array}{r|l|l}
 r & l_L & l_s \\
 \hline
 I' = \frac{r'}{ } & + i l'' & \\
 I'' = \frac{r''}{ } & + i l_L'' & - i l_s'' \\
 I''' = \frac{r'''}{ } & & - i l''' \\
 \hline
 I_x = \Sigma r & + i \Sigma l_L & - i \Sigma l_s \\
 = r_x \pm i l_x. & &
 \end{array}$$

57. Illustration of Analytical Method.—In illustration of this method, solutions to some of the problems to be found on the foregoing pages are given. I , K , and ϕ are used to represent respectively impedance, conductivity, and lag.

Series Circuits (see Sect. 50).

Forming the equations for the non-inductive and inductive coils in problems c , h , i , and j of Sect. 50.

$$\begin{array}{l|l}
 c. \quad I_1 = 5 + i8 \\
 \quad I_{11} = 5 + i0 \\
 \quad \hline
 \quad I = 10 + i8 \\
 \quad C = \frac{100}{I} = \frac{100}{12.8} = 7.82. \\
 \hline
 \tan \phi = \frac{8}{10} = .8, \phi = 38^\circ 40'. \\
 I = \frac{r}{\cos \phi} = \frac{l}{\sin \phi} = 12.8. \\
 E = 10 I = 10 \times 12.8 = 128.
 \end{array}$$

As the prefix of the reactance term in the expression for I is $+i$, the angle ϕ is positive.

$$\begin{array}{l|l}
 h. \quad I_1 = 0 + i12 \\
 \quad I_{11} = 0 - i10 \\
 \quad \hline
 \quad I = 0 + i2 \\
 \quad C = \frac{100}{2} = 50. \\
 \hline
 \tan \phi = \frac{2}{0} = \infty, \phi = 90^\circ. \\
 I = \frac{l}{\sin \phi} = \frac{2}{1} = 2. \\
 E = 10 \times 2 = 20.
 \end{array}$$

$$\begin{array}{l|l}
 i. \quad I_1 = 0 + i12.5 \\
 \quad I_{11} = 0 - i12.5 \\
 \quad \hline
 \quad I = 0 + 0 \\
 \hline
 I = 0.
 \end{array}$$

$$\begin{aligned}
 j. \quad I_1 &= 10 + i0 \\
 I_{11} &= 0 + i8 \\
 I_{111} &= 0 - i12.5 \\
 \hline
 I &= 10 - i4.5 \\
 C &= \frac{100}{10.96} = 9.12.
 \end{aligned}$$

$$\begin{aligned}
 \tan \phi &= \frac{4.5}{10}, \quad \phi = -24^\circ 14'. \\
 I &= \frac{r}{\cos \phi} = \frac{l}{\sin \phi} = 10.96. \\
 E &= 10 \times 10.96 = 109.6.
 \end{aligned}$$

Here the prefix of the reactance term in the expression for I is $-i$, hence the angle ϕ is negative.

Parallel Circuits (see Sect. 52).

Applying the formula for conductance,

$$\begin{aligned}
 b. \quad K_1 &= \frac{10}{100 + 0} - i0 \\
 K_{11} &= 0 \quad -i \frac{8}{64 + 0} \\
 \hline
 K &= .1 - i.125 \\
 C &= \frac{100}{I} = 100 K = 16.
 \end{aligned}$$

$$\begin{aligned}
 \tan \phi &= \frac{.125}{.1} = 1.25; \quad \phi = 51^\circ 20'. \\
 K &= \frac{\rho}{\cos \phi} = \frac{\lambda}{\sin \phi} = .16. \\
 I &= \frac{1}{K} = \frac{\cos \phi}{\rho} = 6.25. \\
 E &= 10 \times 6.25 = 62.5.
 \end{aligned}$$

ϕ is positive in this case, as $-i$ in the expression for K shows that the current lags behind the pressure.

$$\begin{aligned}
 e. \quad K_1 &= \frac{10}{100 + 16} - i \frac{4}{100 + 16} \\
 K_{11} &= \frac{8}{64 + 100} - i \frac{10}{64 + 100} \\
 \hline
 K &= .1349 - i.0954 \\
 C &= \frac{100}{I} = 100 K = 16.5.
 \end{aligned}$$

$$\begin{aligned}
 \tan \phi &= \frac{.0954}{.1349} = .7072. \\
 \phi &= 35^\circ 16'. \\
 K &= \frac{.1349}{\cos \phi} = .165. \\
 I &= \frac{1}{.165} = 6.06. \\
 E &= 10 \times 6.06 = 60.6.
 \end{aligned}$$

$$\begin{aligned}
 h. \quad K_1 &= \frac{10}{100 + 0} - i \frac{0}{100 + 0} \\
 K_{11} &= \frac{10}{100 + 156} + i \frac{12.5}{100 + 156} \\
 \hline
 K &= .1390 + i.0488 \\
 C &= \frac{100}{I} = 100 K = 14.7.
 \end{aligned}$$

$$\begin{aligned}
 \tan \phi &= \frac{.0488}{.1390} = .3509. \\
 \phi &= -19^\circ 20'. \\
 K &= \frac{.1390}{\cos \phi} = .147. \\
 I &= \frac{1}{.147} = 6.8. \\
 E &= 10 \times 6.8 = 68.
 \end{aligned}$$

ϕ is negative in this case, as $+i$ in the expression for K shows that the current leads the pressure.

$$j. K_1 = \frac{5}{25 + 16} - i \frac{4}{25 + 16}$$

$$K_{11} = \frac{10}{100 + 156} + i \frac{12.5}{100 + 156}$$

$$K = .1610 - i.0487$$

$$C = \frac{100}{I} = 100 K = 16.8.$$

$$\tan \phi = \frac{.0487}{.1610} = .3025, \phi = 16^\circ 50'.$$

$$K = \frac{.1610}{\cos \phi} = .168.$$

$$I = \frac{1}{168} = 5.95.$$

$$E = 10 \times 5.95 = 59.5.$$

$$l. K_1 = \frac{10}{100 + 69.4} - i \frac{8.33}{100 + 69.4}$$

$$K_{11} = \frac{10}{100 + 69.4} + i \frac{8.33}{100 + 69.4}$$

$$K = .1181 - i0$$

$$C = \frac{100}{I} = 100 K = 11.8.$$

$$\tan \phi = \frac{0}{.1181}, \phi = 0.$$

$$K = \frac{.1181}{\cos \phi} = .1181.$$

$$I = \frac{1}{.1181} = 8.47.$$

$$E = 10 \times 8.47 = 84.7.$$

The effect of the reactances in this circuit is noteworthy.

$$o. K_1 = \frac{0}{64 + 0} - i \frac{8}{64 + 0}$$

$$K_{11} = \frac{0}{156 + 0} + i \frac{12.5}{156 + 0}$$

$$K = 0 - i.045$$

$$C = \frac{100}{I} = 100 K = 4.5.$$

$$\tan \phi = \frac{.045}{0} = \infty.$$

$$\phi = 90^\circ.$$

$$K = \frac{.045}{\sin \phi} = .045.$$

$$I = 22.2.$$

$$E = 10 \times 22.2 = 222.$$

Series and Parallel Circuits Combined (see Sect. 55).

$$a. K_A = .0862 - i.0345$$

$$K_B = .0487 - i.0609$$

$$K_{AB} = .1349 - i.0954$$

$$I_{AB} = 6.06 (\cos \phi_{AB} + i \sin \phi_{AB})$$

$$= 6.06 (.8165 + i .5774)$$

$$= 4.95 + i 3.50.$$

$$I_{AB} = 4.95 + i 3.50$$

$$I_C = 10 + i 8$$

$$I = 14.95 + i 11.50$$

$$\tan \phi_{AB} = \frac{.0954}{.1349}, \phi_{AB} = 35^\circ 16'.$$

$$K_{AB} = \frac{.1349}{\cos \phi} = .165.$$

$$I_{AB} = \frac{1}{.165} = 6.06.$$

$$\tan \phi = \frac{11.50}{14.95}, \phi = 37^\circ 34'.$$

$$I = 18.8.$$

$$C = \frac{100}{18.8} = 5.32.$$

$$E = 10 \times 18.8 = 188.$$

$$\begin{aligned}
 b_1. \quad K_A &= .025 - i0 \\
 K_B &= .0 + i.0503 \\
 \hline
 K_{AB} &= .025 + i.0503
 \end{aligned}$$

$$\begin{aligned}
 I_{AB} &= 17.8 (\cos \phi_{AB} + i \sin \phi_{AB}) \\
 &= 17.8 (.4456 - i.8960)
 \end{aligned}$$

$$I_{AB} = 7.937 - i 15.749$$

$$I_C = 0 + i 5.027$$

$$I = 7.937 - i 10.922$$

$$\tan \phi_{AB} = \frac{.0503}{.025}, \phi_{AB} = -63^\circ 32'$$

$$K_{AB} = \frac{.025}{\cos \phi} = .0561.$$

$$I_{AB} = \frac{I}{.0561} = 17.8.$$

$$\tan \phi = \frac{10.922}{7.937}, \phi = -54^\circ 0'$$

$$I = \frac{7.94}{\cos \phi} = 13.5.$$

$$C = \frac{100}{13.5} = 7.4.$$

$$E = 10 \times 13.5 = 135.$$

CHAPTER V.

THE MAGNETIC CIRCUIT OF ALTERNATORS.

58. **Losses in an Alternator.**—The principles which enter into the design of alternators have already been thoroughly set forth in Vol. I. and in the first chapter of these notes. There are, however, certain peculiar features in the magnetic circuits and the methods of applying the windings to alternators that require considerable modifications of the deductions found in Vol. I. These will now receive examination in detail. As in continuous-current dynamos (Vol. I., p. 248), the internal losses of alternators are caused by :

1. C^2R loss in the conductors on armature and field.
2. *Foucault* or *eddy currents* in armature cores and field.
3. *Foucault* or *eddy currents* in armature conductors.
4. *Hysteresis* in armature cores.
5. *Friction* of bearings and brushes, and air friction.

In well-designed continuous-current dynamos, the pole pieces usually cover not less than two-thirds of the armature surface (Vol. I., pp. 167 and 272). In alternators, the poles usually cover about one-half of the armature surface, or even less (Sect. 5). This would make it appear, upon a superficial examination, that the field

ampere-turns, and therefore the field losses, must be much greater in the alternator. However, since alternator armatures are made proportionally larger in diameter, in order to give space for the windings and to avoid excessive magnetic leakage, the proportional excitation really required need not be much increased when the magnetic circuit is well designed. In the same way, while not much more than one-half of the armature surface is covered with wire, the surface for winding is made much larger by increasing the diameter, while the number of revolutions is not much reduced. Consequently, the pressure produced in a given length of conductor is entirely commensurable in the two classes of machines. This is illustrated by the table on page 14, and by the following machines of three excellent makers :

1. Two-pole continuous-current dynamo of 60 K.W. output ; armature core, 15'' diameter, 15'' long ; winding requires 185 lbs. wire ; C^2R_a loss, 2.4 per cent ; speed, 900 revolutions per minute ; fields with 15,000 ampere-turns at full load ; field wire, 470 lbs. ; total C^2R_f loss, 1.7 per cent ; total weight of the machine, 10,000 lbs.

2. Four-pole continuous-current dynamo of 75 K.W. output ; armature core, 22'' diameter, 17 $\frac{1}{4}$ '' long ; winding requires 235 lbs. wire ; C^2R_a loss, 3.0 per cent ; fields with 15,000 ampere-turns at full load ; field winding requires 756 lbs. wire ; total C^2R_f loss, 2.3 per cent ; total weight of machine, 11,000 lbs.

3. Alternating-current dynamo of 70 K.W. output ; armature core, 24'' diameter, 18 $\frac{1}{2}$ '' long ; winding requires 70 lbs. wire ; C^2R_a loss, 1.6 per cent ; speed, 1050 revolu-

tions per minute ; fields with 25,000 ampere-turns at full load ; field winding requires 725 lbs. wire ; total C^2R , loss, 2.4 per cent ; total weight of the machine, 9500 lbs.

The table on pages 224 and 225 gives data of two English alternators built by the firm of Elwell & Parker,* and of five American machines of about equal capacity. All but one of these have drum armatures, but in the English machines they are stationary and surround the revolving poles, while in the American machines the poles surround the revolving armature. The armature of one of the American machines is of the disc type. All of the American machines were built about 1890, but all except one have since been superseded by a more substantial construction.

59. Copper Losses. — We may safely say that the percentage C^2R losses given upon pages 108 and 138 of Vol. I. can be taken as a limit towards which practice in the design of alternators is tending. The fact that the copper is divided among many cores increases the length of wire on alternator fields for a given magnetizing power as compared with continuous-current fields, and the C^2R losses allowed are usually somewhat greater than the tabular values and sometimes reach more than twice those values. (Examples : Kapp 30 K.W. alternator with 5.0 per cent loss in the field windings and 2.8 per cent in the armature conductors ; Ferranti 112 K.W. alternator with 2.75 per cent loss in the field windings ; and General Electric 300 K.W. alternator with 2.0 per cent loss in the field windings.) On the other hand, the losses may be brought by careful designing to

* See Thompson's *Dynamo-Electric Machinery*, 4th ed., p. 668.

| | 1 | 2 | 3 | 4 | 5 | 6 | 7 |
|--|----------------------------------|---------------------------------|-----------------------------------|---------------------------------|------|------|---------------------------------|
| Output in kilowatts | 36 | 30 | 50 | 37½ | 37½ | 35 | 50 |
| Amperes | 18 | 30 | 25 | 37½ | 37½ | 35 | 50 |
| Volts..... | 2000 | 1000 | 2000 | 1000 | 1000 | 1000 | 1000 |
| Frequency | 113 | 60 | 83.5 | 125 | 138 | 125 | 133 |
| Revolutions per minute..... | 1350 | 600 | 500 | 1500 | 1650 | 1500 | 1600 |
| Periphery velocity in feet per minute | | 5800 | 6000 | | | 6900 | 9000 |
| Number of poles..... | 10 | 12 | 20 | 10 | 10 | 10 | 10 |
| Diameter of field-magnet pitch circle | 22¼" | 36" | 45 ⁵ / ₁₆ " | | | | 22" |
| Length of magnet cores | 4¼" | 6 ³ / ₄ " | 8 ³ / ₈ " | 5" | 5½ | | 7" |
| Section of magnet cores { length | 5 ⁸ / ₈ " | 6" | 10" | 11" | 12" | 11¼" | 13½" |
| { width | 2 ³ / ₁₆ " | 3" | 2" | 2 ³ / ₄ " | 2¼" | 3" | 3 ³ / ₈ " |
| Pole faces { length | 5 ⁸ / ₈ " | 6" | 10" | 11" | 12" | 11¼" | 13½" |
| { width | 2 ³ / ₁₆ " | 4½" | 3½" | 2¼" | 2¼" | 3" | 3 ³ / ₈ " |
| Turns on each core | 240 | 267 | 344 | | | 315 | 368 |
| Exciter current (full load) | 23 | 18 | 12.3 | | | 5.8 | |
| Resistance of separately excited fields..... | | 3.26 | 9.5 | | | 11 | |
| Resistance of self-excited fields | | | | | | | |
| Pounds of wire on fields | 155 | | | | | 240 | |

approach the average values given in the tables. (Examples: Stanley 40 K.W. alternator with equal losses of 1.2 per cent in fields and armature, and 180 K.W. alternator with .7 per cent loss in fields and 2.0 per cent loss in armature; Mordey 75 K.W. alternator with 1.5 per cent loss in fields and 2.3 per cent in armature; Hopkinson 30 K.W. alternator with 1.6 per cent loss in armature and 2.9 per cent in fields.) These examples may be extended to an indefinite number, but those given illustrate the conditions. The following table may therefore be taken as showing the percentage C^2R losses, which represent the best present practice, and towards which all good practice in the design of alternators must eventually tend. At the present time it is not unusual to build alternators of greater capacity than 75 K.W. with upwards of double the field loss given in this table, notwithstanding the fact that the table gives values for the loss in the fields of alternators which are considerably greater than the tabular values for continuous-current machines (Vol. I, p. 138).

| KILOWATTS. | PER CENT IN ARMATURE. | PER CENT IN FIELDS. |
|------------|-----------------------|---------------------|
| 30 | 2.4 | 2.8 |
| 35 | 2.3 | 2.6 |
| 40 | 2.25 | 2.4 |
| 50 | 2.2 | 2.2 |
| 60 | 2.15 | 2.0 |
| 75 | 2.1 | 1.8 |
| 100 | 2.0 | 1.7 |
| 150 | 1.9 | 1.6 |
| 200 | 1.9 | 1.6 |

Table based on cold resistances at about 25° C. (75° F.).

60. Foucault Current Losses. — Foucault currents in alternator cores must cause much greater loss than in ordinary continuous-current machines. Thus, the armatures of two-pole continuous-current machines of considerable capacity seldom exceed 1500 revolutions per minute, which makes twenty-five complete magnetic cycles in the core per second. In alternators, the commercial frequency commonly lies between 40 and 140, while the greater number of machines are built for frequencies between 60 and 135. The number of magnetic cycles of the armature core is evidently equal to the frequency. Since the heating in the core discs which is caused by foucault currents is proportional to the square of the number of cycles per second, it becomes particularly important that the discs composing alternator armatures be well insulated from each other. It is therefore poor policy to depend upon oxide alone for insulation, and tissue paper should always be placed between the discs, and a cardboard be inserted at intervals. All burrs caused by punching the discs or truing the surface of the core should be carefully avoided or removed.

Foucault currents in the pole pieces are felt quite severely in some types of alternators, but the loss caused by them can always be brought within reasonable limits, in well-designed machines, by making the pole faces of laminated iron which is cast into the frame. (Compare Vol. I., p. 154.) Machines having smooth armature cores and surface windings do not ordinarily require this precaution, but in machines having toothed armature cores, laminated poles are quite important.

The loss due to foucault currents in armature conductors of a fixed size is much greater for alternating than for continuous-current dynamos, on account of the more frequent and sudden changes in the strength of the field through which they pass. However, since alternators are, in general, built for considerably higher pressures than continuous-current machines designed for a similar duty, the conductors on the alternator armatures are of proportionally smaller cross-section. This reduces the eddy currents to such an extent that they are not particularly noticeable except in very large or special machines. The practice of winding armature coils with copper ribbon set on edge (the broad side parallel with the lines of force) also tends to decrease eddy currents. In very large machines built to generate a pressure not exceeding 2000 volts, armature conductors of a large cross-section become essential, but the uniform practice of building large alternator armatures with imbedded conductors avoids all difficulty from eddy currents. (Compare Vol. I., p. 153.)

61. Hysteresis Losses. — The effect of hysteresis in iron core armatures is proportional to the number of magnetic cycles per second, and is therefore much greater in alternator armatures, for a given magnetic density, than in those of continuous-current machines. There are only two ways of decreasing the hysteresis loss per cycle and per unit volume: (1) by reducing the induction; (2) by improving the quality of the iron used in the core. Reducing the induction serves to decrease the foucault current loss also, and is therefore doubly advantageous. As a consequence, the induction in alterna-

tor armatures is sometimes made as low as 4000 lines of force per square centimeter, and seldom exceeds 7000 lines per square centimeter. A fair average value is about 5000 lines per square centimeter. This is just about one-half the average value for continuous-current armatures (Vol. I., p. 111). Halving the induction tends to quarter the foucault-current loss for an equal number of cycles per second. But, as already shown, the number of cycles in alternator armatures commonly varies from three to six times the maximum number occurring in continuous-current machines of the same capacity, so that the special precautions for insulating the discs cannot be neglected. This is rendered more necessary by the fact that reducing the induction requires the armature to be increased in size. In the same way, the hysteresis loss varies nearly in the proportion of B to the 1.6 power, or in other words, halving the induction decreases the hysteresis loss per unit volume to one-third. On the other hand, since the cross-section of iron must be increased to decrease the induction per square centimeter, it is not possible to bring the hysteresis loss to the limit attainable in continuous-current machines. This makes the careful selection and handling of the iron designed to enter alternator cores of special importance. Some manufacturers of electrical machinery not only select their armature iron with great care on this account, but anneal all armature discs after they have been assembled and the surface of the core has been turned up. For this purpose, the cores are carefully taken down after all machine work on the discs has been completed and the discs are annealed, after which the

cores are again assembled. This method of handling the iron removes the hardening effect of the tooling consequent upon turning up the cores (Vol. I., pp. 52 and 73).

62. Armature Ventilation. — Since the hysteresis and foucault-current losses are greater in alternator armatures, it is necessary that more opportunity be given for cooling than is the case in continuous-current machines. The real effect of the velocity of rotation upon cooling has never been thoroughly determined, but the experiments of Rechniewski* seem to show a cooling effect that is roughly proportional to the velocity. Consequently, on account of their high surface velocity, alternator armatures are more efficiently cooled than are continuous-current machines. Internal ventilation is also rendered more effective by reason of the high surface velocity. For the purpose of internal ventilation a revolving armature is virtually converted into a centrifugal blower, which sucks in air at its centre, along the shaft, and ejects it from the surface. For this purpose air ducts are made, which run through the core near the shaft, and which communicate with the surface through radial ducts. The rotation of the armature then causes a continuous circulation of air through the ducts, which is proportional in volume to the surface velocity of the armature.† Since the conductors cover only a portion of the surface and do not cross the ends of drum armatures, the cores may be easily arranged for internal ventilation, and advantage is usually taken of

* *Bulletin de la Société Internationale des Électriciens*, 1892; *Electrical World*, Vol. 19, p. 336; also *Textbook*, Vol. I, p. 109.

† *Kent's Mechanical Engineer's Pocket Book*, p. 516.

this. In the case of revolving disc armatures, wings may be so placed as to blow the air across the face of the disc. Ring armatures and pole armatures are more difficult to arrange for effective internal ventilation, and therefore they are frequently left unventilated. When the fields revolve, the poles cause a vigorous circulation of air, which serves in lieu of the blower action of a revolving armature.

63. Armature Radiating Surface.—With all precautions to avoid excessive heating in alternator cores they still tend to heat to a higher temperature than the cores of continuous-current armatures. It then becomes a matter of some concern to determine the possible amount of energy which may be expended in the armature conductors without placing an excessive additional burden upon the cooling surface. There is no valid reason for admitting a higher temperature limit in alternator armatures than is allowed in continuous-current machines (Vol. I., p. 105). As this fact becomes entirely admitted by all manufacturers of alternating-current machinery, the large C^2R losses in alternator armatures that are now common will rapidly disappear. On account of the large amount of heat caused by core losses which must be radiated, it is not safe to allow an armature C^2R loss of one watt for each square inch of cooling surface. In common practice, for each watt of C^2R_a loss an average of from $1\frac{1}{2}$ to 2 square inches of outside *winding surface* is allowed. This constant is sometimes made much larger, but seldom smaller except in disc armatures. In the latter the core losses need not be provided for, the whole capacity of the radi-

ating surface may be utilized to carry off the C^2R_a loss, and it is possible to decrease the radiation surface to considerably less than one square inch per watt.

64. Density of Current in Armature Conductors.—

The density of current in conductors wound upon iron-core armatures in good practice should usually not much exceed one ampere to from 500 to 600 circular mils. (Compare continuous-current dynamos, Vol. I., p. 110.) Many iron-core armatures are wound with wire having not much more than one-half this cross-section per ampere, but their makers allow an excessive rise of temperature in the machines during working. In disc armatures without iron, the constant may be greatly reduced without danger. Thus the Mordey 75 K.W. alternators have a current density in the armatures of one ampere to about 380 circular mils, and the current density in Ferranti alternator armatures is about one ampere to 335 circular mils. Even with such a great current density, these machines are comparatively cool in operation.

65. Field Radiating Surface.—Since the field cores of alternators are usually quite thin, the windings are often of a depth equal to one-half the thickness of the cores. At the same time this depth is generally no greater than that on many continuous-current dynamo fields. The same radiating constant can therefore be safely used, that is, from .35 to .40 watt per square inch of the outer surface of the winding (Vol. I., p. 142). Since the depth of the winding generally bears a large ratio to the thickness of the core, the energy radiated per square inch of core surface is much greater. The ratio of winding depth to thickness of core is also widely

variable, and the radiation constant must be based upon the external surface of the windings. The field cores should therefore be made of such a length that the area of the external surface of the windings in square inches may be from two to three times the C^2R_f loss in watts. The form of the fields, and therefore the effect of the iron in conducting away the heat in the field windings, has a considerable effect on the allowable value of the constant, as is also the case in continuous-current machines. The area of the field cores is given by the formula, $A = N_a \frac{v}{B_f}$, where N_a is the useful armature flux required from one pole, v is the leakage coefficient, and B_f the induction desired in the field core. The pole width is determined by the mechanical and electrical conditions which fix the pitch, and only the length of the pole faces may be altered to vary B_f . If the winding depth exceeds two inches, it is likely to cause injurious heating in the lower layers.

66. Leakage Coefficient.—The value of the leakage coefficient is quite large in most types of alternators. It probably averages 1.5 in alternators with surface wound drum or ring armatures and with poles set in a circle either without or within the armature. In pole armatures it is doubtless equally as great, but in machines having well-designed, toothed, ring or drum armatures, and small air spaces, the leakage coefficient may be less. In machines with ring or disc armatures in which poles of opposite sign are ranged alternately on either side of the armature, the value of the coefficient may be as great as 2.0. In machines of the Mordey type, where

the poles on each side of a disc armature are of the same sign, or of the Stanley so-called inductor type, the leakage coefficient becomes unity; that is, practically all of the lines of force set up in the magnetic circuit cut the armature conductors, and are therefore useful in developing electric pressure.

The calculation of the leakage coefficient of alternators may be carried out upon the same methods as those used for continuous-current machines.*

67. Determination of the Number of Armature Conductors.—The formula $E = \frac{2KSNVp}{10^8 \times 60}$ (Sect. 5) may be

put into the form $E = \frac{2KSNf}{10^8}$, since $\frac{Vp}{60}$ is equal to the frequency, f . Taking a proper value for K , as already explained, gives the effective value of E . In a well-designed machine of the usual American types, the value of K is about 1.1, which is the value for a machine which gives a sinusoidal electric pressure and in which the differential action is negligible. The conditions of service usually fix the values of E and f in any particular case, and the equation then contains two dependent variables, N and S . The ratio of these is determined from the form and dimensions of the armature which it is desired to make. The number of poles is limited by constructive considerations and the importance of keeping the leakage within reasonable limits. On the latter account the poles must not come too near together. With this in view the frequency cannot be increased beyond a certain limit by increasing the num-

* *Textbook*, Vol. 1, p. 133; also *Electrical Engineer*, Vol. 18, p. 163 *et seq.*

ber of poles, without carrying the periphery velocity of the armature beyond the safe limit. Thus, suppose a machine be designed with a ten-pole stationary field, and its drum armature be designed to drive at the safe limit of velocity. If it be desired to increase the frequency by 20 per cent, two poles must be added to the field and the armature revolutions kept constant, or the armature must be speeded up 20 per cent. The latter is not permissible on account of mechanical safety. If the poles are already as close together as economy admits, in order to increase the number of poles the pitch circle must be increased in diameter, which requires a proportional increase of the armature diameter. This again calls for an increase of the surface velocity, the revolutions per minute remaining constant. Hence in any type of machine a limit of frequency may be reached which cannot be safely exceeded. The limiting frequencies in the ordinary types of machines designed for commercial service are from 100 to 150. In the Mordey type the limit is much higher, since the poles may be very close together and cause no leakage, and structural considerations, only, set the limit. Commercial frequencies are all less than 150 and many are less than 100, so that all practical types of alternators may be used in commercial service.

Fixing the frequency of a machine and the periphery velocity and revolutions of the revolving part, fixes both the diameter of the armature and the number of poles. The diameter of the armature fixes the space for armature coils. With the winding space fixed, the value of S is determined from the number of insulated conduct-

ors of requisite area which can be properly placed on the armature. It is quite usual to wind alternator armatures with only two layers of wire, but this must be determined in any particular case by many conditions affecting the design. The value of S being determined, the length of the armature must be made such that the necessary total magnetization may be set up in the field cores and armature without forcing the magnetic density to too high a value. Finally the ratio of radiating surface to C^2R_a loss should be checked.

It is well to consider here the effect upon the output of an alternator, of making a change in the number of armature conductors. The electric pressure developed in the coils due to their cutting lines of force is proportional to the number of turns in the coils. The electric pressure of self-induction, on the other hand, is proportional to the square of the number of turns. Hence, increasing the number of armature turns beyond a certain limit may actually decrease the output of the machine. It is desirable to determine the number of turns that will give maximum output. If L_1 represents the effective or working self-inductance for each armature conductor, then the total effective self-inductance of the armature is $L = S^2L_1$. In the same way, if E_1 represents the electric pressure developed per conductor, the total pressure developed in the armature is $E = SE_1$. From the fundamental formula

$$C = \frac{E}{\sqrt{R^2 + 4\pi^2f^2L^2}},$$

we get

$$C^2R^2 = E^2 - 4\pi^2f^2C^2L^2,$$

$$\text{or } CR = \sqrt{E^2 - 4\pi^2 f^2 C^2 L^2}.$$

This may be put into the form

$$CR = \sqrt{S^2 E_1^2 - 4\pi^2 f^2 C^2 S^4 L_1^2},$$

if the external circuit to which the alternator is connected is non-inductive. The term, CR , is the active pressure in the alternator circuit, and it is desirable for this to be a maximum for a given armature. Differentiating the equation with respect to S and solving for a maximum, we get the following :

$$\frac{d(CR)}{dS} = \frac{S(E_1^2 - 8\pi^2 f^2 C^2 S^2 L_1^2)}{\sqrt{S^2 E_1^2 - 4\pi^2 f^2 C^2 S^4 L_1^2}} = 0,$$

hence $E_1^2 - 8\pi^2 f^2 C^2 L_1^2 S^2 = 0$. Or CR is a maximum when

$$S = \frac{E_1}{2\sqrt{2}\pi f C L_1}.$$

In this it is assumed that the armature resistance is small compared with that of the external circuit, which is always the case in efficient working. For E_1 may be substituted its value

$$E_1 = \frac{2KNf}{10^8},$$

and the expression for S at maximum output becomes

$$S = \frac{KN}{10^8 \sqrt{2}\pi C L_1} = \frac{N}{C L_1} A,$$

where A is a constant depending upon the type and dimensions of the machine. If K has a value of 1.1, the value of A is practically 25×10^{-10} . The final form of the variable portion of the expression giving the maximum economical value of S is striking. Its numerator

is the total useful magnetization due to the fields, which passes through an armature coil, and its denominator is the magnetization passing through the coil due to the current in each of its own conductors.* This criterion shows that the armatures of some old-style magneto alternators had too much wire for economy; that is, they would have supplied a larger pressure to a non-inductive circuit if fewer conductors had been placed on their armatures.

When the external circuit is inductive, as is usually the case, the number of armature turns which gives a maximum active pressure is smaller than when the external circuit is non-inductive. If S' be the number of conductors giving the maximum active pressure when the external circuit has self-inductance L_e , and S be the number of conductors giving the maximum pressure when the external circuit is non-inductive, then

$$S^2 L_1 = S'^2 L_1 + L_e \quad \text{or} \quad \frac{S'^2}{S^2} = 1 - \frac{L_e}{S^2 L_1}$$

or
$$\frac{S'}{S} = \left(1 - \frac{L_e}{S^2 L_1} \right)^{\frac{1}{2}}.$$

In the latter expression $S^2 L_1$ is the self-inductance of the armature when wound with the proper number of turns to give a maximum active pressure when the external circuit is non-inductive. When L_e is greater than $S^2 L_1$, the right-hand member of the expression for $\frac{S'}{S}$ becomes imaginary. It is impossible to put so many turns on commercial alternator armatures as the criterion shows would give the greatest output, since the ques-

* Picou, *Machines Dynamo-Électriques*, p. 271.

tion of regulation in constant-pressure alternators demands that the fall of pressure in the armature due to resistance and inductance shall be as small as possible.*

68. Example of Armature Calculation.— Suppose it is desired to design a 50 K.W. alternator of the American type, for 1000 volts terminal pressure and 50 amperes, at a frequency of 60, using a smooth core armature with surface windings. Assume K to be 1.1; then, adding 10 per cent to the terminal pressure to allow for loss of pressure in the armature due to C^2R loss and inductance, we have

$$SN = \frac{1100 \times 10^8}{2.2 \times 60} = 833,000,000.$$

We may take 1000 revolutions as a satisfactory maximum speed at which to aim. One thousand revolutions and a frequency of 60 gives a fractional number of poles while the number must be an even integer. Taking 900 revolutions gives exactly eight poles, which is satisfactory. Then taking the safe periphery velocity as 6000 feet per minute makes the diameter of the armature a trifle over two feet. Call the diameter of the core two feet. The periphery of this is 75.4 inches. Somewhat more than one-half of this winding space should be occupied by wire, say 46 inches. Each coil must generate one-eighth of the pressure, or $137\frac{1}{2}$ volts, if the armature is connected in series. The diameter of the pitch circle for the poles may be set approximately as 25 inches, and its

* Compare Kapp's *Dynamos, Alternators, and Transformers*, p. 377; Steinmetz, *Trans. Amer. Inst. E. E.*, Vol. 12, p. 326.

circumference is then 78.5 inches. The combined width of the poles should be somewhat less than half of this, or say 38 inches. This makes each pole $4\frac{3}{4}$ inches or 12.1 centimeters in width. Since 46 inches of the armature circumference are occupied by wire, about 27.4 inches are left for the openings in the centres of the coils when $\frac{1}{4}$ inch is allowed for insulation between the coils. This makes the openings approximately $3\frac{1}{2}$ inches wide. The cross-section of the armature conductors, allowing 525 circular mils to the ampere, must be 26,250 circular mils. This is the cross-section of a No. 6 B. & S. Ga. wire which has a diameter of 178 mils when double cotton-covered. Two hundred and fifty-eight of these will go into 46 inches in one layer, but the number of armature conductors must be a multiple of twice the number of coils, or 16. Two hundred and fifty-six is the multiple which is nearest to 258. This makes 32 conductors or 16 turns per coil, and gives N the value of 3,254,000 lines of force. Allowing an average induction of 5500 under the pole faces makes the length of the pole faces, practically, $19\frac{1}{4}$ inches. This is too great a length to be practical in a machine of the capacity under consideration, and two layers of wire must be put on the armature, thus reducing N ; or by rolling the wire into a rectangular form and placing it on the armature surface on its edge, it may be made to occupy less surface and more conductors may be put on the armature; in which case either the air gap induction or the dimensions of the armature may be reduced, or these may be reduced together. It is therefore quite common to wind

alternator armatures with special rectangular wire or ribbon, and we will take a ribbon which is 250×80 mils in cross-section, which gives an area equivalent to about 25,500 circular mils. When this is triple cotton-covered, its dimensions may be taken to be 270×100 mils, and 464 of these will wind into a space 46.4 inches wide. This makes 58 conductors or 29 turns per coil. This gives N the value of, practically, 1,795,000 lines of force, and makes the length of the pole faces approximately 12 inches when the average induction in the air gap is 5000. It remains then to fix the exact dimensions of the armature and pole pieces. Taking the diameter of the armature core as 24 inches, and adding double the thickness of insulation gives, say, 24.25 inches. This makes allowance for two layers of japanned canvas and a layer of mica under the coils. The winding diameter is 24.25 inches, and the circumference is 76.18 inches. From this is subtracted 46.40 inches, and 2 inches, which is the space occupied by the conductors and the insulation between the coils, and there remains 27.78 inches for the spaces within the coils. The coils, made so as to turn down at the ends of the core, therefore have the following approximate dimensions (also Fig. 86): outside length, $A = 19\frac{7}{8}$ inches; inside length, $B = 14$ inches; outside width, $C = 9\frac{1}{4}$ inches; inside width, $D = 3\frac{1}{2}$ inches. This leaves $\frac{1}{4}$ inch between the coils which may be filled by a strip of vulcanized fibre or paraffined wood. The total length of wire is approximately 950 feet, which has an approximate weight, insulated, of 80 pounds and a cold resistance of .40 ohm. The C^2R_a loss is therefore

1000 watts, or 2.0 per cent, based on the cold resistance, which is not far from the tabular value (page 226); the total winding surface is $76.2 \times 19.8 = 1509$ square inches, and this gives more than $1\frac{1}{2}$ square inches per watt C^2R_a loss, which is satisfactory. Since the armature conductors number 464, it is required that N be equal to 1,795,000 lines of force. One-half this num-

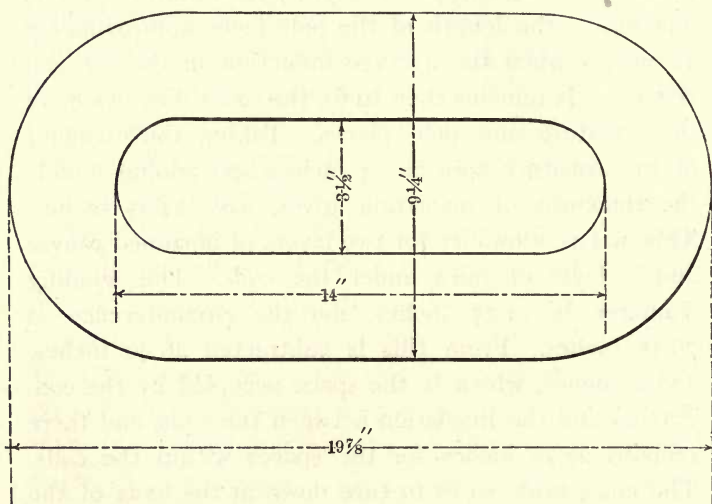

Fig. 86

ber of lines passes through each magnetic circuit in the armature. Putting B_a as 4000 makes the cross-section of the armature core about 225 square centimeters, or 35 square inches. The length of iron in the core may be assumed to be $12 \times .80$, or 9.6 inches. The depth of the core discs must therefore be about $3\frac{3}{4}$ inches, or the inner diameter of the discs is $16\frac{1}{2}$ inches.

The external finished diameter of the armature is

$24.25 + .540 + .164 = 24.95$. This allows 31 mils for the thickness of insulation under the bands, and 51 mils for the wire in the bands. Wire of 51 mils diameter, or 16 B. & S. gauge, is used on account of the high periphery velocity of the armature. Allowing a little under $\frac{1}{4}$ inch (210 mils) for mechanical clearance makes the diameter of the polar circle 25.37 inches, or $25\frac{3}{8}$ inches. The circumference of the polar circle is therefore 79.7 inches. The pitch of the poles is 9.95 inches, and the distance between their tips is 5.2 inches.

69. Armature Self-Inductance. — The self-inductance of a smooth-core alternator armature may be approximately estimated from the magnetic and electric data of the machine. The reluctance of each magnetic circuit must be calculated exactly as in the case of a continuous-current multipolar dynamo, in order to determine the field windings. In the American type of alternator, the reluctance to be overcome by the magnetic pressure of each field core belongs to that part of the circuit which lies between the lines AA' and BB' in Fig. 87. Calling that reluctance P , the ampere-turns for each

field core are in number $\overline{nc} = \frac{NP}{1.25}$. The reluctance

in the different parts of the magnetic circuit met by lines of force which are set up by the armature turns when the fields are excited, may be assumed to be equal to the reluctance in the same parts of the circuit met by the lines set up by the field coils. The number of lines of force set up in the portion of the magnetic circuit between the lines AA' and BB' by a unit current in one armature coil, the centre of which is directly

under a pole face, is $\frac{1.25 S_1}{2P}$, where S_1 is the number of conductors in the coil, and is equal to twice the number of turns in the coil. Each one of these lines of force in completing its circuit must link another armature coil, so that we may say that the number of lines of

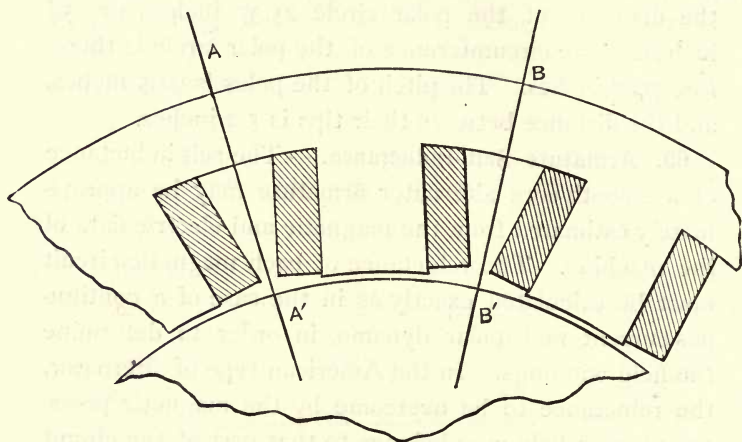

Fig. 87

force set up by each pair of coils is $\frac{1.25 S_1}{2P}$. The self-induction of the pair of coils is therefore

$$L_1 = \frac{1.25 S_1^2}{2 \times P \times 10^8},$$

since S_1 is equal to the number of turns in two coils. The self-induction of the whole armature is equal to L_1 multiplied by the number of pairs of coils, when the armature is connected in series, or

$$L = \frac{1.25 S_1^2 p}{2 \times P \times 10^8}.$$

When the armature is connected with the halves in parallel, the inductance is one-fourth as great as is given by this formula; but in the case of two similar armatures built for the same pressure and output, the one connected with the halves in parallel has twice as many conductors in each coil as has the other armature, and their self-inductances are equal. If the value of P , in the preceding example, is taken as .004, the self-inductance is shown by substitution to be $L = .021$ henry.

The effect of the ampere-turns of the armature coil, within the ordinary load limits of a smooth-core armature, will not greatly alter the permeability of the highly magnetized fields, so that L may be taken to be approximately constant with varying loads, provided the armature pressure be kept constant.

The path of the lines of force set up by the armature coils has been assumed to be the same as the path of those set up by the field magnets. This is approximately true for machines with smooth drum armature cores, or with coreless armatures, and the real effect of the armature turns upon the number of lines of force in the magnetic circuits, is to increase or decrease the number that would exist were the armature turns absent, rather than to set up an independent magnetization. The effects of armature reactions and of self-induction are therefore closely related. In the case of machines with toothed armature cores, the reluctance in the path of the magnetization due to the field is materially smaller than when the cores are smooth, and hence it is to be expected that the self-inductance of toothed-core

armatures will be large. If the teeth are T-shaped as in Fig. 88, the reluctance measured around the path of the lines of force set up by the armature coils may be materially smaller than the reluctance measured along the path of the magnetization due to the field coils. This is due to the effect of the leakage from tooth to tooth. Consequently, the self-inductance of an armature having T-shaped teeth which are close together may be expected to be very large. In some

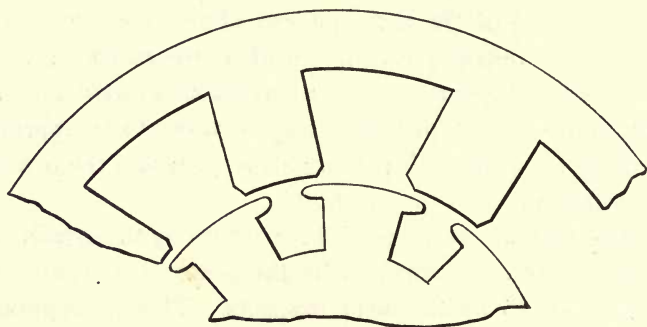

Fig. 88

such machines which are arranged to have a specially large armature self-inductance in order to obtain a self-regulating constant-current machine, as in the Stanley arc light alternator, the inductance may be as much as two or three henrys.

70. Armature Reactions. — The armature reactions of alternators by no means cause as serious consequences as those of continuous-current machines. When the current of the armature is in exact phase with the impressed pressure, the armature current has compara-

tively little opportunity to affect the field magnetism. When the armature conductors are directly between the pole pieces, the instantaneous current is zero, and therefore at this point the armature has no effect upon the field magnetism. When the coils have moved through one-half the pitch, a sheet of current at its maximum value flows directly under the pole faces. This current has such a direction that its magnetic effect tends to crowd the lines of force of the field into the trailing tips

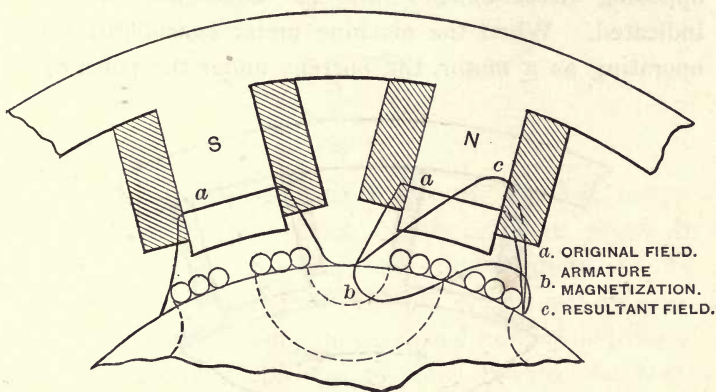

Fig. 89

of the poles (Fig. 89). Hence the field is weakened on account of the increased reluctance of the magnetic circuit. This effect is probably not very marked in the usual forms of alternators, since the reluctance of the path occupied by the armature or cross-lines of force is quite large. The distortion and consequent weakening of the field may be reduced by cutting a slot longitudinally across the pole faces, or by some of the methods described in Vol. I., Chap. VI.

When the armature current is out of phase with the impressed electric pressure, the conditions are quite different. Suppose that the phase of the current is retarded on account of self-induction. When the centres of the coils are under the poles, the current is not zero, but has an instantaneous value which depends upon the amount of retardation. This current in a generator is in such a direction that its magnetic effect opposes that of the field (Fig. 90). As the coils move, this opposing effect merges into the cross-effect already indicated. When the machine under consideration is operating as a motor, the current under the poles evi-

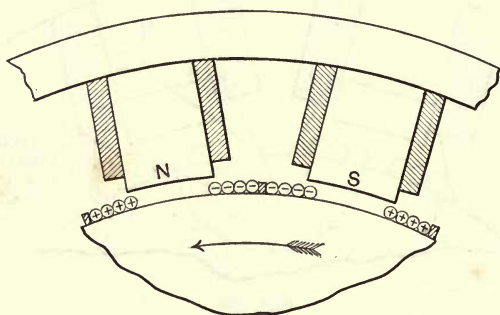

Fig. 90

dently tends to strengthen the fields instead of to weaken them.

If the current is in advance of the phase of the impressed pressure, the armature of a generator tends to strengthen the field magnetism when the coils are directly under the poles (Fig. 91). A motor armature under like conditions tends to weaken the fields. This tendency of the armature current, when in advance

of the impressed pressure, to strengthen the fields, may be taken advantage of to make an alternator completely self-regulating, or even self-exciting, through the action of its armature current. This, however, requires the

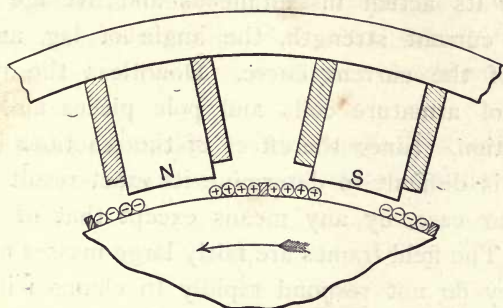

Fig. 91

use of a condenser attached across the armature terminals to give the proper lead to the current, which is undesirable. The opposing and cross-magnetic effects of the retarded armature currents of alternating generators, when operating under usual conditions, cause the external characteristic to slope toward the horizontal axis. This effect must be added to the slope of the characteristic caused by true and inductive resistance in the armature. It is often difficult to distinguish between the effects of armature reactions proper and of self-induction, and they are sometimes treated as alike.*

The quantitative effect of the current, and of the angle of lag, on armature reactions is not readily

* Kapp's *Dynamos, Alternators, and Transformers*, p. 394; and Hawkins and Wallis' *The Dynamo*.

determined. It is evident that the effect is a periodic one which depends for its relative instantaneous values upon the instantaneous positions of the coils with reference to the poles; and which depends further for its actual instantaneous and average values on the current strength, the angle of lag, and the shape of the current curve. Doubtless the relative shapes of armature coils and pole pieces also enter the relation. Since the effect of the reactions is periodic, it is difficult to determine its exact result in any particular case, by any means except that of experiment. The field frames are fairly large masses of iron, and they do not respond rapidly to changes in their magnetic surroundings. This inertia is caused by the effect of Foucault currents and the considerable inductance of the field windings, which tend to suppress sudden magnetic changes. It is therefore safe to assume in general that the discernible effect of armature reactions is an average of the instantaneous values. The instantaneous value of the back turns of each coil at any moment is $\sqrt{2} nC \sin (a - \phi) \cos a$, where n is the number of turns of each coil, C is the effective value of the current which is assumed to be sinusoidal, and ϕ is the angle of lag. This expression may be averaged between the limits $a = 0^\circ$ and $a = \pi$, with the result that the back turns appear to be approximately equal to $2.22 nC \sin \phi$.* This formula purports to give the number of ampere-turns to be added to each pole on account of back turns, and the result is positive or negative as the current lags or leads; but it does not include the

* Compare Kapp's *Dynamos, Alternators, and Transformers*, p. 412.

effect of cross-magnetization, which is sometimes considerable but is difficult to predetermine. The method of figuring the effect of inductance has already been indicated (Sect. 69), and all the corrections necessary can now be made in computing field windings. This is carried out as explained in Vol. I. (p. 143 *et seq.*), due attention being given to modifying conditions already explained.

71. **Field Excitation of Alternators.**—The windings of the field magnets of alternators are usually classified

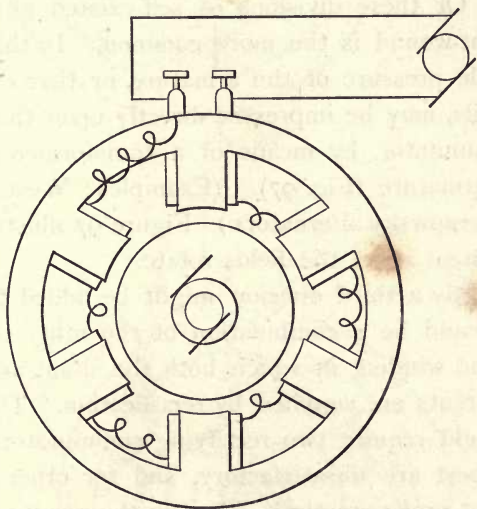

Fig. 92

according to their arrangement in circuit. The principal divisions are three: **separately excited**, **self-excited**, **compositely excited**; so-called, respectively, when the magnetizing current is supplied from an external source (Fig. 92), when it is supplied through a rectifying com-

mutator from the armature of the machine under consideration (Fig. 93), or when these two arrangements are combined (Fig. 94).^{*} Self-excited alternators may again be divided into series-wound and shunt-wound, depending upon, first, whether the whole current is rectified and led through a comparatively small number of turns around the field magnets (Fig. 95), or, second, whether only a portion of the current is rectified and led through a shunt circuit many times around the magnets (Fig. 96). (Example: Zipernowsky alternator.) Of these divisions of self-excited alternators, the shunt-wound is the more common. In this, either the whole pressure of the armature, or that of one or more coils, may be impressed directly upon the rectifying commutator, by means of a transformer attached to the armature (Fig. 97). (Examples: Westinghouse and Zipernowsky alternators.) Figure 97 illustrates the arrangement when the fields rotate.

Evidently a third division might be added to these, which would be a combination of the other two, or a compound winding in which both the shunt and series field currents are supplied by rectification. This, however, would require two rectifying commutators, which at the best are unsatisfactory, and for other reasons would not prove practical. To gain the result for which compounding is used in continuous-current dynamos, the composite winding is used. That is, the alternator is externally excited to its normal pressure on open circuit and the internal losses are compensated by series ampere-turns from self-excitation. The self-exciting

^{*} Compare *Text-book*, Vol. I., p. 136.

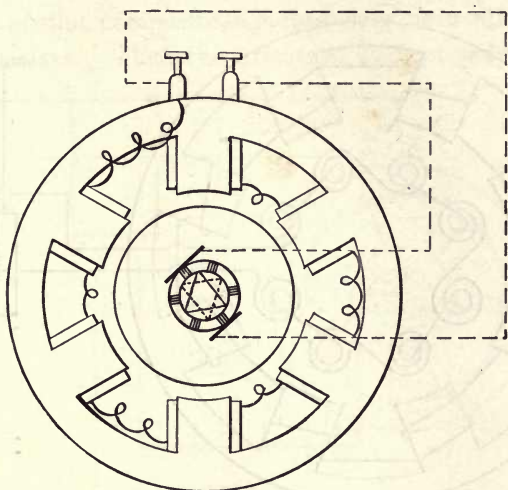

Fig. 93

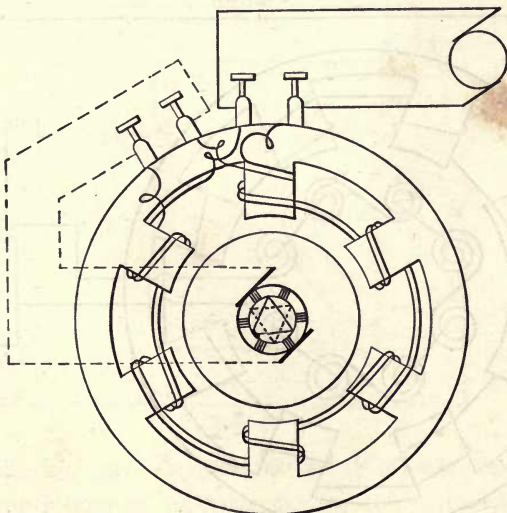

Fig. 94

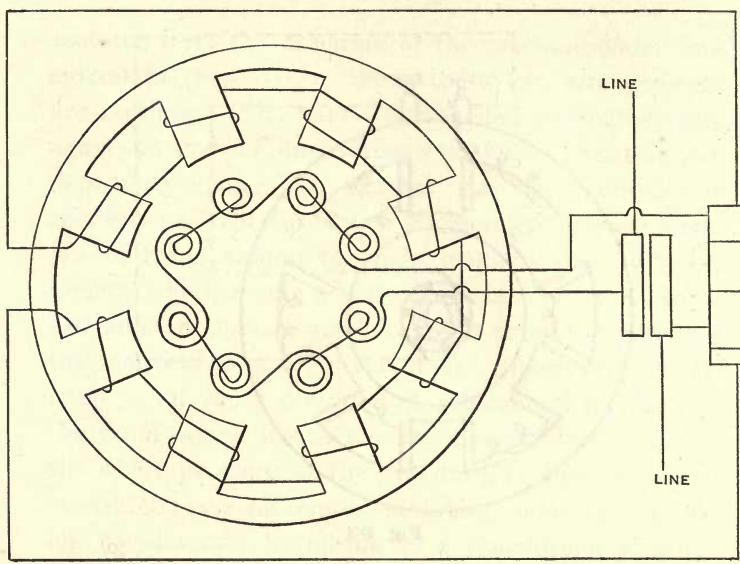

Fig. 95

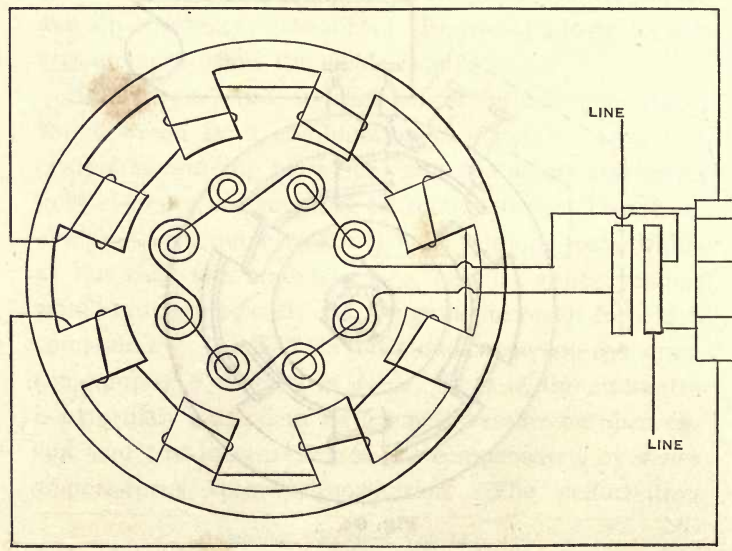

Fig. 96

circuit of the composite winding may be arranged in various ways. Thus the armature current may all be

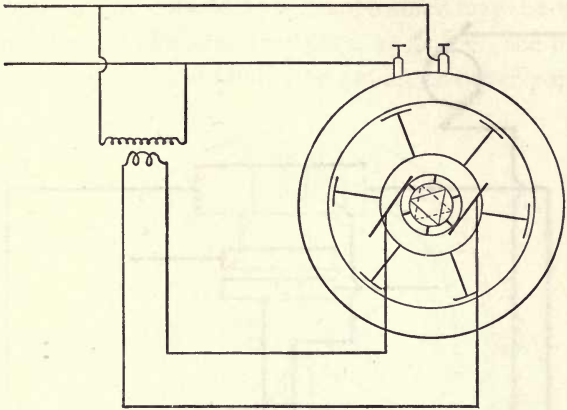

Fig. 97 a

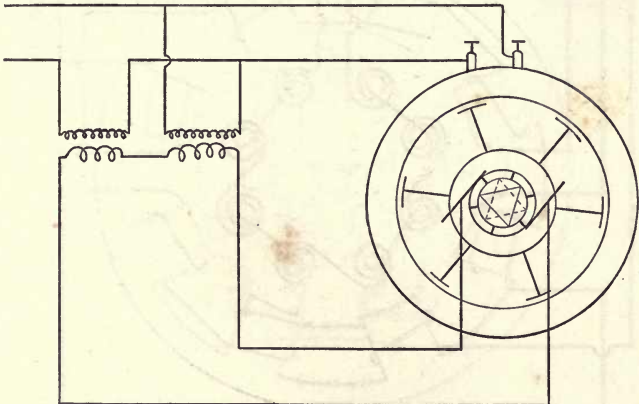

Fig. 97 b

rectified for use in excitation (Fig. 98) (example: Thomson-Houston alternator), or the armature current may pass through a special transformer attached

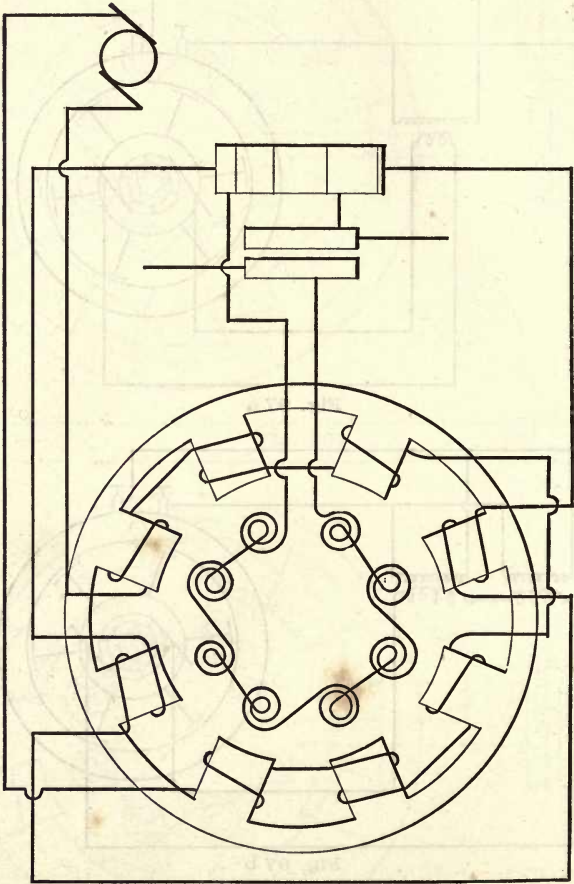

Fig. 98

excited for use in excitation (Fig. 98) (example: Thomson-Houston alternator), or the armature current may pass through a special transformer attached

to the armature, and the secondary of this may then supply the current for rectification and self-excitation (Fig. 99). The core of this transformer may be either independent of the armature core, as at *A* in the figure, or may consist of the laminated spider or other portions

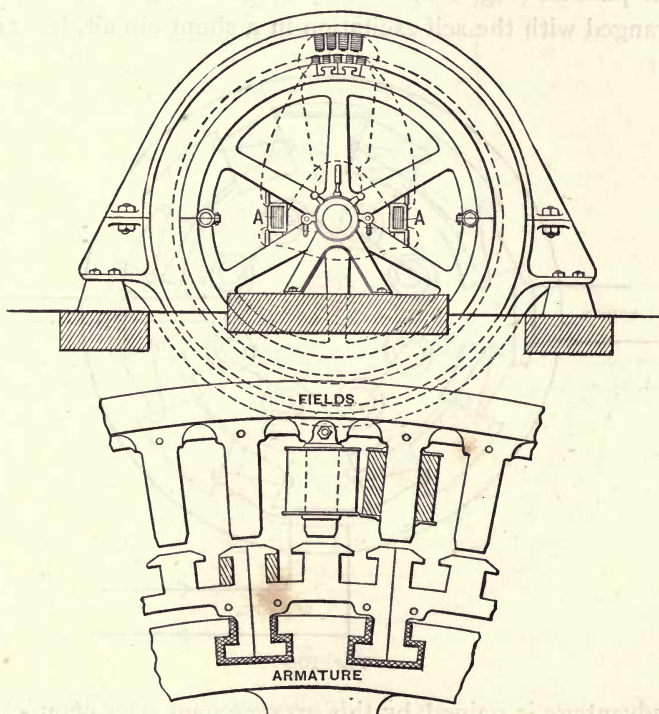

Fig. 99

of the armature core. (Example: some Westinghouse alternators.) Again, the rectified current may be passed through a few turns of wire on each pole (Fig. 100), or all the necessary series turns may be concentrated upon

one or two poles (Figs. 98 and 101). (Examples: Westinghouse, Thomson-Houston, and General Electric alternators.) In the latter case, the series turns must always be equally divided between two poles with symmetrical positions when the armature is connected with its halves in parallel (Fig. 102). Composite windings may be arranged with the self-excitation in a shunt circuit, but no

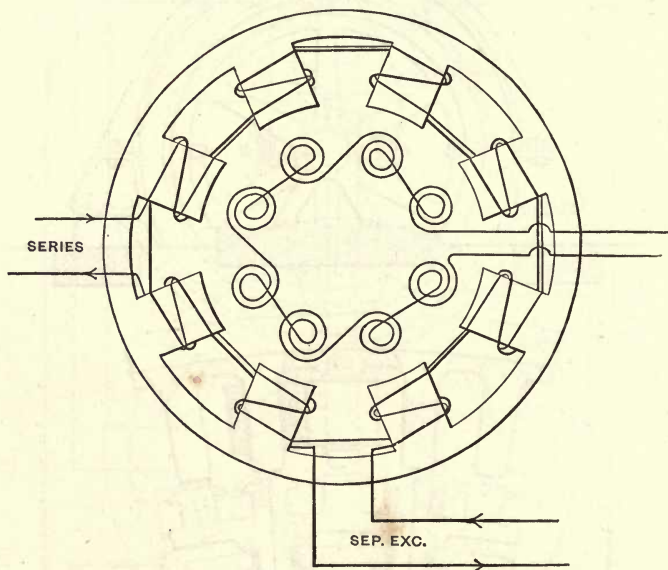

Fig. 100

advantage is gained by this arrangement over complete self-excitation in shunt or by separate excitation. This arrangement is, therefore, not used. In some self-exciting alternators, a separate set of exciting coils is wound on the armature and connected to a rectifying commutator. These may be wound directly with the

main armature coils or across a chord of the armature core (Fig. 103). (Example: old-style Thomson-Houston alternator.) The compounding may be effected in self-excited alternators by means of shunt and series transformers combined as in Fig. 97 *b*, which shows a machine with stationary armature. (Example: Ganz alternators.)

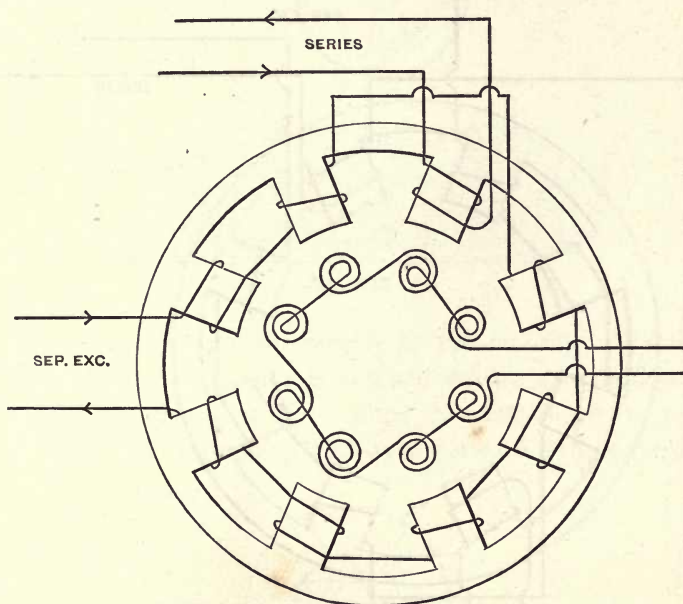

Fig. 101

The rectifying commutator in every case has as many segments as there are poles on the alternator, and alternate segments are connected together, making two sets (Fig. 104). To each of these sets one of the alternating-current terminals is attached. Brushes bearing upon the commutator at opposite non-sparking points

then collect a rectified current. Various devices have been employed to avoid sparking at the rectifying commutator, but in American machines no special precautions are taken. (Examples: Westinghouse, Thomson-Houston, and General Electric alternators.) In the

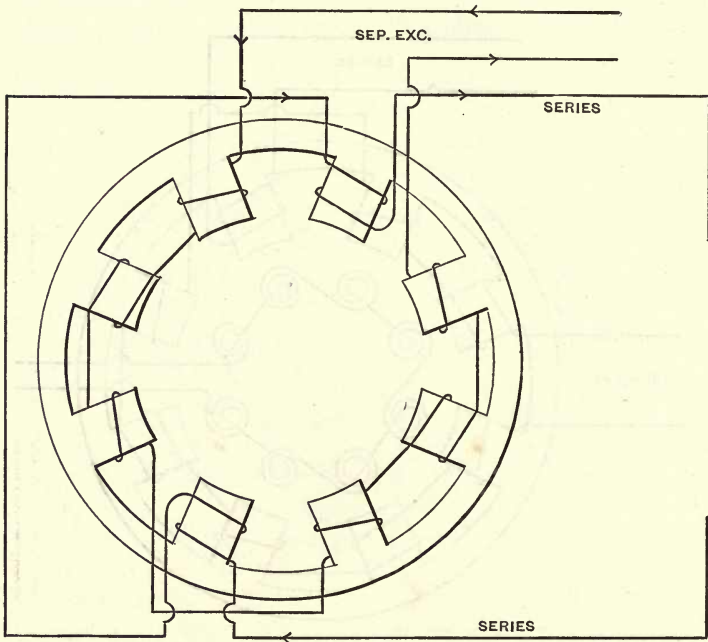

Fig. 102

Zipernowsky alternator, built by Ganz & Co. of Buda-Pesth, the following arrangement of the commutator is employed: Between the commutator divisions are inserted narrow metallic sectors which are connected together. Four brushes are used, two on each side of

the commutator. One brush of each pair is set a little in the lead of the other, and the pair is connected together through a small resistance. The leading

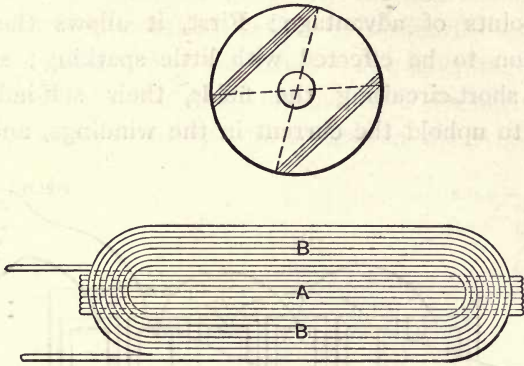

Fig. 103

brushes are connected directly to the circuits. When the commutating point is reached during the rotation of the commutator, the trailing brushes move on to intermediate segments, while the forward brushes are

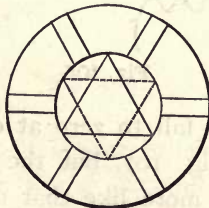

Fig. 104

still on main segments. Hence both the field circuit and supply circuit are short-circuited for an instant through the resistances connecting the brushes (Figs.

105 and 106). Short-circuiting the supply circuit has a disadvantage, but if a transformer is used for excitation it may be so designed that no harm results. The short-circuiting of the field circuit is claimed to give two points of advantage: First, it allows the commutation to be effected with little sparking; second, upon short-circuiting the fields, their self-induction tends to uphold the current in the windings, and this,

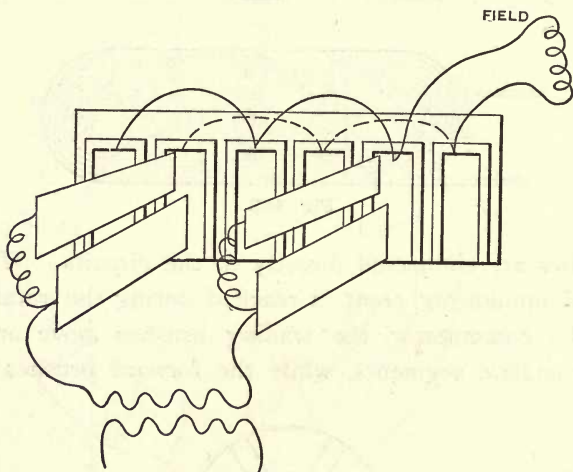

Fig. 105

therefore, does not fall to zero at each commutation, as is shown in Fig. 107, but the current curve becomes a wavy line more like that of Fig. 108. Picou says* that it is preferable to place the brushes ahead of the point of least sparking. In this case the spark is due to a decreasing current, and is thin and weak.

* *Machines Dynamo-Électriques*, p. 99.

With the brushes behind the point of least sparking, the spark is due to a rising current and it is of great magnitude. The method here outlined to avoid sparking does not seem to have any marked advantages over direct commutation, which is ordinarily used in American self-exciting machines. The advantage of a wavy current in the field, instead of a discontinuous one, is doubtless equally well gained in the American

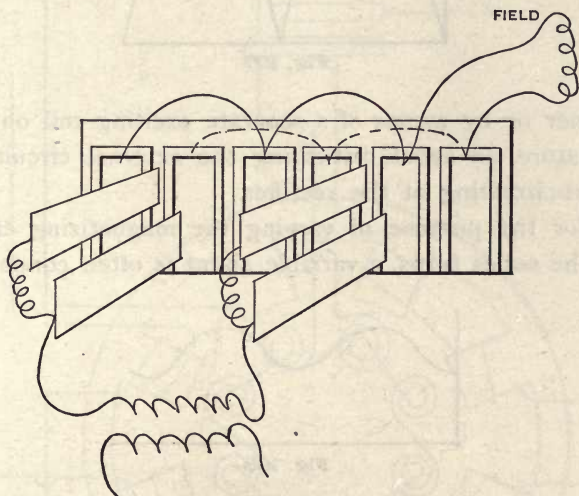

Fig. 106

machines by the use of copper brushes of considerable thickness on the rectifying commutator, which short-circuit the supply circuit and field circuit at the instant when they bridge over the insulation between two segments. In composite-wound machines the short-circuiting of the series field supply, which occurs for an instant at each commutation, is a matter of no mo-

ment, since cutting the small resistance of the series fields in and out of the main circuit cannot have an appreciable effect on the operation of the machine. For shunt-wound self-exciting machines, the current for rectification must either be supplied through a trans-

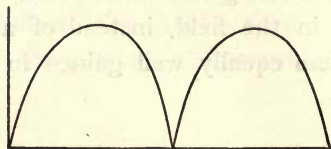

Fig. 107

former or by means of a separate exciting coil on the armature, to avoid disturbing the external circuit by short-circuiting at the rectifier.

For the purpose of varying the magnetizing effect of the series turns, a variable shunt is often connected

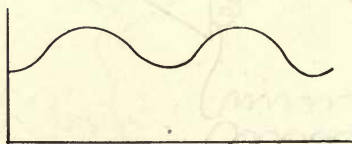

Fig. 108

across their terminals (Fig. 109) and a shunt is sometimes placed across the rectifier terminals in such a way that only a fixed proportion of the total current is rectified and passes through the series field winding. This is for the purpose of reducing the difficulties caused by sparking, by reducing the current to be rectified.

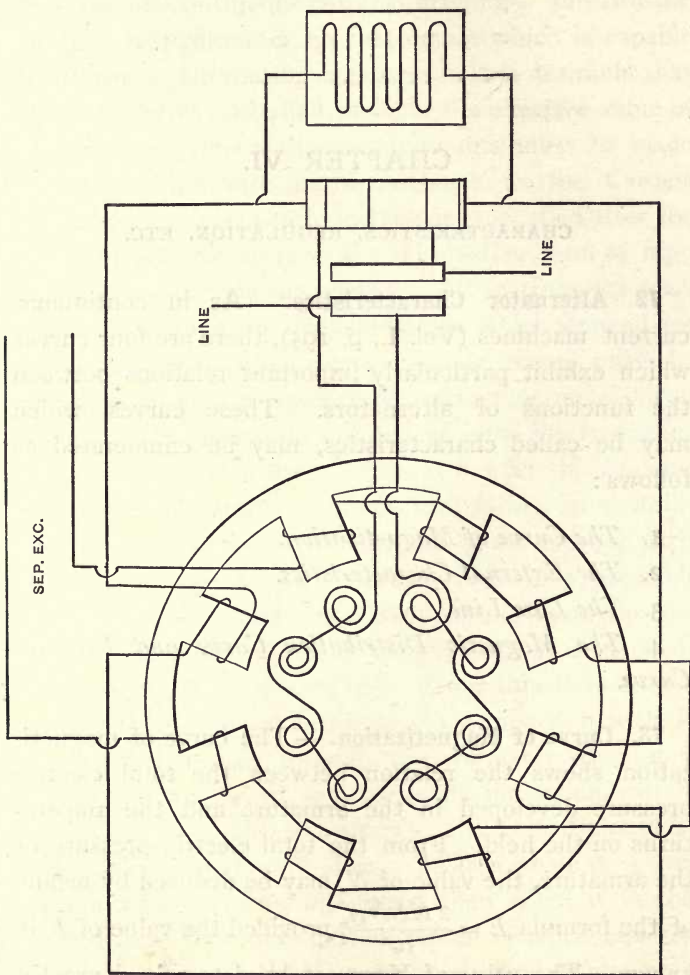

Fig. 109

CHAPTER VI.

CHARACTERISTICS, REGULATION, ETC.

72. Alternator Characteristics.—As in continuous-current machines (Vol. I., p. 195), there are four curves which exhibit particularly important relations between the functions of alternators. These curves, which may be called characteristics, may be enumerated as follows:

1. *The Curve of Magnetization.*
2. *The External Characteristics.*
3. *The Loss Line.*
4. *The Magnetic Distribution Curve and Pressure Curve.*

73. Curve of Magnetization.—The curve of magnetization shows the relation between the total electric pressure developed in the armature and the ampere-turns on the field. From the total electric pressure of the armature, the value of N_a may be deduced by means of the formula $E = \frac{2KSN_a f}{10^8}$, provided the value of K is known. The value of K cannot be determined exactly by calculation, but may be ascertained by means of the fourth curve. The experimental determination of the

curve of magnetization is carried out exactly as in the case of continuous-current machines, substituting for the plain voltmeter an instrument which is capable of measuring alternating pressures. It is desirable that the instrument used shall indicate the effective value of the pressure; hence, the measurements must be made by either a hot wire instrument such as the Cardew voltmeter, an electrostatic instrument modelled after the quadrant electrometer, or a non-inductive form of high resistance electro-dynamometer. All instruments used in alternating-current measurements which depend for their indications upon electrodynamic action, must be constructed with no masses of conducting metal about them, or their constants will depend upon the frequency of the current measured. This is due to the dynamic effect which Foucault currents, circulating in metallic masses, must have on the currents in the moving parts of the instrument. If a voltmeter has an appreciable inductance, its reading will also depend upon the frequency, since the current flowing through it is inversely proportional to $R^2 + 4\pi^2 f^2 L^2$. From this it is readily seen that if L is not negligible in comparison with R , the current flowing through the voltmeter when it is connected to a circuit, and hence its indication, will be dependent upon the frequency. The indications of an inductive voltmeter will always be less when it is connected to an alternating circuit than when it is connected to a continuous-current circuit of equal effective pressure. The self-inductance of electro-dynamometers intended for use as amperemeters is usually quite small, but in some cases may reach a millihenry. Electro-dyna-

mometers which are intended to be used as voltmeters, and have a great many turns of wire in their coils, sometimes have a self-inductance as large as several hundredths of a henry; but the commercial voltmeters that are built on the principle of electro-dynamometers have a considerable non-inductive resistance in series with the inductive coils, so that their time constant is small.

If the alternator under examination was designed to be a self-exciting one, there is some question of the comparative magnetizing effects of continuous and rectified currents. In general, however, as we have already seen (Sect. 71), the rectified current in a self-excited field is doubtless always a wavy one. The effective value of this, as indicated by an electro-dynamometer, is very nearly the same as the average value indicated by an ordinary amperemeter. The average magnetizing effect of the current is also practically equal to that of a continuous current which gives the same indications on the instruments. A wavy current tends to set up Foucault currents in the iron of the magnetic circuit and thus cause heating, but this result is not marked.

The magnetizing current of a separately excited alternator may be caused to become wavy if the armature reactions are very large. It has already been shown that the effect of armature reactions is a periodic one, and when the periodic effect becomes of sufficient magnitude it causes fluctuations in the field magnetism, which react upon the windings and throw the magnetizing current into waves. Curve *I*, Fig. 110, shows the current curve of a Stanley arc-light alternator of high

self-inductance when the machine is on short circuit. The self-inductance of this machine is so great that the current lag is nearly 90° when the machine is short-circuited, and the current therefore has its maximum value when the centres of the coils are almost directly under the centres of the pole pieces. The armature current therefore has a maximum effect upon the field

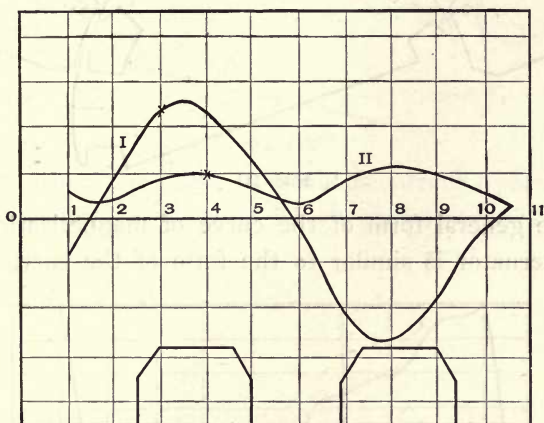

Fig. 110

magnetism, and it causes such a variation that the field current, which is furnished by a separate continuous-current dynamo, is thrown into waves as shown by curve *II* of the figure. The relative location of the poles is shown in the figure, and the forms of the poles and the armature teeth with their relative location at the instant the current is zero are shown in Fig. 111. Figures 112 and 113 show the same features when the machine is worked upon a full load of 40 arc lamps, in

which case the current lag is not quite so great.* This effect has also been found, but to a less degree, in smooth-core machines with surface windings.

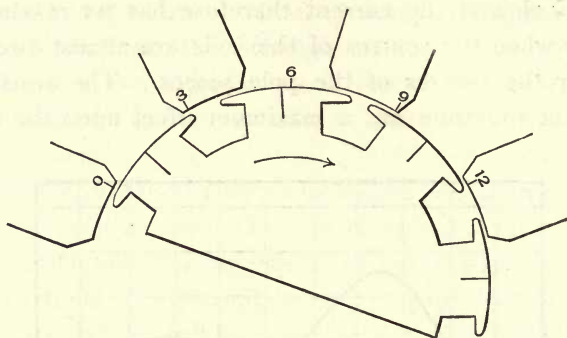

Fig. 111

The general form of the curve of magnetization for an alternator is similar to the form of the curve for a

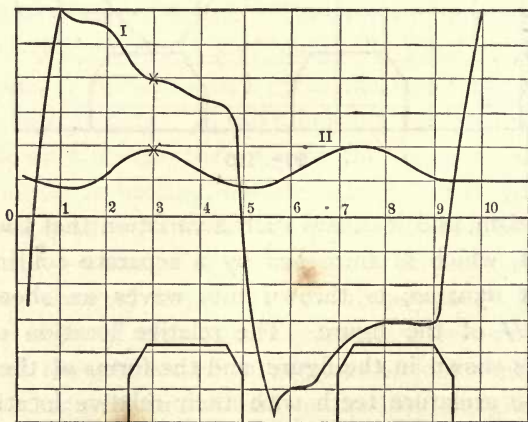

Fig. 112

* Tobey and Walbridge, Stanley Alternate-Current Arc Dynamo, *Trans. Amer. Inst. E. E.*, Vol. 7, p. 367.

continuous-current dynamo. As it is not uncommon for alternators to have a somewhat larger reluctance in

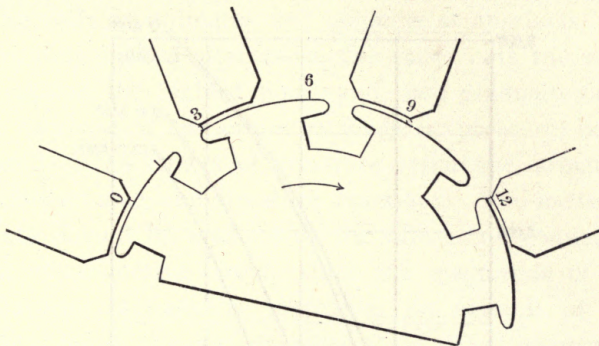

Fig. 113

the air space than have continuous-current dynamos of the same size, the knee in the alternator curve is some-

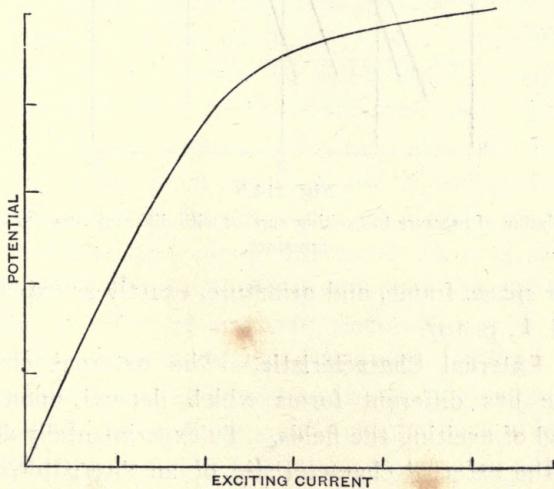

Fig. 114 a

times not so abrupt as it is in the case of continuous-current machines (Fig. 114 a and b). For studying the

details of the design of the magnetic circuit, the curve may be resolved into component curves representing

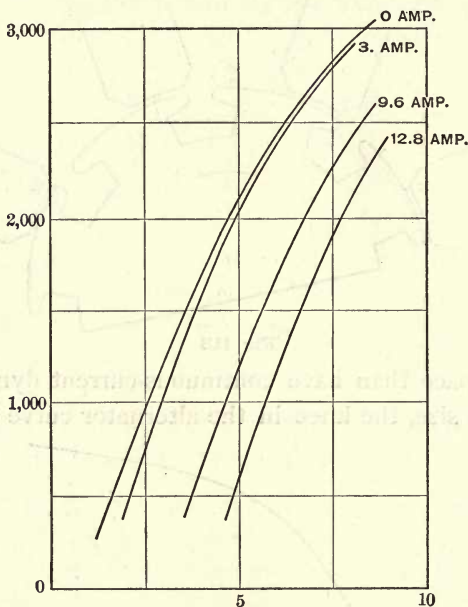

Fig. 114 b

Relation of pressure to exciting current with different currents in armature.

the air space, frame, and armature, exactly as explained in Vol. I., p. 197.

74. External Characteristic.—The external characteristic has different forms which depend upon the method of exciting the fields. To experimentally determine the external characteristic of an alternator, it is excited by the method for which it is designed, so as to give its normal pressure on open circuit. The volts at its terminals, and the current in the external circuit,

are measured with various resistances in the external circuit. The observations may be plotted in a curve, using volts as ordinates and amperes as abscissas. In separately excited alternators, the curve cuts the vertical axis at the highest point, and then gradually falls; the decrease of the ordinates (drop in pressure) being caused by the effects of armature resistance, armature self-inductance, and armature reactions. The measurements should be made with the alternator connected to a non-inductive circuit, since the magnitude of the armature reactions is increased, on account of the greater lag of the current, when there is self-inductance in the external circuit. If it is desired to quantitatively determine the effect of lag on armature reactions, curves may be taken with different values of inductance inserted in the external circuit. The portion of the drop which is caused by self-inductance and armature reactions may be separated from that caused by resistance by the formula, $E_i^2 = E_a^2 + E_s^2$. In this case E_i is the open-circuit pressure, and E_a is equal to the terminal pressure, for the load C , plus CR_a . By taking the characteristics of an alternator when worked on circuits of different known resistances and self-inductances, the effect of armature reactions may be determined for different values of the angle of lag.* The self-inductance of some alternators is so great that the external characteristic droops to the X axis at a current not greatly exceeding full load. Figure 115 *a* shows the characteristics of two alternators, one having a small, and the other a large, self-inductance. The maxi-

* Compare Kapp's *Dynamos, Alternators, and Transformers*, p. 383 *et seq.*

imum output is given by the latter when the armature current has the value, $C = \frac{N}{SL_1} A = \frac{NS}{L_a} A$, according to the formula on page 237.

The external characteristic of a self-excited shunt-wound alternator is shown in Fig. 115 *b*. The droop in

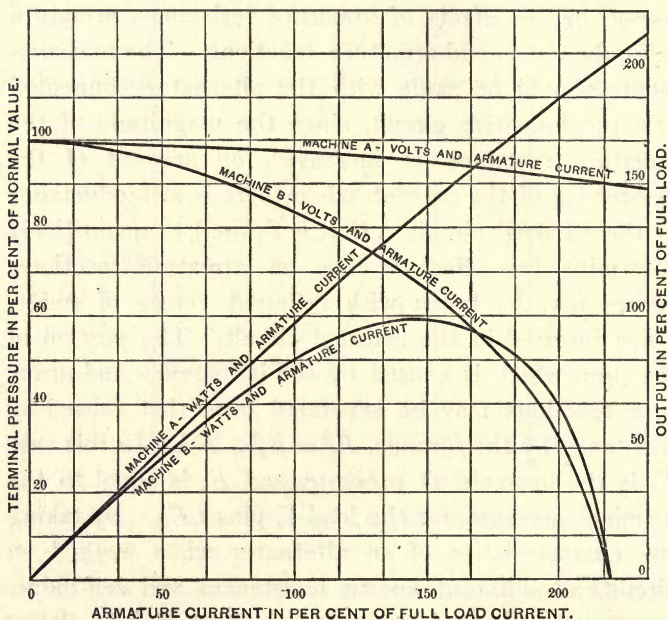

Fig. 115 a

the curve is a little greater than it would be for the same machine separately excited. This is due to the loss of magnetizing current as the armature losses increase, and the terminal pressure decreases accordingly (compare Figs. 110 and 117, Vol. I.). The external characteristic of a shunt-wound self-excited alternator may be

constructed from the curve of magnetization and loss line, by the process that has already been explained for continuous-current dynamos (Vol. I., p. 205).

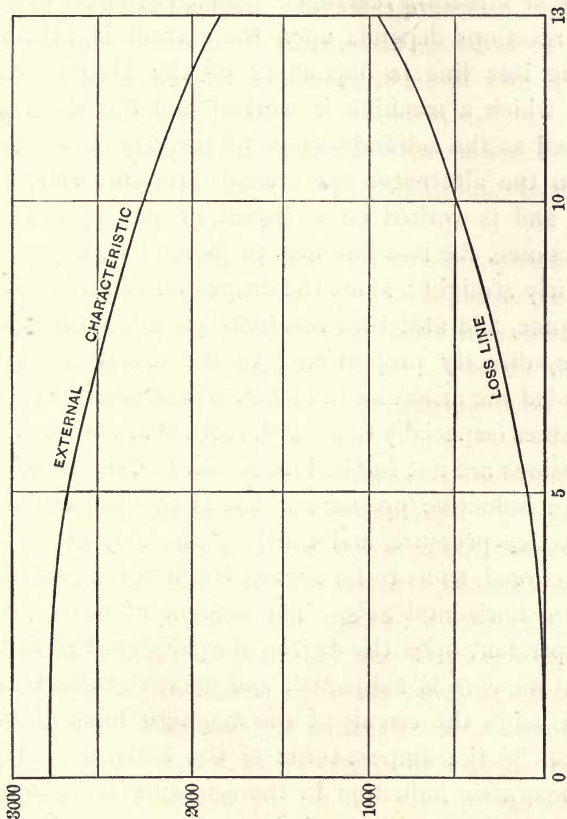

Fig. 115 b

75. **Loss Line.** — The differences between the ordinates of the external characteristic of a separately excited alternator and its terminal pressure on open circuit are the ordinates of the **Loss Line**. This dif-

ference in the ordinates is caused, as already stated, by the loss of pressure due to armature resistance, counter electric pressure due to self-induction, and the effect of armature reactions. Since the effect of armature reactions depends upon the current lag, the slope of the loss line is dependent on the kind of circuit upon which a machine is worked, and the slope is increased as the self-inductance of the circuit is greater. When the alternator has a small armature self-inductance and is worked on a circuit of zero or negligible inductance, the loss line may in general be expected to be fairly straight; since the drops due to resistance, inductance, and armature reactions are all, within narrow limits, directly proportional to the armature current, provided the armature inductance is constant. In some machines (especially those with toothed armatures), these provisions are not fulfilled on account of the large value of the inductive pressure which is in quadrature with the active pressure, and the loss line may be considerably curved, so as to be convex towards the axis of current or horizontal axis. The amount of the curvature is dependent upon the degree of saturation to which the armature core is subjected, and upon the effect of the air space in the circuit of the magnetic lines which are set up by the ampere-turns of the armature. Unless the magnetic induction in the armature is denser than other conditions will admit in good practice (Sect. 61), the self-inductance is not likely to decrease as the current rises. Hence the loss line of alternators worked on non-inductive circuits is likely to be nearly straight, or else convex towards the horizontal axis (Fig. 115 *b*).

76. Instruments. — In all the measurements required in determining alternator characteristics, the instruments which are used must be carefully selected so that they may properly measure alternating currents. Thus the voltmeters must be of the types described in Section 73, and the amperemeters must be of one of the following types :

Electrodynamometers or current balances which have no metal in their frames in which disturbing Foucault currents may be set up.

Known non-inductive resistances through which the current to be measured passes, and the pressure at the terminals of which may be measured by means of an electrostatic or hot wire voltmeter, or by means of an electrodynamic voltmeter having a negligible time constant.

Or finally, amperemeters dependent for their indications upon the heating effect of the current.

These instruments may be standardized and calibrated in the usual manner with continuous currents, after which they will give correct indications of the effective values of alternating currents for any frequency within the usual commercial limits. If other types of amperemeters are used, they must be calibrated by comparison with instruments of one of the types described above, using an alternating current, for the calibrating, which has exactly the same frequency as that which is to be measured in the test. Amperemeters which depend for their indications upon the attraction of a solenoid upon a laminated iron core, are likely to give widely different indications for equal currents of different fre-

quencies. This is principally due to the effects of Foucault currents and hysteresis.

77. The Magnetic Distribution Curve, and Curves of Pressure and Current. — These curves may be experimentally determined by various methods. They consist of a series of curves which are closely interrelated, but may be and in fact are likely to be, of quite dissimilar forms. The form of the curve representing the wave of impressed pressure, or total pressure developed in the armature of an alternator, is directly dependent upon the distribution of the magnetism over the pole faces, and also on the arrangement of the armature windings. By poor designing, either of these may be given a controlling influence to the exclusion of the other. The two-pole machine with Gramme armature, discussed in Section 5, gives an excellent instance. The differential action, which occurs in the coils of this armature, makes its curve of pressure almost independent of the distribution of the magnetism over the pole faces, provided the same total number of lines of force is cut by the conductors per revolution; and the maximum value of the pressure is entirely independent of the magnetic distribution. This is shown by Fig. 116, where the full line in one cut shows the curve of pressure developed in the armature with a uniform distribution of the field, and the full line in the other shows the curve of pressure with the same total field greatly distorted. The dotted lines in the cuts show the distribution of the magnetism over the pole faces. The continuous pressure developed in the armature when the machine is operated as a continuous-current dynamo,

is not affected by the distortion, provided the brushes are always placed on the neutral plane and the total magnetism passing through the armature remains constant. When the machine is converted into an alternator by the addition of collecting rings, the maximum instantaneous pressure is equal to the pressure developed in the continuous-current machine, and is therefore independent of the distribution of the magnetism, but the form of the curve representing the wave of pressure is slightly altered, as shown in Fig. 116. Now sup-

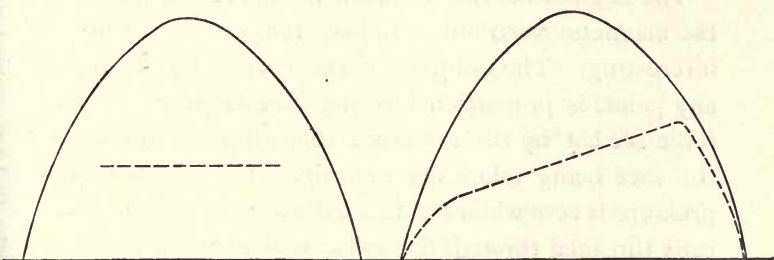

Fig. 116

pose the same machine to be arranged with a single narrow coil on the armature. The change in the magnetic distribution now not only changes the form of the pressure curve proportionally, but also changes in a marked manner the maximum value of the instantaneous pressure. The difference in the curves of pressure developed by the broad and narrow coil armatures is due to the effect of differential action in the broad coil armature. It has already been shown that differential action occurs to some degree in commercial alternators, but it does not occur to a sufficient degree to make the form

of the pressure wave independent of the magnetic distribution. It is therefore true that the magnetic distribution largely influences the form of the pressure wave, and the distribution should therefore be carefully studied during the development of a type of alternators. A proper study of the magnetic distribution and of the arrangement of the armature windings, makes it possible to so design an alternator that it will produce any desired form of pressure wave. This is an important point which will receive additional attention later.

The angular relation between the curves representing the magnetic distribution and the impressed pressure, is interesting. The ordinate of the curve of pressure at any point, is proportional to the rate at which lines of force are cut by the armature conductors at that point, the rate being taken algebraically. Consequently, the pressure is zero when the magnetization is all symmetrically threaded through the coils; that is, when the algebraic rate of cutting lines by the conductors is zero.

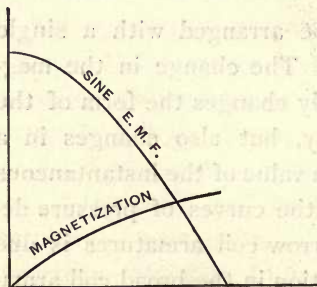

Fig. 117

The pressure is a maximum when the rate of cutting lines is the greatest; that is, when the algebraic summation of the number of lines threaded through the coils is a minimum. A curve which shows the algebraic summation of the number of lines threaded

through the coils at each instant, therefore, has an angular position which is 90° from that of the pressure

curve (Fig. 117). The form and dimensions of this curve evidently depend upon the actual distribution of the magnetism and the arrangement of the armature windings. When the pressure curve is irregular, and the angular relation is not made evident from the curve, as in Fig. 118, the point at which the curve of magnetism cuts the X -axis may yet be easily found, since it is directly under the centre of gravity of the pressure curve. That is, since as many lines of force must be withdrawn from the coils as are inserted, for each loop of the curve, the summation of the ordinates of the pressure curve on each side of the crossing must be equal.

This curve, which shows the algebraic number of lines of force which are threaded at each instant through the coils, may be easily deduced from the curve of pressure. Erect an ordinate to the pressure curve which bisects the area; then by means of ordinates divide the half areas into a number of small areas. The magnetism threaded through the armature coils is algebraically equal to zero at the instant represented by the bisecting ordinate, and the algebraic value of the magnetism threaded through the armature coils at any other instant is proportional to the area enclosed by the pressure curve between the corresponding ordinate and the bisecting ordinate, since $e = \frac{dN}{dt}$ and $N = \Sigma edt$.

Therefore, the ordinates of the curve representing the magnetism threaded through the coils are, at the instants represented by the ordinates which divide the pressure curve into small areas, proportional to the area

between the corresponding instantaneous pressure ordinate and the bisecting ordinate. The full process is, therefore, as follows: lay off on each ordinate a length from the X -axis proportional to the area enclosed by the pressure curve between the respective ordinate and the bisecting ordinate. The points thus found are points on the desired curve. It is evident that the maximum ordinate of the curve comes at the instant

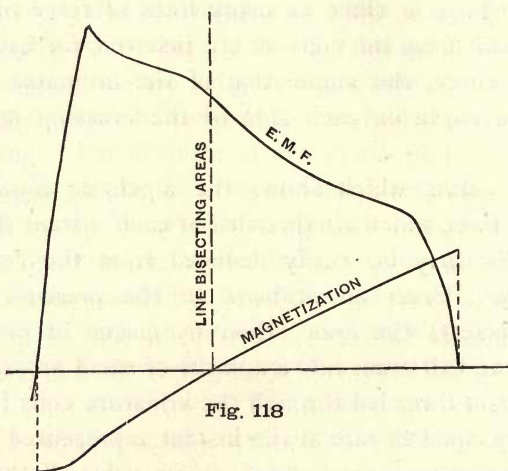

Fig. 118

when E is equal to zero. The length of this ordinate is equal to N_a , and the scale of the curve may thus be conveniently fixed. The curve may not be symmetrical, but, with a fixed value of N_a and a fixed armature winding, the successive loops must always be exactly alike, though they may be looked upon as alternately positive and negative, since the magnetism is alternately threaded through the coils in opposite directions. The corresponding curves of pressure and magnetism for

various forms of pressure curves are shown in the accompanying figures. The construction of the second curve from the first is shown by the dotted lines.

In Fig. 118 the pressure curve is one experimentally determined from a Stanley arc light alternator when working on a full load of arc lights.*

In Fig. 119 the pressure curve is an equilateral triangle, in Fig. 120 it is a sinusoid, and in Fig. 121 it is a rectangle.

The pressure curves of Figs. 122 and 123 are respectively a flat-topped curve and a parabola.†

Since the electrical pressure is proportional to the rate of change of the number of lines of force threaded through the armature coils, the ordinates of the pressure curve are proportional to the tangents of the curve representing the number of lines enclosed

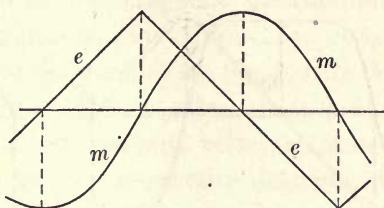

Fig. 119

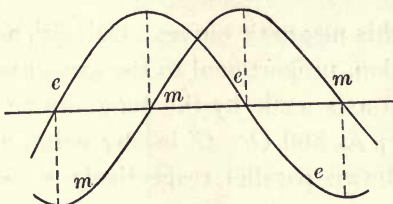

Fig. 120

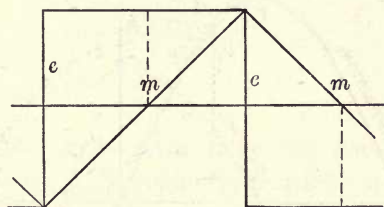

Fig. 121

* Tobey and Walbridge, Stanley Alternate-Current Arc Dynamo, *Trans. Amer. Inst. E. E.*, Vol. 7, p. 367.

† Emery, Alternating Current Curves, *Trans. Amer. Inst. E. E.*, Vol. 12, p. 433.

by the armature coils. Figure 124 shows a graphical construction for determining the pressure curve from

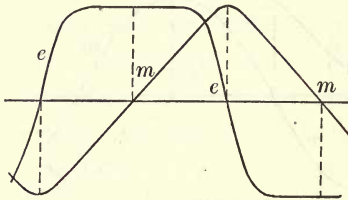

Fig. 122

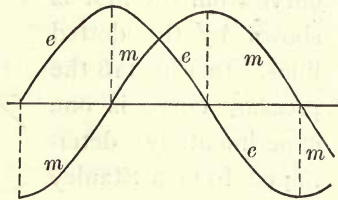

Fig. 123

this magnetic curve. Oa' , Ob' , and OA are, by construction, proportional to the tangents of the angles with the X -axis made by the tangents to the magnetic curve at p_1 , p_2 , and O . O' is any point, and $O'a'$, $O'b'$, $O'A$ are drawn parallel respectively to aa , bb , and the tangent

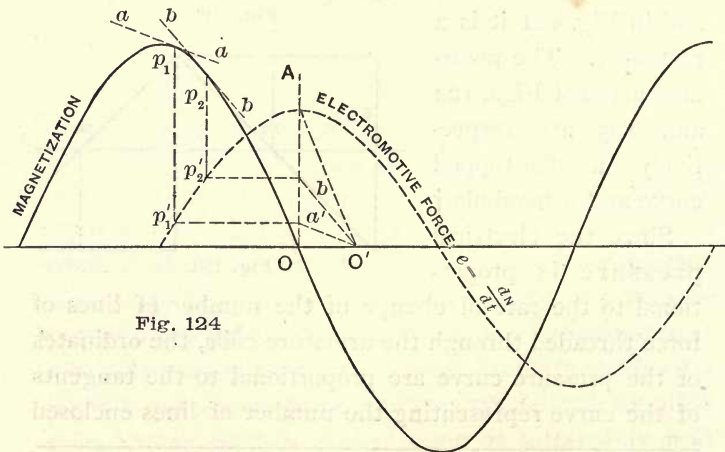

Fig. 124

at O . The points of intersection of horizontals drawn from a' , b' , etc., and verticals drawn from p_1 , p_2 , etc., are points on the required pressure curve.

A more directly useful magnetic curve is one showing the distribution of the lines of force over the pole faces. This curve is analogous to the magnetic distribution curve of continuous-current machines (Vol. I., p. 208). It may be experimentally determined by the fourth or test-coil method given in Vol. I., p. 211. It is probable that the magnitude of the periodic effect of armature reactions may also be experimentally determined by using two test coils, one of which is placed in a position coincident with the armature coils, and the other of which is placed so that its phase is 90° in advance. If

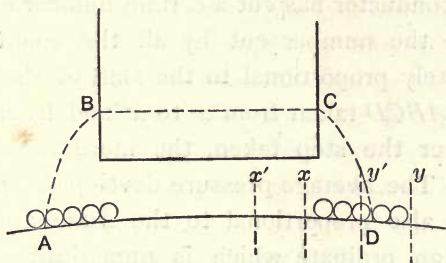

Fig. 125

the average distribution of magnetism over the pole faces of a machine is known, it is evidently possible to approximately determine the form of the pressure curve which will be produced by any particular arrangement of the windings. It is also equally possible to determine the arrangement of the windings required to give any desired form of pressure curve. Again, if a particular form of winding is desirable, the magnetic distribution which is necessary to give a desired pressure curve may be determined. This distribution may then be used as a guide in designing the width and shape of the pole

faces. The application of the magnetic distribution curve is illustrated in Fig. 125. The dimensions and form of the pole pieces and of an armature coil belonging to an alternator, are indicated in the figure. The ordinates of the line $ABCD$ represent the magnetic density in the air space. When the coil is in the instantaneous position represented, the value of the electric pressure is zero. As the coil moves, each conductor cuts lines of force. Suppose that in one twenty-fourth of a period the coil has moved from the position indicated by the letters x, y , to x', y' . During this motion each conductor has cut a certain number of lines of force, and the number cut by all the conductors is approximately proportional to the sum of the areas of the curve $ABCD$ taken from x to x' and from y to y' . The shorter the step taken, the more accurate this becomes. The average pressure developed during this interval is also proportional to the same area. Consequently an ordinate which is numerically equal to the area, may be erected at the point $a = 7\frac{1}{2}^\circ$ (one forty-eighth of a cycle) to approximately represent the pressure at that point in the revolution of the armature. This proceeding may be repeated through the half period taking the algebraic summation of the pressures developed in the two halves of the coil, and the outline of the pressure curve is thus determined.*

The curve representing the current wave also represents, when taken to the proper scale, the curve of active electric pressure. From preceding pages it is evident that the curves of active and impressed press-

* Kapp's *Dynamos, Alternators, and Transformers*, p. 364 et seq.

ures have the same forms and are superposed, if the circuit in which they act is non-inductive and without capacity. They have the same form, also, when the circuit is inductive, if the impressed pressure is sinusoidal, provided the inductance is independent of the instantaneous value of the current and the armature reactions are approximately uniform. The condition of a uniform inductance can only hold when no iron is enclosed in any portion of the circuit. In general this condition is not found in commercial service. Even with a uniform inductance the curves of impressed and active pressures will not coincide in phase, since phase coincidence between them can occur only when the circuit is without either inductance or capacity, or these exactly neutralize each other. As the latter is also a condition not often found in commercial service, it may be said that in general curves of impressed and active pressures are neither similar in form nor coincident in phase; but they are always, perforce, of the same frequency.

The curves are usually plotted to rectangular coördinates; inductions, pressures, or instantaneous currents being plotted as ordinates, and angular degrees or time as abscissas. To more definitely locate the phases it is not unusual to indicate the position of the pole pieces by laying them off at the top or the bottom of the plot (Fig. 126.)* No systematic study has been made of the distribution of magnetism over the pole faces of alternators. Such a study, as already

* Compare *Trans. Amer. Inst. E. E.*, Vol. 7, pp. 1, 311, 324, 367; also *London Electrician*, Vol. 28, p. 90; and *Elect. World*, Vol. 18, p. 368.

intimated, would be of much value in determining the most satisfactory form for pole pieces and the arrangement for armature windings. To make the work complete, it should cover alternators with various types of armatures when worked at various loads under different conditions of current lag. Since, at any instant, the effect of the armature current on the magnetization of the pole pieces, depends upon the position of the armature coils as well as the strength of the current, this effect is evidently a variable, and consequently

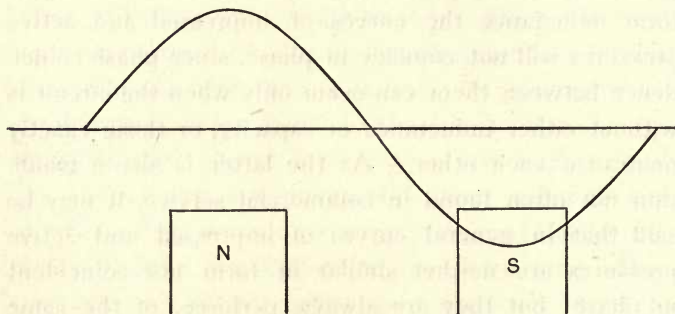

Fig. 126

the distribution of the magnetism will not be constant. In other words, both the cross turns and back turns for any load vary continuously during each period, and therefore the magnetic distribution varies with the position of the armature. The magnitude of the variation of the magnetic distribution has never been fully determined. It probably is not very great in machines with smooth-core armatures, and an average distribution may be assumed as satisfactorily representing working conditions. In machines with toothed or pole armatures, the effect of armature reactions, and the movement of

the teeth across the pole faces, is often sufficient to cause regular pulsations in the field magnetism and extremely marked distortions in the pressure curve. The pulsations are sometimes sufficient to materially affect the magnetizing current. Figure 112, curve *II*, shows an experimentally determined curve of the field current of an alternator having a toothed armature core and a large self-inductance in the armature. The machine was excited by a small shunt-wound exciter.*

The most satisfactory method of studying the magnetic distribution is by means of a test wire laid on the surface of the armature. This is similar to the method by test coil on armature explained on p. 211 of Vol. I. To study the effect of the armature upon the magnetic distribution, the test wire must be successively located at different points on the armature within an angular space equal to the pitch of the poles.

78. Methods of tracing Pressure and Current Waves.

—Various methods may be used for experimentally determining the form of electric pressure or current curves.

1. *Ballistic Method.* A ballistic galvanometer is attached to the terminals of the alternator to be tested. The fields are excited in the usual manner to the degree desired. The armature is then quickly advanced through a small arc of revolution. The throw of the galvanometer is read. The armature is again advanced through an equal arc and the throw read. This is continued until the armature has been advanced through a distance equal to twice the pitch, when one complete period of the pressure curve will

* See *Trans. Amer. Inst. E. E.*, Vol. 7, p. 374.

have been completed. Plotting the galvanometer indications as ordinates corresponding with the angular advance, the pitch being taken as 180° , gives the curve of pressure when no current is flowing in the armature. This method, therefore, gives an opportunity to study the effect of armature reactions by comparison with curves taken by later methods.

This method may be modified by reversing the field current when the armature is in the successive positions, instead of quickly moving the armature. The throws of the galvanometer, which are thus given, are proportional to the number of lines of force which pass through the armature coils when the armature is in the corresponding positions. The experimentally determined curve therefore shows the number of lines of force which pass through the armature coils at each point, and from this curve the form of the pressure curve is easily derived, as already explained (page 284). Figure 124 shows the curves thus determined.

2. *Gerard's Method.* This is another method by which the curve of pressure of an alternator, when no current flows in the armature, may be traced without special apparatus. The alternator to be tested is rotated at a very slow speed, the field being excited in the usual manner. The terminals of the machine to be examined are connected to a shunted d'Arsonval galvanometer. The natural rate of oscillation of the galvanometer bobbin is made quite rapid, as compared with the period of the pressure supplied by the alternator at its slow speed. Then the deflection of the needle at each instant will be proportional to the instantane-

ous pressure. By moving a sheet of sensitized paper before the galvanometer mirror, which throws upon it a beam of light, the curve of pressure may be permanently recorded.*

Each of the following methods requires the use of a revolving contact maker of some kind, and they therefore have much in common. The principal differences in the methods relate to the type of instruments used to give the indications, and the convenience with which the manipulations may be made. Whether current or pressure curves are to be obtained, instantaneous pressure measurements, only, are made. For the former, the instantaneous pressures are taken at the terminals of a non-inductive resistance, and the instantaneous currents are readily deduced.

3. *Joubert's Method* (1880). The terminals of the alternator armature, or of one bobbin of the armature, are connected to a condenser in the following manner: One armature terminal is connected permanently to one terminal of the condenser; the other armature terminal is connected to a rotating point which may be put in connection with the free terminal of the condenser, when the armature is at any desired point in its rotation. At the instant this contact is made, the condenser receives a charge which is proportional to the instantaneous pressure in the armature, and which may be measured by discharging the condenser through a ballistic galvanometer. By setting the contact to correspond with various points in the revolution of the armature, the corresponding instantaneous pressures

* See Gerard's *Leçons sur l'Électricité*, Vol. I., p. 565, 3d ed.

may thus be measured and the curve of pressure may be plotted (Fig. 127). The contact maker used by Joubert was an insulated pin set in the armature shaft, against which a brush could be made to bear at any point in the revolution, as explained on p. 211, Vol. I. A quadrant electrometer may be used in place of the condenser and ballistic galvanometer; in which case it

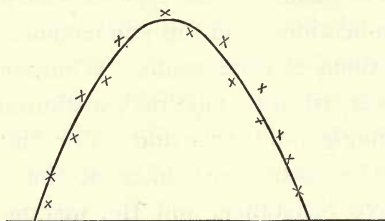

Fig. 127

is desirable to introduce a condenser permanently in parallel with the electrometer, to neutralize the effect of leakage in the test circuit.*

Joubert's investigations made in 1880 resulted in the first determination of the curve of pressure of an alternator (see page 28). The investigations of Duncan, Hutchinson, and Wilkes probably produced the earliest series of experimental curves showing the relations between the waves of pressure and current in circuits of different kinds. The investigations of Searing and

* See Joubert, *Comptes Rendus*, Vol. 91, 1880, p. 161; Joubert, *Journal de Physique*, 1881; Duncan, Hutchinson, and Wilkes, *Electrical World*, Vol. 11, 1888, p. 160; Searing and Hoffman, *Jour. Franklin Institute*, Vol. 128, 1889, p. 93; Ryan, *Trans. Amer. Inst. E. E.*, Vol. 7, 1890, p. 1; Tobey and Walbridge, *Trans. Amer. Inst. E. E.*, Vol. 7, p. 367; Blondel, *La Lumière Électrique*, Vol. 41, pp. 401 and 507; Hopkinson's *Dynamo Machinery and Allied Subjects*, p. 187; etc.

Hoffman were the first made upon an alternator with iron in the armature core. Their results showed the curve of pressure developed in a smooth-core drum armature to approach a sinusoid (Fig. 128).

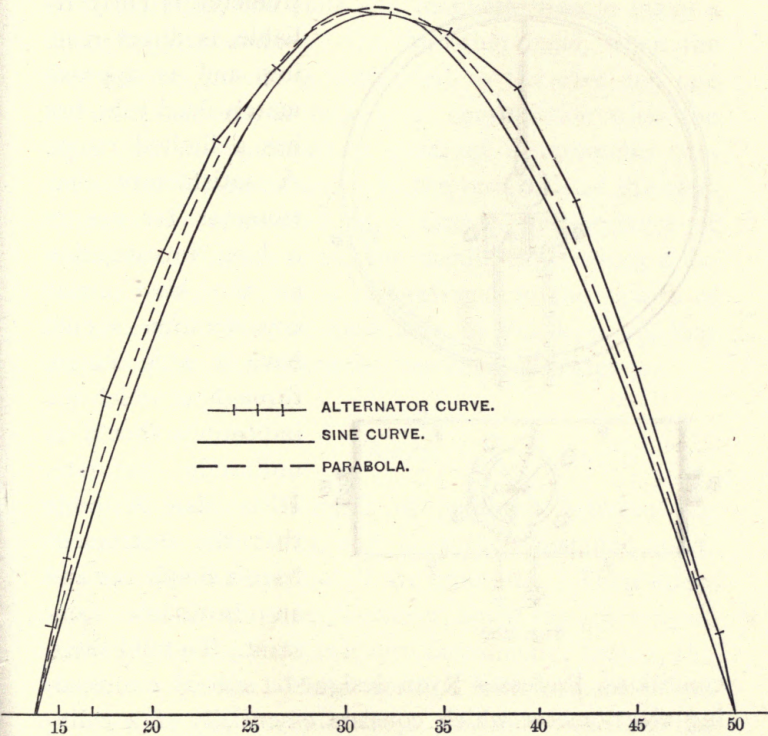

Fig. 128

4. *Ryan's Method* (1889). Professor Ryan of Cornell University, in conjunction with Professor Merritt, carried out a series of investigations in 1889, in which an entirely different and original arrangement of the measuring instruments was used. The use of a con-

denser and ballistic galvanometer in determining points of the pressure and current curves involves long and laborious manipulation, and introduces various elements of inaccuracy. On the other hand, a quadrant electrometer is fairly reliable, is direct reading, and is approximately dead beat, but has a limited range. A satisfactory electrometer for use in a long investigation of the kind under consideration should have a wide range, throughout which the indications should be uniformly accurate. It is also desirable that the instrument have a simple law and an invariable constant. To fulfil these

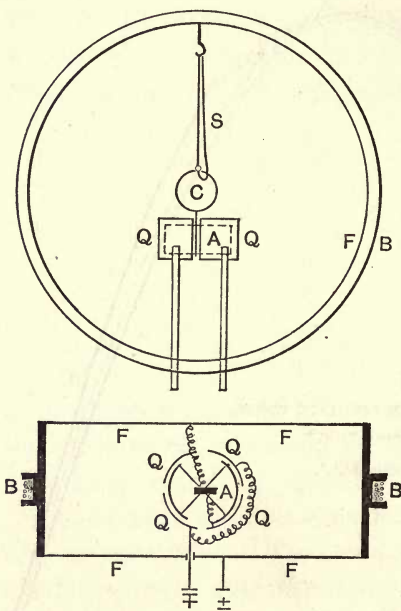

Fig. 129

conditions, Professor Ryan designed a special zero reading electrometer which consists essentially of a cylindrical electrometer needle *A*, and four quadrants *Q, Q* (Fig. 129). On the upper side of the electrometer needle is hung a magnetized steel mirror *C*, which serves both as a magnetic needle and as a mirror. The needle is suspended by a silk fibre, and is put in metallic contact with the case by means of a loop of very

reliable, is direct reading, and is approximately dead beat, but has a limited range. A satisfactory electrometer for use in a long investigation of the kind under consideration should have a wide range, throughout which the indications should be uniformly accurate. It is also desirable that the instrument have a simple law and an invariable constant. To fulfil these

fine silver wire S . The electrometer case is circular, and the magnetic needle is arranged to be in its centre. Around the case is wound a coil BB of fine insulated wire. When the plane of this coil stands in the magnetic meridian, the coils and magnetic needle make a tangent galvanometer. On the other hand, when the electrometer needle is connected to the case and one pair of quadrants, it makes, in combination with the other pair of quadrants, a quadrant electrometer connected for idiostatic use. If the terminals of the electrometer are connected to a circuit, the pressure of which is to be measured, the needle experiences a deflecting couple which is proportional to the square of the pressure. For, we have seen in Vol. I., p. 19, that the attractive force between two charged plates is

$$F = \frac{V^2 A}{8 \pi D^2},$$

where V is the difference of potential between the plates, A is their area, and D is their distance apart. In this case both A and D are unknown. Their effective values are constant, however, since the instrument is designed to be used as a zero instrument; that is, the needle always has a fixed position with respect to the quadrants when its indications are read. To hold the needle at zero when the needle and quadrants are charged, a current is passed through the coils BB in such a direction and of such a strength that its deflecting couple on the magnetized mirror, is opposite and equal to the couple exerted on the electrometer needle by the pressure which is to be measured. The latter is

then proportional to the square root of the balancing current, since the deflecting couple due to a circular current is directly proportional to the current. The electrometer may be calibrated by finding the currents flowing in the coils which are required to balance known pressures, and a curve of calibration, which should be a parabolic line, may be plotted. Instead of using a galvanometer for measuring the current in the balancing coils, a cell of constant pressure and of low resistance may be used to furnish current to the coils which are connected in series with a variable resistance. Then the current flowing is inversely proportional to the total resistance in the circuit of the coils and cells, and therefore the electric pressure between the electrometer terminals is inversely proportional to the square root of the resistance.*

5. *Mershon's Method.* A galvanometer with a sufficiently great time of vibration will be steadily deflected by the succession of impulses which it receives when connected in circuit with a contact maker. This deflection may be balanced by a steady electric pressure which is introduced in the circuit in series with the galvanometer and contact maker (Fig. 130). When the balancing pressure reduces the galvanometer deflection to exactly zero, the balancing pressure is evidently equal to the instantaneous pressure at the contact maker. This arrangement of the apparatus unfortunately lacks sensitiveness when used in measuring pressures which have a wide range of values. To correct this fault, Mr. R. D. Mershon, of the Westing-

* *Trans. Amer. Inst. E. E.*, Vol. 7, p. 1.

house Electric Company, replaced the galvanometer by a telephone receiver (Fig. 131). Whenever contact is made by the contact maker, a sharp click is heard in the telephone, unless a balance of pressure exists.

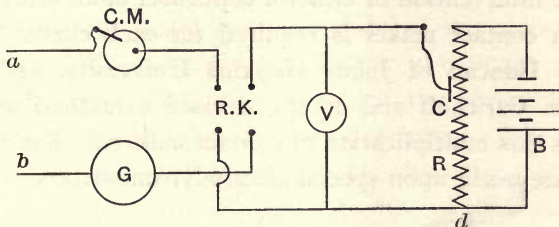

Fig. 130

In order to get the balance with great exactness, it is usually well to find the value of the balancing pressure when it is increased from a smaller value, and also when it is decreased from a larger value. The mean value

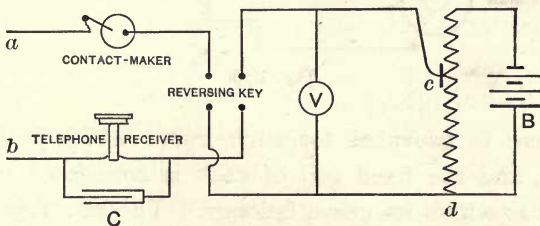

Fig. 131

given by the two balancing points may be taken to represent the true balance. It is best to place a condenser in parallel with either the galvanometer or telephone when this arrangement is used.*

* *Electrical World*, Vol. 18, p. 140; Hopkinson's *Dynamo Machinery and Allied Subjects*, p. 189. This has been modified by Duncan for especially accurate work (*Electrical Engineer*, Vol. 19, p. 192).

6. *Duncan's Method* (1891). It is frequently desirable to make simultaneous determinations of several pressure and current curves. In this case, if one of the methods is used in which the indications are gained by the intervention of either a condenser or an electrometer, a contact maker is required for each curve. Dr. Louis Duncan of Johns Hopkins University, assisted by Mr. Carichoff and others, devised a method which avoids this multiplication of contact makers. The readings are made upon special electro-dynamometers. One

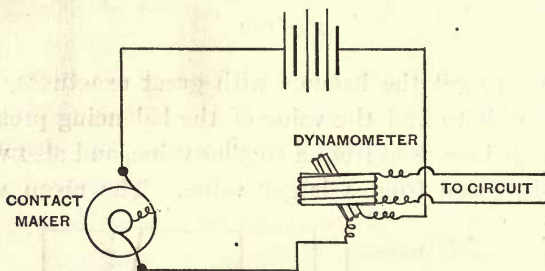

Fig. 132

of these is provided for each curve which is to be traced, and the fixed coil of each is connected to the circuit to which its curve belongs. The movable coils are all wound alike of fine wire, and are connected in series. In circuit with them are connected a few cells of storage battery and a contact maker (Fig. 132).

It is evident that if alternating currents are passed through the fixed coils of the electro-dynamometers and at a certain moment an instantaneous current be passed through the movable coils, each will receive an impulse that is proportional to the instantaneous value

of the alternating current in its fixed coil. If the instantaneous current be passed through the movable coils at recurring intervals of the same frequency as the currents under test, the movable coils will all take permanent deflections which are proportional to the corresponding instantaneous values of the alternating currents. By changing the instant of contact at the contact maker, the point at which the instantaneous current passes through the movable coils may be made coincident with any point on the alternating current waves. Thus various points on the waves may be simultaneously determined, and the curves may be plotted.

The electro-dynamometers must be calibrated, but this may be readily accomplished by passing known continuous currents through the fixed coils of the instruments while the regular interrupted test current is passed through the movable coils. A calibration curve may be plotted from these observations. To assure the constancy of the interrupted test current during a series of observations, a d'Arsonval galvanometer may be inserted in the circuit. In Dr. Duncan's work it was found necessary to make the resist-

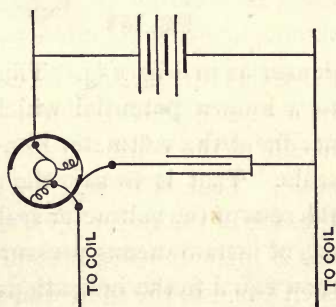

Fig. 133

ance of the circuit of the movable coils quite large (1000 ohms) in order to eliminate the effect of the variable contact resistance at the contact maker. In order that

the current through the coils should be brief and well defined a condenser discharge was found advantageous (Fig. 133).*

7. *Bedell's Method* (1893). Dr. Frederick Bedell of Cornell University, with others, has lately made a disposition of the instruments which is advantageous in many cases. Each of the methods thus far described depends upon the use of a special instrument or of instruments that are difficult to handle satisfactorily. On the other hand, electrostatic voltmeters, which might be made to replace the usual instruments and are portable, generally have a scale which may be read over only a limited range. An instrument reading up to

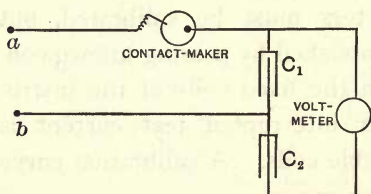

Fig. 134

150 volts, for instance, is likely to give very poor indications below 60 volts. In order that such an instrument may be used, Dr. Bedell arranges it with a condenser as in Fig. 134. This condenser is kept charged to a known potential which is sufficient to bring the needle of the voltmeter to a satisfactory position on the scale. That is to say, the condenser serves to displace the zero of the voltmeter scale a known amount. The values of instantaneous pressures read on the voltmeter are then equal to the indications minus the initial readings.†

8. *Pupin's Resonance Analysis* (1893). Dr. M. I. Pupin of Columbia College has devised and experi-

* *Trans. Amer. Inst. E. E.*, Vol. 9, p. 179.

† *Ibid.*, Vol. 10, p. 503.

mented with a method for determining by resonance the various harmonics which enter into alternating-current curves. If the sinusoidal harmonics are fully known, the principal curve may be drawn (Sect. 30).*

Professor Ayrton several years ago proposed a plan for determining the sinusoidal components of a current curve by means of the vibrations of a stretched wire.

79. Contact Makers. — The earliest and simplest contact maker was, as already pointed out, simply an insulated pin set in the shaft of the alternator furnishing the current for the test. With this was a brush so arranged as to make contact with the pin at any desired point in the revolution. This arrangement is often inconvenient of application, and is likely to give rather irregular results. The contact is likely to be variable in resistance and as the brush wears, the duration of contact varies. Each of these points introduces errors of greater or less magnitude, depending upon the conditions of the test. Various refinements of construction have been introduced by experimenters in order that the defects of the contact makers may be eliminated. Figures 135 to 139 show the contact makers used by Joubert, Searing and Hoffman, Ryan, Duncan, and Blondel.†

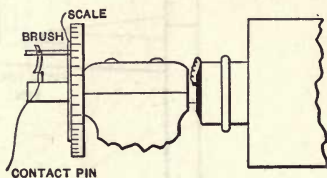

Fig. 135

* Pupin, *Trans. Amer. Inst. E. E.*, Vol. 11, p. 523.

† *Comptes Rendus*, Vol. 91, p. 161; *Four. Franklin Institute*, Vol. 128, p. 93; *Trans. Amer. Inst. E. E.*, Vol. 7, p. 3; *Ibid.*, Vol. 9, p. 181; *La Lumière Électrique*, Vol. 41, p. 512.

The contact makers used by each of these experimenters depend upon the mechanical contact between a point and a brush or spring, and therefore do not entirely avoid the difficulties from poor or variable contacts. If a contact of absolute uniformity were assured, special instruments would not be necessary for taking the indications in determining pressure and current

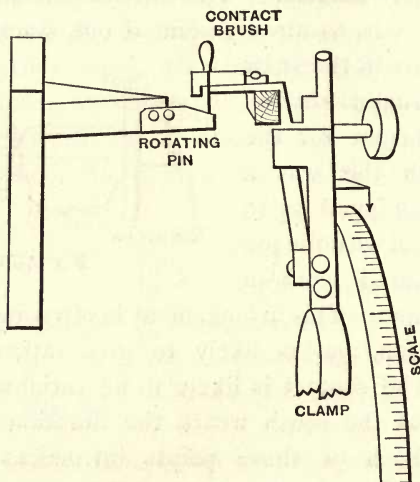

Fig. 136

curves, because the indications of a sensitive electro-dynamometer might then be directly used. Professor Ryan and Dr. Bedell have lately made an ingenious arrangement by which the duration and resistance of the contact are made quite uniform. The arrangement is shown in Fig. 140. It consists essentially of a revolving disc, *D*, attached to the dynamo shaft, and a stationary graduated head, *H*. From the revolving disc

a needle, N , projects. To this one dynamo terminal is attached. Upon the graduated head an insulated brass

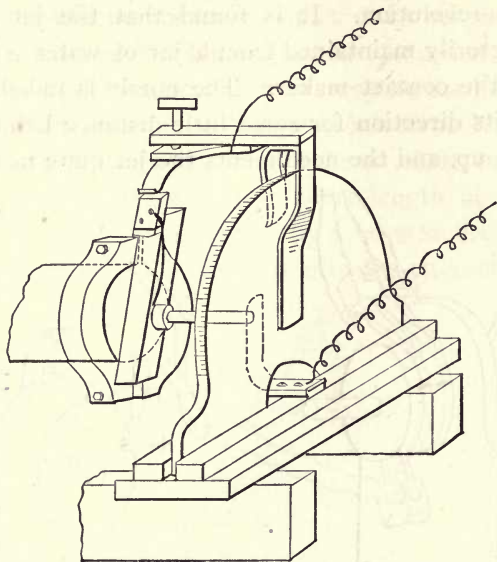

Fig. 137

nozzle, T , is mounted. The nozzle has a fine hole in it, and is so mounted that a thin jet of water flowing

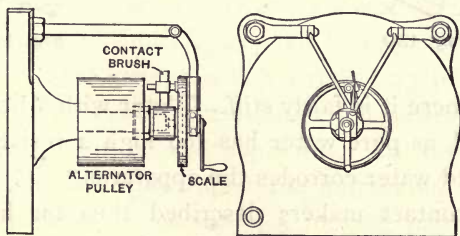

Fig. 138

from it is cut once in a revolution by the needle. A connection from the nozzle to the indicating instrument

completes the contact maker. By means of the graduated head the contact may be made at any desired point of the revolution. It is found that the jet may be satisfactorily maintained from a jar of water a few feet above the contact maker. The nozzle is radial, the jet keeps its direction for some little distance before being broken up, and the needle cuts the jet quite near to the

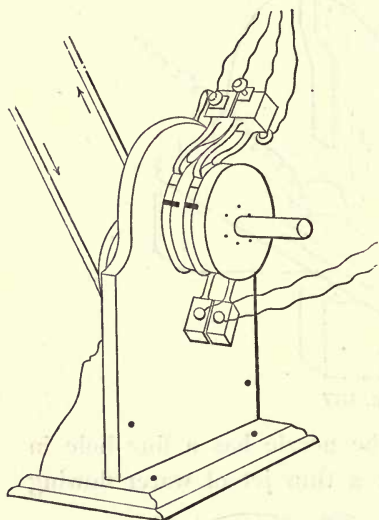

Fig. 139

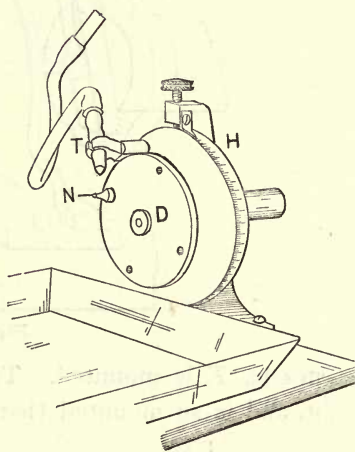

Fig. 140

nozzle where it is fairly stiff. Water with a little salt in it is used, as pure water has too high a resistance, and acidulated water corrodes the apparatus.*

The contact makers described thus far have been arranged for a single contact, but it is frequently desirable to make simultaneous observations of several curves.

* *Trans. Amer. Inst. E. E.*, Vol. 10, p. 500.

When Duncan's method is not available, this may be readily accomplished by using a contact maker with the appropriate number of contact discs on the same spindle (Fig. 139).* Then a satisfactory instrument, such as an electrostatic voltmeter, may be used in each circuit. Sometimes it is not convenient to have the contact maker attached to the dynamo shaft, in which case it may be attached to a short length of flexible shaft (Fig. 141), which may in turn be attached to the dynamo shaft. When connection to the alternator can-

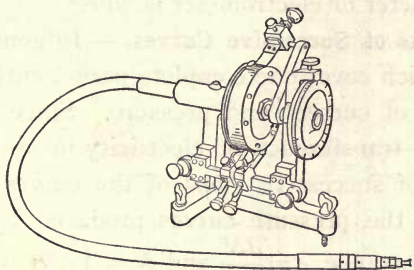

Fig. 141

not be conveniently made, the contact maker may be driven by a synchronous motor as has been done by Blondel,† Siemens and Halske, and Fleming.‡

Any of the methods in which a reflecting instrument is used may be made continuously self-recording by a proper disposition of the apparatus. In this case a beam of light is thrown upon the mirror, and its deviation is recorded by means of a moving photographic

* See Blondel, *La Lumière Électrique*, Vol. 41, p. 512.

† *La Lumière Électrique*, Vol. 50, p. 476.

‡ *London Electrician*, Vol. 34, p. 460.

film. In order that the complete curve may be thus recorded, the contact points must be caused to rotate continuously around the spindle of the contact maker. A form of contact maker designed for this purpose is shown in Fig. 139. Since the needle of the galvanometer or electrometer which is used with the contact maker must rigidly follow the intensity of the current impulses, the instrument must be truly deadbeat and have little inertia. The vibrations of a telephone diaphragm have been used to replace the deviations of a galvanometer or electrometer needle.*

80. Areas of Successive Curves. — In general, observations which cover one complete period entirely define the curves of current and pressure. Since there is no continuous transference of electricity in one direction, the areas of successive loops of the curves should be equal. In the pressure curves produced by an alternator, for instance, $e = \frac{dN}{dt}$, and $N = \int e dt$, where N is the total number of lines of force passing into the armature core and $\int dt$ is the length of the period. If N and T are constant, as would be the case for an alternator with fixed field magnetism and a rigid armature shaft which is driven at a uniform speed, the values of the successive areas must be equal. On account of various irregularities in the construction and working of alternators, experimentally determined curves are not always uniform. In fairly large commercial machines the differences are usually not greater than might be

* See Blondel, *La Lumière Électrique*, Vol. 41, p. 401; Frœlich, *Elektrotechnische Zeitschrift*, Vol. 10, p. 345.

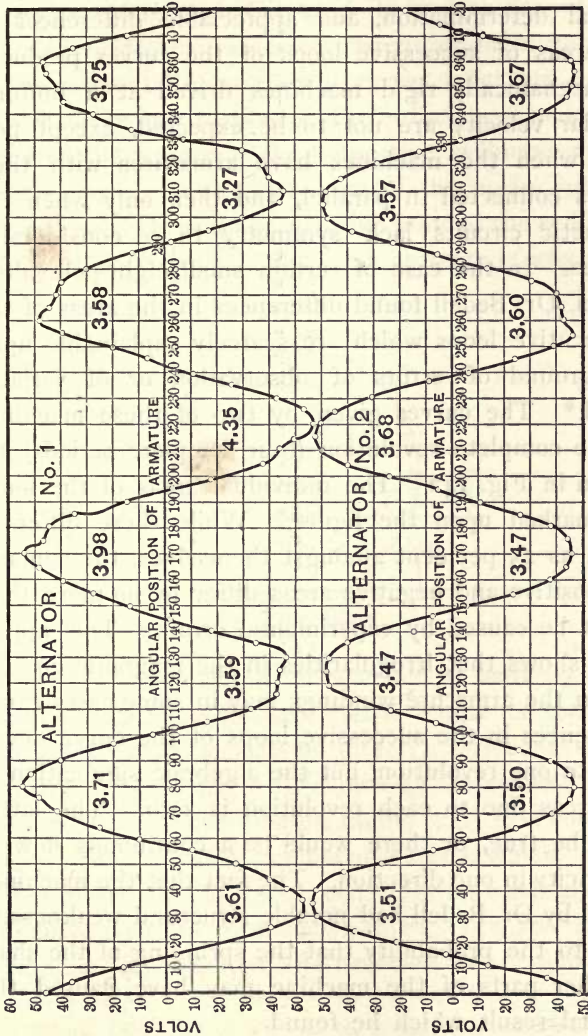

Fig. 142

caused by the errors of observation due to the experimental determination, and appreciable differences in the areas of successive loops of the curves produced by mechanically rigid machines driven at a uniform angular velocity are not to be expected, except possibly when the machines have armatures with their halves connected in parallel, and then only when the magnetic circuits lack symmetry to a considerable degree. In the case of certain small eight-pole alternators, Dr. Bedell found differences in the areas of the consecutive loops which are scarcely explainable upon the ground of errors of observation or of variable speed.* The curves given by two of these machines in one complete revolution (four complete periods) are shown in Fig. 142. The individual areas of the loops are marked upon the figure. While these differ as much as 25 per cent amongst themselves, the sums of the positive and negative areas differ by no more than might be caused by experimental errors. This apparently shows that irregularities in the magnetic circuits and in the armature windings may in some cases cause differences in the successive loops of the curve developed in one revolution, but the algebraic summation of the areas due to each revolution is zero. The latter must be true, or there would be a continuous flow of electricity in one direction. The fact that the machines tested by Dr. Bedell had notable structural weaknesses, leads to the probability that the springing of the shaft or other parts of the machine may have caused the unusual result which he found.

* *Physical Review*, Vol. 1, p. 218.

81. Determination of the Effective Values of Current or Pressure from their Curves. — It is often desirable to determine effective values of current or pressure from the experimentally determined curves. In this case, a second curve may be plotted, the ordinates of which are equal to the square of the respective ordinates of the primary curve. The square root of the mean ordinate of the second curve is the effective value of the ordinates of the primary curve. The mean ordinate of any curve

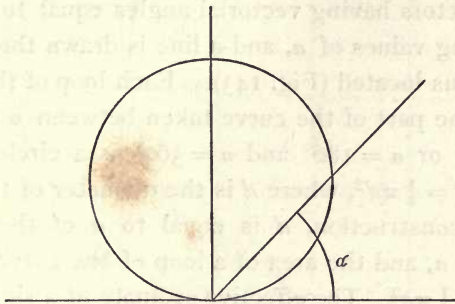

Fig. 143

is readily determined by measuring its area by planimeter and dividing the area by the length of the base. The effective value may be directly derived from the primary curve, as originally shown by Steinmetz,* if it is plotted on polar coördinates, taking 360° to a complete period. This gives a symmetrical curve which crosses the origin at 0° , 180° , 360° , etc. For an exact sinusoid the curve is of the form shown in Fig. 143, and has its maximum value positive and negative, at 90° and 270° .

* *Trans. Amer. Inst. E. E.*, Vol. 10, p. 527; *Elektrotechnische Zeitschrift*, June 20, 1890.

Each loop is a circle with the pole on its circumference and the initial line tangent to the circumference, the maximum ordinate, a , being equal to the diameter. The area of the curve in this form may be shown to be directly proportional to the effective value of the ordinates as follows: In the case of a sinusoidal curve, the polar curve has the equation $e = a \sin a$, where e is the instantaneous pressure corresponding to an angular advance a . In plotting the curve, values of e are laid off on the radius vectors having vectorial angles equal to the corresponding values of a , and a line is drawn through the points thus located (Fig. 143). Each loop of this curve, that is, the part of the curve taken between $a = 0^\circ$ and $a = 180^\circ$, or $a = 180^\circ$ and $a = 360^\circ$ is a circle, and its area is $A = \frac{1}{4} \pi d^2$, where d is the diameter of the circle. By the construction, d is equal to a of the formula $e = a \sin a$, and the area of a loop of the curve is therefore $A = \frac{1}{4} \pi a^2$. The effective ordinate of a sinusoid has already (Vol. I., p. 83) been shown to be

$$E = \frac{1}{\sqrt{2}} e_{\max} = \frac{a}{\sqrt{2}}$$

Consequently
$$E = \sqrt{\frac{2A}{\pi}} = .798 \sqrt{A}.$$

This may be taken for most purposes as $E = .8 \sqrt{A}$.

In the case of any single-valued function

$$e = a \sin a + b \sin 2a + c \sin 3a + \text{etc.} \\ + a' \cos a + b' \cos 2a + c' \cos 3a + \text{etc.},$$

and the area of one loop of the polar curve representing

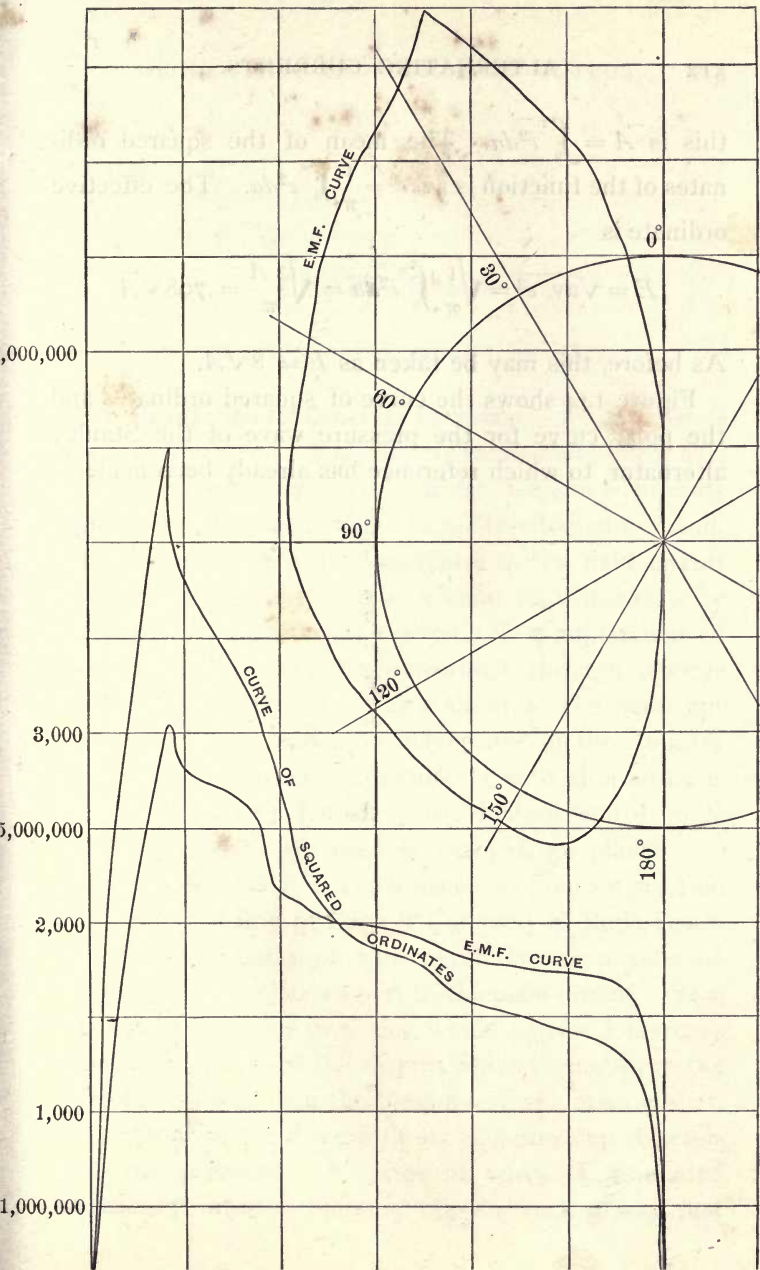

this is $A = \int_0^\pi e^2 da$. The mean of the squared ordinates of the function is $\text{av. } e^2 = \frac{1}{\pi} \int_0^\pi e^2 da$. The effective ordinate is

$$E = \sqrt{\text{av. } e^2} = \sqrt{\frac{1}{\pi} \int_0^\pi e^2 da} = \sqrt{\frac{2A}{\pi}} = .798\sqrt{A}.$$

As before, this may be taken as $E = .8\sqrt{A}$.

Figure 144 shows the curve of squared ordinates and the polar curve for the pressure wave of the Stanley alternator, to which reference has already been made.

CHAPTER VII.

REGULATION AND COMBINED OUTPUT.

82. Regulation for Constant Pressure.—*A. Separately Excited Alternator.* A separately excited alternator has, as already intimated, no inherent tendency towards regulation. The regulation is usually effected by hand, either by means of a hand regulator in the field circuit of the shunt-wound exciter or a hand regulator directly in series with the alternator fields. The adjustment of these regulators may be performed through devices actuated by a relay placed as a shunt to the main circuit, but this is considered inadvisable in this country and the use of automatic regulators with alternators is entirely unknown; but in Great Britain and Europe automatic devices are used in many large plants.

An ingenious device which seems to give satisfaction is made by the firm of Ganz & Company of Buda Pesth. The essential parts of this regulator are a solenoid which is connected as a shunt to the main circuit. This solenoid attracts an iron core which carries a mercury cup at its top. Since the current which circulates in the solenoid depends upon the pressure of the main circuit, the position of the core with its mercury cup depends upon the pressure. A series of wires of graduated lengths dip into the mercury cup in such a way that

the ends of more or less of them are immersed as the pressure falls and rises (Fig. 145). The wires are attached to resistances which are connected in the field circuit of the exciting dynamo, but which are short-circuited when the ends of the wires dip into the mercury.

It is desirable to keep the pressure constant at the point

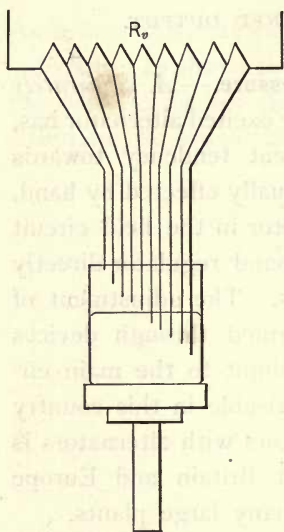

Fig. 145

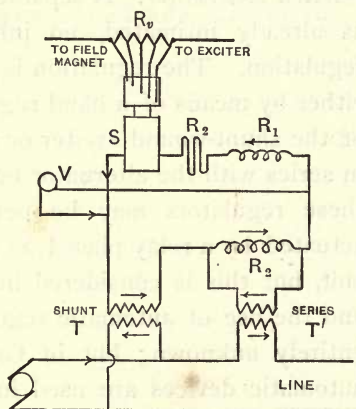

Fig. 146

of consumption rather than at the dynamos, and Ganz & Company have succeeded in arranging their regulators to do this without the inconvenience of "pressure wires" (*i.e.* wires which run from the centre of consumption to the generating station for the purpose of indicating the pressure of consumption). This requires that the pressure acting in the circuit of the automatic regulator shall be caused to remain constant as the dynamo current

increases, while at the same time the dynamo pressure increases by a sufficient amount to compensate for the fall of pressure in the feeders which run to the centre of distribution. In other words, $E - CR$ must be kept constant, E being the dynamo pressure, C the current, and R the resistance of the feeders. This is effected as follows (Fig. 146): The regulator is connected to the secondary of a special transformer T , which is connected in parallel across the feeders. The pressure of the secondary of this transformer is proportional to the dynamo pressure E . Another transformer, T' , is connected with its primary in series with the feeders. The pressure developed in the secondary of this transformer can be adjusted so as to be practically equal to CR for all values of the current. The secondary of this is connected in series with the secondary of the first transformer, and in such a way that their pressures are in opposition. Hence a voltmeter, V , connected across the terminals of the two secondaries indicates a pressure which is proportional to the pressure at the terminals of the feeder, or $E - CR$. If the automatic regulator is also connected across the terminals of the two secondaries, it will adjust the excitation of the alternator so that $E - CR$ is kept constant regardless of the value of C . In the figure, S is the solenoid of the regulator, R_v is the resistance automatically controlled by the solenoid to vary the excitation of the alternator, and R_1, R_2, R_3 are resistances in circuit with the regulator which are used for adjusting it to give proper indications for various values of C and R .*

* Fleming's *Alternate Current Transformer*, Vol. II., p. 137.

The device here used for obtaining at the terminals of the regulator a pressure which is proportional to $E - CR$, is exactly similar in operation to the Westinghouse, so-called, "compensated voltmeter" which is used in this country. In this case hand regulation is exclusively adopted, but it is desirable to give a constant

pressure at the point of consumption. To avoid the expense and annoyance of "pressure wires" the station voltmeter is connected in series with the secondaries of a parallel and a series transformer which act in opposition (Fig. 147). The transformers being

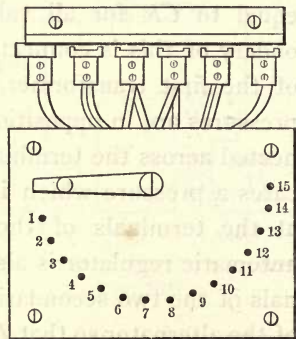
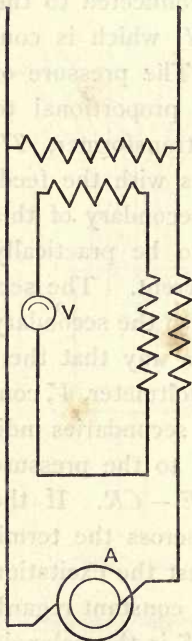

HAND REGULATOR

Fig. 147

properly adjusted, the voltmeter shows at all times the lamp pressure at the centre of consumption.* In the Westinghouse apparatus, several terminals are brought out from the secondary of the series transformer to a

* Compare Fleming's *Alternate Current Transformer*, Vol. II., p. 185.

switch like that shown in Fig. 147, and the adjustment of the apparatus to compensate for any line drop is made by changing the secondary connections and so changing the number of effective secondary turns in the regulator circuit. In some cases, the secondary of the series transformer is not connected into the circuit of the regular voltmeter coil, but is connected to an auxiliary coil which is wound alongside of or over the main coil.

The Westinghouse Company also manufacture a feeder regulator for use in plants where several circuits are fed from one alternator or set of bus bars. This is essentially a special transformer (Fig. 148) with the secondary, *CD*, connected in series with one feed wire, and the primary, *AB*, connected across the mains; the pressure induced in *CD* may be made to either aid or oppose the alternator pressure by means of a reversing switch, *X*.

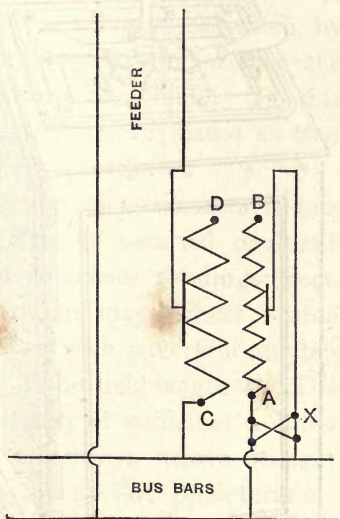

The strength of the induced pressure in *CD* may be varied by changing the number of effective turns in either *CD* or *AB* by means of movable contacts. Figure 149 gives a view of the transformer with the regulator switches. Similar devices, in which the regulation is effected by varying the position of the primary

and secondary coils with respect to each other, or of the core with respect to both, are manufactured by the General Electric Company.

In an English plant, for which the machinery was constructed by the Electric Construction Corporation,

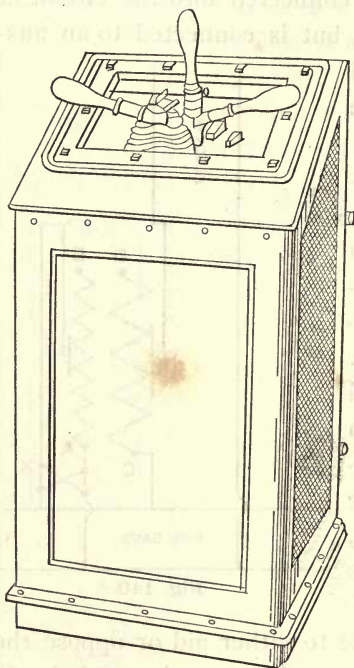

Fig. 149

another plan is used in regulating separately excited alternators. In this case series-wound exciters are used, the regulation of which is effected by shunting their fields. The shunt is composed of a liquid resistance into which dip two plates which are connected across the terminals of the exciter fields. These plates are raised and lowered in the liquid, to vary the resistance of the shunt, by means of a solenoid. This in turn is actuated by an ingenious thermal relay, which consists of two stretched wires connected to the secondary of a transformer. The primary of the transformer is connected across the main circuit of the alternator or across the terminals of one coil of its stationary armature. The pressure developed in the transformer

secondary is therefore proportional to the alternator pressure. When the latter falls below normal, less than the normal current flows through the relay wires, which contract enough to actuate a switch which causes the solenoid to lift the electrolytic plates and thus increase the resistance across the fields of the exciter. When the alternator pressure rises above the normal, more current flows through the relay wires, which, by sagging, actuate the regulating apparatus so that the plates are lowered further into the liquid. In this manner the fields of the exciter are regulated so that the alternator pressure is kept constant.

In this country self-regulation of alternators is preferred to automatic regulation by external devices.* This is effected by means of composite windings (Sect. 71). Composite-wound alternators may be best treated as separately excited alternators with a certain number of self-excited series turns on the field-magnets. The self-excited field turns are usually of sufficient number to make the external characteristic a nearly straight horizontal, or slightly rising line. The predetermination of the number of series turns required to give exact compounding, or a desired degree of over-compounding, is not readily accomplished when no experimental data of the machine is at hand, on account of the complex effect of self-induction and armature reactions upon the pressure of the machine (compare Sect. 70). The compounding that gives regulation on an inductionless load evidently may fail for an inductive load. The ratio of series ampere-turns per pole to

* Compare *Text-book*, Vol. I., p. 216.

armature ampere-turns per coil which is required to give regulation for one alternator of a fixed type, will doubtless give equally satisfactory results on machines of different capacities but of the same type; but the marked differences in the magnitude of the effects of self-induction and armature reactions in alternators of different types, make it impossible to fix any ratio that will even approximately cover all types of machines. For alternators with smooth-core drum armatures the ratio of series ampere-turns per pole to ampere-turns per armature coil is practically unity. In machines with ring, pole, and toothed armatures the ratio is doubtless considerably greater. In machines with disc armatures it may be somewhat smaller. The various arrangements of the circuits that may be made in composite windings have already been pointed out (Sect. 71). It is quite common to place a variable shunt around the series windings so that the magnetizing effect may be varied, exactly as is done in compound-wound continuous-current dynamos (Vol. I., p. 225).

83. Regulation for Constant Pressure.—*B. Self-excited Alternator.* The defect in self-regulation of an alternator excited from an independent winding on the armature is practically the same as that of a separately excited machine. In a shunt-wound machine the defect is greater, as already stated (Sect. 74). The regulation of alternators which are self-excited in shunt or by a separate exciting coil, can only be satisfactorily effected by means of a variable resistance or hand regulator placed in the exciting circuit. The regulation might be effected by moving the brushes

on the rectifying commutator, but only at the expense of prohibitive sparking and wear. The variable rheostat may be operated automatically by the same devices that are sometimes used with separately excited machines. These do not meet with favor in America, however.

84. Regulation for Constant Current.

—Constant-current alternators may be either separately or self-excited. Their regulation is made entirely inherent by designing their armature reactions and self-induction to be so great that the current cannot rise above its normal value. The armature is wound to generate a pressure upon open circuit much greater than that required for full load, and hence the current remains near its full normal value up to, and even considerably beyond, full load. Such machines are worked on short-circuit without injury, but if the circuit is opened, they are liable to injury on account of the excessive open circuit pressure breaking down the insulation. These machines are really worked on a part of the characteristic which is caused to be almost vertical on account of the large self-inductance of the armature.

Constant-current alternators have only been used for arc-lighting. The external characteristic of a Stanley arc-light alternator is given in Fig. 150.

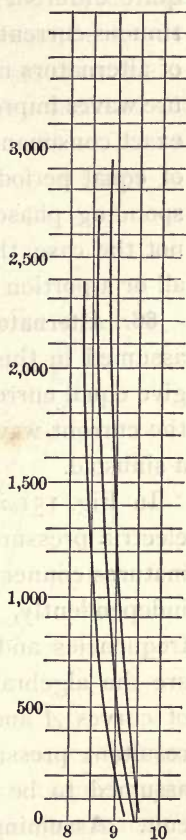

Fig. 150

85. Connecting Alternators for Combined Output. — The conditions required for successfully connecting alternators so that their outputs may be combined, are quite different from those obtaining in the case of continuous-current machines. In order that the output of alternators may be added, it is evident that the pressure waves impressed by them upon the circuit must be in exact consonance. That is, the pressure waves must be of equal period or in **Synchronism**, and also of corresponding phase or **In Step** with each other. If this is not the case, the machines will be in opposition during all or a portion of the current wave.

86. Alternators in Series. — The alternators will be assumed in this discussion to be constructed so as to give equal currents at a fixed frequency. The form of the current waves will also be assumed to approximate a sinusoid.

In Fig. 151 *a* let the curves A and A' represent the electric pressure waves of two alternators with their armatures connected in series, the machines being driven independently, but so as to give practically the same frequencies and pressures. The ordinates of curve R are the algebraic sums of the corresponding ordinates of curves A and A' , and hence curve R represents the resultant pressure of the two machines. Curve C is assumed to be the curve of current flowing in the circuit. Assuming the two machines to be running synchronously, but to be out of step by an angle 2θ , makes the phase difference between the resultant pressure wave and either component wave $\pm\theta$. Finally, the current lags behind the resultant pressure by an angle ϕ on

account of self-inductance in the circuit. The work put into the circuit by either machine is proportional to the algebraic summation of the products of the ordinates of the respective pressure and current waves. The total work done in the circuit is equal to the sum of the products of the ordinates of the current and resultant pressure curves. Therefore, since the pressure wave of the

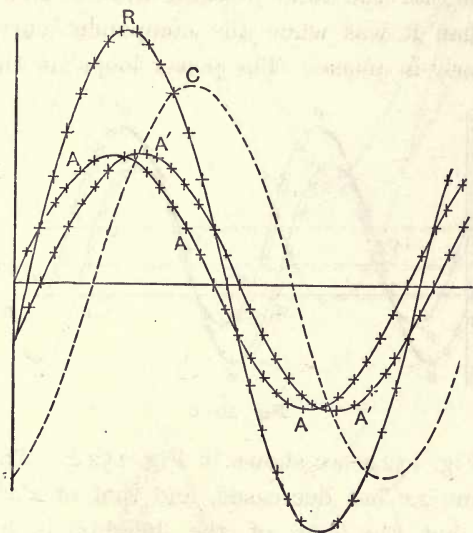
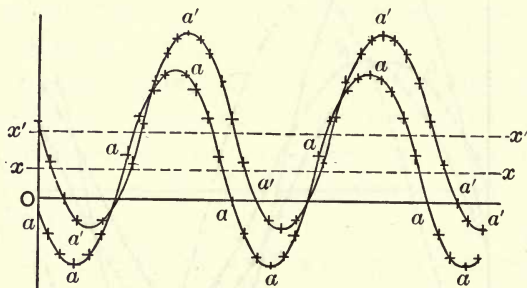

Fig. 151 a

lagging machine is nearest the current wave, that machine furnishes more work to the circuit than does the leading machine. The power loops for the two machines are shown by the curves a and a' in Fig. 151 *b*, and the power delivered to the circuit by the two machines is represented by the heights of the lines xx and $x'x'$. Were the two machines rigidly connected together, this condi-

tion would continue indefinitely. In practice, however, the machines are driven by separate belts or attached to separate engines, and the lagging machine, being heavily loaded, tends to fall further behind its more lightly loaded mate, and a still greater percentage of the load is thrown upon it. At the same time, as is shown by Fig. 152 *a*, this reduces the total work done in the external circuit, for the total pressure wave is now of less height than it was when the component curves were more nearly in phase. The power loops for the condi-

Fig. 151 *b*

tion of Fig. 152 *a* are shown in Fig. 152 *b*. The height of the line xx has decreased, and that of $x'x'$ has increased, but the sum of the heights is less than before. The tendency of the lagging machine to fall further behind continues until the pressure waves of the two machines are exactly opposed (Fig. 153). The machines are then in stable equilibrium, but are giving no energy to the external circuit. If the machines were started with their pressure waves in exact step, they would do equal work, but their equilibrium would be unstable, and any disturbance of their rela-

tions would cause them to fall into opposition. It is therefore not possible to operate alternators in series

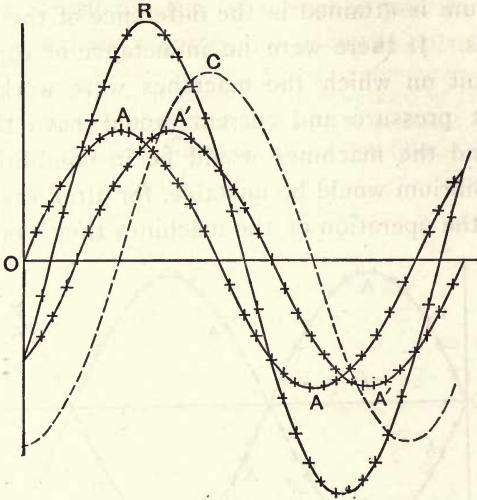

Fig. 152 a

on an inductive circuit unless they are rigidly united by a mechanical coupling.* This result also follows when

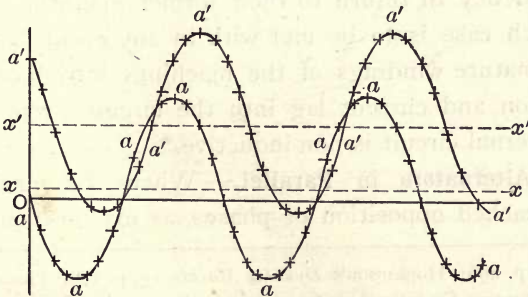

Fig. 152 b

* Compare Hopkinson, Some Points in Electric Lighting, *Proc. Inst. C. E.*, 1883, and Theory of Alternating Currents, *Four. Inst. E. E.*, Vol.

the normal pressures of the machines are different; in which case the pressure impressed on the circuit when equilibrium is attained is the difference of the machine pressures. If there were no inductance or capacity in the circuit on which the machines were working, the resultant pressure and current would have the same phase, and the machines would be in equilibrium, but the equilibrium would be unstable, for after any disturbance of the operation of the machines they would have

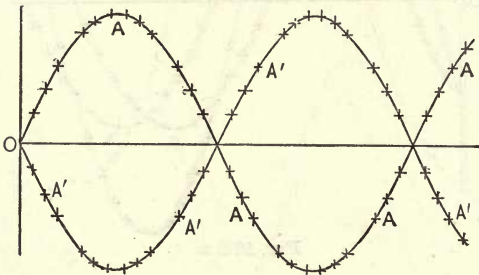

Fig. 153

no tendency to return to their former operating state. No such case is to be met with in any event, because the armature windings of the machines introduce self-induction and current lag into the circuit, even when the external circuit is non-inductive.*

87. Alternators in Parallel.—When the machines have reached opposition of phases, as explained above,

13, 1884, p. 496; Hopkinson's *Dynamo Machinery*, p. 148; Picou's *Machines Dynamo-Électrique*, p. 279; Kapp's *Dynamos, Alternators, and Transformers*, p. 420; Thompson's *Dynamo-Electric Machinery*, 4th ed., p. 689.

* The condition of operation of two alternators connected in series on an inductive circuit is perhaps more plainly indicated by the following

a change in the arrangement of the circuit puts them at once in parallel and in step for working in the circuit; for, it will be seen by reference to Figs. 153 and 154 that when machines A and A' are in opposition, the

figure (Fig. 1), than by the curves which were used in the preceding demonstration, and which follow those originally presented by Dr. John Hopkinson, in 1883 (*Proc. Inst. C. E.*, 1883; *Four. Inst. E. E.*, 1884).

| | |
|--|---|
| Pressure of leading machine | = OA . |
| Pressure of lagging machine | = OA' . |
| Resultant pressure in circuit | = OR . |
| Current in circuit | = OC . |
| Power given to circuit by first machine | = $Oa \times OC$. |
| Power given to circuit by second machine | = $Oa' \times OC$. |
| Total power given to circuit | = $Or \times OC = (Oa + Oa') \times OC$. |

It is evident from the construction that as the angle θ increases, the length of OR decreases, and also that Oa decreases; but Oa' increases for

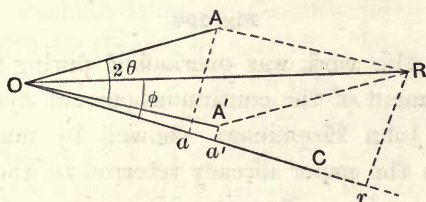

FIG. 1

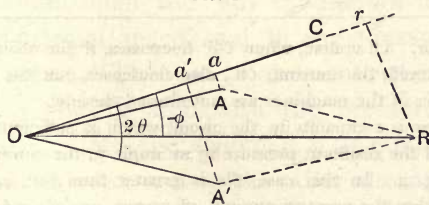

FIG. 2

a time and then decreases at a less rate than Oa , so that the machines tend to get farther apart in phase. When $\theta = 90^\circ - \phi$ the length of Oa vanishes, the first machine gives no power to the circuit, and all the power is furnished by the second machine. When θ approaches more nearly 90° , or the machines are approaching opposition, one machine may actually

points R and S must at every instant be of opposite sign, and that, therefore, the machines will deliver current through the circuit m, m, m .* The operation of alternators in parallel was first achieved by Wilde in

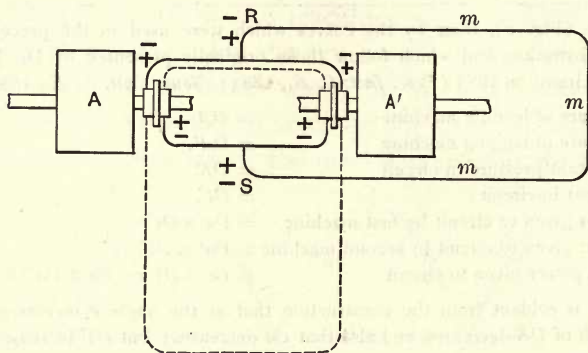

Fig. 154

1868,† but this work was overlooked during the period of development of the continuous-current dynamo. In 1884 Dr. John Hopkinson showed by mathematical analysis, in the paper already referred to, the impracticability of working alternators in series and the prac-

run as a motor. Of course, when OR decreases, if the resistance of the circuit is unaltered, the current, OC , also decreases, but the relative outputs and phases of the machines are not altered thereby.

In case there is a capacity in the circuit which is sufficient to cause the current to lead the resultant pressure by an angle ϕ , the condition is represented by Fig. 2. In this case, Oa is greater than Oa' , or the leading machine furnishes the greatest amount of power, and the machines tend to come together and run in series. This is not a practical condition, however, since a capacity in a commercial alternator circuit sufficient to give the current a lead is practically unknown.

* Compare references given above, and Fleming's *Alternate Current Transformer*, Vol. II., p. 356.

† See *Philosophical Magazine*, Vol. 37, 4th series, 1869, p. 54.

ticability of working them in parallel. This was done without a knowledge of Wilde's earlier experiments, and it led to some experiments which were carried out by Hopkinson and Adams upon De Meritens magneto machines.* These experiments fully bore out Hopkinson's deductions, but their practical bearing was not fully appreciated until a few years later, when the transformer system of alternating-current distribution was developed.†

88. Synchronizers and Synchronizing. — Mechanical imperfections in engine governors and machine pulleys cause slight differences in the speeds of machines intended to run at equal velocities. Consequently it is desirable to arrange some device for determining the moment a machine is in synchronism with one with which it is to be thrown in parallel. When the alternators are to be connected in parallel, the terminals of each may be connected directly to appropriate 'bus or main conductors through convenient indicating instruments, switches, and safety devices. Before switching a new machine upon the 'bus conductors it must be brought to normal speed, and to the pressure of the other machines. Then at a moment when it is in synchronism and in step with the pressure wave of the 'bus bars, it may be switched into circuit without causing a disturbance among the other alternators.

Any device for indicating the synchronous relation is called a **Synchronizer** or **Phase Indicator**. Its simplest

* Adams, *Four. Inst. E. E.*, Vol. 13, 1884, p. 515.

† Compare Hopkinson, *Four. Inst. E. E.*, 1884, and *Dynamo Machinery*, p. 174; Thompson's *Dynamo-Electric Machinery*, 4th ed., p. 696, etc.

form for low-pressure machines consists of one or more incandescent lamps in series, which are connected as in Fig. 155. One terminal of the alternator is connected directly to a 'bus conductor, while the other is connected through the lamps to the other 'bus. When the pressure waves are not in opposition, the lamps will be illuminated, and at the moment of opposition the illumination will die out. If the frequencies of the alternator and the circuit differ materially, the flashes of illumination or "beats" are quite rapid. As the fre-

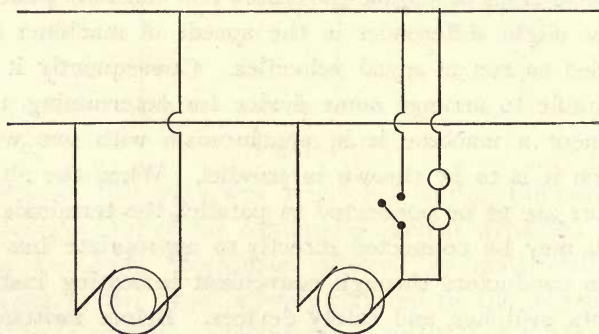

Fig. 155

quencies approach synchronism, the beats lengthen out, exactly as do the beats of two tones which are approaching unison. The alternator should be connected to the 'bus bars at an instant of no illumination during a period when the beats are fairly long. This indicates that the pressure of the alternator is in synchronism with that of the circuit and that it is in proper step or phase. Continued illumination or darkness of the lamps under these circumstances can only occur when

the machines produce the same pressure and run at absolutely the same frequencies, which is not a practical occurrence unless the machines are rigidly connected together.

Since alternators are commonly built for high pressures, it is usual to use a transformer with the synchronizer lamps. The primary circuit of this transformer may be composed of either one or two windings. When

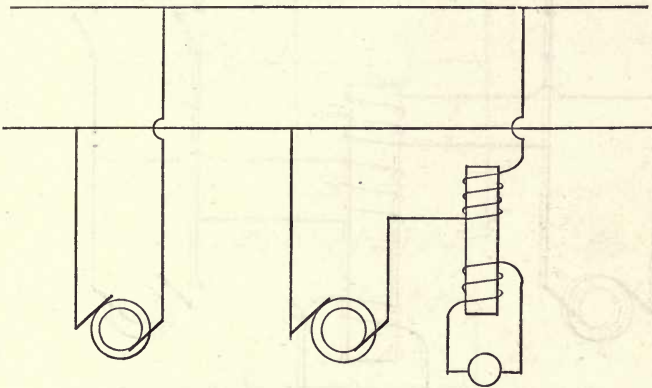

Fig. 156

it is composed of one winding, one terminal of the alternator is connected to a 'bus bar through it, the other terminal of the alternator being connected directly to the other 'bus (Fig. 156). In this case the lamp on the secondary circuit acts exactly as the synchronizer lamps already described. When the primary is composed of two circuits, one is connected between the 'bus conductors and the other between the terminals of the alternator (Fig. 157). In this case the proper phase relation for switching the alternator into

circuit may be indicated either by darkness or by illumination of the lamps, depending upon the connection of the synchronizer primaries. This arrangement is advantageous, since it allows the use of a double-pole switch at the dynamo, while the previously described

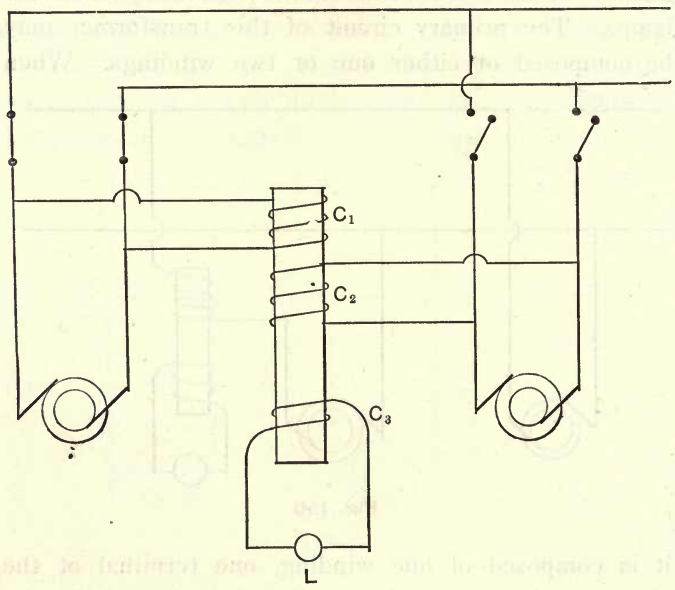

Fig. 157

arrangements require the use of single-pole switches. The latter arrangement may be modified by using two separate transformers, the primary of one being connected to the alternator and that of the other to the circuit. The secondaries are connected together in series with one or two lamps (Figs. 158 and 159). If the secondaries are connected directly in series, as in

Fig. 158, darkness of the lamps indicates the instant for connecting the alternator to the 'bus conductors. If the secondaries are cross-connected, as in Fig. 159, maximum illumination of the lamps indicates the moment when the machines are in proper step. In this country the general practice has been to connect the

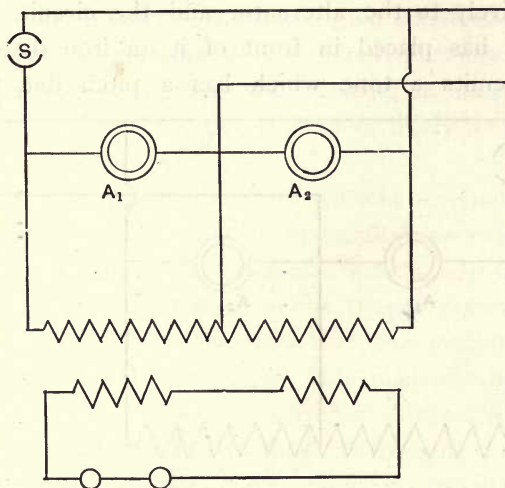

Fig. 158

synchronizer so that darkness indicates when the machines are in step. This has the evident advantage that darkness is a condition which is more readily distinguished than the condition of maximum brightness. This practice, however, does not seem to be always followed in England and Europe.*

In any of these methods, the lamps may be replaced

* Compare Fleming's *Alternate Current Transformer*, Vol. II., pp. 163 and 362; Kapp's *Alternating Currents of Electricity*, p. 129; Gerard's *Leçons sur l'Électricité*, 3d ed., Vol. I, p. 557.

by a sensitive high resistance alternating-current ammeter or galvanometer which is dead-beat.

An ingenious device for use as a synchronizer has lately been developed by the General Electric Company. This consists of two electromagnets made with iron wire cores. The windings of these are connected respectively to the alternator and the circuit. Each magnet has placed in front of it an iron diaphragm which emits a tone which has a pitch due to the

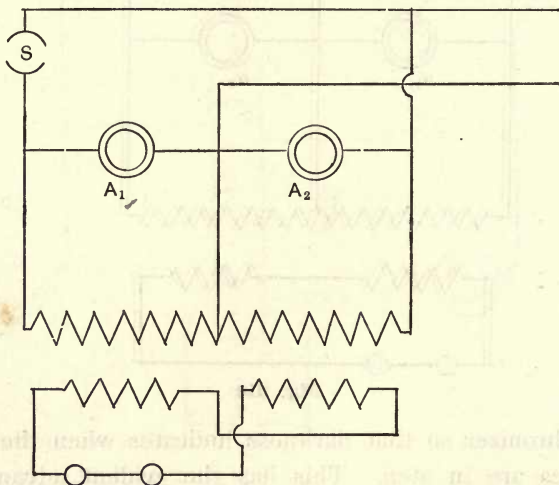

Fig. 159

frequency of the current flowing in the winding. In front of the magnets are placed resonators which magnify the sound emitted by the diaphragms. When the two tones are not in exact harmony, interference causes beats, and the synchronizer emits an intermittent sound. If the speed of the machines is brought nearer and nearer to synchronism, the beats

become less rapid. At exact synchronism, the beats die out and a clear tone results. The alternator may or may not be in step when the clear tone is given, but it may be safely thrown into circuit, for the interaction of the current waves will bring it into proper phase relations. This synchronizer was designed for use with synchronous motors. It cannot give satisfaction with alternators that are furnishing constant pressure current for incandescent lighting, since placing an alternator in the circuit while it is out of step is likely to momentarily disturb the pressure.

It is entirely possible to do without a synchronizer when connecting alternators in parallel, provided they are driven at approximately equal speeds. In this case if the alternator is brought to the proper pressure and is then connected to the 'bus bars, the machine reactions will bring it into step. This plan was practised to some extent in one or two earlier American plants, but it is vicious in its working. Throwing machines onto the 'bus bars under these conditions usually causes a disturbance in the pressure, and it also doubtless strains the armature of the alternator on account of the sudden torque impressed upon it to bring it into step.

89. Usual Practice with Reference to Parallel Operation. — Parallel working of alternators has not been usual in this country heretofore, though it is quite a common practice in Europe. Several of the earlier American plants, installed by the Westinghouse Electric Company, were arranged for parallel working; but the plan was quickly abandoned on account of the machines dividing their load unevenly and thus causing trouble. This

difficulty was quite similar in many respects to that encountered in the early endeavors to operate compound continuous-current dynamos in parallel. It was usual in these early alternating plants, as it is now, to belt the alternators to independent engines. On account of the unsatisfactory results met in the early attempts at parallel working, it has come to be the almost universal practice in this country to operate alternators on separate circuits. This introduces some complications in the station switch-board arrangements, on account of the necessity of making the connections of machines and circuits so flexible that they may be interconnected in any manner; but satisfactory switching arrangements may be very satisfactorily accomplished. A common arrangement of switch boards for this purpose is shown in Fig. 160, where double-pole throw-over switches are connected in such a manner that any feeder may be connected to any alternator in the system. In some of the later arrangements for large stations, plugs and cords are arranged to be used in combination with the throw-over switches (Fig. 161). By these arrangements the feeders may be almost instantly transferred from one alternator to another, so that any readjustment of the alternator loads may be made without more disturbance than a mere wink of the lamps. It is evident, however, that, with this arrangement, no feeder can be designed to supply a district demanding a greater output than that of the station power unit. Figure 160 shows an arrangement for two alternators and four feeders, and Fig. 161 an arrangement for three alternators and three feeders.

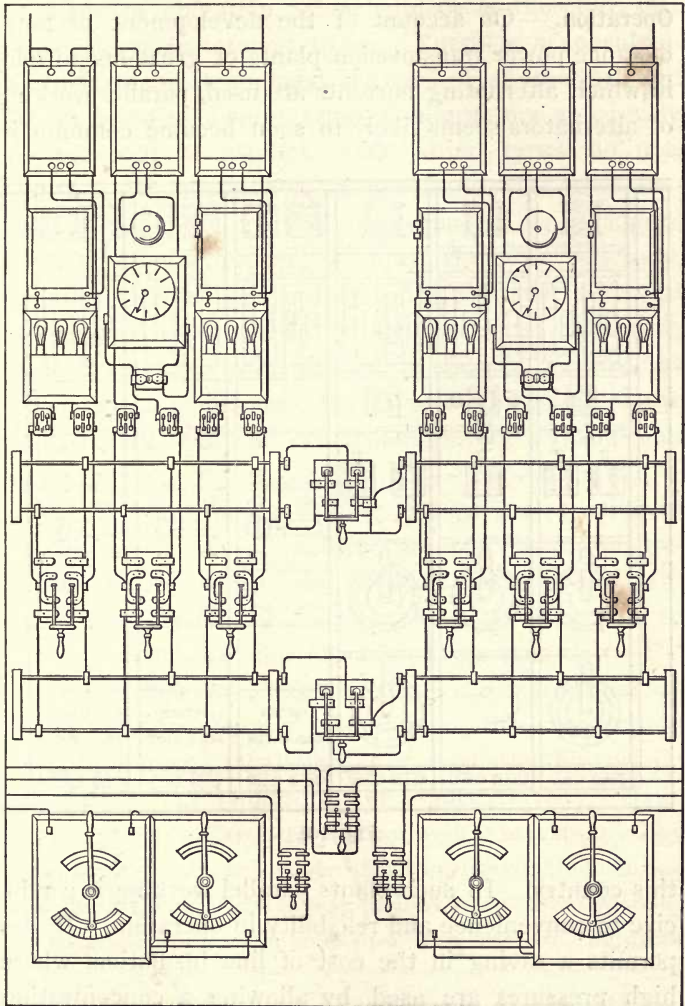

Fig. 160

90. Elements which affect the Success of Parallel Operation. — On account of the development of long-distance power transmission plants of great magnitude, in which alternating currents are used, parallel working of alternators seems likely to soon become common in

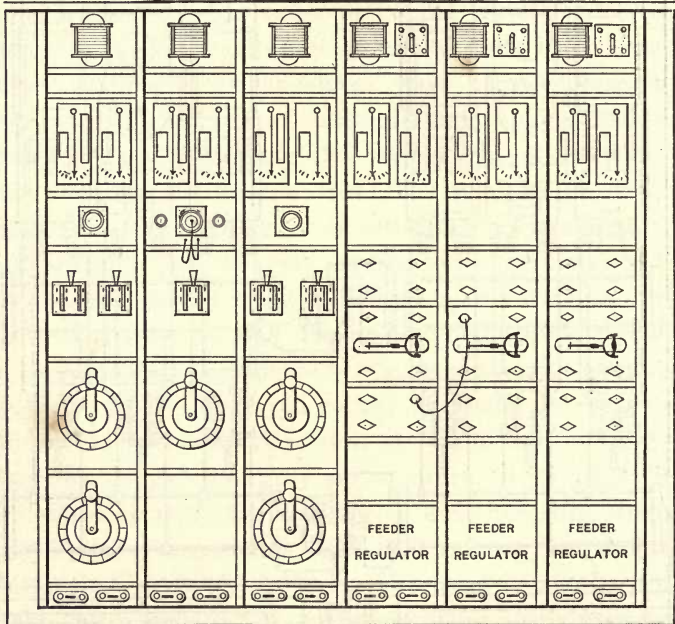

Fig. 161

this country. In such plants parallel working is conducive to convenience and reliability in operation. It also permits a saving in the cost of line insulation, where high pressures are used, by allowing a concentration of conductors. Parallel working of alternators is also advantageous in large electric light stations, where it

may be made conducive to convenience, reliability, and economy of operation. The subject is therefore one of considerable interest to us. There is a considerable disagreement amongst builders of alternators, and others, as to why some types of alternators apparently operate well in parallel, while other types do not. There is also an apparent disagreement as to what constitutes successful parallel operation. This is a pure question of practice, and we must therefore rely upon results that have been and are being attained in central station work. Mr. W. M. Mordey seems to have been the first to clearly point the way to truth in the case,* as he was the first to point out categorically some of the relations between the continuous-current dynamo and motor.†

The three elements causing the greatest friction in the discussion of this subject are the effects of frequency, of the form of the pressure curve, and of self-induction. And it is well in such a discussion to consider with particular attention these points: (1) the effect of frequency; (2) the effect of armature inductance; (3) the effect of the form of the current and pressure curves; (4) the effect of regulation by varying the excitation; (5) uniformity of angular velocity. None of these points have been so thoroughly investigated by experiment as to be decided with entire conclusiveness, and the mathematical investigations have in many cases been based upon erroneous premises, and are therefore

* Alternate Current Working, *Jour. Inst. E. E.*, Vol. 18, p. 583.

† *Philosophical Magazine*, Vol. 21, 5th series, 1886, p. 20, and *The London Electrician*, Vol. 16, p. 193.

incorrect; but the experimental investigations have been sufficiently extended to give a satisfactory clue to the true conclusions.

Successful parallel working of alternators requires: (1) that they synchronize readily when driven at speeds which differ by a few per cent; (2) that they shall instantly fall into step if thrown into parallel when they are practically synchronized, but are out of step; (3) that they shall continue to operate in parallel, dividing all loads proportionally under the varying conditions of service and attention; and (4) that the wattless or synchronizing current passing between the machines, but not into the external circuit, shall be small. The latter condition requires that the apparent watts passing into the external circuit shall be appreciably equal to the sum of the apparent watts delivered by the individual machines. If the machines do not have a strong inherent tendency to remain in step, they are likely to "seesaw" or "hunt"; that is, one machine takes the lead, then falls behind, and after a time again takes the lead, repeating this operation continually. When one of the machines is leading or lagging with respect to its mates, it develops during alternate portions of the periods a higher and a lower pressure than its mates. It is therefore alternately electrically driving and being driven by its mates. This results in a considerable flow of wattless current which interferes with regulation, overloads the machines beyond the demands of the external circuit, and causes irregular and unsatisfactory working. It is not sufficient proof of the adaptability of alternators for parallel working to show that when two machines

are belted to separate engines, one will drive the other as a motor if the steam is shut off one of the engines. We might equally say the proof that shunt-wound continuous-current dynamos will work satisfactorily in parallel is made when it is shown that one will continue to run (as a motor) when the steam is shut off its engine.

91. The Effect of Frequency on Parallel Operation. — The parallel operation of alternators was practised in the earlier plants installed by the Westinghouse Electric Company in this country. In this case the frequency was about 133. The machines worked together quite well when carrying full load, but when their loads changed they would not properly divide the load, which led to hunting, and consequent injury to the service and damage to the machines. At the best, parallel working increased the attention required at the alternators to a great degree.

Thomson-Houston alternators giving a frequency of 125 are worked in parallel with apparent satisfaction in London, England, St. Brieux, France, and elsewhere.

The classical experiments of Dr. John Hopkinson in paralleling alternators were performed with De Meritens permanent-magnet alternators, giving a frequency of about 120. Of the results obtained in these experiments, Dr. Hopkinson says: "The two machines for Tino were driven from the same countershaft by link bands, at a speed of 850 to 900 revolutions per minute; the pulleys on the countershaft were sensibly equal in diameter, but those on the machines differed by rather more than a millimeter, one being 300, the other 299 millimeters in diameter; thus the machines had not,

when unconnected, exactly the same speed. The pulleys have since been equalized. The bands were of course put on as slack as practicable, but no special device for adjusting the tightness of the bands was used. The experiment succeeded perfectly at the very first attempt. The two machines, being at rest, were coupled in series, with a pilot incandescent lamp across the terminals; the two bands were then simultaneously thrown on; for some seconds the machines almost pulled up the engine. As the speed began to increase, the lamp lit up intermittently, but in a few seconds more the machines dropped into step together, and the pilot lamp lit up to full brightness and became perfectly steady, and remained so. An arc lamp was then introduced, and a perfectly steady current of over 200 amperes drawn off without disturbing the harmony. The arc lamp being removed, a Siemens electro-dynamometer was introduced between the machines, and it was found that the current passing was only 18 amperes; whereas, if the machines had been in phase to send the current in the same direction, it would have been more than ten times as great. On throwing off the two bands simultaneously, the machines continued to run by their own momentum, with retarded velocity. It was observed that the current, instead of diminishing from diminished electromotive force, steadily increased to about 50 amperes, owing to the diminished electrical control between the machines, and then dropped to zero as the machines stopped." *

* Theory of Alternating Currents, *Four. Inst. E. E.*, Vol. 13, and Hopkinson's *Dynamo Machinery and Allied Subjects*, p. 175.

The Mordey alternator with a disc armature is reported to operate well in parallel at a frequency of 100. Mr. Mordey says: "With regard to parallel working, I can only say that we find nothing in practice to lead us to suppose that reducing the rate (frequency) would improve the working. We have no difficulty in parallel working at 100 periods per second, and therefore cannot improve in this respect." The Mordey alternator is working in parallel in a number of English and European plants with apparent satisfaction. In experimenting with these machines,* Mr. Mordey made the following tests:

"(1) The alternators were run up to full speed, and each excited to give 2000 volts. When in phase, they were switched parallel without any external load, and without any impedance coils or resistance between them. They ran in parallel perfectly.

"(2) A considerable inductionless load was then put on, varied, and taken off. They ran equally well under all circumstances.

"(3) They were uncoupled, and then, the load being connected to the mains, they were suddenly and simultaneously switched parallel and on to the mains with perfect success.

"(4) One alternator was excited to give 1000 volts, the other giving 2000 volts. They were then switched parallel, and went into step perfectly, giving a terminal P.D. of about 1500 volts. No impedance or resistance was used in this or any other case. A load was then put on without affecting their behavior.

* Alternate Current Working, *Jour. Inst. E. E.*, Vol. 18.

“(5) With one machine at 1000 volts, and the other at 2000 volts, they were switched parallel when out of phase, and instantly went into step. A large current appeared to pass between them for a fraction of a second, but not nearly long enough to enable it to be measured or to do any harm.

“(6) They were then left running parallel while one was disconnected from the engine by its belt being shifted from the fast to the loose pulley. It continued to run as a motor synchronously. A load of lamps was at the same time on the circuit.

“(7) The two machines were then uncoupled, and excited up to 2000 volts. They were then switched parallel when out of phase, and without any external load, and went into step instantly.

“(8) Whilst running as in (7), steam was suddenly and entirely shut off one engine. The alternators kept in step perfectly, one acting as a motor, and driving the large engine and all the heavy countershafting and belts. It was impossible to tell, except by the top of the belt becoming tight instead of the bottom, which machine was the motor.

“To find the power exerted by the alternator acting as a motor in (8), a direct-current motor was put in its place, and the power required to drive the engine and shafting was found to be 20 horse power.”

The capacity of the alternators here experimented with was about 50 horse power.

Siemens alternators, connected directly to their engines, are operated in parallel at Bristol, England.*

* *London Electrical Review*, Vol. 34, p. 274.

Ferranti alternators with disc armatures, giving a frequency of 83, are worked together in England and Europe. At the Deptford station, in London, Ferranti alternators of two sizes, 625 horse power and 1250 horse power, are worked parallel, though their normal pressure is different, and the smaller machines are therefore connected up to the circuit through a transformer.*

Elwell-Parker alternators, giving a frequency of 80, are reported to work together with some satisfaction. These machines are somewhat like the American type turned inside out; that is, they have the equivalent of a drum armature, which surrounds the revolving field magnets.†

In certain European plants Kapp alternators have operated in parallel. These machines have ring armatures, and give a frequency of 70.

Stanley two-phase alternators with frequencies of 60 and 125 are running in parallel with perfect success in this country.

The Gordon alternators, which were among the earliest to be used in commercial service,‡ were shown to be capable of operating in parallel. Of this, however, Mr. Gordon said: "We know that experiments have been made by coupling a number of small alternate-current machines together, and at the South Foreland (Hopkinson's experiment) they were successful, but that was because they were working on arc lamps. Many of us have tried them, and they will, on trial, work together,

* Fleming's *Alternate Current Transformer*, Vol. II., p. 359.

† Fleming's *Alternate Current Transformer*, Vol. II., p. 222; Mordey, *Four. Inst. E. E.*, Vol. 18, p. 588.

‡ See Gordon's *Electric Lighting*.

no doubt ; but they do not work together till they have run for three or four minutes ; they will in that time jump, and that jumping will take months of life out of the 40,000 lamps. That alone is rather a serious difficulty in coupling machines together, and I think we may take it in practice — I am not speaking about the laboratory, or experiments — we do not couple machines.” The frequency of these machines was from 40 to 50.

Alternators with pole armatures of the Ganz type, giving a frequency of 42, are frequently worked in parallel in European plants. In the plant at Rome it has been found possible to operate Ganz alternators of different sizes together.*

Steinmetz has operated alternators of the General Electric Company in parallel, under the following conditions : †

Two 60 K.W. alternators with toothed armature cores, giving a frequency of 125, were experimented upon. These were first excited so as to give a pressure of 1000 volts. The machines were then switched into parallel without making any effort to first get them into step. They quickly dropped into step, and ran synchronously with an interchange of wattless current of only four amperes. Since the normal full load of these machines was 52 amperes at 1150 volts, this is a remarkably good result. Experiments were then made to determine the momentary rush of current at the instant when the machines were

* Fleming, *Alternate Current Transformer*, Vol. II., p. 134; Hedges, *Continental Electric Lighting Stations*, p. 14.

† Parallel Running of Alternators, *Electrical World*, Vol. 23, p. 285.

thrown together, under various conditions of phase. To determine the phase relations, a synchronizer was used. The machines were first brought to equality of pressure (1000 volts) and synchronism, and then approximately into step. They were then switched together. The momentary rush of current was from .5 to 6 amperes greater than the regular wattless synchronizing current, and depended in magnitude upon the care taken to bring the machines into exact step before they were thrown together. The machines were then thrown together, when their phases were 180° from step, so that the machines would act in series on short-circuit instead of in parallel. When the switch was closed, a large instantaneous current passed through the machines for a fraction of a second, and the machines came at once into step.

Mr. Steinmetz then made experiments upon the action of the machines when thrown in parallel with their voltages different. The results are given in the following table and the accompanying figure (Fig. 162):

| A. Machine Pressure. | B. Machine Pressure. | A - B. | Resultant Pressure. | Synchronizing Current. | Phasing Current. |
|----------------------|----------------------|--------|---------------------|------------------------|------------------|
| 1000 | 1000 | 0 | 996 | 4.0 | 2.0 |
| 1100 | 900 | 200 | 1000 | 6.5 | .5 |
| 1200 | 800 | 400 | 1000 | 13.0 | 3.0 |
| 1300 | 700 | 600 | 1000 | 18.0 | 4.0 |
| 1400 | 600 | 800 | 1026 | 24.0 | 6.0 |
| 1500 | 500 | 1000 | 1010 | 28.0 | 6.0 |
| 1600 | 400 | 1200 | 1040 | 39.0 | 3.0 |
| 1700 | 300 | 1400 | 1046 | 44.0 | 3.0 |
| 1800 | 200 | 1600 | 1060 | 50.0 | 6.0 |
| 1900 | 100 | 1800 | 1066 | 56.5 | 5.5 |
| 2000 | 0 | 2000 | 1075 \pm 70 | 62.0 | 10.0 |

The meaning of the first four columns is evident from the headings, the fifth gives the synchronizing current necessary to hold the machines in step, and the sixth the additional current that flows between the machines for an instant when they are first thrown together and are out of step. When the difference in the pressures of

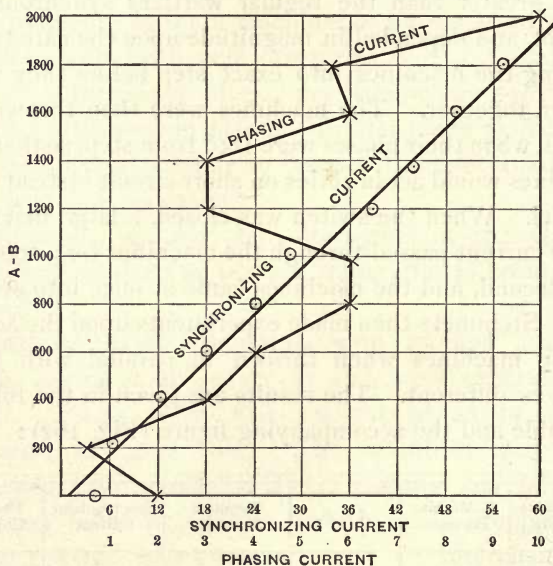

Fig. 162

the two machines became 1900 volts, the resultant pressure began to be unsteady. When the difference was 2000 volts, the resultant pressure varied 70 volts on either side of 1075. The irregularity of the curve of phasing current may be due to the differences in the relative phases of the machines at the instants when they were thrown together.

In discussing these experiments Mr. Steinmetz says : " We may discard all the usual theoretical statements on parallel working relating to the effect of frequency, self-induction, etc., as wholly disproved by experience. . . . With regard to frequency, I investigated the parallel working of alternators at a frequency as high as 125 cycles, and at a frequency as low as 25 cycles per second, and found no difference whatever ; and at the high frequency, as well as at very low frequency, machines properly designed for these frequencies work perfectly in synchronism."

From all the evidence thus presented, it may reasonably be concluded that frequency, within the limits of common practice, is not an element affecting the success of parallel working of alternators. This is in full accord with the deductions of Mordey and Steinmetz.*

92. The Effect of Armature Inductance on Parallel Operation. — Successful parallel operation of alternators depends upon their holding each other in synchronism and step, even when the prime movers do not naturally synchronize. *The effort of the machines to do this is the fundamental cause for the flow of a wattless synchronizing current.* The total synchronizing current flowing

* Compare Mordey, Alternate Current Working, *Four. Inst. E. E.*, Vol. 18, p. 591; Snell, The Distribution of Power by Alternate-Current Motors, *Four. Inst. E. E.*, Vol. 22, p. 280; Mordey, Testing and Working Alternators, *Four. Inst. E. E.*, Vol. 22, p. 116; Mordey, On Parallel Working with special reference to Long Lines, *Four. Inst. E. E.*, Vol. 23; Forbes, Electrical Transmission of Power from Niagara Falls, *Four. Inst. E. E.*, Vol. 22, p. 484; and the discussions on these papers; also Steinmetz, Parallel Running of Alternators, *Electrical World*, Vol. 23, p. 285; C. E. L. Brown, *Four. Inst. E. E.*, Vol. 22, p. 600.

between a machine and the station 'bus bars may be resolved into two components, one in phase with the pressure which causes the synchronizing current to flow, and the other lagging 90° behind the pressure. The former is usually quite small. Thus suppose in Fig. 163 that b is the curve of pressure of a machine, and a the curve for the station 'bus bars. As a and b are slightly out of opposition, there will be a resultant pressure, q , tending to set up a cross or series current. This current may be considered as made up of a component s , in phase with q , and of another component u , in quadrature with q , the former being the active, and the latter the wattless component. The component s has the same effect upon both a and b during a complete period, hence it can have no effect in tending to draw the machine into phase with the 'bus bar pressure; but the wattless component u , which is dependent upon the self-inductance of the series circuit, must, from its position, cause a motor action on the lagging machine (b), and a corresponding generator action on the leading machines connected to the 'bus bars; and it thus tends to draw the machines into synchronism (Sect. 86), for it will be noticed by reference to the figure that u is in phase with m and in opposition to n , and that m and n are respectively the components of a and b , which are in opposition, and therefore working on the parallel circuit. If the machine, b , led the 'bus bar curve, then the synchronizing current would retard instead of assisting it, as the figure plainly shows. The effect of the synchronizing current in dragging the machines into step depends

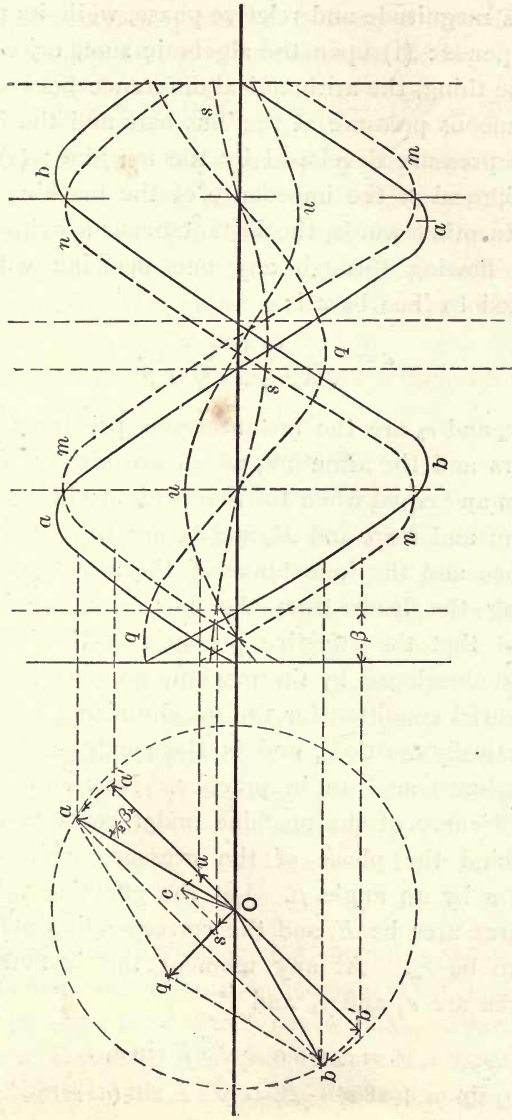

Fig. 163

upon its magnitude and relative phase, while its magnitude depends: (1) upon the algebraic sum, or, what is the same thing, the arithmetical difference between the instantaneous pressure at the 'bus bars and the instantaneous pressure developed by the machine; (2) upon the reciprocal of the impedance of the machine armature. In other words, the instantaneous synchronizing current flowing through any one machine which is connected to 'bus bars is

$$c = \frac{e_a + e_b}{\sqrt{R_a^2 + 4\pi^2 f^2 L_a^2}}$$

where e_a and e_b are the instantaneous pressures of the 'bus bars and the armature, which are always of opposite sign and equal when the machines are in exact synchronism and step, and R_a and L_a are respectively the resistance and the inductance of the armature circuit including the leads from the 'bus bars. It is here assumed that the effective pressure at the 'bus bars and that developed by the machine are equal, which is an essential condition for the synchronizing current to be practically wattless, and is the condition in which the machines are run in practice. Now suppose the pressure curve of the machine under consideration to lag behind the phase of the pressure curve at the 'bus bars by an angle β . Let the effective values of these pressures be E , and the corresponding maximum pressure be e_m . At any moment the instantaneous pressures are e_a and e_b , and

$$e_a = e_m \sin a = \sqrt{2} E \sin a,$$

$$e_b = e_m \sin (a + 180^\circ - \beta) = \sqrt{2} E \sin (a + 180^\circ - \beta).$$

The instantaneous pressure causing a synchronizing current to flow is the algebraic sum of these, or

$$e_a + e_b = \sqrt{2} E [\sin \alpha + \sin (\alpha + 180^\circ - \beta)].$$

It is evident from the figure (Fig. 163) that this is a maximum when e_a and e_b are equal and of similar signs, in which case $\alpha = \frac{1}{2}\beta$. Then the maximum value of the pressure causing a synchronizing current is found by substituting this value of α in the expression for $e_a + e_b$, and $(e_a + e_b)_m = 2\sqrt{2} E \sin \frac{1}{2}\beta$.

The effective value of the pressure is then $2 E \sin \frac{1}{2}\beta$, and the synchronizing current is

$$C_s = \frac{2 E \sin \frac{1}{2}\beta}{\sqrt{R_a^2 + 4\pi^2 f^2 L_a^2}}$$

For smooth and successful working in parallel, C_s must become sufficiently great, in case the machines tend to get out of step, to pull the machines together before β becomes of appreciable magnitude. Hence it is necessary that the denominator in the expression for C_s be as small as possible. In other words, armature impedance must be as small as possible. Figure 163 shows plainly that the pressure (Oq) causing C_s is behind the phase of the machine pressure by an angle $90^\circ - \frac{1}{2}\beta$. The synchronizing current ($C_s = Oc$) lags behind the pressure by an angle ϕ_s (qOc), the tangent of which is $\frac{2\pi f L_a}{R_a}$.

Consequently the synchronizing current is out of phase with the machine pressure by an angle of $90^\circ + (\phi_s - \frac{1}{2}\beta)$. A current (wattless) which has a phase difference of 180° or 0° compared with the pressure of a machine has the strongest effect in bringing the machine into step.

This effect is to retard or accelerate the refractory machine depending on whether the phase difference is 0° or 180° , which in turn depends upon whether the machine is leading or trailing. The action in case of a leading machine would be represented by the left-hand half of Fig. 163 if it were reversed.

The wattless component (C_μ) of the synchronizing current just found is,

$$C_\mu = C_s \sin \phi_s,$$

and therefore,

$$C_\mu = \frac{2 E \sin \frac{1}{2} \beta}{\sqrt{R_a^2 + 4 \pi^2 f^2 L_a^2}} \cdot \frac{2 \pi f L_a}{\sqrt{R_a^2 + 4 \pi^2 f^2 L_a^2}},$$

or,
$$C_\mu = 2 E \sin \frac{1}{2} \beta \cdot \frac{2 \pi f L_a}{R_a^2 + 4 \pi^2 f^2 L_a^2};$$

and, with a fixed value of R_a , this will have a maximum value when

$$R_a = 2 \pi f L_a \text{ or when } \tan \phi_s = 1 \text{ and } \phi_s = 45^\circ.$$

The maximum possible value of C_μ is therefore

$$C_\mu \text{ max} = \frac{2 E \sin \frac{1}{2} \beta}{2 R_a};$$

and the corresponding value of C_s , the total synchronizing current, is

$$C_s = \frac{2 E \sin \frac{1}{2} \beta}{\sqrt{2} R_a}.$$

The limits in the value of R_a are fixed by considerations of economy in construction and of efficiency, and the frequency is fixed by conditions of operation; L_a is therefore the only independent variable in the preceding equations. In order to have the most sensitive mutual control, the self-inductance of the armature circuit, which at its least value is always many times

larger than $\frac{R_a}{2\pi f}$, must be as small as possible. If it were possible to reduce the reactance to the value of the resistance, the jerking of a refractory alternator into phase would probably be too severe for good working, but in commercial machines such trouble is not likely to exist on account of the unavoidable magnitude of the self-inductance, which cannot be reduced beyond certain limits. The correctness of the formulas thus deduced has not been studied experimentally, but it might be readily investigated with the aid of Bedell's ingenious phase indicator.* †

* Bedell, *Trans. Amer. Inst. E. E.*, Vol. 11, p. 502.

† Diagrams 1 and 2 given herewith, which are similar in plan to those given in the footnote on page 326, show the conditions of synchronizing very well. Figure 1 applies to an alternator which lags behind its proper phase, and Fig. 2 to one which leads.

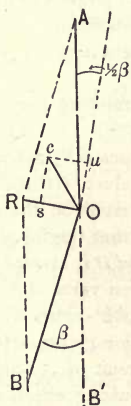

FIG. 1

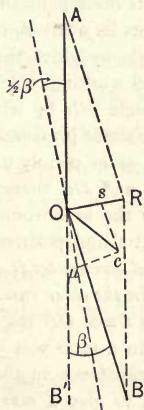

FIG. 2

OA represents the 'bus bar pressure in phase and magnitude.

OB represents the machine pressure in phase and magnitude.

OR represents the resultant, or synchronizing, pressure in phase and magnitude.

The list of examples of parallel working (Sect. 91) contains machines having armatures of very different resistances and inductances. The Westinghouse, Thomson-Houston, and Elwell-Parker machines have smooth iron armature cores and fairly low armature inductances and resistances. The armature inductance of the Mordey and Ferranti machines is probably somewhat smaller, though entirely comparable with these values. The Kapp machines, and the General Electric machines with which Steinmetz experimented, have much greater armature inductances, and the armatures of the Stanley inductor machines probably have inductances of intermediate values. All these machines have been shown to run in parallel with similar machines with fair satisfaction, while Mordey, Steinmetz, and Stanley have

Oc represents the synchronizing current in phase and magnitude.

Ou represents its wattless, or phasing, component.

β is the angle by which the machine differs from its proper phase for parallel working, OB' .

ϕ_s is the angle cOs by which the synchronizing current lags behind the resultant pressure.

The figures show plainly that as β increases OR increases, and at the same time Oc and Ou increase. The product $OB \times Ou \times \cos \frac{1}{2} \beta$ is proportional to the synchronizing torque exerted on the machine; it is negative in Fig. 1 and positive in Fig. 2, so that the torque is exerted on the machine and accelerates it in one case, and it is exerted by the machine and retards it in the other case. For any given value of β , the torque is a maximum when $Ou \times OB$ is a maximum, which occurs when $2\pi fL = R$, or $\phi_s = 45^\circ$. In a 1000 volt 50 K.W. machine giving a frequency of 60 and having a resistance in the armature circuit of .5 ohm, it is required that $L = .0013$ to give a maximum synchronizing effect, which is many times smaller than the smallest value which is commercially attainable in any type of alternator.

An inspection of the figures shows that if the synchronizing current led the resultant pressure there would be no tendency for the machine to come into parallel with the 'bus bars.

experimentally shown that Mordey disc armature machines, the General Electric ironclad armature machines, and Stanley toothed armature inductor two-phase machines will run parallel with machines of their own type with excellent results. On the other hand, Gordon has said that his machines did not come into step well (page 345), and Hopkinson's experiments show that De Meritens machines take an excessive synchronizing current. The armatures of both the Gordon and De Meritens alternators have an excessive resistance and self-inductance as compared with good machines of the present day,* and their actions fully agree with the indications of the formulas already given.

We are therefore entirely justified in drawing the conclusion that in machines intended for parallel working both armature resistance and inductance should be small, but that within the range of resistances and inductances to be found in modern commercial machines of economical design the armature inductance is too small to have a detrimental effect upon parallel working though it is much too large to give a maximum synchronizing torque, which in fact may be an advantage, as it saves the machines from being torn to pieces. Some types of modern alternators of less economical design may have too much armature self-inductance to operate perfectly in parallel.

These deductions are strengthened by the experimental results gained by Mordey and Steinmetz. In discussing his experiments already summarized (page 343)

* Gordon's *Electric Lighting*, pp. 156, 162; *London Electrician*, Vol. 17, p. 51.

Mordey says: "It may be pointed out that these tests were made under the most exacting and onerous conditions that could possibly be imposed, and particularly I would point out that on account of the very great momentum of the revolving masses nothing but the strongest and most instantaneous motor action could have kept the machines in place. There never was a single case when they got out of step, even momentarily or when subjected to sudden and violent variations of load. When it is considered that in order to secure this result, it was imperative that the control of all that mass should be exerted in a fraction of $\frac{1}{200}$ of a second (the periodicity being 100), it will be recognized that there was no time to be lost, and that the use of any self-induction or resistance, or of anything else that could in any way choke, retard, check, or interfere with the strength and instantaneity of the action, was above all things to be avoided.

"I should mention that the machines apparently synchronized equally well at speeds varying very considerably.

"As to the self-induction of the machine itself, that is quite negligible. Its characteristic (Fig. 164) is nearly straight, about half the drop in the curve being due to resistance and half to self-induction." *

Steinmetz says in regard to his experiments: "The self-induction of machines within the limits met in well-designed alternators has nothing to do with the success of synchronous running, and I had three phasers of very low armature self-induction running in parallel

* *London Electrician*, Vol. 23, p. 66.

with each other and ironclad (imbedded armatures) single-phasers of high armature self-induction." *

The comparatively high self-inductance of ironclad alternator armatures has proved advantageous in an-

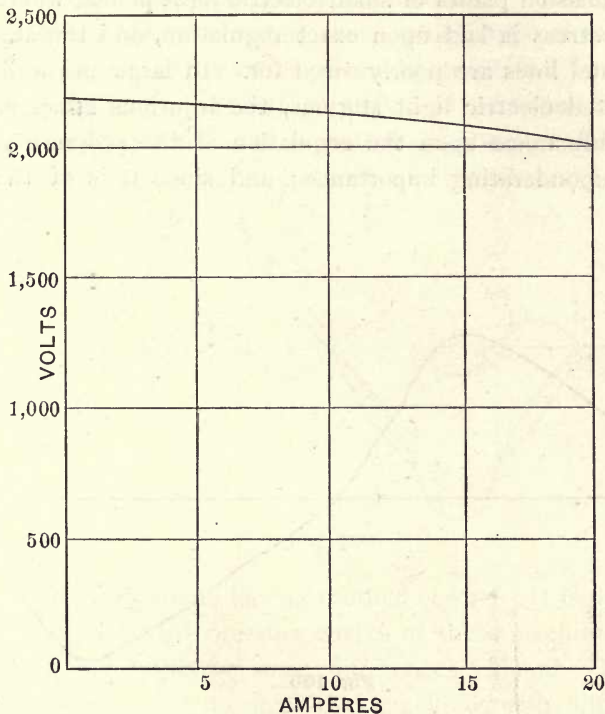

Fig. 164

other direction, that of saving the machine from the damaging effects of sharp short-circuits. A sharp short-circuit upon a machine with a disc armature is likely to cause an enormous momentary rush of current

* *Electrical World*, Vol. 23, p. 285.

which may damage or destroy the armature, while the higher self-inductance of the ironclad armature chokes down the current to a considerable extent. This quality of the ironclad alternator is an advantage in power transmission plants or small electric light plants, where little stress is laid upon exact regulation, and the station and lines are poorly cared for. In large and well-operated electric light stations, the injurious effect of self-inductance upon the regulation of the pressure is of preponderating importance; and since it is of the

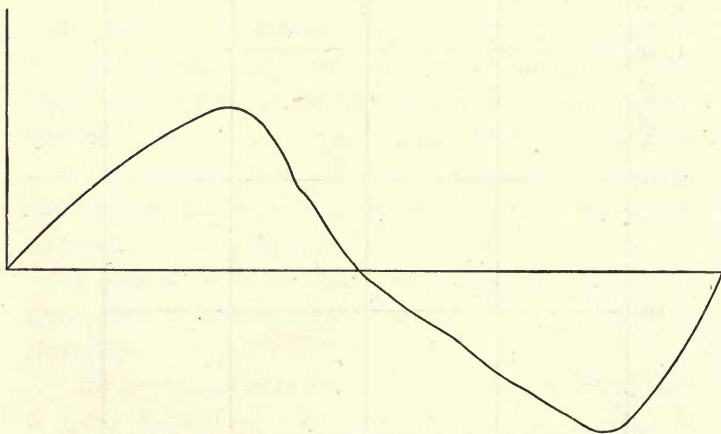

Fig. 165

utmost moment that alternators used in large electric light stations shall have the least possible defect in regulation, the alternator with large self-inductance is not so well adapted to this service (Sects. 67 and 74).

93. Effect of the Form of the Pressure Curve and of Armature Reactions on Parallel Operation.—Little

experimental evidence is available bearing upon this question. The able designer, C. E. L. Brown, states that he has operated his own alternators with smooth iron armature cores in parallel with Ganz alternators which have the usual pole-type armatures.* The former machines give a pressure curve which approximates a sinusoid, while the curve given by the latter is quite irregular and peaked (Fig. 165). Mr. Steinmetz has operated machines with smooth iron armature cores in

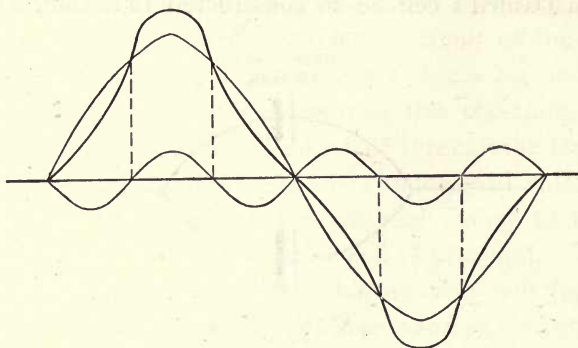

Fig. 165

parallel with others having toothed cores.† It is not related how far the pressure curves of these machines differed, but probably some differences existed. These statements seem to show that machines with different pressure curves can be run together satisfactorily, but they undoubtedly require a considerably increased exchange of current as compared with the synchronizing current of machines which give curves which are exactly

* *Jour. Inst. E. E.*, Vol. 22, p. 600.

† *Electrical World*, Vol. 23, p. 285.

alike. For, since the unlike curves cannot coincide even when the machines are in exact synchronism, a current of more or less irregular form must be exchanged by the machines, and is therefore superposed upon the true synchronizing current. This superposed current may have a very different frequency from that of the machines (Fig. 166) and is not necessarily wattless.

94. The Effect on Parallel Operation of Regulation by Varying the Excitation.— Suppose that a Grove's and a Daniell's cell be so constructed that their inter-

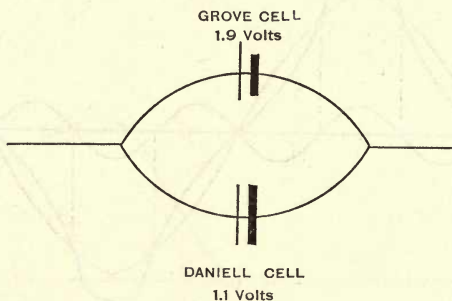

Fig. 167

nal resistances are equal. Their pressures may be assumed to be approximately 1.9 and 1.1 volts. If these cells are connected in parallel (Fig. 167) to a circuit, the pressure impressed upon the circuit is the mean of the pressure developed by the cells, or 1.5 volts. This is brought about as follows: The Daniell cell serves as a shunt across the terminals of the Grove cell, so that current from the Grove cell has two paths, one through the external circuit and one backwards through the Daniell cell. Sufficient current will flow

through the latter to equalize the pressure at the terminals by means of the fall of pressure over the internal resistances of the cells. If the external circuit is open, a current will flow through the cells which is sufficient to cause a loss of pressure in each cell of .4 of a volt. The pressure at the terminals of the Grove cell is then $1.9 - .4 = 1.5$, and at the terminals of the Daniell cell $1.1 + .4 = 1.5$. Suppose the external circuit is closed and demands enough current to cause a pressure loss in the Grove cell of .2 of a volt. Then sufficient additional current will flow through the circuit of the cells to make the terminal pressure $1.7 - .3 = 1.4$ and $1.1 + .3 = 1.4$. From an extension of this reasoning it is seen that a current flows backwards through the Daniell cell under all conditions of the circuit until sufficient current is demanded by the external circuit to make the pressure loss in the Grove cell .8 of a volt. Then the Daniell cell is exactly balanced, and will furnish *half of any additional current demanded by the external circuit.*

The same condition of affairs exists when continuous-current dynamos operate in parallel. If their pressures are not exactly equal, the 'bus bar pressure will be a mean value. The machine of lower pressure will supply sufficiently less current so that an equalization of pressure comes about through changes in the loss of pressure due to the resistances of the armature circuits and the effects of armature reactions. If the low-pressure machine falls behind too much, the current through its armature will be reversed (Vol. I., p. 231). The inequality of load can be readily perceived in the

case of continuous-current dynamos by observing the amperemeters.

In the case of alternators, similar conditions exist. For illustration we will assume the machines to give sine pressure curves which are in synchronism and step. If the machines give equal pressures, they will feed the external circuit equally if they are of the same capacity, or proportionally if they are of unequal capacities. If one machine, which is connected to constant-pressure 'bus bars, gives a pressure which is too low, it will not furnish its share of current to the circuit. The pressure at the 'bus bars is equalized through the influence of the pressure losses caused by the impedances of the various armature circuits. If the pressure of the machine becomes much lower than that of the 'bus bars, a reverse current will flow through the machine, and it will run as a motor. This is not shown by the amperemeter, as in the case of continuous-current machines. It may be observed, however, by altering the excitation. If the machine is doing its work properly, decreasing the excitation will decrease its apparent output to a minimum, after which further decrease in the excitation causes an increase in the apparent output. The machine is then receiving more energy from the 'bus bars than it returns. In order, then, that machines working in parallel may be relied upon to contribute energy to the external circuit, it is necessary that they be so sufficiently excited that an increase in the excitation will cause an increase in the apparent output. This, of course, is exactly what is done with continuous-current dynamos, using the indi-

cations of the amperemeter as a guide, but in the case of alternators, the amperemeters, alone, fail to show what the machines are really doing. This is partly on account of their inability to indicate the direction of the transfer of energy in an alternating circuit, and partly on account of the masking effect of a wattless current; but if direct-reading wattmeters are used in place of amperemeters in the circuits of the alternators, the indications of these instruments may be used as a guide in handling the machines when in parallel, exactly as the indications of amperemeters are used as a guide for handling continuous-current dynamos which are connected in parallel.

When two alternators of unequal pressure are connected together, there is quite a curious result. The terminal pressure is a mean between the machine pressures and *the machines run together without a dangerous exchange of current.** The instantaneous value of the current exchanged by the two machines at any moment, on the supposition that the machines are in step and that the pressure curves are sinusoids, is

$$\frac{\sqrt{2} E' \sin a - \sqrt{2} E'' \sin a}{\sqrt{R^2 + 4 \pi^2 f^2 L^2}} = \frac{\sqrt{2}(E' - E'') \sin a}{\sqrt{R^2 + 4 \pi^2 f^2 L^2}},$$

and its effective value is

$$\frac{E' - E''}{\sqrt{R^2 + 4 \pi^2 f^2 L^2}},$$

where E' and E'' are the effective pressures developed

* Mordey's and Steinmetz's Experiments, Section 91.

by the two machines, and R and L are the resistance and inductance of the two armature circuits taken in series. Take two 50 K.W. alternators designed to give 50 amperes at 1000 volts with a frequency of 125, assuming the armature resistance and inductance of each to be respectively .45 ohm and .015 henry. Then if the two machines be thrown in parallel with one excited to give 1000 volts and the other without excitation, the current exchanged amounts to about 42 amperes, which is less than the full load of the machines; while if an unexcited machine be connected to 'bus bars of a large system, the current sent through its armature only amounts to 85 amperes. The current that would be exchanged under similar conditions by continuous-current machines would be over 1100 amperes, which would immediately ruin the machines. The difference in the two results is due to the inductive effects of the alternating current. If the two alternators have a considerable armature reaction, the difference is likely to be still more marked, since armature reactions tend to weaken an alternator's field when running as a generator, and strengthen it when running as a motor (Sect. 70).

95. The Effect of Irregular Angular Velocity on Parallel Operation.—The angular velocity of the steam engines, which are ordinarily used for driving dynamos, is by no means uniform throughout the stroke, though the strokes may be entirely isochronous. Curves showing the instantaneous crank velocities taken from engines of well-known types are often quite irregular. If alternators are driven from separate engines, this irreg-

ularity of angular velocity may be the cause of more or less difficulty in parallel working, and some machines may work quite satisfactorily in parallel when driven from the same countershaft or from separate turbines (which give a uniform angular velocity), when they will not do so if driven by separate engines.

96. Final Conclusions on Parallel Operation.— 1. There is no difficulty in operating alternators of good commercial design in parallel.

2. Within the limits of practice frequency does not materially affect parallel working.

3. This being accepted, smooth parallel working requires that the armature impedance be reduced to a minimum (Sect. 92). Armature resistance must depend upon considerations of economy.

4. Machines with excessively large armature inductance will run in parallel, but are likely to "hunt."

5. Machines with pressure curves of quite different forms will run together in parallel, but with a continuous interchange of current, the magnitude of which depends upon the value of the armature impedances and the relative form of the pressure curves.

6. The dynamo amperemeters which are ordinarily used should be replaced, or reinforced, when machines are run in parallel, by direct reading wattmeters. The excitation of the machines may then be adjusted so that the wattmeters show a proper division of the load. In that case amperemeters in the dynamo circuits should show an approximately similar division of the current.

7. If the excitation of the machines is properly adjusted the sum of the readings of the machine watt-

meters will equal the reading of a main wattmeter in the main circuit of the 'bus bars, and the sum of the readings of the machine amperemeters will be a little greater than the reading of the main amperemeter (the difference being twice the value of synchronizing current exchanged by the machines).

8. The effect of inductance makes such an overwhelming part of the impedance of even the best commercial machines, that an injuriously excessive current is not likely to flow through a machine even when switched onto the 'bus bars entirely unexcited. (This is true to a marked degree of machines with ironclad armatures.)

9. Parallel working is likely to be more successful when the alternators are driven from the same engine or counter shaft, or when the prime movers are turbines.

These conclusions are based upon the operation of alternators which are driven by self-regulating prime movers; that is, the driving power transmitted to the alternators is automatically adjusted to the demands of the machines, and they are driven at a uniform speed regardless of their load. This is in accord with the usual American practice in operating dynamos. In England it is apparently common to work alternators from engines that are not self-regulating and which furnish a fixed amount of power when running synchronously unless the position of the throttle valve is altered.*

* Kapp's *Dynamos, Alternators, and Transformers*, p. 399; Snell's *Electric Motive Power*, p. 241.

CHAPTER VIII.

EFFICIENCIES, ETC.

97. General Considerations. — The general definitions of efficiencies, which have already been explained with regard to continuous-current machines, are applicable to alternators (Vol. I., p. 244). The principal causes of loss in alternators are the same as those in continuous-current machines; but on account of increased frequencies, the effects of foucault currents and hysteresis are intensified. On this account particular care is required in selecting and annealing the iron for the armature core, and in insulating the armature discs from each other. Advantage should also be taken of every opportunity for ventilation. The magnetic density in alternator armature cores is made considerably less than in continuous-current armatures, as already explained (Sect. 61). The following table of satisfactory densities is given by Snell.* The inductions, which are given in lines of force per square centimeter and per square inch, may be assumed as fair guides for proper judgment in designing.

* *Electric Motive Power*, p. 175.

TABLE OF ARMATURE INDUCTIONS SUITABLE FOR VARIOUS FREQUENCIES.

| Frequencies. | B (per sq. cm.). | B (per sq. in.). |
|--------------|--------------------|--------------------|
| 50 | 5000-6200 | 32,000-40,000 |
| 60 | 4650-5000 | 30,000-32,000 |
| 70 | 4350-4650 | 28,000-30,000 |
| 80 | 4000-4350 | 26,000-28,000 |
| 90 | 3700-4000 | 24,000-26,000 |
| 100 | 3500-3700 | 22,500-24,000 |
| 110 | 3250-3500 | 21,000-22,500 |
| 120 | 3000-3250 | 19,500-21,000 |
| 130 | 2800-3000 | 18,000-19,500 |

As already stated, the values of armature inductions given in this table serve excellently as a guide in designing, but they are frequently exceeded in practice. It is no uncommon thing to find inductions as great as 5000 to 7000 in alternator armatures, giving a frequency of 125 or more. Snell's table is apparently modelled after a table presented by Kolben in an article upon polyphase induction motors, and which gives the range of inductions to be used in such machines. Kolben's table is given in Section 177.

98. Methods of Testing Alternators.—The experimental determination of the efficiency of alternators may be made by methods quite analogous to those used with continuous-current machines (Vol. I., p. 255). However, instead of voltmeters and amperemeters for measuring electrical energy, wattmeters must be used (Fig. 168), unless the load is entirely non-reactive. In case

a transmission dynamometer is used to measure the power absorbed by an alternator, the commercial efficiency is equal to the electrical output, determined from the readings of a wattmeter, divided by the power shown by the dynamometer readings, if the machine is self-excited. If the machine is separately excited, the energy supplied to the fields, measured by amperemeter and voltmeter or by wattmeter, must be added to the power readings. The machine friction may be determined from the dynamometer readings when the machine is run with its fields unexcited and the external circuit open. The total loss due to hysteresis and foucault currents in the armature core and conductors, may be approximately determined from the dynamometer readings when the machine is operated with its fields separately excited and the external circuit open, and the total loss may be approximately separated into its component parts by proceeding in an entirely analogous way to that given for continuous-current machines (Vol. I., p. 253, *First Method*). The C^2R losses in fields and armature may be readily computed. If the machine is self-excited by a rectified current, the field current will be less than that calculated from the pressure and resistance. In that case it is advisable to use an alternating-current amperemeter, such as an electro-dynamometer, to determine the effective current. From this, the C^2R loss may be computed if the field resistance is known. Or, the field loss may be directly determined by a wattmeter in the field circuit.

The following methods are especially adapted to shop testing and determining the efficiency of an alternator.

1. *Modification of Hopkinson's Method.* It is desirable to avoid the use of a power dynamometer, and with this in view a modification of Hopkinson's method of testing (Vol. I., p. 256) may be made (Fig. 169). Two equal alternators are rigidly coupled together in proper step for parallel working. Their armatures are electrically connected together with a wattmeter and an electro-dynamometer in the circuit. The fields being properly excited by a separate exciter, so that one machine will act as a generator and the other as motor, the system may be driven by supplying sufficient power to make up the machine losses. Assuming the armature and stray losses of the two machines to be equal, and representing the wattmeter reading by W , the power supplied by P , and the resistance of the connections by R_1 ; then the efficiency of the generator is

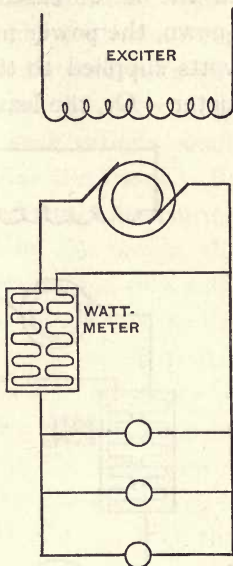

Fig. 168

$$\eta = \frac{W}{W + \frac{1}{2}(P - C^2R_1) + c^2R_g}$$

where c^2R_g is the field loss of the generator. If the machines are self-exciting, the power in the field circuits must be measured and proper allowance made. The power supplied to make up the losses may be measured

by a transmission dynamometer, or a "rated" continuous-current motor may be used to supply the power. In the latter case, if the efficiency of the motor is known, the power may be determined by measuring the watts supplied to the motor by amperemeter and voltmeter. Or, the losses of the motor may be determined

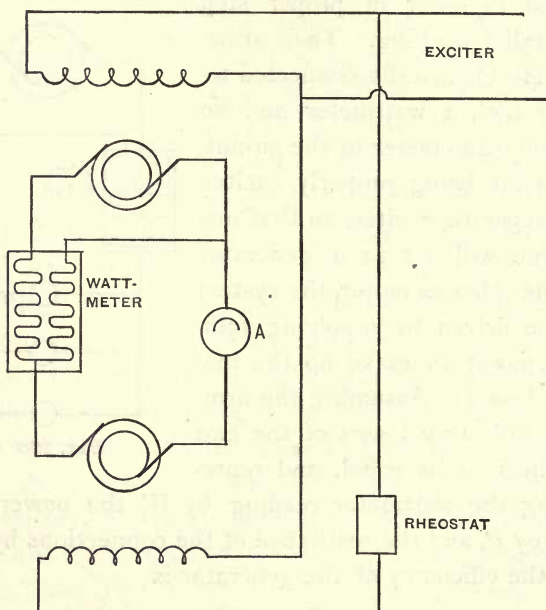

Fig. 169

by the stray power method, and being properly deducted from the readings of power absorbed by it when driving the alternators, the value of P is obtained with sufficient approximation. The three-machine method might be directly applied, but difficulties due to synchronizing are likely to appear.

2. *By Rated Motor.* Where approximate determinations of the various losses of conversion and of the commercial efficiency are sufficient, the alternator tested may be driven directly from a "rated" continuous-current motor. By means of amperemeter and voltmeter the power supplied to the motor may be determined with the alternator operated under such various conditions as may be necessary to determine the losses. By loading the alternator and simultaneously measuring its output and the power absorbed by the motor, the efficiency of the alternator may be determined with sufficient accuracy for ordinary purposes. In each case the power supplied to the alternator is equal to the power absorbed by the motor multiplied by the efficiency of the motor given in per cent. The motor may be rated by determining its efficiency by the stray power method. If the motor efficiency for various loads is determined by some exact method (Vol. I., p. 255), the power transmitted to the alternator may be determined with considerable exactness. When it is desired to carry the accuracy of this method of testing beyond a fairly good approximation, the efficiency at various loads of the rated motor should be plotted, so that the efficiency at any load may be readily read off.

3. *Mordey's Method.* A neat arrangement for testing a single alternator by a method akin to Hopkinson's method has been devised by Mr. Mordey.* It is to be remembered that the Mordey alternator has a stationary armature, the individual coils of which may be connected in any desired combination with perfect facility.

* Testing and Working Alternators, *Four. Inst. E. E.*, Vol. 22, p. 116.

Such an armature may be divided into two parts which are connected in such a way as to oppose each other (Fig. 170). If one part gives a somewhat higher pressure than the other, the first part will operate as a generator and the second as a motor if the alternator is driven in the usual manner. By properly adjusting the difference between the pressures of the two parts, the current flowing in the machine may be caused to have

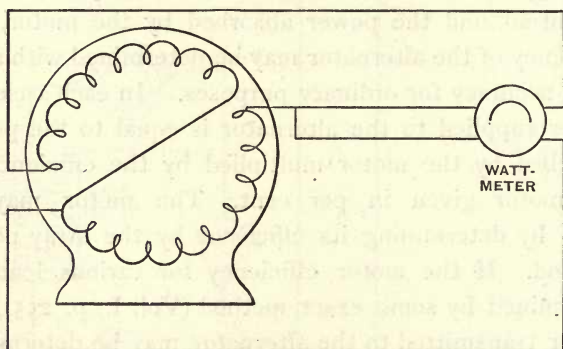

Fig. 170 a

any desired value. The efficiency of the machine is gained by measuring the power absorbed by the machine operating as a self-contained motor-generator and measuring its output by a wattmeter; the pressure coil of the wattmeter being connected across the terminals of the motor and generator coils, and the series coil being connected directly in the circuit. The power thus measured by the wattmeter is evidently about one-half of the total energy of the machine; consequently the corrected efficiency is

$$\eta = \frac{2W}{2W + P + c^2 R_f},$$

where P is the power supplied to the machine. The difference in the pressure developed in the parts of the machine which is necessary to cause the desired current to circulate may be caused by an unsymmetrical division of the armature (Fig. 170a), or by supply-

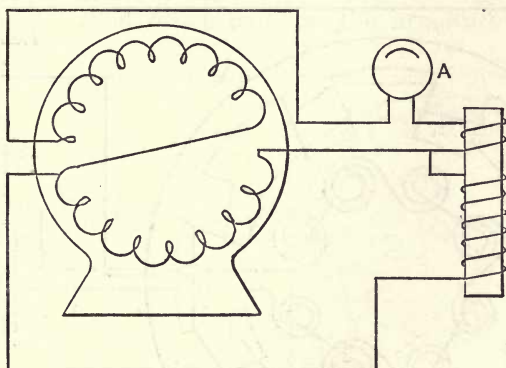

Fig. 170 b

ing a little additional pressure to the generator side by means of a transformer. The latter may be supplied from another alternator operating in synchronism with the machine under test, or it may be supplied directly from the test machine (Fig. 170 b). The transformer is likely, however, to introduce uncertain elements of loss.

4. *Ayrton's Method.* As pointed out by Professor Ayrton,* this arrangement may be modified so as to apply to alternators with rotating armatures. In this case opposite halves of the fields are magnetized in oppo-

* *Four. Inst. E. E.*, Vol. 22, p. 136.

site directions, and the armature is short-circuited through an amperemeter (Fig. 171). By adjusting the relative excitation of the halves of the fields a current of any desired value may be caused to circulate in the armature. If the excitation is practically normal, the measured losses of the machine when any current is flowing will be practically equal to those when the ma-

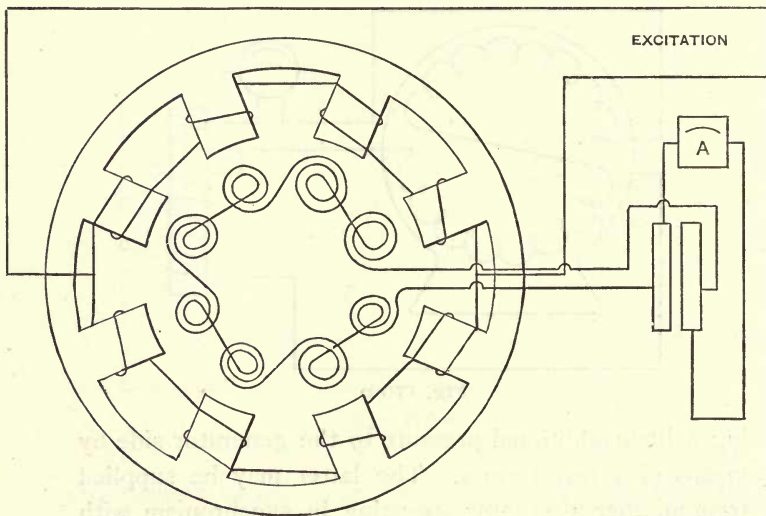

Fig. 171

chine is operating normally on the same current, provided we may assume that the losses in an alternator are appreciably equal when driven as a generator and as a motor. This assumption seems entirely reasonable. The arrangement here described is not applicable to machines with armatures with the halves wound in parallel, since under the test conditions an amperemeter

connected between the terminals of such an armature would not indicate the current circulating in the armature coils.

5. *Motor-Generator Method.* — Mordey has also suggested the following purely electrical method of testing alternators which have stationary armatures.* The machine being properly excited, one-half of the armature is connected as a generator to an external load, R (Fig. 172). The other half of the armature is con-

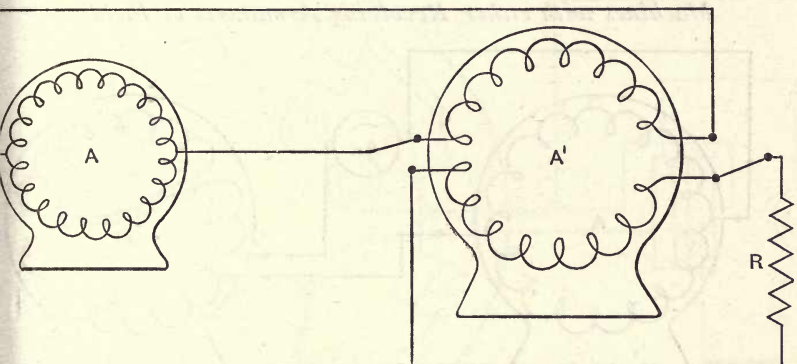

Fig. 172

nected to another alternator and driven as a synchronous motor. The total losses under these conditions are evidently equal to the power absorbed by the motor half of the armature plus the exciting energy and minus the output of the generator half of the armature; that is, $W_m + C^2R_f - W_g$, where W_m and W_g are respectively the power absorbed by the motor and the output of the generator. Since the output, W_g , is the

* *Four. Inst. E. E.*, Vol. 22, p. 122.

output of only half the armature, but the losses thus determined are those of the whole machine, the losses will be the same when the machine is run as a generator with an output of $2W_g$, provided generator losses and motor losses are the same. The efficiency of the machine as a generator is therefore

$$\eta = \frac{2W_g}{2W_g + W_m + C^2R_f - W_g} = \frac{2W_g}{W_g + W_m + C^2R_f}$$

6. *By Driving as a Synchronous Motor—Applicable to Machines with either Revolving Armatures or Fields.*—

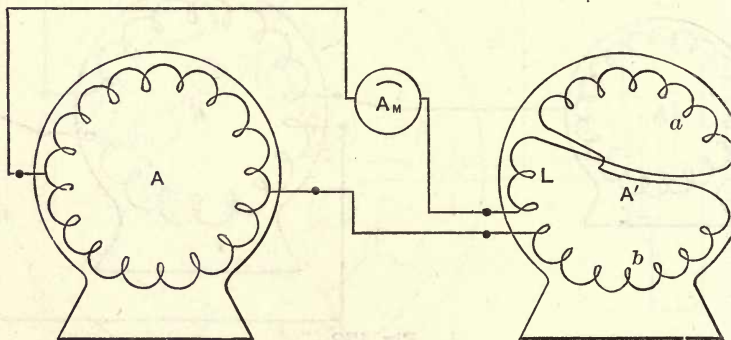

Fig. 173

Another somewhat similar plan is to divide the stationary armature into three divisions which are connected in series. Two of these are made equal and are connected in opposition. The third consists of only a small portion of the armature. The machine is electrically connected to another alternator and operated as a synchronous motor under the influence of the small armature division (Fig. 173). By a proper choice of the number of coils composing the small division any desired current

may be sent through the machine to be tested. The energy given to the machine represents the losses in the machine when operated as a generator and producing the same current with the same excitation. This method is also applicable to determining the losses in machines with revolving armatures the coils of which are all connected in series. In this case the fields are

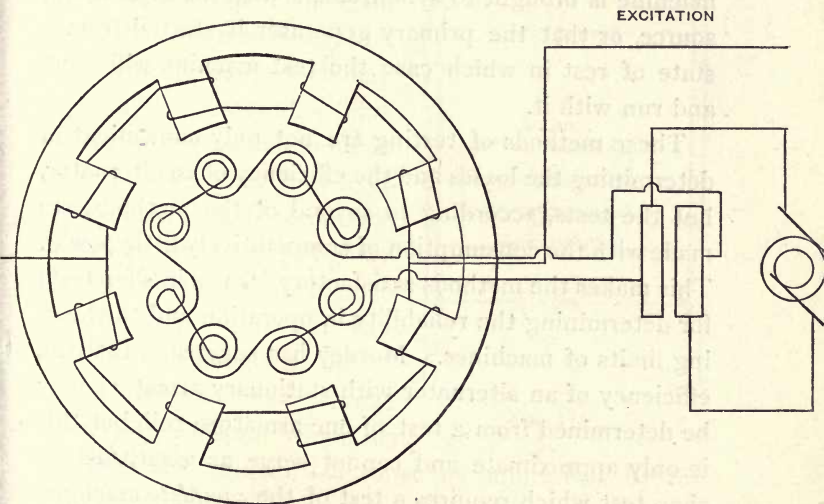

Fig. 174

excited with the poles on one-half reversed (Fig. 174), one-half of the field being slightly stronger than the other. If the armature is connected to that of another alternator, it will run as a motor. The instantaneous counter electric pressure of the machine under test depends upon the relative strength of the two halves of the field, and by adjusting this, with due reference

to the impressed pressure which should be of a relatively small value, the current flowing in the armature circuit may be given any desired value. Under these conditions the losses in the test machine are equal to the power absorbed.

99. Shop Tests. — When, in either of the cases mentioned heretofore, the operation of an alternator as a motor is predicated, it is assumed either that the test machine is brought to synchronism with the alternating source, or that the primary generator is started from a state of rest in which case the test machine will start and run with it.

These methods of testing are not only convenient in determining the losses and the efficiency of an alternator, but the tests, according to several of the methods, are made with the consumption of comparatively little power. This makes the methods satisfactory for use in shop tests for determining the reliability in operation and the heating limits of machines. Mordey has suggested that the efficiency of an alternator with stationary armature may be determined from a test of one armature coil, but this is only approximate and cannot serve as a satisfactory shop test which requires a test of the *complete* machine.

100. Wattmeters on High Pressure Circuits. — In using wattmeters where high pressures are met, considerable difficulty is found in arranging a satisfactory non-inductive resistance for the pressure coil. This difficulty may be readily overcome by a plan suggested by Dr. J. A. Fleming,* and which was successfully used in testing high-pressure alternators at the Chicago

* *Four. Inst. E. E.*, Vol. 22, p. 99; *London Electrician*, Vol. 30, p. 455.

World's Fair. Instead of connecting the pressure coil of the wattmeter across the terminals of the test circuit, the primary of a transformer is so connected, and the pressure coil of the wattmeter is connected to the secondary of the transformer (Fig. 175). The constant of the wattmeter is then dependent upon the ratio of transformation of the transformer, which may be readily measured. This method gives entirely reliable results, since the phases of the primary and secondary pressures of a very lightly loaded transformer are almost exactly 180° apart. If the wattmeter constant be determined without the transformer, its constant when in use with the transformer must be multiplied by the ratio of transformation.

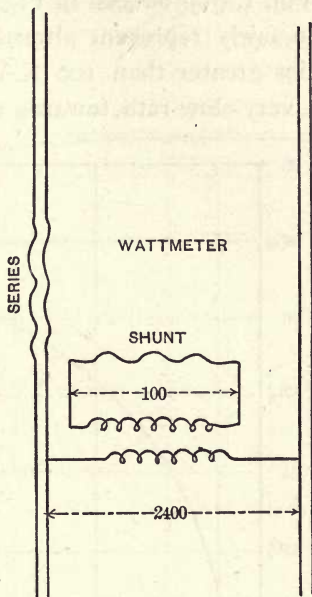

Fig. 175

101. Variation of Efficiency, Weight, and Cost, with Output. — In general, it is safe to say that the efficiency of an alternator should be very nearly the same as that of a continuous-current machine of the same size and built for the same duty. The electrical losses in the two types of dynamos should differ but little, and the conversion losses can be held to an appreciable equality by using proper magnetic densities in alternators, and by

proper construction. The curve showing the relation of commercial efficiency to output, given in Fig. 127 of Vol. I. (reproduced in Fig. 176), may therefore be taken to fairly represent alternator efficiencies. For capacities greater than 100 K.W., the efficiency increases at a very slow rate towards a limit of about 95 per cent.

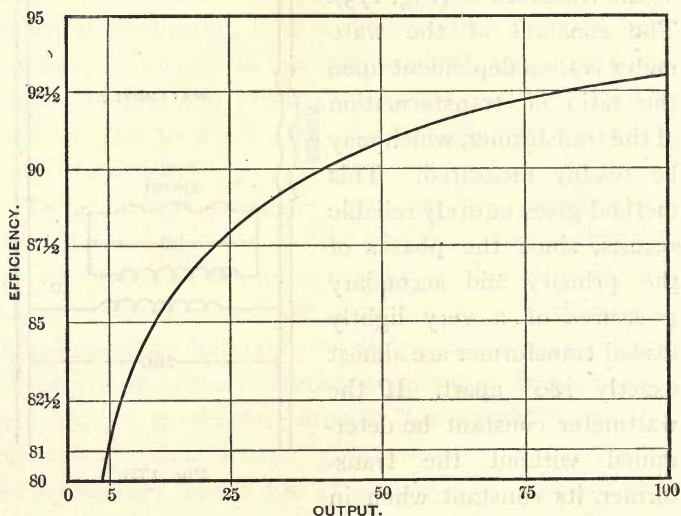

Fig. 176

The great Westinghouse alternators of 1000 horse power capacity, which were tested at the World's Fair at Chicago, showed a commercial efficiency of upwards of 96 per cent. The reported efficiency of various alternators of a capacity of about 200 K.W., varies between 93 per cent and 95 per cent. The efficiencies of continuous-current machines of great capacity are shown by test to be about the same.

The economic curve for alternators is quite similar in form to those given for continuous-current machines (Vol. I., p. 268). Figure 177 gives the experimentally determined curve for an alternator of several hundred kilowatts output.

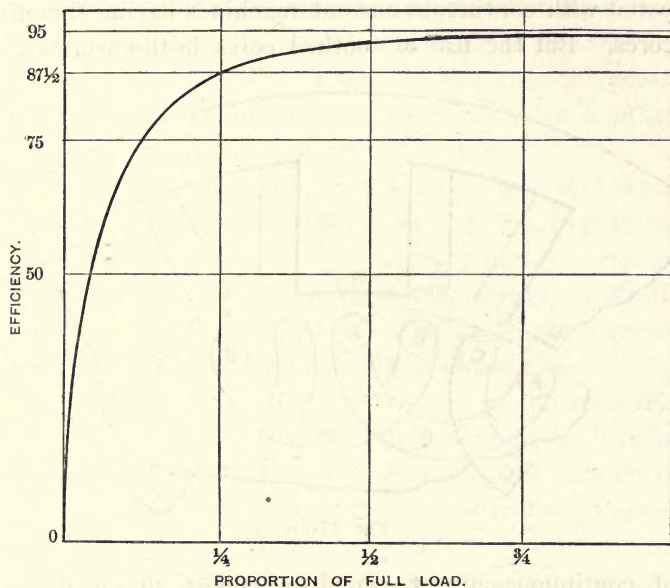

Fig. 177

The relation between weight and output, which has already been discussed in reference to continuous-current dynamos (Vol. I., p. 262), holds equally for alternators, as does also the relation between output and cost. Well-designed continuous-current machines of a greater capacity than 10 K.W. weigh between 75 and 200 pounds per kilowatt, depending upon the type of machine, the material of which the magnetic circuit

is composed, the capacity of the machine, and the use for which it is designed. Practically the same may be said of well-designed *single-phase* alternators. The almost universal use of toothed cores in alternators of the latest design has decreased their weight as compared with continuous-current machines having smooth cores. But the use of toothed cores in the armatures

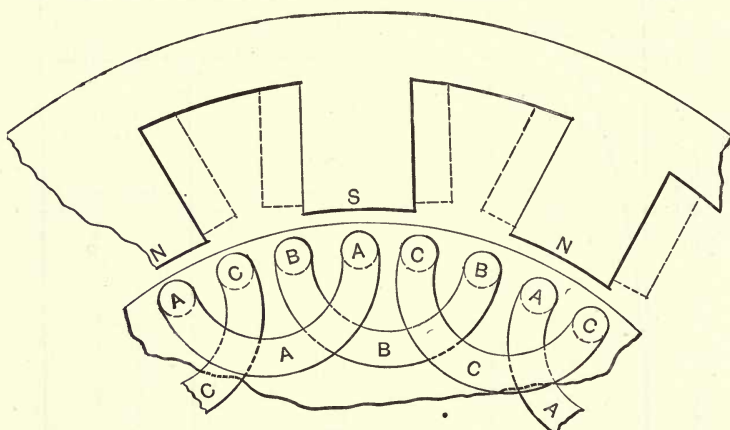

Fig. 178 a

of continuous-current machines makes an equal improvement in them.

If the entire surface of alternator armatures could be effectively covered with wire, as in continuous-current machines, the high allowable periphery speeds and other conditions already discussed (compare Sect. 6) would give them a largely increased output per unit of weight. It has already been shown that this cannot be done for machines with armatures of one circuit. It is possible, however, to wind the armatures with two circuits, which

together entirely fill the surface, each circuit occupying one-half the winding space, as in single-circuit machines, the coils being arranged alternately. The pressure waves of two circuits thus arranged have a phase difference of 90° (Fig. 179). It is also possible to economically fill the winding space with three sets of independent and overlapping coils, which are connected in three independent circuits (Fig. 178). In this case the pressure waves of the different circuits follow each other with a phase difference of 120° (Fig. 180).

Alternators which produce a single pressure wave are called **Single-phase Machines**, or **Single-phasers**. Those that produce more than one pressure wave are called **Poly- or Multi-phase Machines**, or **Poly- or Multi-phasers**. These are divided, according to the number of circuits, into **Two-phasers**, **Three-phasers**, etc.

The conditions at present existing in the construction of polyphase machines enable them to be built at a considerable reduction of cost and weight per unit of output as compared with single-phasers and continuous-current machines. There is, however, a marked tendency toward a reduction in the speeds and frequencies of such machines, and towards increase in the solidity of their construction. The result of this is to increase the comparative cost of the machines per unit of output until they are approximately on a level with the best continuous-current dynamos.

102. Armature Reactions of Poly-phasers. — The armature reactions in poly-phase generators is materially different from that in single-phase generators. Thus, referring to Fig. 89, it is remembered that when

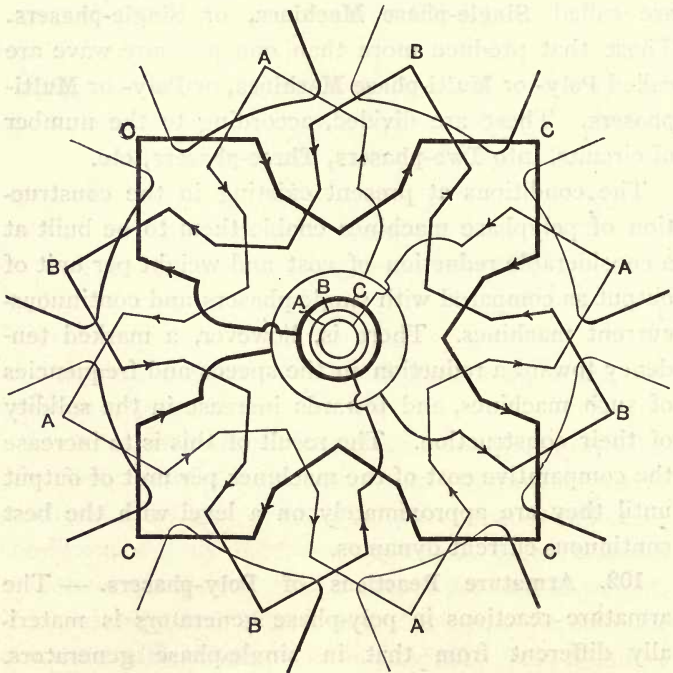
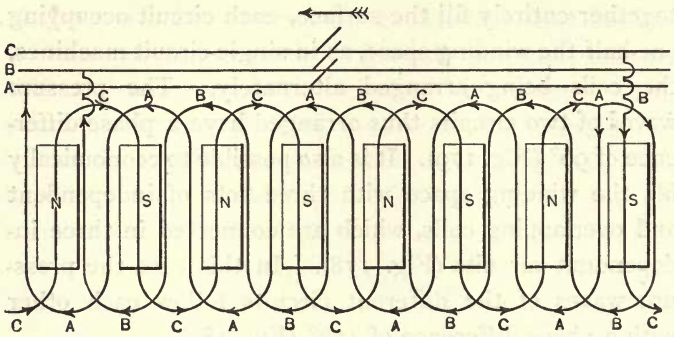

Fig. 178 b

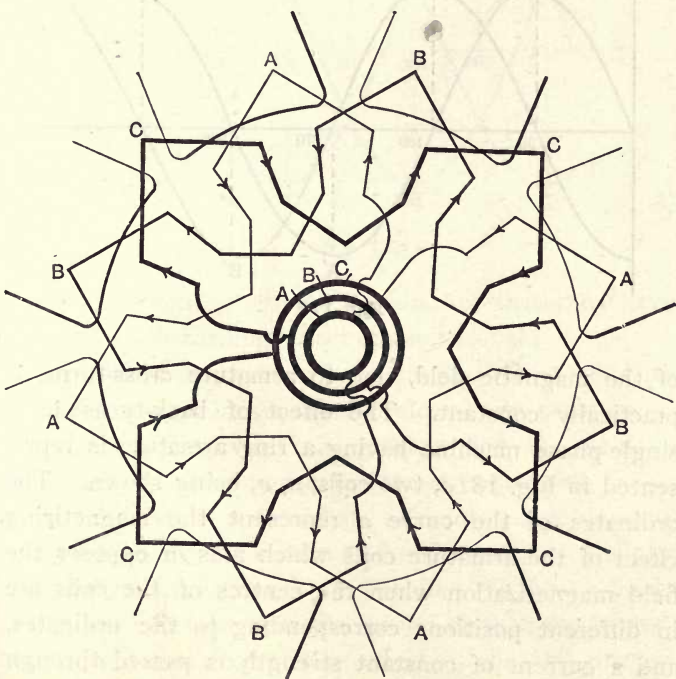
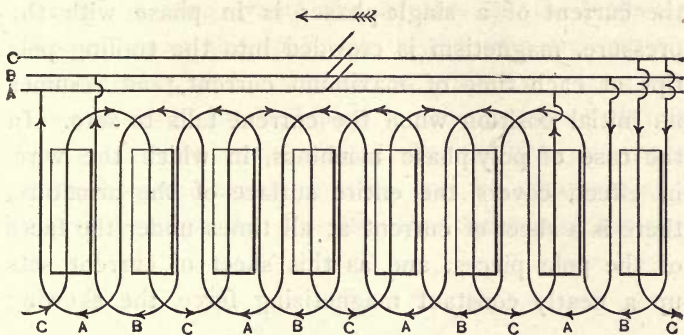

Fig. 178 c

the current of a single-phaser is in phase with the pressure, magnetism is crowded into the trailing pole tips at each time of maximum current, and resumes its initial position when the current falls to zero. In the case of poly-phase machines, in which the wire, in effect, covers the entire surface of the armature, there is a sheet of current at all times under the faces of the pole pieces, and as this sheet of current sets up a nearly constant magnetizing force, the skewing

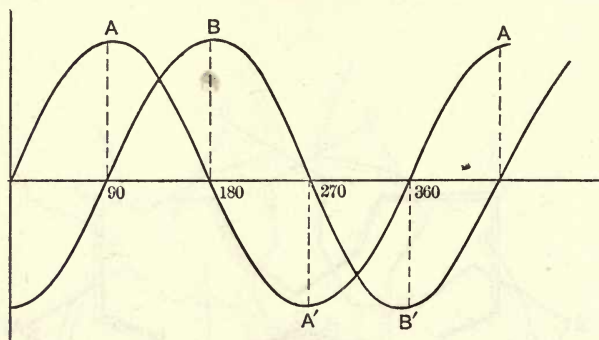

Fig. 179

of the magnetic field, due to armature cross-turns, is practically constant. The effect of back-turns in a single-phase machine having a ring armature is represented in Fig. 181 *a*, two coils, *a*, *a*, being shown. The ordinates of the curve *d* represent the magnetizing effect of the armature coils which aids or opposes the field magnetization when the centres of the coils are in different positions corresponding to the ordinates, and a current of constant strength is passed through them. This magnetizing effect or activity must evi-

dently be zero when the centres of the coils are directly under the poles. E is the pressure curve of the machine, and c the current curve in phase with the pressure. By combining the current curve with the curve of activity, the actual effect of the alternating current in the armature coils may be obtained, as is shown by curve k . It is seen that the sum of the posi-

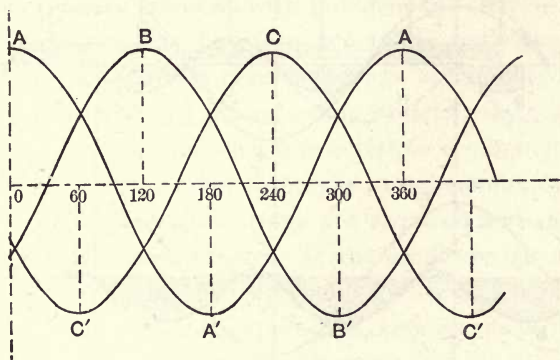

Fig. 180

tive and negative effects is zero, but that they have a periodical disturbing effect upon the field.

In the same manner it is shown in Fig. 181 *b*, that if the current lags behind or leads the pressure, one loop of the curve k' is greater, and the fields are periodically either weakened or strengthened.

In the case of a two-phase alternator, a second curve of reaction exactly similar to k and one-fourth the pitch, or 90° , from k , may be drawn like the heavy lines in Fig. 181 *c* to represent the action of the second set of coils, and the magnetizing effect of the two phases is added together and the skewing effect becomes nearly

uniform when the armature current and pressure are in phase. Similarly, when the current lags or leads, there is a constant weakening or strengthening of the fields, as shown in Fig. 181 *c*, where the ordinates of the line k'' represent this effect. In case the current leads, the

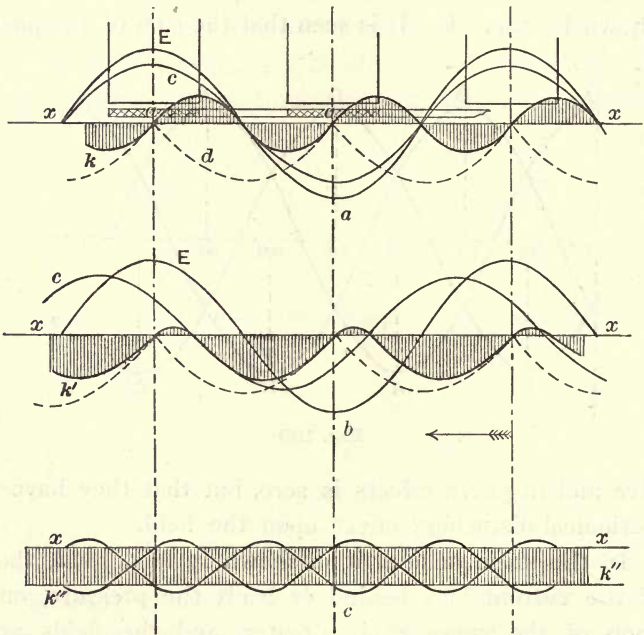

Fig. 181

fields will be strengthened. By the same process it may be shown that the armature reactions* in any poly-phase machine is practically constant and is greater in

* Ossian Chytræus, Armature Reactions, *Electrical World*, Vol. 25, p. 450.

its effect than in a single-phase machine. In machines having large armature reactions this may limit the output of poly-phasers, but in those with small armature reactions poly-phase armatures have much greater capacity than single-phasers.

102 a. Connecting up Poly-phase Armatures.—The connecting up of two-phase armatures is very simple. If the armature is wound with independent concentrated coils, each coil may be connected to its individual collector rings, in which case four rings are required and the two circuits are entirely independent; or, one terminal of each coil may be connected to a common collector ring and the other terminals to independent rings, in which case but three rings are required and the circuits have a common point. If the armature has a continuous-current or closed-circuit distributed winding, such as is treated in Section 5, it may be made into a two-phaser by connecting collector rings to the windings at the ends of two diameters which are 90° apart, if the machine is bipolar; if the machine is multipolar, the connections must be made as described in Section 191. Four rings are necessary in this case, as the use of a common ring would cause the permanent short-circuiting of one-quarter of the armature. A continuous-current armature converted into a polyphaser (of any number of phases) in this manner has a capacity when used as a poly-phase alternator which is equal to its continuous-current capacity, though it has already been shown that its capacity as a single-phaser is only seven-tenths as great as its continuous-current capacity (Sect. 5).

The manner of connecting three-phase armatures is not so immediately evident, but is perfectly simple. It is illustrated in Figs. 178 *b* and 178 *c*. Three collecting rings are universally used, and if the armature is wound with three independent coils, these may be connected to the rings in either of two ways: (1) one end of each of the coils may go to a common point, and the other ends go to independent rings; or, (2) the coil terminals may be connected together two and two, forming a sort of triangle, and connections be carried to the collector rings from these points. The latter arrangement makes each coil terminate at both ends in a collector ring, and, since there are six coil ends and three rings, each ring is connected with two coil terminals. These two arrangements are illustrated respectively in Figs. 178 *b* and 178 *c*, each of which shows the winding diagrammatically as developed and as projected. The following considerations make it perfectly easy to connect the coils in the proper order: Fig. 180 shows that when the current in one coil is at its maximum point, the currents in the other two are equal to each other and opposite to the direction of the first; then, considering the instant at which the conductors of one coil (such as *C* in the figure) are directly under the poles, if we connect its positive end to the common or **Neutral Point**, the negative ends of the other two coils must be connected to the same point. Each of the free terminals may then be connected to one of the collector rings, and the connection is completed according to the first or **Star** arrangement (Fig. 178 *b*). To make the second or **Mesh** arrangement, the coils must be connected

so that, at the instant considered, the current flows by two paths through the armature from the negative to the positive terminal of the first coil (coil *C* of the figure). Consequently the negative terminals of the first and second coils go to one collector ring, the positive terminals of the first and third coils to another ring, and the free terminals of the second and third coils to the third ring (Fig. 178 *c*).

If the armature has a closed-circuit or distributed winding, the connection is very simple, as the rings are connected to points in the windings 120° apart. If the machine is multipolar, it must be remembered that one cycle, or 360 electrical degrees, is comprised within the space of twice the polar pitch. This is more fully treated in Section 191.

In a three-phase machine, if the armature is mesh-connected, the pressure between any two collector rings is equal to the pressure developed in one coil, while the current leaving a brush is the vector sum of the current in two coils; and, if the armature is star connected, the pressure between the rings is equal to the vector sum of the pressure developed in two coils, while the current leaving a brush is equal to the current in a coil. The vector sum in either case is $\sqrt{3}$ times the arithmetical sum, so that the capacity of a machine is independent of the way in which its armature is connected, but, for a given pressure and output, the windings will differ (though the weight of copper will be the same) for the two arrangements. This is treated more fully in Chap. XIII.

CHAPTER IX.

MUTUAL INDUCTION.

103. The Function of a Transformer.—The remarkable development in the use of alternating currents for transmitting and distributing electric power, is mainly due to the facility and economy with which they may be transformed from one pressure to another. The transmission of electric power between two points may be made by alternating currents at high pressure for the sake of economy in the cost of conductors, and the pressure may be reduced at the receiving point by means of induction coils to any value which is deemed entirely safe and convenient for distribution.

The induction coils that are used for this purpose are called **Transformers** or **Converters**, because they are used to transform or convert the electrical energy from one state to another. Formerly transformers were sometimes called **Secondary Generators** on account of the apparent regeneration of the energy of the alternating currents.

The action of transformers is due to the inductive effect which a varying current in one circuit exerts upon an adjacent circuit. Since this effect is a mutually interacting one, it is called **Mutual Induction**. Before proceeding to the study of the commercial trans-

formers, it is essential to examine the relations which exist between two adjacent circuits, one or both of which carry an alternating current.

104. Mutual-Inductance. — Suppose two adjacent coils surrounded by air and in which a current is flowing: the total number of lines of force passing through either one of the coils is the number of lines set up by the current in that coil plus the number of lines set up in the other coil which are embraced by the first. If the current is changed in either of the coils, an electrical pressure is set up in the coil under consideration, which may be called the first coil, which is equal to $E' = \frac{n' dN'}{10^8 dt}$, where n' is the number of turns and N' the magnetic flux in the first coil. The number of lines passing through the coil due to its own current is $\frac{10^8 L' C'}{n'}$. L' and C' are respectively the self-inductance and the current in the first coil (Chap. III.). The number of lines of force due to the first coil which pass through the second coil evidently depends upon the relative positions of the coils, but it cannot be greater than the total number of lines set up by the current in the first coil. For any two fixed coils in a medium of fixed permeability, this number of lines is proportional to the current. The electric pressure developed in the second coil due to the change in the current flowing in the first is $E'' = \frac{n'' dN''}{10^8 dt}$, where n'' and N'' are the turns and magnetism in the second coil. The equation $E' = \frac{n' dN'}{10^8 dt}$ may be written $E' = \frac{L' dC'}{dt}$, when

the permeability is constant. The equation $E'' = \frac{n'' dN''}{10^8 dt}$ may be similarly written $E'' = \frac{MdC'}{dt}$, where $10^9 M$ is the number of turns in the second coil multiplied by the number of lines of force passing through the second coil which are due to the first coil when one ampere is flowing in it; and M is called, by analogy, the **Mutual-Inductance** or the **Coefficient of Mutual Induction** of the coils. The value of N'' is evidently equal to $N'k$, where k is a constant depending on the reluctance of the path of the lines of force which interlink the two coils. If the coils are long solenoids, $N' = \frac{4\pi n' CA}{10l}$, where A is the cross-section and l the length of the coil; and if the solenoids are wound one over the other so that their dimensions are practically equal, the value of k is unity because N'' evidently becomes equal to N' , and M becomes equal to $\frac{N'n''}{10^8 C}$. If the action of the coils be now reversed, that is, if a current flows in the second coil, we have $N'_1 = \frac{4\pi n'' CA}{10l}$, and $M_1 = \frac{N'_1 n'}{10^8 C}$. But $\frac{N'}{N'_1} = \frac{n''}{n'}$, and hence $M = M_1$. In this case, also, $L' = \frac{N'n'}{10^8 C}$ and $L'' = \frac{N'_1 n''}{10^8 C}$. Consequently $L'L'' = M^2$, or $M = \sqrt{L'L''}$.

If the solenoids be now separated by drawing one out of the other, the value of M continually decreases as the separation continues. The self-inductances of the coils remain constant, so that as the coils separate, the mutual-inductance becomes less than $\sqrt{L'L''}$. As the separation of the coils becomes greater, the value of M decreases towards a minimum of zero. It

reaches this value when the coils are at an indefinitely great distance apart or the axis of one is placed symmetrically but at right angles with reference to the axis of the other. The maximum possible value of the mutual-inductance of the two coils is therefore a mean proportional between the values of their self-inductances, and the minimum value is zero. The maximum value can only be attained when all the lines of force due to one coil pass through all the turns of the other, and the value of M may therefore be written $M \leq \sqrt{L'L''}$, from which it is at once seen that the mutual-inductance of the two coils must always be small if the self-inductance of one or both of the coils is very small, while the mutual-inductance may be large if both the self-inductances are large. It is shown on the preceding page that the value of M may be generally written $M = n'N'k$. In this expression N' is proportional to n' , whence it is shown that $M \propto n'n''k$.

The product of the number of lines of force which interlink two coils by the number of turns in the individual coils will not change by changing the point of reference from one coil to the other, and, consequently, the mutual-inductance of two coils is always the same when measured from either coil, provided the reluctance of the magnetic circuit is unchanged. When the magnetic circuit is composed wholly or partly of iron, it is necessary to have an equal number of lines of force in each part of the circuit, when the two measurements are made, in order that they may give equal results. When the magnetic circuit is made up partly of iron and partly of non-magnetic materials, and the coils are quite dif-

ferent, as in dynamos, the condition of equal induction is difficult to fulfil, and the value of M may be quite different when measured from the fields and from the armature. This difference is wholly due to the difference in the permeability of the magnetic circuit during the two measurements.

As shown above, the mutual-inductance is homogeneous with, and therefore of, the same dimensions as self-inductance. Its unit is therefore the henry. The practical unit for mutual-inductance, M , as here developed by comparison with L , is 10^9 times as large as the absolute unit.

If the lines of force due to one coil which enter another do not all pass completely through the second coil, the definition of the mutual-inductance still holds as already given, but the summation of the number of lines of force passing through each individual turn must be taken (compare Sect. 16). If iron be inserted in the path of the lines which interlink two coils, the mutual-inductance is increased in the ratio of $\frac{P}{P'}$, where P and P' are the reluctances of the path before and after the iron is inserted. The ratio $\frac{P}{P'}$ is dependent on the permeability of the iron in the magnetic circuit, and the value of M must therefore vary with the current in the coils in any case where iron is in the magnetic circuit, while it is independent of the value of the current when magnetic material is absent.

105. The Energy of Mutual Induction. — Assume two adjacent coils with a constant mutual-inductance. In one let a current of C' amperes flow, and in the other

a current of C'' amperes. The number of lines of force due to the first coil which pass through the second is $\frac{10^8 MC'}{n''}$, and the change in this number when C' changes is $\frac{10^8 M dC'}{n''}$. If the current C' be varied, the work due to mutual induction which is done in the second coil in changing the magnetic field against the effect of the current C'' is (by Vol. I., p. 69) $dW = MC'' dC'$ (compare Sect. 18). If the current in the first coil be changed from zero to C' , the work done on the second coil is $W = \int_0^{C'} MC'' dC' = MC' C''$, which is all stored in the magnetic field. If the current C' falls again to zero, this work is restored to the circuit. When M varies with the current, the work is still $MC' C''$, but M in the expression must be assigned its equivalent mean value between the limiting values of the current (compare Sect. 18). As the current in the first coil rises to C' , the total work stored in the magnetic field is evidently the sum of the work due to self- and mutual-induction, or $\frac{L' C'^2}{2} + MC' C''$.

If the current varies in both the coils at the same time, the following condition exists at any instant. The total pressure in either coil is the resultant of three elements — the active pressure (cR), the pressure of self-induction $\left(\frac{Ldc}{dt}\right)$, and the pressure of mutual-induction $\left(\frac{Mdc}{dt}\right)$, and

$$c' = \frac{e' - \frac{d(Mc'' + L'c')}{dt}}{r'}$$

$$c'' = \frac{e'' - \frac{d(Mc' + L'c'')}{dt}}{r''},$$

where e' and e'' are the instantaneous impressed pressures in the two coils. By transformation we have

$$\begin{aligned}(e' - c'r') dt &= Mdc'' + L'dc', \\ (e'' - c''r'') dt &= Mdc' + L''dc''.\end{aligned}$$

Multiplying these respectively by c' and c'' and adding, gives

$$\begin{aligned}(c'e' + c''e'') dt - (c'^2r' + c''^2r'') dt &= L'c'dc' + L''c''dc'' \\ &+ M(c'dc'' + c''dc').\end{aligned}$$

The first and second terms of the left-hand member of this equation represent respectively the total work done by the impressed electric pressures and the work expended in the coils in heat during the interval dt . Their difference represents the work done on the magnetic field. The total work done on the magnetic field during any change of the currents, as from zero to C' and C'' , is found by integrating the right-hand member of the equation. Thus,

$$\begin{aligned}L' \int_0^{C'} c'dc' + L'' \int_0^{C''} c''dc'' + M \int_0^{C'} (c'dc'' + c''dc') \\ = \frac{L'C'^2}{2} + \frac{L''C''^2}{2} + MC'C''\end{aligned}$$

If the currents now fall to zero again, the work has the same value as above, but the negative sign. In the first case electrical energy is absorbed from the circuit and stored in the magnetic field which is set up, and in the second case the stored work is restored to the circuit as the magnetic field dies away.

106. Transfer of Electricity by the Effect of Mutual Induction. — Now suppose that no pressure is initially impressed on the second coil (that is, $e'' = 0$), then when the current in the first coil is changed, the conditions in the second coil are given from the equations above; thus

$$c'' = \frac{-d(Mc' + L''c'')}{r''dt}$$

Whence $c'' r'' dt = -Mdc' - L''dc''$,

and $\int_0^t c'' r'' dt = -M \int_0^\sigma dc' - L'' \int_0^\sigma dc''$.

Since the last term reduces to zero, the quantity of electricity which is transferred in the second coil under the inductive influence of the first when its current changes from zero to C' is

$$\int_0^t c'' dt = q'' = -\frac{M}{r''} \int_0^\sigma dc' = -\frac{MC'}{r''} = -\frac{ME'}{r' r''}$$

If the current of the first coil is now brought to its original value, we have

$$q_1'' = -\frac{M}{r''} \int_\sigma^0 dc' - \frac{L''}{r''} \int_0^\sigma dc'' = \frac{MC'}{r''} = \frac{ME'}{r' r''}$$

The two quantities are equal and of opposite sign, so that the transfer of electricity in the secondary coil during the rise and fall of the primary current reduces to zero, provided the original and final values of the primary current are equal (compare Sect. 19).* If the current in the first coil is a simple periodic one, a

* Gerard's *Leçons sur l'Électricité*, 3d ed., Vol. I., p. 227; Hospitalier's *Traité sur l'Énergie Électrique*, Vol. I., p. 486.

periodic current of the same frequency is set up in the second coil. Such an arrangement of two coils is a transformer. The first coil is called the **Primary Coil**, and the second is called the **Secondary Coil**. The pressures or currents in the primary and secondary coils are called respectively primary and secondary pressures or currents. When the primary current wave is a sinusoid and the mutual-inductance is constant, the electric pressure induced in the secondary is also a sinusoid, but lagging in phase 90° behind the phase of the primary current. This is evident from the fact that the induced pressure is proportional to the rate of change of the magnetization, and the magnetization is in phase with the primary current (compare Sect. 15). When iron is present in the magnetic circuit, M is no longer constant, and the rate of change of the magnetization is not proportional to the rate of change of the current; consequently the secondary pressure wave is no longer similar to the wave of primary current, but it is always exactly similar in form to the wave of counter electric pressure set up in the primary coil.

107. The Pressure Relations in a Transformer. — If a sinusoidal current is caused to flow in one of two coils, such as have been considered in the preceding paragraph, the relative positions of the pressures in the two coils may be shown graphically as follows. In Fig. 182, let OE_{1a} be the active pressure in the primary coil acting upon the current (OC_1). This current will set up a self-inductive pressure in the primary, $OE_{1s} = 2\pi fL_1C_1$, and a mutually inductive pressure in the secondary, $OE_{1m} = 2\pi fMC_1$. These pressures are in the same

$= 2 \pi f M C_2$, both lagging 90° behind the current. The active pressure in the secondary is the resultant of OE_{1m} and OE_{2s} , or OE_2 . The pressure impressed upon the primary (OE_1) must be such that when combined with the self and mutually inductive pressures OE_{1s} and OE_{2m} the resultant will be the active pressure OE_{1a} . The vector diagram which gives OE_1 is completed by drawing from E_{1a} the line $E_{1a}A$ which is equal and parallel to OE_{2m} , and from A the line AE_1 which is equal and parallel to OE_{1s} . Then OE_1 is the impressed pressure. If the current OC_2 be increased, E_{2s} and E_{2m} , which depend upon the secondary current, will be larger, and ϕ_1 , the angle of lag of the primary current, will be less, while the secondary current will swing around more nearly into opposition with the primary current. Under these circumstances the active secondary pressure will be smaller if the primary pressure remains constant. If the secondary current be made smaller, the primary pressure remaining constant, the active secondary pressure will be increased, ϕ_1 increased, and the secondary current will swing around towards a phase which is 90° behind the primary current. It is evident that the primary and secondary currents combine to give a resultant magnetizing effect which sets up the magnetization in the magnetic circuit. This property will be used in the chapter on design.

108. Measurement of Mutual-Inductance.—Before leaving this part of the subject, it is well to consider the methods of measuring mutual-inductances. The various practical methods are based on a comparison of the unknown mutual-inductance with a known resistance,

a capacity, a self-inductance, or another mutual-inductance. The latter may be the mutual-inductance of two standard coils which are fixed in a position relative to each other. The mutual-inductance of two such coils may be determined by calculation if the coils are of the proper shape, or it may be made by careful comparative measurements.

I. *Direct Measurement by Amperemeter and Voltmeter* (using an alternating current). The formula

$$E'' = \frac{MdC'}{dt}$$

(Sect. 104) indicates a method of measuring the mutual-inductance of two coils when a source of sinusoidal alternating current is at hand. When the current is sinusoidal and flows continuously through the primary coil, the instantaneous pressure induced at any moment in the secondary coil is

$$e'' = \frac{Mdc'}{dt} = \frac{Md(c'_m \sin a)}{dt} = \frac{Mc'_m \cos a da}{dt}$$

The maximum value of the induced pressure is

$$e''_m = \frac{Mc'_m da}{dt} = 2\pi f Mc'_m,$$

since $\frac{da}{dt} = 2\pi f$ (Sect. 24). The effective value of the induced pressure is therefore $E'' = 2\pi f MC'$, or $M = \frac{E''}{2\pi f C'}$. The mutual-inductance of the coils may therefore be measured by passing through one of them a sinusoidal current the effective value of which is

measured by an amperemeter, and measuring the effective value of the induced pressure (Fig. 183).

2. *Direct Measurement* (using amperemeter and ballistic galvanometer). Connect the primary of the two coils, the mutual-inductance of which is to be measured, in series with a battery, an amperemeter, and a key (Fig. 184). In series with the secondary coil connect a ballistic galvanometer, making the total resistance of the secondary some known value R'' . Then, when the key in the primary is closed, there will be an induced current

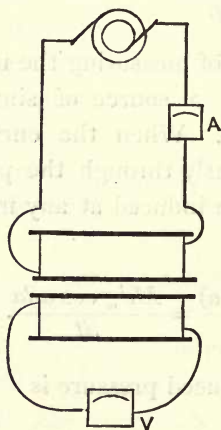

Fig. 183

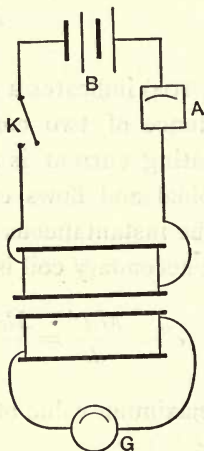

Fig. 184

in the secondary, during the continuance of which the number of coulombs passing will be $Q'' = \frac{MC'}{R''}$ (Sect. 106), where C' is the final value of the current in the primary, and M is the value of the mutual inductance which is sought. The value of Q'' is determined from the throw of the ballistic galvanometer. The equation

then contains only one unknown quantity, the value of M , which is therefore determined by the solution

$$M = \frac{Q'' R''}{C'} = \frac{R'' K \theta}{C'},$$

where θ is the throw of the ballistic galvanometer, and K is its constant. If the known primary current be reversed, the formula becomes

$$M = \frac{Q'' R''}{2 C'} = \frac{R'' K \theta}{2 C'}.$$

3. *Comparison with a Known Capacity* (Carey Foster's Method). By modifying the preceding method, it is possible to make the desired determination without knowing the constant of the ballistic galvanometer. Thus, after the observations have been taken as described, a condenser with the galvanometer in series may be shunted around the resistance r' , which is in the primary circuit (Fig. 185). Then when the key is closed, the quantity of electricity which passes through the galvanometer is (Sect. 35 a)

$$Q_1 = s C' r'.$$

If the resistance r' , shunted by the condenser, is adjusted without altering the total resistance in the circuit, so that the galvanometer deflections in the two positions are equal, or $Q_1 = Q''$, then

$$s C' r' = \frac{M C'}{R''};$$

whence

$$M = s r' R''.$$

If the deflections, and therefore the quantities, of electricity are not equal in the two cases, this becomes

$$M = \frac{sr'R''\theta}{\theta_1},$$

where θ and θ_1 are the respective throws of the galvanometer in the two positions. In order that the adjustment may be readily made, the arrangement shown in Fig. 186 is employed. The variable resistances r' and r'' , which are in the primary and secondary circuits,

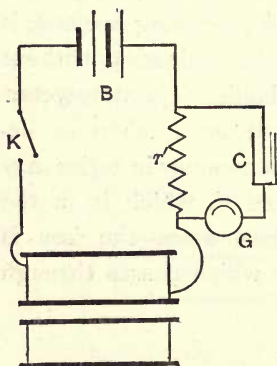

Fig. 185

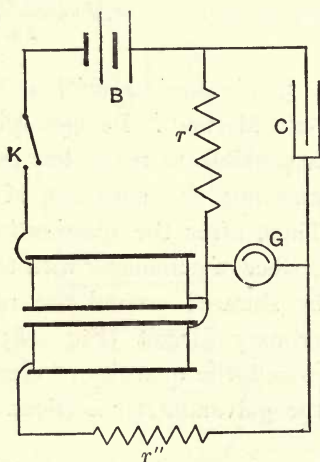

Fig. 186

respectively, are adjusted until the galvanometer gives no throw upon closing the primary circuit. Then the electric flow due to charging the condenser is exactly equal and opposite to the flow in the secondary. In this case we have

$$sC'r' = \frac{MC'}{R''},$$

or, as before,

$$M = sr'R''.$$

In order that the self-induction of the circuits may not disturb the observations, the ballistic galvanometer must have a rather sluggish needle, so that it will not move appreciably during the duration of the discharge* (Sect. 20).

3 a. (Pirani's Method.) This method has much in common with the preceding, but the arrangement of the circuits is quite different (Fig. 187). Here the primary and secondary circuits each contain variable resistances, r' and r'' . These are connected together at the ends where they join their respective coils; at the other end they are joined through a condenser. The battery and galvanometer are connected respectively in the primary and secondary circuits, as shown in the figure.

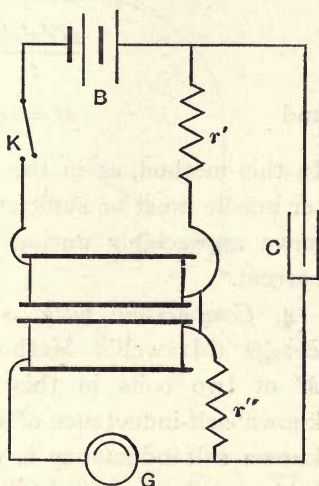

Fig. 187

When a current is set up in the primary, a charging current tends to flow through r'' into the condenser which transfers $sC'r'$ coulombs of electricity. The average difference of electric pressure at the terminals of r'' during the period of charging, t , is therefore $\frac{sC'r'r''}{t}$.

The average pressure set up by induction in the second-

* *Philosophical Magazine*, Vol. 23, 3d Series, p. 121; Gerard's *Leçons sur l'Électricité*, 3d ed., Vol. I., p. 327; Gray's *Absolute Meas. in Elect. and Mag.*, Vol. II., p. 303.

ary circuit, which is opposite in direction to the charging current, is $\frac{MC'}{t}$. When the resistances r' and r'' are adjusted so that the galvanometer shows no deflection, the average fall of pressure in r'' during the period of the transient current which is caused by the condenser charging current, is equal to the average pressure developed in the secondary coil. Consequently,

$$\frac{sC'r'r''}{t} = \frac{MC'}{t},$$

and

$$M = sr'r''.$$

In this method, as in the previous one, the galvanometer needle must be sufficiently heavy, so that it does not move appreciably during the period of the transient current.*

4. *Comparison with a Known Self-inductance by Bridge* (Maxwell's Method). The mutual-inductance M of two coils in this case is compared with the known self-inductance of one of the coils. The coil of known self-inductance is connected in one arm R of a bridge, and the other coil is connected in the battery circuit (Fig. 188); the connections being so made that the magnetic effects of the two coils are in opposition. The resistances of the other arms of the bridge are represented by R_1 , A , and B . The bridge is balanced by trial and approximation for both steady and transient currents, when the fall of pressure in the bridge arm R is equal to that in the arm R_1 . From this con-

* *Elektrotechnische Zeitschrift*, 1887, Vol. 8, p. 336; Hospitalier's *Traité de l'Énergie Électrique*, Vol. I., p. 301.

dition the following equations are formed. If c and c_1 are the currents in the arms R and R_1 , at any instant the fall of pressure in the arm R is

$$Rc + \frac{Ldc}{dt} + \frac{M(dc + dc_1)}{dt},$$

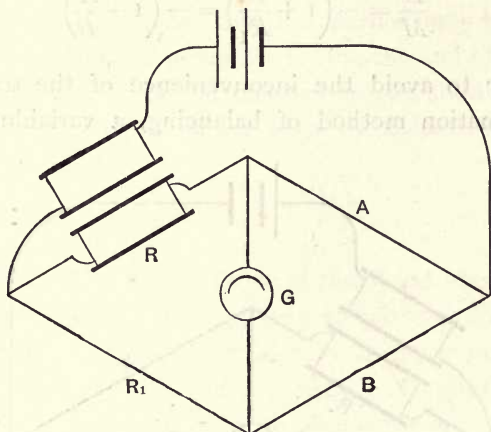

Fig. 188

and the fall of pressure in the arm R_1 is R_1c_1 . The condition of balance for both transient and steady current requires that

$$R_1c_1 = Rc + \frac{Ldc}{dt} + \frac{M(dc + dc_1)}{dt} \text{ and } R_1c_1 = Rc.$$

Hence $\frac{Ldc}{dt} + \frac{M(dc + dc_1)}{dt} = 0$.

That is, the current, $c + c_1$, flowing in the battery circuit, and that in the arm R , c , must have such a ratio that

the effects of self and mutual induction are equal and opposite. Integrating the last equation gives

$$Lc + M(c + c_1) = 0,$$

and combining this with $Rc = R_1c_1$ gives

$$\frac{L}{M} = -\left(1 + \frac{R}{R_1}\right) = -\left(1 + \frac{A}{B}\right).$$

In order to avoid the inconvenience of the trial and approximation method of balancing, a variable resist-

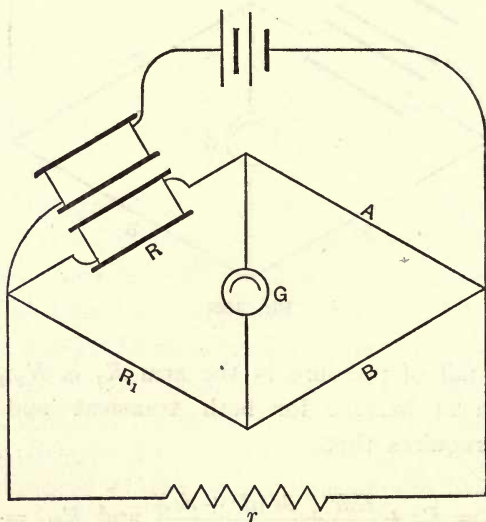

Fig. 189

ance, r , may be connected between the battery terminals of the bridge (Fig. 189), and the required relations between the transient currents in the battery circuit and arm R may be gained by adjusting this resistance with-

out disturbing the steady balance of the bridge. Then we have, by a solution similar to the above,

$$\frac{L}{M} = - \left(1 + \frac{R}{R_1} + \frac{(R + A)}{r} \right).$$

These equations show that the value of L must be greater than M , in order that the method may be used. To make the method generally useful, the coil of known self-inductance should be inserted in the shunt circuit with the resistance r . Then, when the balance is made,

$$\frac{L}{M} = - \left(R + \frac{R_1}{r'} \right),$$

where r' is the total resistance of the shunt branch.

In order that this method may be reliable, the inductances of the bridge coils must be entirely negligible or a proper correction must be made. To gain greater sensibility in the method, a secohmmeter may be used with the bridge (Sect. 37).*

4*a*. (Niven's Method.) In this case, the mutual-inductance, M , of two coils is compared with the known self-inductance of another coil. The coil of known self-inductance is connected in one of the bridge arms, R . One of the coils whose mutual-inductance it is desired to measure is connected in the battery circuit, and the other is connected in series with a variable resistance, as a shunt to the galvanometer (Fig. 190). When the bridge is balanced for steady currents, a balance for

* Maxwell's *Electricity and Magnetism*, 2d ed., Vol. II., p. 365; Gray's *Absolute Measurements*, Vol. II., p. 465.

transient currents may be gained by adjusting the variable resistance in the shunt circuit. This being done, we have

$$\frac{L}{M} = \frac{(R + R_1)^2}{Rr},$$

where r is the resistance of the circuit shunting the galvanometer. The galvanometer needle must have a

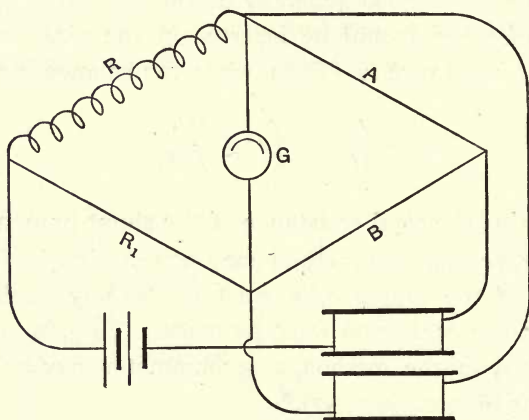

Fig. 190

considerable time of vibration as before, and a secohm-meter must be used to give sensitiveness.*

5. *Comparison of Two Mutual-Inductances* (Maxwell's Method). The primaries of the two pairs of coils are connected in series with a battery and key, and the secondaries are connected in series with variable resistances. A galvanometer is connected as a shunt between the secondaries (Fig. 191). The variable resist-

* Gray's *Absolute Measurements*, Vol. II., p. 475.

ances are adjusted until the galvanometer shows no deflection upon opening and closing the key. Then

$$\frac{M_1}{M_2} = \frac{R_1}{R_2},$$

where R_1 and R_2 are the total resistances in the secondary circuit on either side of the galvanometer.

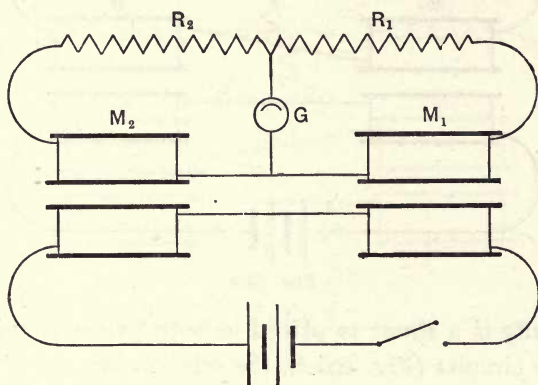

Fig. 191

This method may be modified by connecting the galvanometer in series with the secondaries, which are connected in opposition. A shunt is then connected between the lead wires, as in Fig. 192. When the resistances on either side of the shunt have been adjusted so that the galvanometer shows no deflection on opening and closing the key, the relation obtaining is

$$\frac{M_2}{M_1} = \frac{R_2 + R_s}{R_s},$$

where R_s is the resistance of the shunt connection.

If the shunt connection is placed in the primary circuit

(Fig. 192 *a*) and R_3 is the total resistance of the primary circuit to the right of the shunt, the relation becomes

$$\frac{M_2}{M_1} = \frac{R_p}{R_p + R_3}$$

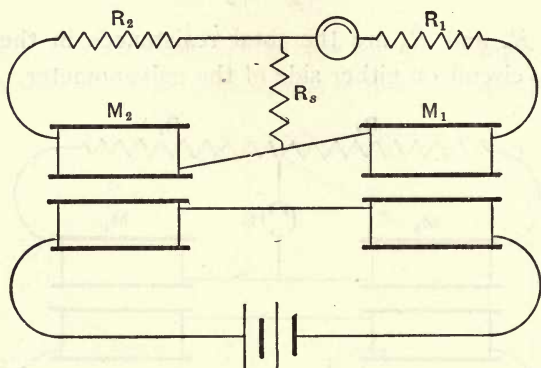

Fig. 192

Finally if a shunt is placed in both primary and secondary circuits (Fig. 192 *b*), the relation becomes *

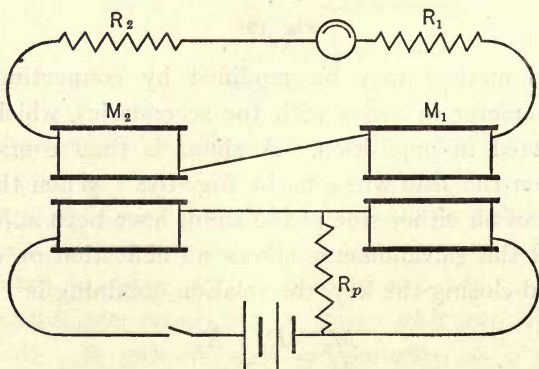

Fig. 192 a

* Maxwell's *Electricity and Magnetism*, 2d ed., Vol. II., p. 363; Gray's *Absolute Measurements*, Vol. II., p. 444.

$$\frac{M_2}{M_1} = \frac{R_p(R_2 + R_s)}{R_s(R_p + R_3)}$$

In this method a secohmmeter may be used, and then the galvanometer terminals will be reversed at each reversal of the current. Therefore, a dead beat galvanometer may be substituted for the ballistic form, and

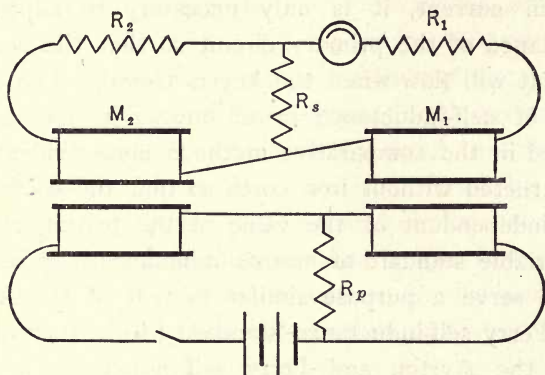

Fig. 192 b

when the desired condition obtains, it will indicate that no current is passing.

109. Coils with Iron Cores.—When measurements of the mutual-inductances of coils with iron cores are made by either of the preceding methods, the value observed will depend upon the magnitude of the current used in making the measurements. Since it is not practicable to use currents of much magnitude in the bridge methods, they are not adapted to the measurement of the mutual-inductances of coils with iron cores which are designed for use with large currents. The

last method is a laborious one, and therefore is not well adapted to general use unless modified by employing a variable standard, as described below. The first, second, and third methods are fairly convenient, and may be used with any desired current in the primary coil. They are also fairly reliable. If the value of M is to be determined for a pair of iron-cored coils using a certain current, it is only necessary to adjust the resistance of the primary circuit so that the required current will flow when the key is closed. The standards of self-inductance or of mutual-inductance employed in the comparative methods must evidently be constructed without iron cores so that the coefficients are independent of the value of the testing current. A variable standard of mutual-inductance may be made up to serve a purpose similar to that of the Ayrton and Perry self-inductance standard (Sect. 36, 3 *a*). In fact, the Ayrton and Perry self-inductance standard may be used as a variable standard mutual-inductance by using the fixed and movable coils for the mutually interacting pair, in which case the mutual-inductance of the pair may be varied at will by rotating the movable coil. With such a variable standard the last method enumerated above may be somewhat simplified. In this case the adjustments required to gain a balance may be made by changing the variable standard. If the unknown mutual-inductance is beyond the range of the standard, the balance may still be gained by making $\frac{R_1}{R_2}$ (page 99) some satisfactory fixed ratio and then balancing by adjusting the standard.

110. Mutual Induction of Parallel Distributing Circuits.

— Where two or more electric light or power circuits carrying alternating currents run parallel to each other, they act inductively upon each other, and in some cases the mutual induction may cause considerable interference with the uniformity of the pressure on the lines. The mutual inductance of any two parallel circuits of indefinitely great length may be easily calculated, provided the distances apart of the different wires composing the circuits are known. The number of lines of force which pass through or link with one circuit, due to one ampere flowing in the other, is numerically equal to 10^9 times the mutual-inductance of the two circuits, and this number of lines of force is equal to the algebraic sum of the number of lines of force embraced by the first circuit which would be set up by the current in the individual conductors of the second circuit taken separately. The method of Section 47 is therefore directly applicable to the calculation of the mutual-inductance of two long and parallel, narrow circuits. The following examples represent the commonest arrangements of circuits on pole lines. Suppose that a, a' and b, b' represent the conductors of two circuits, and that the order of the wires is $a - a' - b - b'$, the distance apart centre to centre of the wires of circuit A is x , of circuit B is y , and of the adjacent wires of the two circuits ($a' - b$) is z ; then, if we consider the currents as concentrated at the centres of the wires, which makes but an insignificant error with the ordinary dimensions of conductors and circuits, and consider the space between two planes perpendicular to the circuits and one centimeter apart, the

number of lines of force due to a current of one ampere in a' , which pass through the circuit B between the planes, is (Sect. 47)

$$N_{a'} = \int_x^{y+z} \frac{2 da}{a} = 2 \log_e \frac{y+z}{z},$$

and the number of lines of force due to a current of one ampere in a which pass through the circuit B between the planes, is

$$N_a = - \int_{x+z}^{x+y+z} \frac{2 da}{a} = - 2 \log_e \frac{x+y+z}{x+z}.$$

The total number of lines of force set up by the current of one ampere in circuit A , which pass through the circuit B between the planes, is $N_a + N_{a'}$, the number which link through the B circuit in a length of l centimeters is

$$l(N_a + N_{a'}),$$

and the mutual-inductance of the parallel circuits of length l is

$$\begin{aligned} M &= \frac{l(N_a + N_{a'})}{10^9} = \frac{2l}{10^9} \left(\log_e \frac{y+z}{z} - \log_e \frac{x+y+z}{x+z} \right) \\ &= \frac{2l}{10^9} \log_e \frac{(x+z)(y+z)}{z(x+y+z)}. \end{aligned}$$

If $x = y$, this becomes

$$M = \frac{2l}{10^9} \log_e \frac{(x+z)^2}{z(2x+z)} = \frac{4.60l}{10^9} \log_{10} \frac{(x+z)^2}{z(2x+z)};$$

and if $x = y = z$, it becomes

$$M = \frac{4.60l}{10^9} \log_{10} \frac{4}{3} = \frac{.575l}{10^9},$$

where l is the length of the parallel circuits in centimeters.

Exchanging the order of the wires so that circuit A is between the conductors of circuit B , thus $b-a-a'-b'$, changes the formulas. Here the algebraic sum of the number of lines of force set up by the circuit A which link with circuit B , is equal to the total number of lines of force set up by circuit A minus the number passing backwards through $b-a$ and $a'-b'$. Suppose $a-a'$ is equal to x and $b-a$ and $a'-b'$ are each equal to y , then the total number of lines of force set up by one ampere in a length of one centimeter of circuit A , is

$$N_a = 4 \log_e \frac{x}{r}$$

(r being the radius of the conductor), and the number of lines due to circuit A , which pass between the planes through the space $b-a$, is

$$N_{ab} = 2 \left(\log_e \frac{y}{r} - \log_e \frac{x+y}{x} \right) = 2 \log_e \frac{xy}{r(x+y)},$$

$$\begin{aligned} \text{and } M &= \frac{l}{10^9} (N_a - 2 N_{ab}) = \frac{4l}{10^9} \left(\log_e \frac{x}{r} - \log_e \frac{xy}{r(x+y)} \right) \\ &= \frac{4l}{10^9} \log_e \frac{x+y}{y} = \frac{9.20l}{10^9} \log_{10} \frac{x+y}{y}. \end{aligned}$$

$$\text{If } x=y, M = \frac{9.20l}{10^9} \log_{10} 2 = \frac{2.77l}{10^9}.$$

If the circuits are not in the same plane, as, for instance, they are arranged thus,

$$\begin{array}{c} a - a', \\ b - b', \end{array}$$

and the distance $a - a'$ is x , the distance $b - b'$ is y , the distance $a' - b'$ is z , the distance $a' - b$ is w , $a - b$ is v , and $a - b'$ is u ; then the formulas are

$$N_a = 2 \left(\log_{\epsilon} \frac{u}{r} - \log_{\epsilon} \frac{v}{r} \right) = 2 \log_{\epsilon} \frac{u}{v},$$

$$N_{a'} = 2 \left(\log_{\epsilon} \frac{w}{r} - \log_{\epsilon} \frac{z}{r} \right) = 2 \log_{\epsilon} \frac{w}{z},$$

and

$$M = \frac{l}{10^9} (N_a + N_{a'}) = \frac{2l}{10^9} \log_{\epsilon} \frac{uw}{vz} = \frac{4.60l}{10^9} \log_{10} \frac{uw}{vz}.$$

If one circuit is directly beneath the other, $x = y$, $v = z$, and $w = u = \sqrt{x^2 + z^2}$, and the formula becomes

$$M = \frac{2l}{10^9} \log_{\epsilon} \frac{x^2 + z^2}{z^2} = \frac{4.60l}{10^9} \log_{10} \frac{x^2 + z^2}{z^2}.$$

If $x = y = v = z$,

$$M = \frac{4.60l}{10^9} \log_{10} 2 = \frac{1.38l}{10^9}.$$

These results plainly show that the mutual-inductance of two circuits is entirely independent of the actual distances apart of the conductors composing the circuits, but depends wholly upon the relative values of the distances. The mutual-inductance of two circuits is a maximum when the circuits are exactly superposed, in which case $M = \sqrt{L'L''} = L$, and decreases as the distance between the circuits is increased in comparison with the distance apart of the conductors of each circuit; consequently, mutual-inductance between circuits on the same pole line may be reduced by decreasing the distance apart of the conductors of each circuit and increasing the distance apart of the circuits. A better way to

avoid mutual induction in some cases is to transpose the position of the circuits with reference to each other, as is done in long distance telephone lines, so that the inductive effects of the circuits on each other are in opposition in different parts of the line, and neutralize each other for the line as a whole.

The effect of mutual induction between two circuits is to set up an electrical pressure in one when the current in the other varies. If the current is a sinusoidal alternating one, this pressure is (Sects. 107 and 108) $2\pi fMC$, and the effect of an alternating current in one circuit upon another circuit is easily determined if M is known. When the two circuits are fed from the same single-phase alternator, the induction of one upon the other is in quadrature with the current in the first, and the relative phase of the pressure induced in the second depends on the current lag in the first. If this is zero, the induced and impressed pressures are in quadrature, while they are in opposition if the lag is 90° . The result is a displacement of the pressure waves and a drop of pressure along the lines. If the circuits are fed from different alternators, the frequency of which is slightly different, the inductive pressure and impressed pressure interfere so as to form pulsations or beats, the frequency of which is equal to the difference of the two alternator frequencies, and the amplitude of which is the sum of the two pressures. This may cause a perceptible winking of incandescent lamps connected to mutually inductive circuits of nearly the same frequency.*

* C. F. Scott, Polyphase Transmission, *Electrical World*, Vol. 23, p. 338; *London Electrician*, Vol. 32, p. 642.

CHAPTER X.

OPERATION OF IDEAL TRANSFORMER, AND EFFECT OF
IRON AND COPPER LOSSES.

111. **Ratio of Transformation in a Transformer.**—
The formulas of Section 104 show that the electric pressure developed in the secondary coil is at any instant

$$e'' = \frac{d(Mc')}{dt}$$

If the current wave is a sinusoid, this becomes

$$e'' = \frac{d(Mc'_m \sin \alpha)}{dt}$$

If the conditions require that M be treated as a variable dependent upon the varying permeability of an iron core, this equation is practically unsolvable. For practical purposes, as has already been said, it is sufficient to assume M as having a constant average value which depends upon the iron of the core and the magnetic density used in the transformer. The equation then becomes $e'' = \frac{Mc'_m \cos \alpha da}{dt}$. The maximum value of the electric pressure is therefore $e''_m = 2 \pi f M c'_m$, where f is the frequency of the current wave. The effective value of the secondary electric pressure is then evidently $E'' = 2 \pi f M C'$, where C' is the effective pri-

mary current. If the secondary circuit is open, the following equations may be written,

$$C' = \frac{E'}{\sqrt{R'^2 + 4\pi^2 f^2 L'^2}}$$

while $E'_s = 2\pi f L' C' = \frac{\sqrt{2}\pi f n' N}{10^8}$, where E'_s is the self-induced primary pressure, E' is the impressed pressure, and N is the maximum number of lines of force in the cycle. If the resistance of the primary be considered negligible, the former equation becomes

$$C' = \frac{E'}{2\pi f L'}$$

and $E' = 2\pi f L' C' = E'_s$.

If the primary and secondary coils are so completely superposed that there is no magnetic leakage, the value of M becomes $M = \sqrt{L' L''}$; whence

$$\frac{E'}{E''} = \frac{2\pi f L' C'}{2\pi f M C'} = \frac{L'}{\sqrt{L' L''}} \quad \text{or} \quad \frac{E'}{E''} = \frac{\sqrt{L'}}{\sqrt{L''}}$$

But $\frac{\sqrt{L'}}{\sqrt{L''}} = \frac{n'}{n''}$, since the reluctance in the magnetic circuit of the two coils is assumed to be the same (Sect. 16), and therefore

$$\frac{E'}{E''} = \frac{n'}{n''}$$

In other words, if the active pressure in the primary may be considered negligible when compared with the impressed pressure, and there is no leakage of magnetic lines, the ratio of the impressed pressure in the primary of a transformer to the induced pressure in the sec-

ondary is equal to the ratio of the number of turns of wire in the two coils. This ratio of pressures is called the **Ratio of Transformation**. The ratio of transformation of well-designed transformers is practically equal to $\frac{n'}{n''}$ when the secondary circuit is open, showing that the assumption that the active pressure and magnetic leakage are negligible in commercial transformers, when the secondary circuit is open, is entirely allowable. An example will show this in a striking manner. In a certain transformer of 22.5 K.W. capacity the resistance of the primary is practically 1 ohm and the inductance is 9.1 henrys. At a frequency of 70 and a pressure of 2000 volts, for which the transformer was designed, the value of $4\pi^2 f^2 L'^2$ is 16,000,000. In another transformer of 11.25 K.W. capacity designed for 2400 volts primary pressure, the value of the primary resistance is 6.45 ohms and the value of $4\pi^2 f^2 L'^2$ is 10,000,000. In three other transformers designed for 1000 volts pressure and respectively of 7.5, 4.5, and 1.5 K.W. capacity, the primary resistances are 1.16, 2.15, and 8.90 ohms, while, at a frequency of 125, $4\pi^2 f^2 L'^2$ is equal respectively to 100,000,000, 125,000,000, and 400,000,000; and in a transformer of .5 K.W. capacity the primary resistance is 25 ohms and $4\pi^2 f^2 L'^2$ is 400,000,000. In each of these cases, which represent common practice in the construction of transformers, the value of R'^2 is entirely negligible when compared with $4\pi^2 f^2 L'^2$. If R'^2 were not negligible, it would evidently increase the ratio of transformation (that is, for a given impressed primary pressure the secondary press-

ure would be decreased) on account of the loss of pressure due to the current flowing through R' .

112. Magnetic Leakage.—The primary and secondary coils in each of these cases are so sandwiched together that magnetic leakage is certainly negligible when there is no current in the secondary coil. A case when leakage is always present is shown in Fig. 193. From the figure it is evident that if there is no current flowing in the secondary, the counter pressure in the primary will

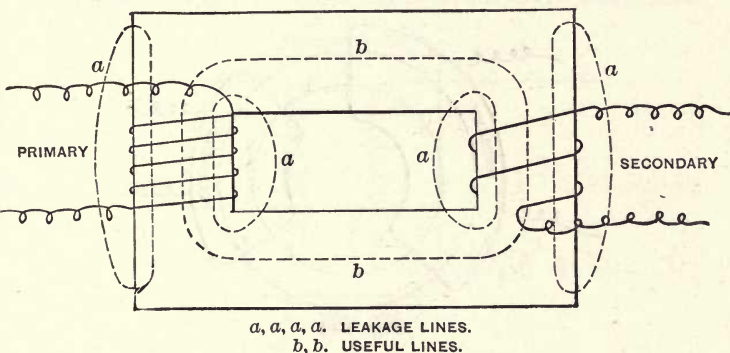

Fig. 193

be greater per turn of wire than the pressure induced in the secondary per turn; hence, as the self-induced or counter pressure in the primary is practically equal and opposite to the impressed pressure, the ratio of transformation will be increased. If a current flows in the secondary, the self-induction due to magnetic leakage in the secondary (lines of force linking with the secondary coil but not linking with the primary coil) will still further reduce the active secondary pressure, and the ratio of transformation will be further increased.

The effect of magnetic leakage in increasing the ratio of transformation (decreasing the proportional pressure induced in the secondary by decreasing the magnetic induction passing through it) is shown by an experiment reported by Professor Ryan.* In the experiment recorded by him, the primary and secondary coils were wound on opposite sides of a laminated iron ring (Fig. 194). The number of turns on the primary and secondary were respectively 500 and 155, or $\frac{n'}{n''} = 3.2$.

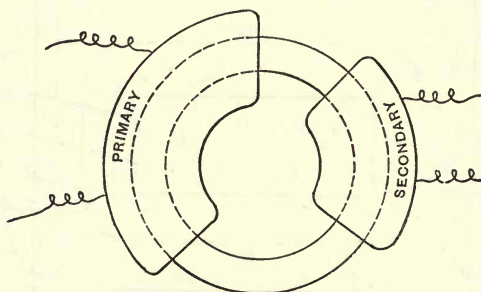

Fig. 194

When a pressure of 75.6 volts was impressed upon the primary with the secondary open, a pressure of only 16.4 volts was induced in the secondary, or $\frac{E'}{E''} = 4.6$. The whole difference in the two ratios was due to magnetic leakage, and the magnitude of the difference shows that M was much less than $\sqrt{L'L''}$. In fact, $\frac{E'}{E''} = \frac{1.44 n'}{n''}$, and assuming that the reluctance of the magnetic circuits of the two coils were equal, $M = \frac{\sqrt{L'L''}}{1.44}$

* Some Experiments upon Alternating Current Apparatus, *Trans. Amer. Inst. E. E.*, Vol. 7, p. 324.

(by Sect. 104). The magnetic leakage was therefore 30 per cent; that is, the number of lines of force that passed through the primary but not through the secondary coil, was 30 per cent of the total magnetic induction set up in the magnetic circuit. The effect of magnetic leakage on a transformer is analogous to the effect produced on one without leakage, of inserting coils having self-inductance, or **Impedance Coils**, in the primary and secondary circuits outside of the transformer (Fig. 195). These coils would have such self-

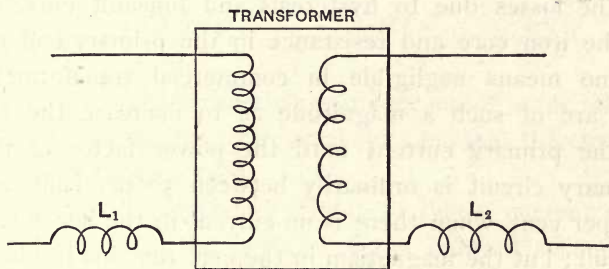

Fig. 195

inductances as to increase the self-inductances of the primary and secondary circuits in the ratio of $a : 100$, where a is the magnetic leakage in per cent. Since leakage causes a proportional increase in the apparent self-inductance of the primary and secondary circuit, it causes an equivalent lag of the currents in the two circuits.

113. Exciting Current.—In the case of an ideal transformer without losses, the lag of the primary current, when the secondary circuit is open, is 90° with respect to the impressed pressure; for, $\tan \phi' = \frac{2 \pi f L'}{R'}$ (Sect.

28), and R' is assumed to be zero. Since the induced secondary pressure lags behind the magnetism, which is in phase with the primary current when the secondary circuit is open, by an angle of 90° , the phases of the primary impressed pressure and the secondary induced pressure are exactly 180° apart, or *they are in exact opposition*. The current in the primary circuit of an ideal transformer, when the secondary is open, is all wattless, and of a magnitude which depends only upon the self-inductance, L' , of the primary coil.

The losses due to hysteresis and Foucault currents in the iron core and resistance in the primary coil are by no means negligible in commercial transformers, but are of such a magnitude as to decrease the lag of the primary current until the power factor of the primary circuit is ordinarily between 50 per cent and 80 per cent, when there is no current in the secondary circuit; but the magnetism in the core remains in phase with the wattless component of the primary current and is 90° behind the phase of the primary pressure, so that *the primary and secondary pressures are still in opposition*.* The current which flows in the primary circuit when the secondary circuit is open, may therefore be considered as composed of two components, one of which supplies the energy required to make up the transformer losses, and the other of which serves simply for magnetizing power, and is therefore wattless. This primary current is often called the **Leakage Cur-**

* Fleming, Experimental Researches on Alternate Current Transformers, *Jour. Inst. E. E.*, 1892. Ford, Tests of Modern Transformers, *Bull. Univ. of Wisconsin*, Vol. 1, No. 11.

rent or **Open-Circuit Current**, but a more satisfactory term is **Exciting Current**. The term **Magnetizing Current** is also applied to the exciting current, but we will reserve the term for its wattless component which is truly a magnetizing current.

114. Core Magnetization.—The maximum magnetic induction during a period, in the iron core of an ideal transformer, is dependent upon the maximum value of the current in the primary circuit, the effect of iron losses being omitted by assumption, and is equal to

$$N_m = \frac{4\sqrt{2} \pi n' C_1'}{10 P} = 1.25 \sqrt{2} \frac{n' C_1'}{P} = 1.77 \frac{n' C_1'}{P},$$

where C_1' is the magnetizing current and P is the reluctance of the magnetic circuit at the time that the current has its maximum value.

Closing the secondary circuit so that a current may flow in it under the impulse of the induced secondary pressure, materially changes the conditions heretofore explained. We will first assume that the secondary circuit is without self-inductance, and continue to neglect hysteresis and foucault current losses in the iron core and resistance losses in the windings, in which case the secondary current C'' will be in unison with the induced or secondary pressure, E'' . This current has its own magnetizing effect on the magnetic circuit. If c' and c'' be the primary and secondary currents at any instant, the total magnetizing force in the circuit is $\frac{4 \pi (n' c' + n'' c'')}{10} = N_i P$, where N_i is the instantaneous value of the magnetic induction, and P is the assumed constant value of the reluctance of the magnetic circuit.

From this is found

$$c' = \left(\frac{10 PN_i}{4 \pi n'} \right) - \left(\frac{n'' c''}{n'} \right),$$

and whence
$$c' = \frac{10 PN_m}{4 \pi n'} \sin a - \frac{n'' \sqrt{2} C''}{n'} \cos a;$$

but
$$\frac{10 PN_m}{4 \pi n'} = \sqrt{2} C_1',$$

whence
$$c' = \sqrt{2} \left(C_1' \sin a - \frac{n''}{n'} C'' \cos a \right)$$

or
$$n' c' = \sqrt{2} (n' C_1' \sin a - n'' C'' \cos a),$$

and
$$\begin{aligned} n'^2 C'^2 &= \frac{2}{\pi} \int_0^\pi (n'^2 C_1'^2 \sin^2 a \\ &\quad - 2 n' n'' C_1' C'' \sin a \cos a \\ &\quad + n''^2 C''^2 \cos^2 a) da, \end{aligned}$$

where C' is the effective value of the primary current when the secondary current is equal to C'' , and C_1' , as before, is the wattless primary current when the secondary is open. Performing the integration gives

$$n'^2 C'^2 = n'^2 C_1'^2 + n''^2 C''^2.$$

Remembering that C_1' and C'' have 90° difference of phase, the three terms of this formula may be represented by the three sides of a right-angled triangle (Fig. 196). The current C' , which flows in the primary when the secondary is loaded, is in advance of the current C_1' by an angle ψ , the tangent of which is shown by the figure to be $\tan \psi = \frac{n'' C''}{n' C_1'}$. We have already seen that C_1' is inversely dependent upon the

self-inductance of the primary circuit, and therefore—when the value of n' is fixed—directly upon the reluctance of the magnetic circuit, which in commercial transformers is made very small. $\tan \psi$ is therefore quite large when C'' has any considerable magnitude

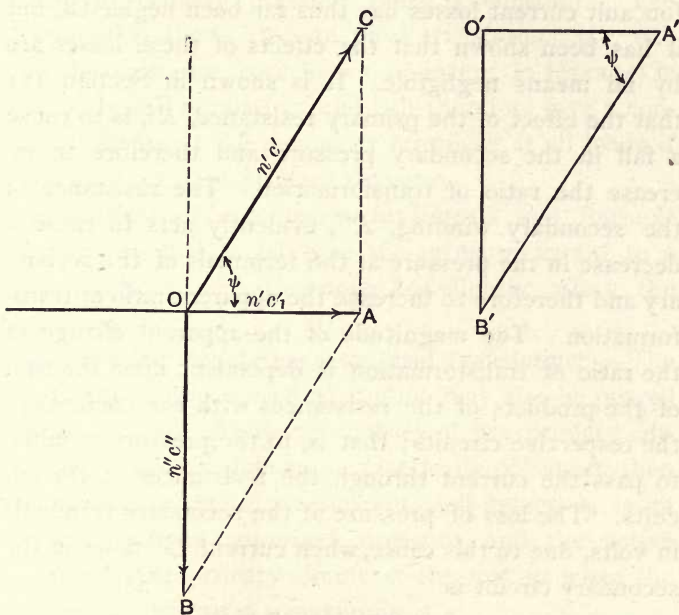

Fig. 196

and ψ approaches 90° as C'' increases, so that the primary and secondary currents are practically in opposite phases in a well loaded transformer. As a transformer is loaded up, its power factor is therefore rapidly increased.* The effect of the secondary current on the

* Compare Fleming, Experimental Researches on Alternate Current Transformers, *Four. Inst. E. E.*, Vol. 21, p. 594; Ford, Tests of Modern Transformers, *Bull. Univ. of Wisconsin*, Vol. 1, No. 11.

primary circuit is to apparently decrease its self-inductance and therefore to decrease its impedance and the lag of the primary current.

115. Effect of Copper and Iron Losses on Regulation.

—Consideration of the effect of C^2R , hysteresis, and foucault current losses has thus far been neglected, but it has been shown that the effects of these losses are by no means negligible. It is shown in Section III that the effect of the primary resistance, R' , is to cause a fall in the secondary pressure and therefore to increase the ratio of transformation. The resistance of the secondary winding, R'' , evidently acts to cause a decrease in the pressure at the terminals of the secondary and therefore to increase the apparent ratio of transformation. The magnitude of the apparent change in the ratio of transformation is dependent upon the sum of the products of the resistances with the currents in the respective circuits; that is, to the pressure required to pass the current through the resistances of the circuits. The loss of pressure at the secondary terminals in volts, due to this cause, when current C'' flows in the secondary circuit is

$$V = C''R'' + \frac{n''}{n'}C'R',$$

and since approximately, with core losses neglected,

$$C'' = \frac{n'}{n''}C',$$

this is

$$V = C'' \left[R'' + \left(\frac{n''}{n'} \right)^2 R' \right].$$

The percentage increase of the ratio of transformation

is $\frac{V}{E''}$, where E'' is the total secondary pressure, the terminal pressure becoming $E'' - V$. This shows that the terminal pressure falls off proportionally as the load on the secondary of the transformer is increased, if the impressed primary pressure remains constant. The formula also shows that an ideal transformer (*i.e.* one without resistance, core losses, or magnetic leakage) is inherently self-regulating, and will therefore give a constant pressure at the secondary terminals at all loads if fed with a constant primary pressure.

The effect of core losses (hysteresis and foucault current losses) is to increase the primary current to a certain extent and therefore to slightly affect the regulation.

116. Perfect Regulation of an Ideal Transformer.—The statements of the preceding section may also be proved as follows: Considering the phases of the primary current and magnetization to be practically 90° apart, then the counter electric pressure of self-induction is in opposition to the impressed pressure, and the active pressure in the primary circuit at the instant when the impressed pressure is a maximum is

$$E'_m - E'_{sm} = c'R',$$

E'_m , being the counter electric pressure of self-induction. At this instant the value of the primary current, c' , is

$$c' = \sqrt{2} C' \sin \psi = \sqrt{2} C' \frac{n''C''}{n'C'}$$

since (Sect. 114) $\sin \psi = \frac{n''C''}{n'C'}$

The counter electric pressure of self-induction is evidently equal to

$$E'_s = \frac{E''n'}{n''} = C''(R'' + R) \frac{n'}{n''},$$

where R is the external resistance in the secondary circuit. Substituting these values for c' and E'_s , and dividing by $\sqrt{2}$ gives

$$E' = \frac{n''C''}{n'C'} C'R' + \frac{n'}{n''} C''(R'' + R),$$

whence, by transposition,

$$C''R = \frac{n''}{n'} E' - \left(\frac{n''}{n'}\right)^2 C''R' - C''R''.$$

From these equations it is seen that the pressure at the secondary terminals, $C''R$, becomes $\frac{E'n''}{n'}$ provided $\left(\frac{n''}{n'}\right)^2 R'$ and R'' can be taken as very small in comparison with R , and therefore under these circumstances the secondary pressure is constant provided the impressed pressure be kept constant. *An ideal transformer is therefore an inherently self-regulating instrument for transforming electric currents at one constant pressure into equivalent currents at another constant pressure, and the faulty regulation found in commercial transformers is wholly due to electrical losses and magnetic leakage.* By transforming the last formula into the equivalent form $C'' = C' \frac{n'}{n''}$, it is seen that *an ideal transformer which is fed with a constant current is an inherently self-regulating instrument for the transformation of that current into an equivalent constant current*

at another pressure. In this case the primary impressed pressure will vary with the resistance of the secondary circuit.

117. Effect on Regulation of Self-inductance or Capacity in Secondary Circuit.—In the service to which trans-

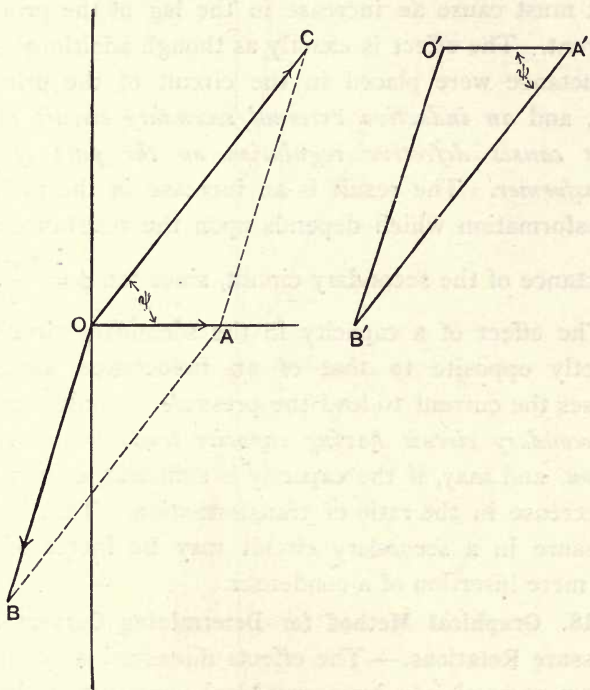

Fig. 197

formers have heretofore been generally applied, the operation of incandescent lamps, the external secondary circuit is practically non-inductive, but when motors or arc lamps are operated on the secondary circuits of transformers, they may add a considerable inductance

to the circuits. In this case the secondary current is caused to lag behind the secondary pressure. The relation which must exist between the secondary and primary ampere-turns and the resultant magnetizing ampere-turns (Fig. 197) shows that such a lag of the secondary current must cause an increase in the lag of the primary current. The effect is exactly as though additional self-inductance were placed in the circuit of the primary coil, and *an inductive external secondary circuit therefore causes defective regulation on the part of the transformer.* The result is an increase in the ratio of transformation which depends upon the resistance and reactance of the secondary circuit, since $\tan \phi = \frac{2 \pi f L}{R}$.

The effect of a capacity in the secondary circuit is exactly opposite to that of an inductance, since it causes the current to lead the pressure. Consequently, *a secondary circuit having capacity tends to aid regulation,* and may, if the capacity is sufficient, even cause a decrease in the ratio of transformation. That is, the pressure in a secondary circuit may be increased by the mere insertion of a condenser.

118. Graphical Method for Determining Current and Pressure Relations.—The effects discussed may all be shown very plainly by a graphical construction based upon the triangle of electrical forces (Sect. 15). In Fig. 198, OC'' on the vertical axis represents the value, on a convenient scale, of the product $n''C''$. If the secondary circuit may be considered non-inductive, as when the transformer is feeding incandescent lamps, the secondary pressure wave is in unison with the cur-

rent, and OE'' may be taken to represent the value and position of the pressure. The current component

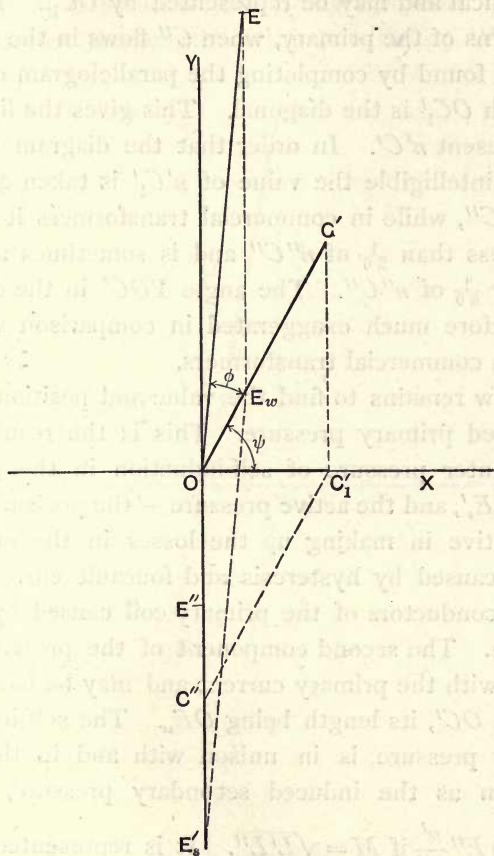

Fig. 198

which is effective in producing magnetization must be 90° in advance of this. Accepting the conventional positive direction for harmonic rotation as left-handed

or counter-clockwise, the magnetizing ampere-turns $n'C_1'$ must be laid off on the horizontal line to the right of the vertical and may be represented by OC_1' . The ampere-turns of the primary, when C'' flows in the secondary, are found by completing the parallelogram on OC'' of which OC_1' is the diagonal. This gives the line OC' to represent $n'C'$. In order that the diagram may be readily intelligible the value of $n'C_1'$ is taken as about $\frac{1}{2}$ of $n''C''$, while in commercial transformers it is generally less than $\frac{1}{20}$ of $n''C''$ and is sometimes as small as $\frac{1}{50}$ or $\frac{1}{60}$ of $n''C''$. The angle YOC' in the diagram is therefore much exaggerated in comparison with its value in commercial transformers.

It now remains to find the value and position of the impressed primary pressure. This is the resultant of the counter pressure of self-induction in the primary circuit, E_s' , and the active pressure — the pressure which is effective in making up the losses in the magnetic circuit caused by hysteresis and foucault currents and in the conductors of the primary coil caused by its resistance. The second component of the pressure is in unison with the primary current and may be laid off on the line OC' , its length being OE_w . The self-inductive primary pressure is in unison with and in the same direction as the induced secondary pressure, and is equal to $E'' \frac{n'}{n''}$ if $M = \sqrt{L'L''}$. It is represented in the figure by OE_s' . Completing the parallelogram gives the line OE' , which represents the direction and magnitude of the impressed electric pressure. In the figure the angle $E'OC' = \phi'$, and the angle $C'OC_1' = \psi$. The

relative phases of the pressures and currents are shown by the relative angular positions of the lines radiating from O . The value of the primary current is taken directly from the length of the line OC' . When the

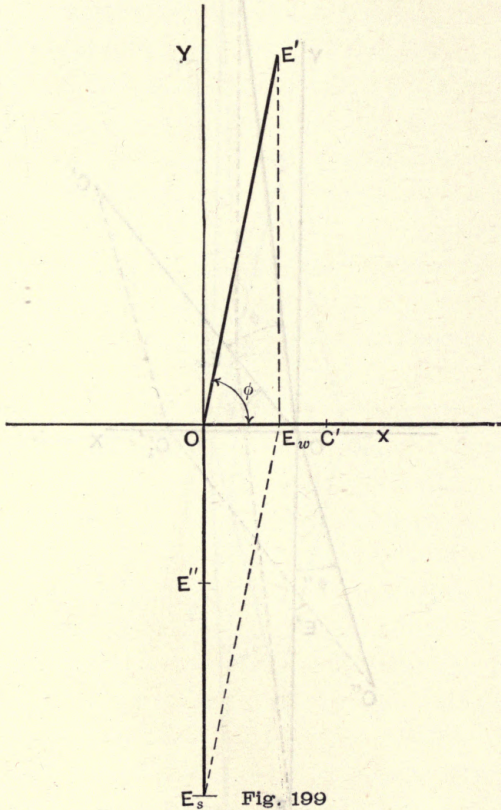

secondary circuit is open, the construction is similar to the preceding, but the value of the primary CR loss is less, making the length of OE' slightly smaller (Fig. 199). The exciting current is taken, as before, directly

from the length of the line OC' , and the figures show that the ratio of transformation is increased by loading the transformer on account of the drop of pressure in

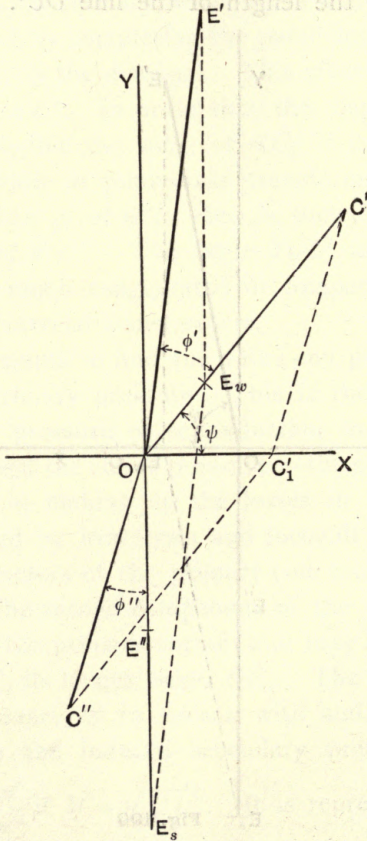

Fig. 200

the windings. The figures plainly show that the deviation of the secondary pressure from the form of the primary pressure is proportional to the value of $C'R'$.

The hysteresis and foucault current losses may be assumed to be independent of the secondary current (Sect. 127).

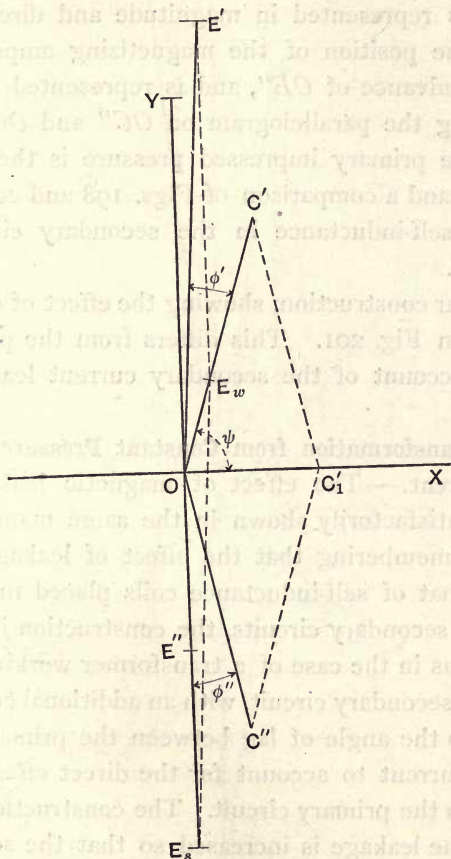

Fig. 201

The effect of inductance in the external secondary circuit is shown in Fig. 200. As before, OC'' represents the secondary ampere-turns $n''C''$. If it is sup-

posed that the inductance in the secondary circuit be sufficient to cause a lag of ϕ'' , then the induced secondary pressure is in advance of the current by an angle ϕ'' , and is represented in magnitude and direction by OE'' . The position of the magnetizing ampere-turns is 90° in advance of OE'' , and is represented by OC_1' . Completing the parallelogram on OC'' and OC_1' , gives OC' . The primary impressed pressure is then found as before, and a comparison of Figs. 198 and 200 shows that the self-inductance in the secondary circuit increases ϕ' .

A similar construction, showing the effect of capacity, is given in Fig. 201. This differs from the preceding only on account of the secondary current leading the pressure.

119. Transformation from Constant Pressure to Constant Current. — The effect of magnetic leakage can also be satisfactorily shown in the same manner (Fig. 202). Remembering that the effect of leakage is the same as that of self-inductance coils placed in the primary and secondary circuits, the construction is exactly the same as in the case of a transformer working on an inductive secondary circuit, with an additional correction applied to the angle of lag between the primary pressure and current to account for the direct effect of the leakage on the primary circuit. The construction shows that, as the leakage is increased so that the secondary angle of lag ϕ'' approaches 90° , the deficiency in the inherent tendency to regulate for constant pressure becomes so great that the secondary terminal pressure actually tends to vary inversely with the current. Such

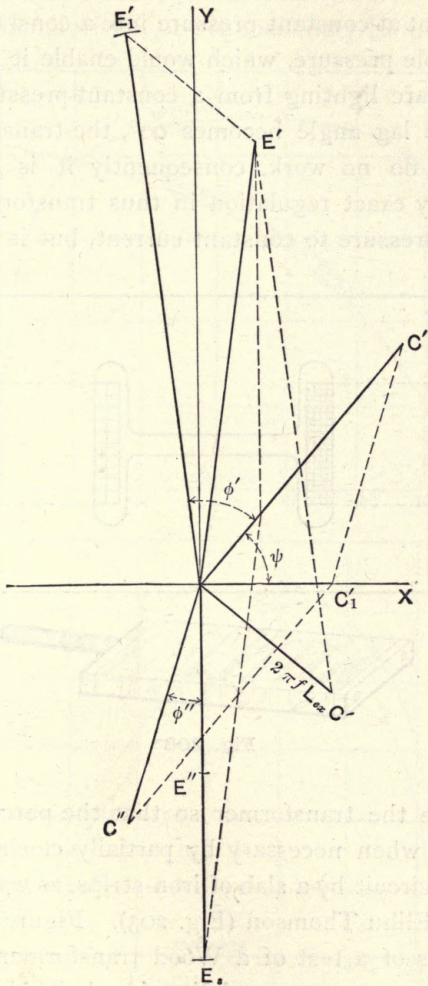

Fig. 202

a transformer would therefore tend to transform a variable current at constant pressure into a constant current at a variable pressure, which would enable it to be used for series arc lighting from a constant-pressure circuit. When the lag angle becomes 90° , the transformer can of course do no work, consequently it is impossible to get very exact regulation in thus transforming from constant pressure to constant current, but it is possible

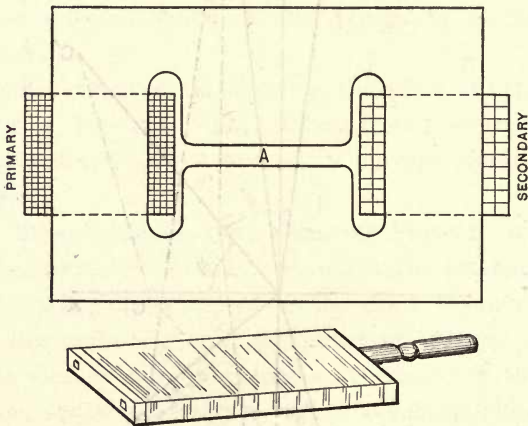

Fig. 203

to arrange the transformer so that the percentage can be varied when necessary by partially closing a shunt magnetic circuit by a slab of iron strips, as was first proposed by Elihu Thomson (Fig. 203). Figure 204 shows the results of a test of a Wood transformer, in which the constant-current regulation is wholly due to magnetic leakage. In the upper half of the figure, one curve shows the efficiency as a function of the current

in the secondary circuit, and the other curve shows the external characteristic, or the secondary terminal press-

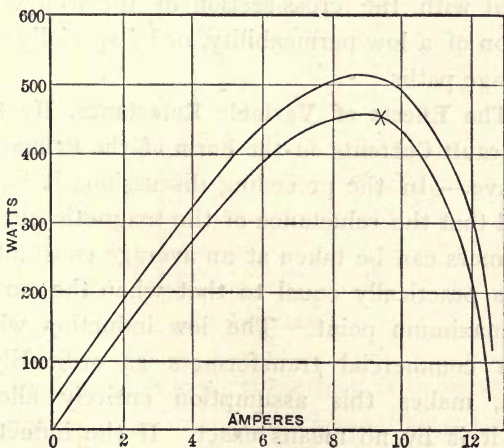
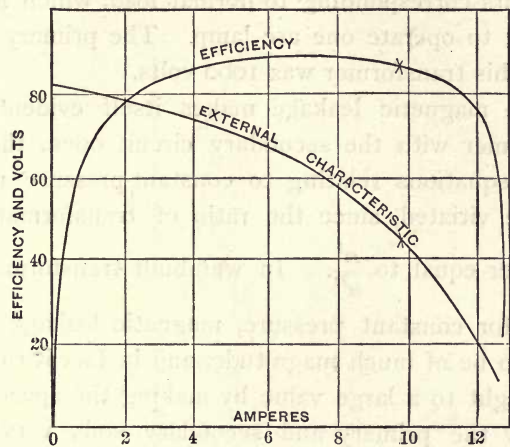

Fig. 204

ure as a function of the secondary current. The lower half of the figure has curves which show the watts in

the primary and secondary circuits as a function of the secondary current. The crosses on the curves show the points corresponding to normal load, which is that required to operate one arc lamp. The primary pressure of this transformer was 1000 volts.

When magnetic leakage makes itself evident in a transformer with the secondary circuit open, the preceding equations relating to constant-pressure regulation are vitiated, since the ratio of transformation is no longer equal to $\frac{n'}{n''}$. In well-built transformers designed for constant pressure, magnetic leakage is not likely to be of much magnitude, and in fact it can only be brought to a large value by making the space occupied by the primary and secondary coils very large compared with the cross-section of the iron core, by using iron of a low permeability, or by specially arranging leakage paths.

120. The Effects of Variable Reluctance, Hysteresis, and Foucault Currents on the Form of the Primary Current Wave.—In the preceding discussions it has been assumed that the reluctance of the magnetic circuits of transformers can be taken at an average constant value which is practically equal to that when the current is at its maximum point. The low induction which is used in commercial transformers as ordinarily constructed, makes this assumption entirely allowable, though it is by no means exact. If the induction be pushed above the bend in the curve of magnetization, however, the influence of the lowered permeability of the iron becomes marked. The curve *OM* in Fig. 205

The construction shows that this decreases the angle of lag between the primary current and pressure, and makes necessary more turns of wire on the primary and secondary coils in order that a given output may be obtained. Since, in this case, the permeability varies through each period with the magnetizing ampere-turns, there is a periodic variation of ϕ' , and the primary current wave is distorted from the form of the primary impressed pressure wave.

The effect of hysteresis in the core of a transformer is to distort the form of the primary current wave to a still more marked degree than would magnetic saturation alone, and the higher the maximum magnetic density is carried, the greater the distortion becomes. The ordinates of the primary current wave are at each instant proportional to the difference of the corresponding ordinates of the primary pressure wave and the wave of counter electric pressure. The latter is of course exactly similar to the form of the secondary pressure wave. With the primary pressure wave sinusoidal and an approximately uniform magnetic reluctance, the primary current wave would be sinusoidal. With a variable reluctance, but no hysteresis, the current wave becomes peaked, but remains symmetrical; but when hysteresis is taken into account, the symmetrical form is lost. This is conveniently illustrated by Figs. 206 and 207. In Fig. 206 the heavy line represents the hysteresis cycle for a piece of wrought iron, and the line $b'Ob$ may be taken to represent the cyclic curve of magnetization which would be given by the iron if hysteresis were absent. In Fig. 207 the curve M represents

the curve of magnetic induction in a transformer with its ordinates plotted on the same scale as Fig. 206. When the transformer is worked with its secondary circuit open, the drop of pressure due to the exciting current flowing through the primary winding is negligible, so that the primary impressed pressure at each instant is proportional to the tangent of

the curve of magnetism and is 90° in advance of the magnetization. In this case, the curves of pressure and magnetism are assumed to be sinusoidal. The tangent relations between the curves of magnetization and pressure (Sect. 77) must exist as long as $C'R'$ is negligible. As an illustration of the fact that the self-induced pressure is of the same form, and is

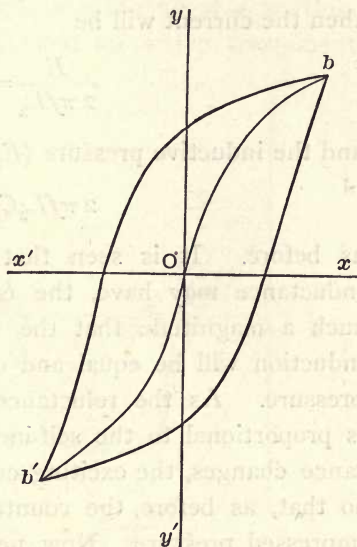

Fig. 206

equal and opposite to the impressed pressure, and that the exciting current varies in such a way as to furnish this induced pressure in a transformer with the secondary open (supposing the C^2R losses negligible), we may consider an inductance coil of negligible resistance with a sinusoidal pressure (E) of, say, 100 volts impressed upon it. Suppose the frequency is $127\frac{1}{2}$, the self-inductance (L_1) is .01 of a henry, and the resistance

is negligible; then $2\pi fL_1 = 8$ will be the impedance (see Chap. IV.). The current (C_1) flowing will be $\frac{E}{2\pi fL_1} = 12.5$ amperes with a lag angle of 90° . The inductive pressure (E_1) will be $2\pi fL_1C_1 = 100$ volts, which is equal and opposite to the impressed pressure. Suppose the self-inductance L_1 change to $L_2 = .005$; then the current will be

$$\frac{E}{2\pi fL_2} = 25,$$

and the inductive pressure (E_2) will be

$$2\pi fL_2C_2 = 100,$$

as before. It is seen that whatever value the self-inductance may have, the exciting current will take such a magnitude that the counter pressure of self-induction will be equal and opposite to the impressed pressure. As the reluctance of the magnetic circuit is proportional to the self-inductance, when the reluctance changes, the exciting current flowing will change so that, as before, the counter pressure will equal the impressed pressure. Now, neglecting hysteresis, when the magnetism is carried through the cycle $ObOb'O$ (Fig. 206), the current corresponding to each ordinate of the curve M in Fig. 207 must be proportional to the current required to produce the corresponding magnetization in Fig. 206. In this way curve C_e is plotted to represent the wave of exciting current in the transformer if there were no hysteresis in the iron. This curve is symmetrical and of the same phase as curve M , and *it represents the true wattless magnetizing current.*

It is easy to plot the curve which shows the form of exciting current of the transformer with the effect of hysteresis included, since it is only necessary to plot as current ordinates in Fig. 207 the currents which correspond to the various values of the magnetization in the hysteresis cycle. This curve is curve C in Fig. 207. It may be considered as made up of a wattless magnetizing component, C_e , and an active component

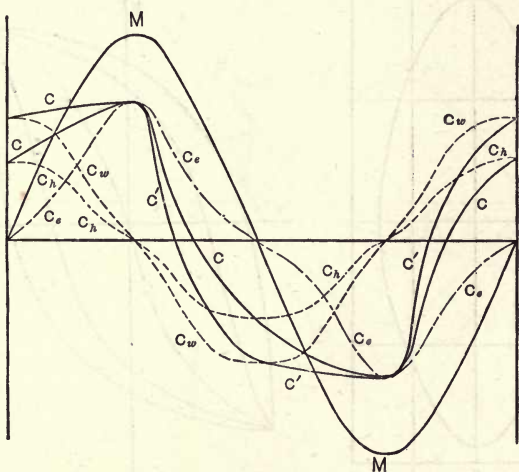

Fig. 207

C_h caused by hysteresis. The ordinates of the active component are proportional to the differences of corresponding abscissas of the curve of magnetization and the hysteresis cycle (Fig. 206), and the curve is nearly sinusoidal. The co-ordinates of the points b and b' in Fig. 206 are not altered by hysteresis and the effect of hysteresis therefore does not alter the position or magnitude of the maximum value of the exciting cur-

rent, though it distorts and enlarges the loop of the curve, and advances its zero points slightly so that the equivalent lag angle becomes slightly less than 90° .

The effect which foucault currents in the core have upon the exciting current may be shown in a similar manner. The instantaneous value of the portion of the exciting current which is required to make up the losses

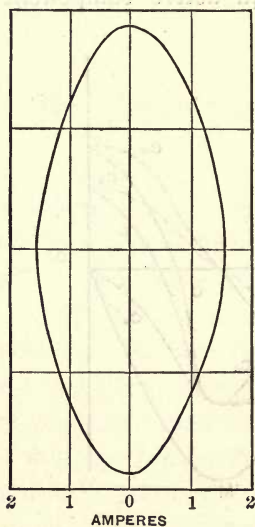

Fig. 208

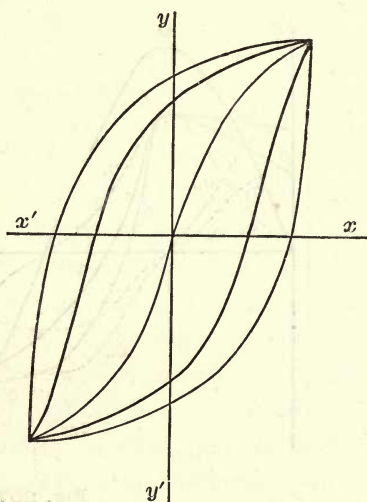

Fig. 209

due to foucault currents at any moment is equal to the corresponding instantaneous value of the foucault current loss divided by the instantaneous value of the primary pressure. The foucault current loss may be represented by the symmetrical cycle shown in Fig. 208, where the ordinates and abscissas are respectively proportional to the magnetism and its rate of change.

The area of this cyclic curve is proportional to the total foucault current loss. Its effect on the total core loss may be shown by plotting a cycle having abscissas equal to the arithmetical sum of the corresponding abscissas of the hysteresis and eddy cycles (Fig. 209). Finally, the total transformer exciting current may be plotted from this as shown by C' in Fig. 207. It is

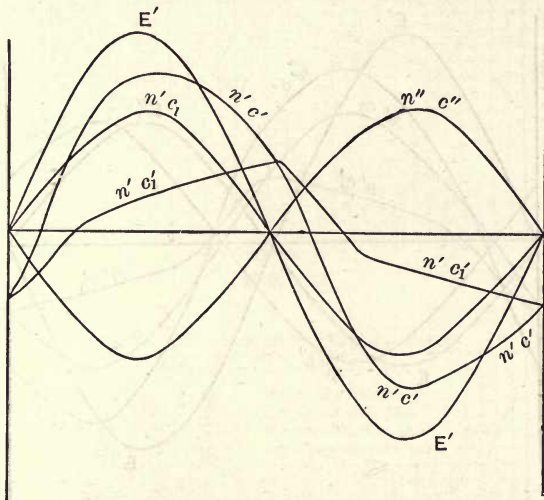

Fig. 210

evident that the hysteresis and eddy components of the exciting current add directly together, giving the total active component C_w , which is nearly sinusoidal when the impressed pressure is sinusoidal. If the foucault current cycle has a large area, its effect may cause a backwards displacement of the maximum point in the exciting current.

When the secondary circuit is closed, the form of the

primary current is changed by the effect of the secondary current. In Fig. 210, curve E' represents the primary pressure curve, $n'C'$ represents the exciting current times the primary turns. Now, if by closing the secondary circuit through the non-inductive resistance, a current C'' is caused to flow, and its ampere-turns may be represented by the curve $n''C''$, the

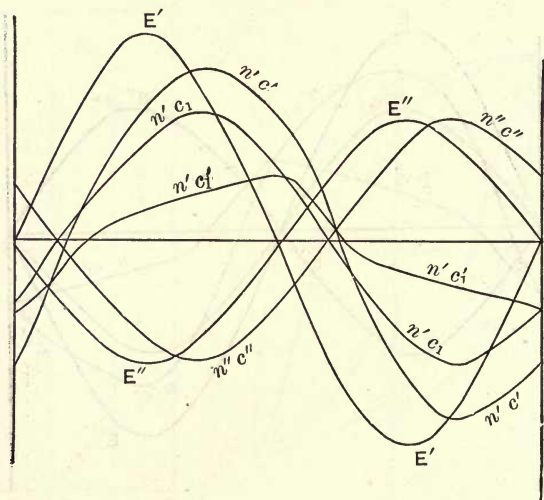
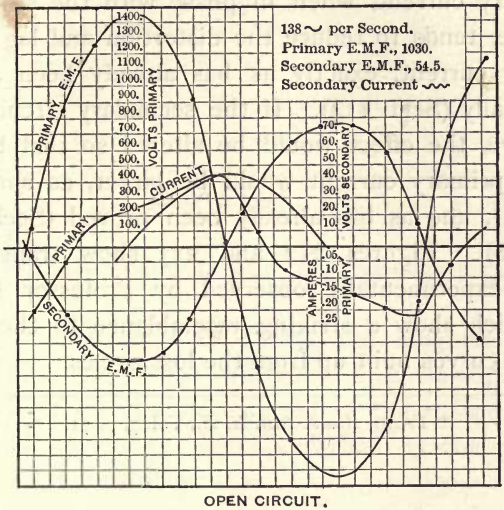

Fig. 211

effect of the current flowing in the secondary is to cause a corresponding increase in the current flowing in the primary (Sect. 114), and the ampere-turns of this increase may be represented by curve $n'C_1$. The total primary wave is similar to curve $n'C'$, which is the sum of $n'C_1'$ and $n'C_1$, and the primary current may be directly shown from this curve by a simple change of scale. It is thus shown by these figures that the



OPEN CIRCUIT.

Fig. 212

SECONDARY CLOSED THROUGH 10 LAMPS.

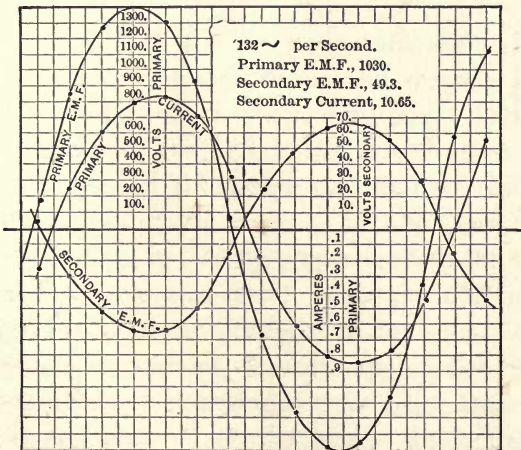

FULL LOAD.

Fig. 213

secondary current, when in phase with the secondary pressure, tends to reduce the distortion and lag of the primary current, exactly as has already been proved analytically (Sect. 114). If the secondary circuit were inductive, the effect would be altered so that the lag of the primary current would be larger, as shown in Fig. 211, and as has already been proved (Sects. 117 and 118). Figures 212 and 213 show transformer curves experimentally observed by Professor Ryan,* and which show a striking resemblance to the hypothetical curves built up from the loss cycles.

* *Trans. Amer. Inst. E. E.*, Vol. 7, p. 71.

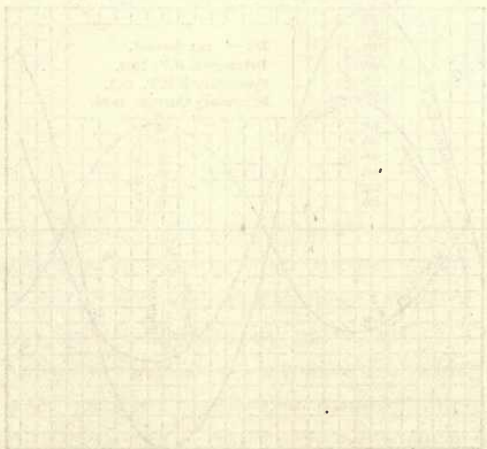

CHAPTER XI.

EFFICIENCY AND LOSSES IN TRANSFORMERS.

121. Transformer Core Losses and Magnetic Densities.—The commercial efficiency of a transformer is the ratio of the electrical output of the secondary coil to the corresponding power absorbed by the primary coil. It may be written

$$\eta = \frac{W''}{W'} = \frac{W''}{W'' + L},$$

where W' and W'' are the power absorbed and delivered respectively by the primary and secondary coils, and L is the total loss in the transformer. This total loss is made up of the C^2R losses in the primary and secondary coils and the losses due to hysteresis and foucault currents in the core. The C^2R loss in the secondary winding is directly proportional to the square of the load (secondary output), while the C^2R loss in the primary is nearly proportional to the square of the load, though it contains a small approximately constant term due to the exciting current (Fig. 214). The hysteresis and foucault current losses, which together constitute the **Iron Losses** or **Core Losses**, have been

shown experimentally to be independent of the load.* The hysteresis loss is directly proportional to the frequency and approximately proportional within the limits of magnetic density used in practice to the 1.55 or 1.6 power of the magnetic density. The Foucault current loss is proportional to the square of both the frequency and the magnetic density. Consequently, for fixed values of the iron losses in transformers designed for use with different frequencies, the magnetic density should vary inversely with some power of the fre-

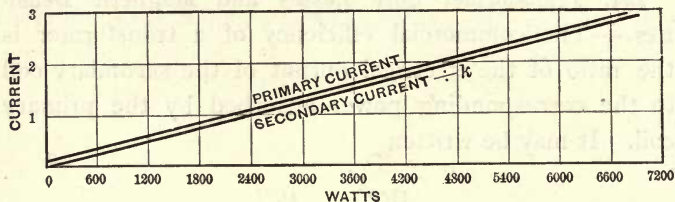

Fig. 214

quency between one and a half and two. The table in Section 97 gives satisfactory values of magnetic densities to be used in transformers for various frequencies, though the values there given are commonly exceeded in American transformers.

The actual magnetic densities aimed at in recent transformers of one large maker may be represented, for a frequency of 133, by the following formulas and the first curve shown in Fig. 215. Where the output is below 1500 watts, $B_{\max} = \frac{250,000}{\text{Output}} + 3330$, and when the watts

* Ewing, The Dissipation of Energy through Reversals of Magnetism in the Core of a Transformer, *London Electrician*, Vol. 28, p. 111; Ewing and Klaassen, Magnetic Qualities of Iron, *London Electrician*, Vol. 32, p. 713.

output is above 1500 watts, $B_{\max} = 3500$. These transformers may be used on circuits having frequencies from 60 to 135, in which case magnetic densities are inversely proportional to the frequencies. In older transformers, where poorer iron was used, the densities aimed at by the same maker are shown by the second curve of Fig. 215.

The magnetic densities in the transformers of another large manufacturer lie between 3600 and 2800 at a frequency of 125, in transformers of capacities between 500 and 30,000 watts. Similar magnetic densities are aimed at in the transformers of a third large manufacturer, and all successful American manufacturers keep pretty closely within these limits.

The percentage which the core losses bear to the output in well-designed transformers varies greatly. The average for transformers not smaller than 6 K.W. capacity and not larger than 20 K.W. capacity, may be said to range between $\frac{3}{4}$ and 2 per cent. For smaller transformers, this percentage increases. For 3 K.W. transformers 2 per cent is a fair value, though 3 per cent is exceeded in some transformers of this size; and for 500 watt transformers 5 per cent is not bad.

First class transformers should have core losses not exceeding the following: 1 K.W., 30 watts; $1\frac{1}{2}$ K.W., 40 watts; 2 K.W., 50 watts; $2\frac{1}{2}$ K.W., 60 watts; 4 K.W., 80 watts; $6\frac{1}{2}$ K.W., 100 watts; $17\frac{1}{2}$ K.W., 150 watts. Intermediate sizes will have proportional losses. In some transformers these figures are bettered on the higher commercial frequencies, as in the case of two of 7500 watts capacity, built by different makers,

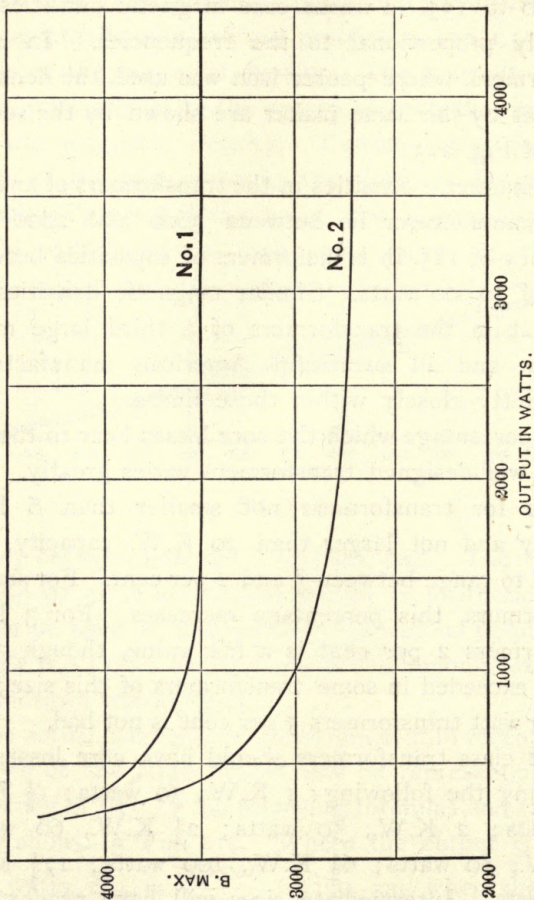

Fig. 215

in which the core losses varied from 75 to 125 watts depending on the frequency, the test frequencies being 60 and 125.*

The following table of the exciting currents of good transformers is taken from the results of numerous tests by Professor Ryan.†

| Capacity. | Exciting Current. | Approximate Per Cent of Primary Full Load Current. |
|-----------|-------------------|--|
| 250 | .040 Ampere | 14. |
| 500 | .050 " | 7.2 |
| 1000 | .055 " | 5.0 |
| 2000 | .080 " | 3.8 |
| 6500 | .100 " | 1.5 |
| 17500 | .200 " | 1.1 |

The data of this table were gained from tests of transformers of various makers designed for a primary pressure of 1000 volts at a frequency of 133, but are rather high for the better grade of transformers.

122. Copper Losses. — The C^2R loss in transformers is ordinarily between $1\frac{1}{2}$ per cent and $3\frac{1}{2}$ per cent. This is divided with approximate equality between the primary and secondary windings. Sometimes this loss is permitted to reach 5 per cent, but in the better transformers it is more often between 2 per cent and 3 per cent. The primary and secondary coils of good commercial transformers of later design are so disposed

* *Bull. Univ. of Wisconsin*, Vol. 1, No. 11; Jackson, *Electrical Journal*, Vol. 1, p. 78, and *N. Y. Elect. Engineer*, Vol. 20, p. 183.

† Ryan, *The Efficiency of Alternating Plants*, *N. Y. Elect. Engineer*, Vol. 13, p. 12.

that the magnetic leakage is practically negligible, though in earlier transformers this was not true.* Consequently, the change in the ratio of transformation causing a drop in the secondary pressure as the load increases, is practically all caused by the copper losses. If the total C^2R loss is equally divided between the primary and secondary windings, and magnetic leakage is negligible, the following relations exist for transformers having a magnetic circuit wholly of iron :

$$\begin{aligned}\frac{E'}{E''} &= k, & \frac{R'}{R''} &= k^2, \\ \frac{n'}{n''} &= k, & \frac{L'}{L''} &= k^2, \\ M &= \sqrt{L'L''} = \frac{L'}{k} = L''k,\end{aligned}$$

and, approximately,

$$\frac{C'}{C''} = \frac{1}{k} + \frac{C_1'}{C''},$$

where k is the ratio of transformation. $\frac{C_1'}{C''}$ is usually very small compared with $\frac{1}{k}$.

123. Rise of Temperature and Radiating Surface. —

The windings of transformers are usually embedded largely in the iron core, and the whole transformer is enclosed in a water-proof iron case; and their rise of temperature is as much due to the heating of the core by core losses as to the copper losses. If transformers were placed in the open air, the entire external surface could be assumed to be effective in dissipating heat by radiation and convection, but on account of

* Ryan, *Trans. Amer. Inst. E. E.*, Vol. 7, p. 11.

the enclosing case, convection from the surface cannot take place, and all the heat must be radiated to the wall of the case, or conducted thereto through the poor heat conductors which are used to electrically insulate the transformer from its case. The conditions therefore point to the conclusion that for a given liberation of heat per square centimeter of surface, the temperature is likely to be higher in transformers than in dynamo fields. On the other hand, transformer coils may always be designed to be lathe wound, and therefore may be more effectually insulated than dynamo field coils; and as space is not so valuable in transformers, more liberal use may be made of mica, varnished canvas, fibre, and wood. It is therefore possible to safely run transformers with the windings at a considerably higher temperature than dynamos, and 60° Centigrade (108° F.) may be set as a safe limit to the rise in temperature. A high temperature limit has a marked disadvantage in causing an undue drop in pressure as the transformer heats up, by increasing the resistance of the windings, and while many transformers exceed the temperature limit named, many of the best types avoid the difficulty from drop in the pressure by not exceeding 40° rise. As the rise in temperature also increases the electrical resistance of the iron core, it decreases the Foucault current loss, so that, as suggested by Elihu Thomson, it would be advantageous to have the core of a transformer operated at a high temperature while the windings were kept cool. This cannot be conveniently arranged in small transformers, but the cooling of the conductors of very large

transformers has been effected by making the conductors tubular and passing a cool liquid through them.

It is practically impossible to fix any averages for the external surface of transformers per watt lost in the core and windings, on account of the very varied arrangements of the coils with reference to the core, and the effect of the containing case. For small and medium transformers it is usual to make the design as compact as possible, and no particular trouble from heating is experienced if the losses are not excessive, since the losses ought to be quite small. In large transformers the same plan may be adopted, and some device may be arranged for cooling the conductors, such as circulating a liquid through them or blowing air through ducts in the core. Figure 215 *a* shows the rise of temperature of the conductors as a function of the period of operation of a 200 K.W. air-blast transformer with and without the blast. Point *D* shows the temperature of the discs after the transformer had been operated seven hours with blast on; curve *A* shows the temperature of the windings when operated at full load without blast; curve *B* shows the temperature of the windings when operated at full load with blast of 1040 cubic feet per minute; and curve *C* shows the temperature of the air issuing from the transformer. The core and windings of some transformers are immersed in oil, which fills the case, so as to give a better opportunity for the heat to escape.

124. Current Density in Transformer Conductors. — The current density in transformer windings varies between 1000 and 2000 circular mils per ampere. It is not unusual to make the density somewhat smaller in

the secondary than in the primary, and the values in the best transformers frequently fall between 1000 and 1500 circular mils per ampere for the primary coil, and between 1200 and 2000 for the secondary coil. On the other hand, some designers make the density of current greater in the secondary windings, while others make the density about the same in each. As the primary

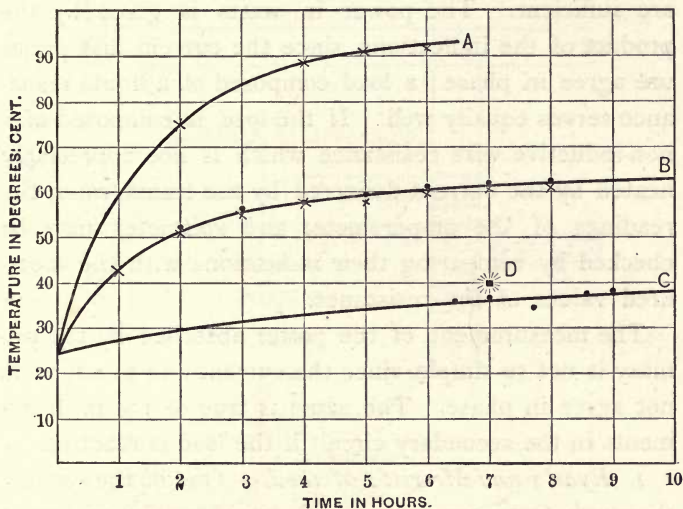

Fig. 215 a

wire of nearly all commercial transformers is much smaller than the secondary conductor, insulation takes up much more space in the primary coil, and this coil occupies more space than the secondary coil unless the primary current density is considerably greater.

125. Testing Transformers.—Methods for testing the efficiency of transformers and for determining their core losses have received a large amount of attention.

The more important methods are explained in the following pages.

Transformers are ordinarily worked on loads composed of incandescent lamps, which are practically non-inductive. Consequently there is no difficulty in determining the power in the secondary circuit, since the indications of a proper amperemeter and voltmeter are sufficient. The power in watts is given by the product of the indications, since the current and pressure agree in phase; a load composed of a liquid resistance serves equally well. If the load is composed of a non-inductive wire resistance which is not appreciably heated by the current delivered by the transformer, the readings of the amperemeter and voltmeter may be checked by comparing their indications with the measured values of the resistance.

The measurement of the power absorbed by the primary is not so simple, since the current and pressure do not agree in phase. The same is true of the measurements in the secondary circuit if the load is reactive.

1. *Ryan's and Merritt's Method.* — One of the earliest thorough tests on commercial transformers was that carried out by Professors Ryan and Merritt in 1889.*

In this series of tests the curves of current and electric pressure were determined by Ryan's method (Sect. 78, 4), and the effective values of these quantities and of the power in the circuit were determined from the curves, by the first method given in Section 81, except in the case of the secondary current, which was directly measured by an amperemeter. The connections are

* *Trans. Amer. Inst. E. E.*, Vol. 7, p. 1; *Elect. World*, Vol. 14, p. 419.

shown in Fig. 216; T is the transformer, MM are the primary leads to the transformer, LL are incandescent lamps connected as load to the secondary, KK is a non-inductive resistance connected across the primary leads, J is an amperemeter, A is a contact maker, E is a Ryan electrometer with accompanying devices, and GG is a series of switches. The object of these switches is to

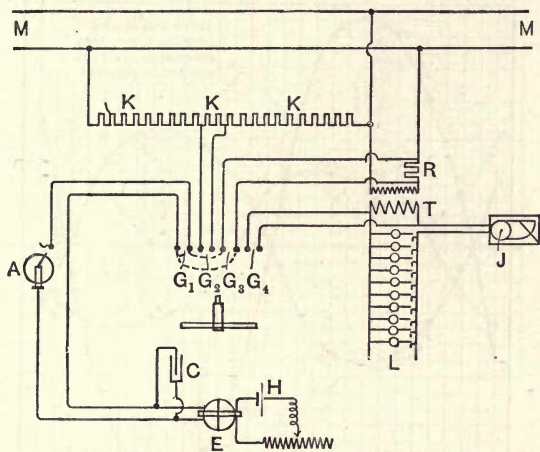

Fig. 216

connect the contact maker alternately with different parts of the circuit, so that the curves of primary and secondary pressure and primary current may be traced.

The curve of pressure at the terminals of the non-inductive resistance R is evidently the same, if taken to a proper scale, as the curve of secondary current. In order to avoid handling the large primary pressure at the contact maker and electrometer, the calibrated resistance KK is used. The curve of pressure taken

between any two points on this resistance, when given a proper scale, is evidently the same as the curve of total pressure. For the non-inductive resistances R and KK , Ryan and Merritt used incandescent lamps which they had "rated."

These tests were carried out on a ten-light (500 watt) transformer when operated with the secondary circuit

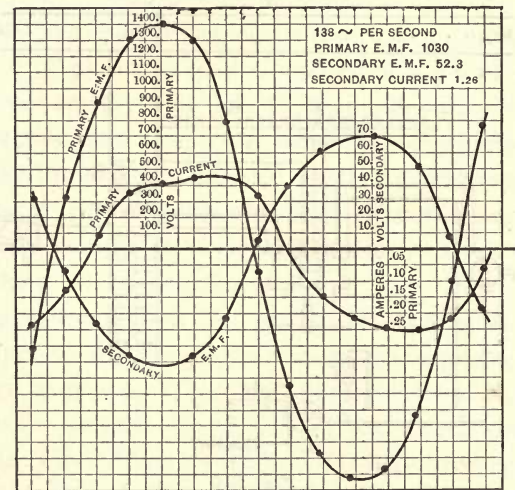

Fig. 217

open, and with the secondary loaded respectively with one lamp, with five lamps, and with ten lamps. The curves gained under these conditions are given in Figs. 212, 217, 218, and 213.

In addition to the determination of the curves of current and pressure, the various quantities were also directly measured. The effective values deduced from the curves agree quite closely with those directly deter-

mined, but are of no use in determining the performance of the transformer, unless the phase differences of pressures and currents be determined in some manner. This is practically done by using the curves.

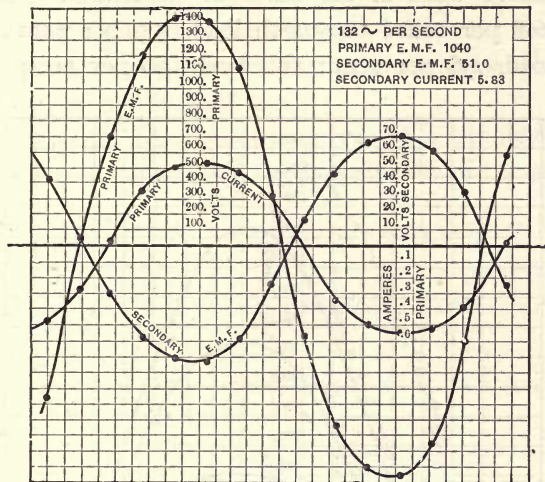

Fig. 218

The results given by these tests reduced to a uniform primary pressure of 1020 volts are as follows :

| | No Load. | $\frac{1}{10}$ Load. | $\frac{1}{2}$ Load. | Full Load. |
|--|----------|----------------------|---------------------|------------|
| Secondary pressure | 52.3 | 52.3 | 50.1 | 47.5 |
| Watts absorbed by primary | 96.1 | 159.1 | 388.6 | 607.9 |
| Watts delivered by secondary | 0.0 | 64.3 | 300.9 | 525.0 |
| Commercial efficiency | 0.0 | 41.1 | 77.5 | 86.6 |
| Total loss in watts | 96.1 | 94.8 | 87.7 | 82.9 |
| C^2R loss in primary | 0.4 | 0.9 | 3.3 | 8.7 |
| C^2R loss in secondary | 0.0 | 0.0 | 1.3 | 4.5 |
| Core losses | 95.7 | 93.9 | 83.1 | 69.7 |

Figure 219 gives the curves obtained by taking the products of the instantaneous pressures and currents through one-half a period. The proportions of negative work due to the wattless component of the current to positive work in the different cases are: open circuit, 6.8 per cent; one-tenth load, 3.9 per cent; one-half load, .96 per cent; full load, .36 per cent. The

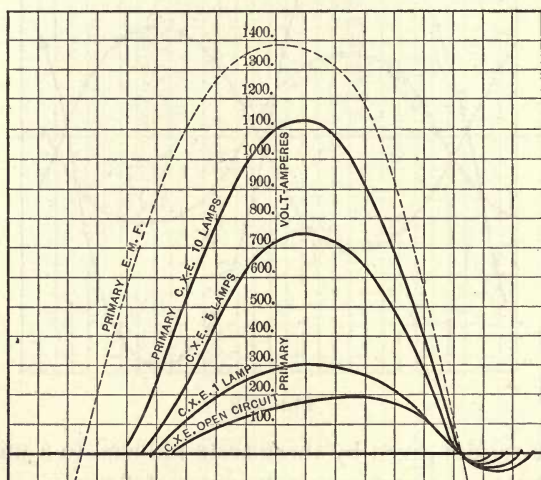

Fig. 219

power factors in the different cases are, therefore, 86.4 per cent, 92.2 per cent, 98.1 per cent, and 99.3 per cent.

The curves of pressure and current, which are here shown, give in an interesting manner the effect of the secondary current on the form of the primary current wave. The curves also show the effect of magnetic leakage in retarding the phase of the secondary pressure in relation to that of the primary pressure. A

cross-section of the transformer is given in Fig. 220, which shows the arrangement of the primary and secondary coils. In this transformer the magnetic leakage amounted to 1.2 per cent on open circuit and increased with the load to as much as 5.4 per cent on full load. At the same time the secondary pressure wave fell back from exact opposition to the primary pressure wave (180° lag) to nearly 190° lag.

In Fig. 218 $\frac{1}{2}$ are given the curves of a Stanley transformer with a capacity of 17500 watts, when the second-

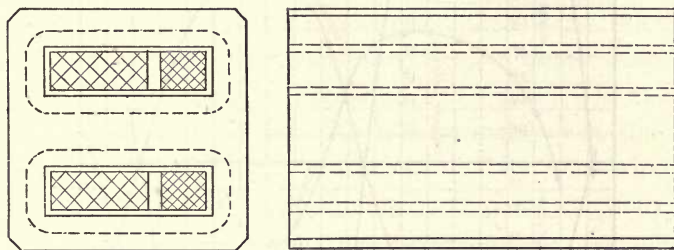

Fig. 220

ary circuit is open. This transformer was tested by Professor Ryan in 1892,* with the following reduced results:

Primary pressure, 1000 volts; secondary pressure, no load, 50.80 volts; full load, 49.67 volts; drop, 1.16 volts or 2.32 per cent; efficiency at full load, 96.9 per cent; at half load, 97.1 per cent; one-quarter load, 96.0 per cent; and one-eighth load, 93.0 per cent; exciting current, .195 amperes; power absorbed with secondary open (core losses), 137 watts; magnetic leakage

* *N. Y. Elect. Engineer*, Vol. 14, p. 298.

practically negligible. The frequency on which the transformer was tested was practically 133. The proportionately small value of the magnetizing component

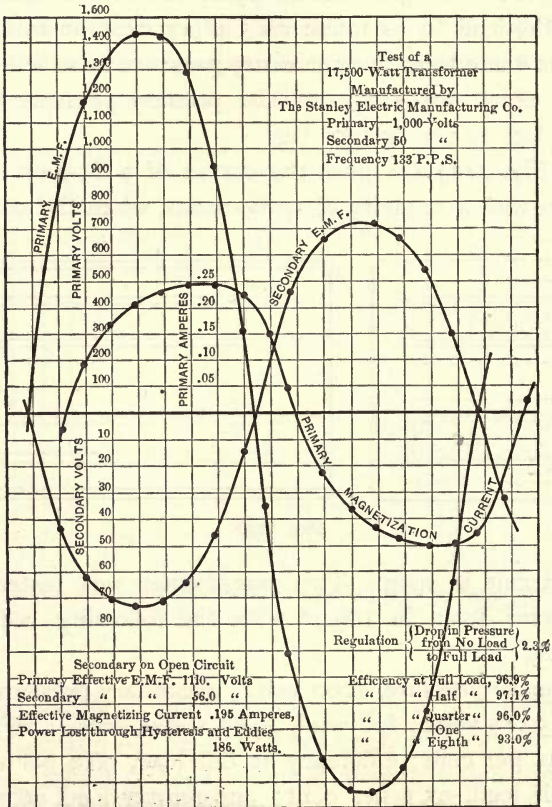

Fig. 218½

of the exciting current in this transformer (the power factor shown by the results marked on the figure is .86) decreases the distortion of the curve of exciting current

and causes its maximum point to be displaced to a position in advance of the position of zero pressure (Sect. 120).

2. *Hopkinson's Method.* In the preceding method the losses and efficiencies are determined by taking differences between measured quantities which are of considerable magnitude, each of which may be affected by considerable errors of observation, which errors enter directly into the value of the difference. The differences thus obtained are therefore not reliable.

Dr. John Hopkinson modified the method by using two similar transformers, connected (Fig. 221) so that one transformed up the pressure supplied to its thick wire coil, and the other transformed this pressure down again. The respective pressures and currents in the low-pressure coils of the two transformers when thus arranged are therefore nearly equal. By measuring their differences and determining their phase relations, the losses in the two transformers are obtained. Assuming the two transformers to be similar, one-half the total loss is due to each. The efficiency is then obtained from this loss measurement and a measurement of the current and pressure in the secondary circuit of the second transformer, which consists of a non-inductive resistance. To determine the differences and their phase relations, a contact maker and electrometer were used (Sect. 78, 3).

The connections were arranged as shown (Fig. 221)* and a series of curves were obtained for various loads which are shown in Fig. 222 (*a*, *b*, *c*, and *d*).

* Hopkinson's *Dynamo Machinery and Allied Subjects*, p. 187; *Elect. World*, Vol. 20, p. 40.

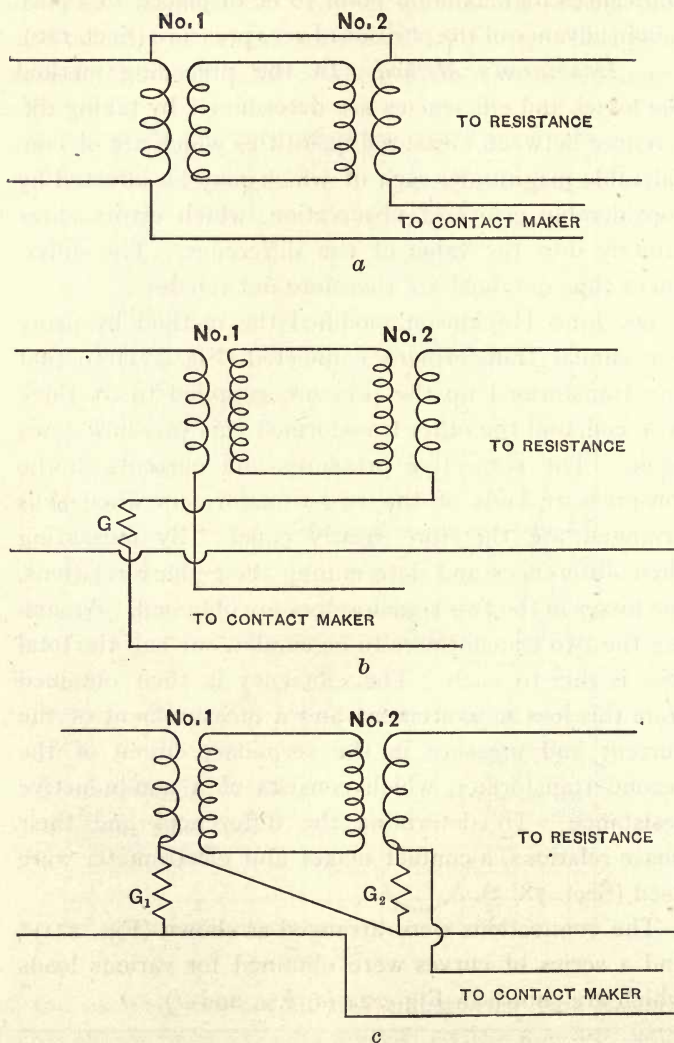

Fig. 221

The results of these tests showed the efficiencies of Westinghouse transformers of 6500 watts capacity to be

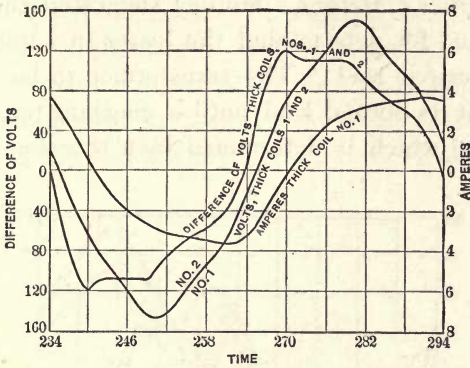

Fig. 222 a

96.9 per cent at full load, 96 per cent at half load, and 92 per cent at quarter load; the drop of pressure between no load and full load to be between 2.2 and 3

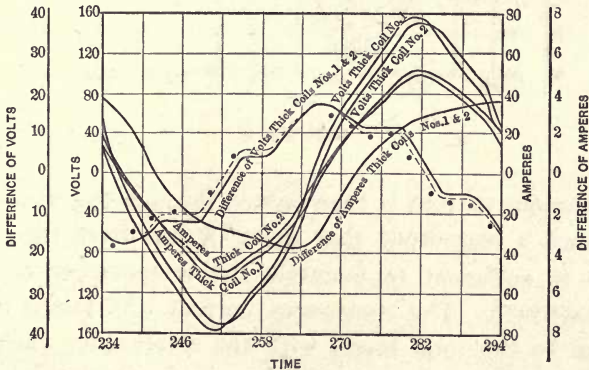

Fig. 222 b

per cent; the core losses in each transformer to be about 114 watts; the magnetic leakage in one trans-

former appeared to be small, but in the other to be considerable.

3. *Mordey's Method.* Mordey suggested the following method for determining the losses in a transformer at any desired load:* The transformer to be tested is worked at its normal load until a constant temperature is reached which is determined by a thermometer. A

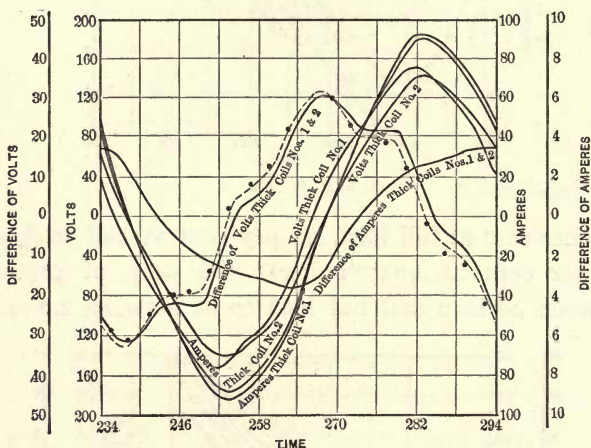

Fig. 222 c

continuous current is then passed through the windings of such a magnitude that the C^2R loss from this current is sufficient to maintain the temperature of the transformer. The continuous current C^2R loss is then equal to the total losses with the alternating current. The continuous current C^2R loss is readily determined by voltmeter and amperemeter, or by wattmeter. The

* Alternate Current Working, *Four. Inst. E. E.*, Vol. 18, p. 608.

tests by this method are laborious and impractical on account of the time required.

4. *Calorimetric Method.* This method has been used by many experimenters.* The transformer is taken from its iron case and sealed up in a tin or copper case which is immersed in a water calorimeter (Fig. 223). The loss in the transformer at any desired load on the

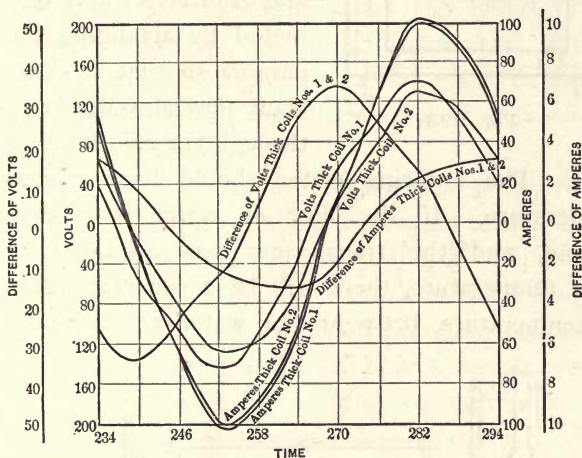

Fig. 222 d

secondary is determined from the rate at which the water in the calorimeter rises in temperature, provided the heat absorbed by the transformer and calorimeter (water equivalent), and the rate of loss of heat from the sides of the calorimeter, have been determined, so that a proper correction may be applied to the results. The determination of the elements entering into this correc-

* Duncan, *Electrical World*, Vol. 9, p. 188; Roiti, *La Lumière Électrique*, Vol. 35, p. 528.

tion is likely to introduce considerable errors. These are decreased somewhat by using oil in the calorimeter,

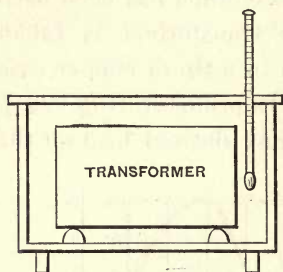

Fig. 223

when the transformer may be directly immersed without the enclosing case. The errors due to the heat absorbed by the transformer and calorimeter may be eliminated by arranging the apparatus so that a slow constant flow of water is passed through the calorimeter (Fig.

224). The entering water should have a constant temperature. If the flow of water is of constant volume, and the transformer has attained a constant temperature, there will be a constant difference of temperature between the water at entrance and

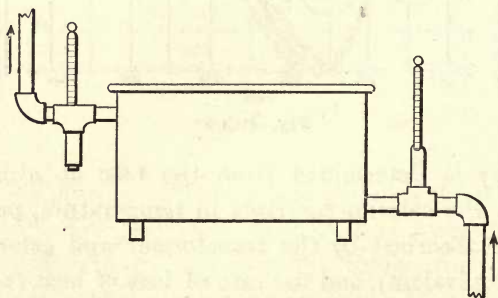

Fig. 224

exit. This may be measured by thermometers. From this difference of temperature and the weight of water flowing per minute through the calorimeter, the energy expended in the transformer and given up to the water

may be deduced. A correction must be applied on account of the loss of heat due to radiation from the calorimeter. A more satisfactory arrangement of the calorimeter test is to place the hermetically sealed transformer in a vessel with ice packed around it. If the vessel is properly protected from external heating effects, the melting of the ice will practically all be due to heat from the transformer, and the losses in the transformer may be determined from the amount melted in a given time. A correction must be applied for the melting before the transformer has reached a constant temperature.

It is difficult, at best, to get very satisfactory results from the calorimetric methods, on account of the difficulties inherent in the exact determination of temperatures or of heat losses. The best method of work is probably to directly calibrate the calorimeter by inserting in the place of the transformer a known resistance and passing through it such a continuous current as will give the same heating effect as the transformer. Then the energy absorbed by the resistance is equal to the transformer losses.

5. *Split Dynamometer Method.* The split dynamometer may be used for directly determining the power absorbed by a loaded transformer if the magnetic leakage is negligible. In this case an electro-dynamometer is connected with one coil in each circuit. Then, practically, $e' = R'c' + \left(\frac{n'}{n''}\right)e''$. But $e'' = c''(R + R'')$, where e' , e'' ; c' , c'' ; n' , n'' ; and R' , R'' are respectively the pressures, currents, turns, and resistances in the pri-

mary and secondary coils, and where R is the resistance of the external secondary circuit. Then

$$e'c' = R'c'^2 + \frac{n'}{n''}(R + R'')c'c''.$$

The energy absorbed by the primary circuit is, therefore,

$$W' = \frac{1}{T} \int_0^T e'c' dt = \frac{R'}{T} \int_0^T c'^2 dt + \frac{n'}{Tn''}(R + R'') \int_0^T c'c'' dt.$$

The integral of the first term of the right-hand member is equal to the square of the primary current, and that of the second term is $C'C'' \cos \phi = kD$, where D is the reading of the split dynamometer and k is its constant (Sect. 44, 5). Consequently,

$$W' = C'^2R' + \frac{n'}{n''}(R + R'')kD.$$

As already said, this method is only accurate when magnetic leakage is negligible.

6. *Voltmeter and Ammeter Methods.* The power in the primary and secondary circuits may be measured by any of the methods given in Section 44 for measuring the power in an alternating-current circuit by means of voltmeters and amperemeters. The numerical efficiency will be found from the ratio of the secondary and primary energies, and the transformer losses from their difference.

7. *Wattmeter Method.* Where satisfactory wattmeters are at hand, it is evident that one may be placed in the primary circuit of a loaded transformer and another in the secondary circuit. Then the ratio of their readings is the efficiency of the transformer. Or,

a wattmeter may be used in the primary circuit and an amperemeter and voltmeter may be used to determine the output, if the transformer is worked on a non-inductive load. The wattmeter was used by Fleming in a very extended series of transformer tests, and found to be more satisfactory than either of the methods in which amperemeters and voltmeters are used to determine the energy absorbed by the primary circuit.*

8. *Stray Power Methods.* A very convenient method of measuring the efficiency of transformers is to determine the various losses directly, and thence the efficiency. The iron losses may be determined by measuring with a wattmeter the power absorbed by the transformer when the secondary circuit is open. The copper losses for any load are readily calculated when the secondary and exciting currents and the primary and secondary resistances are known. The exciting current may be measured at the same time that the iron losses are determined, and the resistances may be measured by a bridge. For a given load, the secondary current is a fixed quantity. The efficiency is then, practically,

$$\frac{W''}{W'' + I + C''^2 R'' + \left(\frac{C''}{k} + C_1'\right)^2 R'}$$

where I represents the measured iron losses and k the ratio of transformation.

8 a. A still more convenient method, which may be readily used in central stations for testing transformers, is to measure the iron losses by a wattmeter, as ex-

* *Jour. Inst. E. E.*, Vol. 21, p. 623; *Elect. World*, Vol. 20, p. 413.

plained above. The copper losses may then be measured by short-circuiting the secondary through an amperemeter, and adjusting the primary pressure until the full load current, or any desired fraction thereof, passes through the amperemeter. The reading of a wattmeter in the primary circuit is now nearly equal to the copper losses, since the pressure and maximum magnetic density must be very small, and the iron losses are therefore almost or entirely negligible. The exact copper losses may be determined by measuring and

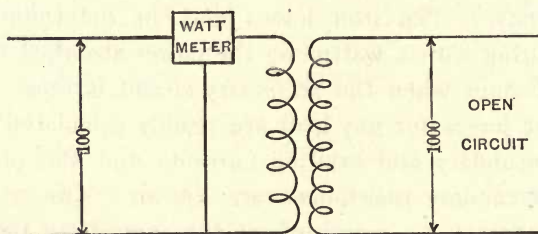

Fig. 225

correcting for the small iron loss. The tests for the iron losses may be most conveniently made by using the low resistance coil of the transformer as the primary coil (Fig. 225).

This method of testing may be used with satisfaction where numerous transformers must be tested, since the losses and efficiency may be determined expeditiously and with the expenditure of little power. When combined with a run of several hours with full load current, the secondary circuit being made up of impedance coils, the method proves very economical for shop tests. The

method was adopted by Mr. A. H. Ford for a very complete series of tests of American transformers.*

8 b. Ayrton and Sumpner have devised a method not so serviceable as the last, but still quite useful, in which two transformers of the same size and make are opposed to each other. The method of connecting

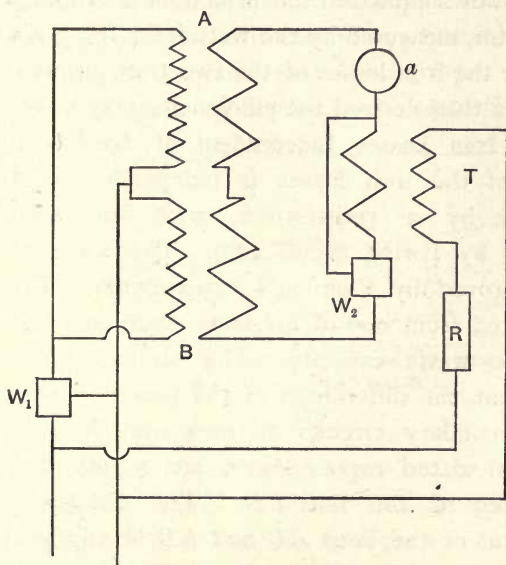

Fig. 225 a

up is as in Fig. 225 a, in which A and B are the transformers with their primaries connected in relatively opposite directions to the leads and their secondaries in series. The pressures of the secondaries are thus opposed. A transformer T is inserted with its secondary

* Tests of American Transformers, *Bull. of Univ. of Wisconsin*, Vol. I, No. 11.

in circuit with the secondaries of A and B . By varying the resistance R , the pressure of T may be regulated so that any desired current will pass through the secondaries of A and B . Then the output of T measured by the wattmeter W_2 will give approximately the copper losses of A and B plus the loss in leads and instruments. The power supplied to the primaries of A and B by the alternator, measured by the wattmeter W_1 , gives approximately the iron losses of the two transformers. From the data thus derived the efficiencies may be obtained.

126. Iron Losses Independent of Load. — That the value of the iron losses is independent of the load carried by a transformer, was first conclusively proved by Ewing (Sect. 127). The same thing has been proved by Fleming's experiments. Figure 226 is plotted from one of his tests made on a transformer of 4000 watts capacity. The ordinates of line AB represent the differences of the power in the primary and secondary circuits as measured by wattmeters. The calculated copper losses are represented by the ordinates of the line CD . The difference of the ordinates of the lines AB and CD at any point is the iron loss for the particular load. The lines AB and CD are approximately parallel, which shows that the iron losses are practically constant, regardless of the load. Therefore the stray power methods of testing transformers give efficiencies which are entirely reliable.

127. Ewing's Experiment showing that Iron Losses are Constant. — Ewing's very neat plan for proving this point was designed to get at the matter directly. Two small transformers were made up exactly alike, the

cores of which consisted of insulated iron wire wound into the form of a ring. Over this were uniformly wound two layers of wire making a primary coil, and another two layers making a secondary coil. In operating, the primary and secondary coils were respectively connected in series, but the two halves of each coil in one transformer were so connected as to be in magnetic opposition (Fig. 227). The core of one transformer was therefore magnetized and that of the other was not. While the C^2R losses at any load were equal in the two,

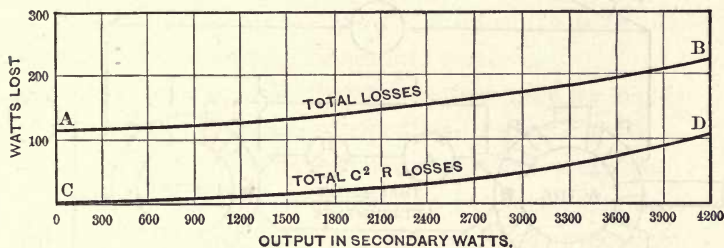

Fig. 226

the transformer with magnetized core heated more when put in operation than the other transformer, but the temperature of the second was brought to equality with that of the first by passing a continuous current through the insulated wire of the core. The energy expended in heating the second core by the continuous current was thus equal to that expended in the first core due to iron losses. The equality of temperature was determined by means of thermo-electric couples embedded in the cores, which were connected in series through a galvanometer (Fig. 227). In this experiment it was found that after a balance of temperature was once

obtained it was unaltered by any changes in the loads of the transformers, thus showing that the core losses in the magnetized transformer were independent of the load.*

128. Regulation Tests.—The regulation of transformers which are used in incandescent lighting is a

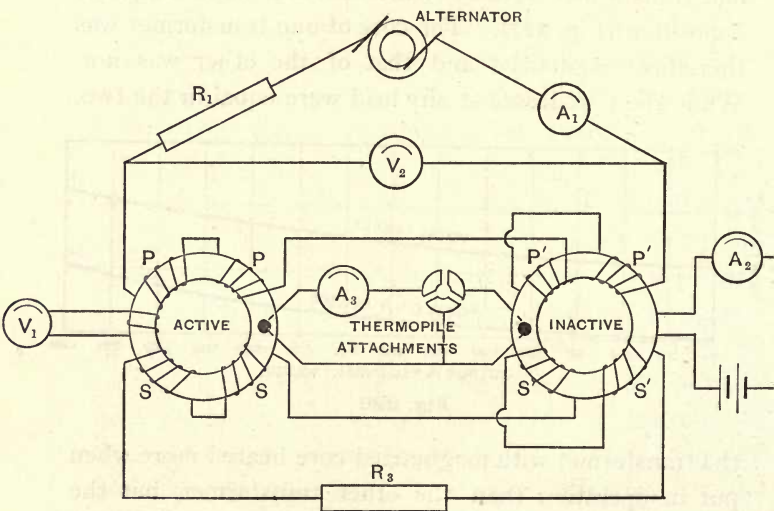

Fig. 227

matter of much moment, and regulation tests are of almost equal importance to the tests of losses and temperatures. The ordinary method of making regulation tests is to place a voltmeter across the primary circuit and another across the secondary circuit of the transformer to be tested. At no load, the reduced readings

* Ewing and Klaassen, Magnetic Qualities of Iron, *London Electrician*, Vol. 32, p. 713.

of the instruments should be equal, and the difference between the reduced readings at any other load gives the corresponding drop of pressure in volts. The reduced readings are gained by multiplying the readings of the two voltmeters by their respective constants and dividing the reading of the voltmeter in the high pressure circuit by the ratio of transformation of the transformer. The drop of pressure, measured in this way, includes the *CR* drop in the windings and the drop due to magnetic leakage, which increases with the load. The magnetic leakage drop may be determined by subtracting from the total drop, the value of the *CR* drop which is calculated from measured resistances and currents.

A much more accurate regulation test may be made by using two transformers of equal transformation ratios and one voltmeter. The primaries are separately connected to the supply mains, and the secondary circuits are connected together on one side. A high resistance or electrostatic voltmeter is connected between the other legs of the secondary circuits. The reading of this voltmeter at any load on one transformer, when the other is unloaded, gives the total drop of pressure caused by loading the former.

Regulation tests are usually made with non-reactive loads, since good regulation is a matter of necessity in incandescent lighting circuits, which are practically non-reactive. The regulation of a transformer is changed for the worse by introducing inductance into the secondary circuit, and for the better by introducing capacity into the secondary, as has already been proven (Sects. 117 and 118). Regulation tests on a reactive load are of little

service except from a comparative standpoint, or to determine whether a transformer will give a satisfactory service to both incandescent lamps and alternating-current motors or arc lamps. The combined service is seldom satisfactory on account of poor regulation which injures the incandescent lighting, though the defective regulation is not a matter of much importance to the power or arc-light service.

129. The All-Day Efficiency of Transformers and the Effect of Magnetic Reluctance. — The working efficiency of a transformer is by no means equal to its full-load efficiency. In the case of dynamos placed in a central station it is usual to divide the generating units so that the plant operating at any part of the day will be fairly loaded. In the same way the capacity of stationary motors, used for distributing electric power, may be chosen so that they seldom operate at very small partial loads. The way that transformers are usually operated, however, makes it quite difficult to keep a uniform load on them, and in fact, for a considerable portion of the day they are worked with the secondary circuit open. This being the case, the iron losses of transformers are of much greater influence on their all-day efficiency than are the copper losses, and it is desirable to reduce the iron losses to a minimum. For instance, suppose a transformer of 5000 watts capacity has an iron loss of 2.5 per cent or 125 watts, and a copper loss at full load of 2 per cent or 100 watts. Then the full-load efficiency of the transformer is 95.5 per cent, the half-load efficiency is 94.3 per cent, and the quarter-load efficiency is 89.5 per cent. Supposing that the daily output of the

transformer is equivalent to 25,000 watts for one hour (25,000 watt-hours), which is equal to full-load operation for five hours and open-circuit operation for the remaining 19 hours, then the losses are equivalent in the iron core to 3000 watts for one hour, and in the copper to 500 watts for one hour, or a total of 3500 watts for one hour. The all-day efficiency is then 87.7 per cent. To increase this all-day efficiency, it is evidently necessary to decrease the iron losses. To do this with a fixed frequency, requires a decrease in the amount of iron in the magnetic circuit or a decrease of the maximum magnetic density. Either process calls for an increase in the windings and consequently in the copper losses. Suppose that decreasing the core losses to $1\frac{1}{2}$ per cent makes it necessary to increase the copper losses to 3 per cent; then, other things being equal, the efficiencies become, full load, 95.5 per cent; half load, 95.7 per cent; quarter load, 93.7 per cent; and the all-day efficiency, on the assumption made above, is 90.7 per cent. There is a saving by the latter construction of 950 watt-hours in twenty-four hours, and in one year of 365 days the saving is nearly 350 kilowatt-hours. If one kilowatt-hour is worth 10 cents to the central station, the difference in the amount of power wasted each year by the two transformers has a value of more than thirty-five dollars, which is several times the difference in the original cost of the two transformers. If the average load of the transformer were less than that assumed, which is frequently the case in practice, the iron losses would have a still greater influence on the all-day efficiency. A still greater decrease

in the iron loss with its attendant increase of copper loss would evidently raise the all-day efficiency to a higher point. Here, however, is met the question of regulation, which will not satisfactorily admit of too great a copper loss at full load on account of the attendant drop of secondary pressure, but this difficulty may be met by increasing the cross-section of the copper. This alternative causes an increase in the cost of the transformer, but a transformer with small losses and good regulation is worth more to the central station than one with large losses or poor regulation. The all-day efficiency, upon the assumed basis, of the 17,500 watt transformer previously referred to (page 475) is 93.8 per cent, and of the 6500 watt transformer (page 479) is 91.3 per cent. The advantage of decreasing the iron losses, which is thus shown, led Swinburne to advocate and build transformers with a cylindrical iron core under the windings, but without closed iron magnetic circuits.* Decreasing the amount of iron in the magnetic circuit decreases the core losses but at the same time increases the reluctance and therefore increases the magnetizing current. This is a decided disadvantage if carried to an excess. While the true magnetizing current is wattless, and therefore requires the expenditure of no power in the transformer, yet it does result in a continuous C^2R loss in the conductors leading to the transformer and in the primary winding of the transformer itself. It also

* Swinburne, *The Design of Transformers*, *Proc. British Assoc. for the Advancement of Science*, 1888, and *London Electrician*, Vol. 23, p. 492; *Transformer Distribution*, *Jour. Inst. E. E.*, Vol. 20, p. 163.

causes an extra demand for current from the dynamo supplying the circuit, so that extra generators must be operated at periods of light load in order to supply the wattless current. In other words, the power factor of the system as a whole is decreased, with an accompanying loss of **Plant Efficiency**. Finally, a large magnetic reluctance causes a considerable magnetic leakage and consequent increase in the secondary drop of a transformer, and therefore interferes with its regulation.

The last two points may become very serious if the reluctance of the magnetic circuit of transformers is made excessive; consequently Swinburne decreased the reluctance in his transformers by making the core of iron wire, which was bent out into a spherical head (Fig. 228). From their prickly appearance these transformers have been called **Hedgehogs**. Figure 229 shows the various results of a test made by Fleming upon a 3000 watt hedgehog transformer with a ratio of transformation of 24:1, and Fig. 230 shows the power factor, at various loads, of a hedgehog transformer compared with two closed iron-circuit transformers. It has been claimed that the transformer tested by Fleming was defective and the results gained by Bedell, in testing a similar machine, were much better.*

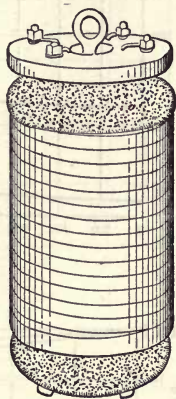

Fig. 228

Without entering a controversy regarding the exact

* *Trans. Amer. Inst. E. E.*, Vol. 10, p. 497; *Elect. World*, Vol. 22, p. 357.

point at which a high reluctance in the magnetic circuit of a transformer causes more disadvantage than is

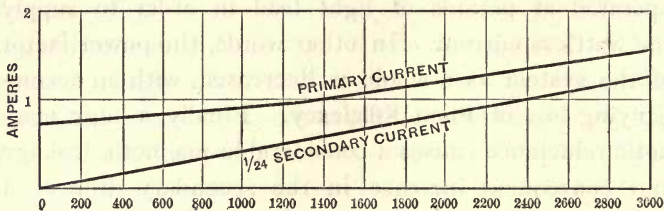

Fig. 229 a

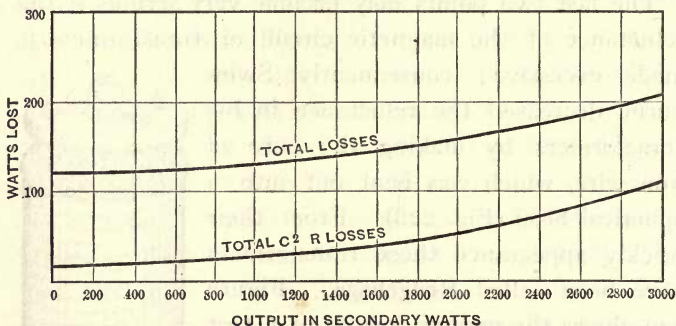

Fig. 229 b

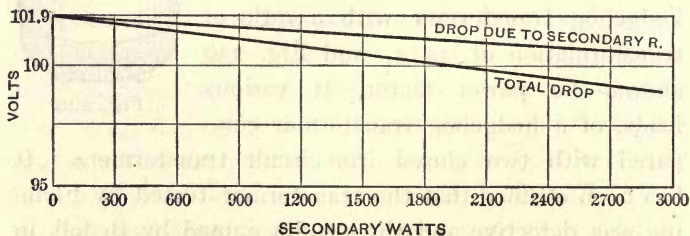

Fig. 229 c

counterbalanced by the decreased iron losses brought about by decreasing the amount of iron, the examples may serve to show the necessity of carefully designing

the magnetic circuit to fit the conditions. Where a fairly large proportion of the full load is carried by the transformer a great portion of the time, as may be the case in many of the proposed power transmissions, the reluctance of the magnetic circuit of the transformer should be made very small, so that the copper losses may be small. On the other hand, where the average load is very small, as in the ordinary

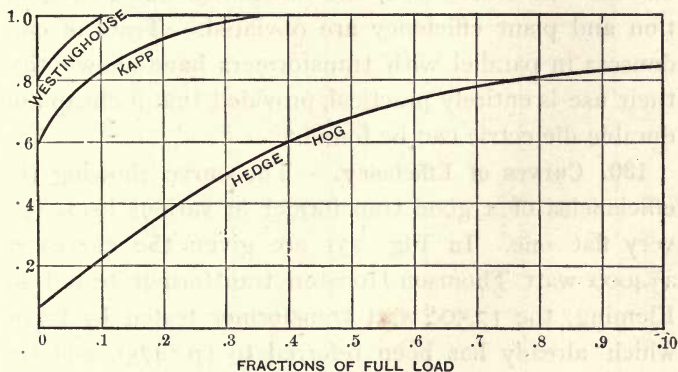

Fig. 230

arrangements of transformers for lighting service, the C^2R loss is of less moment than the iron losses, and every effort must be made to decrease the amount of iron, and hence the iron losses, as far as the requirements of economy of construction, plant efficiency, and regulation will permit. Transformers might even be built without iron in the core, were it not for the immoderate cost caused by the large amount of copper which would be required in their construction to gain a reasonably good degree of regulation.

The unsatisfactory features of transformers having cores of high magnetic reluctance may be largely neutralized by the use of condensers (Sect. 35). These may be put in parallel with each transformer of such a capacity as to practically supply the necessary wattless magnetizing current, or a group of condensers may be connected in parallel to each circuit of sufficient capacity to supply the wattless current for that circuit. In either case, the difficulties due to regulation and plant efficiency are obviated. Tests of condensers in parallel with transformers have shown that their use is entirely practical, provided that a cheap and durable dielectric can be found.*

130. Curves of Efficiency. — The curve showing the efficiencies of a good transformer at various loads is a very flat one. In Fig. 231 are given the curves of a 4000 watt Thomson-Houston transformer tested by Fleming, the 17,500 watt transformer tested by Ryan, which already has been referred to (p. 475), and the 3000 watt hedgehog transformer tested by Bedell, which was referred to directly above (p. 495). These curves are flatter than the similar curves for dynamos (Vol. I., p. 270). To get the best all-day efficiency, it is evident that every effort should be bent to making the knee of the curve at the smallest possible load,

* Swinburne, *The Probable Use of Condensers in Electric Lighting*, *London Electrician*, Vol. 28, p. 227; Le Blanc, *Application of Alternating Currents to the Transmission of Power*, *Soc. Inter. des Électriciens*, 1891; and *London Electrician*, Vol. 27, p. 383; Swinburne, *Transformer Distribution*, *Four. Inst. E. E.*, Vol. 20, p. 191, and *London Electrician*, Vol. 26, p. 548; Bedell and others, *Hedgehog Transformers and Condensers*, Pt. 3, *Trans. Amer. Inst. E. E.*, Vol. 10, p. 513.

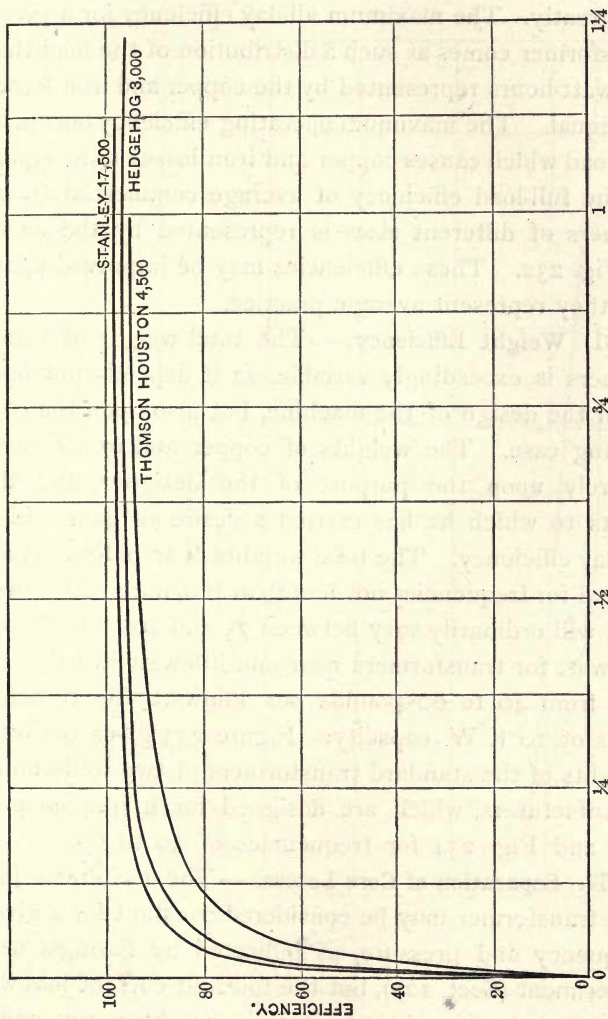

FRACTIONS OF NORMAL LOAD.

Fig. 231

without at the same time increasing the exciting current too greatly. The maximum all-day efficiency for a given transformer comes at such a distribution of the load that the watt-hours represented by the copper and iron losses are equal. The maximum operating efficiency occurs at the load which causes copper and iron losses to be equal.

The full-load efficiency of average commercial transformers of different sizes is represented by the curve of Fig. 232. These efficiencies may be improved upon, but they represent average practice.

131. Weight Efficiency. — The total weight of transformers is exceedingly variable, as it depends not only upon the design of the machine, but also upon the containing case. The weights of copper and iron depend entirely upon the purpose of the designer, and the limits to which he has carried a desire to gain a high all-day efficiency. The total weights of transformers designed for frequencies not less than 100, nor greater than 135, will ordinarily vary between 75 and 100 pounds per kilowatt for transformers near one kilowatt in capacity, and from 40 to 60 pounds per kilowatt for transformers of 10 K.W. capacity. Figure 233 gives the total weights of the standard transformers of two well-known manufacturers, which are designed for a frequency of 135 and Fig. 234 for frequencies of 30 to 60.

132. Separation of Core Losses. — The hysteresis loss in a transformer may be considered constant for a given frequency and pressure, as indicated by Ewing's neat experiment (Sect. 127), but the foucault current loss will become less after the transformer has been run under load and thus become heated up; for, as the core rises

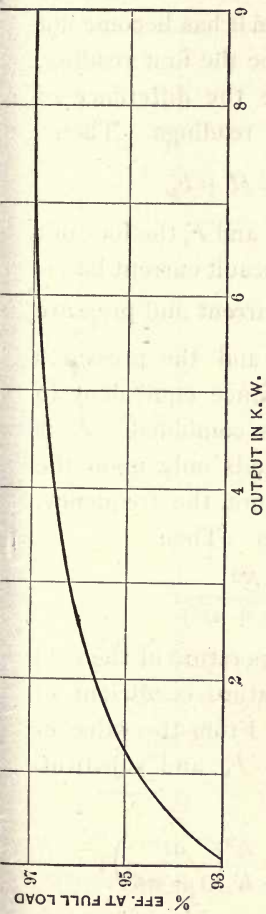

Fig. 232

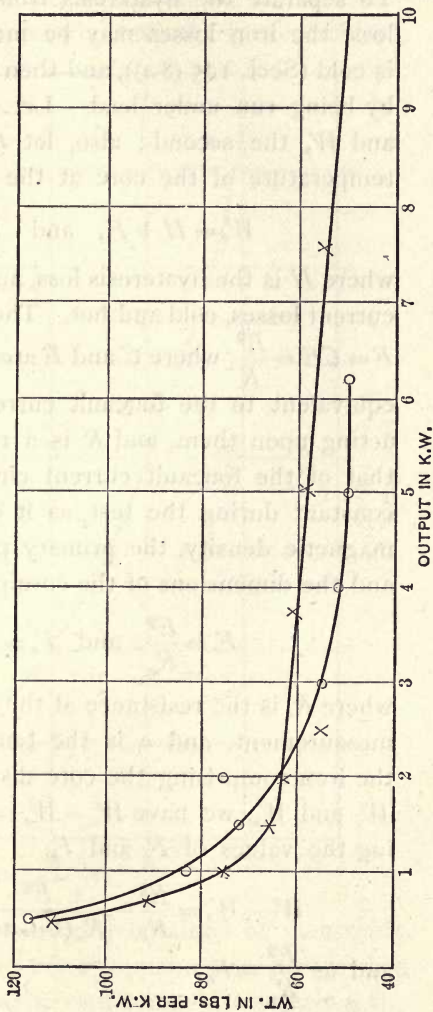

Fig. 233

in temperature, the resistance of the iron increases. To separate the hysteresis from the foucault current loss, the iron losses may be measured when the core is cold (Sect. 125 (8*a*)), and then when it has become hot by being run under load. Let W_c be the first reading, and W_h the second; also, let t° be the difference of temperature of the core at the two readings. Then

$$W_c = H + F, \quad \text{and} \quad W_h = H + F_h,$$

where H is the hysteresis loss, and F_c and F_h the foucault current losses, cold and hot. The foucault current loss is $F = CE = \frac{E^2}{R}$, where C and E are a current and pressure equivalent to the foucault currents and the pressures acting upon them, and R is a resistance equivalent to that of the foucault current circuits combined. E is constant during the test, as it depends only upon the magnetic density, the primary pressure, the frequency, and the dimensions of the core plates. Then

$$F_c = \frac{E^2}{R_c}, \quad \text{and} \quad F_h = \frac{E^2}{R_c(1 + at^\circ)},$$

where R_c is the resistance at the temperature of the cold measurement, and a is the temperature coefficient of the iron comprising the core discs. From the value of W_c and W_h , we have $W_c - W_h = F_c - F_h$, and substituting the values of F_c and F_h ,

$$W_c - W_h = \frac{E^2}{R_c} - \frac{E^2}{R_c(1 + at^\circ)} = \frac{E^2}{R_c} \left(\frac{at^\circ}{1 + at^\circ} \right);$$

and as $\frac{E^2}{R_c} = F_c$,

$$F_c = (W_c - W_h) \left(\frac{1 + at^\circ}{at^\circ} \right).$$

As all the quantities in the right-hand side of the equation are determined by measurement, the foucault current loss may be thus separated from the hysteresis loss.

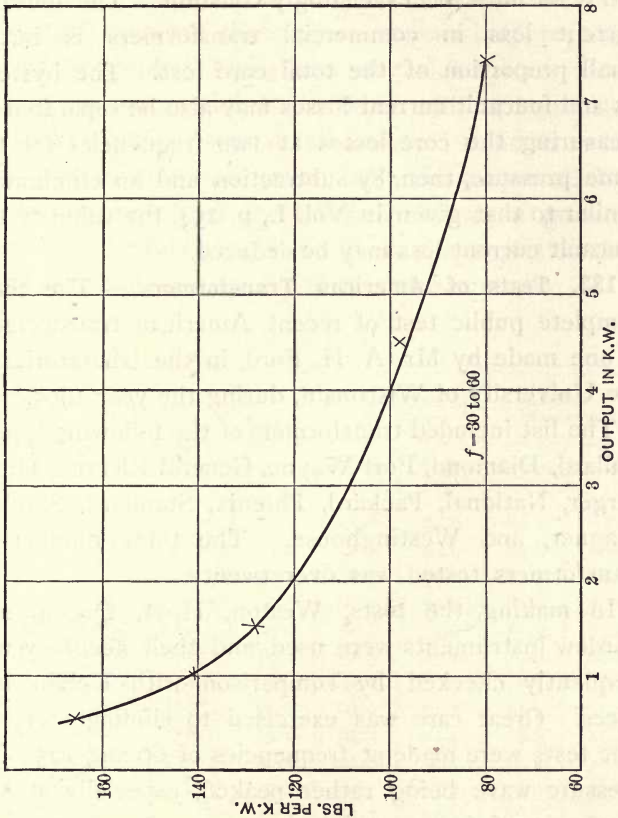

Fig. 234

The coefficient a may be readily obtained by measuring the resistance between any two points on a core disc when the core is at two different temperatures, when the quantity desired will be the per cent change in resist-

ance per degree change in temperature. In order that the results of these measurements may be reasonably reliable, the pressure applied to the transformer during the tests must be exceedingly constant. The foucault current loss in commercial transformers is but a small proportion of the total core loss. The hysteresis and foucault current losses may also be separated by measuring the core losses at two frequencies for the same pressure, then, by subtraction and an elimination similar to that given in Vol. I., p. 254, the value of the foucault current loss may be deduced.

133. Tests of American Transformers.—The most complete public test of recent American transformers is one made by Mr. A. H. Ford, in the laboratories of the University of Wisconsin, during the year 1895.*

The list included transformers of the following types: Bullard, Diamond, Fort Wayne, General Electric, Hornberger, National, Packard, Phoenix, Standard, Stanley, Wagner, and Westinghouse. The total number of transformers tested was over twenty.

In making the tests, Weston, Hoyt, Queen, and Cardew instruments were used, and their accuracy was frequently checked by comparison with Kelvin balances. Great care was exercised to eliminate errors. The tests were made at frequencies of 60 and 125; the pressure wave being rather peaked, especially at the frequency of 60.

The method used for finding the efficiency was that given in Section 125, No. 8 *a*, and the results were

* Complete Tests of Modern American Transformers, *Bull. Univ. of Wisconsin*, Vol. 1, No. 11.

checked by methods 8 *b* and 7. Method 8 *a* was found to be the most accurate, but by using other methods as checks serious errors could be detected and the test repeated. As the method used measures the losses directly, small errors of observation cause an inappreciable error in the result. The all-day efficiencies were calculated on the assumption that during each 24 hours the transformer runs 5 hours at full load, and 19 hours at no load. This assumption gives about the proper all-day efficiency to represent favorable conditions of present practice. The following table gives a synopsis of the results obtained from twelve of the transformers :

TABLE I.

| No. | Capacity in Watts. | Iron Loss. | | Copper Loss. | Maximum Efficiency. | | All-Day Efficiency. | |
|-----|--------------------------|------------|---------|-----------------|------------------------|---------|------------------------|---------|
| | | $f=125.$ | $f=60.$ | | $f=125.$ | $f=60.$ | $f=125.$ | $f=60.$ |
| 1 | 1250 | 37.0 | 48.5 | 29.7 | 95.0 | 94.0 | 85.1 | 83.0 |
| 2 | 1500 | 50.5 | 70.6 | 45.2 | 94.6 | 94.0 | 84.8 | 80.6 |
| 3 | 1500 | 32.2 | 46.5 | 38.1 | 95.7 | 94.5 | 89.4 | 85.0 |
| 4 | 1500 | 57.0 | 82.0 | 35.3 | 93.7 | 92.0 | 83.0 | 77.8 |
| 5 | 1500 | 45.7 | 60.1 | 36.2 | 94.8 | 94.0 | 85.5 | 83.4 |
| 6 | 1500 | 126.0 | 206.0 | 14.8 | 91.5 | 87.4 | 70.8 | 60.0 |
| 7 | 450 | 23.4 | 38.6 | 6.2 | 91.0 | | 76.5 | |
| 8 | 1800 | 53.5 | 108.7 | 66.6 | 94.0 | 91.7 | 84.7 | 75.5 |
| 9 | 2000 | 42.4 | 56.3 | 54.8 | 95.2 | 94.5 | 88.6 | 86.5 |
| 10 | 1500 | 97.5 | 125.0 | 38.5 | 91.7 | 90.1 | 76.5 | 70.2 |
| 11 | 1500 | 57.5 | 76.0 | 30.9 | 94.5 | 93.4 | 83.0 | 79.2 |
| 12 | 1500 | 43.2 | 55.5 | 28.5 | 95.3 | 94.6 | 86.5 | 83.7 |

Some of the transformers giving high maximum efficiencies do not give the highest all-day efficiencies, and in such cases the figures would tend to indicate that an

increase in the number of turns and a decrease in the iron and magnetic density would be of advantage.

The iron losses are so variable that a table was made up of the losses per cubic centimeter, from which rather better comparisons can be made. As the magnetic densities in the transformers are very different, this does not directly give the relative qualities of the iron, hence another column is added of the hysteresis constants.* These constants are calculated from the formula of Steinmetz, $U = vVB^{1.6}$ (see Vol. I., p. 74), where U is energy in watts lost per cubic inch or per cubic centimeter of iron, V is the frequency, B the maximum induction (per square centimeter), and v is a constant of hysteresis which depends upon the quality of the iron. Table II. presents the reduced results.

TABLE II.

| No. | Loss per cu. in. | | Loss per cu. cm. | | B_m | | Constant of Hysteresis. | |
|-----|------------------|---------|------------------|---------|----------|---------|-------------------------|------------------------|
| | $f=125.$ | $f=60.$ | $f=125.$ | $f=60.$ | $f=125.$ | $f=60.$ | $f=125.$ | $f=60.$ |
| 1 | .13 | .18 | .008 | .011 | 2050 | 4280 | 3.2×10^{-10} | 2.9×10^{-10} |
| 2 | .21 | .28 | .013 | .017 | 2600 | 5400 | 3.52×10^{-10} | 3.04×10^{-10} |
| 3 | | | | | | | | |
| 4 | .24 | .34 | .014 | .021 | | | | |
| 5 | .24 | .32 | .015 | .020 | 3640 | 7500 | 2.39×10^{-10} | 2.10×10^{-10} |
| 6 | .68 | 1.10 | .041 | .067 | 3750 | 7720 | 6.26×10^{-10} | 6.57×10^{-10} |
| 7 | .27 | .45 | .017 | .027 | 3770 | 7870 | 2.59×10^{-10} | 2.66×10^{-10} |
| 8 | .20 | .40 | .013 | .025 | 5250 | 10950 | | |
| 9 | .26 | .34 | .017 | .021 | 3540 | 7370 | 2.88×10^{-10} | 2.86×10^{-10} |
| 10 | .40 | .51 | .024 | .031 | | | | |
| 11 | .30 | .39 | .018 | .024 | 4070 | 8480 | 2.42×10^{-10} | 2.08×10^{-10} |
| 12 | .23 | .30 | .014 | .018 | 3210 | 6650 | 2.72×10^{-10} | 2.25×10^{-10} |

In calculating the hysteresis constants, the core losses were considered to be entirely due to hysteresis, which

does not introduce a large error, as the foucault current loss is only a small portion of the total loss. A glance indicates the great difference in the quality of iron used in the different transformers, and shows very distinctly the necessity for testing each batch of iron before it is made up into transformer cores. As the iron losses are the most important factor in determining the all-day efficiency, too much stress cannot be laid upon this point. The table indicates that the practice of making such tests has not, by any means, been universal.

Table III. gives the exciting currents and no-load power factors of the transformers. The power factors

TABLE III.

| No. | Exciting Current. | | Power Factor, No Load. | | B_m | |
|-----|-------------------|---------|------------------------|---------|----------|---------|
| | $f=125.$ | $f=60.$ | $f=125.$ | $f=60.$ | $f=125.$ | $f=60.$ |
| 1 | .043 | .066 | 84.0 | 73.0 | 2050 | 4280 |
| 2 | .076 | .124 | 64.6 | 56.5 | 2600 | 5400 |
| 3 | .052 | .100 | 56.3 | 47.6 | | |
| 4 | .085 | .125 | 67.0 | 65.6 | | |
| 5 | .054 | .099 | 81.7 | 61.5 | | |
| 6 | .173 | .475 | 85.0 | 40.0 | 3750 | 7720 |
| 7 | .043 | .079 | 64.0 | 58.0 | 3770 | 7870 |
| 8 | .076 | .060 | 71.0 | 22.0 | 5250 | 10950 |
| 9 | .055 | .091 | 78.5 | 63.0 | 3540 | 7370 |
| 10 | .124 | .190 | 78.6 | 65.7 | | |
| 11 | .072 | .113 | 79.6 | 67.2 | 4070 | 8460 |
| 12 | .077 | .144 | 55.6 | 38.4 | 3210 | 6650 |

are higher at the higher frequency, due to the fact that a smaller magnetizing current is required on account of

the magnetic density being lower at that frequency. The exciting current is lower at the higher frequency, due to the above cause and to the lower iron losses.

Table IV. gives the results of an independent test of the regulation of the transformers. The total drop is the difference in volts between the secondary pressure at full load and at no load when the primary

TABLE IV.

| No. | Volts Total Drop. | | Volts CR Drop in Secondary. | | Volts CR Drop in Primary. | | Volts Leakage Drop. | |
|-----|----------------------|---------|-----------------------------------|---------|---------------------------------|---------|------------------------|---------|
| | $f=125.$ | $f=60.$ | $f=125.$ | $f=60.$ | $f=125.$ | $f=60.$ | $f=125.$ | $f=60.$ |
| 1 | 2.3 | 3.5 | .80 | 1.00 | 10.9 | 12.4 | .5 | 1.3 |
| 2 | 3.5 | 2.8 | .85 | .88 | 7.9 | 7.7 | 1.9 | 1.1 |
| 3 | 4.9 | 3.3 | 1.05 | 1.10 | 12.6 | 13.0 | 2.6 | .9 |
| 4 | 4.6 | 3.4 | 1.35 | 1.35 | 8.5 | 8.5 | 2.4 | 1.2 |
| 5 | 2.9 | 2.0 | 1.04 | .98 | 9.3 | 8.7 | 1.0 | .1 |
| 6 | 1.8 | 1.2 | .41 | .42 | 3.4 | 3.9 | 1.1 | .4 |
| 7 | 82.0 | 21.0 | 1.94 | 2.48 | 24.2 | 28.0 | 77.7 | 15.7 |
| 8 | 5.2 | 4.7 | 1.40 | 1.40 | 17.0 | 17.8 | 2.1 | 1.5 |
| 9 | 5.3 | 4.2 | 1.71 | 1.75 | 8.2 | 8.4 | 2.8 | 1.7 |
| 10 | 4.0 | 3.1 | | | | | | |
| 11 | 2.8 | 2.2 | 1.04 | 1.04 | 8.2 | 7.9 | 1.0 | .4 |
| 12 | 3.8 | 2.0 | 1.36 | 1.36 | 12.7 | 12.5 | 1.2 | |

pressure is 1000 volts. In one of the transformers it is seen that the total drop is greater for a frequency of 60 than of 125, while in the others the opposite is the case. The leakage drop should be less at the lower frequency, as the total number of leakage lines does not change very much with the change in the frequency, but the inductive pressure varies directly

with the frequency. This is shown very plainly in transformer No. 7, in which the magnetic leakage is sufficiently great to cause a current of almost constant value to flow in the secondary circuit when the frequency is 125, but when the frequency is 60 it fails of its purpose entirely. The characteristic curves of this transformer are given in Fig. 204.

The leakage drop is somewhat less for the transformers which have the apertures for windings with a larger dimension in the direction of the lines of force in the tongue of the transformer and with the coils wound one upon the other (see Figs. 240 and 241). A comparison of the *CR* drops shows that the transformers of high all-day efficiencies have a comparatively large fall of pressure from this cause.

Table V. gives the radiating surface in the transformers and the rise of temperature under various conditions measured in a special test. From the table it is evident that there is little uniformity in the watts radiated per square inch of core and coil, or case, per degree rise of temperature. Taking an average of the test, the watts radiated per square inch of the core and coil surface with the case on may be about .2, and with the case off .3, when the rise of temperature is about 40° C. This requires from 5 to 7 inches of core and coil surface per watt lost with the case on. In an excellent series of transformers of various capacities the product of rise of temperature and square inches of coil and core per watt radiated varies between about 270 and 360, with an average of about 310. This is nearly 50 per cent greater than the average result of

TABLE V.

| No. | Total Watts Lost. | Watts Lost per sq. in. of Case. | Watts Lost per sq. in. of Coils and Core Surface. | Rise of Temperature in Case. Centigrade. | Frequency, f. | Current in Secondary. | Increase of Temperature Due to Case in Per Cent. |
|-----|-------------------|---------------------------------|---|--|---------------|-----------------------|---|
| 1 | 51 | .105 | .121 | 20.8 | 60 | 0 | 2.5 |
| 1 | 39 | .080 | .093 | 17.5 | 125 | 0 | 41.0 |
| 1 | 82 | .168 | .195 | 50.2 | 60 | 13.1 | 51 |
| 1 | 65 | .134 | .155 | 38.4 | 125 | 11.3 | 24 |
| 2 | 75.3 | | .16 | 16.2 | 60 | 0 | } Taken without case. |
| 2 | 53.8 | | .11 | 13.4 | 125 | 0 | |
| 2 | 115.3 | | .24 | 50.4 | 60 | 17.9 | |
| 2 | 93.8 | | .20 | 51.4 | 125 | 17.6 | |
| 3 | 49.6 | .082 | | 20.0 | 60 | 0 | |
| 3 | 34.5 | .058 | | 17.8 | 125 | 0 | 178 |
| 3 | 85.6 | .144 | | 56.3 | 60 | 14.2 | — |
| 3 | 59.5 | .100 | | 36.0 | 125 | 12.5 | 89 |
| a | 233 | .225 | .396 | 73.4 | 60 | 0 | 66 |
| a | 143 | .178 | .243 | 66.1 | 125 | 0 | 110 |
| a | 275 | .340 | .466 | 100.0 | 60 | 18.7 | 55 |
| a | 198 | .242 | .334 | 70.0 | 125 | 19.5 | 63 |
| 5 | 64 | .118 | .166 | 21.8 | 60 | 0 | — |
| 5 | 49 | .090 | .127 | 19.1 | 125 | 0 | — |
| 5 | 93 | .172 | .242 | 40.8 | 60 | 13.7 | — |
| 5 | 78 | .144 | .203 | 40.6 | 125 | 13.6 | — |
| 6 | 210 | .388 | .547 | 62.4 | 60 | 0 | 25 |
| 6 | 133 | .246 | .346 | 52.3 | 125 | 0 | 114 |
| 6 | 223 | .412 | .580 | 86.8 | 60 | 14.7 | 20 |
| 6 | 246 | .455 | .640 | 72.2 | 125 | 14.6 | 23 |
| 7 | 41 | .143 | .175 | 31.4 | 60 | 0 | 12.5 |
| 7 | 25 | .091 | .107 | 24.3 | 125 | 0 | 14.6 |
| 7 | 46 | .162 | .198 | 57.4 | 125 | 8.6 | 12 |
| 8 | 115 | .168 | .266 | 43.4 | 60 | 0 | 49 |
| 8 | 56 | .079 | .130 | 32.1 | 125 | 0 | 33.8 |
| 8 | 171 | .250 | .396 | 101.8 | 60 | 17.1 | 5.3 |
| 8 | 102 | .150 | .234 | 76.9 | 125 | 15.7 | — |
| 9 | 60 | .099 | .150 | 25.4 | 60 | 0 | 1.2 |
| 9 | 45 | .074 | .112 | 21.2 | 125 | 0 | 48 |
| 9 | 102 | .168 | .255 | 67.5 | 60 | 16.9 | 10 |
| 9 | 90 | .149 | .225 | 51.6 | 125 | 17.6 | — |
| b | 29 | .052 | .110 | 20.1 | 60 | 0 | 37.6 |
| b | 26 | .047 | .098 | 15.2 | 125 | 0 | 11.8 |
| b | 57 | .102 | .214 | 47.8 | 60 | 9.4 | 15.5 |
| b | 47 | .085 | .190 | 30.8 | 125 | 8.3 | — |
| 11 | 76 | | .274 | 27.0 | 60 | 0 | } Taken without case. Areas core and coil 277 sq. in., and of case 514. |
| 11 | 57.5 | | .208 | 18.9 | 125 | 0 | |
| 11 | 103.8 | | .372 | 52.2 | 60 | 14.3 | |
| 11 | 88.4 | | .320 | 50.4 | 125 | 15.1 | |
| 12 | 55.5 | .086 | .145 | 31.6 | 60 | 0 | |
| 12 | 43.2 | .067 | .113 | 20.5 | 125 | 0 | 67 |
| 12 | 80.8 | .125 | .211 | 51.8 | 60 | 14.1 | — |
| 12 | 78.8 | .122 | .206 | 20.5 | 125 | 14.2 | — |

Mr. Ford's tests. These figures are very rough approximations, to be used merely as a guide in design; but fairly exact data for any particular type of transformer may be determined from measurements on two or three sizes of the type.

The transformer case increases the temperature on an average of about 43 per cent; but this effect is found to be quite variable. The form of the case does not seem to enter into the result, though when it closely encases the core and coils the heating effect seems to be slightly less.

The table shows the results of four heating tests on each transformer; a no-load and a full-load test at each of the two frequencies used; the temperatures being determined from measurements of the resistance of the primary coils, ample time being allowed in each test for the transformer to come to its maximum temperature, and check measurements being made by thermometer.

The following table, from a test by Fleming,* made in 1892, gives the principal data concerning a number of English transformers and two of American make.

A is the capacity in watts, B the exciting current in amperes, with a primary pressure of 2400 volts and frequency of 83, C the iron loss in watts, D the power factor at no load, E the total drop in volts, F the copper drop in volts, and G the leakage drop in volts. The low power factor and high exciting current of the Swinburne hedgehog transformer is especially noteworthy. This is caused by the high reluctance of the open magnetic circuit.

* *Four. Inst. E. E.*, Vol. 21, p. 594; *Electrical World*, Vol. 21, p. 15.

| Name. | A | B | C | D | E | F | G |
|--------------------|-------|------|------|-----|-----|-----|-----|
| Ferranti | 1875 | .18 | 288 | .66 | | | |
| " | 3750 | .34 | 540 | .68 | 1.6 | 1.9 | |
| " | 7500 | .25 | 444 | .74 | | | |
| " | 11250 | .34 | 578 | .70 | | | |
| " | 15000 | .57 | 1019 | .75 | | | |
| " | 3750 | .11 | 233 | .88 | 2.4 | 2.1 | .3 |
| " | 7500 | .07 | 138 | .77 | | | |
| " | 11250 | .07 | 148 | .81 | 3.4 | 2.7 | .7 |
| " | 15000 | .11 | 228 | .85 | 2.1 | 1.6 | .5 |
| " | 11205 | .10 | 228 | .92 | 2.2 | 1.8 | .4 |
| Swinburne Hedgehog | 3000 | .74 | 112 | .06 | 3.2 | 2.2 | 1.0 |
| " | 6000 | 1.19 | 156 | .05 | | | |
| Westinghouse . . . | 6500 | .05 | 95 | .79 | 2.4 | 1.4 | 1.0 |
| Mordey-Brush . . . | 6000 | .08 | 140 | .77 | 1.8 | 1.8 | |
| " | 750 | .03 | 61 | .81 | | | |
| Thomson-Houston . | 4500 | .08 | 108 | .54 | 3.3 | 2.5 | .8 |
| Kapp | 4000 | .14 | 152 | .61 | 1.9 | 1.8 | |

CHAPTER XII.

DESIGN OF TRANSFORMERS.

134. Effect of Frequency. — The formulas giving the pressures developed in the coils of a transformer

$$E' = 2 \pi f L' C = \frac{\sqrt{2} \pi n' N f}{10^8} \text{ and } E'' = \frac{n''}{n'} E' \quad (\text{Sect. III})$$

show that if the value of the magnetization in the core of a transformer is fixed, then the number of turns in the coils must vary inversely with the frequency. To construct transformers for all frequencies with a fixed value of the total magnetization is not an economical plan, however, since the core loss per cubic centimeter of iron depends upon the frequency. If a certain core loss is determined upon as being that which will give the most satisfactory general results in the case of a transformer of given size, the magnetic density in the core must be made to vary inversely with the frequency. This may be seen from the fact that the foucault current loss varies with the square of the frequency, and the hysteresis loss directly with the frequency. Since the former is between one-tenth and one-fourth of the latter, this makes the total core losses vary somewhere between the first and second powers of the frequency, if the magnetic density is constant. The foucault current

loss also varies with the square of the magnetic density, and hysteresis varies with some degree of approximation within the limits of transformer practice, as the 1.6 power of the induction. Consequently the total losses vary as some power of the magnetic density between the 1.6th and the second. It is thus shown that the core losses will not be greatly changed if the magnetic density, within reasonable limits, varies inversely with the frequency. Now it is seen from the formula that, if the turns and pressures remain unchanged, when the frequency changes, the induction will change inversely; hence a well-built transformer should give nearly the same efficiency for all frequencies reasonably near that for which it was designed, and the number of turns in the coils may be the same in a series of transformers of equal capacities designed for different frequencies. In support of this stands the fact that transformers properly built for 125 to 135 periods a second are capable of giving excellent results at a frequency of 60, as is indicated, for instance, in a number of the transformers as given in Table I. of the preceding section. Changing the frequency alters the wattless component of the exciting current in a proportion which depends upon the saturation of the core, and poorly designed transformers or those built of poor material may give unsatisfactory service and over-heat on lower frequencies than their normal, on account of an excessive magnetic density and an excessive exciting current.

Since the rates of variation of the hysteresis and fault current losses with the frequency and with the

reciprocal of the magnetic density are not exactly the same, though they are quite approximately equal, it is to be expected that the efficiency of a transformer will vary to some degree with the frequency, and that some particular frequency will give the best efficiency. The latter has been found to be the case by Mr. Mordey.*

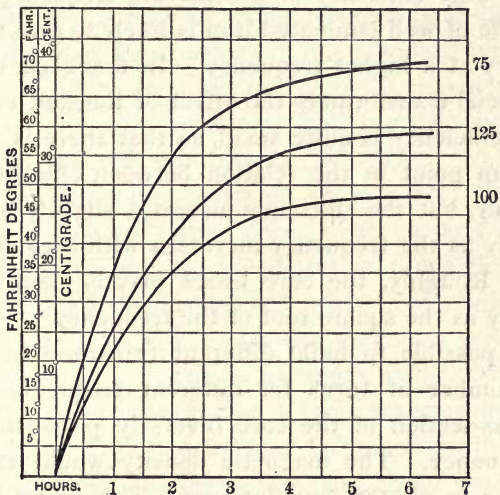

Fig. 235

Figure 235 shows the curves of rise in temperature of a Mordey transformer tested at three different frequencies, showing that the best result is given for an intermediate value. The exact frequency at which a transformer will give the highest efficiency must depend upon the quality of the iron and the effectiveness of the lamina-

* Alternate Current Working, *Jour. Inst. E. E.*, Vol. 18, p. 608; Discussion of papers by Snell and Forbes, *Jour. Inst. E. E.*, Vol. 22, pp. 280 and 484.

tion, since these determine the rate of variation of the losses with the magnetic density and the frequency. The better the magnetic quality of the iron and the more thorough its lamination, the less difference is likely to occur in the efficiencies at various frequencies. A transformer made of poorly laminated iron is likely to give its best efficiency at a moderate frequency, while one made of well laminated iron is likely to give its best efficiency at a higher frequency. In first-class modern commercial transformers the effect of foucault currents on the efficiency is quite small, so that there is no real maximum point in the relation between efficiency and frequency, but the efficiency increases slightly but continuously as the frequency increases within commercial limits. Roughly, the core losses may be said to vary inversely as the square root of the frequency.

It is possible to build different transformers of the same number of turns for different frequencies with the cross-section of the core inversely proportional to the frequency. The magnetic density would then be the same in all the transformers. This is unsatisfactory, however, since it makes low frequency transformers large and expensive: and since the weight of iron in a core must vary more rapidly than the cross-section, this method of construction also causes comparatively large core losses in low frequency transformers and gives them a comparatively low efficiency.

The conclusion is therefore derived that the core and windings of a well designed and well constructed transformer will be almost equally satisfactory in performance on any frequency within the present commercial limits.

This conclusion is shown by experience to be approximately true for frequencies within the limits of 50 and 150. The table of satisfactory magnetic densities for various frequencies, already given (Sect. 97), shows that foreign manufacturers apparently prefer a mean path, and change both the cross-section of the core and the induction when building transformers for different frequencies. American manufacturers have heretofore ordinarily built transformers of one standard type, which are intended to be used on all usual commercial frequencies, but some are now building two types, one designed specially for frequencies above 100, and the other for frequencies between 50 and 100. The latter have a somewhat larger core. The outputs of transformers of a fixed size are almost in proportion to the square root of the frequency,* other things being equal. As the frequency decreases, the magnetic density may be allowed to increase to as much as 12,000 lines of force per square centimeter in large transformers of low frequency. This density may be satisfactorily used in transformers of 30 frequency, and those designed for lower frequencies must increase in weight in inverse proportion to the frequency.

135. Effect of the Form of the Impressed Pressure Curve. — Very few experimental data are at hand which show the effect of the form of the pressure curve, though a good deal has been written upon the subject. No matter what the primary pressure wave may be like, the secondary pressure wave must have practically the

* Steinmetz, Effect of Frequency on the Output of Transformers, *Elect. Engineer*, Vol. 15, p. 260; *Trans. Amer. Inst. E.E.*, Vol. 11, p. 38.

same form, the exciting current and magnetization curves varying to meet this requirement. When the pressure curve is peaked, the magnetization curve will be flat and not reach so high a maximum as for an equivalent sine curve. When the pressure curve is flat the magnetization curve will be peaked (Sect. 77). Since the iron loss of a transformer depends upon the maximum value of the magnetism, it is to be expected that a peaked pressure curve will cause a minimum iron loss in a transformer. Steinmetz gives the appended table in support of this:

HYSTERESIS LOSS IN WATTS.

| Transformer Number. | Sine Wave. | Peaked Wave. | Difference. |
|---------------------|------------|--------------|-------------|
| 35992 | 42.3 | 38.6 | 9.8 % |
| 36067 | 41.1 | 37.8 | 8.95 % |
| 36668 | 36.8 | 33.9 | 8.7 % |
| 35799 | 36.6 | 33.7 | 8.7 % |

Steinmetz also gives another case where the loss in a 200 K.W. transformer was 13 per cent less when worked on a distorted curve than when a sine curve was impressed. The change in efficiency is, however, very slight. Experience has shown that alternating current arc lights give the best results when worked on a flat-topped curve, while Ryan, Duncan, and others claim that a sine curve gives the best efficiency in the operation of induction motors.* The latter is shown to be

* *Electrical World*, Vol. 24, pp. 107, 155, and 178.

theoretically correct in Section 188, and if the deduction proves to be of much importance in practice, an approximate sine form will probably give the best general satisfaction. Roessler has lately shown that the iron loss of a transformer depends upon the ratio of the mean value of the pressure wave to its effective value.

136. Example of Transformer Calculations. — The

formula $E' = \frac{\sqrt{2} \pi n' N f}{10^8}$ in any practical case contains only two unknown quantities, and these may be suitably chosen by a designer to suit his conditions. Thus, suppose it be desired to design a 10 : 1 transformer of 1650 watts capacity, for a primary pressure of 1100 volts and a frequency of 125. This is equivalent to a 1500 watt transformer which is rated on the usual basis of 1000 volts. By solving the equation, the product of $n' N$ is given, thus

$$n' N = \frac{10^8 E'}{\sqrt{2} \pi f} = 200,000,000 \text{ approximately.}$$

Calculation of Copper and Core Dimensions. —

Assuming the number of turns in the primary coil to be 650, makes the maximum magnetization $N = 308,000$. Now taking the maximum magnetic density, $B_m = 3000$, gives the core cross-section 102.7 sq. cm. The forms taken by the cores and coils of transformers which are intended for ordinary single-phase work are quite limited, and the more important ones are shown in Fig. 236. Choosing whichever one of these lends itself to the requirements (in this case, say, the first) the dimensions of the core may be quickly determined. The apertures

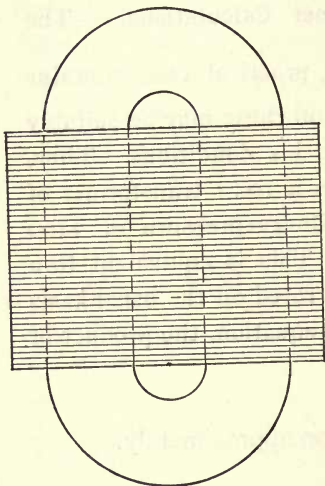
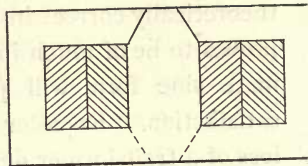
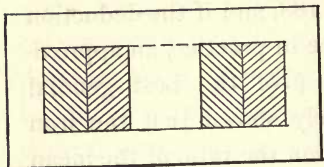

No. 1

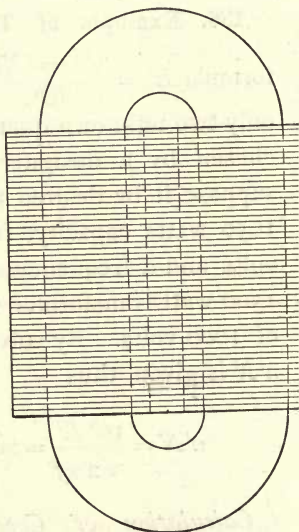

No. 2

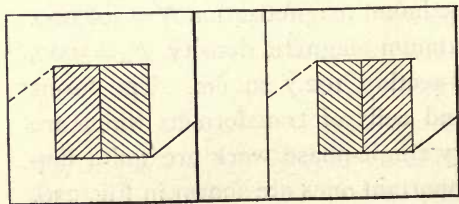

No. 3

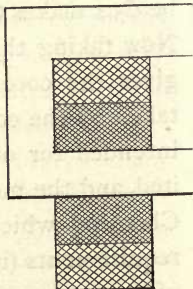

No. 4

Fig. 236

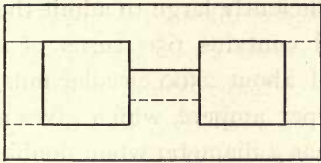

No. 5

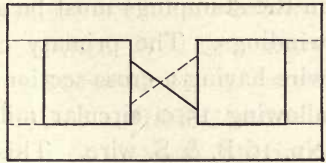

No. 6

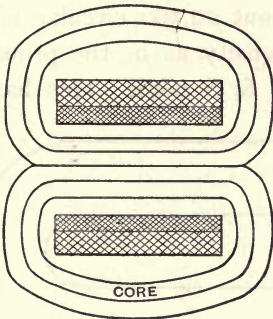

No. 7

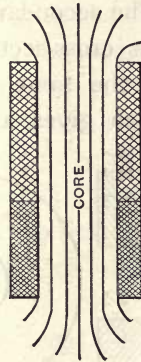

No. 8

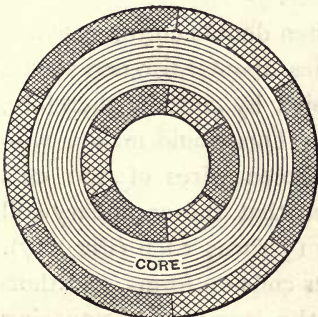

No. 9



No. 10

Fig. 236

in the stampings must be sufficiently large to admit the windings. The primary coil contains 650 turns of a wire having a cross-section of about 2500 circular mils, allowing 1500 circular mils per ampere, which gives a No. 16 B. & S. wire. This has a diameter when double cotton covered of about 67 mils, and consequently the primary coil occupies a space of about 2,920,000 square mils. The secondary winding contains 65 turns of wire having a cross-section of about 22,500 circular mils, allowing the same current density as in the primary coil, which gives a No. 7 B. & S. wire. This has a

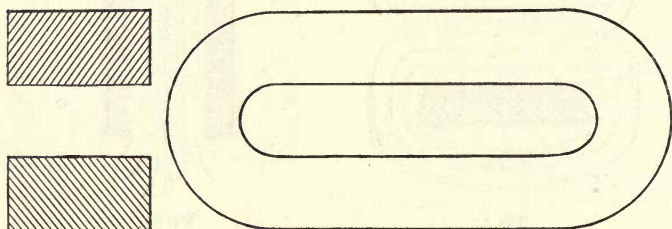

Fig. 237

diameter of about 160 mils when double cotton covered, and the secondary coil occupies about 1,670,000 square mils. The total space occupied by coils is, therefore, about 4,600,000 square mils. This would make a window $2\frac{1}{8}$ inches square. Thirteen wires of 160 mils diameter go into this space, so that the secondary coil may be wound in 5 layers of 13 turns each (Fig. 237). It is usual to wind transformer coils on forms, and thoroughly insulate them before the stampings composing the core are put in place. The insulation consists of mica, micanite, mica cloth, and varnished canvas.

Allowing $\frac{1}{8}$ inch for insulation, the secondary coil will occupy a space 2.2 inches by .92 inches. The primary coil will, under equal conditions, wind in 20 layers of 31 turns each, and one layer of 30 turns; and the space occupied is 2.2 inches by 1.53 inches. The total space occupied by the coils is, therefore, 2.20 inches by 2.45 inches, and allowing about $\frac{1}{4}$ of an inch for extra insulation and clearance, the apertures in the stampings must be $2\frac{3}{8}$ inches by $2\frac{5}{8}$ inches. The width of the tongue between the apertures depends upon the length of the transformer. It is desirable to make the length of the path of the magnetic lines of force as short as possible, and it is also desirable to make the length of copper as short as possible, both on the score of regulation and cost. Consequently, the length of the transformer should not be too great. If the tongue be made $2\frac{1}{2}$ inches wide (6.35 cm.), the length of the iron in the transformer becomes 6.4 inches. To make up this length requires 512 stampings .0125 inch thick. The cores of transformers are usually made of thin stampings without special insulation between, the oxide or a little varnish being relied upon as sufficient; and at least 90 per cent of the total length of the transformer may therefore be considered as made of iron. This makes the total length of the transformer under consideration $7\frac{1}{8}$ inches. The dimensions of the core are shown in Fig. 238. It would perhaps be better in the majority of cases to make the apertures in the stampings $\frac{1}{4}$ inch larger each way, and thus allow additional clearance and insulation.

Calculation of Hysteresis Loss.—In order to deter-

mine whether this transformer will serve its purpose, it is necessary to calculate the core loss, the copper loss, the magnetic leakage, and also the radiating surface per watt. The hysteresis loss in the core is readily calculated by the usual hysteresis formula (Vol. I., p. 74). The number of cubic centimeters of iron in the core is 3900. This gives a loss by hys-

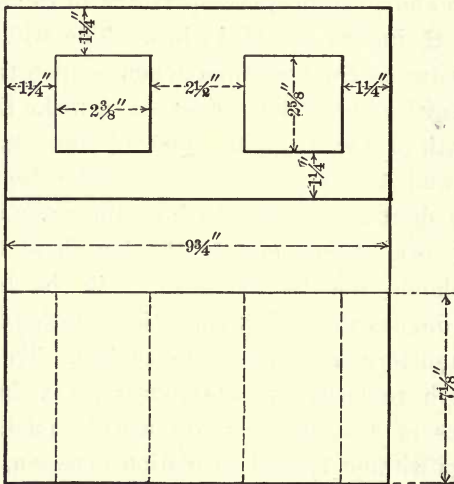

Fig. 238

teresis at a frequency of 125 of 37.5 watts for iron in which the hysteresis constant is 21×10^{-11} based on the cubic centimeter and the cycle per second. This value is 35×10^{-13} when based on the cubic centimeter and cycle per minute, as the constants are given on page 75 of Vol. I. That 21×10^{-11} is a fair average value for the hysteresis constant of the best transformer iron is shown by a series of tests made by Steinmetz, the

average of which gives 17×10^{-11} .* Where a series of transformers is to be designed with the same kind of iron in the core, it is advantageous to plot a curve which gives the hysteresis loss in watts per cubic centimeter, or per pound, of iron at different magnetic densities. Such a curve for a very good quality of iron (hysteresis constant = 21×10^{-11}) is shown in Fig. 239 for a frequency of 100. The loss in the iron when subjected to other frequencies may be determined by multiplying the values shown by the ratio $\frac{f}{100}$. On account of the differences in the quality of iron it is never safe to depend upon curves drawn from tests of one brand to represent the quality of another brand, and in fact some transformer iron shows losses not much more than two-thirds as great as those indicated in Fig. 239; but a better grade than that shown cannot be uniformly obtained in the market.

Hysteresis testing may be carried out on such instruments as those of Professor Ewing † or Mr. Holden, ‡ or it may be carried out by punching the sample into transformer plates, inserting them in a coil, and measuring the losses by a wattmeter. The value of B_m may be determined from the number of turns in the coil and the readings of a voltmeter at its terminals. For the results to be absolute, the wave of impressed pressure must approximate closely to a sinusoid, but satisfactory comparative results may be had independently of the

* *Trans. Amer. Inst. E. E.*, Vol. 11, p. 705.

† *Jour. Inst. E. E.*, Vol. 24, p. 398; *London Electrician*, Vol. 34, p. 786.

‡ *Electrical World*, Vol. 25, p. 687.

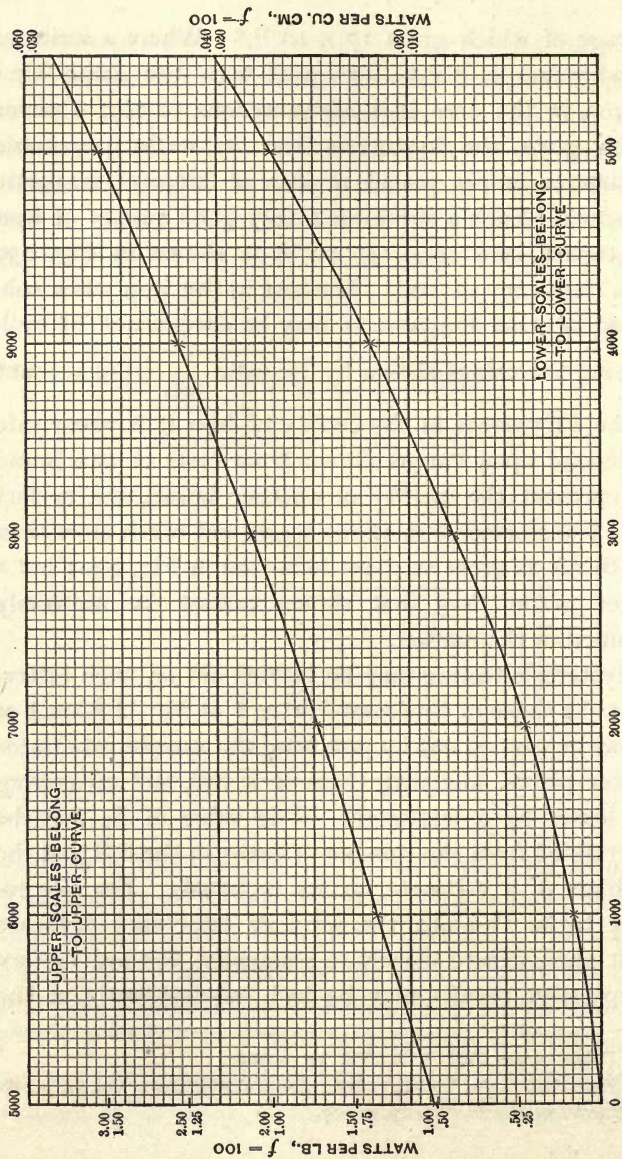

B I N C. G. S. U N I T S

Fig. 230

form of the pressure wave, provided the same form of wave is used in all tests.

Calculation of Foucault Current Loss.—The exact calculation of the foucault current loss in the core of a transformer is more difficult than that of the hysteresis loss; but equal exactness is not essential since the foucault current loss very seldom exceeds 25 per cent of the core losses and often constitutes only from 10 to 15 per cent.

A formula is developed by Mr. Steinmetz* which for laminated iron is $u = (dfB_m)^2 10^{-16}$, where u is the watts lost per cubic centimeter of iron, d is the thickness of the plates in mils, f the frequency of magnetic reversals, and B_m the maximum magnetic density. The total loss in watts for M cubic centimeters of iron is

$$U = M(dfB_m)^2 10^{-16}.$$

Reducing this to the loss per cubic inch of iron simply introduces the constant coefficient 16.4 into the formula. Reducing the formula to the watts lost per pound of iron changes the constant to nearly

$$U' = 6 M'(dfB_m)^2 10^{-15}.$$

A similar formula is deduced by Thomson and Ewing.†

For the transformer under consideration, iron 12.5 mils thick is used and the foucault current loss is

$$3900 \times (12.5 \times 125 \times 3000)^2 \times 10^{-16} = 8.5 \text{ watts.}$$

* *Trans. Amer. Inst. E. E.*, Vol. 11, p. 600.

† *London Electrician*, Vol. 28, p. 631; Weekes' *Alternating Current Transformers*, p. 21.

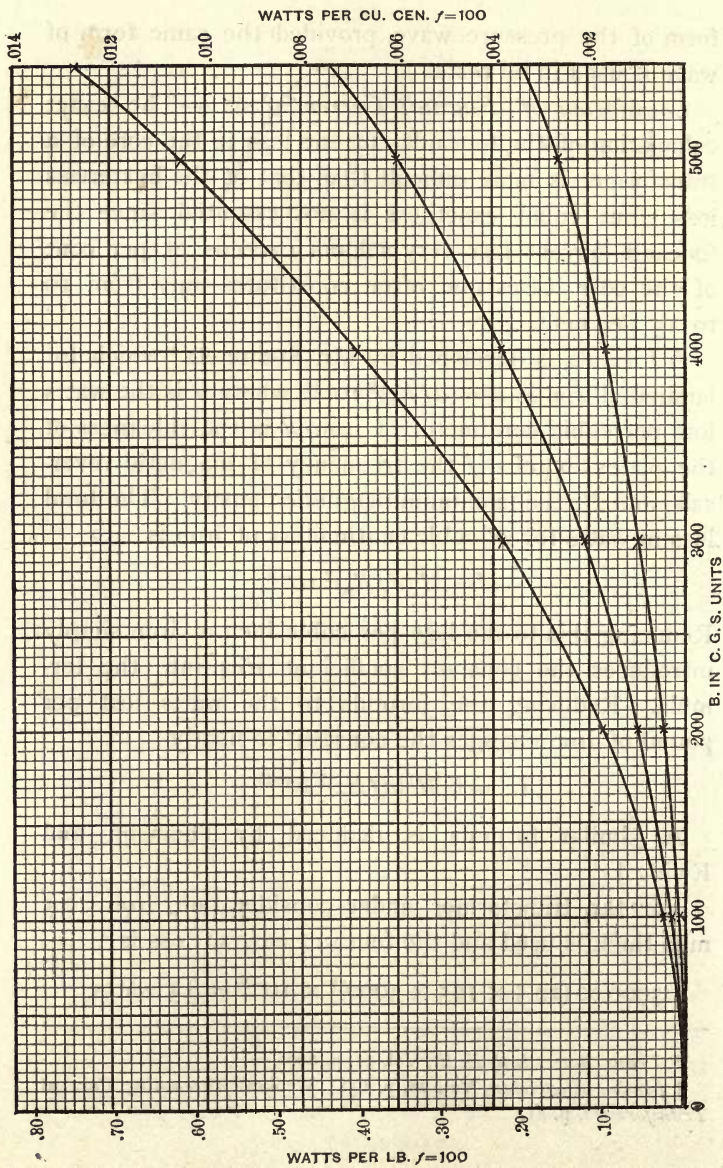

The total core loss for the transformer is therefore 46.0 watts or 2.8 per cent, which is a little high for a transformer of this size, and the number of turns in the coils might be increased and the cross-section of the iron proportionally decreased with advantage. The thickness of iron which is here taken is a usual one, though transformer stampings are made of various thicknesses between 10 and 18 mils. The commonest thicknesses are 12.5 and 15 mils. It is possible to plot a curve of the losses due to foucault currents in sheets of fixed thickness similar to that already given for hysteresis, or a curve may be plotted which gives the combined losses which are found in stampings of a given thickness and made of a fixed quality of iron. Figure 239 *a* shows a curve for the calculated foucault current loss in stampings of the three thicknesses, 10, 15, and 20 mils, at a frequency of 100. The loss at any other frequency may be found by multiplying the values from the curves by $\left(\frac{f}{100}\right)^2$.

Calculation of Copper Loss.—The copper losses of the transformer come out as follows: The mean length of a turn is practically 30 inches. The secondary coil has 65 turns or 165 feet of No. 7 wire, which makes the cold resistance .08 ohms; allowing a rise of 50° C. in temperature gives at full load a loss of 21.6 watts. The primary coil consists of 650 turns, or 1650 feet of No. 16 wire, which makes the cold resistance 6.35 ohms. The copper loss at full load with the transformer hot is therefore practically 40 watts or 2.42 per cent, which is reasonable.

Calculation of Exciting Current.—The final question to be determined in relation to the transformer is the exciting current. This is made up of two factors (Sect. 113) which are in quadrature, *i.e.* the magnetizing component and the loss component. The latter is evidently equal to the core loss in watts divided by the primary pressure, or $\frac{46}{1100} = .042$, and is in step with the primary pressure. The magnetizing component C'_μ is found from the formula

$$\sqrt{2} n' C'_\mu = \frac{N_m P}{1.25} = \frac{N_m l}{1.25 A \mu} = \frac{B_m l}{1.25 \mu}$$

or

$$C'_\mu = \frac{B_m l}{1.75 n' \mu}$$

when l is the length of the lines of force in the core and A the area, which gives for C'_μ in the case under consideration,

$$C'_\mu = \frac{3000 \times 37.5}{1.75 \times 650 \times 2000} = \frac{113,000}{2,300,000} = .049.$$

The total exciting current is therefore,

$$C'_1 = \sqrt{.049^2 + .042^2} = .064,$$

which is a satisfactory value. The value $\mu = 2000$, which is here used, is a fair value for transformer iron.

The value of the magnetizing component is here calculated without considering the effect of the joints in the magnetic circuit upon its reluctance. This is impossible to estimate, and it may cause a considerable increase in the exciting current. Its effect may be experimentally determined from measurements made

on one transformer, and the correction applied in designing other transformers of the same type.

Arrangement of Conductors.—The primary conductors of transformers, except those of very large size, are usually of wire, and the secondary conductors are of wire or ribbon. Wires which are larger than No. 7 or No. 8 B. & S. gauge are not often used, and conductors of larger cross-section are made of single ribbons, or of two or more wires or ribbons in parallel. The thickness of ribbon conductor which is used seldom exceeds 75 mils, since the insulation of thicker conductors is likely to be injured in winding around the small radii at the ends of the coils. The insulation commonly consists of two or three cotton coverings exactly as in armature windings, and the finished coils are very thoroughly insulated with rubber tape, mica, etc. Sometimes tape or cord wrappings are used on ribbon conductors instead of cotton coverings, and bare ribbons may be wound up with tape between; but the latter is not advisable. The primary coil should always be broken into sections by inserting oiled paper or varnished muslin between the layers, and where the coils are divided for the purpose of sandwiching to reduce magnetic leakage, the primary coil should have the least number of divisions so that its insulation may be less interfered with.

Checks.—The total radiating surface from which heat may leave this transformer is nearly 400 square inches, and the total losses at full load make 86 watts, or we have nearly five square inches per watt lost. The efficiency of the transformer at full, half, and

quarter load, is 95.0 per cent, 93.6 per cent, 89.4 per cent. The all-day efficiency, based on five hours full load and 19 hours no load, is 86.4 per cent. The number of turns per volt in the windings is $\frac{24}{\sqrt{\text{Output}}}$ in this transformer. In transformers of the best makes intended for frequencies between 60 and 135, the number of turns per volt in the windings seems to vary between $\frac{15}{\sqrt{\text{Output}}}$ and $\frac{40}{\sqrt{\text{Output}}}$, when the output is given in watts, and the numerator seems usually to be less than 25 for the best transformers. This ratio gives a guide to the choice of the number of turns which shall be used in a transformer, and the number of lines of force in the magnetic circuit is then fixed by the formula. In determining the size of the plates and the length of the core, the ratio of the over-all area of the plates to the area of the apertures may be used as a guide. In the above example this ratio is 4.00, and in a large number of commercial transformers of capacities from 500 watts to 30,000 watts the ratio is found to vary from 2.75 to 4.25, with an average of about 3.00. A final check upon any design may be made to depend upon the calculated core loss per pound or per cubic centimeter of iron, which varies in commercial transformers from .80 to 2.80 watts per pound, or .012 to .042 watts per cubic centimeter, and averages in first-class transformers about 1.00 watt per pound, or .015 watts per cubic centimeter. In any case, the determination of the most economical design in a particular form depends upon working out several designs with different constants. The best design may then be chosen.

137. Dimensions of Various Commercial Transformers.—The data for 1500 watt transformers of various manufacturers are given on page 534 for comparison. All the data are based on a primary pressure of 1100 volts, frequency of 125, and ratio of transformation of 10:1.

138. Calculation of Magnetic Leakage.—In the preceding example no attempt has been made to calculate the magnetic leakage. By properly placing the coils with respect to each other and to the magnetic circuit, the magnetic leakage may be made almost or quite

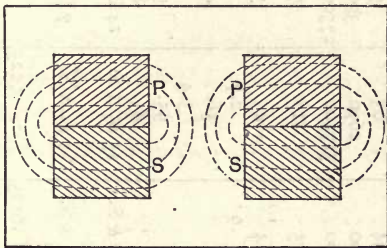

Fig. 240

negligible. Thus in Fig. 240 the coils are so placed that a short-circuiting of lines of force along the path indicated by the dotted lines is to be expected; but when the coils are arranged as shown in Fig. 241, the leakage is not likely to be great; while if the coils are divided and the parts sandwiched together, the leakage may be made very small. The leakage may be calculated quite approximately by the method indicated below. Since the currents in the primary and secondary coils of the transformer are in practical opposition of phase, their magnetizing effects are opposite. This tends to cause

| | No. 1. | No. 2. | No. 3. | No. 4. | No. 5. | No. 6. | No. 7. |
|--|------------|------------|------------|------------|------------|------------|------------|
| Watts | 1400 | 1650 | 1650 | 2200 | 1650 | 1650 | 1650 |
| n' | 760 | 640 | 630 | 720 | 560 | 1080 | 760 |
| n'' | 76 | 64 | 63 | 72 | 56 | 108 | 76 |
| B_{max} | 2300 | 4200 | 2690 | 3900 | 3340 | 3900 | 2000 |
| N_{max} | 263000 | 314000 | 517500 | 275000 | 342500 | 183000 | 263000 |
| $A = \frac{N}{B}$ | 116 | 75 | 118 | 71 | 102.2 | 46.5 | 130 |
| CR in watts | 30 | 14 | 45 | 55 | 32 | 36 | 36 |
| CR in per cent | 2.1 | .9 | 2.7 | 2.5 | 2.14 | 2.2 | 2.2 |
| Core loss in watts | 37 | | 56. | 47. | | 45 | 45 |
| Core loss in per cent | 2.6 | | 3.4 | 2.1 | | 2.73 | 2.73 |
| Per Cent efficiency full load | 95. | | 95. | 95 | | 96 | 96 |
| All-day efficiency per cent | 85. | | 85. | 89 | | 89 | 89 |
| Primary wire | 17 B. & S. | 16 B. & S. | 15 B. & S. | 14 B. & S. | 17 B. & S. | 16 B. & S. | 16 B. & S. |
| Resistance of primary | 7.00 | | | | 7.17 | 8.9 | 8.9 |
| Secondary wire | 7 B. & S. | 8 B. & S. | 7 B. & S. | 7 B. & S. | 7 B. & S. | 7 B. & S. | 7 B. & S. |
| Resistance of secondary | .069 | | | | .072 | .085 | .085 |
| Thickness of stampings | .015 | .0125 | .0125 | .0125 | .017 | .014 | .014 |
| Number of stampings | | 930 | 420 | 43 | 574 | 180 | 180 |
| Pounds of iron | | 46 | | | 57 | 30 | 30 |
| Pounds of copper | | | | | 18 | 27.5 | 27.5 |
| Exciting current | .043 | | .076 | .055 | | .052 | .052 |
| Total drop in pressure, per cent | 2.3 | | 3.5 | 5. | | 3.9 | 3.9 |
| Magnetic leakage drop | .2 | | 0.8 | 2.5 | | 1.7 | 1.7 |

lines of force to short-circuit through the coils, as shown in Fig. 240, the tendency being greatest at the plane where the coils touch each other, and falling

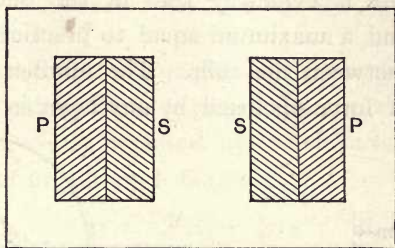

Fig. 241

off to zero at the outer edges of the coils, so that the magnetic leakage will differ for each layer of wire in the coils. The effect of leakage must therefore be calculated for each layer, and the total effect may then be

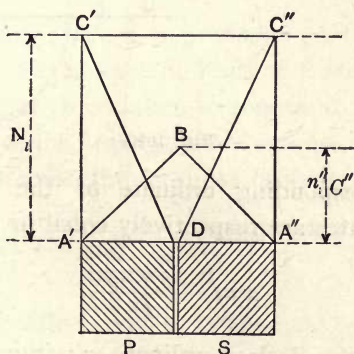

Fig. 242

summed up. In Fig. 242 the ordinates of the line $A'BA''$ are proportional to the ampere-turns acting at any point to cause leakage lines to pass through the coils. These

ordinates are equal to the number of turns in the coils between the foot of the ordinate and the outer edge of the coils, multiplied by the current flowing in the turns. The ordinate is evidently zero at the outer edges of the coils, and a maximum equal to practically $n''C''$ at the plane between the coils. The number of the leakage lines of force enclosed by any layer is proportional

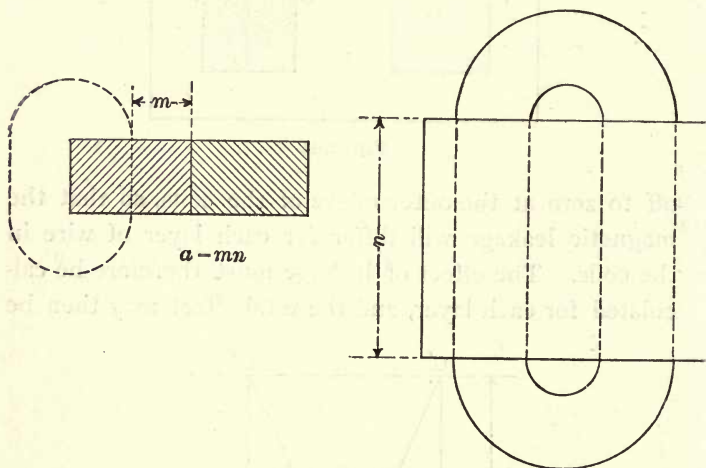

Fig. 243

to the corresponding ordinate of the lines $C'DC''$. These ordinates are respectively equal to

$$x = \frac{1.25 \sqrt{2} y a}{l},$$

where x is the desired ordinate, y is the mean ordinate of the line $A'BA''$ taken from the neutral plane at D to the point under consideration, a is the area of a coil between the neutral plane and the point under consideration, and l is the length of the lines of force through

the coils (Fig. 243). The maximum value of x falls at the outer edges of the coils and is

$$x_m = \frac{1.25 \sqrt{2} n'' C'' A_1}{l},$$

where A_1 is the total iron surface presented to a coil from which leakage lines emerge, and the average number of leakage lines enclosed by the different layers at the instant of maximum leakage is

$$\frac{x_m}{2} = \frac{1.25 n'' C'' A_1}{\sqrt{2} l} = \frac{.90 n'' C'' A_1}{l}.$$

The inductive effect of this leakage on the secondary winding is equal to

$$\frac{\sqrt{2} \pi n'' \frac{x_m}{2} f}{10^8},$$

and an equivalent effect is produced on the secondary on account of the leakage of lines of force through the primary coil. If A be taken to represent the total area of iron from which leakage lines emerge, which is presented to both coils, the formulas become

$$N_i = \frac{1.25 n'' C'' A}{\sqrt{2} l} \quad \text{and} \quad E_i = \frac{\sqrt{2} \pi n'' N_i f}{10^8} = \frac{4 n''^2 C'' A f}{10^8 l}.$$

The inductive effect due to leakage is, as has already been shown (Sect. 112), to be in quadrature with the active pressure in the secondary circuit, E'' . Consequently, the drop in secondary pressure caused by magnetic leakage is

$$E'' - \sqrt{E''^2 - E_i^2},$$

and the total drop of secondary pressure in the transformer is

$$E'' - (\sqrt{E''^2 - E_i^2} + C'R'' + \frac{1}{k}C'R').$$

The value for E_i in the transformer designed above, when the coils are wound one inside of the other, is

$$E_i = \frac{4 \times 65^2 \times 15 \times 218 \times 125}{6.7 \times 10^8} = 10 \text{ volts};$$

when the coils are placed side by side, this becomes

$$E_i = \frac{4 \times 65^2 \times 15 \times 242 \times 125}{6.0 \times 10^8} = 12 \text{ volts.}$$

The leakage drop is, therefore,

$$100 - \sqrt{10000 - 100} = .5 \text{ volt}$$

or

$$100 - \sqrt{10000 - 144} = .72 \text{ volts.}$$

This may be made practically negligible with either arrangement of the coils by dividing one of the windings into two parts and sandwiching the other between them. This reduces N_i to one-fourth and the leakage drop in a still greater ratio.

139. Joints in the Magnetic Circuit.—In this discussion no account has been taken of the position of the joints in the stampings, which really have a marked effect on both the magnetic leakage and exciting current. Every effort is made to reduce the magnetic reluctance of the joints by making them as few in number as possible, and arranging them so that the joints of adjoining plates come in different positions in the core. The joints in the magnetic circuit are usually one or two,

and should never be more than two. Lapping joints are really essential to the best performance, and while butt joints have been used in transformers, their effect has always been detrimental. The arrangement of joints is shown very plainly in Fig. 236. The last four views shown are of antiquated forms. The arrangement of the joints may be made in various ways with each form of built-up core, as the position of the joints depends only on the punching.

140. Ageing of Transformer Cores. — Experience has shown that the core loss in some transformers increases to a very considerable extent during the first few months of operation. The increase in loss is due to an increased hysteresis loss per cycle, and was originally ascribed by Ewing* to magnetic fatigue of the iron. It has, however, been quite conclusively proved by experiments † and the records of transformer manufacturers to be caused by the continuous condition of high temperature at which the iron is operated. The ageing seems to have the greatest effect upon poor qualities of iron, hastily and imperfectly annealed, and the least effect upon the best grades of iron which have been annealed with great care. The conditions under which the annealing of the transformer plates is performed, especially with reference to temperature and duration of the process, have much to do with the extent of the ageing effect, and by proper annealing it can be rendered very small in cores made of proper qualities of iron. The iron now generally used for transformer

* *London Electrician*, Vol. 34, p. 161.

† *Ibid.*, pp. 160, 190, 191, 219, 297, 498.

cores is a very mild steel made by either the bessemer or open-hearth processes, though puddled iron sheets are still used to some extent.

141. Current Rushes. — It has been shown in Section 25 that the exponential term in the complete equation for an alternating current in an inductive circuit is ordinarily negligible, but under certain conditions its effect for a few periods after the current is started in a circuit may be considerable. This question was investigated by Fleming* and others† with especial reference to the action of transformers when first switched onto an alternating-current circuit. If a transformer is switched onto a circuit, the current does not instantly assume the final form of the wave, but rises gradually through a short interval to its final form. The length of the interval and the magnitude of the early current depends upon the reactance of the circuit, the frequency, and the point in the pressure wave at which the connection is made. If the instant of switching onto the circuit is that at which the impressed pressure is passing through zero the current in the transformer is less during the early interval than its final value, while if, at the instant of switching on, the impressed pressure is passing through its maximum value there may be quite an excess of current flow through the circuit for a short time, on account of the relations which exist between the instantaneous impressed and counter electric pressures during the first half period. The abnormal state of the

* *Jour. Inst. E. E.*, Vol. 21, p. 677.

† Hay, On Impulsive Current-rushes in Inductive Circuits, *London Electrician*, Vol. 33, pp. 229, 277, and 305.

current can only exist for a very short time unless the reactance of the circuit approaches a condition of resonance (Appendix D), which is very exceptional. As far as the operation under ordinary conditions of transformers or other commercial alternating-current appliances is concerned, the phenomena of current rushes may be entirely neglected.

142. Impedance Coils, Compensators, etc. — The design of *impedance coils, reactance coils, choking coils, or econ-*

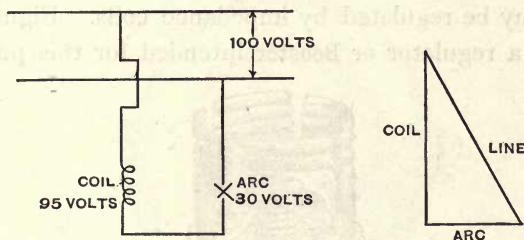

Fig. 244

omy coils as they are variously called, is carried out very much in the same manner as the design of a transformer. These coils consist of a magnetic circuit with a winding of small resistance, but large inductance. The magnetic circuit and winding are proportioned in exactly the same manner as the primary winding of a transformer, using the formula $E = \frac{\sqrt{2} \pi n N_m f}{10^8}$. Coils of this type are used for a variety of purposes where it is desired to throttle the flow of current without the attendant loss of power which always follows the use of resistances. Where arc lamps are used on constant-pressure alternating-current circuits, an economy coil

is ordinarily used to reduce the pressure from the 50 or 100 volts on the wires to the 30 volts required at the lamp (Fig. 244). The pressures upon the distribut-

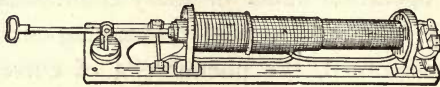

Fig. 245

ing circuits in a theatre, or upon the feeders of a plant furnishing alternating currents for incandescent lighting, may be regulated by impedance coils. Figure 245 shows a regulator or **Booster** intended for this purpose,

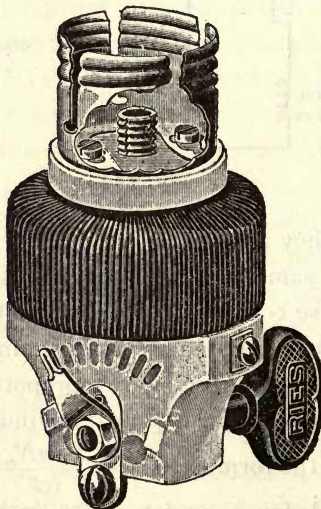

Fig. 246

which may be used either to reduce the pressure in the circuit or to raise it, and which is not a true impedance coil, as its effect is due to transformer action.

Numerous devices of this kind, which depend upon moving the primary and secondary coils with reference to each other or the core with reference to both, have been manufactured. Figure 246 shows an impedance coil adapted to an incandescent lamp socket which is arranged so that by turning the key the number of turns of the winding included in the circuit is varied, and the lamp is thus turned up and down. Figure 247 shows the Thomson impedance coil, in which the reac-

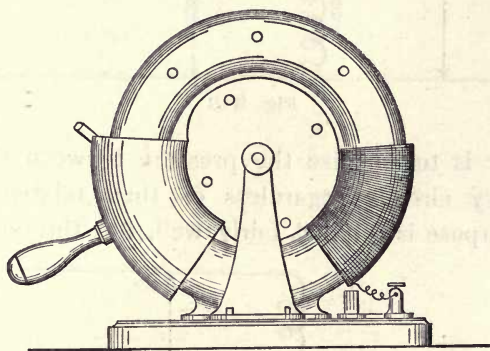

Fig. 247

tive effect is varied by moving a heavy copper shield so as to more or less enclose the winding, instead of varying the number of turns of the winding included in the circuit. This shield acts like the short-circuited secondary of a transformer, and therefore reduces the apparent impedance of the windings as it approaches them.

There is another type of inductive apparatus which is little used and which goes under the name of **Compensator**. This consists of a single winding on a proper mag-

netic circuit, to which both the primary and secondary circuits are connected. Figure 248 shows the connections of a 220 volt compensator which feeds two 110 volt secondary circuits. In this case the function of the com-

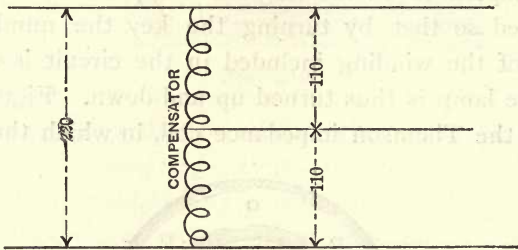

Fig. 248

pensator is to equalize the pressure between the two secondary circuits regardless of their relative loads. This purpose is fulfilled fairly well, but the regulation

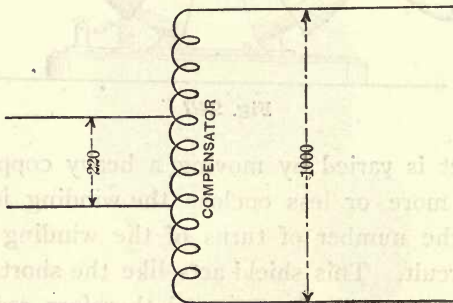

Fig. 249

is not as satisfactory as that of a transformer. Figure 249 shows the connections of a 220 volt compensator which supplies a 1000 volt secondary circuit. When one of the secondary terminals of a compensator is

arranged so that the position of its connection to the winding may be varied, the machine is called an **Auto-transformer**. The secondary pressure and current of an auto-transformer may be arranged to vary through any desired range, while the primary current changes only so far as is required by any change in the power absorbed by the secondary circuit.

CHAPTER XIII.

POLYPHASE CONDUCTING SYSTEMS AND THE MEASUREMENT OF POWER IN POLYPHASE CIRCUITS.

143. Polyphase Conducting Systems. — A full discussion of conducting systems has no place in this book, but a brief explanation of the methods of connecting the coils of polyphase machines and the wires of polyphase circuits is essential for the purposes of the following chapters.

Polyphase systems are usually operated with either two currents with approximately 90° difference of phase, or three currents with approximately 120° phase difference. Polyphase machines arranged for two currents are called **Two-phase Machines**, or **Two-phasers**. Those arranged for three currents are called **Three-phase** or **Tri-phase Machines**, **Three-phasers** or **Tri-phasers** (see page 386).

The transmission circuits for two-phase currents may be arranged to be entirely independent of each other, four wires being then required (Fig. 250); or, three wires may be used, in which case one of them is common to the two currents (Fig. 251); the current in the third or common wire, at any instant, is equal to the algebraic sum of the currents in the other two, and *the algebraic sum of the instantaneous currents in the*

three wires is always equal to zero. The effective current in the common return wire is equal to the vector sum of the two circuit currents; and is, therefore, $\sqrt{2}C$, where C is the effective current in one circuit, provided the currents are equal in the two circuits and have a phase difference of 90° , which is the condition

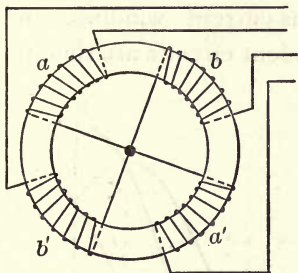

Fig. 250

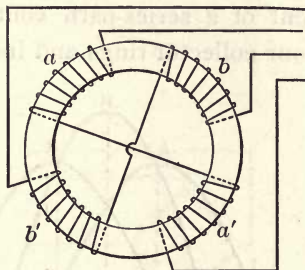

Fig. 250 a

when the system is properly designed and symmetrically loaded or **Balanced**. The pressure between the two outside wires of the two-phase system with common return is the vector sum of the two circuit pressures, and is, therefore, $\sqrt{2}E$ in a balanced system, where E is the pressure between one side and the common return. The common current and pressure in a balanced system are 45°

from the phase of the current in either of the independent wires. Figure 252 shows the graphical composition of the pressures. A and B are the two line press-

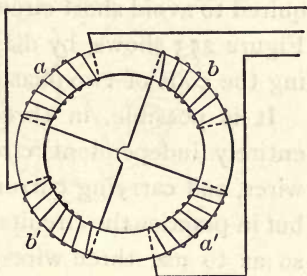

Fig. 251

ures, and R is the resultant pressure measured across the outside wires.

The coils of two-phase machines may be entirely independent of each other, in which case four collector rings are required, or the circuits may be joined so as to require only three collector rings. In some two-phase machines the armature is wound with the equivalent of a series-path continuous-current winding, and four collector rings and independent circuits are then re-

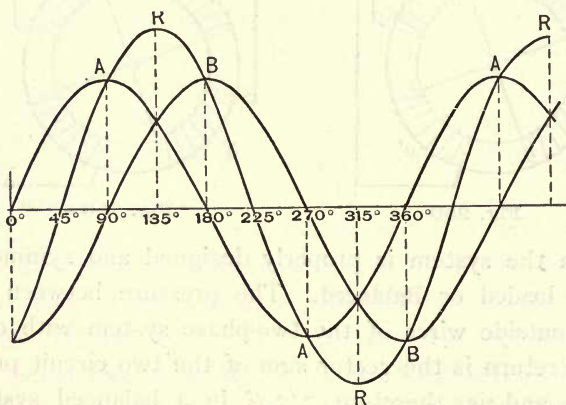

Fig. 252

quired to avoid short-circuiting portions of the armature. Figure 253 shows, by diagram, various ways of connecting the coils of two-phase machines (see Sect. 102 *a*).

It is possible, in three-phase systems, to use three entirely independent circuits, each consisting of two wires, and carrying currents of 120° difference of phase; but in practice the circuits are almost invariably combined so as to use three wires, and the current in each wire is then equal to the vector sum of two circuit currents.

The coils of three-phase machines may be connected together so that they form the three sides of a triangle

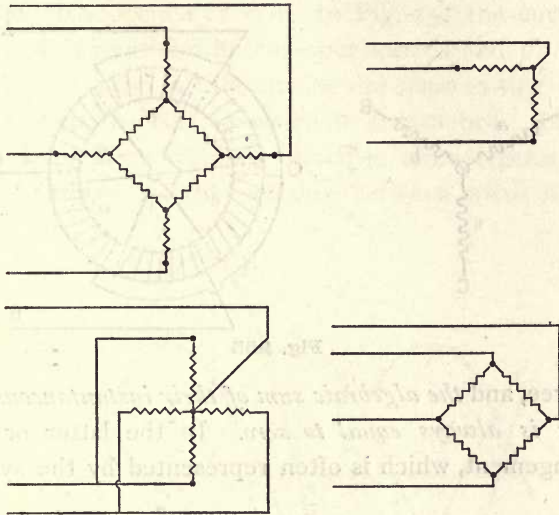

Fig. 253

with the transmission wires connected to the three corners of the triangle (Fig. 254), or one end of each coil

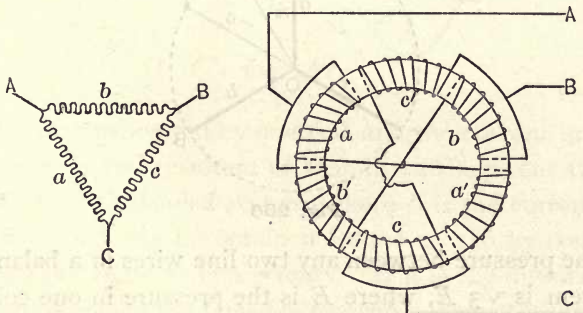

Fig. 254

may be individually connected to the transmission wires,

the free ends of the coils being connected together (Fig. 255).* In either case the number of transmission wires

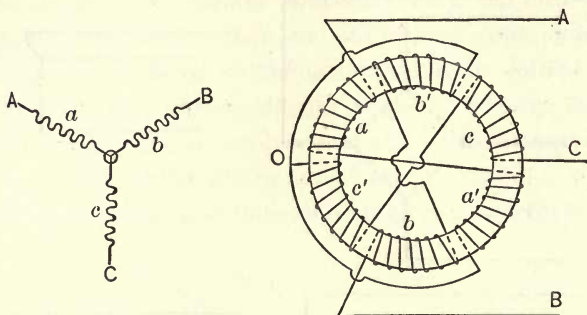

Fig. 255

is three, and *the algebraic sum of their instantaneous currents is always equal to zero*. In the latter or **Star** arrangement, which is often represented by the symbol

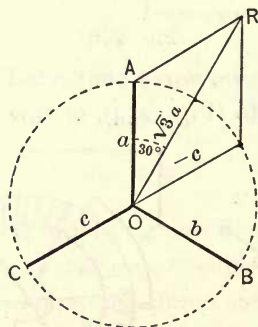

Fig. 256

Y, the pressure between any two line wires in a balanced system is $\sqrt{3} E$, where E is the pressure in one coil of the machine. Thus in Fig. 256, if a , b , and c are the press-

* See Section 102 a.

ures in a vector diagram, the pressure between A and C is OR , which is $\sqrt{3}E$ in magnitude and has 30° difference of phase from a or $-c$. In Fig. 257 the curve R shows the potential difference between A and C . The line current must in this case be the same as that passing through the coil to which it is attached. In the **Triangle** or **Mesh** winding, which is often represented by the symbol Δ , the pressure between wires is evi-

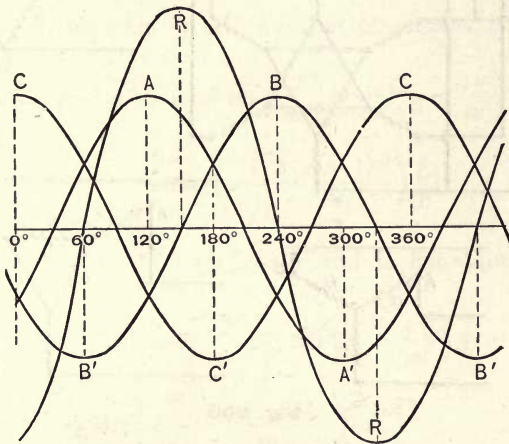

Fig. 257

dently that generated by one coil, and the current in the line wire is the resultant of that in two adjacent coils, or $\sqrt{3}C$ in a balanced system, where C is the current in a coil. This may be obtained from Fig. 256 by considering a , b , and c to be currents. If a is the initial current from which the phase is measured, b must be taken backward, as this current must flow in the opposite direction from a , in order to get to the line which is

connected to the junction of a and b . This makes the resultant current 30° from the current a . Figure 258 shows various ways in which the coils of three-phase machines may be connected. The arrangements are either of the star or mesh connection or a combination thereof.

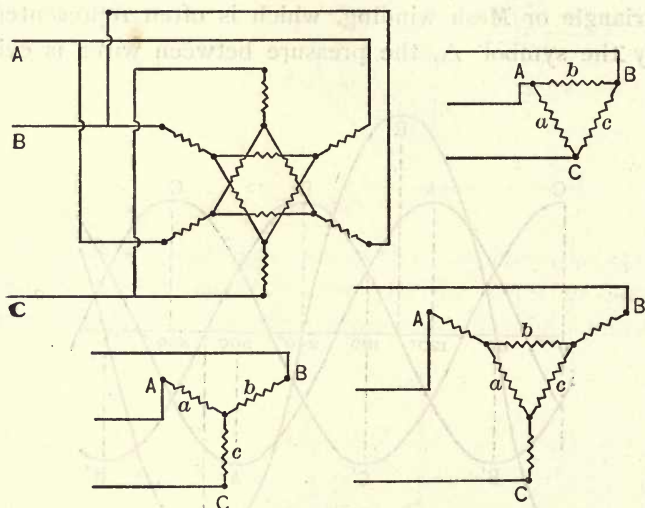

Fig. 258

144. Uniform Power in Polyphase Systems.— In general, the power transferred in a balanced polyphase circuit is uniform throughout each period, and the torque exerted by balanced polyphase machinery is uniform. This is different from the conditions in single-phase circuits, where the power has been shown to vary from a maximum to a minimum during every quarter period (Sect. 43). In the case of a single-phase circuit the power at any instant is $c_m e_m \sin(a - \phi) \sin a$

$= c_m e_m \sin^2 a \cos \phi - c_m e_m \sin a \cos a \sin \phi$, which varies with a . In a balanced two-phase circuit the instantaneous power is $c_m e_m \sin^2 a \cos \phi + c_m e_m \sin^2 (a - 90^\circ) \cos \phi = c_m e_m \cos \phi (\sin^2 a + \cos^2 a) = c_m e_m \cos \phi$, which is constant. In the same way the power in a balanced three-phase circuit is $c_m e_m \cos \phi \{ \sin^2 a + \sin^2 (a - 120^\circ) + \sin^2 (a - 240^\circ) \} = \frac{3}{2} c_m e_m \cos \phi$, which is constant; and, in general, the power in any balanced polyphase circuit in which the phase differences are equal to $\frac{\pi}{m}$ or $\frac{2\pi}{m}$, where m is the even or odd number of phases, is,

$$c_m e_m \cos \phi \left\{ \sin^2 a + \sin^2 \left(a - \frac{2\pi}{m} \right) + \sin^2 \left(a - \frac{4\pi}{m} \right) + \dots \right. \\ \left. + \sin^2 \left(a - \frac{2(m-1)\pi}{m} \right) \right\},$$

which is equal to $\left(\frac{m}{2} \right) c_m e_m \cos \phi$, and is constant, since

$$\sin^2 a + \sin^2 \left(a - \frac{2\pi}{m} \right) + \sin^2 \left(a - \frac{4\pi}{m} \right) + \dots \\ + \sin^2 \left(a - \frac{2(m-1)\pi}{m} \right) = \frac{m}{2}^*.$$

The uniformity of power in a balanced polyphase circuit may also be directly deduced from the proposition that the resultant of m equal harmonic motions acting in lines having an angular difference of $\frac{2\pi}{m}$ is a uniform circular motion with an amplitude equal to $\frac{m}{2}$ times the amplitude of the components.

* Todhunter's *Plane Trigonometry*, p. 243.

145. Algebraic Sum of Instantaneous Currents is Zero.

— It is also easily proved that the algebraic sum of the instantaneous currents in a balanced polyphase circuit of any number of phases, m , is always equal to zero. Thus

$$c_1 = c_{max} \sin a;$$

$$c_2 = c_{max} \sin\left(a - \frac{2\pi}{m}\right);$$

$$c_3 = c_{max} \sin\left(a - \frac{4\pi}{m}\right);$$

.....

$$c_m = c_{max} \sin\left(a - 2\frac{(m-1)\pi}{m}\right).$$

$$\text{Hence, } c_1 + c_2 + c_3 + \dots + c_m = c_{max} \left\{ \sin a + \sin\left(a - \frac{2\pi}{m}\right) \right. \\ \left. + \sin\left(a - \frac{4\pi}{m}\right) + \dots + \sin\left(a - 2\frac{(m-1)\pi}{m}\right) \right\};$$

$$\text{but evidently, } \sin a + \sin\left(a - \frac{2\pi}{m}\right) + \sin\left(a - \frac{4\pi}{m}\right) + \dots \\ + \sin\left(a - 2\frac{(m-1)\pi}{m}\right) = 0, *$$

and therefore $c_1 + c_2 + c_3 + \dots + c_m = 0$. When polyphase circuits have an odd number of phases, the number of line wires may be equal to the number of phases, but when the number of phases is even, the number of line wires must be one greater than the number of phases. †

* Todhunter's *Plane Trigonometry*, p. 243.

† Blondel, *Elementary Theory of Rotary Field Apparatus*, *La Lumière Électrique*, Vol. 50, p. 351.

146. Relations between Currents and Pressures. —

The following are the relations between the currents and the pressures in the lines and coils of a balanced three-phase system developed from the earlier discussion (Sect. 143):

1. *Star Connection.* $C_l = C_c$; $E_{AB} = E_{AC} = E_{BC} = \sqrt{3} E_c$. Line pressure E_{AB} is the vector sum of coil pressures E_a and E_b and is 30° behind the phase of coil pressure E_b . Line pressure E_{AC} is the vector sum of coil pressures E_a and E_c and is 30° behind the phase of coil pressure E_a . Similar relations hold for the other two corners.

2. *Mesh Connections.* $E_{AB} = E_c$, $C_l = \sqrt{3} C_c$. Line current C_A is the vector sum of coil currents C_a and C_b and is 30° ahead of the phase of coil current C_a and 30° behind the phase of coil current C_b . Similar relations hold for the other corners.

The subscripts applied to the letters C and E in the paragraphs above have the following meanings: l , line; c , coil; a , b , specific coils; A , B , specific lines; AB , AC , BC , measurements between the respective corners of the circuits. Figures 254, 255, 256, and 257 should be used for reference.

If the circuits of utilization in a polyphase system are not machines (for instance incandescent lamps), the devices must be connected exactly as would be the coils of a machine, unless transformers intervene, in which case the secondary circuits may be independent; but the load should be uniformly distributed to keep the system balanced. In three-phase circuits in which the generator coils are connected in star fashion, a fourth wire may be introduced which runs from a common junction

of the three branches of the load to the neutral point of the generator, but this method is not used commercially.

147. Effect of Mutual- and Self-Induction between Circuits.—The effects of self- and mutual-induction in polyphase circuits may be determined by using the principles already set forth (Sects. 47 and 110), provided the resultant effect of the differing phases is always properly considered. In unbalanced systems the mutually inductive influence of the circuits tends to increase their defects in balance.* In order to regulate phase pressures independently, pressure regulators such as those described in Section 82, or rheostats, must be introduced in each phase; or, if the generator armature is stationary, the number of active conductors on each phase may be varied by a commutator. (Example: Stanley alternator.) In some polyphase alternators where the armatures of the different phases are influenced by different field frames, the regulation may be effected by varying the field magnetism (Example: large Westinghouse alternators), but this is an unusual construction.

148. Measurement of Power in Two- and Three-phase Circuits.—The principles underlying the methods of measuring power in polyphase circuits differ in no respect from those already deduced in relation to single-phase circuits (Sect. 44), but it is desirable to apply them in such a way as to reduce the number of necessary readings to a minimum. For satisfactory measurements, non-inductive wattmeters are of essential importance, and very satisfactory commercial

* *Electrical World*, Vol. 25, p. 302.

portable wattmeters are now to be had for a reasonable price.

A. Two-Phase Systems.

A 1. Independent Circuits. In a two-phase system with separate circuits, independent wattmeter readings are taken in each circuit and the total power is the sum

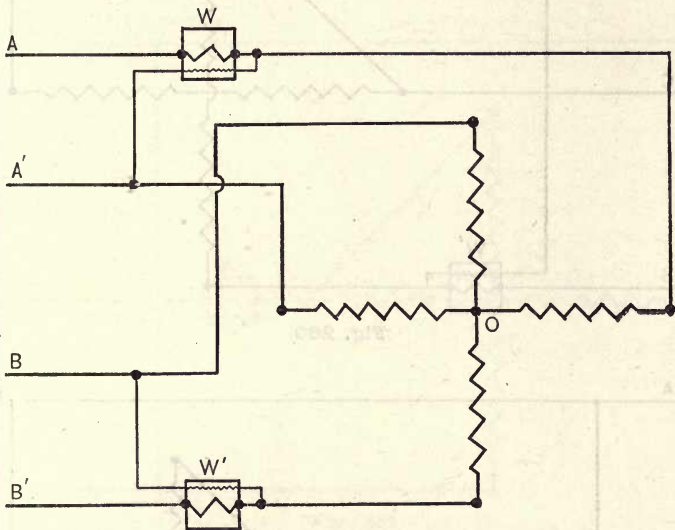

Fig. 259

of the readings. One wattmeter placed in each circuit (Fig. 259), from which simultaneous readings are taken, is the best arrangement; but if two wattmeters are not to be had, one may be inserted successively in the two circuits, and the sum of the readings is equal to the power in the system, provided the load does not vary while the readings are being taken. If the circuit is perfectly balanced, twice the reading of a wattmeter in

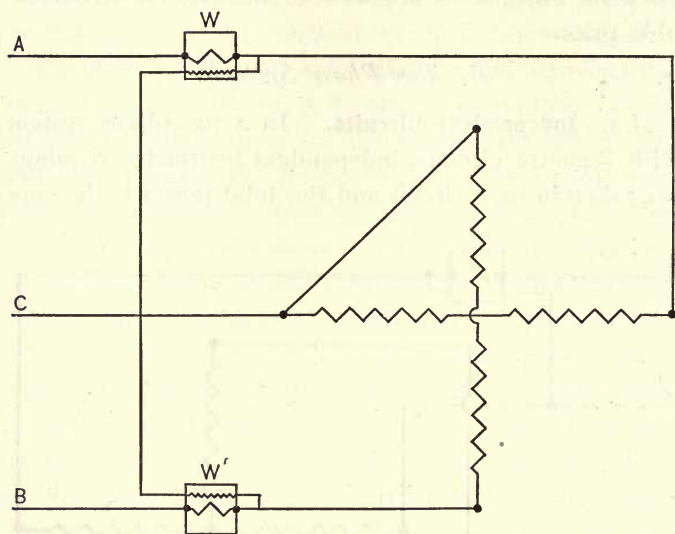

Fig. 260

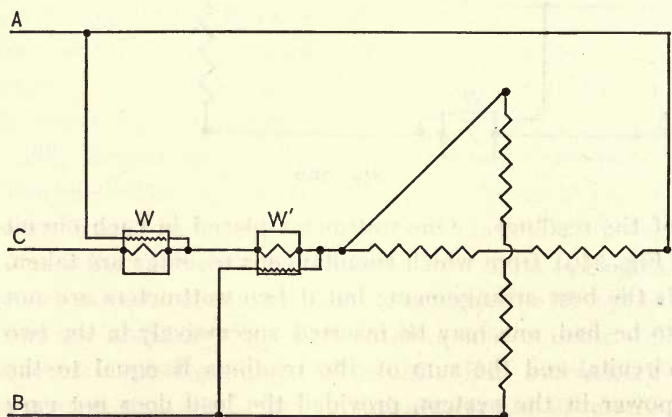

Fig. 260 a

one circuit is equal to the power, but this is a condition which cannot be relied upon.

A 2. Circuits with Common Return. — Two wattmeters may here be used, one for each circuit, connected in the way shown in Fig. 260. The arrangement shown in Fig. 260*a* is equivalent to a single wattmeter connected as in Fig. 261, and is only correct for a system in

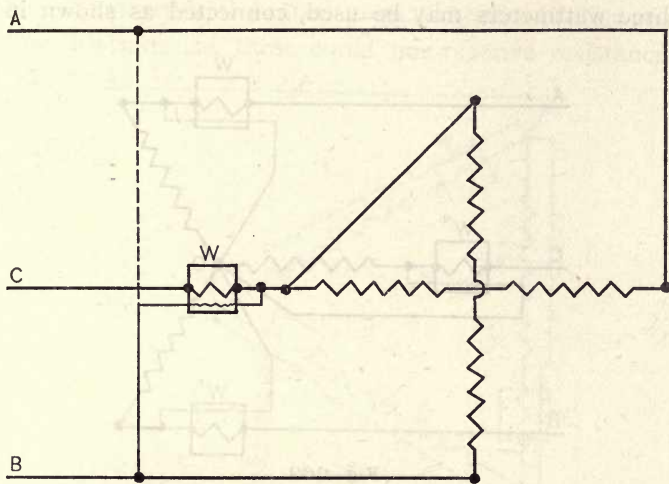

Fig. 261

exact balance. When the single wattmeter is used in a balanced system, the current coil is placed in the common wire, and a reading is taken with the free end of the pressure coil connected to one outside wire. The pressure coil terminal is then quickly transferred to the other outside wire and a new reading taken. The condition of exact balance is not to be relied upon, so that the arrangement of Fig. 260 must ordinarily be used.

The sum of the readings of the two wattmeters then gives the power in the system.

B. Three-Phase Systems.

B I. Three Wattmeters.—*a.* If the power delivered by a generator, or absorbed by a motor or other device, which is connected in star fashion, is to be measured, three wattmeters may be used, connected as shown in

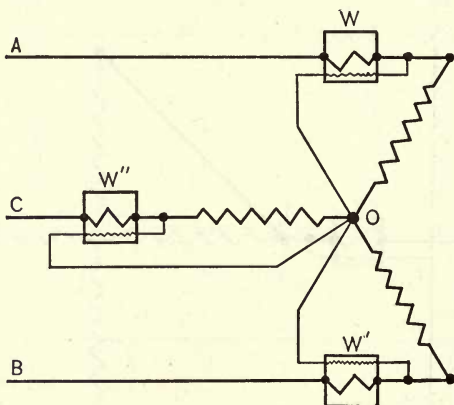

Fig. 262

Fig. 262, provided the common or neutral point is accessible. It is evident that each wattmeter measures the power in one coil so that the sum of the readings gives the power in the system. If the system is exactly balanced, three times the reading of one wattmeter gives the power.

b. If the devices are connected mesh fashion, three wattmeters may still be used, provided the current coils of the wattmeters can be inserted directly into the coil

circuits as shown in Fig. 263. The power in the circuit is equal to the sum of the three wattmeter readings, and if the circuit is exactly balanced, three times the reading of one wattmeter gives the power.

c. When it is impossible to insert the wattmeters in the coil circuits of a device with mesh connection, the three-wattmeter method may still be used by the creation of an artificial neutral point as shown in Fig. 264. For this purpose, three equal non-reactive resistances

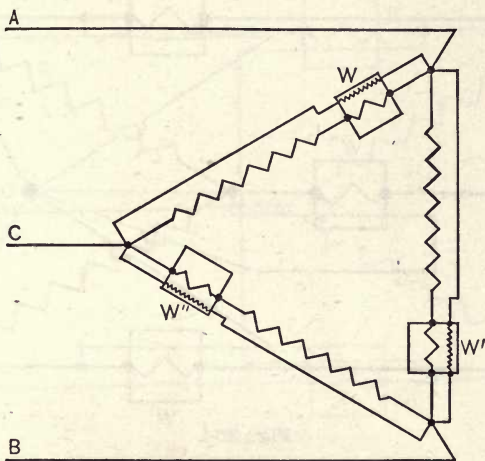

Fig. 263

are connected together at one end, and the other ends are connected to the respective corners of the mesh circuit. The pressure between the neutral point and either corner is equal to $\frac{E}{\sqrt{3}}$, where E is the pressure of one coil, and the phase of this pressure is ϕ degrees in advance of the current entering the corner. A wattmeter with its current coil inserted in the circuit wire

leading to the corner carries a current equal to $\sqrt{3} C$, and if the free end of the pressure coil is connected to the neutral point, the power reading of the wattmeter is

$$\frac{\sqrt{3} CE \cos \phi}{\sqrt{3}} = CE \cos \phi,$$

which is the power in the coil. Care must be taken that the resistances of the wattmeter pressure coils are

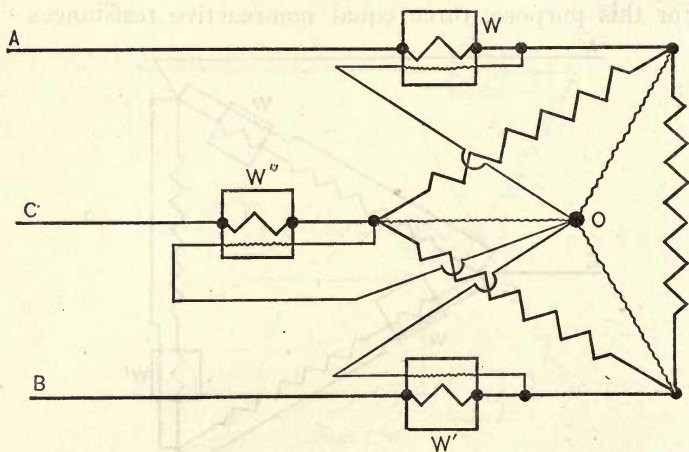

Fig. 264

so large compared with the three auxiliary resistances that connecting them in circuit does not disturb the pressure of the neutral point. If the resistances of the wattmeter pressure coils are exactly equal, auxiliary resistances are unnecessary, and the measurement may be made by joining the free ends of the three pressure coils.

These methods are independent of the condition of balance in the system or the current lag.

B 2. Two Wattmeters.—The algebraic sum of the readings of two wattmeters, inserted in a three-phase circuit as shown in Fig. 265, gives the power in the system with entire independence of the balance of the system or current lag. When the current lag in the circuit is less than 60° , or the power factor is greater than .50, the arithmetical sum of the readings is equal to the power in the circuit; but if the lag is greater

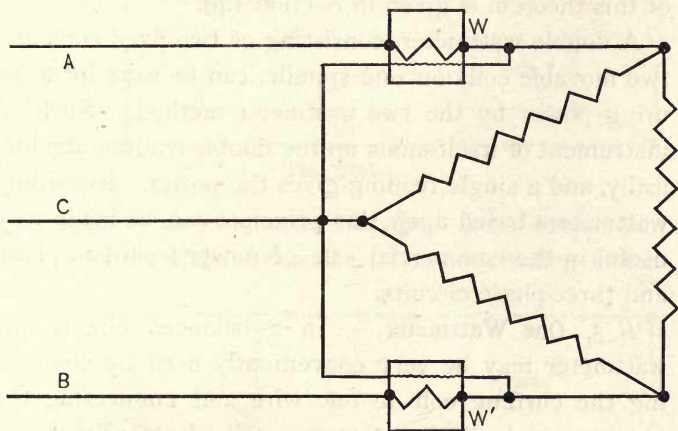

Fig. 265

than 60° (the power factor is less than .50), the relation of the currents in the current and pressure coils of one of the wattmeters causes it to have a negative reading, and the arithmetical difference of the readings of the two instruments gives the power. There is some difficulty in distinguishing which condition exists in many cases, especially when the power absorbed by partially loaded induction motors, in which the power factor is low, is under measurement. As

a general rule, if the conditions do not make the case evident, the truth may be discovered by interchanging the positions of the instruments without altering the relative connections of their main and pressure coils. If the deflections of both needles are reversed, the difference of the original readings represents the power, but if the deflections are in the same direction as before, the sum of the readings is correct. The proof of this theorem is given in Section 149.

A double wattmeter, consisting of two fixed coils and two movable coils on one spindle, can be used in measuring power by the two wattmeter method. Such an instrument of itself sums up the double reading algebraically, and a single reading gives the power. Recording wattmeters based upon this principle can be made very useful in the commercial sale of power from two-phase and three-phase circuits.

B 3. One Wattmeter. — In a balanced circuit one wattmeter may be very conveniently used by connecting the current coil in one wire and connecting the free terminal of the pressure coil alternately to the other two leads (Fig. 266), when the sum of the readings gives the power. For, the power reading of the wattmeter in its first position is $\sqrt{3} CE \cos(\phi + 30^\circ)$, and in its second position, $\sqrt{3} CE \cos(\phi - 30^\circ)$, and the sum of the readings,

$$\sqrt{3} CE \{ \cos(\phi + 30^\circ) + \cos(\phi - 30^\circ) \} = 3 CE \cos \phi,$$

where C , E , and ϕ are the current, pressure, and lag in a coil; but $CE \cos \phi$ is the power in one coil and $3 CE \cos \phi$ is the total power of the three coils, hence

the one wattmeter gives correct indications provided ϕ is the same for all the coils, and the load is uniformly

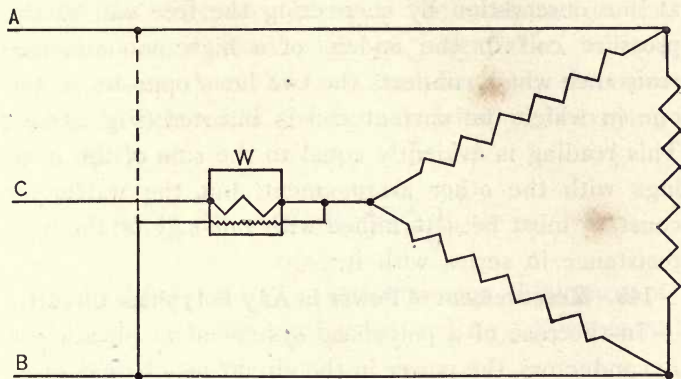

Fig. 266

distributed. A wattmeter having two independent pressure coils could be used as a direct reading instru-

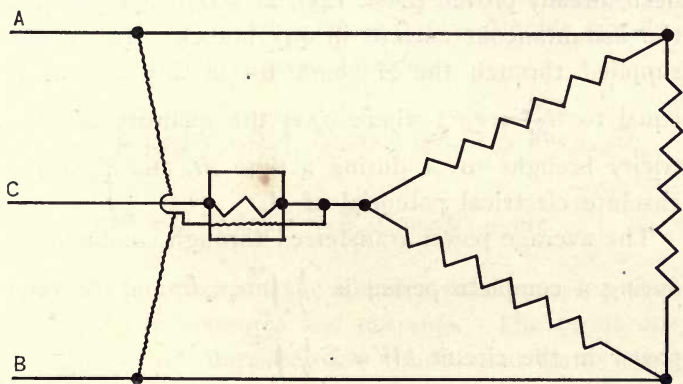

Fig. 266 a

ment for this purpose. A similar wattmeter could also be used in one-wattmeter measurements of power in

two-phase circuits. An ordinary wattmeter with one pressure coil may be used for the double measurement at one observation by connecting the free end of the pressure coil to the middle of a high non-inductive resistance which connects the two lines opposite to the one in which the current coil is inserted (Fig. 266 *a*). This reading is evidently equal to the sum of the readings with the other arrangement, but the wattmeter constant must be determined with one-half of the high resistance in series with it.

149. Measurement of Power in Any Polyphase Circuit.*

— In the case of a polyphase system of m phases and m conductors, the power in the circuit may be measured by $m - 1$ wattmeters. Supposing A, B, C, D , etc., are points where the m conductors of a polyphase supply circuit connect to the circuits under test, then, as has been already proved (Sect. 145), $\Sigma c = 0$, if c represents the instantaneous current in any branch. The power supplied through the A conductor at any instant is equal to $\frac{q_a v_a}{dt} = c_a v_a$, where q_a is the quantity of electricity brought to A during a time dt , and v_a is the absolute electrical potential of A .

The average power transferred through conductor A during a complete period is $\frac{1}{T} \int_0^T c_a v_a dt$, and the total power in the circuit, $W = \Sigma \frac{1}{T} \int_0^T c v dt$.

* Blondel, Measurement of the Energy of Polyphase Currents, *Proc. Elect. Congress held at Chicago*, p. 112; Lunt, Measurement of the Power of Polyphase Currents, *Electrical World*, Vol. 23, p. 771.

The absolute potentials of the points are inconvenient to measure, and it is desirable to introduce into the formula the difference between the pressures at the points and some fixed point of potential v' . Since $\Sigma c = 0$, we also have $\Sigma cv' = 0$, and $\Sigma cv'$ may therefore be directly inserted in the formula without destroying the equality, or

$$W = \Sigma \frac{1}{T} \int_0^T (cv - cv') dt = \Sigma \frac{1}{T} \int_0^T c(v - v') dt.$$

Writing e for $v - v'$ (the instantaneous difference of pressure between the fixed point and any given point in the system) gives

$$W = \Sigma \frac{1}{T} \int_0^T cedt.$$

The fixed point may be taken at one of the corners of the circuit, A for instance, since $\Sigma cv' = 0$ holds equally for it, and the power formula becomes

$$W = \frac{1}{T} \int_0^T c_b e_{ab} dt + \frac{1}{T} \int_0^T c_c e_{ac} dt + \text{etc.} + \frac{1}{T} \int_0^T c_m e_{am} dt,$$

or
$$W = C_b E_{ab} \cos \theta' + C_c E_{ac} \cos \theta'' + \text{etc.}$$

where θ' , θ'' , etc., are the angular differences in the phases of the pressures and currents. The terms on the right of the equation are the familiar forms representing the power readings of a wattmeter, so that if $m - 1$ wattmeters are inserted in circuit with their current coils respectively in the $m - 1$ conductors, B , C , D , etc., and the free ends of their pressure coils

all connected to A , the algebraic sum of their readings is equal to the power in the system.

When the circuit includes three phases only, the formula is $W = C_b E_{ab} \cos \theta' + C_c E_{ac} \cos \theta''$, and only two wattmeters, connected as in Fig. 265, are required to give the power in the circuit, but due regard must be had to the relative signs of $\cos \theta'$ and $\cos \theta''$. From the relative phases of the currents C_b and C_c and pressure E_{ab} (Sect. 146) it is easy to see that in a balanced system $\theta' = \phi' - 30^\circ$, and also that $\theta'' = \phi'' + 30^\circ$, and therefore

$$W = C_b E_{ab} \cos (\phi' - 30^\circ) + C_c E_{ac} \cos (\phi'' + 30^\circ),$$

in which ϕ' and ϕ'' are the angles of lag of the circuit currents. The formula shows that the first term at the right, which represents the reading of one wattmeter, is positive within the limits $\phi' = +90^\circ$ and $\phi' = -60^\circ$, and that its value is negative between the limits $\phi' = -60^\circ$ and $\phi' = -90^\circ$. The second term, which represents the reading of the second wattmeter, is positive between the limits -90° and $+60^\circ$ and negative between $+60^\circ$ and $+90^\circ$. Consequently, *if the current lags equally in the circuits, or $\phi' = \phi''$, both wattmeters have a positive reading, and the power in the circuit is the sum of the readings, for angles of lag between $+60^\circ$ and -60° . If the angle of lag is $+60^\circ$ (the current lags behind the pressure), the second wattmeter reading is zero, and the power in the circuit is equal to the reading of the first wattmeter. If the lag is greater than $+60^\circ$, the reading of the first wattmeter is positive and the second is negative, and the power in the*

circuit is equal to the difference of the two readings. Again, if the angle of lag is -60° (the current leads the pressure), the first wattmeter reading is zero, and

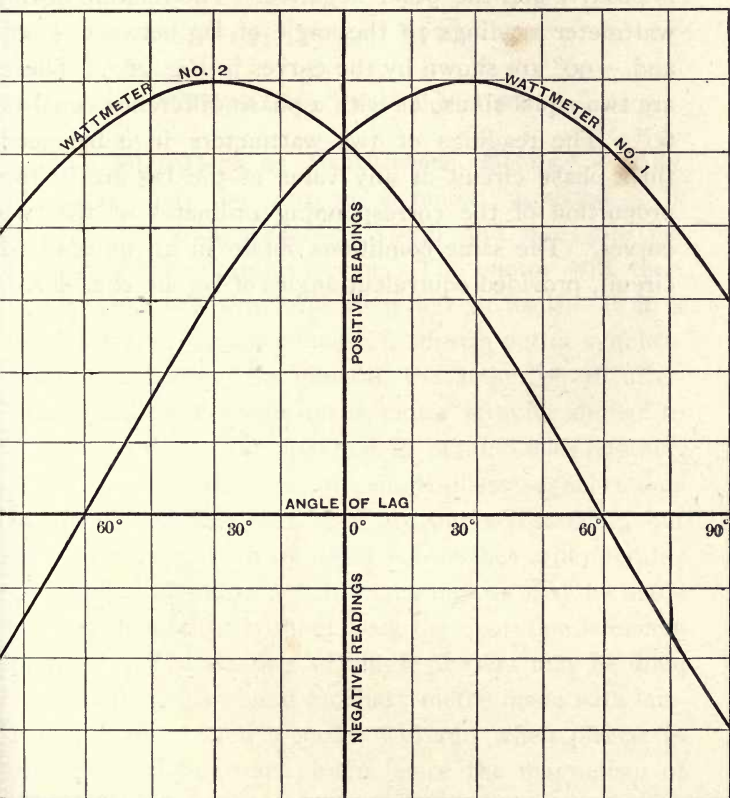
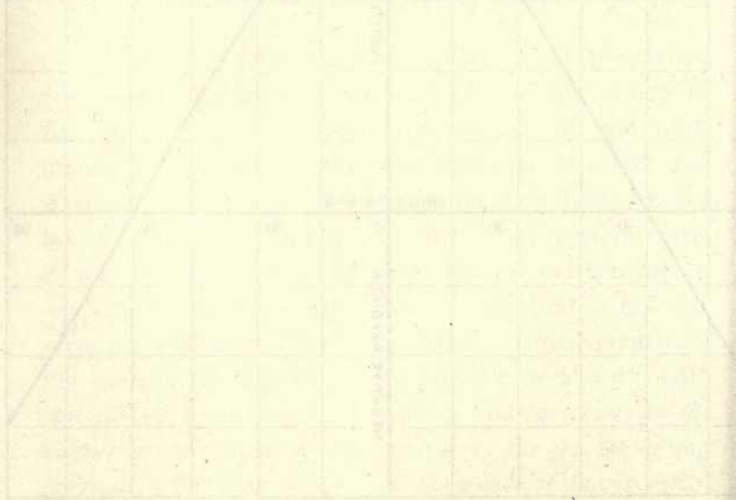

Fig. 267

the power in the circuit is equal to the reading of the second instrument. If the lead is more than 60° , the reading of the first instrument is negative and of the second posi-

tive, and *the power in the circuit is equal to the difference of the two readings*. When the angle of lag is $\pm 90^\circ$, the readings of the two instruments are equal, but one is positive and the other negative. The relation of the wattmeter readings to the angle of lag between $+90^\circ$ and -90° are shown by the curves in Fig. 267. These are two equal sinusoids with a phase difference equal to 60° . The readings of two wattmeters in a balanced three-phase circuit at any value of the lag are in the proportion of the corresponding ordinates of the two curves. The same conditions obtain in an unbalanced circuit, provided equivalent angles of lag are considered.



CHAPTER XIV.

ALTERNATING-CURRENT MOTORS.

150. Alternators as Synchronous Motors.* — Any alternator may be run as a motor, provided it is brought up to synchronous speed and into step before it is thrown into circuit. The motor will then run in complete synchronism if left to itself. If it is overloaded, or by other means is thrown out of synchronism, it will stop. In general, the action of an alternator used as a synchronous motor is quite similar to that of an alternator operated in parallel with another. A great disadvantage of single-phase synchronous motors is the fact that they are not self-starting, but must be brought up to speed before they will operate; and while polyphase synchronous motors may be made to start themselves without load, the operation is uneconomical. The starting of single-phasers may be done by a small series-wound auxiliary motor made with laminated fields. Such a motor will run when placed in an alternating-current circuit, since the magnetism of the fields and armature will reverse together as the cur-

* Picou, *Transmission de Force par Moteurs alternatifs synchrones*, *Bull. Soc. Int. Électriciens*, Vol. 12, p. 60; Blondel, *Couplage et Synchronisation des Alternateurs*, *La Lumière Électrique*, Vol. 45, pp. 425, 563; Rhodes, *A Theory of Synchronous Motors*, *Phil. Mag.*, July, 1895; Alt. Current Motors, *Lond. Elect. Review*, Vol. 37, pp. 182, 222.

rent changes direction; but very little power can be developed by such a machine on account of its enormous self-inductance. A small two-phase motor (Sect. 182), with a device for splitting the current into two phases, may be used (see Fig. 268); or the exciter of

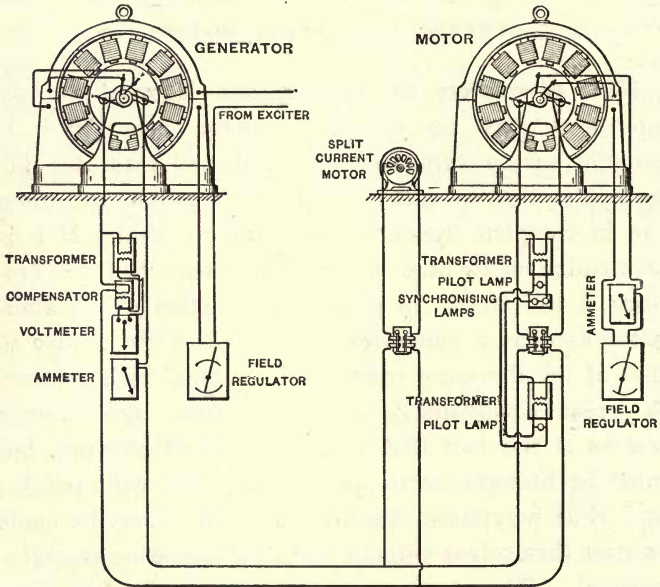

Fig 268

the alternator may be run as a motor by a storage battery and used to bring the alternator into synchronism, the storage battery being recharged by current from the exciter after the alternator is operating on the circuit. Polyphase synchronous motors may be started by an ordinary polyphase induction motor, such as is described in later sections.

While the practical disadvantage of synchronous motors, due to the fact that they are not self-starting, may be overcome by these special devices, the expense of motor equipment is increased, and, at the best, the motor cannot be started under load. Consequently, synchronous motors are not satisfactory for general power distribution. They have been used with considerable satisfaction in certain special plants for the long-distance transmission of power, and may be said to be destined to play an important part for such work; but for general power transmission and distribution purposes, they cannot be satisfactorily used.

151. Relation of Field Strength to the Working of Synchronous Motors.—When a synchronous motor is put in the circuit, a peculiar relation exists between the strength of the field of the motor and the current in its armature. In continuous-current motors, if the strength of the field is slightly changed without altering any of the other conditions, the speed of the motor changes inversely, and the current in the armature remains practically unchanged; but the speed of a synchronous motor cannot change permanently, and, consequently, upon first consideration, it would appear that the field of a synchronous motor must be exactly adjusted, in order that the machine may operate satisfactorily. This, however, is proven not to be the case in practice, on account of the effect which may be gained through variations of the relative phases of the current and of the impressed and counter pressures. The active pressure, which at any instant causes current to flow through the armature of a

motor, is equal to the difference of the corresponding instantaneous values of the impressed and counter pressures. If the field strength of a motor is so adjusted that the values of the impressed and counter pressures are equal, and the motor armature is brought into exact step with the impressed pressure curve, then, when the motor is switched on the supply main, it will fall back in phase with respect to the impressed pressure, sufficiently to permit the proper load current to pass through the armature. Now suppose that at some instant the load is increased, the difference of instantaneous pressures at that instant will be insufficient to pass the current, which is necessary for the new load, through the armature. The motor, therefore, falls back in its phase without losing synchronism, if the load is not too great, and then continues operating in synchronism, but with a greater lag in step. When a motor lags in step behind the phase of impressed electromotive force, its counter pressure lags to an equal extent. The armature current ordinarily takes an intermediate phase, so that it is behind the resultant pressure, but in advance of opposition to the counter pressure.

Were it not for the effect of the current lag with respect to the resultant pressure, caused by self-inductance, it would be necessary to adjust the field excitation of a synchronous motor, so that its counter pressure would be less than the impressed pressure, and the range of load carried with a given excitation would be small. The effects due to the current lag, however, make it possible to adjust the field excitation

once for all, so that the motor may be operated on a widely varying load. It is even possible, on account of the automatic adjustment of the pressure phases, to operate a motor when its excitation is much greater or much less than its normal value. The adjustment is assisted by the effect of armature reactions on the motor, in which a lagging current tends to strengthen the fields and a leading current to weaken them (Sect. 70). When a single motor is operated from an alternator of about its own size, the automatic adjustment of the machines is still more marked, since the current which strengthens the field of the motor tends to weaken that of the alternator as the load is varied, and *vice versa*, which is desired.*

It is evident from the preceding that the armature current of a motor must have a wattless component which depends directly upon the phase differences of the impressed and counter pressures and the angle of lag, and it may readily be seen that the most economical excitation of a synchronous motor field is that which reduces the armature current to a minimum (or makes the power factor a maximum) when the motor is carrying the average load.

152. Graphical Illustrations showing the Relations of Pressure and Current in a Synchronous Motor Armature. — In order to bring out more clearly the facts just given, recourse may be had to a diagram in which rela-

* Compare Ryan, The Behaviour of Single-Phase Synchronous Motors, *Sibley Journal of Engineering*, May, 1894; Scott, Long-Distance Transmission for Electric Lighting and Power, *Trans. Amer. Inst. Elect. Eng.*, Vol. 9, p. 425.

tions of current and pressures are shown much as in parallel working. It was shown (Sect. 87) that in parallel working the machines were held in step by a motor action, and that if one machine was cut off from its prime mover it would continue to run in synchronism as a motor, its pressure being unchanged. In Fig. 269 let OC be the current passing through two alternators, one acting as a motor, and let OL be the pressure of self-induction ($2\pi fLC$), and OS the active pressure

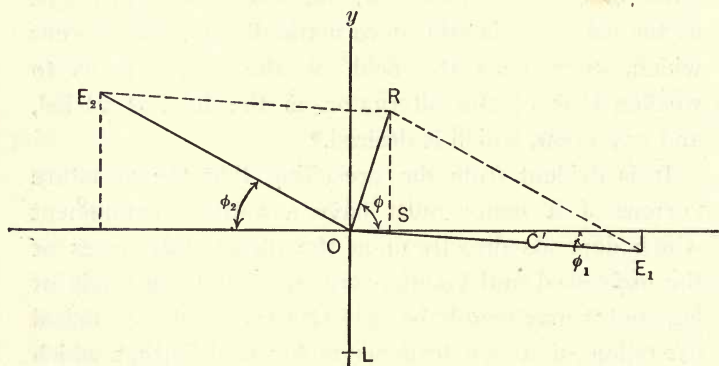

Fig. 269

(CR); then OR will be the resultant pressure required to pass the current OC through the circuit. Suppose the alternator generates a pressure OE_1 , and the motor is excited to give an equal pressure OE_2 ; then OE_1 and OE_2 must be in such a phase as to give the resultant OR , while the elements of pressure resolved upon the current line OC must be such that the element of OE_1 has the same direction as the current and the element of OE_2 is in opposition. The work delivered by the generator is $OC \times OE_1 \cos \phi_1$, and that utilized by the

motor armature in furnishing power and overcoming the magnetic and friction losses is $OC \times OE_2 \cos \phi_2$; while that lost, due to resistance, is their difference, and is equal to

$$OC \times OR \cos \phi = OS \times OC.$$

It will be seen that for small loads the current may lead the generator pressure as shown in Fig. 269, but that as the load increases (and the length of OR

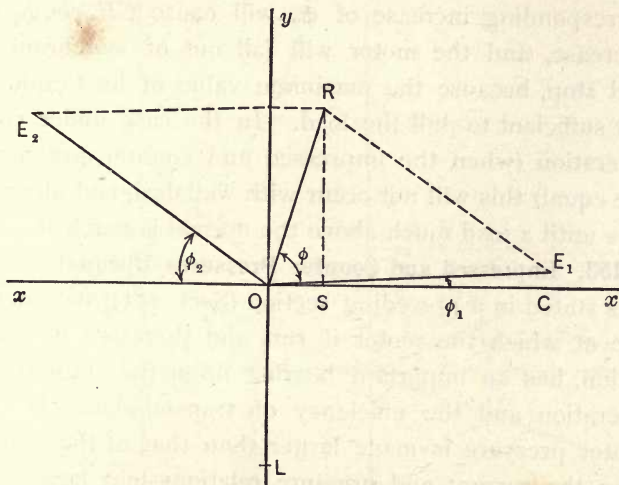

Fig. 269 a

therefore increases), the generator pressure is caused to swing forward so that the current takes a lagging position, as shown in Fig. 269 a. The construction indicates that the current is always in the lead of direct opposition to the counter pressure when the impressed and counter pressures are equal, and that the value of ϕ_2 increases when the load on the motor is increased. The value of C is one-half greater in Fig. 269 a than

in Fig. 269, the input of the motor is 50 per cent greater, and the output about 45 per cent greater. The latter is increased in a smaller proportion because the C^2R loss increases directly as C^2 , while the output increases less rapidly than C . The motor will continue to operate, as the load is increased, until ϕ_2 has attained such a value that $E_2 \cos \phi_2 \times C$ becomes a maximum; then, if an additional load is put on the motor, the corresponding increase of ϕ_2 will cause $CE_2 \cos \phi_2$ to decrease, and the motor will fall out of synchronism and stop, because the maximum value of its torque is not sufficient to pull the load. In the case under consideration (when the impressed and counter pressures are equal) this will not occur with well-designed alternators until a load much above the normal is reached.

153. Impressed and Counter Pressures Unequal. — As was stated in a preceding section (Sect. 151), the pressure at which the motor is run, and therefore its excitation, has an important bearing upon the stability of operation and the efficiency of transmission. If the motor pressure is made larger than that of the generator, the current and pressure relations may be shown by a construction similar to that used in Fig. 269. Let OR in Fig. 270 *a* represent the magnitude and direction of the resultant pressure, and the impressed and counter pressures have magnitudes OE_1 and OE_2 ; then the parallelogram can be completed with but one value of the angles ϕ_1 and ϕ_2 , *i.e.* that shown in the figure. In this case the counter pressure is greater than the impressed pressure. Now suppose the counter pressure is made OE'_2 , having the same horizontal projection as

OE_2 , while OR and the impressed pressure have the same values as before; then the phase relations are as shown by the lines OR , OE_1' , and OE_2' . The values of $OE_2 \cos \phi_2$ and $OE_2' \cos \phi_2'$ are equal by the construction, since the points E_2 and E_2' are in the same vertical line, and since OR has the same magnitude and

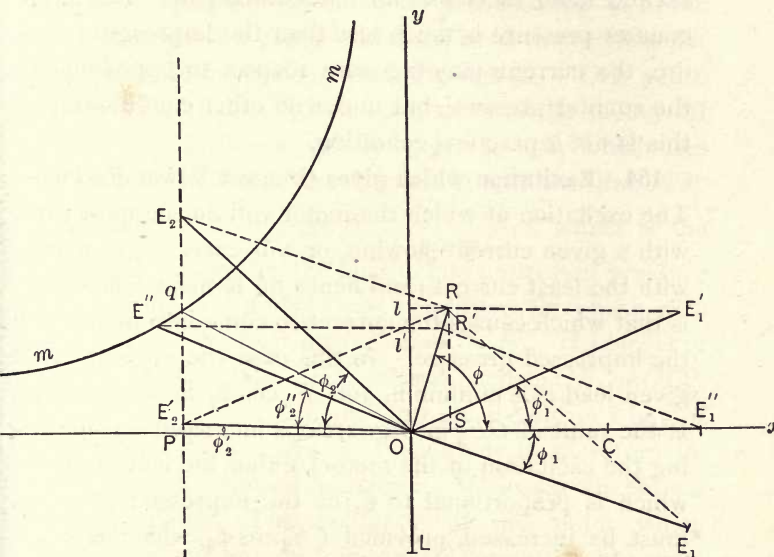

Fig. 270 a

position in the two cases the current is the same, and $OE_1 \cos \phi_1$ and $OE_1' \cos \phi_1'$ are equal; but in the first case the counter pressure is greater than the impressed pressure and the current leads the impressed pressure, and in the second case the impressed pressure is greater and the current lags. This construction shows that for every load on the motor, except that corresponding to a

zero angle of lag, there are two values of the excitation which cause the same armature current to flow, the current leading the impressed pressure with one excitation and lagging by an equal angle with the other excitation; hence an over-excited motor acts upon the line current very much like a condenser, and an under-excited motor acts like an inductance coil. When the counter pressure is much less than the impressed pressure, the current may lag with respect to opposition to the counter pressure, but under no other conditions, and this is not a practical condition.

154. Excitation which gives Greatest Power Factor.—

The excitation at which the motor will do the most work with a given current flowing, or will carry a given load with the least current (and hence do it most efficiently), is that which causes the current to come into phase with the impressed pressure. In this case the current for a given load is a minimum, and $E_2 \cos \phi_2$ is a maximum. If the value of OE_2 in Fig. 270 *a* is increased (by increasing the excitation of the motor), either the length of OR which is proportional to C , or the impressed pressure, must be increased, provided $CE_2 \cos \phi_2$, which is equal to the motor load, is constant. On the other hand, if OE_2 decreases while OE_1 remains constant, the angle of lag, ϕ_1 , and the current, decrease until the current and impressed pressure come into phase, after which a further decrease of OE_2 causes the current to increase again, as is shown by the relations between E_1 , C , and E_2 in the figure. The value of $CE_2 \cos \phi_2$ is proportional to the area of the rectangle $Olqp$, since Ol is proportional to C . Now if the motor load is kept constant,

but its excitation is changed, the corner of the corresponding rectangle must be different from q , but the locus of the motion of the corner is a hyperbola with its origin at O and the rectangular axes x and y , since the rectangles included between the axes and the ordinates and abscissas of all points must be of equal area. Consequently, the point of the vector representing E_2 at the least current for a given load must be in the rectangular hyperbola, mm , which passes through q . This point, which is E_2'' for the given load, is found by laying off the horizontal line equal in length to OE_1 which will just reach between the hyperbola and the line OR . This cuts OR at R' , and $C = \frac{E_1'' (= OR')}{2\pi fL}$, which is the minimum current for the load. The impressed pressure and current are, under these conditions, in phase with each other. At this point $E_2'' \sin \phi_2'' = E_v''$. If a larger or smaller pressure than OE_2'' is used, such as OE_2 or OE_2' , the impressed pressure and current are thrown out of phase, and the current in the circuit is therefore increased, which causes increased C^2R losses and armature reactions. The excitation of the motor which brings the current and impressed pressure into step, depends upon the relation of the impedance of the motor circuit to its resistance. If $I = 2R$, the counter pressure is equal to the impressed pressure at zero angle of lag, and if $I \gtrless 2R$, the counter pressure is respectively greater or less than the impressed pressure at zero lag.* The expression $I = 2R$ is equivalent

* Steinmetz, Theory of the Synchronous Motor, *Trans. Amer. Inst. E. E.*, Vol. 11, p. 767.

to, reactance equals $\sqrt{3}R$ ($I = \sqrt{R^2 + 4\pi^2 f^2 L^2} = 2R$, and, therefore, $2\pi fL = \sqrt{3}R$). In the machines which are now commonly built, the impedance of the armature circuit is commonly equal to or larger than twice the resistance, so that a maximum power factor is gained in such synchronous motors by an excitation which gives a counter pressure that is equal to or greater than the impressed pressure.

155. Curve showing the Relation of Armature Current to Excitation. — We may plot the relation of armature

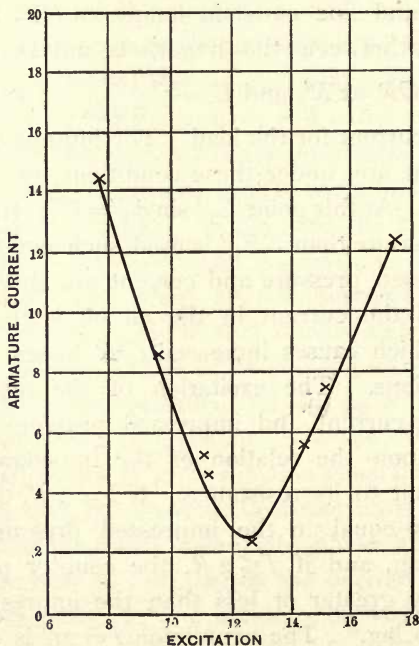

Fig. 270 b

current to field excitation for a motor operating under the conditions considered above, by taking the corre-

sponding values of E_2 and C from a chart made like Fig. 270*a*. This gives a curve like Fig. 270*b*, which has two values of its abscissas for every value of the ordinate except the lowest; or for each value of the armature current there may be two values of the excitation, one being greater and the other less than the impressed pressure, except at the point of minimum armature current, which corresponds to but one excitation, as has already been explained (Sect. 153). The way in which Fig. 270*a* is constructed shows that the smaller the angle ϕ , or the smaller the armature self-inductance, the less will be the difference in the two excitations corresponding to any armature current; and hence the curve showing the relation of excitation to current in a machine having a large time constant is broad and rounded, but the curve for an armature having a small time constant is sharp and narrow. In an ideal machine without self-inductance, the two values of excitation for a leading and lagging impressed pressure are equal, and the curve becomes a straight line.

156. Maximum Load. — When a synchronous motor is operated with a fixed excitation on a variable load, the step of the motor will automatically adjust itself, when the load changes, to the changed conditions, until $CE_2 \cos \phi_2$ is equal to the new load, provided a certain maximum limit is not exceeded. As the load increases, the current must increase, whence it is evident from Fig. 270*a* that the change in phase of the motor pressure must be in the direction which increases ϕ_2 , and that $CE_2 \cos \phi_2$ will therefore reach a maximum point beyond which the motor cannot work, since $\cos \phi_2$ decreases as

ϕ_2 increases. This point depends upon the self-inductance of the armature, which controls ϕ_2 , when the impressed and counter pressures are constant. If the load on the motor is made greater than the maximum value of $CE_2 \cos \phi_2$, the motor must fall out of synchronism and stop. The smaller the impedance of the motor circuit, the less will the angle ϕ_2 change with any change of current, when E_2 remains constant, as is seen by the construction of Fig. 270 *a*, and therefore the maximum load which the motor will carry depends inversely on its impedance; but the greater the angle of lag, ϕ , the less will be the value of ϕ_2 for fixed values of the pressures and impedance, and consequently the less rapidly will $\cos \phi_2$ vary with a given variation of ϕ_2 . So that the maximum load which a motor will carry depends inversely upon the impedance of its armature circuit, and directly upon the angle by which the current lags behind the resultant pressure.* In practice, armature reactions always tend to weaken the field of the motor as the current is in the lead of opposition to the counter pressure; and it is therefore advisable to excite the machine rather above that pressure corresponding to the least current for normal load, as the armature reactions then tend to decrease the field strength and thus modify the motor pressure so as to cause a decrease in the amount of armature current. If the excitation is made smaller than that corresponding to minimum current,

* Mordey, *Alternate-Current Working*, *Jour. Inst. E. E.*, Vol. 18, p. 595; Kolben, *Elektrotechnische Zeitschrift*, Vol. 16, p. 802; *London Electrical Engineer*, 1895; Kapp's *Electrical Transmission of Energy*, 4th ed., p. 278.

the armature reactions cause the deviation from minimum current to become still greater. To decrease the effect of armature reactions as well as make the machine capable of carrying considerable overloads without being dragged out of synchronism, it is advisable to use strong fields, and armatures with the least number of conductors compatible with an economical design. There is ordinarily no danger to the motor if it stops, as the armature inductance cannot be economically reduced below a value sufficient to prevent a destructive flow of current, as was shown in the example in Section 94.

As showing the gain in stability of operation by exciting the motor somewhat above that which would result in the minimum current, were there no armature reactions present, Mr. Kapp gives the following theoretical table.*

TABLE SHOWING WORKING CONDITION OF
TRANSMISSION PLANT.

Total resistance in circuit, 1 ohm; total reactance, 4 ohms.

| | | | |
|---|------|------|--------------|
| Generator excited to give | 1100 | 1100 | 1100 volts |
| Motor excited to give | 1200 | 1300 | 1350 volts |
| Normal power given off by motor | 125 | 125 | 125 H.P. |
| Maximum power given off by motor before breaking from synchronism | 200 | 250 | 268 H.P. |
| Margin of excess load causing breakdown of the system | 60 | 100 | 134 per cent |

With a smaller impedance in circuit, the possible overload before the motor breaks from synchronism would be greater, as is shown by the considerations just

* *Electrical Transmission of Energy*, 4th ed., p. 277.

discussed, the experiments of Kolben,* and the experience in American plants.

157. **Experiments of Bedell and Ryan.**—Bedell and Ryan† made a series of experiments on a pair of diminutive eight-pole, smooth-core Westinghouse alternators, giving a frequency of 139, one of which was run as a motor, and the other as a generator. (The machines were built to each supply ten 16 C.P. lamps.) The resistance of the machine circuit was .31 ohm, and the self-inductance of the motor armature .32 millihenry.

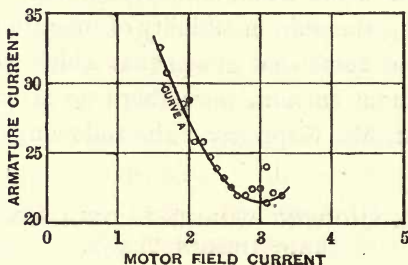

Fig. 271

The curve of magnetization of the motor was practically a straight line. It was found that the motor would operate only under field excitations varying from 1.5 to 3.5 amperes, and required an abnormal armature current to carry its load, the minimum current being at an excitation of 3 amperes (Fig. 271); also, that a very small

* *Elektrotechnische Zeitschrift*, Vol. 16, p. 802; *London Electrical Engineer*, 1895.

† Action of a Single-Phase Synchronous Motor, *Four. Franklin Inst.*, March, 1895.

increase of load would throw it out of synchronism. The load consisted of the friction of a $\frac{1}{2}$ horse-power Edison dynamo. A variable inductance consisting of a coil with a movable iron core was then inserted in the circuit. By moving the core of this coil it was found that when its inductance was 1.68 millihenrys the motor required a minimum armature current for a given load, ran with stability through a wide range of load, and

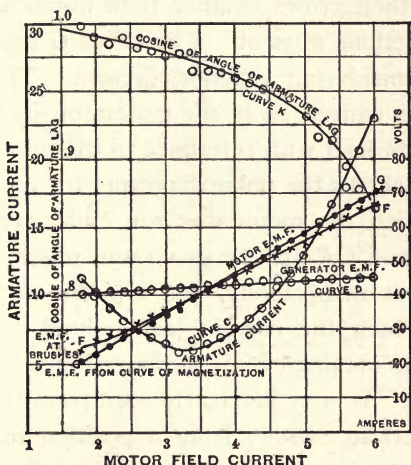
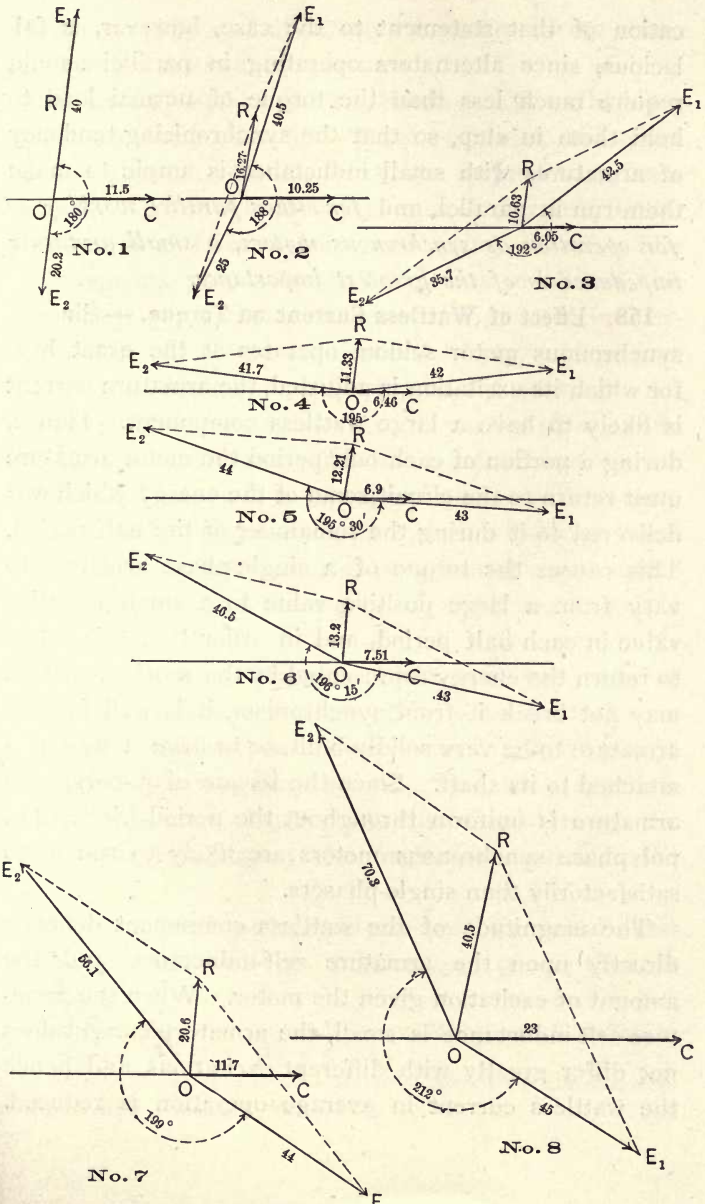

Fig. 272

operated at excitations of from 1.8 to 6 amperes. The excitation was not carried over 6 amperes as there was danger of springing the motor shaft, which was weak. Curve *C*, in Fig. 272, shows the armature current for different excitations when the motor was under the same small constant load, as in the trial without external inductance. Curves *D*, *F*, and *G* show plainly the tendency of the armature reaction referred to above

to hold the generator and motor excitations at the point of maximum efficiency. Curve D represents the generator pressure, and, although the excitation was constant, the generator pressure rises as the motor pressure is increased. This is due to the reaction caused by the current swinging from a lag to a lead with reference to the generator pressure. At the same time the motor pressure, which is represented by curve F , at first is larger and then grows smaller than would be the case were no reactions present. The curve G represents the pressure, considering reactions absent. The effect in the motor is caused, as in the generator, by the current increasing its lead with reference to the motor pressure. Figure 273 shows the polar diagrams for various excitations at which the motor was run under constant load. OE_1 , OE_2 , and OR are the generator, motor, and resultant pressures respectively, and OC the current. The angle by which the current lags behind the resultant pressure was obtained from the impedance of the armature circuit. It may be clearly seen from the diagrams that the current swings from a position of large lag, with reference to the generator pressure, at a small excitation of the motor, into phase with it, — the point of minimum current for the given load on the motor, — and finally into a position of large lead when the motor is greatly over-excited.

This series of experiments and the preceding discussions (Sect. 156) show that there was some foundation for the statement of earlier experimenters, that alternators must have self-inductance in their armature circuits if they are designed to be run in parallel. The appli-



cation of that statement to the case, however, is fallacious, since alternators operating in parallel should require much less than the torque of normal load to hold them in step, so that the synchronizing tendency of armatures with small inductance is ample to make them run in parallel, and *for either parallel working or for operation as synchronous motors, a small armature impedance is of the greatest importance.*

158. Effect of Wattless Current on Torque. — Since a synchronous motor seldom operates at the exact load for which its excitation is adjusted, the armature current is likely to have a large wattless component. Hence, during a portion of each half period the motor armature must return to the circuit some of the energy which was delivered to it during the remainder of the half period. This causes the torque of a single-phase armature to vary from a large positive value to a small negative value in each half period, and in order that this effort to return the energy represented by the wattless current may not break it from synchronism, it is well for the armature to be very solidly built, or to have a fly-wheel attached to its shaft. Since the torque of a polyphase armature is uniform throughout the period (Sect. 144), polyphase synchronous motors are likely to run more satisfactorily than single-phasers.

The magnitude of the wattless component depends directly upon the armature self-inductance and the amount of excitation given the motor. When the armature self-inductance is small, the armature current does not differ greatly with different excitations, and hence the wattless current in average operation is reduced.

This is an additional advantage of motors having armatures with a minimum impedance.

159. Rotary-Field Induction Motor. — The well-known principles which cause the rotation of a disc of copper pivoted above a rotating horseshoe magnet have been put into use through the discoveries of Ferraris, Tesla, Haselwander, Dobrowolsky, and many others. The arrangements proposed by Tesla were doubtless the first direct applications of these principles to commercial use, in which they are destined to play a large part in the transmission and distribution of power.* An almost simultaneous publication of a series of scientific experiments by Ferraris shows the operation of similar apparatus,† and various experiments of a similar nature or for a similar purpose are on record. Each of these experiments caused an iron or copper armature to rotate when placed within the region of a rotating magnetic field.

160. A Rotating Magnetic Field. — If two coils of wire are arranged at right angles so as to enclose a cylindrical iron core, or if two pairs of coils are placed at right angles on a ring core (Fig. 250), the magnetism set up in the core when a current is passed through the coils is the resultant of the magnetization due to the two coils.

If the magnetizing currents are two sinusoidal alternating currents with 90° difference of phase, then, at

* A New System of Alternate-Current Motors and Transformers, *Trans. Amer. Inst. E. E.*, Vol. 5, p. 308.

† Electro-dynamic Rotation by Means of Alternating Currents, *London Electrician*, Vol. 21, p. 86.

any instant, the magnetizing force due to one of the coils is $H_1 = H_m \sin \alpha$, and of the other coil is

$$H_2 = H_m \sin (\alpha - 90^\circ) = H_m \cos \alpha,$$

where H_m is the maximum magnetizing force of either coil (Fig. 274). The resultant magnetizing force is then $H_R = \sqrt{H_1^2 + H_2^2} = H_m$, and is therefore constant in magnitude. The direction of this constant magnetizing force is variable. When $\alpha = 0^\circ$, H_R lies in the plane of the first coil, and when $\alpha = 90^\circ$, H_R lies in the plane of the other coil. The magnetizing force of each coil has a sinusoidal or harmonic variation, and the resultant magnetizing force is the resultant of two harmonic variations with 90° difference of phase. As is well known, such a resultant has a uniform magnitude and a uniformly varying direction. The instantaneous values of the resultant may therefore be diagrammatically represented by the instantaneous positions of a line of fixed length, rotating at a uniform rate around one end, such as OH_R in Fig. 274.

If the maximum ampere-turns of one coil are greater than those of the other coil, the magnitude of the resultant magnetizing force varies. The rotating field, in this case, may be diagrammatically represented by a uniformly rotating line, which varies in length, so that its tip traces an ellipse whose minor and major axes are respectively in the planes of the stronger and weaker coils. If the windings of the coils are similar, and the currents equal, but the phase difference is not 90° , a variable field again results.

If the phases of the two currents are in unison,

$$H_R = \sqrt{H_1^2 + H_2^2} = \sqrt{2} H_m \sin \alpha.$$

This shows that when the two currents are in unison H_R varies with $\sin \alpha$, and therefore varies from zero to a maximum of $\sqrt{2} H_m$, but its direction must be constant, since the values of its two components are equal at every instant. Its direction evidently lies in a plane between the planes of the two coils. The diagrammatic representation of the resultant, here, is a line of fixed direction

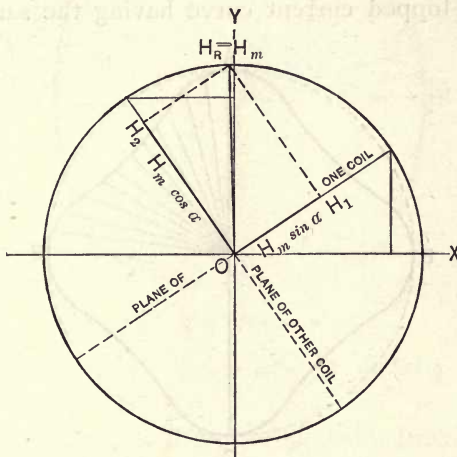
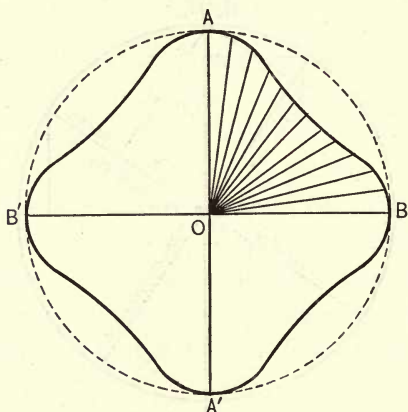

Fig. 274

which harmonically varies in length, the total range of variation being from $-\sqrt{2} H_m$ to $+\sqrt{2} H_m$.

For any difference of the current phases between zero and 90° , both the magnitude and direction of H_R again vary, and the diagrammatic representation is again a line with its tip tracing an ellipse. The ratio of the two axes depends upon the phase difference of the currents. If the currents have 90° phase difference, but the planes of the coils are not 90° apart, the effect on the resultant magnetizing force is evidently the same

as if the conditions were reversed. If the currents are not sinusoidal, the value of the resultant magnetizing force, H_R , varies in a more or less irregular manner. Thus, Fig. 275 *a* indicates in a general manner the strength of the field at different angular positions when a peaked current is applied to two coils having 90° difference of position, and Fig. 275 *b* is the same for a flat-topped current curve having the same maxi-

Fig. 275 *a*

mum value. The dotted circles in each case represent the rotating magnetizing force due to sinusoidal currents in the same coils.

The same argument may be readily seen to apply to the resultant magnetizing force due to any number of coils surrounding a core. When equal coils are at equal angular distances, and equal currents in the individual coils differ in phase by an amount equal to the angular distance of the coils from each other, the resultant magnetizing force is always uniform in mag-

nitude and rotates at a uniform rate, provided the currents are sinusoidal, and its value is $H_R = \frac{m}{2} H_m$, where m is the number of phases* (compare Sect. 144). The

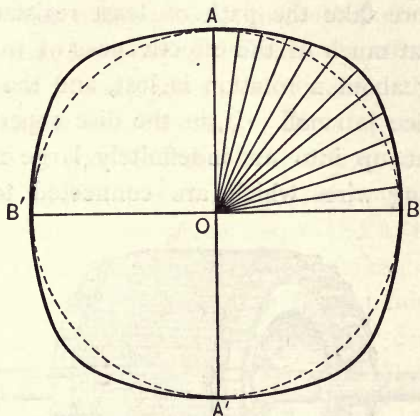

Fig. 275 b

correctness of these deductions is directly indicated by experiment.

The Germans call the rotating field **Drehfelde**, and the polyphase currents which set up a rotating field **Drehstrom**, or rotating current.

161. Action of a Short-circuited Armature Winding within a Rotating Field.—If a drum core of laminated iron be properly pivoted within a ring, on which coils are so situated that the field rotates, it will be dragged into rotation by the magnetic pull. If the pivoted core be of copper, it will be dragged into rotation by the reactions of the foucault currents which are developed in the core. This is directly analogous to the ex-

* E. Arnold, *Elektrotechnische Zeitschrift*, Vol. 14, p. 42.

periment with the Arago disc, to which reference has already been made (Sect. 159).

In the case of either a solid core or Arago disc, the foucault currents are not constrained in position, and therefore take the path of least resistance. The result is that much of the effectiveness of the currents in bringing about a rotation is lost, and the efficiency of the device is small. If, in the disc experiment, the disc be cut up into an indefinitely large number of fine radiating wires which are connected together at

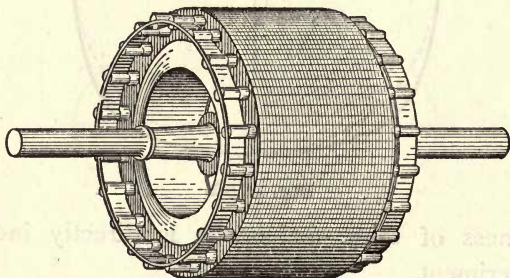

Fig. 276

their inner and outer ends, the useless or parasitic eddies may in a large measure be done away with, and the efficiency of the device be considerably raised. In the same way the drum core may be made of laminated iron in order that the magnetic circuit shall be of small reluctance, and embedded in this may be copper wires which cross the face of the core and are all short-circuited by copper rings at the ends (Fig. 276). These make constrained paths for the induced currents, and, if the core is sufficiently laminated and the copper conductors are not too thick, the

parasitic eddies are largely done away with, and the efficiency of such a motor may be made quite large.

162. Variation in a Rotating Field. — There has been considerable dispute regarding the uniformity of the strength of the rotating field in motors of this class. The question at issue being whether the effective magnetizing force at each instant is equal to the sum of the ampere-turns on the coils, or the ampere-turns are compounded to gain the resultant effect according to the parallelogram of forces. The latter assumption is made in the discussion given above (Sect. 160). Dobrowolsky, Pupin,* and others have taken the other view, and have determined from that standpoint that there is a fluctuation of about 40 per cent in the strength of the field due to two sinusoidal currents with 90° difference of phase, and about 14 per cent fluctuation in the field due to three sinusoidal currents with 120° difference of phase.

With a view of experimentally determining which assumption is correct, Messrs. Hanson and Webster undertook, in the electrical laboratories of the University of Wisconsin, the experimental measurement of the strength of the rotating field of a three-phase motor, when magnetized with three sine currents with phase differences of 120° . For this purpose they placed a test coil on the surface of the motor armature and arranged the armature so that it could be readily rotated through a small arc of fixed value. The reading of a ballistic galvanometer connected to the test coil was therefore proportional to the number of lines of force

* *Trans. Amer. Inst. E. E.*, Vol. 8, p. 562.

cut by the coil when the armature was rotated. The magnetization was effected by continuous currents in the windings of the motor fields, which were so adjusted as to give the proper phase relation to each other. Thus, calling the coils a , b , and c , and supposing the current in a is desired to be the instantaneous zero value of the current, then the current in b must be adjusted so that

$$C_b = c_{max} \sin 120^\circ,$$

and the current in c must be adjusted so that

$$C_c = c_{max} \sin 240^\circ.$$

The resultant magnetism thus produced is equal to the instantaneous magnetization due to an alternating current taken at a corresponding instant. To get the instantaneous magnetization for any other phase of the alternating currents, the test currents must be so adjusted that

$$C_a = c_{max} \sin a,$$

$$C_b = c_{max} \sin (a + 120^\circ),$$

$$C_c = c_{max} \sin (a + 240^\circ).$$

The algebraic sum of the currents must always be equal to zero. The apparatus was arranged somewhat as in Fig. 277. By the method thus outlined it was found that the magnetization due to the field windings advanced uniformly as a wave of fixed magnitude, as closely as the limits of error of the experiment would show. As these errors were well within 2 or 3 per cent, the experiments prove:

- I. That the resultant magnetizing force due to the

several coils arranged as in the rotary-field motor is, for practical purposes, equal to the magnetizing effects of all the coils compounded according to the ordinary methods of composition of harmonic variation.

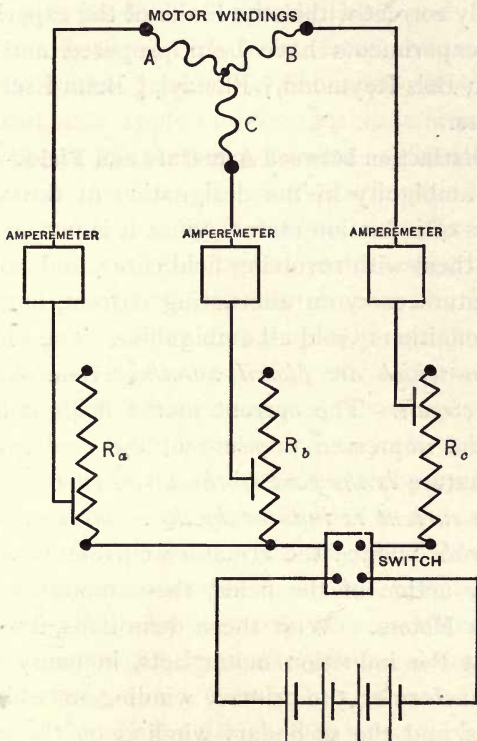

Fig. 277.

2. That the magnetization set up is practically proportional to the magnetizing force when the induction is not pushed too high.

To determine to what extent the saturation of the iron in the magnetic circuit affects the latter deduction,

Hanson and Webster made tests which covered a considerable range of maximum currents, and which were carried above the bend in the curve of magnetization of the motor. The deductions given above appeared to be practically correct within the limits of the experiments.* Similar experiments have been proposed and carried out by du Bois-Reymond,† Blondel, ‡ Behn-Eschenburg, and others.

163. Distinction between Armature and Field. — There is some ambiguity in the designation of the armature and fields of induction motors, since it is not uncommon to make them with revolving field cores, and both fields and armature carry an alternating current, but the following definitions avoid all ambiguities. The **Field** is *the core upon which are placed windings connected to the external circuit*. The current in the fields is therefore due to the impressed pressure of the external circuit. The **Armature** is *the part of the motor in the conductors of which current is induced by the revolving magnetism of the fields*. Since the armature current is wholly induced by action of the fields, these motors are called **Induction Motors**. With these definitions, it is readily seen that the induction motor acts, in many respects, like a transformer, the primary winding of which is on the fields, and the secondary winding on the armature.

* Jackson, Three-Phase Rotary Field, *Electrical Journal*, Vol. 1, p. 185. Also see Pupin, *Trans. Amer. Inst. E. E.*, Vol. 11, p. 549.

† Theoretical and Experimental Study of Polyphase Currents, *Elektrotechnische Zeitschrift*, Vol. 12, p. 303; *Electrical World*, Vol. 17, p. 477.

‡ Elementary Theory of Rotary-Field Apparatus, *La Lumière Électrique*, Vol. 50, p. 358.

The Germans call polyphase induction motors **Drehstrom Motors**.

The energy developed in the secondary circuit of the induction motor is expended in causing rotation of the revolving part instead of causing heat and light in the external circuit, as is the case of the ordinary transformer. The same general methods apply, in designing these motors, that apply in designing transformers.

164. Wattless Magnetizing Current. — Since an air space must be made in the magnetic circuit to allow the motors to operate, it is evident that the wattless magnetizing current of induction motors must be materially greater than that of transformers. In fact, the no-load current of some comparatively small motors of this type, which show quite a high efficiency, is entirely comparable to the full-load current. To reduce the wattless current to a reasonable limit, every effort must be bent to decrease the reluctance of the air space. As the armature conductors may be embedded in the armature core, it is possible to make the air space simply that required for mechanical clearance, and, by care in the workmanship, this may be made very small compared with the air space of dynamos built according to the ordinary methods.

165. Motor Speeds and Slip. — The velocity of rotation of the magnetic field depends upon the frequency of the current supplied to the motor, and the number of pairs of poles in the field. In two-pole machines, the number of rotations which the field makes per second, or the **Field Frequency**, is equal to the current frequency, and, in multipolar machines, the field frequency is equal to

the current frequency divided by the number of pairs of poles, or $\frac{f}{p}$. The number of pairs of poles which is referred to is the number in the rotating field. This is equal to the number of pairs of poles set up by the windings in fields with a smooth magnetic surface, but is equal to $\frac{1}{2m}$ times the number of salient poles in salient-pole machines (m being the number of phases). The latter can scarcely be said to give a uniformly rotating field unless there are m crowns of poles.

The velocity of rotation of the armature can never equal the velocity of rotation of the field magnetism, since the armature conductors must be cut by the lines of force of the fields in order that an electrical pressure may be developed in the armature; that is, the field magnetism must always have a relative velocity of rotation with reference to the armature conductors. In any machine, the relative velocity is $v = V - V'$, where V and V' are respectively the number of revolutions per minute of the field magnetism and the armature conductors. This relative velocity is called the armature **Slip**, and is small, seldom exceeding 5 per cent of the speed of the motor. Since the current in the armature must be proportional to the work done by the motor, it must vary with the load, and v must increase as the load is increased. A little consideration shows that, if the magnetism remains constant, the variation of v with the load must be just sufficient to counterbalance the drop of pressure caused by the current flowing in the armature conductors.

A variation of v demands a variation of V' of equal

magnitude, since V is fixed by the frequency of the current delivered to the motor; consequently, the speed regulation of a rotary-field motor is directly dependent upon the loss of pressure in the armature conductors if we neglect the effect of armature reactions and drop of pressure in the primary windings. This is entirely analogous to the case of continuous-current shunt-wound motors.

At starting, the relative velocity of the field magnetism and the armature is evidently V , since V' is zero. The armature current is therefore very great, and the starting torque may also be very great provided the armature reactions do not too greatly disturb the field. To avoid injury to the armature from the current at starting, means must be taken to prevent its becoming excessive, exactly as in the case of continuous-current machines worked on constant pressure.

166. Graphical Illustration of Relations in Induction Motors.—The reactions of the polyphase induction motor may be set forth very clearly by graphical representation. Suppose we have under consideration a two-phase motor, as shown diagrammatically in Fig. 278, where aa' and bb' are two pairs of coils in series, each pair being connected to a pair of two-phase feeders. The armature we will suppose for convenience is of the squirrel-cage or short-circuited bar type. That is, the conductors are embedded in the face of the armature and are short-circuited by rings extending around the armature at each end (see Fig. 276). From the foregoing discussion (Sect. 160) it is evident that a magnetic north pole on one side and a magnetic south pole

just opposite, will rotate around the field core with the frequency of the alternating current (f). This mag-

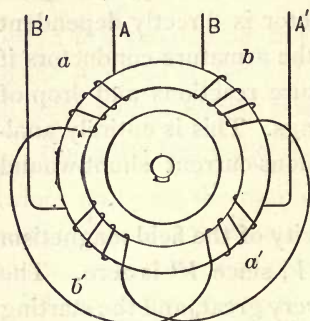

Fig. 278

netic field will induce under it, in the conductors of the armature which it cuts, a pressure which causes a current to flow in the conductors. This current, if the armature is free from self-inductance, will set up a magnetic field lagging 90° behind the magnetism set

up by the field windings (Fig. 278 *a*). Therefore let OB in Fig. 279 be the strength of the rotary field which produces in the armature the resultant current, OC_a . Then OA may be represented as the field due to this armature

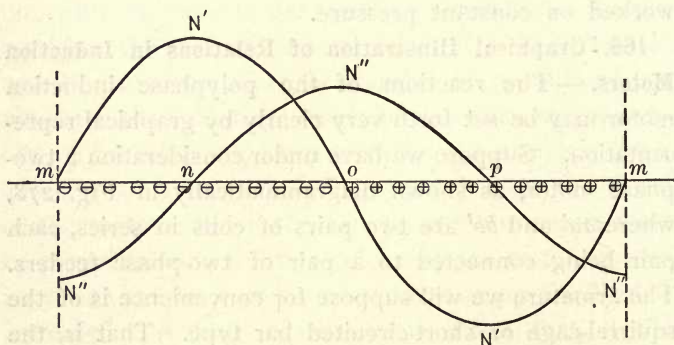

Fig. 278 a

current. The impressed magnetizing force must be sufficient to supply the field OB and overcome OA , or must be sufficient to set up a field OM . OC , represents the relative phase and magnitude of the field cur-

rent, provided the number of primary conductors is equal to the number of secondary conductors. This construction requires us to consider the polyphase currents combined at every instant into a resultant

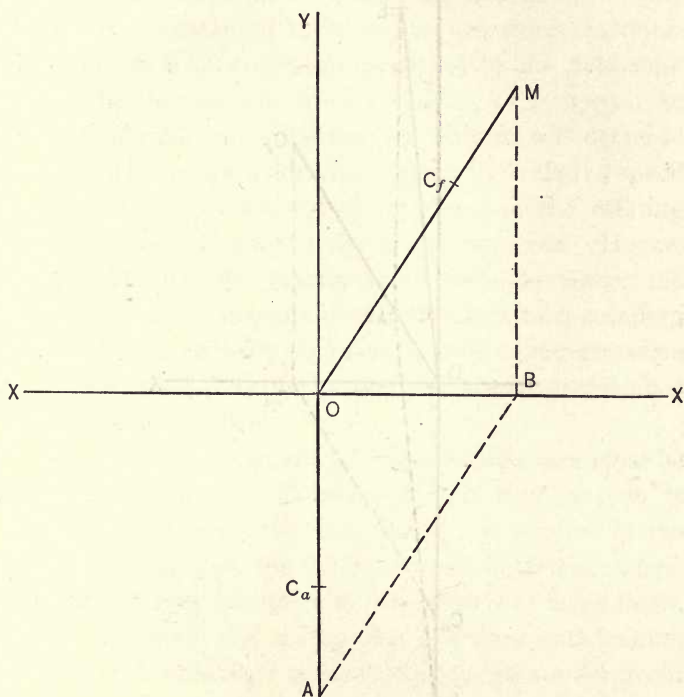

Fig. 279

which may be represented by the sum of the vertical projections of the polyphase current vectors. This assumption simplifies the construction very much and enables the use of exactly the same method as that used for transformers (Sect. 118); namely, in Fig. 280,

if OC_μ is the magnetizing ampere-turns required to set up the desired field, and OC_a the armature ampere-turns, then the field ampere-turns must be OC_f . Also the

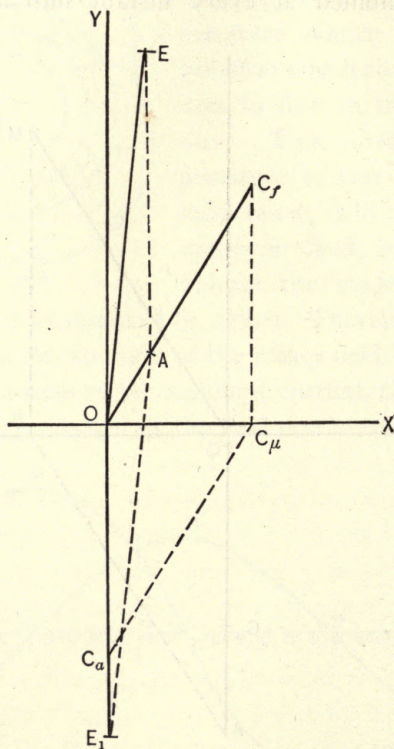

Fig. 280

self-induced pressure in the fields will be OE_1 , drawn to the proper scale, while OE is the pressure that must be applied to the fields when OA is the element of pressure which multiplied by the current furnishes the motor losses.

167. Torque of Ideal Motor. — It is evident that in a motor giving this diagram, the starting torque will be enormous for a low-resistance armature, as the current induced will be enormous, since the wattless magnetizing current, and hence the resultant magnetic field, remains practically constant if there are no armature reactions. The torque is of course proportional to the field multiplied by the current, or to $OB \times OC_a$ (Fig. 279). As the motor comes up to speed, the current will decrease directly as the speed increases, since the relative speed or slip of the armature with reference to the rotating field decreases directly as the speed increases. Hence, neglecting armature reactions and self-inductance, the torque will be a maximum with the armature standing still and will gradually decrease to zero as the armature speed increases towards its limit, which is synchronism with the rotating field.

168. Effect of Magnetic Leakage. — As there must be clearance between the armature and field, a path is made for magnetic leakage, which, on account of the opposing action of the armature and field magnetism, becomes of very considerable magnitude at large loads. Lines of force set up by the armature and leaking through this clearance space cause the armature current to lag exactly as though self-inductance were introduced into the windings, as is also the case in the fields. This effect materially alters the diagram, as is shown in Fig. 281, where OE_2 and OE_1 are respectively the armature and field reactive pressures. The diagram in this case is also drawn exactly as in the case of transformers, where there is self-inductance in the primary

and secondary coils, and gives an impressed field pressure OE' and a field current OC_f , lagging by the angle ϕ_f . The angle of lag ϕ_a in the armature evidently may

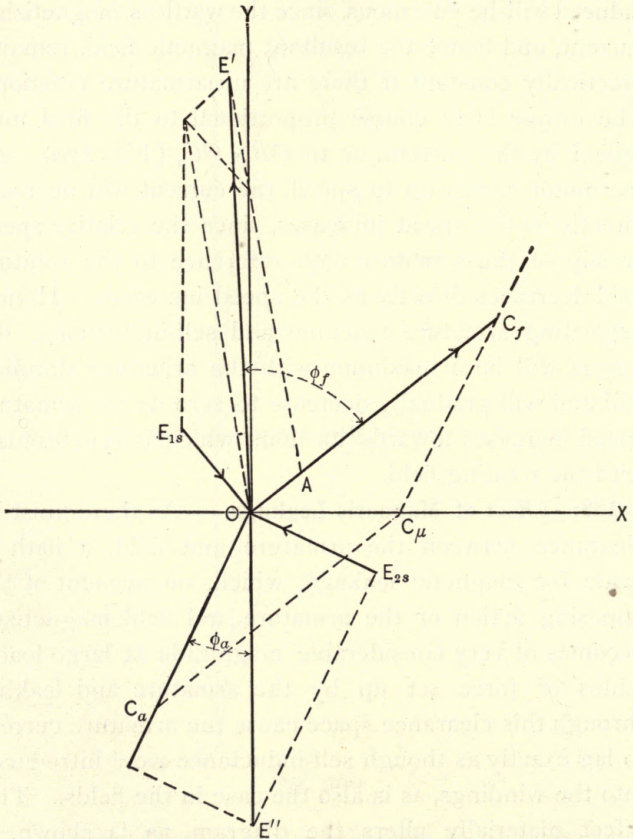

Fig. 281

cause a serious decrease in the motor torque from two causes; first by decreasing the armature current for a given induced pressure, and second by retarding the phase

of the current with respect to the magnetic field. For this reason, added to its effect on the slip, induction motors are built to give as small a leakage field as possible. Figure 282 indicates a method of winding frequently employed, which makes it possible to reduce the leakage field to a minimum by reducing the air space. The windings are placed in evenly distributed slots, thus

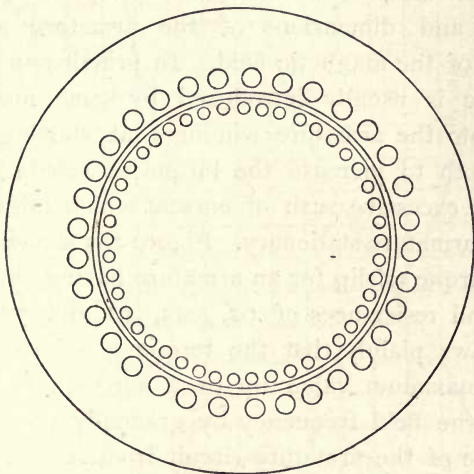

Fig. 282

avoiding polar projections. As the frequency of alternation in an armature bar is a maximum when the motor is at rest, its reactance is then a maximum, and the armature current is caused to have a maximum lag with respect to the induced pressure; and the torque for a given current is reduced in proportion with the cosine of the lag, $\cos \phi_a$. Since

$$\tan \phi_a = \frac{2 \pi f L_a}{R_a}, \text{ or } \cos \phi_a = \frac{R_a}{I_a}$$

it is evident that by increasing the resistance of the armature conductors at starting, $\cos \phi_a$ may be increased, and the starting torque, which is equal to

$$m \frac{C_a E \cos \phi_a}{2 \pi V'} = K \frac{m v_1 \cos \phi_a}{\text{Impedance}}, *$$

may be increased to a maximum.

The constant, K , in this formula depends upon the winding and dimensions of the armature and the strength of the magnetic field. In practice an external resistance is usually introduced by some mechanical device into the armature windings, at starting, which serves both to increase the torque at starting and to avoid the excessive rush of current which might occur with the armature stationary. Figure 283 shows the relation of torque to slip for an armature having a reactance of .18 and resistances of .02, .045, .18, and .75 ohms.† This shows plainly that the torque can be caused to have a maximum value up to a slip equal to 10 per cent of the field frequency by gradually reducing the resistance of the armature circuit from .18 to .02 ohms as the speed of the armature increases. The relations are as follows:

* $C_a = \frac{e}{I} = k \frac{v}{I}$, where k is a constant depending on the strength of the field and the number of armature conductors; $E = k V'$; $K = \frac{k^2}{2 \pi}$. E is the pressure that would be induced in the armature windings if the armature were rotated at a speed of V' revolutions per minute in a stationary field equal in magnitude to the rotating field; e is the pressure that would be induced under similar conditions at a speed v ; v_1 is the frequency with which the field cuts the armature conductors when the slip is v , and, therefore, $v_1 = \frac{p v}{60}$. m is the number of phases.

† Steinmetz, *Trans. Amer. Inst. E. E.*, Vol. XI., p. 760.

$$\frac{\cos \phi_a}{I_a} = \frac{R_a}{I_a^2} = \frac{R_a}{R_a^2 + 4\pi^2 v_1^2 L_a^2}$$

and the torque is therefore equal to

$$mK \frac{v_1 R_a}{R_a^2 + 4\pi^2 v_1^2 L_a^2}$$

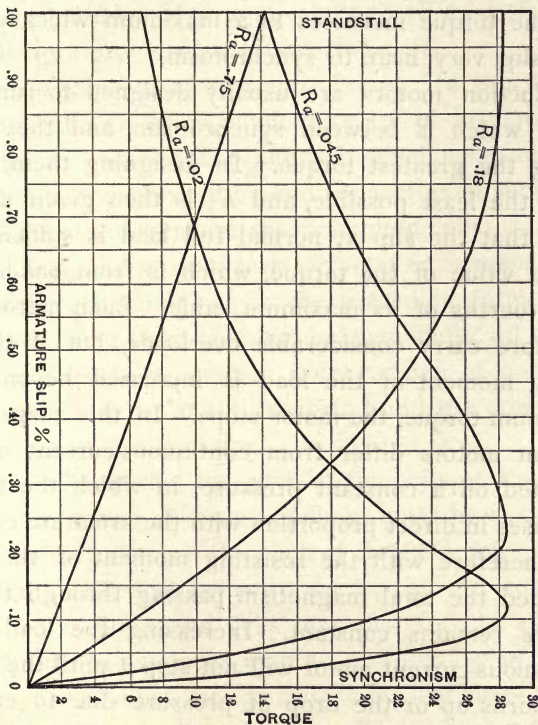

Fig. 283

which is a maximum when $2\pi v_1 L_a = R_a$. When the armature is at rest, $v_1 = f$ and to give maximum torque R_a must be equal to $2\pi f L_a$. If R_a is either greater or less,

the torque is reduced, for armature at rest. If R_a is greater than $2\pi fL_a$, the torque continuously decreases as the speed of the armature rises; while if R_a is less than $2\pi fL_a$, the torque reaches a maximum when v has such a value that $R_a = 2\pi v_1 L_a$. If R_a is very small compared to $2\pi fL_a$, the starting torque is very small, and the torque increases to a maximum which occurs at a slip very near to synchronism.

Induction motors are usually designed to run at a speed which is between synchronism and the speed giving the greatest torque. In designing them, L_a is made the least possible, and R_a is then given such a value that the slip at normal full load is sufficient to give a value of the torque, which is from one-half to three-fourths of its maximum value. Such motors can therefore carry considerable overloads, but if the resisting moment of the load is increased beyond the maximum torque, the motor stops. In this respect, induction motors differ from continuous-current motors operated on a constant pressure, in which the torque increases in direct proportion with the armature current and therefore with the resisting moment of the load, provided the total magnetism passing through the armature remains constant. Increasing the load on a continuous-current motor will not stop it until the armature burns up or the drop of pressure due to current flowing through the armature conductors is equal to the impressed pressure.

169. Forms of Armature Windings.—The armature windings of induction motors may be of either drum or ring types, though the drum type is most commonly

used. The arrangement of the windings may be of three forms :

1. *Squirrel-cage form*, in which single embedded bar conductors are placed on the armature core and all connected together at each end by a copper ring, thus making a conductor system similar in form to the revolving cylinder of a squirrel cage (Fig. 276). The conductors are insulated from the core.

2. *Independent short-circuited coils*. In this form of winding the armature conductors are of insulated wire wound in independent short-circuited coils, or of insulated bars connected by end connectors in such a way as to make independent short-circuited coils.

3. *Independent coils short-circuited in common*. Here the coils are wound as in the preceding form, but instead of being short-circuited independently, all the ends are brought to a common point, or pair of points, one of which may be at the front end and the other at the back end of the armature.

It is evident that the pitch of the coils of the second and third forms of drum windings must be equal to an odd number of times the pitch of the field poles, in order that the electrical pressure set up in the conductors may be additive, and coils may therefore be diametral or chordal in machines with an odd number of pairs of poles, but cannot be diametral in machines with an even number of pairs of poles. The actual number of coils is a matter of perfect freedom, provided it is a multiple of two or three and the connections of conductors be properly made so that the armature surface may be uniformly covered. A three-coil winding for a

drum armature, which is intended to surround the revolving field of an eight-pole machine, is shown diagrammatically in Fig. 284, and a three-coil armature

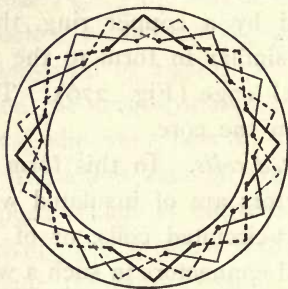

Fig. 284

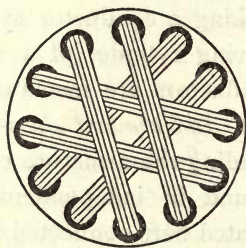

Fig. 285

which is intended to revolve within a six-pole field, is shown in Fig. 285.

170. Field Windings.— The field windings of induction motors are almost always arranged to produce more than two poles, in order to bring the machine to a reasonable speed. The field frequency in revolutions per second, as already shown (Sect. 165), is equal to $\frac{f}{p}$, where f is the frequency of the alternating current and p the number of pairs of poles, and in revolutions per minute this becomes $V = \frac{60f}{p}$, and we therefore have the following table of motor speeds for the frequencies common in this country.

This table shows the futility of attempting to build satisfactory induction motors of small size, intended for use on even the lowest frequencies commonly used in this country, with less than six poles; and on the higher

| Number of poles of motor. | Frequencies in common use. | | | | V_s when $f=25$. |
|---------------------------|----------------------------|--------------------------------|----------------------|----------------------|---------------------|
| | V_s when $f=60$. | V_s when $f=66\frac{2}{3}$. | V_s when $f=125$. | V_s when $f=133$. | |
| 2 | 3600 | 4000 | 7500 | 8000 | 1500 |
| 4 | 1800 | 2000 | 3750 | 4000 | 750 |
| 6 | 1200 | 1333 | 2500 | 2666 | 500 |
| 8 | 900 | 1000 | 1875 | 2000 | 375 |
| 10 | 720 | 800 | 1500 | 1600 | 300 |
| 12 | 600 | 666 | 1250 | 1333 | 250 |
| 16 | 450 | 500 | 937 | 1000 | 187 |
| 20 | 360 | 400 | 750 | 800 | 150 |
| 24 | 300 | 333 | 625 | 666 | 125 |

frequencies not less than twelve poles are required to give a reasonable speed. Motors of greater output than ten horse power should have a sufficiently large number

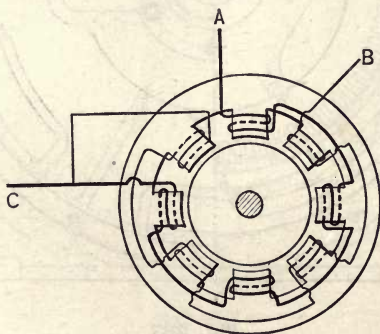

Fig. 286

of poles to give a field velocity which does not exceed 750 or 800 revolutions per minute. The windings for this purpose may be either placed directly upon polar projections of the field frame, as in Fig. 286, which shows a

four-pole two-phase machine, or they may be arranged as embedded conductors in a frame of uniform magnetic surface, as in Fig. 287, which shows a four-pole three-phase machine. The embedded conductors may be

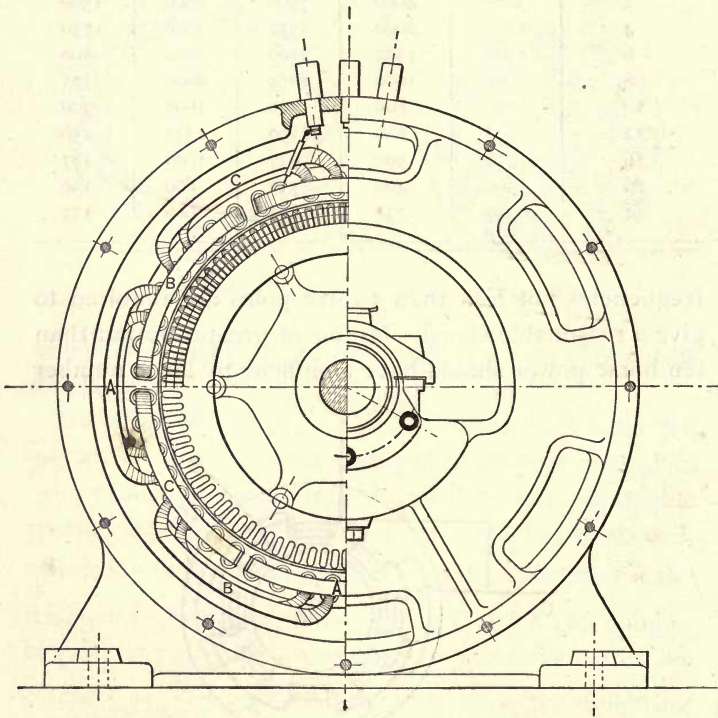

Fig. 287

wound as either a drum (Fig. 287), or ring (Fig. 287 *a*) field, and they give the most approved arrangement, since embedding serves to reduce the reluctance of the magnetic circuit and therefore to increase the power factor of the motor. Since the actual magnet poles are

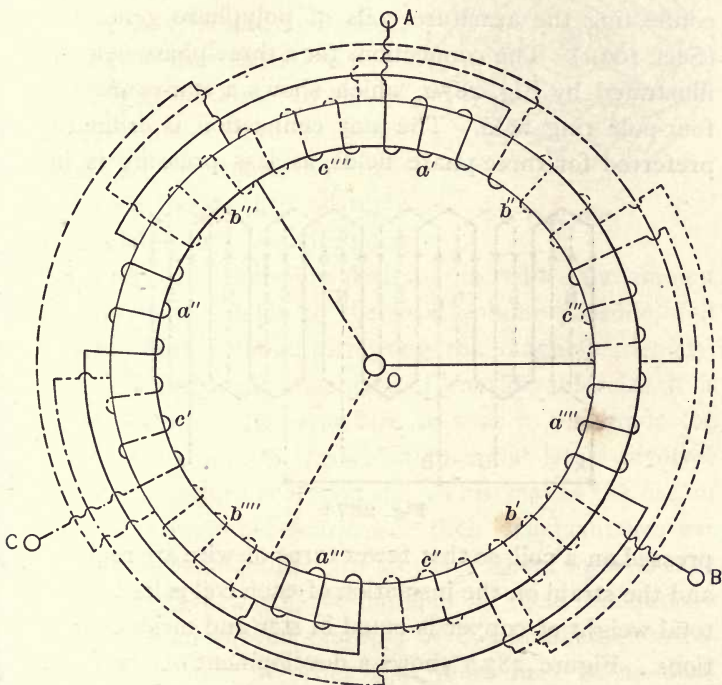

Fig. 287 a

produced by the resultant effects of the polyphase currents, it requires two-coil sections to produce each magnet pole in a two-phase machine, and three-coil sections in a three-phase machine. The connections of the field coils may be traced out according to the instructions given for connecting the armature coils of polyphase generators (Sect. 102*a*). The connections for a three-phase field are illustrated by Fig. 287*a*, which shows a star-connected, four-pole ring field. The star connection is ordinarily preferred for three-phase fields, as less pressure is im-

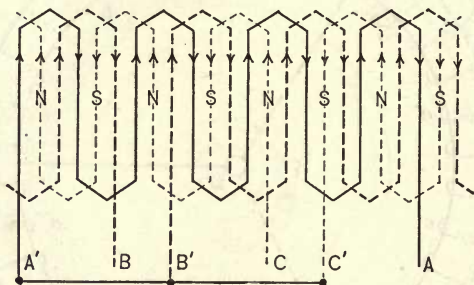

Fig. 287 b

pressed on a coil, so that fewer turns of wire are required and the strain on the insulation of each coil is less. The total weight of copper is equal in star and mesh connections. Figure 287*b* shows a development of the eight-pole, star-connected drum winding of Fig. 288.

The frequency of the magnetic cycles in the iron of the fields is equal to the frequency of the current flowing in the magnetizing coils, but in the armature it is equal to the motor slip; and the hysteresis and foucault current losses per pound of iron are therefore many times greater in the fields. In this respect the charac-

teristics of an induction motor are exactly the reverse of those of a continuous-current machine; where the field loss consists of the C^2R loss only, while the armature loss is the sum of the C^2R and core losses, of which the latter may be the larger portion. In the induction motor, the field-core losses are large and the armature-core losses are scarcely appreciable in a well-designed



Fig. 288

machine; it is therefore desirable to reduce the amount of iron in the fields to the least volume possible, if it can be done without increasing the magnetic density. For this reason, in machines of considerable size, it is usual to arrange the armature so that it surrounds the fields, as in Fig. 288, in which case the latter revolves and the armature is stationary. This makes the use of collector rings necessary, but their disadvantages are usually inconsiderable. In all cases where squirrel-cage armatures are used, the number of field conductors should be an uneven multiple of the number of armature conductors, in order that there may be no dead points in starting.

171. Starting and Regulating Devices. — Four different arrangements may be used for starting polyphase induction motors.

1. *Small machines* are commonly connected directly to the circuit without the intervention of any special starting devices. This is not a safe proceeding for

large machines, as when the armature is at rest and the fields are directly connected to the supply circuit, the machine is in the condition of a transformer with the secondary short-circuited, and is liable to burn up before getting under way. The Allgemeine Elektrizitäts Gesellschaft of Berlin arrange their smaller motor armatures with two rows of conductors, making two independent squirrel-cages (Fig. 289), one considerably farther

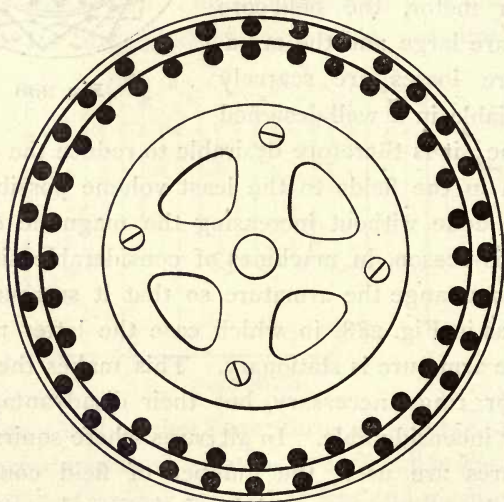

Fig. 289

from the armature surface than the other, which is reported to reduce the starting current of the machines.

2. (a) *Resistances in Field.* Resistances may be inserted in the circuits leading to the motor fields, to be used in much the same manner as starting resistances are used in starting continuous-current, constant-pressure motors. Resistances arranged in this way in each cir-

cuit must be manipulated simultaneously, and therefore must be mechanically coupled. Starting rheostats similar to continuous-current motor starting boxes, and liquid resistances arranged to be varied by dipping plates in a bath, have been used. Three rheostats are required for a three-phase motor, and two for a two-phase motor operated on independent circuits. Two-phase motors on three-wire circuits may be started with a single resistance inserted in the common wire, or by two resistances inserted respectively in the independent wires.

The insertion of resistance in the field circuits of induction motors serves to reduce the starting current on light loads by reducing the pressure at the field terminals; this also causes a reduction of the magnetism, which is equivalent to reducing K in the expression for

the starting torque $\left(mK \frac{v_1 R_a}{R_a^2 + 4 \pi^2 v_1^2 L_a^2}\right)$, which shows

that the starting torque under these conditions is materially smaller than the maximum torque of the armature, since $4 \pi^2 v_1^2 L_a^2$ is bound to be considerably larger than R_a^2 if the armature C^2R losses are not excessive; and the motor must therefore take an excessive current to start a heavy load. This plan has been used quite extensively by European manufacturers, especially for large machines which may be started with belt on loose pulley.

(b) *Variable Compensator or "Auto-transformer."* The pressure at the terminals of the fields may be reduced at starting by introducing an impedance coil across the supply circuits and feeding the motor from variable points on its windings. This arrangement may be caused to supply a large starting current without inter-

fering with the supply circuits, but it has the same effect on the motor torque as a resistance in series with the fields.

3. *Resistance in Armature.* The torque of the armature at starting may be made equal to the maximum running torque by inserting resistances in the armature circuits which increase the total armature resistance at starting in the ratio $\frac{R_e + R_a}{R_a} = \frac{R_t}{R_a} = \frac{f}{v_m}$, where R_e is the external or starting resistance and $\frac{60 v_m}{p}$ the slip at full maximum torque. As already shown (Sect. 168), $v_m = \frac{R_t}{2 \pi L_a}$, and therefore to get a maximum torque when $v_m = f$, requires that $\frac{R_e + R_a}{2 \pi L_a} = f$, or $R_e = 2 \pi f L_a - R_a$, or the external resistance in the armature circuit required at starting in order to give maximum torque must equal the difference between the reactance and the resistance of the armature. The total resistance used should be larger and arrangements made to reduce it gradually. As the maximum torque is usually designed to occur, in running with natural armature circuits, at a slip between one and one-third and two times that corresponding to the normal full-load torque, the armature and field currents at maximum torque do not exceed twice the full-load currents, so that resistances inserted in the armature circuits serve the double purpose of increasing the starting torque and keeping the starting current within bounds.

This plan has been largely used by Siemens and Halske, the General Electric Company, the Stanley Electric Manufacturing Company, the Westinghouse Company, and others. The arrangement of the start-

ing rheostat depends largely upon the type of the armature windings to which it is applied. In armatures of the squirrel-cage type the conductors may be tipped at one end with tapered german silver strips, which come in contact with a sliding copper ring. At starting, this ring may just touch the german silver tips, and as the machine speeds up the ring may be slid along until the tips are cut out and the copper armature conductors are directly connected together through the ring.

If the armature revolves, it is evident that the ring must be arranged to slide on a spline on the shaft, and to be controlled by a grooved sliding collar and loose lever. The same device may be used for armatures with coils having a common short-circuiting point. In this case one set of coil terminals are permanently connected together, and the other set are connected into german silver strips, which may be short-circuited by a sliding ring, as already explained. This arrangement has been used by Siemens and Halske, the General Electric Company, and others.

If the armature windings are arranged so as to have but one coil for each phase, the introduction of resistance is very simple, since only one resistance coil for each phase is required. In this case, if the armature is stationary, the connections of the rheostat are made directly into the armature circuits, or between the armature circuits and one point of common connection; while if the armature revolves, three collector rings may be placed on the shaft, and stationary rheostats may be used to control the resistance of the coils which

are properly connected to the rings, or the resistance may be placed inside the armature spider and controlled by a sliding collar and loose lever. Such arrangements are used by the Stanley Electric Company, the General Electric Company, and others.

4. *Commutated Armature.* The armature may be wound with the coils so arranged that their conductors are in series when starting and in parallel when running. If x is the number of parallels in such an armature, the resistance at the start is x^2 times the running resistance, and the reactance at start is x^2 times the running reactance. The starting current in the armature with the conductors in series is therefore $\frac{I}{x}$ times as great as it would be with the conductors in parallel, but the field current at starting is the same with either arrangement of the armature conductors. On the other hand, since placing the conductors in series increases the resistance and reactance in the same proportion, the starting torque of the armature is the same with the conductors in series or parallel. The armature winding may also be so arranged that, instead of starting with all conductors in series, a portion of the conductors are connected in opposition to the others at the start, and are then reversed and connected properly in series with the others after the machine is in operation. The opposition arrangement affects the current of both armature and field.

The third and fourth arrangements may be combined by making the connectors, by means of which the armature conductors are placed in series, of high resistance

material; these connectors are cut out when the conductors are short-circuited together.

This device has been used in various forms by Siemens and Halske and the Westinghouse Electric Company.

172. Effect of Rotary Field on Field Windings. — The distribution of magnetism in the air space of an induction motor has been found to be approximately sinusoidal, when the motor is fed by sinusoidal currents,* and the counter electric pressure set up in the field windings by the rotating magnetism is exactly the same as though the windings moved with an equal angular velocity in a stationary uniform field. The electrical pressure developed in a conductor depends, in other words, upon the relative angular velocity of conductor and magnetism, and it makes no difference which moves. Therefore, the formula at the bottom of page 80, Vol. I., applies to this case, or

$$e' = \frac{2 \pi n' NV}{10^8 \times 60} \sin \alpha,$$

in which e' is the instantaneous pressure in the coil, n' the number of turns in the coil, N the total magnetization from one pole, V revolutions per minute, and α angular position of the coil. In the case under consideration,

$$N = \frac{2}{\pi} \frac{2 \pi r l B_m}{2 p} = \frac{2 r l B_m}{p},$$

* Blondel, Notes sur la théorie élémentaire des appareils à champ tournant, *La Lumière Électrique*, Vol. 50, p. 351; Jackson, Three-phase Rotary Field, *Electrical Journal*, Vol. 1, p. 185.

where r and l are the inner radius and the length of the field core, B_m the maximum magnetic density in the air space, and p the number of pairs of poles in the field.

Since $\frac{V}{60} = \frac{f}{p}$, and the magnetism per magnetic circuit in a multipolar machine must be multiplied by the number of pairs of poles to get the total number of lines of force cut per conductor per revolution (Vol. I, p. 278), the formula may be written, generally, in the form

$$e' = \frac{2 \pi n' N f}{10^8} \sin \alpha ;$$

whence

$$e_m' = \frac{2 \pi n' N f}{10^8},$$

and

$$E' = \frac{\sqrt{2} \pi n' N f}{10^8}.$$

This is the value of the electrical pressure developed in a narrow coil, but if the coil is spread over a considerable area, the maximum pressure is less than that given above, since the density of the magnetism which is cut by the conductors falls off from B_m at the centre of the coil to some smaller value, which depends upon the width of the coils. If the coil occupies 180 electrical degrees of circumference, when the middle conductor is in a field of density B_m the outer conductors are in a field of zero density. The maximum pressure developed by the total coil is then

$$\frac{2}{\pi} \times \frac{2 \pi n' N f}{10^8}.$$

If the coil spreads over an angle θ , the value of e_m' becomes

$$e_m' = \frac{I}{\theta} \times \frac{2 \pi n' N f}{10^8} \int_{-\frac{1}{2}\theta}^{+\frac{1}{2}\theta} \cos ada.$$

The field windings of induction motors are usually arranged uniformly on the field, so that in two-phase motors $\theta = 90^\circ$, and in three-phase motors $\theta = 60^\circ$. The respective values of e_m' become

$$e_{m2}' = \frac{4\sqrt{2} n' N f}{10^8}, \quad e_{m3}' = \frac{6 n' N f}{10^8},$$

and

$$E_2' = \frac{4 n' N f}{10^8}, \quad E_3' = \frac{3\sqrt{2} n' N f}{10^8}.$$

Hence the electrical pressure set up in a uniformly distributed field winding of a two-phase motor is, other things being equal, about 10 per cent less than if the windings were in narrow coils; and in a three-phase motor the deficit is nearly 5 per cent. The exact ratios are $\pi : 2\sqrt{2}$ and $\pi : 3$. To give the same counter electric pressure in the uniformly distributed field windings of an induction motor arranged for two phases, requires about 6 per cent more turns in the windings than when the same machine is arranged for three phases. If the windings are placed on salient poles, as is sometimes done in two-phase motors, all the lines of force pass through the windings, and the coils therefore act as though they were very narrow, but the increased reluctance of the magnetic circuit caused by this construction more than destroys any advantage pertaining to the form of the winding.

173. Formulas derived from Transformer Formulas. —

In the case of a transformer, the following formula (Sect. 111) gives the relation between electrical pressure, frequency, magnetism, and the turns of the coils:

$$E' = \frac{\sqrt{2} \pi n' N f}{10^8},$$

provided all the magnetism is included within all the turns. This proviso is not true in the ordinary induction motor, since the magnetic density in the air gap may be assumed to vary as a sinusoid, and that condition requires that the number of lines of force passing through the different turns of the coils shall also vary as a sine function. This is illustrated in Fig. 290. Consequently we have for the induction motor,

$$E' = \frac{\sqrt{2} \pi n' N f}{10^8 \theta} \int_{-\theta}^{+\theta} \cos a da,$$

where $\frac{\theta}{2}$ is the value of a corresponding to the sine ordinate which is proportional to the number of lines of force passing through the extreme turns, when the total magnetism, N , passes through the centre turns of the coil.

For uniformly distributed windings in two phases, $\theta = 90^\circ$, and in three phases, $\theta = 60^\circ$, while for coils on salient poles $\theta = 0^\circ$. The values of E' for the field winding of the induction motor become

$$E_2' = \frac{4 n' N f}{10^8} \quad \text{and} \quad E_3' = \frac{3 \sqrt{2} n' N f}{10^8},$$

and the formulas thus developed from the fundamental theorems of the transformer are exactly the same as

those developed from the conception of the rotary field. For various reasons it is more convenient to study induction motors from the transformer standpoint, and we may consider them as *transformers with a relative*

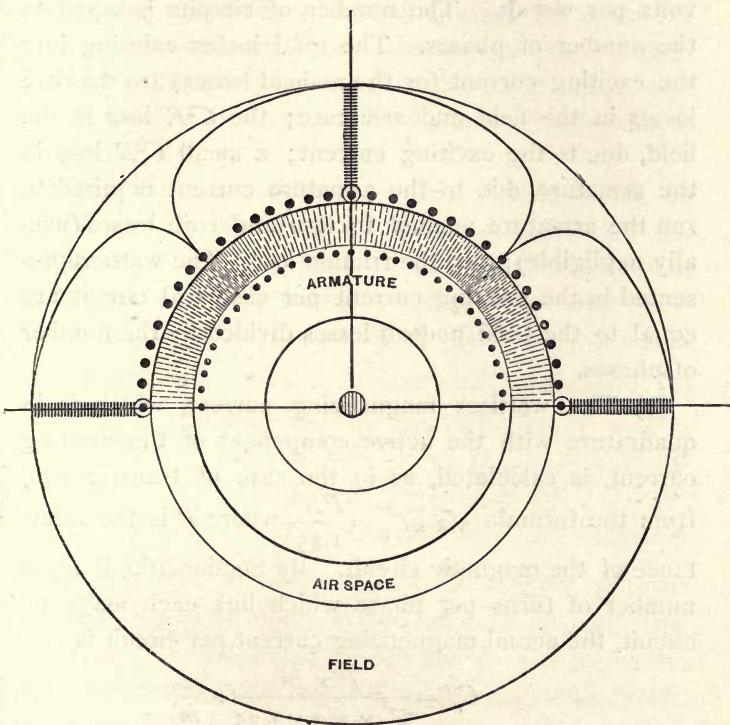

Fig. 290

motion between the primary and secondary windings. In this case, the field winding is always the primary circuit and the armature winding the secondary circuit.

174. Exciting Current. — The exciting current for an induction motor may be calculated for each circuit in

exactly the same manner as that for a transformer. It is composed of two components in quadrature:

(1) The active current, which is equal to the sum of the no-load losses in the circuit, in watts, divided by the volts per circuit. The number of circuits is equal to the number of phases. The total losses entering into the exciting current (or the no-load losses) are the core losses in the field and armature; the C^2R loss in the field, due to the exciting current; a small C^2R loss in the armature, due to the armature current required to run the armature against friction and core losses (usually negligible); and the friction loss. The watts represented in the exciting current per electrical circuit are equal to the total no-load losses divided by the number of phases.

(2) The wattless magnetizing current, which is in quadrature with the active component of the exciting current, is calculated, as in the case of transformers, from the formula $\sqrt{2} \frac{PN}{nC_\mu} = \frac{PN}{1.25}$, where P is the reluctance of the magnetic circuit. By Section 160, if n'_p is number of turns per phase which link each magnetic circuit, the actual magnetizing current per circuit is

$$C_\mu' = \frac{P \times N}{n'_p \times \sqrt{2} \times 1.25} \times \frac{2}{m},$$

which for a two-phase machine becomes

$$C_{2\mu}' = \frac{PN}{1.75 n'_p},$$

and for a three-phase machine,

$$C_{3\mu}' = \frac{PN}{2.65 n'_p}.$$

Since mechanical clearance between the armature and fields is an essential feature of a motor, the reluctance of the motor magnetic circuit is much greater than that of a transformer of corresponding capacity. This makes the magnetizing current greater, increases the exciting current, and reduces the no-load power factor.

The total exciting current is equal to the square root of the sum of the squares of its two components, or

$$C_1 = \sqrt{C_{2\omega} + C_{2\mu}}.$$

175. Field Ampere-Turns. — The ampere-turns on each magnetic circuit of an induction motor are the resultant of the ampere-turns due to all the phases (Sect. 160). It may readily be shown that the resultant of any number of equal sine functions with a uniform phase difference is a circular function equal to $\frac{m}{2}x$, where x is the amplitude of the components, and m the number of components. It is therefore evident, from the deductions of Section 160, that the resultant ampere-turns in the magnetic circuit of an induction motor is $\frac{m}{2}(n'_p C' \sqrt{2})$, where n'_p is the number of turns belonging to each phase which link each magnetic circuit, and C' is the current in each phase. Consequently, if y ampere-turns are required in the magnetic circuit, the winding in each phase must furnish $\frac{2}{m}$ times the whole. For two-phase motors, $\frac{2}{m} = 1$, and for three-phase motors, $\frac{2}{m} = \frac{2}{3}$.

176. Slip and Armature Pressure. — As stated in Section 165, if the field rotation is V , the armature rotation must be somewhat less, or V' , and therefore the slip is

$V - V' = v$. It is evident that v is proportional to the frequency with which the total useful magnetism per pole, N_a , cuts the armature conductors, and it will vary from a value $v = V$ to $v = 0$ as the motor armature changes from a condition of rest to a speed of synchronism. Slip is frequently named in per cent of motor speed. In ordinary practice, the slip varies, at full load, from 2 per cent to 10 per cent of V , having the smaller value in large machines. The maximum pressure induced in any conductor on the armature is

$$e_m'' = \frac{2 \pi N_a v_1}{10^8} = \frac{2 \pi N_a p v}{10^8 \times 60},$$

where N_a is the armature magnetism per pole; and the effective pressure per conductor is

$$E_c'' = \frac{\sqrt{2} \pi N_a p v}{10^8 \times 60},$$

since the pressure curves in the conductor must be sinusoidal if the magnetism has a sinusoidal distribution in the air space, as has been assumed. The effective current flowing in a conductor of a squirrel-cage armature will be

$$C_c'' = \frac{\sqrt{2} \pi N_a p v}{10^8 \times 60 \times I_c''} = \frac{\sqrt{2} \pi N_a p v}{10^8 \times 60 \times R_c''} \cos \phi_a,$$

where I_c'' is the impedance of the armature conductor, ϕ_a is the angle of lag of the current, and R_c'' the resistance of the conductor. The C^2R loss in the armature conductors will be $W_a = S'' C_c''^2 R_c''$, where S'' is the number of armature conductors. The torque is proportional to the current times the magnetic field (which is nearly constant); and, if we neglect the

effect of magnetic leakage, it is evident that the armature must run at a slip which sets up an electric pressure in the armature conductors which is equal to the drop of pressure in the conductors caused by the current demanded to give the torque. So that the slip is directly proportional to the armature current for a fixed armature resistance, and for a fixed armature current is directly proportional to the armature resistance. In actual motors, magnetic leakage is not negligible, and the slip is increased, since the magnetic leakage in a transformer is proportional to the secondary ampere-turns. The slip is also increased by the drop of pressure in the field winding, which increases with the load, and causes a corresponding decrease in the value of N_a .

The fact then stands that the increase of slip between no-load and full-load must be sufficient to increase the pressure in the armature conductors by an amount equal to the increased loss of pressure in the conductors due to the increased current and the decreased armature magnetism. If magnetic leakage increases with the armature current, the total slip becomes proportional to $C_c''R_c'' + AN_t + \frac{S''}{S'}C_c'R_c'$, where A is a constant, N_t the number of leakage lines of force passing through the armature coils, S' , S'' the number of field and armature conductors, $C_c'R_c'$ the drop of pressure per field conductor.

177. Design of Induction Motors. — The general principles of transformer design may be so applied to the induction motor that its construction becomes, in many

respects, the same as that of the transformer. If it is desired to design a rotary-field motor to supply W' horse power, or $W = W' \times 746$ watts, the formula

$$E' = K \frac{\sqrt{2} \pi n' N f}{10^8}$$

will give the product of the field turns into the magnetism, $n'N$; E' and f being given by the conditions of the problem, and p the number of pairs of poles (which is dependent upon armature speed and frequency) being chosen from the table in Section 170.

K is a constant which is equal to $\frac{2\sqrt{2}}{\pi} = .90$ for a two-phase machine, and $\frac{3}{\pi} = .95$ for a three-phase machine (Sect. 172). It must be remembered that E' is the *primary pressure per coil* in each phase, and its relation to the line pressure per phase depends upon the connections of the coils.

The safe circumferential speed for induction motors is even higher than that for alternators, since the conductors are nearly always embedded in both field and armature cores, but the usual periphery velocities are between 4000 and 6000 feet per minute. With a given frequency and number of revolutions per minute, the armature diameter in feet will be

$$D = \frac{U}{\pi V'}$$

where U is circumferential speed in feet per minute. The ratio between n' and N must be determined in a great measure by practice. A reasonably large value

of N with a proportionate iron section increases the no-load losses, but increases the full-load efficiency as in the case of a transformer (Sect. 129). It is usually desirable to have the maximum efficiency of a motor occur at about three-fourths load, as motors commonly run on loads which average less than full load. Kolben* states that for ordinary good practice, the number of ampere-turns per centimeter of the field circumference at full load should be from 100 to 150, when the frequency is from 40 to 80 and the induction in the air gap from 2000 to 3000. This should only be used as a guide or check in making a design. The number of field turns per volt appears from the examination of a limited number of machines to be more than double the number of turns per volt used in transformers (p. 532); the range being from $\frac{50}{\sqrt{\text{output}}}$ to $\frac{100}{\sqrt{\text{output}}}$, when the output is in watts.

The magnetic density in the field cores may be about the same as in transformers. Kolben gives these values for different frequencies.

| f | B | f | B |
|-----|--------------|-----|--------------|
| 40 | 5500 to 6500 | 80 | 4000 to 4500 |
| 50 | 5000 to 6000 | 100 | 4000 to 3500 |
| 60 | 4500 to 5000 | 120 | 3500 to 3000 |

Having the total magnetization N , which is obtained from the pressure formula when n' is assumed, and assuming the maximum magnetic density B_m , the cross-

* *Electrical World*, Vol. 22, p. 284; *London Electrician*, Vol. 31, p. 591.

section of the iron may be found. The magnetic density between the core slots may be allowed to become as great as two or two and a half times the density in the core, but every effort to keep it small in value should be made.

There must be n' turns in the coils of each phase, since the counter pressure E' must be generated in the coils of each phase. The length of field or armature will be dependent upon the magnetic density in the air space, which may be made quite large. The limit being determined by the reluctance permissible in the magnetic circuit and hence by the magnetizing force required to drive the magnetism through the circuit. The air space of the motor may be very small, so that it may be permissible to run the maximum magnetic density somewhat higher than in the case of dynamos or alternators, though the practice for these machines may be safely followed. From 2000 to 6000 lines would be a safe range. If the fields are wound through holes, as in Fig. 287, the length of the field will be

$$l = \frac{\pi}{2} \times \frac{2 p N}{\pi D B_m} = \frac{p N}{D B_m},$$

where p is the number of pairs of poles, B_m the maximum air-space induction, πD the circumference of the polar surface, and N is the magnetism emanating from a pole. The paths of leakage are somewhat as shown in Fig. 291, and the coefficient of leakage may be taken between 1.05 and 1.25 when the motor is running at full load. At starting, the leakage will be increased on account of the strong armature reaction

tending to force the field magnetism across the pole tips. The magnetizing current for a two-phase machine may be found from the formula (Sect. 174)

$$C_{2\mu}' = \frac{PN}{1.75 n_p'} = .56 \frac{PN}{n_p'}$$

where P is the reluctance of the magnetic circuit. For three-phases

$$C_{3\mu}' = \frac{PN}{2.65 n_p'} = .38 \frac{PN}{n_p'}$$



Fig. 291

The working current in each phase of the two-phase winding is

$$C_{2w}' = \frac{\frac{1}{2}W}{E'} \div \text{per cent efficiency.}$$

The efficiency of the motor is assumed during the trial calculation. In the three-phase winding

$$C_{3w}' = \frac{\frac{1}{3}W}{E'} \div \text{per cent efficiency.}$$

The total current in a two-phase machine is

$$C_2' = \sqrt{C_{2w}'^2 + C_{2\mu}'^2},$$

and for the three-phase,

$$C_3' = \sqrt{C_{3w}'^2 + C_{3\mu}'^2}.$$

Having obtained the field current, the size of the field conductors may be obtained, allowing from 900 to 1200 circular mils per ampere.

As in transformers, the radiating surface of a stationary field core should not be less than five to seven square

inches per watt radiated. If the field rotates, this may be greatly reduced. The usual way to wind the coils is to divide them up into sections and place them in slots or holes (Fig. 292). Slots seem to be preferable if the teeth are close together, as there is then less field leakage in the paths indicated by the dotted lines of Fig. 292*a*.

The armature may be wound in any of the ways explained in Section 169. The wires are usually em-

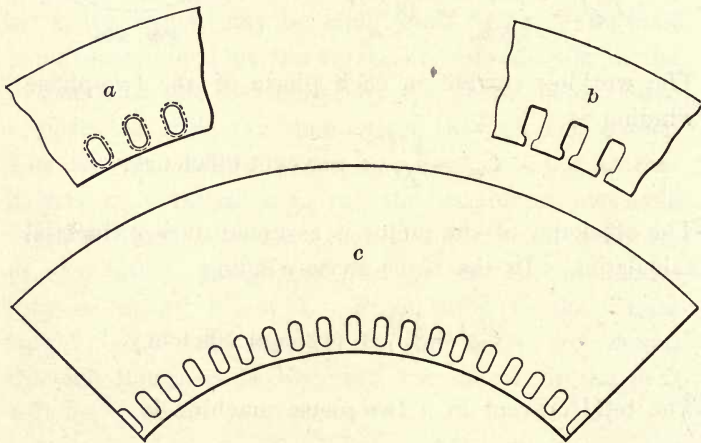

Fig. 292

bedded in the surface of the core, as is the case with the field windings (see Figs. 287 and 288). By this means the air space may be made of exceedingly small depth, and the magnetizing current and magnetic leakage are thus reduced, which is very desirable. The diameter of the armature has already been determined; its speed will be $V' = V - v$. The slip, v , should be made from 2 to 10 per cent, the larger value being for a machine of

about 1 H.P. and the lower for 100 H.P.;* in other words, the regulation of induction motors may be made equal to that of continuous-current motors. The copper loss in the armature bars L_c'' is

$$L_c'' = C_e''^2 R_c'' S'',$$

$$C_e'' R_c'' = K \frac{\sqrt{2} \pi N_a v \phi}{10^8 \times 60} \cos \phi'' \quad (\text{Sect. 176}),$$

$$R_c'' = K \frac{\sqrt{2} \pi N_a v \phi}{10^8 \times 60 \times C_e''} \cos \phi''.$$

In a squirrel-cage armature $K = 1$, but in coil armatures its value depends upon $\frac{1}{\theta} \int_{-\theta}^{\theta} \cos ada$ (Sect. 172). The value of C_e'' is given with ample accuracy from the formula $W = \frac{S''}{S'} E' S'' C_e'' \cos \phi''$, where S' and S'' are respectively the number of embedded conductors of field and armature. If both field and armature are either drum or ring wound, it is evident that $\frac{S''}{S'} = \frac{n''}{n'}$, but if they have different types of windings the equality does not exist. In every case $\frac{S''}{S'} = \frac{E''}{E'}$. The value of $\cos \phi''$ may be taken as 0.90 for a reasonably close approximation, and the value of the resistance of each armature conductor, including its share of the resistance of the end connections, which corresponds to a fixed value of the slip, is then approximately determined from the formula. The value of N_a used in this computation must correspond to full load; it is $N \frac{E_i' - C'R'}{zE_i'}$

* Kapp's *Electrical Transmission of Energy*, 4th ed., p. 323; Steinmetz, *Trans. Am. Inst. E. E.*, Vol. 11, p. 37.

where N is the field magnetization at no load (that is, assuming no CR drop in the primary), E_i' is the impressed circuit pressure, C' is the primary current at full load, and z is the leakage coefficient.

If the armature is not arranged to allow the insertion of a starting resistance, and if a maximum starting torque is desired, R_c'' must be made of such a value as to make $R_c'' = 2\pi fL_c''$, where L_c'' is the self-inductance of an armature bar. Such a value for R_c'' gives an enormously large slip at full load and is unsatisfactory except for special purposes, so that R_c'' is usually smaller.

The density of current in the armature conductors, if the armature rotates, may be made quite large, an allowance of 300 circular mils per ampere being sufficient, since the core losses are insignificant. If the armature is stationary, the current density should not exceed one-third that value. The radiating surface per watt lost in a rotating armature should be the same as that in an alternator or continuous-current dynamo, taking all losses into account. In the same way the radiating surface of a stationary armature should be the same as is allowed for dynamo fields if the same rise of temperatures is admitted.

The foucault current and hysteresis losses may be determined exactly as in the case of a transformer, using v_1 as the frequency of magnetic cycles in the armature, and f as the frequency in the field.

The loss in primary pressure due to C^2R losses in the fields, and foucault currents and hysteresis, will increase proportionally the input required to give a desired output, and proper correction must be made in the design.

The efficiency of a machine is

$$\eta = \frac{W}{W + L}$$

and $L = H_f + H_a + Z_f + Z_a + C'^2 R_f + C''^2 R_a + F$, where W is the output, L the total losses, H hysteresis losses, Z foucault current losses, and F friction losses, all given in watts or horse power. The maximum efficiency evidently occurs, as in continuous-current machines and transformers, at that load which causes the variable copper losses to equal the constant core and friction losses.

The power factor of the machine when running without load is

$$\cos \phi' = \frac{C_\omega'}{\sqrt{C_\omega'^2 + C_\mu'^2}} = \frac{C_\omega'}{C_1'}$$

as shown in Section 174. When the machine is loaded, the power factor is partially dependent upon the lag of current in the armature ($\cos \phi''$), and the self-inductances of both armature and field windings must be calculated before the power factor can be determined. The self-inductances of the windings are due to the leakage lines of force, and the values may be determined from the reluctances of the leakage paths and the arrangements of the windings.* In general, the power factor is approximately equal to

$$\cos \left(\cos^{-1} \frac{R_a}{I_a} + \cos^{-1} \frac{R_f}{I_f} + \cos^{-1} \frac{C_\mu'}{C_1'} \right).$$

* *London Electrician*, Vol. 36, p. 578.

The torque of the armature when the output, W , is given in watts is equal to

$$P = \frac{60 \times W \times 10^7}{2 \pi V'} \text{ in dyne-centimeters,}$$

$$= \frac{W \times 10^7}{2 \pi V' 16.3} \text{ in gramme-centimeters,}$$

$$= \frac{W \times 10^7}{2 \pi V' 226,000} \text{ in pound-feet.}$$

177 a. Output Proportional to Square of Primary Pressure. — The output of the motor, plus the armature-core losses and friction, is equal to the product of the number of armature conductors and the effective current in each conductor, multiplied by the product of the pressure which would be developed in each conductor if the armature were driven at its speed in an equal stationary field and the cosine of the angle of lag of the armature current,

$$\text{or} \quad W = S' C_c'' \frac{V'}{v} E_c'' \cos \phi'',$$

$$\text{but} \quad C_c'' = \frac{E_c''}{\sqrt{R_c''^2 + 4 \pi^2 v_1^2 L_c''^2}},$$

$$\text{and} \quad \cos \phi'' = \frac{R_c''}{\sqrt{R_c''^2 + 4 \pi^2 v_1^2 L_c''^2}},$$

$$\text{and therefore} \quad W = \frac{S' E_c''^2 R_c'' \frac{V'}{v}}{R_c''^2 + 4 \pi^2 v_1^2 L_c''^2}$$

$$\text{Also} \quad E_c''^2 = E_c'^2 \frac{v^2}{V^2} = \frac{I}{S'^2} E'^2 \frac{v^2}{V^2},$$

where E_c' is the induced field pressure per conductor, E'

the total field pressure, and S' the number of field conductors,

$$\text{and } W = \frac{\frac{S''}{S'^2} E'^2 \frac{V'v}{V^2} R_c''}{R_c''^2 + 4\pi^2 v_1^2 L_c''^2} = \frac{\left(\frac{S''}{S'}\right)^2 E'^2 \frac{V'v}{V^2} R_a}{S''(R_a^2 + 4\pi^2 v_1^2 L_a^2)}.$$

This formula is not one which can be made of service in the design of a motor (in fact, it is not needed for such a purpose), but it plainly shows the effect on the output of a motor, which is caused by varying any one of its constructive details while the others remain unchanged. A very important deduction from the formula is: that *the torque and output of an induction motor vary as the square of the primary pressure*, so that a machine which will carry an overload of 50 per cent on its normal pressure will barely run at full load if the pressure is reduced 20 per cent. The formula also shows that the slip is inversely dependent on the primary pressure.

178. Electromagnetic Repulsion. — If a coil of wire is held in an alternating magnetic field in such a way that the lines of force pass through its turns, an alternating pressure is set up in it which has 90° difference of phase from the alternating magnetism. This in turn causes a current in the coil, and the coil experiences a force at each instant tending to move it in the magnetic field, which is proportional in magnitude and direction to the product of the corresponding instantaneous values of current and magnetism, paying due attention to their relative signs; and the force for a period is equal to the average of the instantaneous torques during the period. If the coil could have no self-inductance, and

the phase of the current could therefore be in quadrature with that of the magnetism, the average forces during alternate quarter periods would be equal, but in opposite directions (compare Fig. 49), and the average force during a whole period would be zero, so that the coil would have no tendency to move; but in all practical cases a coil, or even a flat disc, must have some self-induction, so that the current lags behind the impressed pressure, and the current phase is therefore more than 90° behind the phase of the magnetism. In this case the instantaneous values of the force, when plotted in a curve, give a figure similar to Fig. 48, but turned upside down, since the current lags behind the magnetism more than 90° . The ordinates of the large loop represent a negative or repulsive force, and the ordinates of the small loops a positive or attractive force, and the summation of the instantaneous forces during a period is seen to have a finite negative value. This shows that the coil experiences a repulsive force which tends to move it out of the magnetic field. If the coil is pivoted, the force tends to turn it into such a position that the lines of force of the field do not thread through its turns. The conditions here set forth were first fully explained and illustrated in a remarkable lecture by Professor Elihu Thomson,* and a similar lecture by Professor Fleming. †

179. Single-Phase Induction Motors. — If the fields of an induction motor are wound with one set of coils so

* Novel Phenomena of Alternating Currents, *Trans. Amer. Inst. E. E.*, Vol. 4, p. 160.

† Electromagnetic Repulsion, *London Electrician*, Vol. 26, p. 567.

that the field poles are set up by a single alternating current flowing in the coils, the poles will be stationary but alternating, and the effects of electromagnetic repulsion just described may be utilized for the purpose of causing the armature to rotate. If the armature is wound with uniformly spaced short-circuited coils or conductors, the repulsive effects in the different coils will balance each other when the armature stands still;

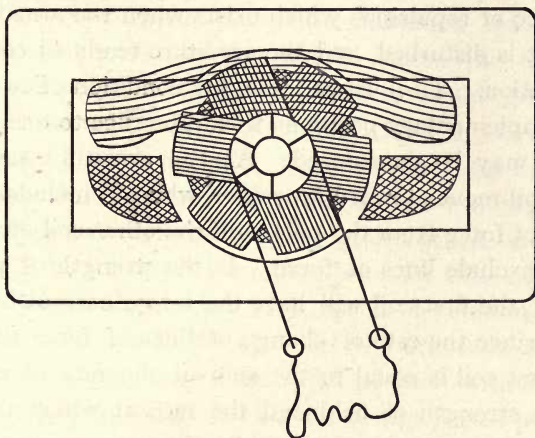

Fig. 293

but if the coils have their independent ends separately connected to the opposite bars of a commutator having as many bars as there are sets of conductors in the armature, brushes may be so arranged as to short-circuit each coil when it is in a position to give a force in one direction. This arrangement was suggested by Professor Thomson* and is illustrated in Fig. 293. The motor is self-starting, and runs by virtue of the repulsion

* *Trans. Amer. Inst. E. E.*, Vol. 4, p. 160.

between the magnetic field and the coils which, as they come into the active position, are short-circuited by the brush connections. Such a motor is bulky, inefficient, and expensive, since only a portion of the armature can be made continuously effective; but if a uniformly wound short-circuited armature (such as is used for polyphase induction motors) is started to revolving in a single-phase alternating magnetic field, the balance of repulsions which exists when the armature is at rest is disturbed, and the armature tends to continue its motion. To illustrate this, the condition of two coils in complementary positions with reference to one of the poles may be considered. As the armature revolves, one coil moves toward a position where it includes more lines of force from the pole, and the other coil moves so as to exclude lines of force. If the strength of pole is rising, the first coil will have the larger current induced in it, since the rate of change of lines of force through the first coil is equal to the sum of the rate of change in the strength of field and the rate at which the coil moves through the field, while the rate of change of lines of force through the second coil is the difference of these two rates. Thanks to the lag in the coil circuits, the currents in both coils are in such a direction as to result in an attractive force on the poles, but a much stronger force is experienced by the first coil than the second. When the field is falling, the magnetic condition of the second coil is changing most rapidly, but the direction of the induced currents in the coils is reversed with respect to the direction of the fields, and the coils experience a repulsive force with

reference to the pole. The effect during one complete period of the magnetism therefore tends to cause the armature to rotate in the same direction in which it was started. The torque is a maximum when the positive product of current and magnetism is a maximum, which is when the current lags behind the induced pressure by an angle between 45° and 90° . The torque at any speed (slip, $v = V - V'$) is equal to the torque which would be given by a polyphase induction motor of similar construction at that speed, minus the torque which the polyphase induction motor would give in a field of double the frequency, and with a slip equal to $V + V' = 2V - v$; but with the ordinary ratio of the resistance and inductance in the armature winding, the torque due to the latter slip is negligible at such full-load slips as are satisfactory in practice. In this case, V need not be looked upon as a speed of rotation of a magnetic field, but as the speed of the armature which keeps each conductor at the same position with reference to a pole for any fixed instant in the period of the magnetism. Hence $V = \frac{60f}{p}$, exactly as in rotary-field machines. When the armature is stationary, $v = V$, and the two torques are equal and opposite. A single-phase induction motor may therefore be designed in exactly the same manner as a polyphaser in respect to its operation after it has reached its normal speed, but it requires special treatment in the design for the purpose of making it self-starting.

180. Resolution of Alternating Field.—The single-phase alternating field may be treated in a different

manner to get exactly the same result. An alternating field stationary in position may be resolved into two rotary fields, revolving in opposite directions, having the same frequency as the stationary field, and of one-half its magnitude or strength.* This is exactly similar to the principle of mechanics by which a simple harmonic motion may be resolved into two uniform opposite circular motions of one-half the amplitude.

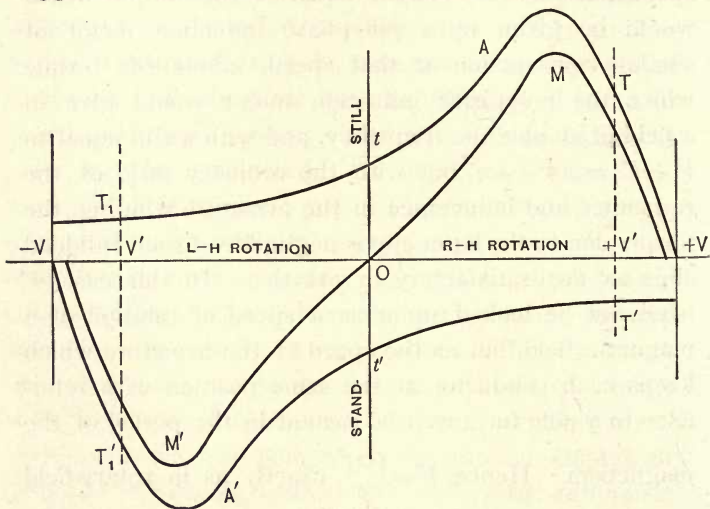

Fig. 294

The torque diagrams of each of these fields acting alone are shown in Fig. 294, where O is the point of armature rest, and armature speed is counted from that point along the horizontal axis. The curves A and A' are the torque curves that would be given by either field acting alone, the torque due to one being in one direc-

* Ferraris, A Method for the Treatment of Rotating or Alternating Vectors, *London Electrician*, Vol. 33, p. 110.

tion, and that of the other in the opposite direction. It is evident that when the armature is at rest it has no tendency to revolve, as the slip of the armature with respect to the two fields is equal, and torques Ot and Ot' created by the two fields are equal and opposite; but if the armature is started in one direction, for instance toward the right, the slip with respect to field A decreases, the torque caused by it increases and tends to continue the rotation, while the slip with respect to field A' increases, and the torque caused by A' decreases. When the armature speed becomes V' , the torque caused by A is T , which is due to a slip $V - V' = v$; while the torque caused by A' is T' , which is due to a slip in relative speed between armature and field of

$$V + V' = 2V - v.$$

From the relations of torque to slip, which have already been discussed (Sects. 167 and 168), it is evident that the torque caused by A' decreases as the relative speed increases above V . If the differences between the corresponding ordinates of the curves of torque due to A and A' are plotted in a curve, the actual torque curve, M , is given. The ordinates of this will give the actual motor torque with respect to slip. From this curve it is seen that the motor will work at no load at an almost synchronous speed, and may then be loaded until the speed has dropped to a point where the torque is at a maximum. If the load exceeds this, the motor will stop.

If the armature should be started toward the left, instead of the right as here assumed, the conditions

would be reversed and the motor would operate under the torque line M' . The ratio $\frac{L}{R}$ should be large in a single-phase motor, in order that the curve A' may be close to the X axis at ordinary running speeds, but the ordinary values of resistance and inductance which are required in an efficient and economical design make the effect of A' so small at the speed of normal full load that the action of A only need be considered.

181. Formulas for Single-Phase Induction Motors.— From these considerations it is seen that a single-phase motor may be designed in exactly the same manner as a polyphaser, and that for equal output the resultant ampere-turns upon the field must be equal to the number on a polyphase motor.* The field winding may be arranged, as in polyphase motors, covering the entire polar surface, as is shown in Fig. 295, for a four-pole machine; but the differential action in this case reduces the effectiveness of the winding in the proportion of $1 : \frac{2}{\pi}$, as has already been shown in Section 172. Consequently, the equation from which the field windings are determined becomes

$$E' = K \frac{\sqrt{2} \pi n' N f}{10^8} = \frac{2}{\pi} \times \frac{\sqrt{2} \pi n' N f}{10^8} = \frac{2 \sqrt{2} n' N f}{10^8}.$$

The value of K may be increased, and material saved, by leaving space between the coils as in Fig. 296, which shows the windings for a two-pole field.

Not only may the armatures of single-phase induc-

* Kolben, Design of Alternating-Current Motors, *Electrical World*, Vol. 22, p. 284; *London Electrician*, Vol. 31, p. 590.

tion motors be designed in exactly the same way as are those of polyphasers, but an armature which gives the

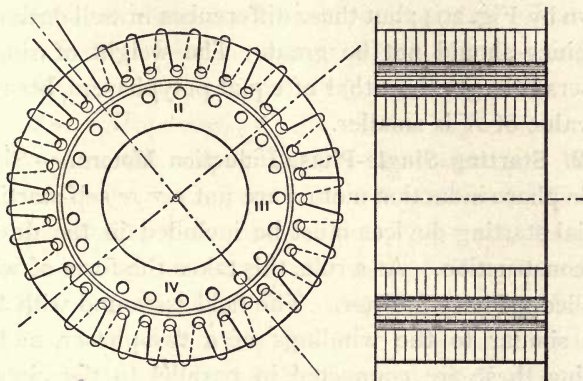

Fig. 295

best results when running in a polyphase field is likely to be best for a single-phase machine, other things being equal.

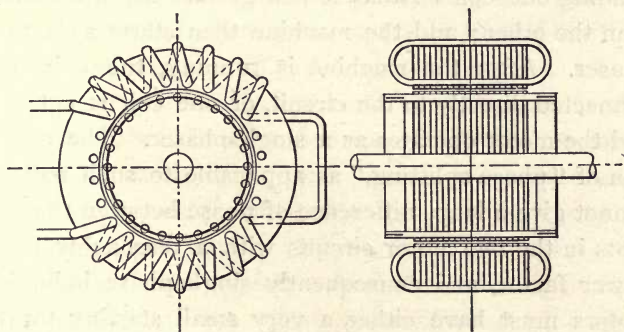

Fig. 296

The efficiency of single-phasers should be slightly less than that of polyphasers, since the armature-core losses are proportional to the frequency of the main field instead of to the slip; their slip for a given load

and similar design is slightly greater, and their maximum torque is slightly less than that of polyphasers, as is shown by Fig. 294; but these differences in well-designed machines should not be great. The weight of singlephasers is larger than that of equal polyphasers, because the value of K is smaller.

182. Starting Single-Phase Induction Motors. — Since single-phase induction motors are not *per se* self-starting, special starting devices must be included in the design and construction. As a rule, this takes the form of what is called a **Phase Splitter**. The field is wound with two coils similar to the windings of a two-phaser, and at starting these are connected in parallel to the circuit; one directly, and the other through a dead resistance or capacity. This throws the current in the two coils into a difference of phase, which may be accentuated by winding one coil so that it has greater self-inductance than the other; and the machine then starts as a two-phaser. After the machine is running, the coils are connected directly to the circuit, or one coil is cut out, and the motor operates as a single-phaser. The operation of "phase splitting," as applicable to such motors, cannot give a large difference of phase between the currents in the two motor circuits with a reasonably large power factor, and consequently single-phase induction motors must have either a very small starting torque or an unreasonably small power factor at starting.

183. Efficiency of Induction Motors and Methods of Making Tests. — Polyphase induction motors can be built with about the same efficiency as continuous-current motors, and with somewhat less cost on account

of the absence of a commutator and the low insulation required on the armature conductors, but with a counterbalancing extra cost on account of the high grade and expensive sheet iron stampings which are required for the field.

1. *Direct Measurement.* In testing the efficiency of these motors, the output may be measured by a brake or transmission dynamometer, as is explained for testing continuous-current motors in Vol. I., p. 255, but the input must be measured by one of the wattmeter methods of Section 44. The two-wattmeter method is the best, but care must be taken to determine whether the readings are additive or subtractive, since the power factor of a partially loaded induction motor is likely to be quite low and at no load may be only a few per cent. The power factor is determined by taking simultaneous readings of amperemeter, voltmeter, and wattmeter in one circuit, if the machine is balanced; but if the circuits differ, readings for each circuit must be taken. The power factor is then the true watts divided by the apparent watts. This method requires that the motor shall be operated with its full load, and therefore may prove inconvenient, and it does not give any way of separating the losses.

2. *Stray Power Method.* A method similar to that described for testing transformers (Sect. 125, 8a) is often more convenient and satisfactory. By this plan the core losses and friction losses are determined by measuring by wattmeter the power which is absorbed by the motor when running light under normal pressure and frequency. As the power factor under such condi-

tions is likely to be very small, the field current flowing is considerable and the C^2R loss cannot be neglected, but a correction can be made after the test for copper losses is completed. To measure the copper losses, the machine is locked so as to remain stationary, in which case the armature serves the purpose of a short-circuited secondary, and such a reduced impressed pressure is applied as to cause any desired current to flow in the fields. The wattmeter readings give the C^2R losses for the current flowing, and the losses for any other current may be at once calculated. A small core loss is included in this measurement, but should commonly be negligible; an approximate correction may be made on account of it, when necessary, by considering its ratio to the total corrected core losses as the 1.6 power of the pressure applied in the copper loss test is to the 1.6 power of the normal pressure. From these results the total losses and the efficiency at any load may be calculated.

A motor running, without load, or with part load, on an unbalanced circuit, is likely to absorb widely different amounts of power in its coils; one coil may even return power to the circuit, while the others absorb the power required for operation plus that returned. In all such cases, the two-wattmeter method of measuring the power gives the net power absorbed by the machine.

3. *Power Factor.* The power factor at any load may also be calculated from the results of the two loss tests. Thus, from the power factor of the machine running light, which is determined in the core-loss tests, is readily deduced the wattless magnetizing current, since the power factor is equal to $\cos \phi'$ and the magnetizing cur-

rent per coil, C_{μ}' , is equal to $C_1' \sin \phi'$, where C_1' is the current per coil as shown by the amperemeter. The field current at any load is equal to the resultant of the active current corresponding to that load and the wattless current, or

$$C' = \left\{ \left(\frac{W}{mE'} + \frac{L}{mE'} \right)^2 + C_{\mu}'^2 \right\}^{\frac{1}{2}}$$

where C' is the field current per coil, E' is the normal pressure per coil, W is the total output, L is the total losses, m is the number of phases, and C_{μ}' the wattless magnetizing current per coil. The power factor at any load is

$$\cos \phi' = \frac{W + L}{mC'E'}$$

4. *Regulation and Torque.* — All desired information in regard to the operation of induction motors (except regulation and starting torque) may therefore be determined by purely electrical measurements, and to a high degree of accuracy. Using commercial amperemeters, voltmeters, and wattmeters which have been properly calibrated, the errors probably affecting the full-load efficiency and power factor need not exceed one per cent. The exact regulation of a machine can be determined only by actual running tests under load, in which the actual slip is measured, but the percentage slip may be taken to be approximately equal to the percentage drop of pressure in the windings. The starting torque can be measured by clamping a lever upon the pulley, and measuring the pull at the end of a fixed length of arm. For machines having an improperly divided starting resistance in the armature, this gives a value which is

higher than the torque against which the motor will start and run up to speed. In such machines, the *standing torque* and *starting torque* are different, but in machines having a properly arranged starting resistance in the armature, the standing torque and starting torque are equal, and are practically equal to the maximum torque which the machine can exert.

The following table gives the efficiency, power factors, and other characteristics of a number of European poly-phase motors.*

| | | | | | |
|-------------------------------------|---------------|------|------|------|-----|
| Designation | 0 | 1 | 2 | 3 | 4 |
| Capacity — H.P | $\frac{3}{4}$ | 2 | 6 | 24 | 60 |
| Field speed | 1500 | 1500 | 1000 | 1000 | 750 |
| Speed at full load | 1435 | 1445 | 960 | 970 | 730 |
| Number of phases | 3 | 3 | 3 | 3 | 3 |
| Frequency | 50 | 50 | 50 | 50 | 50 |
| Pressure | 190 | 190 | 190 | 190 | 190 |
| No-load current | 2.2 | 3.6 | 12 | 25 | 48 |
| Full-load current | 3.3 | 7.5 | 20.5 | 70 | 160 |
| Full-load efficiency | 68 | 75 | 82 | 91 | 93 |
| Power factor at full load | .75 | .80 | .80 | .85 | .90 |
| Number of poles | 4 | 4 | 6 | 6 | 8 |
| Slip at full load | 4.3 | 3.7 | 4 | 3 | 2.7 |
| Designation | 5 | 6 | 7 | 8 | 9 |
| Capacity — H.P | 100 | 125 | 1 | 5 | 50 |
| Field speed | 600 | 500 | 1500 | 1500 | 750 |
| Speed at full load | 588 | 488 | 1375 | 1395 | 725 |
| Number of phases | 3 | 3 | 3 | 3 | 3 |
| Frequency | 50 | 50 | 50 | 50 | 50 |
| Pressure | 190 | 190 | 100 | 100 | 100 |
| No-load current | 75 | 90 | 4.5 | 15 | 150 |
| Full-load current | 265 | 330 | 8 | 36 | 280 |
| Full-load efficiency | 93 | 94 | 75 | 84 | 91 |
| Power factor at full load | .91 | .91 | .70 | .70 | .82 |
| Number of poles | 10 | 12 | 4 | 4 | 8 |
| Slip at full load | 2 | 2.4 | 8 | 7 | 3.3 |

* Thompson's *Polyphase Electric Currents*, p. 203; Rodet et Busquet's *Courants Polyphasés*, p. 89.

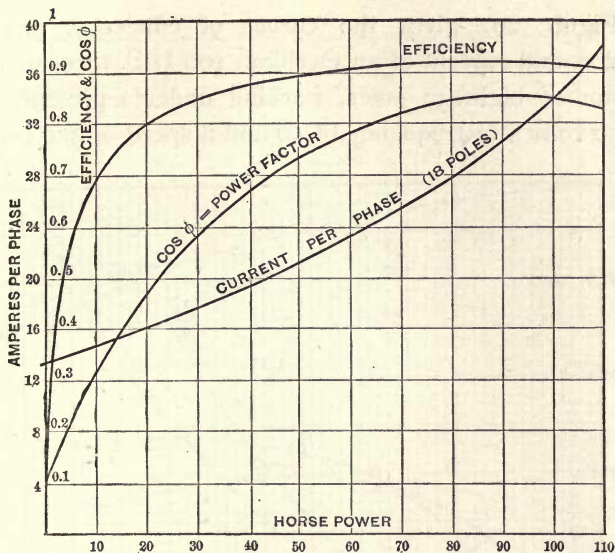

Fig. 297

TORQUE IN KILOGRAMS ON RADIUS OF EIGHT CM.

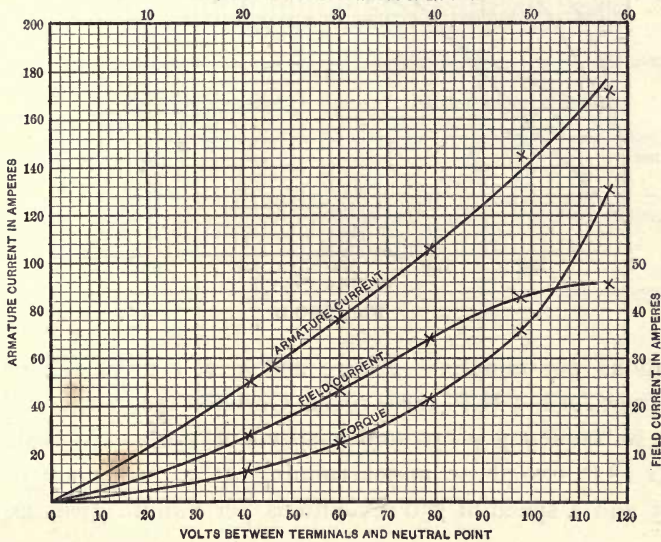

Fig. 298 a

Figure 297 gives the curves of efficiency, power factor, and current of an Oerlikon 100 H.P. three-phase motor of eighteen poles, working under a pressure of 1730 volts at a frequency of 50 and a speed of 320 revo-

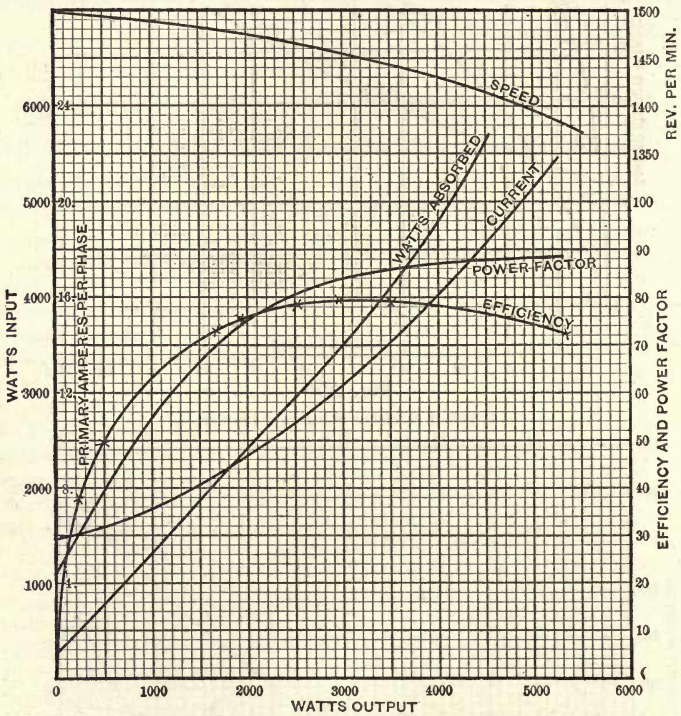

Fig. 298 b

lutions per minute. Figure 298 *a*, *b*, *c* gives similar curves for a 3 H.P. three-phase Oerlikon motor running at a frequency of 50 and a speed of 1500. A Tesla 50 H.P. two-phase motor running at a frequency of 25 and a speed of 750 revolutions per minute gives an

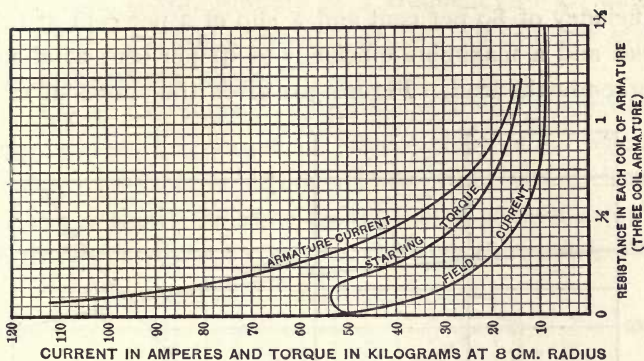

Fig. 298 c

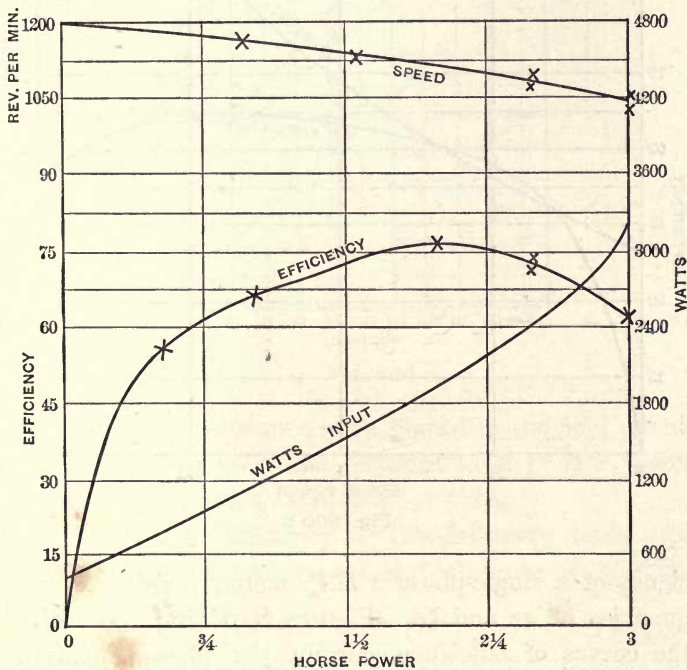

Fig. 299 a

efficiency of 89 per cent and a slip of 2 per cent at full load and a maximum efficiency of 91 per cent at about three-fourths load. Figure 302 gives the curves of effi-

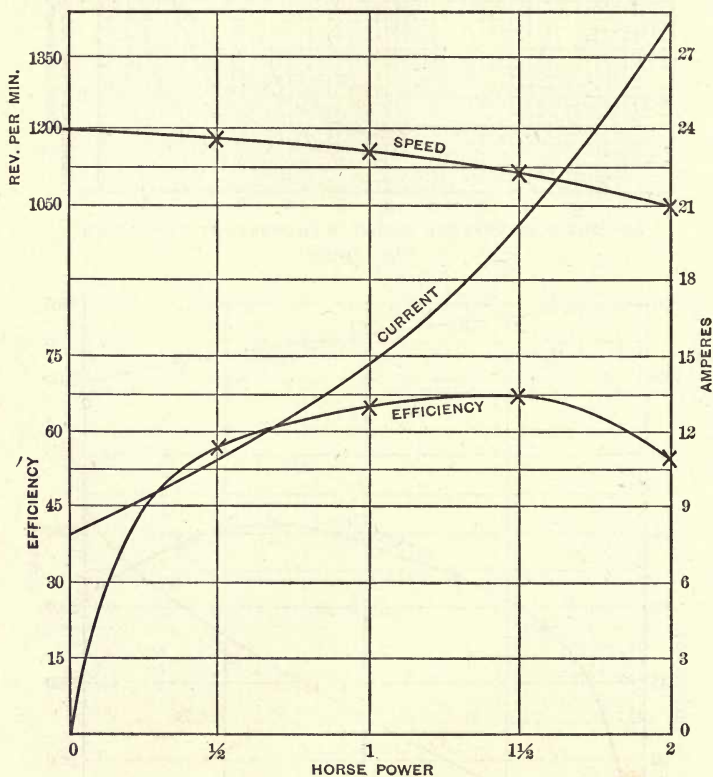

Fig. 299 b

ciency of a single-phase 2 H.P. motor, running at frequencies of 42 and 50. Figures 299 *a* and 299 *b* give the curves of efficiency, current per phase, apparent watts, true watts, and regulation for a 3 H.P. Brown

two-phase motor, running at a frequency of 40 and a speed of 1200 when operated on two phases and when operated on one phase.*

In Fig. 300, curve *A* shows the relation between current and starting torque of a three-phase motor when a proper resistance is introduced into the armature circuit. Curve *B* shows the same for the motor without external armature resistance; this would give the relations ob-

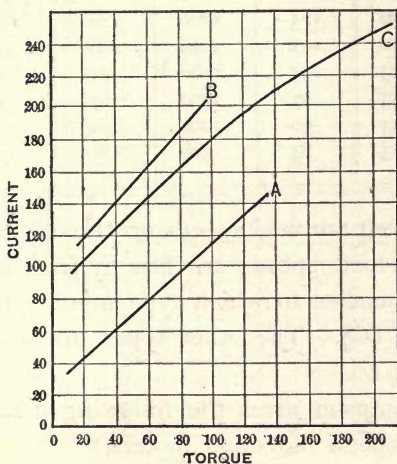

Fig. 300

taining if the resistance were placed in the field circuit. Curve *C* gives the same relations for a 15 H.P. motor, which has a full-load torque of 52.5 lbs.

184. Weight Efficiency.—The following table gives the weights per horse-power of three types of American induction motors.

* Boucherot, *Bull. Soc. Inter. des Électriciens*, Vol. II., p. 264.

| Horse-power. | TYPE NUMBER 1. | | TYPE NUMBER 2. | | TYPE NUMBER 3. | |
|--------------|-------------------------|-----------------|-------------------------|-----------------|-------------------------|-----------------|
| | Revolutions per minute. | Pounds per H.P. | Revolutions per minute. | Pounds per H.P. | Revolutions per minute. | Pounds per H.P. |
| 1 | 2666 | 246 | 1800 | 150 | 1800 | 275 |
| 2 | 2666 | 165 | — | — | 1800 | 175 |
| 3 | 2000 | 180 | 1800 | 167 | — | — |
| 5 | 2000 | 164 | 1200 | 140 | 1200 | 125 |
| 7 | 2000 | 182 | — | — | — | — |
| 7½ | — | — | 1200 | 160 | — | — |
| 10 | 1600 | 125 | 1200 | 120 | 1200 | 85 |
| 15 | 1600 | 101 | 1200 | 100 | 900 | 80 |
| 20 | 1333 | 105 | 1200 | 75 | 900 | 100 |
| 30 | 1333 | 97 | 1200 | 67 | 900 | 88 |
| 40 | 1333 | 90 | 1200 | 62 | — | — |
| 50 | 1333 | 84 | 900 | 84 | 720 | 100 |

Speeds given are field speeds or "theoretical speeds," and the full-load speeds are less by from 2 to 10 per cent. Frequencies to which type number 1 is adapted are 133 and $66\frac{2}{3}$. The other types are adapted to a frequency of 60.

S. P. Thompson gives the following data as representing European induction motors.*

| Horse-power. | Weight, pounds per horse-power. | Horse-power. | Weight, pounds per horse-power. |
|--------------|---------------------------------|--------------|---------------------------------|
| 2 | 120 | 50 | 70 |
| 6 | 100 | 70 | 66 |
| 13 | 88 | 100 | 58 |

Figure 301 gives the averages for the American motors in the form of a curve (A), with the addition of

* Thompson's *Polyphase Electric Currents*, p. 209.

the curve (*B*) for continuous-current machines reproduced from the equations on page 263 of Vol. I. This shows that the alternating-current machines are the lighter in the larger sizes, on account of their higher speeds, but for equal speeds the two classes of machines are very near an equality in respect to weight efficiency.

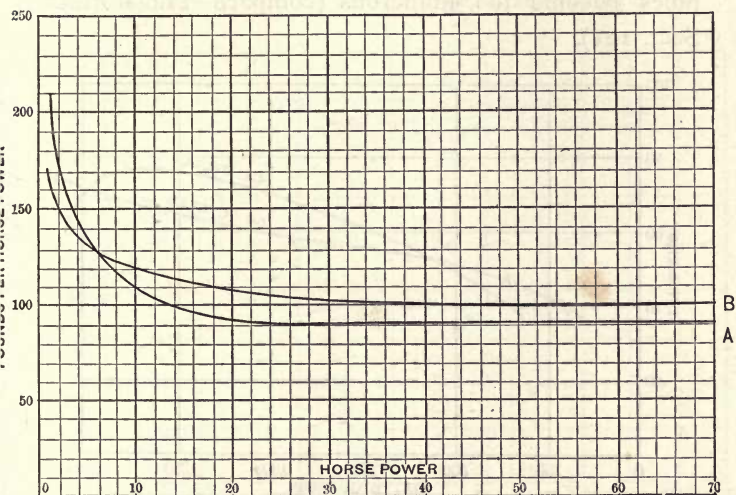

Fig. 301

185. Effect of Frequency.* An examination of the formulas relating to the design of induction motors shows that the frequency of the current for which a machine is designed does not affect its efficiency, slip, power factor, or starting torque, but that for a given speed the number of poles must be directly as the frequency. Increasing the number of poles of a given

* Steinmetz, *Trans. Amer. Inst. E. E.*, Vol. 11, p. 47; Stanley, Effect of Frequency in Induction Motors, *Electrical Engineer*, Vol. 17, p. 125.

machine reduces the cross-section of each pole, but the number of lines of force at each pole is equally reduced so that the magnetizing current is unaltered. Consequently, induction motors of equal merit may be designed for all reasonable frequencies, though magnetic leakage may interfere with the operation when the poles become too numerous (compare Transformers, Sect. 121).

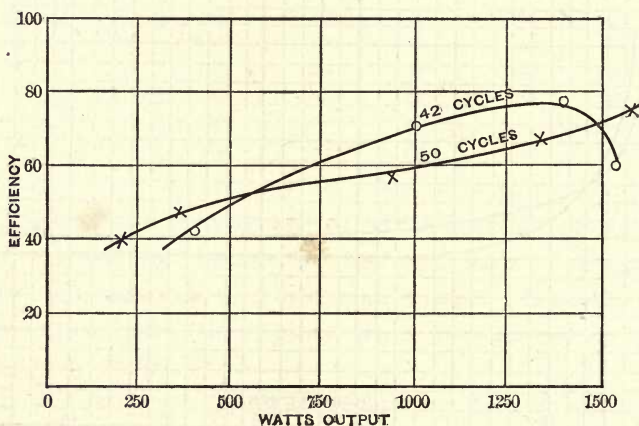

Fig. 302

On the other hand, when a machine which has been designed for a certain frequency is operated at another frequency, the speed is changed in direct proportion to the frequency, its percentage slip is practically unaltered, the starting torque varies inversely with the frequency, and the efficiency and power factor both vary directly with the frequency because the magnetic density is inversely as the frequency, as in transformers. Figure 302 shows the

curves of efficiency of an Oerlikon single-phase induction motor for two frequencies; * and Figs. 303 and 304 give the curves of efficiency and power factor for a 50-frequency Allgemeine three-phase motor when operated on four different frequencies. †

The frequencies which are commonly used with induction motors cover a wide range. In Europe, 50

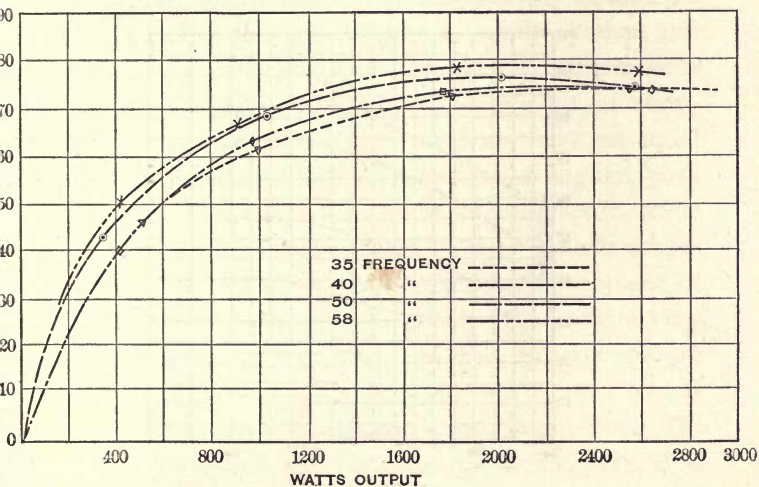

Fig. 303

seems to be quite universally adopted for three-phase and single-phase motors; while in this country the General Electric Company prefers 60, which is equally suitable for lighting and power purposes. The Westinghouse Company has built two-phase machines for

* Kolben, Design of Alternating-Current Motors, *Electrical World*, Vol. 22, p. 284; and *London Electrician*, Vol. 31, p. 590.

† Jackson, Tests of a Polyphase Motor, *Electrical Journal*, Vol. 1, p. 101.

60 frequency, but appears to prefer about 25, which is that adopted at Niagara Falls, for plants where power service is of greater importance than the lighting service. The Stanley Company, on the other hand, prefers a frequency of 133 for its two-phasers, though it also builds standard machines for a frequency of $66\frac{2}{3}$, both of which are excellent frequencies for lighting

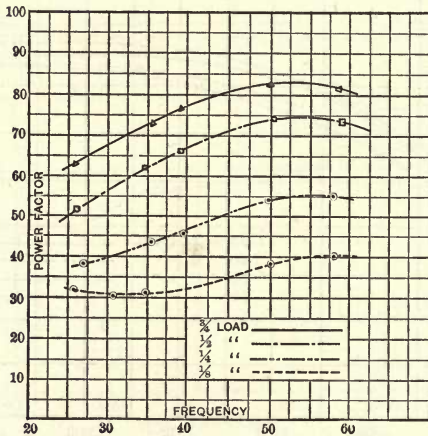

Fig. 304

circuits. The Fort Wayne Electric Corporation and the Emerson Electric Company build self-starting synchronous single-phasers for frequencies of 60, 125, and 133.

186. Other Forms of Induction Motors. — The effects of a rotary field, electromagnetic repulsion, or magnetic screening may be utilised in an almost indefinite number of ways, of which only a few will be indicated here.

1. *Motor of Stanley Electric Manufacturing Company.**

This is a two-phase machine which may be classified either as a rotary-field motor, or as a sort of double single-phaser; and its design may be worked out upon either hypothesis, though it should properly be worked out upon the rotary-field basis. It consists essentially of two fields set side by side. The field windings are placed upon salient poles, and respectively connected to the two circuits of a two-phase supply system, and corresponding to the two fields are two armature cores on the same shaft, which carry a single set of short-circuited armature coils. The two fields have an equal number of poles, but they are set with the angular position of the poles ninety electrical degrees apart, while the armature conductors are laid in slots straight across both armature cores. A diagrammatic development of a six-pole machine which shows the arrangement very plainly is given in Fig. 305. A view of an armature is shown in Fig. 306. The operation of the machine is easily understood by referring to Fig. 305. When the armature is stationary in the position shown, current is induced in the *a* armature windings by the lower crown of poles belonging to the *A* field. The conductors of the *a* coil lie directly under the upper or *B* field, and a torque tending to move the coil is developed, which, at any instant, is proportional to the product of the instantaneous strength of the *B* field and the current induced in the coil by the *A* field. At the same time, the *B* field induces a current in the *b* coil, which causes

* *Electrical World*, Vol. 21, p. 326; *Electrical Engineer*, Vol. 17, p. 505.

a torque with the A field. The motor is therefore self-starting. After the machine has rotated through an

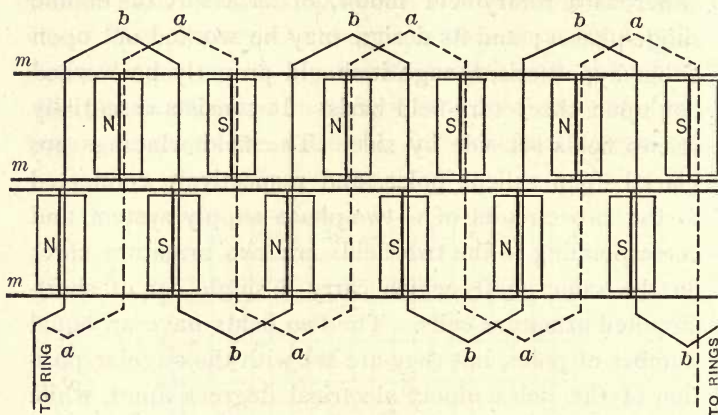

Fig. 305

angle corresponding to one-fourth the polar pitch, both coils are inductively acted upon to an equal extent by both poles, and opposite torques are produced by the

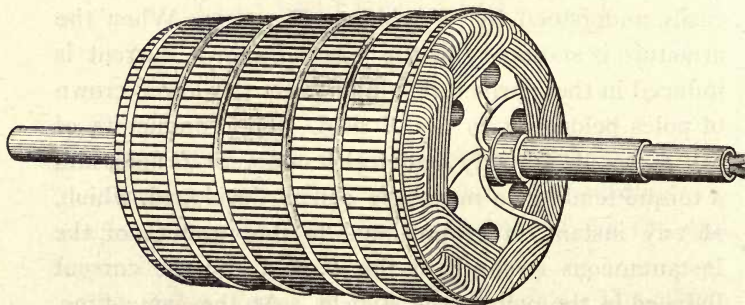

Fig. 306

two fields. A further rotation places the b coil in inductive relation with the A field, and the a coil with

the B field, and the torque again becomes positive. It is possible, with such a winding, to have dead points, though they may be avoided by a proper disposition of the armature winding. The Stanley motors are usually equipped with a well-proportioned external starting resistance which is introduced into the armature circuit by means of collector rings, and the motors have a fairly large starting torque. A set of short-circuited windings, $m m m$, is placed in the pole faces to decrease the apparent self-inductance of the armature windings, and condensers are used in parallel with the field circuits to supply the wattless magnetizing current, and thus increase the power factor.

Capacity of Condenser required to supply Wattless Current. As the current of a condenser is equal to $2 \pi f s E$, a high frequency and a high pressure both serve to reduce the capacity of a condenser which is required to give any desired current, and in order that the condensers which are required for the Stanley Company's motors may be of reasonable capacity, the motors are designed for 500 volts pressure, and the use of high frequencies is recommended by the company. In illustration of this, supposing that a 500 volt motor for 120 frequency requires 20 microfarads to exactly supply its wattless current, an exactly similar machine designed for a frequency of 60 would require from 40 to 50 microfarads, while if the pressure is also reduced to 250 volts the capacity required is increased to from 160 to 250 microfarads. Figure 307 shows the regulation, power factor, and efficiency as a function of load for a 2 H.P. Stanley motor, and Fig. 308 shows the same for

a 6 H.P. machine. The armature core losses in Stanley machines are similar to those of single-phasers, and are, therefore, greater than those of plain rotary-field machines. A properly built machine of this type gives a true rotary field in its effect on the armature windings,

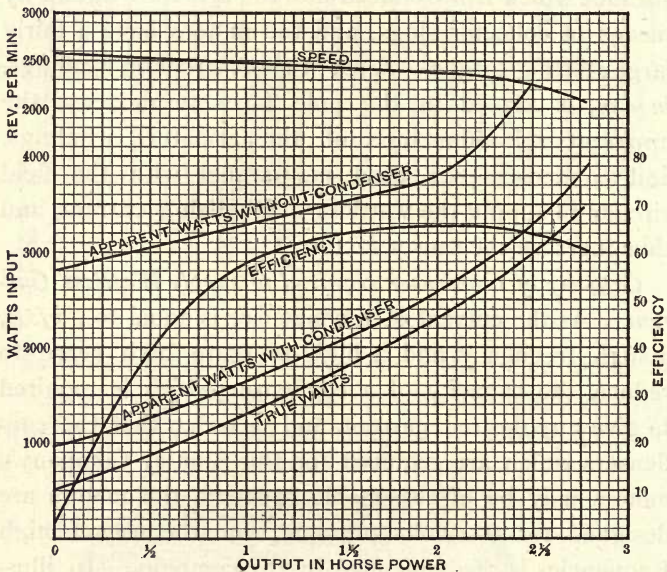

Fig. 307

as was early pointed out by Sahulka,* but the effect on the armature core losses is similar to that found in a single-phase machine. The number of pairs of poles in the rotating field is equal to the number of salient poles on one ring.

2. *Shallenberger Meter.* The running parts of the

* Sahulka's *Ueber Wechselstrom-Motoren mit magnetischem Drehfelde.*

electrical meter manufactured by the Westinghouse Company consist essentially of a single-phase induction motor. The armature consists of an iron disc, across one diameter of which is wound a stationary coil that carries the main current. A short-circuited coil, consisting of heavy copper strips, lies within and at a slight angle with the main coil, and the lagging induced cur-

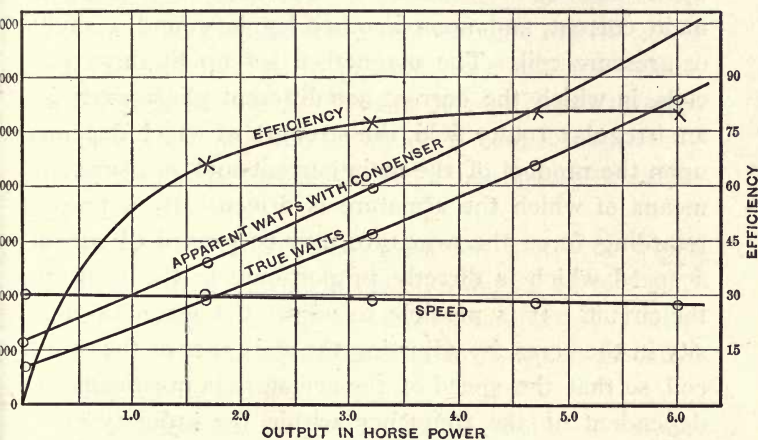

Fig. 308

rent in this coil sets up a magnetic field which joins with the magnetism of the main coil to set up an irregularly rotating field with a frequency equal to that of the main current. This causes the iron armature to rotate. The strength of the resultant field and the torque on the armature are proportional to the main current. A proper retarding force is used to cause the armature to rotate at a speed directly proportional to the main current as long as the frequency is constant.

The speed of the armature depends on the frequency of the main current.

3. *Scheeffer Meter.* The running parts of a recording wattmeter, manufactured by the Diamond Electric Company, consist of a split-phase induction motor. The armature is an iron cylinder, which is embraced by a three-legged magnet made of iron stampings, upon one leg of which is wound a coil carrying the main current, and upon another leg is wound a shunt or pressure coil. The magnetism set up by these two coils, in which the current has different phases, sets up an irregular rotary field, the strength of which depends upon the product of the main current and pressure, by means of which the armature is driven. By a proper retarding force the armature may be caused to run at a speed which is directly proportional to the watts in the circuit. It is possible to adjust the magnetic density in the cores, by adjusting the resistance of the shunt coil, so that the speed of the armature is practically independent of the frequency within the ordinary commercial limits.

4. *Ferranti Meter.* The armature in this is an iron disc which is embraced by two elongated pole pieces, and these are surrounded at equal intervals by short-circuited copper bands. The bands exert what may be called a shielding effect on the magnetism, and cause magnetic poles to apparently creep along the pole-pieces. These cause the revolution of the armature. The speed of the poles and the armature torque depend upon the strength of the magnetism set up in the main coil.

Thomson's recording wattmeter consists of a small motor with a Gramme armature, and without iron in fields or armature cores, so that it works equally well on alternating or continuous currents. It is not an induction motor, but seems to require notice amongst the other meters already described. It is well known that a small series motor, with either Gramme or Siemens armature, will run on alternating circuits exactly as it runs on continuous-current circuits, but its power factor is so minute as to preclude its commercial value. In the Thomson meter, the main current passes through the field coils, and the armature is connected directly across the leads through a large non-inductive resistance.

The only other type of induction motor to which attention can be given is that developed by Mr. C. P. Steinmetz, together with a special arrangement of alternator windings and transmission lines which is called the **Monocyclic System**.

187. Monocyclic System.* — A diagram of a "monocyclic" alternator armature is shown in Fig. 309, and the same is developed in Fig. 310*a*. The winding on this alternator consists of an ordinary coil winding in slots or grooves, which may be called the main winding or coil, and an auxiliary or "teaser" winding placed in smaller slots half-way between the main slots. The electrical pressure developed in the auxiliary winding has, on account of the position of the coil, a phase difference of ninety degrees from that developed in the main winding, exactly as would

* *Electrical World*, Vol. 25, pp. 182 and 302.

be the case in a two-phase alternator, but one end of the auxiliary coil is connected to the middle of the main coil. The free end of the auxiliary coil and

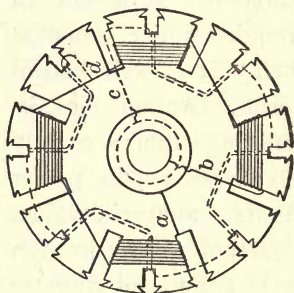

Fig. 309

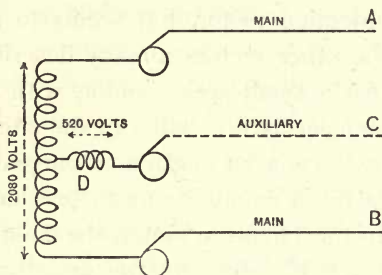

Fig. 310 a

the ends of the main coil are connected to separate collector rings. If the number of turns in the auxiliary coil bore the relation to the number in the main coil of $\frac{\sqrt{3}}{2} : 1$, the pressure measured between the collector rings taken in pairs would be equal for each pair, and

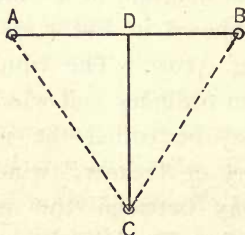

Fig. 310 b

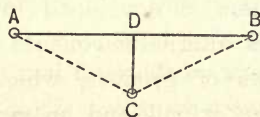

Fig. 310 c

the machine would be a balanced three-phase generator giving three equal pressures at 120° difference of phase (Fig. 310 b). But in the monocyclic generator the aux-

iliary coil has only one-fourth as many turns as the main coil, and therefore the three phases developed by the machine are not 120° apart, but have the angular relations shown in Fig. 310 *c*, in which AB is the pressure measured between the main terminals, AC and BC pressures measured between the auxiliary terminal and the main terminals, and CD the pressure developed in the auxiliary coil. The angle ACD is nearly 60° and AC is nearly .56 of AB .

If two transformers are connected in circuit with a monocyclic generator, it is possible to get a three-phase

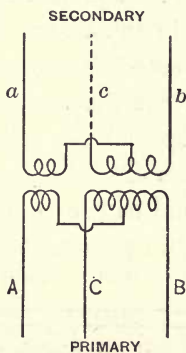

Fig. 311 a

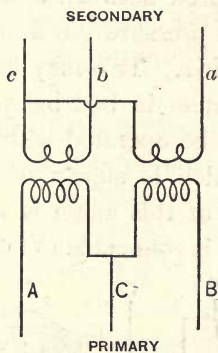
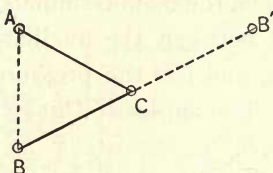

Fig. 311 b

secondary circuit with 120° difference of phase by the arrangement shown in Fig. 311 *a*, provided the ratios of the number of turns cb to ab and CB to AB are properly proportioned. Two ordinary transformers with the same ratio of transformation may be used as shown in Fig. 311 *b*, one of the secondaries being reversed, though the pressures in the three circuits are then not exactly equal. The way in which the pressures come out in this case

is illustrated in Fig. 311 *c*, where AC is the pressure measured from a to c , BC is the pressure measured from b to c , $B'C$ shows the phase of the pressure BC without a reversed transformer, and AB is the resultant press-

Fig. 311 *c*

ure measured between a and b . The last is equal to twice the pressure developed in the teaser coil, or CD in Fig. 310 *c*. This may be treated as a regular three-phase system in bad balance, but the system was designed to be operated with a special two-coil induction motor which is shown diagrammatically in Fig. 312. The field of this motor is wound with two coils, one of which, m , is connected to the main circuit, and the other,

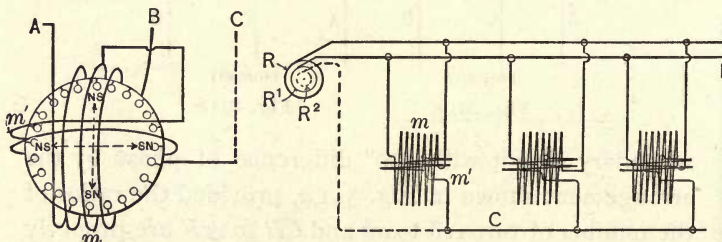

Fig. 312

m' , which has fewer turns, is connected to the auxiliary conductor. The motor acts in starting as an unbalanced three-phaser, but after getting under way takes most of its power from the main circuit. This arrangement was

intended to avoid the unbalancing which is likely to occur in polyphase systems where lighting and power are used together. The monocyclic system is essentially a single-phase system; all the lighting apparatus is operated from the main circuit, and while the motors are, broadly speaking, polyphasers, and may be ordinary three-phasers, they operate more after the manner of single-phasers which are started by splitting the phase, than as balanced three-phasers. Quite a large number of monocyclic alternators have been put in service in this country as ordinary single-phase lighting generators * but comparatively few have been put into operation for use in a combined light and power service. The motors in use, where the combined service is furnished, are standard three-phasers.

The accomplished designer of the monocyclic system has made many plans in which it is proposed to utilize in remarkably varied ways the flexibility of alternating-current machinery of the induction types. One of these plans is shown diagrammatically in Fig. 313, and is introduced here for the purpose of illustrating more fully the varied purposes to which alternating-current apparatus lends itself.† *G*, in the figure, is an ordinary single-phase generator, with its field excited by exciter, *E*, and its armature, *A*, connected, through the collector rings, *rr*, to feeders, to which lighting circuits may be directly connected through transformers, as at *a*. At *b*

* Jackson and Fortenbaugh, Some Observations on a 300 K. W. Monocyclic Alternator, *Trans. Amer. Inst. E. E.*, Vol. 12, p. 350.

† See also Emmett, Existing Commercial Applications of Electrical Power from Niagara Falls, *Trans. Amer. Inst. E. E.*, Vol. 12, p. 482.

is a circuit containing several monocyclic motors, which, after one is started, furnish each other the current required for the auxiliary winding; while at M is a synchronous motor wound like a monocyclic generator, but which operates as a single-phase synchronous motor

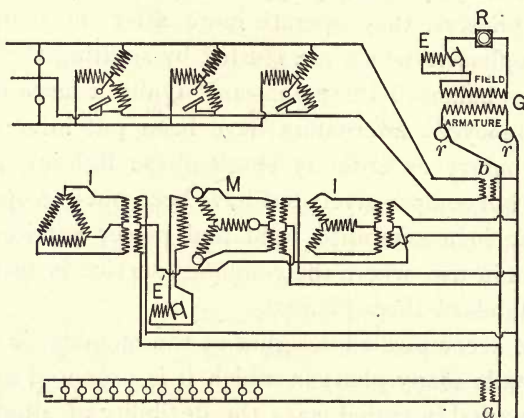

Fig. 313

with its main coil connected to the generator circuit. Its auxiliary coil serves to furnish the additional current needed to operate plain three-phase induction motors, I, I , which are on the circuit.

188. Effect of the Form of Curves of Pressure. — The effect of distorted curves upon the operation of induction motors depends upon the number of phases. The harmonics of three and five times the fundamental frequency are the only ones which need be considered; and indeed, that of three times the frequency is the only one which has an appreciable influence (Sect. 30, and Appendix A). In single-phase motors the har-

monics must affect the magnetic field exactly as they affect that of a transformer, so that peaked pressure curves should cause a decrease in core losses, and the operation of the motor should not be otherwise greatly influenced. In polyphase motors, however, the harmonics may set up a rotating field of their own, which is superposed upon the regular field, and may interfere with the operation of the machine. The harmonics with three times the fundamental frequency belonging to the two circuits of a two-phase system, have a phase difference of 90° (Fig. 314), and these set up a superposed rotating field in the induction motor which has a field velocity of three times that of the main field. The figure shows that the harmonics of triple frequency, belonging to the two phases, are reversed in relative position compared with the fundamental waves. The field due to these harmonics rotates in the reverse direction from that of the main field, and therefore tends directly to decrease the torque of the motor and to increase the slip. The field due to the harmonics of five times the frequency rotates in the same direction as the main field, and its only disadvantageous effect is in causing eddy currents which may slightly decrease the efficiency of the motor. The frequency of the harmonic curves is indicated in the figure by subscripts.

In three-phase circuits the harmonics of triple frequency belonging to the different currents are directly superposed in phase as is shown in Fig. 315, and therefore the superposed field which they cause in three-phase induction motors is a stationary one whose

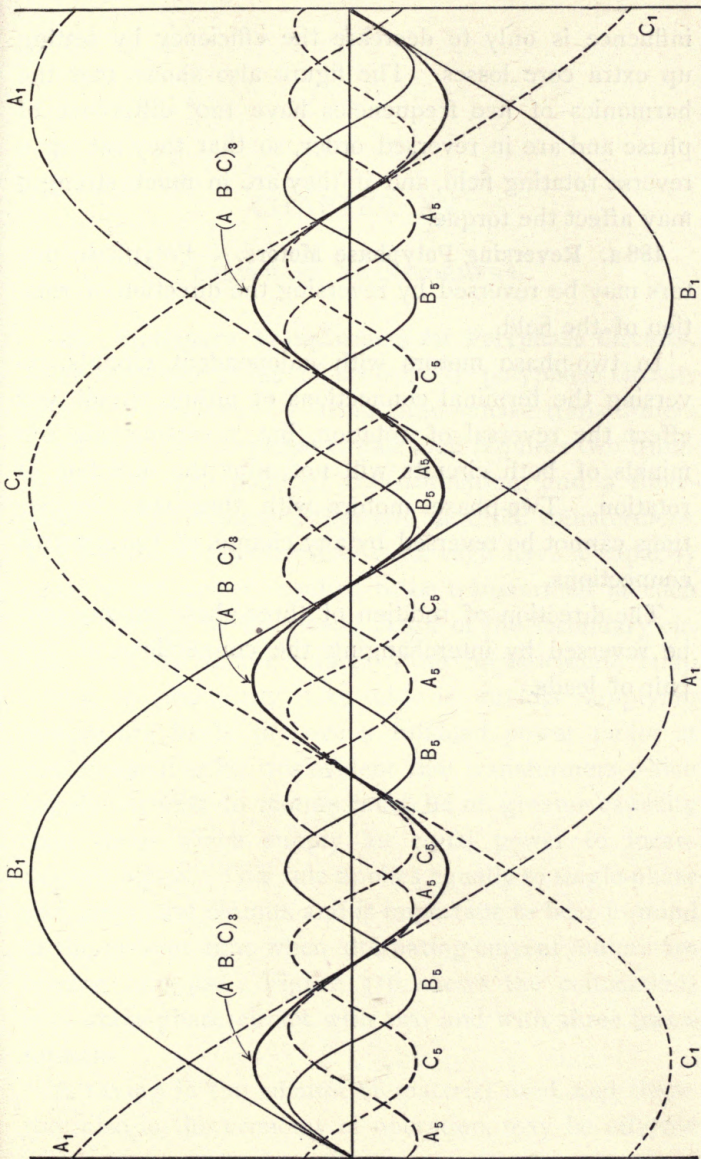

Fig. 315

influence is only to decrease the efficiency by setting up extra core losses. The figure also shows that the harmonics of five frequencies have 120° difference of phase and are in reversed order, so that they set up a reverse rotating field, and if they are in much strength may affect the torque.

188 a. Reversing Polyphase Motors. — Polyphase motors may be reversed by reversing the direction of rotation of the field.

In two-phase motors with independent circuits, reversing the terminal connections of either circuit will effect the reversal of rotation, but reversing the terminals of both circuits will not alter the direction of rotation. Two-phase motors with three-wire connections cannot be reversed by any change of the external connections.

The direction of rotation of three-phase motors may be reversed by interchanging the connections of any pair of leads.

CHAPTER XV.

POLYPHASE TRANSFORMERS.

189. Stationary Transformers for Polyphase Circuits.

—The transformation of pressure in polyphase circuits may be compassed by using single-phase transformers in groups. A two-phase circuit then requires two transformers at each point of transformation, and a three-phase circuit requires either two or three transformers. The individual transformers must each have a capacity equal to the power required to be transformed in each phase divided by the power factor of the secondary circuit. As the power factor of an incandescent lamp circuit is practically 100, and as circuits supplying motors are likely to have a full-load power factor at best as small as 80, it is evident that transformers which supply currents to motors must be of greater capacity than those which supply an equal power to incandescent lamps. This rule applies equally to single-phase and polyphase circuits and is important to bear in mind at the present time when alternating-current motors are coming into use. Figure 316 shows the connections of a three-phase circuit with two and with three transformers.

A saving in the amount of material used, and therefore also in the economy of operation, may be effected

by combining the magnetic circuits of the individual transformers in the several phases, exactly as polyphase electric circuits are combined into common wires (Chap. XIII.). Figure 317 represents a two-phase transformer with a combined magnetic circuit. Since the phases of the magnetism in the two halves of the transformer are 90° apart, the resultant magnetism in the middle tongue

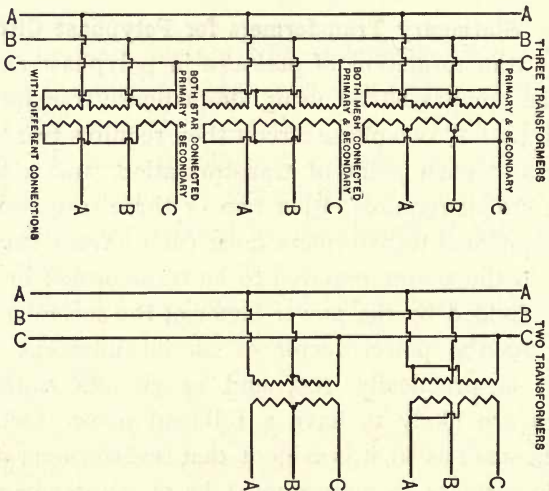

Fig. 316

is $\sqrt{2}$ times as great as that in the cores under the windings, so that this central tongue must have $\sqrt{2}$ times as great a cross-section as the remainder of the magnetic circuit. There is a saving of iron in the combined transformer, as compared with two independent transformers, which is equal to $\sqrt{2}$ times the weight of the central tongue. This is of little moment in small transformers, but may make quite a difference in the

cost and efficiency of transformers of very large capacity. The same sort of combination may be effected in

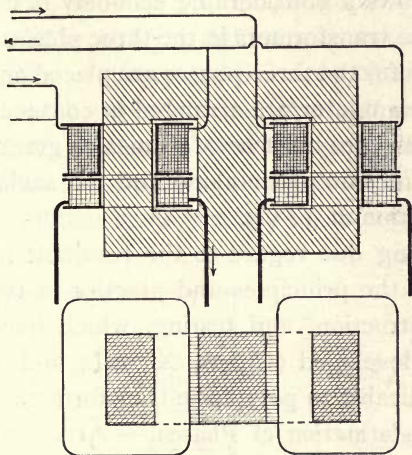

Fig. 317

three-phase transformers, and the magnetic circuit may be coupled in either the star or the mesh arrangement.

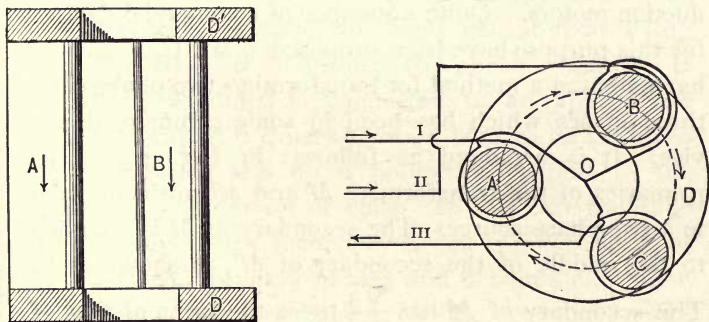

Fig. 318

Figure 318 shows a three-phase transformer used by Siemens and Halske, and others, in which the magnetism

in the yokes, DD' , which join the cores A , B , and C , is $\sqrt{3}$ times as great as that in the cores, and the construction allows a considerable economy in comparison with separate transformers in the three phases; while, if the windings for the three phases are placed on the three sides of a triangle or are arranged in consecutive order on a ring, the core must be $\sqrt{3}$ times as great as would be required for one phase alone and the saving of iron is in the relation of $3 : \sqrt{3}$.

After giving due regard to the resultant magnetism in the cores, the principles and practice in transformer design, construction, and testing, which have already been fully developed (Chaps. X., XI., and XII.), are directly applicable to polyphase transformers.

190. Transformation of Phases. — Arrangements for transforming one polyphase system into another system with a different number of phases may be readily developed from the principles which have been fully set forth in the chapters on single-phase transformers and induction motors. Quite a number of commercial devices for this purpose have been proposed. Mr. C. F. Scott* has patented a method for transforming two-phases into three-phases which has been in some commercial service. It is arranged as follows: in Fig. 319*a*, the primaries of the transformers M and M' are connected to a two-phase source. The secondary of M is attached to the middle of the secondary of M' , as shown at O . The secondary of M has $\frac{\sqrt{3}}{2}$ times the turns of that of

* Polyphase Transmission, *Electrical World*, Vol. 23, p. 358; *Lond. Electrician*, Vol. 32, p. 640.

M' . Then in Fig. 319 *b* the line OB represents the pressure between the points O and B in the former figure, OC that between O and C , and OA that between O and A . OA must be at right angles to OB or OC , as the two-phases of the primaries are 90° apart. Thus it is seen that between the points A , B , and C three equal pressures are set up at 120° apart. By reversing the apparatus, three-phases may be transformed into two-phases. Other arrangements for effecting the same

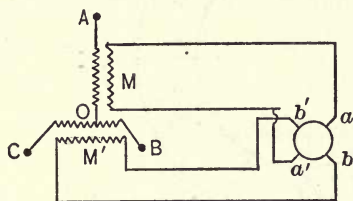

Fig. 319 a

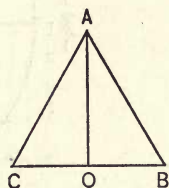

Fig. 319 b

result may be readily suggested, such as that shown in Fig. 320, where aa' , bb' , cc' represent the three coils of a three-phase winding uniformly placed upon a ring core, and AA' , BB' a uniform two-phase winding. If one of the windings is connected to an appropriate polyphase circuit it causes a rotary field to be set up in the core which sets up a polyphase current in the circuit of the other set of coils. In this case the number of phases in the secondary circuit is independent of the number of primary phases and depends only upon the number and arrangement of the secondary coils. The magnetic circuit should be completed by filling the central space with iron stampings.

The transformation of single-phase into polyphase

currents by means of stationary transformers may be accomplished by phase-splitting devices,* but no satisfactory commercial method has been developed which does not include moving parts in the transformer.

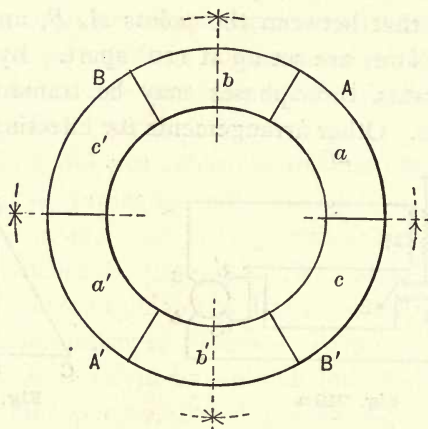

Fig. 320

191. Rotary Transformers. — The possibility of converting a continuous-current dynamo into a single-phase alternator was referred to in Section 5 and later sections, and a machine so constructed with a continuous-current commutator and alternating-current collector rings may be used to convert a continuous current which is fed into its commutator end, and by which it is driven, into an alternating current which is taken from the collector rings. Or, the transformation may be from alternat-

* Bradley, Phasing Transformers, *Trans. Amer. Inst. E. E.*, Vol. 12, p. 505; Steinmetz, Some Features of Alternating-Current Systems, *Trans. Amer. Inst. E. E.*, Vol. 12, p. 329.

ing to continuous currents, if the armature is properly synchronized so that it runs as a synchronous motor.

It is possible in the same manner to make a two-phaser to be used *with separate circuits* out of any continuous-current machine with Gramme or Siemens armature, by arranging four collector rings on the shaft and connecting them to the armature windings at points which are 90 electrical degrees apart. It is also possible to make a three-phaser out of a continuous-current

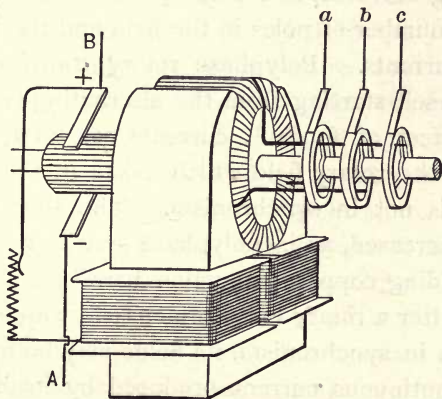

Fig. 321

machine by arranging three collector rings on the shaft, and connecting them to the armature winding, at 120 electrical degrees apart. Such machines may be used to transform continuous currents into polyphase currents or *vice versa*. (See Fig. 321.) In the case of two-phasers, it is evident that the maximum value of the alternating pressure is equal to the value of the

continuous pressure, and hence the ratio of transformation is theoretically $1 : \sqrt{2}$. In the case of three-phasers a little consideration will show that the ratio of transformation is $1 : \sqrt{3}$. These theoretical values are found to hold very closely in commercial machines. They are independent of the speed of the machines and of the strength of the fields, provided armature reactions are small.

Machines so constructed are called **Rotary Transformers**. They will run in synchronism when fed with alternating currents, and their speed therefore depends upon the number of poles in the field and the frequency of the currents. Polyphase rotary transformers are generally self-starting from the alternating-current end by the effect of foucault currents set up in the pole pieces by the rotary field which exists in the armature when it is not in synchronism. The starting torque may be increased, as in polyphase synchronous motors, by embedding copper "induction bars" across the pole faces. After a rotary transformer fed by an alternating current is in synchronism, its fields may be magnetized by the continuous current produced by itself and collected from its commutator.

In connecting the armature windings of rotary transformers to the collector rings, the relative angles corresponding to the current phases must be carefully distinguished (compare Sect. 102 *a*). One complete revolution of an armature in a two-pole field corresponds to one complete period of the alternating current, and therefore 360 mechanical degrees corresponds to 360 electrical degrees, but in multipolar machines a

rotation of the armature equal to twice the angular pitch of the poles corresponds to one complete period, so that, in general, the relation of electrical degrees to mechanical degrees is $p:1$, where p is the number of pairs of poles. Two-pole rotary transformers evidently utilize the whole of the armature winding with each collector ring connected to a single point, and the same is true of multipolar machines with series path windings (Vol. I., p. 276). If single connections to the collector rings are used in multipolar machines with multiple path windings, a portion only of the armature, corresponding to 360 electrical degrees, is occupied in the delivery of alternating currents, and the armature capacity is therefore not fully utilized. To fully utilize the armature in this case, each collector ring must be connected to the winding at as many points as there are pairs of poles, the points being 360 electrical degrees apart.

The capacity of a rotary transformer of this type is greater than the same machine used either as an alternator or as a continuous-current generator, and the excess capacity increases with the number of phases. This is due to the fact that the transformed current does not traverse all of the armature conductors, but takes the path from the continuous-current brushes to the alternating-current brushes in which it meets the least opposition, and the heating and armature reactions for a given output are reduced.* The ratio of transformation of the machine when operated to transform alternating currents into continuous currents may be

* Mershon, Output of Polyphase Generators, *Electrical World*, Vol. 25, p. 684.

increased by unbalancing the polyphase circuit by the introduction of unequal inductances.

Rotary transformers are also constructed with two independent armature windings, or by rigidly connecting independent machines together.

APPENDICES.

- A. THE APPLICATION OF FOURIER'S THEOREM TO ALTERNATING-CURRENT CURVES.
- B. THE CHARACTERISTIC FEATURES OF ALTERNATING-CURRENT CURVES.
- C. OSCILLATORY DISCHARGES.
- D. ELECTRICAL RESONANCE.



APPENDICES

- A. THE HISTORY OF THE UNITED STATES IN ALABAMA
- B. THE QUANTITATIVE ANALYSIS OF ALABAMA
- C. THE PHYSICAL GEOGRAPHY OF ALABAMA
- D. THE ECONOMIC GEOGRAPHY OF ALABAMA

APPENDIX A.

THE APPLICATION OF FOURIER'S SERIES TO ALTERNATING-CURRENT CURVES.

It has been stated in Section 30 of the text that alternating-current curves may be represented by a special form of Fourier's series,

$$e \text{ (or } c) = a_1 \sin a + a_3 \sin 3 a + a_5 \sin 5 a + \text{etc.} \\ + b_1 \cos a + b_3 \cos 3 a + b_5 \cos 5 a + \text{etc.},$$

but it is a matter of some labor to determine the constants a and b which apply to any particular curve. This may be done in the following manner, first assuming that an alternating-current curve has been experimentally determined and plotted in the usual manner to rectangular co-ordinates and it is desired to find the constants to be inserted in the Fourier series in order to give the equations of the curve. Divide the base of one loop of the curve into $n + 1$ equal divisions, then there will be n points between $a = 0$ and $a = 180^\circ$, which will correspond to $\Delta a = \left(\frac{180}{n + 1}\right)^\circ$, $2 \Delta a = \left(\frac{2 \times 180}{n + 1}\right)^\circ$, etc., and the abscissa of any of the points may be represented in general by $k \Delta a = \left(\frac{k 180}{n + 1}\right)^\circ$. Corresponding to each abscissa there will be an ordinate which represents a value of e (or c), which may be called e_k (or c_k). Substituting in the original equation gives

$$e_k \text{ (or } c_k) \\ = a_1 \sin \left(\frac{k 180}{n + 1}\right)^\circ + a_3 \sin 3 \left(\frac{k 180}{n + 1}\right)^\circ + a_5 \sin 5 \left(\frac{k 180}{n + 1}\right)^\circ + \text{etc.} \\ + b_1 \cos \left(\frac{k 180}{n + 1}\right)^\circ + b_3 \cos 3 \left(\frac{k 180}{n + 1}\right)^\circ + b_5 \cos 5 \left(\frac{k 180}{n + 1}\right)^\circ + \text{etc.}$$

By giving k successive numerical values from unity to n , there are found n equations of the first degree from which the values of a_1, a_3, a_5 , etc., b_1, b_3, b_5 , etc. to n terms, may be determined by the usual algebraic methods. Putting m as a general subscript for a or b , then

$$a_m = \frac{2}{n+1} \left[e_1 \sin \left(m \frac{180}{n+1} \right)^\circ + e_2 \sin \left(2m \frac{180}{n+1} \right)^\circ + \dots + e_n \sin \left(nm \frac{180}{n+1} \right)^\circ \right],$$

$$b_m = \frac{2}{n+1} \left[e_1 \cos \left(m \frac{180}{n+1} \right)^\circ + e_2 \cos \left(2m \frac{180}{n+1} \right)^\circ + \dots + e_n \cos \left(nm \frac{180}{n+1} \right)^\circ \right].$$

These expressions may be written for convenience

$$a_m = \frac{2}{n+1} \sum_{k=1}^{k=n} e \sin \left(km \frac{180}{n+1} \right)^\circ, \quad b_m = \frac{2}{n+1} \sum_{k=1}^{k=n} e \cos \left(km \frac{180}{n+1} \right)^\circ.$$

The pressure wave of an alternator is represented by the heavy line of Fig. A, and the constants of Fourier's series for

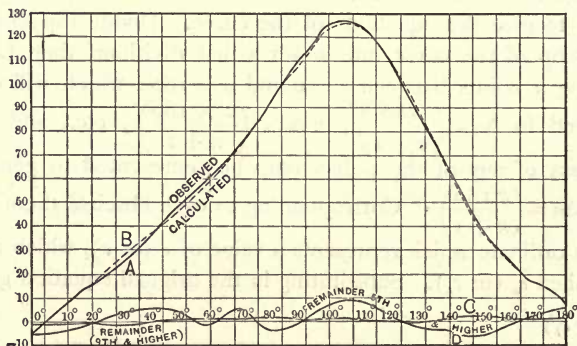

Fig. A

this curve have been determined up to the seventh harmonic, giving the values

$$\begin{array}{ll}
 a_1 = + 98.6, & b_1 = - 14.7, \\
 a_3 = - 13.3, & b_3 = + 18.2, \\
 a_5 = - 1.6, & b_5 = - 4.8, \\
 a_7 = + .25, & b_7 = + 1.2.
 \end{array}$$

The equation for the curves as determined by this means is

$$\begin{aligned}
 e = & 98.6 \sin a - 13.3 \sin 3 a - 1.6 \sin 5 a + .25 \sin 7 a \\
 & - 14.7 \cos a + 18.2 \cos 3 a - 4.8 \cos 5 a + 1.2 \cos 7 a.
 \end{aligned}$$

Substituting various values of a in this equation, the corresponding values of e are given, and the corresponding curve, which is dotted, has been plotted in the figure. It will be noticed that the calculated curve crosses the original in seven points, and very closely approximates to its exact form. If a larger number of constants had been determined, the calculated curve would have crossed the original curve a proportionally larger number of times, and the approximation would have been still closer. The number of times the calculated curve crosses the original curve is equal to n , and consequently the calculated curve cannot exactly coincide with the original curve unless $n = \infty$. The series used is rapidly convergent, and in this particular curve the effect of the fifth and seventh harmonics is quite small, and the curve is sufficiently well represented for practical purposes by the fundamental and third harmonics, in which case the equation is

$$\begin{aligned}
 e = & 98.6 \sin a - 13.3 \sin 3 a \\
 & - 14.7 \cos a + 18.2 \cos 3 a.
 \end{aligned}$$

The corresponding sine and cosine terms of the series

$$\left. \begin{array}{l} a_1 \sin a \\ + b_1 \cos a \end{array} \right\} + \left\{ \begin{array}{l} a_3 \sin 3 a \\ + b_3 \cos 3 a \end{array} \right\} + \left\{ \begin{array}{l} a_5 \sin 5 a \\ + b_5 \cos 5 a \end{array} \right\} + \left\{ \begin{array}{l} + \text{etc.}, \\ + \text{etc.} \end{array} \right.$$

may be conceived as representing the rectangular sine components of the terms of a single sine or cosine curve. This is illustrated in Fig. *B*, from which it is evident that

$$a_m \sin ma \pm b_m \cos ma = c_m \sin (ma + \theta_m)$$

or
$$a_m \sin ma \pm b_m \cos ma = c_m \cos (ma - \theta_m').$$

Where $c_m = \sqrt{a_m^2 + b_m^2}$, and $\tan \theta_m = \frac{b_m}{a_m}$ or $\tan \theta_m' = \frac{a_m}{b_m}$.

Substitution gives

$$\begin{aligned} e &= c_1 \sin (a + \theta_1) + c_3 \sin (3a + \theta_3) + c_5 \sin (5a + \theta_5) + \text{etc.} \\ &= c_1 \cos (a - \theta_1') + c_3 \cos (3a - \theta_3') + c_5 \cos (5a - \theta_5') + \text{etc.} \end{aligned}$$

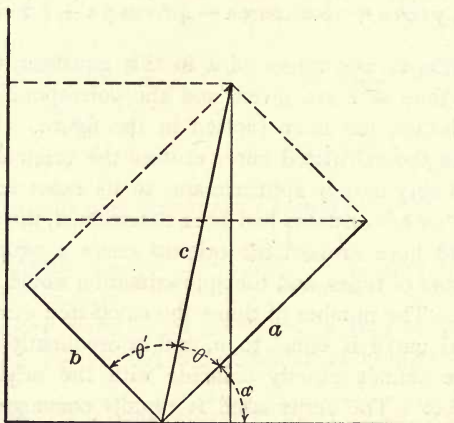

Fig. B

The equation given previously, when reduced to this form (using θ), has the following constants :

| | |
|---------------|------------------------------|
| $c_1 = 99.7,$ | $\theta_1 = - 8^\circ 29',$ |
| $c_3 = 22.5,$ | $\theta_3 = - 53^\circ 50',$ |
| $c_5 = 5.1,$ | $\theta_5 = + 71^\circ 34',$ |
| $c_7 = 1.2,$ | $\theta_7 = + 78^\circ 34',$ |

and the equation is

$$\begin{aligned} e &= 99.7 \sin (a - 8^\circ 29') - 22.5 \sin (3a - 53^\circ 50') \\ &\quad - 5.1 \sin (5a + 71^\circ 34') + 1.2 \sin (7a + 78^\circ 34'), \end{aligned}$$

and its value to a considerable degree of approximation is

$$e = 99.7 \sin (a - 8^\circ 29') - 22.5 \sin (3a - 53^\circ 50').$$

Following are examples of the calculation of the constants of these equations :

$$n = 7, \quad n + 1 = 8, \quad \left(\frac{180}{n + 1} \right)^\circ = 22^\circ \frac{1}{2}.$$

Values of e from curve :

$$e_1 = 18, \quad e_3 = 70, \quad e_5 = 125, \quad e_7 = 30.$$

$$e_2 = 42, \quad e_4 = 110, \quad e_6 = 80,$$

$$a_1 = \frac{1}{4} \{ 18 \sin 22^\circ \frac{1}{2} + 42 \sin 45^\circ + 70 \sin 67^\circ \frac{1}{2} + \dots \\ + 30 \sin 157^\circ \frac{1}{2} \} = 98.6,$$

$$a_3 = \frac{1}{4} \{ 18 \sin 67^\circ \frac{1}{2} + 42 \sin 135^\circ + 70 \sin 202^\circ \frac{1}{2} + \dots \\ + 30 \sin 112^\circ \frac{1}{2} \} = -13.3,$$

$$b_3 = \frac{1}{4} \{ 18 \cos 67^\circ \frac{1}{2} + 42 \cos 135^\circ + 70 \cos 202^\circ \frac{1}{2} + \dots \\ + 30 \cos 112^\circ \frac{1}{2} \} = 18.2.$$

$$c_3 = \sqrt{a_3^2 + b_3^2} = 22.5, \quad \theta_3 = \tan^{-1} \frac{b_3}{a_3} = -53^\circ 50'.$$

The effective ordinate of an alternating-current curve may be determined by integrating directly from its equation. The effective value squared is

$$E^2 = \frac{1}{\pi} \sum_0^\pi e^2 = \frac{1}{\pi} \int_0^\pi e^2 da \\ = \frac{1}{\pi} \int_0^\pi (a_1 \sin a + a_3 \sin 3a + \text{etc.} + b_1 \cos a + b_3 \cos 3a + \text{etc.})^2 da,$$

and since

$$\int_0^\pi \sin ma \sin n a da, \quad \int_0^\pi \sin ma \cos m a da, \quad \int_0^\pi \cos ma \cos n a da$$

are each equal to zero when m and n are unequal integers, there results

$$E^2 = \frac{1}{\pi} \int_0^\pi e^2 da = \frac{a_1^2}{\pi} \int_0^\pi \sin^2 a da + \frac{a_3^2}{\pi} \int_0^\pi \sin^2 3 a da \\ + \frac{a_5^2}{\pi} \int_0^\pi \sin^2 5 a da + \text{etc.} + \frac{b_1^2}{\pi} \int_0^\pi \cos^2 a da \\ + \frac{b_3^2}{\pi} \int_0^\pi \cos^2 3 a da + \frac{b_5^2}{\pi} \int_0^\pi \cos^2 5 a da + \text{etc.}$$

But $\int_0^\pi \sin^2 mada$ and $\int_0^\pi \cos^2 mada$ are always equal to $\frac{\pi}{2}$;

hence $E^2 = \frac{a_1^2}{2} + \frac{a_3^2}{2} + \frac{a_5^2}{2} + \text{etc.} + \frac{b_1^2}{2} + \frac{b_3^2}{2} + \frac{b_5^2}{2} + \text{etc.}$,

and
$$E = \left\{ \sum_{k=1}^{k=n} \frac{a^2}{2} + \sum_{k=1}^{k=n} \frac{b^2}{2} \right\}^{\frac{1}{2}} = \left\{ \sum_{k=1}^{k=n} \frac{c^2}{2} \right\}^{\frac{1}{2}}$$

In the example which has been given, the value of E calculated from the constants up to the seventh is $E = 72.4$.

Taking the first and third constants only, gives $E = 72.3$, which is correct to a close approximation.

The value of E found by plotting the curve to polar co-ordinates is $E = 72\frac{1}{2}$.

The example which has been taken fairly represents the complexity of the average distorted waves. Some alternating-cur-

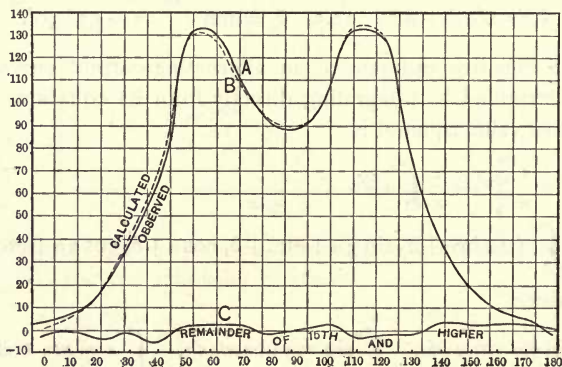

Fig. C

rent curves are so greatly distorted that a larger number of terms of the series is required to closely represent them, but for practical purposes three or four terms are always sufficient. In a large number of waves the forms are so simple that two terms of the series give ample approximation for practical purposes. Examples of waves of greater or less complexity than that already operated upon are given in figures *C*, *D*, and *E* of

this appendix and various figures of the text. Figure *C* is a curve given by Steinmetz* for which the constants up to the 13th are

| | |
|-------------------|-------------------|
| $a_1 = + 109.5$ | $b_1 = + 10.5$ |
| $a_3 = - 12.8$ | $b_3 = - 3.25$ |
| $a_5 = - 22.8$ | $b_5 = - 10.6$ |
| $a_7 = - 12.4$ | $b_7 = + 7.87$ |
| $a_9 = - .55$ | $b_9 = + .245$ |
| $a_{11} = - 2.95$ | $b_{11} = - 4.2$ |
| $a_{13} = + .595$ | $b_{13} = + 3.38$ |

The ninth and higher constants are practically negligible, so that the curve may be represented by the formula

$$e = 109.5 \sin a + -12.8 \sin 3a + -22.8 \sin 5a + -12.4 \sin 7a + 10.5 \cos a - 3.25 \cos 3a - 10.6 \cos 5a + 7.87 \cos 7a$$

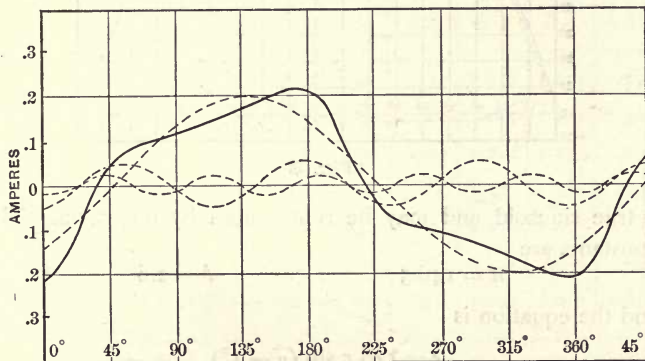

Fig. D

Figure *D* is a curve given by Fleming† after the results of tests by Merritt and Ryan. Its equation is

$$e = .196 \sin (a - 48^\circ 55') + .048 \sin (3a - 76^\circ 50') + .016 \sin (5a - 90^\circ)$$

* *Trans. Amer. Inst. E. E.*, Vol. 12, p. 476.

† Fleming's *Alternate Current Transformer in Theory and Practice*, Vol. II., p. 454.

$$a_1 = +.129$$

$$b_1 = -.148$$

$$a_3 = +.011$$

$$b_3 = -.047$$

$$a_5 = 0$$

$$b_5 = -.016$$

The component sinusoids of this curve are given in the figure. Figure *E* is another curve given by Steinmetz, which is almost

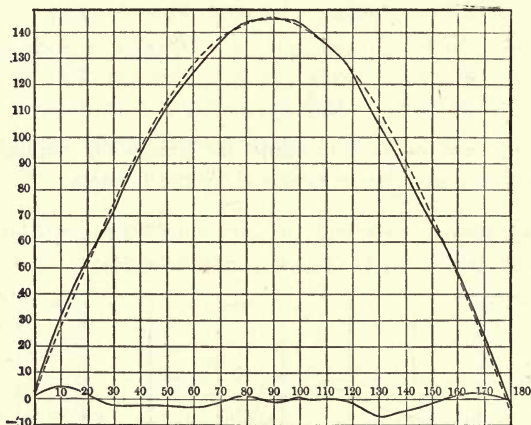

Fig. E

a true sinusoid and may be represented by one term. The constants are

$$a = 146.5$$

$$b = 2.6$$

and the equation is

$$e = 146.5 \sin(a - 1^\circ).$$

The errors of observation in experimentally determining such a curve are greater than the deviations of this curve from a sinusoid, so that its equation may properly be written

$$e = 146.5 \sin a.$$

A theoretical discussion of Fourier's series will be found in the first three chapters of Byerly's *Fourier's Series and Spherical Harmonics*; and the following articles are of considerable

interest in this connection: Periodic Functions Developed in Fourier Series; The Graphical Method, by Professor John Perry, *London Electrician*, Vol. 35, p. 285; Wave Form Synthesis, *London Electrician*, Vol. 35, p. 257.

APPENDIX B.

CHARACTERISTIC FEATURES OF DIFFERENT FORMS OF ALTERNATING-CURRENT AND PRESSURE CURVES.

| Name of Curve. | Figure in Text. | Ratio of Average to Maximum Value. | Ratio of Effective to Maximum Value. | Ratio of Maximum to Effective Value. | Ratio of Effective to Average Value. | Area of Squared Curve corresponding to Unit Maximum Value. |
|---------------------------|-----------------|------------------------------------|--------------------------------------|--------------------------------------|--------------------------------------|--|
| Triangle | 119 | .500 | .577 | 1.732 | 1.155 | .333 |
| Approximate Sinusoid . . | — | .637 | .707 | 1.414 | 1.112 | .500 |
| Sinusoid | 120 | .637 | .707 | 1.414 | 1.112 | .500 |
| Parabolic Curve | 123 | .666 | .730 | 1.369 | 1.096 | .533 |
| Semicircle | — | .785 | .835 | 1.198 | 1.063 | .697 |
| Approximate Rectangle . . | 122 | .856 | .889 | 1.124 | 1.038 | .791 |
| Rectangle | 121 | 1.000 | 1.000 | 1.000 | 1.000 | 1.000 |

APPENDIX C.

OSCILLATORY DISCHARGES.

The discharge of a condenser in a circuit containing resistance is considered in Section 31 and following sections of the text, and the mutually neutralizing effect of self-inductance and capacity is fully explained in later sections. The con-

ditions brought about by the discharge of a condenser through an inductive circuit are not entered upon in the text, and as they have some incidental interest to the electrical engineer they will be explained here.

If a condenser of capacity s , charged to a difference of potential or electric pressure E , be introduced into an electric circuit, it will at once discharge; that is, it will send a current through the circuit and thus bring the difference of potential of its plates to zero. At any instant the electrical pressure in the circuit will be

$$e = L \frac{dc}{dt} + cR,$$

where L and R are the self-inductance and resistance of the circuit. From the fundamental definition of a condenser,

$$e = \frac{q}{s} \quad \text{and} \quad c = -\frac{dq}{dt},$$

q representing the quantity of electricity in the condenser at any instant during the discharge, when the electrical pressure is e , and the current c . Substituting these values gives

$$\frac{q}{s} = -L \frac{d^2q}{dt^2} - \frac{dq}{dt} R,$$

or

$$\frac{d^2q}{dt^2} + \frac{R}{L} \frac{dq}{dt} + \frac{q}{Ls} = 0.$$

In order to find the value of the quantity of electricity in the condenser at any instant, and thus determine the rate at which the condenser discharges, this equation must be solved by integration.* The characteristic equation is

$$x^2 + \frac{Rx}{L} + \frac{1}{Ls} = 0,$$

and the roots of this determine the form of the solution. As this is a quadratic equation, it may have either two real or two

* Price's *Calculus*, Vol. II., p. 458; Forsyth's *Differential Equations*, p. 86.

imaginary roots depending upon circumstances; these roots are

$$x_1 = -\frac{R}{2L} + \sqrt{\frac{1}{4} \frac{R^2}{L^2} - \frac{1}{Ls}},$$

$$x_2 = -\frac{R}{2L} - \sqrt{\frac{1}{4} \frac{R^2}{L^2} - \frac{1}{Ls}}.$$

It is evident that the roots are real when

$$\frac{1}{4} \frac{R^2}{L^2} \geq \frac{1}{Ls} \quad \text{or} \quad R^2 > \frac{4L}{s};$$

and that they are imaginary when

$$R^2 < \frac{4L}{s}.$$

In the first case the solution takes the form

$$q = A\epsilon^{x_1 t} + B\epsilon^{x_2 t},$$

and

$$c = -\frac{dq}{dt} = -Ax_1\epsilon^{x_1 t} - Bx_2\epsilon^{x_2 t},$$

where A and B are constants which must be found by substituting the value of zero for t , in which case $q = Q$, and $c = 0$. Whence,

$$Q = A + B, \quad \text{and} \quad Ax_1 + Bx_2 = 0,$$

from which

$$A = -\frac{Qx_2}{x_1 - x_2}, \quad \text{and} \quad B = \frac{Qx_1}{x_1 - x_2}.$$

Hence

$$q = \frac{Q}{x_1 - x_2} (x_1\epsilon^{x_2 t} - x_2\epsilon^{x_1 t})$$

and

$$c = -\frac{dq}{dt} = \frac{x_1 x_2}{x_1 - x_2} Q (\epsilon^{x_1 t} - \epsilon^{x_2 t})$$

$$- \frac{Q}{2Ls \sqrt{\frac{R^2}{4L^2} - \frac{1}{Ls}}} \left[\epsilon^{(-\frac{R}{2L} + \sqrt{\frac{1}{4} \frac{R^2}{L^2} - \frac{1}{Ls}})t} - \epsilon^{(-\frac{R}{2L} - \sqrt{\frac{1}{4} \frac{R^2}{L^2} - \frac{1}{Ls}})t} \right]$$

These equations show that q and c never fall to zero, but gradually decrease according to a logarithmic function as t increases.

The time constant of the circuit decreases as $\frac{1}{4} \frac{R^2}{L^2}$ approaches $\frac{1}{Ls}$ in value and is a minimum of $\frac{1}{2} sR$ when they are equal.*

When $R^2 < \frac{4L}{s}$ the roots are imaginary, and if i be taken to indicate the imaginary unit $\sqrt{-1}$,

$$x_1 = -\frac{R}{2L} + i \sqrt{\frac{1}{Ls} - \frac{1}{4} \frac{R^2}{L^2}}$$

$$x_2 = -\frac{R}{2L} - i \sqrt{\frac{1}{Ls} - \frac{1}{4} \frac{R^2}{L^2}}$$

Inserting these values in the formulas for q and c and reducing to trigonometrical forms, the equations become

$$q = \epsilon^{-\frac{tR}{2L}} \left\{ C \cos t \sqrt{\frac{1}{Ls} - \frac{R^2}{4L^2}} + D \sin t \sqrt{\frac{1}{Ls} - \frac{R^2}{4L^2}} \right\}$$

$$c = \frac{Q}{Ls \sqrt{\frac{1}{Ls} - \frac{R^2}{4L^2}}} \epsilon^{-\frac{tR}{2L}} \sin t \sqrt{\frac{1}{Ls} - \frac{R^2}{4L^2}}$$

From these formulas we see that when the roots of the differential equations are imaginary, q and c are periodic functions which have alternately positive and negative values, so that the discharge is an oscillatory one. In other words, when the condenser is discharged, during the first flow of current a certain amount of energy has been stored in the magnetic field and in the return of this to the circuit the condenser is charged up in the opposite direction. This is repeated over and over again with incredible rapidity but with decreasing intensity, until the total energy of the original charge is dissipated in overcoming the resistance of the circuit. The current passes through one complete period while $t \sqrt{\frac{1}{Ls} - \frac{R^2}{4L^2}}$ passes through all values from 0 to 2π and therefore the period $T = \frac{2\pi}{\sqrt{\frac{1}{Ls} - \frac{R^2}{L^2}}}$, and if

* Lodge, On the Influence of Self-induction on the Rate of Discharge of a Condenser, *Lond. Electrician*, Vol. 21, p. 39.

R is very small compared with L this becomes $T = 2\pi\sqrt{Ls}$. The period of oscillation set up in any circuit may therefore be controlled by increasing L . By this means Professor Lodge succeeded in getting periods a considerable fraction of a second in length, but in general the discharge of a condenser may be said to be practically instantaneous. If iron cores are used in self-inductance coils for use with oscillating discharges they must be very finely subdivided, or the excessive foucault currents set up in the outer layers of the cores screen the inner parts from any magnetic effects.

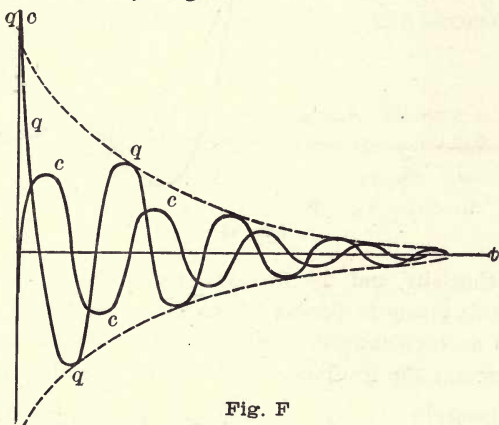

Fig. F

The formulas for the discharge of a condenser, through an inductive circuit, apply equally well to the charging current, which may be logarithmic or oscillating depending upon whether $\frac{R^2}{4L^2} > \frac{1}{Ls}$. Figure *F* shows the dying away of the charge and the oscillations of the discharge current in an oscillating circuit. The curve which touches the maximum points of the quantity curve is logarithmic, and a similar curve similarly touching the current curve would be logarithmic. Figure *G* shows the growth and dying away of a current due to a transient pressure in an oscillating circuit. Figure *H* shows the curve of discharge and of the discharging current in a non-oscillating circuit.

The oscillating electric circuit may be likened to a pendulum or an oscillating spring (Fig. *I*). Such a spring will have a period of vibration dependent upon the mass (inertia) of its

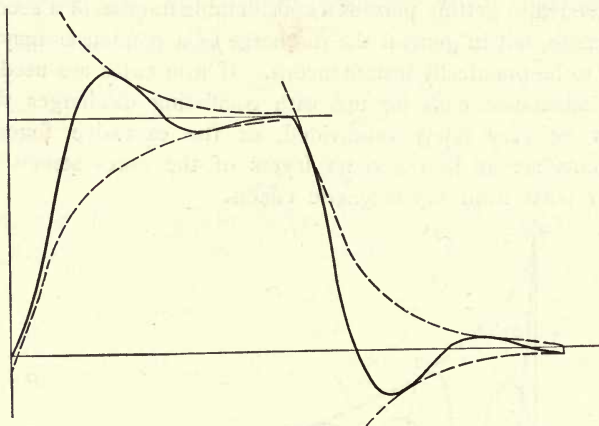

Fig. G

load, its elasticity, and the frictional resistance to its motion. The formula giving its period is exactly similar to that for the period of an oscillating discharge, putting mass for self-inductance, friction for resistance, and the reciprocal of elasticity

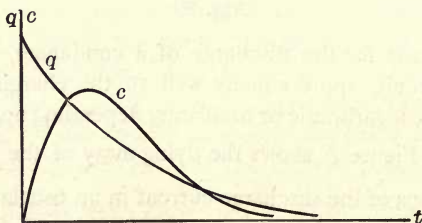

Fig. H

(compressibility) for capacity. When the spring stands at its neutral point it is analogous to the condenser when discharged. Extending or compressing the spring is equivalent to charging the condenser. If the resistance to motion is small and the

extended spring is released, it will oscillate through decreasing distances with an isochronous period until the energy stored in the spring by its extension is used up in overcoming the frictional resistance to its motion. If the resistance to its motion is increased, its period will be lengthened and the number of oscillations decreased. While if the resistance is made sufficiently great (as for instance, if the spring is immersed in syrup) the motion will be dead beat. This condition is analogous to the electric discharge in a circuit in which

$$\frac{R^2}{4L^2} > \frac{1}{Ls}$$

This subject is treated at great length in Fleming's *Alternate Current Transformers*, Vol. I, p. 364, *et seq.*; Bedell and Crehore's *Alternating Currents*, Chaps. 7 and 8; and Gerard's *Leçons sur l'Électricité*, 3d ed., Vol. I, p. 253, *et seq.*



Fig. I

APPENDIX D.

ELECTRICAL RESONANCE.

The deductions of Chapters III. and IV. of the text have shown very clearly that self-inductance and capacity in a circuit may be made to neutralize each other when a sinusoidal alternating pressure is applied to the circuit, and the self-inductance and capacity are constant. In this case the self-inductance and capacity act in opposition, so that at each instant energy is being stored or released in the magnetic field at exactly the same rate as energy is being released or stored in the charge of the condenser. The self-inductance and capacity may therefore be said to supply each other's demands, and the pressure impressed on the circuit may be wholly utilized in doing work on a non-reactive receiver, such as incandescent lamps, and in heating the wires of the circuit.

The actual energy which is transferred back and forth between the self-inductance and capacity may be many times as great as that given to the circuit by the generator, and the pressure at the terminals of the self-inductance and of the condenser must then be proportionally greater than that of the generator.

This condition can exist only when $2\pi fL = \frac{I}{2\pi fs}$ * or $Ls = \frac{I}{4\pi^2 f^2}$, and when $T = 2\pi\sqrt{Ls}$.† From the condition

$2\pi fL = \frac{I}{2\pi fs}$ it is seen that $\frac{I}{f} = 2\pi\sqrt{Ls}$, and $\frac{I}{f}$ is therefore equal to T , the natural period of the circuit. The natural period of discharge of the circuit is therefore exactly equal to the period of the impressed pressure, or, as we may say, to the actual rate of the electrical vibrations impressed on the circuit by the generator. This relation between the vibrations of the line and of the generator is similar to that of a vibrating tuning fork or string and its sounding board when they are in resonance, and therefore the term **Electrical Resonance** has, on account of the analogy, been applied to the electrical circuit. *An electrical circuit is said to be in resonance with an impressed pressure when the natural period of the circuit is equal to the period of the impressed pressure.* When this condition exists, the maximum current is caused to flow in the circuit by the application of a given impressed pressure, the value of the current in a resonant circuit from which no external work is supplied being

$$C = \frac{E}{\sqrt{R^2 + \left(2\pi fL - \frac{I}{2\pi fs}\right)^2}} = \frac{E}{R}, \text{ since } 2\pi fL = \frac{I}{2\pi fs}.$$

If the self-inductance and capacity are in series in the circuit, it is evident that when the circuit and applied pressure are in resonance the pressure between the terminals of the capacity, $= \left(\frac{C}{2\pi fs}\right)$,‡ is a maximum, since the circuit current is a maxi-

* *Text*, Chapters III. and IV. † Appendix C. ‡ *Text*, Section 33.

num. If either the frequency, the self-inductance, or the capacity is changed in value, the value of the current falls, and the condenser pressure falls, unless the other elements are changed in value in such a way as to continue the condition of resonance. A condenser in a resonant circuit may be used as a transformer of pressure by connecting non-reactive apparatus across its terminals, as has been suggested by Blakesley,* Loppé et Bouquet,† Pupin,‡ and others.

If the self-inductance and capacity are in parallel in the circuit, the pressure at their terminals cannot be greater than that impressed upon the circuit minus the loss of pressure in the lead wires, but when the circuit is resonant, the circuit current furnished by the generator is at a maximum which is equal to $\frac{E}{R}$, while the current transferred between the inductance and capacity is also a maximum which may be a great many times as great as the maximum value of the generator current.

Resonant circuits in the hands of renowned experimenters such as Hertz, Lodge, and others have produced remarkable results, which have led to great advances in our knowledge of electricity, while mathematical analysis of such circuits has led to further discoveries. These results have caused some to expect remarkable effects to be gained from the use of resonant circuits (or *tuned circuits*, as they are sometimes called) for the purposes of the electrical transmission of power. Circuits which are installed for the transmission of energy over considerable distances (whether the wires are overhead or underground) always contain capacity and self-inductance § distributed along their length. It would be possible in such lines to adjust the capacity and self-inductance so as to give resonance, and the results to be gained from so doing may be examined through analogy.

* Blakesley's *Alternating Current of Electricity*, 2d ed., p. 53.

† Loppé et Bouquet's *Courants Alternatifs Industriels*, p. 77.

‡ Pupin, *Trans. Amer. Inst. E. E.*, Vol. 10., p. 382.

§ *Text*, Section 47.

A mechanical analogue of a resonant circuit is shown in Fig. *J*. This consists of a tube fitted with two plungers and filled with a perfectly elastic fluid. The properties of this fluid may be used to represent electrical quantities according to the analogies; fluid velocity—electric current; fluid pressure—electric pressure; inertia—self-inductance; compressibility*—capacity; frictional resistance—electrical resistance. Now suppose the fluid to be without inertia and perfectly incompressible; then if plunger *A* be moved toward *D*, a uniform

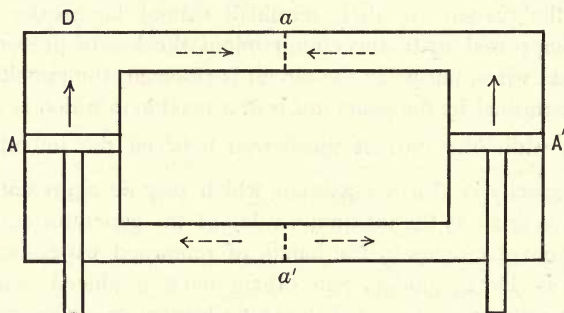

Fig. J

current will be instantly set up in the whole tube, the velocity of which is equal (in proper units) to the pressure applied to the plunger divided by the frictional resistance. If plunger *A* is caused to move up and down harmonically, the other plunger will have an exactly equal synchronous harmonic motion. This is exactly analogous to the state of an electric circuit without inductance or capacity. Figure *K* shows diagrammatically the state of the circuit, where the distance of the broken line from the heavy line is equal to the current at each point, and the light line shows the gradual fall of pressure between *A* and *A'*, caused by the resistance, and the sudden fall of pressure at *A'*, caused by the external work done by plunger *A'*.

* Compressibility of a fluid is the ratio of compression (change of volume) to the pressure producing it, and electrical capacity is the ratio of the charge (change of quantity) to the electrical pressure producing it.

If the fluid be compressible but have no inertia, it is evident that the motion of the plunger at A' will be less than that at A , which is analogous to the decadence of current as it flows along a circuit having capacity, due to the quantity of

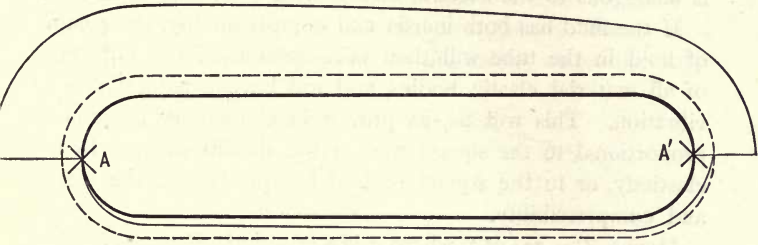

Fig. K

electricity entering into the static charge. The movements of the plungers are isochronous but not in synchronism. In this case the motion of the plunger A will exert its maximum pressure when the fluid is most compressed, or at the end of

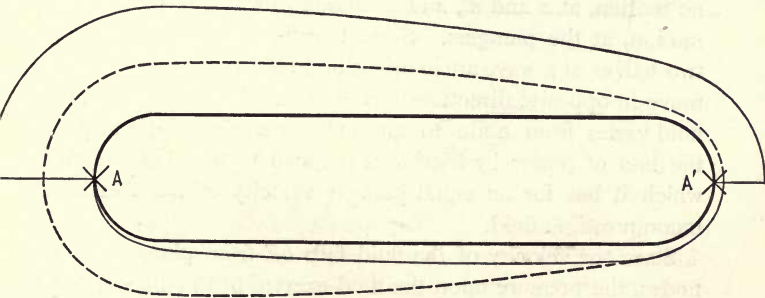

Fig. L

its stroke where its velocity is least. Hence the velocity (current), which is greatest at the middle of the stroke, leads the pressure by 90° of phase. The electric circuit corresponding to this is shown in Fig. L .

If the fluid has inertia but is incompressible, the velocity at A and A' will be equal, or the current through the circuit

will be uniform, but the pressure exerted upon piston A must be greatest where the acceleration is greatest, which is at the beginning of the stroke where the velocity is least. Consequently the current lags behind the pressure by 90° . This is analogous to the electric circuit with self-inductance only.

If the fluid has both inertia and compressibility, the column of fluid in the tube will then take upon itself the properties of all material elastic bodies, and will have a natural rate of vibration. This will be, as proven in elementary mechanics, proportional to the square root of the density divided by the elasticity, or to the square root of the product of the inertia and compressibility.

Hence $T = a\sqrt{MK}$ where a is a constant, M mass, K compressibility, and T time of vibration. In this case if the plunger A (Fig. J) be moved with a sinusoidal velocity of period T , the fluid will be thrown into vibrations which require one complete traversal of the circuit to make a wave length. Hence if there is no power taken from the circuit there are nodes, or points of no motion, at a and a' , and antinodes, or points of maximum motion, at the plungers. Since the direction of motion in the two halves of a wave are in opposite directions, the two plungers move in opposite directions in the tube. As the velocity of the fluid varies from node to antinode as a sinusoidal function, the loss of power by friction is reduced to one-half the value which it has for an equal plunger velocity in the inertialess, incompressible fluid.

Since the velocity of the fluid falls off from plungers to the nodes, the pressure upon the fluid exerted by the plungers must be proportionally multiplied at the nodes, in order that the same power may be transmitted there as was applied at the prime plunger A . The condition of pressure and velocity is diagrammatically represented in Fig. M . If power is transferred to an outside object by plunger A' , it is impossible for the velocity at the nodal points to be zero, but it must be sufficiently great to transfer the power through the nodal point with the

pressure at that point. The relative motions of the plungers, under the conditions here cited, require that *the power be transferred from one to the other wholly through its absorption and redelivery by the fluid through the effects of inertia and elasticity*. The fluid must therefore have a sufficient mass so that, at the slow velocity of the nodes, its kinetic energy shall be sufficient to carry the energy in the circuit across the nodal points.

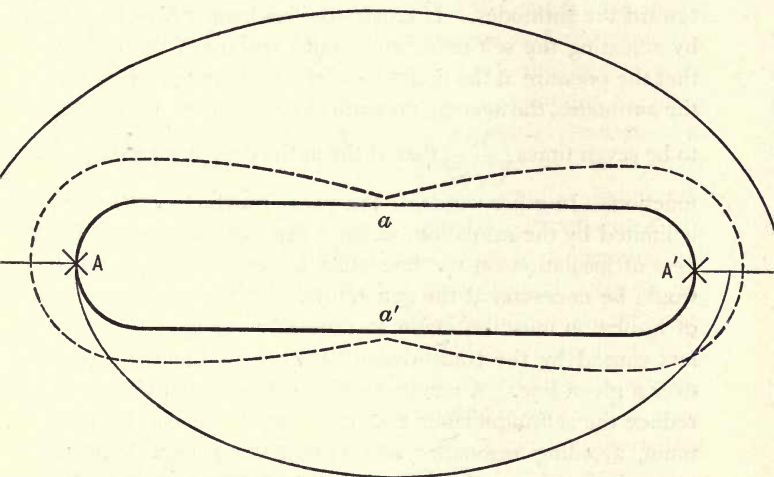

Fig. M

This analogue fully represents the conditions in the resonant electric circuit. Carrying the analogue, and the diagrammatic representation of current and pressure in Fig. *M*, in mind, it is easy to draw definite conclusions in regard to the effect of resonance on the operation of circuits for the transmission of power by currents of electricity.

The advantages of a resonant circuit for electrical transmission are then: (1) a gain of upwards of one-half of the C^2R loss that would be caused by the transmission of an equal amount of power at an equal receiving pressure over the same

circuit when out of resonance ; (2) more satisfactory regulation than would be found in a non-resonant but reactive line, since the difference in pressure between generator and receiver is equal to current times resistance instead of current times an impedance which is greater than the resistance.

The principal disadvantage of a resonant circuit for electrical transmission is : a very large excess of pressure on the line at certain points, or nodes of current, which excess decreases toward the antinodes. If satisfactory resonance is to be gained by adjusting the self-inductance and capacity of the circuit so that the pressure at the nodes is no greater than ten times that at the antinodes, the average pressure along the line must be caused to be seven times $\left(\frac{10}{\sqrt{2}}\right)$ that of the antinodes, using a sinusoidal function. In other words, if the pressure which is safe for use is limited by the insulation, we may say that the average thickness of insulation on the line must be seven times as great as would be necessary at the generators. This enormous increase of insulation must be made to save fifty per cent of the C^2R loss caused by the transmission of a certain amount of power over a given line. A much more reasonable plan would be to reduce the self-inductance and capacity of the line to a minimum, avoiding resonance and raising the generator pressure to 1.4 its previous value. Now the same power could be transferred over the line with the same resistance as before, the C^2R loss being the same as when the line was resonant, but the average strain on the insulation would be only one-fifth as great as in the resonant line.

The highest pressure which can be economically used on circuits for the electrical transmission of power over long distances is generally conceded to be set at the limit which may be properly insulated. If this is true, the preceding paragraph shows that, with equal insulation, the generator pressure may be safely made $\frac{X}{\sqrt{2}}$ times greater on a non-resonant, long-dis-

tance transmission line than that which is safe on a resonant line, where X is the ratio of the maximum pressure to the generator pressure on the resonant line. This shows that the non-resonant line would be by far the most economical for long-distance transmission of power, even if it were commercially possible to maintain resonance on service circuits. For the distribution of power over short distances, the pressure is usually quite low, and the pressure limit is not approached, so that resonance might be introduced without adding to the insulation; but the reactions of transformers and motors on the line make it practically impossible to keep the line in resonance. Similar defects are seen in the propositions for using resonant lines for various other classes of electrical transmission.

These deductions in regard to resonance have been made upon the assumption of exactly sinusoidal currents. In practice these are now seldom met, since iron-cored transformers and motors, and tooth-cored alternators, introduce distortions, and a circuit which is resonant for the fundamental wave is not resonant for its harmonics. As the question of resonance now rests, it does not present any opportunities for application in practice, nor does it enter into problems relating to ordinary electric circuits in such a way as to modify practice. In some cases of long-distance transmission of power by alternating currents with a distorted wave of pressure, the harmonics may accidentally come into resonance with the line and cause an undue strain on the insulation; but this is readily guarded against by using a generator which generates an approximate sine pressure curve.

Many articles have been written upon resonance and its effects in electric circuits, but the following will serve to give a general view of the subject:—

April, 1891. Lodge, The Effect of a Condenser Introduced into an Alternate-Current Circuit, *London Electrician*, Vol. 26, p. 762.

- May, 1891. Fleming, On Some Effects of Alternating-Current Flow in Circuits having Capacity and Self-Induction, *Jour. Inst. E. E.*, Vol. 20, p. 362.
- May, 1893. Pupin, Practical Aspects of Low Frequency Electrical Resonance, *Trans. Amer. Inst. E. E.*, Vol. 10, p. 370.
- June, 1894. Anthony, Electrical Resonance as Related to the Transmission of Energy, *Electrical Engineer* (N.Y.), Vol. 17, p. 545.
- October, 1894. Blondel, Inductance des Lignes Aériennes pour Courants Alternatifs, *L'Éclairage Électrique*, Vol. I, p. 241.
- April, 1895. Houston and Kennelly, Resonance in Alternating-Current Lines, *Trans. Amer. Inst. E. E.*, Vol. 12, p. 133.

INDEX.

A.

- Active current, 117.
Active pressure, 40.
Ageing of transformer cores, 539.
All-day efficiency of transformers, 492.
Allgemeine Elektrizitäts Gesellschaft, induction motors, 620, 665.
Alternating circuit, current in, 65; power in, 109, 112; methods of measuring power in, 121.
Alternating-current curves, characteristic features of, 703.
Alternating field, resolution of, 647.
Alternations, definition, 7.
Alternator, 7; armatures, 10, 15, 16, 25, 26, 28, 31, 35, 230, 231, 232, 234, 236, 239, 243, 246, 366; characteristics, 266; design, 239; dimensions, 13, 224; efficiency, 370; field excitation, 8, 251, 268, 362; leakage coefficient, 233; losses, 221; copper losses, 223, 226; foucault current losses, 227; hysteresis losses, 228; rectifying commutator, 259; testing, 371.
Alternators, 7; as synchronous motors, 571; combined output of, 322; inductor, 33; in parallel, 326; in series, 322; on separate feeders, 336.
American transformers, tests of, 504.
Amperemeter (three) method of measuring power, 127.
Amperemeters, alternating current, 267, 277.
Ampere-turns on field of induction motor, 631.
Analytical method of solving problems, 208, 217.
Angle of lag, 42, 111; method of measuring, 111.
Apparent energy, 116; resistance, 71; watts, 116.
Arago disc, 596.
Areas of successive loops of alternating-current curves, 306.
Armature, action of short-circuited in rotary field, 595; calculation of alternators, 239; classification, 15; collectors, 31, 32; commutated in induction motors, 624; conductors of alternator, 232; conductors, differential action of alternator, 10; conductors, number of alternator, 234; conductors, number of alternator, maximum, 236; current and excitation, relation in synchronous motors, 582; disc, 26; drum, 16; insulating and core materials, 35; pole, 29; poly-phase, connections of, 393; pressure, alternator, 1, 9; pressure induction motors, 631; radiating surface, 231, 637; reactions in alternators, 246, 250; reactions, effect on parallel operation, 360; reactions of poly-phasers, 387; resistance in starting induction motors, 622; self-inductance, 243, 349, 368, 581, 641; ventilation, 230; winding, 15, 612.
Arrangement of conductors in transformer windings, 531.
Auto-transformer, 545; for starting induction motors, 621.
Average pressure or current, 4, 9.
Ayrton, testing alternators, 377; tracing curves, 301.

- Ayrton and Perry's inductance standard, 98, 420; secohmmeter, 105, 415, 416, 419.
- Ayrton and Sumpner, transformer testing, 487.
- B.**
- Balanced poly-phase systems, 547.
- Ballistic galvanometer, 57.
- Ballistic method of tracing curves, 289.
- Bedell's contact maker, 302; test of hedgehog transformer, 495; tracing curves, 300.
- Bedell and Ryan, synchronous motor experiments, 586.
- Blakesley, measurement of power, 112, 128, 129; split dynamometer, 128, 483.
- Blondel, contact maker, 301; tracing curves, 305.
- Booster, 542.
- Brown, C. E. L., induction motors, 660; parallel operation of alternators, 361.
- C.**
- Calculation of core and windings for impedance coils, 541; for induction motors, 633; for transformers, 519.
- Calculation of losses, regulation, exciting current, and efficiencies of induction motors, 629, 633, 640, 641; of transformers, 461, 492, 523, 527, 529, 530, 538.
- Calorimetric method of testing transformers, 481.
- Capacity, 78; and self-inductance combined, 88, 89, 703, 709; effect on regulation of transformers, 439; pressure, 80, 164; required for Stanley motor, 669.
- Capacity circuit, 178; time constant of, 83.
- Carey Foster's method of measuring mutual induction, 409.
- Characteristics, alternator, 266; curve of magnetization, 266; distribution curve, 278; external, 272; loss line, 275.
- Checks on transformer design, 531.
- Choking coils, 541.
- Circuits in parallel, 57, 72, 175, 193, 196; in series, 72, 159, 171, 196.
- Circumferential velocity, 13, 230, 634.
- Coefficient of leakage, 233, 429, 533, 636, 639; of mutual induction, 398; of self-induction, 43.
- Coils, embedded, 24, 601, 638; lathewound, 24.
- Coil winding, 20.
- Collector rings, 31, 32.
- Collectors, armature, 31, 32.
- Commutated winding, induction motor, 624.
- Commutator, rectifying, 259; sparking of, 262; Zipernowsky, 260.
- Compensated voltmeter, 316.
- Compensators, 543.
- Composite winding, 251, 319, 369.
- Composite-wound alternators in parallel, 369.
- Condenser, 79; circuits, 178; curves of charge and discharge of, 81; energy of charged, 81; pressure, 80, 164.
- Conducting systems, poly-phase, 546, 552, 554, 555, 556; poly-phase, balanced, 547.
- Conductors, arrangement of in transformer windings, 531.
- Constants for use in design of induction motors, 634, 635, 636, 637; of transformers, 463, 465, 467, 468, 532.
- Contact makers, 301.
- Continuous winding, 19.
- Converter, 396.
- Copper losses, calculation for transformer, 529; in alternator, 223; in alternator, table, 226; in transformer, 428, 436, 465; in transformer, effect on regulation, 436; in induction motor, 612, 619, 640.
- Core losses in alternator armature, 227, 228; in induction motor, 618, 640, 651, 670; in transformer, 436, 452, 456, 461, 523, 527; in transformer are independent of load, 488; separation of, in alternator, 372; in transformer, 500.
- Core materials, 38, 539, 633.
- Core of transformer, ageing, 539.
- Corrections for wattmeter, 131.
- Cost *vs.* output in alternators, 383.

- Current, active, 117.
 Current and pressure curves, tracing of, 289.
 Current and pressure relations, in induction motors, 603; in poly-phase systems, 555; in synchronous motors, 575; in transformers, 404, 440.
 Current, determination of effective, 309; distribution of, in a wire, 144; exciting, of induction motors, 629; of transformers, 431, 530; in capacity circuit, 85; in inductive circuit, 65; magnetizing, 433; of induction motors, 601, 630; of transformers, 433, 530; relations in transformer, 434; rushes in inductive circuit, 540; summation zero in poly-phase circuits, 554; wattless, 117.
 Current density, in armature conductors, 232, 640; in collectors, 32; in field windings, 233, 637; in transformer windings, 468.
 Curve, resolution of, 75, 695.
 Curve of alternator efficiency, 384, 385; of motor efficiency, 657, 658, 659, 660, 664, 665, 670, 671; of transformer efficiency, 498.
 Curve of magnetization, 266.
 Curve of pressure, effect of form on induction motor, 678; effect of form on transformer, 517.
 Curve of squared ordinates, 309, 312.
 Curves, characteristic features of alternating-current, 703; charge and discharge of condenser, 81; of current in capacity circuit, 81; of current in inductive circuit, 53; successive areas equal, 306.
- D.**
- Delta connection, 394, 551.
 Densities, current, 33, 232, 233, 468, 637, 640; magnetic, 228, 370, 462, 635.
 Design of alternators, 239; of induction motors, 633; of transformers, 519.
 Diamond meter, 672.
 Differential action in alternator armatures, 10; in induction motors, 627, 639.
 Dimensions of alternators, 13, 224; of transformers, 534.
 Dimmer, 542.
 Direct measurement of efficiency of induction motors, 653.
 Disc armature, 26.
 Discharges, oscillatory, 703.
 Distribution of alternating current in a conductor, 144.
 Distribution of magnetism over alternator pole faces, 278.
 Divided circuits, 57, 72, 175, 193, 196.
 Double armature winding for induction motors, 620.
 Drehfelde, 595.
 Drehstrom, 595, 601.
 Drum armatures, 16.
 Duncan electro-dynamometer, 298.
 Duncan, tracing curves, 298.
- E.**
- Economy coils, 541.
 Eddy current losses, alternator, 227; induction motor, 618, 640; transformer, 432, 436, 450, 456, 461, 500, 527.
 Effect of form of pressure curve on motor operation, 678; on paralleling of alternators, 360; on transformer efficiency, 517.
 Effective pressure, 4, 8, 699; and current, determination of, from curves, 309.
 Efficiency curves, of alternator, 384, 385; of transformer, 498.
 Efficiency, of alternators, 370; of alternators, variation with output, 383; of induction motors, 652; of transformers, 461; of transformers, all day, 492; plant, 495; point of maximum, 500, 641; weight, of alternators, 383; weight, of induction motors, 661; weight, of transformers, 500.
 Electrical resonance, 709.
 Electricity, transfer by mutual induction, 403.
 Electro-dynamometer, Duncan, 298.
 Electro-dynamometers, 267, 277.
 Electromagnetic repulsion, 643.
 Electrometer, method of measuring power, 121.

- Electrometer, quadrant, 121; Ryan, 294.
 Electrostatic wattmeter, 124.
 Elwell-Parker alternators in parallel, 345.
 Embedded windings, 24, 601, 609, 638.
 Emerson synchronous motor, 666.
 Emmett, tables, impedances and reactances of circuits, 144; induction factors and power factors, 120; skin effect, 148.
 Energy, apparent, 116.
 Energy of charged condenser, 81; of mutual induction, 400; of self-induced magnetic field, 52.
 Equalizing connection for composite alternators in parallel, 369.
 Equivalent sinusoid, 78.
 Ewing's experiment on iron losses, 488.
 Exciter, 8, 313, 318.
 Exciting current, 431; of induction motor, 629; of transformer, 530.
 External characteristic, alternator, 272.
 Extra current, 135.
- F.**
- Factor, impedance, 143; induction, 120; power, 116.
 Features of alternating-current curves, 703.
 Ferranti alternator, 345; meter, 672; transformer, 512.
 Field, resolution of alternating, 647; rotary, 591; rotary, constant, 597; rotary, definition, 600; rotary, irregular, 593; strength in synchronous motors, 573; strength in synchronous motors, maximum power factor, 580; strength in relation to armature current in synchronous motors, 582; turns per volt in induction motors, 635; windings, alternators, 251; windings, induction motors, 614, 634, 650; windings, induction motors, differential action, 627.
 Field ampere-turns, induction motors, 631.
 Field current, wavy alternator, 268.
 Field excitation, alternator, 8, 251, 268, 362; composite, 251, 319, 369; separate, 251, 313, 321; self, 251, 320, 321.
 Field frequency, 601.
 Field induced pressure, induction motor, 625.
 Field resistance, starting induction motors, 620.
 Fleming, tracing curves, 305; transformer tests, 485, 488, 495, 511.
 Ford, transformer tests, 504.
 Form of pressure curve, influence of, 360, 517, 678, 717.
 Fort Wayne synchronous motor, 666.
 Foucault current losses, alternator, 227; induction motor, 618, 641; transformer, 432, 436, 450, 456, 461, 500, 527; calculation for transformer, 527; effect on transformer current, 456.
 Fourier's series applied to alternating curves, 75, 695.
 Frequency, 6; alternator, 7, 8, 227, 341, 665; effect of, on induction motors, 663; effect of, on parallel operation, 341; effect of, on transformers, 513.
- G.**
- Galvanometer, shunted ballistic, 57.
 Ganz & Co., regulator, 313.
 General Electric Co., alternators in parallel, 346; induction motors, 622-624, 665; monocyclic system, 673; regulators, 318.
 Gerard, tracing curves, 290.
 Gordon, alternators in parallel, 345; on parallel operation, 345.
 Graphical construction of pressure curve, 284, 285.
 Graphical determination of induction motor relations, 603; of synchronous motor relations, 575; of transformer relations, 440.
 Graphical solutions of problems, 151; in parallel circuits, 175; in parallel circuits, conclusions, 193; in series circuits, 159; in series circuits, conclusions, 171; in series and parallel circuits combined, 196.
- H.**
- Hanson and Webster, experiments on rotary field, 597.
 Hedgehog transformer, 495, 512.

- Henry, 44, 47.
 Hopkinson, testing transformers, 477;
 on parallel operation, 341.
 Hysteresis loss in alternators, 228; in
 induction motors, 618, 640; in trans-
 formers, 432, 436, 450, 455, 461, 500,
 523; in transformers, calculation of,
 523; in transformers, effect on excit-
 ing current 452.
- I.**
- Ideal induction motor, 607.
 Ideal transformer, regulation, 437.
 Idle current, 118.
 Impedance, definition, 71, 72; coils,
 541; factor, 143.
 Impedance coils in transformer circuit,
 431.
 Impressed pressure, 40.
 Impulsive current rushes, 540.
 Inductance, 42, 397.
 Inductance standards, 98, 420.
 Induction densities (see Magnetic den-
 sities).
 Induction factor, 120.
 Induction motor, armature winding,
 612, 638; design, 633; differential
 action in fields, 627, 639; effect of
 form of pressure curve, 678; effect of
 frequency, 663; efficiency, 652; excit-
 ing current, 629; field ampere-turns,
 631; field windings, 614, 625, 634,
 650; formula from transformer, 628;
 leakage, 607, 609, 633, 636, 639, 641;
 maximum load, 612; monocyclic
 system, 676; output and pressure,
 642; power factor measurement, 654;
 regulation, 655; rotary field, 591;
 single-phase, 644; single-phase, form-
 ula for, 650; slip, 601, 631; speed, 601;
 Stanley, 667; starting and regulating
 devices, 619; torque and regulation,
 655; torque diagram, 611; wattless
 current, 630; weight efficiency, 661.
 Induction motor armature, definition
 of, 600.
 Induction motor field, definition of,
 600.
 Induction motors, miscellaneous, 666.
 Inductive circuit, definition, 178; effect
 of breaking, 56, 135.
- Inductive resistance, 71.
 Inductor alternator, 33.
 Influence of form of pressure curve,
 360, 517, 678, 717.
 Instruments, 277, 382.
 Insulating materials, 35.
 International Electrical Congress, the
 henry, 44 47.
 Iron losses, constant, Ewing's experi-
 ment, 488; in alternators, 227, 228;
 in induction motors, 618, 640, 651,
 670; in transformers, 436, 452, 456,
 461, 500, 523, 527; in transformers,
 effect on regulation, 436; in trans-
 formers, relation to load, 488.
 Irregular rotary field, 593.
- J.**
- Joints in magnetic circuit of trans-
 former, 538.
 Joubert, tracing curves, 28, 291.
 Joubert's contact maker, 301.
- K.**
- Kapp alternators in parallel, 345; trans-
 former, 512.
 Kennelly, distribution of current in a
 wire, 149; impedance factor, 143.
 Kolben, design of induction motors,
 635; magnetic densities, 371.
- L.**
- Lag angle, 42; measurement of, 111.
 Lamp with impedance coil, 541.
 Lap or loop winding, 20.
 Leakage, coefficient, 233, 429, 533, 607,
 636; in alternators, 233; in induction
 motors, 607, 609, 633, 636, 639, 641;
 in transformers, 429; in transformers,
 calculation of, 533.
 Leakage current, 432.
 Load, synchronous motor maximum,
 583.
 Loop or lap winding, 20.
 Loss line, alternator, 275.
 Losses in alternators, 221; in alterna-
 tors, copper, 223, 226; in alternators,
 foucault current, 227; in alternators,
 hysteresis, 228; in induction motors,
 copper, 612, 619, 633, 640; in induc-
 tion motors, foucault current, 618,

- 640; in induction motors, hysteresis, 618, 640; in transformers, copper, 436, 465, 529; in transformers, fault current, 432, 436, 450, 456, 461, 500, 527; in transformers, hysteresis, 432, 436, 450, 455, 461, 500, 523.
- M.**
- Magnetic circuit, joints in transformer 538.
- Magnetic densities in alternator armatures, 228, 370; in induction motors, 635; in transformers, 462.
- Magnetic distribution curve, 278.
- Magnetic field, energy of self-induced, 52; rotary, 591.
- Magnetic leakage, in alternators, 233; in induction motors, 607, 609, 633, 636, 639, 641; in transformers, 429; in transformer, calculation of, 533.
- Magnetic reluctance, effect on transformer, 450, 492.
- Magnetic shunt transformer, 448.
- Magnetization curve, alternator, 266.
- Magnetization of transformer core, 433.
- Magnetizing current, 433; induction motor, 601, 630; transformer, 433, 530.
- Magneto machines, 25.
- Maximum efficiency, point of, in induction motors, 641; in transformers, 500.
- Maximum load of induction motors, 612; of synchronous motors, 583.
- Maximum output of alternators, 274.
- Maxwell, measurement of mutual inductance, 412, 416; measurement of self-inductance, 96.
- Maxwell and Rayleigh, measurement of self-inductance, 93.
- Measurement of lag angle, III; of mutual inductance, 406; of power in single-phase circuits, 121; of power in poly-phase circuits, 556; of self-inductance, 90.
- Merritt and Ryan, transformer tests, 470.
- Mershon, tracing curves, 296.
- Mesh connection, 394, 551.
- Meter, Ferranti's, 672; Scheeffer's, 672; Shallenberger's, 670; Thomson's, 673.
- Monocyclic system, 673.
- Mordey, on parallel operation, 339, 343, 358; on transformer frequency, 515; testing alternators, 375; testing transformers, 480.
- Motor-generator method of testing alternators, 379.
- Multi-phase, 387.
- Multi-phaser, 387.
- Mutual inductance, 397, 398; measurement, 406; measurement by amperemeter and voltmeter, 407; measurement by amperemeter and galvanometer, 408; measurement by comparison, 416; comparison with capacity, 409, 411; comparison with self-inductance, 412, 415; secohmmeter in measuring, 415, 416, 419.
- Mutual induction, 396; coefficient of, 398; coils with iron cores, 419; energy of, 400; of distributing circuits, 421; of poly-phase circuits, 556; transfer of electricity by, 403.
- N.**
- Neutral point, 394.
- Niven, measurement of mutual inductance, 415.
- O.**
- Oerlikon induction motors, 658, 665.
- Open-circuit current, 433.
- Oscillatory discharges, 703.
- Output proportional to square of pressure in induction motors, 642.
- Output *vs.* efficiency, weight, and cost, alternators, 383; induction motors, 661; transformers, 500.
- P.**
- Parallel, alternators in, 326.
- Parallel circuits, 57, 72, 175, 193, 196; mutual inductance of, 421; pressure and current relations, 72, 193.
- Parallel distributing circuits, mutual inductance of, 421.
- Parallel operation, 326; conclusions, 367; effect of armature reactions, 360; effect of form of pressure curve, 360; effect of frequency, 341; effect of self-inductance, 349; Elwell-Parker

- alternators in, 345; Ferranti alter-
 nators in, 345; Ganz alternators in,
 345; General Electric alternators in,
 346; Gordon alternators in, 345;
 Gordon on, 345; Hopkinson on,
 341; Kapp alternators in, 345;
 Mordey on, 339, 343, 358; regulation
 for, 362; Stanley alternators in, 345;
 Steinmetz on, 346, 349, 358; success
 of, 338; Thomson-Houston alter-
 nators in, 341; usual practice, 335;
 wattless current, 353; Westinghouse
 alternators in, 341.
- Parallel wires, self-inductance of, 140.
- Period of alternating current, 6.
- Periodicity, 7.
- Periphery velocity, 13, 230, 634.
- Permeability, effect of variable, 107;
 419, 450; on mutual inductance, 399;
 on self-inductance, 45.
- Phase, 40.
- Phase diagram, definition, 157.
- Phase indicator, 330.
- Phase-splitter, 572, 652, 688.
- Phase transformation, 686.
- Phasing current, 347.
- Pirani, measurement of mutual induc-
 tance, 411; of self-inductance, 103.
- Pitch of poles, 12.
- Plant efficiency, 495.
- Polar curves of current and pressure,
 309, 700.
- Pole armatures, 29.
- Polygon of currents or pressures, 42,
 73, 87, 151.
- Poly-phase, 387.
- Poly-phaser, 387.
- Poly-phase circuits, connecting up, 393,
 546, 548, 683; self and mutual induc-
 tion of, 556.
- Poly-phase conducting systems, 546;
 connecting up armatures, 393; ma-
 chines, 387; systems, balanced, 547;
 systems, current summation zero,
 554; systems, power uniform, 552;
 relations of currents and pressures
 in, 555.
- Poly-phase transformers, 683.
- Power factor, 116.
- Power in alternating circuit, 109, 112,
 measurement, 121; measurement by
- electrometer, 121; by electrostatic
 wattmeter, 124; by split dynamom-
 eter, 128; by three amperemeters,
 127; by three instruments, 128; by
 three voltmeters, 125; by wattmeter,
 131.
- Power in any poly-phase circuit, 566.
- Power in poly-phase system, measure-
 ment, 556; two-phase, common re-
 turn, 559; two-phase, independent
 circuits, 557; three-phase, one watt-
 meter, 564; three-phase, two watt-
 meters, 563; three-phase, three
 wattmeters, 560.
- Predetermination of losses, regulation,
 exciting current, and efficiencies of
 induction motors, 629, 633, 640, 641;
 of transformers, 461, 492, 523, 527,
 529, 530, 531, 533, 538.
- Pressure, active, 40; effective, 4, 8;
 determination of effective value from
 curve, 309; formula for induction
 motors, 625, 628, 650; formula for
 transformers, 427, 513; formula for
 alternators, 1, 9; impressed, 40; of
 alternators, form of curve, 1; of self-
 induction, 39; triangles, 42, 73, 87.
- Pressure and current relations, induc-
 tion motors, 603; poly-phase sys-
 tems, 555; synchronous motors, 575;
 transformers, 404, 440.
- Pressure curve, effect of form on in-
 duction motor, 678; effect of form
 on transformer, 517; graphical con-
 struction, 284, 285; tracing of, 289.
- Prevention of spark on breaking cir-
 cuit, 136.
- Primary coil, 404.
- Primary current wave, form of, 450.

Q.

Quadrant, 44.

Quadrant electrometer, 121.

R.

Radiating surface, armatures, 231, 640;
 fields, 232, 637; transformers, 468,
 509.

Rate of work in inductive circuit when
 current is rising or falling, 60.

Rated motor, testing alternators, 375.

- Ratio of transformation, 426, 428, 466.
 Reactance, 71, 72; coils, 541.
 Reactions, alternator armature, 246, 250, 360; induction motors, 607, 636; poly-phasers, 387.
 Reactive circuit, definition, 178.
 Reactive circuits in parallel, 57, 72, 175, 193, 196; in series, 72, 159, 171, 196.
 Rectifying commutator, 259.
 Regulating devices, alternators, 313, 321; induction motors, 619.
 Regulating for constant current, 321; pressure, 313.
 Regulation by series exciter, 318; of alternator, 313, 320, 321; of induction motor, 602, 619, 632, 639, 655; of ideal transformer, 437; of transformer, effect of losses, 436; of transformer, effect of self-inductance or capacity, 439; tests of transformers, 490.
 Regulator, Ganz and Co., 313; General Electric Co., 318; Westinghouse, 317.
 Relations of currents and pressures in poly-phase systems, 555.
 Reluctance, magnetic, of transformer core, 450, 492.
 Repulsion, electromagnetic, 643.
 Resistance, apparent, 71.
 Resistance triangles, 42, 73, 87.
 Resolution of alternating field, 647; of curves, 75, 695.
 Resonance, 709.
 Resonance analysis, 300.
 Reversing poly-phase motors, 682.
 Ring armatures, 25.
 Rise of temperature, 231, 466.
 Rotary field, 591; constancy, 597; effect on armature, 595; effect on field windings, 625; induction motor, 591; irregular, 593.
 Rotary transformers, 688.
 Rotating magnetic field, 591; irregular, 593.
 Rush of current on closing inductive circuit, 540.
 Ryan and Bedell, synchronous motor experiment, 586.
 Ryan and Merritt, testing transformers, 470.
 Ryan contact maker, 301, 302; electrometer, 294; experiment on transformer leakage, 430; tracing curves, 293; transformer curves, 460, 472.
- S.**
- Scheeffe's meter, 672.
 Searing and Hoffmann contact maker, 301.
 Secohm, 44.
 Secohmmeter, 105.
 Secondary coil, 404.
 Secondary generator, 396.
 Self-excited alternator, regulation, 320, 321.
 Self-induced field, energy of, 52.
 Self-inductance, 42, 43; and capacity combined, 88, 89, 703, 709; divided circuits, 57, 72; effect on parallel operation, 349; effect on transformer regulation, 439, 491; measurement, 90; measurement by bridge, 93; measurement, comparison with capacity, 100, 103; measurement, comparison with resistance, 90; measurement, comparison with standard self-inductance, 98; measurement, comparison of two self-inductances, 96; of alternator armature, 243, 349; of induction motor armature, 607, 622; of parallel wires, 140.
 Self-induction, 39; coefficient of, 43; pressure of, 39.
 Self-inductive circuits, current in, 65; current rushes in, 540; in parallel and series, 72; poly-phase, 556; power in, 109, 112; rate of work in, 60; rise and fall of current in, 53; time constant, 62; under sinusoidal pressure, 65; variable permeability, 45, 107.
 Separately excited alternator, regulation, 313, 321.
 Separation of foucault current and hysteresis losses, in alternators, 372; in transformers, 500.
 Series, alternators in, 322.
 Series circuits, reactive, pressure and current relations in, 72, 159, 171, 196.
 Series and parallel circuits combined, 196.

- Shop tests of alternators, 382; of transformers, 486.
- Siemens and Halske, induction motors, 622, 623, 625; tracing curves, 365.
- Single-phase, 387.
- Single-phaser, 387.
- Single-phase induction motors, 644, 650.
- Skin effect, 149.
- Slip of induction motor, 601, 631, 655.
- Snell, magnetic densities, 370.
- Sparking, commutator, 262.
- Sparking on breaking a circuit, 56, 135.
- Speed of alternators, 13, 239; of induction motors, 601, 615, 634.
- Split dynamometer, 128, 483.
- Split-phase motor, 572.
- Standard inductance, 98, 420.
- Standing torque, 656.
- Stanley alternators in parallel, 345; arc-light alternator, 269, 321; induction motors, 622, 624, 667; transformers, 475, 494, 498, 504.
- Star connection, 394, 550.
- Starting induction motors, 619, 652.
- Starting torque, 607, 656.
- Steinmetz, monocyclic system, 673; on parallel operation, 346, 349, 358.
- Step, 322.
- Stray power method of testing alternators, 375; induction motors, 653; transformers, 485.
- Surface velocity, 13, 230, 634.
- Swinburne electrostatic watt-meter, 125; hedgehog transformer, 495, 512.
- Synchronism, 322.
- Synchronizers, 329.
- Synchronizing current, 340, 349, 353.
- Synchronous motor method of testing alternators, 380.
- Synchronous motors, 571; field strength, 573, 578, 580, 582; maximum load, 583; pressure and current relations, 575; relation of armature current to excitation, 582.
- T.**
- Table, alternator copper loss, 226; alternator dimensions, 14, 224; alternator frequencies and inductions, 371; characteristic features of alternating curves, 703; dynamo dimensions, 14; efficiency, power factor, etc. of induction motors, 656; Fleming's transformer tests, 512; Ford's transformer tests, 505-508, 510; increased resistance to alternating currents, 147, 148, 149; inductions for induction motors, 635; maximum wire diameters for alternating currents, 149; number of poles for induction motors, 615; polarized relays, inductance of, 49; power and induction factors, 120; resistance, reactance, and impedance of circuits, 145; self-inductance of alternator, 52; synchronous motor overloads, 585; tests of transformers, 473, 505, 506, 507, 508, 510, 512; transformer hysteresis loss, 518; transformer dimensions, 534; weight of American induction motors, 662; weight of European induction motors, 662.
- Teeth, armature, 24; field, 638.
- Temperature of alternators, 231; of transformers, 466.
- Tesla motor, 591, 658.
- Testing alternators, 371; Ayrton's method, 377; by dynamometer, 372; Hopkinson's method, 373; Mordy's method, 375; motor-generator method, 379; rated motor method, 375; shop tests, 382; synchronous motor method, 380.
- Testing induction motors, 652; for efficiency, 653; for power factor, 654; for regulation, 655; for torque, 655.
- Testing transformers, 469; Ayrton and Sumpner's method, 487; calorimetric method, 481; for regulation, 490; Hopkinson's method, 477; Mordy's method, 480; Ryan and Merritt's method, 470; split dynamometer method, 483; stray power methods, 485; voltmeter and ammeter methods, 484; wattmeter method, 484.
- Tests of American transformers, 504.

- Thompson on weights of induction motors, 662.
- Thomson's impedance coil, 543; magnetic shunt transformer, 448; motor, 645; recording wattmeter, 673.
- Three instrument methods of measuring power, 125, 127, 128.
- Three-phase, 387, 546.
- Three-phaser, 387, 546.
- Three-phase systems, 548; mesh connection, 394, 551; power measurement, 560; star connection, 394, 550; transformers, 683, 685.
- Time constant, 63; examples, 64; of capacity circuit, 83; of inductive circuit, 62.
- Torque diagram, induction motor, 611; of ideal induction motor, 607.
- Torque of induction motors, measurement of, 655; standing, 656; starting, 656.
- Torque of synchronous motors, 580, 590, 690.
- Tracing curves, 289; Ayrton's method, 301; ballistic method, 289; Bedell's method, 300; Duncan's method, 298; Gerard's method, 290; Joubert's method, 291; Mershon's method, 296; Pupin's method, 300; Ryan's method, 293.
- Transfer of electricity in mutually inductive circuits, 403; in self-inductive circuits, 55.
- Transformation of constant pressure to constant current, 446.
- Transformation of phases, 686.
- Transformer, 396; ageing of core, 539; all-day efficiency, 492; arrangement of conductors, 531; calculations, 519; calculation of copper and core, 519; calculation of copper losses, 529; calculation of exciting current, 530; calculation of foucault current loss, 527; calculation of hysteresis loss, 523; calculation of magnetic leakage, 533; checks, 531; core losses, 461, 523, 527; core losses, separation of, 500; core magnetization, 433; copper loss, 465, 529; current density, 468; current relations, 434; curves by Ryan, 460; efficiency, 461; exciting current, 431; for poly-phase circuits, 683; formula applied to induction motor, 628; frequency, 513; functions of, 396; hedgehog, 495; magnetic densities, 462; magnetic leakage, 429, 533; magnetic leakage, Ryan's experiments, 430; magnetizing current, 433; pressure relations, 404, 440; primary coil, 404; radiating surface, 468, 509; ratio of transformation, 426, 466; regulation, 436, 437, 439; regulation tests, 490; relations determined graphically, 440; rotary, 688; secondary coil, 404; windings, 465, 468, 513, 519, 529, 531, 532.
- Triangle connection, 394, 551.
- Tri-phase, 387, 546.
- Tri-phaser, 387, 546.
- Two-phase systems, common return, 548; systems, independent, 546; systems, power measurement, 557; transformers, 684.
- Two-phase, 387, 546.
- Two-phaser, 387, 546.

U.

- Undulatory or wave winding, 18.
- Uniform rotary field, 597.

V.

- Variation in alternator exciting current, 268.
- Vector analysis applied to problems, 208.
- Vector diagram, definition, 157.
- Velocity, surface, 13, 230, 634.
- Ventilation, armature, 230.
- Voltmeter and amperemeter method of testing transformers, 484.
- Voltmeter (three) method of measuring power, 125; Westinghouse, compensated, 316.
- Voltmeters, alternating, 267, 277.

W.

- Wattless current, 117; effect on torque of synchronous motors, 590; in parallel operation, 353.
- Wattless magnetizing current, induc-

- tion motor, 601, 630; transformer, 433.
- Wattmeter, 111, 131; corrections, 131; electrostatic, 124; for high pressure, 382; for measuring power, 131; for poly-phase measurement, 556; method of testing transformers, 484; Scheffer's recording, 672; Thomson's recording, 673.
- Watts, apparent, 116.
- Wave winding, 18.
- Wavy field current in alternator, 268.
- Webster and Hanson experiments on rotary field, 597.
- Weight efficiency, alternators, 383; induction motors, 661; transformers, 500.
- Weights of induction motors, 662; of transformers, 500.
- Westinghouse compensated voltmeter, 316; induction motor, 591, 622, 625, 658, 665; regulator, 317; transformer, 479, 494, 504, 512.
- Winding, alternator armature, 15; alternator field, 251; induction motor armature, 612, 638; induction motor field, 614, 625, 634, 650; transformer, 465, 468, 513, 519, 529, 531, 532.
- Working current, 117.
- Y.**
- Y connection, 394, 550.
- Z.**
- Zipernowsky commutator, 260.

A TEXT-BOOK ON

ELECTRO-MAGNETISM

AND THE

CONSTRUCTION OF DYNAMOS.

BY

DUGALD C. JACKSON, B.S., C.E.,

Professor of Electrical Engineering in the University of Wisconsin.

Crown 8vo. Cloth. \$2.25.

“Among the many books on dynamos that have appeared within the last few years, this volume must undoubtedly be classed as one of the best. It is written in a logical, clear, and yet concise form, and treats of the fundamental principles and their application in a sufficiently complete manner without resorting to voluminous padding, old cuts, and unnecessary and historical details.

“The book is not intended for, nor will it be of much use to, so-called ‘beginners,’ and ‘practical men,’ and others having little knowledge of physics and mathematics, but to advanced students and those desiring to study the subject of the theory and design of dynamos, it cannot be too highly recommended.”—*Journal of Franklin Institute.*

“The work as a whole is a very concise presentation of the subject, and can be studied with much profit by all who are pursuing a course of dynamo design.”—*The Electrical Engineer.*

THE MACMILLAN COMPANY,
66 FIFTH AVENUE, NEW YORK.

MACMILLAN & CO.'S

PUBLICATIONS ON

ELECTRICITY AND MAGNETISM.

BOTTONE. — **A Guide to Electric Lighting.** By R. S. BOTTONE, author of "Electric Bells, and All About Them," "Electromotors, How Made and How Used," etc. With many Illustrations. 75 cents.

CAVENDISH. — **The Electrical Researches of the Honourable Henry Cavendish, F.R.S.** Written between 1771 and 1781. Edited from the original manuscripts by the late J. CLERK MAXWELL, F.R.S. 8vo. \$5.00.

CUMMING. — **An Introduction to the Theory of Electricity.** By LINNÆUS CUMMING, M.A. With Illustrations. 12mo. \$2.25.

DAY. — **Electric Light Arithmetic.** By R. E. DAY, M.A. 18mo. 40 cents.

"I have not thought it necessary to go into minute details about electrical formulæ and theories, because these will be found in all the recognized text-books on the subject, and this collection of examples is not intended to replace, but to supplement, whatever text-book on electricity the student may be using." — *From the Author's Preface.*

EMTAGE. — **An Introduction to the Mathematical Theory of Electricity and Magnetism.** By W. T. A. EMTAGE, M.A., of Pembroke College, Oxford. 12mo. \$1.90.

"This book has been written with the object of supplying an Introduction to the Mathematical Treatment of Electricity and Magnetism. . . . It is complete in itself, and may be read without previous knowledge of the subject. Purely experimental parts of the subject, requiring no special mathematical treatment, have been entirely omitted." — *From the Author's Preface.*

"The book is chiefly valuable for the care and accuracy with which the fundamental ideas of the subject are defined, and the elementary laws stated. It gives the latest developments of the more elementary parts of the mathematical theory of electricity, and will prove useful for the student preparing for examination." — *Scotsman.*

GRAY. — **The Theory and Practice of Absolute Measurements in Electricity and Magnetism.** By ANDREW GRAY, M.A., F.R.S.E. In two volumes. Vol. I., 12mo. \$3.25.

THE MACMILLAN COMPANY,
66 FIFTH AVENUE, NEW YORK.

WORKS ON ELECTRICITY AND MAGNETISM.

GRAY. — **Absolute Measurements in Electricity and Magnetism for Beginners.** By ANDREW GRAY, M.A., F.R.S.E. Students' edition abridged from the larger work. 16mo. \$1.25.

GUILLEMIN. — **Electricity and Magnetism.** A Popular Treatise. By AMÉDÉE GUILLEMIN, author of "The Forces of Nature," "The Applications of Physical Forces," etc. Translated and Edited, with Additions and Notes, by Professor Silvanus P. Thompson, author of "Elementary Lessons in Electricity and Magnetism," etc. With 600 Illustrations. Super Royal 8vo. \$8.00.

"In the first part M. Guillemin expounds with his usual skill the phenomena and laws of electricity and magnetism; and in the second part he considers the applications in modern life of these two wonder-working forces. . . . It will undoubtedly receive, as it deserves, the same warm reception as its predecessors from the same hand." — *The Literary World*.

LODGE. — **Modern Views of Electricity.** By OLIVER J. LODGE, LL.D., D.Sc., F.R.S. With Illustrations. 12mo. \$2.00.

"This book is likely to attract much attention in the electrical world. It aims at setting forth in popular guise the results of modern attempts to explain the phenomena of electricity, magnetism, and light, by known principles of mechanics and hydrodynamics. . . . Dr. Lodge is an admirable exponent. . . . To those who value science chiefly for its practical applications, the most interesting portion of the book will be that which proposes the direct manufacture of light." — *London Athenæum*.

MAXWELL. — **An Elementary Treatise on Electricity.** By JAMES CLERK MAXWELL, M.A. Edited by WILLIAM GARNETT, M.A. Second edition. *Clarendon Press Series*. 8vo. \$1.90.

MAXWELL. — **A Treatise on Electricity and Magnetism.** By JAMES CLERK MAXWELL, M.A. *Clarendon Press Series*. Two volumes. 8vo. New Edition. \$8.00.

MAYCOCK. — **A First Book of Electricity and Magnetism.** For the Use of Elementary Science and Art and Engineering Students and General Readers. By W. PERREN MAYCOCK, M.I.E.E. With 84 Illustrations. Crown 8vo. 60 cents.

MURDOCK. — **Notes on Electricity and Magnetism.** Designed as a companion to Silvanus P. Thompson's "Elementary Lessons in Electricity and Magnetism." By J. B. MURDOCK, Lieut. U. S. N. 18mo. New Edition. 60 cents.

"Occasional extensions and additions are also made which add much value to the book. It is likely to be of considerable use to the student of Professor Thompson's 'Elementary Lessons,' and it may be used alone with little difficulty." — *Science*.

THE MACMILLAN COMPANY,

66 FIFTH AVENUE, NEW YORK.

WORKS ON ELECTRICITY AND MAGNETISM.

POOLE. — The Practical Telephone Handbook. By JOSEPH POOLE. With 227 Illustrations. Small crown 8vo. \$1.00.

STEWART and GEE. — Practical Physics for Schools and Junior Students of Colleges. By BALFOUR STEWART, M.A., LL.D., F.R.S., and W. W. HALDANE GEE, B.Sc.

Vol. I. ELECTRICITY AND MAGNETISM. 16mo. 60 cents.

"The authors have succeeded in presenting the subject in such a way that it may be easily grasped by the class in schools; and the more difficult parts make an excellent introduction to advanced work. . . . We can heartily recommend the book to those about to take up the study of electricity." — *Electrical World*.

STEWART and GEE. — Lessons in Elementary Practical Physics. By BALFOUR STEWART, M.A., LL.D., F.R.S., and W. W. HALDANE GEE, B.Sc.

Vol. II. ELECTRICITY AND MAGNETISM. 12mo. \$2.25.

"Not a book to be read straight through, this work of Messrs. Stewart and Gee is one to be worked steadily through by any student who intends to acquire a real knowledge of the principles of electricity and magnetism." — *Journal of Education*.

"The book is essentially an exposition of those parts of electrical philosophy with which the student who would become an electrician must necessarily be acquainted. It is well illustrated, clearly arranged, and well printed, and is likely to be of valuable aid to students." — *The Westminster Review*.

THOMSON. — Reprints of Papers on Electrostatics and Magnetism. By Sir WILLIAM THOMSON, D.C.L., LL.D., F.R.S., F.R.S.E. 8vo. \$5.00.

THOMPSON. — Elementary Lessons in Electricity and Magnetism. By SILVANUS P. THOMPSON, D.Sc., B.A., F.R.A.S. New Edition. With Illustrations. 16mo. \$1.40.

"The best book for its expressed purpose that I happen to be acquainted with." — Prof. A. V. DOLBEAR, Tufts College.

"The text-book itself is a model of what an elementary work should be. . . . We do not think that any student of moderate intelligence who reads this work slowly and with care, could fail to understand every word of it, and yet every part of the complex and manifold phenomena of electricity and magnetism is treated of in this small volume." — *Saturday Review*.

WATSON and BURBURY. — The Mathematical Theory of Electricity and Magnetism. By H. W. WATSON, D.Sc., F.R.S., and S. H. BURBURY, M.A.

Vol. I. ELECTROSTATICS. 8vo. \$2.75.

Vol. II. MAGNETISM AND ELECTRODYNAMICS. 8vo. \$2.60.

THE MACMILLAN COMPANY,
66 FIFTH AVENUE, NEW YORK.

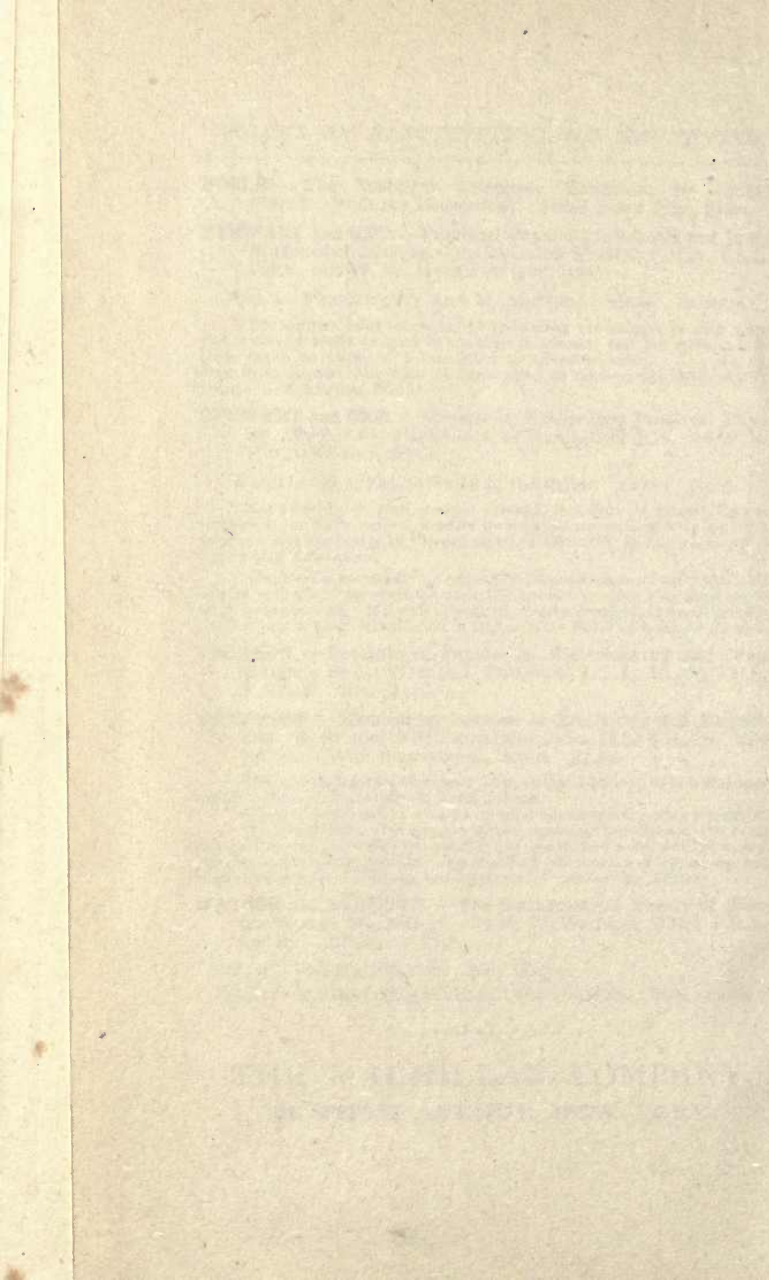

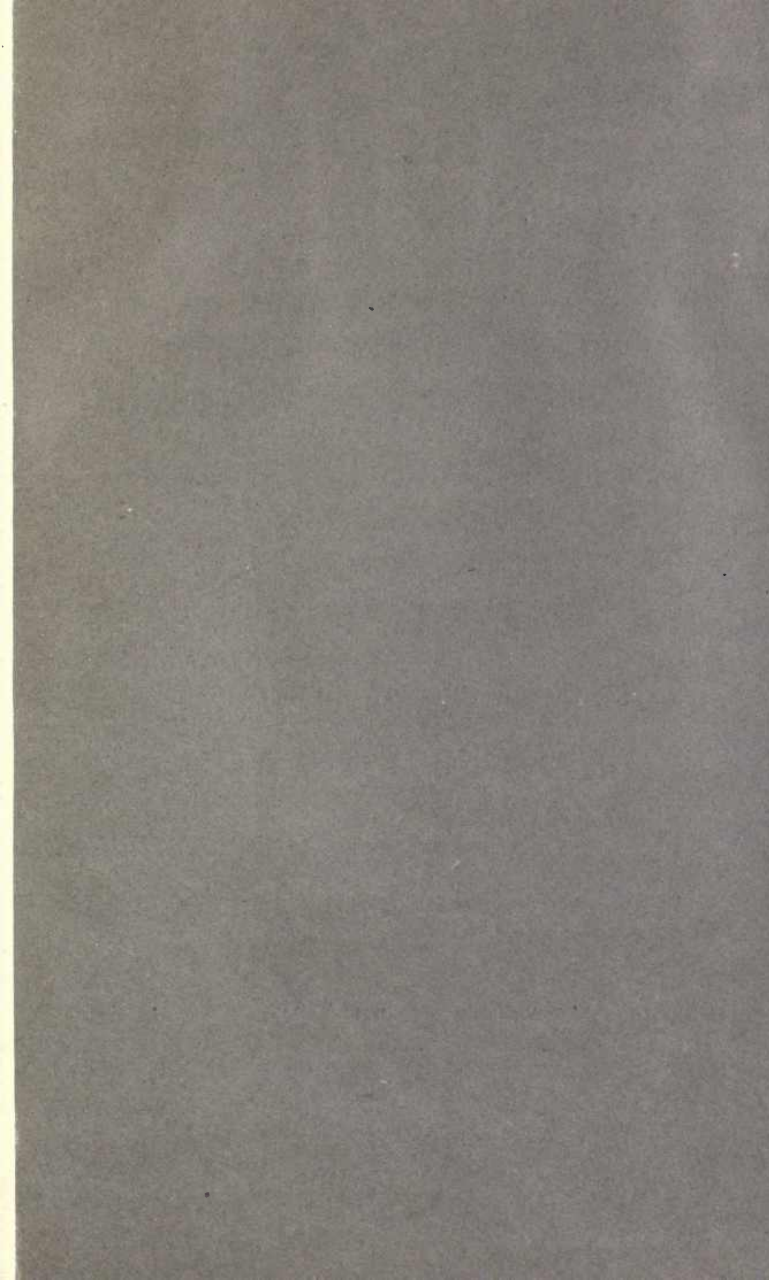

**UNIVERSITY OF CALIFORNIA LIBRARY
BERKELEY**

Return to desk from which borrowed.
This book is **DUE** on the last date stamped below.

A 6 Sep W M '49

YB 53649

870724

TK

1141

J2

THE UNIVERSITY OF CALIFORNIA LIBRARY

